

## Veneer

Effective January 1, 2023 USA

Revised October 1, 2024



# PRICE LIST wood veneer



# think global

## THE GLOBAL EDGE

### ERGONOMICS IN THE TOTAL OFFICE

- One stop shopping for a full range of office furniture.
- Seating, desks, tables, files, modular furniture, panels and accessories.
- Ergonomics, competitive pricing and built-in value.

### STRENGTH AND STABILITY

- Established in 1966.
- One of North America's largest office furniture manufacturers.
- Manufacturing and showrooms worldwide.

### QUICK SHIP - INSTOCK

- Hundreds of products in stock for immediate delivery.

### STRONG LOCAL REPRESENTATION

- Service and expert advice where you are, when you need it!

### MANUFACTURING CAPABILITY

- Vertical integration ensures "start to finish" control.
- Ongoing research and investment in new, innovative production technology.

### QUALITY ASSURANCE

- Quality Assurance Program is qualified by C.G.S.B. ISO9001 standards.
- On-site furniture testing facility.
- Product and components are tested to ANSI/BIFMA standards.

### ENVIRONMENTAL COMMITMENT

- Continuous development of "earth friendly" programs.
- One of the first molded foam manufacturers to create ozone-friendly, CFC and HFC-free process.
- Seat and back pans are made from recyclable plastics and wood waste, enabling little waste and cost effective products.

## SYMBOL IDENTIFICATION



Global's Certified Products are in compliance with the stringent emission guidelines set by the GREENGUARD Environmental Institute and include all Upholstered Seating. To obtain a GREENGUARD Certificate for any product, please go to the product page on our website [www.globaltotaloffice.com](http://www.globaltotaloffice.com) and click on "View GREENGUARD Certificate".



level™ certification, based on the ANSI/BIFMA e3-2012 furniture sustainability standard, sets furniture manufacturers on a path toward greater sustainability over time. Based on environmental and social criteria set forth in the standard, a product's entire supply chain is assessed.



Certification assessment includes an evaluation of specific corporate policies and guidelines and an assessment of associated company manufacturing facilities. Products must meet quantifiable milestones of environmental and social performance at every step of development.

The quantitative assessment addresses four categories: material use, energy and atmosphere impacts, human and ecosystem health and social responsibility.

Manufacturers earn points in each of the four categories. The level™ brand and its numeric rating of 1, 2 or 3 indicate what threshold of certification a product has achieved. level™ 3 is the highest rating.

## TABLE OF CONTENTS

### WOOD VENEER DESKS

Corby.....	4
Dufferin.....	60
Foundations.....	142
Kingston.....	204
Lufton.....	266
Philadelphia.....	326

### WOOD VENEER TABLES

Boardroom Tables.....	374
-----------------------	-----

### REFERENCE

Care and Maintenance Guide.....	421
Custom Grommet Location Forms.....	418
Terms + Conditions.....	422
Textiles + Finishes.....	414
Warranty.....	424

# WOOD VENEER DESK NOTES

The following applies to all VENEER Series - Corby, Dufferin, Foundations, Kingston, Lufton and Philadelphia (unless otherwise noted).

## CONSTRUCTION:

- "Number one select, architectural grade A" oak, American black walnut, American black cherry, and hard maple. Wood worksurface moulded edges are solid oak, walnut, cherry, or maple (except where square self-edges exist, i.e. credenza and computer worksurface back edges that are most commonly against walls).

## FINISH:

- Conversion varnish (similar to catalyzed lacquer, but tougher), 25 degree sheen. Finishes are not buffed or rubbed.
- All Global wood casegood products are veneered and finished on the back sides (360 degree finishing), except modular under-surface storage - tops and backs are unfinished.
- Touch up kits available, includes a touch up marker and fill crayon. Order **VTOUCHUPKIT, \$164** list. Specify finish when ordering.

## PEDESTALS:

- Pedestals are fully assembled units. Undersurface storage units provide standard locks.
- All drawers are standard as vinyl-wrapped black embossed with V-groove construction.
- Drawers are "5-sided". The drawer front is an applied element to a four-sided drawer. Drawer fronts can be removed or replaced in the field.
- Pedestal drawers and lateral file drawers are supported by steel ball bearing suspensions. All suspensions carry a full lifetime warranty against defects.
- All drawers have full extension.

## HARDWARE:

- All necessary hardware items for attaching furniture items are included in the shipment. Actual wall attachment fasteners for wall cabinets, tackboards and visualboards are not included due to variation between site conditions.
- **Leveling glides** are shipped installed on the unit. Levelers have a 1" range of adjustment.
- **Hanging file rails** are pre-installed on file drawer perimeters with additional front-to-back rails found in the bottom of the filing drawers. These rails hang onto plastic clips and do not require any tools to install. Legal filing can be achieved either as side-to-side or front-to-back. Letter filing can be achieved as front-to-back filing only.
- **Flat plates** for attaching bridge and return to desk are shipped pre-attached to the bottom of the bridge or return. **Mini flat plates** for securing bridge modesty panels to desk or credenza end panels, and **quick connectors** for securing modular corner units to adjacent pieces (Dufferin Series) are shipped along with screws in a plastic bag attached to the bottom of the bridge or return. CAUTION: using screws other than those supplied by Global could result in damage to finished tops.

## INSTALLATION:

**Wall-mounted cabinets and visual boards** are pre-attached with horizontal wall rails to the back of each unit. The wall-side components need to be detached from the unit and fastened to the wall accordingly. Wall fasteners are not included due to variation between site conditions. Securing the wall rail to a vertical structural member is the required manner of installation. The cabinet or visualboard is then lowered on to the wall rail. It is important to level the wall rail before installation. Wall cabinets are equipped with levelers at the bottoms of the side panels for proper cabinet alignment. It is recommended to use a single drywall screw through the back of the cabinet and the wall-mounted rail, to further secure the wall attachment.

**Wall-mounted tackboards** have vertical grooves in the back for tasklight wiring. Horizontal wall rails are provided. Fasteners are not included due to variation between site conditions. The site installer need to position the wall rail and determine the type of screw to be used for the application. The tackboard is hung on the wall rail. Using a level will also aid in the tackboard installation.

**Hutches** are installed with double-faced tape applied on the bottom of the end panels. Global utilizes a non-marring method of hutch attachment. The tape is shipped in a plastic bag found in the hutch. Removal of the hutch requires moderate pressure to be applied on the top of the unit towards the wall for at least a minute for the pressure-sensitive tape to release. At the dealer or installer's discretion, additional support may be added by installing flat plates along the back of the attached units. These flat plates are not included in the shipment.

**Hutch tackboards** are factory installed.

**Modular storage units** have pre-drilled holes through the tops for securing to the bottom of the worksurfaces. Disassemble the modular unit first before relocating the entire unit to avoid damage or body injuries.

**5-Sided corner tables** and adjoining bridge and credenza run-offs are attached with MP-53 mending plates. Accurate leveling is critical for these units to align and connect properly.

**NOTE: Leveling wood office furniture properly is the most important procedure to ensure proper functioning and alignment of drawers, locks and doors. Upon completing installation, wipe furniture with a damp cloth, followed with a dry soft cloth - always in the direction of the grain.**

# corby



global





Introducing the Corby Collection of wood veneer and laminate desks, tables and storage elements. Christopher Wright has reflected on the mid-century modern vernacular to design a unique series of workplace furnishings that reward a new generation of pioneers and nation builders.

Corby is suited for any office environment, private office, boardrooms, open desking and collaborative areas. Its timeless design is expressed in subtle details - flared legs that elevate storage off the floor, tapered aprons on the bottom of storage pieces which reflect the knife edge detail of the worksurface. Standard height and counter height tables combined with tiered storage pieces offer a reprieve from formal boardrooms and deliver a more casual style for meeting areas.

Corby is a fresh take on desking, blending the warmth and comfort of residential-style furniture with the features and long lasting quality you'd expect from Global.

**Features and Benefits**

- Tapered solid wood legs in two heights
- Modesty panel in two heights
- Drawers are standard vinyl-wrapped construction with black drawer sides and bottom.
- 75 lb box - 150 lb. file drawer weight capacity with full height sides with pencil tray included in box drawer
- Lateral file drawers can accommodate legal or letter documents
- Premium full extension progressive ball bearing slides on file drawers
- Box drawers mounted on 3/4 extension premium ball bearing slides.
- Power / data accessories are available to be factory installed
- Designed by Christopher Wright



Overlapping worksurface with knife edge



Pedestal with optional cushion (shown with low base)

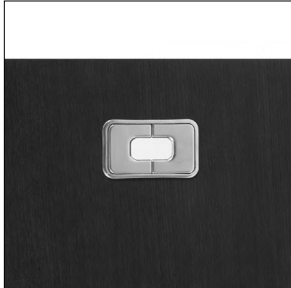

Rectangular grommet in tungsten

## GENERAL INFORMATION

- Corby detailing is new century modern with a knife edge on table tops.
- Solid walnut, cherry, oak and maple edging on 1-3/8" tops (veneer).
- 3mm matching PVC edge on laminate surfaces.
- Tapered, solid wood legs are used to support the peninsula, work, collaboration and occasional tables.
- Pedestal, credenza and bookcase bottoms include 1 3/8" thick painted, beveled profile and tapered solid wood legs (4"H or 11 1/2"H).
- Productivity Solutions by Global offers multiple desktop power options that can be retrofitted into grommets, or clamp mounting on the edge of worksurfaces. Under mount options provide a clean way to power accessories in storage cabinets.
- For environmental certifications, please visit [globalfurnituregroup.com](http://globalfurnituregroup.com).

## WORKSURFACES

- Standard with 1 3/8" top thickness
- Veneer surfaces constructed from grade "A" veneers
- When laminate is specified, all surfaces constructed using high pressure laminate.
- Peninsula tables, freestanding work tables, collaboration tables and coffee tables feature a contemporary 2" overhang knife edge on all sides. All other surfaces feature a self-edge veneer.

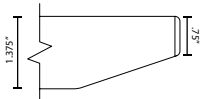

## CONSTRUCTION

- "Number one select, architectural grade A" oak, American black walnut, American black cherry, and hard maple. Wood worksurface moulded edges are solid oak, walnut, cherry or maple (except where square self-edges exist, i.e. credenza and computer worksurface back edges that are most commonly against walls).
- Stack-on unit back panels are a solid thermally fused laminate color.
- When veneer is specified, tapered, solid wood legs (walnut, cherry, oak and maple) are used to support the Peninsula, Work, Collaboration and Occasional Tables.
- When laminate is specified, tapered, solid poplar legs are used to support the Peninsula, Work, Collaboration and Occasional Tables.
- Pedestal, Credenza and Bookcase bottoms include 1 3/8" thick painted, beveled profile and tapered solid wood legs.

## FINISHES

- Conversion varnish (similar to catalyzed lacquer, but tougher), 25 degree sheen. Finishes are not buffed or rubbed.
- Global Corby Wood Veneer Desking products are veneered and finished on the back sides (360° finishing)
- Touch up kits available, includes a touch up marker and fill crayon. Order **VTOUCHUPKIT, \$164** list. Specify finish when ordering.
- Global standard finish, on oak and walnut, is open pore and on cherry and maple is semi-closed pore. If a full finish is required for walnut, cherry, anigre and maple tops, Add the suffix "2" to the finish code and Add 5% to the base pricing for each product.

### CUSTOM FINISH IS AVAILABLE.

## PEDESTALS, STORAGE CABINETS, CRENZAS AND BOOKCASES

- All units are elevated 4" (xxLB = Low Base), or 11.5" (xxHB = High Base) off the floor by tapered, solid wood legs.

## HANDLES

- All box and lateral drawers have one vertical handle PL89 (chrome finish) installed. Doors are equipped with touch latch mechanism with no handles.
- Handles can be purchased separately and installed in the field - no template is provided.



## STACK-ON BOOKCASES AND STORAGE CABINETS

- Stack-on units are designed to be placed and installed on top of the credenzas with low and high base

## LOCKS

- Front locking is standard on the Pedestals with box/file and file drawers, credenzas with box/lateral and lateral drawers. Box/box drawer units are non-locking. Optional locking on doors is available. Specify **LO, add \$134**.

## DRAWER SUSPENSIONS

- Pedestal drawer suspensions are metal ball-bearing type. Both box and file drawers are full extension.

## HANGING FILE RAILS

- Pre-installed on file drawer perimeters. The back rail in a lateral file drawer is designed for both legal and letter size filing. Legal filing can be achieved either as side-to-side or front-to-back. Letter filing can be achieved as front-to-back filing only.

## DRAWER CONSTRUCTION

- Drawers are standard vinyl-wrapped construction with black drawer sides and bottom

## DRAWER FRONTS

- The drawer front is an applied element to a four sided drawer. Drawer fronts are veneered on all surfaces. Drawer fronts can be removed or replaced in the field.

## LEVELING GLIDES

- Levelers have a 1" range of adjustment

## HARDWARE

- All necessary hardware for attaching furniture is included in the shipment

## 1. SPECIFY MODEL NUMBER

## 2. SPECIFY FINISH

### VENEER FINISHES - Top, Chassis, Doors and Fronts:

Code	Finish	Veneer Type	Cut
AMW	Almond Cherry	Cherry	Flat Sliced
ACW	Amber Cherry	Cherry	Flat Sliced
BTW	Biscotti	White Oak	Rift
CAW	Cocoa Walnut	Walnut	Flat Sliced
CRW	Coral	White Oak	Rift
DCW	Dark Cherry	Cherry	Flat Sliced
DWW	Dark Walnut	Walnut	Flat Sliced
EWV	Espresso Walnut	Walnut	Flat Sliced
EW	Evening Oak	White Oak	Rift
GRW	Grey on Oak	White Oak	Rift
HAW	Hazelnut	Maple	Flat Sliced
JAW	Java	White Oak	Rift
LTW	Latte Walnut	Walnut	Flat Sliced
MHW	Mahogany on Walnut	Walnut	Flat Sliced
MTW	Milestone	White Oak	Rift
MPW	Natural Maple	Maple	Flat Sliced
NLW	Natural Walnut	Walnut	Flat Sliced
RCW	Red Cherry	Cherry	Flat Sliced
VNW	Vintage Cherry	Cherry	Flat Sliced
ULW	Umber Walnut	Walnut	Flat Sliced
WLW	Walnut	Walnut	Flat Sliced
WCW	Warm Cherry	Cherry	Flat Sliced
WMW	White Maple	Maple	Flat Sliced

### LAMINATE FINISHES - Top, Chassis, Doors and Fronts:

ACJ	Absolute Acajou	NBL	Noce Biondo
ASN	Asian Night	NGL	Noce Grigio
BLK	Black	NEL	Noce Leggero
BZD	Blizzard	NML	Noce Medio
CMB	Clear Maple	SBY	Sheer Beauty
CGY	Custom Grey	SDT	Stonedust
DES	Dark Espresso	SOG	Storm Grey
DWT	Designer White	WHE	Walnut Heights
FAS	Fashionista	WCR	Winter Cherry
FCL	First Class		

### LAMINATE FINISHES - Back Panel\*, Painted Legs and Base\*\*:

BLK	Black	BZD	Blizzard
CGY	Custom Grey	DWT	Designer White
SOG	Storm Grey	STG	String
MSM	Moss	SDT	Stonedust
SEM	Sienna	SPM	Spice
SRM	Surf		

\*Back panel only when unit is specified in veneer.

\*\*Back panel, painted legs + base when unit is specified in laminate.

## 3. SPECIFY OPTIONS

### Grommets

- Standard grommet on all components is GM5C. Grommet is included with products where shown in line drawings in price book.
- Optional grommets may be ordered along the centerline of Peninsula, Work and Collaboration tables. Order as GM5CTL, GM5CTC, GM5CTR. **Add \$96.**
- Grommet hole dimensions are 3.4" x 1.85". GM5C metal chrome grommet is available exclusively on Corby. Order as G5CTL, G5CTC, G5CTR. **Add \$96.**
- Components that come standard with grommet may be ordered without a grommet. Order as **RSG - Add \$53.**

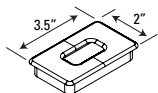

### OPTIONAL GM5C GROMMET SPECIFICATION



Work and Collaboration Table  
From 32" to 42" deep tops

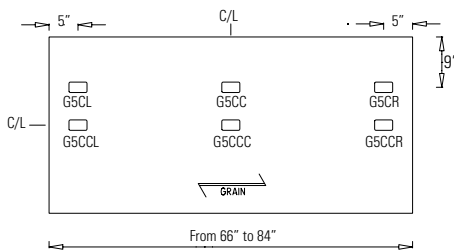

Peninsula Table  
For 32" deep tops

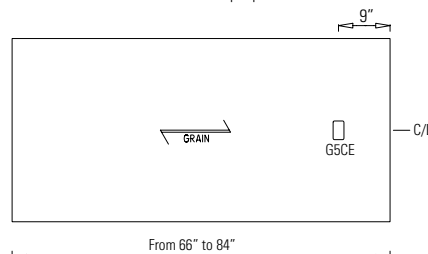

Executive Returns

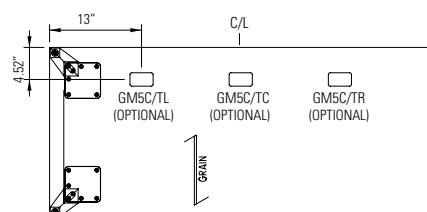

Executive Bridges

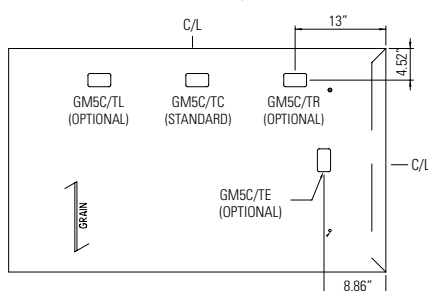

### Cushions

- Cushions are standard in Global Grade 2 seating textiles. Please refer to the website for the current offering: [www.globalfurnituregroup.com](http://www.globalfurnituregroup.com)

### Wood Back Panel

- For units that come with a laminate back panel (all stack-on and freestanding bookcases), an option is available for veneer back panel. Specify **WBP. Add \$687.**

### Custom Cut-out

- Optional custom sized cut-out available in standard locations - **CCUTL** (left), **CCUTC** (center) and **CCUTR** (right) for all CBYRTxxxx and CBYRTCxxxx tables. Submit appropriate form (beginning on page 402) with order. **Add \$300** for each cut-out.

POWER BLOCKS

OPTIONAL GM5C  
CUT-OUT SPECIFICATION



Work and Collaboration Table  
From 32" to 42" deep tops

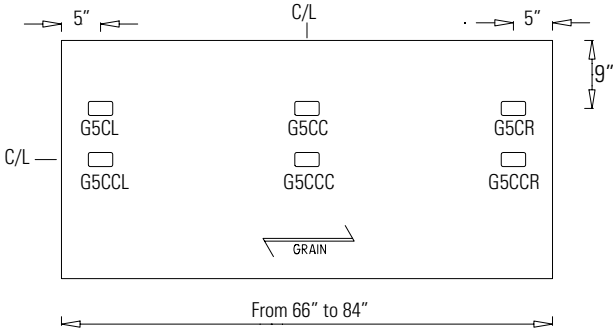

Peninsula Table  
For 32" deep tops

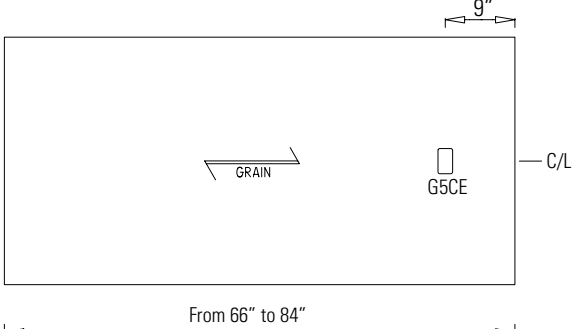

## CREDENZA WIRE MANAGEMENT CUTOUT

- Option C275

### Cut-out Specification

- Available on all 27.5"H credenzas, above open positions only (not available on door or drawer positions).
- Use in conjunction with CBYRxxxx Peninsula Tops that have G5CE grommet specified to provide a means of wire management from the surface, thru the credenza top and out the credenza back.
- When specified, the C275 includes a 5.90" w x 3.90" d cut-out in the credenza top and a standard GM5C grommet in the back, upper section of the open cavity.
- Order as **C275L**, **C275C**, **C275R**. Add **\$402** list.

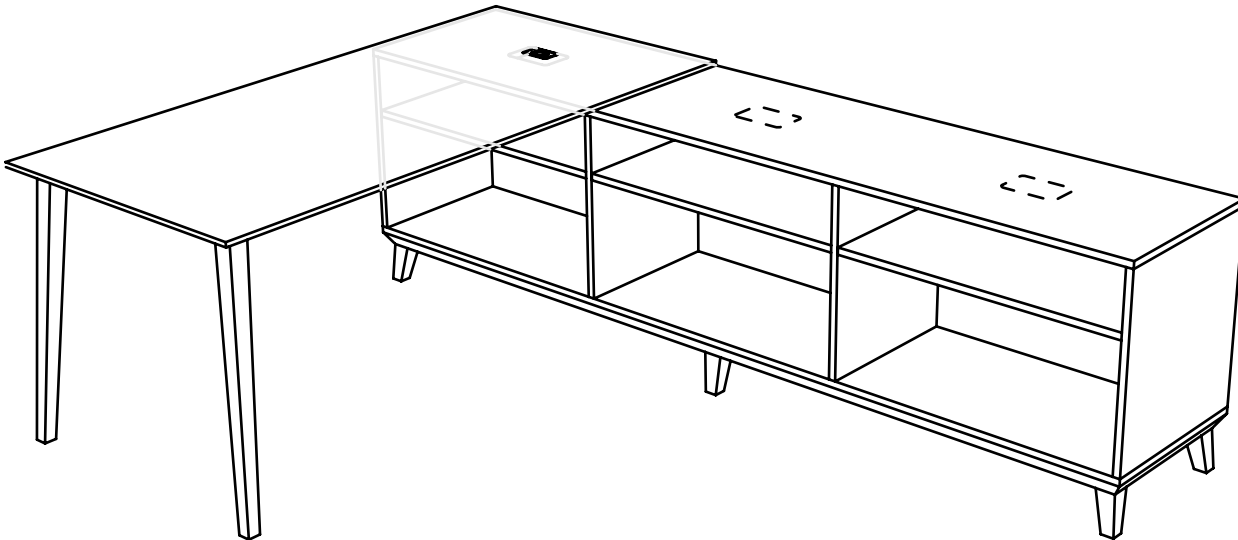
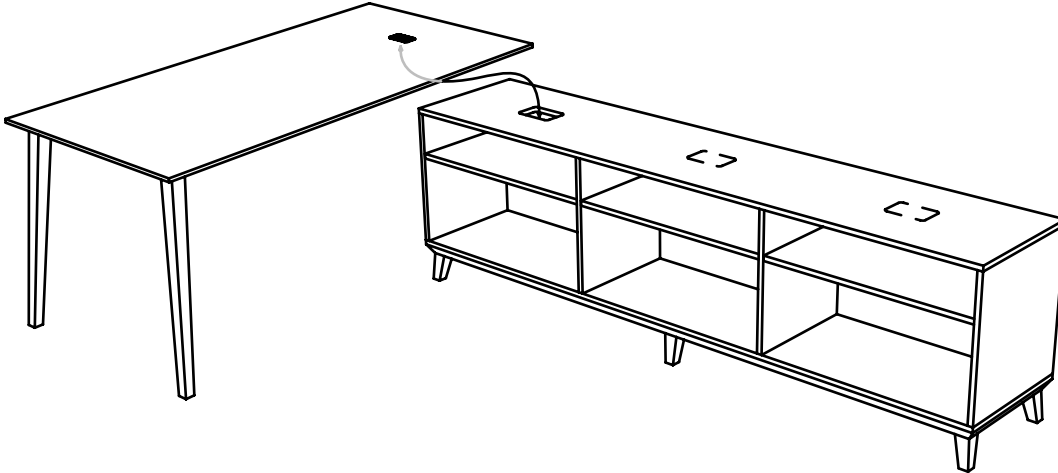

**MODESTY PANEL OPTIONS**

- Wood Modesty Panels are available in 15" and 22" height.
- To be used on Work Tables and on the Peninsula Table with and without the Riser Box.
- Recommended position for installation is 6" inset.

**PENINSULA TABLE WITH HIGH BASE PEDESTAL**MODESTY SIZES:

CBYCMPW44H15 - 44" x 15" x 0.75"

CBYCMPW50H15 - 50" x 15" x 0.75"

CBYCMPW56H15 - 56" x 15" x 0.75"

CBYCMPW62H15 - 62" x 15" x 0.75"

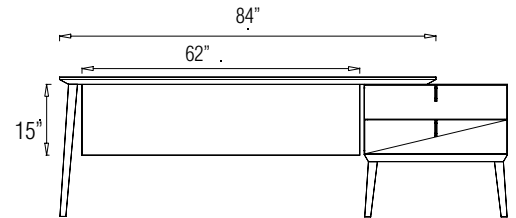
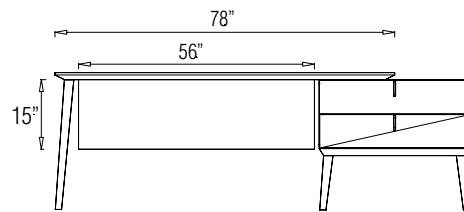
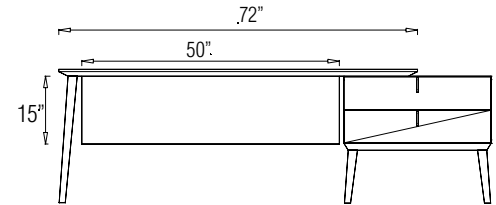
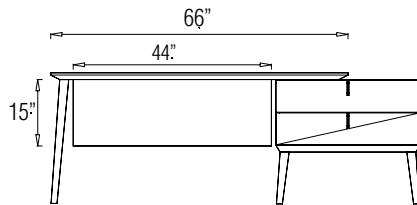
**PENINSULA TABLE WITH LOW BASE PEDESTAL**MODESTY SIZES:

CBYCMPW44H22 - 44" x 22" x 0.75"

CBYCMPW50H22 - 50" x 22" x 0.75"

CBYCMPW56H22 - 56" x 22" x 0.75"

CBYCMPW62H22 - 62" x 22" x 0.75"

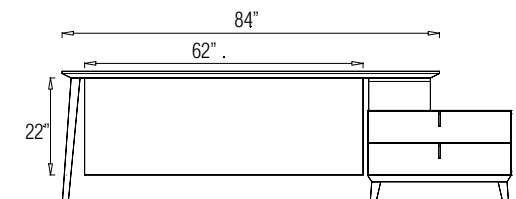
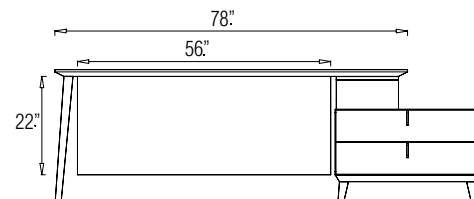
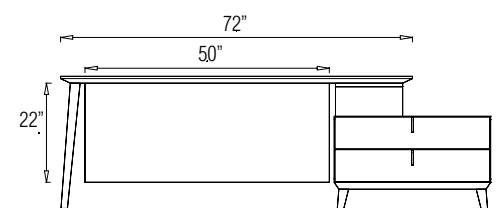
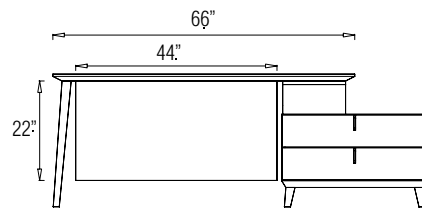
**PENINSULA TABLE WITH HIGH BASE CREDENZA**MODESTY SIZES:

CBYCMPW38H15 - 38" x 15" x 0.75"

CBYCMPW44H15 - 44" x 15" x 0.75"

CBYCMPW50H15 - 50" x 15" x 0.75"

CBYCMPW56H15 - 56" x 15" x 0.75"

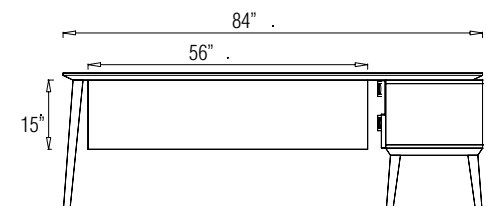
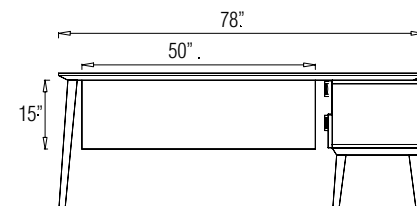
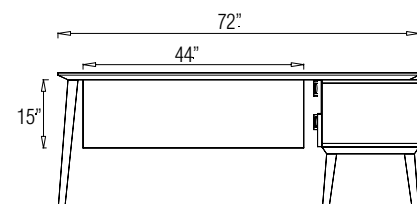
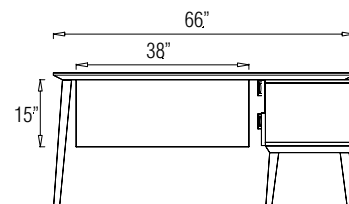

**MODESTY PANEL OPTIONS  
PENINSULA TABLE WITH  
LOW BASE CREDENZA**

**MODESTY SIZES:**

- CBYCMWPW38H22 - 38" x 22" x 0.75"
- CBYCMWPW44H22 - 44" x 22" x 0.75"
- CBYCMWPW50H22 - 50" x 22" x 0.75"
- CBYCMWPW56H22 - 56" x 22" x 0.75"

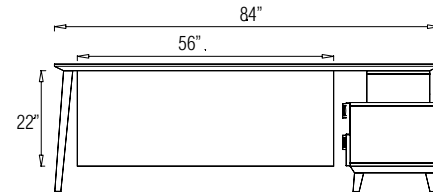
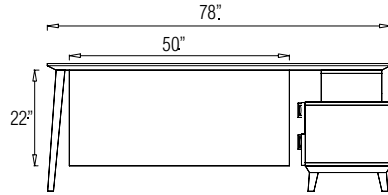
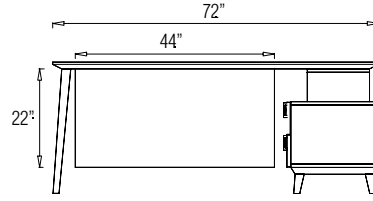
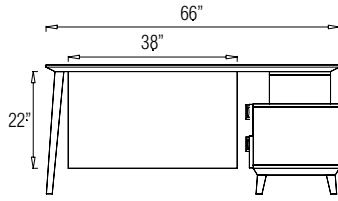

**FREESTANDING WORK TABLES  
& COLLABORATION TABLES**

**MODESTY SIZES:**

- CBYCMWPW56H15 - 56" x 15" x 0.75"
- CBYCMWPW62H15 - 62" x 15" x 0.75"
- CBYCMWPW68H15 - 68" x 15" x 0.75"
- CBYCMWPW74H15 - 74" x 15" x 0.75"

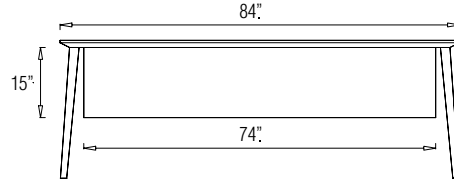
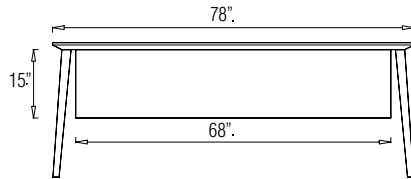
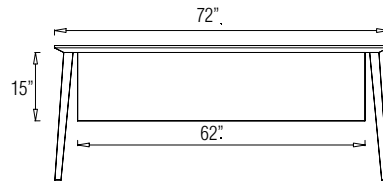
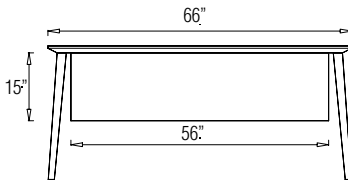

**RISER BOX**

- Riser Box is to be used as a spacer between the peninsula table and 20"H pedestals and credenzas
- CBYSPBOX2814 to be used with 32"D peninsula tables and executive bridges
- CBYSPBOX2014 to be used with 24"D executive bridges

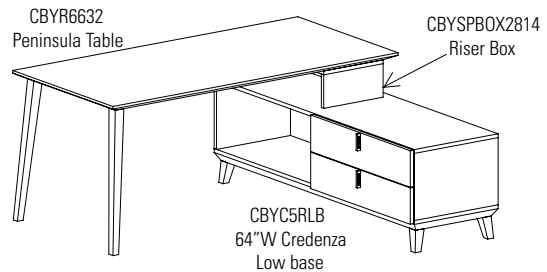
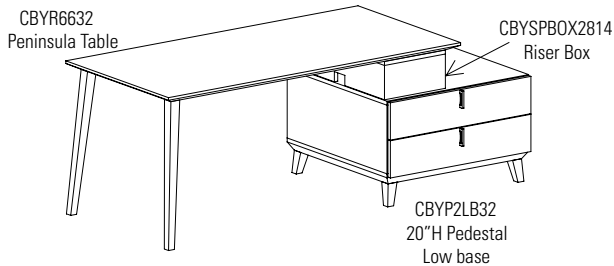

- On Peninsula Table, the Riser Box can be installed as below:

Riser Box opening is on the outside.

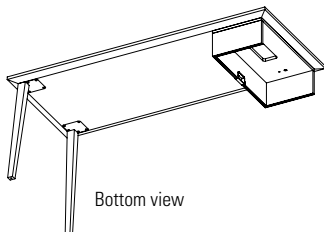

Riser Box opening is on the inside.

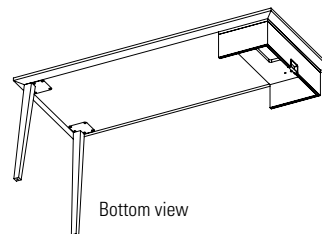

**HEIGHT GRID - FLOOR UNITS, LOW BASE**

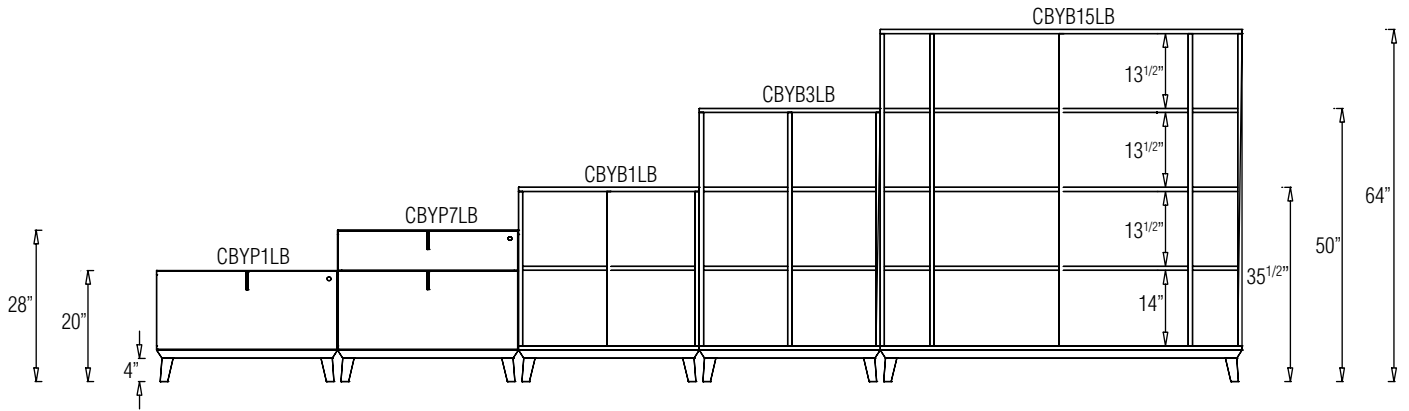

**HEIGHT GRID - FLOOR UNITS, HIGH BASE**

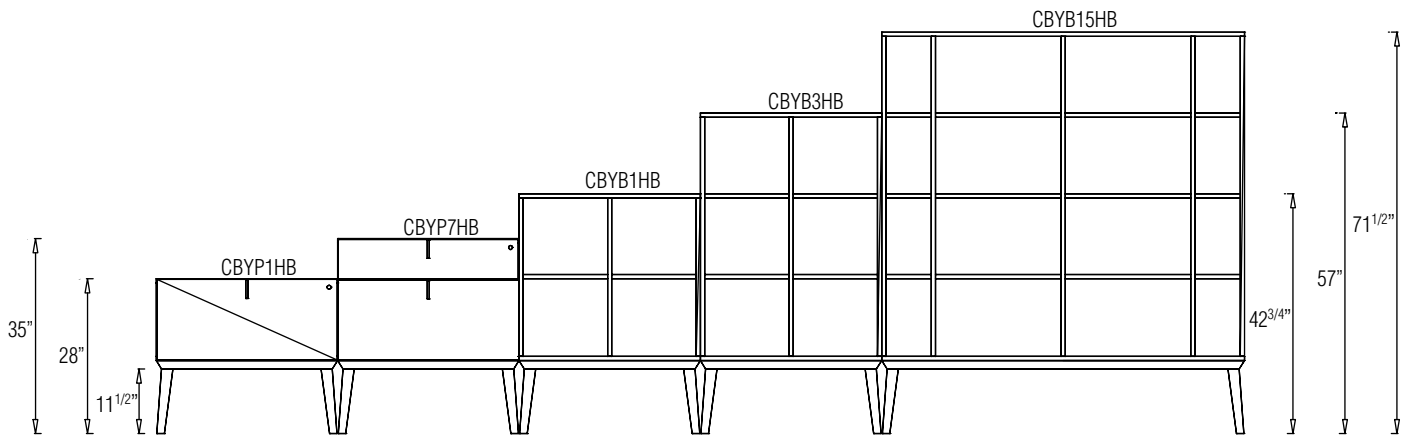

**HEIGHT GRID - STACK-ON UNITS**

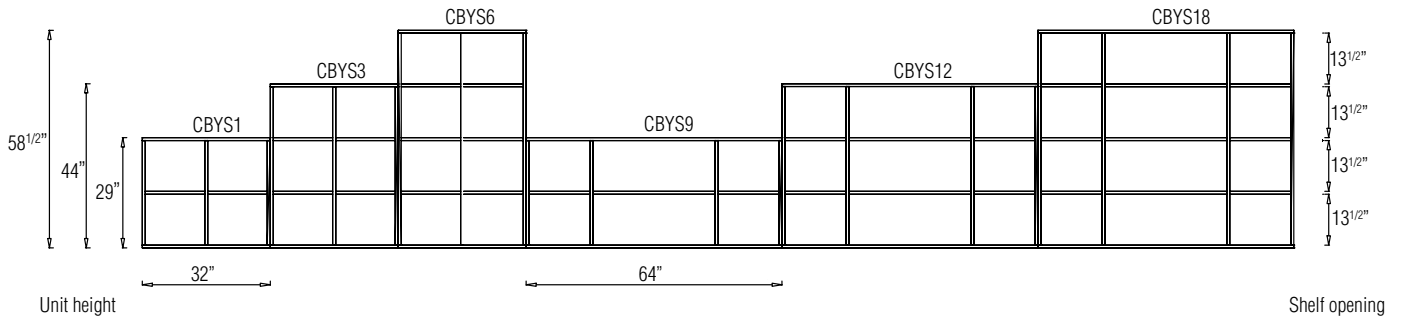



## TABLES

D x W x H

- All tables are shipped Knock Down (KD). Please see assembly instructions included with product.
- Available modesty panels are 15" and 22" height
- Peninsula table has metal inserts installed for quick assembly to the pedestal or pedestal with riser box

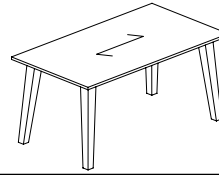

**Note** - Arrow indicates grain direction

### TABLES + RETURNS

MODEL#	DIMENSIONS	FREIGHT CLASS	WT/LBS.	CUBIC FT.	LAMINATE	VENEER
--------	------------	---------------	---------	-----------	----------	--------

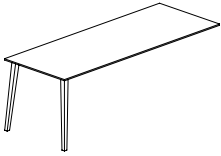

**Peninsula Table**

CBYR8432	32 x 84 x 29	100	119	12	<b>\$2948</b>	<b>\$3685</b>
CBYR7832	32 x 78 x 29	92.5	112	12	<b>\$2801</b>	<b>\$3503</b>
CBYR7232	32 x 72 x 29	100	105	11	<b>\$2669</b>	<b>\$3338</b>
CBYR6632	32 x 66 x 29	100	98	10	<b>\$2532</b>	<b>\$3167</b>

Table with two legs. Connects to 27.5"H storage. Must be supported by 32"D storage on one side (sold separately).



**Round Table**

CBY42H29	42 x 42 x 29	300	89	38	<b>\$4185</b>	<b>\$5233</b>
CBY36H29	36 x 36 x 29	300	77	31	<b>\$3947</b>	<b>\$4935</b>
CBY30H29	30 x 30 x 29	300	65	22	<b>\$3657</b>	<b>\$4574</b>

Round table with four legs.

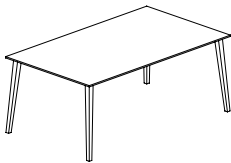

**Freestanding Work Table\***

CBYRT8442	42 x 84 x 29	65	170	15	<b>\$4569</b>	<b>\$5712</b>
CBYRT7842	42 x 78 x 29	92.5	161	14	<b>\$4378</b>	<b>\$5472</b>
CBYRT7242	42 x 72 x 29	65	152	13	<b>\$4204</b>	<b>\$5257</b>
CBYRT6642	42 x 66 x 29	70	142	13	<b>\$4028</b>	<b>\$5036</b>
CBYRT8432	32 x 84 x 29	65	139	12	<b>\$3970</b>	<b>\$4965</b>
CBYRT7832	32 x 78 x 29	92.5	132	12	<b>\$3825</b>	<b>\$4784</b>
CBYRT7232	32 x 72 x 29	65	125	11	<b>\$3690</b>	<b>\$4614</b>
CBYRT6632	32 x 66 x 29	65	118	10	<b>\$3558</b>	<b>\$4448</b>

Freestanding work table with four legs.



**Conference Tables\***

CBYRT16848	48 x 168 x 29	85	400	30	<b>\$22193</b>	<b>\$27742</b>
CBYRT14448	48 x 144 x 29	85	356	28	<b>\$20510</b>	<b>\$25638</b>
CBYRT12048	48 x 120 x 29	92.5	284	24	<b>\$18826</b>	<b>\$23533</b>
CBYRT9648	48 x 96 x 29	92.5	240	21	<b>\$17141</b>	<b>\$21428</b>
CBYRT16842	42 x 168 x 29	85	360	27	<b>\$20721</b>	<b>\$25901</b>
CBYRT14442	42 x 144 x 29	85	324	25	<b>\$19246</b>	<b>\$24059</b>
CBYRT12042	42 x 120 x 29	85	260	21	<b>\$17774</b>	<b>\$22218</b>
CBYRT9642	42 x 96 x 29	92.5	219	19	<b>\$16300</b>	<b>\$20376</b>
CBYRT16832	32 x 168 x 29	85	296	21	<b>\$18404</b>	<b>\$23006</b>
CBYRT14432	32 x 144 x 29	85	268	19	<b>\$17141</b>	<b>\$21428</b>
CBYRT12032	32 x 120 x 29	85	212	17	<b>\$16089</b>	<b>\$20112</b>
CBYRT9632	32 x 96 x 29	85	183	15	<b>\$14827</b>	<b>\$18533</b>

Freestanding conference table with six legs. 96" tables shipped in 4 cartons.

- 120", 144" and 168" tables are in two sections. Shipped in 5 cartons.

#### Required Specifications

Finish

#### Optional Specifications

Grommet  
Custom cut-out\*

## MODESTY PANELS

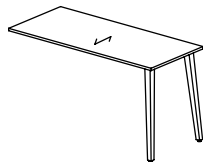
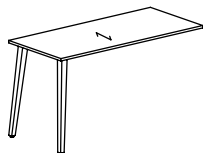
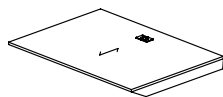
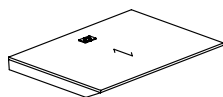
**Executive Return****Executive Bridge**

## MODEL#

## DIMENSIONS

## FREIGHT CLASS

## WT./LBS.

## CUBIC FT.

## LAMINATE

## VENEER

## D x W x H

**Left:**

CBYERL6024CG	24 x 60 x 29	70	56	3.30	<b>\$2170</b>	<b>\$2714</b>
CBYERL5424CG	24 x 54 x 29	70	50	3	<b>\$2062</b>	<b>\$2578</b>
CBYERL4824CG	24 x 48 x 29	70	45	2.60	<b>\$1952</b>	<b>\$2442</b>
CBYERL4224CG	24 x 42 x 29	70	39	2.30	<b>\$1844</b>	<b>\$2306</b>
CBYERL3624CG	24 x 36 x 29	70	34	2	<b>\$1736</b>	<b>\$2172</b>

**Right:**

CBYERR6024CG	24 x 60 x 29	70	56	3.30	<b>\$2170</b>	<b>\$2714</b>
CBYERR5424CG	24 x 54 x 29	70	50	3	<b>\$2062</b>	<b>\$2578</b>
CBYERR4824CG	24 x 48 x 29	70	45	2.60	<b>\$1952</b>	<b>\$2442</b>
CBYERR4224CG	24 x 42 x 29	70	39	2.30	<b>\$1844</b>	<b>\$2306</b>
CBYERR3624CG	24 x 36 x 29	70	34	2	<b>\$1736</b>	<b>\$2172</b>

Executive return with two legs. Coped edge on opposite side to connect to a freestanding work table, creating an "L" workstation. CBYERRxxxxCG has legs on right side. CBYERLxxxxCG has legs on left side.

**Left:**

CBY6024TLCG	24 x 60 x 29	70	56	3.30	<b>\$1545</b>	<b>\$1933</b>
CBY5424TLCG	24 x 54 x 29	70	50	3	<b>\$1395</b>	<b>\$1744</b>
CBY4824TLCG	24 x 48 x 29	70	45	2.60	<b>\$1240</b>	<b>\$1553</b>
CBY4224TLCG	24 x 42 x 29	70	39	2.30	<b>\$1087</b>	<b>\$1359</b>
CBY3624TLCG	24 x 36 x 29	70	34	2	<b>\$931</b>	<b>\$1165</b>

CBY6032TLCG	32 x 60 x 29	70	75	4.20	<b>\$2062</b>	<b>\$2578</b>
CBY5432TLCG	32 x 54 x 29	70	68	3.80	<b>\$1861</b>	<b>\$2327</b>
CBY4832TLCG	32 x 48 x 29	70	60	3.40	<b>\$1653</b>	<b>\$2068</b>
CBY4232TLCG	32 x 42 x 29	70	53	3	<b>\$1447</b>	<b>\$1810</b>
CBY3632TLCG	32 x 36 x 29	70	45	1	<b>\$1240</b>	<b>\$1553</b>

**Right:**

CBY6024TRCG	24 x 60 x 29	70	56	3.30	<b>\$1545</b>	<b>\$1933</b>
CBY5424TRCG	24 x 54 x 29	70	50	3	<b>\$1395</b>	<b>\$1744</b>
CBY4824TRCG	24 x 48 x 29	70	45	2.60	<b>\$1240</b>	<b>\$1553</b>
CBY4224TRCG	24 x 42 x 29	70	39	2.30	<b>\$1087</b>	<b>\$1359</b>
CBY3624TRCG	24 x 36 x 29	70	34	2	<b>\$931</b>	<b>\$1165</b>

CBY6032TRCG	32 x 60 x 29	70	75	4.20	<b>\$2062</b>	<b>\$2578</b>
CBY5432TRCG	32 x 54 x 29	70	68	3.80	<b>\$1861</b>	<b>\$2327</b>
CBY4832TRCG	32 x 48 x 29	70	60	3.40	<b>\$1653</b>	<b>\$2068</b>
CBY4232TRCG	32 x 42 x 29	70	53	3	<b>\$1447</b>	<b>\$1810</b>
CBY3632TRCG	32 x 36 x 29	70	45	1	<b>\$1240</b>	<b>\$1553</b>

Executive return with coped edge on one side to connect to a freestanding work table, overlapping a 27.5" h or 20" h storage piece (using "Riser Box", sold separately) on the opposite side. Standard with grommet.

- Available in 32" d to match cavity opening on credenzas and storage, or 24" d for a narrower workspace
- CBYxxxxTLCG units have a coped edge on the **left, forming a right return**
- CBYxxxxTRCG units have a coped edge on the **right, forming a left return**

**Required Specifications**

Finish

**Optional Specifications**Additional grommet  
Custom cut-out\*

**COLLABORATION TABLE**

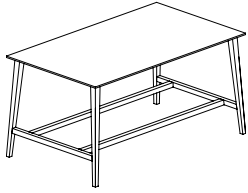

**Freestanding Collaboration Table\***

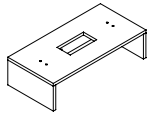

**Riser Box**

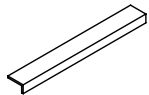

**Footrest Cover**

MODEL#	DIMENSIONS D x W x H	FREIGHT CLASS	WT/LBS.	CUBIC FT.	LIST PRICE	
CBYRTC8442	42 x 84 x 36	250	230	79	\$5593	\$6993
CBYRTC7842	42 x 78 x 36	250	211	73	\$5406	\$6759
CBYRTC7242	42 x 72 x 36	250	192	68	\$5230	\$6539
CBYRTC6642	42 x 66 x 36	250	172	62	\$5053	\$6318
CBYRTC8432	32 x 84 x 36	250	189	61	\$4993	\$6243
CBYRTC7832	32 x 78 x 36	250	172	56	\$4845	\$6059
CBYRTC7232	32 x 72 x 36	250	155	52	\$4715	\$5895
CBYRTC6632	32 x 66 x 36	250	138	48	\$4583	\$5730

Freestanding collaboration table with four legs and foot rests. Long footrests are steel and available in Brushed Chrome (**BCH**) or Black (**BLK**). Short footrests are wood and stained to match the veneer surface. Footrest covers are available as an option - please see page 14. Ships assembled.

CBYSPBOX2814	14 x 28 x 7.5	150	14	3	\$220	\$277
CBYSPBOX2014	14 x 20 x 7.5	250	2	1	\$405	\$508

Riser box for 20"H storage to support peninsula table. For wire pass through grommets, both top and back are included.

- CBYSPBOX2814 for use with 32"D peninsula tables and executive bridges.
- CBYSPBOX2014 for use with 24"D executive bridges

FRC8442	--	70	--	--	\$1141	
FRC7842	--	70	--	--	\$1077	
FRC7242	--	70	--	--	\$1015	
FRC6642	--	70	--	--	\$952	
FRC8432	--	70	--	--	\$1015	
FRC7832	--	70	--	--	\$952	
FRC7232	--	70	--	--	\$889	
FRC6632	--	70	--	--	\$825	

Factory installed.

**MODESTY PANELS**

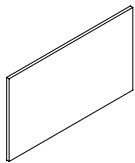

**Hanging Wood Modesty Panel**

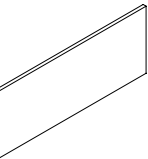

**Hanging Wood Modesty Panel**

MODEL#	DIMENSIONS	FREIGHT CLASS	WT/LBS.	CUBIC FT.	LAMINATE	VEENER
CBYCMPW62H22	.75 x 62 x 22	100	28	3	\$836	\$1047
CBYCMPW56H22	.75 x 56 x 22	100	26	3	\$779	\$976
CBYCMPW50H22	.75 x 50 x 22	100	24	3	\$735	\$920
CBYCMPW44H22	.75 x 44 x 22	92.5	22	2	\$675	\$845
CBYCMPW38H22	.75 x 38 x 22	92.5	20	2	\$619	\$775

22" hanging wood modesty panel.

CBYCMPW74H15	.75 x 74 x 15	100	24	3	\$860	\$1077
CBYCMPW68H15	.75 x 68 x 15	125	23	3	\$811	\$1015
CBYCMPW62H15	.75 x 62 x 15	92.5	21	2	\$811	\$1015
CBYCMPW56H15	.75 x 56 x 15	92.5	20	2	\$755	\$945
CBYCMPW50H15	.75 x 50 x 15	100	18	2	\$709	\$889
CBYCMPW44H15	.75 x 44 x 15	100	17	2	\$648	\$812
CBYCMPW38H15	.75 x 38 x 15	125	15	2	\$593	\$742

15" hanging wood modesty panel.

**Required Specifications**

Veneer finish  
Long footrest finish\*

**Optional Specifications**

Additional grommet  
Custom cut-out\*

## COLLABORATION MEDIA TABLES

D x W x H

## COLLABORATION MEDIA TABLE (CBYxx32) AND WALL MOUNT MEDIA STORAGE (CBYFO-GM)

## 32" Wide, Wall Mount Media Storage

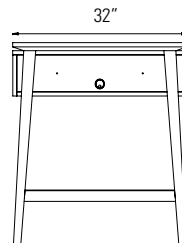
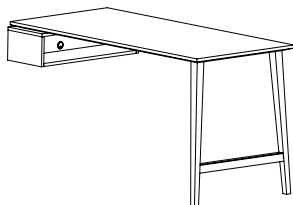

## 64" Wide, Wall Mount Media Storage

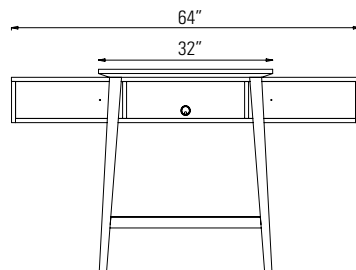
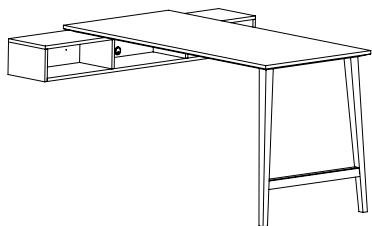

## 96" Wide, Wall Mount Media Storage

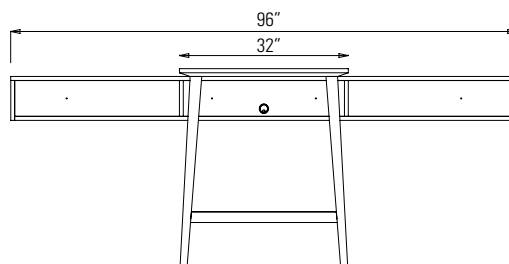
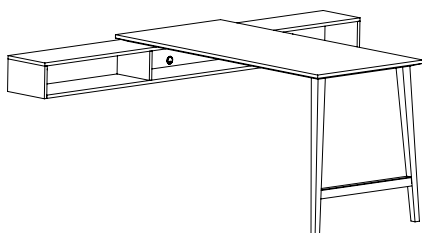

## COLLABORATION MEDIA TABLES

## MODEL#

## DIMENSIONS

## FREIGHT CLASS

## WT./LBS.

## CUBIC FT.

## LAMINATE

## VENEER

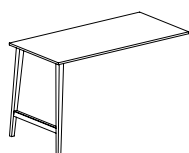

Collaboration Media Table

CBYRC8432	32 x 84 x 36	250	140	57	<b>\$4122</b>	<b>\$5154</b>
CBYRC7832	32 x 78 x 36	250	124	52	<b>\$3969</b>	<b>\$4963</b>
CBYRC7232	32 x 72 x 36	250	117	49	<b>\$3831</b>	<b>\$4791</b>
CBYRC6632	32 x 66 x 36	250	110	45	<b>\$3690</b>	<b>\$4614</b>

Table with two legs. To be used with Wall Mount Media Storage (CBYFOxxD12H8-GM).

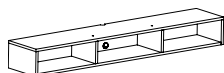

Wall Mounted Media Storage

CBYFO96D12H8-GM	12 x 96 x 8	125	78	10	<b>\$2227</b>	<b>\$2785</b>
CBYFO64D12H8-GM	12 x 64 x 8	125	50	8	<b>\$1485</b>	<b>\$1858</b>
CBYFO32D12H8-GM	12 x 32 x 8	100	35	4	<b>\$1358</b>	<b>\$1699</b>

To be used with Collaboration Media Table (CBYxx32). GM grommet on the back panel is included. For wire pass through, scoop cutouts on both top and bottom are included. Pre-drilled insert holes on top panel.

## Required Specifications

Veneer finish

**OCCASIONAL TABLES**

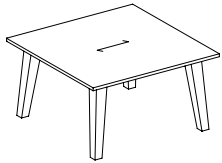

**Square Occasional Table**

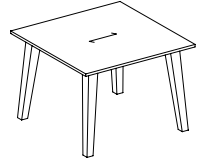

**Square Occasional Table**

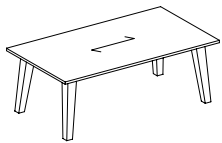

**Rectangular Occasional Table**

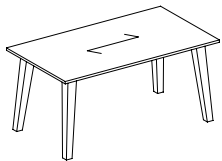

**Rectangular Occasional Table**



**Round Occasional Table**

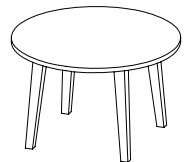

**Round Occasional Table**

MODEL#	DIMENSIONS D x W x H	FREIGHT CLASS	WT/LBS.	CUBIC FT.	LAMINATE	veneer
CBYCT3636H13	36 x 36 x 13	125	73	8	<b>\$2388</b>	<b>\$2986</b>
CBYCT3030H13	30 x 30 x 13	125	59	6	<b>\$2107</b>	<b>\$2637</b>
CBYCT2424H13	24 x 24 x 13	125	47	5	<b>\$1876</b>	<b>\$2347</b>

13"H square occasional table.

CBYCT3636H17	36 x 36 x 17	150	78	9	<b>\$2680</b>	<b>\$3351</b>
CBYCT3030H17	30 x 30 x 17	150	64	7	<b>\$2400</b>	<b>\$3001</b>
CBYCT2424H17	24 x 24 x 17	125	52	6	<b>\$2170</b>	<b>\$2714</b>

17"H square occasional table.

CBYCT4820H13	48 x 20 x 13	125	61	7	<b>\$2154</b>	<b>\$2693</b>
CBYCT4220H13	42 x 20 x 13	125	57	6	<b>\$2055</b>	<b>\$2570</b>
CBYCT3620H13	36 x 20 x 13	125	52	6	<b>\$1978</b>	<b>\$2473</b>

13"H rectangular occasional table.

CBYCT4820H17	48 x 20 x 17	125	66	8	<b>\$2448</b>	<b>\$3061</b>
CBYCT4220H17	42 x 20 x 17	125	62	7	<b>\$2345</b>	<b>\$2933</b>
CBYCT3620H17	36 x 20 x 17	125	57	7	<b>\$2272</b>	<b>\$2841</b>

17"H rectangular occasional table.

CBY36H13	36 x 36 x 13	150	73	16	<b>\$3316</b>	<b>\$4147</b>
CBY30H13	30 x 30 x 13	150	59	12	<b>\$2723</b>	<b>\$3405</b>
CBY24H13	24 x 24 x 13	150	47	8	<b>\$2481</b>	<b>\$3102</b>

13"H round occasional table.

CBY36H17	36 x 36 x 17	250	78	20	<b>\$3578</b>	<b>\$4475</b>
CBY30H17	30 x 30 x 17	150	64	14	<b>\$3027</b>	<b>\$3784</b>
CBY24H17	24 x 24 x 17	150	52	10	<b>\$2785</b>	<b>\$3483</b>

17"H round occasional table.

**Required Specifications**

Veneer finish

## 32"W FREESTANDING PEDESTALS + STORAGE

D x W x H

- All pedestals and storage units are shipped assembled
- Freestanding Pedestals and Storage may be used as stand alone units or as the Peninsula Table Support (20" and 27.5" height units).
- To support the Peninsula Table with 20"H Pedestal, the Riser Box is required (see Tables / Accessories section).
- Pedestal and Storage units are available in two base heights: 4" (xxLB = Low Base) or 11.5" (xxHB = High Base)
- All drawer fronts have one vertical handle (PL89) installed.
- Front locking is standard on the Pedestals with box/file and file drawers.
- Optional locking on doors (Storage units) is available (see Accessories section).
- Optional Cushions (32" x 14") for Pedestal tops are available (see Accessories section).

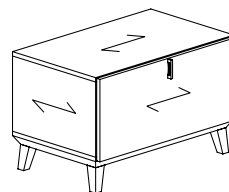
**Note** - Arrow indicates grain direction

## 32"W PEDESTALS - LOW BASE

MODEL#	DIMENSIONS	FREIGHT CLASS	WT/LBS.	CUBIC FT.	LAMINATE	VENEER
--------	------------	---------------	---------	-----------	----------	--------

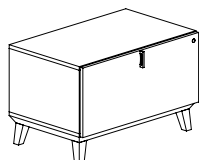
**Pedestal**

CBYP1LB	20 x 32 x 20	92.5	106	9	\$2374	\$2970
---------	--------------	------	-----	---	--------	--------

20"H freestanding pedestal with front locking lateral drawer. Low base.

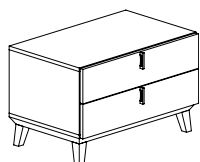
**Pedestal**

CBYP2LB	20 x 32 x 20	92.5	105	9	\$2360	\$2951
---------	--------------	------	-----	---	--------	--------

20"H freestanding pedestal with two box drawers. Low base.

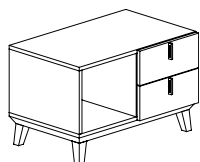
**Pedestal**

CBYP3LB	20 x 32 x 20	92.5	105	9	\$2508	\$3137
---------	--------------	------	-----	---	--------	--------

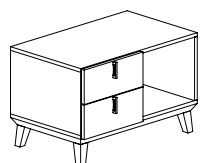
20"H freestanding pedestal with open cabinet on **left**, two box drawers on **right**. Low base.**Pedestal**

CBYP4LB	20 x 32 x 20	92.5	105	9	\$2508	\$3137
---------	--------------	------	-----	---	--------	--------

20"H freestanding pedestal with open cabinet on **right**, two box drawers on **left**. Low base.**Required Specifications**

Veneer finish

**32"W PEDESTALS - LOW BASE**

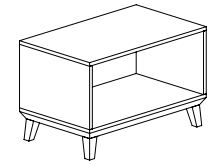

**Pedestal**

MODEL#	DIMENSIONS D x W x H	FREIGHT CLASS	WT/LBS.	CUBIC FT.	LAMINATE	veneer
CBYP5LB	20 x 32 x 20	100	86	9	\$2055	\$2570

20"H freestanding pedestal with open cabinet. Low base.

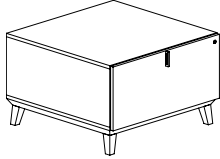

**Pedestal**

CBYP1LB32	32 x 32 x 20	100	136	14	\$2522	\$3154
-----------	--------------	-----	-----	----	--------	--------

20"H freestanding pedestal with front locking lateral drawer. Can be used to support peninsula table in conjunction with optional riser box ("CBYSPBOX2814"). Low base.

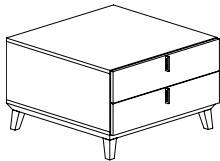

**Pedestal**

CBYP2LB32	32 x 32 x 20	100	135	14	\$2508	\$3137
-----------	--------------	-----	-----	----	--------	--------

20"H freestanding pedestal with two box drawers. Can be used to support peninsula table in conjunction with optional riser box ("CBYSPBOX2814"). Low base.

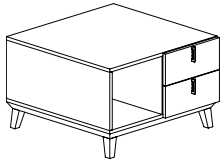

**Pedestal**

CBYP3LB32	32 x 32 x 20	100	135	14	\$2653	\$3318
-----------	--------------	-----	-----	----	--------	--------

20"H freestanding pedestal with open cabinet on **left**, two box drawers on **right**. Can be used to support peninsula table in conjunction with optional riser box ("CBYSPBOX2814"). Low base.

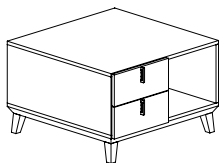

**Pedestal**

CBYP4LB32	32 x 32 x 20	100	135	14	\$2653	\$3318
-----------	--------------	-----	-----	----	--------	--------

20"H freestanding pedestal with open cabinet on **right**, two box drawers on **left**. Can be used to support peninsula table in conjunction with optional riser box ("CBYSPBOX2814"). Low base.

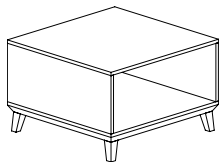

**Pedestal**

CBYP5LB32	32 x 32 x 20	100	135	14	\$2198	\$2750
-----------	--------------	-----	-----	----	--------	--------

20"H freestanding pedestal with open cabinet. Can be used to support peninsula table in conjunction with optional riser box ("CBYSPBOX2814"). Low base.

**Required Specifications**  
Veneer finish

**Optional Specifications**

## 32"W PEDESTALS - LOW BASE

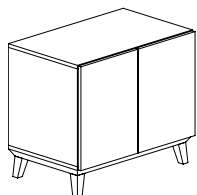

Pedestal\*

MODEL#	DIMENSIONS	FREIGHT CLASS	WT/LBS.	CUBIC FT.	LAMINATE	VENEER
--------	------------	---------------	---------	-----------	----------	--------

D x W x H

CBYP6LB	20 x 32 x 27.5	100	117	12	\$2492	\$3117
---------	----------------	-----	-----	----	--------	--------

27.5"H freestanding storage cabinet with two doors, one adjustable shelf. Low base.

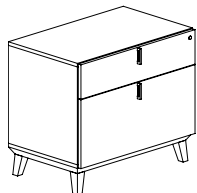

Pedestal

CBYP7LB	20 x 32 x 27.5	92.5	124	12	\$3180	\$3976
---------	----------------	------	-----	----	--------	--------

27.5"H freestanding pedestal with front locking lateral and box drawer. Low base.

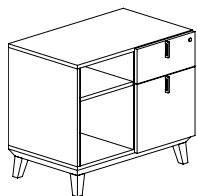

Pedestal

CBYP8LB	20 x 32 x 27.5	92.5	124	12	\$3324	\$4156
---------	----------------	------	-----	----	--------	--------

27.5"H freestanding pedestal with open fixed shelf on **left**, front locking box file drawer on **right**. Low base.

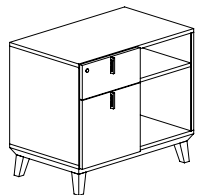

Pedestal

CBYP9LB	20 x 32 x 27.5	92.5	124	12	\$3324	\$4156
---------	----------------	------	-----	----	--------	--------

27.5"H freestanding pedestal with open fixed shelf on **right**, front locking box file drawer on **left**. Low base.

## 32"W PEDESTALS - HIGH BASE

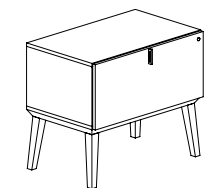

Pedestal

MODEL#	DIMENSIONS	FREIGHT CLASS	WT/LBS.	CUBIC FT.	LAMINATE	VENEER
--------	------------	---------------	---------	-----------	----------	--------

CBYP1HB	20 x 32 x 27.5	100	111	12	\$2669	\$3338
---------	----------------	-----	-----	----	--------	--------

27.5"H freestanding pedestal with front locking lateral drawer. High base.

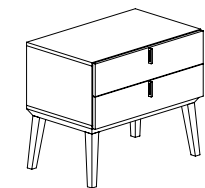

Pedestal

CBYP2HB	20 x 32 x 27.5	100	111	12	\$2653	\$3318
---------	----------------	-----	-----	----	--------	--------

27.5"H freestanding pedestal with two box drawers. High base.

**Required Specifications**

Veneer finish

**Optional Specifications**Lock\*  
Handles\*



**32"W PEDESTALS - HIGH BASE**

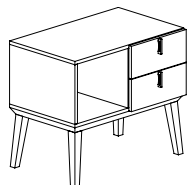

**Pedestal**

MODEL#	DIMENSIONS D x W x H	FREIGHT CLASS	WT/LBS.	CUBIC FT.	LAMINATE	veneer
CBYP3HB	20 x 32 x 27.5	100	111	12	<b>\$2508</b>	<b>\$3137</b>

27.5"H freestanding pedestal with open cabinet on **left**, two box drawers on **right**. High base.

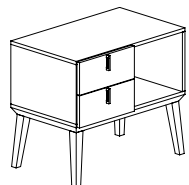

**Pedestal**

CBYP4HB	20 x 32 x 27.5	100	110	12	<b>\$2508</b>	<b>\$3137</b>
---------	----------------	-----	-----	----	---------------	---------------

27.5"H freestanding pedestal with open cabinet on **right**, two box drawers on **left**. High base.

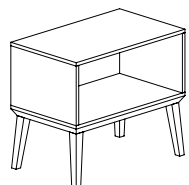

**Pedestal**

CBYP5HB	20 x 32 x 27.5	125	91	12	<b>\$2055</b>	<b>\$2570</b>
---------	----------------	-----	----	----	---------------	---------------

27.5"H freestanding pedestal with open cabinet. High base.

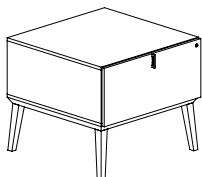

**Pedestal**

CBYP1HB32	32 x 32 x 27.5	125	141	18	<b>\$2814</b>	<b>\$3520</b>
-----------	----------------	-----	-----	----	---------------	---------------

27.5"H freestanding pedestal with front locking lateral drawer. Can be used to support peninsula table. High base.

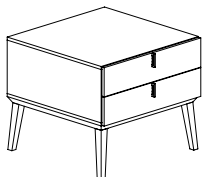

**Pedestal**

CBYP2HB32	32 x 32 x 27.5	125	140	18	<b>\$2731</b>	<b>\$3503</b>
-----------	----------------	-----	-----	----	---------------	---------------

27.5"H freestanding pedestal with two box drawers. Can be used to support peninsula table. High base.

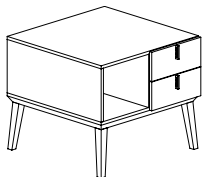

**Pedestal**

CBYP3HB32	32 x 32 x 27.5	125	140	18	<b>\$2653</b>	<b>\$3318</b>
-----------	----------------	-----	-----	----	---------------	---------------

27.5"H freestanding pedestal with open cabinet on **left**, two box drawers on **right**. Can be used to support peninsula table. High base.

**Required Specifications**  
Veneer finish

**Optional Specifications**



## 64"W AND 96"W FREESTANDING CREDENZAS

D x W x H

- All Credenzas are shipped assembled.
- Freestanding Credenzas may be used as stand alone units or as the Peninsula Table Support (20" and 27.5" Height units)
- To support the Peninsula Table with 20"H Credenza, the Riser Box is required (see Tables or Accessories section).
- Credenza units are available in two base heights: 4" (xxLB = Low Base), or 11.5" (xxHB = High Base).
- All drawer fronts have vertical handle (PL89) installed where indicated.
- Front locking is standard on the Credenzas with box/lateral and lateral drawers.
- Optional locking on doors (Storage units) is available (see Accessories section).
- Optional Cushions (32" x 14") for Credenza tops are available (see Accessories section).

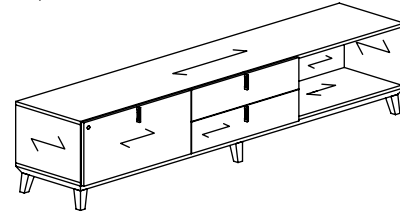

**Note** - Arrow indicates grain direction

### 64"W FREESTANDING CREDENZAS - LOW BASE

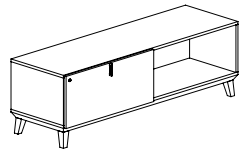

**Credenza**

MODEL#	DIMENSIONS	FREIGHT CLASS	WT/LBS.	CUBIC FT.	LAMINATE	VENEER
CBYC1LLB	20 x 64 x 20	125	161	17	\$4204	\$5257

Freestanding credenza with front locking lateral drawer on **left**, open on **right**. Low base.

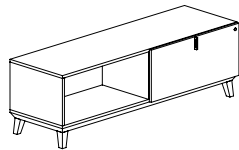

**Credenza**

CBYC1RLB	20 x 64 x 20	125	161	17	\$4204	\$5257
----------	--------------	-----	-----	----	--------	--------

Freestanding credenza with front locking lateral drawer on **right**, open on **left**. Low base.

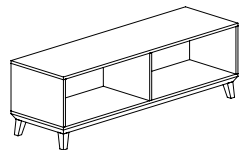

**Credenza**

CBYC2LB	20 x 64 x 20	100	141	17	\$3588	\$4487
---------	--------------	-----	-----	----	--------	--------

Freestanding credenza, open on left and right. Low base.

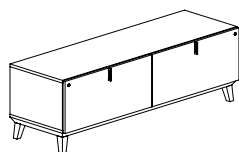

**Credenza**

CBYC3LB	20 x 64 x 20	92.5	180	17	\$4673	\$5844
---------	--------------	------	-----	----	--------	--------

Freestanding credenza, two front locking lateral drawers. Low base.

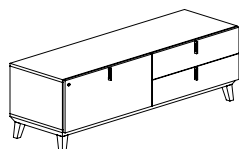

**Credenza**

CBYC4LLB	20 x 64 x 20	92.5	179	17	\$4660	\$5826
----------	--------------	------	-----	----	--------	--------

Freestanding credenza, front locking lateral drawer on **left**, two box drawers **right**. Low base.

**Required Specifications**

Veneer finish

**Optional Specifications**

## 64"W FREESTANDING CRENZAS - LOW BASE

## MODEL#

## DIMENSIONS

## FREIGHT CLASS

## WT/LBS.

## CUBIC FT.

## LAMINATE

## VENEER

D x W x H

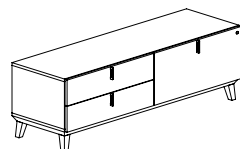
**Credenza**

MODEL#	DIMENSIONS (D x W x H)	FREIGHT CLASS	WT/LBS.	CUBIC FT.	LAMINATE	VENEER
CBYC4RLB	20 x 64 x 20	92.5	179	17	\$4660	\$5826
CBYC5LLB	20 x 64 x 20	100	160	17	\$4204	\$5257
CBYC5RLB	20 x 64 x 20	100	160	17	\$4204	\$5257
CBYC6LB	20 x 64 x 20	92.5	179	17	\$4498	\$5624
CBYC7LB	20 x 64 x 27.5	100	213	23	\$5638	\$7050
CBYC8LLB	20 x 64 x 27.5	100	194	23	\$5010	\$6263

Freestanding credenza, front locking lateral drawer on **right**, two box drawers **left**. Low base.

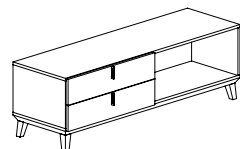
**Credenza**

Freestanding credenza, two box drawers on **left**, open on **right**. Low base.

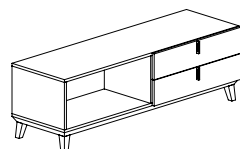
**Credenza**

Freestanding credenza, two box drawers on **right**, open on **left**. Low base.

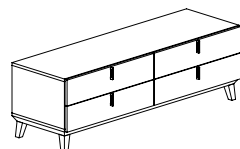
**Credenza**

Freestanding credenza, four box drawers. Low base.

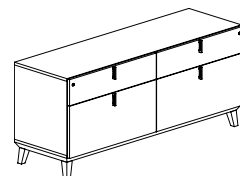
**Credenza**

Freestanding credenza, front locking lateral drawer with box drawer on left and right. Low base.

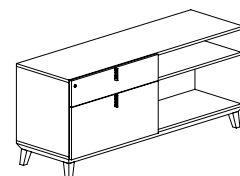
**Credenza\***

Freestanding credenza, front locking lateral drawer with box drawer on **left**, open with fixed shelf on **right**. Low base.

**Required Specifications**

Veneer finish

**Optional Specifications**

Wire management (C275)\*

**64"W FREESTANDING CREDENZAS - LOW BASE**

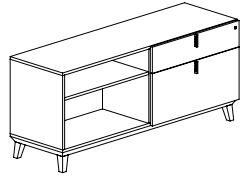

**Credenza\*\***

MODEL#	DIMENSIONS D x W x H	FREIGHT CLASS	WT/LBS.	CUBIC FT.	LAMINATE	ENEER
CBYC8RLB	20 x 64 x 27.5	100	194	23	<b>\$5010</b>	<b>\$6263</b>

Freestanding credenza, front locking lateral drawer with box drawer on **right**, open with fixed shelf on **left**. Low base.

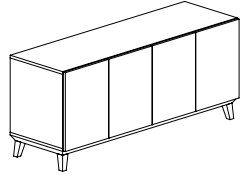

**Credenza\***

CBYC9LB	20 x 64 x 27.5	100	189	23	<b>\$4982</b>	<b>\$6230</b>
---------	----------------	-----	-----	----	---------------	---------------

Freestanding storage credenza, four doors with two adjustable shelves. Low base.

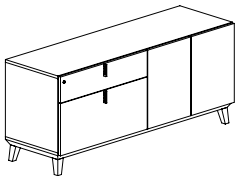

**Credenza\***

CBYC10LLB	20 x 64 x 27.5	100	206	23	<b>\$5299</b>	<b>\$6626</b>
-----------	----------------	-----	-----	----	---------------	---------------

Freestanding credenza, front locking lateral drawer with box drawer on **left**, two doors with adjustable shelf on **right**. Low base.

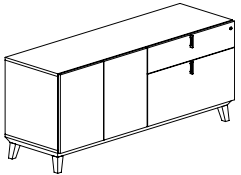

**Credenza\***

CBYC10RLB	20 x 64 x 27.5	100	206	23	<b>\$5299</b>	<b>\$6626</b>
-----------	----------------	-----	-----	----	---------------	---------------

Freestanding credenza, front locking lateral drawer with box drawer on **right**, two doors with adjustable shelf on **left**. Low base.

**64"W FREESTANDING CREDENZAS - HIGH BASE**

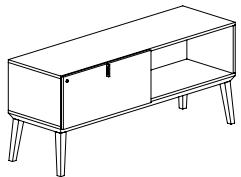

**Credenza\*\***

MODEL#	DIMENSIONS	FREIGHT CLASS	WT/LBS.	CUBIC FT.	LAMINATE	ENEER
CBYC1LHB	20 x 64 x 27.5	125	166	23	<b>\$4498</b>	<b>\$5624</b>

Freestanding credenza with front locking lateral drawer on **left**, open on **right**. High base.

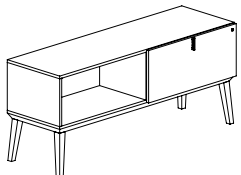

**Credenza\*\***

CBYC1RHB	20 x 64 x 27.5	125	166	23	<b>\$4498</b>	<b>\$5624</b>
----------	----------------	-----	-----	----	---------------	---------------

Freestanding credenza with front locking lateral drawer on **right**, open on **left**. High base.

**Required Specifications**

Veneer finish

**Optional Specifications**

Lock\*  
Handles\*  
Wire management (C275)\*\*

## 64"W FREESTANDING CREDENZAS - HIGH BASE

MODEL#	DIMENSIONS	FREIGHT CLASS	WT/LBS.	CUBIC FT.	LAMINATE	VENEER
	<b>D x W x H</b>					
CBYC2HB	20 x 64 x 27.5	125	146	23	\$3882	\$4854
CBYC3HB	20 x 64 x 27.5	100	185	23	\$4819	\$6026
CBYC4LHB	20 x 64 x 27.5	100	184	23	\$4807	\$6010
CBYC4RHB	20 x 64 x 27.5	100	184	23	\$4807	\$6010
CBYC5LHB	20 x 64 x 27.5	125	165	23	\$4498	\$5624
CBYC5RHB	20 x 64 x 27.5	125	165	23	\$4498	\$5624

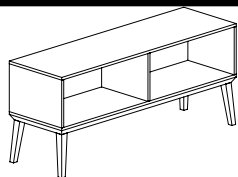

Credenza\*

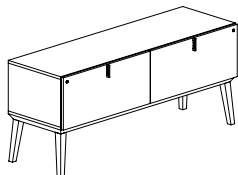
Freestanding credenza open on **left** and **right**. High base.

Credenza

Freestanding credenza, two front locking lateral drawers. High base.

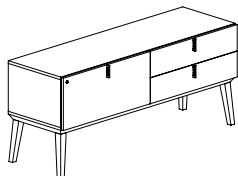

Credenza

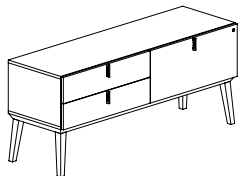
Freestanding credenza, front locking lateral drawer on **left**, two box drawers on **right**. High base.

Credenza

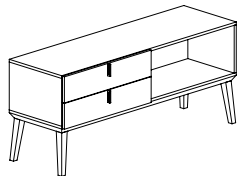
Freestanding credenza, front locking lateral drawer on **right**, two box drawers on **left**. High base.

Credenza\*

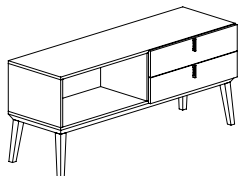
Freestanding credenza, two box drawers on **left**, open on **right**. High base.

Credenza\*

Freestanding credenza, two box drawers on **right**, open on **left**. High base.**Required Specifications**Veneer finish  
Laminate finish**Optional Specifications**Lock\*  
Handles\*

## 64"W FREESTANDING CREDENZAS - HIGH BASE

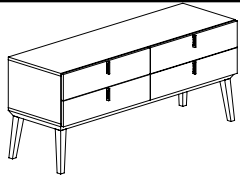

**Credenza**

MODEL#	DIMENSIONS D x W x H	FREIGHT CLASS	WT/LBS.	CUBIC FT.	LAMINATE	veneer
CBYC6HB	20 x 64 x 27.5	100	184	23	<b>\$4791</b>	<b>\$5990</b>

Freestanding credenza with four box drawers. High base.

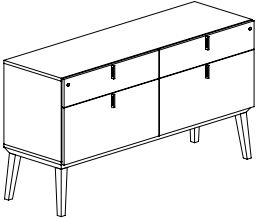

**Credenza**

CBYC7HB	20 x 64 x 35	125	218	29	<b>\$5933</b>	<b>\$7418</b>
---------	--------------	-----	-----	----	---------------	---------------

Freestanding credenza, front locking lateral drawer with box drawer on **left** and **right**. High base.

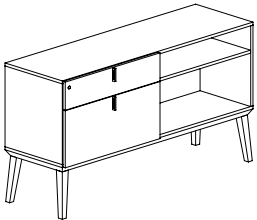

**Credenza**

CBYC8LHB	20 x 64 x 35	125	199	29	<b>\$5299</b>	<b>\$6626</b>
----------	--------------	-----	-----	----	---------------	---------------

Freestanding credenza, front locking lateral with box drawer on **left**, open with fixed shelf on **right**. High base.

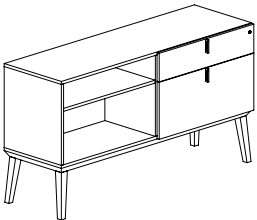

**Credenza**

CBYC8RHB	20 x 64 x 35	125	199	29	<b>\$5299</b>	<b>\$6626</b>
----------	--------------	-----	-----	----	---------------	---------------

Freestanding credenza, front locking lateral with box drawer on **right**, open with fixed shelf on **left**. High base.

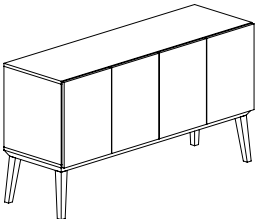

**Credenza\***

CBYC9HB	20 x 64 x 35	125	194	29	<b>\$5270</b>	<b>\$6588</b>
---------	--------------	-----	-----	----	---------------	---------------

Freestanding storage credenza, four doors with two adjustable shelves. High base.

### Required Specifications

Veneer finish  
Laminate finish

### Optional Specifications

Lock\*  
Handles\*

## 64"W FREESTANDING CREDENZAS - HIGH BASE

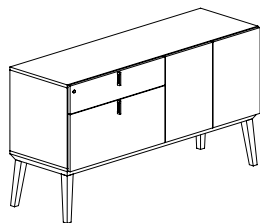

Credenza\*

## MODEL# DIMENSIONS FREIGHT CLASS WT./LBS. CUBIC FT. LAMINATE VENEER

	D x W x H					
CBYC10LHB	20 x 64 x 35	125	211	29	\$5593	\$6993

Freestanding credenza, front locking lateral with box drawer on **left**, two doors with adjustable shelf on **right**. High base.

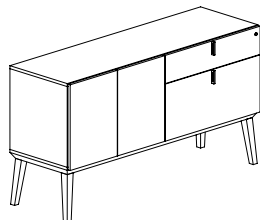

Credenza\*

CBYC10RHB	20 x 64 x 35	125	211	29	\$5593	\$6993
-----------	--------------	-----	-----	----	--------	--------

Freestanding credenza, front locking lateral with box drawer on **right**, two doors with adjustable shelf on **left**. High base.

## 96"W FREESTANDING CREDENZAS - LOW BASE

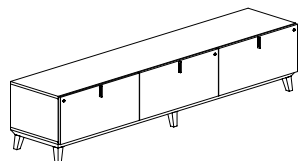

Credenza

## MODEL# DIMENSIONS FREIGHT CLASS WT./LBS. CUBIC FT. LAMINATE VENEER

CBYC11LB	20 x 96 x 20	92.5	259	25	\$6973	\$8717
----------	--------------	------	-----	----	--------	--------

Freestanding credenza, three front locking lateral drawers. Low base.

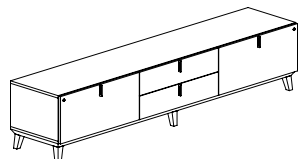

Credenza

CBYC12LB	20 x 96 x 20	92.5	258	25	\$6958	\$8699
----------	--------------	------	-----	----	--------	--------

Freestanding credenza, front locking lateral drawer on **left**, two box drawers **center**, and front locking lateral drawer on **right**. Low base.

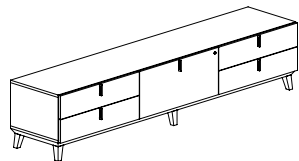

Credenza

CBYC13LB	20 x 96 x 20	92.5	258	25	\$6941	\$8678
----------	--------------	------	-----	----	--------	--------

Freestanding credenza, two box drawers on **left**, front locking lateral drawer **center**, and two box drawers on **right**. Low base.

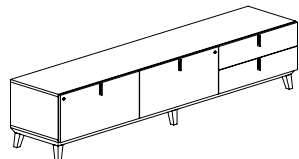

Credenza

CBYC14LB	20 x 96 x 20	92.5	258	25	\$6958	\$8699
----------	--------------	------	-----	----	--------	--------

Freestanding credenza, front locking lateral drawers **left** and **center**, and two box drawers on **right**. Low base.

## Required Specifications

Veneer finish  
Laminate finish

## Optional Specifications

Lock\*  
Handles\*



**96"W FREESTANDING CREDENZAS - LOW BASE**

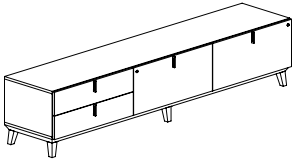

**Credenza**

MODEL#	DIMENSIONS D x W x H	FREIGHT CLASS	WT/LBS.	CUBIC FT.	LAMINATE	VENEER
CBYC15LB	20 x 96 x 20	92.5	258	25	<b>\$6958</b>	<b>\$8699</b>

Freestanding credenza, two box drawers on **left**, front locking lateral drawer **center** and **right**. Low base.

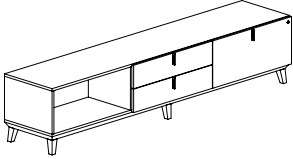

**Credenza**

CBYC16LB	20 x 96 x 20	100	239	25	<b>\$6488</b>	<b>\$8112</b>
----------	--------------	-----	-----	----	---------------	---------------

Freestanding credenza, open on **left**, two box drawers **center**, and front locking lateral drawer on **right**. Low base.

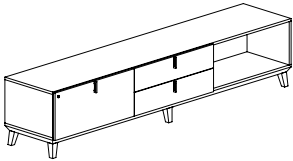

**Credenza**

CBYC17LB	20 x 96 x 20	100	239	25	<b>\$6488</b>	<b>\$8112</b>
----------	--------------	-----	-----	----	---------------	---------------

Freestanding credenza, front locking lateral drawer on **left**, two box drawers **center**, and open on **right**. Low base.

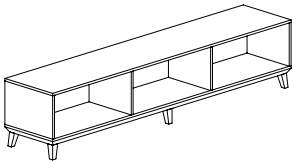

**Credenza**

CBYC18LB	20 x 96 x 20	100	201	25	<b>\$5564</b>	<b>\$6956</b>
----------	--------------	-----	-----	----	---------------	---------------

Freestanding credenza, open **left**, **center** and **right**. Low base.

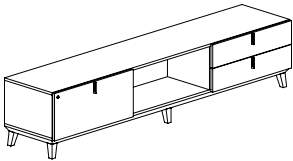

**Credenza**

CBYC19LB	20 x 96 x 20	100	239	25	<b>\$6488</b>	<b>\$8112</b>
----------	--------------	-----	-----	----	---------------	---------------

Freestanding credenza, front locking lateral drawer on **left**, open **center**, and two box drawers on **right**. Low base.

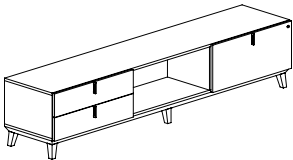

**Credenza**

CBYC20LB	20 x 96 x 20	100	239	25	<b>\$6488</b>	<b>\$8112</b>
----------	--------------	-----	-----	----	---------------	---------------

Freestanding credenza, two box drawers on **left**, open **center**, and front locking lateral drawer on **right**. Low base.

**Required Specifications**

- Veneer finish
- Laminate finish

## 96"W FREESTANDING CRENZAS - LOW BASE

MODEL#	DIMENSIONS	FREIGHT CLASS	WT/LBS.	CUBIC FT.	LAMINATE	VENEER
	<b>D x W x H</b>					
CBYC21LB	20 x 96 x 20	100	225	25	\$6149	\$7688
CBYC22LB	20 x 96 x 20	100	217	25	\$6002	\$7504
CBYC23LB	20 x 96 x 20	92.5	256	25	\$6926	\$8659
CBYC24LB	20 x 96 x 27.5	100	304	34	\$7659	\$9576
CBYC25LB	20 x 96 x 27.5	100	284	34	\$6958	\$8699
CBYC26LB	20 x 96 x 27.5	100	296	34	\$7103	\$8881

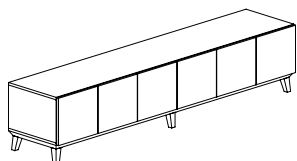

Credenza\*

Freestanding storage credenza with six doors. Low base.

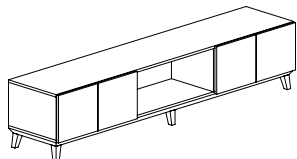

Credenza\*

Freestanding storage credenza with two doors on **left**, open **center**, and two doors on **right**. Low base.

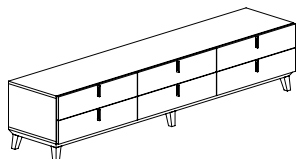

Credenza

Freestanding credenza with six box drawers. Low base.

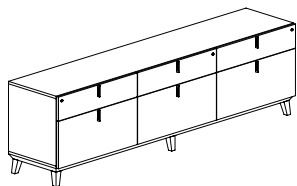

Credenza

Freestanding credenza, front locking lateral drawer with box drawer **left**, **center** and **right**. Low base.

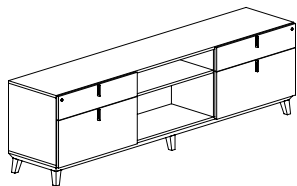

Credenza\*\*

Freestanding credenza, front locking lateral drawer with box drawer on **left**, open with fixed shelf **center**, and front locking lateral drawer with box drawer on **right**. Low base.

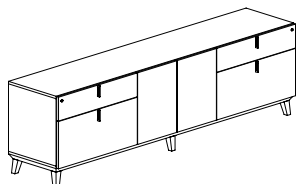

Credenza\*

Freestanding credenza, front locking lateral drawer with box drawer on **left**, two door storage with adjustable shelf **center**, and front locking lateral drawer with box drawer on **right**. Low base.

**Required Specifications**

Veneer finish  
Laminate finish

**Optional Specifications**

Lock  
Handles  
Wire management (C275)\*

**96"W FREESTANDING CREDENZAS - LOW BASE**

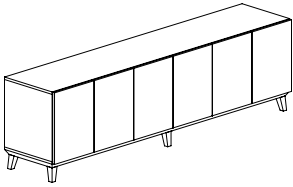

**Credenza**

MODEL#	DIMENSIONS D x W x H	FREIGHT CLASS	WT/LBS.	CUBIC FT.	LAMINATE	veneer
CBYC27LB	20 x 96 x 27.5	100	281	34	<b>\$6589</b>	<b>\$8237</b>

Freestanding storage credenza, six doors with three adjustable shelves. Low base.

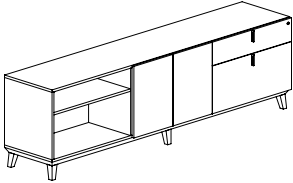

**Credenza\***

CBYC28LB	20 x 96 x 27.5	100	277	34	<b>\$6401</b>	<b>\$8003</b>
----------	----------------	-----	-----	----	---------------	---------------

Freestanding credenza, open with fixed shelf on **left**, two door storage with adjustable shelf **center**, and front locking lateral drawer with box drawer on **right**. Low base.

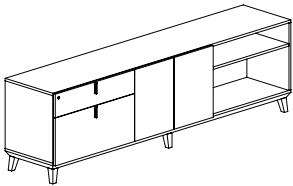

**Credenza\***

CBYC29LB	20 x 96 x 27.5	100	277	34	<b>\$6401</b>	<b>\$8003</b>
----------	----------------	-----	-----	----	---------------	---------------

Freestanding credenza, front locking lateral drawer with box drawer on **left**, two door storage with adjustable shelf **center**, and open with fixed shelf on **right**. Low base.

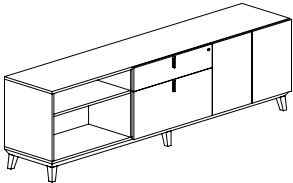

**Credenza\***

CBYC30LB	20 x 96 x 27.5	100	277	34	<b>\$6401</b>	<b>\$8003</b>
----------	----------------	-----	-----	----	---------------	---------------

Freestanding credenza, open with fixed shelf on **left**, front locking lateral drawer with box drawer **center**, and two door storage with adjustable shelf on **right**. Low base.

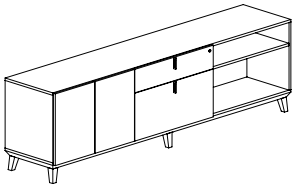

**Credenza\***

CBYC31LB	20 x 96 x 27.5	100	277	34	<b>\$6401</b>	<b>\$8003</b>
----------	----------------	-----	-----	----	---------------	---------------

Freestanding credenza, two door storage with adjustable shelf on **left**, front locking lateral drawer with box drawer **center**, and open with fixed shelf on **right**. Low base.

**Required Specifications**

Veneer finish  
Laminate finish

**Optional Specifications**

Lock  
Handles  
Wire management (C275)\*

## 96"W FREESTANDING CREDENZAS - LOW BASE

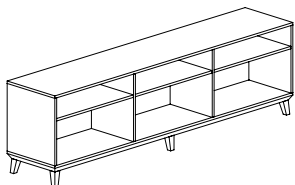

Credenza\*

MODEL#	DIMENSIONS	FREIGHT CLASS	WT/LBS.	CUBIC FT.	LAMINATE	VENEER
CBYC32LB	20 x 96 x 27.5	125	277	34	\$6149	\$7688

D x W x H

Freestanding credenza, open with fixed shelf **left, center** and **right**. Low base.

## 96"W FREESTANDING CREDENZAS - HIGH BASE

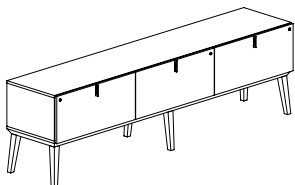

Credenza

MODEL#	DIMENSIONS	FREIGHT CLASS	WT/LBS.	CUBIC FT.	LAMINATE	VENEER
CBYC11HB	20 x 96 x 27.5	125	264	34	\$7266	\$9084

Freestanding credenza, three front locking lateral drawers. High base.

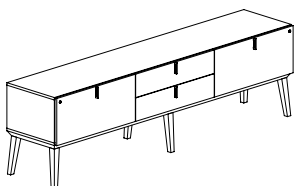

Credenza

CBYC12HB	20 x 96 x 27.5	125	263	34	\$7250	\$9064
----------	----------------	-----	-----	----	--------	--------

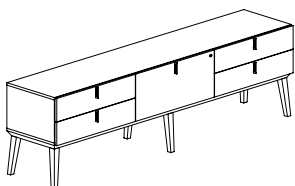
Freestanding credenza, front locking lateral drawer on **left**, two box drawers **center**, and front locking lateral drawer on **right**. High base.

Credenza

CBYC13HB	20 x 96 x 27.5	125	263	34	\$7235	\$9046
----------	----------------	-----	-----	----	--------	--------

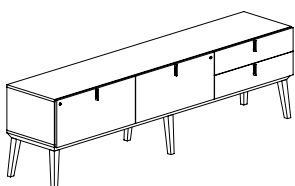
Freestanding credenza, two box drawers on **left**, front locking lateral drawer **center**, and two box drawers on **right**. High base.

Credenza

CBYC14HB	20 x 96 x 27.5	125	263	34	\$7250	\$9064
----------	----------------	-----	-----	----	--------	--------

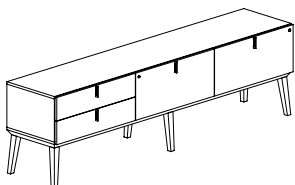
Freestanding credenza, front locking lateral drawer on **left** and **center**, two box drawers on **right**. High base.

Credenza

CBYC15HB	20 x 96 x 27.5	125	263	34	\$7250	\$9064
----------	----------------	-----	-----	----	--------	--------

Freestanding credenza, two box drawers on **left** and front locking lateral drawer **center** and **right**. High base.**Required Specifications**Veneer finish  
Laminate finish**Optional Specifications**

Wire management (C275)\*

**96"W FREESTANDING CREDENZAS - HIGH BASE**

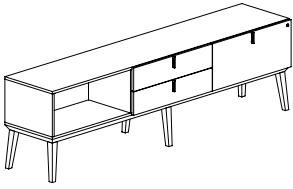

**Credenza\***

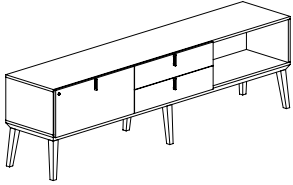

**Credenza\***

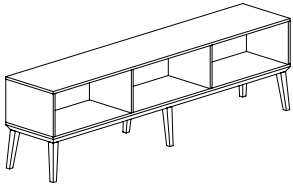

**Credenza\***

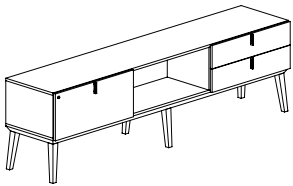

**Credenza\***

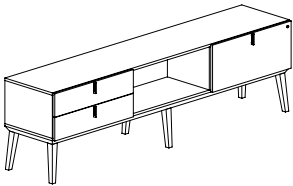

**Credenza\***

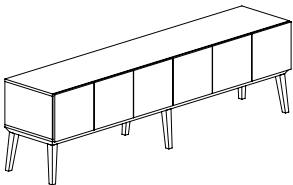

**Credenza\*\***

MODEL#	DIMENSIONS D x W x H	FREIGHT CLASS	WT/LBS.	CUBIC FT.	LAMINATE	veneer
CBYC16HB	20 x 96 x 27.5	125	244	34	<b>\$6781</b>	<b>\$8478</b>
Freestanding credenza, open on <b>left</b> , two box drawers <b>center</b> , and front locking lateral drawer on <b>right</b> . High base.						
CBYC17HB	20 x 96 x 27.5	125	244	34	<b>\$6781</b>	<b>\$8478</b>
Freestanding credenza, front locking lateral drawer on <b>left</b> , two box drawers <b>center</b> , and open on <b>right</b> . High base.						
CBYC18HB	20 x 96 x 27.5	125	206	34	<b>\$5855</b>	<b>\$7321</b>
Freestanding credenza, open <b>left</b> , <b>center</b> and <b>right</b> . High base.						
CBYC19HB	20 x 96 x 27.5	125	244	34	<b>\$6781</b>	<b>\$8478</b>
Freestanding credenza, front locking lateral drawer on <b>left</b> , open <b>center</b> , and two box drawers on <b>right</b> . High base.						
CBYC20HB	20 x 96 x 27.5	125	244	34	<b>\$6781</b>	<b>\$8478</b>
Freestanding credenza, two box drawers on <b>left</b> , open <b>center</b> , and front locking lateral drawer on <b>right</b> . High base.						
CBYC21HB	20 x 96 x 27.5	125	230	34	<b>\$6443</b>	<b>\$8054</b>
Freestanding storage credenza, six doors. High base.						

**Required Specifications**

Veneer finish  
Laminate finish

**Optional Specifications**

Wire management (C275)\*  
Lock\*\*  
Handles\*\*

## 96"W FREESTANDING CREDENZAS - HIGH BASE

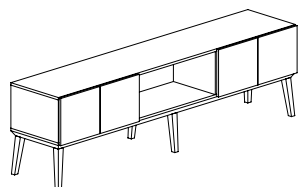

Credenza\*\*

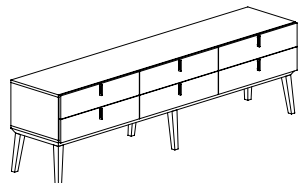

Credenza

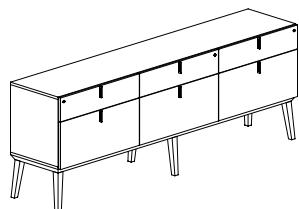

Credenza

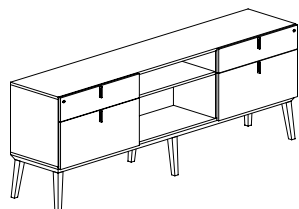

Credenza

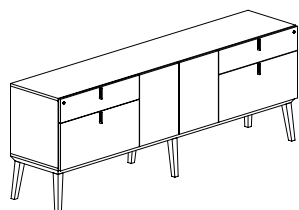

Credenza\*

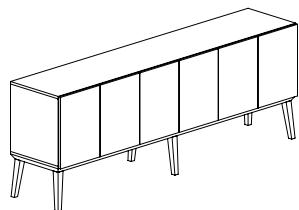

Credenza\*

MODEL#	DIMENSIONS	FREIGHT CLASS	WT/LBS.	CUBIC FT.	LAMINATE	VENEER
	<b>D x W x H</b>					
CBYC22HB	20 x 96 x 27.5	125	222	34	\$6295	\$7870
CBYC23HB	20 x 96 x 27.5	125	261	34	\$7220	\$9026
CBYC24HB	20 x 96 x 35	125	309	43	\$7951	\$9940
CBYC25HB	20 x 96 x 35	125	289	43	\$7250	\$9064
CBYC26HB	20 x 96 x 35	125	301	43	\$7395	\$9246
CBYC27HB	20 x 96 x 35	125	286	43	\$6882	\$8604

Freestanding storage credenza with two doors on **left**, open **center**, and two doors on **right**. High base.

Freestanding credenza with six box drawers. High base.

Freestanding credenza, front locking lateral drawer with box drawer **left**, **center** and **right**. High base.

Freestanding credenza, front locking lateral drawer with box drawer on **left**, open with fixed shelf **center**, and front locking lateral drawer with box drawer on **right**. High base.

Freestanding credenza, front locking lateral drawer with box drawer on **left**, two door storage with adjustable shelf **center**, and front locking lateral drawer with box drawer on **right**. High base.

Freestanding storage credenza, six doors with three adjustable shelves. High base.

**Required Specifications**

Veneer finish  
Laminate finish

**Optional Specifications**

Lock\*  
Handles\*  
Wire management (C275)\*\*

**96"W FREESTANDING CRENZAS - HIGH BASE**

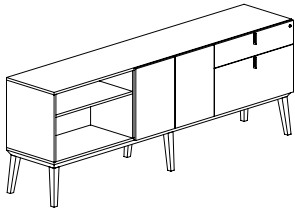

**Credenza\***

MODEL#	DIMENSIONS D x W x H	FREIGHT CLASS	WT/LBS.	CUBIC FT.	LAMINATE	VENEER
CBYC28HB	20 x 96 x 35	125	282	43	<b>\$6694</b>	<b>\$8370</b>

Freestanding credenza, open with fixed shelf on **left**, two door storage with adjustable shelf **center**, and front locking lateral drawer with box drawer on **right**. High base.

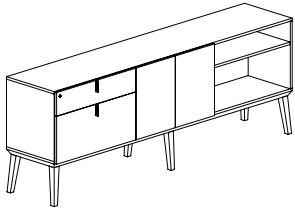

**Credenza\***

CBYC29HB	20 x 96 x 35	125	282	43	<b>\$6694</b>	<b>\$8370</b>
----------	--------------	-----	-----	----	---------------	---------------

Freestanding credenza, front locking lateral drawer with box drawer on **left**, two door storage with adjustable shelf **center**, and open with fixed shelf on **right**. High base.

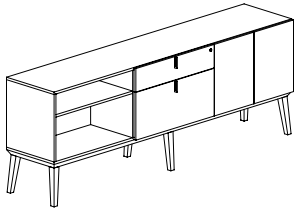

**Credenza\***

CBYC30HB	20 x 96 x 35	125	282	43	<b>\$6694</b>	<b>\$8370</b>
----------	--------------	-----	-----	----	---------------	---------------

Freestanding credenza, open with fixed shelf on **left**, front locking lateral drawer with box drawer **center**, and two door storage with adjustable shelf on **right**. High base.

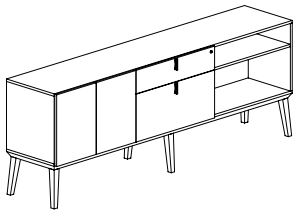

**Credenza\***

CBYC31HB	20 x 96 x 35	125	282	43	<b>\$6694</b>	<b>\$8370</b>
----------	--------------	-----	-----	----	---------------	---------------

Freestanding credenza, two door storage with adjustable shelf on **left**, front locking lateral drawer with box drawer **center**, and open with fixed shelf on **right**. High base.

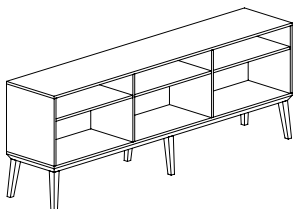

**Credenza**

CBYC32HB	20 x 96 x 35	150	250	43	<b>\$6442</b>	<b>\$8054</b>
----------	--------------	-----	-----	----	---------------	---------------

Freestanding credenza, open with fixed shelf **left, center** and **right**. High base.

**Required Specifications**

Veneer finish  
Laminate finish

**Optional Specifications**

Veneer back panel

## 32"W AND 64"W STACK-ON BOOKCASES AND STORAGE CABINETS

D x W x H

- All Stack-on Bookcases and Storage Cabinets are shipped assembled.
- Stack-on units are designed to be placed and installed on top of the Credenzas with Low or High Base.
- Stack on Units are available in three heights 29.5", 44" and 58.5". For the overall height, please see page A.7.
- Back Panels of the Stack-on units are made of LP solid color laminate.
- Optional locking on doors (Storage units) is available (see Accessories section)

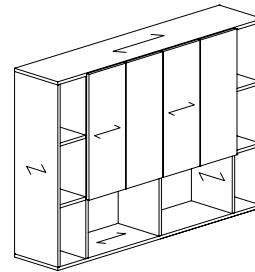

**Note** - Arrow indicates grain direction

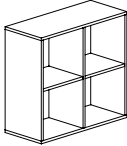
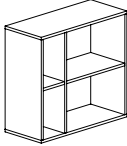
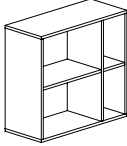
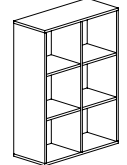
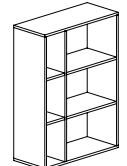
32"W STACK-ON BOOKCASES	MODEL#	DIMENSIONS D x W x H	FREIGHT CLASS	WT/LBS.	CUBIC FT.	LAMINATE	VENEER
 <b>Stack-on Bookcase</b>	CBYS1	14.5 x 32 x 29.5	125	69	9	<b>\$1978</b>	<b>\$2473</b>
Two-high stack-on bookcase with symmetrical 16" wide openings, fixed shelves. LP laminate back.							
 <b>Stack-on Bookcase</b>	CBYS2L	14.5 x 32 x 29.5	125	69	9	<b>\$1978</b>	<b>\$2473</b>
Two-high stack-on bookcase with asymmetrical openings - <b>8" left / 24" right</b> , fixed shelves. LP laminate back.							
 <b>Stack-on Bookcase</b>	CBYS2R	14.5 x 32 x 29.5	125	69	9	<b>\$1978</b>	<b>\$2473</b>
Two-high stack-on bookcase with asymmetrical openings - <b>24" left / 8" right</b> , fixed shelves. LP laminate back.							
 <b>Stack-on Bookcase</b>	CBYS3	14.5 x 32 x 44	125	95	14	<b>\$2709</b>	<b>\$3387</b>
Three-high stack-on bookcase with symmetrical 16" wide openings, fixed shelves. LP laminate back.							
 <b>Stack-on Bookcase</b>	CBYS4L	14.5 x 32 x 44	125	95	14	<b>\$2709</b>	<b>\$3387</b>
Three-high stack-on bookcase with asymmetrical openings - <b>8" left / 24" right</b> , fixed shelves. LP laminate back.							

**Required Specifications**

Veneer finish  
Laminate finish

**Optional Specifications**

Veneer back panel



**32"W STACK-ON BOOKCASES**

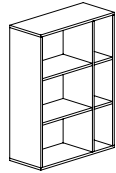

**Stack-on Bookcase**

MODEL#	DIMENSIONS D x W x H	FREIGHT CLASS	WT./LBS.	CUBIC FT.	LAMINATE	VENEER
CBYS4R	14.5 x 32 x 44	125	95	14	<b>\$2709</b>	<b>\$3387</b>

Three-high stack-on bookcase with asymmetrical openings - **24" left / 8" right**, fixed shelves. LP laminate back.

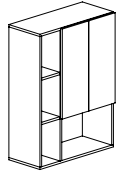

**Stack-on Bookcase\***

CBYS5L	14.5 x 32 x 44	125	106	14	<b>\$3208</b>	<b>\$4013</b>
--------	----------------	-----	-----	----	---------------	---------------

Three-high stack-on bookcase with asymmetrical openings - **8" left / 24" right**, fixed shelves, two door storage upper right with one adjustable shelf. LP laminate back.

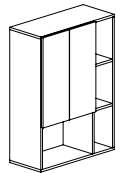

**Stack-on Bookcase\***

CBYS5R	14.5 x 32 x 44	125	106	14	<b>\$3208</b>	<b>\$4013</b>
--------	----------------	-----	-----	----	---------------	---------------

Three-high stack-on bookcase with asymmetrical openings - **24" left / 8" right**, fixed shelves, two door storage upper left with one adjustable shelf. LP laminate back.

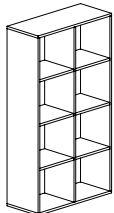

**Stack-on Bookcase**

CBYS6	14.5 x 32 x 58.5	125	111	18	<b>\$3588</b>	<b>\$4487</b>
-------	------------------	-----	-----	----	---------------	---------------

Four-high stack-on bookcase with symmetrical 16" wide openings, fixed shelves. LP laminate back.

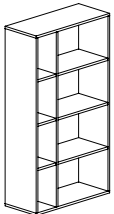

**Stack-on Bookcase**

CBYS7L	14.5 x 32 x 58.5	125	111	18	<b>\$3588</b>	<b>\$4487</b>
--------	------------------	-----	-----	----	---------------	---------------

Four-high stack-on bookcase with asymmetrical openings - **8" left / 24" right**, fixed shelves. LP laminate back.

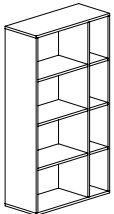

**Stack-on Bookcase**

CBYS7R	14.5 x 32 x 58.5	125	111	18	<b>\$3588</b>	<b>\$4487</b>
--------	------------------	-----	-----	----	---------------	---------------

Four-high stack-on bookcase with asymmetrical openings - **24" left / 8" right**, fixed shelves. LP laminate back.

**Required Specifications**

Veneer finish  
Laminate finish

**Optional Specifications**

Lock\*  
Handles\*  
Veneer back panel

## 32"W STACK-ON BOOKCASES

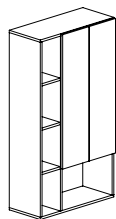

Stack-on Bookcase\*

MODEL#	DIMENSIONS	FREIGHT CLASS	WT/LBS.	CUBIC FT.	LAMINATE	veneer
--------	------------	---------------	---------	-----------	----------	--------

D x W x H

CBYS8L	14.5 x 32 x 58.5	125	129	18	\$4350	\$5441
--------	------------------	-----	-----	----	--------	--------

Four-high stack-on bookcase with asymmetrical openings - **8" left / 24" right**, fixed shelves. two door storage upper right with two adjustable shelves. LP laminate back.

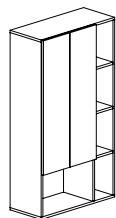

Stack-on Bookcase\*

CBYS8R	14.5 x 32 x 58.5	125	129	18	\$4350	\$5441
--------	------------------	-----	-----	----	--------	--------

Four-high stack-on bookcase with asymmetrical openings - **24" left / 8" right**, fixed shelves. two door storage upper left with two adjustable shelves. LP laminate back.

## 64"W STACK-ON BOOKCASES

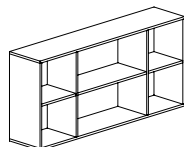

Stack-on Bookcase

MODEL#	DIMENSIONS	FREIGHT CLASS	WT/LBS.	CUBIC FT.	LAMINATE	veneer
--------	------------	---------------	---------	-----------	----------	--------

CBYS9	14.5 x 64 x 29.5	125	119	18	\$3442	\$4304
-------	------------------	-----	-----	----	--------	--------

Two-high stack-on bookcase, 32" open fixed shelf center, 16" open fixed shelves on either side. LP laminate back.

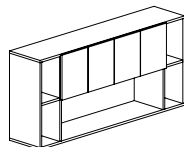

Stack-on Bookcase\*

CBYS10	14.5 x 64 x 29.5	125	134	18	\$4071	\$5091
--------	------------------	-----	-----	----	--------	--------

Two-high stack-on bookcase, four door storage upper center, 48" open fixed shelf lower center, and 8" open fixed shelves on either side. LP laminate back.

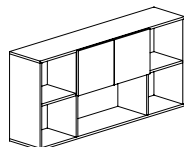

Stack-on Bookcase\*

CBYS11	14.5 x 64 x 29.5	125	127	18	\$3825	\$4784
--------	------------------	-----	-----	----	--------	--------

Two-high stack-on bookcase, two door storage upper center, 32" open fixed shelves center, and 16" open fixed shelves on either side. LP laminate back.

**Required Specifications**

Veneer finish  
Laminate finish

**Optional Specifications**

Lock\*  
Handles\*  
Veneer back panel

**64"W STACK-ON BOOKCASES**

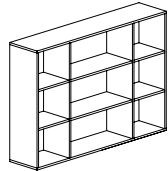

**Stack-on Bookcase**

MODEL#	DIMENSIONS D x W x H	FREIGHT CLASS	WT/LBS.	CUBIC FT.	LAMINATE	VENEER
CBYS12	14.5 x 64 x 44	125	164	27	<b>\$4837</b>	<b>\$6047</b>

Three-high stack-on bookcase, 32" open fixed shelves center, 16" open fixed shelves on either side. LP laminate back.

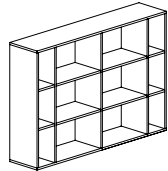

**Stack-on Bookcase**

CBYS13	14.5 x 64 x 44	125	174	27	<b>\$5100</b>	<b>\$6376</b>
--------	----------------	-----	-----	----	---------------	---------------

Three-high stack-on bookcase, two 24" open fixed shelves center, 8" open fixed shelves on either side. LP laminate back.

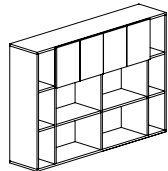

**Stack-on Bookcase\***

CBYS14	14.5 x 64 x 44	125	186	27	<b>\$5802</b>	<b>\$7253</b>
--------	----------------	-----	-----	----	---------------	---------------

Three-high stack-on bookcase, four door storage upper center, two 24" open fixed shelves lower center, 8" open fixed shelves on either side. LP laminate back.

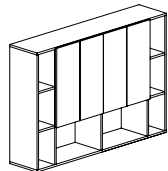

**Stack-on Bookcase\***

CBYS15	14.5 x 64 x 44	125	198	27	<b>\$6163</b>	<b>\$7706</b>
--------	----------------	-----	-----	----	---------------	---------------

Three-high stack-on bookcase, four door storage upper center, two 24" open fixed shelves lower center, 8" open fixed shelves on either side. LP laminate back.

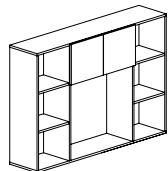

**Stack-on Bookcase\***

CBYS16	14.5 x 64 x 44	125	172	27	<b>\$5214</b>	<b>\$6520</b>
--------	----------------	-----	-----	----	---------------	---------------

Three-high stack-on bookcase, two door storage upper center, 32" open shelf lower center, 16" open fixed shelves on either side. LP laminate back.

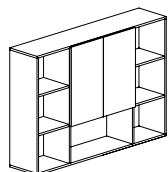

**Stack-on Bookcase\***

CBYS17	14.5 x 64 x 44	125	172	27	<b>\$5461</b>	<b>\$6829</b>
--------	----------------	-----	-----	----	---------------	---------------

Three-high stack-on bookcase, two door storage upper center with adjustable shelf, 32" open fixed shelf lower center, 16" open fixed shelves on either side. LP laminate back.

**Required Specifications**

Veneer finish  
Laminate finish

**Optional Specifications**

Lock\*  
Handles\*  
Veneer back panel

## 64"W STACK-ON BOOKCASES

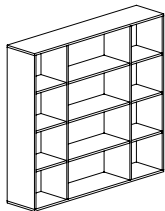
**Stack-on Bookcase**

MODEL#	DIMENSIONS D x W x H	FREIGHT CLASS	WT/LBS.	CUBIC FT.	LAMINATE	VENEER
CBYS18	14.5 x 64 x 58.5	150	208	35	\$6224	\$7782

Four-high stack-on bookcase, 32" open fixed shelves center, 16" open fixed shelves on either side. LP laminate back.

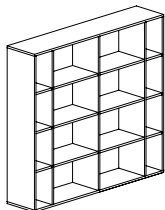
**Stack-on Bookcase**

CBYS19	14.5 x 64 x 58.5	125	222	35	\$6665	\$8332
--------	------------------	-----	-----	----	--------	--------

Four-high stack-on bookcase, two 24" open fixed shelves center, 8" open fixed shelves on either side. LP laminate back.

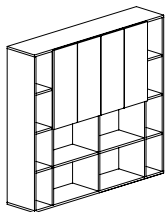
**Stack-on Bookcase\***

CBYS20	14.5 x 64 x 58.5	125	245	35	\$7659	\$9576
--------	------------------	-----	-----	----	--------	--------

Four-high stack-on bookcase, four door storage upper center, with adjustable shelves, two 24" open fixed shelves lower center, 8" open fixed shelves on either side. LP laminate back.

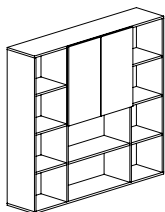
**Stack-on Bookcase\***

CBYS21	14.5 x 64 x 58.5	125	224	35	\$6720	\$8401
--------	------------------	-----	-----	----	--------	--------

Four-high stack-on bookcase, two door storage upper center, with adjustable shelf, 32" open fixed shelf lower center, 16" open fixed shelves on either side. LP laminate back.

**Required Specifications**

Veneer finish  
Laminate finish

**Optional Specifications**

Lock\*  
Handles\*  
Veneer back panel

## 32"W AND 64"W FREESTANDING BOOKCASES AND STORAGE CABINETS

D x W x H

- All Bookcases and Storage cabinets are shipped assembled.
- Bookcases and Storage cabinets are available in two base heights: 4" (xxLB = Low Base) or 11.5" (xxHB = High Base)
- Back Panels of the Bookcases and storage cabinets are made of LP solid color laminate.
- Optional locking on doors (Storage units) is available (see Accessories section).

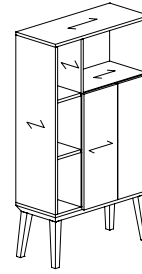

**Note** - Arrow indicates grain direction

### 32"W FREESTANDING BOOKCASES - LOW BASE

MODEL#	DIMENSIONS	FREIGHT CLASS	WT/LBS.	CUBIC FT.	LAMINATE	VENEER
--------	------------	---------------	---------	-----------	----------	--------

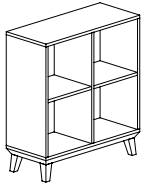

**Freestanding Bookcase**

CBYB1LB	14.5 x 32 x 35.5	100	101	11	<b>\$2563</b>	<b>\$3205</b>
---------	------------------	-----	-----	----	---------------	---------------

Freestanding two-high bookcase with symmetrical 16" wide openings, fixed shelves. Low base. LP Laminate back.

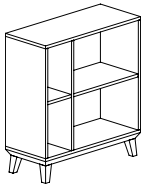

**Freestanding Bookcase**

CBYB2LLB	14.5 x 32 x 35.5	100	101	11	<b>\$2563</b>	<b>\$3205</b>
----------	------------------	-----	-----	----	---------------	---------------

Freestanding two-high bookcase with asymmetrical openings - **8" left / 24" right**, fixed shelves. Low base. LP laminate back.

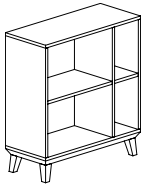

**Freestanding Bookcase**

CBYB2RLB	14.5 x 32 x 35.5	100	101	11	<b>\$2563</b>	<b>\$3205</b>
----------	------------------	-----	-----	----	---------------	---------------

Freestanding two-high bookcase with asymmetrical openings - **24" left / 8" right**, fixed shelves. Low base. LP laminate back.

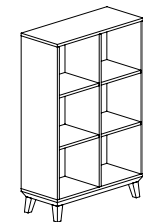

**Freestanding Bookcase**

CBYB3LB	14.5 x 32 x 50	125	119	15	<b>\$3297</b>	<b>\$4122</b>
---------	----------------	-----	-----	----	---------------	---------------

Freestanding three-high bookcase with symmetrical 16" wide openings, fixed shelves. Low base. LP Laminate back.

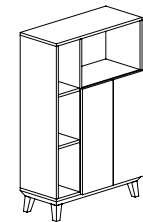

**Freestanding Bookcase\***

CBYB4LLB	14.5 x 32 x 50	100	138	15	<b>\$3796</b>	<b>\$4746</b>
----------	----------------	-----	-----	----	---------------	---------------

Freestanding three-high bookcase with asymmetrical openings - **8" left / 24" right**, fixed shelves, two door storage lower right with one adjustable shelf. Low base. LP Laminate back.

**Required Specifications**

Veneer finish  
Laminate finish

**Optional Specifications**

Lock\*  
Handles\*  
Veneer back panel

## 32"W FREESTANDING BOOKCASES - LOW BASE

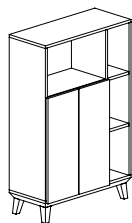

Freestanding Bookcase\*

MODEL#	DIMENSIONS	FREIGHT CLASS	WT/LBS.	CUBIC FT.	LAMINATE	VENEER
	<b>D x W x H</b>					
CBYB4RLB	14.5 x 32 x 50	100	138	15	\$3796	\$4746

Freestanding three-high bookcase with asymmetrical openings - **24" left / 8" right**, fixed shelves, two door storage lower left with one adjustable shelf. Low base. LP Laminate back.

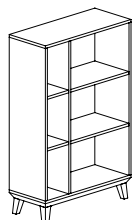

Freestanding Bookcase

CBYB5LLB	14.5 x 32 x 50	100	126	15	\$3297	\$4122
----------	----------------	-----	-----	----	--------	--------

Freestanding three-high bookcase with asymmetrical openings - **8" left / 24" right**, fixed shelves. Low base. LP Laminate back.

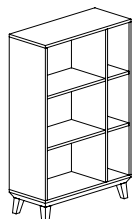

Freestanding Bookcase

CBYB5RLB	14.5 x 32 x 50	100	126	15	\$3297	\$4122
----------	----------------	-----	-----	----	--------	--------

Freestanding three-high bookcase with asymmetrical openings - **24" left / 8" right**, fixed shelves. Low base. LP Laminate back.

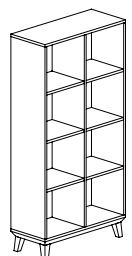

Freestanding Bookcase

CBYB6LB	14.5 x 32 x 64	125	152	20	\$4175	\$5219
---------	----------------	-----	-----	----	--------	--------

Freestanding four-high bookcase with symmetrical 16" wide openings, fixed shelves. Low base. LP Laminate back.

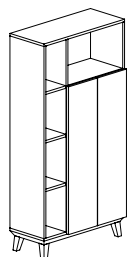

Freestanding Bookcase\*

CBYB7LLB	14.5 x 32 x 64	100	169	20	\$4937	\$6173
----------	----------------	-----	-----	----	--------	--------

Freestanding four-high bookcase with asymmetrical openings - **8" left / 24" right**, fixed shelves, two door storage lower right with two adjustable shelves. Low base. LP Laminate back.

**Required Specifications**

Veneer finish  
Laminate finish

**Optional Specifications**

Lock\*  
Handles\*  
Veneer back panel

32"W FREESTANDING BOOKCASES - LOW BASE

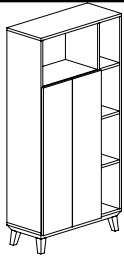

Freestanding Bookcase\*

MODEL#	DIMENSIONS D x W x H	FREIGHT CLASS	WT/LBS.	CUBIC FT.	LAMINATE	ENEER
CBYB7RLB	14.5 x 32 x 64	100	169	20	\$4937	\$6173

Freestanding four-high bookcase with asymmetrical openings - **24" left / 8" right**, fixed shelves, two door storage lower left with two adjustable shelves. Low base. LP Laminate back.

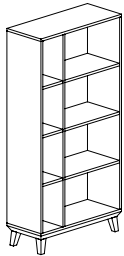

Freestanding Bookcase

CBYB8LLB	14.5 x 32 x 64	125	152	20	\$4175	\$5219
----------	----------------	-----	-----	----	--------	--------

Freestanding four-high bookcase with asymmetrical openings - **8" left / 24" right**, fixed shelves. Low base. LP Laminate back.

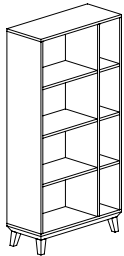

Freestanding Bookcase

CBYB8RLB	14.5 x 32 x 64	125	152	20	\$4175	\$5219
----------	----------------	-----	-----	----	--------	--------

Freestanding four-high bookcase with asymmetrical openings - **24" left / 8" right**, fixed shelves. Low base. LP Laminate back.

32"W FREESTANDING BOOKCASES - HIGH BASE

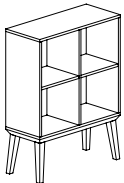

Freestanding Bookcase

MODEL#	DIMENSIONS	FREIGHT CLASS	WT/LBS.	CUBIC FT.	LAMINATE	ENEER
CBYB1HB	14.5 x 32 x 42.75	100	106	13	\$2856	\$3571

Freestanding two-high bookcase with symmetrical 16" wide openings, fixed shelves. High base. LP Laminate back.

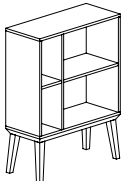

Freestanding Bookcase

CBYB2LHB	14.5 x 32 x 42.75	100	106	13	\$2856	\$3571
----------	-------------------	-----	-----	----	--------	--------

Freestanding two-high bookcase with asymmetrical openings - **8" left / 24" right**, fixed shelves. High base. LP laminate back.

**Required Specifications**

Veneer finish  
Laminate finish

**Optional Specifications**

Lock\*  
Handles\*  
Veneer back panel

## 32"W FREESTANDING BOOKCASES - HIGH BASE

## MODEL#

## DIMENSIONS

## FREIGHT CLASS

## WT/LBS.

## CUBIC FT.

## LAMINATE

## VENEER

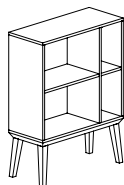

Freestanding Bookcase

	D x W x H						
CBYB2RHB	14.5 x 32 x 42.75	100	106	13	\$2856	\$3571	

Freestanding two-high bookcase with asymmetrical openings - **24" left / 8" right**, fixed shelves. High base. LP laminate back.

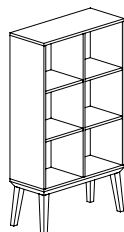

Freestanding Bookcase

CBYB3HB	14.5 x 32 x 57	125	119	18	\$3588	\$4487	
---------	----------------	-----	-----	----	--------	--------	--

Freestanding three-high bookcase with symmetrical 16" wide openings, fixed shelves. High base. LP Laminate back.

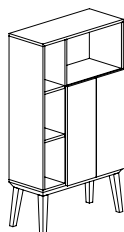

Freestanding Bookcase\*

CBYB4LHB	14.5 x 32 x 57	125	143	18	\$4088	\$5111	
----------	----------------	-----	-----	----	--------	--------	--

Freestanding three-high bookcase with asymmetrical openings - **8" left / 24" right**, fixed shelves, two door storage lower right with one adjustable shelf. High base. LP Laminate back.

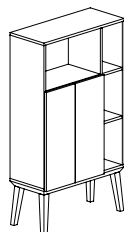

Freestanding Bookcase\*

CBYB4RHB	14.5 x 32 x 57	125	143	18	\$4088	\$5111	
----------	----------------	-----	-----	----	--------	--------	--

Freestanding three-high bookcase with asymmetrical openings - **24" left / 8" right**, fixed shelves, two door storage lower right with one adjustable shelf. High base. LP Laminate back.

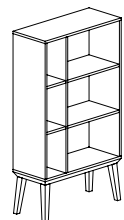

Freestanding Bookcase

CBYB5LHB	14.5 x 32 x 57	125	131	18	\$3588	\$4487	
----------	----------------	-----	-----	----	--------	--------	--

Freestanding three-high bookcase with asymmetrical openings - **8" left / 24" right**, fixed shelves. High base. LP Laminate back.

**Required Specifications**

Veneer finish  
Laminate finish

**Optional Specifications**

Lock\*  
Handles\*  
Veneer back panel



32"W FREESTANDING BOOKCASES - HIGH BASE

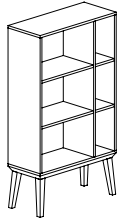

Freestanding Bookcase

MODEL#	DIMENSIONS D x W x H	FREIGHT CLASS	WT/LBS.	CUBIC FT.	LAMINATE	VENEER
CBYB5RHB	14.5 x 32 x 57	125	131	18	\$3588	\$4487

Freestanding three-high bookcase with asymmetrical openings - **24" left / 8" right**, fixed shelves. High base. LP Laminate back.

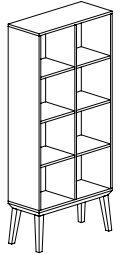

Freestanding Bookcase

CBYB6HB	14.5 x 32 x 71.5	125	157	22	\$4467	\$5585
---------	------------------	-----	-----	----	--------	--------

Freestanding four-high bookcase with symmetrical 16" wide openings, fixed shelves. High base. LP Laminate back.

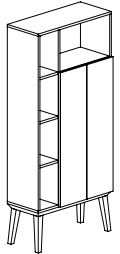

Freestanding Bookcase\*

CBYB7LHB	14.5 x 32 x 71.5	125	174	22	\$5230	\$6539
----------	------------------	-----	-----	----	--------	--------

Freestanding four-high bookcase with asymmetrical openings - **8" left / 24" right**, fixed shelves, two door storage lower right with two adjustable shelves. High base. LP Laminate back.

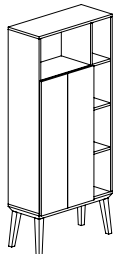

Freestanding Bookcase\*

CBYB7RHB	14.5 x 32 x 71.5	125	174	22	\$5230	\$6539
----------	------------------	-----	-----	----	--------	--------

Freestanding four-high bookcase with asymmetrical openings - **24" left / 8" right**, fixed shelves, two door storage lower left with two adjustable shelves. High base. LP Laminate back.

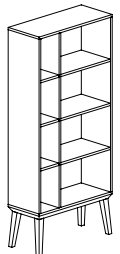

Freestanding Bookcase

CBYB8LHB	14.5 x 32 x 71.5	125	157	22	\$4467	\$5585
----------	------------------	-----	-----	----	--------	--------

Freestanding four-high bookcase with asymmetrical openings - **8" left / 24" right**, fixed shelves. High base. LP Laminate back.

**Required Specifications**

Veneer finish  
Laminate finish

**Optional Specifications**

Lock\*  
Handles\*  
Veneer back panel

## 32"W FREESTANDING BOOKCASES - HIGH BASE

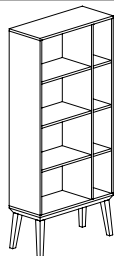

Freestanding Bookcase

## MODEL#

## DIMENSIONS

## FREIGHT CLASS

## WT/LBS.

## CUBIC FT.

## LAMINATE

## VENEER

## D x W x H

CBYB8RHB	14.5 x 32 x 71.5	125	157	22	\$4467	\$5585
----------	------------------	-----	-----	----	--------	--------

Freestanding four-high bookcase with asymmetrical openings - **24" left / 8" right**, fixed shelves. High base. LP Laminate back.

## 64"W FREESTANDING BOOKCASES - LOW BASE

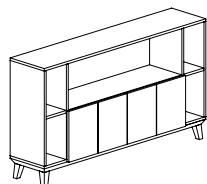

Freestanding Bookcase\*

## MODEL#

## DIMENSIONS

## FREIGHT CLASS

## WT/LBS.

## CUBIC FT.

## LAMINATE

## VENEER

CBYB9LB	14.5 x 64 x 35.5	100	177	21	\$4660	\$5826
---------	------------------	-----	-----	----	--------	--------

Freestanding two-high bookcase with four door storage lower center, 48" open fixed upper shelf and 8" open fixed shelves on either side. Low base. LP Laminate back.

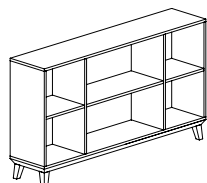

Freestanding Bookcase

CBYB10LB	14.5 x 64 x 35.5	125	162	21	\$4028	\$5036
----------	------------------	-----	-----	----	--------	--------

Freestanding two-high bookcase, 32" open fixed shelf center, and 16" open fixed shelves on either side. Low base. LP Laminate back.

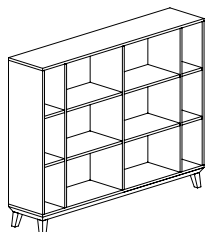

Freestanding Bookcase

CBYB11LB	14.5 x 64 x 50	125	217	30	\$4290	\$5364
----------	----------------	-----	-----	----	--------	--------

Freestanding three-high bookcase, two 24" open fixed shelves center, and 8" open fixed shelves on either side. Low base. LP Laminate back.

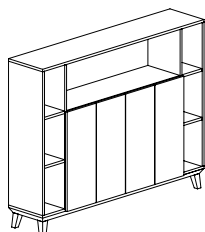

Freestanding Bookcase\*

CBYB12LB	14.5 x 64 x 50	125	237	30	\$6750	\$8439
----------	----------------	-----	-----	----	--------	--------

Freestanding three-high bookcase, four door storage lower center with adjustable shelves, 48" open fixed shelf upper, and 8" open fixed shelves on either side. Low base. LP Laminate back.

**Required Specifications**

Veneer finish  
Laminate finish

**Optional Specifications**

Lock\*  
Handles\*  
Veneer back panel

**64"W FREESTANDING BOOKCASES - LOW BASE**

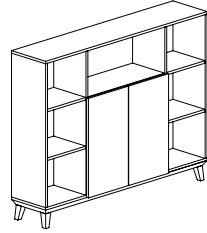

**Freestanding Bookcase\***

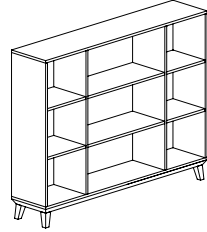

**Freestanding Bookcase**

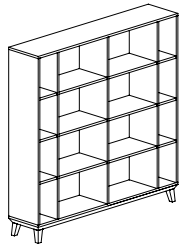

**Freestanding Bookcase**

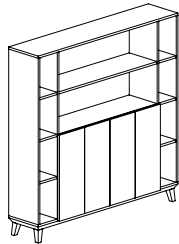

**Freestanding Bookcase\***

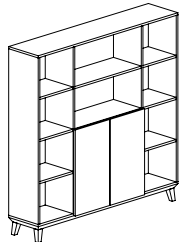

**Freestanding Bookcase\***

MODEL#	DIMENSIONS	FREIGHT CLASS	WT/LBS.	CUBIC FT.	LAMINATE	veneer
--------	------------	---------------	---------	-----------	----------	--------

CBYB13LB	14.5 x 64 x 50	125	223	30	<b>\$6049</b>	<b>\$7562</b>
----------	----------------	-----	-----	----	---------------	---------------

Freestanding three-high bookcase, two door storage lower center with adjustable shelves, 32" open fixed shelf upper, and 8" open fixed shelves on either side. Low base. LP Laminate back.

CBYB14LB	14.5 x 64 x 50	125	207	30	<b>\$5416</b>	<b>\$6772</b>
----------	----------------	-----	-----	----	---------------	---------------

Freestanding three-high bookcase, 32" open fixed shelves center, and 16" open fixed shelves on either side. Low base. LP Laminate back.

CBYB15LB	14.5 x 64 x 64	125	265	38	<b>\$7250</b>	<b>\$9064</b>
----------	----------------	-----	-----	----	---------------	---------------

Freestanding four-high bookcase, two 24" open fixed shelves center, and 8" open fixed shelves on either side. Low base. LP Laminate back.

CBYB16LB	14.5 x 64 x 64	125	281	38	<b>\$8244</b>	<b>\$10307</b>
----------	----------------	-----	-----	----	---------------	----------------

Freestanding four-high bookcase, four door storage lower center with adjustable shelves, 48" open fixed upper shelves, and 8" open fixed shelves on either side. Low base. LP Laminate back.

CBYB17LB	14.5 x 64 x 64	125	267	38	<b>\$7304</b>	<b>\$9133</b>
----------	----------------	-----	-----	----	---------------	---------------

Freestanding four-high bookcase, two door storage lower center with adjustable shelves, 32" open fixed upper shelves, and 8" open fixed shelves on either side. Low base. LP Laminate back.

**Required Specifications**

Veneer finish  
Laminate finish

**Optional Specifications**

Lock\*  
Handles\*  
Veneer back panel

## 64"W FREESTANDING BOOKCASES - LOW BASE

MODEL#	DIMENSIONS	FREIGHT CLASS	WT/LBS.	CUBIC FT.	LAMINATE	VENEER
--------	------------	---------------	---------	-----------	----------	--------

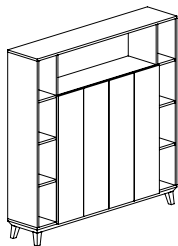

Freestanding Bookcase\*

	D x W x H					
CBYB18LB	14.5 x 64 x 64	125	295	38	\$8391	\$10490

Freestanding four-high bookcase, four door storage lower center with adjustable shelves, 48" open fixed upper shelf, and 8" open fixed shelves on either side. Low base. LP Laminate back.

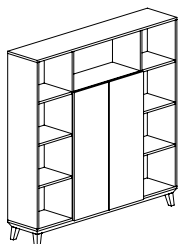

Freestanding Bookcase\*

CBYB19LB	14.5 x 64 x 64	125	275	38	\$7453	\$9317
----------	----------------	-----	-----	----	--------	--------

Freestanding four-high bookcase, four door storage lower center with adjustable shelves, 32" open fixed upper shelf, and 16" open fixed shelves on either side. Low base. LP Laminate back.

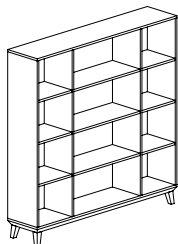

Freestanding Bookcase

CBYB20LB	14.5 x 64 x 64	125	251	38	\$6812	\$8516
----------	----------------	-----	-----	----	--------	--------

Freestanding four-high bookcase, 32" open fixed shelves center, and 16" open fixed shelves on either side. Low base. LP Laminate back.

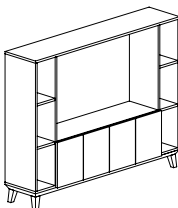

Freestanding Media Cabinet\*

CBYTV1LB	14.5 x 64 x 50	125	222	30	\$6387	\$7984
----------	----------------	-----	-----	----	--------	--------

Freestanding media cabinet, 48" wide two high opening can accommodate up to a 50" monitor, four door storage lower center, 8" open fixed shelf center on either side. Monitor mount is optional. Please see accessories. Low base. LP Laminate back.

## 64"W FREESTANDING BOOKCASES - HIGH BASE

MODEL#	DIMENSIONS	FREIGHT CLASS	WT/LBS.	CUBIC FT.	LAMINATE	VENEER
--------	------------	---------------	---------	-----------	----------	--------

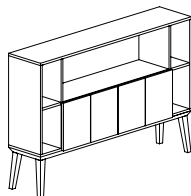

Freestanding Bookcase\*

CBYB9HB	14.5 x 64 x 42.75	125	182	26	\$4953	\$6192
---------	-------------------	-----	-----	----	--------	--------

Freestanding two-high bookcase with four door storage lower center, 48" open fixed upper shelf and 8" open fixed shelves on either side. High base. LP Laminate back.

**Required Specifications**

Veneer finish  
Laminate finish

**Optional Specifications**

Lock\*  
Handles\*  
Veneer back panel

**64"W FREESTANDING BOOKCASES - HIGH BASE**



**Freestanding Bookcase**

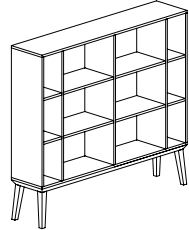

**Freestanding Bookcase**

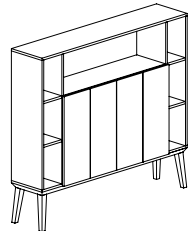

**Freestanding Bookcase\***

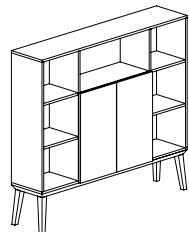

**Freestanding Bookcase\***

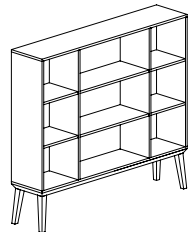

**Freestanding Bookcase**

MODEL#	DIMENSIONS	FREIGHT CLASS	WT/LBS.	CUBIC FT.	LAMINATE	VENEER
--------	------------	---------------	---------	-----------	----------	--------

**D x W x H**

CBYB10HB	14.5 x 64 x 42.75	125	167	26	<b>\$4321</b>	<b>\$5403</b>
----------	-------------------	-----	-----	----	---------------	---------------

Freestanding two-high bookcase, 32" open fixed shelf center, and 16" open fixed shelves on either side. High base. LP Laminate back.

CBYB11HB	14.5 x 64 x 57	125	222	34	<b>\$4583</b>	<b>\$5730</b>
----------	----------------	-----	-----	----	---------------	---------------

Freestanding three-high bookcase, two 24" open fixed shelves center, and 8" open fixed shelves on either side. High base. LP Laminate back.

CBYB12HB	14.5 x 64 x 57	125	242	34	<b>\$7043</b>	<b>\$8806</b>
----------	----------------	-----	-----	----	---------------	---------------

Freestanding three-high bookcase, four door storage lower center with adjustable shelves, 48" open fixed shelf upper, and 8" open fixed shelves on either side. High base. LP Laminate back.

CBYB13HB	14.5 x 64 x 57	125	228	34	<b>\$6340</b>	<b>\$7927</b>
----------	----------------	-----	-----	----	---------------	---------------

Freestanding three-high bookcase, two door storage lower center with adjustable shelves, 32" open fixed shelf upper, and 8" open fixed shelves on either side. High base. LP Laminate back.

CBYB14HB	14.5 x 64 x 57	125	212	34	<b>\$5710</b>	<b>\$7139</b>
----------	----------------	-----	-----	----	---------------	---------------

Freestanding three-high bookcase, 32" open fixed shelves center, and 16" open fixed shelves on either side. High base. LP Laminate back.

**Required Specifications**

Veneer finish  
Laminate finish

**Optional Specifications**

Lock\*  
Handles\*  
Veneer back panel

## 64"W FREESTANDING BOOKCASES - HIGH BASE

## MODEL#

## DIMENSIONS

## FREIGHT CLASS

## WT/LBS.

## CUBIC FT.

## LAMINATE

## VENEER

## D x W x H

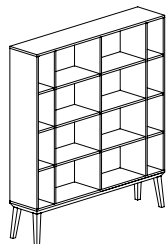

Freestanding Bookcase

MODEL#	DIMENSIONS	FREIGHT CLASS	WT/LBS.	CUBIC FT.	LAMINATE	VENEER
CBYB15HB	14.5 x 64 x 71.5	125	270	43	\$7543	\$9431

Freestanding four-high bookcase, two 24" open fixed shelves center, and 8" open fixed shelves on either side. High base. LP Laminate back.

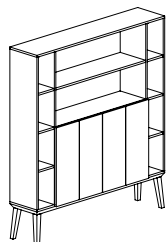

Freestanding Bookcase\*

CBYB16HB	14.5 x 64 x 71.5	125	286	43	\$8539	\$10675
----------	------------------	-----	-----	----	--------	---------

Freestanding four-high bookcase, four door storage lower center with adjustable shelves, 48" open fixed upper shelves, and 8" open fixed shelves on either side. High base. LP Laminate back.

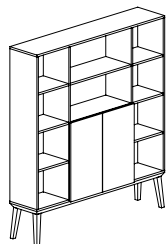

Freestanding Bookcase\*

CBYB17HB	14.5 x 64 x 71.5	125	272	43	\$7599	\$9500
----------	------------------	-----	-----	----	--------	--------

Freestanding four-high bookcase, two door storage lower center with adjustable shelves, 32" open fixed upper shelves, and 8" open fixed shelves on either side. High base. LP Laminate back.

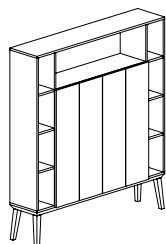

Freestanding Bookcase\*

CBYB18HB	14.5 x 64 x 71.5	125	300	43	\$8684	\$10857
----------	------------------	-----	-----	----	--------	---------

Freestanding four-high bookcase, four door storage lower center with adjustable shelves, 48" open fixed upper shelf, and 8" open fixed shelves on either side. High base. LP Laminate back.

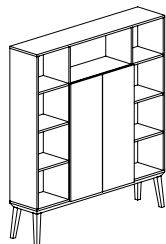

Freestanding Bookcase\*

CBYB19HB	14.5 x 64 x 71.5	125	280	43	\$7746	\$9684
----------	------------------	-----	-----	----	--------	--------

Freestanding four-high bookcase, four door storage lower center with adjustable shelves, 32" open fixed upper shelf, and 16" open fixed shelves on either side. High base. LP Laminate back.

**Required Specifications**

Veneer finish  
Laminate finish

**Optional Specifications**

Lock\*  
Handles\*  
Veneer back panel

64"W FREESTANDING BOOKCASES - HIGH BASE

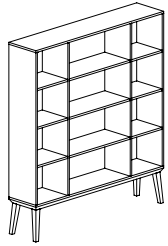

Freestanding Bookcase

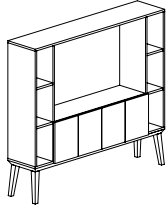

Freestanding Media Cabinet\*

MODEL#	DIMENSIONS	FREIGHT CLASS	WT/LBS.	CUBIC FT.	LAMINATE	VENEER
--------	------------	---------------	---------	-----------	----------	--------

	D x W x H					
CBYB20HB	14.5 x 64 x 71.5	150	256	43	\$7103	\$8881

Freestanding four-high bookcase, 32" open fixed shelves center, and 16" open fixed shelves on either side. High base. LP Laminate back.

CBYTV1HB	14.5 x 64 x 57	125	227	34	\$6680	\$8349
----------	----------------	-----	-----	----	--------	--------

Freestanding media cabinet, 48" wide two high opening can accommodate up to a 50" monitor, four door storage lower center, 8" open fixed shelf center on either side. Monitor mount is optional. Please see accessories. High base. LP Laminate back.

ROOM DIVIDING BOOKCASES - LOW BASE

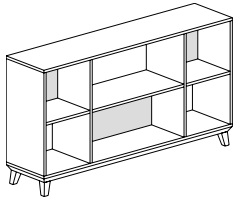

Freestanding Bookcase

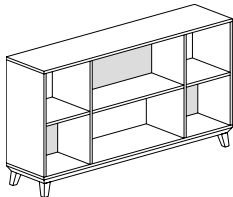

Freestanding Bookcase

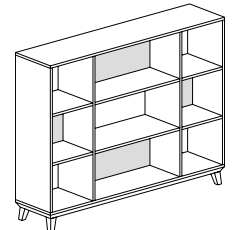

Freestanding Bookcase

MODEL#	DIMENSIONS	FREIGHT CLASS	WT/LBS.	CUBIC FT.	LAMINATE	VENEER
--------	------------	---------------	---------	-----------	----------	--------

CBYB28LB	15 x 64 x 35	125	162	21	\$5765	\$7209
----------	--------------	-----	-----	----	--------	--------

Shaded areas indicate closed cavities.

Freestanding two-high bookcase for use in open plan areas as space division. Low base. LP laminate back.

- Two 24" fixed shelves in center. Top cavity is open as a pass-through, bottom cavity is closed.
- 8" fixed shelves on either side. Top cavity is closed, bottom is open as a pass-through.

CBYB29LB	15 x 64 x 35	125	162	21	\$5765	\$7209
----------	--------------	-----	-----	----	--------	--------

Shaded areas indicate closed cavities.

Freestanding two-high bookcase for use in open plan areas as space division. Low base. LP laminate back.

- Two 24" fixed shelves in center. Top cavity is closed, bottom cavity is open as a pass-through.
- 8" fixed shelves on either side. Top cavity is open as a pass-through, bottom is closed.

CBYB26LB	15 x 64 x 49	125	217	30	\$6644	\$8307
----------	--------------	-----	-----	----	--------	--------

Shaded areas indicate closed cavities.

Freestanding three-high bookcase for use in open plan areas as space division. Low base. LP laminate back.

- Three 24" fixed shelves in center. Top and bottom cavities are closed, middle is open as a pass-through.
- Three 8" fixed shelves on either side. Top and bottom cavities are open as a pass-through, middle is closed.

Required Specifications

Veneer finish  
Laminate finish

Optional Specifications

Lock\*  
Handles\*  
Veneer back panel

## ROOM DIVIDING BOOKCASES - LOW BASE

MODEL#	DIMENSIONS	FREIGHT CLASS	WT/LBS.	CUBIC FT.	LAMINATE	veneer
--------	------------	---------------	---------	-----------	----------	--------

D x W x H

CBYB27LB	15 x 64 x 49	125	217	30	\$6644	\$8307
----------	--------------	-----	-----	----	--------	--------

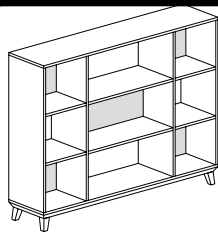

Freestanding Bookcase

*Shaded areas indicate closed cavities.*

Freestanding three-high bookcase for use in open plan areas as space division. Low base. LP laminate back.

- Three 24" fixed shelves in center. Top and bottom cavities are open as a pass-through, middle is closed.
- Three 8" fixed shelves on either side. Top and bottom cavities are closed, middle is open as a pass-through.

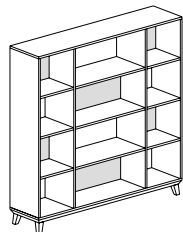

Freestanding Bookcase

CBYB22LB	15 x 64 x 64	125	265	38	\$8376	\$10471
----------	--------------	-----	-----	----	--------	---------

*Shaded areas indicate closed cavities.*

Freestanding four-high bookcase for use in open plan areas as space division. Low base. LP laminate back.

- Four 24" fixed shelves in center. Cavities alternate from top to bottom: open/closed/open/closed.
- Four 8" fixed shelves on either side. Cavities alternate from top to bottom: closed/open/closed/open.

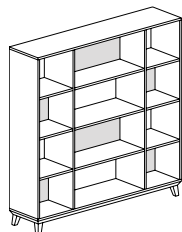

Freestanding Bookcase

CBYB23LB	15 x 64 x 64	125	265	38	\$8376	\$10471
----------	--------------	-----	-----	----	--------	---------

*Shaded areas indicate closed cavities.*

Freestanding four-high bookcase for use in open plan areas as space division. Low base. LP laminate back.

- Four 24" fixed shelves in center. Cavities alternate from top to bottom: closed/open/closed/open.
- Four 8" fixed shelves on either side. Cavities alternate from top to bottom: open/closed/open/closed.

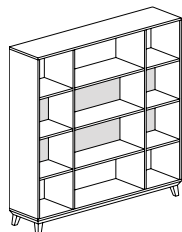

Freestanding Bookcase

CBYB24LB	15 x 64 x 64	125	265	38	\$8376	\$10471
----------	--------------	-----	-----	----	--------	---------

*Shaded areas indicate closed cavities.*

Freestanding four-high bookcase for use in open plan areas as space division. Low base. LP laminate back.

- Four 24" fixed shelves in center. Top and bottom cavities are open as a pass-through. Two middle cavities are closed.
- Four 8" fixed shelves on either side. Top and bottom cavities are closed. Two middle cavities are open as a pass-through.

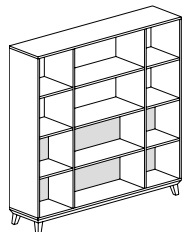

Freestanding Bookcase

CBYB25LB	15 x 64 x 64	125	265	38	\$8376	\$10471
----------	--------------	-----	-----	----	--------	---------

*Shaded areas indicate closed cavities.*

Freestanding four-high bookcase for use in open plan areas as space division. Low base. LP laminate back.

- Four 24" fixed shelves in center. Top two cavities are open as a pass-through. Bottom two cavities are closed.
- Four 8" fixed shelves on either side. Top two cavities are open as a pass-through. Bottom two cavities are closed.

**Required Specifications**

Veneer finish  
Laminate finish

**Optional Specifications**

Veneer back panel



**ROOM DIVIDING BOOKCASES - HIGH BASE**

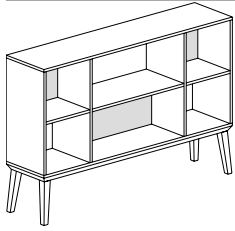

**Freestanding Bookcase**

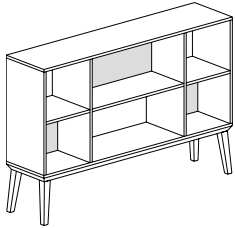

**Freestanding Bookcase**

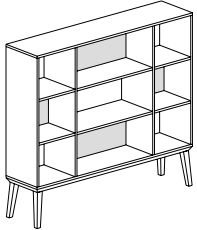

**Freestanding Bookcase**

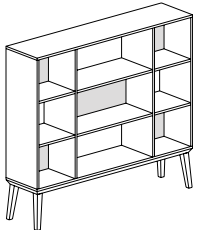

**Freestanding Bookcase**

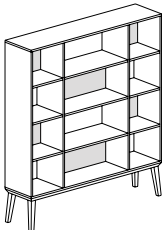

**Freestanding Bookcase**

MODEL#	DIMENSIONS D x W x H	FREIGHT CLASS	WT/LBS.	CUBIC FT.	LAMINATE	veneer
CBYB28HB	15 x 64 x 43	125	167	26	<b>\$6049</b>	<b>\$7562</b>

*Shaded areas indicate closed cavities.*

Freestanding two-high bookcase for use in open plan areas as space division. High base. LP laminate back.

- Two 24" fixed shelves in center. Top cavity is open as a pass-through, bottom cavity is closed.
- 8" fixed shelves on either side. Top cavity is closed, bottom is open as a pass-through.

CBYB29HB	15 x 64 x 43	125	167	26	<b>\$6049</b>	<b>\$7562</b>
----------	--------------	-----	-----	----	---------------	---------------

*Shaded areas indicate closed cavities.*

Freestanding two-high bookcase for use in open plan areas as space division. High base. LP laminate back.

- Two 24" fixed shelves in center. Top cavity is closed, bottom cavity is open as a pass-through.
- 8" fixed shelves on either side. Top cavity is open as a pass-through, bottom is closed.

CBYB26HB	15 x 64 x 57	125	222	34	<b>\$6923</b>	<b>\$8656</b>
----------	--------------	-----	-----	----	---------------	---------------

*Shaded areas indicate closed cavities.*

Freestanding three-high bookcase for use in open plan areas as space division. High base. LP laminate back.

- Three 24" fixed shelves in center. Top and bottom cavities are closed, middle is open as a pass-through.
- Three 8" fixed shelves on either side. Top and bottom cavities are open as a pass-through, middle is closed.

CBYB27HB	15 x 64 x 57	125	222	34	<b>\$6923</b>	<b>\$8656</b>
----------	--------------	-----	-----	----	---------------	---------------

*Shaded areas indicate closed cavities.*

Freestanding three-high bookcase for use in open plan areas as space division. High base. LP laminate back.

- Three 24" fixed shelves in center. Top and bottom cavities are open as a pass-through, middle is closed.
- Three 8" fixed shelves on either side. Top and bottom cavities are closed, middle is open as a pass-through.

CBYB22HB	15 x 64 x 72	125	270	43	<b>\$8713</b>	<b>\$10894</b>
----------	--------------	-----	-----	----	---------------	----------------

*Shaded areas indicate closed cavities.*

Freestanding four-high bookcase for use in open plan areas as space division. High base. LP laminate back.

- Four 24" fixed shelves in center. Cavities alternate from top to bottom: open/closed/open/closed.
- Four 8" fixed shelves on either side. Cavities alternate from top to bottom: closed/open/closed/open.

**Required Specifications**

Veneer finish  
Laminate finish

**Optional Specifications**

Veneer back panel

## ROOM DIVIDING BOOKCASES - HIGH BASE

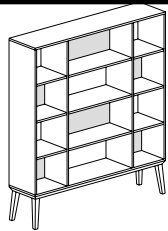

Freestanding Bookcase

MODEL#	DIMENSIONS D x W x H	FREIGHT CLASS	WT/LBS.	CUBIC FT.	LAMINATE	veneer
CBYB23HB	15 x 64 x 72	125	270	43	<b>\$8713</b>	<b>\$10894</b>

*Shaded areas indicate closed cavities.*

Freestanding four-high bookcase for use in open plan areas as space division. High base. LP laminate back.

- Four 24" fixed shelves in center. Cavities alternate from top to bottom: closed/open/closed/open.
- Four 8" fixed shelves on either side. Cavities alternate from top to bottom: open/closed/open/closed.

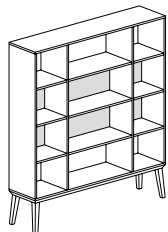

Freestanding Bookcase

CBYB24HB	15 x 64 x 72	125	270	43	<b>\$8713</b>	<b>\$10894</b>
----------	--------------	-----	-----	----	---------------	----------------

*Shaded areas indicate closed cavities.*

Freestanding four-high bookcase for use in open plan areas as space division. High base. LP laminate back.

- Four 24" fixed shelves in center. Top and bottom cavities are open as a pass-through. Two middle cavities are closed.
- Four 8" fixed shelves on either side. Top and bottom cavities are closed. Two middle cavities are open as a pass-through.

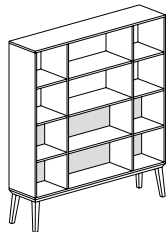

Freestanding Bookcase

CBYB25HB	15 x 64 x 72	125	270	43	<b>\$8713</b>	<b>\$10894</b>
----------	--------------	-----	-----	----	---------------	----------------

*Shaded areas indicate closed cavities.*

Freestanding four-high bookcase for use in open plan areas as space division. High base. LP laminate back.

- Four 24" fixed shelves in center. Top two cavities are open as a pass-through. Bottom two cavities are closed.
- Four 8" fixed shelves on either side. Top two cavities are open as a pass-through. Bottom two cavities are closed.

## FLOATING SHELF

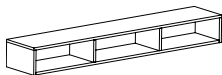

Wall Mounted Open Storage

MODEL#	DIMENSIONS	FREIGHT CLASS	WT/LBS.	CUBIC FT.	LAMINATE	veneer
CBYF096D12H8	12 x 96 x 8	125	78	10	<b>\$2150</b>	<b>\$2688</b>
CBYF064D12H8	12 x 64 x 8	125	50	8	<b>\$1404</b>	<b>\$1758</b>
CBYF032D12H8	12 x 32 x 8	100	35	4	<b>\$1272</b>	<b>\$1593</b>

To be used as a stand alone unit.

**Required Specifications**

Veneer finish  
Laminate finish

**Optional Specifications**

Veneer back panel

**ACCESSORIES**

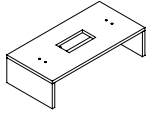

**Riser Box\***

MODEL#	DIMENSIONS D x W x H	FREIGHT CLASS	WT/LBS.	CUBIC FT.	LAMINATE	VENEER
CBYSPBOX2814	14 x 28 x 7.5	150	14	3	<b>\$220</b>	<b>\$277</b>
CBYSPBOX2014	14 x 20 x 7.5	250	2	1	<b>\$405</b>	<b>\$508</b>

Riser box for 20"H storage to support peninsula table. For wire pass through grommets, both top and back are included.

- CBYSPBOX2814 for use with 32"D peninsula tables and executive bridges.
- CBYSPBOX2014 for use with 24"D executive bridges

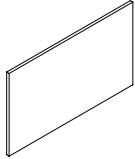

**Hanging Wood Modesty Panel\***

CBYCMWP62H22	.75 x 62 x 22	100	28	3	<b>\$836</b>	<b>\$1047</b>
CBYCMWP56H22	.75 x 56 x 22	100	26	3	<b>\$779</b>	<b>\$976</b>
CBYCMWP50H22	.75 x 50 x 22	100	24	3	<b>\$735</b>	<b>\$920</b>
CBYCMWP44H22	.75 x 44 x 22	92.5	22	2	<b>\$675</b>	<b>\$845</b>
CBYCMWP38H22	.75 x 38 x 22	92.5	20	2	<b>\$619</b>	<b>\$775</b>

22" hanging wood modesty panel.

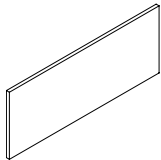

**Hanging Wood Modesty Panel\***

CBYCMWP74H15	.75 x 74 x 15	100	24	3	<b>\$860</b>	<b>\$1077</b>
CBYCMWP68H15	.75 x 68 x 15	125	23	3	<b>\$811</b>	<b>\$1015</b>
CBYCMWP62H15	.75 x 62 x 15	92.5	21	2	<b>\$811</b>	<b>\$1015</b>
CBYCMWP56H15	.75 x 56 x 15	92.5	20	2	<b>\$755</b>	<b>\$945</b>
CBYCMWP50H15	.75 x 50 x 15	100	18	2	<b>\$709</b>	<b>\$889</b>
CBYCMWP44H15	.75 x 44 x 15	100	17	2	<b>\$648</b>	<b>\$812</b>
CBYCMWP38H15	.75 x 38 x 15	125	15	2	<b>\$593</b>	<b>\$742</b>

15" hanging wood modesty panel.

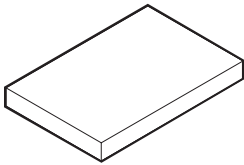

**Cushion\*\***

CU3020	20 x 30 x 2.5	150	6	1.30	1	<b>\$232</b>	7	<b>\$501</b>
	2				<b>\$275</b>	8	<b>\$594</b>	
	3				<b>\$304</b>	9	<b>\$666</b>	
	4				<b>\$350</b>	10	<b>\$744</b>	
	5				<b>\$412</b>	11	<b>\$907</b>	
	6				<b>\$444</b>	12	<b>\$1085</b>	

Cushion attaches with Velcro strips. For use on cabinets of coordinating size..

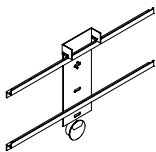

**Flat Screen Monitor Mount**

FVMED	2 x 28 x 17	70	14	.70	<b>\$735</b>
-------	-------------	----	----	-----	--------------

Flat screen monitor mount up to 50". To be used on CBYTV1LB and CBYTV1HB media cabinets. GM1K (tungsten) grommet on the back panel is included.

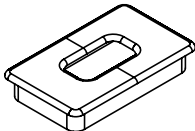

**Grommet**

GM5C	2 x 3.5 x --	70	--	--	<b>\$107</b>
------	--------------	----	----	----	--------------

Rectangular grommet in metal, tungsten finish.

**Required Specifications**

- Finish
- Fabric (cushion)\*\*

## POWER/DATA



Single Sided Recessed Power Block

## MODEL# DIMENSIONS FREIGHT CLASS WT/LBS. CUBIC FT. LIST PRICE

## D x W x H

PRTMCS401B	4.22 x 10.78 x 4.86	100	4.3	0.51	<b>\$456</b>
PRTMCS401T	4.22 x 10.78 x 4.86	100	4.3	0.51	<b>\$456</b>
PRTMCS401W	4.22 x 10.78 x 4.86	100	4.3	0.51	<b>\$456</b>

Single-sided recessed power block with **one regular duplex and one telecom knockout on top; one power duplex on bottom**. 10' power cord with straight plug. Specify telecom options separately, see page 56. Available in Black (**B**), Tungsten (**T**) or Designer White (**W**) as indicated by the last letter of model number. Duplexes always Grey. Corresponding cut-out options are **R1, R2** or **R3**. Units are not approved for daisy chaining. UL listed: UL 1363.



Single Sided Recessed Power Block - USB-A + USB-C

PRTMCS421B	4.22 x 10.78 x 4.86	100	4.3	0.51	<b>\$599</b>
PRTMCS421T	4.22 x 10.78 x 4.86	100	4.3	0.51	<b>\$599</b>
PRTMCS421W	4.22 x 10.78 x 4.86	100	4.3	0.51	<b>\$599</b>

Single-sided recessed power block with **one power/USB-A/USB-C duplex and one telecom knockout on top; one power duplex on bottom**. USB-A port charges max 2.4 amps at 5V and USB-C port charges max 3 amps at 5V. 10' power cord with straight plug. Specify telecom options separately, see page 56. Available in Black (**B**), Tungsten (**T**) or Designer White (**W**) as indicated by the last letter of model number. Duplexes always Grey (duplex with USB ports is glossy finish). Corresponding cut-out options are **R1, R2** or **R3**. Units are not approved for daisy chaining. UL listed: UL 1363.



Double Sided Recessed Power Block

PRTMCD602B	6.22 x 10.78 x 4.86	92.5	5.9	0.51	<b>\$521</b>
PRTMCD602T	6.22 x 10.78 x 4.86	92.5	5.9	0.51	<b>\$521</b>
PRTMCD602W	6.22 x 10.78 x 4.86	92.5	5.9	0.51	<b>\$521</b>

Double-sided recessed power block with **two regular power duplexes and two telecom knockouts on top; one power duplex on bottom**. 10' power cord with straight plug. Specify telecom options separately, see page 56. Available in Black (**B**), Tungsten (**T**) or Designer White (**W**) as indicated by last letter of model number. Duplexes always Grey. Corresponding cut-out options are **T1, T2** or **T3**. Units are not approved for daisy chaining. UL listed: UL 1363.



Double Sided Recessed Power Block - USB-A + USB-C

PRTMCD622B	6.22 x 10.78 x 4.86	92.5	6.1	0.51	<b>\$656</b>
PRTMCD622T	6.22 x 10.78 x 4.86	92.5	6.1	0.51	<b>\$656</b>
PRTMCD622W	6.22 x 10.78 x 4.86	92.5	6.1	0.51	<b>\$656</b>

Double-sided recessed power block with **one regular power duplex, one power/USB-A/USB-C duplex and two telecom knockouts on top; one power duplex on bottom**. USB-A port charges max 2.4 amps at 5V and USB-C port charges max 3 amps at 5V. 10' power cord with straight plug. Specify telecom options separately, see page 56. Available in Black (**B**), Tungsten (**T**) or Designer White (**W**) as indicated by last letter of model number. Duplexes always Grey (duplex with USB ports is glossy finish). Corresponding cut-out options are **T1, T2** or **T3**. Units are not approved for daisy chaining. UL listed: UL 1363.



Double Sided Recessed Power Block - USB-A + USB-C

PRTMCD642B	6.22 x 10.78 x 4.86	85	6.3	0.51	<b>\$790</b>
PRTMCD642T	6.22 x 10.78 x 4.86	85	6.3	0.51	<b>\$790</b>
PRTMCD642W	6.22 x 10.78 x 4.86	85	6.3	0.51	<b>\$790</b>

Double-sided recessed power block with **two power/USB-A/USB-C duplexes and two telecom knockouts on top; one power duplex on bottom**. USB-A port charges max 2.4 amps at 5V and USB-C port charges max 3 amps at 5V. 10' power cord with straight plug. Specify telecom options separately, see page 56. Available in Black (**B**), Tungsten (**T**) or Designer White (**W**) as indicated by last letter of model number. Duplexes always Grey (duplex with USB ports is glossy finish). Corresponding cut-out options are **T1, T2** or **T3**. Units are not approved for daisy chaining. UL listed: UL 1363.

## Required Specifications

Finish

**POWER / DATA**

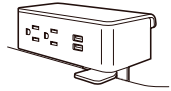

**Edge Mounted 2 Power/USB**

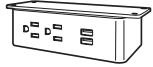

**Under Mounted 2 Power/USB\***

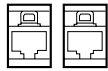

**Telecom Plate - 2 x 6**



**Telecom Plate - 3 x 6**

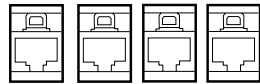

**Telecom Plate - 4 x 6**



**Telecom Plate - 3TSV**

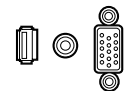

**Telecom Plate - 3SVH**

MODEL#	DIMENSIONS D x W x H	FREIGHT CLASS	WT/LBS.	CUBIC FT.	LIST PRICE
PS305057	5.5 x 3.2 x 3	60	3.01	0.05	<b>\$386</b>
PS305002	5.5 x 3.2 x 3	60	3.01	0.05	<b>\$386</b>

Edge mounted power module with two power outlets and two 2.1 amp USB ports. Edge clamp accommodates worksurfaces 0.5" to 1.5" thick; fastened with thumb screws. 6' cord.

PS305057 - White module with Silver bracket. PS305002 - Black module with Silver bracket

PS305157	5.5 x 2.8 x 1.8	60	3.2	0.05	<b>\$335</b>
PS305102	5.5 x 2.8 x 1.8	60	3.2	0.05	<b>\$335</b>

Under mount power module with two power outlets and two 2.1 amp USB ports. Mountable under most worksurfaces. Installation template provided. 6' cord.

PS305157 - White module with Silver bracket. PS305102 - Black module with Silver bracket.

PTEL01	- x - x -	70	0.01	0.05	<b>\$164</b>
--------	-----------	----	------	------	--------------

Includes 2 x RJ45 cat 6 data. Black telecom plate. To be hardwired by data contractor.

PTEL02	- x - x -	70	0.01	0.05	<b>\$222</b>
--------	-----------	----	------	------	--------------

Includes 2 x RJ45 cat 6 data and 1 RJ11 cat phone. Black telecom plate. To be hardwired by data contractor.

PTEL03	- x - x -	70	0.01	0.05	<b>\$340</b>
--------	-----------	----	------	------	--------------

Includes 4 x RJ45 cat 6 data. Black telecom plate. To be hardwired by data contractor.

PTEL04	- x - x -	70	0.01	0.05	<b>\$290</b>
--------	-----------	----	------	------	--------------

Includes 1 x RJ45 cat 6 data, mini stereo and 15 pin HD VGA. Black telecom plate. To be hardwired by data contractor.

PTEL05	- x - x -	70	0.01	0.05	<b>\$401</b>
--------	-----------	----	------	------	--------------

Includes mini stereo, 15 pin HD VGA and HDMI. Black telecom plate.

**Required Specifications**

Finish\*

## ACCESSORIES

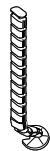

Cable Snake

MODEL#	DIMENSIONS	FREIGHT CLASS	WT/LBS.	CUBIC FT.	LIST PRICE
--------	------------	---------------	---------	-----------	------------

D x W x H

BRTCS	2 x 8 x 30	70	3	.19	<b>\$152</b>
-------	------------	----	---	-----	--------------

Flexible cable management trough. Two pathways within the snake, one for data/communication and one for routing power cables. Translucent White finish only.



Cable Snake

PCSN01	-- x -- x --	92.5	2.10	.20	<b>\$135</b>
--------	--------------	------	------	-----	--------------

Flexible cable management. Provides access to power/data from floor to underside of worksurface where it attaches. Two pathways within Cable Snake. Length under desk is 31.25". Silver (SIL) plastic only.



Cable Snake Extension

PCSN01E	- x - x -	92.5	2.1	0.2	<b>\$108</b>
---------	-----------	------	-----	-----	--------------

Extension kit to use with cable snake PCSN01. Additional 8 links extend cable snake up to 49" in length. Ideal for height adjustable tables. Silver plastic only.

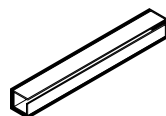

Wire Management Track - Single

C2M72	2 x 72 x 2	70	0.10	0.10	<b>\$83</b>
C2M60	2 x 60 x 2	70	0.10	0.10	<b>\$69</b>
C2M48	2 x 48 x 2	70	0.10	0.10	<b>\$57</b>
C2M36	2 x 36 x 2	70	0.10	0.10	<b>\$42</b>
C2M24	2 x 24 x 2	70	0.10	0.10	<b>\$31</b>
C2M12	2 x 12 x 2	70	0.10	0.10	<b>\$17</b>

To conceal and organize wires and cords. Attaches to Modesty Panel with double sided tape. Plastic.

• Available in Black Plastic Only.

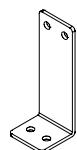

L Bracket

BAR526	--	70	.25	.10	<b>\$131</b>
--------	----	----	-----	-----	--------------

Set of two. For securing the stack-on units to the credenza.

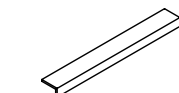

Foot Rest Cover

FRC8442	--	70	--	.10	<b>\$1141</b>
FRC7842	--	70	--	.10	<b>\$1077</b>
FRC7242	--	70	--	.10	<b>\$1015</b>
FRC6642	--	70	--	.10	<b>\$952</b>
FRC8432	--	70	--	.10	<b>\$1015</b>
FRC7832	--	70	--	.10	<b>\$952</b>
FRC7232	--	70	--	.10	<b>\$889</b>
FRC6632	--	70	--	.10	<b>\$825</b>

Factory installed.

**ACCESSORIES**



**Handle**

MODEL#	DIMENSIONS	FREIGHT CLASS	WT/LBS.	CUBIC FT.	LIST PRICE
--------	------------	---------------	---------	-----------	------------

**D x W x H**

PL89	--	70	--	--	<b>\$35</b>
------	----	----	----	----	-------------

Chrome finish.

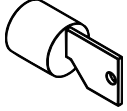

**Lock Assembly**

LO/C	--	70	--	--	<b>\$106</b>
------	----	----	----	----	--------------

Tungsten.

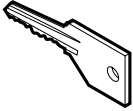

**Extra Key**

LOCK	--	70	--	--	<b>\$43</b>
------	----	----	----	----	-------------

Specify key #. Key range 401 - 420.

# dufferin



global





The **Dufferin** series is a unique entity in that it integrates wood veneer and laminate. Worksurfaces, drawer and cabinet fronts use genuine wood veneer while the chassis and cabinets are finished in your choice of laminate or wood veneer. The result is a rich, two tone appearance to coordinate with any contemporary business interior.

Key features include a two inch knife edge providing clean, crisp detailing, grommets, a reverse profile/self edge edge on connecting worksurfaces, square or round post leg on islands, base and modesty panel upgrades and endless electrical options.

Storage options are available in 29", 48", 54", 66", 72" and 84" heights. Various models include storage cabinets, file modules, mixed storage cabinets, open shelving, wardrobe cabinets and personal towers.

Above worksurface storage selections include overhead storage and hutches with or without pigeon-hole storage. Hutch doors are available in a choice of veneer or glass with an aluminum frame. Tackboards are offered in all fabric or with a built-in accessory rail for organizing folders, binders, cds and more!



Contemporary **two inch overhang knife edge** on user and guest sides. Self-edge veneer on ends and wall sides.



Optional **base upgrades** include a rectangular two tone base (shown) and elliptical base. Available on most islands.

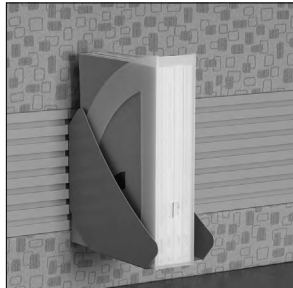

Tackboards with **accessory rails** accommodate letter trays, binder bins and file holders.



**Features and Benefits**

- Choice of ten handle options on every door/drawer that features handles
- Modesty panel options include veneer and straight glass (translucent) tungsten frame.
- Base upgrades to replace standard monopost on islands are available in four styles
- Drawers are standard vinyl-wrapped construction with black drawer sides and bottom.
- 75 lb box - 150 lb. file drawer weight capacity with full height sides with pencil tray included in box drawer
- Lateral file drawers can accommodate legal or letter documents
- Premium full extension progressive ball bearing slides on file drawers
- Box drawers mounted on 3/4 extension premium ball bearing slides.
- Power / Data accessories are available to be factory installed on any Dufferin unit, including Boardroom Tables, to meet all today's technological requirements
- A full array of complementary Boardroom and Reception area furnishings are available to coordinate the entire office

**GENERAL INFORMATION**

- Dufferin is a veneer and laminate desking system composed of hundreds of models, capable of furnishing executive suites, boardrooms and reception areas.
- 1 3/16" thick worksurfaces utilizing pedestal and panel construction with top over side panel design.
- Full modesty panels on desks are available in either a straight or breakfront style
- For environmental certification, please visit [globalfurnituregroup.com](http://globalfurnituregroup.com)

**WORKSURFACES**

- Standard with 1 3/16" top thickness
- All surfaces constructed from grade "A" veneers
- All top surfaces feature a contemporary 2" overhang knife edge on user and guest sides. Self-edge veneer on ends and wall sides.

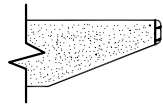

Contemporary 2" overhanging knife edge

**CONSTRUCTION**

- "Number one select, architectural grade A" oak, American black walnut, American black cherry, hard maple and lyptus. Wood worksurface molded edges are solid oak, walnut, cherry, maple or lyptus (except where square self-edges exist, i.e. credenza and computer worksurface back edges that are most commonly against walls).

**FINISHES**

- Conversion varnish (similar to catalyzed lacquer, but tougher), 35 to 40 degree sheen. Finishes are not buffed or rubbed.
- All Global wood casegood products are veneered and finished on the back sides (360° finishing), except modular under-surface storage - tops and backs are unfinished.
- Touch up kits available, includes a touch up marker and fill crayon. Order **VTUOUCHUPKIT, \$164** list. Specify finish when ordering.
- Global standard finish, on oak and walnut, is open pore and on cherry and maple is semi-closed pore. If a full finish is required for walnut, cherry, anigre and maple tops, Add the suffix "2" to the finish code and Add 5% to the base pricing for each product. **CUSTOM FINISH IS AVAILABLE.**
- High Pressure laminate inlays are available at no upcharge. Contact Customer Care for specification information.

**PEDESTALS**

- Black embossed vinyl-wrapped construction drawer sides and bottom are standard.
- All pedestals are full to floor and locking.
- Double pedestal models feature a choice of four drawer configurations: two file/file pedestals (EE), two box/box/file pedestals (DD), file/file on left, box/box/file on right (ED), or file/file on right, box/box/file on left (DE).
- Single pedestal models feature a choice of two drawer configurations: one file/file pedestal (E) or one box/box/file pedestal (D) on the left or right.

**HARDWARE**

- All necessary hardware items for attaching furniture items are included in the shipment. Actual wall attachment fasteners for wall cabinets, tackboards and visualboards are not included due to variation between site conditions.
- **Leveling glides** are shipped in a plastic bag attached to the bottom of the item or inside the pedestal. It is important to install leveling glides to ensure the unit is level. Levelers have a 1" range of adjustment.

- **Hanging file rails** are pre-installed on file drawer perimeters with additional front-to-back rails found in the bottom of the filing drawers. These rails hang onto plastic clips and do not require any tools to install. Legal filing can be achieved either as side-to-side or front-to-back. Letter filing can be achieved as front-to-back filing only.
- **Flat plates** for attaching bridge and return to desk are shipped pre-attached to the bottom of the bridge or return. **Mini flat plates** for securing bridge modesty panels to desk or credenza end panels, and quick connectors for securing modular corner units to adjacent pieces (Dufferin Series) are shipped along with screws in a plastic bag attached to the bottom of the bridge or return. **CAUTION:** using screws other than those supplied by Global could result in damage to finished tops.

**LOCKS**

- Locks are standard on all "below worksurface level" drawer and door storage units with the exception of the stationary organizer, pull-out tray units and single lateral file drawer combination tray/slot units. Combination storage unit comes with lock for file and lateral file drawer only, box drawers cannot lock.
- Optional locks may be ordered on all "above worksurface level" closed storage, Factory Installed. Please specify **LO, add \$134.**

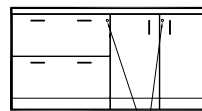
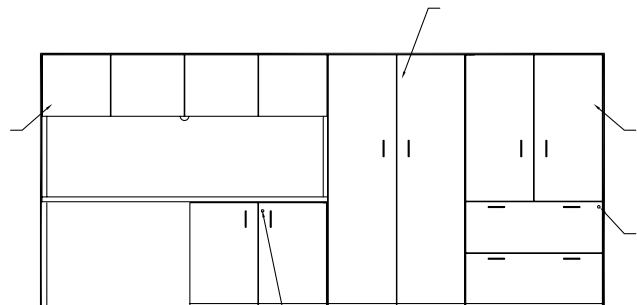

**DCF7224**  
Style Credenza: File lock is on the inside gable behind the bookcase door. Lock for doors is on the front.

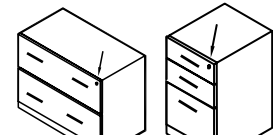

**DWF**      **DWD**  
Modular Furniture: Lock is on the front

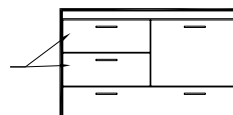

**DZ3622**  
Combination storage unit Z comes with lock for file and lateral file drawer only, box drawers cannot lock.

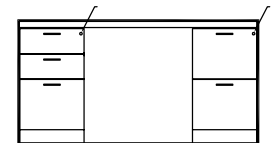

**DD7236DE**  
Fully assembled furniture: Lock for D and E pedestals are inside the gable.

## 1. SPECIFY MODEL NUMBER

## 2. SPECIFY FINISH

### WORKSURFACE TOP & DRAWER/DOOR FRONTS, BODY FINISHES (including pedestals)

#### VENEER:

Code	Finish	Veneer Type	Cut
AMW	Almond Cherry	Cherry	Flat Sliced
ACW	Amber Cherry	Cherry	Flat Sliced
BTW	Biscotti	White Oak	Rift
CAW	Cocoa Walnut	Walnut	Flat Sliced
CRW	Coral	White Oak	Rift
DCW	Dark Cherry	Cherry	Flat Sliced
DWW	Dark Walnut	Walnut	Flat Sliced
EWV	Espresso Walnut	Walnut	Flat Sliced
EVW	Evening Oak	White Oak	Rift
GRW	Grey on Oak	White Oak	Rift
HAW	Hazelnut	Maple	Flat Sliced
JAW	Java	White Oak	Rift
LTW	Latte Walnut	Walnut	Flat Sliced
MHW	Mahogany on Walnut	Walnut	Flat Sliced
MTW	Milestone	White Oak	Rift
MPW	Natural Maple	Maple	Flat Sliced
NLW	Natural Walnut	Walnut	Flat Sliced
RCW	Red Cherry	Cherry	Flat Sliced
VNW	Vintage Cherry	Cherry	Flat Sliced
ULW	Umber Walnut	Walnut	Flat Sliced
WLW	Walnut	Walnut	Flat Sliced
WCW	Warm Cherry	Cherry	Flat Sliced
WMW	White Maple	Maple	Flat Sliced

#### BODY FINISHES (INCLUDING PEDESTALS) - LAMINATE:

BLK	Black
BZD	Blizzard
CGY	Custom Grey
DWT	Designer White
SDT	Stonedust
STG	String
SOG	Storm Grey

#### MONOPOST FINISHES:

E	Black
K	Tungsten

## 3. SPECIFY OPTIONS

### Handles

- Handles are standard on most drawers/storage modules. Each handle is identified by letters: **PL33, PL34, PL64, PL66, PL92, PL93, PL94, PL95, PL96, PL97, PL98, PL99, PLS7, and PLS8**. To specify a handle, specify the code after the model number and finish selections.



**PL33** Black Moon Pull



**PL34** Nickel Moon Pull



**PL64** Contemporary Nickel



**PL66** Transitional Nickel



**PL92** Silver Bar



**PL93** Black Bar



**PL94** Silver Rectangular



**PL95** Black Rectangular



**PL96** Silver Slimline Pull

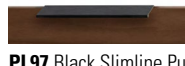

**PL97** Black Slimline Pull



**PL98** Silver Princeton Bar

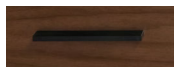

**PL99** Black Princeton Bar



**PLS7** Black Spaghetti



**PLS8** Silver Spaghetti

### Grommets

- Standard grommet on all components is GM1. Grommet is included with products where shown in line drawings in price book.
- Optional grommets may be ordered in standard worksurface locations (left, center or right). Order as **GM1TL, GM1TC or GM1TR**. Add \$96.
- Grommet hole dimensions are 2 3/4" in diameter. Specify **GM1E** for **Black** or **GM1K** for **Tungsten**.
- Color of grommet will be automatically coordinated with handle color where applicable

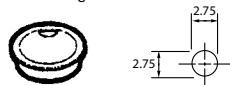

- Components that come standard with grommet may be ordered without a grommet. Order as RSG - Add \$53.

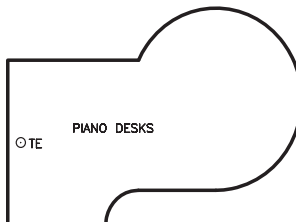
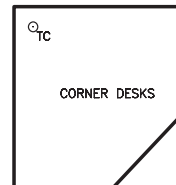
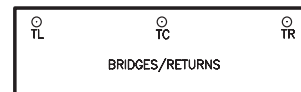
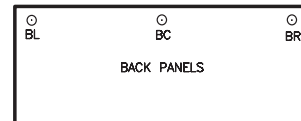
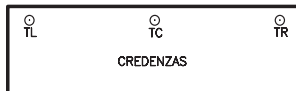
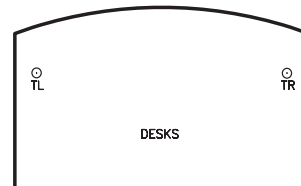

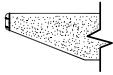

● Molding Edge

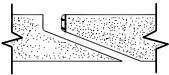

■ Reverse Profile / Molding Edge



▼ Self Edge Joint

- D - Desks and Credenzas
- B - Executive Bridges
- E - Executive Returns
- C - Corner Components
- L - Linking Bridges
- P - Piano Desks

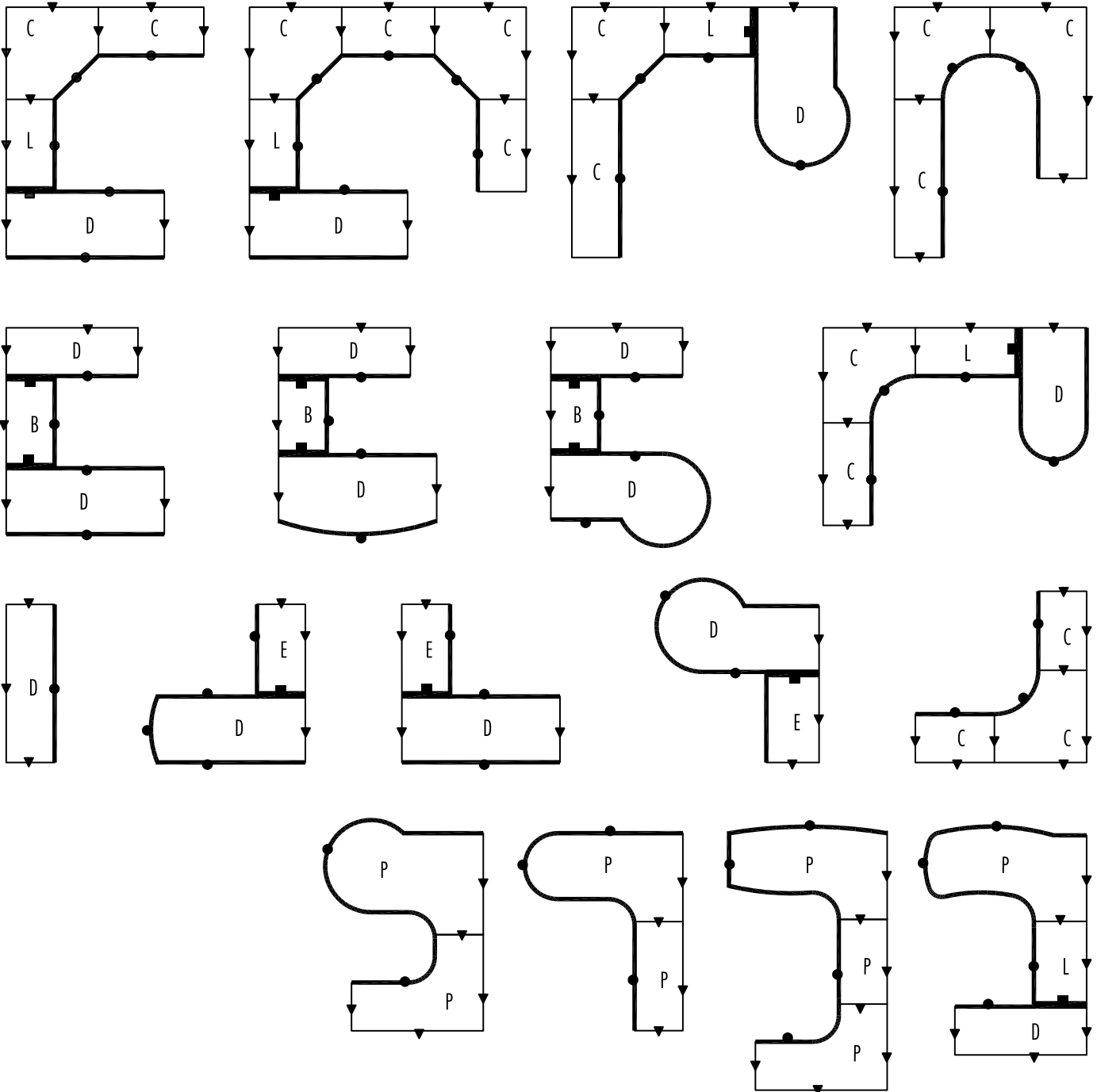

# D DUFFERIN

## DOUBLE PEDESTAL DESKS

### MODEL#

### DIMENSIONS

### FREIGHT CLASS

### WT/LBS.

### CUBIC FT.

### VENEER/LAMINATE

### ALL VENEER

D x W x H

- Can be ordered as a shell or with pedestals.
- Grommets are available an option on Desks and most Credenzas.
- Hand of Rectangular Desk is determined by location of pedestal from user side.
- Hand of "P" Top is determined by outward orientation of conference end from user projection.

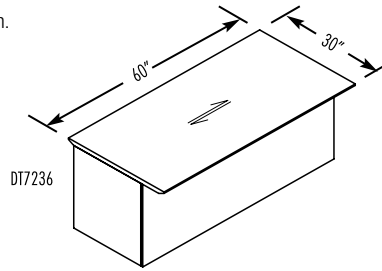
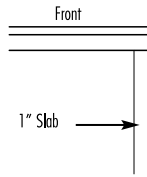
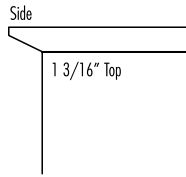
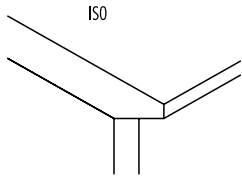

### MODESTY PANEL CLEARANCE:

DT7236

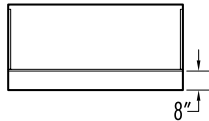

DT7230

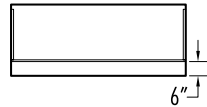

DMT7242

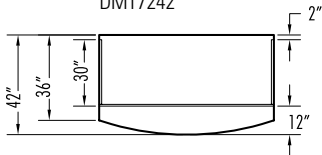

DMT6636

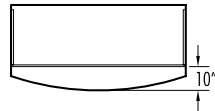

DISR8442D

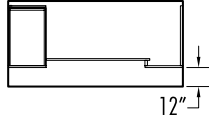

DISR7230D

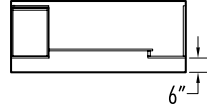

DDD7236



DDDBE7236



DDDBS7236



DTPL7242 (left shown)

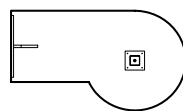

### DESK MODESTY OPTIONS:

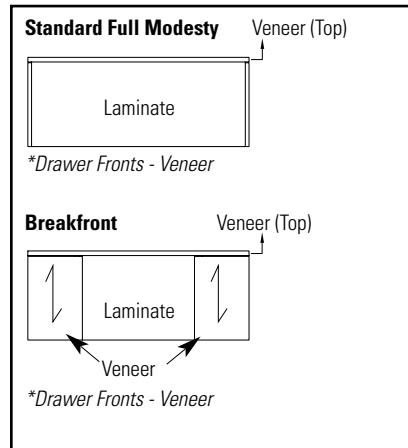

### Breakfront Style - Modesty

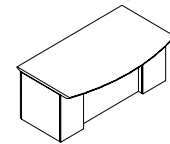

view from guest side

### Standard Full Modesty

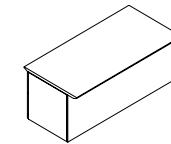

view from guest side

## DOUBLE PEDESTAL DESKS - RECESSED FRONT MODESTY

### DIMENSIONS

### FREIGHT CLASS

### WT/LBS.

### CUBIC FT.

### VENEER/LAMINATE

### ALL VENEER

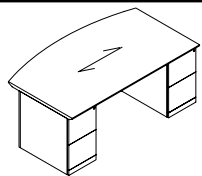

### Double Pedestal Bow Top Desk

MODEL#	DIMENSIONS	FREIGHT CLASS	WT/LBS.	CUBIC FT.	VENEER/LAMINATE	ALL VENEER
DMD8442EE	42 x 84 x 29	125	443	59	\$6132	\$7359
DMD7842EE	42 x 78 x 29	125	412	55	\$5691	\$6829
DMD7242EE	42 x 72 x 29	125	380	51	\$5256	\$6306
DMD6636EE	36 x 66 x 29	125	240	40	\$5098	\$6116

Standard with full to floor **file/file** pedestals on **left and right**. Bow top. Pedestals lock. Refer to the Desks and Credenzas Notes above for overhang dimensions.

### Required Specifications

Veneer Finish  
Laminate Finish  
Handle Style

### Optional Specifications

Grommet

**DOUBLE PEDESTAL DESKS**

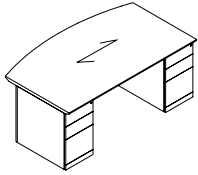

**Double Pedestal Bow Top Desk**

MODEL#	DIMENSIONS	FREIGHT CLASS	WT./LBS.	CUBIC FT.	VENEER/LAMINATE	ALL VENEER
<b>D x W x H</b>						
DMD8442DD	42 x 84 x 29	125	443	59	<b>\$6132</b>	<b>\$7359</b>
DMD7842DD	42 x 78 x 29	125	412	55	<b>\$5691</b>	<b>\$6829</b>
DMD7242DD	42 x 72 x 29	125	380	51	<b>\$5256</b>	<b>\$6306</b>
DMD6636DD	36 x 66 x 29	125	240	40	<b>\$5098</b>	<b>\$6116</b>

Standard with full to floor **box/box/file** pedestals on **left** and **right**. Bow top. Pedestals lock. One pencil tray. Refer to the Desks and Credenzas Notes Section on previous page for overhang dimensions.

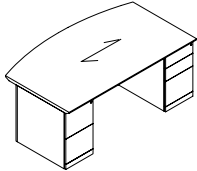

**Double Pedestal Bow Top Desk**

DMD8442ED	42 x 84 x 29	125	443	59	<b>\$6132</b>	<b>\$7359</b>
DMD7842ED	42 x 78 x 29	125	412	55	<b>\$5691</b>	<b>\$6829</b>
DMD7242ED	42 x 72 x 29	125	380	51	<b>\$5256</b>	<b>\$6306</b>
DMD6636ED	36 x 66 x 29	125	240	40	<b>\$5098</b>	<b>\$6116</b>

Standard with full to floor **file/file** pedestal on **left** and **box/box/file** pedestal on **right**. Bow top. Pedestals lock. One pencil tray. Refer to the Desks and Credenzas Notes Section on previous page for overhang dimensions.

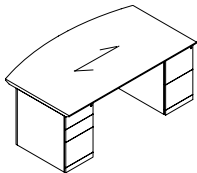

**Double Pedestal Bow Top Desk**

DMD8442DE	42 x 84 x 29	125	443	59	<b>\$6132</b>	<b>\$7359</b>
DMD7842DE	42 x 78 x 29	125	412	55	<b>\$5691</b>	<b>\$6829</b>
DMD7242DE	42 x 72 x 29	125	380	51	<b>\$5256</b>	<b>\$6306</b>
DMD6636DE	36 x 66 x 29	125	240	40	<b>\$5098</b>	<b>\$6116</b>

Standard with full to floor **box/box/file** pedestal on **left** and **file/file** pedestal on **right**. Bow top. Pedestals lock. One pencil tray. Refer to the Desks and Credenzas Notes Section on previous page for overhang dimensions.

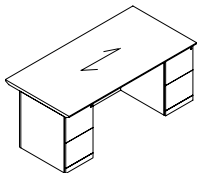

**Double Pedestal Desk**

DD8442EE	42 x 84 x 29	125	432	59	<b>\$5213</b>	<b>\$6255</b>
DD7842EE	42 x 78 x 29	125	401	55	<b>\$4843</b>	<b>\$5808</b>
DD7236EE	36 x 72 x 29	100	370	44	<b>\$4470</b>	<b>\$5362</b>
DD7230EE	30 x 72 x 29	100	349	36	<b>\$4399</b>	<b>\$5280</b>
DD6636EE	36 x 66 x 29	100	339	40	<b>\$4399</b>	<b>\$5280</b>
DD6630EE	30 x 66 x 29	100	320	33	<b>\$4330</b>	<b>\$5196</b>
DD6030EE	30 x 60 x 29	92.5	305	30	<b>\$4195</b>	<b>\$5035</b>

Standard with full to floor **file/file** pedestals on **left** and **right**. Pedestals lock. Refer to the Desks and Credenzas Notes Section on previous page for overhang dimensions.

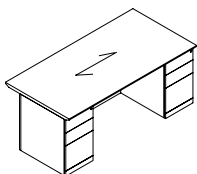

**Double Pedestal Desk**

DD8442DD	42 x 84 x 29	125	432	59	<b>\$5213</b>	<b>\$6255</b>
DD7842DD	42 x 78 x 29	125	401	55	<b>\$4843</b>	<b>\$5808</b>
DD7236DD	36 x 72 x 29	100	370	44	<b>\$4470</b>	<b>\$5362</b>
DD7230DD	30 x 72 x 29	100	349	36	<b>\$4399</b>	<b>\$5280</b>
DD6636DD	36 x 66 x 29	100	339	40	<b>\$4399</b>	<b>\$5280</b>
DD6630DD	30 x 66 x 29	100	320	33	<b>\$4330</b>	<b>\$5196</b>
DD6030DD	30 x 60 x 29	92.5	305	30	<b>\$4195</b>	<b>\$5035</b>

Standard with full to floor **box/box/file** pedestals on **left** and **right**. Pedestals lock. Refer to the Desks and Credenzas Notes Section on previous page for overhang dimensions.

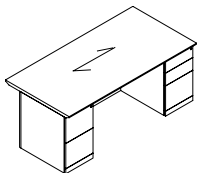

**Double Pedestal Desk**

DD8442ED	42 x 84 x 29	125	432	59	<b>\$5213</b>	<b>\$6255</b>
DD7842ED	42 x 78 x 29	125	401	55	<b>\$4843</b>	<b>\$5808</b>
DD7236ED	36 x 72 x 29	100	370	44	<b>\$4470</b>	<b>\$5362</b>
DD7230ED	30 x 72 x 29	100	349	36	<b>\$4399</b>	<b>\$5280</b>
DD6636ED	36 x 66 x 29	100	339	40	<b>\$4399</b>	<b>\$5280</b>
DD6630ED	30 x 66 x 29	100	320	33	<b>\$4330</b>	<b>\$5196</b>
DD6030ED	30 x 60 x 29	92.5	305	30	<b>\$4195</b>	<b>\$5035</b>

Standard with full to floor **file/file** pedestal on **left** and **box/box/file** pedestal on **right**. Pedestals lock. Refer to the Desks and Credenzas Notes Section on previous page for overhang dimensions.

**Required Specifications**

Veneer Finish  
Laminate Finish  
Handle Style

**Optional Specifications**

Grommet

DOUBLE PEDESTAL DESKS

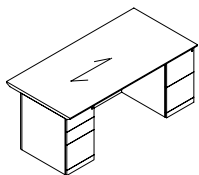

Double Pedestal Desk

MODEL#	DIMENSIONS	FREIGHT CLASS	WT/LBS.	CUBIC FT.	VENEER/LAMINATE	ALL VENEER
	<b>D x W x H</b>					
DD8442DE	42 x 84 x 29	125	432	59	\$5213	\$6255
DD7842DE	42 x 78 x 29	125	401	55	\$4843	\$5808
DD7236DE	36 x 72 x 29	100	370	44	\$4470	\$5362
DD7230DE	30 x 72 x 29	100	349	36	\$4399	\$5280
DD6636DE	36 x 66 x 29	100	339	40	\$4399	\$5280
DD6630DE	30 x 66 x 29	100	320	33	\$4330	\$5196
DD6030DE	30 x 60 x 29	92.5	305	30	\$4195	\$5035

Standard with full to floor **box/box/file** pedestal on **left** and **file/file** pedestal on **right**. Pedestals lock. Refer to the Desks and Credenzas Notes Section on page 64 for overhang dimensions.

DOUBLE PEDESTAL DESKS - BREAKFRONT STYLE

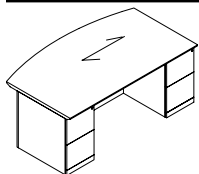

Double Pedestal Bow Top Desk Breakfront Style

MODEL#	DIMENSIONS	FREIGHT CLASS	WT/LBS.	CUBIC FT.	VENEER/LAMINATE	ALL VENEER
DMID8442EE	42 x 84 x 29	125	443	59	\$7279	\$8733
DMID7842EE	42 x 78 x 29	125	412	55	\$6758	\$8111
DMID7242EE	42 x 72 x 29	125	380	51	\$6241	\$7488
DMID6636EE	36 x 66 x 29	125	240	40	\$5609	\$6731

Standard with full to floor **file/file** pedestals on **left** and **right**. Bow top. Pedestals lock. Refer to the Desks and Credenzas Notes Section on page 64. for overhang dimensions.

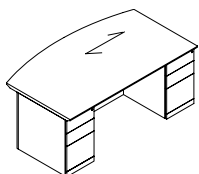

Double Pedestal Bow Top Desk Breakfront Style

DMID8442DD	42 x 84 x 29	125	443	59	\$7279	\$8733
DMID7842DD	42 x 78 x 29	125	412	55	\$6758	\$8111
DMID7242DD	42 x 72 x 29	125	380	51	\$6241	\$7488
DMID6636DD	36 x 66 x 29	125	240	40	\$5609	\$6731

Standard with full to floor **box/box/file** pedestals on **left** and **right**. Bow top. Pedestals lock. Refer to the Desks and Credenzas Notes Section on page 64. for overhang dimensions.

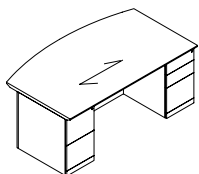

Double Pedestal Bow Top Desk Breakfront Style

DMID8442ED	42 x 84 x 29	125	443	59	\$7279	\$8733
DMID7842ED	42 x 78 x 29	125	412	55	\$6758	\$8111
DMID7242ED	42 x 72 x 29	125	380	51	\$6241	\$7488
DMID6636ED	36 x 66 x 29	125	240	40	\$5609	\$6731

Standard with full to floor **file/file** pedestal on **left** and **box/box/file** pedestal on **right**. Bow top. Pedestals lock. One pencil tray. Refer to the Desks and Credenzas Notes Section on page 64 for overhang dimensions.

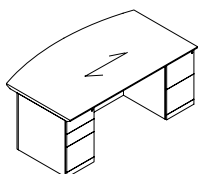

Double Pedestal Bow Top Desk Breakfront Style

DMID8442DE	42 x 84 x 29	125	443	59	\$7279	\$8733
DMID7842DE	42 x 78 x 29	125	412	55	\$6758	\$8111
DMID7242DE	42 x 72 x 29	125	380	51	\$6566	\$7881
DMID6636DE	36 x 66 x 29	125	240	40	\$5609	\$6731

Standard with full to floor **box/box/file** pedestal on **left** and **file/file** pedestal on **right**. Bow top. Pedestals lock. One pencil tray. Refer to the Desks and Credenzas Notes Section on page 64 for overhang dimensions.

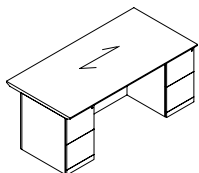

Double Pedestal Desk, Breakfront Style

DID8442EE	42 x 84 x 29	125	432	59	\$7160	\$8591
DID7842EE	42 x 78 x 29	125	401	55	\$6643	\$7975
DID7236EE	36 x 72 x 29	100	370	44	\$5308	\$6368
DID7230EE	30 x 72 x 29	100	349	36	\$5227	\$6269
DID6636EE	36 x 66 x 29	100	339	40	\$5227	\$6269
DID6630EE	30 x 66 x 29	100	320	33	\$5142	\$6170
DID6030EE	30 x 60 x 29	92.5	305	30	\$4982	\$5976

Standard with full to floor **file/file** pedestals on **left** and **right**. Pedestals lock. Refer to the Desks and Credenzas Notes Section on page 64 for overhang dimensions.

Required Specifications

Veneer Finish  
Laminate Finish  
Handle Style

Optional Specifications

Grommet



**DOUBLE PEDESTAL DESKS - BREAKFRONT STYLE**

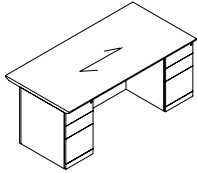

**Double Pedestal Desk, Breakfront Style**

MODEL#	DIMENSIONS	FREIGHT CLASS	WT/LBS.	CUBIC FT.	veneer/LAMINATE	ALL VENEER
<b>D x W x H</b>						
DID8442DD	42 x 84 x 29	125	432	59	<b>\$7160</b>	<b>\$8591</b>
DID7842DD	42 x 78 x 29	125	401	55	<b>\$6643</b>	<b>\$7975</b>
DID7236DD	36 x 72 x 29	100	370	44	<b>\$5308</b>	<b>\$6368</b>
DID7230DD	30 x 72 x 29	100	349	36	<b>\$5227</b>	<b>\$6269</b>
DID6636DD	36 x 66 x 29	100	339	40	<b>\$5227</b>	<b>\$6269</b>
DID6630DD	30 x 66 x 29	100	320	33	<b>\$5142</b>	<b>\$6170</b>
DID6030DD	30 x 60 x 29	92.5	305	30	<b>\$4982</b>	<b>\$5976</b>

Standard with full to floor **box/box/file** pedestals on **left and right**. Pedestals lock. Refer to the Desks and Credenzas Notes Section on page 64 for overhang dimensions.

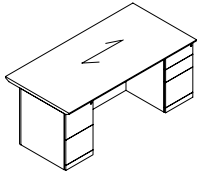

**Double Pedestal Desk, Breakfront Style**

DID8442ED	42 x 84 x 29	125	432	59	<b>\$7160</b>	<b>\$8591</b>
DID7842ED	42 x 78 x 29	125	401	55	<b>\$6643</b>	<b>\$7975</b>
DID7236ED	36 x 72 x 29	100	370	44	<b>\$5308</b>	<b>\$6368</b>
DID7230ED	30 x 72 x 29	100	349	36	<b>\$5227</b>	<b>\$6269</b>
DID6636ED	36 x 66 x 29	100	339	40	<b>\$5308</b>	<b>\$6368</b>
DID6630ED	30 x 66 x 29	100	320	33	<b>\$5142</b>	<b>\$6170</b>
DID6030ED	30 x 60 x 29	92.5	305	30	<b>\$4982</b>	<b>\$5976</b>

Standard with full to floor **file/file** pedestal on **left** and **box/box/file** pedestal on **right**. Pedestals lock. Refer to the Desks and Credenzas Notes Section on page 64 for overhang dimensions.

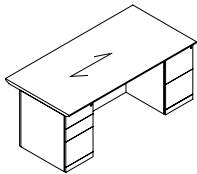

**Double Pedestal Desk, Breakfront Style**

DID8442DE	42 x 84 x 29	125	432	59	<b>\$7160</b>	<b>\$8591</b>
DID7842DE	42 x 78 x 29	125	401	55	<b>\$6643</b>	<b>\$7975</b>
DID7236DE	36 x 72 x 29	100	370	44	<b>\$5308</b>	<b>\$6368</b>
DID7230DE	30 x 72 x 29	100	349	36	<b>\$5227</b>	<b>\$6269</b>
DID6636DE	36 x 66 x 29	100	339	40	<b>\$5227</b>	<b>\$6269</b>
DID6630DE	30 x 66 x 29	100	320	33	<b>\$5142</b>	<b>\$6170</b>
DID6030DE	30 x 60 x 29	92.5	305	30	<b>\$4982</b>	<b>\$5976</b>

Standard with full to floor **box/box/file** pedestal on **left** and **file/file** pedestal on **right**. Pedestals lock. Refer to the Desks and Credenzas Notes Section on page 64 for overhang dimensions.

**SINGLE PEDESTAL DESKS - RECESSED FRONT MODESTY**

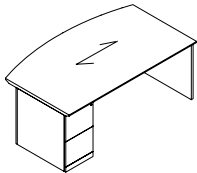

**Single Pedestal Bow Top Desk - LEFT**

MODEL#	DIMENSIONS	FREIGHT CLASS	WT/LBS.	CUBIC FT.	veneer/LAMINATE	ALL VENEER
DMSL8442E	42 x 84 x 29	125	432	59	<b>\$5769</b>	<b>\$6922</b>
DMSL7842E	42 x 78 x 29	125	401	55	<b>\$5360</b>	<b>\$6434</b>
DMSL7242E	42 x 72 x 29	125	370	51	<b>\$4948</b>	<b>\$5938</b>
DMSL6636E	36 x 66 x 29	150	230	40	<b>\$4759</b>	<b>\$5708</b>

Standard with full to floor **file/file** pedestal on **left**. Bow top. Pedestal locks. Refer to the Desks and Credenzas Notes Section on page 64 for overhang dimensions.

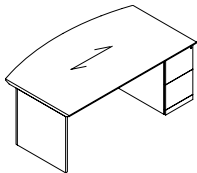

**Single Pedestal Bow Top Desk - RIGHT**

DMSR8442E	42 x 84 x 29	125	432	59	<b>\$5769</b>	<b>\$6922</b>
DMSR7842E	42 x 78 x 29	125	401	55	<b>\$5360</b>	<b>\$6434</b>
DMSR7242E	42 x 72 x 29	125	370	51	<b>\$4948</b>	<b>\$5938</b>
DMSR6636E	36 x 66 x 29	150	230	40	<b>\$4759</b>	<b>\$5708</b>

Standard with full to floor **file/file** pedestal on **right**. Bow top. Pedestal locks. Refer to the Desks and Credenzas Notes Section on page 64 for overhang dimensions.

**Required Specifications**

Veneer Finish  
Laminate Finish  
Handle Style

**Optional Specifications**

Grommet



SINGLE PEDESTAL DESKS

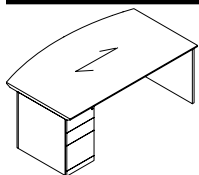

Single Pedestal Bow Top Desk - LEFT

MODEL#	DIMENSIONS D x W x H	FREIGHT CLASS	WT/LBS.	CUBIC FT.	VENEER/LAMINATE	ALL VENEER
DMSL8442D	42 x 84 x 29	125	432	59	<b>\$5769</b>	<b>\$6922</b>
DMSL7842D	42 x 78 x 29	125	401	55	<b>\$5360</b>	<b>\$6434</b>
DMSL7242D	42 x 72 x 29	125	370	51	<b>\$4948</b>	<b>\$5938</b>
DMSL6636D	36 x 66 x 29	150	230	40	<b>\$4759</b>	<b>\$5708</b>

Standard with full to floor **box/box/file** pedestal on **left**. Bow top. Pedestal locks. Refer to the Desks and Credenzas Notes Section on page 64 for overhang dimensions.

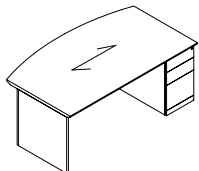

Single Pedestal Bow Top Desk - RIGHT

DMSR8442D	42 x 84 x 29	125	432	59	<b>\$5769</b>	<b>\$6922</b>
DMSR7842D	42 x 78 x 29	125	401	55	<b>\$5360</b>	<b>\$6434</b>
DMSR7242D	42 x 72 x 29	125	370	51	<b>\$4948</b>	<b>\$5938</b>
DMSR6636D	36 x 66 x 29	150	230	40	<b>\$4759</b>	<b>\$5708</b>

Standard with full to floor **box/box/file** pedestal on **right**. Bow top. Pedestal locks. Refer to the Desks and Credenzas Notes Section on page 64 for overhang dimensions.

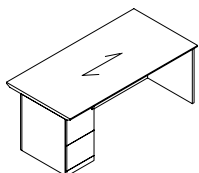

Single Pedestal Desk - LEFT

DSL8442E	42 x 84 x 29	125	463	59	<b>\$4636</b>	<b>\$5561</b>
DSL7842E	42 x 78 x 29	125	430	55	<b>\$4304</b>	<b>\$5165</b>
DSL7236E	36 x 72 x 29	125	340	44	<b>\$3407</b>	<b>\$4086</b>
DSL7230E	30 x 72 x 29	125	283	36	<b>\$3258</b>	<b>\$3909</b>
DSL6636E	36 x 66 x 29	125	312	40	<b>\$3258</b>	<b>\$3909</b>
DSL6630E	30 x 66 x 29	100	295	33	<b>\$3109</b>	<b>\$3731</b>
DSL6030E	30 x 60 x 29	100	265	30	<b>\$2969</b>	<b>\$3563</b>

Standard with full to floor **file/file** pedestal on **left**. Pedestal locks. Refer to the Desks and Credenzas Notes Section on page 64 for overhang dimensions.

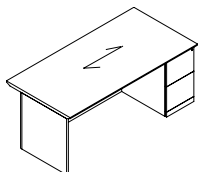

Single Pedestal Desk - RIGHT

DSR8442E	42 x 84 x 29	125	463	59	<b>\$4636</b>	<b>\$5561</b>
DSR7842E	42 x 78 x 29	125	430	55	<b>\$4304</b>	<b>\$5165</b>
DSR7236E	36 x 72 x 29	125	340	44	<b>\$3407</b>	<b>\$4086</b>
DSR7230E	30 x 72 x 29	125	283	36	<b>\$3258</b>	<b>\$3909</b>
DSR6636E	36 x 66 x 29	125	312	40	<b>\$3258</b>	<b>\$3909</b>
DSR6630E	30 x 66 x 29	100	295	33	<b>\$3109</b>	<b>\$3731</b>
DSR6030E	30 x 60 x 29	100	265	30	<b>\$2969</b>	<b>\$3563</b>

Standard with full to floor **file/file** pedestal on **right**. Pedestal locks. Refer to the Desks and Credenzas Notes Section on page 64 for overhang dimensions.

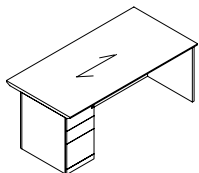

Single Pedestal Desk - LEFT

DSL8442D	42 x 84 x 29	125	463	59	<b>\$4636</b>	<b>\$5561</b>
DSL7842D	42 x 78 x 29	125	430	55	<b>\$4304</b>	<b>\$5165</b>
DSL7236D	36 x 72 x 29	125	340	44	<b>\$3407</b>	<b>\$4086</b>
DSL7230D	30 x 72 x 29	125	283	36	<b>\$3258</b>	<b>\$3909</b>
DSL6636D	36 x 66 x 29	125	312	40	<b>\$3258</b>	<b>\$3909</b>
DSL6630D	30 x 66 x 29	100	295	33	<b>\$3109</b>	<b>\$3731</b>
DSL6030D	30 x 60 x 29	100	265	30	<b>\$2969</b>	<b>\$3563</b>

Standard with full to floor **box/box/file** pedestal on **left**. Pedestal locks. Refer to the Desks and Credenzas Notes Section on page 64 for overhang dimensions.

**Required Specifications**

Veneer Finish  
Laminate Finish  
Handle Style

**Optional Specifications**

Grommet

**SINGLE PEDESTAL DESKS**

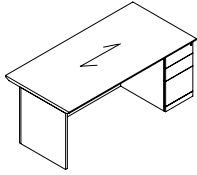

**Single Pedestal Desk - RIGHT**

MODEL#	DIMENSIONS	FREIGHT CLASS	WT/LBS.	CUBIC FT.	VENEER/LAMINATE	ALL VENEER
<b>D x W x H</b>						
DSR8442D	42 x 84 x 29	125	463	59	<b>\$4636</b>	<b>\$5561</b>
DSR7842D	42 x 78 x 29	125	430	55	<b>\$4304</b>	<b>\$5165</b>
DSR7236D	36 x 72 x 29	125	340	44	<b>\$3407</b>	<b>\$4086</b>
DSR7230D	30 x 72 x 29	125	283	36	<b>\$3258</b>	<b>\$3909</b>
DSR6636D	36 x 66 x 29	125	312	40	<b>\$3258</b>	<b>\$3909</b>
DSR6630D	30 x 66 x 29	100	295	33	<b>\$3109</b>	<b>\$3731</b>
DSR6030D	30 x 60 x 29	100	265	30	<b>\$2969</b>	<b>\$3563</b>

Standard with full to floor **box/box/file** pedestal on **right**. Pedestal locks. Refer to the Desks and Credenzas Notes Section on page 64 for overhang dimensions.

**SINGLE PEDESTAL DESKS - BREAKFRONT STYLE**

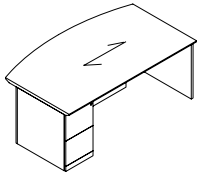

**Single Pedestal Bow Top Desk - LEFT Breakfront Style**

MODEL#	DIMENSIONS	FREIGHT CLASS	WT/LBS.	CUBIC FT.	VENEER/LAMINATE	ALL VENEER
DMISL8442E	42 x 84 x 29	125	432	59	<b>\$5769</b>	<b>\$6922</b>
DMISL7842E	42 x 78 x 29	125	401	55	<b>\$5357</b>	<b>\$6429</b>
DMISL7242E	42 x 72 x 29	125	370	51	<b>\$4946</b>	<b>\$5936</b>
DMISL6636E	36 x 66 x 29	150	230	40	<b>\$4758</b>	<b>\$5707</b>

Standard with full to floor **file/file** pedestal on **left**. Bow top. Pedestal locks. Refer to the Desks and Credenzas Notes Section on page 64 for overhang dimensions.

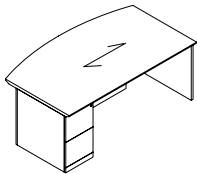

**Single Pedestal Bow Top Desk - RIGHT Breakfront Style**

DMISR8442E	42 x 84 x 29	125	432	59	<b>\$5769</b>	<b>\$6922</b>
DMISR7842E	42 x 78 x 29	125	401	55	<b>\$5357</b>	<b>\$6429</b>
DMISR7242E	42 x 72 x 29	125	370	51	<b>\$4946</b>	<b>\$5936</b>
DMISR6636E	36 x 66 x 29	150	230	40	<b>\$4758</b>	<b>\$5707</b>

Standard with full to floor **file/file** pedestal on **right**. Bow top. Pedestal locks. Refer to the Desks and Credenzas Notes Section on page 64 for overhang dimensions.

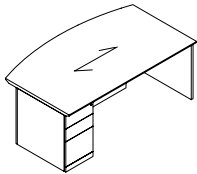

**Single Pedestal Bow Top Desk - LEFT Breakfront Style**

DMISL8442D	42 x 84 x 29	125	432	59	<b>\$5769</b>	<b>\$6922</b>
DMISL7842D	42 x 78 x 29	125	401	55	<b>\$5357</b>	<b>\$6429</b>
DMISL7242D	42 x 72 x 29	125	370	51	<b>\$4946</b>	<b>\$5936</b>
DMISL6636D	36 x 66 x 29	150	230	40	<b>\$4758</b>	<b>\$5707</b>

Standard with full to floor **box/box/file** pedestal on **left**. Bow top. Pedestal locks. Refer to the Desks and Credenzas Notes Section on page 64 for overhang dimensions.

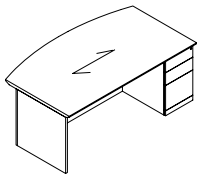

**Single Pedestal Bow Top Desk - RIGHT Breakfront Style**

DMISR8442D	42 x 84 x 29	125	432	59	<b>\$5769</b>	<b>\$6922</b>
DMISR7842D	42 x 78 x 29	125	401	55	<b>\$5357</b>	<b>\$6429</b>
DMISR7242D	42 x 72 x 29	125	370	51	<b>\$4946</b>	<b>\$5936</b>
DMISR6636D	36 x 66 x 29	150	230	40	<b>\$4758</b>	<b>\$5707</b>

Standard with full to floor **box/box/file** pedestal on **right**. Bow top. Pedestal locks. Refer to the Desks and Credenzas Notes Section on page 64 for overhang dimensions.

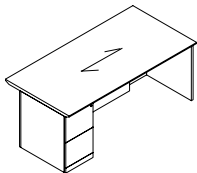

**Single Pedestal Desk - LEFT Breakfront Style**

DISL8442E	42 x 84 x 29	125	463	59	<b>\$5504</b>	<b>\$6605</b>
DISL7842E	42 x 78 x 29	125	430	55	<b>\$5111</b>	<b>\$6134</b>
DISL7236E	36 x 72 x 29	125	340	44	<b>\$4047</b>	<b>\$4856</b>
DISL7230E	30 x 72 x 29	125	283	36	<b>\$3867</b>	<b>\$4639</b>
DISL6636E	36 x 66 x 29	125	312	40	<b>\$3867</b>	<b>\$4639</b>
DISL6630E	30 x 66 x 29	100	295	33	<b>\$3690</b>	<b>\$4429</b>
DISL6030E	30 x 60 x 29	100	265	30	<b>\$3528</b>	<b>\$4235</b>

Standard with full to floor **file/file** pedestal on **left**. Pedestal locks. Refer to the Desks and Credenzas Notes Section on page 64 for overhang dimensions.

**Required Specifications**

- Veneer Finish
- Laminate Finish
- Handle Style

**Optional Specifications**

- Grommet

# D DUFFERIN

ELECTRIC HEIGHT ADJUSTABLE UNITS      MODEL#      DIMENSIONS      FREIGHT CLASS      WT/LBS.      CUBIC FT.      LIST PRICE

D x W x H

- All Height Adjustable (HA) units are shipped fully assembled.
- Simple Up / Down function enables the height adjustment of the worksurface.
- The height adjustment range for desks is 29" to 45", for table and bridge top 26" to 43" (including worksurface).
- Single stage HA mechanism with an electric motor in each column is used.
- The height adjustable mechanism operates at 1.5" per second.
- Max. weight / lift is 265 lbs.
- All columns are integrated into fully functional pedestals, or pedestal bases with the exception of the HA table and the HA bridge top.
- Height adjustable bases are available in three colors: **Black (BLK)**, **Tungsten (TUN)**, and **Designer White (DWT)**
- All desks include two (2) PVC wire management channels (L & R side) allowing for cabling through the pedestals.
- Hanging wood modesty panel on desk is standard. Hanging glass (aluminum framed) modesty panel is optional.
- To avoid risk of pinching:
  - 4.9" / 124mm gap is kept between the pedestal and the lowest point of the worksurface.
  - Wood spacer HASP must be used to attach height adjustable unit in the "U" or "L" configuration. See assembly instructions.
  - 2" gap is required between the worksurfaces when using the HA Table or the HA Bridge Top.
  - Includes collision detector
- Optional grommet locations: **TL** - Top Left or **TR** - Top Right

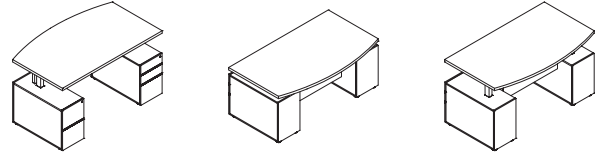
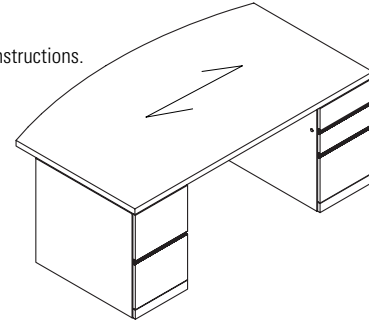

**Note:** Arrow indicates direction of grain.

HEIGHT ADJUSTABLE DOUBLE PEDESTAL DESKS      MODEL#      DIMENSIONS      FREIGHT CLASS      WT/LBS.      CUBIC FT.      VENEER/LAMINATE      ALL VENEER

D x W x H

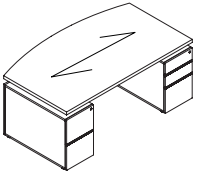

**Height Adj. Double Ped. Bow Top Desk  
Breakfront Style**

Built-in electric height adjustable double pedestal, standard with full to floor **box/box/file** pedestal on **right** and **file/file** pedestal on **left**. Bow top. Pedestals lock. One pencil tray. Refer to the Desks and Credenzas Notes Section on page 64 for overhang dimensions.

DHAMID8442ED	42 x 84 x 29	150	450	81	<b>\$12323</b>	<b>\$13691</b>
DHAMID7842ED	42 x 78 x 29	150	430	72	<b>\$11801</b>	<b>\$13112</b>
DHAMID7242ED	42 x 72 x 29	125	410	67	<b>\$11281</b>	<b>\$12532</b>
DHAMID6636ED	36 x 66 x 29	125	390	54	<b>\$10700</b>	<b>\$11889</b>

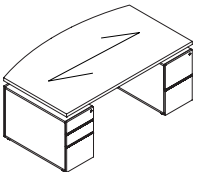

**Height Adj. Double Ped. Bow Top Desk  
Breakfront Style**

Built-in electric height adjustable double pedestal, standard with full to floor **box/box/file** pedestal on **left** and **file/file** pedestal on **right**. Bow top. Pedestals lock. One pencil tray. Refer to the Desks and Credenzas Notes Section on page 64 for overhang dimensions.

DHAMID8442DE	42 x 84 x 29	150	450	81	<b>\$12323</b>	<b>\$13691</b>
DHAMID7842DE	42 x 78 x 29	150	430	72	<b>\$11801</b>	<b>\$13112</b>
DHAMID7242DE	42 x 72 x 29	125	410	67	<b>\$11281</b>	<b>\$12532</b>
DHAMID6636DE	36 x 66 x 29	125	390	54	<b>\$10700</b>	<b>\$11889</b>

**Required Specifications**

Top Finish  
Edge  
Base finish  
Handle style

**Optional Specifications**

Grommet  
Glass modesty

**HEIGHT ADJUSTABLE DOUBLE PEDESTAL DESKS**    **MODEL#**    **DIMENSIONS**    **FREIGHT CLASS**    **WT./LBS.**    **CUBIC FT.**    **VENEER/LAMINATE**    **ALL VENEER**

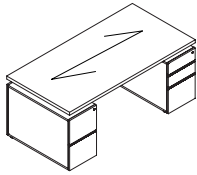

**Height Adj. Double Ped. Desk  
Breakfront Style**

	<b>D x W x H</b>						
DHAID8436ED	36 x 84 x 29	125	440	68	<b>\$10492</b>	<b>\$11658</b>	
DHAID7836ED	36 x 78 x 29	125	420	63	<b>\$10422</b>	<b>\$11579</b>	
DHAID7236ED	36 x 72 x 29	125	400	58	<b>\$10345</b>	<b>\$11495</b>	
DHAID7230ED	30 x 72 x 29	125	390	49	<b>\$10269</b>	<b>\$11410</b>	
DHAID6630ED	30 x 66 x 29	100	380	46	<b>\$10127</b>	<b>\$11251</b>	

Built-in electric height adjustable double pedestal, standard with full to floor **box/box/file** pedestal on **right** and **file/file** pedestal on **left**. Pedestals lock. One pencil tray. Refer to the Desks and Credenzas Notes Section on page 64 for overhang dimensions.

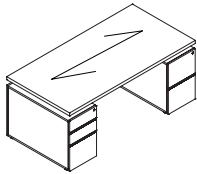

**Height Adj. Double Ped. Desk  
Breakfront Style**

DHAID8436DE	36 x 84 x 29	125	440	68	<b>\$10492</b>	<b>\$11658</b>	
DHAID7836DE	36 x 78 x 29	125	420	63	<b>\$10422</b>	<b>\$11579</b>	
DHAID7236DE	36 x 72 x 29	125	400	58	<b>\$10345</b>	<b>\$11495</b>	
DHAID7230DE	30 x 72 x 29	125	390	49	<b>\$10269</b>	<b>\$11410</b>	
DHAID6630DE	30 x 66 x 29	100	380	46	<b>\$10127</b>	<b>\$11251</b>	

Built-in electric height adjustable double pedestal, standard with full to floor **box/box/file** pedestal on **left** and **file/file** pedestal on **right**. Pedestals lock. One pencil tray. Refer to the Desks and Credenzas Notes Section on page 64 for overhang dimensions.

**HEIGHT ADJUSTABLE SINGLE PEDESTAL DESKS**    **MODEL#**    **DIMENSIONS**    **FREIGHT CLASS**    **WT./LBS.**    **CUBIC FT.**    **VENEER/LAMINATE**    **ALL VENEER**

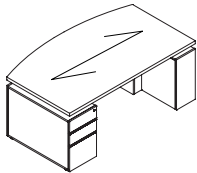

**Height Adj. Single Ped. Bow Top Desk  
Breakfront Style - LEFT**

DHAMISL8442D	42 x 84 x 29	150	440	59	<b>\$10808</b>	<b>\$12006</b>	
DHAMISL7842D	42 x 78 x 29	150	420	55	<b>\$10399</b>	<b>\$11554</b>	
DHAMISL7242D	42 x 72 x 29	150	400	51	<b>\$9988</b>	<b>\$11101</b>	
DHAMISL6636D	36 x 66 x 29	125	390	40	<b>\$9481</b>	<b>\$10535</b>	

Built-in electric height adjustable single pedestal bow top desk. Standard with full to floor locking **box/box/file** pedestal on **left** and support pedestal on **right**. Refer to the Desks and Credenzas Notes Section on page 64 for overhang dimensions.

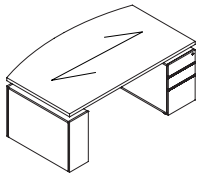

**Height Adj. Single Ped. Bow Top Desk  
Breakfront Style - RIGHT**

DHAMISR8442D	42 x 84 x 29	150	440	59	<b>\$10808</b>	<b>\$12006</b>	
DHAMISR7842D	42 x 78 x 29	150	420	55	<b>\$10399</b>	<b>\$11554</b>	
DHAMISR7242D	42 x 72 x 29	150	400	51	<b>\$9988</b>	<b>\$11101</b>	
DHAMISR6636D	36 x 66 x 29	125	390	40	<b>\$9481</b>	<b>\$10535</b>	

Built-in electric height adjustable single pedestal bow top desk. Standard with full to floor locking **box/box/file** pedestal on **right** and support pedestal on **left**. Refer to the Desks and Credenzas Notes Section on page 64 for overhang dimensions.

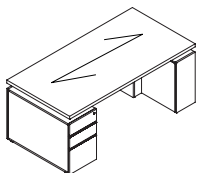

**Height Adjustable Single Ped. Desk  
Breakfront Style - LEFT**

DHAISL8436D	36 x 84 x 29	125	430	55	<b>\$9233</b>	<b>\$10257</b>	
DHAISL7836D	36 x 78 x 29	125	410	50	<b>\$9196</b>	<b>\$10218</b>	
DHAISL7236D	36 x 72 x 29	125	390	44	<b>\$9085</b>	<b>\$10094</b>	
DHAISL7230D	30 x 72 x 29	125	380	40	<b>\$8907</b>	<b>\$10031</b>	
DHAISL6630D	30 x 66 x 29	125	360	36	<b>\$8676</b>	<b>\$9639</b>	
DHAISL6030D	30 x 60 x 29	100	340	35	<b>\$8510</b>	<b>\$9456</b>	

Built-in electric height adjustable single pedestal desk. Standard with full to floor locking **box/box/file** pedestal on **left** and support pedestal on **right**. Refer to the Desks and Credenzas Notes Section on page 64 for overhang dimensions.

**Required Specifications**

- Top Finish
- Edge
- Base finish
- Handle style

**Optional Specifications**

- Grommet
- Glass modesty

HEIGHT ADJUSTABLE SINGLE PEDESTAL DESKS

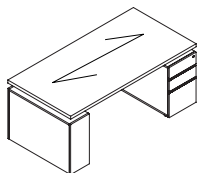

Height Adjustable Single Ped. Desk\*  
Breakfront Style - RIGHT

MODEL#	DIMENSIONS D x W x H	FREIGHT CLASS	WT/LBS.	CUBIC FT.	VENEER/LAMINATE	ALL VENEER
DHAISR8436D	36 x 84 x 29	125	430	55	\$9233	\$10257
DHAISR7836D	36 x 78 x 29	125	410	50	\$9196	\$10218
DHAISR7236D	36 x 72 x 29	125	390	44	\$9085	\$10094
DHAISR7230D	30 x 72 x 29	125	380	40	\$8907	\$9897
DHAISR6630D	30 x 66 x 29	125	360	36	\$8676	\$9639
DHAISR6030D	30 x 60 x 29	100	340	35	\$8510	\$9456

Built-in electric height adjustable single pedestal desk. Standard with full to floor locking **box/box/file** pedestal on **right** and support pedestal on **left**. Refer to the Desks and Credenzas Notes Section on page 64 for overhang dimensions.

HEIGHT ADJUSTABLE DESK SHELLS

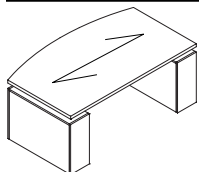

Height Adjustable Bow Top Desk Shell  
Breakfront Style

MODEL#	DIMENSIONS	FREIGHT CLASS	WT/LBS.	CUBIC FT.	VENEER/LAMINATE	ALL VENEER
DHAMIT8442	42 x 84 x 29	150	350	59	\$10470	\$11632
DHAMIT7842	42 x 78 x 29	150	330	55	\$10245	\$11382
DHAMIT7242	42 x 72 x 29	150	310	51	\$10014	\$11127
DHAMIT6636	36 x 66 x 29	150	280	40	\$9036	\$10041

Built-in electric height adjustable bow top desk shell.  
Refer to the Desks and Credenzas Notes Section on page 64 for overhang dimensions.

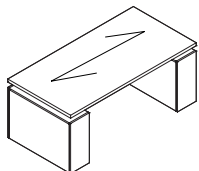

Height Adjustable Desk Shell  
Breakfront Style

DHAIT8436	36 x 84 x 29	150	330	68	\$9315	\$10349
DHAIT7836	36 x 78 x 29	150	310	63	\$9143	\$10158
DHAIT7236	36 x 72 x 29	150	290	44	\$8961	\$9957
DHAIT7230	30 x 72 x 29	150	280	40	\$8398	\$9332
DHAIT6636	36 x 66 x 29	150	260	36	\$8604	\$9561
DHAIT6630	30 x 66 x 29	150	250	35	\$8398	\$9332
DHAIT6030	30 x 60 x 29	150	240	42	\$8250	\$9166

Built-in electric height adjustable desk shell.  
Refer to the Desks and Credenzas Notes Section on page 64 for overhang dimensions.

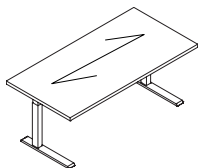

Height Adjustable Table

DHA8436	36 x 84 x 29	250	160	68	\$7539	\$8376
DHA7836	36 x 78 x 29	250	150	63	\$7368	\$8184
DHA7236	36 x 72 x 29	250	140	58	\$7182	\$7982
DHA7230	30 x 72 x 29	250	130	49	\$6621	\$7356
DHA6636	36 x 66 x 29	250	140	54	\$6829	\$7587
DHA6630	30 x 66 x 29	250	120	46	\$6621	\$7356
DHA6030	30 x 60 x 29	250	115	42	\$6474	\$7192

Electric height adjustable table.

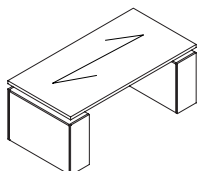

Height Adjustable Desk

DHA8436TP	36 x 84 x 29	150	320	68	\$9020	\$10035
DHA7836TP	36 x 78 x 29	150	300	63	\$8848	\$9830
DHA7236TP	36 x 72 x 29	150	280	58	\$8664	\$9627
DHA7230TP	30 x 72 x 29	150	270	49	\$8101	\$9001
DHA6636TP	36 x 66 x 29	150	250	54	\$8309	\$9231
DHA6630TP	30 x 66 x 29	150	240	46	\$8101	\$9001
DHA6030TP	30 x 60 x 29	150	230	42	\$7953	\$8837

Built-in electric height adjustable desk on TP bases.

Required Specifications

- Top Finish
- Edge
- Base finish
- Handle style

Optional Specifications

- Grommet
- Glass modesty

HEIGHT ADJUSTABLE

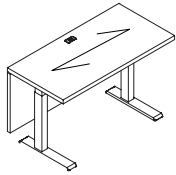

Height Adjustable Bridge Top

MODEL#	DIMENSIONS	FREIGHT CLASS	WT/LBS.	CUBIC FT.	veneer/LAMINATE	ALL VENEER
	<b>D x W x H</b>					
DHABT6024	24 x 60 x 29	150	150	35	<b>\$7025</b>	<b>\$7805</b>
DHABT5424	24 x 54 x 29	150	140	31	<b>\$6816</b>	<b>\$7574</b>
DHABT4824	24 x 48 x 29	150	130	28	<b>\$6610</b>	<b>\$7344</b>
DHABT4224	24 x 42 x 29	300	29	26	<b>\$6396</b>	<b>\$7105</b>

Electric height adjustable executive bridge top. Grommet in worksurface.

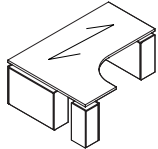

Height Adj. Right Extended Corner Desk\*

DHAEKR60842436	24-36 x 60-84 x 29	150	450	108	<b>\$13967</b>	<b>\$15519</b>
DHAEKR60782436	24-36 x 60-78 x 29	150	430	100	<b>\$13933</b>	<b>\$15481</b>
DHAEKR60722436	24-36 x 60-72 x 29	150	410	93	<b>\$13626</b>	<b>\$15139</b>
DHAEKR60662436	24-36 x 60-66 x 29	150	390	86	<b>\$13228</b>	<b>\$14699</b>
DHAEKR60602436	24-36 x 60-60 x 29	150	370	79	<b>\$12832</b>	<b>\$14256</b>

Built-in electric height adjustable right extended corner table desk with a 24" return connection. Extended worksurface on **right. Full end panel on right, narrow end panel on left.** Connects to Linking Bridges, Extended Corners and Connectable Tables.

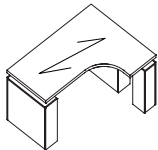

Height Adj. Left Extended Corner Desk\*

DHAEKL84603624	24-36 x 60-84 x 29	150	450	108	<b>\$13967</b>	<b>\$15519</b>
DHAEKL78603624	24-36 x 60-78 x 29	150	430	100	<b>\$13933</b>	<b>\$15481</b>
DHAEKL72603624	24-36 x 60-72 x 29	150	410	93	<b>\$13626</b>	<b>\$15139</b>
DHAEKL66603624	24-36 x 60-66 x 29	150	390	86	<b>\$13228</b>	<b>\$14699</b>
DHAEKL60603624	24-36 x 60-60 x 29	150	370	79	<b>\$12832</b>	<b>\$14256</b>

Built-in electric height adjustable right extended corner table desk with a 24" return connection. Extended worksurface on **left. Full end panel on left, narrow end panel on right.** Connects to Linking Bridges, Extended Corners and Connectable Tables.



Spacer

DHASP	2 x 8 x 23	70	15	.75	<b>\$505</b>	<b>\$561</b>
-------	------------	----	----	-----	--------------	--------------

Connects height adjustable desks with linking bridges and returns.

**Required Specifications**

Top Finish  
Edge  
Base finish

**Optional Specifications**

Grommet\*  
Glass modesty

MODESTY PANEL OPTIONS

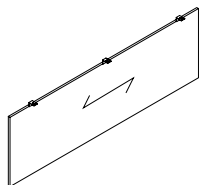

Veneer Modesty Panel Upgrade\*

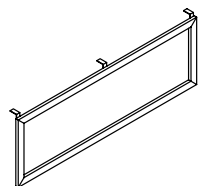

Glass Modesty Panel Upgrade

MODEL#	DIMENSIONS D x W x H	FREIGHT CLASS	WT/LBS.	CUBIC FT.	LIST PRICE
CMP72W	0.75 x 67 x 18	--	20	1	<b>\$1622</b>
CMP66W	0.75 x 61 x 18	--	18	1	<b>\$1570</b>
CMP60W	0.75 x 55 x 18	--	16	1	<b>\$1546</b>
CMP54W	0.75 x 49 x 18	--	14	1	<b>\$1520</b>
CMP48W	0.75 x 43 x 18	--	13	1	<b>\$1496</b>

Straight modesty panel. Attaches to underside of worksurface. **Cannot be retrofitted in the field. Not sold individually - to be ordered as an upgrade option only.**

- CMP72W - Specify on "P" Top Islands or 96" x 48" Islands for Piano Desks.
- CMP66W - Specify on 84" x 36" "D" Top Islands.
- CMP60W - Specify on 84" x 42" "P" Top Islands or 84" x 48" Islands for Piano Desks.
- CMP54W - Specify on 72" x 30" "D" Top Islands.
- CMP48W - Specify on 66" x 36" , 60" x 30" "D" Top Islands, 72" x 42" "P" Top Islands or 72" x 48" Islands for Piano Desks.

CMP72G	0.75 x 67 x 18	--	20	1	<b>\$2485</b>
CMP66G	0.75 x 61 x 18	--	18	1	<b>\$2351</b>
CMP60G	0.75 x 55 x 18	--	16	1	<b>\$2149</b>
CMP54G	0.75 x 49 x 18	--	14	1	<b>\$2001</b>
CMP48G	0.75 x 43 x 18	--	13	1	<b>\$1911</b>

Straight modesty panel. Translucent, screened glass. Aluminum box frame construction in Tungsten Only. Attaches to underside of worksurface. **Cannot be retrofitted in the field. Not sold individually - to be ordered as an upgrade option only.**

- CMP72G - Specify on "P" Top Islands or 96" x 48" Islands for Piano Desks.
- CMP66G - Specify on 84" x 36" "D" Top Islands.
- CMP60G - Specify on 84" x 42" "P" Top Islands or 84" x 48" Islands for Piano Desks.
- CMP54G - Specify on 72" x 30" "D" Top Islands.
- CMP48G - Specify on 66" x 36" , 60" x 30" "D" Top Islands, 72" x 42" "P" Top Islands or 72" x 48" Islands for Piano Desks.
- Tungsten finish on the aluminum box frame closely resembles the existing Tungsten finish.

**SINGLE PEDESTAL DESKS - BREAKFRONT STYLE**

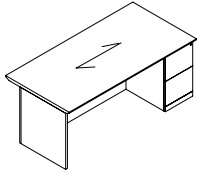

**Single Pedestal Desk - RIGHT Breakfront Style**

MODEL#	DIMENSIONS	FREIGHT CLASS	WT/LBS.	CUBIC FT.	VENEER/LAMINATE	ALL VENEER
<b>D x W x H</b>						
DISR8442E	42 x 84 x 29	125	463	59	<b>\$5504</b>	<b>\$6605</b>
DISR7842E	42 x 78 x 29	125	430	55	<b>\$5111</b>	<b>\$6134</b>
DISR7236E	36 x 72 x 29	125	340	44	<b>\$4047</b>	<b>\$4856</b>
DISR7230E	30 x 72 x 29	125	283	36	<b>\$3867</b>	<b>\$4639</b>
DISR6636E	36 x 66 x 29	125	312	40	<b>\$3867</b>	<b>\$4639</b>
DISR6630E	30 x 66 x 29	100	295	33	<b>\$3690</b>	<b>\$4429</b>
DISR6030E	30 x 60 x 29	100	265	30	<b>\$3528</b>	<b>\$4235</b>

Standard with full to floor **file/file** pedestal on **right**. Pedestal locks. Refer to the Desks and Credenzas Notes Section on page 64 for overhang dimensions.

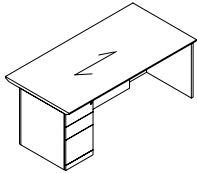

**Single Pedestal Desk - LEFT Breakfront Style**

DISL8442D	42 x 84 x 29	125	463	59	<b>\$5504</b>	<b>\$6605</b>
DISL7842D	42 x 78 x 29	125	430	55	<b>\$5111</b>	<b>\$6134</b>
DISL7236D	36 x 72 x 29	125	340	44	<b>\$4047</b>	<b>\$4856</b>
DISL7230D	30 x 72 x 29	125	283	36	<b>\$3867</b>	<b>\$4639</b>
DISL6636D	36 x 66 x 29	125	312	40	<b>\$3867</b>	<b>\$4639</b>
DISL6630D	30 x 66 x 29	100	295	33	<b>\$3690</b>	<b>\$4429</b>
DISL6030D	30 x 60 x 29	100	265	30	<b>\$3528</b>	<b>\$4235</b>

Standard with full to floor **box/box/file** pedestal on **left**. Pedestal locks. Refer to the Desks and Credenzas Notes Section on page 64 for overhang dimensions.

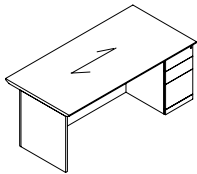

**Single Pedestal Desk - RIGHT Breakfront Style**

DISR8442D	42 x 84 x 29	125	463	59	<b>\$5504</b>	<b>\$6605</b>
DISR7842D	42 x 78 x 29	125	430	55	<b>\$5111</b>	<b>\$6134</b>
DISR7236D	36 x 72 x 29	125	340	44	<b>\$4047</b>	<b>\$4856</b>
DISR7230D	30 x 72 x 29	125	283	36	<b>\$3867</b>	<b>\$4639</b>
DISR6636D	36 x 66 x 29	125	312	40	<b>\$3867</b>	<b>\$4639</b>
DISR6630D	30 x 66 x 29	100	295	33	<b>\$3690</b>	<b>\$4429</b>
DISR6030D	30 x 60 x 29	100	265	30	<b>\$3528</b>	<b>\$4235</b>

Standard with full to floor **box/box/file** pedestal on **right**. Pedestal locks. Refer to the Desks and Credenzas Notes Section on page 64 for overhang dimensions.

**DESK SHELLS WITH RECESSED FRONT**

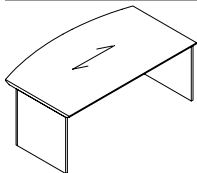

**Bow Top Desk Shell**

MODEL#	DIMENSIONS	FREIGHT CLASS	WT/LBS.	CUBIC FT.	VENEER/LAMINATE	ALL VENEER
DMT8442	42 x 84 x 29	125	380	59	<b>\$4436</b>	<b>\$5321</b>
DMT7842	42 x 78 x 29	125	353	55	<b>\$4117</b>	<b>\$4939</b>
DMT7242	42 x 72 x 29	125	331	51	<b>\$3803</b>	<b>\$4564</b>
DMT6636	36 x 66 x 29	125	287	40	<b>\$3626</b>	<b>\$4351</b>

Bow top and recessed modesty panel. Refer to the Desks and Credenzas Notes Section on page 64 for overhang dimensions.

**Required Specifications**

- Veneer Finish
- Laminate Finish
- Handle Style (Single Pedestal Desks)

**Optional Specifications**

- Grommet



## DESK SHELLS

MODEL#	DIMENSIONS D x W x H	FREIGHT CLASS	WT/LBS.	CUBIC FT.	veneer/LAMINATE	ALL VENEER
DT8436	36 x 84 x 29	125	362	51	<b>\$3536</b>	<b>\$4244</b>
DT7836	36 x 78 x 29	125	336	47	<b>\$3284</b>	<b>\$3942</b>
DT7236	36 x 72 x 29	125	315	44	<b>\$3031</b>	<b>\$3637</b>
DT6636	36 x 66 x 29	125	271	40	<b>\$2855</b>	<b>\$3429</b>
DT7230	30 x 72 x 29	125	271	36	<b>\$2855</b>	<b>\$3429</b>
DT6630	30 x 66 x 29	100	265	33	<b>\$2680</b>	<b>\$3218</b>
DT6030	30 x 60 x 29	100	241	30	<b>\$2453</b>	<b>\$2944</b>
DT4824	24 x 48 x 29	125	123	20	<b>\$1615</b>	<b>\$1938</b>
DT4224	24 x 42 x 29	150	98	17	<b>\$1353</b>	<b>\$1623</b>
DT3624	24 x 36 x 29	150	82	14	<b>\$1302</b>	<b>\$1564</b>
DT3024	24 x 30 x 29	125	76	12	<b>\$1278</b>	<b>\$1534</b>
DT4822	22 x 48 x 29	150	105	18	<b>\$1481</b>	<b>\$1777</b>
DT4222	22 x 42 x 29	150	90	16	<b>\$1240</b>	<b>\$1488</b>
DT3622	22 x 36 x 29	150	75	13	<b>\$1197</b>	<b>\$1436</b>
DT3022	22 x 30 x 29	150	65	11	<b>\$1173</b>	<b>\$1407</b>
DT4820	20 x 48 x 29	125	105	18	<b>\$1347</b>	<b>\$1616</b>
DT4220	20 x 42 x 29	125	90	16	<b>\$1126</b>	<b>\$1351</b>
DT3620	20 x 36 x 29	125	75	13	<b>\$1091</b>	<b>\$1307</b>
DT3020	20 x 30 x 29	125	65	11	<b>\$1065</b>	<b>\$1278</b>

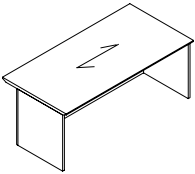

**Desk Shell**

Recessed modesty panel. Refer to the Desks and Credenzas Notes Section on page 64 for overhang dimensions.

## RETURNS

- An Executive Return is used to attach to a Single Pedestal Desk, Single Pedestal Credenza, Desk Shell or Credenza Shell.
- Grommets are available as an option.
- Hand of Executive Return is determined by location of full end panel from user side.
- Hand of Desk or Credenza is determined by location of pedestal from user side.
- To remove cross grain veneer pattern on top, delete suffix "CG" from the model number. Available as a special - no upcharge.

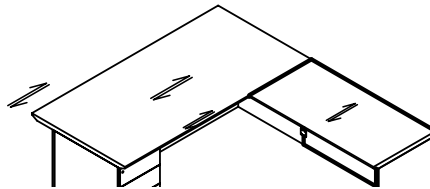
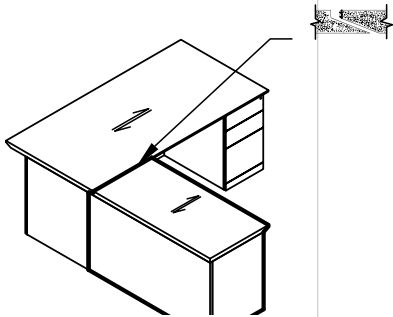

## RETURNS

MODEL#	DIMENSIONS	FREIGHT CLASS	WT/LBS.	CUBIC FT.	veneer/LAMINATE	ALL VENEER
DERL7224CG	24 x 72 x 29	150	135	29	<b>\$2336</b>	<b>\$2803</b>
DERL6624CG	24 x 66 x 29	150	127	27	<b>\$2137</b>	<b>\$2566</b>
DERL6024CG	24 x 60 x 29	150	120	24	<b>\$1945</b>	<b>\$2335</b>
DERL5424CG	24 x 54 x 29	150	112	22	<b>\$1756</b>	<b>\$2108</b>
DERL4824CG	24 x 48 x 29	150	105	19	<b>\$1558</b>	<b>\$1868</b>
DERL4224CG	24 x 42 x 29	150	97	17	<b>\$1367</b>	<b>\$1639</b>

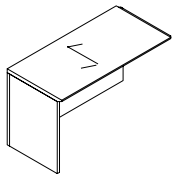

**Flush Return - LEFT 24" Deep**

Return has **no pedestal**. For use with right handed single pedestal desks, credenzas, desk shells, credenza shells, "D" islands or "P" islands.

### Required Specifications

Veneer Finish  
Laminate Finish

### Optional Specifications

Grommet

**RETURNS**

**MODEL# DIMENSIONS FREIGHT CLASS WT/LBS. CUBIC FT. VENEER/LAMINATE ALL VENEER**

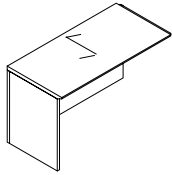

**Flush Return - LEFT  
22" Deep**

	<b>D x W x H</b>						
DERL7222CG	22 x 72 x 29	150	130	27	<b>\$2227</b>	<b>\$2672</b>	
DERL6622CG	22 x 66 x 29	150	122	24	<b>\$1865</b>	<b>\$2238</b>	
DERL6022CG	22 x 60 x 29	150	115	22	<b>\$1701</b>	<b>\$2039</b>	
DERL5422CG	22 x 54 x 29	150	105	20	<b>\$1633</b>	<b>\$1958</b>	
DERL4822CG	22 x 48 x 29	150	100	18	<b>\$1367</b>	<b>\$1639</b>	
DERL4222CG	22 x 42 x 29	150	90	16	<b>\$1194</b>	<b>\$1434</b>	

Return has **no pedestal**. For use with right handed single pedestal desks, credenzas, desk shells, credenza shells, "D" islands or "P" islands.

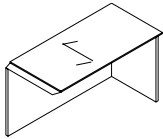

**Flush Return - RIGHT  
24" Deep**

DERR7224CG	24 x 72 x 29	150	135	29	<b>\$2336</b>	<b>\$2803</b>	
DERR6624CG	24 x 66 x 29	150	127	27	<b>\$2137</b>	<b>\$2566</b>	
DERR6024CG	24 x 60 x 29	150	120	24	<b>\$1945</b>	<b>\$2335</b>	
DERR5424CG	24 x 54 x 29	150	112	22	<b>\$1756</b>	<b>\$2108</b>	
DERR4824CG	24 x 48 x 29	150	105	19	<b>\$1558</b>	<b>\$1868</b>	
DERR4224CG	24 x 42 x 29	150	97	17	<b>\$1367</b>	<b>\$1639</b>	

Return has **no pedestal**. For use with left handed single pedestal desks, credenzas, desk shells, credenza shells, "D" islands or "P" islands.

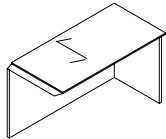

**Flush Return - RIGHT  
22" Deep**

DERR7222CG	22 x 72 x 29	150	130	27	<b>\$2227</b>	<b>\$2672</b>	
DERR6622CG	22 x 66 x 29	150	122	24	<b>\$1865</b>	<b>\$2238</b>	
DERR6022CG	22 x 60 x 29	150	115	22	<b>\$1701</b>	<b>\$2039</b>	
DERR5422CG	22 x 54 x 29	150	105	20	<b>\$1529</b>	<b>\$1835</b>	
DERR4822CG	22 x 48 x 29	150	100	18	<b>\$1359</b>	<b>\$1632</b>	
DERR4222CG	22 x 42 x 29	150	90	16	<b>\$1188</b>	<b>\$1424</b>	

Return has **no pedestal**. For use with left handed single pedestal desks, credenzas, desk shells, credenza shells, "D" islands or "P" islands.

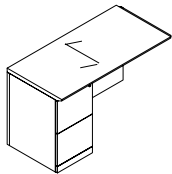

**Flush Return - LEFT\*  
24" Deep**

DERL7224ECG	24 x 72 x 29	100	250	29	<b>\$4123</b>	<b>\$4946</b>	
DERL6624ECG	24 x 66 x 29	100	236	27	<b>\$3964</b>	<b>\$4758</b>	
DERL6024ECG	24 x 60 x 29	100	227	24	<b>\$3608</b>	<b>\$4329</b>	
DERL5424ECG	24 x 54 x 29	100	205	22	<b>\$3479</b>	<b>\$4174</b>	
DERL4824ECG	24 x 48 x 29	100	185	19	<b>\$3088</b>	<b>\$3705</b>	
DERL4224ECG	24 x 42 x 29	92.5	178	17	<b>\$2979</b>	<b>\$3574</b>	

Return has **file/file** pedestal on the **left**. Pedestal locks. For use with right handed single pedestal desks, credenzas, desk shells, credenza shells, "D" islands or "P" islands.

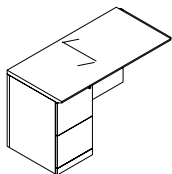

**Flush Return - LEFT\*  
22" Deep**

DERL7222ECG	22 x 72 x 29	100	240	27	<b>\$3964</b>	<b>\$4758</b>	
DERL6622ECG	22 x 66 x 29	100	231	24	<b>\$3498</b>	<b>\$4200</b>	
DERL6022ECG	22 x 60 x 29	92.5	222	22	<b>\$3185</b>	<b>\$3822</b>	
DERL5422ECG	22 x 54 x 29	92.5	200	20	<b>\$3068</b>	<b>\$3682</b>	
DERL4822ECG	22 x 48 x 29	92.5	180	18	<b>\$2727</b>	<b>\$3272</b>	
DERL4222ECG	22 x 42 x 29	92.5	173	16	<b>\$2624</b>	<b>\$3148</b>	

Return has **file/file** pedestal on the **left**. Pedestal locks. For use with right handed single pedestal desks, credenzas, desk shells, credenza shells, "D" islands or "P" islands.

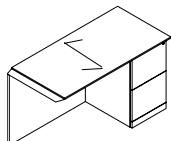

**Flush Return - RIGHT\*  
24" Deep**

DERR7224ECG	24 x 72 x 29	100	250	29	<b>\$4123</b>	<b>\$4946</b>	
DERR6624ECG	24 x 66 x 29	100	236	27	<b>\$3964</b>	<b>\$4758</b>	
DERR6024ECG	24 x 60 x 29	100	227	24	<b>\$3608</b>	<b>\$4329</b>	
DERR5424ECG	24 x 54 x 29	100	205	22	<b>\$3479</b>	<b>\$4174</b>	
DERR4824ECG	24 x 48 x 29	100	185	19	<b>\$3088</b>	<b>\$3705</b>	
DERR4224ECG	24 x 42 x 29	92.5	178	17	<b>\$2979</b>	<b>\$3574</b>	

Return has **file/file** pedestal on the **right**. Pedestal locks. For use with right handed single pedestal desks, credenzas, desk shells, credenza shells, "D" islands or "P" islands.

**Required Specifications**

Veneer Finish  
Laminate Finish  
Handle Style\*

**Optional Specifications**

Grommet

**RETURNS**

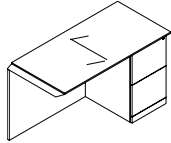

**Flush Return - RIGHT  
22" Deep**

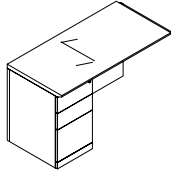

**Flush Return - LEFT  
24" Deep**

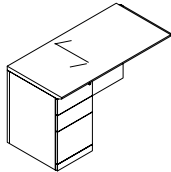

**Flush Return - LEFT  
22" Deep**

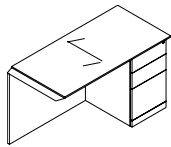

**Flush Return - RIGHT  
24" Deep**

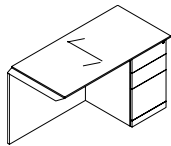

**Flush Return - RIGHT  
22" Deep**

MODEL#	DIMENSIONS	FREIGHT CLASS	WT/LBS.	CUBIC FT.	veneer/LAMINATE	ALL VENEER
--------	------------	---------------	---------	-----------	-----------------	------------

D x W x H

DERR7222ECG	22 x 72 x 29	100	240	27	<b>\$3964</b>	<b>\$4758</b>
DERR6622ECG	22 x 66 x 29	100	231	24	<b>\$3498</b>	<b>\$4200</b>
DERR6022ECG	22 x 60 x 29	92.5	222	22	<b>\$3185</b>	<b>\$3822</b>
DERR5422ECG	22 x 54 x 29	92.5	200	20	<b>\$3068</b>	<b>\$3682</b>
DERR4822ECG	22 x 48 x 29	92.5	180	18	<b>\$2727</b>	<b>\$3272</b>
DERR4222ECG	22 x 42 x 29	92.5	173	16	<b>\$2624</b>	<b>\$3148</b>

Return has **file/file** pedestal on the **right**. Pedestal locks. For use with right handed single pedestal desks, credenzas, desk shells, credenza shells, "D" islands or "P" islands.

DERL7224DCG	24 x 72 x 29	100	250	29	<b>\$4123</b>	<b>\$4946</b>
DERL6624DCG	24 x 66 x 29	100	236	27	<b>\$3964</b>	<b>\$4758</b>
DERL6024DCG	24 x 60 x 29	100	227	24	<b>\$3608</b>	<b>\$4329</b>
DERL5424DCG	24 x 54 x 29	100	205	22	<b>\$3479</b>	<b>\$4174</b>
DERL4824DCG	24 x 48 x 29	100	185	19	<b>\$3088</b>	<b>\$3705</b>
DERL4224DCG	24 x 42 x 29	92.5	178	17	<b>\$2979</b>	<b>\$3574</b>

Return has **box/box/file** pedestal on the **left**. Pedestal locks. For use with right handed single pedestal desks, credenzas, desk shells, credenza shells, "D" islands or "P" islands.

DERL7222DCG	22 x 72 x 29	100	240	27	<b>\$3964</b>	<b>\$4758</b>
DERL6622DCG	22 x 66 x 29	100	231	24	<b>\$3498</b>	<b>\$4200</b>
DERL6022DCG	22 x 60 x 29	92.5	222	22	<b>\$3185</b>	<b>\$3822</b>
DERL5422DCG	22 x 54 x 29	92.5	200	20	<b>\$3068</b>	<b>\$3682</b>
DERL4822DCG	22 x 48 x 29	150	180	18	<b>\$2727</b>	<b>\$3272</b>
DERL4222DCG	22 x 42 x 29	92.5	173	16	<b>\$2624</b>	<b>\$3148</b>

Return has **box/box/file** pedestal on the **left**. Pedestal locks. For use with right handed single pedestal desks, credenzas, desk shells, credenza shells, "D" islands or "P" islands.

DERR7224DCG	24 x 72 x 29	100	250	29	<b>\$4123</b>	<b>\$4946</b>
DERR6624DCG	24 x 66 x 29	100	236	27	<b>\$3964</b>	<b>\$4758</b>
DERR6024DCG	24 x 60 x 29	100	227	24	<b>\$3608</b>	<b>\$4329</b>
DERR5424DCG	24 x 54 x 29	100	205	22	<b>\$3479</b>	<b>\$4174</b>
DERR4824DCG	24 x 48 x 29	100	185	19	<b>\$3088</b>	<b>\$3705</b>
DERR4224DCG	24 x 42 x 29	92.5	178	17	<b>\$2979</b>	<b>\$3574</b>

Return has **box/box/file** pedestal on the **right**. Pedestal locks. For use with right handed single pedestal desks, credenzas, desk shells, credenza shells, "D" islands or "P" islands.

DERR7222DCG	22 x 72 x 29	100	240	27	<b>\$3964</b>	<b>\$4758</b>
DERR6622DCG	22 x 66 x 29	100	231	24	<b>\$3498</b>	<b>\$4200</b>
DERR6022DCG	22 x 60 x 29	92.5	222	22	<b>\$3185</b>	<b>\$3822</b>
DERR5422DCG	22 x 54 x 29	92.5	200	20	<b>\$3068</b>	<b>\$3682</b>
DERR4822DCG	22 x 48 x 29	92.5	180	18	<b>\$2727</b>	<b>\$3272</b>
DERR4222DCG	22 x 42 x 29	92.5	173	16	<b>\$2624</b>	<b>\$3148</b>

Return has **box/box/file** pedestal on the **right**. Pedestal locks. For use with right handed single pedestal desks, credenzas, desk shells, credenza shells, "D" islands or "P" islands.

**Required Specifications**

Veneer Finish  
Laminate Finish  
Handle Style

**Optional Specifications**

Grommet

**BRIDGES - EXECUTIVE**

MODEL#

DIMENSIONS

FREIGHT CLASS

WT/LBS.

CUBIC FT.

VENEER/LAMINATE

ALL VENEER

D x W x H

- An Executive Bridge is used to connect a Desk to a Credenza.
- Not to be used with Corner Components or Piano Desks,
- Three Modesty Panel options - Full Modesty, 8" Modesty and No Modesty (Flush Bridge Top).
- Modesty panel flush with end panels of Desk and Credenza.
- Includes GM1 grommet in the top center position.
- Both connecting sides of executive bridges feature a reverse profile edge

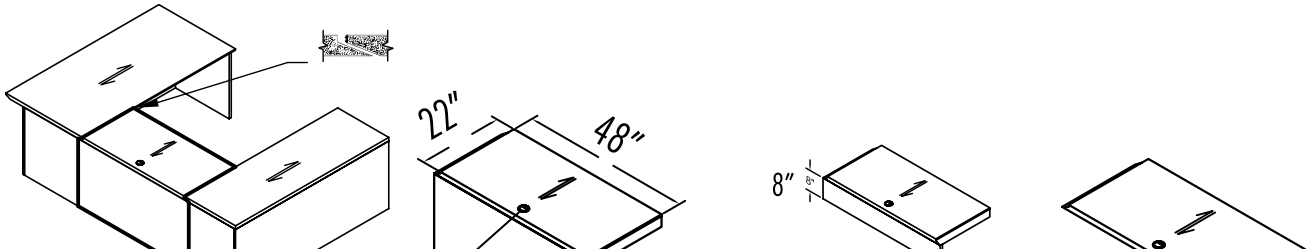

**BRIDGES - LINKING**

- A linking bridge is used to connect corner components to a single pedestal desk, HA desk, single pedestal credenza, desk shell or credenza shell.
- When connecting HA desk, must specify DHASP spacer.
- Two modesty panel options - full modesty and 8" modesty.
- Includes GM1 grommet in the top center position.
- Hand of linking bridge is determined by location of half end panel from user side.
- Linking bridges are handed **left and right** (handedness is determined by connecting side with the self edge). The opposite connecting side features a reverse profile edge.

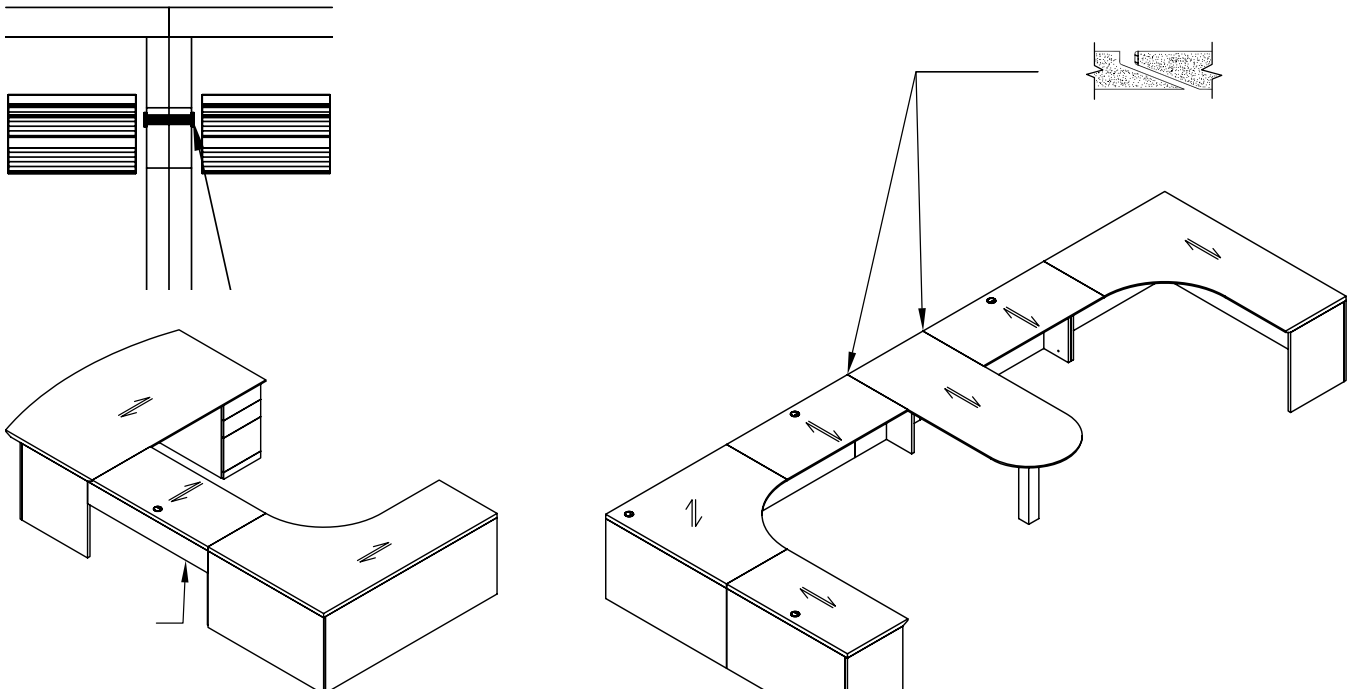

BRIDGES - FLUSH

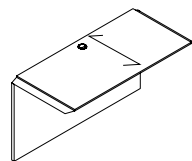

Flush Bridge

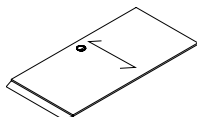

Flush Bridge Top

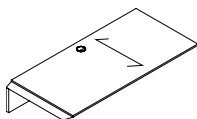

Flush Bridge Top, 8" Modesty Panel

MODEL#	DIMENSIONS D x W x H	FREIGHT CLASS	WT/LBS.	CUBIC FT.	VENEER/LAMINATE	ALL VENEER
DBT6024CG	24 x 60 x 29	70	144	10	\$1670	\$2007
DBT5424CG	24 x 54 x 29	70	129	9	\$1509	\$1808
DBT4824CG	24 x 48 x 29	70	120	8	\$1338	\$1606
DBT4224CG	24 x 42 x 29	85	105	7	\$1172	\$1404
DBT6022CG	22 x 60 x 29	70	138	9	\$1369	\$1642
DBT5422CG	22 x 54 x 29	70	124	8	\$1355	\$1624
DBT4822CG	22 x 48 x 29	85	115	7	\$1202	\$1445
DBT4222CG	22 x 42 x 29	85	101	6	\$1055	\$1268
DBT6020CG	20 x 60 x 29	70	131	8	\$1369	\$1642
DBT5420CG	20 x 54 x 29	85	118	8	\$1235	\$1481
DBT4820CG	20 x 48 x 29	85	110	7	\$1097	\$1316
DBT4220CG	20 x 42 x 29	85	96	6	\$942	\$1127

Top surface, back panel and hardware to create a "U" configuration with a single pedestal desk or credenza. **Cannot be used with corners.** Grommet in worksurface. Shipped RTA (ready to assemble).

- If linking to bookcase or open storage, add **/S** to end of model number

DBT5424TCG	24 x 54 x --	70	129	9	N/A	\$1129
DBT4824TCG	24 x 48 x --	70	120	8	N/A	\$1004
DBT4224TCG	24 x 42 x --	70	105	7	N/A	\$879
DBT5422TCG	22 x 54 x --	70	124	8	N/A	\$907
DBT4822TCG	22 x 48 x --	70	115	7	N/A	\$807
DBT4222TCG	22 x 42 x --	70	101	6	N/A	\$707
DBT5420TCG	20 x 54 x --	70	118	8	N/A	\$829
DBT4820TCG	20 x 48 x --	70	110	7	N/A	\$735
DBT4220TCG	20 x 42 x --	70	96	6	N/A	\$632

Top surface only to create a "U" configuration with a single pedestal desk or credenza. **Cannot be used with corners.** Grommet in worksurface. Shipped RTA (ready to assemble).

- If linking to bookcase or open storage, add **/S** to end of model number

DBT6024Q8CG	24 x 60 x --	70	144	10	\$1502	\$1803
DBT5424Q8CG	24 x 54 x --	70	129	9	\$1355	\$1624
DBT4824Q8CG	24 x 48 x --	70	120	8	\$1203	\$1446
DBT4224Q8CG	24 x 42 x --	70	105	7	\$1053	\$1267
DBT6022Q8CG	22 x 60 x --	70	138	9	\$1355	\$1624
DBT5422Q8CG	22 x 54 x --	70	124	8	\$1219	\$1463
DBT4822Q8CG	22 x 48 x --	70	115	7	\$1082	\$1296
DBT4222Q8CG	22 x 42 x --	70	101	6	\$950	\$1141
DBT6020Q8CG	20 x 60 x --	70	131	8	\$1235	\$1481
DBT5420Q8CG	20 x 54 x --	70	118	8	\$1108	\$1331
DBT4820Q8CG	20 x 48 x --	70	110	7	\$987	\$1185
DBT4220Q8CG	20 x 42 x --	70	96	6	\$846	\$1015

Top surface with 8" modesty panel for utility access. Create a "U" configuration with a single pedestal desk or credenza. **Cannot be used with corners.** Grommet in worksurface. Shipped RTA (ready to assemble).

- If linking to bookcase or open storage, add **/S** to end of model number

Required Specifications

Veneer finish  
Laminate finish

Optional Specifications

Additional grommet

BRIDGES - LINKING

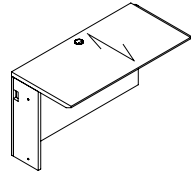

Linking Bridge - LEFT

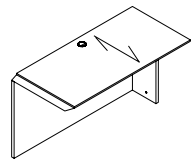

Linking Bridge - RIGHT

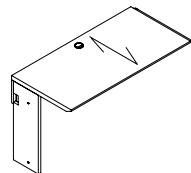

Linking Bridge, 8" Modesty Panel - LEFT

MODEL#	DIMENSIONS	FREIGHT CLASS	WT/LBS.	CUBIC FT.	veneer/LAMINATE	ALL VENEER
<b>D x W x H</b>						
DBT6024NLLCG	24 x 60 x 29	125	145	24	<b>\$1658</b>	<b>\$1987</b>
DBT5424NLLCG	24 x 54 x 29	150	131	22	<b>\$1493</b>	<b>\$1791</b>
DBT4824NLLCG	24 x 48 x 29	125	116	19	<b>\$1327</b>	<b>\$1593</b>
DBT4224NLLCG	24 x 42 x 29	125	102	17	<b>\$1075</b>	<b>\$1290</b>
DBT3624NLLCG	24 x 36 x 29	150	87	15	<b>\$978</b>	<b>\$1174</b>
DBT3024NLLCG	24 x 30 x 29	125	73	12	<b>\$954</b>	<b>\$1144</b>
DBT6022NLLCG	22 x 60 x 29	150	131	22	<b>\$1578</b>	<b>\$1894</b>
DBT5422NLLCG	22 x 54 x 29	150	118	20	<b>\$1423</b>	<b>\$1709</b>
DBT4822NLLCG	22 x 48 x 29	125	110	18	<b>\$1263</b>	<b>\$1514</b>
DBT4222NLLCG	22 x 42 x 29	150	95	16	<b>\$1026</b>	<b>\$1230</b>
DBT3622NLLCG	22 x 36 x 29	125	80	13	<b>\$929</b>	<b>\$1116</b>
DBT3022NLLCG	22 x 30 x 29	150	65	11	<b>\$908</b>	<b>\$1092</b>

Top surface, back panel and hardware. **Left side** connects to a 5-Sided Corner, Extended Corner or Connectable Table. Right side connects to a single pedestal desk or credenza, "D" island, Boat shaped island, "P" island and Delta island with a "T" base. Grommet in worksurface.

DBT6024NLRCG	24 x 60 x 29	125	145	24	<b>\$1658</b>	<b>\$1987</b>
DBT5424NLRCG	24 x 54 x 29	150	131	22	<b>\$1493</b>	<b>\$1791</b>
DBT4824NLRCG	24 x 48 x 29	125	116	19	<b>\$1327</b>	<b>\$1593</b>
DBT4224NLRCG	24 x 42 x 29	125	102	17	<b>\$1075</b>	<b>\$1290</b>
DBT3624NLRCG	24 x 36 x 29	150	87	15	<b>\$978</b>	<b>\$1174</b>
DBT3024NLRCG	24 x 30 x 29	125	73	12	<b>\$954</b>	<b>\$1144</b>

DBT6022NLRCG	22 x 60 x 29	150	131	22	<b>\$1578</b>	<b>\$1894</b>
DBT5422NLRCG	22 x 54 x 29	150	118	20	<b>\$1423</b>	<b>\$1709</b>
DBT4822NLRCG	22 x 48 x 29	125	110	18	<b>\$1263</b>	<b>\$1514</b>
DBT4222NLRCG	22 x 42 x 29	150	95	16	<b>\$1026</b>	<b>\$1230</b>
DBT3622NLRCG	22 x 36 x 29	125	80	13	<b>\$929</b>	<b>\$1116</b>
DBT3022NLRCG	22 x 30 x 29	150	65	11	<b>\$908</b>	<b>\$1092</b>

Top surface, back panel and hardware. **Right side** connects to a 5-Sided Corner, Extended Corner or Connectable Table. Left side connects to a single pedestal desk or credenza, "D" island, Boat shaped island, "P" island and Delta island with a "T" base. Grommet in worksurface.

DBT6024NLLQ8CG	24 x 60 x 29	125	145	24	<b>\$1824</b>	<b>\$2188</b>
DBT5424NLLQ8CG	24 x 54 x 29	150	131	22	<b>\$1645</b>	<b>\$1975</b>
DBT4824NLLQ8CG	24 x 48 x 29	125	116	19	<b>\$1462</b>	<b>\$1755</b>
DBT4224NLLQ8CG	24 x 42 x 29	125	102	17	<b>\$1315</b>	<b>\$1575</b>
DBT3624NLLQ8CG	24 x 36 x 29	150	87	15	<b>\$1075</b>	<b>\$1290</b>
DBT3024NLLQ8CG	24 x 30 x 29	125	73	12	<b>\$1052</b>	<b>\$1263</b>

DBT6022NLLQ8CG	22 x 60 x 29	150	131	22	<b>\$1738</b>	<b>\$2085</b>
DBT5422NLLQ8CG	22 x 54 x 29	150	118	20	<b>\$1565</b>	<b>\$1879</b>
DBT4822NLLQ8CG	22 x 48 x 29	125	110	18	<b>\$1391</b>	<b>\$1667</b>
DBT4222NLLQ8CG	22 x 42 x 29	150	95	16	<b>\$1125</b>	<b>\$1348</b>
DBT3622NLLQ8CG	22 x 36 x 29	125	80	13	<b>\$1023</b>	<b>\$1229</b>
DBT3022NLLQ8CG	22 x 30 x 29	150	65	11	<b>\$1000</b>	<b>\$1199</b>

Top surface with 8" modesty panel for utility access and hardware. **Left side** connects to a 5-Sided Corner, Extended Corner or Connectable Table. Right side connects to a single pedestal desk or credenza, "D" island, Boat shaped island, "P" island and Delta island with a "T" base. Grommet in worksurface. Shipped RTA (ready to assemble).

**Required Specifications**

Veneer finish  
Laminate finish

**Optional Specifications**

Additional grommet

## BRIDGES - LINKING

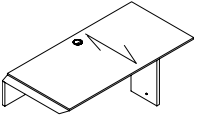

**Linking Bridge, 8" Modesty Panel - RIGHT**

MODEL#	DIMENSIONS	FREIGHT CLASS	WT/LBS.	CUBIC FT.	VENEER/LAMINATE	ALL VENEER
<b>D x W x H</b>						
DBT6024NLRQ8CG	24 x 60 x 29	125	145	24	<b>\$1824</b>	<b>\$2188</b>
DBT5424NLRQ8CG	24 x 54 x 29	150	131	22	<b>\$1645</b>	<b>\$1975</b>
DBT4824NLRQ8CG	24 x 48 x 29	125	116	19	<b>\$1462</b>	<b>\$1755</b>
DBT4224NLRQ8CG	24 x 42 x 29	125	102	17	<b>\$1315</b>	<b>\$1575</b>
DBT3624NLRQ8CG	24 x 36 x 29	150	87	15	<b>\$1075</b>	<b>\$1290</b>
DBT3024NLRQ8CG	24 x 30 x 29	125	73	12	<b>\$1052</b>	<b>\$1263</b>
DBT6022NLRQ8CG	22 x 60 x 29	150	131	22	<b>\$1738</b>	<b>\$2085</b>
DBT5422NLRQ8CG	22 x 54 x 29	150	118	20	<b>\$1565</b>	<b>\$1879</b>
DBT4822NLRQ8CG	22 x 48 x 29	125	110	18	<b>\$1391</b>	<b>\$1667</b>
DBT4222NLRQ8CG	22 x 42 x 29	150	95	16	<b>\$1125</b>	<b>\$1348</b>
DBT3622NLRQ8CG	22 x 36 x 29	125	80	13	<b>\$1023</b>	<b>\$1229</b>
DBT3022NLRQ8CG	22 x 30 x 29	150	65	11	<b>\$1000</b>	<b>\$1199</b>

Top surface with 8" modesty panel for utility access and hardware. **Right side** connects to a 5-Sided Corner, Extended Corner or Connectable Table. Right side connects to a single pedestal desk or credenza, "D" island, Boat shaped island, "P" island and Delta island with a "T" base. Grommet in worksurface. Shipped RTA (ready to assemble).

## CREDENZAS

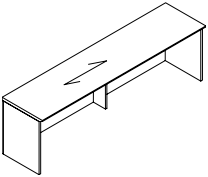

sizes 96" and larger

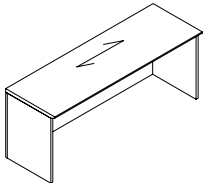

sizes less than 96"

**Credenza Shell\***

MODEL#	DIMENSIONS	FREIGHT CLASS	WT/LBS.	CUBIC FT.	VENEER/LAMINATE	ALL VENEER
DC12024	24 x 120 x 29	100	387	48	<b>\$4169</b>	<b>\$5003</b>
DC11424	24 x 114 x 29	125	367	46	<b>\$3960</b>	<b>\$4754</b>
DC10824	24 x 108 x 29	125	348	44	<b>\$3754</b>	<b>\$4502</b>
DC10224	24 x 102 x 29	100	329	41	<b>\$3545</b>	<b>\$4253</b>
DC9624	24 x 96 x 29	125	309	39	<b>\$3335</b>	<b>\$4001</b>
DC9024	24 x 90 x 29	100	290	36	<b>\$3128</b>	<b>\$3754</b>
DC8424	24 x 84 x 29	125	271	34	<b>\$2920</b>	<b>\$3505</b>
DC7824	24 x 78 x 29	100	251	31	<b>\$2711</b>	<b>\$3252</b>
DC7224	24 x 72 x 29	100	232	29	<b>\$2502</b>	<b>\$3002</b>
DC6624	24 x 66 x 29	125	213	27	<b>\$2408</b>	<b>\$2892</b>
DC6024	24 x 60 x 29	100	193	24	<b>\$2189</b>	<b>\$2627</b>
DC5424	24 x 54 x 29	125	174	22	<b>\$2076</b>	<b>\$2493</b>
DC4824	24 x 48 x 29	100	155	19	<b>\$1961</b>	<b>\$2353</b>
DC4224	24 x 42 x 29	125	135	17	<b>\$1661</b>	<b>\$1993</b>
DC12022	22 x 120 x 29	100	358	44	<b>\$3822</b>	<b>\$4585</b>
DC11422	22 x 114 x 29	100	340	42	<b>\$3630</b>	<b>\$4355</b>
DC10822	22 x 108 x 29	100	323	40	<b>\$3438</b>	<b>\$4128</b>
DC10222	22 x 102 x 29	100	305	38	<b>\$3245</b>	<b>\$3898</b>
DC9622	22 x 96 x 29	100	287	35	<b>\$3061</b>	<b>\$3671</b>
DC9022	22 x 90 x 29	100	269	33	<b>\$2868</b>	<b>\$3442</b>
DC8422	22 x 84 x 29	100	251	31	<b>\$2678</b>	<b>\$3216</b>
DC7822	22 x 78 x 29	100	233	29	<b>\$2484</b>	<b>\$2983</b>
DC7222	22 x 72 x 29	125	215	27	<b>\$2296</b>	<b>\$2754</b>
DC6622	22 x 66 x 29	100	197	24	<b>\$2213</b>	<b>\$2656</b>
DC6022	22 x 60 x 29	100	179	22	<b>\$2009</b>	<b>\$2408</b>
DC5422	22 x 54 x 29	100	161	20	<b>\$1903</b>	<b>\$2284</b>
DC4822	22 x 48 x 29	125	143	18	<b>\$1802</b>	<b>\$2162</b>
DC4222	22 x 42 x 29	125	125	16	<b>\$1522</b>	<b>\$1829</b>

Standard with **no pedestals**. Flush full modesty panel. 96" w and larger includes a center support leg. If using storage component shells underneath to support the worksurface, **no more than 72" may be left unsupported**.

### Required Specifications

Veneer finish  
Laminate finish

### Optional Specifications

Additional grommet

### Accessories

Modular Storage\*

CREDENZAS

MODEL# DIMENSIONS FREIGHT CLASS WT/LBS. CUBIC FT. VENEER/LAMINATE ALL VENEER

D x W x H

DCK8424EE	24 x 84 x 29	92.5	348	34	\$6178	\$7413
DCK7824EE	24 x 78 x 29	92.5	319	31	\$5740	\$6888
DCK7224EE	24 x 72 x 29	100	280	29	\$5301	\$6360
DCK6624EE	24 x 66 x 29	100	261	27	\$5220	\$6265
DCK6024EE	24 x 60 x 29	100	238	24	\$4856	\$5826

DCK8422EE	22 x 84 x 29	92.5	320	34	\$5663	\$6796
DCK7822EE	22 x 78 x 29	92.5	298	31	\$5262	\$6313
DCK7222EE	22 x 72 x 29	92.5	280	29	\$4857	\$5827
DCK6622EE	22 x 66 x 29	92.5	257	27	\$4784	\$5742
DCK6022EE	22 x 60 x 29	92.5	233	24	\$4449	\$5339

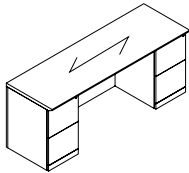

Kneespace Credenza

Standard with full to floor **file/file** pedestals on **left and right**. **Center is open** Pedestals lock.

DCK8424DD	24 x 84 x 29	92.5	348	34	\$6178	\$7413
DCK7824DD	24 x 78 x 29	92.5	319	31	\$5740	\$6888
DCK7224DD	24 x 72 x 29	100	280	29	\$5301	\$6360
DCK6624DD	24 x 66 x 29	100	261	27	\$5220	\$6265
DCK6024DD	24 x 60 x 29	100	238	24	\$4856	\$5826

DCK8422DD	22 x 84 x 29	92.5	320	34	\$5663	\$6796
DCK7822DD	22 x 78 x 29	92.5	298	31	\$5262	\$6313
DCK7222DD	22 x 72 x 29	92.5	280	29	\$4857	\$5827
DCK6622DD	22 x 66 x 29	92.5	257	27	\$4784	\$5742
DCK6022DD	22 x 60 x 29	92.5	233	24	\$4449	\$5339

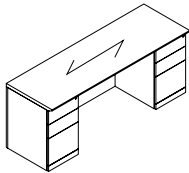

Kneespace Credenza

Standard with full to floor **box/box/file** pedestals on **left and right**. **Center is open** Pedestals lock. One pencil tray.

DCK8424ED	24 x 84 x 29	92.5	348	34	\$6178	\$7413
DCK7824ED	24 x 78 x 29	92.5	319	31	\$5740	\$6888
DCK7224ED	24 x 72 x 29	100	280	29	\$5301	\$6360
DCK6624ED	24 x 66 x 29	100	261	27	\$5220	\$6265
DCK6024ED	24 x 60 x 29	100	238	24	\$4856	\$5826

DCK8422ED	22 x 84 x 29	92.5	320	34	\$5663	\$6796
DCK7822ED	22 x 78 x 29	92.5	298	31	\$5262	\$6313
DCK7222ED	22 x 72 x 29	92.5	280	29	\$4857	\$5827
DCK6622ED	22 x 66 x 29	92.5	257	27	\$4784	\$5742
DCK6022ED	22 x 60 x 29	92.5	233	24	\$4449	\$5339

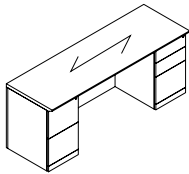

Kneespace Credenza

Standard with full to floor **file/file** pedestal on **left** and **box/box/file** pedestal on **right**. **Center is open** Pedestals lock. One pencil tray.

DCK8424DE	24 x 84 x 29	92.5	348	34	\$6178	\$7413
DCK7824DE	24 x 78 x 29	92.5	319	31	\$5740	\$6888
DCK7224DE	24 x 72 x 29	100	280	29	\$5301	\$6360
DCK6624DE	24 x 66 x 29	100	261	27	\$5220	\$6265
DCK6024DE	24 x 60 x 29	100	238	24	\$4856	\$5826

DCK8422DE	22 x 84 x 29	92.5	320	34	\$5663	\$6796
DCK7822DE	22 x 78 x 29	92.5	298	31	\$5262	\$6313
DCK7222DE	22 x 72 x 29	92.5	280	29	\$4857	\$5827
DCK6622DE	22 x 66 x 29	92.5	257	27	\$4784	\$5742
DCK6022DE	22 x 60 x 29	92.5	233	24	\$4449	\$5339

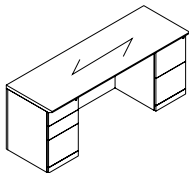

Kneespace Credenza

Standard with full to floor **box/box/file** pedestal on **left** and **file/file** pedestal on **right**. **Center is open** Pedestals lock. One pencil tray.

**Required Specifications**

- Veneer Finish
- Laminate Finish
- Handle style

**Optional Specifications**

- Grommet



CREDENZAS

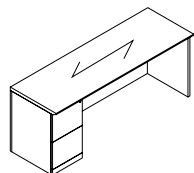

Single Pedestal Credenza - LEFT

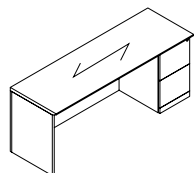

Single Pedestal Credenza - RIGHT

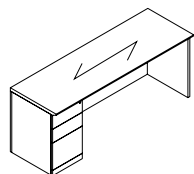

Single Pedestal Credenza - LEFT

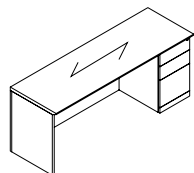

Single Pedestal Credenza - RIGHT

MODEL#	DIMENSIONS D x W x H	FREIGHT CLASS	WT/LBS.	CUBIC FT.	VENEER/LAMINATE	ALL VENEER
DCL8424E	24 x 84 x 29	100	315	34	\$4673	\$5608
DCL7824E	24 x 78 x 29	100	292	31	\$4340	\$5205
DCL7224E	24 x 72 x 29	100	270	29	\$4007	\$4807
DCL6624E	24 x 66 x 29	100	247	27	\$3857	\$4629
DCL6024E	24 x 60 x 29	100	225	24	\$3507	\$4207
DCL8422E	22 x 84 x 29	100	286	34	\$4284	\$5140
DCL7822E	22 x 78 x 29	100	265	31	\$3980	\$4777
DCL7222E	22 x 72 x 29	100	250	29	\$3676	\$4407
DCL6622E	22 x 66 x 29	100	229	27	\$3537	\$4245
DCL6022E	22 x 60 x 29	100	208	24	\$3216	\$3857

Standard with full to floor **file/file** pedestal on **left**. Pedestal locks.

DCR8424E	24 x 84 x 29	100	315	34	\$4673	\$5608
DCR7824E	24 x 78 x 29	100	292	31	\$4340	\$5205
DCR7224E	24 x 72 x 29	100	270	29	\$4007	\$4807
DCR6624E	24 x 66 x 29	100	247	27	\$3857	\$4629
DCR6024E	24 x 60 x 29	100	225	24	\$3507	\$4207
DCR8422E	22 x 84 x 29	100	286	34	\$4284	\$5140
DCR7822E	22 x 78 x 29	100	265	31	\$3980	\$4777
DCR7222E	22 x 72 x 29	100	250	29	\$3676	\$4407
DCR6622E	22 x 66 x 29	100	229	27	\$3537	\$4245
DCR6022E	22 x 60 x 29	100	208	24	\$3216	\$3857

Standard with full to floor **file/file** pedestal on **right**. Pedestal locks.

DCL8424D	24 x 84 x 29	100	315	34	\$4673	\$5608
DCL7824D	24 x 78 x 29	100	292	31	\$4340	\$5205
DCL7224D	24 x 72 x 29	100	270	29	\$4007	\$4807
DCL6624D	24 x 66 x 29	100	247	27	\$3857	\$4629
DCL6024D	24 x 60 x 29	100	225	24	\$3507	\$4207
DCL8422D	22 x 84 x 29	100	286	34	\$4284	\$5140
DCL7822D	22 x 78 x 29	100	265	31	\$3980	\$4777
DCL7222D	22 x 72 x 29	100	250	29	\$3676	\$4407
DCL6622D	22 x 66 x 29	100	229	27	\$3537	\$4245
DCL6022D	22 x 60 x 29	100	208	24	\$3216	\$3857

Standard with full to floor **box/box/file** pedestal on **left**. Pedestal locks.

DCR8424D	24 x 84 x 29	100	315	34	\$4673	\$5608
DCR7824D	24 x 78 x 29	100	292	31	\$4340	\$5205
DCR7224D	24 x 72 x 29	100	270	29	\$4007	\$4807
DCR6624D	24 x 66 x 29	100	247	27	\$3857	\$4629
DCR6024D	24 x 60 x 29	100	225	24	\$3507	\$4207
DCR8422D	22 x 84 x 29	100	286	34	\$4284	\$5140
DCR7822D	22 x 78 x 29	100	265	31	\$3980	\$4777
DCR7222D	22 x 72 x 29	100	250	29	\$3676	\$4407
DCR6622D	22 x 66 x 29	100	229	27	\$3537	\$4245
DCR6022D	22 x 60 x 29	100	208	24	\$3216	\$3857

Standard with full to floor **box/box/file** pedestal on **right**. Pedestal locks.

**Required Specifications**

Veneer Finish  
Laminate Finish  
Handle style

**Optional Specifications**

Grommet

CRENZAS

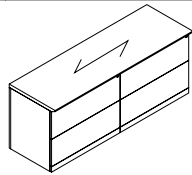

Lateral File Credenza

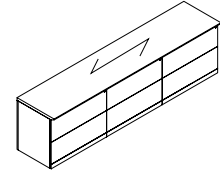

Lateral File Credenza

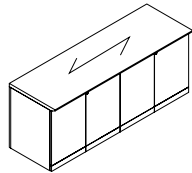

Storage Cabinet Credenza

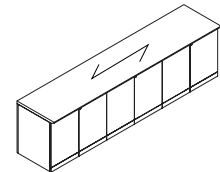

Storage Cabinet Credenza

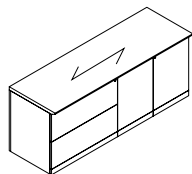

Lateral File/Storage Cabinet Credenza

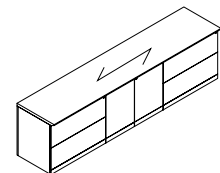

Lateral File/Storage Cabinet Credenza

MODEL#	DIMENSIONS D x W x H	FREIGHT CLASS	WT/LBS.	CUBIC FT.	VENEER/LAMINATE	ALL VENEER
DC7224FF	24 x 72 x 29	92.5	328	29	\$6445	\$7738
DC7222FF	22 x 72 x 29	92.5	300	27	\$5912	\$7092
DC6024NN	24 x 60 x 29	92.5	273	24	\$5911	\$7091
DC6022NN	22 x 60 x 29	100	218	22	\$5422	\$6508

Two 2-drawer lateral files side-by-side. Locking drawers. Anti-lock tilt suspension. **Not for stacking materials on lateral file drawer bottom.**

- "FF" models use two 36" wide lateral files, "NN" models use 30" wide.

DC10824FFF	24 x 108 x 29	92.5	457	44	\$11339	\$13606
DC10822FFF	22 x 108 x 29	92.5	435	40	\$10393	\$12472
DC9024NNN	24 x 90 x 29	92.5	381	36	\$9452	\$11341
DC9022NNN	22 x 90 x 29	92.5	372	33	\$8666	\$10400

Three 2-drawer lateral files side-by-side. Locking drawers. Anti-lock tilt suspension. **Not for stacking materials on lateral file drawer bottom.**

- "FFF" models use two 36" wide lateral files, "NNN" models use 30" wide.

DC7224GG	24 x 72 x 29	92.5	300	29	\$4785	\$5744
DC7222GG	22 x 72 x 29	92.5	277	27	\$4387	\$5264
DC6024MM	24 x 60 x 29	92.5	254	24	\$4387	\$5264
DC6022MM	22 x 60 x 29	92.5	232	22	\$4023	\$4828

Two 2-door storage cabinets side-by-side. Locking doors. Self-closing hinged doors cover one adjustable shelf.

- "GG" models use two 36" wide storage cabinets, "MM" models use 30" wide.

DC10824GGG	24 x 108 x 29	100	392	44	\$9041	\$10849
DC10822GGG	22 x 108 x 29	100	348	40	\$8287	\$9944
DC9024MMM	24 x 90 x 29	100	326	36	\$7535	\$9042
DC9022MMM	22 x 90 x 29	100	302	33	\$6910	\$8291

Three 2-door storage cabinets side-by-side. Locking doors. Self-closing hinged doors cover one adjustable shelf.

- "GGG" models use two 36" wide storage cabinets, "MMM" models use 30" wide.

DCF7224	24 x 72 x 29	92.5	305	29	\$5044	\$6053
DCF7222	22 x 72 x 29	92.5	285	27	\$4624	\$5550
DCF6024	24 x 60 x 29	92.5	254	24	\$4204	\$5044
DCF6022	22 x 60 x 29	92.5	233	22	\$3853	\$4622

One 2-drawer lateral file and one storage cabinet. Locking door/drawers. Storage cabinet includes one adjustable shelf. Anti-lock tilt suspension. **Not for stacking materials on lateral file drawer bottom.**

DC10824FGF	24 x 108 x 29	92.5	392	44	\$10576	\$12692
DC10822FGF	22 x 108 x 29	92.5	348	40	\$9691	\$11631
DC9024NMN	24 x 90 x 29	92.5	326	36	\$8813	\$10576
DC9022NMN	22 x 90 x 29	92.5	302	33	\$8080	\$9696

One 2-drawer lateral file and one storage cabinet. Locking door/drawers. Storage cabinet includes one adjustable shelf. Anti-lock tilt suspension. **Not for stacking materials on lateral file drawer bottom.**

- "FGF" models use two 36" wide lateral files and one 36" wide storage cabinet, "NMN" models use 30" wide.

**Required Specifications**

- Veneer Finish
- Laminate Finish
- Handle style

**CREDENZAS**

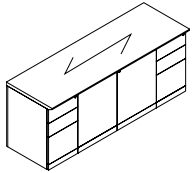

**Vertical File/Storage Cabinet Credenza**

MODEL#	DIMENSIONS D x W x H	FREIGHT CLASS	WT./LBS.	CUBIC FT.	VENEER/LAMINATE	ALL VENEER
DCD7224D	24 x 72 x 29	92.5	319	29	<b>\$5912</b>	<b>\$7092</b>
DCD7222D	22 x 72 x 29	92.5	298	24	<b>\$5422</b>	<b>\$6508</b>
DCD6024D	24 x 60 x 29	92.5	266	24	<b>\$5422</b>	<b>\$6508</b>
DCD6022D	22 x 60 x 29	92.5	246	20	<b>\$4969</b>	<b>\$5965</b>

Two box/box/file vertical files and one storage cabinet. Locking door/drawers. Storage cabinet includes one adjustable shelf. One pencil tray.

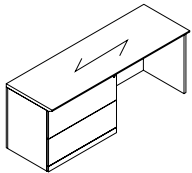

**Kneespace Lateral File Credenza - LEFT\***

DCL8424F	24 x 84 x 29	100	305	34	<b>\$5429</b>	<b>\$6515</b>
DCL7824F	24 x 78 x 29	100	285	31	<b>\$5042</b>	<b>\$6052</b>
DCL7224F	24 x 72 x 29	100	261	29	<b>\$4653</b>	<b>\$5584</b>
DCL6624F	24 x 66 x 29	100	239	27	<b>\$4480</b>	<b>\$5375</b>
DCL6024F	24 x 60 x 29	100	218	24	<b>\$4070</b>	<b>\$4884</b>
DCL8422F	22 x 84 x 29	100	266	31	<b>\$4982</b>	<b>\$5976</b>
DCL7822F	22 x 78 x 29	100	245	29	<b>\$4622</b>	<b>\$5548</b>
DCL7222F	22 x 72 x 29	100	230	27	<b>\$4270</b>	<b>\$5124</b>
DCL6622F	22 x 66 x 29	100	209	24	<b>\$4109</b>	<b>\$4932</b>
DCL6022F	22 x 60 x 29	100	188	22	<b>\$3732</b>	<b>\$4477</b>

One 2-drawer lateral file on the **left**. Locking drawers. Anti-lock tilt suspension. **Not for stacking materials on lateral file drawer bottom.**

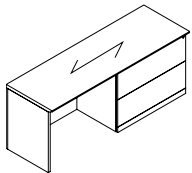

**Kneespace Lateral File Credenza - RIGHT\***

DCR8424F	24 x 84 x 29	100	305	34	<b>\$5429</b>	<b>\$6515</b>
DCR7824F	24 x 78 x 29	100	285	31	<b>\$5042</b>	<b>\$6052</b>
DCR7224F	24 x 72 x 29	100	261	29	<b>\$4653</b>	<b>\$5584</b>
DCR6624F	24 x 66 x 29	100	239	27	<b>\$4480</b>	<b>\$5375</b>
DCR6024F	24 x 60 x 29	100	218	24	<b>\$4070</b>	<b>\$4884</b>
DCR8422F	22 x 84 x 29	100	266	31	<b>\$4982</b>	<b>\$5976</b>
DCR7822F	22 x 78 x 29	100	245	29	<b>\$4622</b>	<b>\$5548</b>
DCR7222F	22 x 72 x 29	100	230	27	<b>\$4270</b>	<b>\$5124</b>
DCR6622F	22 x 66 x 29	100	209	24	<b>\$4109</b>	<b>\$4932</b>
DCR6022F	22 x 60 x 29	100	188	22	<b>\$3732</b>	<b>\$4477</b>

One 2-drawer lateral file on the **right**. Locking drawers. Anti-lock tilt suspension. **Not for stacking materials on lateral file drawer bottom.**

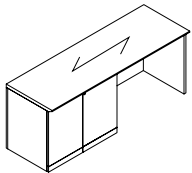

**Kneespace Storage Cabinet \* Credenza - LEFT**

DCL8424G	24 x 84 x 29	100	338	34	<b>\$4872</b>	<b>\$5848</b>
DCL7824G	24 x 78 x 29	92.5	314	31	<b>\$4527</b>	<b>\$5433</b>
DCL7224G	24 x 72 x 29	92.5	290	29	<b>\$4178</b>	<b>\$5014</b>
DCL6624G	24 x 66 x 29	100	266	27	<b>\$4022</b>	<b>\$4826</b>
DCL6024G	24 x 60 x 29	92.5	242	24	<b>\$3659</b>	<b>\$4391</b>
DCL8422G	22 x 84 x 29	100	266	31	<b>\$4474</b>	<b>\$5370</b>
DCL7822G	22 x 78 x 29	100	245	29	<b>\$4153</b>	<b>\$4985</b>
DCL7222G	22 x 72 x 29	100	230	27	<b>\$3832</b>	<b>\$4597</b>
DCL6622G	22 x 66 x 29	92.5	209	24	<b>\$3687</b>	<b>\$4424</b>
DCL6022G	22 x 60 x 29	92.5	188	22	<b>\$3357</b>	<b>\$4026</b>

One storage cabinet on **left**. Locking doors. Storage cabinet has one adjustable shelf.

**Required Specifications**

Veneer Finish  
Laminate Finish  
Handle style

**Optional Specifications**

Grommet\*

CRENZAS

MODEL# DIMENSIONS FREIGHT CLASS WT/LBS. CUBIC FT. VENEER/LAMINATE ALL VENEER

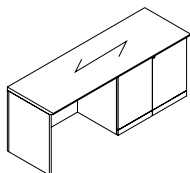

**Kneespace Storage Cabinet Credenza - RIGHT**

	D x W x H						
DCR8424G	24 x 84 x 29	100	338	34	\$4872	\$5848	
DCR7824G	24 x 78 x 29	92.5	314	31	\$4527	\$5433	
DCR7224G	24 x 72 x 29	92.5	290	29	\$4178	\$5014	
DCR6624G	24 x 66 x 29	100	266	27	\$4022	\$4826	
DCR6024G	24 x 60 x 29	92.5	242	24	\$3659	\$4391	
DCR8422G	22 x 84 x 29	100	266	31	\$4474	\$5370	
DCR7822G	22 x 78 x 29	100	245	29	\$4153	\$4985	
DCR7222G	22 x 72 x 29	100	230	27	\$3832	\$4597	
DCR6622G	22 x 66 x 29	92.5	209	24	\$3687	\$4424	
DCR6022G	22 x 60 x 29	92.5	188	22	\$3357	\$4026	

One storage cabinet on **right**. Locking doors. Storage cabinet has one adjustable shelf.

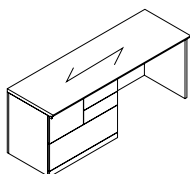

**Mixed Storage Credenza - LEFT**

DCL8424Z	24 x 84 x 29	100	338	34	\$5929	\$7116	
DCL7824Z	24 x 78 x 29	92.5	314	31	\$5506	\$6606	
DCL7224Z	24 x 72 x 29	92.5	290	29	\$5084	\$6099	
DCL6624Z	24 x 66 x 29	100	266	27	\$4893	\$5872	
DCL6024Z	24 x 60 x 29	92.5	242	24	\$4447	\$5335	
DCL8422Z	22 x 84 x 29	92.5	309	31	\$5434	\$6523	
DCL7822Z	22 x 78 x 29	100	287	29	\$5047	\$6057	
DCL7222Z	22 x 72 x 29	92.5	270	27	\$4661	\$5592	
DCL6622Z	22 x 66 x 29	92.5	248	24	\$4486	\$5382	
DCL6022Z	22 x 60 x 29	92.5	225	22	\$4077	\$4893	

Standard with two box drawers, one file drawer, and one 36"W lateral file drawer on the **left**. File drawer and lateral file drawer lock. Front-to-back and side-to-side filing. **Not for stacking materials on lateral file drawer bottom.**

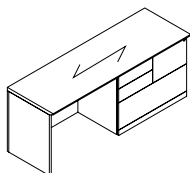

**Mixed Storage Credenza - RIGHT**

DCR8424Z	24 x 84 x 29	100	338	34	\$5929	\$7116	
DCR7824Z	24 x 78 x 29	92.5	314	31	\$5506	\$6606	
DCR7224Z	24 x 72 x 29	92.5	290	29	\$5084	\$6099	
DCR6624Z	24 x 66 x 29	100	266	27	\$4893	\$5872	
DCR6024Z	24 x 60 x 29	92.5	242	24	\$4447	\$5335	
DCR8422Z	22 x 84 x 29	92.5	309	31	\$5434	\$6523	
DCR7822Z	22 x 78 x 29	100	287	29	\$5048	\$6058	
DCR7222Z	22 x 72 x 29	92.5	270	27	\$4661	\$5592	
DCR6622Z	22 x 66 x 29	92.5	248	24	\$4486	\$5382	
DCR6022Z	22 x 60 x 29	92.5	225	22	\$4077	\$4893	

Standard with two box drawers, one file drawer, and one 36"W lateral file drawer on the **right**. File drawer and lateral file drawer lock. Front-to-back and side-to-side filing. **Not for stacking materials on lateral file drawer bottom.**

**Required Specifications**

Veneer Finish  
Laminate Finish  
Handle style

**Optional Specifications**

Grommet

# D DUFFERIN

**CORNERS**      **MODEL#**      **DIMENSIONS**      **FREIGHT CLASS**      **WT./LBS.**      **CUBIC FT.**      **VENEER/LAMINATE**      **ALL VENEER**

**D x W x H**

- A Corner Desk is used to connect to a Linking Bridge and Linking Credenza, or Connectable Table
- Cable management tray is included.
- Full Modesty Panel option.
- 5-Sided Corners include a GM1 grommet in the top center position. Grommets are available as an option on Extended Corners.
- Hand of Linking Credenza is determined by location of full end panel from user side.
- Hand of Extended Corner is determined by location of long narrow end from user side.
- Connecting sides feature a self edge.

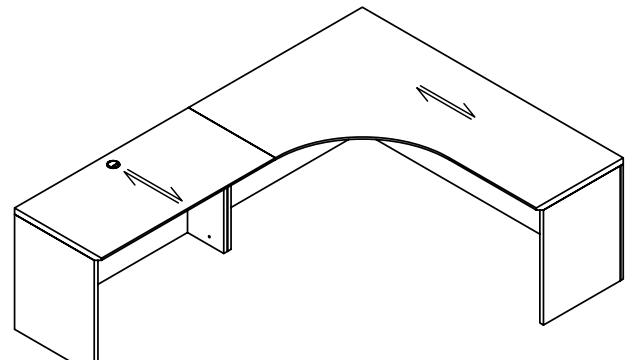
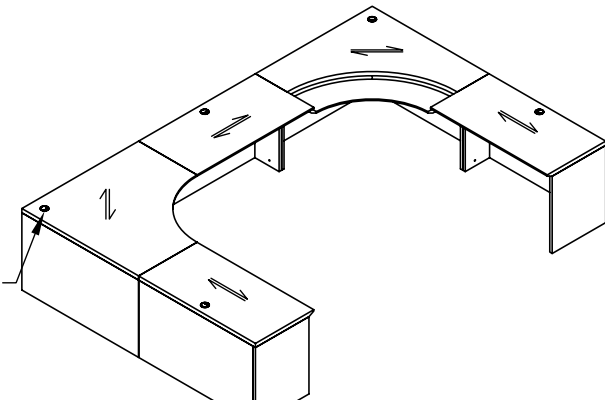
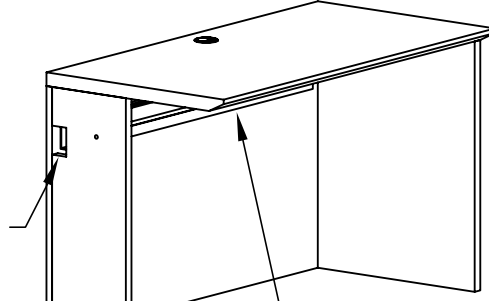
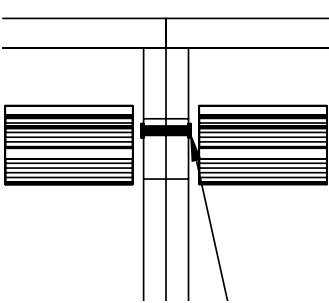

**5-SIDED CORNERS**      **MODEL#**      **DIMENSIONS**      **FREIGHT CLASS**      **WT./LBS.**      **CUBIC FT.**      **VENEER/LAMINATE**      **ALL VENEER**

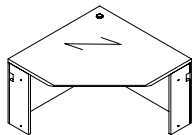

**5-Sided Corner**

DE484824	48 x 48 x 29	150	201	39	<b>\$2832</b>	<b>\$3398</b>
DE424224	42 x 42 x 29	150	155	30	<b>\$2172</b>	<b>\$2604</b>
DE363624	36 x 36 x 29	125	135	22	<b>\$2064</b>	<b>\$2477</b>

Connects to **24"D** connectables, returns, extended corners, storage/lateral file credenzas, credenzas and bridges. Includes grommet and installed horizontal wire management. Narrow end panels on left and right.

- *Not freestanding*

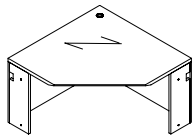

**5-Sided Corner**

DE484822	48 x 48 x 29	150	196	39	<b>\$2832</b>	<b>\$3398</b>
DE424222	42 x 42 x 29	150	150	30	<b>\$2172</b>	<b>\$2604</b>
DE363622	36 x 36 x 29	150	130	22	<b>\$2064</b>	<b>\$2477</b>

Connects to **22"D** connectables, returns, extended corners, storage/lateral file credenzas, credenzas and bridges. Includes grommet and installed horizontal wire management. Narrow end panels on left and right.

- *Not freestanding*

**Required Specifications**

Veneer Finish  
Laminate Finish

**Optional Specifications**

Additional grommet

**LEFT EXTENDED CORNERS**

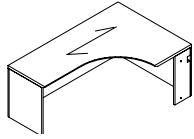

**Left Extended Corner**

MODEL#	DIMENSIONS	FREIGHT CLASS	WT/LBS.	CUBIC FT.	VENEER/LAMINATE	ALL VENEER
	<b>D x W x H</b>					
DEKL964824	24-48 x 96 x 29	150	387	77	<b>\$4714</b>	<b>\$5654</b>
DEKL904824	24-48 x 90 x 29	150	363	73	<b>\$4384</b>	<b>\$5260</b>
DEKL844824	24-48 x 84 x 29	150	338	68	<b>\$4378</b>	<b>\$5255</b>
DEKL784824	24-48 x 78 x 29	150	314	63	<b>\$4308</b>	<b>\$5169</b>
DEKL724824	24-48 x 72 x 29	150	290	58	<b>\$4039</b>	<b>\$4847</b>
DEKL664824	24-48 x 66 x 29	150	266	52	<b>\$3820</b>	<b>\$4583</b>
DEKL604824	24-48 x 60 x 29	150	242	48	<b>\$3539</b>	<b>\$4246</b>

Extended worksurface on **left. Full end panel on left, narrow end panel on right.** Connects to Linking Bridges, Extended Corners and Connectable Tables.

**RIGHT EXTENDED CORNERS**

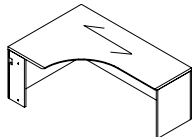

**Right Extended Corner**

MODEL#	DIMENSIONS	FREIGHT CLASS	WT/LBS.	CUBIC FT.	VENEER/LAMINATE	ALL VENEER
DEKR489624	24-48 x 96 x 29	150	387	77	<b>\$4714</b>	<b>\$5654</b>
DEKR489024	24-48 x 90 x 29	150	363	73	<b>\$4384</b>	<b>\$5260</b>
DEKR488424	24-48 x 84 x 29	150	338	68	<b>\$4378</b>	<b>\$5255</b>
DEKR487824	24-48 x 78 x 29	150	314	63	<b>\$4308</b>	<b>\$5169</b>
DEKR487224	24-48 x 72 x 29	150	290	58	<b>\$4039</b>	<b>\$4847</b>
DEKR486624	24-48 x 66 x 29	150	266	52	<b>\$3820</b>	<b>\$4583</b>
DEKR486024	24-48 x 60 x 29	150	242	48	<b>\$3539</b>	<b>\$4246</b>

Extended worksurface on **right. Full end panel on right, narrow end panel on left.** Connects to Linking Bridges, Extended Corners and Connectable Tables.

**FREESTANDING TABLES**

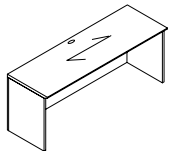

**24" Deep Freestanding Table**

MODEL#	DIMENSIONS	FREIGHT CLASS	WT/LBS.	CUBIC FT.	VENEER/LAMINATE	ALL VENEER
DVT9624	24 x 96 x 29	150	213	39	<b>\$2810</b>	<b>\$3371</b>
DVT9024	24 x 90 x 29	150	199	36	<b>\$2633</b>	<b>\$3160</b>
DVT8424	24 x 84 x 29	150	186	34	<b>\$2459</b>	<b>\$2951</b>
DVT7824	24 x 78 x 29	150	173	31	<b>\$2284</b>	<b>\$2741</b>
DVT7224	24 x 72 x 29	150	160	29	<b>\$2108</b>	<b>\$2528</b>
DVT6624	24 x 66 x 29	150	146	27	<b>\$1982</b>	<b>\$2379</b>
DVT6024	24 x 60 x 29	150	133	24	<b>\$1856</b>	<b>\$2227</b>
DVT5424	24 x 54 x 29	150	128	22	<b>\$1755</b>	<b>\$2105</b>
DVT4824	24 x 48 x 29	125	120	19	<b>\$1649</b>	<b>\$1980</b>
DVT4224	24 x 42 x 29	125	104	17	<b>\$1397</b>	<b>\$1678</b>
DVT3624	24 x 36 x 29	150	88	15	<b>\$1353</b>	<b>\$1623</b>
DVT3024	24 x 30 x 29	125	82	12	<b>\$1327</b>	<b>\$1593</b>
DVT2424	24 x 24 x 29	125	65	10	<b>\$1115</b>	<b>\$1338</b>

Two full end panels. **Cannot be connected on left or right side.**

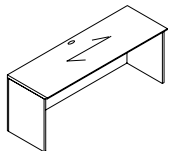

**22" Deep Freestanding Table**

DVT9622	22 x 96 x 29	150	193	35	<b>\$2677</b>	<b>\$3214</b>
DVT9022	22 x 90 x 29	150	181	33	<b>\$2507</b>	<b>\$3011</b>
DVT8422	22 x 84 x 29	150	169	31	<b>\$2345</b>	<b>\$2813</b>
DVT7822	22 x 78 x 29	150	157	29	<b>\$2174</b>	<b>\$2609</b>
DVT7222	22 x 72 x 29	150	145	27	<b>\$2009</b>	<b>\$2408</b>
DVT6622	22 x 66 x 29	150	138	24	<b>\$1887</b>	<b>\$2263</b>
DVT6022	22 x 60 x 29	150	130	22	<b>\$1768</b>	<b>\$2123</b>
DVT5422	22 x 54 x 29	125	123	20	<b>\$1668</b>	<b>\$2006</b>
DVT4822	22 x 48 x 29	125	115	18	<b>\$1573</b>	<b>\$1890</b>
DVT4222	22 x 42 x 29	125	100	16	<b>\$1331</b>	<b>\$1598</b>
DVT3622	22 x 36 x 29	125	85	13	<b>\$1290</b>	<b>\$1546</b>
DVT3022	22 x 30 x 29	125	80	11	<b>\$1263</b>	<b>\$1514</b>
DVT2422	22 x 24 x 29	125	64	9	<b>\$1061</b>	<b>\$1274</b>

Two full end panels. **Cannot be connected on left or right side.**

**Required Specifications**

Veneer Finish  
Laminate Finish

**Optional Specifications**

Grommet

CONNECTABLE TABLES

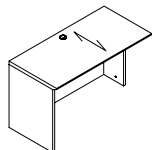

24" Deep Connectable Table - LEFT

MODEL#	DIMENSIONS D x W x H	FREIGHT CLASS	WT./LBS.	CUBIC FT.	VENEER/LAMINATE	ALL VENEER
DVL9624CG	24 x 96 x 29	150	200	39	\$3109	\$3731
DVL9024CG	24 x 90 x 29	150	187	36	\$2911	\$3493
DVL8424CG	24 x 84 x 29	150	174	34	\$2719	\$3263
DVL7824CG	24 x 78 x 29	150	162	31	\$2522	\$3024
DVL7224CG	24 x 72 x 29	150	149	29	\$2330	\$2796
DVL6624CG	24 x 66 x 29	150	141	27	\$2185	\$2623
DVL6024CG	24 x 60 x 29	150	132	24	\$2043	\$2453
DVL5424CG	24 x 54 x 29	150	121	22	\$1928	\$2309
DVL4824CG	24 x 48 x 29	125	115	19	\$1810	\$2173
DVL4224CG	24 x 42 x 29	150	99	17	\$1529	\$1835
DVL3624CG	24 x 36 x 29	150	83	15	\$1473	\$1770
DVL3024CG	24 x 30 x 29	125	77	12	\$1447	\$1737
DVL2424CG	24 x 24 x 29	125	61	10	\$1216	\$1458

**Full end panel on left.** Right narrow end panel connects to 24"D center/right connectable table; 24"D extended corners, 24"D 5-sided corners; Grommet in worksurface.

- To remove cross grain veneer pattern on top, delete suffix "CG" from the model number. Available as a special - no upcharge.

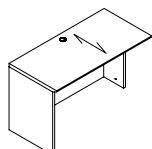

22" Deep Connectable Table - LEFT

DVL9622CG	22 x 96 x 29	150	187	39	\$2958	\$3549
DVL9022CG	22 x 90 x 29	150	175	36	\$2776	\$3332
DVL8422CG	22 x 84 x 29	150	163	34	\$2591	\$3109
DVL7822CG	22 x 78 x 29	150	152	31	\$2403	\$2882
DVL7222CG	22 x 72 x 29	150	140	29	\$2219	\$2662
DVL6622CG	22 x 66 x 29	150	133	27	\$2085	\$2501
DVL6022CG	22 x 60 x 29	150	125	24	\$1947	\$2338
DVL5422CG	22 x 54 x 29	150	113	22	\$1840	\$2207
DVL4822CG	22 x 48 x 29	125	110	19	\$1729	\$2074
DVL4222CG	22 x 42 x 29	150	95	17	\$1460	\$1749
DVL3622CG	22 x 36 x 29	125	80	15	\$1403	\$1685
DVL3022CG	22 x 30 x 29	125	75	12	\$1379	\$1658
DVL2422CG	22 x 24 x 29	125	60	10	\$1160	\$1392

**Full end panel on left.** Right narrow end panel connects to 22"D center/right connectable table; 22"D 5-sided corners; Grommet in worksurface.

- To remove cross grain veneer pattern on top, delete suffix "CG" from the model number. Available as a special - no upcharge.

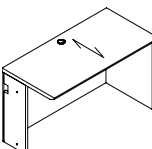

24" Deep Connectable Table - RIGHT

DVR9624CG	24 x 96 x 29	150	200	39	\$3109	\$3731
DVR9024CG	24 x 90 x 29	150	187	36	\$2911	\$3493
DVR8424CG	24 x 84 x 29	150	174	34	\$2719	\$3263
DVR7824CG	24 x 78 x 29	150	162	31	\$2522	\$3024
DVR7224CG	24 x 72 x 29	150	149	29	\$2330	\$2796
DVR6624CG	24 x 66 x 29	150	141	27	\$2185	\$2623
DVR6024CG	24 x 60 x 29	150	132	24	\$2040	\$2449
DVR5424CG	24 x 54 x 29	150	121	22	\$1928	\$2309
DVR4824CG	24 x 48 x 29	125	115	19	\$1812	\$2174
DVR4224CG	24 x 42 x 29	150	99	17	\$1529	\$1835
DVR3624CG	24 x 36 x 29	150	83	15	\$1473	\$1770
DVR3024CG	24 x 30 x 29	125	77	12	\$1447	\$1737
DVR2424CG	24 x 24 x 29	125	61	10	\$1216	\$1458

**Full end panel on right.** Left narrow end panel connects to 24"D center/left connectable table; 24"D extended corners, 24"D 5-sided corners; Grommet in worksurface.

- To remove cross grain veneer pattern on top, delete suffix "CG" from the model number. Available as a special - no upcharge.

**Required Specifications**

Veneer Finish  
Laminate Finish

**Optional Specifications**

Additional grommet

CONNECTABLE TABLES

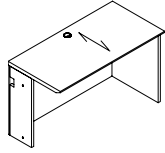

22" Deep Connectable Table - RIGHT

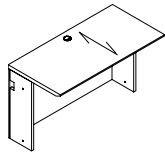

24" Deep Connectable Table

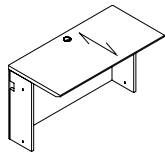

22" Deep Connectable Table

MODEL#	DIMENSIONS D x W x H	FREIGHT CLASS	WT./LBS.	CUBIC FT.	veneer/LAMINATE	ALL veneer
DVR9622CG	22 x 96 x 29	150	187	39	\$2958	\$3549
DVR9022CG	22 x 90 x 29	150	175	36	\$2776	\$3332
DVR8422CG	22 x 84 x 29	150	163	34	\$2591	\$3109
DVR7822CG	22 x 78 x 29	150	152	31	\$2403	\$2882
DVR7222CG	22 x 72 x 29	150	140	29	\$2219	\$2662
DVR6622CG	22 x 66 x 29	150	133	27	\$2085	\$2501
DVR6022CG	22 x 60 x 29	150	125	24	\$1947	\$2338
DVR5422CG	22 x 54 x 29	150	113	22	\$1840	\$2207
DVR4822CG	22 x 48 x 29	125	110	19	\$1729	\$2074
DVR4222CG	22 x 42 x 29	150	95	17	\$1460	\$1749
DVR3622CG	22 x 36 x 29	125	80	15	\$1403	\$1685
DVR3022CG	22 x 30 x 29	125	75	12	\$1379	\$1658
DVR2422CG	22 x 24 x 29	125	60	10	\$1160	\$1392

**Full end panel on right.** Left narrow end panel connects to 22"D center/left connectable table; 22"D 5-sided corners; Grommet in worksurface.

- To remove cross grain veneer pattern on top, delete suffix "CG" from the model number. Available as a special - no upcharge.

DV9624CG	24 x 96 x 29	150	197	39	\$3035	\$3640
DV9024CG	24 x 90 x 29	150	185	36	\$2848	\$3418
DV8424CG	24 x 84 x 29	150	173	34	\$2658	\$3190
DV7824CG	24 x 78 x 29	150	160	31	\$2468	\$2961
DV7224CG	24 x 72 x 29	150	145	29	\$2276	\$2730
DV6624CG	24 x 66 x 29	150	136	27	\$2303	\$2765
DV6024CG	24 x 60 x 29	150	123	24	\$1987	\$2384
DV5424CG	24 x 54 x 29	150	119	22	\$1870	\$2246
DV4824CG	24 x 48 x 29	150	107	19	\$1756	\$2108
DV4224CG	24 x 42 x 29	150	91	17	\$1473	\$1770
DV3624CG	24 x 36 x 29	150	76	15	\$1421	\$1704
DV3024CG	24 x 30 x 29	150	70	12	\$1392	\$1668
DV2424CG	24 x 24 x 29	150	53	10	\$1169	\$1402

**Narrow end panels on left and right** connects to 24"D connectable table; 24"D extended corners, 24"D 5-sided corners; Grommet in worksurface.

- To remove cross grain veneer pattern on top, delete suffix "CG" from the model number. Available as a special - no upcharge.

DV9622CG	22 x 96 x 29	150	181	35	\$2891	\$3468
DV9022CG	22 x 90 x 29	150	169	33	\$2714	\$3256
DV8422CG	22 x 84 x 29	150	157	31	\$2528	\$3035
DV7822CG	22 x 78 x 29	150	145	29	\$2350	\$2820
DV7222CG	22 x 72 x 29	150	133	27	\$2164	\$2598
DV6622CG	22 x 66 x 29	150	126	24	\$2030	\$2435
DV6022CG	22 x 60 x 29	150	118	22	\$1898	\$2279
DV5422CG	22 x 54 x 29	150	111	20	\$1782	\$2137
DV4822CG	22 x 48 x 29	150	103	18	\$1671	\$2008
DV4222CG	22 x 42 x 29	150	88	16	\$1399	\$1680
DV3622CG	22 x 36 x 29	150	73	13	\$1352	\$1622
DV3022CG	22 x 30 x 29	125	68	11	\$1325	\$1589
DV2422CG	22 x 24 x 29	150	52	9	\$1111	\$1333

**Narrow end panels on left and right** connects to 22"D connectable table; 22"D extended corners, 22"D 5-sided corners; Grommet in worksurface.

- To remove cross grain veneer pattern on top, delete suffix "CG" from the model number. Available as a special - no upcharge.

**Required Specifications**

Veneer Finish  
Laminate Finish

**Optional Specifications**

Additional grommet



# DUFFERIN

## "D" ISLANDS

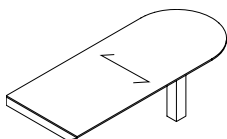

"D" Island with Monopost

MODEL#	DIMENSIONS D x W x H	FREIGHT CLASS	WT/LBS.	CUBIC FT.	VENEER/LAMINATE	ALL VENEER
DRD8436CG	36 x 84 x 29	250	135	51	N/A	<b>\$2865</b>
DRD7236CG	36 x 72 x 29	250	121	44	N/A	<b>\$2453</b>
DRD7230CG	30 x 72 x 29	250	99	36	N/A	<b>\$2296</b>
DRD6636CG	36 x 66 x 29	250	99	40	N/A	<b>\$2296</b>
DRD6030CG	30 x 60 x 29	250	83	30	N/A	<b>\$2137</b>

Attaches to edge of worksurfaces with Dufferin knife (molding) edge. Attaching hardware included. Shipped RTA (ready to assemble).

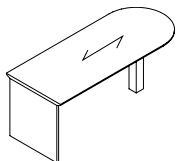

"D" Island - Full End Panel\* (T-Base) & Monopost

DDD8436	36 x 84 x 29	125	343	51	<b>\$4547</b>	<b>\$5458</b>
DDD7236	36 x 72 x 29	125	294	44	<b>\$3897</b>	<b>\$4674</b>
DDD7230	30 x 72 x 29	125	264	36	<b>\$3622</b>	<b>\$4345</b>
DDD6636	36 x 66 x 29	125	245	40	<b>\$3622</b>	<b>\$4345</b>
DDD6030	30 x 60 x 29	125	225	30	<b>\$3482</b>	<b>\$4176</b>

Connects to Linking Bridges or Executive Returns. Attaching hardware included. **Not freestanding.**

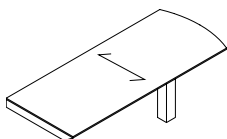

"D" Island with Monopost, Bow End

DRDBE8436CG	36 x 84 x 29	250	135	51	N/A	<b>\$2865</b>
DRDBE7236CG	36 x 72 x 29	250	121	44	N/A	<b>\$2453</b>
DRDBE7230CG	30 x 72 x 29	250	99	36	N/A	<b>\$2296</b>
DRDBE6636CG	36 x 66 x 29	250	99	40	N/A	<b>\$2296</b>
DRDBE6030CG	30 x 60 x 29	250	83	30	N/A	<b>\$2137</b>

Attaches to edge of worksurfaces with Dufferin knife (molding) edge. Attaching hardware included. Shipped RTA (ready to assemble).

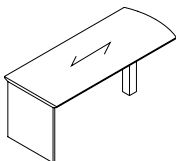

"D" Island - Full End Panel, Bow End (T-Base) & Monopost

DRDBE8436	36 x 84 x 29	125	343	51	<b>\$4546</b>	<b>\$5455</b>
DRDBE7236	36 x 72 x 29	125	294	44	<b>\$3897</b>	<b>\$4674</b>
DRDBE7230	30 x 72 x 29	125	264	36	<b>\$3621</b>	<b>\$4344</b>
DRDBE6636	36 x 66 x 29	125	245	40	<b>\$3621</b>	<b>\$4344</b>
DRDBE6030	30 x 60 x 29	125	225	30	<b>\$3479</b>	<b>\$4174</b>

Connects to Linking Bridges or Executive Returns. Attaching hardware included. **Not freestanding.**

## BOAT SHAPED ISLANDS

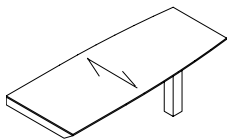

Boat Shaped Island with Monopost

MODEL#	DIMENSIONS	FREIGHT CLASS	WT/LBS.	CUBIC FT.	VENEER/LAMINATE	ALL VENEER
DRDBS8442CG	42 x 84 x 29	250	179	59	N/A	<b>\$3335</b>
DRDBS8436CG	36 x 84 x 29	250	155	51	N/A	<b>\$2865</b>
DRDBS7236CG	36 x 72 x 29	250	141	44	N/A	<b>\$2453</b>
DRDBS7230CG	30 x 72 x 29	250	119	36	N/A	<b>\$2296</b>
DRDBS6636CG	36 x 66 x 29	250	119	40	N/A	<b>\$2296</b>
DRDBS6030CG	30 x 60 x 29	250	103	30	N/A	<b>\$2137</b>

Attaches to edge of worksurfaces with Dufferin knife (molding) edge. Attaching hardware included. Shipped RTA (ready to assemble).

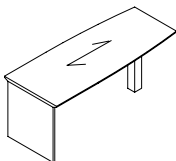

Boat Shaped Island - Full End Panel\* (T-Base) & Monopost

DRDBS8442	42 x 84 x 29	125	414	59	<b>\$5382</b>	<b>\$6460</b>
DRDBS8436	36 x 84 x 29	125	343	51	<b>\$4546</b>	<b>\$5455</b>
DRDBS7236	36 x 72 x 29	125	314	44	<b>\$3897</b>	<b>\$4674</b>
DRDBS7230	30 x 72 x 29	125	284	36	<b>\$3621</b>	<b>\$4344</b>
DRDBS6636	36 x 66 x 29	125	265	40	<b>\$3621</b>	<b>\$4344</b>
DRDBS6030	30 x 60 x 29	100	245	30	<b>\$3479</b>	<b>\$4174</b>

Connects to Linking Bridges or Executive Returns. Attaching hardware included. **Not freestanding.**

### Required Specifications

- Veneer finish
- Laminate finish\*
- Monopost finish

### Optional Specifications

- Grommet
- Modesty panel
- Monopost (Base) upgrade

**"P" ISLANDS**

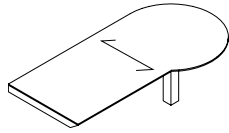

**"P" Island - LEFT with Monopost**

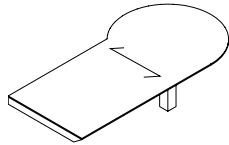

**"P" Island - RIGHT with Monopost**

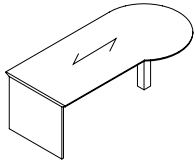

**"P" Island - LEFT with Monopost (T-Base) & Monopost\***

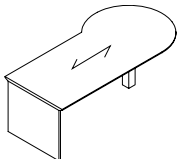

**"P" Island - RIGHT with Monopost (T-Base) & Monopost\***

MODEL#	DIMENSIONS	FREIGHT CLASS	WT/LBS.	CUBIC FT.	LIST PRICE
	<b>D x W x H</b>				
DRPL9642CG	42 x 96 x 29	250	239	68	N/A <b>\$4408</b>
DRPL8442CG	42 x 84 x 29	250	209	59	N/A <b>\$3855</b>
DRPL7242CG	42 x 72 x 29	250	143	51	N/A <b>\$3309</b>

Attaches to edge of worksurfaces with Dufferin knife (molding) edge. Attaching hardware included. Shipped RTA (ready to assemble).

DRPR9642CG	42 x 96 x 29	250	239	68	N/A <b>\$4408</b>
DRPR8442CG	42 x 84 x 29	250	209	59	N/A <b>\$3855</b>
DRPR7242CG	42 x 72 x 29	250	143	51	N/A <b>\$3309</b>

Attaches to edge of worksurfaces with Dufferin knife (molding) edge. Attaching hardware included. Shipped RTA (ready to assemble).

DTPL9642	42 x 96 x 29	125	440	68	<b>\$4163</b> <b>\$4993</b>
DTPL8442	42 x 84 x 29	125	385	59	<b>\$3641</b> <b>\$4371</b>
DTPL7242	42 x 72 x 29	125	319	51	<b>\$3319</b> <b>\$3982</b>

Connects to Linking Bridges or Executive Returns. Attaching hardware included. **Not freestanding.**

DTPR9642	42 x 96 x 29	125	440	68	<b>\$4163</b> <b>\$4993</b>
DTPR8442	42 x 84 x 29	125	385	59	<b>\$3641</b> <b>\$4371</b>
DTPR7242	42 x 72 x 29	125	319	51	<b>\$3319</b> <b>\$3982</b>

Connects to Linking Bridges or Executive Returns. Attaching hardware included. **Not freestanding.**

**Required Specifications**

Veneer finish  
Laminate finish\*  
Monopost finish

**Optional Specifications**

Grommet  
Modesty panel  
Monopost (Base) upgrade

# D DUFFERIN

## PIANO DESKS

## MODEL#

## DIMENSIONS

## FREIGHT CLASS

## WT./LBS.

## CUBIC FT.

## VENEER/LAMINATE

## ALL VENEER

D x W x H

- Can be ordered as a shell or with pedestals.
- Components include a GM1 grommet in the top center position.
- Hand of Rectangular Desk is determined by location of pedestal from user side.
- Hand of "D" Top is determined by outward orientation of curved end from user projection.
- Hand of "P" Top is determined by outward orientation of conference end from user projection.
- Connectable Tables and Bridges - To remove cross grain veneer pattern on top, delete suffix "CG" from the model number. Available as a special - no upcharge.

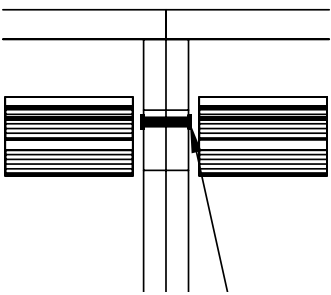

Piano Return (Right Hand Shown)

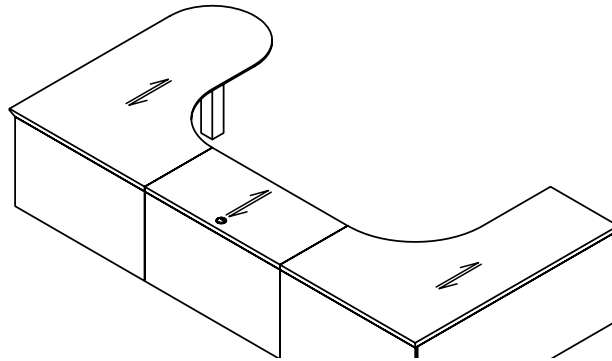
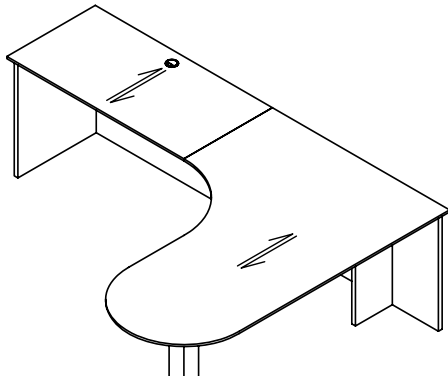
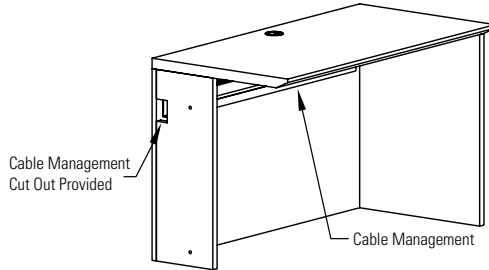

### "D" ISLANDS (PIANO DESKS)

### MODEL#

### DIMENSIONS

### FREIGHT CLASS

### WT./LBS.

### CUBIC FT.

### VENEER/LAMINATE

### ALL VENEER

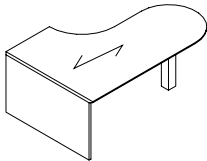

"D" Island LEFT - Full End Panel & Monopost, Piano Desk

DTDPL96304824	48 x 96 x 29	125	464	77	<b>\$4317</b>	<b>\$5179</b>
DTDPL84304824	48 x 84 x 29	150	406	68	<b>\$3843</b>	<b>\$4613</b>
DTDPL72304824	48 x 72 x 29	125	348	58	<b>\$3366</b>	<b>\$4039</b>

Extended island worksurface on the **left**. Narrow end panel on right connects to **24"D** returns or bridges **for Piano Desks Only** (see above). **Not freestanding**. Includes installed horizontal wire management.

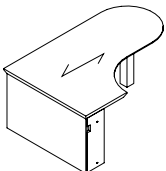

"D" Island RIGHT - Full End Panel & Monopost, Piano Desk

DTDPR96304824	48 x 96 x 29	125	464	77	<b>\$4317</b>	<b>\$5179</b>
DTDPR84304824	48 x 84 x 29	150	406	68	<b>\$3843</b>	<b>\$4613</b>
DTDPR72304824	48 x 72 x 29	125	348	58	<b>\$3366</b>	<b>\$4039</b>

Extended island worksurface on the **right**. Narrow end panel on left connects to **24"D** returns or bridges **for Piano Desks Only** (see above). **Not freestanding**. Includes installed horizontal wire management.

#### Required Specifications

Veneer finish  
Laminate finish  
Monopost finish

#### Optional Specifications

Grommet  
Modesty panel  
Monopost (Base) upgrade

**BOAT SHAPED ISLANDS (PIANO DESKS)**

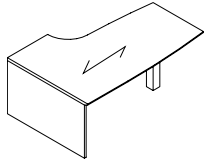

**Boat Shaped Island LEFT - Full End Panel & Monopost, Piano Desk**

MODEL#	DIMENSIONS	FREIGHT CLASS	WT./LBS.	CUBIC FT.	VENEER/LAMINATE	ALL VENEER
<b>D x W x H</b>						
DTBPL96304824	48 x 96 x 29	125	522	87	<b>\$5131</b>	<b>\$6157</b>
DTBPL84304824	48 x 84 x 29	125	457	76	<b>\$5131</b>	<b>\$6157</b>
DTBPL72304824	48 x 72 x 29	125	392	65	<b>\$4480</b>	<b>\$5375</b>

Extended island worksurface on the **left**. Narrow end panel on right connects to **24"D** returns or bridges **for Piano Desks Only** (see pg. 35). **Not freestanding**. Includes installed horizontal wire management.

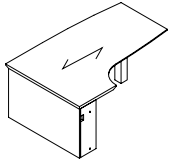

**Boat Shaped Island RIGHT - Full End Panel & Monopost, Piano Desk**

DTBPR96304824	48 x 96 x 29	125	522	87	<b>\$5131</b>	<b>\$6157</b>
DTBPR84304824	48 x 84 x 29	125	457	76	<b>\$5131</b>	<b>\$6157</b>
DTBPR72304824	48 x 72 x 29	125	392	65	<b>\$4477</b>	<b>\$5374</b>

Extended island worksurface on the **right**. Narrow end panel on left connects to **24"D** returns or bridges **for Piano Desks Only** (see pg. 35). **Not freestanding**. Includes installed horizontal wire management.

**"P" ISLANDS (PIANO DESKS)**

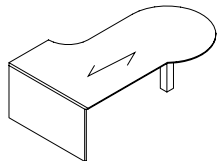

**"P" Shaped Island LEFT - Full End Panel & Monopost, Piano Desk**

MODEL#	DIMENSIONS	FREIGHT CLASS	WT./LBS.	CUBIC FT.	VENEER/LAMINATE	ALL VENEER
DTPPL96424824	60 x 96 x 29	150	580	97	<b>\$4924</b>	<b>\$5911</b>
DTPPL84424824	60 x 84 x 29	150	508	85	<b>\$4405</b>	<b>\$5285</b>
DTPPL72424824	60 x 72 x 29	150	435	73	<b>\$4084</b>	<b>\$4901</b>

Extended island worksurface on the **left**. Narrow end panel on right connects to **24"D** returns or bridges **for Piano Desks Only** (see pg. 35). **Not freestanding**. Includes installed horizontal wire management.

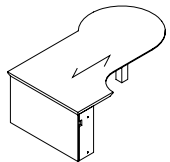

**Boat Shaped Island RIGHT - Full End Panel & Monopost, Piano Desk**

DTPPR96424824	60 x 96 x 29	150	580	97	<b>\$4921</b>	<b>\$5905</b>
DTPPR84424824	60 x 84 x 29	150	508	85	<b>\$4405</b>	<b>\$5285</b>
DTPPR72424824	60 x 72 x 29	150	435	73	<b>\$4084</b>	<b>\$4901</b>

Extended island worksurface on the **right**. Narrow end panel on left connects to **24"D** returns or bridges **for Piano Desks Only** (see pg. 35). **Not freestanding**. Includes installed horizontal wire management.

**DELTA ISLANDS (PIANO DESKS)**

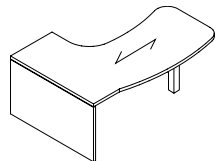

**Delta Island LEFT - Full End Panel & Monopost, Piano Desk**

MODEL#	DIMENSIONS	FREIGHT CLASS	WT./LBS.	CUBIC FT.	VENEER/LAMINATE	ALL VENEER
DBTHPL96304824	54 x 96 x 29	125	531	87	<b>\$4669</b>	<b>\$5603</b>
DBTHPL84304824	54 x 84 x 29	125	464	76	<b>\$4151</b>	<b>\$4982</b>
DBTHPL72304824	54 x 72 x 29	125	398	65	<b>\$3831</b>	<b>\$4595</b>

Extended island worksurface on the **left**. Narrow end panel on right connects to **24"D** returns or bridges **for Piano Desks Only** (see pg. 35). **Not freestanding**. Includes installed horizontal wire management.

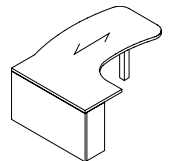

**Delta Island RIGHT - Full End Panel & Monopost, Piano Desk**

DBTHPR96304824	54 x 96 x 29	125	531	87	<b>\$4669</b>	<b>\$5603</b>
DBTHPR84304824	54 x 84 x 29	125	464	76	<b>\$4151</b>	<b>\$4982</b>
DBTHPR72304824	54 x 72 x 29	125	398	65	<b>\$3831</b>	<b>\$4595</b>

Extended island worksurface on the **right**. Narrow end panel on left connects to **24"D** returns or bridges **for Piano Desks Only** (see pg. 35). **Not freestanding**. Includes installed horizontal wire management.

**Required Specifications**

Veneer finish  
Laminate finish  
Monopost finish

**Optional Specifications**

Grommet  
Modesty panel  
Monopost (Base) upgrade

CONNECTABLE TABLES - LEFT (FOR PIANO DESKS)

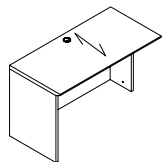

24" Deep Connectable Table - LEFT  
For Piano Desk

MODEL#	DIMENSIONS D x W x H	FREIGHT CLASS	WT/LBS.	CUBIC FT.	veneER/LAMINATE	ALL veneER
DVEL9624CG	24 x 96 x 29	150	200	39	\$3226	\$3872
DVEL9024CG	24 x 90 x 29	150	187	36	\$3027	\$3634
DVEL8424CG	24 x 84 x 29	150	174	34	\$2822	\$3386
DVEL7824CG	24 x 78 x 29	150	162	31	\$2624	\$3148
DVEL7224CG	24 x 72 x 29	150	149	29	\$2425	\$2910
DVEL6624CG	24 x 66 x 29	150	141	27	\$2268	\$2723
DVEL6024CG	24 x 60 x 29	150	132	24	\$2126	\$2550
DVEL5424CG	24 x 54 x 29	150	121	22	\$2001	\$2402
DVEL4824CG	24 x 48 x 29	125	115	19	\$1885	\$2262
DVEL4224CG	24 x 42 x 29	150	99	17	\$1586	\$1901
DVEL3624CG	24 x 36 x 29	150	83	15	\$1538	\$1843
DVEL3024CG	24 x 30 x 29	125	77	12	\$1645	\$1975
DVEL2424CG	24 x 24 x 29	125	61	10	\$1263	\$1514

**Full end panel on left.** Right narrow end panel connects to 24"D right connectable table, "D" islands, Boat shaped islands, "P" islands or Delta islands with "T" bases **for Piano Desks Only**. Grommet in worksurface. Shipped RTA (ready to assemble).

- To remove cross grain veneer pattern on top, **delete suffix "CG"** from the model number. Available as a special - no upcharge.

CONNECTABLE TABLES - RIGHT (FOR PIANO DESKS)

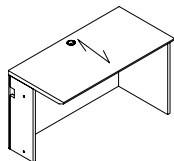

24" Deep Connectable Table - RIGHT  
For Piano Desk

MODEL#	DIMENSIONS	FREIGHT CLASS	WT/LBS.	CUBIC FT.	veneER/LAMINATE	ALL veneER
DVER9624CG	24 x 96 x 29	150	200	39	\$3226	\$3872
DVER9024CG	24 x 90 x 29	150	187	36	\$3027	\$3634
DVER8424CG	24 x 84 x 29	150	174	34	\$2822	\$3386
DVER7824CG	24 x 78 x 29	150	162	31	\$2624	\$3148
DVER7224CG	24 x 72 x 29	150	149	29	\$2425	\$2910
DVER6624CG	24 x 66 x 29	150	141	27	\$2268	\$2723
DVER6024CG	24 x 60 x 29	150	132	24	\$2126	\$2550
DVER5424CG	24 x 54 x 29	150	121	22	\$2001	\$2402
DVER4824CG	24 x 48 x 29	125	115	19	\$1885	\$2262
DVER4224CG	24 x 42 x 29	150	99	17	\$1586	\$1901
DVER3624CG	24 x 36 x 29	150	83	15	\$1538	\$1843
DVER3024CG	24 x 30 x 29	125	77	12	\$1522	\$1829
DVER2424CG	24 x 24 x 29	125	61	10	\$1263	\$1514

**Full end panel on right.** Left narrow end panel connects to 24"D left connectable table, "D" islands, Boat shaped islands, "P" islands or Delta islands with "T" bases **for Piano Desks Only**. Grommet in worksurface. Shipped RTA (ready to assemble).

- To remove cross grain veneer pattern on top, **delete suffix "CG"** from the model number. Available as a special - no upcharge.

BRIDGES (FOR PIANO DESKS)

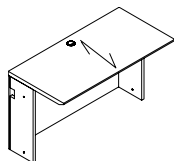

Flush Bridge

MODEL#	DIMENSIONS	FREIGHT CLASS	WT/LBS.	CUBIC FT.	veneER/LAMINATE	ALL veneER
DBTN4824CG	24 x 48 x 29	125	116	19	\$1617	\$1941
DBTN4224CG	24 x 42 x 29	92.5	102	17	\$1359	\$1632
DBTN3624CG	24 x 36 x 29	150	87	15	\$1302	\$1564
DBTN3024CG	24 x 30 x 29	125	73	12	\$1276	\$1533
DBTN2424CG	24 x 24 x 29	150	58	10	\$1073	\$1287
DBTN1824CG	24 x 18 x 29	150	43	8	\$805	\$966
DBTN1224CG	24 x 12 x 29	150	29	5	\$537	\$647

**Full end panel on both sides** connects to 24"D worksurfaces, "D" islands, Boat shaped islands, "P" islands or Delta islands with "T" bases **for Piano Desks Only**. Grommet in worksurface. Shipped RTA (ready to assemble).

- To remove cross grain veneer pattern on top, **delete suffix "CG"** from the model number. Available as a special - no upcharge.

**Required Specifications**

Veneer finish  
Laminate finish

**Optional Specifications**

Additional grommet

**TABLE DESK**

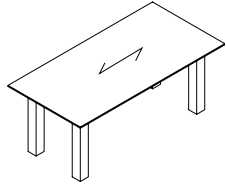
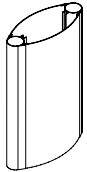

**Table Desk\*\***

MODEL#	DIMENSIONS	FREIGHT CLASS	WT/LBS.	CUBIC FT.	VENEER/LAMINATE	ALL VENEER
<b>D x W x H</b>						
DTB8442	42 x 84 x 29	150	272	59	N/A	<b>\$7689</b>
DTB7842	42 x 78 x 29	150	253	55	N/A	<b>\$7141</b>
DTB7236	36 x 72 x 29	150	205	44	N/A	<b>\$5651</b>
DTB7230	30 x 72 x 29	150	192	36	N/A	<b>\$5544</b>
DTB6636	36 x 66 x 29	150	192	40	N/A	<b>\$5544</b>
DTB6630	30 x 66 x 29	150	188	33	N/A	<b>\$5436</b>
DTB6030	30 x 60 x 29	150	171	30	N/A	<b>\$5180</b>

Four 4" square metal legs. Includes centered pencil drawer.

**MONOPOST (BASE) UPGRADES**



**Elliptical Base Upgrade**

MODEL#	DIMENSIONS	FREIGHT CLASS	WT/LBS.	CUBIC FT.	VENEER/LAMINATE	ALL VENEER
TE18	5 x 18 x 28	70	30	2	N/A	<b>\$1291</b>

To replace one standard monopost on Islands ONLY. Must specify at time of order. **Cannot be retrofitted in the field.**

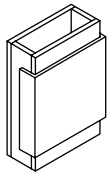

**Rectangular Base Upgrade**

TPML18	8 x 18 x 28	70	36	2	N/A	<b>\$1229</b>
--------	-------------	----	----	---	-----	---------------

To replace one standard monopost on Islands ONLY. Must specify at time of order. **Cannot be retrofitted in the field. Not sold individually - to be ordered as an upgrade option only.**

**Required Specifications**

Veneer Finish  
Laminate Finish  
Metal finish\*

**Optional Specifications**

Lock\*\*  
Veneer top\*\*

MODESTY PANEL OPTIONS

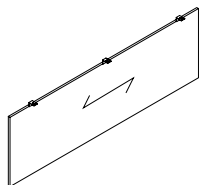

Veneer Modesty Panel Upgrade\*

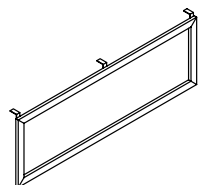

Glass Modesty Panel Upgrade

MODEL#	DIMENSIONS D x W x H	FREIGHT CLASS	WT/LBS.	CUBIC FT.	LIST PRICE
CMP72W	0.75 x 67 x 18	--	20	1	<b>\$1622</b>
CMP66W	0.75 x 61 x 18	--	18	1	<b>\$1570</b>
CMP60W	0.75 x 55 x 18	--	16	1	<b>\$1546</b>
CMP54W	0.75 x 49 x 18	--	14	1	<b>\$1520</b>
CMP48W	0.75 x 43 x 18	--	13	1	<b>\$1496</b>

Straight modesty panel. Attaches to underside of worksurface. **Can not be retrofitted in the field *Not sold individually - to be ordered as an upgrade option only.***

- CMP72W - Specify on "P" Top Islands or 96" x 48" Islands for Piano Desks.
- CMP66W - Specify on 84" x 36" "D" Top Islands.
- CMP60W - Specify on 84" x 42" "P" Top Islands or 84" x 48" Islands for Piano Desks.
- CMP54W - Specify on 72" x 30" "D" Top Islands.
- CMP48W - Specify on 66" x 36" , 60" x 30" "D" Top Islands, 72" x 42" "P" Top Islands or 72" x 48" Islands for Piano Desks.

CMP72G	0.75 x 67 x 18	--	20	1	<b>\$2485</b>
CMP66G	0.75 x 61 x 18	--	18	1	<b>\$2351</b>
CMP60G	0.75 x 55 x 18	--	16	1	<b>\$2149</b>
CMP54G	0.75 x 49 x 18	--	14	1	<b>\$2001</b>
CMP48G	0.75 x 43 x 18	--	13	1	<b>\$1911</b>

Straight modesty panel. Translucent, screened glass. Aluminum box frame construction in Tungsten Only. Attaches to underside of worksurface. **Can not be retrofitted in the field. *Not sold individually - to be ordered as an upgrade option only.***

- CMP72G - Specify on "P" Top Islands or 96" x 48" Islands for Piano Desks.
- CMP66G - Specify on 84" x 36" "D" Top Islands.
- CMP60G - Specify on 84" x 42" "P" Top Islands or 84" x 48" Islands for Piano Desks.
- CMP54G - Specify on 72" x 30" "D" Top Islands.
- CMP48G - Specify on 66" x 36" , 60" x 30" "D" Top Islands, 72" x 42" "P" Top Islands or 72" x 48" Islands for Piano Desks.
- Tungsten finish on the aluminum box frame closely resembles the existing Tungsten finish.

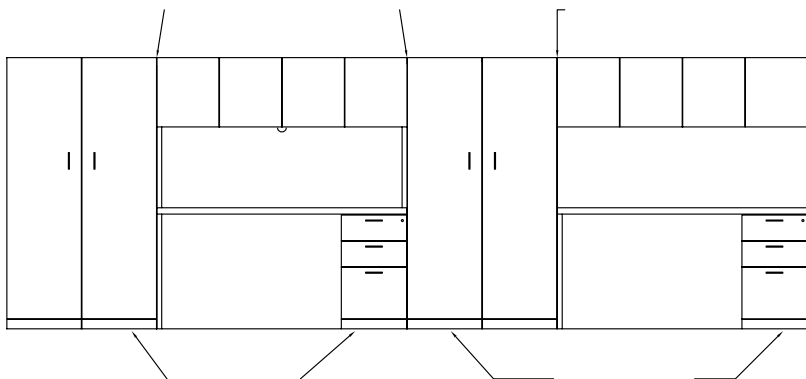

**Required Specifications**

Veneer finish

**STORAGE SHELLS**      **MODEL#**      **DIMENSIONS**      **FREIGHT CLASS**      **WT/LBS.**      **CUBIC FT.**      **VENEER/LAMINATE**      **ALL VENEER**

D x W x H

- When using Storage Shells, laminate gables will show.
- Credenza shell cannot be completely filled up with storage shells to create a full storage credenza.
- Handle style must be specified.

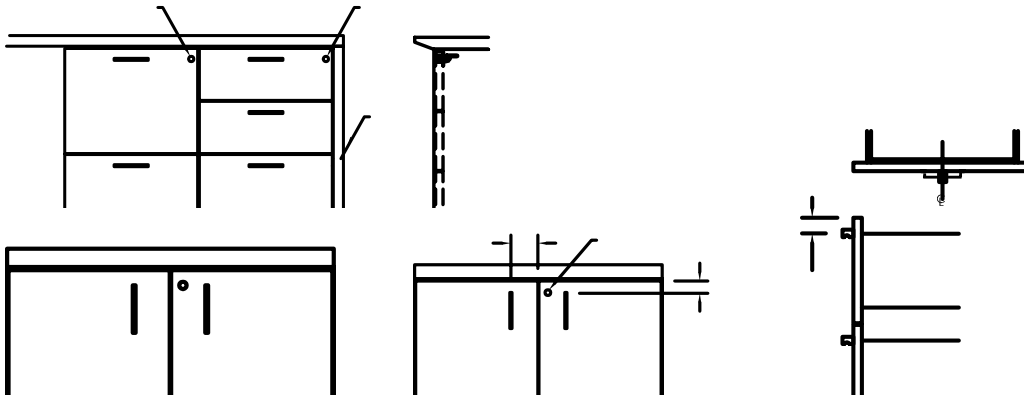

**STORAGE SHELLS**      **MODEL#**      **DIMENSIONS**      **FREIGHT CLASS**      **WT/LBS.**      **CUBIC FT.**      **VENEER/LAMINATE**      **ALL VENEER**

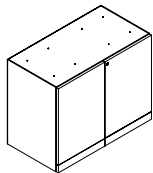

**Storage Shell**

DWG	19.1 x 36.75 x 28	92.5	115	11	<b>\$1582</b>	<b>\$1896</b>
DWM	19.1 x 31.625 x 28	92.5	96	9	<b>\$1399</b>	<b>\$1680</b>

For use **under a freestanding worksurface (22", 24", 30" or 36"D)**. Top drilled to attach to worksurface. One adjustable shelf. **Standard with lock.**

- **Unfinished top and back**

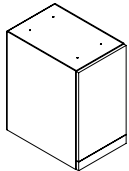

**Storage Shell - LEFT**

DWWIL	23 x 15.6 x 28	100	53	6	<b>\$1406</b>	<b>\$1687</b>
DWIL	19.1 x 15.6 x 28	100	45	5	<b>\$1162</b>	<b>\$1393</b>

For use **under a freestanding worksurface (22", 24", 30" or 36"D)**. Top drilled to attach to worksurface. One adjustable shelf. Handle is on the **right**, door opens to the **left**.

- For 22" or 24"D worksurface, order **DWIL**. For 30" or 36"D worksurface, order **DWWIL**.

- **Unfinished top and back**

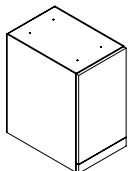

**Storage Shell - RIGHT**

DWWIR	23 x 15.6 x 28	100	53	6	<b>\$1406</b>	<b>\$1687</b>
DWIR	19.1 x 15.6 x 28	100	45	5	<b>\$1162</b>	<b>\$1393</b>

For use **under a freestanding worksurface (22", 24", 30" or 36"D)**. Top drilled to attach to worksurface. One adjustable shelf. Handle is on the **left**, door opens to the **right**.

- For 22" or 24"D worksurface, order **DWIR**. For 30" or 36"D worksurface, order **DWWIR**.

- **Unfinished top and back**

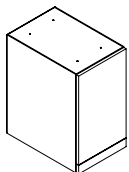

**Storage Shell - LEFT**  
**Eight Storage Slot Shelves**

DWWIL8S	23 x 15.6 x 28	125	45	6	<b>\$1922</b>	<b>\$2306</b>
DWIL8S	19.1 x 15.6 x 28	125	37	5	<b>\$1670</b>	<b>\$2007</b>

For use **under a freestanding worksurface (22", 24", 30" or 36"D)**. Top drilled to attach to worksurface. Eight adjustable storage slot shelves. Handle is on the **right**, door opens to the **left**.

- For 22" or 24"D worksurface, order **DWIL8S**. For 30" or 36"D worksurface, order **DWWIL8S**.

- **Unfinished top and back**

**Required Specifications**

Veneer Finish (doors)  
Laminate Finish (body)  
Handle Style

**Optional Specifications**

Lock



STORAGE SHELLS

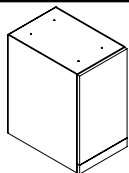

Storage Shell - RIGHT  
Eight Storage Slot Shelves

MODEL#	DIMENSIONS D x W x H	FREIGHT CLASS	WT/LBS.	CUBIC FT.	VENEER/LAMINATE	ALL VENEER
DWWIR8S	23 x 15.6 x 28	125	45	6	\$1922	\$2306
DWIR8S	19.1 x 15.6 x 28	125	37	5	\$1670	\$2007

For use **under a freestanding worksurface (22", 24", 30" or 36"D)**. Top drilled to attach to worksurface. Eight adjustable storage slot shelves. Handle is on the **left**, door opens to the **right**.

- For 22" or 24"D worksurface, order **DWIR8S**. For 30" or 36"D worksurface, order **DWWIR8S**.
- **Unfinished top and back**

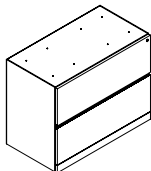

File/File Shell - Lateral

DWF	19.1 x 36.75 x 28	92.5	115	11	\$2264	\$2719
DWN	19.1 x 31.625 x 28	92.5	96	9	\$1983	\$2380

For use **under a freestanding worksurface (22", 24", 30" or 36"D)**. Top drilled to attach to worksurface. **Two lateral file drawers**. Lock secures all drawers. Side-to-side file bars included.

- **Unfinished top and back**

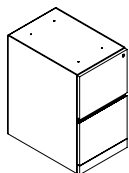

File/File Shell - Vertical\*

LETTER						
DWWE	23 x 15.6 x 28	85	72	6	\$1745	\$2096
DWE	19.1 x 15.6 x 28	85	70	5	\$1521	\$1825
LEGAL						
DWWLE	23 x 18.5 x 28	85	85	7	\$2098	\$2518
DWLE	19.1 x 18.5 x 28	85	83	6	\$1825	\$2189

For use **under a freestanding worksurface (22", 24", 30" or 36"D)**. Top drilled to attach to worksurface. **Two file drawers**. Lock secures all drawers.

- For 22" or 24"D worksurface, order **DWE or DWLE**. For 30" or 36"D worksurface, order **DWWE or DWWLE**.
- **Unfinished top and back**

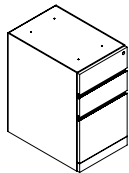

Box/Box/File Shell - Vertical\*

LETTER						
DWWD	23 x 15.6 x 28	85	72	6	\$1745	\$2096
DWD	19.1 x 15.6 x 28	85	70	5	\$1521	\$1825
LEGAL						
DWWLD	23 x 18.5 x 28	85	85	7	\$2098	\$2518
DWLD	19.1 x 18.5 x 28	85	83	6	\$1825	\$2189

For use **under a freestanding worksurface (22", 24", 30" or 36"D)**. Top drilled to attach to worksurface. **Two box and one file drawers**. One pencil tray. Lock secures all drawers.

- For 22" or 24"D worksurface, order **DWD or DWLD**. For 30" or 36"D worksurface, order **DWWD or DWWLD**.
- **Unfinished top and back**

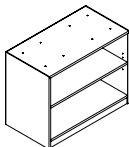

Open Shelving Shell

DWOB36	19.1 x 36.75 x 28	100	92	11	\$1196	\$1435
DWOB30	19.1 x 31.625 x 28	100	77	9	\$1059	\$1271

For use **under a freestanding worksurface (22", 24", 30" or 36"D)**. Top drilled to attach to worksurface. One adjustable veneer shelf.

- **Unfinished top and back**

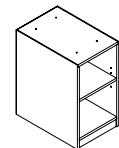

Open Shelving Shell

DWWQ	23 x 15.6 x 28	125	45	6	\$1238	\$1484
DWQ	19.1 x 15.6 x 28	125	37	5	\$1023	\$1229

For use **under a freestanding worksurface (22", 24", 30" or 36"D)**. Top drilled to attach to worksurface. One adjustable veneer shelf.

- For 22" or 24"D worksurface, order **DWQ**. For 30" or 36"D worksurface, order **DWWQ**.
- **Unfinished top and back**

**Required Specifications**

Veneer Finish (doors, drawer fronts, open shelves)  
Laminate Finish (body)  
Handle Style

**Optional Specifications**

Additional Lock\*

**STORAGE SHELLS**

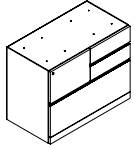

**Mixed Storage Shell - LEFT**

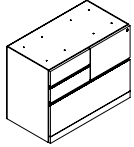

**Mixed Storage Shell - RIGHT**

**MODEL# DIMENSIONS FREIGHT CLASS WT/LBS. CUBIC FT. VENEER/LAMINATE ALL VENEER**

**D x W x H**

DWZL	19.1 x 36.75 x 28	92.5	115	11	<b>\$2629</b>	<b>\$3156</b>
------	-------------------	------	-----	----	---------------	---------------

For use **under a freestanding worksurface (22", 24", 30" or 36"D)**. Top drilled to attach to worksurface. One file drawer on **left**, two box drawers on **right** and one lateral file drawer on bottom. File drawer and lateral file drawer lock. One pencil tray. **Not for stacking materials on lateral file drawer bottom.**

- **Unfinished top and back**

DWZR	19.1 x 36.75 x 28	92.5	115	11	<b>\$2629</b>	<b>\$3156</b>
------	-------------------	------	-----	----	---------------	---------------

For use **under a freestanding worksurface (22", 24", 30" or 36"D)**. Top drilled to attach to worksurface. One file drawer on **right**, two box drawers on **left** and one lateral file drawer on bottom. File drawer and lateral file drawer lock. One pencil tray. **Not for stacking materials on lateral file drawer bottom.**

- **Unfinished top and back**

**STORAGE MODULES - (FREESTANDING)**

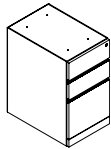

**Box/Box/File Freestanding Pedestal**

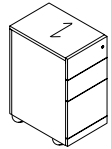

**Box/Box/File Module, Mobile**

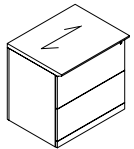

**File/File Module, Lateral**

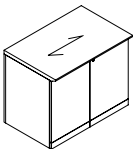

**Storage Cabinet w/Doors**

**MODEL# DIMENSIONS FREIGHT CLASS WT/LBS. CUBIC FT. VENEER/LAMINATE ALL VENEER**

DWDB	19.8 x 15.5 x 28	85	70	5	<b>\$1648</b>	<b>\$1979</b>
DWWDB	23.8 x 15.5 x 28	300	75	6	<b>\$1898</b>	<b>\$2279</b>

**Two box and one file drawer.** One pencil tray. Lock secures all drawers. Finished back.

DWDM	19.8 x 15.5 x 28	85	70	5	<b>\$1774</b>	<b>\$2128</b>
DWWDM	23.8 x 15.5 x 28	300	75	6	<b>\$2038</b>	<b>\$2447</b>

**Two box and one file drawer.** One pencil tray. Lock secures all drawers. Casters.

DF3624	24 x 36 x 29	85	184	15	<b>\$3153</b>	<b>\$3783</b>
DN3024	24 x 30 x 29	85	153	12	<b>\$2761</b>	<b>\$3314</b>
DF3622	22 x 36 x 29	85	170	13	<b>\$2890</b>	<b>\$3467</b>
DN3022	22 x 30 x 29	85	142	11	<b>\$2532</b>	<b>\$3039</b>

**Two lateral file drawers.** Lock secures all drawers. Side-to-side file bars included.

DBD3624	24 x 36 x 29	92.5	152	15	<b>\$1972</b>	<b>\$2365</b>
DBD3024	24 x 30 x 29	92.5	127	12	<b>\$1725</b>	<b>\$2068</b>
DBD3622	22 x 36 x 29	92.5	140	13	<b>\$1806</b>	<b>\$2165</b>
DBD3022	22 x 30 x 29	92.5	117	11	<b>\$1582</b>	<b>\$1896</b>

Includes one adjustable shelf. Standard with lock.

**Required Specifications**

Veneer Finish (doors, drawer fronts, open shelves)

Laminate Finish (top/body)

Handle Style

STORAGE MODULES - FREESTANDING

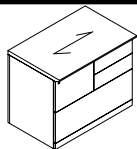

Mixed Storage Cabinet - LEFT

MODEL#	DIMENSIONS D x W x H	FREIGHT CLASS	WT/LBS.	CUBIC FT.	VENEER/LAMINATE	ALL VENEER
DZL3624	24 x 36 x 29	85	184	15	\$3138	\$3764
DZL3622	22 x 36 x 29	85	170	13	\$2876	\$3453

One file drawer on the **left**, two box drawers on the **right** and one lateral file drawer on the bottom. File drawer and lateral file drawer lock. One pencil tray. Not for stacking materials on lateral file drawer bottom.

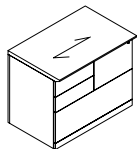

Mixed Storage Cabinet - RIGHT

DZR3624	24 x 36 x 29	85	184	15	\$3138	\$3764
DZR3622	22 x 36 x 29	85	170	13	\$2876	\$3453

One file drawer on the **right**, two box drawers on the **left** and one lateral file drawer on the bottom. File drawer and lateral file drawer lock. One pencil tray. Not for stacking materials on lateral file drawer bottom.

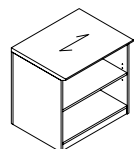

Open Storage Cabinet

DOB3624	24 x 36 x 29	100	123	15	\$1521	\$1825
DOB3024	24 x 30 x 29	100	103	12	\$1333	\$1599
DOB3622	22 x 36 x 29	100	115	13	\$1397	\$1678
DOB3022	22 x 30 x 29	100	96	11	\$1223	\$1467

One fixed and **one** adjustable veneer shelf. Shelves are 3/4" thick.

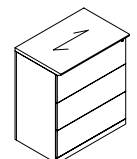

Three File Module

DF36243	24 x 36 x 42	92.5	231	21	\$3809	\$4573
DN30243	24 x 30 x 42	92.5	193	18	\$3341	\$4010
DF36223	22 x 36 x 42	92.5	212	19	\$3527	\$4231
DN30223	22 x 30 x 42	92.5	176	16	\$3095	\$3712

**Three lateral file drawers.** Lock secures all drawers.

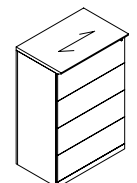

Four File Module

DF36244	24 x 36 x 54	92.5	297	27	\$5041	\$6049
DN30244	24 x 30 x 54	92.5	248	23	\$4304	\$5165
DF36224	22 x 36 x 54	92.5	270	25	\$4297	\$5156
DN30224	22 x 30 x 54	92.5	225	21	\$3765	\$4520

**Four lateral file drawers.** Lock secures all drawers.

STORAGE MODULES - 48" HIGH (FREESTANDING)

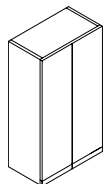

Storage Cabinet w/Doors\*

MODEL#	DIMENSIONS	FREIGHT CLASS	WT/LBS.	CUBIC FT.	VENEER/LAMINATE	ALL VENEER
D1D22H48	22 x 36 x 48	150	107	22	\$3040	\$3647
D1D22W30H48	22 x 30 x 48	150	90	19	\$2969	\$3563
D1D22W24H48	22 x 24 x 48	150	72	15	\$2911	\$3493
D1D20H48	20 x 36 x 48	150	97	20	\$2766	\$3317
D1D20W30H48	20 x 30 x 48	150	81	17	\$2706	\$3245
D1D20W24H48	20 x 24 x 48	150	63	13	\$2647	\$3175

Includes four adjustable shelves.

**Required Specifications**

Veneer finish  
Laminated finish (body)  
Handle Style

**Optional Specifications**

Lock\*  
Veneer Top\*

**STORAGE MODULES - 48" HIGH (FREESTANDING)**

**MODEL# DIMENSIONS FREIGHT CLASS WT/LBS. CUBIC FT. VENEER/LAMINATE ALL VENEER**

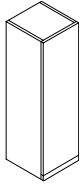

**Storage Cabinet w/Door - LEFT\***

D x W x H							
D1D22W18H48L	22 x 18 x 48	150	60	11	<b>\$1919</b>	<b>\$2304</b>	
D1D22W16H48L	22 x 16 x 48	150	54	10	<b>\$1707</b>	<b>\$2050</b>	
D1D20W18H48L	20 x 18 x 48	125	60	10	<b>\$1747</b>	<b>\$2099</b>	
D1D20W16H48L	20 x 16 x 48	125	54	9	<b>\$1549</b>	<b>\$1859</b>	

Includes three adjustable shelves. Handle is on the **right**, door opens to the **left**.

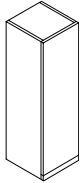

**Storage Cabinet w/Door - RIGHT\***

D1D22W18H48R	22 x 18 x 48	150	60	11	<b>\$1919</b>	<b>\$2304</b>
D1D22W16H48R	22 x 16 x 48	150	54	10	<b>\$1707</b>	<b>\$2050</b>
D1D20W18H48R	20 x 18 x 48	125	60	10	<b>\$1747</b>	<b>\$2099</b>
D1D20W16H48R	20 x 16 x 48	125	54	9	<b>\$1549</b>	<b>\$1859</b>

Includes three adjustable shelves. Handle is on the **left**, door opens to the **right**.

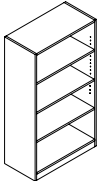

**Open Storage Cabinet**

D7D22W36H48	22 x 36 x 48	150	118	22	<b>\$2398</b>	<b>\$2878</b>
D7D22W30H48	22 x 30 x 48	150	98	19	<b>\$1782</b>	<b>\$2137</b>
D7D22W24H48	22 x 24 x 48	150	78	15	<b>\$1421</b>	<b>\$1704</b>
D7D22W18H48	22 x 18 x 48	150	59	11	<b>\$1194</b>	<b>\$1434</b>
D7D20W36H48	20 x 36 x 48	150	108	20	<b>\$2180</b>	<b>\$2616</b>
D7D20W30H48	20 x 30 x 48	150	90	17	<b>\$1617</b>	<b>\$1941</b>
D7D20W24H48	20 x 24 x 48	100	72	13	<b>\$1584</b>	<b>\$1898</b>
D7D20W18H48	20 x 18 x 48	150	54	10	<b>\$1140</b>	<b>\$1368</b>

One fixed and **three** adjustable veneer shelves. Shelves are 3/4" thick.

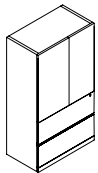

**Two File Module w/Doors\***

D13D22H48	22 x 36 x 48	150	117	23	<b>\$3239</b>	<b>\$3885</b>
D13D22W30H48	22 x 30 x 48	150	101	19	<b>\$2932</b>	<b>\$3517</b>
D13H48	20 x 36 x 48	150	107	23	<b>\$3102</b>	<b>\$3725</b>
D13W30H48	20 x 30 x 48	150	91	19	<b>\$3793</b>	<b>\$4550</b>

Two lateral file drawers on bottom. Includes two adjustable shelves. Lower lock secures two file drawers. **Not for stacking materials on lateral file drawer bottom.**

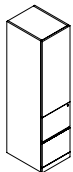

**Two File Module w/Door - LEFT\***

D17D22H48L	22 x 16 x 48	125	97	13	<b>\$2404</b>	<b>\$2885</b>
D17D20H48L	20 x 16 x 48	125	88	13	<b>\$2193</b>	<b>\$2631</b>

Two file drawers on bottom. Includes two adjustable shelves. Lower lock secures two file drawers. Handle is on the right, door opens to the left.

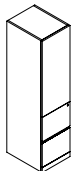

**Two File Module w/Door - RIGHT\***

D17D22H48R	22 x 16 x 48	125	97	13	<b>\$2404</b>	<b>\$2885</b>
D17D20H48R	20 x 16 x 48	125	88	13	<b>\$2193</b>	<b>\$2631</b>

Two file drawers on bottom. Includes two adjustable shelves. Lower lock secures two file drawers. Handle is on the left, door opens to the right.

**Required Specifications**

Veneer finish (doors, drawer fronts)  
Laminate finish (top/body)  
Handle Style\*

**Optional Specifications**

Lock\*  
Veneer top

**STORAGE MODULES - 48" HIGH (FREESTANDING)    MODEL#    DIMENSIONS    FREIGHT CLASS    WT/LBS.    CUBIC FT.    VENEER/LAMINATE    ALL VENEER**

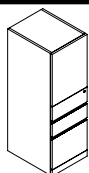

**Box/Box/File Module w/Door - LEFT**

	D x W x H						
D18D22H48L	22 x 16 x 48	125	64	9	<b>\$2404</b>	<b>\$2885</b>	
D18D20H48L	20 x 16 x 48	125	59	9	<b>\$2193</b>	<b>\$2631</b>	

Two box drawers and one file drawer on bottom. Includes two adjustable shelves. Lower lock secures all drawers. Handle is on the **right**, door opens to the **left**.

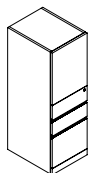

**Box/Box/File Module w/Door - RIGHT**

D18D22H48R	22 x 16 x 48	125	64	9	<b>\$2404</b>	<b>\$2885</b>	
D18D20H48R	20 x 16 x 48	125	59	9	<b>\$2193</b>	<b>\$2631</b>	

Two box drawers and one file drawer on bottom. Includes two adjustable shelves. Lower lock secures all drawers. Handle is on the **left**, door opens to the **right**.

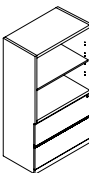

**Two File Module w/Open Shelf**

D12D22H48	22 x 36 x 48	150	117	23	<b>\$3041</b>	<b>\$3650</b>	
D12D22W30H48	22 x 30 x 48	150	101	19	<b>\$2629</b>	<b>\$3156</b>	
D12H48	20 x 36 x 48	150	107	23	<b>\$2919</b>	<b>\$3503</b>	
D12W30H48	20 x 30 x 48	150	91	19	<b>\$3561</b>	<b>\$4272</b>	

Two open veneer shelves and two lateral file drawers on bottom. Includes one adjustable shelf. Lock secures all drawers. **Not for stacking materials on lateral file drawer bottom.**

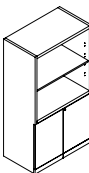

**Storage Module w/Open Shelf**

D22D22H48	22 x 36 x 48	150	117	23	<b>\$2745</b>	<b>\$3292</b>	
D22D22W30H48	22 x 30 x 48	150	101	19	<b>\$1879</b>	<b>\$2253</b>	
D22D20H48	20 x 36 x 48	150	107	23	<b>\$2160</b>	<b>\$2591</b>	
D22D20W30H48	20 x 30 x 48	150	91	19	<b>\$1795</b>	<b>\$2154</b>	

Two open veneer shelves and storage cabinet on bottom. Includes one adjustable shelf in upper compartment and one adjustable shelf in storage cabinet. Lock secures storage cabinet.

**WARDROBE CABINETS - 48" HIGH    MODEL#    DIMENSIONS    FREIGHT CLASS    WT/LBS.    CUBIC FT.    VENEER/LAMINATE    ALL VENEER**

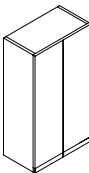

**Wardrobe Cabinet\***

D2D22H48	22 x 36 x 48	150	107	22	<b>\$2485</b>	<b>\$2986</b>	
D2D22W30H48	22 x 30 x 48	150	107	19	<b>\$2433</b>	<b>\$2919</b>	
D2D22W24H48	22 x 24 x 48	150	85	15	<b>\$2911</b>	<b>\$3493</b>	
D2H48	20 x 36 x 48	150	102	20	<b>\$2261</b>	<b>\$2714</b>	
D2W30H48	20 x 30 x 48	150	89	17	<b>\$2213</b>	<b>\$2656</b>	
D2W24H48	20 x 24 x 48	150	72	13	<b>\$2164</b>	<b>\$2598</b>	

Includes full length hanging rod and fixed hat shelf.

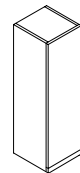

**Wardrobe Cabinet - LEFT\***

D2D22W24H48L	22 x 24 x 48	150	80	15	<b>\$2384</b>	<b>\$2864</b>	
D2D22W18H48L	22 x 18 x 48	150	60	11	<b>\$1919</b>	<b>\$2304</b>	
D2D22W12H48L	22 x 12 x 48	150	40	7	<b>\$1832</b>	<b>\$2199</b>	
D2D20W24H48L	20 x 24 x 48	150	72	13	<b>\$2164</b>	<b>\$2598</b>	
D2D20W18H48L	20 x 18 x 48	150	54	10	<b>\$1747</b>	<b>\$2099</b>	
D2D20W12H48L	20 x 12 x 48	125	36	7	<b>\$2032</b>	<b>\$2437</b>	

Includes full length hanging rod and fixed hat shelf. Handle is on the **right**, door opens to the **left**.

**Required Specifications**

Veneer Finish (doors, drawer fronts)  
Laminate Finish (top/body)  
Handle Style

**Optional Specifications**

Lock\*  
Veneer Top

**WARDROBE CABINETS - 48" HIGH**

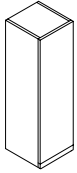

**Wardrobe Cabinet - RIGHT\***

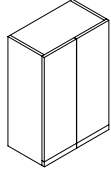

**Wardrobe Cabinet/Shelving Combo\***

MODEL#	DIMENSIONS	FREIGHT CLASS	WT/LBS.	CUBIC FT.	VENEER/LAMINATE	ALL VENEER
<b>D x W x H</b>						
D2D22W24H48R	22 x 24 x 48	150	80	15	<b>\$2384</b>	<b>\$2864</b>
D2D22W18H48R	22 x 18 x 48	150	60	11	<b>\$1919</b>	<b>\$2304</b>
D2D22W12H48R	22 x 12 x 48	150	40	7	<b>\$1832</b>	<b>\$2199</b>
D2D20W24H48R	20 x 24 x 48	150	72	13	<b>\$2164</b>	<b>\$2598</b>
D2D20W18H48R	20 x 18 x 48	150	54	10	<b>\$1747</b>	<b>\$2099</b>
D2D20W12H48R	20 x 12 x 48	125	36	7	<b>\$2032</b>	<b>\$2437</b>

Includes full length hanging rod and fixed hat shelf. Handle is on the **left**, door opens to the **right**.

D25D22H48	22 x 36 x 48	150	117	23	<b>\$2646</b>	<b>\$3174</b>
D25D22W30H48	22 x 30 x 48	150	101	19	<b>\$2596</b>	<b>\$3115</b>
D25D20H48	20 x 36 x 48	150	107	23	<b>\$2534</b>	<b>\$3041</b>
D25D20W30H48	20 x 30 x 48	60	91	19	<b>\$2485</b>	<b>\$2986</b>

Wardrobe compartment on **left** includes hanging rod and fixed hat shelf. Storage compartment on **right** includes three adjustable shelves.

**STORAGE MODULES - 54" HIGH (FREESTANDING)**

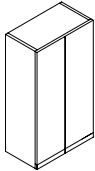

**Storage Cabinet w/Doors\***

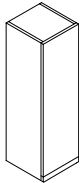

**Storage Cabinet w/Door - LEFT\***

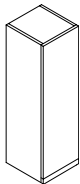

**Storage Cabinet w/Door - RIGHT\***

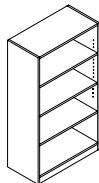

**Open Storage Cabinet**

MODEL#	DIMENSIONS	FREIGHT CLASS	WT/LBS.	CUBIC FT.	VENEER/LAMINATE	ALL VENEER
D1D22H54	22 x 36 x 54	150	120	22	<b>\$2692</b>	<b>\$3231</b>
D1D22W30H54	22 x 30 x 54	150	102	19	<b>\$2678</b>	<b>\$3216</b>
D1D22W24H54	22 x 24 x 54	150	81	17	<b>\$3272</b>	<b>\$3929</b>
D1D20H54	20 x 36 x 54	150	110	20	<b>\$2543</b>	<b>\$3049</b>
D1D20W30H54	20 x 30 x 54	150	92	17	<b>\$2485</b>	<b>\$2986</b>
D1D20W24H54	20 x 24 x 54	150	71	13	<b>\$2440</b>	<b>\$2925</b>

Includes four adjustable shelves.

D1D22W18H54L	22 x 18 x 54	150	68	12	<b>\$2164</b>	<b>\$2598</b>
D1D22W16H54L	22 x 16 x 54	150	61	11	<b>\$1919</b>	<b>\$2304</b>
D1D20W18H54L	20 x 18 x 54	125	68	11	<b>\$1961</b>	<b>\$2353</b>
D1D20W16H54L	20 x 16 x 54	125	61	10	<b>\$1747</b>	<b>\$2099</b>

Includes three adjustable shelves. Handle is on the **right**, door opens to the **left**.

D1D22W18H54R	22 x 18 x 54	150	68	12	<b>\$2164</b>	<b>\$2598</b>
D1D22W16H54R	22 x 16 x 54	150	61	11	<b>\$1919</b>	<b>\$2304</b>
D1D20W18H54R	20 x 18 x 54	125	68	11	<b>\$1961</b>	<b>\$2353</b>
D1D20W16H54R	20 x 16 x 54	125	61	10	<b>\$1747</b>	<b>\$2099</b>

Includes three adjustable shelves. Handle is on the **left**, door opens to the **right**.

D7D22W36H54	22 x 36 x 54	150	132	25	<b>\$2700</b>	<b>\$3239</b>
D7D22W30H54	22 x 30 x 54	150	110	21	<b>\$2001</b>	<b>\$2402</b>
D7D22W24H54	22 x 24 x 54	150	88	17	<b>\$1606</b>	<b>\$1928</b>
D7D22W18H54	22 x 18 x 54	150	67	12	<b>\$1254</b>	<b>\$1509</b>
D7D20W36H54	20 x 36 x 54	150	122	23	<b>\$2453</b>	<b>\$2944</b>
D7D20W30H54	20 x 30 x 54	150	102	19	<b>\$1824</b>	<b>\$2188</b>
D7D20W24H54	20 x 24 x 54	150	81	15	<b>\$1455</b>	<b>\$1744</b>
D7D20W18H54	20 x 18 x 54	150	61	11	<b>\$1180</b>	<b>\$1417</b>

One fixed and **three** adjustable veneer shelves. Shelves are 3/4" thick.

**Required Specifications**

Veneer Finish (doors)  
Laminate Finish (top/body)  
Handle Style\*

**Optional Specifications**

Lock\*  
Veneer Top

STORAGE MODULES - 54" HIGH (FREESTANDING)

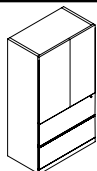

Two File Module w/Doors

MODEL#	DIMENSIONS D x W x H	FREIGHT CLASS	WT/LBS.	CUBIC FT.	VENEER/LAMINATE	ALL VENEER
D13D22H54	22 x 36 x 54	150	130	24	\$4449	\$5339
D13D22W30H54	22 x 30 x 54	150	112	20	\$3293	\$3954
D13H54	20 x 36 x 54	125	120	19	\$3493	\$4193
D13W30H54	20 x 30 x 54	150	102	21	\$3159	\$3788

Two lateral file drawers on bottom. Includes two adjustable shelves. Lower lock secures two file drawers. Front-to-back and side-to-side filing. **Not for stacking materials on lateral file drawer bottom.**



Two File Module w/Door - LEFT

D17D22H54L	22 x 16 x 54	100	110	13	\$2714	\$3256
D17D20H54L	20 x 16 x 54	125	99	13	\$2468	\$2961

Two file drawers on bottom. Includes two adjustable shelves. Lower lock secures two file drawers. Handle is on the right, door opens to the left.



Two File Module w/Door - RIGHT

D17D22H54R	22 x 16 x 54	100	110	13	\$2714	\$3256
D17D20H54R	20 x 16 x 54	125	99	13	\$2468	\$2961

Two file drawers on bottom. Includes two adjustable shelves. Lower lock secures two file drawers. Handle is on the left, door opens to the right.

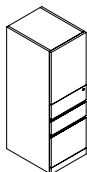

Box/Box/File Module w/Door - LEFT

D18D22H54L	22 x 16 x 54	125	71	10	\$2714	\$3256
D18D20H54L	20 x 16 x 54	125	66	10	\$2468	\$2961

Two box drawers and one file drawer on bottom. Includes two adjustable shelves. Lower lock secures all drawers. Handle is on the **right**, door opens to the **left**.

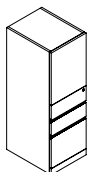

Box/Box/File Module w/Door - RIGHT

D18D22H54R	22 x 16 x 54	125	71	10	\$2714	\$3256
D18D20H54R	20 x 16 x 54	125	66	10	\$2468	\$2961

Two box drawers and one file drawer on bottom. Includes two adjustable shelves. Lower lock secures all drawers. Handle is on the **left**, door opens to the **right**.

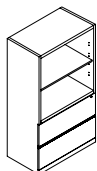

Two File Module w/Open Shelf

D12D22H54	22 x 36 x 54	150	130	24	\$3641	\$4371
D12D22W30H54	22 x 30 x 54	150	112	20	\$2958	\$3549
D12H54	20 x 36 x 54	125	120	19	\$3641	\$4371
D12W30H54	20 x 30 x 54	150	102	21	\$2835	\$3405

Two open veneer shelves and two lateral file drawers on bottom. Includes one adjustable shelf. Lock secures all drawers. Front-to-back and side-to-side filing. **Not for stacking materials on lateral file drawer bottom.**

**Required Specifications**

Veneer Finish (doors, drawer fronts, open shelves)  
Laminate Finish (top/body)  
Handle Style

**Optional Specifications**

Additional Lock (storage compartments)  
Veneer Top

**STORAGE MODULES - 54" HIGH (FREESTANDING)**

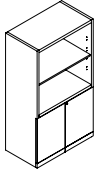

**Storage Module w/Open Shelf**

MODEL#	DIMENSIONS	FREIGHT CLASS	WT/LBS.	CUBIC FT.	veneer/LAMINATE	ALL VENEER
<b>D x W x H</b>						
D22D22H54	22 x 36 x 54	150	130	24	<b>\$2528</b>	<b>\$3035</b>
D22D22W30H54	22 x 30 x 54	150	112	20	<b>\$2110</b>	<b>\$2533</b>
D22D20H54	20 x 36 x 54	150	120	24	<b>\$2425</b>	<b>\$2910</b>
D22D20W30H54	20 x 30 x 54	150	102	20	<b>\$2021</b>	<b>\$2427</b>

Two open veneer shelves and storage cabinet on bottom. Includes one adjustable shelf in upper compartment and one adjustable shelf in storage cabinet. Lock secures storage cabinet.

**WARDROBE CABINETS - 54" HIGH**

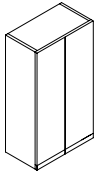

**Wardrobe Cabinet\***

MODEL#	DIMENSIONS	FREIGHT CLASS	WT/LBS.	CUBIC FT.	veneer/LAMINATE	ALL VENEER
D2D22H54	22 x 36 x 54	150	120	25	<b>\$2692</b>	<b>\$3231</b>
D2D22W30H54	22 x 30 x 54	150	120	21	<b>\$2678</b>	<b>\$3216</b>
D2D22W24H54	22 x 24 x 54	150	95	17	<b>\$3272</b>	<b>\$3929</b>
D2H54	20 x 36 x 54	150	119	23	<b>\$2543</b>	<b>\$3049</b>
D2W30H54	20 x 30 x 54	150	101	19	<b>\$2485</b>	<b>\$2986</b>
D2W24H54	20 x 24 x 54	150	81	15	<b>\$2440</b>	<b>\$2925</b>

Includes full length hanging rod and fixed hat shelf.

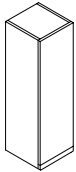

**Wardrobe Cabinet - LEFT\***

D2D22W24H54L	22 x 24 x 54	150	90	17	<b>\$2678</b>	<b>\$3216</b>
D2D22W18H54L	22 x 18 x 54	150	68	12	<b>\$2160</b>	<b>\$2591</b>
D2D22W12H54L	22 x 12 x 54	150	45	8	<b>\$2056</b>	<b>\$2468</b>
D2D20W24H54L	20 x 24 x 54	150	81	15	<b>\$2974</b>	<b>\$3571</b>
D2D20W18H54L	20 x 18 x 54	150	61	11	<b>\$1961</b>	<b>\$2353</b>
D2D20W12H54L	20 x 12 x 54	150	41	8	<b>\$2286</b>	<b>\$2743</b>

Includes full length hanging rod and fixed hat shelf. Handle is on the **right**, door opens to the **left**.

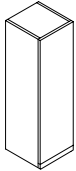

**Wardrobe Cabinet - RIGHT\***

D2D22W24H54R	22 x 24 x 54	150	90	17	<b>\$2678</b>	<b>\$3216</b>
D2D22W18H54R	22 x 18 x 54	150	68	12	<b>\$2160</b>	<b>\$2591</b>
D2D22W12H54R	22 x 12 x 54	150	45	8	<b>\$2056</b>	<b>\$2468</b>
D2D20W24H54R	20 x 24 x 54	150	81	15	<b>\$2974</b>	<b>\$3571</b>
D2D20W18H54R	20 x 18 x 54	150	61	11	<b>\$1961</b>	<b>\$2353</b>
D2D20W12H54R	20 x 12 x 54	150	41	8	<b>\$2286</b>	<b>\$2743</b>

Includes full length hanging rod and fixed hat shelf. Handle is on the **left**, door opens to the **right**.

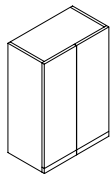

**Wardrobe Cabinet/Shelving Combo\***

D25D22H54	22 x 36 x 54	150	130	24	<b>\$2972</b>	<b>\$3566</b>
D25D22W30H54	22 x 30 x 54	150	112	20	<b>\$2919</b>	<b>\$3503</b>
D25D20H54	20 x 36 x 54	150	120	24	<b>\$2848</b>	<b>\$3418</b>
D25D20W30H54	20 x 30 x 54	150	102	20	<b>\$2802</b>	<b>\$3361</b>

Wardrobe compartment on **left** includes hanging rod and fixed hat shelf. Storage compartment on **right** includes three adjustable shelves.

**STORAGE MODULES - 66" HIGH (FREESTANDING)**

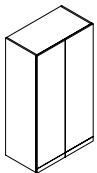

**Storage Cabinet w/Doors**

MODEL#	DIMENSIONS	FREIGHT CLASS	WT/LBS.	CUBIC FT.	veneer/LAMINATE	ALL VENEER
D1D22	22 x 36 x 66	100	259	30	<b>\$3328</b>	<b>\$3992</b>
D1D22W30	22 x 30 x 66	100	259	25	<b>\$2914</b>	<b>\$3496</b>
D1D22W24	22 x 24 x 66	125	173	22	<b>\$2501</b>	<b>\$3001</b>
D1	20 x 36 x 66	100	245	28	<b>\$3173</b>	<b>\$3805</b>
D1W30	20 x 30 x 66	100	202	23	<b>\$2646</b>	<b>\$3174</b>
D1W24	20 x 24 x 66	125	163	18	<b>\$2111</b>	<b>\$2534</b>

Includes four adjustable shelves.

**Required Specifications**

Veneer Finish (doors, drawer fronts, open shelves)  
Laminate Finish (top/body)  
Handle Style

**Optional Specifications**

Lock\*  
Veneer Top



STORAGE MODULES - 66" HIGH (FREESTANDING)

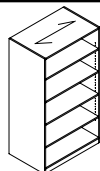

Open Storage Cabinet

MODEL#	DIMENSIONS D x W x H	FREIGHT CLASS	WT/LBS.	CUBIC FT.	VENEER/LAMINATE	ALL VENEER
D7D24	24 x 36 x 66	100	281	33	<b>\$3062</b>	<b>\$3676</b>
D7D24W30	24 x 30 x 66	100	234	28	<b>\$2678</b>	<b>\$3216</b>
D7	20 x 36 x 66	100	234	28	<b>\$2538</b>	<b>\$3046</b>
D7W30	20 x 30 x 66	100	193	23	<b>\$2227</b>	<b>\$2672</b>

Includes one fixed and **four** adjustable veneer shelves. Shelves are 3/4" thick.

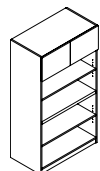

Open Storage Cabinet w/Doors

D9D22	22 x 36 x 66	92.5	308	30	<b>\$2865</b>	<b>\$3436</b>
D9D22W30	22 x 30 x 66	92.5	257	25	<b>\$2506</b>	<b>\$3009</b>
D9	20 x 36 x 66	92.5	294	28	<b>\$2726</b>	<b>\$3271</b>
D9W30	20 x 30 x 66	92.5	243	23	<b>\$2276</b>	<b>\$2730</b>

Storage compartment with fixed shelf. One fixed and **two** adjustable veneer shelves. Fixed shelf is at 29" high. Shelves are 3/4" thick.

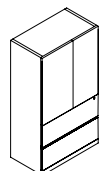

Two File Module w/Doors

D13D22	22 x 36 x 66	92.5	313	30	<b>\$4118</b>	<b>\$4942</b>
D13D22W30	22 x 30 x 66	92.5	261	25	<b>\$3608</b>	<b>\$4329</b>
D13	20 x 36 x 66	92.5	299	28	<b>\$3923</b>	<b>\$4708</b>
D13W30	20 x 30 x 66	92.5	247	23	<b>\$3271</b>	<b>\$3925</b>

Two lateral file drawers on bottom. Includes **two** adjustable shelves. Lower lock secures two file drawers. Front-to-back and side-to-side filing. **Not for stacking materials on lateral file drawer bottom.**



Two File Module w/Door - LEFT

D17D22L	22 x 16 x 66	125	91	13	<b>\$2865</b>	<b>\$3436</b>
D17D20L	20 x 16 x 66	125	83	12	<b>\$2602</b>	<b>\$3123</b>

Two file drawers on bottom. Includes two adjustable shelves. Lower lock secures two file drawers. Handle is on the **right**, door opens to the **left**.

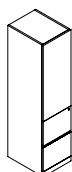

Two File Module w/Door - RIGHT

D17D22R	22 x 16 x 66	125	91	13	<b>\$2865</b>	<b>\$3436</b>
D17D20R	20 x 16 x 66	125	83	12	<b>\$2602</b>	<b>\$3123</b>

Two file drawers on bottom. Includes two adjustable shelves. Lower lock secures two file drawers. Handle is on the **left**, door opens to the **right**.

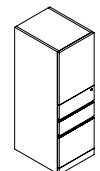

Box/Box/File Module w/Door - LEFT

D18D22L	22 x 16 x 66	125	91	13	<b>\$2865</b>	<b>\$3436</b>
D18D20L	20 x 16 x 66	125	83	12	<b>\$2602</b>	<b>\$3123</b>

Two box drawers and one file drawer on bottom. Includes two adjustable shelves. Lower lock secures all drawers. Handle is on the **right**, door opens to the **left**.

**Required Specifications**

Veneer Finish (doors, drawer fronts, open shelves)  
Laminate Finish (top/body)  
Handle Style

**Optional Specifications**

Additional Lock (storage compartments)  
Veneer Top

**PERSONAL TOWERS - 66" HIGH (FREESTANDING) MODEL# DIMENSIONS FREIGHT CLASS WT/LBS. CUBIC FT. VENEER/LAMINATE ALL VENEER**

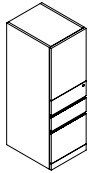

**Box/Box/File Module w/Door - RIGHT**

	D x W x H						
D18D22R	22 x 16 x 66	125	91	13	\$2865	\$3436	
D18D20R	20 x 16 x 66	125	83	12	\$2602	\$3123	

Two box drawers and one file drawer on bottom. Includes two adjustable shelves. Lower lock secures all drawers. Handle is on the left, door opens to the right.

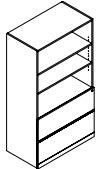

**Two File Module w/Open Shelves**

D12D22	22 x 36 x 66	92.5	303	30	\$3615	\$4342	
D12D22W30	22 x 30 x 66	92.5	253	25	\$3166	\$3801	
D12	20 x 36 x 66	92.5	289	28	\$3442	\$4129	
D12W30	20 x 30 x 66	92.5	239	23	\$2871	\$3448	

Three open veneer shelves and two lateral file drawers on bottom. Includes two adjustable shelves. Lock secures all drawers. Front-to-back and side-to-side filing. **Not for stacking materials on lateral file drawer bottom.**

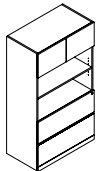

**Two File Module w/Doors and Open Shelves**

D10D22	22 x 36 x 66	92.5	308	30	\$4001	\$4803	
D10D22W30	22 x 30 x 66	92.5	257	25	\$3505	\$4204	
D10	20 x 36 x 66	92.5	294	28	\$3808	\$4572	
D10W30	20 x 30 x 66	92.5	243	23	\$3177	\$3811	

Storage compartment with fixed shelf. Two open veneer shelves and two lateral file drawers on bottom. Includes one adjustable shelf. Lock secures all drawers. Front-to-back and side-to-side filing. **Not for stacking materials on lateral file drawer bottom.**

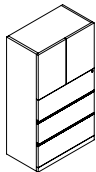

**Three File Module w/Doors**

D14D22	22 x 36 x 66	100	286	30	\$4429	\$5316	
D14D22W30	22 x 30 x 66	100	238	25	\$3879	\$4655	
D14	20 x 36 x 66	100	272	28	\$4220	\$5063	
D14W30	20 x 30 x 66	100	224	23	\$3514	\$4219	

Three lateral file drawers on bottom. Includes one adjustable shelf. Lock secures all drawers. Front-to-back and side-to-side filing. **Not for stacking materials on lateral file drawer bottom.**

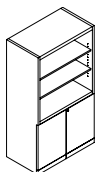

**Storage Module w/Open Shelves**

D22D22	22 x 36 x 66	100	275	30	\$3035	\$3640	
D22D22W30	22 x 30 x 66	100	243	25	\$2655	\$3186	
D22	20 x 36 x 66	100	278	28	\$2892	\$3469	
D22W30	20 x 30 x 66	100	229	23	\$2406	\$2890	

Three open veneer shelves and storage cabinet on bottom. Includes two adjustable shelves in upper compartment and one adjustable shelf in storage cabinet. Lock secures storage cabinet.

**WARDROBE CABINETS - 66" HIGH (FREESTANDING) MODEL# DIMENSIONS FREIGHT CLASS WT/LBS. CUBIC FT. VENEER/LAMINATE ALL VENEER**

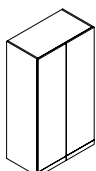

**Wardrobe Cabinet\***

D2D22	22 x 36 x 66	100	259	30	\$2892	\$3469	
D2D22W30	22 x 30 x 66	100	216	30	\$2528	\$3035	
D2D22W24	22 x 24 x 66	100	198	22	\$2166	\$2600	
D2	20 x 36 x 66	100	245	28	\$2753	\$3306	
D2W30	20 x 30 x 66	100	202	23	\$2293	\$2752	
D2W24	20 x 24 x 66	125	163	18	\$1835	\$2203	

Includes full length hanging rod and fixed hat shelf.

**Required Specifications**

Veneer Finish (doors, drawer fronts)  
Laminate Finish (top/body)  
Handle Style

**Optional Specifications**

Additional Lock (storage compartments)  
Lock\*  
Veneer Top

**WARDROBE CABINETS - 66" HIGH (FREESTANDING) MODEL# DIMENSIONS FREIGHT CLASS WT/LBS. CUBIC FT. VENEER/LAMINATE ALL VENEER**

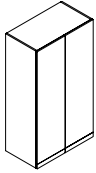

**Wardrobe Cabinet/Shelving Combo\***

	D x W x H					
D25D22	22 x 36 x 66	100	292	30	<b>\$3734</b>	<b>\$4480</b>
D25D22W30	22 x 30 x 66	100	243	25	<b>\$3267</b>	<b>\$3921</b>
D25D22W24	22 x 24 x 66	100	195	22	<b>\$2799</b>	<b>\$3359</b>
D25	20 x 36 x 66	100	278	28	<b>\$3553</b>	<b>\$4265</b>
D25W30	20 x 30 x 66	100	229	23	<b>\$2964</b>	<b>\$3557</b>
D25W24	20 x 24 x 66	100	185	18	<b>\$2371</b>	<b>\$2846</b>

Wardrobe compartment on **left** includes hanging rod and fixed hat shelf. Storage compartment on **right** includes three adjustable shelves.

**PERSONAL TOWERS - 66" HIGH (FREESTANDING) MODEL# DIMENSIONS FREIGHT CLASS WT/LBS. CUBIC FT. VENEER/LAMINATE ALL VENEER**

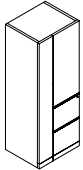

**Personal Tower - LEFT**

D29D22W24L	22 x 24 x 66	125	141	20	<b>\$3887</b>	<b>\$4667</b>
D29W24L	20 x 24 x 66	125	128	18	<b>\$3684</b>	<b>\$4421</b>

**Two file** drawers on bottom. Wardrobe compartment on **left** includes hanging rod. Storage compartment on **right** includes one adjustable shelf. Lower lock secures all drawers.

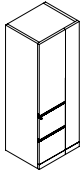

**Personal Tower - RIGHT**

D29D22W24R	22 x 24 x 66	125	141	20	<b>\$3887</b>	<b>\$4667</b>
D29W24R	20 x 24 x 66	125	128	18	<b>\$3684</b>	<b>\$4421</b>

**Two file** drawers on bottom. Wardrobe compartment on **right** includes hanging rod. Storage compartment on **left** includes one adjustable shelf. Lower lock secures all drawers.

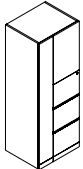

**Personal Tower - LEFT**

D27D22W24L	22 x 24 x 66	125	141	20	<b>\$4422</b>	<b>\$5308</b>
D27W24L	20 x 24 x 66	125	128	18	<b>\$4211</b>	<b>\$5053</b>

**Three file** drawers on bottom. Wardrobe compartment on **left** includes hanging rod. Storage compartment on **right** includes one adjustable shelf. Lower lock secures all drawers.

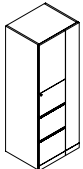

**Personal Tower - RIGHT**

D27D22W24R	22 x 24 x 66	125	141	20	<b>\$4422</b>	<b>\$5308</b>
D27W24R	20 x 24 x 66	125	128	18	<b>\$4211</b>	<b>\$5053</b>

**Three file** drawers on bottom. Wardrobe compartment on **right** includes hanging rod. Storage compartment on **left** includes one adjustable shelf. Lower lock secures all drawers.

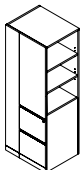

**Personal Tower w/Open Bookcase - LEFT**

D30D22W24L	22 x 24 x 66	125	141	20	<b>\$3887</b>	<b>\$4667</b>
D30W24L	20 x 24 x 66	125	128	18	<b>\$3684</b>	<b>\$4421</b>

**Two file drawers** on bottom. Wardrobe compartment on **left** includes hanging rod. Storage compartment on **right** includes one adjustable shelf. Open bookcase on **right** includes two adjustable shelves. Lower lock secures all drawers.

**Required Specifications**

Veneer Finish (doors, drawer fronts)  
Laminate Finish (top/body)  
Handle Style

**Optional Specifications**

Additional Lock (storage compartments)  
Lock\*  
Veneer Top

**PERSONAL TOWERS - 66" HIGH (FREESTANDING)**

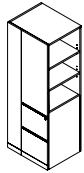

**Personal Tower w/Open Bookcase - RIGHT**

MODEL#	DIMENSIONS D x W x H	FREIGHT CLASS	WT/LBS.	CUBIC FT.	veneer/LAMINATE	ALL VENEER
D30D22W24R	22 x 24 x 66	125	141	20	<b>\$3887</b>	<b>\$4667</b>
D30W24R	20 x 24 x 66	125	128	18	<b>\$3684</b>	<b>\$4421</b>

**Two file drawers** on bottom. Wardrobe compartment on **right** includes hanging rod. Storage compartment on **left** includes one adjustable shelf. Open bookcase on **left** includes two adjustable shelves. Lower lock secures all drawers.

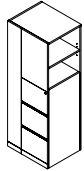

**Personal Tower w/Open Bookcase - LEFT**

D26D22W24L	22 x 24 x 66	125	141	20	<b>\$5356</b>	<b>\$6427</b>
D26W24L	20 x 24 x 66	125	128	18	<b>\$5102</b>	<b>\$6122</b>

**Three file drawers** on bottom. Wardrobe compartment on **left** includes hanging rod. Storage compartment on **right** includes one adjustable shelf. Open bookcase on **right** includes one adjustable shelf. Lower lock secures all drawers.

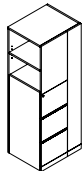

**Personal Tower w/Open Bookcase - RIGHT**

D26D22W24R	22 x 24 x 66	125	141	20	<b>\$5356</b>	<b>\$6427</b>
D26W24R	20 x 24 x 66	125	128	18	<b>\$5102</b>	<b>\$6122</b>

**Three file drawers** on bottom. Wardrobe compartment on **right** includes hanging rod. Storage compartment on **left** includes one adjustable shelf. Open bookcase on **left** includes one adjustable shelf. Lower lock secures all drawers.

**STORAGE MODULES - 72" HIGH (FREESTANDING)**

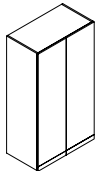

**Storage Cabinet w/Doors**

MODEL#	DIMENSIONS	FREIGHT CLASS	WT/LBS.	CUBIC FT.	veneer/LAMINATE	ALL VENEER
D1D22H72	22 x 36 x 72	100	283	33	<b>\$3633</b>	<b>\$4359</b>
D1D22W30H72	22 x 30 x 72	100	283	28	<b>\$3177</b>	<b>\$3811</b>
D1D22W24H72	22 x 24 x 72	125	255	24	<b>\$2724</b>	<b>\$3269</b>
D1H72	20 x 36 x 72	100	269	30	<b>\$3461</b>	<b>\$4152</b>
D1W30H72	20 x 30 x 72	100	233	25	<b>\$2882</b>	<b>\$3459</b>
D1W24H72	20 x 24 x 72	125	179	20	<b>\$2307</b>	<b>\$2769</b>

Includes four adjustable shelves.

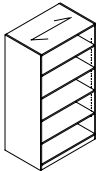

**Open Storage Cabinet**

D7D24H72	24 x 36 x 72	100	306	36	<b>\$3341</b>	<b>\$4010</b>
D7D24W30H72	24 x 30 x 72	100	255	30	<b>\$2923</b>	<b>\$3509</b>
D7H72	20 x 36 x 72	100	257	30	<b>\$2770</b>	<b>\$3326</b>
D7W30H72	20 x 30 x 72	100	223	25	<b>\$2308</b>	<b>\$2771</b>

Includes one fixed and **four** adjustable veneer shelves. Shelves are 3/4" thick.

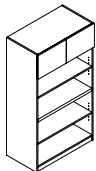

**Open Storage Cabinet w/Doors**

D9D22H72	22 x 36 x 72	92.5	336	33	<b>\$3123</b>	<b>\$3749</b>
D9D22W30H72	22 x 30 x 72	92.5	294	28	<b>\$2732</b>	<b>\$3281</b>
D9H72	20 x 36 x 72	92.5	322	30	<b>\$2972</b>	<b>\$3566</b>
D9W30H72	20 x 30 x 72	92.5	280	25	<b>\$2480</b>	<b>\$2974</b>

Storage compartment with fixed shelf. One fixed and **two** adjustable veneer shelves. Fixed shelf is at 29" high. Shelves are 3/4" thick.

**Required Specifications**

Veneer Finish (doors, drawer fronts, open shelves)  
Laminate Finish (top/body)  
Handle Style

**Optional Specifications**

Additional Lock (storage compartments)  
Veneer Top

STORAGE MODULES - 72" HIGH (FREESTANDING)

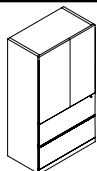

Two File Module w/Doors

MODEL#	DIMENSIONS D x W x H	FREIGHT CLASS	WT/LBS.	CUBIC FT.	VENEER/LAMINATE	ALL VENEER
D13D22H72	22 x 36 x 72	92.5	341	33	<b>\$4496</b>	<b>\$5396</b>
D13D22W30H72	22 x 30 x 72	125	299	28	<b>\$3932</b>	<b>\$4717</b>
D13H72	20 x 36 x 72	92.5	327	30	<b>\$4281</b>	<b>\$5136</b>
D13W30H72	20 x 30 x 72	92.5	285	25	<b>\$3566</b>	<b>\$4281</b>

Two lateral file drawers on bottom. Includes **two** adjustable shelves. Lower lock secures two file drawers. Front-to-back and side-to-side filing. **Not for stacking materials on lateral file drawer bottom.**



Two File Module w/Door - LEFT

D17D22H72L	22 x 16 x 72	125	99	15	<b>\$3129</b>	<b>\$3756</b>
D17D20H72L	20 x 16 x 72	125	90	13	<b>\$2844</b>	<b>\$3412</b>

Two file drawers on bottom. Includes two adjustable shelves. Lower lock secures two file drawers. Handle is on the **right**, door opens to the **left**.



Two File Module w/Door - RIGHT

D17D22H72R	22 x 16 x 72	125	99	15	<b>\$3129</b>	<b>\$3756</b>
D17D20H72R	20 x 16 x 72	125	90	13	<b>\$2844</b>	<b>\$3412</b>

Two file drawers on bottom. Includes two adjustable shelves. Lower lock secures two file drawers. Handle is on the **left**, door opens to the **right**.

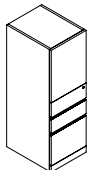

Box/Box/File Module w/Door - LEFT

D18D22H72L	22 x 16 x 72	125	99	15	<b>\$3129</b>	<b>\$3756</b>
D18D20H72L	20 x 16 x 72	125	90	13	<b>\$2844</b>	<b>\$3412</b>

Two box drawers and one file drawer on bottom. Includes two adjustable shelves. Lower lock secures all drawers. Handle is on the **right**, door opens to the **left**.

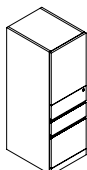

Box/Box/File Module w/Door - RIGHT

D18D22H72R	22 x 16 x 72	125	99	15	<b>\$3129</b>	<b>\$3756</b>
D18D20H72R	20 x 16 x 72	125	90	13	<b>\$2844</b>	<b>\$3412</b>

Two box drawers and one file drawer on bottom. Includes two adjustable shelves. Lower lock secures all drawers. Handle is on the **left**, door opens to the **right**.

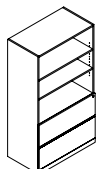

Two File Module w/Open Shelves

D12D22H72	22 x 36 x 72	92.5	331	33	<b>\$3947</b>	<b>\$4736</b>
D12D22W30H72	22 x 30 x 72	92.5	289	28	<b>\$3453</b>	<b>\$4143</b>
D12H72	20 x 36 x 72	92.5	317	30	<b>\$3757</b>	<b>\$4508</b>
D12W30H72	20 x 30 x 72	92.5	275	25	<b>\$3288</b>	<b>\$3945</b>

Three open veneer shelves and two lateral file drawers on bottom. Includes two adjustable shelves. Lock secures all drawers. Front-to-back and side-to-side filing. **Not for stacking materials on lateral file drawer bottom.**

**Required Specifications**

Veneer Finish (doors, drawer fronts, open shelves)  
Laminate Finish (top/body)  
Handle Style

**Optional Specifications**

Additional Lock (storage compartments)  
Lock (Wardrobe Cabinets)  
Veneer Top

STORAGE MODULES - 72" HIGH (FREESTANDING)

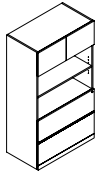

Two File Module w/Doors and Open Shelves

MODEL#	DIMENSIONS	FREIGHT CLASS	WT./LBS.	CUBIC FT.	VENEER/LAMINATE	ALL VENEER
<b>D x W x H</b>						
D10D22H72	22 x 36 x 72	92.5	336	33	\$4365	\$5238
D10D22W30H72	22 x 30 x 72	92.5	294	28	\$3820	\$4583
D10H72	20 x 36 x 72	92.5	322	30	\$4154	\$4986
D10W30H72	20 x 30 x 72	92.5	280	25	\$3463	\$4155

Storage compartment with fixed shelf. Two open veneer shelves and two lateral file drawers on bottom. Includes one adjustable shelf. Lock secures all drawers. Front-to-back and side-to-side filing. **Not for stacking materials on lateral file drawer bottom.**

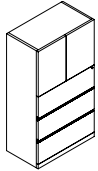

Three File Module w/Doors

D14D22H72	22 x 36 x 72	100	312	33	\$4832	\$5797
D14D22W30H72	22 x 30 x 72	100	273	28	\$4228	\$5075
D14H72	20 x 36 x 72	100	298	30	\$4600	\$5522
D14W30H72	20 x 30 x 72	92.5	259	25	\$3835	\$4601

Three lateral file drawers on bottom. Includes one adjustable shelf. Lock secures all drawers. Front-to-back and side-to-side filing. **Not for stacking materials on lateral file drawer bottom.**

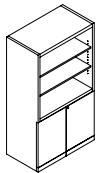

Storage Module w/Open Shelves

D22D22H72	22 x 36 x 72	100	300	33	\$3313	\$3974
D22D22W30H72	22 x 30 x 72	100	279	28	\$2899	\$3479
D22H72	20 x 36 x 72	100	305	30	\$3149	\$3780
D22W30H72	20 x 30 x 72	100	265	25	\$2627	\$3153

Three open veneer shelves and storage cabinet on bottom. Includes two adjustable shelves in upper compartment and one adjustable shelf in storage cabinet. Lock secures storage cabinet.

WARDROBE CABINETS - 72" HIGH (FREESTANDING)

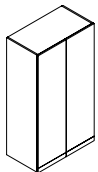

Wardrobe Cabinet

MODEL#	DIMENSIONS	FREIGHT CLASS	WT./LBS.	CUBIC FT.	VENEER/LAMINATE	ALL VENEER
D2D22H72	22 x 36 x 72	100	283	33	\$3149	\$3780
D2D22W30H72	22 x 30 x 72	100	247	33	\$2756	\$3309
D2D22W24H72	22 x 24 x 72	125	216	24	\$2341	\$2809
D2H72	20 x 36 x 72	100	269	30	\$3001	\$3603
D2W30H72	20 x 30 x 72	100	233	25	\$2501	\$3001
D2W24H72	20 x 24 x 72	125	179	20	\$2001	\$2402

Includes full length hanging rod and fixed hat shelf.

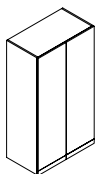

Wardrobe Cabinet/ Shelving Combo

D25D22H72	22 x 36 x 72	100	319	33	\$4074	\$4888
D25D22W30H72	22 x 30 x 72	100	279	28	\$3562	\$4274
D25D22W24H72	22 x 24 x 72	100	213	24	\$3054	\$3663
D25H72	20 x 36 x 72	92.5	305	30	\$4744	\$5691
D25W30H72	20 x 30 x 72	92.5	265	25	\$3236	\$3881
D25W24H72	20 x 24 x 72	100	203	20	\$2588	\$3104

Wardrobe compartment on **left** includes hanging rod and fixed hat shelf. Storage compartment on **right** includes three adjustable shelves.

PERSONAL TOWERS - 72" HIGH (FREESTANDING)

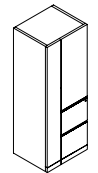

Personal Tower - LEFT

MODEL#	DIMENSIONS	FREIGHT CLASS	WT./LBS.	CUBIC FT.	VENEER/LAMINATE	ALL VENEER
D29D22W24H72L	22 x 24 x 72	125	154	22	\$4287	\$5142
D29W24H72L	20 x 24 x 72	125	140	20	\$4960	\$5951

**Two file** drawers on bottom. Wardrobe compartment on **left** includes hanging rod. Storage compartment on **right** includes one adjustable shelf. Lower lock secures all drawers.

**Required Specifications**

Veneer Finish (doors, drawer fronts, open shelves)  
Laminate Finish (top/body)  
Handle Style

**Optional Specifications**

Additional Lock (storage compartments)  
Veneer Top

PERSONAL TOWERS - 72" HIGH (FREESTANDING)    MODEL#    DIMENSIONS    FREIGHT CLASS    WT/LBS.    CUBIC FT.    VENEER/LAMINATE    ALL VENEER

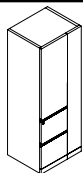

Personal Tower - RIGHT

	D x W x H						
D29D22W24H72R	22 x 24 x 72	125	154	22	<b>\$4287</b>	<b>\$5142</b>	
D29W24H72R	20 x 24 x 72	125	140	20	<b>\$4059</b>	<b>\$4871</b>	

**Two file** drawers on bottom. Wardrobe compartment on **right** includes hanging rod. Storage compartment on **left** includes one adjustable shelf. Lower lock secures all drawers.

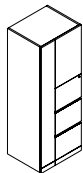

Personal Tower - LEFT

D27D22W24H72L	22 x 24 x 72	125	154	22	<b>\$4822</b>	<b>\$5788</b>	
D27W24H72L	20 x 24 x 72	125	140	20	<b>\$4595</b>	<b>\$5514</b>	

**Three file** drawers on bottom. Wardrobe compartment on **left** includes hanging rod. Storage compartment on **right** includes one adjustable shelf. Lower lock secures all drawers.

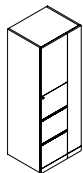

Personal Tower - RIGHT

D27D22W24H72R	22 x 24 x 72	125	154	22	<b>\$4822</b>	<b>\$5788</b>	
D27W24H72R	20 x 24 x 72	125	140	20	<b>\$4595</b>	<b>\$5514</b>	

**Three file** drawers on bottom. Wardrobe compartment on **right** includes hanging rod. Storage compartment on **left** includes one adjustable shelf. Lower lock secures all drawers.

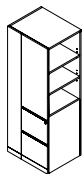

Personal Tower w/Open Bookcase - LEFT

D30D22W24H72L	22 x 24 x 72	125	154	22	<b>\$4287</b>	<b>\$5142</b>	
D30W24H72L	20 x 24 x 72	125	140	20	<b>\$4059</b>	<b>\$4871</b>	

**Two file drawers** on bottom. Wardrobe compartment on **left** includes hanging rod. Storage compartment on **right** includes one adjustable shelf. Open bookcase on **right** includes two adjustable shelves. Lower lock secures all drawers.

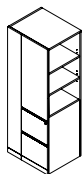

Personal Tower w/Open Bookcase - RIGHT

D30D22W24H72R	22 x 24 x 72	125	154	22	<b>\$4287</b>	<b>\$5142</b>	
D30W24H72R	20 x 24 x 72	125	140	20	<b>\$4059</b>	<b>\$4871</b>	

**Two file drawers** on bottom. Wardrobe compartment on **right** includes hanging rod. Storage compartment on **left** includes one adjustable shelf. Open bookcase on **left** includes two adjustable shelves. Lower lock secures all drawers.

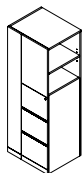

Personal Tower w/Open Bookcase - LEFT

D26D22W24H72L	22 x 24 x 72	125	154	22	<b>\$4778</b>	<b>\$5733</b>	
D26W24H72L	20 x 24 x 72	125	140	20	<b>\$5562</b>	<b>\$6675</b>	

**Three file drawers** on bottom. Wardrobe compartment on **left** includes hanging rod. Storage compartment on **right** includes one adjustable shelf. Open bookcase on **right** includes one adjustable shelf. Lower lock secures all drawers.

**Required Specifications**

Veneer Finish (doors, drawer fronts, open shelves)  
Laminate Finish (top/body)  
Handle Style

**Optional Specifications**

Additional Lock (storage compartments)  
Veneer Top

PERSONAL TOWERS - 72" HIGH (FREESTANDING)

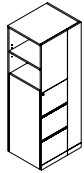

Personal Tower w/Open Bookcase - RIGHT

MODEL#	DIMENSIONS	FREIGHT CLASS	WT/LBS.	CUBIC FT.	veneER/LAMINATE	ALL VENEER
<b>D x W x H</b>						
D26D22W24H72R	22 x 24 x 72	125	154	22	<b>\$4778</b>	<b>\$5733</b>
D26W24H72R	20 x 24 x 72	125	140	20	<b>\$5562</b>	<b>\$6675</b>

**Three file drawers** on bottom. Wardrobe compartment on **right** includes hanging rod. Storage compartment on **left** includes one adjustable shelf. Open bookcase on **left** includes one adjustable shelf. Lower lock secures all drawers.

STORAGE MODULES - 84" HIGH (FREESTANDING)

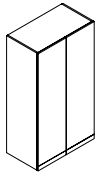

Storage Cabinet w/Doors

MODEL#	DIMENSIONS	FREIGHT CLASS	WT/LBS.	CUBIC FT.	veneER/LAMINATE	ALL VENEER
D1D22H84	22 x 36 x 84	125	304	42	<b>\$4197</b>	<b>\$5036</b>
D1D22W30H84	22 x 30 x 84	100	304	35	<b>\$3669</b>	<b>\$4404</b>
D1D22W24H84	22 x 24 x 84	92.5	320	28	<b>\$3142</b>	<b>\$3770</b>
D1H84	20 x 36 x 84	100	297	35	<b>\$3999</b>	<b>\$4796</b>
D1W30H84	20 x 30 x 84	100	257	29	<b>\$3328</b>	<b>\$3992</b>
D1W24H84	20 x 24 x 84	100	198	23	<b>\$2666</b>	<b>\$3197</b>

Includes four adjustable shelves. Standard with lock.

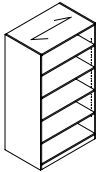

Open Storage Cabinet

D7D24H84	24 x 36 x 84	125	331	43	<b>\$3897</b>	<b>\$4674</b>
D7D24W30H84	24 x 30 x 84	125	280	36	<b>\$3410</b>	<b>\$4095</b>
D7H84	20 x 36 x 84	100	282	35	<b>\$3405</b>	<b>\$4084</b>
D7W30H84	20 x 30 x 84	100	248	29	<b>\$2835</b>	<b>\$3405</b>

Includes one fixed and **four** adjustable veneer shelves. Shelves are 3/4" thick.

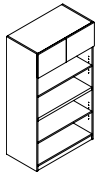

Open Storage Cabinet w/Doors

D9D22H84	22 x 36 x 84	92.5	364	36	<b>\$3641</b>	<b>\$4371</b>
D9D22W30H84	22 x 30 x 84	92.5	330	31	<b>\$3192</b>	<b>\$3831</b>
D9H84	20 x 36 x 84	92.5	348	33	<b>\$3464</b>	<b>\$4156</b>
D9W30H84	20 x 30 x 84	92.5	317	28	<b>\$2891</b>	<b>\$3468</b>

Storage compartment with fixed shelf. One fixed and **two** adjustable veneer shelves. Fixed shelf is at 29" high. Shelves are 3/4" thick.

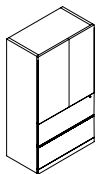

Two File Module w/Doors

D13D22H84	22 x 36 x 84	92.5	364	36	<b>\$5195</b>	<b>\$6234</b>
D13D22W30H84	22 x 30 x 84	92.5	330	31	<b>\$4546</b>	<b>\$5455</b>
D13H84	20 x 36 x 84	92.5	365	35	<b>\$4943</b>	<b>\$5931</b>
D13W30H84	20 x 30 x 84	92.5	305	29	<b>\$4513</b>	<b>\$5412</b>

Two lateral file drawers on bottom. Includes **two** adjustable shelves. Lower lock secures two file drawers. Front-to-back and side-to-side filing. **Not for stacking materials on lateral file drawer bottom.**

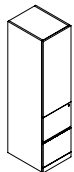

Two File Module w/Door - LEFT

D17D22H84L	22 x 16 x 84	125	116	17	<b>\$3754</b>	<b>\$4502</b>
D17D20H84L	20 x 16 x 84	125	105	15	<b>\$3410</b>	<b>\$4095</b>

Two file drawers on bottom. Includes two adjustable shelves. Lower lock secures two file drawers. Handle is on the **right**, door opens to the **left**.

**Required Specifications**

Veneer Finish (doors, drawer fronts, open shelves)  
Laminate Finish (top/body)  
Handle Style

**Optional Specifications**

Additional Lock (storage compartments)  
Veneer Top



STORAGE MODULES - 84" HIGH (FREESTANDING) MODEL# DIMENSIONS FREIGHT CLASS WT/LBS. CUBIC FT. VENEER/LAMINATE ALL VENEER



	D x W x H					
D17D22H84R	22 x 16 x 84	125	116	17	<b>\$3754</b>	<b>\$4502</b>
D17D20H84R	20 x 16 x 84	125	105	15	<b>\$3410</b>	<b>\$4095</b>

Two File Module w/Door - RIGHT

Two file drawers on bottom. Includes two adjustable shelves. Lower lock secures two file drawers. Handle is on the **left**, door opens to the **right**.

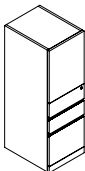

D18D22H84L	22 x 16 x 84	125	116	17	<b>\$3754</b>	<b>\$4502</b>
D18D20H84L	20 x 16 x 84	125	105	15	<b>\$3410</b>	<b>\$4095</b>

Box/Box/File Module w/Door - LEFT

Two box drawers and one file drawer on bottom. Includes two adjustable shelves. Lower lock secures all drawers. Handle is on the **right**, door opens to the **left**.

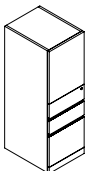

D18D22H84R	22 x 16 x 84	125	116	17	<b>\$3754</b>	<b>\$4502</b>
D18D20H84R	20 x 16 x 84	125	105	15	<b>\$3410</b>	<b>\$4095</b>

Box/Box/File Module w/Door - RIGHT

Two box drawers and one file drawer on bottom. Includes two adjustable shelves. Lower lock secures all drawers. Handle is on the **left**, door opens to the **right**.

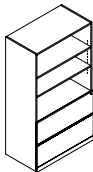

D12D22H84	22 x 36 x 84	92.5	364	36	<b>\$4561</b>	<b>\$5472</b>
D12D22W30H84	22 x 30 x 84	92.5	330	31	<b>\$3992</b>	<b>\$4791</b>
D12H84	20 x 36 x 84	92.5	348	33	<b>\$4389</b>	<b>\$5265</b>
D12W30H84	20 x 30 x 84	92.5	317	28	<b>\$3801</b>	<b>\$4561</b>

Two File Module w/Open Shelves

Three open veneer shelves and two lateral file drawers on bottom. Includes two adjustable shelves. Lock secures all drawers. Front-to-back and side-to-side filing. **Not for stacking materials on lateral file drawer bottom.**

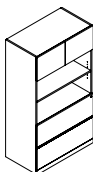

D10D22H84	22 x 36 x 84	92.5	364	36	<b>\$5045</b>	<b>\$6055</b>
D10D22W30H84	22 x 30 x 84	92.5	330	31	<b>\$4418</b>	<b>\$5301</b>
D10H84	20 x 36 x 84	92.5	348	33	<b>\$4805</b>	<b>\$5766</b>
D10W30H84	20 x 30 x 84	92.5	317	28	<b>\$4007</b>	<b>\$4807</b>

Two File Module w/Doors and Open Shelves

Storage compartment with fixed shelf. Two open veneer shelves and two lateral file drawers on bottom. Includes one adjustable shelf. Lock secures all drawers. Front-to-back and side-to-side filing. **Not for stacking materials on lateral file drawer bottom.**

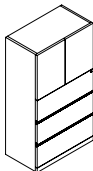

D14D22H84	22 x 36 x 84	100	340	42	<b>\$5605</b>	<b>\$6728</b>
D14D22W30H84	22 x 30 x 84	100	308	35	<b>\$4888</b>	<b>\$5867</b>
D14H84	20 x 36 x 84	100	330	35	<b>\$5319</b>	<b>\$6384</b>
D14W30H84	20 x 30 x 84	92.5	298	29	<b>\$4436</b>	<b>\$5321</b>

Three File Module w/Doors

Three lateral file drawers on bottom. Includes one adjustable shelf. Lock secures all drawers. Front-to-back and side-to-side filing. **Not for stacking materials on lateral file drawer bottom.**

**Required Specifications**

Veneer Finish (doors, drawer fronts, open shelves)  
Laminate Finish (top/body)  
Handle Style

**Optional Specifications**

Additional Lock (storage compartments)  
Veneer Top

STORAGE MODULES - 84" HIGH (FREESTANDING)

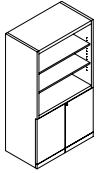

Storage Module w/Open Shelves

MODEL#	DIMENSIONS	FREIGHT CLASS	WT/LBS.	CUBIC FT.	veneer/LAMINATE	ALL VENEER
<b>D x W x H</b>						
D22D22H84	22 x 36 x 84	125	325	42	<b>\$3827</b>	<b>\$4592</b>
D22D22W30H84	22 x 30 x 84	100	304	35	<b>\$3347</b>	<b>\$4019</b>
D22H84	20 x 36 x 84	100	327	33	<b>\$3641</b>	<b>\$4371</b>
D22W30H84	20 x 30 x 84	92.5	301	28	<b>\$3041</b>	<b>\$3650</b>

Three open veneer shelves and storage cabinet on bottom. Includes two adjustable shelves in upper compartment and one adjustable shelf in storage cabinet. Lock secures storage cabinet.

WARDROBE CABINETS - 84" HIGH (FREESTANDING)

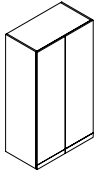

Wardrobe Cabinet

MODEL#	DIMENSIONS	FREIGHT CLASS	WT/LBS.	CUBIC FT.	veneer/LAMINATE	ALL VENEER
D2D22H84	22 x 36 x 84	125	307	42	<b>\$3641</b>	<b>\$4371</b>
D2D22W30H84	22 x 30 x 84	125	260	42	<b>\$3192</b>	<b>\$3831</b>
D2D22W24H84	22 x 24 x 84	100	242	28	<b>\$2732</b>	<b>\$3281</b>
D2H84	20 x 36 x 84	100	297	35	<b>\$3464</b>	<b>\$4156</b>
D2W30H84	20 x 30 x 84	100	257	29	<b>\$2891</b>	<b>\$3468</b>
D2W24H84	20 x 24 x 84	100	198	23	<b>\$2315</b>	<b>\$2777</b>

Includes full length hanging rod and fixed hat shelf.

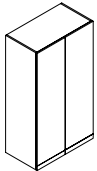

Wardrobe Cabinet/Shelving Combo

D25D22H84	22 x 36 x 84	100	348	42	<b>\$4712</b>	<b>\$5652</b>
D25D22W30H84	22 x 30 x 84	100	307	35	<b>\$4114</b>	<b>\$4938</b>
D25D22W24H84	22 x 24 x 84	100	254	28	<b>\$3527</b>	<b>\$4231</b>
D25H84	20 x 36 x 84	100	330	35	<b>\$4484</b>	<b>\$5381</b>
D25W30H84	20 x 30 x 84	92.5	300	29	<b>\$3738</b>	<b>\$4486</b>
D25W24H84	20 x 24 x 84	92.5	235	23	<b>\$2995</b>	<b>\$3591</b>

Wardrobe compartment on **left** includes hanging rod and fixed hat shelf. Storage compartment on **right** includes three adjustable shelves.

PERSONAL TOWERS - 84" HIGH (FREESTANDING)

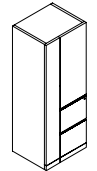

Personal Tower - LEFT

MODEL#	DIMENSIONS	FREIGHT CLASS	WT/LBS.	CUBIC FT.	veneer/LAMINATE	ALL VENEER
D29D22W24H84L	22 x 24 x 84	125	167	24	<b>\$5086</b>	<b>\$6101</b>
D29W24H84L	20 x 24 x 84	125	152	22	<b>\$4818</b>	<b>\$5782</b>

**Two file** drawers on bottom. Wardrobe compartment on **left** includes hanging rod. Storage compartment on **right** includes one adjustable shelf. Lower lock secures all drawers.

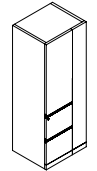

Personal Tower - RIGHT

D29D22W24H84R	22 x 24 x 84	125	167	24	<b>\$5086</b>	<b>\$6101</b>
D29W24H84R	20 x 24 x 84	125	152	22	<b>\$4818</b>	<b>\$5782</b>

**Two file** drawers on bottom. Wardrobe compartment on **right** includes hanging rod. Storage compartment on **left** includes one adjustable shelf. Lower lock secures all drawers.

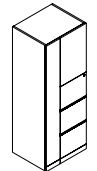

Personal Tower - LEFT

D27D22W24H84L	22 x 24 x 84	125	167	24	<b>\$6815</b>	<b>\$8180</b>
D27W24H84L	20 x 24 x 84	125	152	22	<b>\$6488</b>	<b>\$7786</b>

**Three file** drawers on bottom. Wardrobe compartment on **left** includes hanging rod. Storage compartment on **right** includes one adjustable shelf. Lower lock secures all drawers.

**Required Specifications**

Veneer Finish (doors, drawer fronts, open shelves)  
Laminate Finish (top/body)  
Handle Style

**Optional Specifications**

Additional Lock (storage compartments)  
Veneer Top

PERSONAL TOWERS - 84" HIGH (FREESTANDING)

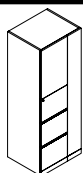

Personal Tower - RIGHT

MODEL#	DIMENSIONS D x W x H	FREIGHT CLASS	WT/LBS.	CUBIC FT.	veneer/LAMINATE	ALL VENEER
D27D22W24H84R	22 x 24 x 84	125	167	24	<b>\$6815</b>	<b>\$8180</b>
D27W24H84R	20 x 24 x 84	125	152	22	<b>\$6488</b>	<b>\$7786</b>

**Three file drawers** on bottom. Wardrobe compartment on **right** includes hanging rod. Storage compartment on **left** includes one adjustable shelf. Lower lock secures all drawers.

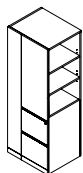

Personal Tower w/Open Bookcase - LEFT

D30D22W24H84L	22 x 24 x 84	125	167	24	<b>\$5086</b>	<b>\$6101</b>
D30W24H84L	20 x 24 x 84	125	152	22	<b>\$4818</b>	<b>\$5782</b>

**Two file drawers** on bottom. Wardrobe compartment on **left** includes hanging rod. Storage compartment on **right** includes one adjustable shelf. Open bookcase on **right** includes two adjustable shelves. Lower lock secures all drawers.

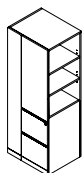

Personal Tower w/Open Bookcase - RIGHT

D30D22W24H84R	22 x 24 x 84	125	167	24	<b>\$5086</b>	<b>\$6101</b>
D30W24H84R	20 x 24 x 84	125	152	22	<b>\$4818</b>	<b>\$5782</b>

**Two file drawers** on bottom. Wardrobe compartment on **right** includes hanging rod. Storage compartment on **left** includes one adjustable shelf. Open bookcase on **left** includes two adjustable shelves. Lower lock secures all drawers.

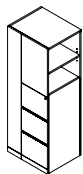

Personal Tower w/Open Bookcase - LEFT

D26D22W24H84L	22 x 24 x 84	125	167	24	<b>\$6815</b>	<b>\$8180</b>
D26W24H84L	20 x 24 x 84	125	152	22	<b>\$6488</b>	<b>\$7786</b>

**Three file drawers** on bottom. Wardrobe compartment on **left** includes hanging rod. Storage compartment on **right** includes one adjustable shelf. Open bookcase on **right** includes one adjustable shelf. Lower lock secures all drawers.

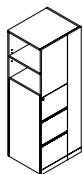

Personal Tower w/Open Bookcase - RIGHT

D26D22W24H84R	22 x 24 x 84	125	167	24	<b>\$6815</b>	<b>\$8180</b>
D26W24H84R	20 x 24 x 84	125	152	22	<b>\$6488</b>	<b>\$7786</b>

**Three file drawers** on bottom. Wardrobe compartment on **right** includes hanging rod. Storage compartment on **left** includes one adjustable shelf. Open bookcase on **left** includes one adjustable shelf. Lower lock secures all drawers.

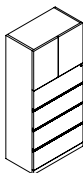

Four File Module w/Doors

D6W30H84	20 x 30 x 84	85	351	29	<b>\$5405</b>	<b>\$6484</b>
----------	--------------	----	-----	----	---------------	---------------

Four lateral file drawers on bottom. Includes one adjustable shelf. Lock secures all drawers. Front-to-back and side-to-side filing. **Not for stacking materials on lateral file drawer bottom.**

**Required Specifications**

Veneer Finish (doors, drawer fronts, open shelves)  
Laminate Finish (top/body)  
Handle Style

**Optional Specifications**

Additional Lock (storage compartments)  
Veneer Top

TOPS FOR STORAGE MODELS

MODEL#	DIMENSIONS	FREIGHT CLASS	WT./LBS.	CUBIC FT.	VENEER/LAMINATE	ALL VENEER
	<b>D x W x H</b>					
D12024T	24 x 120 x 1	60	115	2	N/A	<b>\$2303</b>
D11824T	24 x 118 x 1	60	109	2	N/A	<b>\$2268</b>
D11624T	24 x 116 x 1	60	107	2	N/A	<b>\$2235</b>
D11424T	24 x 114 x 1	60	105	2	N/A	<b>\$2206</b>
D11224T	24 x 112 x 1	60	103	2	N/A	<b>\$2152</b>
D11024T	24 x 110 x 1	60	102	2	N/A	<b>\$2110</b>
D10824T	24 x 108 x 1	60	100	2	N/A	<b>\$2071</b>
D10624T	24 x 106 x 1	60	98	2	N/A	<b>\$2034</b>
D10424T	24 x 104 x 1	60	96	2	N/A	<b>\$1994</b>
D10224T	24 x 102 x 1	60	94	2	N/A	<b>\$1961</b>
D10024T	24 x 100 x 1	60	92	2	N/A	<b>\$1919</b>
D9824T	24 x 98 x 1	60	90	2	N/A	<b>\$1879</b>
D9624T	24 x 96 x 1	60	88	2	N/A	<b>\$1843</b>
D9424T	24 x 94 x 1	60	86	2	N/A	<b>\$1803</b>
D9224T	24 x 92 x 1	60	85	2	N/A	<b>\$1768</b>
D9024T	24 x 90 x 1	60	83	2	N/A	<b>\$1729</b>
D8824T	24 x 88 x 1	60	81	2	N/A	<b>\$1693</b>
D8624T	24 x 86 x 1	60	80	2	N/A	<b>\$1652</b>
D8424T	24 x 84 x 1	60	78	2	N/A	<b>\$1611</b>
D8224T	24 x 82 x 1	60	75	2	N/A	<b>\$1575</b>
D8024T	24 x 80 x 1	60	74	2	N/A	<b>\$1538</b>
D7824T	24 x 78 x 1	60	72	2	N/A	<b>\$1516</b>
D7624T	24 x 76 x 1	60	70	2	N/A	<b>\$1462</b>
D7424T	24 x 74 x 1	60	69	2	N/A	<b>\$1425</b>
D7224T	24 x 72 x 1	60	66	2	N/A	<b>\$1386</b>
D7024T	24 x 70 x 1	60	64	2	N/A	<b>\$1345</b>
D6824T	24 x 68 x 1	60	62	2	N/A	<b>\$1313</b>
D6624T	24 x 66 x 1	60	61	2	N/A	<b>\$1270</b>
D6424T	24 x 64 x 1	60	59	1	N/A	<b>\$1228</b>
D6224T	24 x 62 x 1	60	57	1	N/A	<b>\$1194</b>
D6024T	24 x 60 x 1	60	55	1	N/A	<b>\$1152</b>
D5824T	24 x 58 x 1	60	54	1	N/A	<b>\$1111</b>
D5624T	24 x 56 x 1	60	52	1	N/A	<b>\$1077</b>
D5424T	24 x 54 x 1	60	50	1	N/A	<b>\$1038</b>
D5224T	24 x 52 x 1	60	48	1	N/A	<b>\$1001</b>
D5024T	24 x 50 x 1	60	46	1	N/A	<b>\$961</b>
D4824T	24 x 48 x 1	60	44	1	N/A	<b>\$921</b>
D4224T	24 x 42 x 1	60	39	1	N/A	<b>\$894</b>
D4024T	24 x 40 x 1	60	37	1	N/A	<b>\$853</b>
D3824T	24 x 38 x 1	60	35	1	N/A	<b>\$811</b>
D3624T	24 x 36 x 1	60	33	1	N/A	<b>\$763</b>
D3424T	24 x 34 x 1	60	31	1	N/A	<b>\$714</b>
D3224T	24 x 32 x 1	65	29	1	N/A	<b>\$675</b>
D3024T	24 x 30 x 1	65	28	1	N/A	<b>\$578</b>
D2424T	24 x 24 x 1	65	23	1	N/A	<b>\$578</b>
D1824T	24 x 18 x 1	70	17	1	N/A	<b>\$420</b>
D1624T	24 x 16 x 1	70	15	1	N/A	<b>\$407</b>
D1224T	24 x 12 x 1	92.5	11	1	N/A	<b>\$305</b>

**EXAMPLE:**

(1) D9024T  
Veneer Top

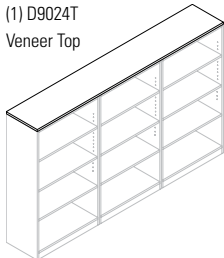

(3) D7D22W30H48 - Open Storage Cabinet

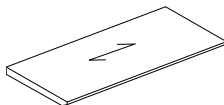

**Tops - 24" Deep**

For use with 22" deep units. Tops are 1" thick.

- **This is an OPTION for Storage Modules, Wardrobe Cabinets and Personal Towers.**  
**Specify a Veneer Top from the listing above (either a single model or straight run).**

**Required Specifications**

Veneer finish

TOPS FOR STORAGE MODELS

MODEL#	DIMENSIONS	FREIGHT CLASS	WT./LBS.	CUBIC FT.	VENEER/LAMINATE	ALL VENEER
D x W x H						
D12022T	22 x 120 x 1	60	101	2	N/A	\$2110
D11822T	22 x 118 x 1	60	100	2	N/A	\$2076
D11622T	22 x 116 x 1	60	97	2	N/A	\$2040
D11422T	22 x 114 x 1	60	96	2	N/A	\$2009
D11222T	22 x 112 x 1	60	95	2	N/A	\$1975
D11022T	22 x 110 x 1	60	92	2	N/A	\$1933
D10822T	22 x 108 x 1	60	91	2	N/A	\$1898
D10622T	22 x 106 x 1	60	89	2	N/A	\$1865
D10422T	22 x 104 x 1	60	87	2	N/A	\$1832
D10222T	22 x 102 x 1	60	86	2	N/A	\$1795
D10022T	22 x 100 x 1	60	84	2	N/A	\$1762
D9822T	22 x 98 x 1	60	83	2	N/A	\$1720
D9622T	22 x 96 x 1	60	81	2	N/A	\$1687
D9422T	22 x 94 x 1	60	79	2	N/A	\$1652
D9222T	22 x 92 x 1	60	77	2	N/A	\$1617
D9022T	22 x 90 x 1	60	76	2	N/A	\$1617
D8822T	22 x 88 x 1	60	74	2	N/A	\$1549
D8622T	22 x 86 x 1	60	73	2	N/A	\$1516
D8422T	22 x 84 x 1	60	71	2	N/A	\$1481
D8222T	22 x 82 x 1	60	69	2	N/A	\$1447
D8022T	22 x 80 x 1	60	67	2	N/A	\$1407
D7822T	22 x 78 x 1	60	66	2	N/A	\$1371
D7622T	22 x 76 x 1	60	65	2	N/A	\$1338
D7422T	22 x 74 x 1	60	63	2	N/A	\$1302
D7222T	22 x 72 x 1	60	61	2	N/A	\$1302
D7022T	22 x 70 x 1	65	59	2	N/A	\$1237
D6822T	22 x 68 x 1	65	57	2	N/A	\$1201
D6622T	22 x 66 x 1	65	55	2	N/A	\$1169
D6422T	22 x 64 x 1	65	54	1	N/A	\$1126
D6222T	22 x 62 x 1	60	52	1	N/A	\$1094
D6022T	22 x 60 x 1	60	50	1	N/A	\$1056
D5822T	22 x 58 x 1	60	49	1	N/A	\$1022
D5622T	22 x 56 x 1	60	47	1	N/A	\$990
D5422T	22 x 54 x 1	60	46	1	N/A	\$955
D5222T	22 x 52 x 1	60	44	1	N/A	\$921
D5022T	22 x 50 x 1	60	42	1	N/A	\$879
D4822T	22 x 48 x 1	60	40	1	N/A	\$846
D4222T	22 x 42 x 1	60	36	1	N/A	\$819
D4022T	22 x 40 x 1	60	34	1	N/A	\$777
D3822T	22 x 38 x 1	60	32	1	N/A	\$742
D3622T	22 x 36 x 1	60	30	1	N/A	\$703
D3422T	22 x 34 x 1	65	28	1	N/A	\$660
D3222T	22 x 32 x 1	65	27	1	N/A	\$621
D3022T	22 x 30 x 1	65	25	1	N/A	\$578
D2422T	22 x 24 x 1	70	20	1	N/A	\$557
D1822T	22 x 18 x 1	70	15	1	N/A	\$420
D1622T	22 x 16 x 1	85	14	1	N/A	\$372
D1222T	22 x 12 x 1	92.5	10	1	N/A	\$279

EXAMPLE:

(1) D9022T  
Veneer Top

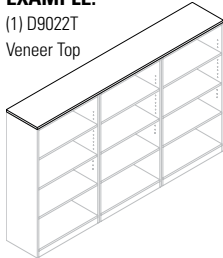

(3) D7D20W30H48 - Open Storage Cabinet

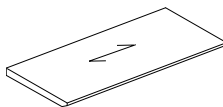

Tops - 22" Deep

For use with 20" deep units. Tops are 1" thick.

- **This is an OPTION for Storage Modules, Wardrobe Cabinets and Personal Towers.**  
**Specify a Veneer Top from the listing above (either a single model or straight run).**

FLOATING SHELF

MODEL#	DIMENSIONS	FREIGHT CLASS	WT./LBS.	CUBIC FT.	LIST PRICE
CBYF096D12H8	12 x 96 x 8	125	78	10	\$2688
CBYF064D12H8	12 x 64 x 8	125	50	8	\$1758
CBYF032D12H8	12 x 32 x 8	100	35	4	\$1593

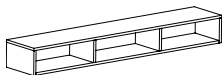

Wall Mounted Open Storage\*

To be used as a stand alone unit.

Required Specifications

Veneer finish

OVERHEAD STORAGE

sizes 48" and larger

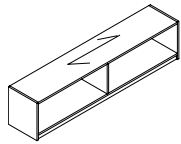

sizes less than 48"

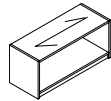

Open Front Overhead Storage

sizes 48" and larger

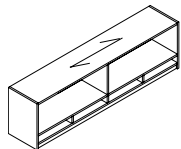

sizes less than 48"

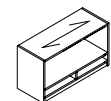

Open Front Overhead Storage - Pigeon-Hole Storage

sizes 48" and larger

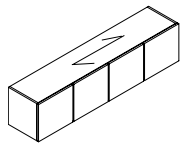

sizes less than 48"

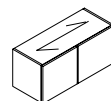

Closed Front Overhead Storage with Hinge Doors\*

sizes 48" and larger

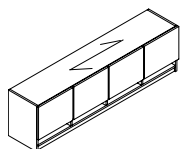

sizes less than 48"

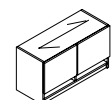

Closed Front Overhead Storage with Hinge Doors & Pigeon-Hole Storage\*

MODEL#	DIMENSIONS D x W x H	FREIGHT CLASS	WT./LBS.	CUBIC FT.	VENEER/LAMINATE	ALL VENEER
DCSF072	14.5 x 72 x 16.5	125	100	10	\$1627	\$1954
DCSF066	14.5 x 66 x 16.5	125	83	9	\$1494	\$1792
DCSF060	14.5 x 60 x 16.5	100	75	8	\$1357	\$1627
DCSF054	14.5 x 54 x 16.5	100	68	7	\$1223	\$1467
DCSF048	14.5 x 48 x 16.5	100	60	7	\$1088	\$1305
DCSF042	14.5 x 42 x 16.5	100	55	6	\$1005	\$1204
DCSF036	14.5 x 36 x 16.5	100	50	5	\$995	\$1192
DCSF030	14.5 x 30 x 16.5	100	45	4	\$972	\$1169

Includes pre-mounted "J" brackets for wall mount applications.

- **NOTE:** Care should be taken to mount the units. Units should be mounted to wall studs using correct fasteners. Failure to do so may result in collapse of the unit and subsequent personal injury. **Mounting hardware not included.** Mounting hardware used should be based on wall material. Consult an installation professional for proper wall mounting.

DCSFOP72	14.5 x 72 x 19.5	125	100	12	\$1954	\$2345
DCSFOP66	14.5 x 66 x 19.5	125	83	11	\$1791	\$2150
DCSFOP60	14.5 x 60 x 19.5	125	75	10	\$1627	\$1954
DCSFOP54	14.5 x 54 x 19.5	125	68	9	\$1469	\$1763
DCSFOP48	14.5 x 48 x 19.5	125	60	8	\$1301	\$1562
DCSFOP42	14.5 x 42 x 19.5	125	55	7	\$1223	\$1467
DCSFOP36	14.5 x 36 x 19.5	125	50	6	\$1185	\$1422
DCSFOP30	14.5 x 30 x 19.5	125	45	5	\$1171	\$1403

Includes pre-mounted "J" brackets for wall mount applications. Horizontal pigeon-hole storage on bottom of overhead.

- **NOTE:** Care should be taken to mount the units. Units should be mounted to wall studs using correct fasteners. Failure to do so may result in collapse of the unit and subsequent personal injury. **Mounting hardware not included.** Mounting hardware used should be based on wall material. Consult an installation professional for proper wall mounting.

DSF72	14.5 x 72 x 16.5	92.5	100	10	\$2105	\$2525
DSF66	14.5 x 66 x 16.5	100	83	9	\$1933	\$2320
DSF60	14.5 x 60 x 16.5	100	75	8	\$1756	\$2108
DSF54	14.5 x 54 x 16.5	100	68	7	\$1575	\$1891
DSF48	14.5 x 48 x 16.5	60	60	7	\$1549	\$1859
DSF42	14.5 x 42 x 16.5	100	55	6	\$1291	\$1548
DSF36	14.5 x 36 x 16.5	92.5	50	5	\$1263	\$1514
DSF30	14.5 x 30 x 16.5	92.5	45	4	\$1241	\$1491

Includes pre-mounted "J" brackets for wall mount applications.

- **NOTE:** Care should be taken to mount the units. Units should be mounted to wall studs using correct fasteners. Failure to do so may result in collapse of the unit and subsequent personal injury. **Mounting hardware not included.** Mounting hardware used should be based on wall material. Consult an installation professional for proper wall mounting.

DSFP72	14.5 x 72 x 19.5	100	100	12	\$2528	\$3035
DSFP66	14.5 x 66 x 19.5	125	83	11	\$2315	\$2777
DSFP60	14.5 x 60 x 19.5	125	75	10	\$2110	\$2533
DSFP54	14.5 x 54 x 19.5	125	68	9	\$1898	\$2279
DSFP48	14.5 x 48 x 19.5	125	60	8	\$1681	\$2015
DSFP42	14.5 x 42 x 19.5	125	55	7	\$1606	\$1928
DSFP36	14.5 x 36 x 19.5	100	50	6	\$1516	\$1819
DSFP30	14.5 x 30 x 19.5	100	45	5	\$1495	\$1793

Includes pre-mounted "J" brackets for wall mount applications. Horizontal pigeon-hole storage on bottom of overhead.

- **NOTE:** Care should be taken to mount the units. Units should be mounted to wall studs using correct fasteners. Failure to do so may result in collapse of the unit and subsequent personal injury. **Mounting hardware not included.** Mounting hardware used should be based on wall material. Consult an installation professional for proper wall mounting.

Required Specifications

Veneer Finish  
Laminate Finish (top/body)

Optional Specifications

Lock\*  
Handle style\*

OVERHEAD STORAGE

sizes 48" and larger

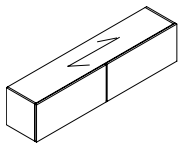

sizes less than 48"

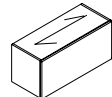

**Closed Front Overhead Storage - with Flipper Doors**

sizes 48" and larger

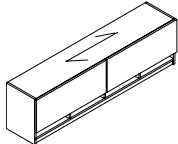

sizes less than 48"

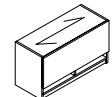

**Closed Front Overhead Storage with Flipper Doors & Pigeon-Hole Storage**

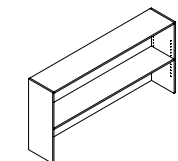

**Open Hutch with Closed Back**

MODEL# DIMENSIONS FREIGHT CLASS WT/LBS. CUBIC FT. VENEER/LAMINATE ALL VENEER

	D x W x H					
DSFF72	14.5 x 72 x 16.5	92.5	100	10	\$2282	\$2738
DSFF66	14.5 x 66 x 16.5	100	83	9	\$2089	\$2507
DSFF60	14.5 x 60 x 16.5	100	75	8	\$1898	\$2279
DSFF54	14.5 x 54 x 16.5	100	68	7	\$1714	\$2057
DSFF48	14.5 x 48 x 16.5	100	60	7	\$1522	\$1829
DSFF42	14.5 x 42 x 16.5	100	55	6	\$1414	\$1694
DSFF36	14.5 x 36 x 16.5	92.5	50	5	\$1386	\$1664
DSFF30	14.5 x 30 x 16.5	92.5	45	4	\$1367	\$1639

Includes pre-mounted "J" brackets for wall mount applications. Horizontal pigeon-hole storage on bottom of overhead.

- **NOTE:** Care should be taken to mount the units. Units should be mounted to wall studs using correct fasteners. Failure to do so may result in collapse of the unit and subsequent personal injury. **Mounting hardware not included.** Mounting hardware used should be based on wall material. Consult an installation professional for proper wall mounting.

DSFFP72	14.5 x 72 x 19.5	100	100	12	\$2992	\$3590
DSFFP66	14.5 x 66 x 19.5	125	83	11	\$2506	\$3009
DSFFP60	14.5 x 60 x 19.5	125	75	10	\$2282	\$2738
DSFFP54	14.5 x 54 x 19.5	125	68	9	\$2051	\$2458
DSFFP48	14.5 x 48 x 19.5	125	60	8	\$1824	\$2188
DSFFP42	14.5 x 42 x 19.5	125	55	7	\$1693	\$2032
DSFFP36	14.5 x 36 x 19.5	100	50	6	\$1660	\$1991
DSFFP30	14.5 x 30 x 19.5	100	45	5	\$1633	\$1958

Includes pre-mounted "J" brackets for wall mount applications. Horizontal pigeon-hole storage on bottom of overhead.

- **NOTE:** Care should be taken to mount the units. Units should be mounted to wall studs using correct fasteners. Failure to do so may result in collapse of the unit and subsequent personal injury. **Mounting hardware not included.** Mounting hardware used should be based on wall material. Consult an installation professional for proper wall mounting.

D72CL36	16 x 72 x 36	125	155	23	\$1817	\$2180
D66CL36	16 x 66 x 36	125	140	21	\$1685	\$2020
D60CL36	16 x 60 x 36	125	130	19	\$1495	\$1793
D48CL36	16 x 48 x 36	125	110	15	\$1423	\$1709
D42CL36	16 x 42 x 36	125	95	13	\$1291	\$1548
D36CL36	16 x 36 x 36	125	80	11	\$1214	\$1455
D30CL36	16 x 30 x 36	125	67	9	\$1008	\$1214

One adjustable shelf. Closed back. All hutches shipped pre-assembled.

- **A Tackboard cannot be used with this hutch.**

CLOSED HUTCHES

sizes 120"-108"w

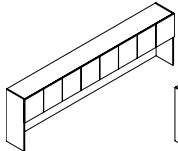

sizes 102"-84"w

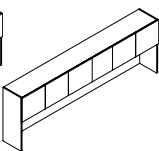

sizes 78"-60"w

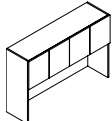

sizes 36"-30"w

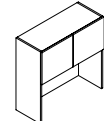

**Closed Hutch w/Veneer Doors 36" High\***

MODEL# DIMENSIONS FREIGHT CLASS WT/LBS. CUBIC FT. VENEER/LAMINATE ALL VENEER

D120SH36	16 x 120 x 36	125	295	38	\$4910	\$5893
D114SH36	16 x 114 x 36	125	281	36	\$4663	\$5596
D108SH36	16 x 108 x 36	125	268	34	\$4419	\$5302
D102SH36	16 x 102 x 36	125	254	32	\$4174	\$5009
D96SH36	16 x 96 x 36	100	241	30	\$3930	\$4715
D90SH36	16 x 90 x 36	100	227	28	\$3682	\$4419
D84SH36	16 x 84 x 36	100	214	26	\$3436	\$4124
D78SH36	16 x 78 x 36	100	200	24	\$3192	\$3831
D72SH36	16 x 72 x 36	125	187	23	\$2947	\$3537
D66SH36	16 x 66 x 36	100	173	21	\$2840	\$3406
D60SH36	16 x 60 x 36	100	160	19	\$2701	\$3241
D36SH36	16 x 36 x 36	100	94	11	\$1844	\$2214
D30SH36	16 x 30 x 36	100	78	9	\$1613	\$1935

One fixed shelf. Closed back features one grommet. All hutches shipped pre-assembled.

- Models 120"w- 108"w have three fixed shelf dividers.
- Models 84"w- 102"w have two fixed shelf dividers.
- Models 60"w - 78"w have one fixed shelf divider.
- *Clearance from worksurface to valance is 19.5".*

**Required Specifications**

Veneer Finish  
Laminate Finish (top/body)

**Optional Specifications**

Lock (models with doors)  
Handle Style (models with doors)

**Accessories**

Tackboard\*  
Tasklight\*

**CLOSED HUTCHES**

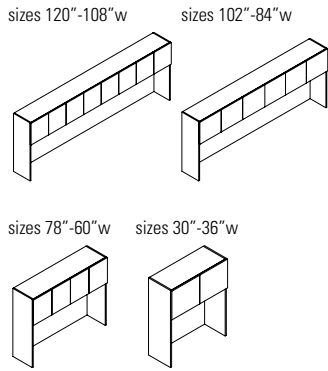

**Closed Hutch w/Veneer Doors 42" H**

MODEL#	DIMENSIONS	FREIGHT CLASS	WT./LBS.	CUBIC FT.	veneER/LAMINATE	ALL veneER
	<b>D x W x H</b>					
D120SH42	16 x 120 x 42	125	341	44	<b>\$5727</b>	<b>\$6871</b>
D114SH42	16 x 114 x 42	125	324	42	<b>\$5437</b>	<b>\$6526</b>
D108SH42	16 x 108 x 42	125	307	39	<b>\$5414</b>	<b>\$6497</b>
D102SH42	16 x 102 x 42	125	290	37	<b>\$4867</b>	<b>\$5841</b>
D96SH42	16 x 96 x 42	125	273	35	<b>\$4582</b>	<b>\$5498</b>
D90SH42	16 x 90 x 42	125	256	33	<b>\$4295</b>	<b>\$5154</b>
D84SH42	16 x 84 x 42	125	239	31	<b>\$4211</b>	<b>\$5053</b>
D78SH42	16 x 78 x 42	125	222	38	<b>\$3725</b>	<b>\$4469</b>
D72SH42	16 x 72 x 42	125	205	26	<b>\$3436</b>	<b>\$4124</b>
D66SH42	16 x 66 x 42	125	188	24	<b>\$3310</b>	<b>\$3973</b>
D60SH42	16 x 60 x 42	125	171	22	<b>\$3149</b>	<b>\$3780</b>
D36SH42	16 x 36 x 42	125	102	13	<b>\$2151</b>	<b>\$2579</b>
D30SH42	16 x 30 x 42	125	85	11	<b>\$1883</b>	<b>\$2259</b>

One fixed shelf. Closed back features one grommet. All hutches shipped pre-assembled.

- Models 120" w- 108" w have three fixed shelf dividers.
- Models 84" w- 102" w have two fixed shelf dividers.
- Models 60" w - 78" w have one fixed shelf divider.
- Clearance from worksurface to valance is 19.5".

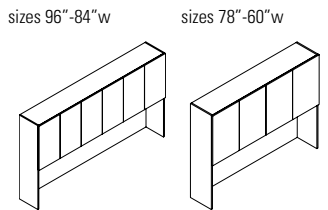

**Closed Hutch w/Veneer Doors 54" H**

D962SH54	15 x 96 x 54	125	351	45	<b>\$5885</b>	<b>\$7062</b>
D902SH54	15 x 90 x 54	125	329	42	<b>\$5522</b>	<b>\$6625</b>
D842SH54	15 x 84 x 54	125	307	39	<b>\$5153</b>	<b>\$6180</b>
D782SH54	15 x 78 x 54	125	285	37	<b>\$4784</b>	<b>\$5742</b>
D722SH54	15 x 72 x 54	300	263	34	<b>\$4418</b>	<b>\$5301</b>
D662SH54	15 x 66 x 54	125	241	31	<b>\$4253</b>	<b>\$5104</b>
D602SH54	15 x 60 x 54	125	219	28	<b>\$4051</b>	<b>\$4860</b>

One fixed shelf and one adjustable shelf (per compartment). Closed back features one grommet. All hutches shipped pre-assembled.

- Clearance from worksurface to valance is 25.5".

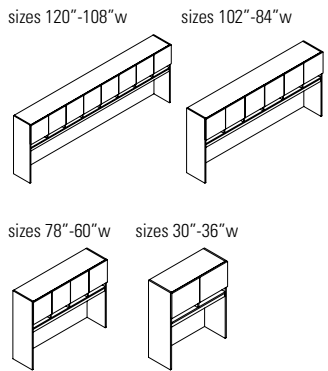

**Closed Hutch w/Veneer Doors Pigeon-Hole Storage, 42" High**

D120SHP42	15 x 120 x 42	125	341	44	<b>\$6871</b>	<b>\$8246</b>
D114SHP42	15 x 114 x 42	125	324	42	<b>\$6527</b>	<b>\$7834</b>
D108SHP42	15 x 108 x 42	125	307	39	<b>\$6187</b>	<b>\$7421</b>
D102SHP42	15 x 102 x 42	125	290	37	<b>\$5841</b>	<b>\$7009</b>
D96SHP42	15 x 96 x 42	125	273	35	<b>\$5498</b>	<b>\$6597</b>
D90SHP42	15 x 90 x 42	125	256	33	<b>\$5154</b>	<b>\$6187</b>
D84SHP42	15 x 84 x 42	125	239	31	<b>\$4811</b>	<b>\$5772</b>
D78SHP42	15 x 78 x 42	125	222	38	<b>\$4468</b>	<b>\$5360</b>
D72SHP42	15 x 72 x 42	125	205	26	<b>\$4318</b>	<b>\$5180</b>
D66SHP42	15 x 66 x 42	125	188	24	<b>\$4169</b>	<b>\$5003</b>
D60SHP42	15 x 60 x 42	125	171	22	<b>\$3973</b>	<b>\$4767</b>
D36SHP42	15 x 36 x 42	125	102	13	<b>\$2579</b>	<b>\$3096</b>
D30SHP42	15 x 30 x 42	125	85	11	<b>\$2259</b>	<b>\$2712</b>

One fixed shelf. Closed back features one grommet. Horizontal pigeon-hole storage top mounted to hutch. All hutches shipped pre-assembled.

- Models 120" w- 108" w have three fixed shelf dividers.
- Models 84" w- 102" w have two fixed shelf dividers.
- Models 60" w - 78" w have one fixed shelf divider.
- Clearance from worksurface to valance is 21.5".

**Required Specifications**

Veneer Finish (doors)  
Laminate Finish (top/body)

**Optional Specifications**

Lock  
Handle Style

**Accessories**

Tackboard  
Tasklight



CLOSED HUTCHES

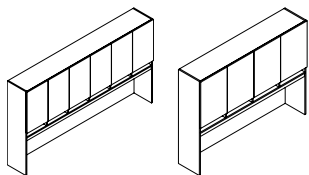

**Closed Hutch w/Veneer Doors**  
**Pigeon-Hole Storage, 54"H\***

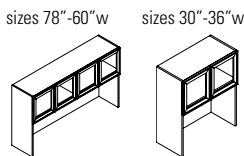
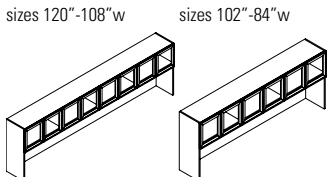

**Closed Hutch w/Glass Doors 36"H\*\***

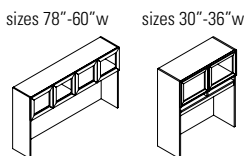
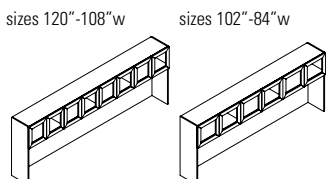

**Closed Hutch w/Glass Doors 42"H\*\***

MODEL#	DIMENSIONS	FREIGHT CLASS	WT./LBS.	CUBIC FT.	VENEER/LAMINATE	ALL VENEER
	<b>D x W x H</b>					
D962SHP54	15 x 96 x 54	125	351	45	<b>\$7067</b>	<b>\$8481</b>
D902SHP54	15 x 90 x 54	125	329	42	<b>\$6622</b>	<b>\$7945</b>
D842SHP54	15 x 84 x 54	125	307	39	<b>\$6178</b>	<b>\$7413</b>
D782SHP54	15 x 78 x 54	125	285	37	<b>\$5740</b>	<b>\$6888</b>
D722SHP54	15 x 72 x 54	125	263	34	<b>\$5301</b>	<b>\$6360</b>
D662SHP54	15 x 66 x 54	125	241	31	<b>\$5102</b>	<b>\$6122</b>
D602SHP54	15 x 60 x 54	125	219	28	<b>\$4858</b>	<b>\$5829</b>

One fixed shelf and one adjustable shelf (per compartment). Closed back features one grommet. Horizontal pigeon-hole storage top mounted to hutch. All hutches shipped pre-assembled.

- Clearance from worksurface to valance is 21.5".

D120SH36G	15 x 120 x 36	125	295	38	<b>\$7344</b>	<b>\$8811</b>
D114SH36G	15 x 114 x 36	125	281	36	<b>\$7049</b>	<b>\$8459</b>
D108SH36G	15 x 108 x 36	125	268	34	<b>\$6762</b>	<b>\$8114</b>
D102SH36G	15 x 102 x 36	125	254	32	<b>\$6071</b>	<b>\$7285</b>
D96SH36G	15 x 96 x 36	85	241	30	<b>\$5791</b>	<b>\$6949</b>
D90SH36G	15 x 90 x 36	100	227	28	<b>\$5504</b>	<b>\$6605</b>
D84SH36G	15 x 84 x 36	100	214	26	<b>\$5223</b>	<b>\$6267</b>
D78SH36G	15 x 78 x 36	85	200	24	<b>\$4949</b>	<b>\$5939</b>
D72SH36G	15 x 72 x 36	100	187	23	<b>\$4300</b>	<b>\$5159</b>
D66SH36G	15 x 66 x 36	100	173	21	<b>\$4114</b>	<b>\$4938</b>
D60SH36G	15 x 60 x 36	100	160	19	<b>\$3931</b>	<b>\$4716</b>
D36SH36G	15 x 36 x 36	100	94	11	<b>\$2500</b>	<b>\$2999</b>
D30SH36G	15 x 30 x 36	100	78	9	<b>\$2235</b>	<b>\$2679</b>

One fixed shelf. Closed back features one grommet. Aluminum frame available in Tungsten finish only. All hutches shipped pre-assembled. Translucent, screened glass.

- Models 120"w- 108"w have three fixed shelf dividers.
- Models 84"w- 102"w have two fixed shelf dividers.
- Models 60"w - 78"w have one fixed shelf divider.
- Clearance from worksurface to valance is 19.5".
- **Locks are not available on hutches with Glass Doors.**

D120SH42G	15 x 120 x 42	125	341	44	<b>\$7720</b>	<b>\$9265</b>
D114SH42G	15 x 114 x 42	125	324	42	<b>\$7405</b>	<b>\$8886</b>
D108SH42G	15 x 108 x 42	125	307	39	<b>\$7098</b>	<b>\$8517</b>
D102SH42G	15 x 102 x 42	125	290	37	<b>\$6398</b>	<b>\$7680</b>
D96SH42G	15 x 96 x 42	125	273	35	<b>\$6098</b>	<b>\$7317</b>
D90SH42G	15 x 90 x 42	125	256	33	<b>\$5872</b>	<b>\$7047</b>
D84SH42G	15 x 84 x 42	125	239	31	<b>\$5483</b>	<b>\$6580</b>
D78SH42G	15 x 78 x 42	150	222	38	<b>\$5181</b>	<b>\$6217</b>
D72SH42G	15 x 72 x 42	125	205	26	<b>\$4472</b>	<b>\$5364</b>
D66SH42G	15 x 66 x 42	125	188	24	<b>\$4314</b>	<b>\$5177</b>
D60SH42G	15 x 60 x 42	125	171	22	<b>\$4163</b>	<b>\$4993</b>
D36SH42G	15 x 36 x 42	125	102	13	<b>\$3250</b>	<b>\$3900</b>
D30SH42G	15 x 30 x 42	125	85	11	<b>\$2363</b>	<b>\$2840</b>

One fixed shelf. Closed back features one grommet. Aluminum frame available in Tungsten finish only. All hutches shipped pre-assembled. Translucent, screened glass.

- Models 120"w- 108"w have three fixed shelf dividers.
- Models 84"w- 102"w have two fixed shelf dividers.
- Models 60"w - 78"w have one fixed shelf divider.
- Clearance from worksurface to valance is 25.5".
- **Locks are not available on hutches with Glass Doors.**

**Required Specifications**

Veneer finish\*  
Laminate finish (body)\*\*  
Handle Style

**Optional Specifications**

Lock\*  
Veneer top\*

**Accessories**

Tackboard  
Tasklight

**CLOSED HUTCHES**

sizes 96"-84"w

sizes 78"-60"w

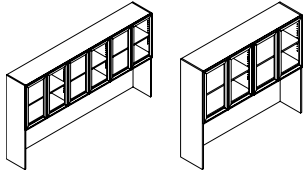

**Closed Hutch w/Glass Doors 54"H**

MODEL#	DIMENSIONS	FREIGHT CLASS	WT./LBS.	CUBIC FT.	VENEER/LAMINATE	ALL VENEER
<b>D x W x H</b>						
D962SH54G	15 x 96 x 54	125	351	45	<b>\$7788</b>	<b>\$9345</b>
D902SH54G	15 x 90 x 54	125	329	42	<b>\$7227</b>	<b>\$8674</b>
D842SH54G	15 x 84 x 54	125	307	39	<b>\$6714</b>	<b>\$8058</b>
D782SH54G	15 x 78 x 54	125	285	37	<b>\$6173</b>	<b>\$7409</b>
D722SH54G	15 x 72 x 54	125	263	34	<b>\$5640</b>	<b>\$6767</b>
D662SH54G	15 x 66 x 54	125	241	31	<b>\$5443</b>	<b>\$6532</b>
D602SH54G	15 x 60 x 54	125	219	28	<b>\$5202</b>	<b>\$6243</b>

One fixed shelf and one adjustable shelf (per compartment). Closed back features one grommet. Aluminum frame available in Tungsten finish only. All hutches shipped pre-assembled. Translucent, screened glass.

- Clearance from worksurface to valance is 25.5".
- Locks are not available on hutches with Glass Doors.

sizes 120"-108"w

sizes 102"-84"w

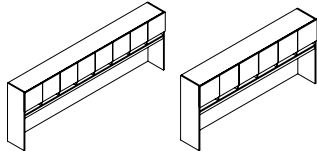

**Closed Hutch w/Glass Doors Pigeon-Hole Storage, 42"H**

D120SHP42G	15 x 120 x 42	125	341	44	<b>\$8799</b>	<b>\$10560</b>
D114SHP42G	15 x 114 x 42	125	324	42	<b>\$8419</b>	<b>\$10101</b>
D108SHP42G	15 x 108 x 42	125	307	39	<b>\$8068</b>	<b>\$9683</b>
D102SHP42G	15 x 102 x 42	125	290	37	<b>\$7322</b>	<b>\$8787</b>
D96SHP42G	15 x 96 x 42	125	273	35	<b>\$6982</b>	<b>\$8379</b>
D90SHP42G	15 x 90 x 42	125	256	33	<b>\$6960</b>	<b>\$8353</b>
D84SHP42G	15 x 84 x 42	125	239	31	<b>\$6236</b>	<b>\$7480</b>
D78SHP42G	15 x 78 x 42	150	222	38	<b>\$5879</b>	<b>\$7054</b>
D72SHP42G	15 x 72 x 42	125	205	26	<b>\$5128</b>	<b>\$6152</b>
D66SHP42G	15 x 66 x 42	125	188	24	<b>\$4963</b>	<b>\$5956</b>
D60SHP42G	15 x 60 x 42	125	171	22	<b>\$4723</b>	<b>\$5668</b>
D36SHP42G	15 x 36 x 42	125	102	13	<b>\$3068</b>	<b>\$3682</b>
D30SHP42G	15 x 30 x 42	125	85	11	<b>\$2739</b>	<b>\$3288</b>

One fixed shelf. Closed back features one grommet. Aluminum frame available in Tungsten finish only. Horizontal pigeon-hole storage top mounted to hutch. All hutches shipped pre-assembled. Translucent, screened glass.

- Models 120"w- 108"w have three fixed shelf dividers.
- Models 84"w- 102"w have two fixed shelf dividers.
- Models 60"w - 78"w have one fixed shelf divider.
- Clearance from worksurface to valance is 21.5".
- Locks are not available on hutches with Glass Doors.

sizes 78"-60"w

sizes 30"-36"w

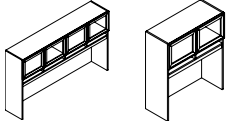

**Closed Hutch w/Glass Doors Pigeon-Hole Storage, 54"H**

D962SHP54G	15 x 96 x 54	125	351	45	<b>\$8950</b>	<b>\$10742</b>
D902SHP54G	15 x 90 x 54	125	329	42	<b>\$8342</b>	<b>\$10010</b>
D842SHP54G	15 x 84 x 54	125	307	39	<b>\$7732</b>	<b>\$9280</b>
D782SHP54G	15 x 78 x 54	125	285	37	<b>\$7125</b>	<b>\$8549</b>
D722SHP54G	15 x 72 x 54	125	263	34	<b>\$6516</b>	<b>\$7819</b>
D662SHP54G	15 x 66 x 54	125	241	31	<b>\$6283</b>	<b>\$7538</b>
D602SHP54G	15 x 60 x 54	125	219	28	<b>\$6002</b>	<b>\$7204</b>

One fixed shelf and one adjustable shelf (per compartment). Closed back features one grommet. Aluminum frame available in Tungsten finish only. Horizontal pigeon-hole storage top mounted to hutch. All hutches shipped pre-assembled. Translucent, screened glass.

- Clearance from worksurface to valance is 21.5".
- Locks are not available on hutches with Glass Doors.

**Required Specifications**  
Laminate Finish (body)

**Accessories**  
Tackboard  
Task Light

**CLOSED HUTCHES**

**MODEL#**      **DIMENSIONS**      **FREIGHT CLASS**      **WT/LBS.**      **CUBIC FT.**      **GR. 1-3**      **GR. 4-5**

**D x W x H**

**TACKBOARD** Notes: Tackboards can be upholstered in all of the following fabrics:

**Grade 1:** Hudson, Jenny, Quilt, Terrace, Urban, Waterfall

**Grade 2:** Couture, Imprint, Lola, Match, Replay, Silhouette

**Grade 3:** Anchorage, Merge

**WALL MOUNTED TACKBOARDS FOR OVERHEAD STORAGE**

**GR. 1-3**

**GR. 4-5**

TS120	1 x 120 x 20	70	26	2	<b>\$1522</b>	<b>\$1902</b>
TS114	1 x 114 x 20	70	25	2	<b>\$1449</b>	<b>\$1814</b>
TS108	1 x 108 x 20	70	23	2	<b>\$1370</b>	<b>\$1713</b>
TS102	1 x 102 x 20	85	19	2	<b>\$1298</b>	<b>\$1623</b>
TS96	1 x 96 x 20	70	17	1	<b>\$1214</b>	<b>\$1520</b>
TS90	1 x 90 x 20	70	15	1	<b>\$1141</b>	<b>\$1428</b>
TS84	1 x 84 x 20	70	14	1	<b>\$1069</b>	<b>\$1335</b>
TS78	1 x 78 x 20	70	13	1	<b>\$990</b>	<b>\$1238</b>
TS72	1 x 72 x 20	70	12	1	<b>\$557</b>	<b>\$698</b>
TS66	1 x 66 x 20	85	11	1	<b>\$512</b>	<b>\$644</b>
TS60	1 x 60 x 20	85	10	1	<b>\$471</b>	<b>\$592</b>
TS54	1 x 54 x 20	85	10	1	<b>\$427</b>	<b>\$537</b>
TS48	1 x 48 x 20	85	10	1	<b>\$382</b>	<b>\$479</b>
TS42	1 x 42 x 20	85	10	1	<b>\$338</b>	<b>\$425</b>
TS36	1 x 36 x 20	100	8	1	<b>\$302</b>	<b>\$383</b>
TS30	1 x 30 x 20	150	5	1	<b>\$251</b>	<b>\$316</b>

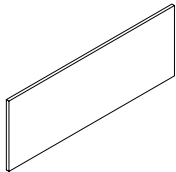

**Tackboard**

For use on **16.5" H** overhead storage (**DCSFO\_**, **DSF\_**, **DSFF\_**) at a finished height of **66"**. See Tackboard Notes above for exact fabric availability. List Price shown applies for all fabric grades.

- **NOTE:** Care should be taken to mount the units. Units should be mounted to wall studs using correct fasteners. Failure to do so may result in collapse of the unit and subsequent personal injury. **Mounting hardware not included.** Mounting hardware used should be based on wall material. Consult an installation professional for proper wall mounting.

TS120H26	1 x 120 x 26	70	34	2	<b>\$1979</b>	<b>\$2474</b>
TS114H26	1 x 114 x 26	70	32	2	<b>\$1880</b>	<b>\$2351</b>
TS108H26	1 x 108 x 26	70	30	2	<b>\$1782</b>	<b>\$2229</b>
TS102H26	1 x 102 x 26	85	24	2	<b>\$1678</b>	<b>\$2098</b>
TS96H26	1 x 96 x 26	92.5	22	2	<b>\$1587</b>	<b>\$1986</b>
TS90H26	1 x 90 x 26	92.5	20	2	<b>\$1488</b>	<b>\$1859</b>
TS84H26	1 x 84 x 26	100	18	2	<b>\$1383</b>	<b>\$1729</b>
TS78H26	1 x 78 x 26	100	17	2	<b>\$1286</b>	<b>\$1609</b>
TS72H26	1 x 72 x 26	70	16	1	<b>\$714</b>	<b>\$897</b>
TS66H26	1 x 66 x 26	85	14	1	<b>\$658</b>	<b>\$825</b>
TS60H26	1 x 60 x 26	85	13	1	<b>\$601</b>	<b>\$755</b>
TS54H26	1 x 54 x 26	85	13	1	<b>\$552</b>	<b>\$692</b>
TS48H26	1 x 48 x 26	85	13	1	<b>\$488</b>	<b>\$613</b>
TS42H26	1 x 42 x 26	85	13	1	<b>\$433</b>	<b>\$538</b>
TS36H26	1 x 36 x 26	100	8	1	<b>\$378</b>	<b>\$475</b>
TS30H26	1 x 30 x 26	150	5	1	<b>\$317</b>	<b>\$401</b>

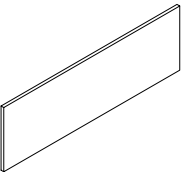

**Tackboard**

For use on **16.5" H** overhead storage (**DCSFO\_**, **DSF\_**, **DSFF\_**) at a finished height of **72"**. See Tackboard Notes above for exact fabric availability. List Price shown applies for all fabric grades.

- **NOTE:** Care should be taken to mount the units. Units should be mounted to wall studs using correct fasteners. Failure to do so may result in collapse of the unit and subsequent personal injury. **Mounting hardware not included.** Mounting hardware used should be based on wall material. Consult an installation professional for proper wall mounting.

**Required Specifications**

Fabric

TACKBOARDS FOR OVERHEAD STORAGE & HUTCHES

MODEL#	DIMENSIONS	FREIGHT CLASS	WT/LBS.	CUBIC FT.	GR. 1-3	GR. 4-5
<b>D x W x H</b>						
TSP120H23	1 x 120 x 23	70	34	2	<b>\$1718</b>	<b>\$2148</b>
TSP114H23	1 x 114 x 23	70	32	2	<b>\$1632</b>	<b>\$2039</b>
TSP108H23	1 x 108 x 23	70	30	2	<b>\$1600</b>	<b>\$1920</b>
TSP102H23	1 x 102 x 23	85	24	2	<b>\$1525</b>	<b>\$1831</b>
TSP96H23	1 x 96 x 23	92.5	20	2	<b>\$1377</b>	<b>\$1720</b>
TSP90H23	1 x 90 x 23	92.5	20	1	<b>\$1286</b>	<b>\$1609</b>
TSP84H23	1 x 84 x 23	70	18	1	<b>\$1201</b>	<b>\$1501</b>
TSP78H23	1 x 78 x 23	70	17	1	<b>\$983</b>	<b>\$1195</b>
TSP72H23	1 x 72 x 23	70	16	1	<b>\$913</b>	<b>\$1147</b>
TSP66H23	1 x 66 x 23	85	14	1	<b>\$830</b>	<b>\$1041</b>
TSP60H23	1 x 60 x 23	85	13	1	<b>\$601</b>	<b>\$755</b>
TSP54H23	1 x 54 x 23	85	13	1	<b>\$762</b>	<b>\$955</b>
TSP48H23	1 x 48 x 23	85	13	1	<b>\$602</b>	<b>\$613</b>
TSP42H23	1 x 42 x 23	85	13	1	<b>\$530</b>	<b>\$538</b>
TSP36H23	1 x 36 x 23	100	8	1	<b>\$458</b>	<b>\$474</b>
TSP30H23	1 x 30 x 23	150	5	1	<b>\$379</b>	<b>\$403</b>

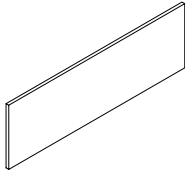

Tackboard

For use on **19.5"H** overhead storage (**DCSFOP\_**, **DSFP\_**, **DSFFP\_**) with Pigeon-Hole Storage at a finished height of **72"**. See Tackboard Notes above for exact fabric availability. List Price shown applies for all fabric grades.

- **NOTE:** Care should be taken to mount the units. Units should be mounted to wall studs using correct fasteners. Failure to do so may result in collapse of the unit and subsequent personal injury. **Mounting hardware not included.** Mounting hardware used should be based on wall material. Consult an installation professional for proper wall mounting.

TSA120	1 x 120 x 20	85	26	2	<b>\$2679</b>	<b>\$3349</b>
TSA114	1 x 114 x 20	85	25	2	<b>\$2549</b>	<b>\$3187</b>
TSA108	1 x 108 x 20	92.5	23	2	<b>\$2412</b>	<b>\$3014</b>
TSA102	1 x 102 x 20	100	19	2	<b>\$2287</b>	<b>\$2859</b>
TSA96	1 x 96 x 20	70	15	1	<b>\$2143</b>	<b>\$2679</b>
TSA90	1 x 90 x 20	70	15	1	<b>\$2011</b>	<b>\$2514</b>
TSA84	1 x 84 x 20	85	14	1	<b>\$1874</b>	<b>\$2345</b>
TSA78	1 x 78 x 20	85	13	1	<b>\$1743</b>	<b>\$2180</b>
TSA72	1 x 72 x 20	85	12	1	<b>\$1606</b>	<b>\$2008</b>
TSA66	1 x 66 x 20	92.5	11	1	<b>\$1474</b>	<b>\$1844</b>
TSA60	1 x 60 x 20	92.5	10	1	<b>\$1338</b>	<b>\$1674</b>
TSA54	1 x 54 x 20	92.5	10	1	<b>\$1207</b>	<b>\$1511</b>
TSA48	1 x 48 x 20	92.5	10	1	<b>\$1076</b>	<b>\$1346</b>
TSA42	1 x 42 x 20	92.5	10	1	<b>\$938</b>	<b>\$1173</b>
TSA36	1 x 36 x 20	125	6	1	<b>\$801</b>	<b>\$1004</b>
TSA30	1 x 30 x 20	150	4	1	<b>\$624</b>	<b>\$780</b>

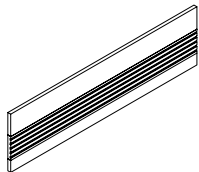

Tackboard - Accessory Rail

For use on **16.5"H** overhead storage (**DCSF0\_**, **DSF\_**, **DSFF\_**) at a finished height of **66"**. See Tackboard Notes above for exact fabric availability. List Price shown applies for all fabric grades.

- **Must Specify Black (E) or Tungsten (K) Accessory Rail finish.**
- **NOTE:** Care should be taken to mount the units. Units should be mounted to wall studs using correct fasteners. Failure to do so may result in collapse of the unit and subsequent personal injury. **Mounting hardware not included.** Mounting hardware used should be based on wall material. Consult an installation professional for proper wall mounting.

**Required Specifications**

- Fabric
- Accessory Rail Finish

WALL MOUNTED TACKBOARDS FOR OVERHEAD STORAGE

MODEL#	DIMENSIONS	FREIGHT CLASS	WT/LBS.	CUBIC FT.	GR. 1-3	GR. 4-5
D x W x H						
TSA120H26	1 x 120 x 26	85	26	2	\$3217	\$4021
TSA114H26	1 x 114 x 26	85	25	2	\$3053	\$3816
TSA108H26	1 x 108 x 26	92.5	23	2	\$2903	\$3628
TSA102H26	1 x 102 x 26	100	19	2	\$2738	\$3424
TSA96H26	1 x 96 x 26	70	15	1	\$2424	\$3031
TSA90H26	1 x 90 x 26	70	15	1	\$2418	\$3024
TSA84H26	1 x 84 x 26	85	14	1	\$2228	\$2785
TSA78H26	1 x 78 x 26	85	13	1	\$2090	\$2615
TSA72H26	1 x 72 x 26	85	12	1	\$1901	\$2378
TSA66H26	1 x 66 x 26	92.5	11	1	\$1777	\$2220
TSA60H26	1 x 60 x 26	92.5	10	1	\$1606	\$2008
TSA54H26	1 x 54 x 26	92.5	10	1	\$1449	\$1814
TSA48H26	1 x 48 x 26	92.5	10	1	\$1292	\$1615
TSA42H26	1 x 42 x 26	92.5	10	1	\$1136	\$1418
TSA36H26	1 x 36 x 26	125	6	1	\$965	\$1207
TSA30H26	1 x 30 x 26	150	4	1	\$807	\$1010

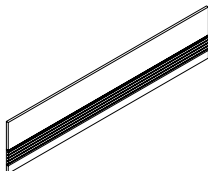

Tackboard - Accessory Rail

For use on **16.5" H** overhead storage (**DCSF0\_**, **DSF\_**, **DSFF\_**) at a finished height of **72"**. See Tackboard Notes above for exact fabric availability. List Price shown applies for all fabric grades.

- **Must Specify Black (E) or Tungsten (K) Accessory Rail finish.**
- **NOTE:** Care should be taken to mount the units. Units should be mounted to wall studs using correct fasteners. Failure to do so may result in collapse of the unit and subsequent personal injury. **Mounting hardware not included.** Mounting hardware used should be based on wall material. Consult an installation professional for proper wall mounting.

TSPA120H23	1 x 120 x 23	70	34	2	\$2929	\$3661
TSPA114H23	1 x 114 x 23	70	32	2	\$2771	\$3468
TSPA108H23	1 x 108 x 23	70	30	2	\$2614	\$3269
TSPA102H23	1 x 102 x 23	85	24	2	\$2490	\$3112
TSPA96H23	1 x 96 x 23	92.5	20	2	\$2332	\$2918
TSPA90H23	1 x 90 x 23	70	20	2	\$2189	\$2737
TSPA84H23	1 x 84 x 23	100	18	2	\$2038	\$2548
TSPA78H23	1 x 78 x 23	100	17	2	\$1895	\$2370
TSPA72H23	1 x 72 x 23	70	16	1	\$1749	\$2188
TSPA66H23	1 x 66 x 23	85	14	1	\$1606	\$2008
TSPA60H23	1 x 60 x 23	85	13	1	\$1456	\$1821
TSPA54H23	1 x 54 x 23	85	13	1	\$1286	\$1609
TSPA48H23	1 x 48 x 23	85	13	1	\$1166	\$1460
TSPA42H23	1 x 42 x 23	85	13	1	\$1023	\$1280
TSPA36H23	1 x 36 x 23	100	6	1	\$879	\$1098
TSPA30H23	1 x 30 x 23	150	4	1	\$729	\$913

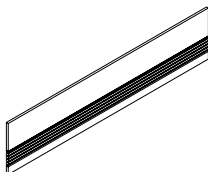

Tackboard - Accessory Rail

For use on **19.5" H** overhead storage (**DCSF0P\_**, **DSFP\_**, **DSFFP\_**) with Pigeon-Hole Storage at a finished height of **72"**. See Tackboard Notes above for exact fabric availability. List Price shown applies for all fabric grades.

- **Must Specify Black (E) or Tungsten (K) Accessory Rail finish.**
- **NOTE:** Care should be taken to mount the units. Units should be mounted to wall studs using correct fasteners. Failure to do so may result in collapse of the unit and subsequent personal injury. **Mounting hardware not included.** Mounting hardware used should be based on wall material. Consult an installation professional for proper wall mounting.

**Required Specifications**

- Fabric
- Accessory Rail Finish

WALL MOUNTED TACKBOARDS FOR OVERHEAD STORAGE MODEL# DIMENSIONS FREIGHT CLASS WT/LBS. CUBIC FT. GR. 1-3 GR. 4-5

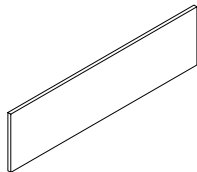

Tackboard

	D x W x H						
DTS120	1 x 118 x 20	70	26	2	\$904	\$1133	
DTS114	1 x 112 x 20	70	25	2	\$858	\$1075	
DTS108	1 x 106 x 20	70	23	2	\$816	\$1024	
DTS102	1 x 100 x 20	85	19	2	\$773	\$969	
DTS96	1 x 94 x 20	70	15	1	\$728	\$913	
DTS90	1 x 88 x 20	70	15	1	\$689	\$867	
DTS84	1 x 82 x 20	70	14	1	\$647	\$811	
DTS78	1 x 76 x 20	70	13	1	\$601	\$755	
DTS72	1 x 70 x 20	70	12	1	\$557	\$698	
DTS66	1 x 64 x 20	85	11	1	\$512	\$644	
DTS60	1 x 58 x 20	85	10	1	\$471	\$592	
DTS36	1 x 34 x 20	100	6	1	\$302	\$383	
DTS30	1 x 28 x 20	150	4	1	\$251	\$316	

For use on 36" H hutches (D\_SH36, D\_SH36G, D\_SH36DGD, D\_SH36GDG). **Factory installed**, with velcro tape. Please specify hutch to be installed on. See Tackboard Notes above for exact fabric availability. List Price shown applies for all fabric grades.

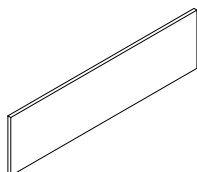

Tackboard

DTS120H26	1 x 118 x 26	70	34	2	\$1169	\$1463
DTS114H26	1 x 112 x 26	70	32	2	\$1111	\$1392
DTS108H26	1 x 106 x 26	70	30	2	\$1053	\$1319
DTS102H26	1 x 100 x 26	85	24	2	\$998	\$1253
DTS96H26	1 x 94 x 26	92.5	20	2	\$943	\$1182
DTS90H26	1 x 88 x 26	92.5	20	2	\$883	\$1108
DTS84H26	1 x 82 x 26	100	18	2	\$828	\$1039
DTS78H26	1 x 76 x 26	100	17	2	\$773	\$969
DTS72H26	1 x 70 x 26	70	16	1	\$714	\$897
DTS66H26	1 x 64 x 26	85	14	1	\$658	\$825
DTS60H26	1 x 58 x 26	85	13	1	\$601	\$755
DTS36H26	1 x 34 x 26	100	8	1	\$378	\$475
DTS30H26	1 x 28 x 26	150	5	1	\$317	\$401

For use on 42" H and 54" H hutches (D\_SH42/54, D\_SH42/54G, D\_SH42/54DGD, D\_SH42/54GDG). **Factory installed**, with velcro tape. Please specify hutch to be installed on. See Tackboard Notes above for exact fabric availability. List Price shown applies for all fabric grades.

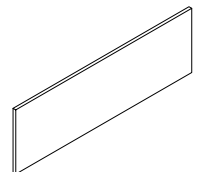

Tackboard

DTSP120H23	1 x 118 x 23	70	34	2	\$1169	\$1463
DTSP114H23	1 x 112 x 23	70	32	2	\$1111	\$1392
DTSP108H23	1 x 106 x 23	70	30	2	\$1053	\$1319
DTSP102H23	1 x 100 x 23	85	24	2	\$998	\$1253
DTSP96H23	1 x 94 x 23	92.5	20	2	\$943	\$1182
DTSP90H23	1 x 88 x 23	92.5	20	1	\$883	\$1108
DTSP84H23	1 x 82 x 23	70	18	1	\$828	\$1039
DTSP78H23	1 x 76 x 23	70	17	1	\$773	\$969
DTSP72H23	1 x 70 x 23	70	16	1	\$714	\$897
DTSP66H23	1 x 64 x 23	85	14	1	\$658	\$825
DTSP60H23	1 x 58 x 23	85	13	1	\$601	\$755
DTSP54H23	1 x 52 x 23	85	13	1	\$552	\$692
DTSP48H23	1 x 46 x 23	85	13	1	\$488	\$613
DTSP42H23	1 x 40 x 23	85	13	1	\$433	\$545
DTSP36H23	1 x 34 x 23	100	8	1	\$378	\$475
DTSP30H23	1 x 28 x 23	150	5	1	\$317	\$401

For use on 42" H and 54" H hutches (D\_SHP42/54, D\_SHP42/54G, D\_SHP42/54DGD, D\_SHP42/54GDG) with Pigeon-Hole Storage. **Factory installed**, with velcro tape. Please specify hutch to be installed on. See Tackboard Notes above for exact fabric availability. List Price shown applies for all fabric grades.

Required Specifications

Fabric

## TACKBOARDS FOR HUTCHES

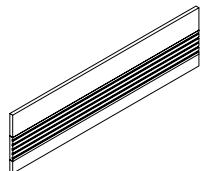

Tackboard - Accessory Rail

MODEL#	DIMENSIONS	FREIGHT CLASS	WT/LBS.	CUBIC FT.	GR. 1-3	GR. 4-5
D x W x H						
DTSA120	1 x 118 x 20	85	26	2	\$1575	\$1974
DTSA114	1 x 112 x 20	85	25	2	\$1501	\$1881
DTSA108	1 x 106 x 20	92.5	23	2	\$1418	\$1776
DTSA102	1 x 100 x 20	100	19	2	\$1344	\$1683
DTSA96	1 x 94 x 20	70	15	1	\$1263	\$1581
DTSA90	1 x 88 x 20	70	15	1	\$1193	\$1496
DTSA84	1 x 82 x 20	85	14	1	\$1111	\$1392
DTSA78	1 x 76 x 20	85	13	1	\$1037	\$1299
DTSA72	1 x 70 x 20	85	12	1	\$960	\$1202
DTSA66	1 x 64 x 20	92.5	11	1	\$878	\$1101
DTSA60	1 x 58 x 20	92.5	10	1	\$803	\$1008
DTSA54	1 x 52 x 20	92.5	10	1	\$728	\$913
DTSA48	1 x 46 x 20	92.5	10	1	\$652	\$817
DTSA42	1 x 40 x 20	92.5	10	1	\$577	\$725
DTSA36	1 x 34 x 20	125	6	1	\$495	\$623
DTSA30	1 x 28 x 20	150	4	1	\$417	\$526

For use on 36"H hutches (D\_SH36, D\_SH36G, D\_SH36DGD, D\_SH36GDG). Factory installed, with velcro tape. Please specify hutch to be installed on. See Tackboard Notes above for exact fabric availability. List Price shown applies for all fabric grades.

- Must Specify Black (E) or Tungsten (K) Accessory Rail finish.

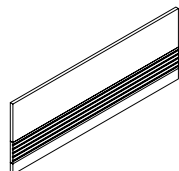

Tackboard - Accessory Rail

DTSA120H26	1 x 118 x 26	85	26	2	\$1884	\$2359
DTSA114H26	1 x 112 x 26	85	25	2	\$1791	\$2244
DTSA108H26	1 x 106 x 26	92.5	23	2	\$1702	\$2133
DTSA102H26	1 x 100 x 26	100	19	2	\$1609	\$2014
DTSA96H26	1 x 94 x 26	70	15	1	\$1513	\$1895
DTSA90H26	1 x 88 x 26	70	15	1	\$1425	\$1784
DTSA78H26	1 x 76 x 26	85	13	1	\$1238	\$1551
DTSA72H26	1 x 70 x 26	85	12	1	\$1124	\$1409
DTSA66H26	1 x 64 x 26	92.5	11	1	\$1053	\$1319
DTSA60H26	1 x 58 x 26	92.5	10	1	\$960	\$1202
DTSA54H26	1 x 52 x 26	92.5	10	1	\$867	\$1086
DTSA48H26	1 x 46 x 26	92.5	10	1	\$777	\$975
DTSA42H26	1 x 40 x 26	92.5	10	1	\$684	\$857
DTSA36H26	1 x 34 x 26	125	6	1	\$588	\$737
DTSA30H26	1 x 28 x 26	150	4	1	\$501	\$630

For use on 42"H and 54"H hutches (D\_SH42/54, D\_SH42/54G, D\_SH42/54DGD, D\_SH42/54GDG). Factory installed, with velcro tape. Please specify hutch to be installed on. See Tackboard Notes above for exact fabric availability. List Price shown applies for all fabric grades.

- Must Specify Black (E) or Tungsten (K) Accessory Rail finish.

## Required Specifications

Fabric  
Accessory Rail finish

TACKBOARDS FOR HUTCHES

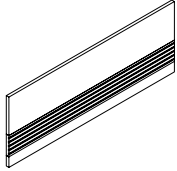

Tackboard - Accessory Rail\*

MODEL#	DIMENSIONS	FREIGHT CLASS	WT./LBS.	CUBIC FT.	GR. 1-3	GR. 4-5
<b>D x W x H</b>						
DTSPA120H23	1 x 118 x 23	70	34	2	<b>\$1960</b>	<b>\$2452</b>
DTSPA114H23	1 x 112 x 23	70	32	2	<b>\$1866</b>	<b>\$2337</b>
DTSPA108H23	1 x 106 x 23	70	30	2	<b>\$1764</b>	<b>\$2207</b>
DTSPA102H23	1 x 100 x 23	85	24	2	<b>\$1685</b>	<b>\$2111</b>
DTSPA96H23	1 x 94 x 23	92.5	20	2	<b>\$1575</b>	<b>\$1974</b>
DTSPA90H23	1 x 88 x 23	92.5	20	2	<b>\$1483</b>	<b>\$1860</b>
DTSPA84H23	1 x 82 x 23	100	18	2	<b>\$1382</b>	<b>\$1732</b>
DTSPA78H23	1 x 76 x 23	100	17	2	<b>\$1289</b>	<b>\$1615</b>
DTSPA72H23	1 x 70 x 23	70	16	1	<b>\$1193</b>	<b>\$1496</b>
DTSPA66H23	1 x 64 x 23	85	14	1	<b>\$1094</b>	<b>\$1372</b>
DTSPA60H23	1 x 58 x 23	85	13	1	<b>\$998</b>	<b>\$1253</b>
DTSPA54H23	1 x 52 x 23	85	13	1	<b>\$904</b>	<b>\$1133</b>
DTSPA48H23	1 x 46 x 23	85	13	1	<b>\$803</b>	<b>\$1008</b>
DTSPA42H23	1 x 40 x 23	85	13	1	<b>\$709</b>	<b>\$890</b>
DTSPA36H23	1 x 34 x 23	100	8	1	<b>\$613</b>	<b>\$772</b>
DTSPA30H23	1 x 28 x 23	150	5	1	<b>\$521</b>	<b>\$655</b>

For use on **42"H and 54"H** hutches (**D\_SHP42/54, D\_SHP42/54G, D\_SHP42/54DGD, D\_SHP42/54GDG**) with Pigeon-Hole Storage. **Factory installed**, with velcro tape. Please specify hutch to be installed on. See *Tackboard Notes above* for exact fabric availability. List Price shown applies for all fabric grades.

- **Must Specify Black (E) or Tungsten (K) Accessory Rail finish.**

HUTCH ACCESSORIES

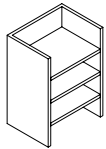

Vertical Pigeon-Hole Storage, Letter\*\*

MODEL#	DIMENSIONS	FREIGHT CLASS	WT./LBS.	CUBIC FT.	veneer/LAMINATE	ALL VENEER
DCPH131226	12 x 13 x 26	100	16	2	<b>\$575</b>	<b>\$688</b>
DCPH131223	12 x 13 x 23	125	15	2	<b>\$488</b>	<b>\$586</b>
DCPH131219	12 x 13 x 19	125	12	2	<b>\$368</b>	<b>\$443</b>

Used in conjunction with overhead storage units and hutches that incorporate horizontal pigeon-hole storage. Not freestanding. Shipped RTA (ready to assemble).

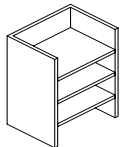

Vertical Pigeon-Hole Storage, Legal\*\*

DCPH161226	12 x 16 x 26	125	20	3	<b>\$707</b>	<b>\$850</b>
DCPH161223	12 x 16 x 23	125	18	3	<b>\$599</b>	<b>\$719</b>
DCPH161219	12 x 16 x 19	125	15	2	<b>\$455</b>	<b>\$543</b>

Used in conjunction with overhead storage units and hutches that incorporate horizontal pigeon-hole storage. Not freestanding. Shipped RTA (ready to assemble).

**Required Specifications**

- Fabric\*
- Accessory Rail finish\*
- Veneer finish\*\*
- Laminate finish\*\*



ACCESSORY RAIL/PANEL ORGANIZERS

MODEL# DIMENSIONS FREIGHT CLASS WT/LBS. CUBIC FT. LIST PRICE

Available Finishes:

		D x W x H		
BLK	Black	SIL	Silver	
CHR	Charcoal	TPE	Taupe	
DWT	Designer White	TUN	Tungsten	
NEV	Nevada			

MODEL# DIMENSIONS FREIGHT CLASS WT/LBS. CUBIC FT. LIST PRICE

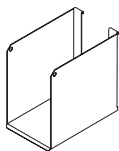

**Binder Bin**

BABB01	10.25 x 4 x 9	100	2	.21	<b>\$70</b>
--------	---------------	-----	---	-----	-------------

Load bar/accessory rail mounted metal binder bin.

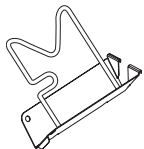

**Flip Sorter**

BAFS01	9.25 x 2.75 x 9.25	70	.06	.14	<b>\$54</b>
--------	--------------------	----	-----	-----	-------------

Load bar/accessory rail mounted metal flip sorter. Comes with chrome wire.

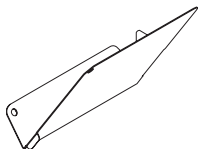

**Slant Sorter**

BASS01L (Left)	10.25 x 5 x 9.5	70	1	.28	<b>\$44</b>
BASS01R (Right)	10.25 x 5 x 9.5	70	1	.28	<b>\$44</b>

Load bar/accessory rail mounted metal slant sorter.

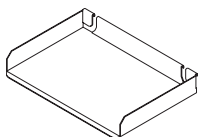

**Letter Tray**

BALTO1	9.25 x 13.5 x 2	70	.50	.15	<b>\$58</b>
--------	-----------------	----	-----	-----	-------------

Load bar/accessory rail mounted metal letter tray.

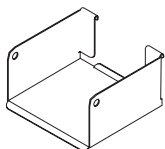

**Media Bin**

BAMB01	5.25 x 5.75 x 3	70	.08	.05	<b>\$58</b>
--------	-----------------	----	-----	-----	-------------

Load bar/accessory rail mounted metal media bin.

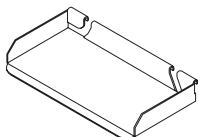

**Utility Tray**

BAUT01	3.75 x 5.75 x 3	70	.05	.02	<b>\$38</b>
--------	-----------------	----	-----	-----	-------------

Load bar/accessory rail mounted metal utility tray.

**Required Specifications**

Metal finish

ACCESSORY RAIL/PANEL ORGANIZERS

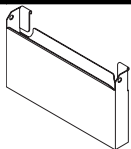

Mail Box\*



Telephone Holder\*

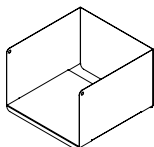

Elevated Shelf Binder Bin\*

MODEL#	DIMENSIONS D x W x H	FREIGHT CLASS	WT/LBS.	CUBIC FT.	LIST PRICE
BAPP01	2.75 x 16 x 9	100	2	.25	<b>\$88</b>
Load bar/accessory rail mounted metal mail box.					
BATH01	10 x 9 x 2	125	2	.26	<b>\$85</b>
Load bar/accessory rail mounted metal telephone holder.					
BRTESBBIN	12 x 12 x 8	100	6	.66	<b>\$181</b>
Load bar/accessory rail mounted elevated shelf binder bin.					

BOOKCASES

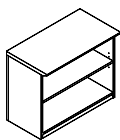

Bookcase - 29" High\*\*

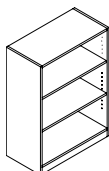

Bookcase - 48" High\*\*

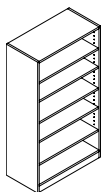

Bookcase - 66" High\*\*

MODEL#	DIMENSIONS	FREIGHT CLASS	WT/LBS.	CUBIC FT.	VENEER/LAMINATE	ALL VENEER
DB23615	15 x 36 x 29	92.5	90	9	<b>\$1267</b>	<b>\$1518</b>
DB23015	15 x 30 x 29	92.5	90	8	<b>\$1107</b>	<b>\$1329</b>
Includes <b>one adjustable</b> veneer shelf. Shelf is 3/4" thick.						
DB43615	15 x 36 x 48	100	140	15	<b>\$1581</b>	<b>\$1895</b>
DB43015	15 x 30 x 48	92.5	140	13	<b>\$1384</b>	<b>\$1660</b>
Includes <b>two adjustable</b> veneer shelves. Shelf is 3/4" thick.						
DB53615	15 x 36 x 66	100	188	21	<b>\$1917</b>	<b>\$2301</b>
DB53015	15 x 30 x 66	92.5	188	17	<b>\$1678</b>	<b>\$2012</b>
Includes <b>five adjustable</b> veneer shelves. Shelf is 3/4" thick.						

Required Specifications

- Metal finish\*
- Veneer finish (shelves)\*\*
- Laminate finish (top/body)\*\*

BOOKCASES

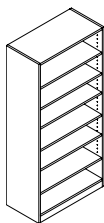

Bookcase - 72" High

MODEL#	DIMENSIONS D x W x H	FREIGHT CLASS	WT/LBS.	CUBIC FT.	VENEER/LAMINATE	ALL VENEER
DB63615	15 x 36 x 72	100	210	23	\$2078	\$2495
DB63015	15 x 30 x 72	92.5	210	19	\$1820	\$2184

Includes **six adjustable** veneer shelves. Shelf is 3/4" thick.

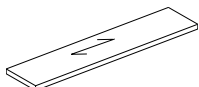

Tops 15" Deep

DT3617D	17 x 36 x 1	65	27	1	N/A	\$622
DT3017D	17 x 30 x 1	65	23	1	N/A	\$517

For use with 15" deep bookcases. Tops are 1" thick.

END SHELVES

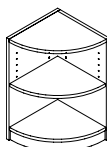

End Shelf - 29" High

MODEL#	DIMENSIONS	FREIGHT CLASS	WT/LBS.	CUBIC FT.	VENEER/LAMINATE	ALL VENEER
DB2R1515	15 x 15 x 29	100	37	4	\$998	\$1197

For use at end of **worksurfaces or storage modules**. Includes one adjustable veneer shelf. Shipped RTA (ready to assemble).

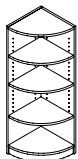

End Shelf - 48" High

DB4R1515	15 x 15 x 48	100	59	6	\$1242	\$1492
----------	--------------	-----	----	---	--------	--------

For use at end of **storage modules or wardrobe cabinets**. Includes **three adjustable** veneer shelves. Shipped RTA (ready to assemble).

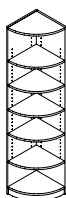

End Shelf - 66" High

DB5R1515	15 x 15 x 66	100	81	9	\$1511	\$1812
----------	--------------	-----	----	---	--------	--------

For use at end of **storage modules, wardrobe cabinets or personal towers**. Includes **five adjustable** veneer shelves. Shipped RTA (ready to assemble).

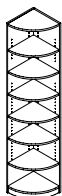

End Shelf - 72" High

DB6R1515	15 x 15 x 72	100	83	9	\$1641	\$1968
----------	--------------	-----	----	---	--------	--------

For use at end of **storage modules, wardrobe cabinets or personal towers**. Includes **six adjustable** veneer shelves. Shipped RTA (ready to assemble).

Required Specifications

- Veneer finish (shelves)
- Laminate finish (top/body)

END SHELVES

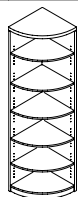

End Shelf - 66" High

MODEL#	DIMENSIONS	FREIGHT CLASS	WT/LBS.	CUBIC FT.	veneer/LAMINATE	ALL VENEER
	<b>D x W x H</b>					
DB7R2424	24 x 24 x 66	100	187	22	<b>\$2754</b>	<b>\$3307</b>
DB7R2222	22 x 22 x 66	100	157	18	<b>\$2398</b>	<b>\$2878</b>
DB7R2020	20 x 20 x 66	100	130	15	<b>\$2287</b>	<b>\$2746</b>

For use at end of **storage modules, wardrobe cabinets or personal towers**. Includes **five adjustable** veneer shelves. Shipped RTA (ready to assemble).

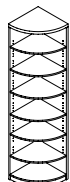

End Shelf - 72" High

DB7R2424H72	24 x 24 x 72	125	204	28	<b>\$3007</b>	<b>\$3608</b>
DB7R2222H72	22 x 22 x 72	100	171	20	<b>\$2620</b>	<b>\$3141</b>
DB7R2020H72	20 x 20 x 72	100	142	17	<b>\$2495</b>	<b>\$2995</b>

For use at end of **storage modules, wardrobe cabinets or personal towers**. Includes **six adjustable** veneer shelves. Shipped RTA (ready to assemble).

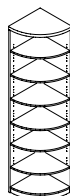

End Shelf - 84" High

DB7R2424H84	24 x 24 x 84	100	234	28	<b>\$3507</b>	<b>\$4207</b>
DB7R2222H84	22 x 22 x 84	100	189	20	<b>\$3214</b>	<b>\$3855</b>
DB7R2020H84	20 x 20 x 84	100	163	19	<b>\$3062</b>	<b>\$3676</b>

For use at end of **storage modules, wardrobe cabinets or personal towers**. Includes **seven adjustable** veneer shelves. Shipped RTA (ready to assemble).

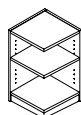

End Shelf - 29" High - Square

DB2S1515	15 x 15 x 29	100	37	4	<b>\$1050</b>	<b>\$1262</b>
----------	--------------	-----	----	---	---------------	---------------

For use at end of **worksurfaces or storage modules**. Includes **one adjustable** veneer shelf. Shipped RTA (ready to assemble).

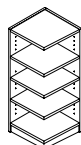

End Shelf - 48" High - Square

DB4S1515	15 x 15 x 48	100	59	6	<b>\$1313</b>	<b>\$1571</b>
----------	--------------	-----	----	---	---------------	---------------

For use at end of **storage modules or wardrobe cabinets**. Includes **three adjustable** veneer shelves. Shipped RTA (ready to assemble).

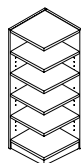

End Shelf - 66" High - Square

DB5S1515	15 x 15 x 66	100	81	9	<b>\$1591</b>	<b>\$1910</b>
----------	--------------	-----	----	---	---------------	---------------

For use at end of **storage modules, wardrobe cabinets or personal towers**. Includes **five adjustable** veneer shelves. Shipped RTA (ready to assemble).

**Required Specifications**

- Veneer finish (shelves)
- Laminate finish (top/body)

# D DUFFERIN

## END SHELVES

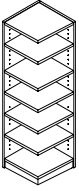

**End Shelf - 72" High - Square**

MODEL#	DIMENSIONS D x W x H	FREIGHT CLASS	WT/LBS.	CUBIC FT.	VENEER/LAMINATE	ALL VENEER
DB6S1515	15 x 15 x 72	100	83	9	\$1729	\$2074

For use at end of **storage modules, wardrobe cabinets or personal towers**. Includes **six adjustable** veneer shelves. Shipped RTA (ready to assemble).

## RECEPTION DESKS

- To add storage use storage shells. See pages 40-42.
- Includes GM1 grommet.
- Transaction tops to be specified separately, handed by square edge from user side.
- Decorative Front Panels should be specified separately. Size chosen should be 12" less than desk dimensions. Available in Reverse Diamond, Vertical Rib, Vertical Grain and Horizontal Grain Patterns.

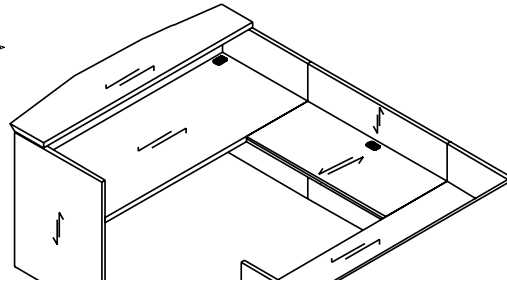
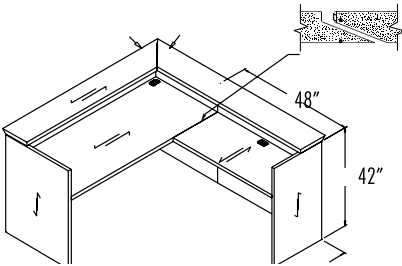

### OPTION DETAILS

Decorative Front Panel (Reverse Diamond Pattern)  
DGFDP5430F

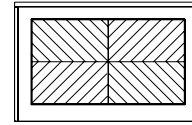

Decorative Front Panel (Vertical Rib Pattern)  
DGFDP5430RIB

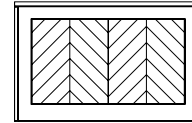

MODEL#	DIMENSIONS	FREIGHT CLASS	WT/LBS.	CUBIC FT.	VENEER/LAMINATE	ALL VENEER
DGC10836	36 x 108 x 42	150	533	95	\$6462	\$7753
DGC10236	36 x 102 x 42	150	503	89	\$6101	\$7322
DGC9636	36 x 96 x 42	150	473	84	\$5744	\$6892
DGC9036	36 x 90 x 42	150	444	79	\$5385	\$6463
DGC8436	36 x 84 x 42	150	414	74	\$5025	\$6028
DGC7236	36 x 72 x 42	150	355	63	\$4308	\$5169
DGC7230	30 x 72 x 42	150	315	53	\$4168	\$5001
DGC6630	30 x 66 x 42	125	295	48	\$3756	\$4506
DGC6030	30 x 60 x 42	125	275	44	\$4064	\$4875

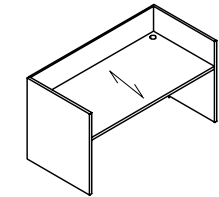

**Gallery/Reception Desk Shell\***

No pedestals. Two grommets in worksurface. For use with modular storage components.

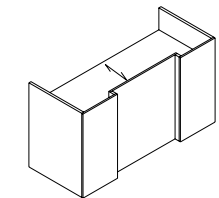

**Gallery/Reception Desk Shell  
Breakfront Style**

DGIC10836	36 x 108 x 42	150	533	95	\$7938	\$9526
DGIC10236	36 x 102 x 42	150	503	89	\$7498	\$8997
DGIC9636	36 x 96 x 42	150	473	84	\$7058	\$8469
DGIC9036	36 x 90 x 42	150	444	79	\$6617	\$7940
DGIC8436	36 x 84 x 42	150	414	74	\$6176	\$7412
DGIC7236	36 x 72 x 42	150	355	63	\$5295	\$6354
DGIC7230	30 x 72 x 42	150	315	53	\$5122	\$6145
DGIC6630	30 x 66 x 42	125	295	48	\$4993	\$5993
DGIC6030	30 x 60 x 42	125	275	44	\$4712	\$5652

No pedestals. Two grommets in worksurface. For use with modular storage components.

### Required Specifications

Veneer Finish  
Laminate Finish

### Optional Specifications

Additional Grommet (Reception Desks)  
Decorative Panel\*

### Accessories

Storage Shells (Reception Desks)

RECEPTION DESKS

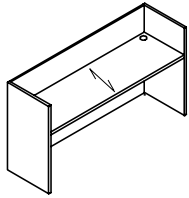

Gallery/Reception Credenza Shell\*

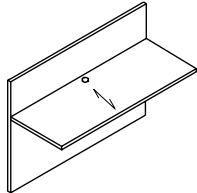

Bridge

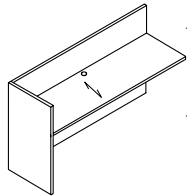

Reception Return - LEFT

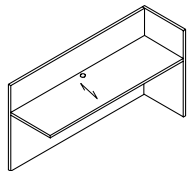

Reception Return - RIGHT

MODEL#	DIMENSIONS D x W x H	FREIGHT CLASS	WT/LBS.	CUBIC FT.	VENEER/LAMINATE	ALL VENEER
DGC10824	24 x 108 x 42	150	353	63	\$5064	\$6077
DGC10224	24 x 102 x 42	150	333	60	\$4784	\$5742
DGC9624	24 x 96 x 42	150	314	56	\$4501	\$5403
DGC9024	24 x 90 x 42	150	294	53	\$4220	\$5063
DGC8424	24 x 84 x 42	150	274	49	\$3937	\$4727
DGC7224	24 x 72 x 42	150	235	42	\$3379	\$4053
DGC6624	24 x 66 x 42	150	216	39	\$3175	\$3809
DGC6024	24 x 60 x 42	150	196	35	\$2973	\$3569

**No pedestals.** Two grommets in worksurface. For use with modular storage components.

DGBT5624CG	24 x 56 x 42	150	178	32	\$2833	\$3403
DGBT5424CG	24 x 54 x 42	150	169	29	\$2833	\$3403
DGBT5024CG	24 x 50 x 42	150	151	27	\$2518	\$3020
DGBT4824CG	24 x 48 x 42	150	142	26	\$2518	\$3020
DGBT4424CG	24 x 44 x 42	150	134	23	\$2204	\$2643
DGBT4224CG	24 x 42 x 42	150	127	22	\$2204	\$2643
DGBT3824CG	24 x 38 x 42	150	119	20	\$1985	\$2382
DGBT3624CG	24 x 36 x 42	150	112	19	\$1985	\$2382

Attaches between **Gallery Desk and Gallery Credenza Only**. One grommet in center of worksurface. Shipped RTA (ready to assemble).

- To remove cross-grain veneer pattern on top, **delete "CG"** from model number. Available as a special - no upcharge.

DGRL7224	24 x 72 x 42	125	273	42	\$4253	\$5104
DGRL6624	24 x 66 x 42	125	250	39	\$3899	\$4679
DGRL6024	24 x 60 x 42	125	228	35	\$3547	\$4254
DGRL5424	24 x 54 x 42	125	205	32	\$3192	\$3831
DGRL4824	24 x 48 x 42	125	182	28	\$2840	\$3406
DGRL4224	24 x 42 x 42	125	159	25	\$2482	\$2979
DGRL3624	24 x 36 x 42	125	137	21	\$2235	\$2679

**No pedestal.** One grommet in center of worksurface. For use with modular storage components.

DGRR7224	24 x 72 x 42	125	273	42	\$4253	\$5104
DGRR6624	24 x 66 x 42	125	250	39	\$3899	\$4679
DGRR6024	24 x 60 x 42	125	228	35	\$3547	\$4254
DGRR5424	24 x 54 x 42	125	205	32	\$3192	\$3831
DGRR4824	24 x 48 x 42	125	182	28	\$2840	\$3406
DGRR4224	24 x 42 x 42	125	159	25	\$2482	\$2979
DGRR3624	24 x 36 x 42	125	137	21	\$2235	\$2679

**No pedestal.** One grommet in center of worksurface. For use with modular storage components.

**Required Specifications**

Veneer Finish  
Laminate Finish

**Optional Specifications**

Additional grommet\*  
Decorative panel\*

**Accessories**

Storage shells\*

TRANSACTION TOPS

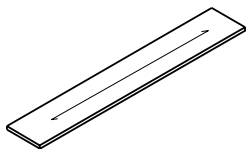

Transaction Counter Top

MODEL#	DIMENSIONS D x W x H	FREIGHT CLASS	WT./LBS.	CUBIC FT.	VENEER/LAMINATE	ALL VENEER
DGTT10810	10 x 108 x 1.50	100	78	8	N/A	<b>\$1198</b>
DGTT10210	10 x 102 x 1.50	92.5	72	7	N/A	<b>\$1133</b>
DGTT9610	10 x 96 x 1.50	100	66	7	N/A	<b>\$1067</b>
DGTT9010	10 x 90 x 1.50	92.5	60	6	N/A	<b>\$1000</b>
DGTT8410	10 x 84 x 1.50	100	54	6	N/A	<b>\$933</b>
DGTT7210	10 x 72 x 1.50	100	48	5	N/A	<b>\$801</b>
DGTT6610	10 x 66 x 1.50	100	42	5	N/A	<b>\$732</b>
DGTT6010	10 x 60 x 1.50	100	36	4	N/A	<b>\$668</b>

**Rectangular top** for main reception desk. Counter sits on top of Gallery panels. Does not overhang. **Factory installed - specify Gallery to be used on.** Size must match dimension of desk front or combined desk side and return length. Hardware included.

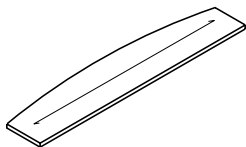

Bow Front Transaction Counter Top

DGTTM1081013	10-13 x 108 x 1.50	125	78	10	N/A	<b>\$2395</b>
DGTTM1021013	10-13 x 102 x 1.50	100	72	9	N/A	<b>\$2658</b>
DGTTM961013	10-13 x 96 x 1.50	125	66	9	N/A	<b>\$2129</b>
DGTTM901013	10-13 x 90 x 1.50	125	60	8	N/A	<b>\$1996</b>
DGTTM841013	10-13 x 84 x 1.50	125	54	8	N/A	<b>\$1864</b>
DGTTM721013	10-13 x 72 x 1.50	125	48	7	N/A	<b>\$1598</b>
DGTTM661013	10-13 x 66 x 1.50	125	42	6	N/A	<b>\$1466</b>
DGTTM601013	10-13 x 60 x 1.50	125	36	5	N/A	<b>\$1331</b>

**Bow top** for main reception desk. Counter sits on top of Gallery panels. Bow front overhangs 3". **Factory installed - specify Gallery to be used on.** Size must match dimension of desk front or combined desk side and return length. Hardware included.

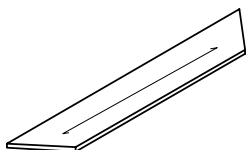

Trapezoid Transaction Counter Top

DGTTA10810	10 x 108 x 1.50	100	78	8	N/A	<b>\$1360</b>
DGTTA10210	10 x 102 x 1.50	92.5	72	7	N/A	<b>\$1293</b>
DGTTA9610	10 x 96 x 1.50	100	66	7	N/A	<b>\$1227</b>
DGTTA9010	10 x 90 x 1.50	92.5	60	6	N/A	<b>\$1160</b>
DGTTA8410	10 x 84 x 1.50	100	54	6	N/A	<b>\$1096</b>
DGTTA7210	10 x 72 x 1.50	100	48	5	N/A	<b>\$961</b>
DGTTA6610	10 x 66 x 1.50	100	42	5	N/A	<b>\$897</b>
DGTTA6010	10 x 60 x 1.50	100	36	4	N/A	<b>\$828</b>

**Trapezoid top** for main reception desk. 45° mitered ends on left and right. For use with left and right 45° mitered return transaction counters. Counter sits on top of Gallery panels. Does not overhang. **Factory installed - specify Gallery to be used on.** Width must match dimension of desk front. Hardware included.

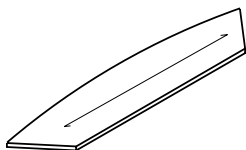

Bow Front Trapezoid Transaction Counter Top

DGTTMA1081013	10-13 x 108 x 1.50	125	78	10	N/A	<b>\$2552</b>
DGTTMA1021013	10-13 x 102 x 1.50	100	72	9	N/A	<b>\$2420</b>
DGTTMA961013	10-13 x 96 x 1.50	125	66	9	N/A	<b>\$2288</b>
DGTTMA901013	10-13 x 90 x 1.50	125	60	8	N/A	<b>\$2155</b>
DGTTMA841013	10-13 x 84 x 1.50	125	54	8	N/A	<b>\$2026</b>
DGTTMA721013	10-13 x 72 x 1.50	125	48	7	N/A	<b>\$1757</b>
DGTTMA661013	10-13 x 66 x 1.50	125	42	6	N/A	<b>\$1623</b>
DGTTMA601013	10-13 x 60 x 1.50	125	36	5	N/A	<b>\$1493</b>

**Trapezoid bow top** for main reception desk. 45° mitered ends on left and right. For use with left and right 45° mitered return transaction counters. Counter sits on top of Gallery panels. Bow front overhangs 3". **Factory installed - specify Gallery to be used on.** Width must match dimension of desk front. Hardware included.

**Required Specifications**  
Veneer Finish

TRANSACTION TOPS

MODEL# DIMENSIONS FREIGHT CLASS WT/LBS. CUBIC FT. VENEER/LAMINATE ALL VENEER

D x W x H

DGTTAL12010	10 x 120 x 1.50	92.5	84	8	N/A	<b>\$1437</b>
DGTTAL11410	10 x 114 x 1.50	92.5	81	8	N/A	<b>\$1366</b>
DGTTAL10810	10 x 108 x 1.50	100	78	8	N/A	<b>\$1305</b>
DGTTAL10210	10 x 102 x 1.50	92.5	72	7	N/A	<b>\$1240</b>
DGTTAL9610	10 x 96 x 1.50	100	66	7	N/A	<b>\$1174</b>
DGTTAL9010	10 x 90 x 1.50	92.5	60	6	N/A	<b>\$1106</b>
DGTTAL8410	10 x 84 x 1.50	100	54	6	N/A	<b>\$1042</b>
DGTTAL7210	10 x 72 x 1.50	100	48	5	N/A	<b>\$907</b>
DGTTAL6610	10 x 66 x 1.50	100	42	5	N/A	<b>\$843</b>
DGTTAL6010	10 x 60 x 1.50	100	36	4	N/A	<b>\$776</b>
DGTTAL3610	10 x 36 x 1.50	100	24	3	N/A	<b>\$466</b>
DGTTAL3010	10 x 30 x 1.50	92.5	20	2	N/A	<b>\$391</b>
DGTTAL2410	10 x 24 x 1.50	100	16	2	N/A	<b>\$343</b>

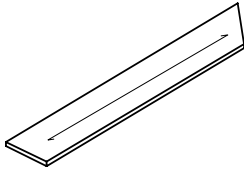

Transaction Counter Top - LEFT

**Rectangular top** for main reception desk with 45° mitered end on **left**. For use with rectangular or bow front transaction counters with miters at both ends. Width must match dimension of Gallery Desk end and Return width. Counter sits on top of Gallery panels. Does not overhang. **Factory installed - specify Gallery to be used on.** Hardware included.

DGTTAR12010	10 x 120 x 1.50	92.5	84	8	N/A	<b>\$1437</b>
DGTTAR11410	10 x 114 x 1.50	92.5	81	8	N/A	<b>\$1366</b>
DGTTAR10810	10 x 108 x 1.50	100	78	8	N/A	<b>\$1305</b>
DGTTAR10210	10 x 102 x 1.50	92.5	72	7	N/A	<b>\$1240</b>
DGTTAR9610	10 x 96 x 1.50	100	66	7	N/A	<b>\$1174</b>
DGTTAR9010	10 x 90 x 1.50	92.5	60	6	N/A	<b>\$1106</b>
DGTTAR8410	10 x 84 x 1.50	100	54	6	N/A	<b>\$1042</b>
DGTTAR7210	10 x 72 x 1.50	100	48	5	N/A	<b>\$907</b>
DGTTAR6610	10 x 66 x 1.50	100	42	5	N/A	<b>\$843</b>
DGTTAR6010	10 x 60 x 1.50	100	36	4	N/A	<b>\$776</b>
DGTTAR3610	10 x 36 x 1.50	100	24	3	N/A	<b>\$466</b>
DGTTAR3010	10 x 30 x 1.50	92.5	20	2	N/A	<b>\$391</b>
DGTTAR2410	10 x 24 x 1.50	100	16	2	N/A	<b>\$343</b>

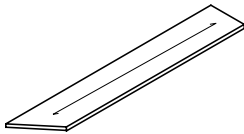

Transaction Counter Top - RIGHT

**Rectangular top** for main reception desk with 45° mitered end on **right**. For use with rectangular or bow front transaction counters with miters at both ends. Width must match dimension of Gallery Desk end and Return width. Counter sits on top of Gallery panels. Does not overhang. **Factory installed - specify Gallery to be used on.** Hardware included.

**Required Specifications**

Veneer Finish



RECEPTION DESKS

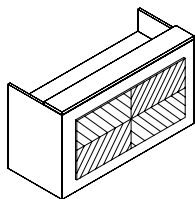

**Decorative Front Panel  
Reverse Diamond Pattern**

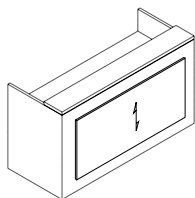

**Decorative Front Panel  
Vertical Grain Pattern**

MODEL#	DIMENSIONS D x W x H	FREIGHT CLASS	WT/LBS.	CUBIC FT.	VENEER/LAMINATE	ALL VENEER
DGFDP9630F	1 x 96 x 30	92.5	81	8	N/A	<b>\$2384</b>
DGFDP9030F	1 x 90 x 30	100	78	8	N/A	<b>\$2231</b>
DGFDP8430F	1 x 84 x 30	92.5	72	7	N/A	<b>\$2086</b>
DGFDP7230F	1 x 72 x 30	100	66	7	N/A	<b>\$1787</b>
DGFDP6030F	1 x 60 x 30	92.5	60	6	N/A	<b>\$1493</b>
DGFDP5430F	1 x 54 x 30	100	54	6	N/A	<b>\$1341</b>
DGFDP4830F	1 x 48 x 30	100	48	5	N/A	<b>\$1194</b>

Raised decorative front panel for a reception desk. Size should be 12" less than desk dimensions. **Factory installed.** Hardware included.

DGFDP9630V	1 x 96 x 30	92.5	81	8	N/A	<b>\$2075</b>
DGFDP9030V	1 x 90 x 30	100	78	8	N/A	<b>\$1942</b>
DGFDP8430V	1 x 84 x 30	92.5	72	7	N/A	<b>\$1817</b>
DGFDP7230V	1 x 72 x 30	100	66	7	N/A	<b>\$1555</b>
DGFDP6030V	1 x 60 x 30	92.5	60	6	N/A	<b>\$1296</b>
DGFDP5430V	1 x 54 x 30	100	54	6	N/A	<b>\$1172</b>
DGFDP4830V	1 x 48 x 30	100	48	5	N/A	<b>\$1037</b>

Raised decorative front panel for a reception desk. Size should be 12" less than desk dimensions. **Factory installed.** Hardware included.

**Required Specifications**

Veneer finish

# foundations





Contemporary. Minimal. Inspirational. **Foundations** desking draws upon a contemporary minimal aesthetic, paring down furniture structure and surface to its essence to reveal an architecture of simple horizontal and vertical planar elements.

Each piece is designed to serve the needs of a changing office landscape, elevating the look and function of the private office and taking into account the diverse uses of meeting rooms in the modern work environment. Designed by Christopher Wright.

Foundations components for the private office include modular desks, credenzas and wall storage units punctuated by niches set into the vertical plane of the unit. Personal items or work tools can be stored in niches, desks and storage components that combine to suit individual work styles.

#### Features and Benefits

- Workwalls support configurations or function as display backdrops
- Niches are designed to accept tackboards, remote-controlled LED lighting and flat screen monitors
- Wall units can be specified with LED lighting.
- Power, data and cable management accessories are available on any Foundations unit, including boardroom tables to meet exact requirements.
- A full array of complementary conference room furnishings are available to coordinate the entire office.



Open frame leg



Workwall niche offers a surface, storage or display.



Workwall with integrated storage credenza.

**GENERAL INFORMATION**

- Foundations includes workwalls, single- and double-pedestal desks and executive desk extensions, bridges and transaction counters
- Storage components include credenzas, bench storage, wall-mounted and freestanding storage
- Two- or three-tone finish options allow for a distinctive aesthetic
- Executive desk extensions are supported by an open frame leg or elevated pedestals
- Modular wall units, pedestals and credenzas allow for scalable storage solutions; components accommodate L- and U-shaped configurations, as well as desk and workwall/credenza combinations.
- For environmental certification, please visit [globalfurnituregroup.com](http://globalfurnituregroup.com)

**CONSTRUCTION**

- Engineered veneer is real wood that through a manufacturing process of slicing, dyeing, gluing and re-slicing achieves consistent wood grain and color structure.
- Veneer is purchased by the block and sliced into a rift cut slip matched pattern to a thickness of 0.6mm (1/42"). Global lays up rift cut veneers in a slip match method.

**FINISHES**

- Conversion varnish (similar to catalyzed lacquer, but tougher), 25 degree sheen. Finishes are not buffed or rubbed.
- All Global wood casegood products are veneered and finished on the back sides (360° finishing), except modular under-surface storage - tops and backs are unfinished.
- Touch up kits available, includes a touch up marker and fill crayon. Order **VTOUCHUPKIT, \$164** list. Specify finish when ordering.
- Global standard finish, on oak and walnut, is open pore and on cherry and maple is semi-closed pore. If a full finish is required for walnut, cherry, anigre and maple tops, Add the suffix "2" to the finish code and Add 5% to the base pricing for each product.

**CUSTOM FINISH IS AVAILABLE.****PEDESTALS AND CRENZAS**

- Suspended 7.5" off the floor by an open framed aluminum leg
- Locks are always located on the side panel.
- Handle placement is offset from the center, towards the lock
- Overall height is 26.5"
- Pedestal drawer suspensions are metal ball bearing type. Both box and file drawers are full extension.
- Hanging file rails are pre-installed on file drawer perimeters. The back rail in a lateral file drawer is designed for both letter and legal size filing.
- Drawer sides and bottoms are wrapped black vinyl.
- Drawer front is an applied element to a four sided drawer. Drawer fronts are veneered on all surfaces. Drawer fronts can be removed or replaced in the field.
- Leveling glides have 1" range of adjustment.

**HARDWARE**

- All necessary hardware to assemble the furniture is included in the shipment. Actual wall-attachment fasteners for wall cabinets and tackboards are not included due to variable site conditions.
- Hanging file rails are pre-installed on file drawer perimeters and accommodate both legal and letter size filing. Legal filing can be achieved either as side-to-side or front-to-back. Letter filing can be achieved as front-to-back filing only.
- Connecting brackets are used to attached bridges and returns to desk, and are shipped pre-attached to the bottom of the bridge or return. Additional screws are shipped in a plastic bag.

**INSTALLATION**

- **Wall-mounted cabinets and tackboards** are shipped with preattached horizontal wall rails at the back of each unit. The wall-side components must be detached from the unit and fastened to the wall accordingly. Wall fasteners are not included due to the variable site conditions. Securing the wall rail to a vertical structural member is the required manner of installation. The cabinet or tackboard is then lowered on to the wall rail. It is important to level the wall rail before installation. Wall cabinets are equipped with levelers at the bottom of the back panels for proper cabinet alignment. Units with doors are equipped with adjustable European door hinges to assist in door alignment. It is required to use a #8 wood screw through the back of the cabinet and the wall-mounted rail, to further secure the wall attachment. Tackboards have vertical grooves in the back for tasklight wiring.
- **Transaction counter and decorative panels** are shipped knock down. To assemble it follow the assembly instruction sheet included. To secure the transaction counter to the desk, double sided tape is applied to the bottom of the end panels. Included screws must be used to attach the decorative panel to the desk.
- **Modular storage units:** Have pre-drilled holes through the tops for securing to the bottom of the work surfaces. Screws and lock keys are included in a plastic bag fastened inside the pedestal. Pedestals may be installed flush or offset. Disassemble the modular unit first before relocating the entire unit to avoid damage or bodily injuries.
- **Work Walls:** Incorporate storage units, credenzas and niches of different sizes, attached to the base with connecting bolts. Upper units are installed with plastic dowels. Small connectors are supplied to secure the units thru the side panels. Complete assembly instruction is included with the wall unit. All necessary connectors and dowels are shipped in a plastic bag.
- **Credenza backpanels and display walls:** Optional credenza backpanels and display walls are attached to the units with supplied quick connectors. To assemble the display wall follow the assembly instructions included. All connectors and screws are shipped in a plastic bag.
- **Tables:** All table components are shipped in multiple boxes. Screws and table connectors are packed in a separate box identified with the label "Hardware Enclosed". Assembly instructions for specific tables are included.

# F FOUNDATIONS - HOW TO SPECIFY

## 1. SPECIFY MODEL NUMBER

## 2. SPECIFY FINISH

### WORKSURFACE TOP & DRAWER/DOOR FRONTS, BODY FINISHES (INCLUDING PEDESTALS) - VENEER

#### Foundations Engineered Veneer Finishes (Horizontal Grain Standard):

Code	Finish	Veneer Type	Cut
NTF	Natural	Maple Reconstituted	Rift
TLF	Twilight	Maple Reconstituted	Rift
CIF	Chai	White Oak Reconstituted	Rift
FGF	Fig	White Oak Reconstituted	Rift
STF	Sumatra	White Oak Reconstituted	Rift
MTF	Metro	White Oak Reconstituted	Rift
MSF	Mesa	White Oak Reconstituted	Rift
CHF	Cashmere	White Oak Reconstituted	Rift
SNF	Sienna	White Oak Reconstituted	Rift
WIF	Winter	White Oak Reconstituted	Rift

#### METAL LEG FINISH (Casegoods):

SGR Silver Glimmer

#### METAL LEG FINISHES (Conference Tables):

BLKT Black Textured  
TUNT Tungsten Textured  
DWTT Designer White Textured

## 3. SPECIFY OPTIONS

### Handle

- Handles are standard on most drawers/storage modules.

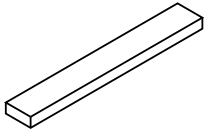

PL83 Anodized Aluminum, 7.2"

### Edges

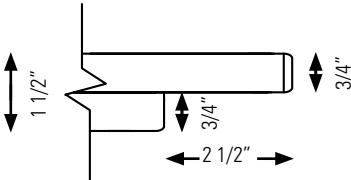

Edge Detail - Casegoods

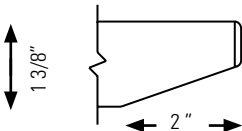

Edge Detail - Conference Tables

### Grommets

- Standard grommet on all components is **GM5K**. Grommet is included with products where shown in line drawings in price book.
- Optional grommets may be ordered in standard worksurface locations (left, center or right). Order as **GM5KL, GM5KC or GM5KR**. **Add \$96**.
- Grommet hole dimensions are 2 3/4" in diameter. Specify **GM1E** for **Black** or **GM1K** for **Tungsten**.
- Color of grommet will be automatically coordinated with handle color where applicable



- Components that come standard with grommet may be ordered without a grommet. Order as RSG - **Add \$53**.
- View diagrams on the following pages for additional details.

For tops up to 24"D

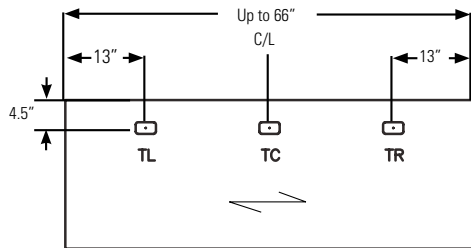
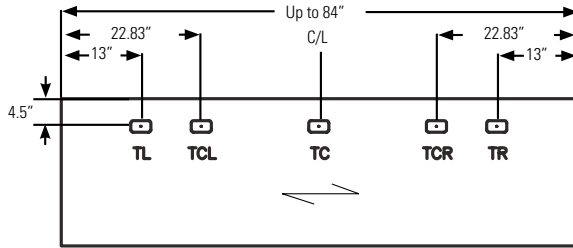

For tops 30" to 36"D

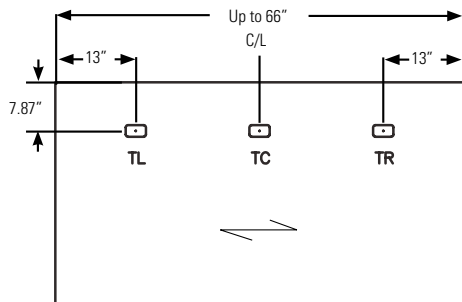
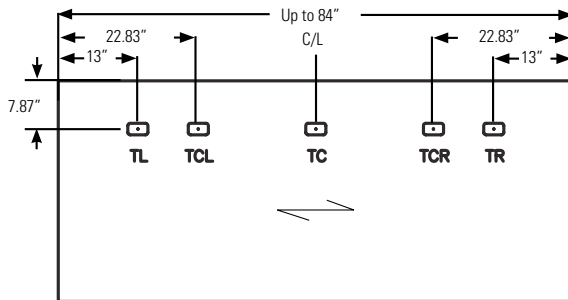

# F FOUNDATIONS - NOTES

## Optional Grommet Locations on Work Walls

Grommets and Grommet Locations must be specified.

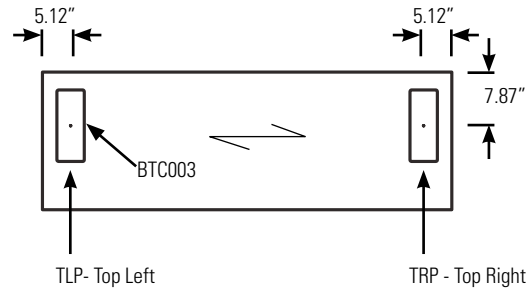
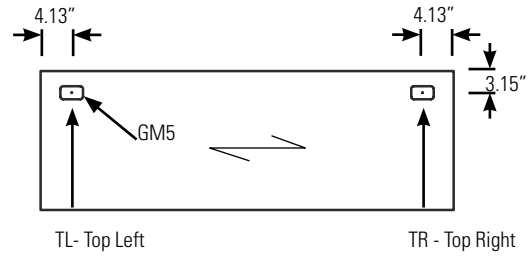
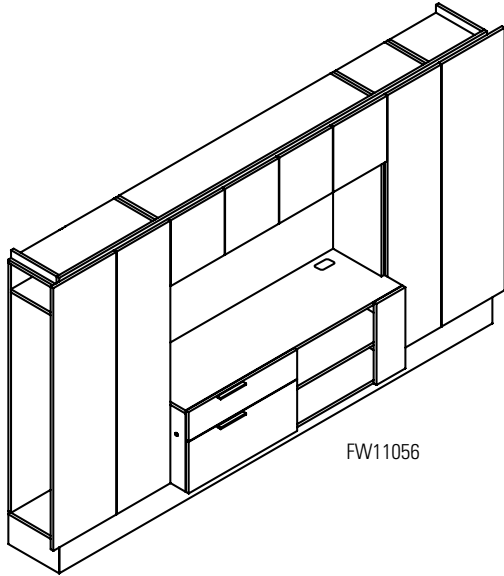

## Standard Grommet Locations on Work Walls

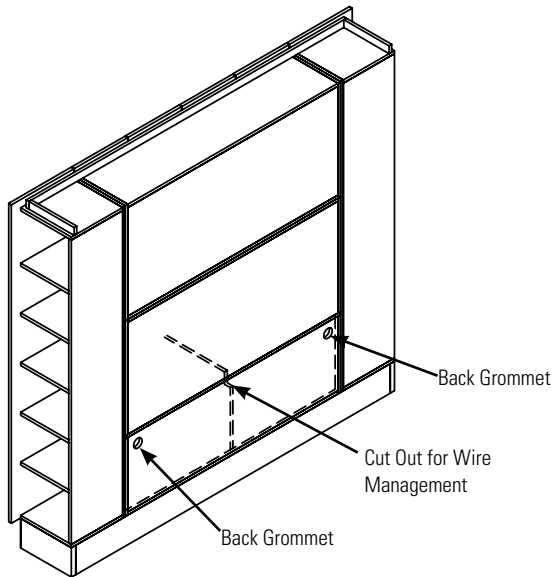

FW9570-IR Back View

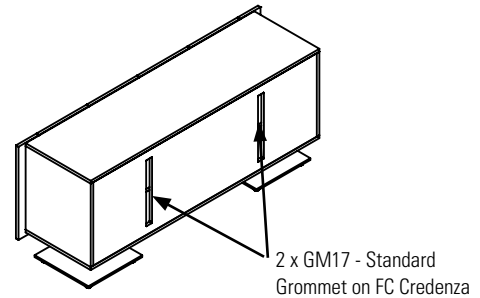
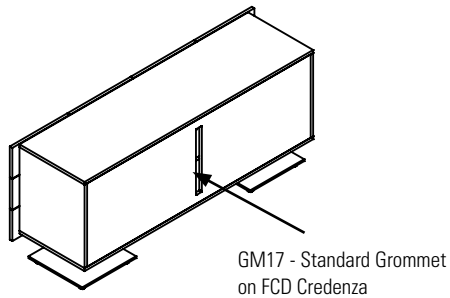
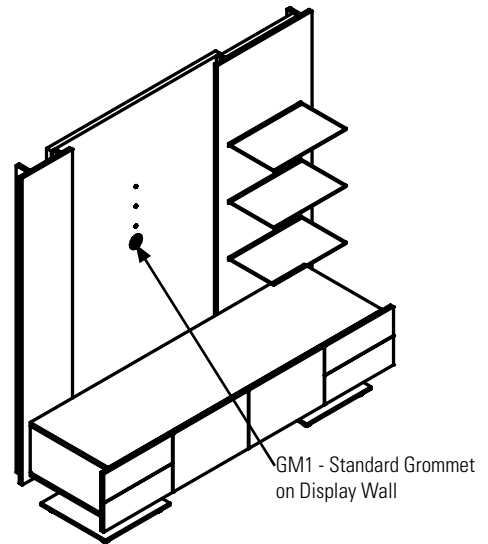

**Work Wall Display Niches**

- Available widths 15", 30", 45", 60" wide.
- Available heights 14", 28", 42" high.
- Maximum niche dimension 60" wide is 42" high.
- Maximum niche dimension 75" wide is 28" high.

When a niche is placed on 20" cantilevered storage there is no bottom. When a niche is placed between storage components it always has a bottom.

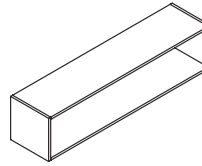
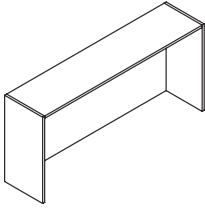

**Work Wall Lighting**

- LED lights for niches must be specified at time of manufacture. When more than one LED light is required in a work wall configuration, a single remote switch is included. Up to four LED lights can work off a single transformer.

Four sided niche with routed upper panel for LED light.

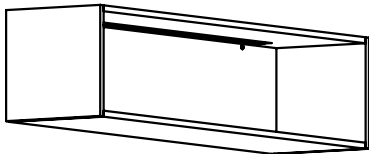

Niche is routed on inside top panel & back is drilled for wire pass through.

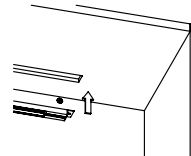

Open bottom niche with routed upper panel for LED light.

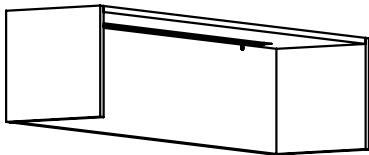

LED lights available in 12", 24", 36" and 48" widths.

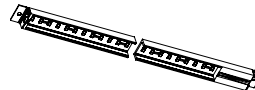



# F FOUNDATIONS - NOTES

## CONFERENCE TABLES DETAILS

### Optional Grommet Locations for Conference Table Tops

Grommets and Grommet Locations must be specified.

For tables that are 48" wide and 96", 120", 144" or 168" long:

**TCL** - Top Center Left

**TCR** - Top Left

**TC** - Top Center

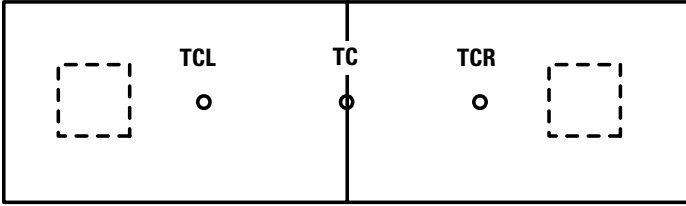

For tables that are 48" wide and 192" or 216" long and tables that are 60" wide and 168", 192", 216" or 240" long:

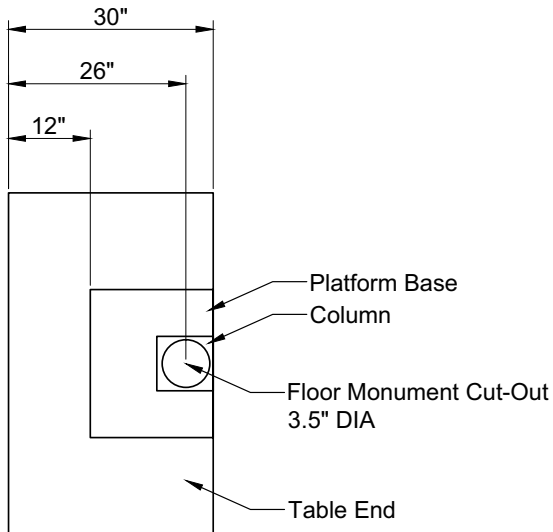
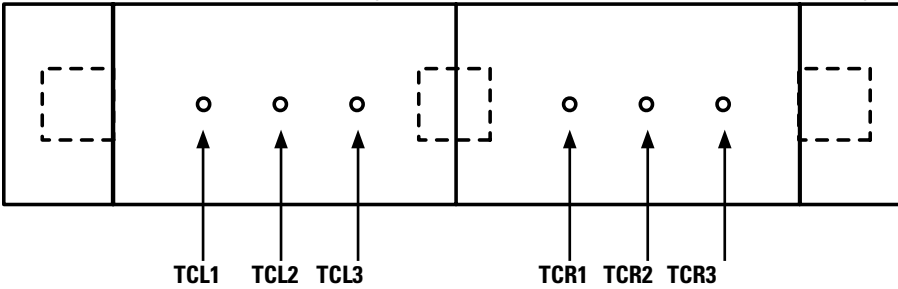

**Conference Table Top and Base Guide**

**Conference Table, two piece Top with 3 Bases**

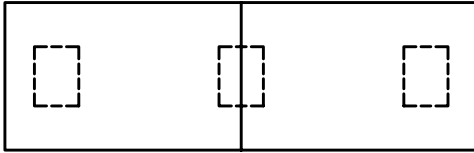

**Sectional Conference Table with 3 Bases**

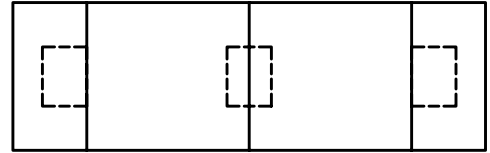

**Conference Table, two piece Top with 2 Bases**

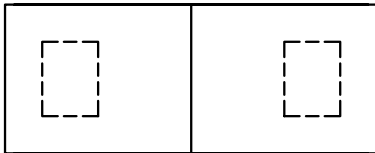

**Sectional Conference Table with 2 Bases**



**Conference Table, one piece Top with 2 Bases**

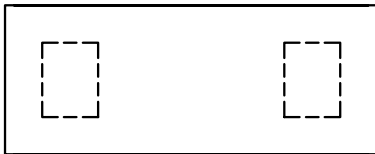

**Square Table Top with Mono Base**

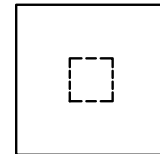

**Sectional Conference Table with Technology Trough and 3 Bases**

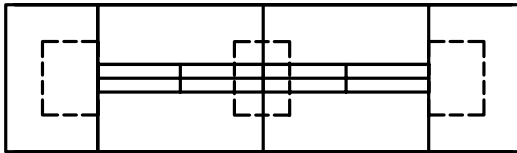

**Round Table Top with Mono Base**

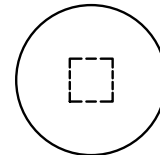

**Sectional Conference Table with Technology Trough and 2 Bases**

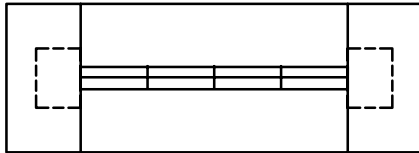

**Sectional Conference Table with Technology Trough and 2 Bases**



**Note:** Different Table Shapes are available.

## Technology Trough Details

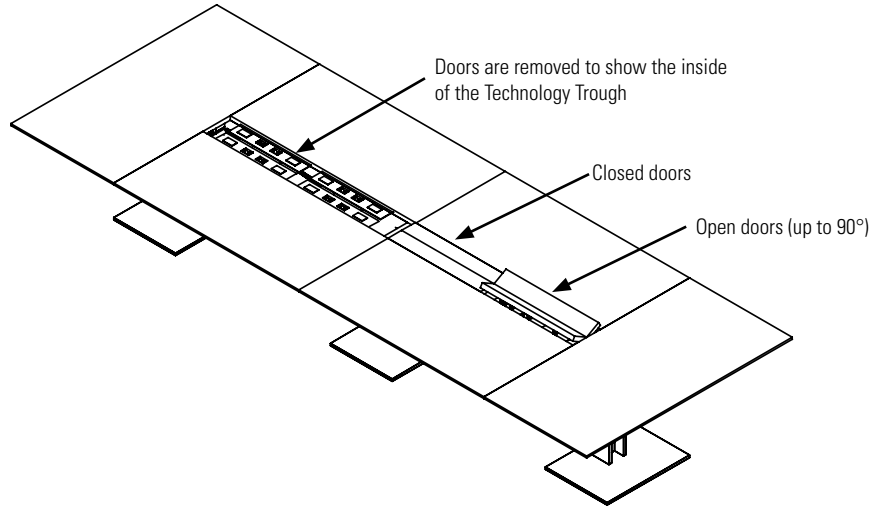

Side View

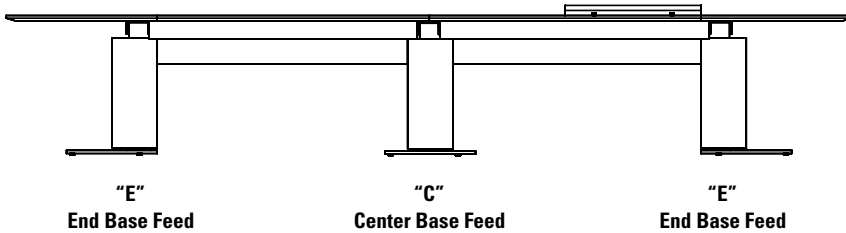

End View

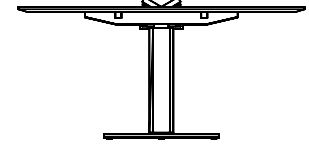

Power kits are included.

Two power receptacles and two telecom knockouts per door are standard.

Telecom plates will be shipped separately. If no telecom plate is specified, blank coverplate will be included.

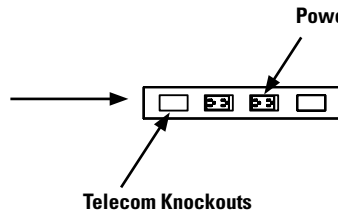

Doors are opened with touch latch to access the the Power/Data plates

opens up to 90°

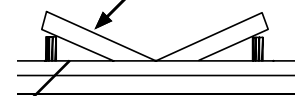

End View Detail

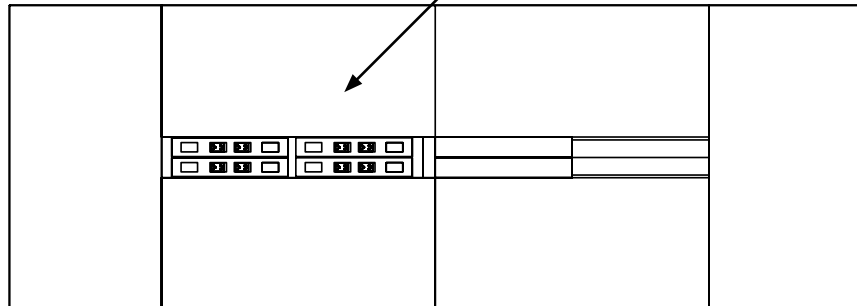

**FINISH SPECIFICATIONS**

**Double and Single Pedestal Desks**

- For desks two finishes can be specified.
- The first finish in the product string, indicated as #1.
- The second finish in the product string indicated as #2.
- If only one finish is indicated, the entire unit will be monotone.
- **Note:** Horizontal grain direction is standard on all engineered finishes. If natural veneer is required, the grain direction will be vertical. Arrow indicates direction of grain.

**User Side**

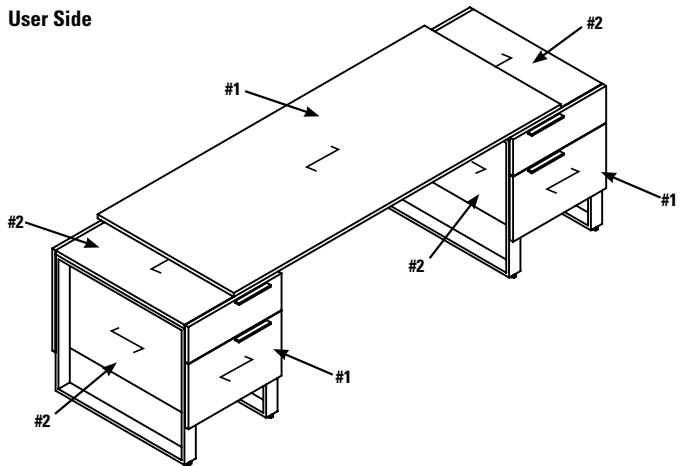

**Back View**

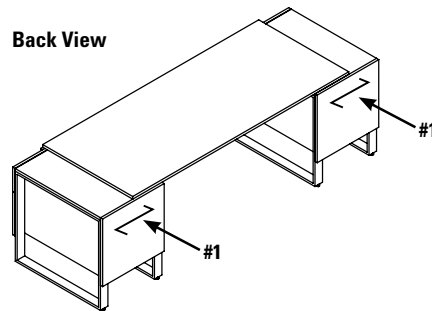

**Transaction Counter and Decorative Panel**

- For Transaction Counter and Decorative Panel, only one finish can be specified.
- Arrow indicates direction of grain

**User Side**

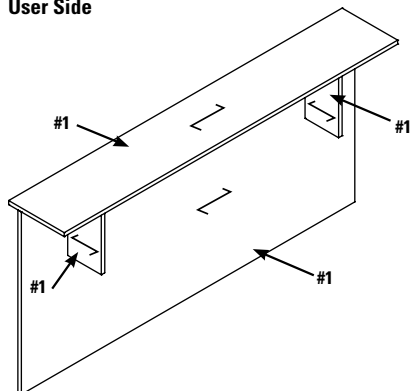

**Back View**

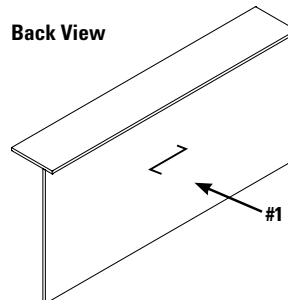

**Pedestals**

- For Pedestals, two finishes can be specified.
- The first finish in the product string, indicated as #1.
- The second finish in the product string indicated as #2.
- If only one finish is indicated, the entire unit will be monotone.

**User Side**

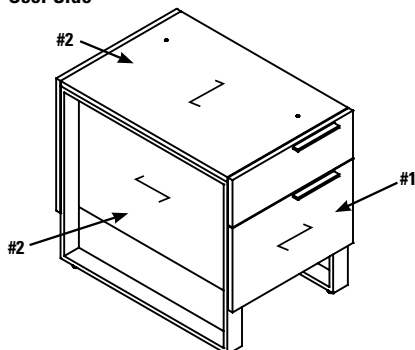

**Back View**

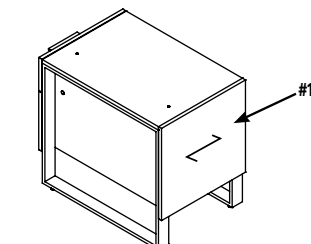

# F FOUNDATIONS - NOTES

## Lateral Files

- For Lateral Files two finishes can be specified.
- The first finish in the product string, indicated as **#1**.
- The second finish in the product string indicated as **#2**.
- If only one finish is indicated, the entire unit will be monotone.
- Arrow indicates direction of grain

### User Side

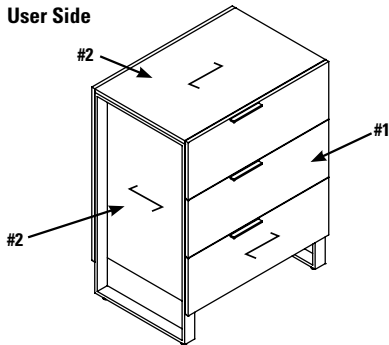

### Back View

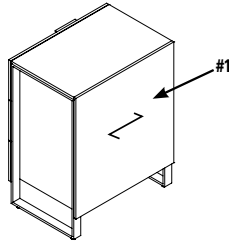

## Mobile Pedestals

- For Mobile Pedestals, two finishes can be specified.
- The first finish in the product string, indicated as **#1**.
- The second finish in the product string indicated as **#2**.
- If only one finish is indicated, the entire unit will be monotone.
- Arrow indicates direction of grain

### User Side

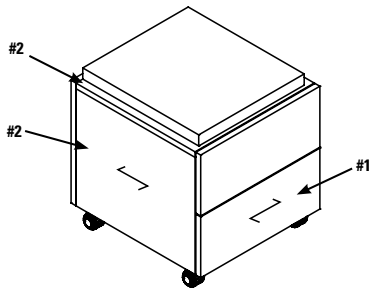

### Back View

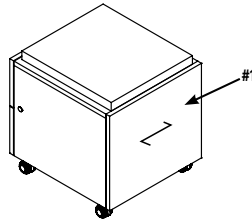

## Benches

- For Benches, two finishes can be specified.
- The first finish in the product string, indicated as **#1**.
- The second finish in the product string indicated as **#2**.
- If only one finish is indicated, the entire unit will be monotone.
- Arrow indicates direction of grain

### User Side

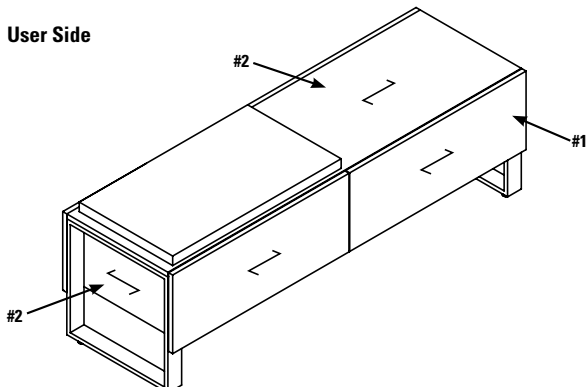

### Back View

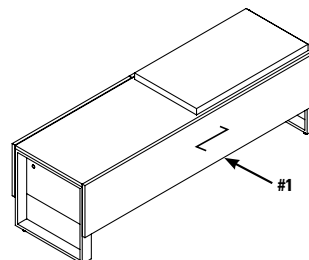

**Credenzas**

- For Credenzas, two finishes can be specified.
- The first finish in the product string, indicated as **#1**.
- The second finish in the product string indicated as **#2**.
- If only one finish is indicated, the entire unit will be monotone.
- Arrow indicates direction of grain

**User Side**

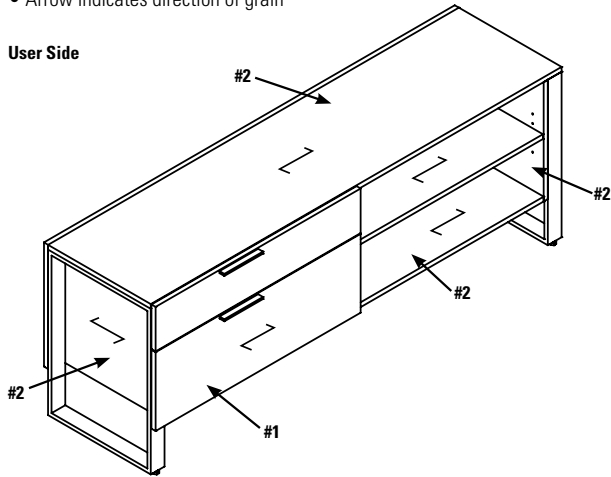

**Back View**

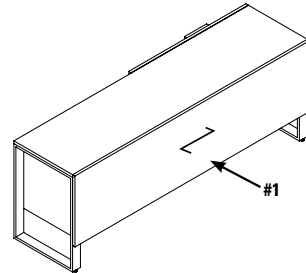

**Modular Tops**

- For Modular Tops, only one finish can be specified.
- Arrow indicates direction of grain

**Isometric View**

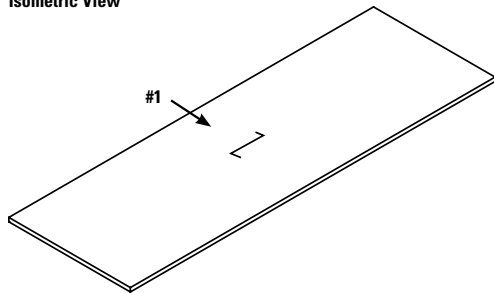

**End View**

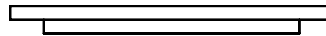

**Wall Mounted Overheads**

- For wall mounted overheads, two finishes can be specified.
- The first finish in the product string, indicated as **#1**.
- The second finish in the product string indicated as **#2**.
- If only one finish is indicated, the entire unit will be monotone.
- Arrow indicates direction of grain

**User Side**

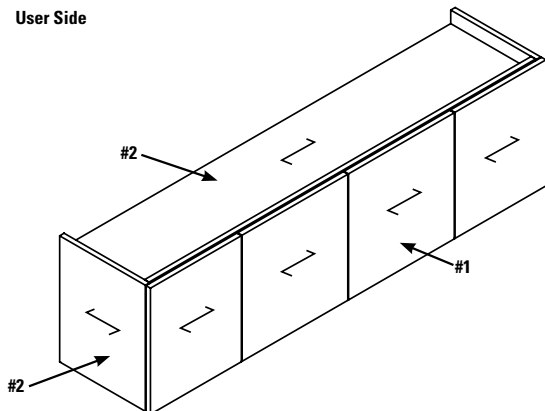

**Back View**

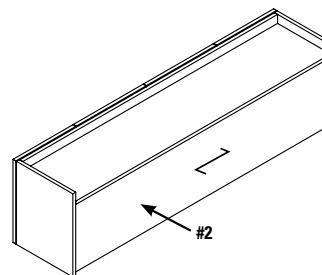

# F FOUNDATIONS - NOTES

## Work Wall Credenzas

- Two finishes can be specified.
- The first finish in the product string, indicated as **#1**.
- The second finish in the product string indicated as **#2**.
- If only one finish is indicated, the entire unit will be monotone.
- Arrow indicates direction of grain

User Side

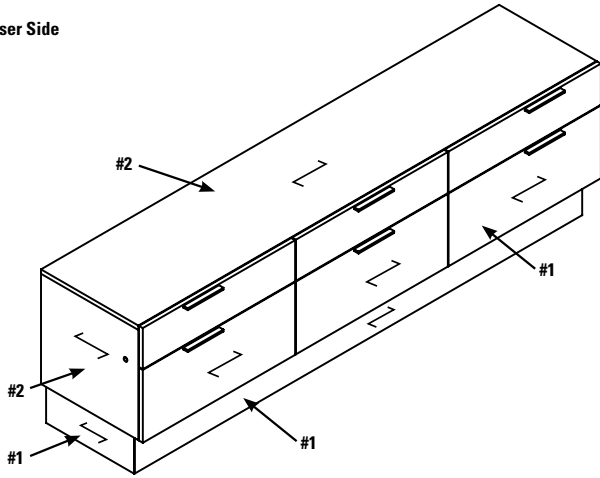

Back View

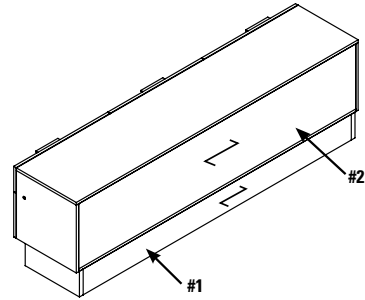

**Work Wall Credenzas**

- Three finishes can be specified.
- The first finish in the product string, indicated as **#1**.
- The second finish in the product string indicated as **#2**.
- The third finish in the product string indicated as **#3**.
- If only one finish is indicated, the entire unit will be monotone.
- Horizontal grain direction is standard on all engineered finishes. If natural veneer is required, the grain direction will be vertical. Arrow indicates direction of grain

**Front View**

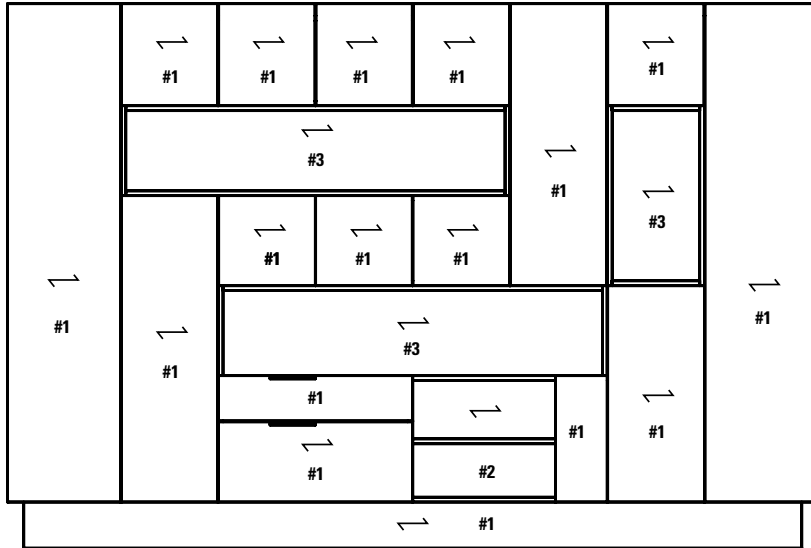

**Side View**

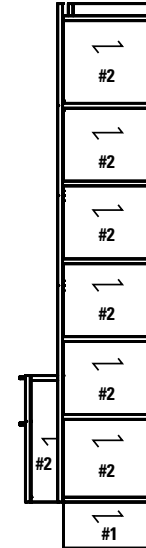

**Isometric View**

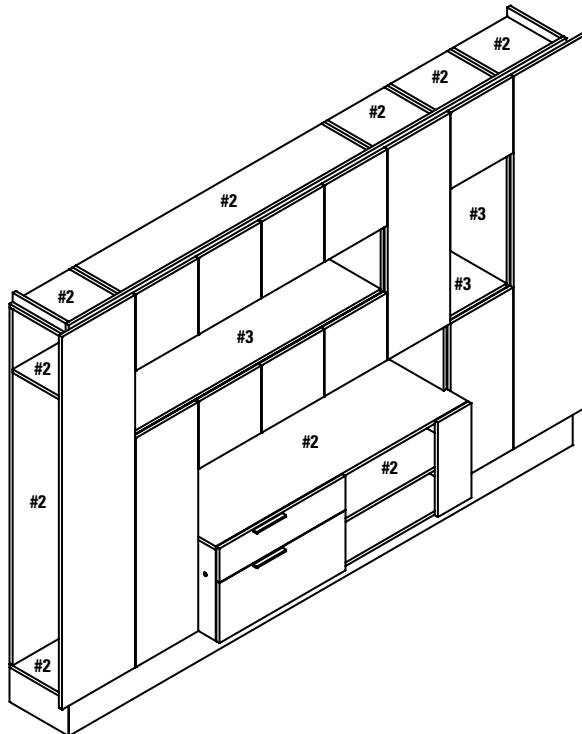



# F FOUNDATIONS - NOTES

## Sectional Top with two bases

- Two finishes can be specified.
- The first finish in the product string, indicated as #1.
- The second finish in the product string indicated as #2.
- If only one finish is indicated, the entire unit will be monotone.
- Arrow indicates direction of grain

Top View

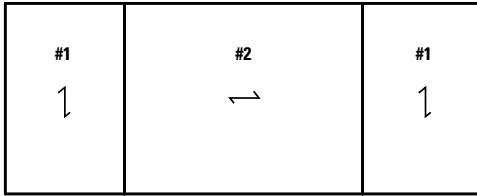

Side View

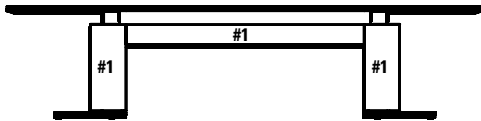

End View

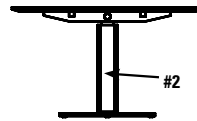

## Sectional Top with Technology Trough and bases

- Three finishes can be specified.
- The first finish in the product string, indicated as #1.
- The second finish in the product string indicated as #2.
- The third finish in the product string indicated as #3.
- If only one finish is indicated, the entire unit will be monotone.
- Arrow indicates direction of grain

Top View

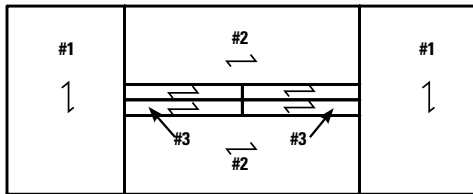

Side View

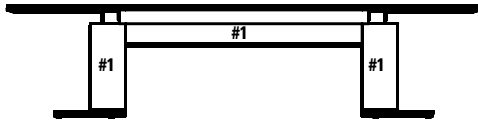

End View

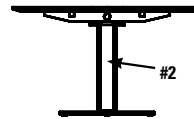

**Full Storage Credenza with two sets of Storage Cabinets and Display Wall**

- Two finishes can be specified.
- The first finish in the product string, indicated as #1.
- The second finish in the product string indicated as #2.
- If only one finish is indicated, the entire unit will be monotone.
- Arrow indicates direction of grain

Front View

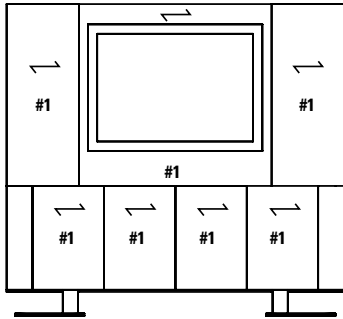

Side View

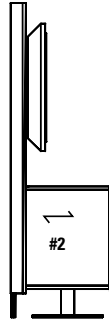

Top View

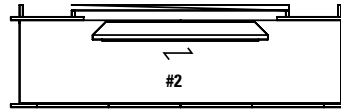

**Full Storage Credenza with BBB, Storage Cabinet, BBB and Display Wall**

- Two finishes can be specified.
- The first finish in the product string, indicated as #1.
- The second finish in the product string indicated as #2.
- If only one finish is indicated, the entire unit will be monotone.
- Arrow indicates direction of grain

Front View

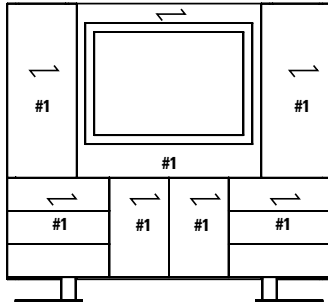

Side View

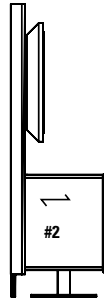

Top View

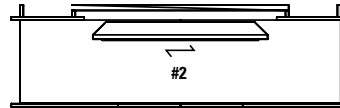

**Full Storage Credenza with BB, Storage Cabinet, BB and Display Wall**

- Two finishes can be specified.
- The first finish in the product string, indicated as #1.
- The second finish in the product string indicated as #2.
- If only one finish is indicated, the entire unit will be monotone.
- Arrow indicates direction of grain

Front View

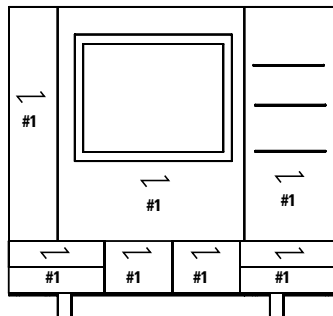

Side View

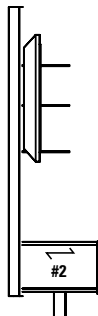

Top View

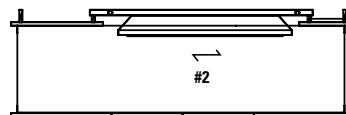

# F FOUNDATIONS - NOTES

## Lectern

- Two finishes can be specified.
- The first finish in the product string, indicated as **#1**.
- The second finish in the product string indicated as **#2**.
- If only one finish is indicated, the entire unit will be monotone.
- Arrow indicates direction of grain

### FLEC-36 Lectern

Front View

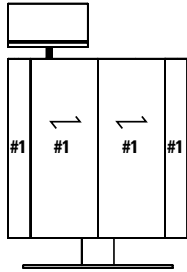

Side View

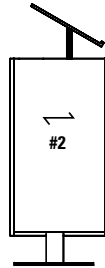

Top View

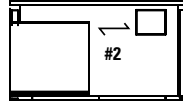

### FLEC-24 Lectern

Front View

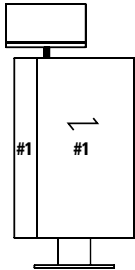

Side View

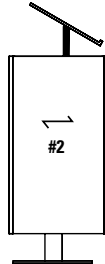

Top View

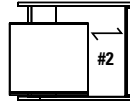

**Mobile Units**

- Two finishes can be specified.
- The first finish in the product string, indicated as **#1**.
- The second finish in the product string indicated as **#2**.
- If only one finish is indicated, the entire unit will be monotone.
- Arrow indicates direction of grain

**Mobile Lectern**

**Front View**

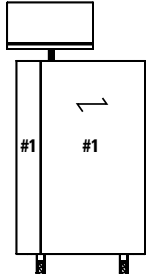

**Side View**

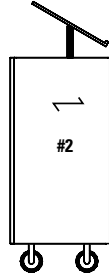

**Top View**

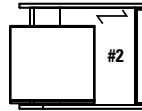

**Mobile Tech Cart**

**Front View**

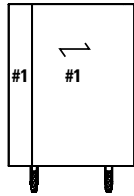

**Side View**

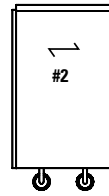

**Top View**

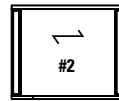

**Mobile Server**

**Front View**

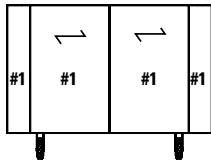

**Side View**

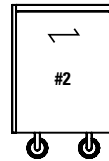

**Top View**

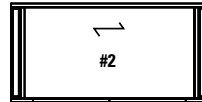

## DESKS - NOTES

- Horizontal grain direction is standard on all engineered finishes.
- Tops are constructed with two 3/4" thick panels, laminated together to create a total thickness of 1.5".
- All pedestals are suspended 7.5" off the floor by an open framed leg, and can be installed flush or offset
- Pedestals are handed:
  - Left pedestals have the handle offset from the center to the right, and the lock is placed on the right end panel
  - Right pedestals have the handle offset from the center to the left, and the lock is placed on the left end panel
- Modesty panels are available as an optional upgrade in wood or glass on Desks
- Grommets are available as an option on Desks and most Credenzas.
- **NOTE:** Arrow indicates direction of grain

Double Pedestal Desk with Box/File installed flush.

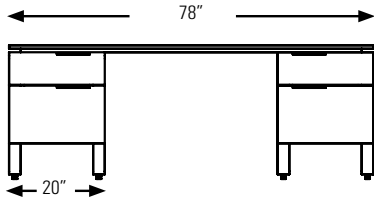

Double Pedestal Desk with Box/File installed offset.  
Add 20" to the overall width of the top.

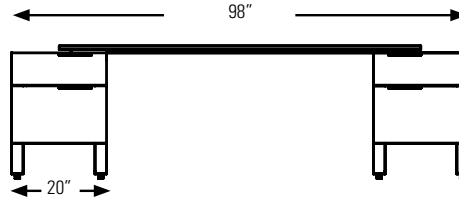

Single Pedestal Desk with Box/File installed flush.

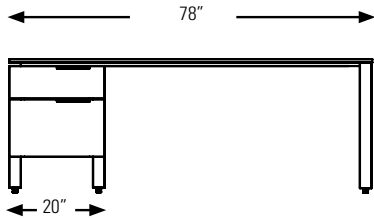

Single Pedestal Desk with Box/File installed offset.  
Add 10" to the overall width of the top.

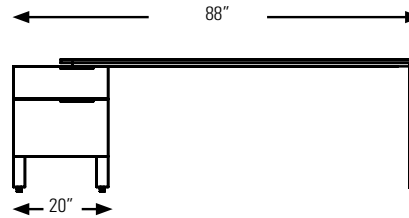

By adding a Transaction Counter Top with Decorative Front Panel (**FGTT**) to a Desk, the Desk can be used as a Reception Desk:

**User View**

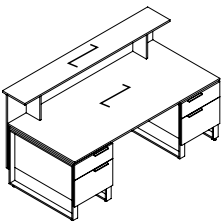

**Guest View**

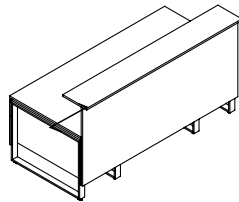

### Required Specifications

Veneer Finish  
Edge

### Optional Specifications

Grommet

## DOUBLE PEDESTAL DESKS

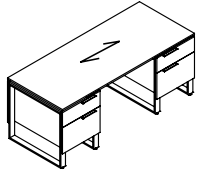

Double Pedestal Desk

MODEL#	DIMENSIONS	FREIGHT CLASS	WT/LBS.	CUBIC FT.	LIST PRICE
--------	------------	---------------	---------	-----------	------------

D x W x H

FD8436BB	36 x 84 x 28	85	201	15	\$11450
FD7836BB	36 x 78 x 28	85	192	15	\$11227
FD7236BB	36 x 72 x 28	92.5	177	15	\$10948
FD8430BB	30 x 84 x 28	85	184	15	\$10879
FD7830BB	30 x 78 x 28	92.5	176	15	\$10701
FD7230BB	30 x 72 x 28	92.5	163	14	\$10446

Standard with **flush box/file** pedestals on **left and right**.

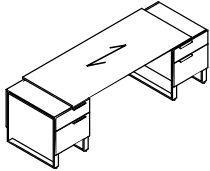

Double Pedestal Desk

FD8436BBOS	36 x 84 x 28	85	201	15	\$11810
FD7836BBOS	36 x 78 x 28	85	192	15	\$11590
FD7236BBOS	36 x 72 x 28	92.5	177	15	\$11307
FD8430BBOS	30 x 84 x 28	85	184	15	\$11244
FD7830BBOS	30 x 78 x 28	92.5	176	15	\$11063
FD7230BBOS	30 x 72 x 28	92.5	163	14	\$10808

Standard with **offset box/file** pedestals on **left and right**.

## SINGLE PEDESTAL DESKS

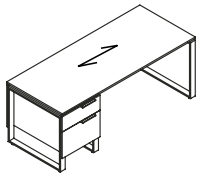

Single Pedestal Desk - LEFT

MODEL#	DIMENSIONS	FREIGHT CLASS	WT/LBS.	CUBIC FT.	LIST PRICE
--------	------------	---------------	---------	-----------	------------

FSL8436B	36 x 84 x 28	85	201	15	\$8330
FSL7836B	36 x 78 x 28	85	192	15	\$8107
FSL7236B	36 x 72 x 28	92.5	177	15	\$7802
FSL8430B	30 x 84 x 28	85	184	15	\$7760
FSL7830B	30 x 78 x 28	92.5	176	15	\$7578
FSL7230B	30 x 78 x 28	92.5	163	14	\$7326

Standard with **flush box/file** pedestal on **left**.

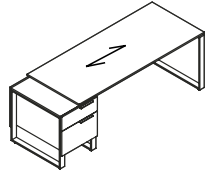

Single Pedestal Desk - LEFT

FSL8436BOS	36 x 84 x 28	85	201	15	\$8693
FSL7836BOS	36 x 78 x 28	85	192	15	\$8469
FSL7236BOS	36 x 72 x 28	92.5	177	15	\$8162
FSL8430BOS	30 x 84 x 28	85	184	15	\$8122
FSL7830BOS	30 x 78 x 28	92.5	176	15	\$7944
FSL7230BOS	30 x 78 x 28	92.5	163	14	\$7688

Standard with **offset box/file** pedestal on **left**.

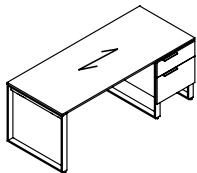

Single Pedestal Desk - RIGHT

FSR8436B	36 x 84 x 28	85	201	15	\$8330
FSR7836B	36 x 78 x 28	85	192	15	\$8107
FSR7236B	36 x 72 x 28	92.5	177	15	\$7802
FSR8430B	30 x 84 x 28	85	184	15	\$7760
FSR7830B	30 x 78 x 28	92.5	176	15	\$7578
FSR7230B	30 x 78 x 28	92.5	163	14	\$7326

Standard with **flush box/file** pedestal on **right**.

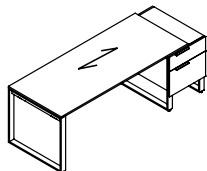

Single Pedestal Desk - RIGHT

FSR8436BOS	36 x 84 x 28	85	201	15	\$8693
FSR7836BOS	36 x 78 x 28	85	192	15	\$8469
FSR7236BOS	36 x 72 x 28	92.5	177	15	\$8162
FSR8430BOS	30 x 84 x 28	85	184	15	\$8122
FSR7830BOS	30 x 78 x 28	92.5	176	15	\$7944
FSR7230BOS	30 x 78 x 28	92.5	163	14	\$7688

Standard with **offset box/file** pedestal on **right**.

### Required Specifications

Top finish  
Body finish

### Optional Specifications

Grommet  
Modesty Panel

# F FOUNDATIONS

## DESK SHELL

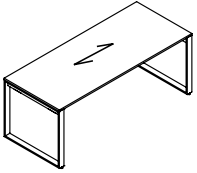

Desk Shell\*

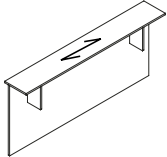

Transaction Counter

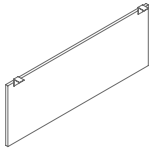

Hanging Wood Modesty Panel

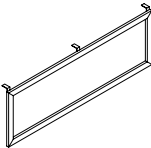

Hanging Glass Modesty Panel

MODEL#	DIMENSIONS	FREIGHT CLASS	WT/LBS.	CUBIC FT.	LIST PRICE
--------	------------	---------------	---------	-----------	------------

D x W x H

FT7236	36 x 72 x 28	85	201	15	\$5493
FT6636	36 x 66 x 28	85	192	15	\$5244
FT6036	36 x 60 x 28	92.5	177	15	\$5011
FT7230	30 x 72 x 28	85	184	15	\$4828
FT6630	30 x 66 x 28	92.5	176	15	\$4636
FT6030	30 x 60 x 28	92.5	163	14	\$4448

FGTT8412	12 x 84 x 42	250	73	21	\$3666
FGTT7812	12 x 78 x 42	250	68	19	\$3514
FGTT7212	12 x 72 x 42	250	63	18	\$3281

Rectangular transaction counter with decorative panel.

FCMP70W	0.75 x 70 x 18	--	25	1	\$1639
FCMP66W	0.75 x 66 x 18	--	24	1	\$1602
FCMP64W	0.75 x 64 x 18	--	23	1	\$1589
FCMP62W	0.75 x 62 x 18	--	22	1	\$1571
FCMP60W	0.75 x 60 x 18	--	22	1	\$1562
FCMP58W	0.75 x 58 x 18	--	21	1	\$1551
FCMP56W	0.75 x 56 x 18	--	20	1	\$1545
FCMP54W	0.75 x 54 x 18	--	20	1	\$1537
FCMP50W	0.75 x 50 x 18	--	18	1	\$1522
FCMP48W	0.75 x 48 x 18	--	18	1	\$1514
FCMP42W	0.75 x 42 x 18	--	16	1	\$1412
FCMP36W	0.75 x 36 x 18	--	14	1	\$1213
FCMP30W	0.75 x 30 x 18	--	12	1	\$1014

Hanging wood modesty panel. Attaches to underside of worksurface. **Cannot be retrofitted in the field.**

**Not sold individually - to be ordered as an upgrade option only.**

FCMP70G	0.75 x 70 x 18	--	25	1	\$2640
FCMP66G	0.75 x 66 x 18	--	24	1	\$1602
FCMP64G	0.75 x 64 x 18	--	23	1	\$2496
FCMP62G	0.75 x 62 x 18	--	22	1	\$2357
FCMP60G	0.75 x 60 x 18	--	22	1	\$2281
FCMP58G	0.75 x 58 x 18	--	21	1	\$2222
FCMP56G	0.75 x 56 x 18	--	20	1	\$2204
FCMP54G	0.75 x 54 x 18	--	20	1	\$2127
FCMP50G	0.75 x 50 x 18	--	18	1	\$2070
FCMP48G	0.75 x 48 x 18	--	18	1	\$2032
FCMP42G	0.75 x 42 x 18	--	16	1	\$2010
FCMP36G	0.75 x 36 x 18	--	14	1	\$1994
FCMP30G	0.75 x 30 x 18	--	12	1	\$1972

Aluminum framed glass modesty panel with frosted glass (standard). Attaches to underside of worksurface. **Cannot be retrofitted in the field. Not sold individually - to be ordered as an upgrade option only.**

- For white back painted glass, please contact Customer Care for pricing.

### Required Specifications

Top finish  
Body finish

### Optional Specifications

Grommet  
Modesty Panel\*

## CRENZAS - NOTES

D x W x H

- Horizontal grain direction is standard on all engineered finishes.
- Tops are constructed with two 3/4" thick panels, laminated together to create a total thickness of 1.5".
- All pedestals are suspended 7.5" off the floor by an open framed leg, and can be installed flush or offset
- Pedestals are handed:
  - Left pedestals have the handle offset from the center to the right, and the lock is placed on the right end panel
  - Right pedestals have the handle offset from the center to the left, and the lock is placed on the left end panel
- Modesty panels are available in wood or glass
- Grommets can be specified on Credenza Tops.
- **NOTE:** Arrow indicates direction of grain

Single Pedestal Credenza with 35" Lat. Box/File installed flush

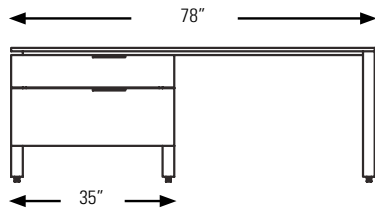

Single Pedestal Credenza with 35" Lat. Box/File installed offset  
Adds 10" to overall width

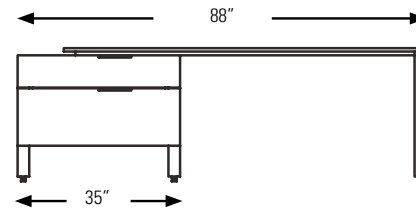

Single Pedestal Credenza with 40" Lat. Box/File installed flush.

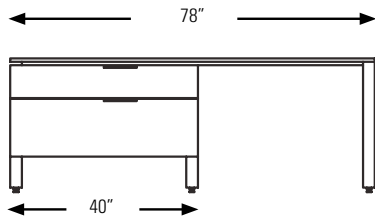

Double Pedestal Credenza with 40" Lat. Box/File installed offset.  
Adds 10" to overall width

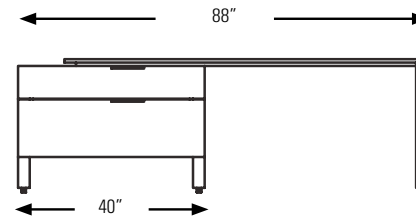

### SINGLE PEDESTAL CRENZAS

MODEL#      DIMENSIONS      FREIGHT CLASS      WT/LBS.      CUBIC FT.      LIST PRICE

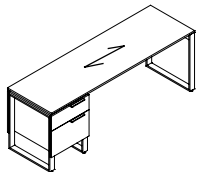

Single Pedestal Credenza - LEFT

FCCL7824B	24 x 78 x 28	85	160	12	<b>\$7520</b>
FCCL7224B	24 x 72 x 28	85	151	12	<b>\$7279</b>
FCCL7820B	20 x 78 x 28	85	153	11	<b>\$7061</b>
FCCL7220B	20 x 72 x 28	85	144	11	<b>\$6839</b>

Standard with **flush box/file** pedestal on **left**.

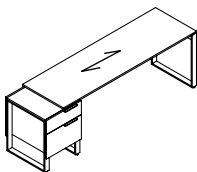

Single Pedestal Credenza - LEFT

FCCL7824BOS	24 x 88 x 28	85	160	12	<b>\$7567</b>
FCCL7224BOS	24 x 82 x 28	85	151	12	<b>\$7279</b>
FCCL7820BOS	20 x 88 x 28	85	153	11	<b>\$7110</b>
FCCL7220BOS	20 x 82 x 28	85	144	11	<b>\$6839</b>

Standard with **offset box/file** pedestal on **left**.

#### Required Specifications

Top finish  
Body finish

#### Optional Specifications

Grommet



## SINGLE PEDESTAL CREDENZAS

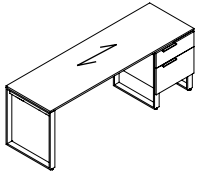

Single Pedestal Credenza - RIGHT

MODEL#	DIMENSIONS D x W x H	FREIGHT CLASS	WT/LBS.	CUBIC FT.	LIST PRICE
FCCR7824B	24 x 78 x 28	85	160	12	<b>\$7520</b>
FCCR7224B	24 x 72 x 28	85	151	12	<b>\$7279</b>
FCCR7820B	20 x 78 x 28	85	153	11	<b>\$7061</b>
FCCR7220B	20 x 72 x 28	85	144	11	<b>\$6839</b>

Standard with **flush box/file** pedestal on **right**.

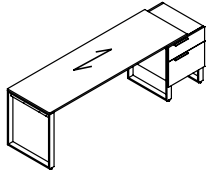

Single Pedestal Credenza - RIGHT

FCCR7824BOS	24 x 88 x 28	85	160	12	<b>\$7567</b>
FCCR7224BOS	24 x 82 x 28	85	151	12	<b>\$7279</b>
FCCR7820BOS	20 x 88 x 28	85	153	11	<b>\$7110</b>
FCCR7220BOS	20 x 82 x 28	85	144	11	<b>\$6839</b>

Standard with **offset box/file** pedestal on **right**.

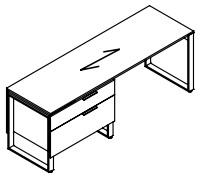

Single Pedestal Credenza - LEFT

FCC35L7824H	24 x 78 x 28	92.5	188	18	<b>\$8111</b>
FCC35L7224H	24 x 72 x 28	100	179	18	<b>\$7869</b>
FCC35L7820H	20 x 78 x 28	92.5	179	15	<b>\$7611</b>
FCC35L7220H	20 x 72 x 28	92.5	170	15	<b>\$7387</b>

Standard with **flush 35" lateral box/file** pedestal on **left**.

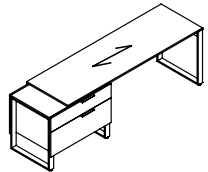

Single Pedestal Credenza - LEFT

FCC35L7824HOS	24 x 88 x 28	92.5	188	18	<b>\$8436</b>
FCC35L7224HOS	24 x 82 x 28	100	179	18	<b>\$8192</b>
FCC35L7820HOS	20 x 88 x 28	92.5	179	15	<b>\$7938</b>
FCC35L7220HOS	20 x 82 x 28	92.5	170	15	<b>\$7713</b>

Standard with **offset 35" lateral box/file** pedestal on **left**.

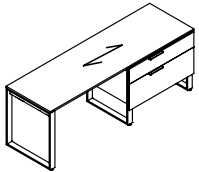

Single Pedestal Credenza - RIGHT

FCC35R7824H	24 x 78 x 28	92.5	188	18	<b>\$8111</b>
FCC35R7224H	24 x 72 x 28	100	179	18	<b>\$7869</b>
FCC35R7820H	20 x 78 x 28	92.5	179	15	<b>\$7611</b>
FCC35R7220H	20 x 72 x 28	92.5	170	15	<b>\$7387</b>

Standard with **flush 35" lateral box/file** pedestal on **right**.

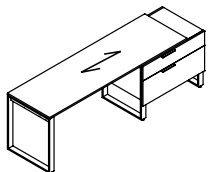

Single Pedestal Credenza - RIGHT

FCC35R7824HOS	24 x 88 x 28	92.5	188	18	<b>\$8436</b>
FCC35R7224HOS	24 x 82 x 28	100	179	18	<b>\$8192</b>
FCC35R7820HOS	20 x 88 x 28	92.5	179	15	<b>\$7938</b>
FCC35R7220HOS	20 x 82 x 28	92.5	170	15	<b>\$7713</b>

Standard with **offset 35" lateral box/file** pedestal on **right**.

### Required Specifications

Top finish  
Body finish

### Optional Specifications

Grommet

**SINGLE PEDESTAL CREDENZAS**

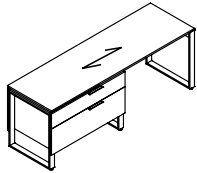

**Single Pedestal Credenza - LEFT**

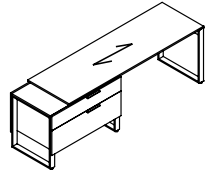

**Single Pedestal Credenza - LEFT**

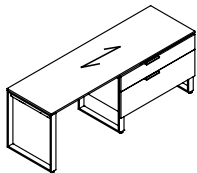

**Single Pedestal Credenza - RIGHT**

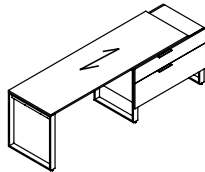

**Single Pedestal Credenza - RIGHT**

**MODEL# DIMENSIONS FREIGHT CLASS WT/LBS. CUBIC FT. LIST PRICE**

**D x W x H**

FCC40L7824H	24 x 78 x 28	100	198	20	<b>\$8393</b>
FCC40L7224H	24 x 72 x 28	100	189	20	<b>\$8477</b>
FCC40L7820H	20 x 78 x 28	92.5	188	17	<b>\$7974</b>
FCC40L7220H	20 x 72 x 28	92.5	179	17	<b>\$7748</b>

Standard with **flush 40" lateral box/file** pedestal on **left**.

FCC40L7824HOS	24 x 88 x 28	100	198	20	<b>\$8717</b>
FCC40L7224HOS	24 x 82 x 28	100	189	20	<b>\$8477</b>
FCC40L7820HOS	20 x 88 x 28	92.5	188	17	<b>\$8297</b>
FCC40L7220HOS	20 x 82 x 28	92.5	179	17	<b>\$8074</b>

Standard with **offset 40" lateral box/file** pedestal on **left**.

FCC40R7824H	24 x 78 x 28	100	198	20	<b>\$8393</b>
FCC40R7224H	24 x 72 x 28	100	189	20	<b>\$8477</b>
FCC40R7820H	20 x 78 x 28	92.5	188	17	<b>\$7974</b>
FCC40R7220H	20 x 72 x 28	92.5	179	17	<b>\$7748</b>

Standard with **flush 40" lateral box/file** pedestal on **right**.

FCC40R7824HOS	24 x 88 x 28	100	198	20	<b>\$8717</b>
FCC40R7224HOS	24 x 82 x 28	100	189	20	<b>\$8477</b>
FCC40R7820HOS	20 x 88 x 28	92.5	188	17	<b>\$8297</b>
FCC40R7220HOS	20 x 82 x 28	92.5	179	17	<b>\$8074</b>

Standard with **offset 40" lateral box/file** pedestal on **right**.

**Required Specifications**

Top finish  
Body finish

**Optional Specifications**

Grommet

## FULL STORAGE CREDENZAS - NOTES

D x W x H

- Horizontal grain direction is standard on all engineered finishes.
- Tops are 3/4" thick with flat edge.
- All pedestals are suspended 7.5" off the floor by an open framed leg, and can be installed flush or offset
- Handles are standard on all drawer fronts
- Doors will open with touch latch.
- Units placed on the Left have the handle offset from the center to the left, and the lock is placed on the left side panel.
- Units placed on the right have the handle offset from the center to the right, and the lock is placed on the right side panel
- Modesty panels are available in wood or glass
- **NOTE:** Arrow indicates direction of grain

### FULL STORAGE CREDENZAS

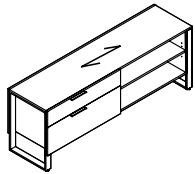

Storage Credenza

MODEL#	DIMENSIONS	FREIGHT CLASS	WT/LBS.	CUBIC FT.	LIST PRICE
FCC7424HO	24 x 74.5 x 26.75	125	203	29	<b>\$7332</b>
FCC6424HO	24 x 64.5 x 26.75	125	186	25	<b>\$6463</b>
FCC7420HO	20 x 74.5 x 26.75	125	187	24	<b>\$6985</b>
FCC6420HO	20 x 64.5 x 26.75	100	171	21	<b>\$6145</b>

Standard with **lateral box/file** on **left** and **open storage** on **right**. Handle and lock on left.

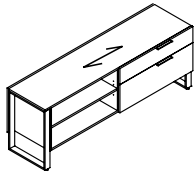

Storage Credenza

FCC7424OH	24 x 74.5 x 26.75	125	203	29	<b>\$7332</b>
FCC6424OH	24 x 64.5 x 26.75	125	186	25	<b>\$6463</b>
FCC7420OH	20 x 74.5 x 26.75	125	187	24	<b>\$6985</b>
FCC6420OH	20 x 64.5 x 26.75	100	171	21	<b>\$6145</b>

Standard with **open storage** on **left** and **lateral box/file** on **right**. Handle and lock on right.

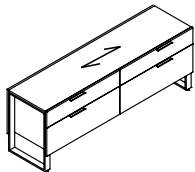

Storage Credenza

FCC7424HH	24 x 74.5 x 26.75	100	265	29	<b>\$8321</b>
FCC6424HH	24 x 64.5 x 26.75	100	238	25	<b>\$7291</b>
FCC7420HH	20 x 74.5 x 26.75	92.5	251	24	<b>\$7924</b>
FCC6420HH	20 x 64.5 x 26.75	92.5	226	21	<b>\$6947</b>

Standard with **lateral box/file** on **left** and **right**. Handles and locks on left and right.

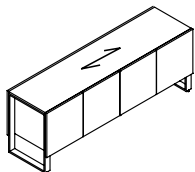

Storage Credenza

FCC7424GG	24 x 74.5 x 26.75	150	171	29	<b>\$7282</b>
FCC6424MM	24 x 64.5 x 26.75	125	152	25	<b>\$6599</b>
FCC7420GG	20 x 74.5 x 26.75	125	153	24	<b>\$6691</b>
FCC6420MM	20 x 64.5 x 26.75	125	136	21	<b>\$6068</b>

Standard with **four doors and adjustable shelves** on **left** and **right**.

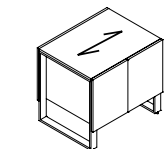

Storage Credenza

FCC3624G	24 x 36 x 26.75	150	171	29	<b>\$4553</b>
FCC3024M	24 x 30 x 26.75	125	152	25	<b>\$3795</b>
FCC3620G	20 x 36 x 26.75	125	153	24	<b>\$4069</b>
FCC3020M	20 x 30 x 26.75	125	136	21	<b>\$3391</b>

Standard with **two doors and adjustable shelves**.

#### Required Specifications

Top finish  
Body finish

#### Optional Specifications

Grommet

## MODULAR STORAGE - NOTES

D x W x H

- Horizontal grain direction is standard on all engineered finishes.
- All pedestals are suspended 7.5" off the floor by an open framed leg, and can be installed flush or offset
- Pedestals are handed:
  - Left pedestals have the handle offset from the center to the right, and the lock is placed on the right gable
  - Right pedestals have the handle offset from the center to the left, and the lock is placed on the left gable
- All modular pedestals have pre-drilled holes on the top for easy connection to worksurface.
- **NOTE:** Arrow indicates direction of grain

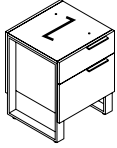
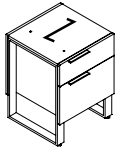
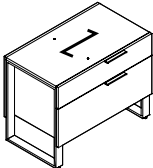
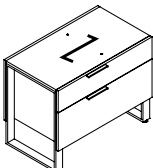
MODULAR STORAGE	MODEL#	DIMENSIONS	FREIGHT CLASS	WT./LBS.	CUBIC FT.	LIST PRICE
 <p><b>Box/File Pedestal - LEFT</b></p>	F2036BL	36 x 20.5 x 26.75	100	99	11	<b>\$4384</b>
	F2030BL	30 x 20.5 x 26.75	100	90	10	<b>\$4177</b>
	F2024BL	24 x 20.5 x 26.75	92.5	83	8	<b>\$3936</b>
	F2020BL	20 x 20.5 x 26.75	92.5	78	7	<b>\$3744</b>
For use under a freestanding desk or credenza. Top pre-drilled to attach to worksurface. One <b>box/file</b> drawer.						
 <p><b>Box/File Pedestal - RIGHT</b></p>	F2036BR	36 x 20.5 x 26.75	100	99	11	<b>\$4384</b>
	F2030BR	30 x 20.5 x 26.75	100	90	10	<b>\$4177</b>
	F2024BR	24 x 20.5 x 26.75	92.5	83	8	<b>\$3936</b>
	F2020BR	20 x 20.5 x 26.75	92.5	78	7	<b>\$3744</b>
For use under a freestanding desk or credenza. Top pre-drilled to attach to worksurface. One <b>box/file</b> drawer.						
 <p><b>Lateral Box/File Pedestal - LEFT</b></p>	F4024HL	24 x 40 x 26.75	125	121	16	<b>\$5154</b>
	F3524HL	24 x 35 x 26.75	125	111	14	<b>\$4869</b>
	F4020HL	20 x 40 x 26.75	100	113	13	<b>\$5000</b>
	F3520HL	20 x 35 x 26.75	100	104	11	<b>\$4636</b>
For use under a freestanding desk or credenza. Top pre-drilled to attach to worksurface. One <b>lateral box/file</b> drawer.						
 <p><b>Lateral Box/File Pedestal - RIGHT</b></p>	F4024HR	24 x 40 x 26.75	125	121	16	<b>\$5154</b>
	F3524HR	24 x 35 x 26.75	125	111	14	<b>\$4869</b>
	F4020HR	20 x 40 x 26.75	100	113	13	<b>\$5000</b>
	F3520HR	20 x 35 x 26.75	100	104	11	<b>\$4636</b>
For use under a freestanding desk or credenza. Top pre-drilled to attach to worksurface. One <b>lateral box/file</b> drawer.						

### Required Specifications

Front finish  
Top/body finish

### Optional Specifications

Grommet

# F FOUNDATIONS

## MODULAR STORAGE

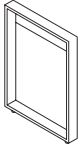

Frame Leg

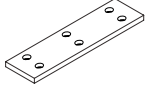

Top Connecting Bracket

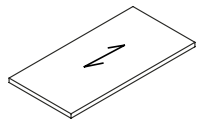

Modular Top\*

MODEL#	DIMENSIONS D x W x H	FREIGHT CLASS	WT/LBS.	CUBIC FT.	LIST PRICE
FLEG36	2.5 x 36 x 27.5	250	6	3	<b>\$1183</b>
FLEG30	2.5 x 30 x 27.5	250	6	3	<b>\$1084</b>
FLEG24	2.5 x 24 x 27.5	250	5	2	<b>\$1004</b>
FLEG20	2.5 x 20 x 27.5	250	5	2	<b>\$919</b>

FCON36	31 x 10 x .75	150	4	1	<b>\$249</b>
FCON30	25 x 10 x .75	150	4	1	<b>\$230</b>
FCON24	19 x 10 x .75	250	3	1	<b>\$225</b>
FCON20	15 x 10 x .75	250	3	1	<b>\$208</b>

F8436T	36 x 84 x 1.5	60	95	3	<b>\$3251</b>
F7836T	36 x 78 x 1.5	65	88	3	<b>\$3025</b>
F7236T	36 x 72 x 1.5	65	82	3	<b>\$2791</b>
F8430T	30 x 84 x 1.5	65	80	3	<b>\$2720</b>
F7830T	30 x 78 x 1.5	65	73	3	<b>\$2536</b>
F7230T	30 x 72 x 1.5	60	67	2	<b>\$2321</b>
F6630T	30 x 66 x 1.5	60	62	2	<b>\$2149</b>
F6030T	30 x 60 x 1.5	65	56	2	<b>\$1960</b>
F5430T	30 x 54 x 1.5	65	51	2	<b>\$1771</b>
F8424T	24 x 84 x 1.5	60	67	2	<b>\$2417</b>
F7824T	24 x 78 x 1.5	60	62	2	<b>\$2244</b>
F7424T	24 x 74 x 1.5	65	58	2	<b>\$2129</b>
F7224T	24 x 72 x 1.5	65	53	2	<b>\$2005</b>
F6624T	24 x 66 x 1.5	65	51	2	<b>\$1929</b>
F6424T	24 x 64 x 1.5	65	49	2	<b>\$1807</b>
F6024T	24 x 60 x 1.5	65	47	2	<b>\$1689</b>
F5424T	24 x 54 x 1.5	70	42	2	<b>\$1566</b>
F4824T	24 x 48 x 1.5	60	38	1	<b>\$1447</b>
F4224T	24 x 42 x 1.5	60	34	1	<b>\$1269</b>
F8420T	20 x 84 x 1.5	60	64	2	<b>\$2226</b>
F7820T	20 x 78 x 1.5	60	60	2	<b>\$2064</b>
F7420T	20 x 74 x 1.5	65	51	2	<b>\$1960</b>
F7220T	20 x 72 x 1.5	65	51	2	<b>\$1841</b>
F6620T	20 x 66 x 1.5	65	49	2	<b>\$1782</b>
F6420T	20 x 64 x 1.5	65	47	2	<b>\$1680</b>
F6020T	20 x 60 x 1.5	65	45	2	<b>\$1561</b>
F5420T	20 x 54 x 1.5	60	40	1	<b>\$1444</b>
F4820T	20 x 48 x 1.5	60	36	1	<b>\$1328</b>
F4220T	20 x 42 x 1.5	60	31	1	<b>\$1163</b>

3/4" top with flat edge. 3/4" subtop inset 2.5" all around. For crossgrain veneer pattern, add **(CG)** to the end of the product code. When connecting two tops together, a connecting bracket must be specified. Use the width of the smallest top to determine the correct bracket size (i.e. for a 20"D top, order FCON20). Optional grommet may be specified.



**Required Specifications**  
Top finish\*

**Optional Specifications**  
Grommet\*

## FREESTANDING STORAGE - NOTES

D x W x H

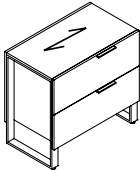
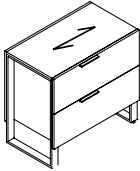
- Horizontal grain direction is standard on all engineered finishes.
- All pedestals are suspended 7.5" off the floor by an open framed leg, and can be installed flush or offset
- Pedestals are handed:
  - Left pedestals have the handle offset from the center to the right, and the lock is placed on the right gable
  - Right pedestals have the handle offset from the center to the left, and the lock is placed on the left gable
- Bench drawers do not come with a handle. They open by pulling the bottom edge of the drawer.
- Cushions will be field installed. On double width benches, the cushion can either be installed left or right.
- On mobile pedestals, the lock will be placed on the right gable.
- **NOTE:** Arrow indicates direction of grain

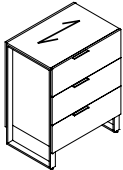
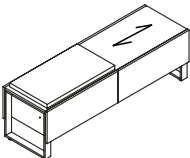
FREESTANDING STORAGE	MODEL#	DIMENSIONS	FREIGHT CLASS	WT./LBS.	CUBIC FT.	LIST PRICE
 <p><b>2H Lateral File Pedestal - LEFT</b></p>	FN3524L	24 x 35 x 32	100	152	17	<b>\$5348</b>
	FN3520L	20 x 35 x 32	100	144	15	<b>\$5089</b>
 <p><b>2H Lateral File Pedestal - RIGHT</b></p>	FN3524R	24 x 35 x 32	100	152	17	<b>\$5348</b>
	FN3520R	20 x 35 x 32	100	144	15	<b>\$5089</b>
 <p><b>3H Lateral File Pedestal - LEFT</b></p>	FN35243L	24 x 35 x 44.5	92.5	220	22	<b>\$6808</b>
	FN35203L	20 x 35 x 44.5	92.5	212	19	<b>\$6506</b>
 <p><b>3H Lateral File Pedestal - RIGHT</b></p>	FN35243R	24 x 35 x 44.5	92.5	220	22	<b>\$6808</b>
	FN35203R	20 x 35 x 44.5	92.5	212	19	<b>\$6506</b>
 <p><b>Bench, Two File Drawers w/Cushion*</b></p>	FBENKK6420	20 x 64.5 x 21	100	167	17	<b>\$5836</b>
<p>With <b>two file drawers</b> and <b>cushion</b>. Standard in grade 2 seating fabric. Locks on left and right.</p>						

### Required Specifications

Front finish  
Top/body finish  
Fabric\*

# F FOUNDATIONS

## FREESTANDING STORAGE

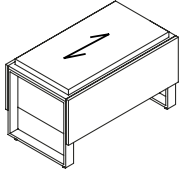

**Bench, One File Drawer w/Cushion**

MODEL#	DIMENSIONS	FREIGHT CLASS	WT/LBS.	CUBIC FT.	LIST PRICE
	<b>D x W x H</b>				
FBENK3520	20 x 35 x 21	92.5	99	9	<b>\$4239</b>

With **one file drawer** and **cushion**. Standard in grade 2 seating fabric. Lock on right.

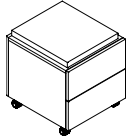

**Mobile Box/Box Pedestal w/Cushion**

F20BMCU	20 x 20.5 x 20.5	70	87	5	<b>\$2878</b>
---------	------------------	----	----	---	---------------

With **two box drawers** and **cushion**. Standard in grade 2 seating fabric. Lock on right. Casters are locking.

### Required Specifications

Front finish  
Top/body finish  
Fabric

## RETURNS - NOTES

D x W x H

- Horizontal grain direction is standard on all engineered finishes.
- Tops are constructed with two 3/4" thick panels, laminated together to create a total thickness of 1.5".
- Returns can be connected to wall credenzas and single pedestal desks
- All pedestals are suspended 7.5" off the floor by an open framed leg, and can be installed flush or offset
- Pedestals are handed:
  - Left pedestals have the handle offset from the center to the right, and the lock is placed on the left gable.
  - Right pedestals have the handle offset from the center to the left, and the lock is placed on the right gable.
- The standard grain direction on return tops is cross grain (**CG**). To remove cross grain veneer pattern on top, delete suffix "**CG**" from the model number (no upcharge)
- One Connecting Bracket is included.
- **NOTE:** Arrow indicates direction of grain

### RETURNS

MODEL# DIMENSIONS FREIGHT CLASS WT/LBS. CUBIC FT. LIST PRICE

D x W x H

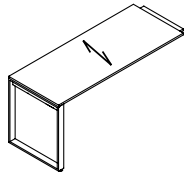

**Executive Return - LEFT**

FERL6624CG	24 x 66 x 28	85	59	4	<b>\$3603</b>
FERL6024CG	24 x 60 x 28	85	55	4	<b>\$3361</b>
FERL5424CG	24 x 54 x 28	85	50	4	<b>\$3177</b>
FERL4824CG	24 x 48 x 28	70	46	3	<b>\$3047</b>
FERL4224CG	24 x 42 x 28	85	42	3	<b>\$2511</b>
FERL6620CG	20 x 66 x 28	85	57	4	<b>\$3276</b>
FERL6020CG	20 x 60 x 28	85	53	4	<b>\$3056</b>
FERL5420CG	20 x 54 x 28	70	48	3	<b>\$2887</b>
FERL4820CG	20 x 48 x 28	85	44	3	<b>\$2770</b>
FERL4220CG	20 x 42 x 28	85	39	3	<b>\$2281</b>

Return has **no pedestal**. For use with right handed single pedestal desks, credenzas, or desk shells.

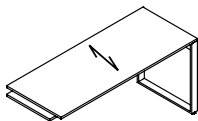

**Executive Return - RIGHT**

FERR6624CG	24 x 66 x 28	85	59	4	<b>\$3603</b>
FERR6024CG	24 x 60 x 28	85	55	4	<b>\$3361</b>
FERR5424CG	24 x 54 x 28	85	50	4	<b>\$3177</b>
FERR4824CG	24 x 48 x 28	70	46	3	<b>\$3047</b>
FERR4224CG	24 x 42 x 28	85	42	3	<b>\$2511</b>
FERR6620CG	20 x 66 x 28	85	57	4	<b>\$3276</b>
FERR6020CG	20 x 60 x 28	85	53	4	<b>\$3056</b>
FERR5420CG	20 x 54 x 28	70	48	3	<b>\$2887</b>
FERR4820CG	20 x 48 x 28	85	44	3	<b>\$2770</b>
FERR4220CG	20 x 42 x 28	85	39	3	<b>\$2281</b>

Return has **no pedestal**. For use with left handed single pedestal desks, credenzas, or desk shells.

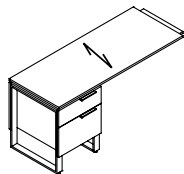

**Executive Return - LEFT**

FERL6624BCG	24 x 66 x 28	85	137	10	<b>\$6014</b>
FERL6024BCG	24 x 60 x 28	85	133	10	<b>\$5781</b>
FERL5424BCG	24 x 54 x 28	85	128	10	<b>\$5656</b>
FERL4824BCG	24 x 48 x 28	85	124	9	<b>\$5537</b>
FERL4224BCG	24 x 42 x 28	85	120	9	<b>\$5362</b>
FERL6620BCG	20 x 66 x 28	85	130	9	<b>\$5729</b>
FERL6020BCG	20 x 60 x 28	85	126	9	<b>\$5508</b>
FERL5420BCG	20 x 54 x 28	70	121	8	<b>\$5388</b>
FERL4820BCG	20 x 48 x 28	85	117	8	<b>\$5275</b>
FERL4220BCG	20 x 42 x 28	85	112	8	<b>\$5108</b>

Return has **flush box/file pedestal** on the **left**. For use with right handed single pedestal desks, credenzas, or desk shells.

#### Required Specifications

Top finish  
Body finish

#### Optional Specifications

Grommet



## EXECUTIVE RETURNS

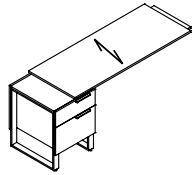

**Executive Return - LEFT**

MODEL#	DIMENSIONS D x W x H	FREIGHT CLASS	WT/LBS.	CUBIC FT.	LIST PRICE
FERL6624BOSCG	24 x 76 x 28	85	137	10	<b>\$6661</b>
FERL6024BOSCG	24 x 70 x 28	85	133	10	<b>\$5781</b>
FERL5424BOSCG	24 x 64 x 28	85	128	10	<b>\$5656</b>
FERL4824BOSCG	24 x 58 x 28	85	124	9	<b>\$5537</b>
FERL4224BOSCG	24 x 52 x 28	85	120	9	<b>\$5362</b>
FERL6620BOSCG	20 x 76 x 28	85	130	9	<b>\$6053</b>
FERL6020BOSCG	20 x 70 x 28	85	126	9	<b>\$5508</b>
FERL5420BOSCG	20 x 64 x 28	70	121	8	<b>\$5388</b>
FERL4820BOSCG	20 x 58 x 28	85	117	8	<b>\$5275</b>
FERL4220BOSCG	20 x 52 x 28	85	112	8	<b>\$5108</b>

Return has **offset box/file pedestal** on the **left**. For use with right handed single pedestal desks, credenzas, or desk shells.

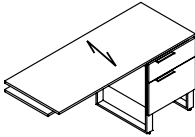

**Executive Return - RIGHT**

FERR6624BCG	24 x 66 x 28	85	137	10	<b>\$6014</b>
FERR6024BCG	24 x 60 x 28	85	133	10	<b>\$5781</b>
FERR5424BCG	24 x 54 x 28	85	128	10	<b>\$5656</b>
FERR4824BCG	24 x 48 x 28	85	124	9	<b>\$5537</b>
FERR4224BCG	24 x 42 x 28	85	120	9	<b>\$5362</b>
FERR6620BCG	20 x 66 x 28	85	130	9	<b>\$5729</b>
FERR6020BCG	20 x 60 x 28	85	126	9	<b>\$5508</b>
FERR5420BCG	20 x 54 x 28	70	121	8	<b>\$5388</b>
FERR4820BCG	20 x 48 x 28	85	117	8	<b>\$5275</b>
FERR4220BCG	20 x 42 x 28	85	112	8	<b>\$5108</b>

Return has **flush box/file pedestal** on the **right**. For use with left-handed single pedestal desks, credenzas, or desk shells.

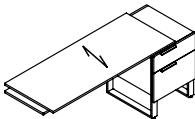

**Executive Return - RIGHT**

FERR6624BOSCG	24 x 76 x 28	85	137	10	<b>\$6661</b>
FERR6024BOSCG	24 x 70 x 28	85	133	10	<b>\$5781</b>
FERR5424BOSCG	24 x 64 x 28	85	128	10	<b>\$5656</b>
FERR4824BOSCG	24 x 58 x 28	85	124	9	<b>\$5537</b>
FERR4224BOSCG	24 x 52 x 28	85	120	9	<b>\$5362</b>
FERR6620BOSCG	20 x 76 x 28	85	130	9	<b>\$6053</b>
FERR6020BOSCG	20 x 70 x 28	85	126	9	<b>\$5508</b>
FERR5420BOSCG	20 x 64 x 28	70	121	8	<b>\$5388</b>
FERR4820BOSCG	20 x 58 x 28	85	117	8	<b>\$5275</b>
FERR4220BOSCG	20 x 52 x 28	85	112	8	<b>\$5108</b>

Return has **offset box/file pedestal** on the **right**. For use with left-handed single pedestal desks, credenzas, or desk shells.

### Required Specifications

Top finish  
Body finish

### Optional Specifications

Grommet

DESKS	MODEL#	DIMENSIONS	FREIGHT CLASS	WT/LBS.	CUBIC FT.	LIST PRICE
-------	--------	------------	---------------	---------	-----------	------------

D x W x H

- Horizontal grain direction is standard on all engineered finishes.
- Tops are constructed with two 3/4" thick panels, laminated together to create a total thickness of 1.5".
- All pedestals are suspended 7.5" off the floor by an open framed leg, and can be installed flush or offset
- The standard grain direction on Bridge tops is cross grain (**CG**). To remove cross grain veneer pattern on top, delete suffix "**CG**" from the model number (no upcharge)
- Two Connecting Brackets are included.
- GM5K (Tungsten) TC grommet location is standard
- **NOTE:** Arrow indicates direction of grain

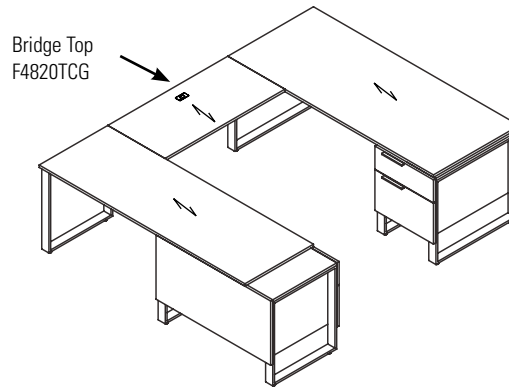

BRIDGES	MODEL#	DIMENSIONS	FREIGHT CLASS	WT/LBS.	CUBIC FT.	LIST PRICE
---------	--------	------------	---------------	---------	-----------	------------

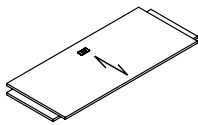

**Bridge Top**

FBT6624CG	24 x 66 x 1.5	65	57	2	<b>\$2879</b>
FBT6024CG	24 x 60 x 1.5	65	53	2	<b>\$2638</b>
FBT5424CG	24 x 54 x 1.5	65	48	2	<b>\$2502</b>
FBT4824CG	24 x 48 x 1.5	60	44	1	<b>\$2030</b>
FBT4224CG	24 x 42 x 1.5	60	40	1	<b>\$1840</b>
FBT6620CG	20 x 66 x 1.5	65	55	2	<b>\$2617</b>
FBT6020CG	20 x 60 x 1.5	65	51	2	<b>\$2396</b>
FBT5420CG	20 x 54 x 1.5	60	46	1	<b>\$2279</b>
FBT4820CG	20 x 48 x 1.5	60	42	1	<b>\$1840</b>
FBT4220CG	20 x 42 x 1.5	60	37	1	<b>\$1671</b>

Top surface only to create a "U" configuration with a single pedestal desk or credenza. **Cannot be used with corners.** Grommet in worksurface. Shipped RTA (ready to assemble).

**Required Specifications**  
Top finish

**Optional Specifications**  
Grommet

# F FOUNDATIONS

## WALL-MOUNTED STORAGE - NOTES

D x W x H

- Horizontal grain direction is standard on all engineered finishes.
- Wall Mount Overheads have a 2" deep valance on top and bottom and it can accommodate LED or T5 lighting in either location
- Tackboards are installed flush.
- Standard Heights for Tackboards are:
  - 19.2" (overall height above worksurface = 36.5")
  - 26" (overall height above worksurface = 42.5")
- **NOTE:** Arrow indicates direction of grain

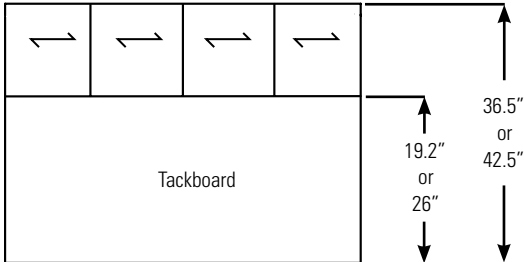

## WALL-MOUNTED STORAGE

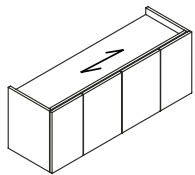

Wall Mount Storage w/Doors

MODEL# DIMENSIONS FREIGHT CLASS WT/LBS. CUBIC FT. LIST PRICE

FSF74	15 x 74.5 x 18.5	125	103	13	<b>\$3904</b>
FSF72	15 x 72 x 18.5	100	101	12	<b>\$3746</b>
FSF66	15 x 66 x 18.5	100	94	11	<b>\$3523</b>
FSF64	15 x 64.5 x 18.5	100	92	11	<b>\$3449</b>
FSF60	15 x 60 x 18.5	100	87	10	<b>\$3304</b>
FSF54	15 x 54 x 18.5	100	80	9	<b>\$3148</b>
FSF48	15 x 48 x 18.5	100	74	8	<b>\$2862</b>

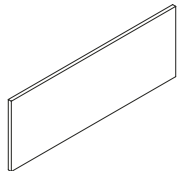

Wall Mount Tackboard\*

FTS74H26	.75 x 74.5 x 26	100	17	2	<b>\$1183</b>
FTS72H26	.75 x 72 x 26	70	16	1	<b>\$1092</b>
FTS66H26	.75 x 66 x 26	85	14	1	<b>\$1004</b>
FTS64H26	.75 x 64.5 x 26	85	13	1	<b>\$972</b>
FTS60H26	.75 x 60 x 26	85	13	1	<b>\$909</b>
FTS54H26	.75 x 54 x 26	85	13	1	<b>\$820</b>
FTS48H26	.75 x 48 x 26	85	13	1	<b>\$729</b>
FTS74	.75 x 74.5 x 19.2	85	13	1	<b>\$908</b>
FTS72	.75 x 72 x 19.2	85	12	1	<b>\$839</b>
FTS66	.75 x 66 x 19.2	92.5	11	1	<b>\$765</b>
FTS64	.75 x 64.5 x 19.2	92.5	11	1	<b>\$726</b>
FTS60	.75 x 60 x 19.2	92.5	10	1	<b>\$699</b>
FTS54	.75 x 54 x 19.2	92.5	10	1	<b>\$633</b>
FTS48	.75 x 48 x 19.2	92.5	10	1	<b>\$564</b>

### Required Specifications

Front finish  
Top/body finish  
Fabric\*

## WORK WALLS - NOTES

D x W x H

- Horizontal grain direction is standard on all engineered finishes.
- Tackboards and tasklights must be specified
- When the tackboard option is specified, the price includes a tackboard for each niche of the Work Wall.
- When the Task Light option is specified, the price includes LED Tasklight installed in the top of each niche. If more than one niche is needed in the configuration, remote on/off switch is included for simultaneous operation.
- All Storage Doors open with touch latch
- Side access to open storage or wardrobe - front panels are fixed.
- Standard heights are 26.5", 56", 70" and 84"
- Walls are available in 15" increments starting at 95" (i.e. 110", 125" 140", 155")
- Wall credenzas are only available in 90" width
- Cantilevered storage units are side locking
- For modifications to the wall configurations, size or finish, please contact customer care.

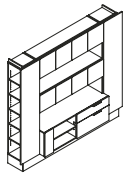
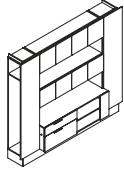
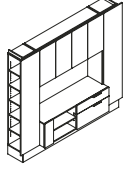
WORK WALLS - 84" H	MODEL#	DIMENSIONS	FREIGHT CLASS	WT/LBS.	CUBIC FT.	LIST PRICE
 <p><b>Work Wall - 95"W</b></p>	FW9584-1L	20 x 95 x 84	100	634	79	<b>\$25919</b>
		Vertical storage with 5 adjustable shelves, 60" wide wall credenza with adjustable shelf and box/file, 60" wide niche, 60" wide single height storage, 60" wide niche, 60" wide single height storage, wardrobe with coat hook and hat shelf.				<ul style="list-style-type: none"> <li>• To add tackboard to niche, add <b>TB</b> to end of product code. <b>Add \$1930</b> to list price for grades 1-3. Add <b>\$2316</b> for grades 4-5.</li> <li>• To add LED light to niche, add <b>LT</b> to end of product code. <b>Add \$2027</b> to list price.</li> </ul>
 <p><b>Work Wall - 95"W</b></p>	FW9584-1R	20 x 95 x 84	100	634	79	<b>\$25919</b>
		Wardrobe with coat hook and hat shelf, 60" wide wall credenza with box/file and adjustable shelf, 60" wide niche, 60" wide single height storage, 60" wide niche, 60" wide single height storage, vertical storage with 5 adjustable shelves..				<ul style="list-style-type: none"> <li>• To add tackboard to niche, add <b>TB</b> to end of product code. <b>Add \$1930</b> to list price for grades 1-3. Add <b>\$2316</b> for grades 4-5.</li> <li>• To add LED light to niche, add <b>LT</b> to end of product code. <b>Add \$2027</b> to list price.</li> </ul>
 <p><b>Work Wall - 95"W</b></p>	FW9584-2L	20 x 95 x 84	125	568	77	<b>\$22787</b>
		Vertical storage with 5 adjustable shelves, 60" wide wall credenza with adjustable shelf and box/file, 60" wide double height niche, 60" wide double height storage, wardrobe with coat hook and hat shelf.				<ul style="list-style-type: none"> <li>• To add tackboard to niche, add <b>TB</b> to end of product code. <b>Add \$1198</b> to list price for grades 1-3. Add <b>\$1438</b> for grades 4-5.</li> <li>• To add LED light to niche, add <b>LT</b> to end of product code. <b>Add \$819</b> to list price.</li> </ul>

### Required Specifications

Front finish  
Top/body finish  
Cubby interior finish

### Optional Specifications

Grommet  
LED light  
Tackboard

## WORK WALLS - 84"H

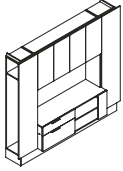

**Work Wall - 95\"/>**

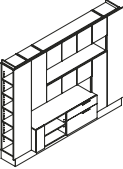

**Work Wall - 110\"/>**

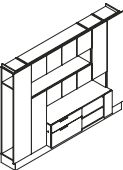

**Work Wall - 110\"/>**

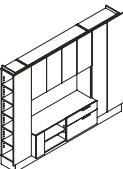

**Work Wall - 110\"/>**

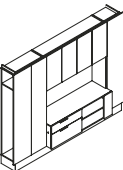

**Work Wall - 110\"/>**

MODEL#	DIMENSIONS	FREIGHT CLASS	WT/LBS.	CUBIC FT.	LIST PRICE
--------	------------	---------------	---------	-----------	------------

	D x W x H				
FW9584-2R	20 x 95 x 84	125	568	77	<b>\$22787</b>

Wardrobe with coat hook and hat shelf, 60" wide wall credenza with box/file and adjustable shelf, 60" wide double height niche, 60" wide double height storage, vertical storage with 5 adjustable shelves.

- To add tackboard to niche, add **TB** to end of product code. **Add \$1198** to list price for grades 1-3. Add **\$1438** for grades 4-5.
- To add LED light to niche, add **LT** to end of product code. **Add \$819** to list price.

FW11084-1L	20 x 110 x 84	100	741	91	<b>\$29510</b>
------------	---------------	-----	-----	----	----------------

Vertical storage with 5 adjustable shelves, 60" wide wall credenza with adjustable shelf and box/file, 60" wide niche, triple height storage, 45" wide single height storage, 60" wide niche, 60" wide single height storage, triple height storage, wardrobe with coat hook and hat shelf.

- To add tackboard to niche, add **TB** to end of product code. **Add \$1924** to list price for grades 1-3. Add **\$2309** for grades 4-5.
- To add LED light to niche, add **LT** to end of product code. **Add \$2030** to list price.

FW11084-1R	20 x 110 x 84	100	741	91	<b>\$29510</b>
------------	---------------	-----	-----	----	----------------

Wardrobe with coat hook and hat shelf, triple height storage, 60" wide niche, 60" wide single height storage, 60" wide wall credenza with box/file and adjustable shelf, 60" wide niche, 45" wide single height storage, triple height storage, vertical storage with 5 adjustable shelves.

- To add tackboard to niche, add **TB** to end of product code. **Add \$1924** to list price for grades 1-3. Add **\$2309** for grades 4-5.
- To add LED light to niche, add **LT** to end of product code. **Add \$2030** to list price.

FW11084-2L	20 x 110 x 84	125	628	88	<b>\$25185</b>
------------	---------------	-----	-----	----	----------------

Vertical storage with 5 adjustable shelves, 60" wide wall credenza with adjustable shelf and box/file, 60" wide double height niche, 60" wide double height storage, double depth wardrobe with coat rod and hat shelf.

- To add tackboard to niche, add **TB** to end of product code. **Add \$1196** to list price for grades 1-3. Add **\$1435** for grades 4-5.
- To add LED light to niche, add **LT** to end of product code. **Add \$819** to list price.

FW11084-2R	20 x 110 x 84	125	628	88	<b>\$25185</b>
------------	---------------	-----	-----	----	----------------

Double depth wardrobe with coat rod and hat shelf, 60" wide wall credenza with adjustable shelf and box/file, 60" wide double height niche, 60" wide double height storage, vertical storage with 5 adjustable shelves.

- To add tackboard to niche, add **TB** to end of product code. **Add \$1196** to list price for grades 1-3. Add **\$1435** for grades 4-5.
- To add LED light to niche, add **LT** to end of product code. **Add \$819** to list price.

### Required Specifications

Front finish  
Top/body finish  
Cubby interior finish

### Optional Specifications

Grommet  
LED light  
Tackboard

**WORK WALLS - 84"H**

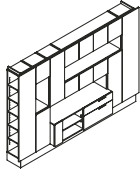

**Work Wall - 125"W**

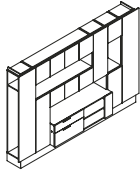

**Work Wall - 125"W**

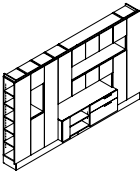

**Work Wall - 140"W**

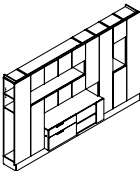

**Work Wall - 140"W**

MODEL#	DIMENSIONS	FREIGHT CLASS	WT/LBS.	CUBIC FT.	LIST PRICE
--------	------------	---------------	---------	-----------	------------

**D x W x H**

FW12584-1L	20 x 125 x 84	100	858	103	<b>\$33132</b>
------------	---------------	-----	-----	-----	----------------

Vertical storage with 5 adjustable shelves, 15" wide double height niche, single height storage, 60" wide wall credenza with adjustable shelf and box/file, 60" wide niche, triple height storage, 45" wide single height storage, 60" wide niche, 60" wide single height storage, triple height storage, wardrobe with coat hook and hat shelf.

- To add tackboard to niche, add **TB** to end of product code. **Add \$2350** to list price for grades 1-3. Add **\$2821** for grades 4-5.
- To add LED light to niche, add **LT** to end of product code. **Add \$2358** to list price.

FW12584-1R	20 x 125 x 84	100	858	103	<b>\$33132</b>
------------	---------------	-----	-----	-----	----------------

Wardrobe with coat hook and hat shelf, triple height storage, 60" wide niche, 60" wide single height storage, 60" wide wall credenza with box/file and adjustable shelf, 60" wide niche, 45" wide single height storage, triple height storage, 15" wide double height niche, single height storage, vertical storage with 5 adjustable shelves.

- To add tackboard to niche, add **TB** to end of product code. **Add \$2350** to list price for grades 1-3. Add **\$2821** for grades 4-5.
- To add LED light to niche, add **LT** to end of product code. **Add \$2358** to list price.

FW14084-1L	20 x 140 x 84	100	936	115	<b>\$35732</b>
------------	---------------	-----	-----	-----	----------------

Vertical storage with 5 adjustable shelves, triple height storage, 15" wide double height niche, single height storage, vertical storage with 5 adjustable shelves, 60" wide wall credenza with adjustable shelf and box/file, 60" wide niche, triple height storage cabinet, 45" wide single height storage, 60" wide niche, 60" wide single height storage, double depth wardrobe with coat rod and two shelves.

- To add tackboard to niche, add **TB** to end of product code. **Add \$2350** to list price for grades 1-3. Add **\$2821** for grades 4-5.
- To add LED light to niche, add **LT** to end of product code. **Add \$2357** to list price.

FW14084-1R	20 x 125 x 84	100	936	115	<b>\$35732</b>
------------	---------------	-----	-----	-----	----------------

Double depth wardrobe with coat rod and two shelves, 60" wide niche, 60" wide single height storage, 60" wide wall credenza with box/file and adjustable shelf, 60" wide niche, 45" wide single height storage, triple height storage, vertical storage with 5 adjustable shelves, triple height storage, 15" wide double height niche, single height storage, vertical storage with 5 adjustable shelves.

- To add tackboard to niche, add **TB** to end of product code. **Add \$2350** to list price for grades 1-3. Add **\$2821** for grades 4-5.
- To add LED light to niche, add **LT** to end of product code. **Add \$2357** to list price.

**Required Specifications**

Front finish  
Top/body finish  
Cubby interior finish

**Optional Specifications**

Grommet  
LED light  
Tackboard

## WORK WALLS - 70"W

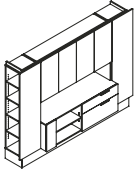

**Work Wall - 95"W**

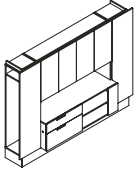

**Work Wall - 95"W**

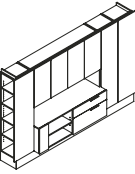

**Work Wall - 110"W**

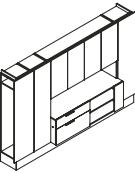

**Work Wall - 110"W**

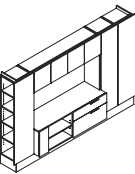

**Work Wall - 110"W**

MODEL#	DIMENSIONS	FREIGHT CLASS	WT./LBS.	CUBIC FT.	LIST PRICE
--------	------------	---------------	----------	-----------	------------

D x W x H

FW9570-1L	20 x 95 x 70	125	523	66	<b>\$21754</b>
-----------	--------------	-----	-----	----	----------------

Vertical storage with 4 adjustable shelves, 60" wide wall credenza with adjustable shelf and box/file, 60" wide niche, 60" wide double height storage, wardrobe with coat hook and hat shelf.

- To add tackboard to niche, add **TB** to end of product code. **Add \$966** to list price for grades 1-3. Add **\$1160** for grades 4-5.
- To add LED light to niche, add **LT** to end of product code. **Add \$817** to list price.

FW9570-1R	20 x 95 x 70	125	523	66	<b>\$21754</b>
-----------	--------------	-----	-----	----	----------------

Wardrobe with coat hook and hat shelf, 60" wide wall credenza with box/file and adjustable shelf, 60" wide niche, 60" wide double height storage, vertical storage with 4 adjustable shelves.

- To add tackboard to niche, add **TB** to end of product code. **Add \$966** to list price for grades 1-3. Add **\$1160** for grades 4-5.
- To add LED light to niche, add **LT** to end of product code. **Add \$817** to list price.

FW11070-1L	20 x 110 x 70	100	618	76	<b>\$23751</b>
------------	---------------	-----	-----	----	----------------

Vertical storage with 4 adjustable shelves, 60" wide wall credenza with adjustable shelf and box/file, 60" wide niche, 60" wide double height storage, vertical storage with 4 adjustable shelves, wardrobe with coat hook and hat shelf.

- To add tackboard to niche, add **TB** to end of product code. **Add \$963** to list price for grades 1-3. Add **\$1155** for grades 4-5.
- To add LED light to niche, add **LT** to end of product code. **Add \$817** to list price.

FW11070-1R	20 x 110 x 70	100	618	76	<b>\$23751</b>
------------	---------------	-----	-----	----	----------------

Wardrobe with coat hook and hat shelf, vertical storage with 4 adjustable shelves, 60" wide wall credenza with box/file and adjustable shelf, 60" wide niche, 60" wide double height storage, vertical storage with 4 adjustable shelves.

- To add tackboard to niche, add **TB** to end of product code. **Add \$963** to list price for grades 1-3. Add **\$1155** for grades 4-5.
- To add LED light to niche, add **LT** to end of product code. **Add \$817** to list price.

FW11070-2L	20 x 110 x 70	125	586	76	<b>\$22383</b>
------------	---------------	-----	-----	----	----------------

Vertical storage with 4 adjustable shelves, 60" wide wall credenza with adjustable shelf and box/file, 60" wide double height niche, 60" wide single height storage, vertical storage with 4 adjustable shelves, wardrobe with coat hook and hat shelf.

- To add tackboard to niche, add **TB** to end of product code. **Add \$1193** to list price for grades 1-3. Add **\$1432** for grades 4-5.
- To add LED light to niche, add **LT** to end of product code. **Add \$819** to list price.

### Required Specifications

Front finish  
Top/body finish  
Cubby interior finish

### Optional Specifications

Grommet  
LED light  
Tackboard

## WORK WALLS - 70"H

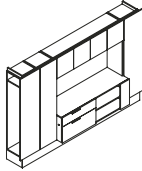

**Work Wall - 110"W**

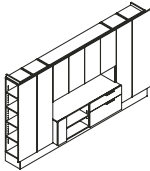

**Work Wall - 125"W**

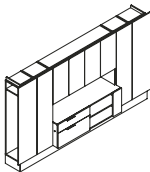

**Work Wall - 125"W**

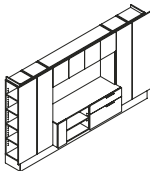

**Work Wall - 125"W**

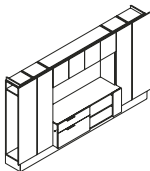

**Work Wall - 125"W**

MODEL#	DIMENSIONS	FREIGHT CLASS	WT/LBS.	CUBIC FT.	LIST PRICE
--------	------------	---------------	---------	-----------	------------

**D x W x H**

FW11070-2R	20 x 110 x 70	125	586	76	<b>\$22383</b>
------------	---------------	-----	-----	----	----------------

Wardrobe with coat hook and hat shelf, vertical storage with 4 adjustable shelves, 60" wide wall credenza with box/file and adjustable shelf, 60" wide double height niche, 60" wide single height storage, vertical storage with 4 adjustable shelves.

- To add tackboard to niche, add **TB** to end of product code. **Add \$1193** to list price for grades 1-3. Add **\$1432** for grades 4-5.
- To add LED light to niche, add **LT** to end of product code. **Add \$819** to list price.

FW12570-1L	20 x 125 x 70	100	713	85	<b>\$24955</b>
------------	---------------	-----	-----	----	----------------

Vertical storage with 4 adjustable shelves, vertical storage with 4 adjustable shelves, 60" wide wall credenza with adjustable shelf and box/file, 60" wide niche, 60" wide double height storage, vertical storage with 4 adjustable shelves, wardrobe with coat hook and hat shelf.

- To add tackboard to niche, add **TB** to end of product code. **Add \$966** to list price for grades 1-3. Add **\$1160** for grades 4-5.
- To add LED light to niche, add **LT** to end of product code. **Add \$819** to list price.

FW12570-1R	20 x 125 x 70	100	713	85	<b>\$24955</b>
------------	---------------	-----	-----	----	----------------

Wardrobe with coat hook and hat shelf, vertical storage with 4 adjustable shelves, 60" wide wall credenza with box/file and adjustable shelf, 60" wide niche, 60" wide double height storage, vertical storage with 4 adjustable shelves, vertical storage with 4 adjustable shelves.

- To add tackboard to niche, add **TB** to end of product code. **Add \$966** to list price for grades 1-3. Add **\$1160** for grades 4-5.
- To add LED light to niche, add **LT** to end of product code. **Add \$819** to list price.

FW12570-2L	20 x 125 x 70	100	681	85	<b>\$23583</b>
------------	---------------	-----	-----	----	----------------

Vertical storage with 4 adjustable shelves, vertical storage with 4 adjustable shelves, 60" wide wall credenza with adjustable shelf and box/file, 60" wide double height niche, 60" wide single height storage, vertical storage with 4 adjustable shelves, wardrobe with coat hook and hat shelf.

- To add tackboard to niche, add **TB** to end of product code. **Add \$1196** to list price for grades 1-3. Add **\$1435** for grades 4-5.
- To add LED light to niche, add **LT** to end of product code. **Add \$819** to list price.

FW12570-2R	20 x 125 x 70	100	681	85	<b>\$23583</b>
------------	---------------	-----	-----	----	----------------

Wardrobe with coat hook and hat shelf, vertical storage with 4 adjustable shelves, 60" wide wall credenza with box/file and adjustable shelf, 60" wide double height niche, 60" wide single height storage, vertical storage with 4 adjustable shelves, vertical storage with 4 adjustable shelves.

- To add tackboard to niche, add **TB** to end of product code. **Add \$1196** to list price for grades 1-3. Add **\$1435** for grades 4-5.
- To add LED light to niche, add **LT** to end of product code. **Add \$819** to list price.

### Required Specifications

Front finish  
Top/body finish  
Cubby interior finish

### Optional Specifications

Grommet  
LED light  
Tackboard



## WORK WALLS - 70"H

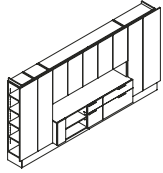

**Work Wall - 140"W**

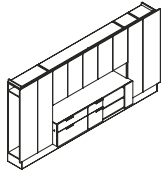

**Work Wall - 140"W**

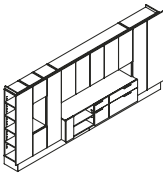

**Work Wall - 155"W**

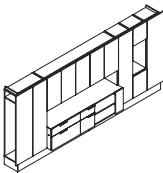

**Work Wall - 155"W**

MODEL#	DIMENSIONS	FREIGHT CLASS	WT/LBS.	CUBIC FT.	LIST PRICE
--------	------------	---------------	---------	-----------	------------

D x W x H

FW14070-1L	20 x 140 x 70	125	750	95	<b>\$26997</b>
------------	---------------	-----	-----	----	----------------

Vertical storage with 4 adjustable shelves, vertical storage with 4 adjustable shelves, 75" wide wall credenza with adjustable shelf, narrow box/file and box file, 75" wide single height niche, 75" wide double height storage, double depth wardrobe with coat rod and hat shelf.

- To add tackboard to niche, add **TB** to end of product code. **Add \$1210** to list price for grades 1-3. Add **\$1452** for grades 4-5.
- To add LED light to niche, add **LT** to end of product code. **Add \$1851** to list price.

FW14070-1R	20 x 140 x 70	125	750	95	<b>\$26997</b>
------------	---------------	-----	-----	----	----------------

Double depth wardrobe with coat rod and hat shelf, 75" wide wall credenza with box/file, narrow box/file and adjustable shelf, 75" wide single height niche, 75" wide double height storage, vertical storage with 4 adjustable shelves, vertical storage with 4 adjustable shelves.

- To add tackboard to niche, add **TB** to end of product code. **Add \$1210** to list price for grades 1-3. Add **\$1452** for grades 4-5.
- To add LED light to niche, add **LT** to end of product code. **Add \$1851** to list price.

FW15570-1L	20 x 155 x 70	125	849	107	<b>\$32612</b>
------------	---------------	-----	-----	-----	----------------

Vertical storage with 4 adjustable shelves, double height storage, 15" wide double height niche, single height storage, vertical storage with 4 adjustable shelves, 75" wide wall credenza with adjustable shelf, narrow box/file and box file, 75" wide niche, 75" wide double height storage, double depth wardrobe with coat rod and hat shelf.

- To add tackboard to niche, add **TB** to end of product code. **Add \$1630** to list price for grades 1-3. Add **\$1956** for grades 4-5.
- To add LED light to niche, add **LT** to end of product code. **Add \$2176** to list price.

FW15570-1R	20 x 155 x 70	125	849	107	<b>\$32612</b>
------------	---------------	-----	-----	-----	----------------

Double depth wardrobe with coat rod and hat shelf, 75" wide wall credenza with box/file, narrow box/file and adjustable shelf, 75" wide niche, 75" wide double height storage, vertical storage with 4 adjustable shelves, double height storage, 15" wide double height niche, single height storage, vertical storage with 4 adjustable shelves.

- To add tackboard to niche, add **TB** to end of product code. **Add \$1630** to list price for grades 1-3. Add **\$1956** for grades 4-5.
- To add LED light to niche, add **LT** to end of product code. **Add \$2176** to list price.

### Required Specifications

Front finish  
Top/body finish  
Cubby interior finish

### Optional Specifications

Grommet  
LED light  
Tackboard

## WORK WALLS - 56"H

MODEL#	DIMENSIONS	FREIGHT CLASS	WT/LBS.	CUBIC FT.	LIST PRICE
--------	------------	---------------	---------	-----------	------------

D x W x H

FW9556-1	20 x 95 x 56	100	488	55	<b>\$20156</b>
----------	--------------	-----	-----	----	----------------

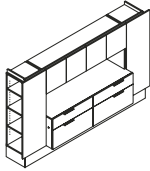

**Work Wall - 95"W**

Vertical storage with 3 adjustable shelves, 60" wide wall credenza with two box/files, 60" wide single height niche, 60" wide single height storage, vertical storage with 3 adjustable shelves.

- To add tackboard to niche, add **TB** to end of product code. **Add \$965** to list price for grades 1-3. Add **\$1159** for grades 4-5.
- To add LED light to niche, add **LT** to end of product code. **Add \$817** to list price.

FW9556-2	20 x 95 x 56	125	420	55	<b>\$18157</b>
----------	--------------	-----	-----	----	----------------

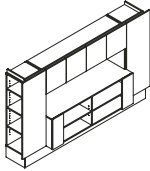

**Work Wall - 95"W**

Vertical storage with 3 adjustable shelves, 60" wide wall open credenza with two adjustable shelves, 60" wide single height niche, 60" wide single height storage, vertical storage with 3 adjustable shelves.

- To add tackboard to niche, add **TB** to end of product code. **Add \$965** to list price for grades 1-3. Add **\$1159** for grades 4-5.
- To add LED light to niche, add **LT** to end of product code. **Add \$819** to list price.

FW11056-1L	20 x 110 x 56	100	533	63	<b>\$19755</b>
------------	---------------	-----	-----	----	----------------

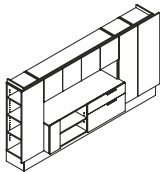

**Work Wall - 110"W**

Vertical storage with 3 adjustable shelves, 60" wide wall credenza with adjustable shelf and box/file, 60" wide niche, 60" wide single height storage, vertical storage with 3 adjustable shelves, wardrobe with coat hook and hat shelf.

- To add tackboard to niche, add **TB** to end of product code. **Add \$965** to list price for grades 1-3. Add **\$1159** for grades 4-5.
- To add LED light to niche, add **LT** to end of product code. **Add \$817** to list price.

FW11056-1R	20 x 110 x 56	100	533	63	<b>\$19755</b>
------------	---------------	-----	-----	----	----------------

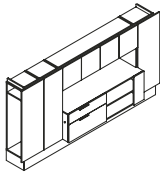

**Work Wall - 110"W**

Wardrobe with coat hook and hat shelf, vertical storage with 3 adjustable shelves, 60" wide wall credenza with box/file and adjustable shelf, 60" wide single height niche, 60" wide single height storage, vertical storage with 3 adjustable shelves.

- To add tackboard to niche, add **TB** to end of product code. **Add \$965** to list price for grades 1-3. Add **\$1159** for grades 4-5.
- To add LED light to niche, add **LT** to end of product code. **Add \$817** to list price.

FW11056-2L	20 x 110 x 56	100	549	62	<b>\$21753</b>
------------	---------------	-----	-----	----	----------------

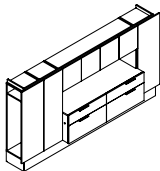

**Work Wall - 110"W**

Wardrobe with coat hook and hat shelf, vertical storage with 3 adjustable shelves, 60" wide wall credenza with two box/files, 60" wide niche, 60" wide single height storage, vertical storage with 3 adjustable shelves.

- To add tackboard to niche, add **TB** to end of product code. **Add \$965** to list price for grades 1-3. Add **\$1160** for grades 4-5.
- To add LED light to niche, add **LT** to end of product code. **Add \$817** to list price.

### Required Specifications

Front finish  
Top/body finish  
Cubby interior finish

### Optional Specifications

Grommet  
LED light  
Tackboard

**WORK WALLS - 56"H**

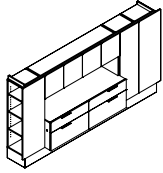

**Work Wall - 110"W\***

MODEL#	DIMENSIONS D x W x H	FREIGHT CLASS	WT/LBS.	CUBIC FT.	LIST PRICE
FW11056-2R	20 x 110 x 56	100	549	62	<b>\$21753</b>

Vertical storage with 3 adjustable shelves, 60" wide wall credenza with two box/files, 60" wide niche, 60" wide single height storage, vertical storage with 3 adjustable shelves, wardrobe with coat hook and hat shelf.

- To add tackboard to niche, add **TB** to end of product code. **Add \$965** to list price for grades 1-3. Add **\$1160** for grades 4-5.
- To add LED light to niche, add **LT** to end of product code. **Add \$817** to list price.

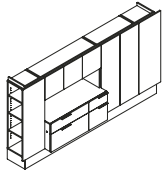

**Work Wall - 110"W\***

FW11056-3L	20 x 110 x 56	100	538	62	<b>\$21558</b>
------------	---------------	-----	-----	----	----------------

Vertical storage with 3 adjustable shelves, 45" wide wall credenza with box/file and narrow box/file, 45" wide niche, 45" wide single height storage, double width vertical storage with 3 adjustable shelves, wardrobe with coat hook and hat shelf.

- To add tackboard to niche, add **TB** to end of product code. **Add \$968** to list price for grades 1-3. Add **\$1162** for grades 4-5.
- To add LED light to niche, add **LT** to end of product code. **Add \$664** to list price.

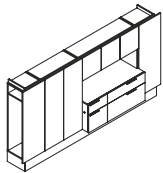

**Work Wall - 110"W\***

FW11056-3R	20 x 110 x 56	100	538	62	<b>\$21558</b>
------------	---------------	-----	-----	----	----------------

Wardrobe with coat hook and hat shelf, double width vertical storage with 3 adjustable shelves, 45" wide wall credenza with narrow box/file and box/file, 45" wide niche, 45" wide single height storage, vertical storage with 3 adjustable shelves.

- To add tackboard to niche, add **TB** to end of product code. **Add \$968** to list price for grades 1-3. Add **\$1162** for grades 4-5.
- To add LED light to niche, add **LT** to end of product code. **Add \$664** to list price.

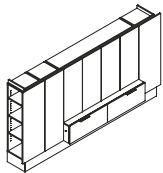

**Work Wall - 110"W**

FW11056-4L	20 x 110 x 56	100	530	61	<b>\$20691</b>
------------	---------------	-----	-----	----	----------------

Vertical storage with 3 adjustable shelves, vertical storage with 3 adjustable shelves, 60" wide single height wall credenza with two files, 60" wide triple height storage with 2 adjustable shelves, wardrobe with coat hook and hat shelf.

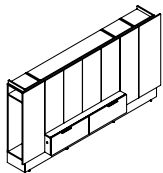

**Work Wall - 110"W**

FW11056-4R	20 x 110 x 56	100	530	61	<b>\$20691</b>
------------	---------------	-----	-----	----	----------------

Wardrobe with coat hook and hat shelf, single height 60" wide wall credenza with two files, 60" wide triple height storage with 2 adjustable shelves, vertical storage with 3 adjustable shelves, vertical storage with 3 adjustable shelves.

**Required Specifications**

Front finish  
Top/body finish  
Cubby interior finish

**Optional Specifications**

Grommet  
LED light\*  
Tackboard\*

## WORK WALLS - 84"H

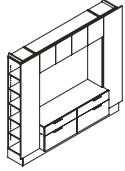

**Work Wall - 95"W**

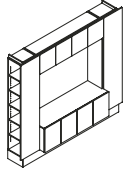

**Work Wall - 95"W**

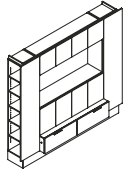

**Work Wall - 95"W**

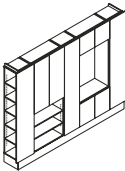

**Work Wall - 110"W**

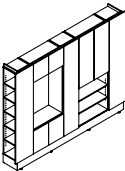

**Work Wall - 110"W**

MODEL#	DIMENSIONS	FREIGHT CLASS	WT/LBS.	CUBIC FT.	LIST PRICE
--------	------------	---------------	---------	-----------	------------

**D x W x H**

FW9584-20	20 x 95 x 84	125	565	77	<b>\$25182</b>
-----------	--------------	-----	-----	----	----------------

Vertical storage with 5 adjustable shelves, 60" wide wall credenza with two box/files, 60" wide triple height niche, 60" wide single height storage, vertical storage with 5 adjustable shelves.

- To add tackboard to niche, add **TB** to end of product code. **Add \$1793** to list price for grades 1-3. Add **\$2152** for grades 4-5.
- To add LED light to niche, add **LT** to end of product code. **Add \$817** to list price.

FW9584-21	20 x 95 x 84	125	512	77	<b>\$23182</b>
-----------	--------------	-----	-----	----	----------------

Vertical storage with 5 adjustable shelves, 60" wide wall credenza with two cabinets with adjustable shelves, 60" wide triple height niche, 60" wide single height storage, vertical storage with 5 adjustable shelves.

- To add tackboard to niche, add **TB** to end of product code. **Add \$1793** to list price for grades 1-3. Add **\$2152** for grades 4-5.
- To add LED light to niche, add **LT** to end of product code. **Add \$820** to list price.

FW9584-22	20 x 95 x 84	125	611	77	<b>\$24181</b>
-----------	--------------	-----	-----	----	----------------

Vertical storage with 5 adjustable shelves, 60" wide single height wall credenza with two files, 60" wide double height storage, 60" wide double height niche, 60" wide single height storage, vertical storage with 5 adjustable shelves.

- To add tackboard to niche, add **TB** to end of product code. **Add \$1193** to list price for grades 1-3. Add **\$1432** for grades 4-5.
- To add LED light to niche, add **LT** to end of product code. **Add \$817** to list price.

FW11084-20L	15 x 110 x 84	125	659	87	<b>\$23685</b>
-------------	---------------	-----	-----	----	----------------

Vertical storage with 5 adjustable shelves, 30" wide triple height open bookcase, 30" wide triple height double width storage, vertical storage with 5 adjustable shelves, 30" wide and double height storage, 30" triple height niche, 30" wide single height storage, vertical storage with 5 adjustable shelves.

- To add tackboard to niche, add **TB** to end of product code. **Add \$897** to list price for grades 1-3. Add **\$1076** for grades 4-5.
- To add LED light to niche, add **LT** to end of product code. **Add \$500** to list price.

FW11084-20R	15 x 110 x 84	125	659	87	<b>\$23685</b>
-------------	---------------	-----	-----	----	----------------

Vertical storage with 5 adjustable shelves, 30" wide double height storage, 30" wide triple height niche, 30" wide single height storage, vertical storage with 5 adjustable shelves, 30" wide triple height open bookcase, 30" wide triple height double width storage, vertical storage with 5 adjustable shelves.

- To add tackboard to niche, add **TB** to end of product code. **Add \$897** to list price for grades 1-3. Add **\$1076** for grades 4-5.
- To add LED light to niche, add **LT** to end of product code. **Add \$500** to list price.

**Required Specifications**

Front finish  
Top/body finish  
Cubby interior finish

**Optional Specifications**

Grommet  
LED light  
Tackboard

## WORK WALLS - 84"H

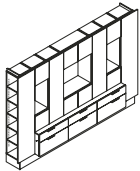

**Work Wall - 125"W**

MODEL#	DIMENSIONS D x W x H	FREIGHT CLASS	WT/LBS.	CUBIC FT.	LIST PRICE
FW12584-20	20 x 125 x 84	100	962	101	<b>\$36610</b>

Vertical storage with 5 adjustable shelves, 90" wide wall credenza with three box/files, single height storage, 15" wide double height niche, single height storage, four-fold height vertical storage with 3 adjustable shelves, double width single height storage, 30" wide double height niche, double width single height storage, fourfold height vertical storage with 3 adjustable shelves, single height storage, 15" wide double height niche, single height storage, vertical storage with 5 adjustable shelves.

- To add tackboard to niche, add **TB** to end of product code. **Add \$1630** to list price for grades 1-3. **Add \$1956** for grades 4-5.
- To add LED light to niche, add **LT** to end of product code. **Add \$1635** to list price.

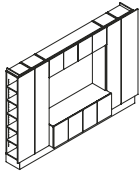

**Work Wall - 125"W**

FW12584-21	20 x 125 x 84	125	738	100	<b>\$27777</b>
------------	---------------	-----	-----	-----	----------------

Vertical storage with 5 adjustable shelves, vertical storage with 5 adjustable shelves, 60" wide wall credenza with two cabinets and adjustable shelf, 60" wide triple height niche, 60" wide single height storage, vertical storage with 5 adjustable shelves, vertical storage with 5 adjustable shelves.

- To add tackboard to niche, add **TB** to end of product code. **Add \$1788** to list price for grades 1-3. **Add \$2147** for grades 4-5.
- To add LED light to niche, add **LT** to end of product code. **Add \$819** to list price.

## WORK WALLS - 70"H

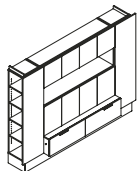

**Work Wall - 95"W**

MODEL#	DIMENSIONS	FREIGHT CLASS	WT/LBS.	CUBIC FT.	LIST PRICE
FW9570-20	20 x 95 x 70	100	563	66	<b>\$21754</b>

Vertical storage with 4 adjustable shelves, 60" wide single height wall credenza with two files, 60" wide double height storage, 60" wide niche, 60" wide single height storage, vertical storage with 4 adjustable shelves.

- To add tackboard to niche, add **TB** to end of product code. **Add \$966** to list price for grades 1-3. **Add \$1160** for grades 4-5.
- To add LED light to niche, add **LT** to end of product code. **Add \$817** to list price.

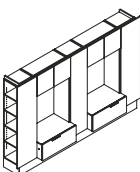

**Work Wall - 110"W**

FW11070-20	20 x 110 x 70	125	602	78	<b>\$24977</b>
------------	---------------	-----	-----	----	----------------

Vertical storage with 4 adjustable shelves, 30" wide single height wall credenza with file, 30" wide triple height niche, 30" wide single height storage, vertical storage with 4 adjustable shelves, 30" wide single height wall credenza with file, 30" wide triple height niche, 30" wide single height storage, vertical storage with 4 adjustable shelves.

- To add tackboard to niche, add **TB** to end of product code. **Add \$1791** to list price for grades 1-3. **Add \$2149** for grades 4-5.
- To add LED light to niche, add **LT** to end of product code. **Add \$1296** to list price.

### Required Specifications

Front finish  
Top/body finish  
Cubby interior finish

### Optional Specifications

Grommet  
LED light  
Tackboard

## WORK WALLS - 70"H

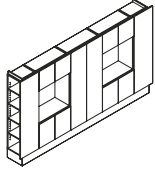

**Work Wall - 125"W**

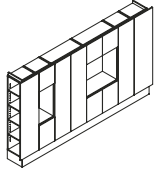

**Work Wall - 125"W**

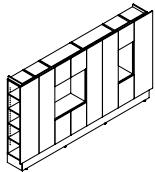

**Work Wall - 125"W**

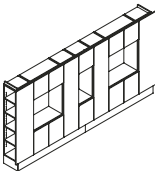

**Work Wall - 140"W**

MODEL#	DIMENSIONS	FREIGHT CLASS	WT/LBS.	CUBIC FT.	LIST PRICE
--------	------------	---------------	---------	-----------	------------

D x W x H

FW12570-20	20 x 125 x 70	125	645	84	<b>\$25185</b>
------------	---------------	-----	-----	----	----------------

Vertical storage with 4 adjustable shelves, 30" wide double height storage, 30" wide double height niche, 30" wide single height storage, double width vertical storage with 4 adjustable shelves, 30" wide double height storage, 30" wide double height niche, 30" wide single height storage, vertical storage with 4 adjustable shelves.

- To add tackboard to niche, add **TB** to end of product code. **Add \$1196** to list price for grades 1-3. Add **\$1435** for grades 4-5.
- To add LED light to niche, add **LT** to end of product code. **Add \$1295** to list price.

FW12570-21L	20 x 125 x 70	100	685	84	<b>\$26403</b>
-------------	---------------	-----	-----	----	----------------

Vertical storage with 4 adjustable shelves, 15" wide double height storage, 15" wide double height niche, 15" wide single height storage, double width vertical storage with 4 adjustable shelves, 30" wide double height storage, 30" wide double height niche, 30" wide single height storage, vertical storage with 4 adjustable shelves, vertical storage with 4 adjustable shelves.

- To add tackboard to niche, add **TB** to end of product code. **Add \$817** to list price for grades 1-3. Add **\$981** for grades 4-5.
- To add LED light to niche, add **LT** to end of product code. **Add \$981** to list price.

FW12570-21R	20 x 125 x 70	100	685	84	<b>\$26403</b>
-------------	---------------	-----	-----	----	----------------

Vertical storage with 4 adjustable shelves, vertical storage with 4 adjustable shelves, 30" wide double height storage, 30" wide double height niche, 30" wide single height storage, double width vertical storage with 4 adjustable shelves, 15" wide double height storage, 15" wide double height niche, 15" wide single height storage, vertical storage with 4 adjustable shelves.

- To add tackboard to niche, add **TB** to end of product code. **Add \$817** to list price for grades 1-3. Add **\$981** for grades 4-5.
- To add LED light to niche, add **LT** to end of product code. **Add \$981** to list price.

FW14070-20	20 x 140 x 70	100	779	96	<b>\$29802</b>
------------	---------------	-----	-----	----	----------------

Vertical storage with 4 adjustable shelves, 30" wide double height storage, 30" wide double height niche, 30" wide single height storage, vertical storage cabinet with 4 adjustable shelves, 15" wide double height storage, 15" wide double height niche, 15" wide single height storage, vertical storage with 4 adjustable shelves, 30" wide double height storage, 30" wide double height niche, 30" wide single height storage, vertical storage with 4 adjustable shelves.

- To add tackboard to niche, add **TB** to end of product code. **Add \$1616** to list price for grades 1-3. Add **\$1939** for grades 4-5.
- To add LED light to niche, add **LT** to end of product code. **Add \$1638** to list price.

### Required Specifications

Front finish  
Top/body finish  
Cubby interior finish

### Optional Specifications

Grommet  
LED light  
Tackboard

## WORK WALLS - 70"H

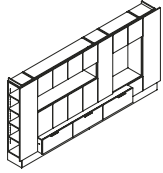

**Work Wall - 140"W**

MODEL#	DIMENSIONS D x W x H	FREIGHT CLASS	WT/LBS.	CUBIC FT.	LIST PRICE
FW14070-21L	20 x 140 x 70	100	832	96	<b>\$29802</b>

Vertical storage with 4 adjustable shelves, 60" wide double height storage, 60" wide niche, 60" wide single height storage, 15" wide triple height storage, 15" wide single height storage, 30" wide double height niche, 30" wide single height storage, 90" wide single height wall credenza with three files, vertical storage with 4 adjustable shelves.

- To add tackboard to niche, add **TB** to end of product code. **Add \$1901** to list price for grades 1-3. Add **\$2282** for grades 4-5.
- To add LED light to niche, add **LT** to end of product code. **Add \$1703** to list price.

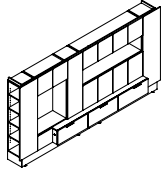

**Work Wall - 140"W**

FW14070-21R	20 x 140 x 70	100	832	96	<b>\$29802</b>
-------------	---------------	-----	-----	----	----------------

Vertical storage with 4 adjustable shelves, 15" wide single height storage, 30" wide double height niche, 30" wide single height storage, 90" wide single height wall credenza with three files, 15" wide triple height storage, 60" wide double height storage, 60" wide niche, 60" wide single height storage, vertical storage with 4 adjustable shelves.

- To add tackboard to niche, add **TB** to end of product code. **Add \$1901** to list price for grades 1-3. Add **\$2282** for grades 4-5.
- To add LED light to niche, add **LT** to end of product code. **Add \$1703** to list price.

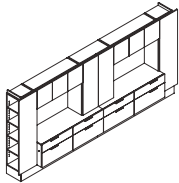

**Work Wall - 155"W**

FW15570-20	20 x 155 x 70	100	900	108	<b>\$29802</b>
------------	---------------	-----	-----	-----	----------------

Vertical storage with 4 adjustable shelves, 60" wide wall credenza with two box/files, 45" wide double height niche, 45" wide single height storage, 30" wide double width storage with 2 adj. shelves, 60" wide wall credenza with two box/files, 45" wide double height niche, 45" wide single height storage, vertical storage with 4 adjustable shelves.

- To add tackboard to niche, add **TB** to end of product code. **Add \$2436** to list price for grades 1-3. Add **\$2923** for grades 4-5.
- To add LED light to niche, add **LT** to end of product code. **Add \$1744** to list price.

## WORK WALLS - 84"H

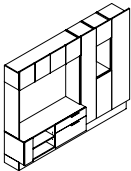

**Work Wall - 107"W**

MODEL#	DIMENSIONS	FREIGHT CLASS	WT/LBS.	CUBIC FT.	LIST PRICE
FW10784L	20 x 95 x 84	100	832	96	<b>\$27643</b>

60" wide wall credenza with adjustable shelf and box/file, 60" wide triple height niche, 60" wide single height storage, vertical storage with 5 adjustable shelves, triple height storage, 15" wide double height niche, single height storage, vertical storage with 5 adjustable shelves.

- To add tackboard to niche, add **TB** to end of product code. **Add \$1218** to list price for grades 1-3. Add **\$1462** for grades 4-5.
- To add LED light to niche, add **LT** to end of product code. **Add \$1218** to list price.

### Required Specifications

Front finish  
Top/body finish  
Cubby interior finish

### Optional Specifications

Grommet  
LED light  
Tackboard

## OPEN KNEE SPACE WORK WALLS

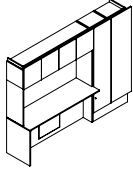

**Open Knee Space Work Wall - 92"W**

MODEL#	DIMENSIONS	FREIGHT CLASS	WT/LBS.	CUBIC FT.	LIST PRICE
	<b>D x W x H</b>				
FW927002R	20 x 92.5 x 84	100	832	96	<b>\$16297</b>

60" wide work surface wall credenza, 60" wide double height niche, 60" wide single height storage, vertical storage with 4 adjustable shelves, wardrobe with coat hook and hat shelf.

- To add tackboard to niche, add **TB** to end of product code. **Add \$1218** to list price for grades 1-3. Add **\$1462** for grades 4-5.
- To add LED light to niche, add **LT** to end of product code. **Add \$1218** to list price.

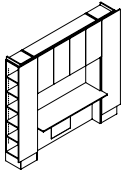

**Open Knee Space Work Wall - 95"W**

FW95840WR	20 x 95 x 84	100	832	96	<b>\$17021</b>
-----------	--------------	-----	-----	----	----------------

Vertical storage with 5 adjustable shelves, 60" wide work surface wall credenza, 60" wide double height niche, 60" wide double height storage, wardrobe with coat hook and hat shelf.

- To add tackboard to niche, add **TB** to end of product code. **Add \$1218** to list price for grades 1-3. Add **\$1462** for grades 4-5.
- To add LED light to niche, add **LT** to end of product code. **Add \$834** to list price.

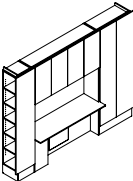

**Open Knee Space Work Wall - 110"W**

FW110840W2R	20 x 110 x 84	100	832	96	<b>\$19495</b>
-------------	---------------	-----	-----	----	----------------

Vertical storage with 5 adjustable shelves, 60" wide work surface wall credenza, 60" wide double height niche, 60" wide double height storage, double depth wardrobe with coat rod and hat shelf.

- To add tackboard to niche, add **TB** to end of product code. **Add \$1219** to list price for grades 1-3. Add **\$1463** for grades 4-5.
- To add LED light to niche, add **LT** to end of product code. **Add \$839** to list price.

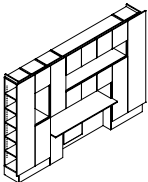

**Open Knee Space Work Wall - 125"W**

FW125840IL	20 x 110 x 84	100	832	96	<b>\$27471</b>
------------	---------------	-----	-----	----	----------------

Vertical storage with 5 adjustable shelves, triple height storage, 15" wide triple height storage, 15" wide double height niche, single high storage, 60" wide work surface wall credenza, 60" wide single height niche, triple height storage, 45" wide single height storage, 60" wide single height niche, 60" wide single height storage, triple height storage, wardrobe with coat hook and hat shelf.

- To add tackboard to niche, add **TB** to end of product code. **Add \$2398** to list price for grades 1-3. Add **\$2879** for grades 4-5.
- To add LED light to niche, add **LT** to end of product code. **Add \$2406** to list price.

### Required Specifications

Front finish  
Top/body finish  
Cubby interior finish

### Optional Specifications

Grommet  
LED light  
Tackboard



# F FOUNDATIONS

## WORK WALL CREDENZAS

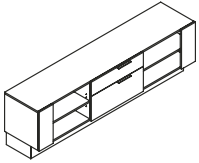

**Work Wall Credenza**

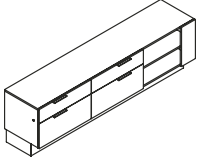

**Work Wall Credenza**

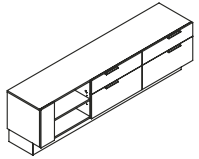

**Work Wall Credenza**

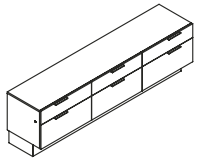

**Work Wall Credenza**

MODEL#	DIMENSIONS	FREIGHT CLASS	WT/LBS.	CUBIC FT.	LIST PRICE
--------	------------	---------------	---------	-----------	------------

	D x W x H				
FW9026-1	20 x 90 x 26	100	254	27	<b>\$9397</b>

Standard with adjustable shelf, box/file and adjustable shelf.

FW9026-2	20 x 90 x 26	92.5	270	27	<b>\$9798</b>
----------	--------------	------	-----	----	---------------

Standard with box/file, box/file and adjustable shelf.

FW9026-3	20 x 90 x 26	92.5	270	27	<b>\$9798</b>
----------	--------------	------	-----	----	---------------

Standard with adjustable shelf, box/file and box/file.

FW9026-4	20 x 90 x 26	92.5	310	27	<b>\$10395</b>
----------	--------------	------	-----	----	----------------

Standard with three box/file drawers. Center pedestal does not lock.

### Required Specifications

Front finish  
Top/body finish

### Optional Specifications

Grommet

## CONFERENCE ROOM FURNITURE - NOTES

D x W x H

- Horizontal grain direction is standard on all engineered finishes.
- Full Storage Credenza backs include GM17 vertical cut out
- Optional decorative credenza back panels (**FBP**) are available as a factory installed upgrade on FC/FCD models only.
- Doors open with touch latch
- To open the drawer, pull drawer front overhang - no handles available
- Display Wall can be purchased with optional monitor mount installed
- Mobile and stationary lecterns are available.
- Two Connecting Brackets are included.
- For optional light and microphone, see page 201 in the accessories section
- **Metal Leg finishes (conference furniture):**
  - BLKT Black Textured
  - TUNT Tungsten Textured
  - DWTT Designer White Textured
- **NOTE:** Arrow indicates direction of grain

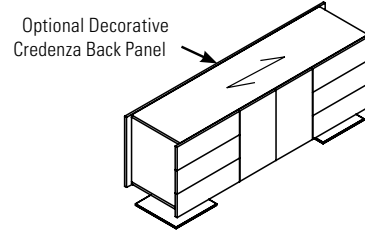

### CONFERENCE ROOM FURNITURE

MODEL# DIMENSIONS FREIGHT CLASS WT/LBS. CUBIC FT. LIST PRICE

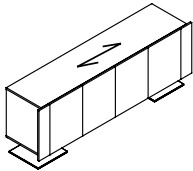

**Full Storage Credenza**

FC9020GG	20 x 90 x 29	125	241	36	<b>\$10595</b>
FC8420GG	20 x 84 x 29	125	232	33	<b>\$10175</b>
FC7820GG	20 x 78 x 29	125	223	31	<b>\$9445</b>
FC7220GG	20 x 72 x 29	125	213	29	<b>\$9189</b>
FC6020MM	20 x 60 x 29	125	194	26	<b>\$8528</b>

Standard with two sets of storage cabinets.

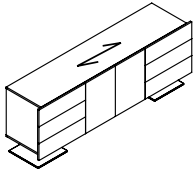

**Full Storage Credenza**

FCD9020A	20 x 90 x 29	125	249	36	<b>\$11226</b>
FCD8420A	20 x 84 x 29	125	240	33	<b>\$10809</b>
FCD7820A	20 x 78 x 29	125	230	31	<b>\$10036</b>
FCD7220A	20 x 72 x 29	125	221	29	<b>\$9820</b>
FCD6020A	20 x 60 x 29	125	202	26	<b>\$9167</b>

Standard with three box drawers on left, storage cabinets in center, and three box drawers on right.

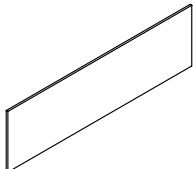

**Decorative Back Panel**

FBP9020	20 x 90 x 29	92.5	41	4	<b>\$1806</b>
FBP8420	20 x 84 x 29	100	38	4	<b>\$1715</b>
FBP7820	20 x 78 x 29	85	36	3	<b>\$1597</b>
FBP7220	20 x 72 x 29	92.5	33	3	<b>\$1391</b>
FBP6020	20 x 60 x 29	100	27	3	<b>\$1177</b>

For FC/FCD credenza models only. Not sold individually. Must be ordered as an upgrade option only.

### Required Specifications

Front finish  
Top/body finish  
Leg finish

## CONFERENCE ROOM FURNITURE

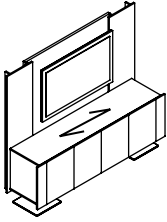

**Display Wall Storage Credenza**

MODEL#	DIMENSIONS D x W x H	FREIGHT CLASS	WT/LBS.	CUBIC FT.	LIST PRICE
FC9024GGTWH72	24 x 90 x 72	100	463	47	<b>\$16421</b>
FC8424GGTWH72	24 x 84 x 72	92.5	460	45	<b>\$15642</b>
FC7824GGTWH72	24 x 78 x 72	125	286	41	<b>\$14526</b>
FC7224GGTWH72	24 x 72 x 72	92.5	418	39	<b>\$14088</b>

FC9024GGTWH66	24 x 90 x 66	100	444	48	<b>\$15851</b>
FC8424GGTWH66	24 x 84 x 66	100	422	45	<b>\$15228</b>
FC7824GGTWH66	24 x 78 x 66	100	402	42	<b>\$14138</b>
FC7224GGTWH66	24 x 72 x 66	100	381	39	<b>\$13701</b>

With two sets of storage cabinets and display wall. Monitors and TV mounts are not included. Display wall includes GM1 grommet.

Monitor size chart based on display wall size:

Display Wall Width	Monitor Size
90"	54"
84"	50"
78"	46"
72"	42"

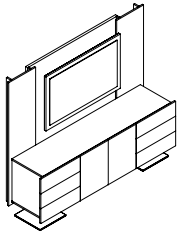

**Display Wall Storage Credenza**

FCD9024ATWH72	24 x 90 x 72	92.5	481	48	<b>\$16673</b>
FCD8424ATWH72	24 x 84 x 72	92.5	460	45	<b>\$15895</b>
FCD7824ATWH72	24 x 78 x 72	92.5	439	42	<b>\$13259</b>
FCD7224ATWH72	24 x 72 x 72	100	381	39	<b>\$14293</b>

FCD9024ATWH66	24 x 90 x 66	100	444	48	<b>\$16106</b>
FCD8424ATWH66	24 x 84 x 66	100	422	45	<b>\$15479</b>
FCD7824ATWH66	24 x 78 x 66	100	402	42	<b>\$14394</b>
FCD7224ATWH66	24 x 72 x 66	100	381	39	<b>\$13955</b>

With three box drawers on left, storage cabinets in center, and three box drawers on right, and display wall. Monitors and TV mounts are not included. Display wall includes GM1 grommet.

Monitor size chart based on display wall size:

Display Wall Width	Monitor Size
90"	54"
84"	50"
78"	46"
72"	42"

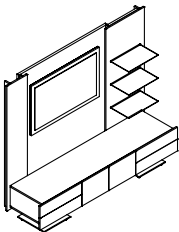

**Display Wall Storage Credenza**

FFTWA90WH72	24 x 90 x 72	92.5	482	41	<b>\$17453</b>
FFTWA84WH72	24 x 84 x 72	85	462	38	<b>\$16857</b>
FFTWA78WH72	24 x 78 x 72	85	442	35	<b>\$15986</b>
FFTWA72WH72	24 x 72 x 72	85	421	32	<b>\$15030</b>

FFTWA90WH66	24 x 90 x 66	92.5	462	40	<b>\$16887</b>
FFTWA84WH66	24 x 84 x 66	92.5	443	37	<b>\$16290</b>
FFTWA78WH66	24 x 78 x 66	85	424	34	<b>\$15453</b>
FFTWA72WH66	24 x 72 x 66	85	404	31	<b>\$14586</b>

With two box drawers on left, storage cabinets in center, and two box drawers on right, and display wall with shelves. Monitors and TV mounts are not included. Display wall includes GM1 grommet.

Monitor size chart based on display wall size:

Display Wall Width	Monitor Size
90"	54"
84"	50"
78"	46"
72"	42"

### Required Specifications

Front/wall finish  
Top/body finish  
Leg finish

## CONFERENCE ROOM ACCESSORIES

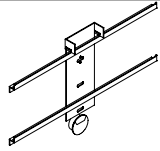

**Flat Screen Monitor Mount**

MODEL#	DIMENSIONS	FREIGHT CLASS	WT/LBS.	CUBIC FT.	LIST PRICE
FVMED	D x W x H 2 x 28 x 17	70	14	0.7	<b>\$735</b>

Flat screen monitor mount up to 50". To be used on Foundations display wall storage credenzas. GM1K (tungsten) grommet on the back panel is included.

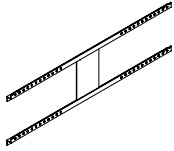

**Flat Screen Monitor Mount**

FVLRG	2 x 38 x 21	60	25	0.75	<b>\$611</b>
-------	-------------	----	----	------	--------------

Flat screen monitor mount for over 50". To be used on Foundations display wall storage credenzas.

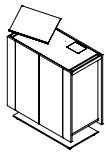

**Lectern\***

FLEC36	20 x 36 x 42	125	166	22	<b>\$10140</b>
--------	--------------	-----	-----	----	----------------

With pop-up door to reveal concealed power/data monument (power duplex, 15 pin VGA, data and telephone connectors). Optional light and/or microphone to be specified. Metal finish on base, book rest and handles must be specified. Includes 1 adjustable shelf.

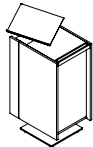

**Lectern\***

FLEC24	20 x 24 x 42	100	135	15	<b>\$8367</b>
--------	--------------	-----	-----	----	---------------

With laptop pull-out tray to reveal concealed power/data monument (power duplex, 15 pin VGA, data and telephone connectors). Optional light and/or microphone to be specified. Metal finish on base, book rest and handles must be specified. Includes 1 adjustable shelf.

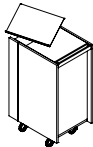

**Mobile Lectern\***

FLEC24M	20 x 24 x 42	100	135	15	<b>\$6198</b>
---------	--------------	-----	-----	----	---------------

With laptop pull-out tray. Optional light and/or microphone to be specified. Metal finish on base, book rest and handles must be specified. Includes 1 adjustable shelf. Locking casters (Tungsten only).

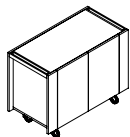

**Mobile Server\***

FSM4020	20 x 40 x 30	150	108	21	<b>\$6753</b>
---------	--------------	-----	-----	----	---------------

With cutlery drawer and adjustable shelf. Metal finish on handles must be specified. Locking casters (Tungsten only).

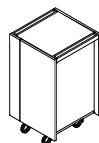

**Mobile Tech Cart**

FTCM2020H42	20 x 20 x 42	150	67	13.5	<b>\$4921</b>
FTCM2020H36	20 x 20 x 36	150	54	10.5	<b>\$4219</b>

Metal finish on handles must be specified. Includes 1 adjustable shelf. Locking casters (Tungsten only).

**Required Specifications**

Front finish  
Top/body finish  
Metal finish\*

**Optional Specifications**

Light\*  
Microphone\*

# F FOUNDATIONS

## BOARDROOM TABLES - NOTES

D x W x H

- Table tops are 1.5" thick with a 2" undercut knife edge.

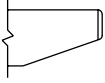

- All tops have a 1/8" (3mm) solid edge of walnut, cherry, maple and oak
- See notes section for optional grommet locations on tables without technology trough
- See "Technology Trough Details" on page 150
- For tables with 3 bases and technology trough, add **C** (for center base feed) or **E** (for end base feed) to the end of the model number (Example: FRESTCT19298**C**)
- **NOTE:** Arrow indicates direction of grain

### BOARDROOM TABLES - RECTANGULAR

MODEL# DIMENSIONS FREIGHT CLASS WT/LBS. CUBIC FT. LIST PRICE

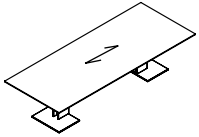

Rectangular Table

FRE12048	48 x 120 x 29	100	450	54	<b>\$14359</b>
FRE9648	48 x 96 x 29	125	390	49	<b>\$13001</b>

One piece top. Two bases.

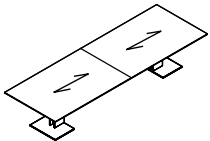

Rectangular Table

FRE16848	48 x 168 x 29	100	571	65	<b>\$17540</b>
FRE14448	48 x 144 x 29	100	511	60	<b>\$15880</b>
FRE12048-2	48 x 120 x 29	100	450	56	<b>\$14549</b>

Two piece top. Two bases.

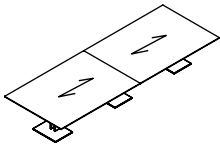

Rectangular Table

FRE24060	60 x 240 x 29	100	965	109	<b>\$27998</b>
FRE21660	60 x 216 x 29	100	893	104	<b>\$26428</b>
FRE19260	60 x 192 x 29	100	821	99	<b>\$24805</b>
FRE16860	60 x 168 x 29	100	748	93	<b>\$23201</b>
FRE21648	48 x 216 x 29	92.5	872	87	<b>\$24252</b>
FRE19248	48 x 192 x 29	100	744	82	<b>\$22812</b>

Two piece top. Three bases.

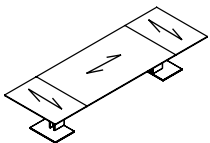

Rectangular Table, Sectional\*

FREST16848	48 x 168 x 29	100	571	65	<b>\$17875</b>
FREST14448	48 x 144 x 29	100	511	60	<b>\$16459</b>
FREST12048	48 x 120 x 29	100	450	54	<b>\$15031</b>

Three piece top. Two bases.

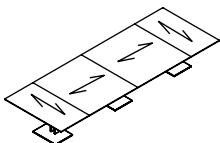

Rectangular Table, Sectional\*

FREST24060	60 x 240 x 29	100	965	109	<b>\$27998</b>
FREST21660	60 x 216 x 29	100	893	104	<b>\$26428</b>
FREST19260	60 x 192 x 29	100	821	99	<b>\$24805</b>
FREST16860	60 x 168 x 29	100	748	93	<b>\$23201</b>
FREST21648	48 x 216 x 29	92.5	872	87	<b>\$24252</b>
FREST19248	48 x 192 x 29	100	744	82	<b>\$22812</b>

Four piece top. Three bases.  
 • 168"W table - midsection is one piece

#### Required Specifications

Top finish/base side finish  
 Base end finish  
 Metal finish

#### Optional Specifications

Grommet

## BOARDROOM TABLES - RECTANGULAR

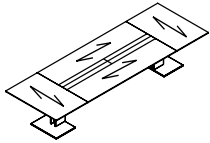

**Rectangular Table, Sectional**

MODEL#	DIMENSIONS	FREIGHT CLASS	WT/LBS.	CUBIC FT.	LIST PRICE
--------	------------	---------------	---------	-----------	------------

**D x W x H**

FRESTCT16848	48 x 168 x 29	100	659	69	<b>\$27276</b>
FRESTCT14448	48 x 144 x 29	100	584	63	<b>\$21852</b>
FRESTCT12048	48 x 120 x 29	100	508	57	<b>\$20259</b>

Four piece top. Two bases / power kit included.

- 168"W table includes technology trough with 8 doors
- 144"W and 120" tables include technology trough with 4 doors

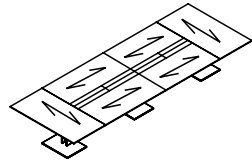

**Rectangular Table, Sectional**

FRESTCT24060	60 x 240 x 29	100	1113	116	<b>\$39872</b>
FRESTCT21660	60 x 216 x 29	100	1021	109	<b>\$37755</b>
FRESTCT19260	60 x 192 x 29	100	920	103	<b>\$35464</b>
FRESTCT16860	60 x 168 x 29	100	836	96	<b>\$33101</b>
FRESTCT21648	48 x 216 x 29	92.5	1000	92	<b>\$35770</b>
FRESTCT19248	48 x 192 x 29	100	843	87	<b>\$33691</b>

Six piece top. Three bases. Add **C** or **E** to end of model number to specify base feed location. Includes technology trough with 8 doors.

- 168"W table - midsection is one piece

## BOARDROOM TABLES - BOW END

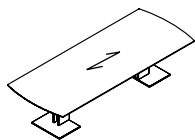

**Bow End Table**

MODEL#	DIMENSIONS	FREIGHT CLASS	WT/LBS.	CUBIC FT.	LIST PRICE
--------	------------	---------------	---------	-----------	------------

FREBE12048	48 x 120 x 29	100	450	54	<b>\$15076</b>
FREBE9648	48 x 96 x 29	125	390	49	<b>\$13651</b>

One piece top. Two bases.

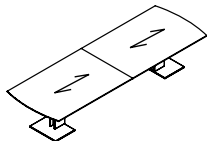

**Bow End Table**

FREBE16848	48 x 168 x 29	100	571	65	<b>\$18414</b>
FREBE14448	48 x 144 x 29	100	511	60	<b>\$16674</b>
FREBE12048-2	48 x 120 x 29	100	450	56	<b>\$15277</b>

Two piece top. Two bases.

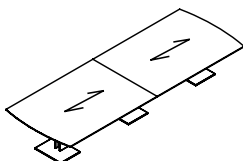

**Bow End Table**

FREBE24060	60 x 240 x 29	100	965	109	<b>\$29396</b>
FREBE21660	60 x 216 x 29	100	893	104	<b>\$27748</b>
FREBE19260	60 x 192 x 29	100	821	99	<b>\$26045</b>
FREBE16860	60 x 168 x 29	100	748	93	<b>\$24361</b>
FREBE21648	48 x 216 x 29	92.5	872	87	<b>\$25464</b>
FREBE19248	48 x 192 x 29	100	744	82	<b>\$23951</b>

Two piece top. Three bases.

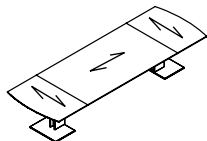

**Bow End Table, Sectional**

FREBEST16848	48 x 168 x 29	100	571	65	<b>\$18770</b>
FREBEST14448	48 x 144 x 29	100	511	60	<b>\$17281</b>
FREBEST12048	48 x 120 x 29	100	450	54	<b>\$15784</b>

Three piece top. Two bases.

### Required Specifications

Top finish/base side finish  
Base end finish  
Metal finish

### Optional Specifications

Grommet

# F FOUNDATIONS

## BOARDROOM TABLES - BOW END

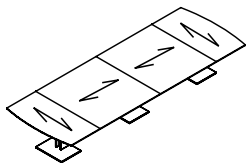

**Bow End Table, Sectional**

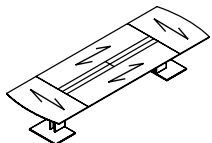

**Bow End Table, Sectional**

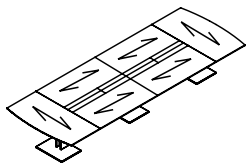

**Bow End Table, Sectional**

MODEL#	DIMENSIONS D x W x H	FREIGHT CLASS	WT/LBS.	CUBIC FT.	LIST PRICE
FREBEST24060	60 x 240 x 29	100	965	109	<b>\$30030</b>
FREBEST21660	60 x 216 x 29	100	893	104	<b>\$28349</b>
FREBEST19260	60 x 192 x 29	100	821	99	<b>\$26459</b>
FREBEST16860	60 x 168 x 29	100	748	93	<b>\$24646</b>
FREBEST21648	48 x 216 x 29	92.5	872	87	<b>\$26160</b>
FREBEST19248	48 x 192 x 29	100	744	82	<b>\$24545</b>

Four piece top. Three bases.  
 • 168"W table - midsection is one piece

FREBESTCT16848	48 x 168 x 29	100	659	69	<b>\$28640</b>
FREBESTCT14448	48 x 144 x 29	100	584	63	<b>\$22942</b>
FREBESTCT12048	48 x 120 x 29	100	508	57	<b>\$21271</b>

Four piece top. Two bases / power kit included.  
 • 168"W table includes technology trough with 8 doors  
 • 144"W and 120" tables include technology trough with 4 doors

FREBESTCT24060	60 x 240 x 29	100	1113	116	<b>\$41863</b>
FREBESTCT21660	60 x 216 x 29	100	1021	109	<b>\$39640</b>
FREBESTCT19260	60 x 192 x 29	100	920	103	<b>\$37238</b>
FREBESTCT16860	60 x 168 x 29	100	836	96	<b>\$34755</b>
FREBESTCT21648	48 x 216 x 29	92.5	1000	92	<b>\$37558</b>
FREBESTCT19248	48 x 192 x 29	100	843	87	<b>\$35373</b>

Six piece top. Three bases. Add **C** or **E** to end of model number to specify base feed location. Includes technology trough with 8 doors.  
 • 168"W table - midsection is one piece

## BOARDROOM TABLES - BOAT SHAPED

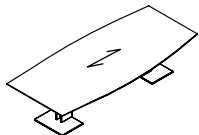

**Boat Shaped Table**

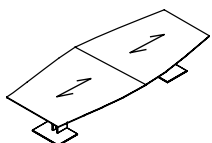

**Boat Shaped Table**

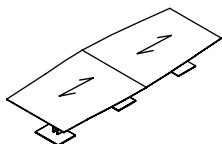

**Boat Shaped Table**

MODEL#	DIMENSIONS	FREIGHT CLASS	WT/LBS.	CUBIC FT.	LIST PRICE
FBO12048	48 x 120 x 29	100	450	54	<b>\$15827</b>
FBO9648	48 x 96 x 29	125	390	49	<b>\$14332</b>

One piece top. Two bases.

FBO16848	48 x 168 x 29	100	571	65	<b>\$19333</b>
FBO14448	48 x 144 x 29	100	511	60	<b>\$17506</b>
FBO12048-2	48 x 120 x 29	100	450	56	<b>\$16038</b>

Two piece top. Two bases.

FBO24060	60 x 240 x 29	100	965	109	<b>\$30864</b>
FBO21660	60 x 216 x 29	100	893	104	<b>\$29134</b>
FBO19260	60 x 192 x 29	100	821	99	<b>\$27346</b>
FBO16860	60 x 168 x 29	100	748	93	<b>\$25574</b>
FBO21648	48 x 216 x 29	92.5	872	87	<b>\$26735</b>
FBO19248	48 x 192 x 29	100	744	82	<b>\$25149</b>

Two piece top. Three bases.

### Required Specifications

Top finish/base side finish  
 Base end finish  
 Metal finish

### Optional Specifications

Grommet

## BOARDROOM TABLES - BOAT SHAPED

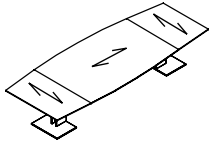

**Boat Shaped Table, Sectional**

MODEL#	DIMENSIONS	FREIGHT CLASS	WT./LBS.	CUBIC FT.	LIST PRICE
--------	------------	---------------	----------	-----------	------------

**D x W x H**

FBOST16848	48 x 168 x 29	100	571	65	<b>\$19709</b>
FBOST14448	48 x 144 x 29	100	511	60	<b>\$18145</b>
FBOST12048	48 x 120 x 29	100	450	54	<b>\$16572</b>

Three piece top. Two bases.

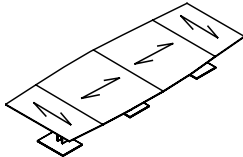

**Boat Shaped Table, Sectional**

FBOST24060	60 x 240 x 29	100	965	109	<b>\$31532</b>
FBOST21660	60 x 216 x 29	100	893	104	<b>\$29765</b>
FBOST19260	60 x 192 x 29	100	821	99	<b>\$27781</b>
FBOST16860	60 x 168 x 29	100	748	93	<b>\$25876</b>
FBOST21648	48 x 216 x 29	92.5	872	87	<b>\$27464</b>
FBOST19248	48 x 192 x 29	100	744	82	<b>\$25771</b>

Four piece top. Three bases.

- 168"W table - midsection is one piece

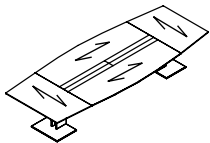

**Boat Shaped Table, Sectional**

FBOSTCT16848	48 x 168 x 29	100	659	69	<b>\$30072</b>
FBOSTCT14448	48 x 144 x 29	100	584	63	<b>\$24086</b>
FBOSTCT12048	48 x 120 x 29	100	508	57	<b>\$22335</b>

Four piece top. Two bases / power kit included.

- 168"W table includes technology trough with 8 doors
- 144"W and 120" tables include technology trough with 4 doors

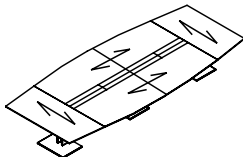

**Boat Shaped Table, Sectional**

FBOSTCT24060	60 x 240 x 29	100	1113	116	<b>\$43954</b>
FBOSTCT21660	60 x 216 x 29	92.5	1021	91	<b>\$41619</b>
FBOSTCT19260	60 x 192 x 29	100	920	103	<b>\$39099</b>
FBOSTCT16860	60 x 168 x 29	100	836	96	<b>\$36491</b>
FBOSTCT21648	48 x 216 x 29	92.5	1000	92	<b>\$38925</b>
FBOSTCT19248	48 x 192 x 29	100	843	87	<b>\$37141</b>

Six piece top. Three bases. Add **C** or **E** to end of model number to specify base feed location. Includes technology trough with 8 doors.

- 168"W table - midsection is one piece

## BOARDROOM TABLES - BOAT SHAPED, BOW END

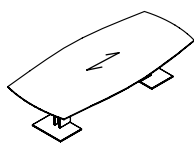

**Boat Shaped Table, Bow End**

MODEL#	DIMENSIONS	FREIGHT CLASS	WT./LBS.	CUBIC FT.	LIST PRICE
--------	------------	---------------	----------	-----------	------------

FBOBE12048	48 x 120 x 29	100	450	54	<b>\$16362</b>
FBOBE9648	48 x 96 x 29	125	390	49	<b>\$14795</b>

One piece top. Two bases.

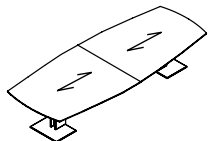

**Boat Shaped Table, Bow End**

FBOBE16848	48 x 168 x 29	100	571	65	<b>\$20044</b>
FBOBE14448	48 x 144 x 29	100	511	60	<b>\$18130</b>
FBOBE12048-2	48 x 120 x 29	100	450	56	<b>\$16585</b>

Two piece top. Two bases.

### Required Specifications

Top finish/base side finish  
Base end finish  
Metal finish

### Optional Specifications

Grommet



# F FOUNDATIONS

## BOARDROOM TABLES - BOAT SHAPED, BOW END

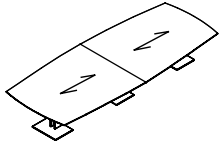

**Boat Shaped Table, Bow End**

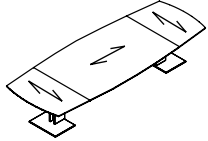

**Boat Shaped Table, Bow End, Sectional**

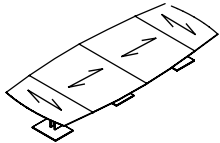

**Boat Shaped Table, Bow End, Sectional**

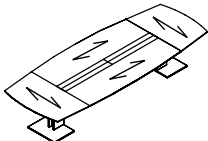

**Boat Shaped Table, Bow End, Sectional**

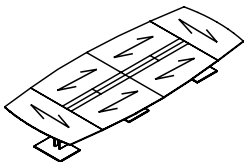

**Boat Shaped Table, Bow End, Sectional**

MODEL#	DIMENSIONS D x W x H	FREIGHT CLASS	WT/LBS.	CUBIC FT.	LIST PRICE
FBOBE24060	60 x 240 x 29	100	965	109	<b>\$32155</b>
FBOBE21660	60 x 216 x 29	100	893	104	<b>\$30332</b>
FBOBE19260	60 x 192 x 29	100	821	99	<b>\$28459</b>
FBOBE16860	60 x 168 x 29	100	748	93	<b>\$26600</b>
FBOBE21648	48 x 216 x 29	92.5	872	87	<b>\$27814</b>
FBOBE19248	48 x 192 x 29	100	744	82	<b>\$26152</b>

Two piece top. Three bases.

FBOBEST16848	48 x 168 x 29	100	571	65	<b>\$20438</b>
FBOBEST14448	48 x 144 x 29	100	511	60	<b>\$18798</b>
FBOBEST12048	48 x 120 x 29	100	450	54	<b>\$17135</b>

Three piece top. Two bases.

FBOBEST24060	60 x 240 x 29	100	965	109	<b>\$32856</b>
FBOBEST21660	60 x 216 x 29	100	893	104	<b>\$30996</b>
FBOBEST19260	60 x 192 x 29	100	821	99	<b>\$28650</b>
FBOBEST16860	60 x 168 x 29	100	748	93	<b>\$26917</b>
FBOBEST21648	48 x 216 x 29	92.5	872	87	<b>\$28585</b>
FBOBEST19248	48 x 192 x 29	100	744	82	<b>\$26802</b>

Four piece top. Three bases.

- 168"W table - midsection is one piece

FBOBESTCT16848	48 x 168 x 29	100	659	69	<b>\$31320</b>
FBOBESTCT14448	48 x 144 x 29	100	584	63	<b>\$25038</b>
FBOBESTCT12048	48 x 120 x 29	100	508	57	<b>\$23196</b>

Four piece top. Two bases / power kit included.

- 168"W table includes technology trough with 8 doors
- 144"W and 120" tables include technology trough with 4 doors

FBOBESTCT24060	60 x 240 x 29	100	1113	116	<b>\$45897</b>
FBOBESTCT21660	60 x 216 x 29	100	1021	109	<b>\$43446</b>
FBOBESTCT19260	60 x 192 x 29	100	920	103	<b>\$40797</b>
FBOBESTCT16860	60 x 168 x 29	100	836	96	<b>\$38075</b>
FBOBESTCT21648	48 x 216 x 29	92.5	1000	92	<b>\$40618</b>
FBOBESTCT19248	48 x 192 x 29	100	843	87	<b>\$38741</b>

Six piece top. Three bases. Add **C** or **E** to end of model number to specify base feed location. Includes technology trough with 8 doors.

- 168"W table - midsection is one piece

### Required Specifications

Top finish/base side finish  
Base end finish  
Metal finish

### Optional Specifications

Grommet

## BOARDROOM TABLES - RACETRACK

MODEL#	DIMENSIONS	FREIGHT CLASS	WT/LBS.	CUBIC FT.	LIST PRICE
--------	------------	---------------	---------	-----------	------------

D x W x H

FRA12048	48 x 120 x 29	100	450	54	<b>\$16619</b>
FRA9648	48 x 96 x 29	125	390	49	<b>\$15050</b>

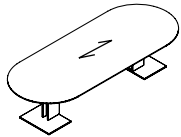

**Racetrack Table**

One piece top. Two bases.

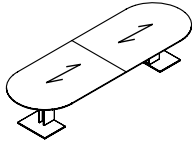

**Racetrack Table**

FRA16848	48 x 168 x 29	100	571	65	<b>\$20298</b>
FRA14448	48 x 144 x 29	100	511	60	<b>\$18380</b>
FRA12048-2	48 x 120 x 29	100	450	56	<b>\$16840</b>

Two piece top. Two bases.

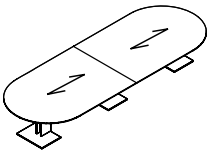

**Racetrack Table**

FRA24060	60 x 240 x 29	100	965	109	<b>\$32409</b>
FRA21660	60 x 216 x 29	100	893	104	<b>\$30587</b>
FRA19260	60 x 192 x 29	100	821	99	<b>\$28713</b>
FRA16860	60 x 168 x 29	100	748	93	<b>\$26851</b>
FRA21648	48 x 216 x 29	92.5	872	87	<b>\$28070</b>
FRA19248	48 x 192 x 29	100	744	82	<b>\$26404</b>

Two piece top. Three bases.

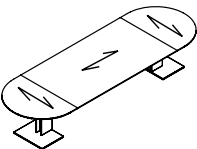

**Racetrack Table, Sectional**

FRAST16848	48 x 168 x 29	100	571	65	<b>\$20689</b>
FRAST14448	48 x 144 x 29	100	511	60	<b>\$19052</b>
FRAST12048	48 x 120 x 29	100	450	54	<b>\$17391</b>

Three piece top. Two bases.

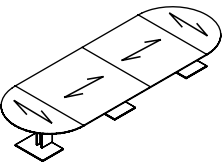

**Racetrack Table, Sectional**

FRAST24060	60 x 240 x 29	100	965	109	<b>\$33108</b>
FRAST21660	60 x 216 x 29	100	893	104	<b>\$31253</b>
FRAST19260	60 x 192 x 29	100	821	99	<b>\$28904</b>
FRAST16860	60 x 168 x 29	100	748	93	<b>\$27170</b>
FRAST21648	48 x 216 x 29	92.5	872	87	<b>\$28839</b>
FRAST19248	48 x 192 x 29	100	744	82	<b>\$27058</b>

Four piece top. Three bases.

- 168"W table - midsection is one piece

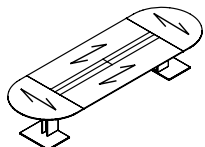

**Racetrack Table, Sectional**

FRASTCT16848	48 x 168 x 29	100	659	69	<b>\$31574</b>
FRASTCT14448	48 x 144 x 29	100	584	63	<b>\$25291</b>
FRASTCT12048	48 x 120 x 29	100	508	57	<b>\$23449</b>

Four piece top. Two bases / power kit included.

- 168"W table includes technology trough with 8 doors
- 144"W and 120" tables include technology trough with 4 doors

### Required Specifications

Top finish/base side finish  
Base end finish  
Metal finish

### Optional Specifications

Grommet

# F FOUNDATIONS

## BOARDROOM TABLES - RACETRACK

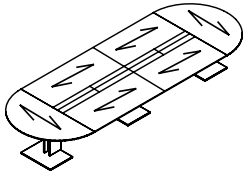

**Racetrack Table, Sectional**

MODEL#	DIMENSIONS D x W x H	FREIGHT CLASS	WT/LBS.	CUBIC FT.	LIST PRICE
FRASTCT24060	60 x 240 x 29	100	1113	116	<b>\$46152</b>
FRASTCT21660	60 x 216 x 29	100	1021	109	<b>\$43698</b>
FRASTCT19260	60 x 192 x 29	100	920	103	<b>\$41052</b>
FRASTCT16860	60 x 168 x 29	100	836	96	<b>\$38311</b>
FRASTCT21648	48 x 216 x 29	92.5	1000	92	<b>\$40872</b>
FRASTCT19248	48 x 192 x 29	100	843	87	<b>\$38998</b>

Six piece top. Three bases. Add **C** or **E** to end of model number to specify base feed location. Includes technology trough with 8 doors.

- 168"W table - midsection is one piece

## BOARDROOM TABLES - WEDGE

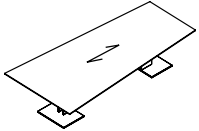

**Wedge Table**

MODEL#	DIMENSIONS	FREIGHT CLASS	WT/LBS.	CUBIC FT.	LIST PRICE
FWE1206048	60-48 x 120 x 29	100	511	60	<b>\$14610</b>

One piece top. Two bases.

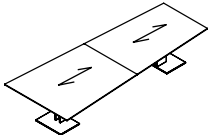

**Wedge Table**

FWE1446048	48 x 144 x 29	100	571	65	<b>\$17793</b>
FWE1206048-2	48 x 120 x 29	100	511	60	<b>\$16134</b>

Two piece top. Two bases.

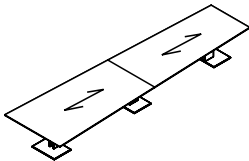

**Wedge Table**

FWE2406048	60-48 x 240 x 29	100	1037	114	<b>\$28252</b>
FWE2166048	60-48 x 216 x 29	100	965	109	<b>\$26679</b>
FWE1926048	60-48 x 192 x 29	100	893	104	<b>\$25058</b>
FWE1686048	60-48 x 168 x 29	100	630	70	<b>\$23452</b>

Two piece top. Three bases.

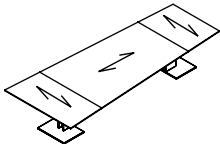

**Wedge Table, Sectional**

FWEST1446048	60-48 x 144 x 29	100	571	65	<b>\$18132</b>
FWEST1206048	60-48 x 120 x 29	100	511	60	<b>\$16716</b>

Three piece top. Two bases.

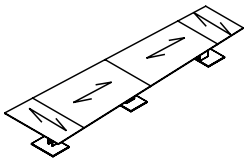

**Wedge Table, Sectional**

FWEST2406048	60-48 x 240 x 29	100	1037	114	<b>\$28351</b>
FWEST2166048	60-48 x 216 x 29	100	965	109	<b>\$27254</b>
FWEST1926048	60-48 x 192 x 29	100	893	104	<b>\$26459</b>
FWEST1686048	60-48 x 168 x 29	100	630	70	<b>\$23726</b>

Four piece top. Three bases.

- 168"W table - midsection is one piece

### Required Specifications

Top finish/base side finish  
Base end finish  
Metal finish

### Optional Specifications

Grommet

## BOARDROOM TABLES - WEDGE

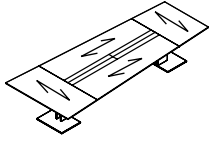

**Wedge Table, Sectional\***

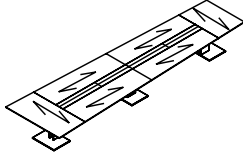

**Wedge Table, Sectional\***

MODEL#	DIMENSIONS	FREIGHT CLASS	WT/LBS.	CUBIC FT.	LIST PRICE
--------	------------	---------------	---------	-----------	------------

**D x W x H**

FWESTCT1446048	60-48 x 144 x 29	100	571	65	<b>\$27541</b>
FWESTCT1206048	60-48 x 120 x 29	100	511	60	<b>\$22105</b>

Four piece top. Two bases / power kit included. Includes technology trough with 4 doors

FWESTCT2406048	60 x 240 x 29	100	1037	114	<b>\$40125</b>
FWESTCT2166048	60 x 216 x 29	100	965	109	<b>\$38007</b>
FWESTCT1926048	60 x 192 x 29	100	893	104	<b>\$35464</b>
FWESTCT1686048	60 x 168 x 29	100	823	99	<b>\$33352</b>

Six piece top. Three bases. Add **C** or **E** to end of model number to specify base feed location. Includes technology trough with 8 doors.

- 168"W table - midsection is one piece

## BOARDROOM TABLES - SQUARE

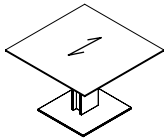

**Square Table**

MODEL#	DIMENSIONS	FREIGHT CLASS	WT/LBS.	CUBIC FT.	LIST PRICE
--------	------------	---------------	---------	-----------	------------

FRE6060	60 x 60 x 29	150	261	44	<b>\$8518</b>
FRE5454	54 x 54 x 29	150	233	42	<b>\$7950</b>
FRE4848	48 x 48 x 29	150	207	40	<b>\$7354</b>
FRE4242	42 x 42 x 29	150	185	39	<b>\$6906</b>

One base. No grommet option available.

## BOARDROOM TABLES - ROUND

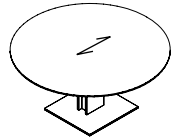

**Round Table**

MODEL#	DIMENSIONS	FREIGHT CLASS	WT/LBS.	CUBIC FT.	LIST PRICE
--------	------------	---------------	---------	-----------	------------

FRO60	60 x 60 x 29	150	261	44	<b>\$8943</b>
FRO54	54 x 54 x 29	150	233	42	<b>\$8348</b>
FRO48	48 x 48 x 29	150	207	40	<b>\$7721</b>
FRO42	42 x 42 x 29	150	185	39	<b>\$7252</b>

One base. No grommet option available.

**Required Specifications**

Top finish/base side finish  
Base end finish  
Metal finish

**Optional Specifications**

Grommet\*

POWER/DATA



Single Sided Recessed Power Block

MODEL#	DIMENSIONS D x W x H	FREIGHT CLASS	WT/LBS.	CUBIC FT.	LIST PRICE
PRTMCS401B	4.22 x 10.78 x 4.86	100	4.3	0.51	<b>\$456</b>
PRTMCS401T	4.22 x 10.78 x 4.86	100	4.3	0.51	<b>\$456</b>
PRTMCS401W	4.22 x 10.78 x 4.86	100	4.3	0.51	<b>\$456</b>

Single-sided recessed power block with **one regular duplex and one telecom knockout on top; one power duplex on bottom**. 10' power cord with straight plug. Specify telecom options separately. Available in Black (**B**), Tungsten (**T**) or Designer White (**W**) as indicated by the last letter of model number. Duplexes always Grey. Corresponding cut-out options are **R1, R2** or **R3**. Units are not approved for daisy chaining. UL listed: UL 1363.



Single Sided Recessed Power Block - USB-A + USB-C

PRTMCS421B	4.22 x 10.78 x 4.86	100	4.3	0.51	<b>\$599</b>
PRTMCS421T	4.22 x 10.78 x 4.86	100	4.3	0.51	<b>\$599</b>
PRTMCS421W	4.22 x 10.78 x 4.86	100	4.3	0.51	<b>\$599</b>

Single-sided recessed power block with **one power/USB-A/USB-C duplex and one telecom knockout on top; one power duplex on bottom**. USB-A port charges max 2.4 amps at 5V and USB-C port charges max 3 amps at 5V. 10' power cord with straight plug. Specify telecom options separately. Available in Black (**B**), Tungsten (**T**) or Designer White (**W**) as indicated by the last letter of model number. Duplexes always Grey (duplex with USB ports is glossy finish). Corresponding cut-out options are **R1, R2** or **R3**. Units are not approved for daisy chaining. UL listed: UL 1363.



Double Sided Recessed Power Block

PRTMCD602B	6.22 x 10.78 x 4.86	92.5	5.9	0.51	<b>\$521</b>
PRTMCD602T	6.22 x 10.78 x 4.86	92.5	5.9	0.51	<b>\$521</b>
PRTMCD602W	6.22 x 10.78 x 4.86	92.5	5.9	0.51	<b>\$521</b>

Double-sided recessed power block with **two regular power duplexes and two telecom knockouts on top; one power duplex on bottom**. 10' power cord with straight plug. Specify telecom options separately. Available in Black (**B**), Tungsten (**T**) or Designer White (**W**) as indicated by last letter of model number. Duplexes always Grey. Corresponding cut-out options are **T1, T2** or **T3**. Units are not approved for daisy chaining. UL listed: UL 1363.



Double Sided Recessed Power Block - USB-A + USB-C

PRTMCD622B	6.22 x 10.78 x 4.86	92.5	6.1	0.51	<b>\$656</b>
PRTMCD622T	6.22 x 10.78 x 4.86	92.5	6.1	0.51	<b>\$656</b>
PRTMCD622W	6.22 x 10.78 x 4.86	92.5	6.1	0.51	<b>\$656</b>

Double-sided recessed power block with **one regular power duplex, one power/USB-A/USB-C duplex and two telecom knockouts on top; one power duplex on bottom**. USB-A port charges max 2.4 amps at 5V and USB-C port charges max 3 amps at 5V. 10' power cord with straight plug. Specify telecom options separately. Available in Black (**B**), Tungsten (**T**) or Designer White (**W**) as indicated by last letter of model number. Duplexes always Grey (duplex with USB ports is glossy finish). Corresponding cut-out options are **T1, T2** or **T3**. Units are not approved for daisy chaining. UL listed: UL 1363.



Double Sided Recessed Power Block - USB-A + USB-C

PRTMCD642B	6.22 x 10.78 x 4.86	85	6.3	0.51	<b>\$790</b>
PRTMCD642T	6.22 x 10.78 x 4.86	85	6.3	0.51	<b>\$790</b>
PRTMCD642W	6.22 x 10.78 x 4.86	85	6.3	0.51	<b>\$790</b>

Double-sided recessed power block with **two power/USB-A/USB-C duplexes and two telecom knockouts on top; one power duplex on bottom**. USB-A port charges max 2.4 amps at 5V and USB-C port charges max 3 amps at 5V. 10' power cord with straight plug. Specify telecom options separately. Available in Black (**B**), Tungsten (**T**) or Designer White (**W**) as indicated by last letter of model number. Duplexes always Grey (duplex with USB ports is glossy finish). Corresponding cut-out options are **T1, T2** or **T3**. Units are not approved for daisy chaining. UL listed: UL 1363.

**Required Specifications**

Finish

ACCESSORIES

MODEL# DIMENSIONS FREIGHT CLASS WT/LBS. CUBIC FT. LIST PRICE



LED Snake Light with Dimmer

	D x W x H				
LIG400	2.5 x 6.5 x 13	70	1	1	\$381

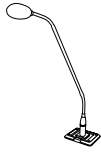

Microphone

MIC400	2 x 2 x 24	70	1	1	\$995
--------	------------	----	---	---	-------

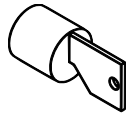

Lock Assembly

LO/C	--	70	--	--	\$106
------	----	----	----	----	-------

Tungsten.

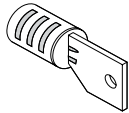

Lock Drum with Key

LOB/C	--	70	--	--	\$44
-------	----	----	----	----	------

Tungsten.

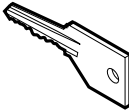

Extra Key

LOCK	--	70	--	--	\$43
------	----	----	----	----	------

Specify key #. Key range 401 - 420.



Grommet Cover Round

GM1	2 dia x --	70	--	--	\$65
GM1K	2 dia x --	70	--	--	\$65

2.75" diameter.

• Specify GM1 for Black or GM1K for Tungsten.

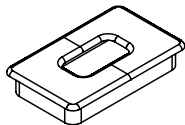

Grommet

GM5C	2 x 3.5 x --	70	--	--	\$107
------	--------------	----	----	----	-------

Rectangular grommet in metal, tungsten finish.

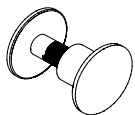

Quick Connector

QC50	--	70	.01	.01	\$10
QC30	--	70	.01	.01	\$10

Required Specifications

Top finish  
Body finish

Optional Specifications

Grommet  
Modesty Panel

# F FOUNDATIONS

ACCESSORIES

MODEL#

DIMENSIONS

FREIGHT CLASS

WT/LBS.

CUBIC FT.

LIST PRICE

D x W x H

kingston







Kingston is a modern expression of old world craftsmanship. The classic proportion, attentive detailing, exquisite hand-matched veneers and solid wood edge details convey refined elegance with timeless beauty. Designed to highlight the warmth and majestic nature of real wood, Kingston offers an impressive array of storage components, fixed and freestanding worksurfaces that can be arranged to meet virtually any functional requirement.

Kingston detailing is contemporary with a 1" overhang on all edges. Solid walnut, cherry, maple, oak that bands worksurface perimeter is 1" wide by 1-3/8" thick for an overall thickness of 1-3/8". Kingston is a "top over pedestal" detailed series with a 1/4" reveal between the top and end panel. Tops have a 1" overhang. Floor storage unit bases are integrated in drawer faces. Products that are normally positioned against walls, such as credenzas, have a self-edge veneered back edge detail.

**Features and Benefits**

- Choice of 15 handle options for every door/drawer that features handles.
- Choice of six edge options
- Wide selection of storage components, fixed and freestanding worksurfaces.
- Sleek design



Interior veneer drawer edge

Edge options



K16



K18



K21



K22



K29



K30

**GENERAL INFORMATION**

- Distinguished by an elegant overhang detailed edge, Kingston pairs sleek European styling with functional design features that address the needs of today's dynamic and tech-savvy executive office.
- Kingston offers six distinctive edge shapes, as well as a multitude of drawer pull options.
- For environmental certification, please visit [globalfurnituregroup.com](http://globalfurnituregroup.com)

**CONSTRUCTION**

- Number One select, architectural grade "A" oak, American black walnut, American black cherry or maple. Wood worksurface molded edges are solid oak, walnut, cherry, or maple.
- Contemporary detailing with 1" overhang on all edges.
- Solid walnut, cherry, maple, oak that bands worksurface perimeter is 1" wide by 1-3/8" thick for an overall thickness of 1-3/8".

**FINISHES**

- Conversion varnish (similar to catalyzed lacquer, but tougher), 25 degree sheen. Finishes are not buffed or rubbed.
- All Global wood casegood products are veneered and finished on the back sides (360° finishing), except modular under-surface storage - tops and backs are unfinished.
- Touch up kits available, includes a touch up marker and fill crayon. Order **VTOUCHUPKIT, \$164** list. Specify finish when ordering.
- Global standard finish, on oak and walnut, is open pore and on cherry and maple is semi-closed pore. If a full finish is required for walnut, cherry, anigre and maple tops, Add the suffix "2" to the finish code and Add 5% to the base pricing for each product. **CUSTOM FINISH IS AVAILABLE.**

**PEDESTALS**

- Full-to-the-floor. Pedestals are fully assembled units that are either installed into desk and credenza shells, or available as modular units. Undersurface storage units include locks.
- Pedestal drawer suspensions are metal ball bearing type. Both box and file drawers are full extension.
- Hanging file rails are pre-installed on file drawer perimeters and accommodate both legal and letter size filing. Legal filing can be achieved either as side-to-side or front-to-back. Letter filing can be achieved as front-to-back filing only.
- Drawers are standard vinyl-wrapped construction with black drawer sides and bottom.
- The drawer front is an applied element to a four sided drawer. Drawer fronts are veneered on all surfaces except the vertical edges, which are solid oak, walnut, cherry and maple then routed with series detailing. Drawer fronts can be removed or replaced in the field.
- Levelers have 1" range of adjustment.

**LOCKS**

- Locks are standard on all below worksurface level drawer and door storage units, with the exception of pull-out tray units and single lateral file drawer combination tray/slot units.
- Combination storage unit comes with lock for file and lateral file drawer only; box drawers cannot lock.
- Lock color will match the handle option.
- Locks are optional on all above worksurface level closed storage

**HANDLES**

- If no handle is specified, there will be a routed finger pull in drawer fronts and touch latch mechanism for doors.
- See next page for options.

## 1. SPECIFY MODEL NUMBER

## 2. SPECIFY FINISH

### WORKSURFACE TOP & DRAWER/DOOR FRONTS, BODY FINISHES (INCLUDING PEDESTALS) - VENEER

Code	Finish	Veneer Type	Cut
AMW	Almond Cherry	Cherry	Flat Sliced
ACW	Amber Cherry	Cherry	Flat Sliced
BTW	Biscotti	White Oak	Rift
CAW	Cocoa Walnut	Walnut	Flat Sliced
CRW	Coral	White Oak	Rift
DCW	Dark Cherry	Cherry	Flat Sliced
DWW	Dark Walnut	Walnut	Flat Sliced
EWV	Espresso Walnut	Walnut	Flat Sliced
EVW	Evening Oak	White Oak	Rift
GRW	Grey on Oak	White Oak	Rift
HAW	Hazelnut	Maple	Flat Sliced
JAW	Java	White Oak	Rift
LTW	Latte Walnut	Walnut	Flat Sliced
MHW	Mahogany on Walnut	Walnut	Flat Sliced
MTW	Milestone	White Oak	Rift
MPW	Natural Maple	Maple	Flat Sliced
NLW	Natural Walnut	Walnut	Flat Sliced
RCW	Red Cherry	Cherry	Flat Sliced
VNW	Vintage Cherry	Cherry	Flat Sliced
ULW	Umber Walnut	Walnut	Flat Sliced
WLW	Walnut	Walnut	Flat Sliced
WCW	Warm Cherry	Cherry	Flat Sliced
WMW	White Maple	Maple	Flat Sliced

### METAL FINISHES (see model # notes for available finish):

E	Black
K	Tungsten
DWT	Designer White
P	Brushed Chrome

### GLASS FINISHES (for Glass Doors and Modesty Panels):

- Frosted Glass (standard)
- White back painted glass - contact customer care

## 3. SPECIFY OPTIONS

### EDGES

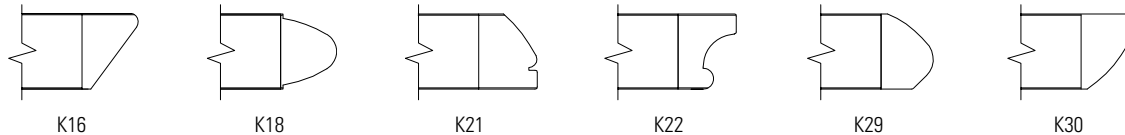

### HANDLES

- If Handle is not specified Routed Pull, Black Lock & Grommet are standard
- If Handle is specified:
  - Black and Brass handle = Black Lock & Grommet
  - Silver, Nickel and Tungsten handle = Tungsten Lock & Grommet
- Handles are standard on most drawers/storage modules. Each handle is identified by letters: **PL33, PL34, PL64, PL66, PL92, PL93, PL94, PL95, PL96, PL97, PL98, PL99, PLS7, and PLS8**. To specify a handle, specify the code after the model number and finish selections.



**PL33** Black Moon Pull, 4"



**PL34** Nickel Moon Pull, 4"



**PL64** Contemporary Nickel 5-3/8"

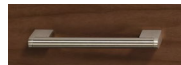

**PL66** Transitional Nickel, 6-3/4"



**PL92** Silver Bar, 5-3/8"



**PL93** Black Bar, 5-3/8"



**PL94** Silver Rectangular, 5-3/8"



**PL95** Black Rectangular, 5-3/8"



**PL96** Silver Slimline Pull, 5-3/8"



**PL97** Black Slimline Pull, 5-3/8"



**PL98** Silver Princeton Bar, 5-3/8"



**PL99** Black Princeton Bar, 5-3/8"



**PLS7** Black Spaghetti, 7-3/8"



**PLS8** Silver Spaghetti, 7-3/8"

**GROMMETS**

- Standard grommet on all components is **GM5**. Grommet is included with products where shown in line drawings in price book.
- Optional grommets may be ordered in standard worksurface locations (left, center or right). Order as **GM5TL, GM5TC or GM5TR**. **Add \$96.**
- Grommet hole dimensions are 3.5" x 2". Specify **GM5E** for Black or **GM5K** for Tungsten.
- To order a grommet cover only, **Add \$57.**
- Color of grommet will be automatically coordinated with handle color where applicable
- Components that come standard with grommet may be ordered without a grommet. Order as RSG - **Add \$53.**

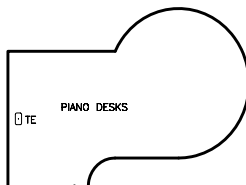
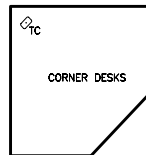
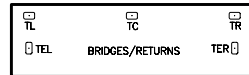
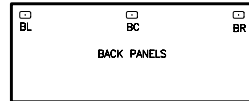
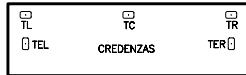
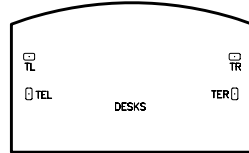
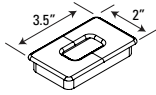

# K KINGSTON - EDGE DETAILS

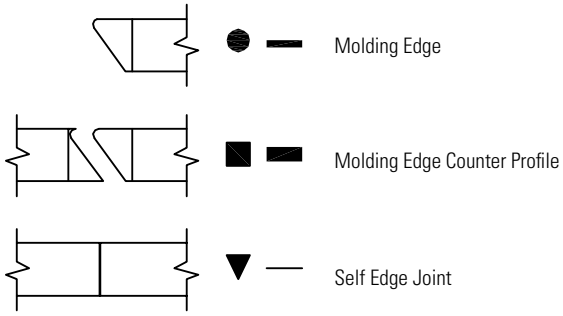

- D** - Desks and Credenzas
- B** - Executive Bridges
- E** - Executive Returns
- C** - Corner Components
- L** - Linking Bridges
- P** - Piano Desks

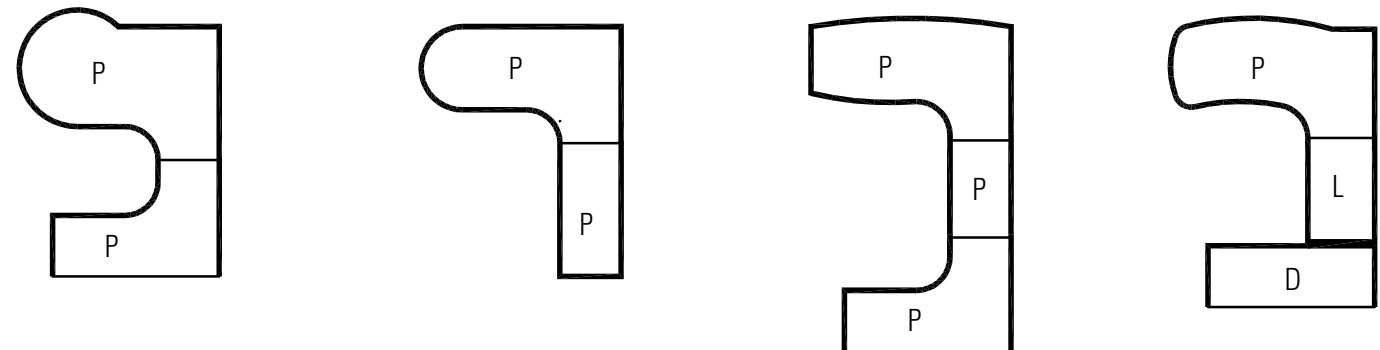
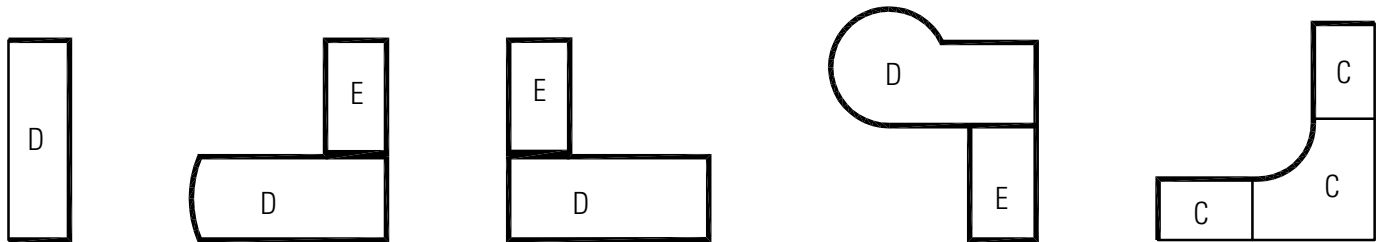
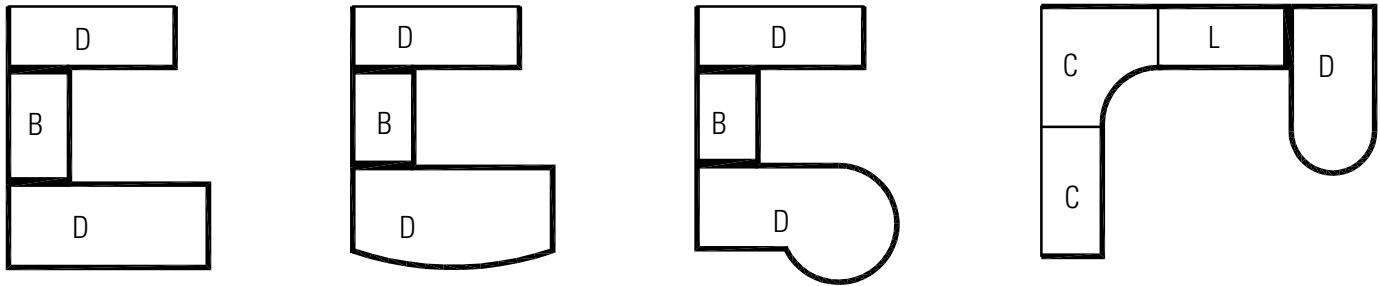
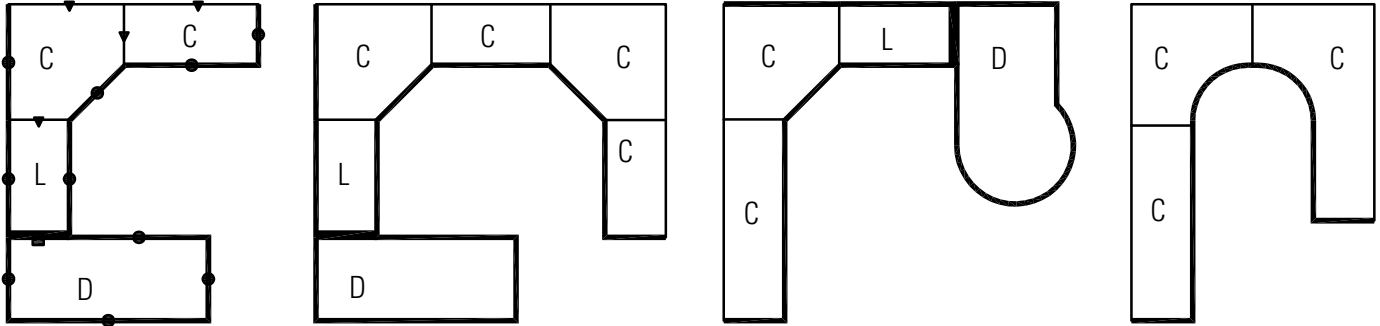

**DESK AND CREDENZA NOTES**

- Can be ordered as a shell or with pedestals
- Hand of Rectangular Desk is determined by location of pedestal from user side
- Hand of "D" Top is determined by outward orientation of curved end from user projection.
- Hand of "P" Top is determined by outward orientation of conference end from user projection.

Isometric View

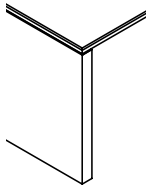

Side View  
1-3/8" Top

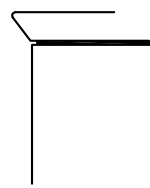

Front View  
1-3/16" Slab

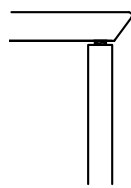

KT6030

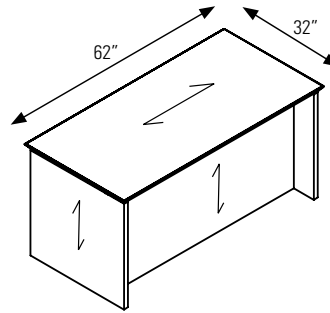

**MODESTY PANEL CLEARANCE**

KT7236

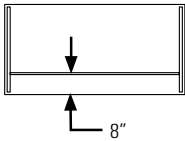

KMT7242

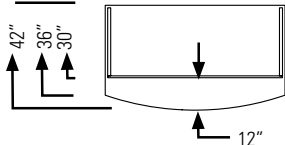

KiSR7230D

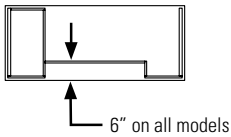

KDDCL7236

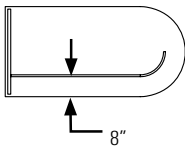

KT7236



Full Back Panel

KT7230

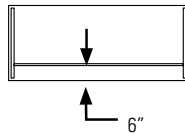

KMT7236

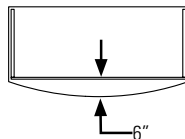

KDDF7230

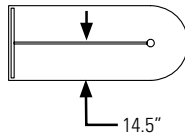

KDDCL7230

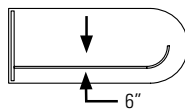

KTPL7242

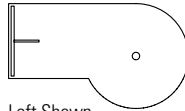

Left Shown

Field "punch out" to accommodate center drawer and keyboard

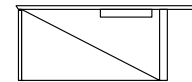

**MODESTY PANEL OPTIONS**

Standard Full Modesty

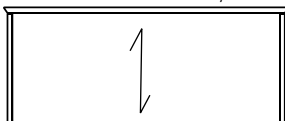

Glass Modesty

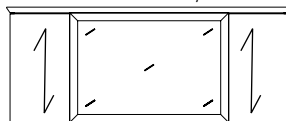

Breakfront

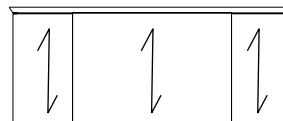

## PIANO DESKS AND LINKING RETURNS

- All Desks are shipped assembled.
- Units include standard Grommets shown and installed horizontal wire management
- Unit is handed by Post Leg
- Not for use with regular Corner Units
- The standard grain direction is cross grain (**CG**). To remove cross grain veneer pattern on top, delete suffix "**CG**" from the model number (no upcharge)

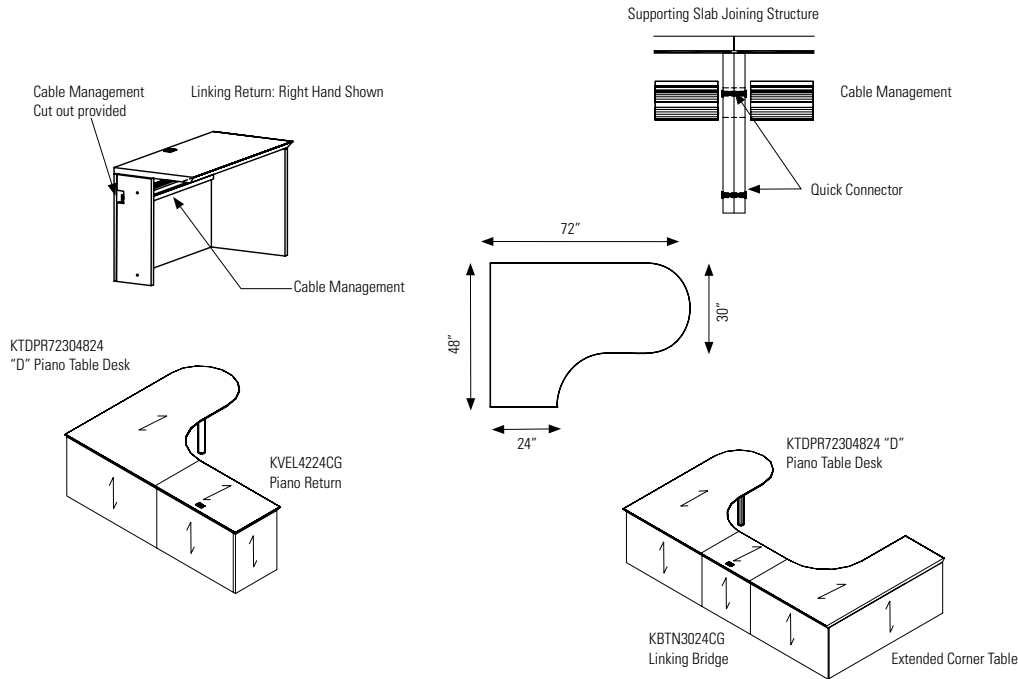

## EXECUTIVE BRIDGES

- Executive Bridge is used to connect a Desk to a Credenza.
- Not to be used with Corner Components or Piano Desks.
- Three Back Panel options
- Back panel flush with end panels of Desk and Credenza
- Includes GM5 Grommet Top Center
- The standard grain direction is cross grain (**CG**). To remove cross grain veneer pattern on top, delete suffix "**CG**" from the model number (no upcharge)

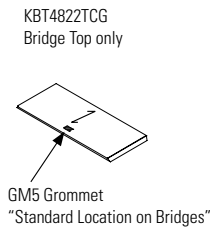
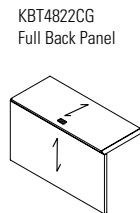
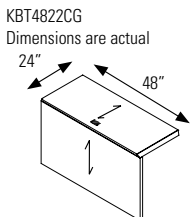
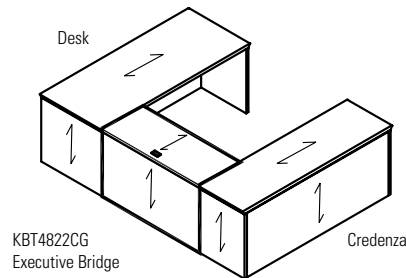

**EXECUTIVE RETURNS**

- Executive Return is used to attach to a Single Pedestal Desk, Single Pedestal Credenza, Desk Shell or Credenza Shell.
- Can be specified as a Shell or with a Pedestal.
- Back Panels are available as either full height or 8" from the underside of the worksurface.
- Hand of Executive Return is determined by location of full end panel from user side.
- Hand of Desk or Credenza is determined by location of pedestal from user side.
- The standard grain direction on return tops is cross grain (**CG**). To remove cross grain veneer pattern on top, delete suffix "**CG**" from the model number (no upcharge)

Executive Return attached to Desk or Credenza

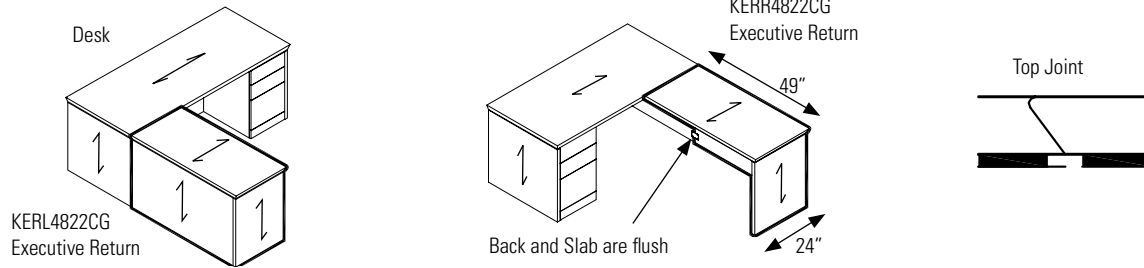

**CORNER COMPONENTS**

- Corner Table is used to connect to Linking Bridge and Linking Credenza.
- Cable management tray included.
- Back Panels are available as either full height or 8" from the underside of the worksurface.
- Hand of Linking Credenza is determined by location of full end panel from user side.
- Hand of Extended Corner is determined by location of long narrow end from user side
- The standard grain direction is cross grain (**CG**). To remove cross grain veneer pattern on top, delete suffix "**CG**" from the model number (no upcharge)

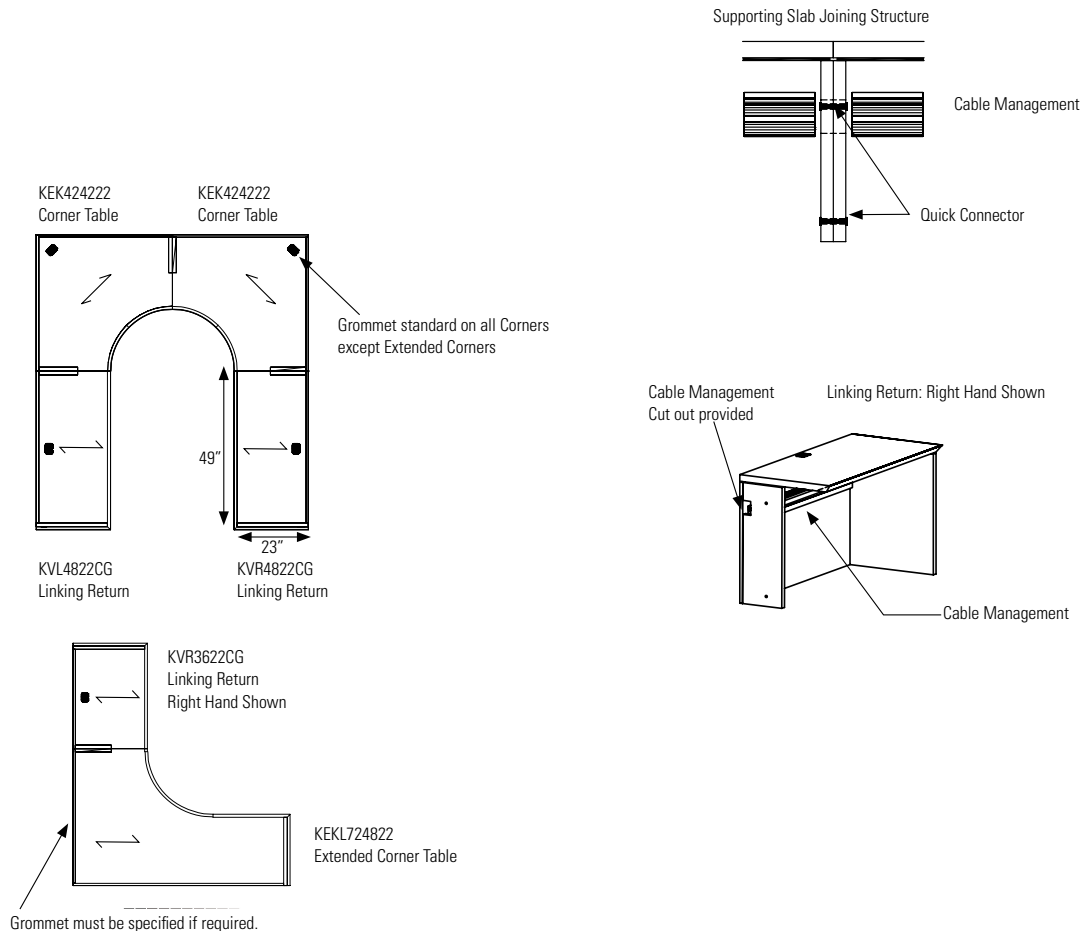



## LINKING BRIDGES

- Linking Bridge is used to connect Corner Components to Single Pedestal Desk, Single Pedestal Credenza, Desk Shell or Credenza Shell.
- Back panels are available as either full height or 8" from the underside of the worksurface.
- Includes GM5 Grommet Top Center
- Hand of Linking Bridge is determined by location of half end panel from user side
- The standard grain direction is cross grain (**CG**). To remove cross grain veneer pattern on top, delete suffix "**CG**" from the model number (no upcharge)

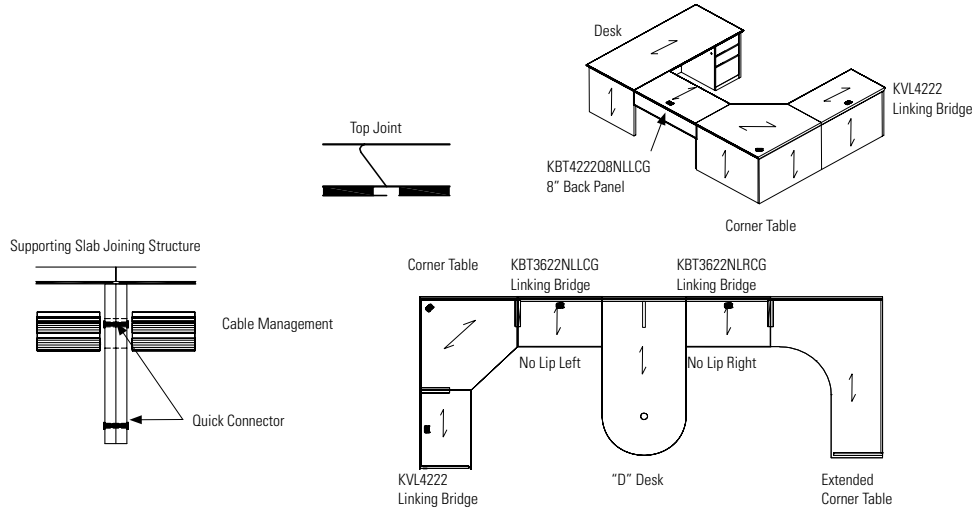

## MODULAR PEDESTALS AND HANDLES

- Modular Pedestal for Kingston.
- Credenza Shells can only be completely filled with modular components that end in ".5" to create a full storage credenza.

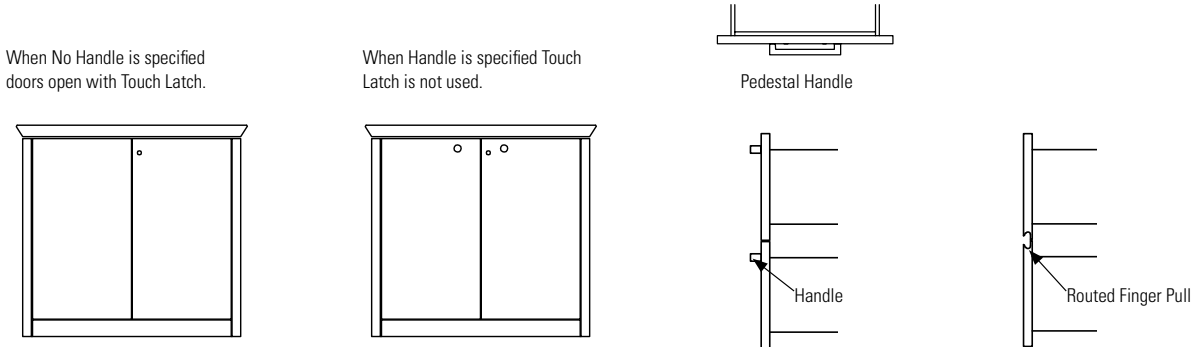

**COPING AND SELF-EDGE OPTIONS**

- Coping option provides an undercut on hutches only so that storage cabinets placed next to the hutch fit flush.
  - Specify **COP** for coping on both sides, **COPR** for coping on the right side and **COPL** for coping on the left side. No upcharge.
- Self edge options provide a flush fit when storage units are placed next to one another.
  - Specify **SE** for self-edge on both sides, **SER** for self-edge on the right side and **SEL** for self-edge on the left side. No upcharge.
  - Coping and self-edge handedness are from the users perspective. See diagram below.

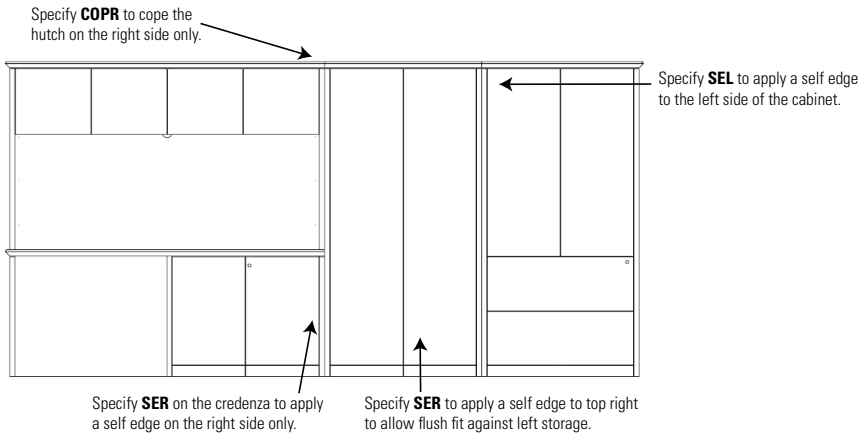

**LOCKING**

- Locks are standard on all below worksurface level drawer and door storage units with the exception of the pull-out tray units and single lateral file drawer combination tray/slot units.
- Locks are optional on all above worksurface level closed storage units. See Accessories Section (page 264) for lock specification details.

**Standard Lock Positions**

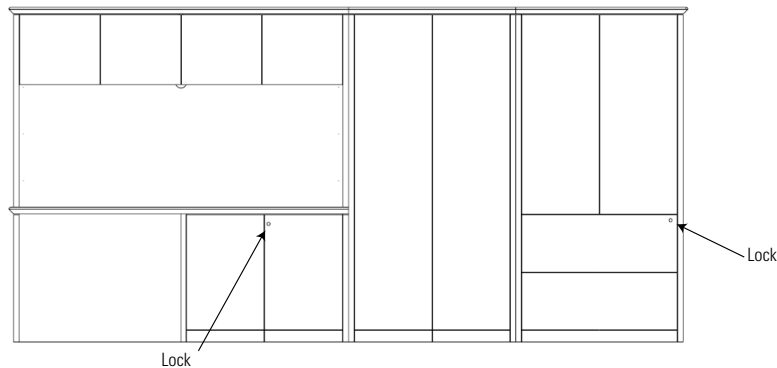

KZR  
Combination Storage Unit:  
Lock for File and Lateral File Drawer only,  
Box Drawers do not lock.

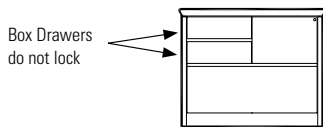

KD7236DE  
Double Pedestal Desk/Credenza:  
Lock for D and E Pedestals are on the inside Gable.

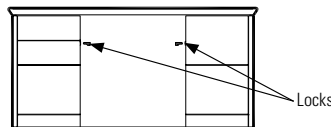

KCF7222  
Full Storage Credenza: Locks are on the front.

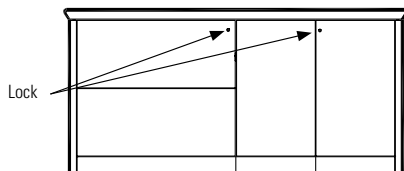

KWD  
Modular Furniture:  
Lock is on the front.

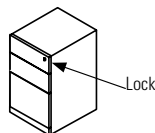

KWF  
Modular Furniture:  
Lock is on the front.

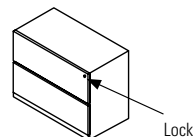

## HUTCH POSITIONING

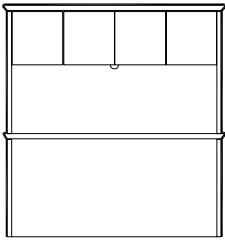

There must be an end panel under the hutch

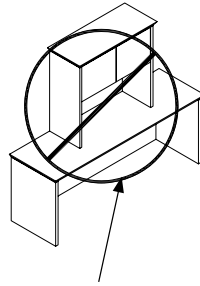
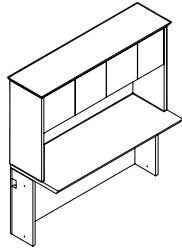

Missing Support  
NOT Recommended

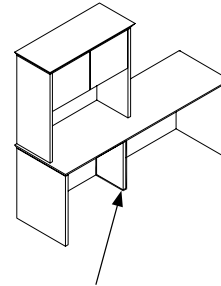

Add optional Support  
SLAB12 (as Special)

## TACKBOARDS

### Tackboards for Storage Hutches

K72SH36

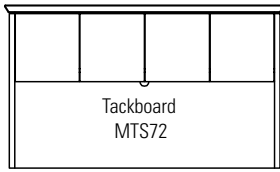

K72SHP42 and K72SHP42

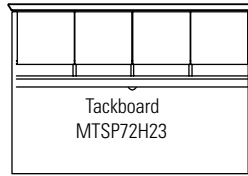

K72SH42 and K722SH54

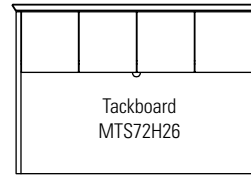

### Tackboards with Accessory Rail

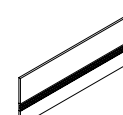
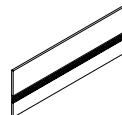
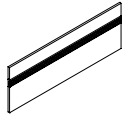

### Tackboards for Wall Mount Overheads

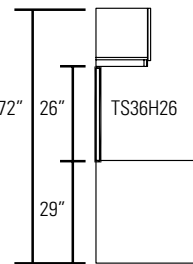
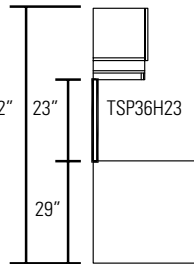
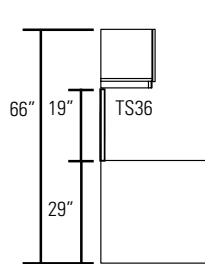

## LIGHTING

### For hutches and wall mount overheads

Wall Mount

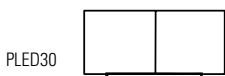

30" and 36" units

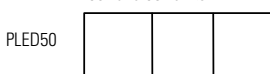

42" and 48" units

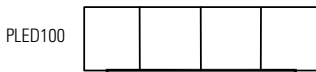

60" and longer units

Hutch

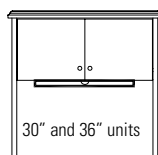

30" and 36" units

PLED50 on 42" units

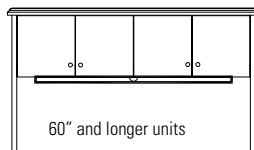

DESKS - NOTES

D x W x H

NOTE: Arrow indicates direction of grain

- All desks are shipped assembled
- Kneewell locking standard
- Desks available with a variety of modesty options: flush, breakfront, recessed and glass
- If Handle is not specified Routed Pull, Black Lock & Grommet are standard
- If Handle is specified:
  - Black and Brass handle = Black Lock & Grommet
  - Silver, Nickel and Tungsten handle = Tungsten Lock & Grommet
- Grommets are available as an option on Desks and most Credenzas.
- Edge options - must specify:

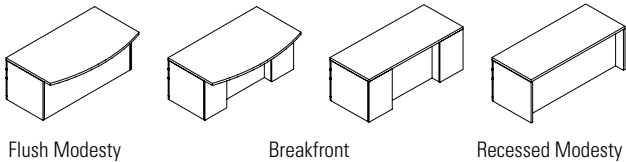
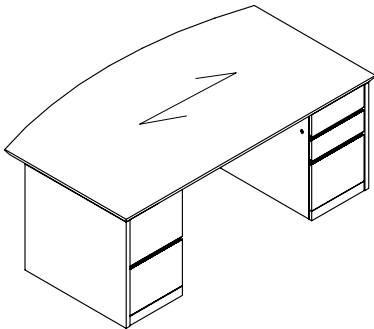
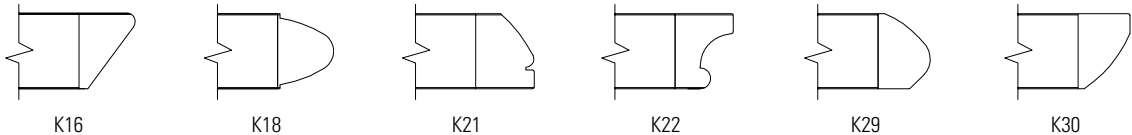

## DOUBLE PEDESTAL DESKS

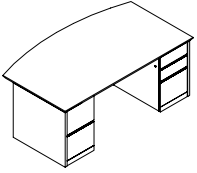

**Double Pedestal Bow Top Desk**

MODEL#	DIMENSIONS D x W x H	FREIGHT CLASS	WT/LBS.	CUBIC FT.	LIST PRICE
KMD8442ED	44 x 86 x 29	125	407	59	<b>\$10120</b>
KMD7842ED	44 x 80 x 29	125	392	55	<b>\$9398</b>
KMD7242ED	44 x 74 x 29	125	377	51	<b>\$8672</b>
KMD6636ED	38 x 68 x 29	100	340	40	<b>\$8412</b>

Standard with full to floor **file/file** pedestal on **left** and **box/box/file** pedestal on **right**. Pedestals lock.  
Full Height Modesty Panel.

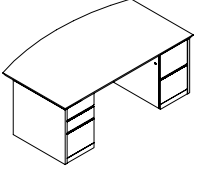

**Double Pedestal Bow Top Desk**

KMD8442DE	44 x 86 x 29	125	407	59	<b>\$10120</b>
KMD7842DE	44 x 80 x 29	125	392	55	<b>\$9398</b>
KMD7242DE	44 x 74 x 29	125	377	51	<b>\$8672</b>
KMD6636DE	38 x 68 x 29	100	340	40	<b>\$8412</b>

Standard with full to floor **file/file** pedestal on **right** and **box/box/file** pedestal on **left**. Pedestals lock.  
Full Height Modesty Panel.

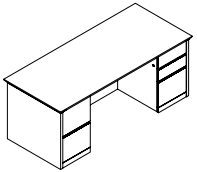

**Double Pedestal Desk**

KD8442ED	44 x 86 x 29	125	442	59	<b>\$8604</b>
KD7842ED	44 x 80 x 29	125	421	55	<b>\$7992</b>
KD7236ED	38 x 74 x 29	100	375	44	<b>\$7378</b>
KD7230ED	32 x 74 x 29	100	345	36	<b>\$7266</b>
KD6636ED	38 x 68 x 29	100	360	40	<b>\$7266</b>
KD6630ED	32 x 68 x 29	92.5	330	33	<b>\$7149</b>
KD6030ED	32 x 62 x 29	92.5	315	30	<b>\$6925</b>

Standard with full to floor **file/file** pedestal on **left** and **box/box/file** pedestal on **right**. Pedestals lock.  
Full height modesty panel.

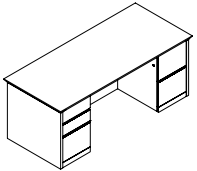

**Double Pedestal Desk**

KD8442DE	44 x 86 x 29	125	442	59	\$8604
KD7842DE	44 x 80 x 29	125	421	55	<b>\$7992</b>
KD7236DE	38 x 74 x 29	100	375	44	<b>\$7378</b>
KD7230DE	32 x 74 x 29	100	345	36	<b>\$7266</b>
KD6636DE	38 x 68 x 29	100	360	40	<b>\$7266</b>
KD6630DE	32 x 68 x 29	92.5	330	33	<b>\$7149</b>
KD6030DE	32 x 62 x 29	92.5	315	30	<b>\$6925</b>

Standard with full to floor **file/file** pedestal on **right** and **box/box/file** pedestal on **left**. Pedestals lock.  
Full height modesty panel.

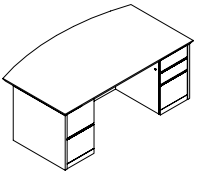

**Double Pedestal Bow Top Desk\*  
Breakfront Style**

KMID8442ED	44 x 86 x 29	125	407	59	\$11129
KMID7842ED	44 x 80 x 29	125	392	55	<b>\$10336</b>
KMID7242ED	44 x 74 x 29	125	377	51	<b>\$9544</b>
KMID6636ED	38 x 68 x 29	100	345	40	<b>\$9250</b>

Standard with full to floor **file/file** pedestal on **left** and **box/box/file** pedestal on **right**. Pedestals lock.  
Inset Full Height Modesty Panel.

- For Aluminum Framed Glass Modesty option on Breakfront Style add "G" to the end of the product code. Add **\$1776**.

### Required Specifications

Finish  
Edge

### Optional Specifications

Handles  
Additional grommet  
Glass modesty panel\*

DESKS

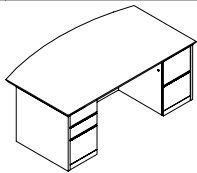

**Double Pedestal Bow Top Desk\*  
Breakfront Style**

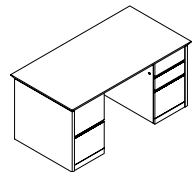

**Double Pedestal Desk\*  
Breakfront Style**

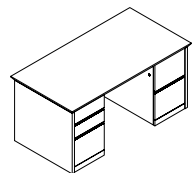

**Double Pedestal Desk\*  
Breakfront Style**

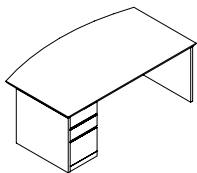

**Single Pedestal Bow Top Desk - Left**

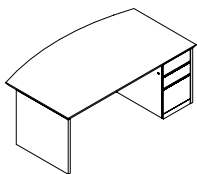

**Single Pedestal Bow Top Desk - Right**

MODEL# DIMENSIONS FREIGHT CLASS WT/LBS. CUBIC FT. LIST PRICE

D x W x H

KMID8442DE	44 x 86 x 29	125	407	59	<b>\$11129</b>
KMID7842DE	44 x 80 x 29	125	392	55	<b>\$10336</b>
KMID7242DE	44 x 74 x 29	125	377	51	<b>\$9544</b>
KMID6636DE	38 x 68 x 29	100	345	40	<b>\$9250</b>

Standard with full to floor **box/box/file** pedestal on **left** and **file/file** pedestal on **right**. Pedestals lock.  
Inset Full Height Modesty Panel.

- For Aluminum Framed Glass Modesty option on Breakfront Style add "G" to the end of the product code. Add **\$1776**.

KID8442ED	44 x 86 x 29	125	442	59	<b>\$9469</b>
KID7842ED	44 x 80 x 29	125	421	55	<b>\$8789</b>
KID7236ED	38 x 74 x 29	100	375	44	<b>\$8115</b>
KID7230ED	32 x 74 x 29	100	345	36	<b>\$7992</b>
KID6636ED	38 x 68 x 29	100	360	40	<b>\$7992</b>
KID6630ED	32 x 68 x 29	92.5	330	33	<b>\$7868</b>
KID6030ED	32 x 62 x 29	92.5	315	30	<b>\$7615</b>

Standard with full to floor **file/file** pedestal on **left** and **box/box/file** pedestal on **right**. Pedestals lock.  
Inset Full Height Modesty Panel.

- For Aluminum Framed Glass Modesty option on Breakfront Style add "G" to the end of the product code. Add **\$1776**.

KID8442DE	44 x 86 x 29	125	442	59	<b>\$9469</b>
KID7842DE	44 x 80 x 29	125	421	55	<b>\$8789</b>
KID7236DE	38 x 74 x 29	100	375	44	<b>\$8115</b>
KID7230DE	32 x 74 x 29	100	345	36	<b>\$7992</b>
KID6636DE	38 x 68 x 29	100	360	40	<b>\$7992</b>
KID6630DE	32 x 68 x 29	92.5	330	33	<b>\$7868</b>
KID6030DE	32 x 62 x 29	92.5	315	30	<b>\$7615</b>

Standard with full to floor **box/box/file** pedestal on **left** and **file/file** pedestal on **right**. Pedestals lock.  
Inset Full Height Modesty Panel.

- For Aluminum Framed Glass Modesty option on Breakfront Style add "G" to the end of the product code. Add **\$1776**.

KMSL8442D	44 x 86 x 29	150	352	59	<b>\$8019</b>
KMSL7842D	44 x 80 x 29	125	337	55	<b>\$7447</b>
KMSL7242D	44 x 74 x 29	125	322	51	<b>\$6874</b>
KMSL6636D	38 x 68 x 29	125	290	40	<b>\$6611</b>

Standard with full to floor **box/box/file** pedestal on **left**. Pedestal locks.  
Full height modesty panel.

KMSR8442D	44 x 86 x 29	150	352	59	<b>\$8019</b>
KMSR7842D	44 x 80 x 29	125	337	55	<b>\$7447</b>
KMSR7242D	44 x 74 x 29	125	322	51	<b>\$6874</b>
KMSR6636D	38 x 68 x 29	125	290	40	<b>\$6611</b>

Standard with full to floor **box/box/file** pedestal on **right**. Pedestal locks.  
Full height modesty panel.

**Required Specifications**

Finish  
Edge

**Optional Specifications**

Handles  
Additional grommet  
Glass modesty panel\*

## DESKS

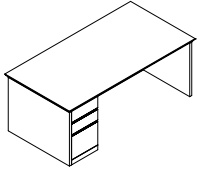

**Single Pedestal Desk**

MODEL#	DIMENSIONS D x W x H	FREIGHT CLASS	WT./LBS.	CUBIC FT.	LIST PRICE
KSL8442D	44 x 86 x 29	125	387	59	\$7540
KSL7842D	44 x 80 x 29	125	366	55	<b>\$7103</b>
KSL7236D	38 x 74 x 29	125	320	44	<b>\$5627</b>
KSL7230D	32 x 74 x 29	100	290	36	<b>\$5374</b>
KSL6636D	38 x 68 x 29	125	305	40	<b>\$5374</b>
KSL6630D	32 x 68 x 29	100	275	33	<b>\$5129</b>
KSL6030D	32 x 62 x 29	100	260	30	<b>\$4903</b>

Standard with full to floor **box/box/file** pedestal on **left**. Pedestals lock.  
Full Height Modesty Panel.

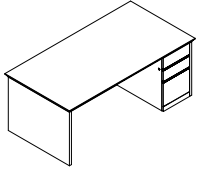

**Single Pedestal Desk**

KSR8442D	44 x 86 x 29	125	387	59	\$7540
KSR7842D	44 x 80 x 29	125	366	55	<b>\$7103</b>
KSR7236D	38 x 74 x 29	125	320	44	<b>\$5627</b>
KSR7230D	32 x 74 x 29	100	290	36	<b>\$5374</b>
KSR6636D	38 x 68 x 29	125	305	40	<b>\$5374</b>
KSR6630D	32 x 68 x 29	100	275	33	<b>\$5129</b>
KSR6030D	32 x 62 x 29	100	260	30	<b>\$4903</b>

Standard with full to floor **box/box/file** pedestal on **right**. Pedestals lock.  
Full Height Modesty Panel.

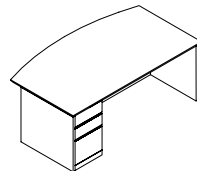

**Single Pedestal Desk - Left\*  
Breakfront Style**

KMISL8442D	44 x 86 x 29	125	452	59	\$8819
KMISL7842D	44 x 80 x 29	125	337	55	<b>\$8190</b>
KMISL7242D	44 x 74 x 29	125	322	51	<b>\$7563</b>
KMISL6636D	38 x 68 x 29	125	290	40	<b>\$7273</b>

Standard with full to floor **box/box/file** pedestal on **left**. Pedestals lock.  
Inset Full Height Modesty Panel.

- For Aluminum Framed Glass Modesty option on Breakfront Style add "**G**" to the end of the product code. Add **\$1776**.

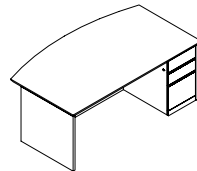

**Single Pedestal Desk - Right\*  
Breakfront Style**

KMISR8442D	44 x 86 x 29	125	452	59	\$8819
KMISR7842D	44 x 80 x 29	125	337	55	<b>\$8190</b>
KMISR7242D	44 x 74 x 29	125	322	51	<b>\$7563</b>
KMISR6636D	38 x 68 x 29	125	290	40	<b>\$7273</b>

Standard with full to floor **box/box/file** pedestal on **right**. Pedestals lock.  
Inset Full Height Modesty Panel.

- For Aluminum Framed Glass Modesty option on Breakfront Style add "**G**" to the end of the product code. Add **\$1776**.

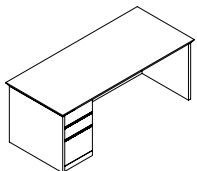

**Single Pedestal Desk - Left\*  
Breakfront Style**

KISL8442D	44 x 86 x 29	125	387	59	\$8421
KISL7842D	44 x 80 x 29	125	366	55	<b>\$7820</b>
KISL7236D	38 x 74 x 29	125	320	44	<b>\$6187</b>
KISL7230D	32 x 74 x 29	100	290	36	<b>\$5911</b>
KISL6636D	38 x 68 x 29	125	305	40	<b>\$5911</b>
KISL6630D	32 x 68 x 29	100	275	33	<b>\$5642</b>
KISL6030D	32 x 62 x 29	100	260	30	<b>\$5392</b>

Standard with full to floor **box/box/file** pedestal on **left**. Pedestals lock.  
Inset Full Height Modesty Panel.

- For Aluminum Framed Glass Modesty option on Breakfront Style add "**G**" to the end of the product code. Add **\$1776**.

### Required Specifications

Finish  
Edge

### Optional Specifications

Handles  
Additional grommet  
Glass modesty panel\*

DESKS

MODEL# DIMENSIONS FREIGHT CLASS WT/LBS. CUBIC FT. LIST PRICE

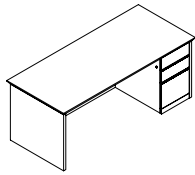

**Single Pedestal Desk - Right\*  
Breakfront Style**

	D x W x H				
KISR8442D	44 x 86 x 29	125	387	59	\$8421
KISR7842D	44 x 80 x 29	125	366	55	<b>\$7820</b>
KISR7236D	38 x 74 x 29	125	320	44	<b>\$6187</b>
KISR7230D	32 x 74 x 29	100	290	36	<b>\$5911</b>
KISR6636D	38 x 68 x 29	125	305	40	<b>\$5911</b>
KISR6630D	32 x 68 x 29	100	275	33	<b>\$5642</b>
KISR6030D	32 x 62 x 29	100	260	30	<b>\$5392</b>

Standard with full to floor **box/box/file** pedestal on **right**. Pedestals lock.  
Inset Full Height Modesty Panel.

- For Aluminum Framed Glass Modesty option on Breakfront Style add "G" to the end of the product code. Add **\$1776**.

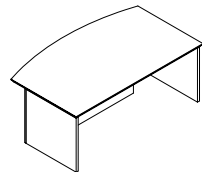

**Desk Shell, Bow Top  
Breakfront Style**

KMIT8442	44 x 86 x 29	125	380	59	\$6804
KMIT7842	44 x 80 x 29	125	353	55	<b>\$6361</b>
KMIT7242	44 x 74 x 29	125	331	51	<b>\$5923</b>
KMIT6636	38 x 68 x 29	125	287	40	<b>\$5619</b>

Inset Full Height Modesty Panel.

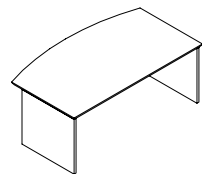

**Desk Shell, Bow Top**

KMT8442	44 x 86 x 29	150	297	59	\$6164
KMT7842	44 x 80 x 29	150	282	55	<b>\$5720</b>
KMT7242	44 x 74 x 29	150	267	51	<b>\$5283</b>
KMT6636	38 x 68 x 29	150	235	40	<b>\$4980</b>

Recessed Modesty Panel.

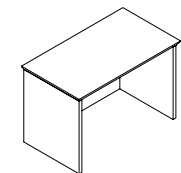

**Desk Shell**

KT8442	44 x 86 x 29	125	337	55	\$5730
KT7842	44 x 80 x 29	125	317	51	<b>\$5321</b>
KT8436	38 x 86 x 29	125	317	51	\$4913
KT7836	38 x 80 x 29	125	296	47	<b>\$4564</b>
KT7236	38 x 74 x 29	125	265	44	<b>\$4216</b>
KT7230	32 x 74 x 29	125	235	36	<b>\$3967</b>
KT6636	38 x 68 x 29	125	250	40	<b>\$3967</b>
KT6630	32 x 68 x 29	125	220	33	<b>\$3727</b>
KT6030	32 x 62 x 29	125	205	30	<b>\$3407</b>

Recessed Modesty Panel.

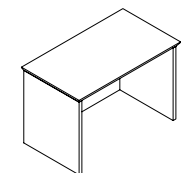

**Desk Shell**

KT4822	24 x 50 x 29	150	95	17	\$2440
KT4222	24 x 44 x 29	150	85	15	<b>\$2044</b>
KT3622	24 x 38 x 29	150	75	13	\$1972
KT3022	24 x 32 x 29	150	65	11	<b>\$1933</b>
KT4820	22 x 50 x 29	150	95	17	<b>\$2222</b>
KT4220	22 x 44 x 29	150	85	15	<b>\$1858</b>
KT3620	22 x 38 x 29	125	75	12	<b>\$1795</b>
KT3020	22 x 32 x 29	125	65	10	<b>\$1760</b>

Flush modesty panel.

**Required Specifications**

Finish  
Edge

**Optional Specifications**

Handles  
Additional grommet  
Glass modesty panel\*



## DESKS

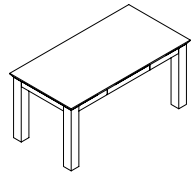

**Table Desk\***

MODEL#	DIMENSIONS D x W x H	FREIGHT CLASS	WT/LBS.	CUBIC FT.	LIST PRICE
KTB8442	44 x 86 x 29	150	272	59	\$10790
KTB7842	44 x 80 x 29	150	253	55	<b>\$10021</b>
KTB7236	38 x 74 x 29	150	205	44	<b>\$7925</b>
KTB7230	32 x 74 x 29	150	192	36	<b>\$7782</b>
KTB6636	38 x 68 x 29	150	192	40	<b>\$7782</b>
KTB6630	32 x 68 x 29	150	188	33	<b>\$7630</b>
KTB6030	32 x 62 x 29	150	171	30	<b>\$7267</b>

3" apron, center pencil drawer. 4" square legs.

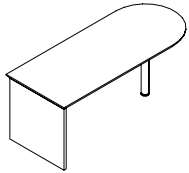

**"D" Shaped Connecting Table Desk\***

KDD8436	36 x 84 x 29	125	343	51	<b>\$5497</b>
KDD7236	36 x 72 x 29	125	294	44	<b>\$4708</b>
KDD7230	30 x 72 x 29	125	264	36	<b>\$4377</b>
KDD6636	36 x 66 x 29	125	245	40	<b>\$4377</b>
KDD6030	30 x 60 x 29	125	225	30	<b>\$4206</b>

3" wood post and full end panel.

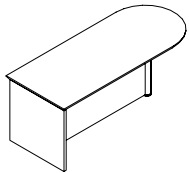

**"D" Shaped Connecting Table Desk**

KDDF8436	36 x 84 x 29	125	343	51	<b>\$6751</b>
KDDF7236	36 x 72 x 29	125	294	44	<b>\$5794</b>
KDDF7230	30 x 72 x 29	125	264	36	<b>\$5456</b>
KDDF6636	36 x 66 x 29	125	245	40	<b>\$5456</b>
KDDF6030	30 x 60 x 29	125	225	30	<b>\$5285</b>

3" wood post, full modesty panel, and full end panel.

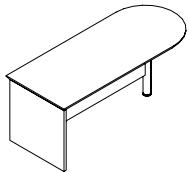

**"D" Shaped Connecting Table Desk**

KQDD8436	36 x 84 x 29	125	357	51	<b>\$6340</b>
KQDD7236	36 x 72 x 29	125	311	44	<b>\$5431</b>
KQDD7230	30 x 72 x 29	125	281	36	<b>\$5099</b>
KQDD6636	36 x 66 x 29	125	264	40	<b>\$5099</b>
KQDD6030	30 x 60 x 29	100	247	30	<b>\$4930</b>

3" wood post, 3/4 modesty panel, and full end panel.

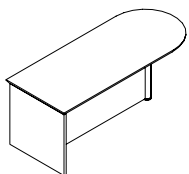

**"D" Shaped Connecting Table Desk - Left**

KDDCL8436	36 x 84 x 29	125	368	51	<b>\$7178</b>
KDDCL7236	36 x 72 x 29	125	320	44	<b>\$6152</b>
KDDCL7230	30 x 72 x 29	100	290	36	<b>\$5815</b>
KDDCL6636	36 x 66 x 29	125	270	40	<b>\$5815</b>
KDDCL6030	30 x 60 x 29	100	242	30	<b>\$5648</b>

Full height curved modesty panel, 3" wood post, and full end panel.

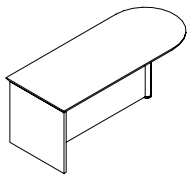

**"D" Shaped Connecting Table Desk - Right**

KDDCR8436	36 x 84 x 29	125	368	51	<b>\$7178</b>
KDDCR7236	36 x 72 x 29	125	320	44	<b>\$6152</b>
KDDCR7230	30 x 72 x 29	100	290	36	<b>\$5815</b>
KDDCR6636	36 x 66 x 29	125	270	40	<b>\$5815</b>
KDDCR6030	30 x 60 x 29	100	242	30	<b>\$5648</b>

Full height curved modesty panel, 3" wood post, and full end panel.

### Required Specifications

Finish  
Edge

### Optional Specifications

Additional grommet  
Base upgrade\* (see accessories for options)

DESKS

MODEL# DIMENSIONS FREIGHT CLASS WT/LBS. CUBIC FT. LIST PRICE

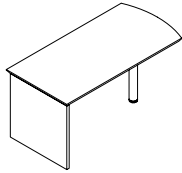

Connecting Bow End Table Desk\*

D x W x H						
KDDBE8436	36 x 84 x 29	125	343	51		\$5497
KDDBE7236	36 x 72 x 29	125	294	44		\$4708
KDDBE7230	30 x 72 x 29	125	264	36		\$4377
KDDBE6636	36 x 66 x 29	125	245	40		\$4377
KDDBE6030	30 x 60 x 29	125	225	30		\$4206

3" wood post and full end panel.

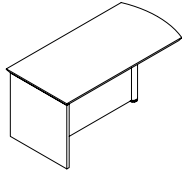

Connecting Bow End Table Desk

KDDBEF8436	36 x 84 x 29	125	368	51		\$6751
KDDBEF7236	36 x 72 x 29	125	320	44		\$5791
KDDBEF7230	30 x 72 x 29	100	290	36		\$5456
KDDBEF6636	36 x 66 x 29	125	271	40		\$5456
KDDBEF6030	30 x 60 x 29	100	247	30		\$5285

3" wood post, full modesty panel, and full end panel.

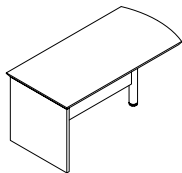

Connecting Bow End Table Desk

KQDDBE8436	36 x 84 x 29	125	357	51		\$6340
KQDDBE7236	36 x 72 x 29	125	311	44		\$5431
KQDDBE7230	30 x 72 x 29	125	281	36		\$5099
KQDDBE6636	36 x 66 x 29	125	264	40		\$5099
KQDDBE6030	30 x 60 x 29	100	247	30		\$4930

3" wood post, 3/4 modesty panel, and full end panel.

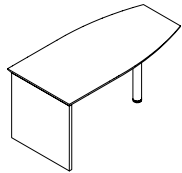

Connecting Boat Shaped Table Desk\*

KDDBS8442	42 x 84 x 29	125	414	59		\$6507
KDDBS8436	36 x 84 x 29	125	343	51		\$5497
KDDBS7236	36 x 72 x 29	125	314	44		\$4708
KDDBS7230	30 x 72 x 29	125	284	36		\$4377
KDDBS6636	36 x 66 x 29	125	265	40		\$4377
KDDBS6030	30 x 60 x 29	100	245	30		\$4206

3" wood post and full end panel.

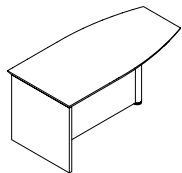

Connecting Boat Shaped Table Desk

KDDBSF8442	42 x 84 x 29	125	429	59		\$7879
KDDBSF8436	36 x 84 x 29	125	368	51		\$6751
KDDBSF7236	36 x 72 x 29	125	320	44		\$5791
KDDBSF7230	30 x 72 x 29	100	290	36		\$5456
KDDBSF6636	36 x 66 x 29	125	271	40		\$5456
KDDBSF6030	30 x 60 x 29	100	247	30		\$5285

3" wood post, full modesty panel, and full end panel.

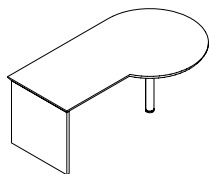

"P" Shaped Connecting Table - Left\*

KTPL9642	42 x 96 x 29	125	440	68		\$6867
KTPL8442	42 x 84 x 29	125	385	59		\$6008
KTPL7242	42 x 72 x 29	125	319	51		\$5480

3" wood post and full end panel.

Required Specifications

Finish  
Edge

Optional Specifications

Additional grommet  
Base upgrade\* (see accessories for options)

## P-SHAPED CONNECTING TABLES

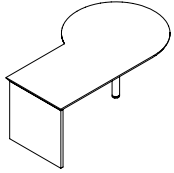

**"P" Shaped Connecting Table - Right\***

MODEL#	DIMENSIONS D x W x H	FREIGHT CLASS	WT/LBS.	CUBIC FT.	LIST PRICE
KTPR9642	42 x 96 x 29	125	440	68	<b>\$6867</b>
KTPR8442	42 x 84 x 29	125	385	59	<b>\$6008</b>
KTPR7242	42 x 72 x 29	125	319	51	<b>\$5480</b>

3" wood post and full end panel.

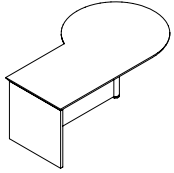

**"P" Shaped Connecting Table - Left**

KTPFL9642	42 x 96 x 29	150	317	68	<b>\$8102</b>
KTPFL8442	42 x 84 x 29	150	277	59	<b>\$6250</b>
KTPFL7242	42 x 72 x 29	150	211	51	<b>\$6562</b>

3" wood post, full height modesty panel, and full end panel.

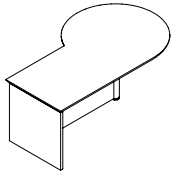

**"P" Shaped Connecting Table - Right**

KTPFR9642	42 x 96 x 29	150	317	68	<b>\$8102</b>
KTPFR8442	42 x 84 x 29	150	277	59	<b>\$6250</b>
KTPFR7242	42 x 72 x 29	150	211	51	<b>\$6562</b>

3" wood post, full height modesty panel, and full end panel.

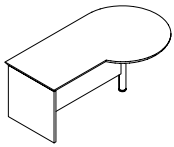

**"P" Shaped Connecting Table - Left**

KQTPL9642	42 x 96 x 29	150	291	68	<b>\$7691</b>
KQTPL8442	42 x 84 x 29	150	255	59	<b>\$6730</b>
KQTPL7242	42 x 72 x 29	250	189	51	<b>\$6198</b>

3" wood post, 3/4 height modesty panel, and full end panel.

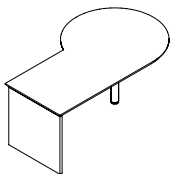

**"P" Shaped Connecting Table - Right**

KQTPR9642	42 x 96 x 29	150	291	68	<b>\$7691</b>
KQTPR8442	42 x 84 x 29	150	255	59	<b>\$6730</b>
KQTPR7242	42 x 72 x 29	250	189	51	<b>\$6198</b>

3" wood post, 3/4 height modesty panel, and full end panel.

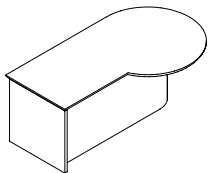

**"P" Shaped Connecting Table - Left**

KTPCL9642	42 x 96 x 29	150	317	68	<b>\$8509</b>
KTPCL8442	42 x 84 x 29	150	277	59	<b>\$7451</b>
KTPCL7242	42 x 72 x 29	150	211	51	<b>\$6591</b>

3" wood post, curved modesty panel, and full end panel.

### Required Specifications

Finish  
Edge

### Optional Specifications

Additional grommet  
Base upgrade\* (see accessories for options)

P-SHAPED CONNECTING TABLES

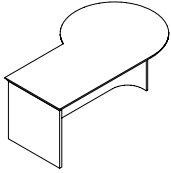

"P" Shaped Connecting Table - Right

MODEL#	DIMENSIONS D x W x H	FREIGHT CLASS	WT/LBS.	CUBIC FT.	LIST PRICE
KTPCR9642	42 x 96 x 29	150	317	68	\$8509
KTPCR8442	42 x 84 x 29	150	277	59	\$7451
KTPCR7242	42 x 72 x 29	150	211	51	\$6591

3" wood post, curved modesty panel, and full end panel.

RETURNS - NOTES

- All returns are shipped assembled
- Kneewell locking standard
- The standard grain direction on returns is cross grain (**CG**). To remove cross grain veneer pattern on top, delete suffix "**CG**" from the model number (no upcharge)
- If Handle is not specified Routed Pull, Black Lock & Grommet are standard
- If Handle is specified:
  - Black and Brass handle = Black Lock & Grommet
  - Silver, Nickel and Tungsten handle = Tungsten Lock & Grommet
- Grommets are available as an option on Desks and most Credenzas.
- Edge options - must specify:

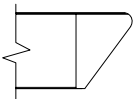

K16

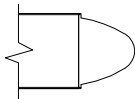

K18

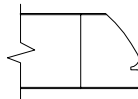

K21

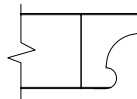

K22

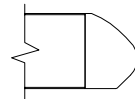

K29

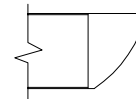

K30

• **NOTE:** Arrow indicates direction of grain

RETURNS

MODEL# DIMENSIONS FREIGHT CLASS WT/LBS. CUBIC FT. LIST PRICE

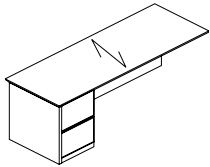

Executive Return - Left\*

KERL7222ECG	24 x 73 x 29	100	250	29	\$5564
KERL6622ECG	24 x 67 x 29	100	236	27	\$5360
KERL6022ECG	24 x 61 x 29	100	227	24	\$4872
KERL5422ECG	24 x 55 x 29	100	205	22	\$4699
KERL4822ECG	24 x 49 x 29	100	185	19	\$4176
KERL4222ECG	24 x 43 x 29	92.5	178	17	\$4020

Standard with full to floor **file/file** pedestal on **left**. Pedestal locks. Full height flush back panel.

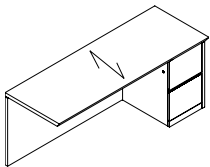

Executive Return - Right\*

KERR7222ECG	24 x 73 x 29	100	250	29	\$5564
KERR6622ECG	24 x 67 x 29	100	236	27	\$5360
KERR6022ECG	24 x 61 x 29	100	227	24	\$4872
KERR5422ECG	24 x 55 x 29	100	205	22	\$4699
KERR4822ECG	24 x 49 x 29	100	185	19	\$4176
KERR4222ECG	24 x 43 x 29	92.5	178	17	\$4020

Standard with full to floor **file/file** pedestal on **right**. Pedestal locks. Full height flush back panel.

Required Specifications

Finish  
Edge

Optional Specifications

Handles\*  
Additional grommet

## EXECUTIVE RETURNS

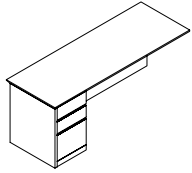

**Executive Return - Left\***

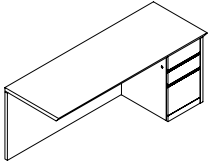

**Executive Return - Right\***

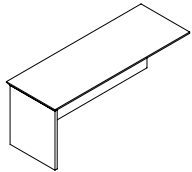

**Executive Return - Left**

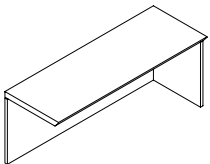

**Executive Return - Right**

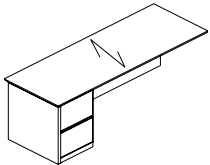

**Executive Return - Left\***

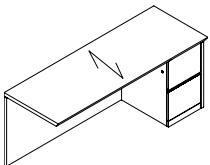

**Executive Return - Right\***

MODEL#	DIMENSIONS	FREIGHT CLASS	WT/LBS.	CUBIC FT.	LIST PRICE
--------	------------	---------------	---------	-----------	------------

**D x W x H**

KERL7222DCG	24 x 73 x 29	92.5	178	17	<b>\$5564</b>
KERL6622DCG	24 x 67 x 29	100	236	27	<b>\$5360</b>
KERL6022DCG	24 x 61 x 29	100	227	24	<b>\$4872</b>
KERL5422DCG	24 x 55 x 29	100	205	22	<b>\$4699</b>
KERL4822DCG	24 x 49 x 29	100	185	19	<b>\$4176</b>
KERL4222DCG	24 x 43 x 29	92.5	178	17	<b>\$4020</b>

Standard with full to floor **box/box/file** pedestal on **left**. Pedestal locks. Full height flush back panel.

KERR7222DCG	24 x 73 x 29	92.5	178	17	<b>\$5564</b>
KERR6622DCG	24 x 67 x 29	100	236	27	<b>\$5360</b>
KERR6022DCG	24 x 61 x 29	100	227	24	<b>\$4872</b>
KERR5422DCG	24 x 55 x 29	100	205	22	<b>\$4699</b>
KERR4822DCG	24 x 49 x 29	100	185	19	<b>\$4176</b>
KERR4222DCG	24 x 43 x 29	92.5	178	17	<b>\$4020</b>

Standard with full to floor **box/box/file** pedestal on **right**. Pedestal locks. Full height flush back panel.

KERL7222CG	24 x 73 x 29	150	135	29	<b>\$3123</b>
KERL6622CG	24 x 67 x 29	150	127	27	<b>\$2864</b>
KERL6022CG	24 x 61 x 29	150	120	24	<b>\$2602</b>
KERL5422CG	24 x 55 x 29	150	112	22	<b>\$2340</b>
KERL4822CG	24 x 49 x 29	150	105	19	<b>\$2083</b>
KERL4222CG	24 x 43 x 29	150	97	17	<b>\$1819</b>

Full height flush back panel.

KERR7222CG	24 x 73 x 29	150	135	29	<b>\$3123</b>
KERR6622CG	24 x 67 x 29	150	127	27	<b>\$2864</b>
KERR6022CG	24 x 61 x 29	150	120	24	<b>\$2602</b>
KERR5422CG	24 x 55 x 29	150	112	22	<b>\$2340</b>
KERR4822CG	24 x 49 x 29	150	105	19	<b>\$2083</b>
KERR4222CG	24 x 43 x 29	150	97	17	<b>\$1819</b>

Full height flush back panel.

KERL7220ECG	22 x 73 x 29	100	240	27	<b>\$5298</b>
KERL6620ECG	22 x 67 x 29	100	231	24	<b>\$5103</b>
KERL6020ECG	22 x 61 x 29	92.5	222	22	<b>\$4640</b>
KERL5420ECG	22 x 55 x 29	92.5	200	20	<b>\$4473</b>
KERL4820ECG	22 x 49 x 29	92.5	180	18	<b>\$3975</b>
KERL4220ECG	22 x 43 x 29	92.5	173	16	<b>\$3831</b>

Standard with full to floor **file/file** pedestal on **left**. Pedestal locks. Full height flush back panel.

KERR7220ECG	22 x 73 x 29	100	240	27	<b>\$5298</b>
KERR6620ECG	22 x 67 x 29	100	231	24	<b>\$5103</b>
KERR6020ECG	22 x 61 x 29	92.5	222	22	<b>\$4640</b>
KERR5420ECG	22 x 55 x 29	92.5	200	20	<b>\$4473</b>
KERR4820ECG	22 x 49 x 29	92.5	180	18	<b>\$3975</b>
KERR4220ECG	22 x 43 x 29	92.5	173	16	<b>\$3831</b>

Standard with full to floor **file/file** pedestal on **right**. Pedestal locks. Full height flush back panel.

**Required Specifications**

Finish  
Edge

**Optional Specifications**

Handles\*  
Additional grommet

EXECUTIVE RETURNS

MODEL# DIMENSIONS FREIGHT CLASS WT/LBS. CUBIC FT. LIST PRICE

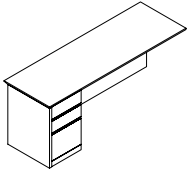

Executive Return - Left\*

	D x W x H				
KERL7220DCG	22 x 73 x 29	100	240	27	\$5298
KERL6620DCG	22 x 67 x 29	100	231	24	\$5103
KERL6020DCG	22 x 61 x 29	92.5	222	22	\$4640
KERL5420DCG	22 x 55 x 29	92.5	200	20	\$4473
KERL4820DCG	22 x 49 x 29	92.5	180	18	\$3975
KERL4220DCG	22 x 43 x 29	92.5	173	16	\$3831

Standard with full to floor **box/box/file** pedestal on **left**. Pedestal locks. Full height flush back panel.

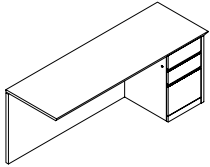

Executive Return - Right\*

KERR7220DCG	22 x 73 x 29	100	240	27	\$5298
KERR6620DCG	22 x 67 x 29	100	231	24	\$5103
KERR6020DCG	22 x 61 x 29	92.5	222	22	\$4640
KERR5420DCG	22 x 55 x 29	92.5	200	20	\$4473
KERR4820DCG	22 x 49 x 29	92.5	180	18	\$3975
KERR4220DCG	22 x 43 x 29	92.5	173	16	\$3831

Standard with full to floor **box/box/file** pedestal on **right**. Pedestal locks. Full height flush back panel.

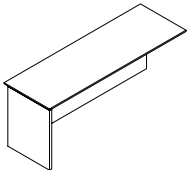

Executive Return - Left

KERL7220CG	22 x 73 x 29	150	130	27	\$2974
KERL6620CG	22 x 67 x 29	150	122	24	\$2728
KERL6020CG	22 x 61 x 29	150	115	22	\$2479
KERL5420CG	22 x 55 x 29	150	105	20	\$2229
KERL4820CG	22 x 49 x 29	150	100	18	\$1985
KERL4220CG	22 x 43 x 29	150	90	16	\$1733

Full height flush back panel.

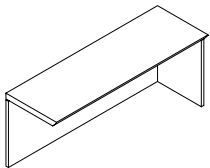

Executive Return - Right

KERR7220CG	22 x 73 x 29	150	130	27	\$2974
KERR6620CG	22 x 67 x 29	150	122	24	\$2728
KERR6020CG	22 x 61 x 29	150	115	22	\$2479
KERR5420CG	22 x 55 x 29	150	105	20	\$2229
KERR4820CG	22 x 49 x 29	150	100	18	\$1985
KERR4220CG	22 x 43 x 29	150	90	16	\$1733

Full height flush back panel.

Required Specifications

Finish  
Edge

Optional Specifications

Handles\*  
Additional grommet

## PIANO DESKS - NOTES

D x W x H

- All desks are shipped assembled
- Units include installed horizontal wire management
- Unit is handed by Post leg.
- Not for use with regular corner units
- If grommet (optional) color is not specified, Black grommet is standard.
- Grommets are available as an option on Desks and most Credenzas.
- Edge options - must specify:

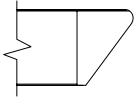

K16

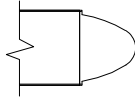

K18

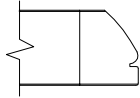

K21

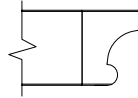

K22

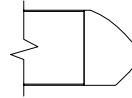

K29

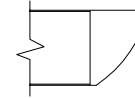

K30

- **NOTE:** Arrow indicates direction of grain
- For cross grain veneer pattern on top, add **(CG)**.

### PIANO DESKS

#### MODEL#

#### DIMENSIONS

#### FREIGHT CLASS

#### WT./LBS.

#### CUBIC FT.

#### LIST PRICE

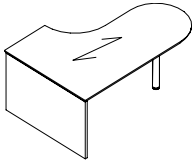

**D-shaped Piano Desk - Left\***

KTDP L96304822	48 x 96 x 29	125	464	77	<b>\$7127</b>
KTDP L84304822	48 x 84 x 29	150	406	68	<b>\$6343</b>
KTDP L72304822	48 x 72 x 29	125	348	58	<b>\$5554</b>

3" wood post and full end panel, 30"D worksurface and 24" return connection.

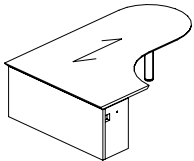

**D-shaped Piano Desk - Right\***

KTDP R96304822	48 x 96 x 29	125	464	77	<b>\$7127</b>
KTDP R84304822	48 x 84 x 29	150	406	68	<b>\$6343</b>
KTDP R72304822	48 x 72 x 29	125	348	58	<b>\$5554</b>

3" wood post and full end panel, 30"D worksurface and 24" return connection.

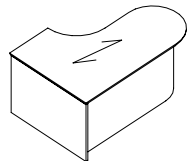

**D-shaped Piano Desk - Left**

KTDP CL96304822	48 x 96 x 29	125	479	77	<b>\$9046</b>
KTDP CL84304822	48 x 84 x 29	125	420	68	<b>\$8022</b>
KTDP CL72304822	48 x 72 x 29	125	360	58	<b>\$6995</b>

Full height curved modesty panel, 3" wood post, and full end panel, 30"D worksurface and 24" return connection.

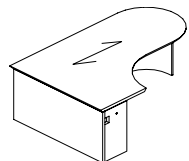

**D-shaped Piano Desk - Right**

KTDP CR96304822	48 x 96 x 29	125	479	77	<b>\$9046</b>
KTDP CR84304822	48 x 84 x 29	125	420	68	<b>\$8022</b>
KTDP CR72304822	48 x 72 x 29	125	360	58	<b>\$6995</b>

Full height curved modesty panel, 3" wood post, and full end panel, 30"D worksurface and 24" return connection.

#### Required Specifications

Finish  
Edge

#### Optional Specifications

Additional grommet  
Base upgrade\* (see accessories for options)

PIANO DESKS

MODEL# DIMENSIONS FREIGHT CLASS WT/LBS. CUBIC FT. LIST PRICE

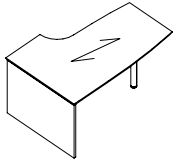

Boat-shaped Piano Desk - Left\*

D x W x H					
KTBPPL96364822	48 x 96 x 29	125	522	87	<b>\$8022</b>
KTBPPL84364822	48 x 84 x 29	125	457	76	<b>\$7132</b>
KTBPPL72364822	48 x 72 x 29	125	392	65	<b>\$6246</b>

3" wood post and full end panel, with 36"/30"D worksurface and 24" return connection.

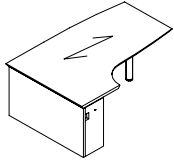

Boat-shaped Piano Desk - Right\*

KTBPRL96364822	48 x 96 x 29	125	522	87	<b>\$8022</b>
KTBPRL84364822	48 x 84 x 29	125	457	76	<b>\$7132</b>
KTBPRL72364822	48 x 72 x 29	125	392	65	<b>\$6246</b>

3" wood post and full end panel, with 36"/30"D worksurface and 24" return connection.

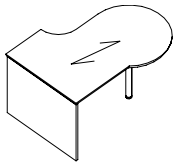

P-shaped Piano Desk - Left\*

KTPPL96424822	48 x 96 x 29	150	580	97	<b>\$8133</b>
KTPPL84424822	48 x 84 x 29	150	508	85	<b>\$7276</b>
KTPPL72424822	48 x 72 x 29	150	435	73	<b>\$6742</b>

3" wood post and full end panel, with 42"/30"D worksurface and 24" return connection.

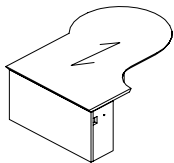

P-shaped Piano Desk - Right\*

KTPPR96424822	48 x 96 x 29	150	580	97	<b>\$8133</b>
KTPPR84424822	48 x 84 x 29	150	508	85	<b>\$7276</b>
KTPPR72424822	48 x 72 x 29	150	435	73	<b>\$6742</b>

3" wood post and full end panel, with 42"/30"D worksurface and 24" return connection.

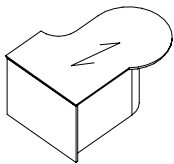

P-shaped Piano Desk - Left

KTPPCL96424822	48 x 96 x 29	125	590	97	<b>\$9773</b>
KTPPCL84424822	48 x 84 x 29	125	516	85	<b>\$8710</b>
KTPPCL72424822	48 x 72 x 29	125	442	73	<b>\$8187</b>

Full curved modesty panel, 3" wood post, and full end panel, with 42"/30"D worksurface and 24" return connection.

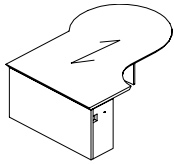

P-shaped Piano Desk - Right

KTPPCR96424822	48 x 96 x 29	125	590	97	<b>\$9773</b>
KTPPCR84424822	48 x 84 x 29	125	516	85	<b>\$8710</b>
KTPPCR72424822	48 x 72 x 29	125	442	73	<b>\$8187</b>

Full curved modesty panel, 3" wood post, and full end panel, with 42"/30"D worksurface and 24" return connection.

**Required Specifications**

Finish  
Edge

**Optional Specifications**

Additional grommet  
Base upgrade\* (see accessories for options)



## EXTENDED CORNERS

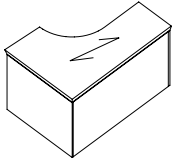

**Extended Corner Table - Right**

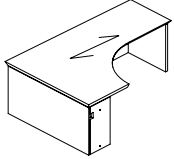

**Extended Corner Table - Right**

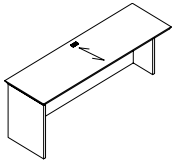

**Linking Return - Left**

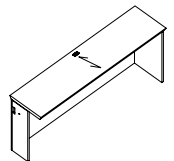

**Linking Return - Right**

MODEL#	DIMENSIONS D x W x H	FREIGHT CLASS	WT/LBS.	CUBIC FT.	LIST PRICE
KEKL964822MR	98 x 48 x 29	150	387	77	<b>\$7744</b>
KEKL904822MR	92 x 48 x 29	150	363	73	<b>\$7314</b>
KEKL844822MR	86 x 48 x 29	150	338	68	<b>\$7225</b>
KEKL784822MR	80 x 48 x 29	150	314	63	<b>\$7188</b>
KEKL724822MR	74 x 48 x 29	150	290	58	<b>\$6209</b>
KEKL664822MR	68 x 48 x 29	150	266	52	<b>\$6371</b>
KEKL604822MR	62 x 48 x 29	150	242	48	<b>\$5901</b>

Self edge on back edge, and 24" return connection.

KEKR489622ML	98 x 48 x 29	150	387	77	<b>\$7744</b>
KEKR489022ML	92 x 48 x 29	150	363	73	<b>\$7314</b>
KEKR488422ML	86 x 48 x 29	150	338	68	<b>\$7225</b>
KEKR487822ML	80 x 48 x 29	150	314	63	<b>\$7188</b>
KEKR487222ML	74 x 48 x 29	150	290	58	<b>\$6830</b>
KEKR486622ML	68 x 48 x 29	150	266	52	<b>\$6371</b>
KEKR486022ML	62 x 48 x 29	150	242	48	<b>\$5901</b>

Self edge on back edge, and 24" return connection.

KVEL9622CG	24 x 97 x 29	150	200	39	<b>\$4706</b>
KVEL9022CG	24 x 91 x 29	150	187	36	<b>\$4411</b>
KVEL8422CG	24 x 85 x 29	150	174	34	<b>\$4118</b>
KVEL7822CG	24 x 79 x 29	150	162	31	<b>\$3823</b>
KVEL7222CG	24 x 73 x 29	150	149	29	<b>\$3533</b>
KVEL6622CG	24 x 67 x 29	150	141	27	<b>\$3316</b>
KVEL6022CG	24 x 61 x 29	150	132	24	<b>\$2948</b>
KVEL5422CG	24 x 55 x 29	150	121	22	<b>\$2924</b>
KVEL4822CG	24 x 47 x 29	125	115	19	<b>\$2748</b>
KVEL4222CG	24 x 43 x 29	150	99	17	<b>\$2312</b>
KVEL3622CG	24 x 37 x 29	150	83	15	<b>\$2231</b>
KVEL3022CG	24 x 31 x 29	125	77	12	<b>\$2220</b>
KVEL2422CG	24 x 25 x 29	125	61	10	<b>\$1839</b>

Used in conjunction with Extended Corner Units or Piano Table Desks

KVER9622CG	24 x 97 x 29	150	200	39	<b>\$4706</b>
KVER9022CG	24 x 91 x 29	150	187	36	<b>\$4411</b>
KVER8422CG	24 x 85 x 29	150	174	34	<b>\$4118</b>
KVER7822CG	24 x 79 x 29	150	162	31	<b>\$3823</b>
KVER7222CG	24 x 73 x 29	150	149	29	<b>\$3533</b>
KVER6622CG	24 x 67 x 29	150	141	27	<b>\$3316</b>
KVER6022CG	24 x 61 x 29	150	132	24	<b>\$2948</b>
KVER5422CG	24 x 55 x 29	150	121	22	<b>\$2924</b>
KVER4822CG	24 x 47 x 29	125	115	19	<b>\$2748</b>
KVER4222CG	24 x 43 x 29	150	99	17	<b>\$2312</b>
KVER3622CG	24 x 37 x 29	150	83	15	<b>\$2231</b>
KVER3022CG	24 x 31 x 29	125	77	12	<b>\$2220</b>
KVER2422CG	24 x 25 x 29	125	61	10	<b>\$1839</b>

Used in conjunction with Extended Corner Units or Piano Table Desks

### Required Specifications

Finish  
Edge

### Optional Specifications

Additional grommet

EXTENDED CORNERS

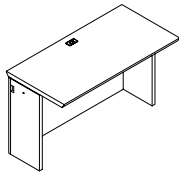

Bridge

MODEL# DIMENSIONS FREIGHT CLASS WT/LBS. CUBIC FT. LIST PRICE

	D x W x H				
KBTN4822CG	24 x 48 x 29	125	116	19	\$2662
KBTN4222CG	24 x 42 x 29	125	102	17	\$2231
KBTN3622CG	24 x 36 x 29	150	87	15	\$2152
KBTN3022CG	24 x 30 x 29	125	73	12	\$2107
KBTN2422CG	24 x 24 x 29	150	58	10	\$1768
KBTN1822CG	24 x 18 x 29	150	43	8	\$1330
KBTN1222CG	24 x 12 x 29	150	29	5	\$885

For Extended Corner Units or Piano Table Desks, with full back panel and recessed end panels.

BRIDGES

- All bridges are shipped knockdown.
- Not for use with corner units.
- The standard grain direction is cross grain (CG). To remove cross grain veneer pattern on top, delete suffix "CG" from the model number (no upcharge).
- GM5 TC location is standard. If grommet color is not specified, Black grommet is standard.
- Edge options - must specify:

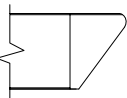

K16

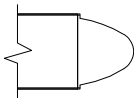

K18

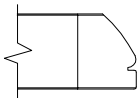

K21

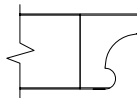

K22

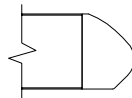

K29

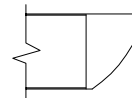

K30

• NOTE: Arrow indicates direction of grain

BRIDGES

MODEL# DIMENSIONS FREIGHT CLASS WT/LBS. CUBIC FT. LIST PRICE

KBT6022CG	24 x 60 x 29	85	108	9	\$2479
KBT5422CG	24 x 54 x 29	85	99	8	\$2231
KBT4822CG	24 x 48 x 29	85	90	7	\$1985
KBT4222CG	24 x 42 x 29	85	81	6	\$1735
KBT6020CG	22 x 60 x 29	85	105	8	\$2258
KBT5420CG	22 x 54 x 29	85	96	8	\$2031
KBT4820CG	22 x 48 x 29	85	87	7	\$1804
KBT4220CG	22 x 42 x 29	85	78	6	\$1547

With full back panel.

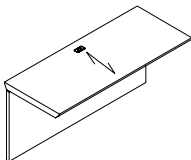

Executive Bridge Top

KBT6022Q8CG	24 x 60 x 9.5	100	83	9	\$2231
KBT5422Q8CG	24 x 54 x 9.5	100	74	8	\$2010
KBT4822Q8CG	24 x 48 x 9.5	100	65	7	\$1780
KBT4222Q8CG	24 x 42 x 9.5	100	56	6	\$1561

KBT6020Q8CG	22 x 60 x 9.5	92.5	80	8	\$2031
KBT5420Q8CG	22 x 54 x 9.5	100	71	8	\$1833
KBT4820Q8CG	22 x 48 x 9.5	100	62	7	\$1630
KBT4220Q8CG	22 x 42 x 9.5	100	53	6	\$1393

With 8" back panel.

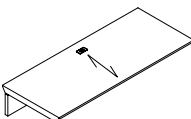

Executive Bridge Top

Required Specifications

Finish  
Edge

Optional Specifications

Additional grommet

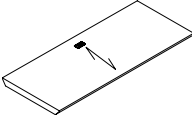

DESKS	MODEL#	DIMENSIONS D x W x H	FREIGHT CLASS	WT./LBS.	CUBIC FT.	LIST PRICE
	KBT5422TCG	24 x 54 x 1.5	100	64	8	<b>\$1335</b>
	KBT4822TCG	24 x 48 x 1.5	125	55	7	<b>\$1192</b>
	KBT4222TCG	24 x 42 x 1.5	125	46	6	<b>\$1045</b>
	KBT5420TCG	22 x 54 x 1.5	125	61	8	<b>\$1223</b>
	KBT4820TCG	22 x 48 x 1.5	125	52	7	<b>\$1086</b>
	KBT4220TCG	22 x 42 x 1.5	125	43	6	<b>\$930</b>

**Executive Bridge Top**

No back panel.

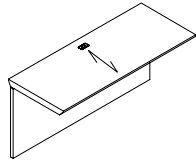

**Executive Bridge Top**

KHBT6022CG	24 x 60 x 29	85	108	9	<b>\$2848</b>
KHBT5422CG	24 x 54 x 29	85	99	8	<b>\$2607</b>
KHBT4822CG	24 x 48 x 29	85	90	7	<b>\$2358</b>
KHBT4222CG	24 x 42 x 29	85	81	6	<b>\$2108</b>
KHBT6020CG	22 x 60 x 29	85	105	8	<b>\$2631</b>
KHBT5420CG	22 x 54 x 29	85	96	8	<b>\$2405</b>
KHBT4820CG	22 x 48 x 29	85	87	7	<b>\$2180</b>
KHBT4220CG	22 x 42 x 29	85	78	6	<b>\$1920</b>

With hinged back panel, for U configurations.

### CREDENZA NOTES

- All credenzas are shipped assembled.
- All Storage Cabinets include one adjustable shelf per set of doors.
- "F" and "G" depict 36", and "M" and "N" depict 30".
- "F" and "N" indicate lateral file drawers and "G" and "M" indicate storage cabinets with doors.
- Credenza shells accept modular storage. Use modular storage for top support, allowing no more than 72" unsupported.
- Credenza shells with a width of 96" and more will have a 12" center support gable.
- Credenza shells can only be completely filled with modular storage units with ".5" at the end of the model number.
- If Handle is not specified Routed Pull, Black Lock & Grommet are standard
- If Handle is specified:
  - Black and Brass handle = Black Lock & Grommet
  - Silver, Nickel and Tungsten handle = Tungsten Lock & Grommet
- **NOTE:** Arrow indicates direction of grain
- Edge options - must specify:

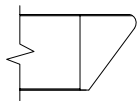
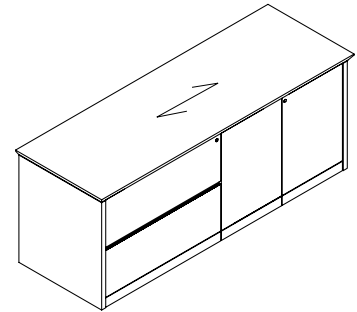

K16

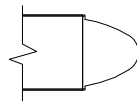

K18

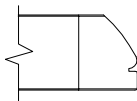

K21

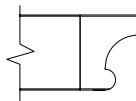

K22

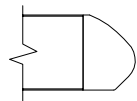

K29

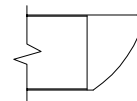

K30

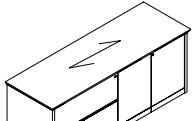
CREDENZAS	MODEL#	DIMENSIONS	FREIGHT CLASS	WT./LBS.	CUBIC FT.	LIST PRICE
	KC7222FG	23 x 74 x 29	92.5	285	27	<b>\$6676</b>
	KC6022NM	23 x 62 x 29	92.5	233	22	<b>\$5563</b>
	KC7220FG	21 x 74 x 29	92.5	272	24	<b>\$6355</b>
	KC6020NM	21 x 62 x 29	92.5	220	20	<b>\$5294</b>

**Full Storage Credenza\***

Standard with **lateral box/file** on **left** and **storage cabinet** on **right**.

- For Aluminum Framed Glass Door option, contact Customer Care.

#### Required Specifications

Finish  
Edge

#### Optional Specifications

Handles\*  
Additional grommet

CRENZAS

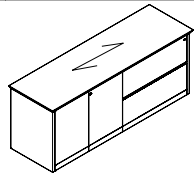

Full Storage Credenza

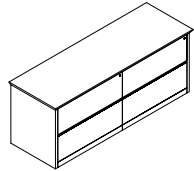

Full Storage Credenza

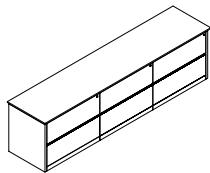

Full Storage Credenza

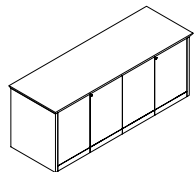

Full Storage Credenza

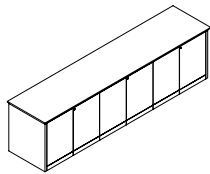

Full Storage Credenza

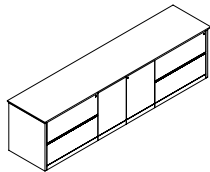

Full Storage Credenza

MODEL# DIMENSIONS FREIGHT CLASS WT/LBS. CUBIC FT. LIST PRICE

D x W x H

KC7222GF	23 x 74 x 29	92.5	285	27	\$6676
KC6022MN	23 x 62 x 29	92.5	233	22	\$5563
KC7220GF	21 x 74 x 29	92.5	272	24	\$6355
KC6020MN	21 x 62 x 29	92.5	220	20	\$5294

Standard with **lateral box/file** on **right** and **storage cabinet** on **left**.

- For Aluminum Framed Glass Door option, contact Customer Care.

KC7222FF	23 x 74 x 29	92.5	300	27	\$8535
KC6022NN	23 x 62 x 29	100	218	22	\$7828
KC7220FF	21 x 74 x 29	92.5	287	24	\$8128
KC6020NN	21 x 62 x 29	92.5	205	20	\$7119

Standard with **lateral box/file** on **left** and **right**.

KC10822FFF	23 x 110 x 29	92.5	435	40	\$15014
KC9022NNN	23 x 92 x 29	92.5	372	33	\$12512
KC10820FFF	21 x 110 x 29	92.5	412	36	\$13648
KC9020NNN	21 x 92 x 29	92.5	337	30	\$11376

Standard with **lateral box/file** on **left, center** and **right**.

KC7222GG	23 x 74 x 29	92.5	277	27	\$6335
KC6022MM	23 x 62 x 29	92.5	232	22	\$5808
KC7220GG	21 x 74 x 29	92.5	253	24	\$6034
KC6020MM	21 x 62 x 29	92.5	209	20	\$5280

Standard with **storage cabinets** on **left** and **right**.

KC10822GGG	23 x 110 x 29	100	348	40	\$11973
KC9022MMM	23 x 92 x 29	100	302	33	\$9977
KC10820GGG	21 x 110 x 29	125	278	36	\$10881
KC9020MMM	21 x 92 x 29	125	228	30	\$9011

Standard with **storage cabinets** on **left, center** and **right**.

KC10822FGF	23 x 110 x 29	100	348	40	\$14001
KC9022NMN	23 x 92 x 29	100	302	33	\$11669
KC10820FGF	21 x 110 x 29	125	278	36	\$12726
KC9020NMN	21 x 92 x 29	125	228	30	\$10606

**Lateral files** on **left** and **right**; **storage cabinet** in **center**

Required Specifications

Finish  
Edge

Optional Specifications

Handles  
Additional grommet

## CRENZAS

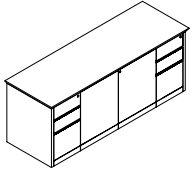

**Full Storage Credenza**

MODEL#	DIMENSIONS D x W x H	FREIGHT CLASS	WT/LBS.	CUBIC FT.	LIST PRICE
KC7222DGD	23 x 74 x 29	92.5	319	29	<b>\$7828</b>
KC6022DMD	23 x 62 x 29	92.5	266	24	<b>\$7176</b>
KC7220DGD	21 x 74 x 29	85	298	24	<b>\$7452</b>
KC6020DMD	21 x 62 x 29	85	246	20	<b>\$6523</b>

Standard with **box/box/file** on **left** and **right**; **storage cabinet** in **center**.

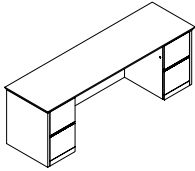

**Double Pedestal Credenza**

KCK8422EE	23 x 86 x 29	100	320	34	<b>\$8179</b>
KCK7822EE	23 x 80 x 29	100	298	31	<b>\$7596</b>
KCK7222EE	23 x 74 x 29	100	280	29	<b>\$7014</b>
KCK6622EE	23 x 68 x 29	100	257	27	<b>\$6907</b>
KCK6022EE	23 x 62 x 29	100	233	24	<b>\$6426</b>
KCK8420EE	21 x 86 x 29	92.5	307	28	<b>\$7795</b>
KCK7820EE	21 x 80 x 29	92.5	285	26	<b>\$7238</b>
KCK7220EE	21 x 74 x 29	92.5	267	24	<b>\$6679</b>
KCK6620EE	21 x 68 x 29	92.5	244	22	<b>\$6122</b>
KCK6020EE	21 x 62 x 29	92.5	220	20	<b>\$5566</b>

**File/file** pedestals on **left** and **right**. Full height back panel. Kneespace in center.

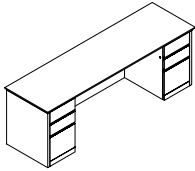

**Double Pedestal Credenza**

KCK8422DD	23 x 86 x 29	100	320	34	<b>\$8179</b>
KCK7822DD	23 x 80 x 29	100	298	31	<b>\$7596</b>
KCK7222DD	23 x 74 x 29	100	280	29	<b>\$7014</b>
KCK6622DD	23 x 68 x 29	100	257	27	<b>\$6907</b>
KCK6022DD	23 x 62 x 29	100	233	24	<b>\$6426</b>
KCK8420DD	21 x 86 x 29	92.5	307	28	<b>\$7795</b>
KCK7820DD	21 x 80 x 29	92.5	285	26	<b>\$7238</b>
KCK7220DD	21 x 74 x 29	92.5	267	24	<b>\$6679</b>
KCK6620DD	21 x 68 x 29	92.5	244	22	<b>\$6122</b>
KCK6020DD	21 x 62 x 29	92.5	220	20	<b>\$5566</b>

**Box/box/file** pedestals on **left** and **right**. Full height back panel. Kneespace in center.

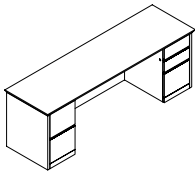

**Double Pedestal Credenza**

KCK8422ED	23 x 86 x 29	100	320	34	<b>\$8179</b>
KCK7822ED	23 x 80 x 29	100	298	31	<b>\$7596</b>
KCK7222ED	23 x 74 x 29	100	280	29	<b>\$7014</b>
KCK6622ED	23 x 68 x 29	100	257	27	<b>\$6907</b>
KCK6022ED	23 x 62 x 29	100	233	24	<b>\$6426</b>
KCK8420ED	21 x 86 x 29	92.5	307	28	<b>\$7795</b>
KCK7820ED	21 x 80 x 29	92.5	285	26	<b>\$7238</b>
KCK7220ED	21 x 74 x 29	92.5	267	24	<b>\$6679</b>
KCK6620ED	21 x 68 x 29	92.5	244	22	<b>\$6122</b>
KCK6020ED	21 x 62 x 29	92.5	220	20	<b>\$5566</b>

**File/file** pedestal on **left**, **box/box/file** pedestal on **right**. Full height back panel. Kneespace in center.

### Required Specifications

Finish  
Edge

### Optional Specifications

Handles  
Additional grommet

CREENZAS

MODEL# DIMENSIONS FREIGHT CLASS WT/LBS. CUBIC FT. LIST PRICE

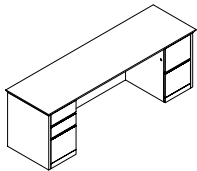

Double Pedestal Credenza

	D x W x H				
KCK8422DE	23 x 86 x 29	100	320	34	\$8179
KCK7822DE	23 x 80 x 29	100	298	31	\$7596
KCK7222DE	23 x 74 x 29	100	280	29	\$7014
KCK6622DE	23 x 68 x 29	100	257	27	\$6907
KCK6022DE	23 x 62 x 29	100	233	24	\$6426
KCK8420DE	21 x 86 x 29	92.5	307	28	\$7795
KCK7820DE	21 x 80 x 29	92.5	285	26	\$7238
KCK7220DE	21 x 74 x 29	92.5	267	24	\$6679
KCK6620DE	21 x 68 x 29	92.5	244	22	\$6122
KCK6020DE	21 x 62 x 29	92.5	220	20	\$5566

Box/box/file pedestal on left and file/file pedestal on right. Full height back panel. Kneespace in center.

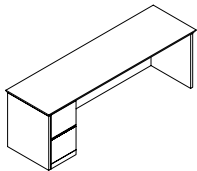

Single Pedestal Credenza - Left

KCL8422E	23 x 86 x 29	100	286	34	\$6184
KCL7822E	23 x 80 x 29	100	265	31	\$5745
KCL7222E	23 x 74 x 29	100	250	29	\$5298
KCL6622E	23 x 68 x 29	100	229	27	\$5103
KCL6022E	23 x 62 x 29	100	208	24	\$4640
KCL8420E	21 x 86 x 29	100	273	28	\$5892
KCL7820E	21 x 80 x 29	100	252	26	\$5473
KCL7220E	21 x 74 x 29	100	237	24	\$5049
KCL6620E	21 x 68 x 29	100	216	22	\$4860
KCL6020E	21 x 62 x 29	100	195	20	\$4422

File/file pedestal on left. Full height back panel.

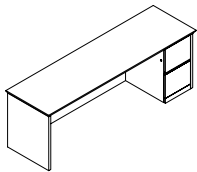

Single Pedestal Credenza - Right

KCR8422E	23 x 86 x 29	100	286	34	\$6184
KCR7822E	23 x 80 x 29	100	265	31	\$5745
KCR7222E	23 x 74 x 29	100	250	29	\$5298
KCR6622E	23 x 68 x 29	100	229	27	\$5103
KCR6022E	23 x 62 x 29	100	208	24	\$4640
KCR8420E	21 x 86 x 29	100	273	28	\$5892
KCR7820E	21 x 80 x 29	100	252	26	\$5473
KCR7220E	21 x 74 x 29	100	237	24	\$5049
KCR6620E	21 x 68 x 29	100	216	22	\$4860
KCR6020E	21 x 62 x 29	100	195	20	\$4422

File/file pedestal on right. Full height back panel.

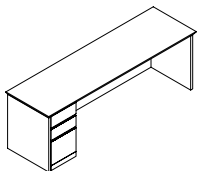

Single Pedestal Credenza - Left

KCL8422D	23 x 86 x 29	100	286	34	\$6184
KCL7822D	23 x 80 x 29	100	265	31	\$5745
KCL7222D	23 x 74 x 29	100	250	29	\$5298
KCL6622D	23 x 68 x 29	100	229	27	\$5103
KCL6022D	23 x 62 x 29	100	208	24	\$4640
KCL8420D	21 x 86 x 29	100	273	28	\$5892
KCL7820D	21 x 80 x 29	100	252	26	\$5473
KCL7220D	21 x 74 x 29	100	237	24	\$5049
KCL6620D	21 x 68 x 29	100	216	22	\$4860
KCL6020D	21 x 62 x 29	100	195	20	\$4422

Box/box/file pedestal on left. Full height back panel.

Required Specifications

Finish  
Edge

Optional Specifications

Handles  
Additional grommet

## CREDENZAS

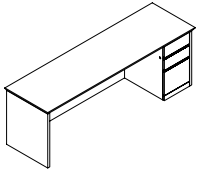

**Single Pedestal Credenza - Right**

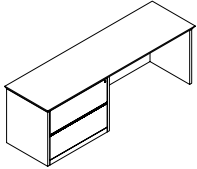

**Single Pedestal Credenza - Left**

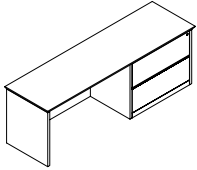

**Single Pedestal Credenza - Right**

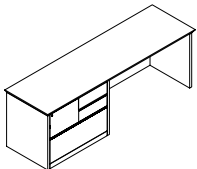

**Single Pedestal Credenza - Left**

MODEL#	DIMENSIONS D x W x H	FREIGHT CLASS	WT./LBS.	CUBIC FT.	LIST PRICE
KCR8422D	23 x 86 x 29	100	286	34	<b>\$6184</b>
KCR7822D	23 x 80 x 29	100	265	31	<b>\$5745</b>
KCR7222D	23 x 74 x 29	100	250	29	<b>\$5298</b>
KCR6622D	23 x 68 x 29	100	229	27	<b>\$5103</b>
KCR6022D	23 x 62 x 29	100	208	24	<b>\$4640</b>
KCR8420D	21 x 86 x 29	100	273	28	<b>\$5892</b>
KCR7820D	21 x 80 x 29	100	252	26	<b>\$5473</b>
KCR7220D	21 x 74 x 29	100	237	24	<b>\$5049</b>
KCR6620D	21 x 68 x 29	100	216	22	<b>\$4860</b>
KCR6020D	21 x 62 x 29	100	195	20	<b>\$4422</b>

**Box/box/file** pedestal on **right**. Full height back panel.

KCL8422F	23 x 86 x 29	100	266	31	<b>\$7188</b>
KCL7822F	23 x 80 x 29	100	245	29	<b>\$6674</b>
KCL7222F	23 x 74 x 29	100	230	27	<b>\$6164</b>
KCL6622F	23 x 68 x 29	100	209	24	<b>\$5933</b>
KCL6022F	23 x 62 x 29	100	188	22	<b>\$5385</b>
KCL8420F	21 x 86 x 29	100	253	28	<b>\$6844</b>
KCL7820F	21 x 80 x 29	100	233	26	<b>\$6353</b>
KCL7220F	21 x 74 x 29	100	218	24	<b>\$5865</b>
KCL6620F	21 x 68 x 29	100	197	22	<b>\$5649</b>
KCL6020F	21 x 62 x 29	100	176	20	<b>\$5129</b>

**36" lateral file** pedestal on **left**. Full height back panel.

KCR8422F	23 x 86 x 29	100	266	31	<b>\$7188</b>
KCR7822F	23 x 80 x 29	100	245	29	<b>\$6674</b>
KCR7222F	23 x 74 x 29	100	230	27	<b>\$6164</b>
KCR6622F	23 x 68 x 29	100	209	24	<b>\$5933</b>
KCR6022F	23 x 62 x 29	100	188	22	<b>\$5385</b>
KCR8420F	21 x 86 x 29	100	253	28	<b>\$6844</b>
KCR7820F	21 x 80 x 29	100	233	26	<b>\$6353</b>
KCR7220F	21 x 74 x 29	100	218	24	<b>\$5865</b>
KCR6620F	21 x 68 x 29	100	197	22	<b>\$5649</b>
KCR6020F	21 x 62 x 29	100	176	20	<b>\$5129</b>

**36" lateral file** pedestal on **right**. Full height back panel.

KCL8422Z	23 x 86 x 29	100	309	31	<b>\$7846</b>
KCL7822Z	23 x 80 x 29	100	287	29	<b>\$7288</b>
KCL7222Z	23 x 74 x 29	92.5	270	27	<b>\$6730</b>
KCL6622Z	23 x 68 x 29	92.5	248	24	<b>\$6472</b>
KCL6022Z	23 x 62 x 29	92.5	225	22	<b>\$5891</b>
KCL8420Z	21 x 86 x 29	92.5	296	28	<b>\$7477</b>
KCL7820Z	21 x 80 x 29	92.5	274	26	<b>\$6943</b>
KCL7220Z	21 x 74 x 29	92.5	257	24	<b>\$6104</b>
KCL6620Z	21 x 68 x 29	92.5	235	22	<b>\$6166</b>
KCL6020Z	21 x 62 x 29	92.5	212	20	<b>\$5606</b>

**Modular combination storage** pedestal with 1 lateral file, 1 file drawer on top left, and two box drawers on top right.

### Required Specifications

Finish  
Edge

### Optional Specifications

Handles  
Additional grommet

CREENZAS

MODEL# DIMENSIONS FREIGHT CLASS WT/LBS. CUBIC FT. LIST PRICE

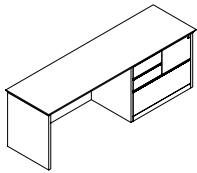

Single Pedestal Credenza - Right

	D x W x H				
KCR8422Z	23 x 86 x 29	100	309	31	\$7846
KCR7822Z	23 x 80 x 29	100	287	29	\$7288
KCR7222Z	23 x 74 x 29	92.5	270	27	\$6730
KCR6622Z	23 x 68 x 29	92.5	248	24	\$6472
KCR6022Z	23 x 62 x 29	92.5	225	22	\$5891
KCR8420Z	21 x 86 x 29	92.5	296	28	\$7477
KCR7820Z	21 x 80 x 29	92.5	274	26	\$6943
KCR7220Z	21 x 74 x 29	92.5	257	24	\$6104
KCR6620Z	21 x 68 x 29	92.5	235	22	\$6166
KCR6020Z	21 x 62 x 29	92.5	212	20	\$5606

Modular combination storage pedestal with 1 lateral file, 1 file drawer on top right, and two box drawers on top left.

96" and larger:

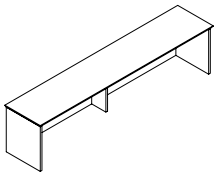

Less than 96":

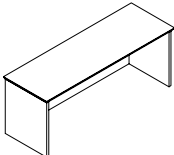

Credenza Shell

KC10822	23 x 108 x 29	125	320	41	\$4967
KC10222	23 x 104 x 29	100	305	38	\$4692
KC9622	23 x 98 x 29	100	287	35	\$4417
KC9022	23 x 92 x 29	100	269	33	\$3942
KC8422	23 x 86 x 29	100	251	31	\$3866
KC7822	23 x 80 x 29	100	233	29	\$3588
KC7222	23 x 74 x 29	125	215	27	\$3316
KC6622	23 x 68 x 29	100	197	24	\$3189
KC6022	23 x 62 x 29	100	179	22	\$2902
KC5422	23 x 56 x 29	100	161	20	\$2748
KC4822	23 x 50 x 29	125	143	18	\$2598
KC4222	23 x 44 x 29	125	125	16	\$2198
KC10820	21 x 108 x 29	100	310	36	\$4734
KC10220	21 x 104 x 29	100	291	34	\$4472
KC9620	21 x 98 x 29	100	273	32	\$4208
KC9020	21 x 92 x 29	100	255	30	\$3948
KC8420	21 x 86 x 29	100	237	28	\$3684
KC7820	21 x 80 x 29	100	219	26	\$3418
KC7220	21 x 74 x 29	100	206	24	\$3153
KC6620	21 x 68 x 29	100	188	22	\$3036
KC6020	21 x 62 x 29	100	169	20	\$2764
KC5420	21 x 56 x 29	100	147	18	\$2614
KC4820	21 x 50 x 29	125	101	16	\$2472
KC4220	21 x 44 x 29	125	86	14	\$2094

With full back panel.

Required Specifications

Finish  
Edge

Optional Specifications

Handles  
Additional grommet



## CORNERS - NOTES

**NOTE:** Arrow indicates direction of grain

### Corners

- All units are shipped assembled
- Unit includes grommets shown and installed horizontal wire management
- Corner units and extended corner units must be used exclusively with linking bridges and linking returns
- Edge options - must specify:

- **Linking bridges** are handed by recessed end panel
- **Extended corner tables** have no molding on back side.
- **Linking returns** include grommets shown and installed horizontal wire management. Handed by full end panel.
- **Tables** include grommets shown and installed horizontal wire management.

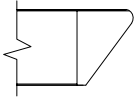

K16

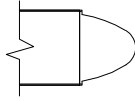

K18

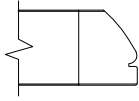

K21

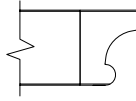

K22

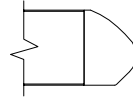

K29

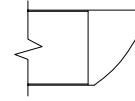

K30

## CORNERS AND COMPONENTS

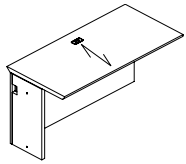

**Linking Bridge - Left**

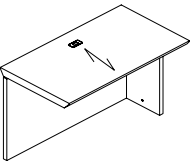

**Linking Bridge - Right**

MODEL#	DIMENSIONS	FREIGHT CLASS	WT/LBS.	CUBIC FT.	LIST PRICE
--------	------------	---------------	---------	-----------	------------

D x W x H

KBT6022NLLCG	24 x 60 x 29	125	145	24	<b>\$2733</b>
KBT5422NLLCG	24 x 54 x 29	150	131	22	<b>\$2462</b>
KBT4822NLLCG	24 x 48 x 29	125	116	19	<b>\$2189</b>
KBT4222NLLCG	24 x 42 x 29	125	102	17	<b>\$1770</b>
KBT3622NLLCG	24 x 36 x 29	150	87	15	<b>\$1611</b>
KBT3022NLLCG	24 x 30 x 29	125	73	12	<b>\$1570</b>
KBT6020NLLCG	22 x 60 x 29	150	131	22	<b>\$2602</b>
KBT5420NLLCG	22 x 54 x 29	150	118	20	<b>\$2343</b>
KBT4820NLLCG	22 x 48 x 29	125	110	18	<b>\$2083</b>
KBT4220NLLCG	22 x 42 x 29	150	95	16	<b>\$1686</b>
KBT3620NLLCG	22 x 36 x 29	125	80	13	<b>\$1531</b>
KBT3020NLLCG	22 x 30 x 29	150	65	11	<b>\$1495</b>

To join corner worksurface to desk or credenza. Full back panel.

KBT6022NLR CG	24 x 60 x 29	125	145	24	<b>\$2733</b>
KBT5422NLR CG	24 x 54 x 29	150	131	22	<b>\$2462</b>
KBT4822NLR CG	24 x 48 x 29	125	116	19	<b>\$2189</b>
KBT4222NLR CG	24 x 42 x 29	125	102	17	<b>\$1770</b>
KBT3622NLR CG	24 x 36 x 29	150	87	15	<b>\$1611</b>
KBT3022NLR CG	24 x 30 x 29	125	73	12	<b>\$1570</b>
KBT6020NLR CG	22 x 60 x 29	150	131	22	<b>\$2602</b>
KBT5420NLR CG	22 x 54 x 29	150	118	20	<b>\$2343</b>
KBT4820NLR CG	22 x 48 x 29	125	110	18	<b>\$2083</b>
KBT4220NLR CG	22 x 42 x 29	150	95	16	<b>\$1686</b>
KBT3620NLR CG	22 x 36 x 29	125	80	13	<b>\$1531</b>
KBT3020NLR CG	22 x 30 x 29	150	65	11	<b>\$1495</b>

To join corner worksurface to desk or credenza. Full back panel.

### Required Specifications

Finish  
Edge

### Optional Specifications

Additional grommet

CORNER COMPONENTS

MODEL# DIMENSIONS FREIGHT CLASS WT/LBS. CUBIC FT. LIST PRICE

D x W x H

KBT6022NLLQ8CG	24 x 60 x 9.5	125	145	24	\$2462
KBT5422NLLQ8CG	24 x 54 x 9.5	150	131	22	\$2220
KBT4822NLLQ8CG	24 x 48 x 9.5	125	116	19	\$1972
KBT4222NLLQ8CG	24 x 42 x 9.5	125	102	17	\$1591
KBT3622NLLQ8CG	24 x 36 x 9.5	150	87	15	\$1449
KBT3022NLLQ8CG	24 x 30 x 9.5	125	73	12	\$1417

KBT6020NLLQ8CG	22 x 60 x 9.5	150	131	22	\$2343
KBT5420NLLQ8CG	22 x 54 x 9.5	150	118	20	\$2111
KBT4820NLLQ8CG	22 x 48 x 9.5	125	110	18	\$1877
KBT4220NLLQ8CG	22 x 42 x 9.5	150	95	16	\$1520
KBT3620NLLQ8CG	22 x 36 x 9.5	125	80	13	\$1380
KBT3020NLLQ8CG	22 x 30 x 9.5	150	65	11	\$1350

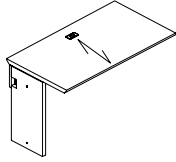

Linking Bridge - Left

To join corner worksurface to desk or credenza. 8" back panel.

KBT6022NLRQ8CG	24 x 60 x 9.5	125	145	24	\$2462
KBT5422NLRQ8CG	24 x 54 x 9.5	150	131	22	\$2220
KBT4822NLRQ8CG	24 x 48 x 9.5	125	116	19	\$1972
KBT4222NLRQ8CG	24 x 42 x 9.5	125	102	17	\$1591
KBT3622NLRQ8CG	24 x 36 x 9.5	150	87	15	\$1449
KBT3022NLRQ8CG	24 x 30 x 9.5	125	73	12	\$1417

KBT6020NLRQ8CG	22 x 60 x 9.5	150	131	22	\$2343
KBT5420NLRQ8CG	22 x 54 x 9.5	150	118	20	\$2111
KBT4820NLRQ8CG	22 x 48 x 9.5	125	110	18	\$1877
KBT4220NLRQ8CG	22 x 42 x 9.5	150	95	16	\$1520
KBT3620NLRQ8CG	22 x 36 x 9.5	125	80	13	\$1380
KBT3020NLRQ8CG	22 x 30 x 9.5	150	65	11	\$1350

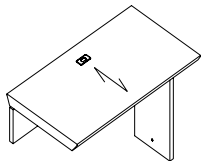

Linking Bridge - Right

To join corner worksurface to desk or credenza. 8" back panel.

KE484822	48 x 48 x 29	150	201	39	\$3932
KE424222	42 x 42 x 29	150	155	30	\$3018
KE363622	36 x 36 x 29	125	135	22	\$2866

KE484820	48 x 48 x 29	150	196	39	\$3932
KE424220	42 x 42 x 29	150	150	30	\$3018
KE363620	36 x 36 x 29	150	130	22	\$2866

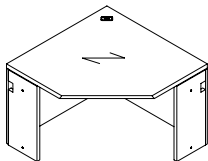

Corner Table

Connects to linking returns and linking bridges. 2 recessed end panels.

KEK484822	48 x 48 x 29	150	201	39	\$4527
KEK424222	42 x 42 x 29	150	155	30	\$3464
KEK363622	36 x 36 x 29	125	135	22	\$3292

KEK484820	48 x 48 x 29	150	196	39	\$4527
KEK424220	42 x 42 x 29	150	150	30	\$3464
KEK363620	36 x 36 x 29	150	130	22	\$3292

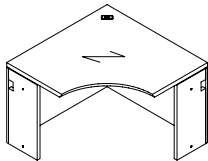

Corner Table

Connects to linking returns and linking bridges. 2 recessed end panels and inner curve.

Required Specifications

Finish  
Edge

Optional Specifications

Additional grommet

## CORNER COMPONENTS

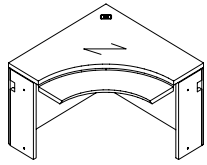

**Corner Table**

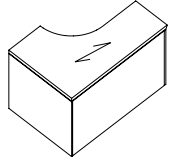

**Extended Corner Table - Left**

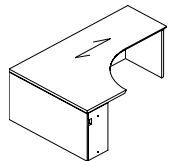

**Extended Corner Table - Right**

MODEL#	DIMENSIONS D x W x H	FREIGHT CLASS	WT./LBS.	CUBIC FT.	LIST PRICE
KEKS484822	48 x 48 x 29	150	201	39	<b>\$7516</b>
KEKS424222	42 x 42 x 29	150	155	30	<b>\$6296</b>
KEKS363622	36 x 36 x 29	125	135	22	<b>\$6096</b>
KEKS484820	48 x 48 x 29	150	196	39	<b>\$7516</b>
KEKS424220	42 x 42 x 29	150	150	30	<b>\$6296</b>
KEKS363620	36 x 36 x 29	150	130	22	<b>\$6096</b>

Connects to linking returns and linking bridges. 2 recessed end panels and inner curve. Adjustable keyboard tray and an articulating arm.

KEKL964822	48 x 97 x 29	150	387	77	<b>\$7039</b>
KEKL904822	48 x 91 x 29	150	363	73	<b>\$6644</b>
KEKL844822	48 x 85 x 29	150	338	68	<b>\$6566</b>
KEKL784822	48 x 79 x 29	150	314	63	<b>\$6534</b>
KEKL724822	48 x 73 x 29	150	290	58	<b>\$6208</b>
KEKL664822	48 x 67 x 29	150	266	52	<b>\$5789</b>
KEKL604822	48 x 61 x 29	150	242	48	<b>\$5113</b>

24" return connection.

KEKR489622	48 x 97 x 29	150	387	77	<b>\$7039</b>
KEKR489022	48 x 91 x 29	150	363	73	<b>\$6644</b>
KEKR488422	48 x 85 x 29	150	338	68	<b>\$6566</b>
KEKR487822	48 x 79 x 29	150	314	63	<b>\$6534</b>
KEKR487222	48 x 73 x 29	150	290	58	<b>\$6208</b>
KEKR486622	48 x 67 x 29	150	266	52	<b>\$5789</b>
KEKR486022	48 x 61 x 29	150	242	48	<b>\$5113</b>

24" return connection.

### Required Specifications

Finish  
Edge

### Optional Specifications

Additional grommet

LINKING RETURNS

MODEL# DIMENSIONS FREIGHT CLASS WT/LBS. CUBIC FT. LIST PRICE

D x W x H

KVL9622CG	23 x 97 x 29	150	200	39	\$4532
KVL9022CG	23 x 91 x 29	150	187	36	\$4246
KVL8422CG	23 x 85 x 29	150	174	34	\$3964
KVL7822CG	23 x 79 x 29	150	162	31	\$3682
KVL7222CG	23 x 73 x 29	150	149	29	\$3398
KVL6622CG	23 x 67 x 29	150	141	27	\$3186
KVL6022CG	23 x 61 x 29	150	132	24	\$2980
KVL5422CG	23 x 55 x 29	150	121	22	\$2812
KVL4822CG	23 x 49 x 29	125	115	19	\$2642
KVL4222CG	23 x 43 x 29	150	99	17	\$2229
KVL3622CG	23 x 37 x 29	150	83	15	\$2150
KVL3022CG	23 x 31 x 29	125	77	12	\$2111
KVL2422CG	23 x 23 x 29	125	61	10	\$1768

KVL9620CG	21 x 97 x 29	150	187	39	\$4315
KVL9020CG	21 x 91 x 29	150	175	36	\$4044
KVL8420CG	21 x 85 x 29	150	163	34	\$3778
KVL7820CG	21 x 79 x 29	150	152	31	\$3506
KVL7220CG	21 x 73 x 29	150	140	29	\$3239
KVL6620CG	21 x 67 x 29	150	133	27	\$3036
KVL6020CG	21 x 61 x 29	150	125	24	\$2840
KVL5420CG	21 x 55 x 29	150	113	22	\$2678
KVL4820CG	21 x 49 x 29	150	110	19	\$2514
KVL4220CG	21 x 43 x 29	150	95	17	\$2123
KVL3620CG	21 x 37 x 29	150	80	15	\$2044
KVL3020CG	21 x 31 x 29	125	75	12	\$2010
KVL2420CG	21 x 23 x 29	125	60	10	\$1686

To be used with corner unit.

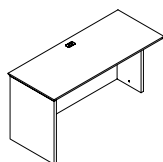

Linking Return - Left

KVR9622CG	23 x 97 x 29	150	200	39	\$4532
KVR9022CG	23 x 91 x 29	150	187	36	\$4246
KVR8422CG	23 x 85 x 29	150	174	34	\$3964
KVR7822CG	23 x 79 x 29	150	162	31	\$3682
KVR7222CG	23 x 73 x 29	150	149	29	\$3398
KVR6622CG	23 x 67 x 29	150	141	27	\$3186
KVR6022CG	23 x 61 x 29	150	132	24	\$2980
KVR5422CG	23 x 55 x 29	150	121	22	\$2812
KVR4822CG	23 x 49 x 29	125	115	19	\$2642
KVR4222CG	23 x 43 x 29	150	99	17	\$2229
KVR3622CG	23 x 37 x 29	150	83	15	\$2150
KVR3022CG	23 x 31 x 29	125	77	12	\$2111
KVR2422CG	23 x 23 x 29	125	61	10	\$1768

KVR9620CG	21 x 97 x 29	150	187	39	\$4315
KVR9020CG	21 x 91 x 29	150	175	36	\$4044
KVR8420CG	21 x 85 x 29	150	163	34	\$3778
KVR7820CG	21 x 79 x 29	150	152	31	\$3506
KVR7220CG	21 x 73 x 29	150	140	29	\$3239
KVR6620CG	21 x 67 x 29	150	133	27	\$3036
KVR6020CG	21 x 61 x 29	150	125	24	\$2840
KVR5420CG	21 x 55 x 29	150	113	22	\$2678
KVR4820CG	21 x 49 x 29	150	110	19	\$2514
KVR4220CG	21 x 43 x 29	150	95	17	\$2123
KVR3620CG	21 x 37 x 29	150	80	15	\$2044
KVR3020CG	21 x 31 x 29	125	75	12	\$2010
KVR2420CG	21 x 23 x 29	125	60	10	\$1686

To be used with corner unit.

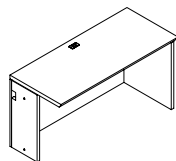

Linking Return - Right

Required Specifications

Finish  
Edge

Optional Specifications

Additional grommet

## CORNER COMPONENTS

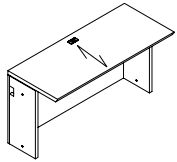

**Center Surface\***

MODEL#	DIMENSIONS D x W x H	FREIGHT CLASS	WT/LBS.	CUBIC FT.	LIST PRICE
KV9622CG	24 x 96 x 29	150	197	39	\$4426
KV9022CG	24 x 90 x 29	150	185	36	\$4152
KV8422CG	24 x 84 x 29	150	173	34	\$3871
KV7822CG	24 x 78 x 29	150	160	31	\$3592
KV7222CG	24 x 72 x 29	150	145	29	\$3318
KV6622CG	24 x 66 x 29	150	136	27	\$3111
KV6022CG	24 x 60 x 29	150	123	24	\$2904
KV5422CG	24 x 54 x 29	150	119	22	\$2733
KV4822CG	24 x 48 x 29	150	107	19	\$2565
KV4222CG	24 x 42 x 29	150	91	17	\$2363
KV3622CG	24 x 36 x 29	150	76	15	\$2150
KV3022CG	24 x 30 x 29	150	70	12	\$2028
KV2422CG	24 x 24 x 29	150	53	10	\$1704
KV9620CG	22 x 96 x 29	150	181	35	\$4219
KV9020CG	22 x 90 x 29	150	169	33	\$3956
KV8420CG	22 x 84 x 29	150	157	31	\$3689
KV7820CG	22 x 78 x 29	150	145	29	\$3425
KV7220CG	22 x 72 x 29	150	133	27	\$3161
KV6620CG	22 x 66 x 29	150	126	24	\$2964
KV6020CG	22 x 60 x 29	150	118	22	\$2767
KV5420CG	22 x 54 x 29	150	111	20	\$2602
KV4820CG	22 x 48 x 29	150	103	18	\$2440
KV4220CG	22 x 42 x 29	150	88	16	\$2044
KV3620CG	22 x 36 x 29	150	73	13	\$1972
KV3020CG	22 x 30 x 29	125	68	11	\$1933
KV2420CG	22 x 24 x 29	150	52	9	\$1622

With recessed end panels.

## MODULAR STORAGE - NOTES

- All storage components are shipped assembled
- Components 28" high are intended for use with a desk, credenza or return shell
- Backs on 28" high pedestals and cabinets are unfinished. If finished back is required, see page 241.
- If a profiled top is required, see "Freestanding Storage" on page 250.
- If Handle is not specified Routed Pull, Black Lock & Grommet are standard
- If Handle is specified:
  - Black and Brass handle = Black Lock & Grommet
  - Silver, Nickel and Tungsten handle = Tungsten Lock & Grommet

## MODULAR STORAGE

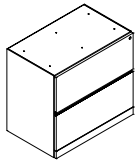

**Modular Lateral File\*\***

MODEL#	DIMENSIONS	FREIGHT CLASS	WT/LBS.	CUBIC FT.	LIST PRICE
KWF	19 x 35.1 x 28	92.5	115	11	\$3201
KWN	19 x 30 x 28	92.5	96	9	\$2801
KWF.5	19 x 34.5 x 28	92.5	115	11	\$3201

Units with ".5" at end of code are intended to be used if a Full Storage Credenza is to be created. For Single Pedestal installations either style can be used.

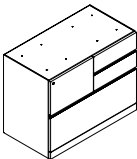

**Modular Combination Storage - Left\*\***

KWZL	19 x 35.1 x 28	92.5	115	11	\$3717
KWZL.5	19 x 34.5 x 28	92.5	115	11	\$3717

1 lateral file, 2 box drawers top right, and 1 file top left.

- Units with ".5" at end of code are intended to be used if a Full Storage Credenza is to be created. For Single Pedestal installations either style can be used.

### Required Specifications

Finish  
Edge\*

### Optional Specifications

Handles\*\*  
Additional grommet

DESKS

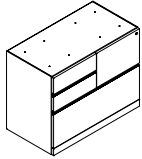

Modular Combination Storage - Right\*

MODEL# DIMENSIONS FREIGHT CLASS WT/LBS. CUBIC FT. LIST PRICE

D x W x H

KWZR	19 x 35.1 x 28	92.5	115	11	<b>\$3717</b>
KWZR.5	19 x 34.5 x 28	92.5	115	11	<b>\$3717</b>

1 lateral file, 2 box drawers top left, and 1 file top right.

- Units with ".5" at end of code are intended to be used if a Full Storage Credenza is to be created. For Single Pedestal installations either style can be used.

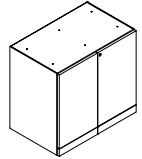

Modular Storage Cabinet w/Doors\*

KWG	19 x 35.1 x 28	92.5	115	11	<b>\$2231</b>
KWM	19 x 30 x 28	92.5	96	9	<b>\$1881</b>
KWG.5	19 x 34.5 x 28	92.5	115	11	<b>\$2231</b>

Storage with 1 adjustable shelf.

- Units with ".5" at end of code are intended to be used if a Full Storage Credenza is to be created. For Single Pedestal installations either style can be used.

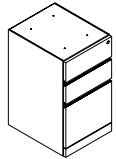

Modular Pedestal\*

Letter width:

KWWD	23 x 15.6 x 28	85	72	6	<b>\$2472</b>
KWD	19 x 15.6 x 28	85	70	5	<b>\$2153</b>

Legal width:

KWWLD	23 x 18.5 x 28	85	85	7	<b>\$2967</b>
KWLD	19 x 18.5 x 28	85	83	6	<b>\$2581</b>

Box/box/file pedestal.

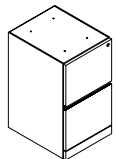

Modular Pedestal\*

Letter width:

KWWE	23 x 15.6 x 28	85	72	6	<b>\$2472</b>
KWE	19 x 15.6 x 28	85	70	5	<b>\$2153</b>

Legal width:

KWWLE	23 x 18.5 x 28	85	85	7	<b>\$2967</b>
KWLE	19 x 18.5 x 28	85	83	6	<b>\$2581</b>

File/file pedestal.

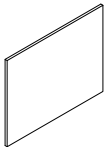

Finished Back

KBA36	0.8 x 35 x 27.5	125	18	3	<b>\$467</b>
KBA30	0.8 x 30 x 27.5	150	15	3	<b>\$388</b>
KBA18	0.8 x 18.5 x 27.5	150	10	2	<b>\$226</b>
KBA15	0.8 x 15.5 x 27.5	150	8	2	<b>\$196</b>

For modular pedestals.

Required Specifications

Finish

Optional Specifications

Handles\*

## HUTCHES & WALL MOUNTED STORAGE NOTES

### Hutches

- All hutches are shipped assembled
- Handles can be specified for hutches with wood doors.
- Handles cannot be specified on Aluminum framed glass doors.
- Frosted glass door is standard. White back painted clear glass is available, please contact customer care.

### Closed pigeon hole storage hutch

- 42" unit has 21.5" of clearance

**NOTE:** Arrow indicates direction of grain

Edge options - must specify:

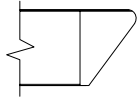

K16

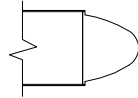

K18

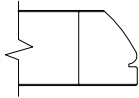

K21

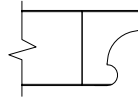

K22

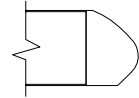

K29

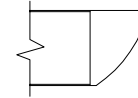

K30

### Closed storage hutch

- 36" unit has 19.5" of clearance.
- 42" and 54" units have 25.5" of clearance
- For lock option, see page 264

### Tasklight

- For proper size, see page 264.
- If Handle is specified:
  - Black and Brass handle = Black Lock & Grommet
  - Silver, Nickel and Tungsten handle = Tungsten Lock & Grommet

## HUTCHES & WALL MOUNTED STORAGE

MODEL#	DIMENSIONS	FREIGHT CLASS	WT/LBS.	CUBIC FT.	LIST PRICE
--------	------------	---------------	---------	-----------	------------

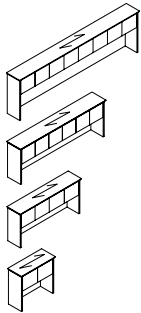

36" H Storage Hutch w/Wood Doors\*

K108SH36	16 x 110 x 36	125	268	34	<b>\$7296</b>
K102SH36	16 x 104 x 36	125	254	32	<b>\$6891</b>
K96SH36	16 x 98 x 36	100	241	30	<b>\$6378</b>
K90SH36	16 x 92 x 36	100	227	28	<b>\$6078</b>
K84SH36	16 x 86 x 36	100	214	26	<b>\$5673</b>
K78SH36	16 x 80 x 36	100	200	24	<b>\$5269</b>
K72SH36	16 x 74 x 36	100	187	23	<b>\$4861</b>
K66SH36	16 x 68 x 36	100	173	21	<b>\$4677</b>
K60SH36	16 x 62 x 36	100	160	19	<b>\$4459</b>
K36SH36	16 x 38 x 36	100	94	11	<b>\$3040</b>
K30SH36	16 x 32 x 36	100	78	9	<b>\$2661</b>

Hutches longer than 102" have 8 doors, hutches between 102" and 86" have 6 doors, hutches between 80" and 62" have 4 doors, and 32" and 38" hutches have 2 doors

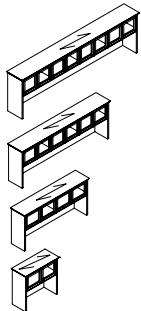

36" H Storage Hutch w/Glass Doors

K108SH36G	16 x 110 x 36	125	268	34	<b>\$10607</b>
K102SH36G	16 x 104 x 36	125	254	32	<b>\$9521</b>
K96SH36G	16 x 98 x 36	100	241	30	<b>\$9079</b>
K90SH36G	16 x 92 x 36	100	227	28	<b>\$8633</b>
K84SH36G	16 x 86 x 36	100	214	26	<b>\$8194</b>
K78SH36G	16 x 80 x 36	100	200	24	<b>\$7759</b>
K72SH36G	16 x 74 x 36	100	187	23	<b>\$6643</b>
K66SH36G	16 x 68 x 36	100	173	21	<b>\$6462</b>
K60SH36G	16 x 62 x 36	100	160	19	<b>\$6134</b>
K36SH36G	16 x 38 x 36	100	94	11	<b>\$3923</b>
K30SH36G	16 x 32 x 36	100	78	9	<b>\$3496</b>

Aluminum framed glass doors. Hutches longer than 102" have 8 doors, hutches between 102" and 86" have 6 doors, hutches between 80" and 62" have 4 doors, and 32" and 38" hutches have 2 doors.

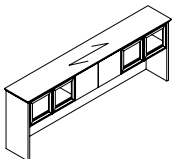

36" H Storage Hutch w/Doors\*

K102SH36GDG	16 x 104 x 3	125	254	32	<b>\$8563</b>
K96SH36GDG	16 x 98 x 36	100	241	30	<b>\$8157</b>
K90SH36GDG	16 x 92 x 36	100	227	28	<b>\$7751</b>
K84SH36GDG	16 x 86 x 36	100	214	26	<b>\$7000</b>

Wood doors in the center and Aluminum framed glass doors on left and right.

### Required Specifications

Finish  
Edge

### Optional Specifications

Handles\* (wood doors only)

HUTCHES & WALL MOUNTED STORAGE

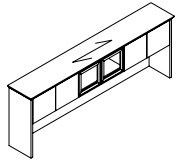

36" H Storage Hutch w/Doors\*

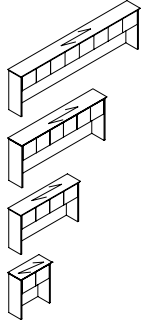

42" H Storage Hutch w/Wood Doors\*

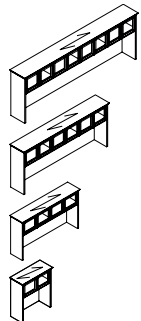

42" H Storage Hutch w/Glass Doors

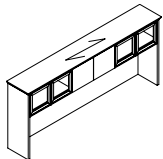

42" H Storage Hutch w/Doors\*

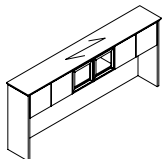

42" H Storage Hutch w/Doors\*

MODEL#	DIMENSIONS	FREIGHT CLASS	WT/LBS.	CUBIC FT.	LIST PRICE
<b>D x W x H</b>					
K102SH36DGD	16 x 104 x 3	125	254	32	<b>\$8563</b>
K96SH36DGD	16 x 98 x 36	100	241	30	<b>\$7105</b>
K90SH36DGD	16 x 92 x 36	100	227	28	<b>\$6910</b>
K84SH36DGD	16 x 86 x 36	100	214	26	<b>\$6507</b>

Aluminum framed glass doors in the center and wood doors on left and right.

K108SH42	16 x 110 x 43	125	307	39	<b>\$8507</b>
K102SH42	16 x 104 x 43	125	290	37	<b>\$8030</b>
K96SH42	16 x 98 x 43	125	273	35	<b>\$7563</b>
K90SH42	16 x 92 x 43	125	256	33	<b>\$7089</b>
K84SH42	16 x 86 x 43	125	239	31	<b>\$6614</b>
K78SH42	16 x 80 x 43	150	222	38	<b>\$6148</b>
K72SH42	16 x 74 x 43	125	205	26	<b>\$5673</b>
K66SH42	16 x 68 x 43	125	188	24	<b>\$5458</b>
K60SH42	16 x 62 x 43	125	171	22	<b>\$5200</b>
K36SH42	16 x 38 x 43	125	102	13	<b>\$3549</b>
K30SH42	16 x 32 x 43	125	85	11	<b>\$3105</b>

Hutches longer than 102" have 8 doors, hutches between 102" and 86" have 6 doors, hutches between 80" and 62" have 4 doors, and 32" and 38" hutches have 2 doors.

K108SH42G	16 x 110 x 43	125	307	39	<b>\$11821</b>
K102SH42G	16 x 104 x 43	125	290	37	<b>\$10665</b>
K96SH42G	16 x 98 x 43	125	273	35	<b>\$10156</b>
K90SH42G	16 x 92 x 43	125	256	33	<b>\$9649</b>
K84SH42G	16 x 86 x 43	125	239	31	<b>\$9140</b>
K78SH42G	16 x 80 x 43	150	222	38	<b>\$8632</b>
K72SH42G	16 x 74 x 43	125	205	26	<b>\$7453</b>
K66SH42G	16 x 68 x 43	125	188	24	<b>\$7190</b>
K60SH42G	16 x 62 x 43	125	171	22	<b>\$6934</b>
K36SH42G	16 x 38 x 43	125	102	13	<b>\$4431</b>
K30SH42G	16 x 32 x 43	125	85	11	<b>\$3941</b>

Aluminum framed glass doors. Hutches longer than 102" have 8 doors, hutches between 102" and 86" have 6 doors, hutches between 80" and 62" have 4 doors, and 32" and 38" hutches have 2 doors.

K102SH42GDG	16 x 104 x 43	125	290	37	<b>\$11126</b>
K96SH42GDG	16 x 98 x 43	125	273	35	<b>\$10472</b>
K90SH42GDG	16 x 92 x 43	125	256	33	<b>\$9819</b>
K84SH42GDG	16 x 86 x 43	125	239	31	<b>\$9163</b>

Wood doors in the center and Aluminum framed glass doors on left and right.

K102SH42DGD	16 x 104 x 43	125	290	37	<b>\$9313</b>
K96SH42DGD	16 x 98 x 43	125	273	35	<b>\$8396</b>
K90SH42DGD	16 x 92 x 43	125	256	33	<b>\$7923</b>
K84SH42DGD	16 x 86 x 43	125	239	31	<b>\$7453</b>

Aluminum framed glass doors in the center and wood doors on left and right.

**Required Specifications**

Finish  
Edge

**Optional Specifications**

Handles\* (wood doors only)



## HUTCHES & WALL MOUNTED STORAGE

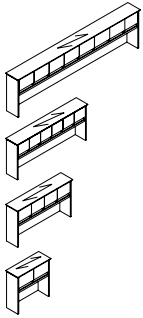

**42" H Storage Hutch w/Wood Doors & Pigeon-Holes**

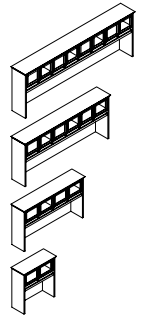

**42" H Storage Hutch w/Glass Doors & Pigeon-Holes**

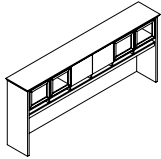

**42" H Storage Hutch w/Doors & Pigeon-Holes**

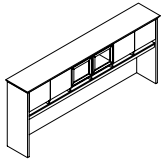

**42" H Storage Hutch w/Doors & Pigeon-Holes**

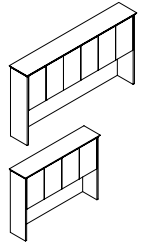

**54" H Storage Hutch w/Wood Doors\***

MODEL#	DIMENSIONS D x W x H	FREIGHT CLASS	WT./LBS.	CUBIC FT.	LIST PRICE
K108SHP42	16 x 110 x 43	125	307	39	<b>\$10203</b>
K102SHP42	16 x 104 x 43	125	290	37	<b>\$9641</b>
K96SHP42	16 x 98 x 43	125	273	35	<b>\$9072</b>
K90SHP42	16 x 92 x 43	125	256	33	<b>\$8507</b>
K84SHP42	16 x 86 x 43	125	239	31	<b>\$7939</b>
K78SHP42	16 x 80 x 43	150	222	38	<b>\$7370</b>
K72SHP42	16 x 74 x 43	125	205	26	<b>\$6806</b>
K66SHP42	16 x 68 x 43	125	188	24	<b>\$6554</b>
K60SHP42	16 x 62 x 43	125	171	22	<b>\$6239</b>
K36SHP42	16 x 38 x 43	125	102	13	<b>\$4259</b>
K30SHP42	16 x 32 x 43	125	85	11	<b>\$3727</b>

Hutches longer than 102" have 8 doors, hutches between 102" and 86" have 6 doors, hutches between 80" and 62" have 4 doors, and 32" and 38" hutches have 2 doors.

K108SHP42G	16 x 110 x 43	125	307	39	<b>\$13445</b>
K102SHP42G	16 x 104 x 43	125	290	37	<b>\$12208</b>
K96SHP42G	16 x 98 x 43	125	273	35	<b>\$11633</b>
K90SHP42G	16 x 92 x 43	125	256	33	<b>\$11598</b>
K84SHP42G	16 x 86 x 43	125	239	31	<b>\$10387</b>
K78SHP42G	16 x 80 x 43	150	222	38	<b>\$9792</b>
K72SHP42G	16 x 74 x 43	125	205	26	<b>\$8539</b>
K66SHP42G	16 x 68 x 43	125	188	24	<b>\$8269</b>
K60SHP42G	16 x 62 x 43	125	171	22	<b>\$7870</b>
K36SHP42G	16 x 38 x 43	125	102	13	<b>\$5113</b>
K30SHP42G	16 x 32 x 43	125	85	11	<b>\$4563</b>

Aluminum framed glass doors. Hutches longer than 102" have 8 doors, hutches between 102" and 86" have 6 doors, hutches between 80" and 62" have 4 doors, and 32" and 38" hutches have 2 doors.

K102SHP42GDG	16 x 104 x 43	125	290	37	<b>\$11269</b>
K96SHP42GDG	16 x 98 x 43	125	273	35	<b>\$10700</b>
K90SHP42GDG	16 x 92 x 43	125	256	33	<b>\$10139</b>
K84SHP42GDG	16 x 86 x 43	125	239	31	<b>\$9114</b>

Wood doors in the center and Aluminum framed glass doors on left and right.

K102SHP42DGD	16 x 104 x 43	125	290	37	<b>\$10477</b>
K96SHP42DGD	16 x 98 x 43	125	273	35	<b>\$9415</b>
K90SHP42DGD	16 x 92 x 43	125	256	33	<b>\$8978</b>
K84SHP42DGD	16 x 86 x 43	125	239	31	<b>\$8755</b>

Aluminum framed glass doors in the center and wood doors on left and right.

K962SH54	16 x 98 x 55	125	351	45	<b>\$9723</b>
K902SH54	16 x 92 x 55	125	329	42	<b>\$9114</b>
K842SH54	16 x 86 x 55	125	307	39	<b>\$8507</b>
K782SH54	16 x 80 x 55	125	285	37	<b>\$7898</b>
K722SH54	16 x 74 x 55	125	263	34	<b>\$7290</b>
K662SH54	16 x 68 x 55	125	241	31	<b>\$7017</b>
K602SH54	16 x 62 x 55	125	219	28	<b>\$6682</b>

Hutches between 98" and 86" have 6 doors; hutches less than 86" have 4 doors. One adjustable shelf.

### Required Specifications

Finish  
Edge

### Optional Specifications

Handles\* (wood doors only)

HUTCHES & WALL MOUNTED STORAGE

MODEL# DIMENSIONS FREIGHT CLASS WT./LBS. CUBIC FT. LIST PRICE

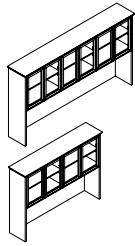

54" H Storage Hutch w/Glass Doors

	D x W x H					
K962SH54G	16 x 98 x 55	125	351	45		<b>\$12972</b>
K902SH54G	16 x 92 x 55	125	329	42		<b>\$12082</b>
K842SH54G	16 x 86 x 55	125	307	39		<b>\$11187</b>
K782SH54G	16 x 80 x 55	125	285	37		<b>\$10291</b>
K722SH54G	16 x 74 x 55	125	263	34		<b>\$9402</b>
K662SH54G	16 x 68 x 55	125	241	31		<b>\$9063</b>
K602SH54G	16 x 62 x 55	125	219	28		<b>\$8663</b>

Aluminum framed glass doors. Hutches between 98" and 86" have 6 doors; hutches less than 86" have 4 doors. One adjustable shelf.

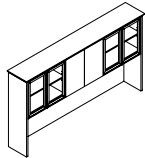

54" H Storage Hutch w/Doors\*

K962SH54GDG	16 x 98 x 55	125	351	45		<b>\$11702</b>
K902SH54GDG	16 x 92 x 55	125	329	42		<b>\$11091</b>
K842SH54GDG	16 x 86 x 55	125	309	39		<b>\$10485</b>

Wood doors in the center and Aluminum framed glass doors on left and right. One adjustable shelf.

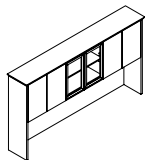

54" H Storage Hutch w/Doors\*

K962SH54DGD	16 x 98 x 55	125	351	45		<b>\$10708</b>
K902SH54DGD	16 x 92 x 55	125	329	42		<b>\$10103</b>
K842SH54DGD	16 x 86 x 55	125	307	39		<b>\$9497</b>

Aluminum framed glass doors in the center and wood doors on left and right. One adjustable shelf.

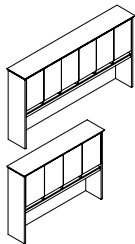

54" H Storage Hutch w/Wood Doors & Pigeon-Holes

K962SHP54	16 x 98 x 55	125	351	45		<b>\$11669</b>
K902SHP54	16 x 92 x 55	125	329	42		<b>\$10933</b>
K842SHP54	16 x 86 x 55	125	307	39		<b>\$10201</b>
K782SHP54	16 x 80 x 55	125	285	37		<b>\$10201</b>
K722SHP54	16 x 74 x 55	125	263	34		<b>\$8744</b>
K662SHP54	16 x 68 x 55	125	241	31		<b>\$8422</b>
K602SHP54	16 x 62 x 55	125	219	28		<b>\$8023</b>

Hutches between 98" and 86" have 6 doors; hutches less than 86" have 4 doors. One adjustable shelf.

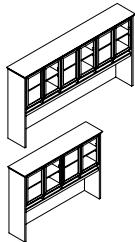

54" H Storage Hutch w/Glass Doors & Pigeon-Holes

K962SHP54G	16 x 98 x 55	125	351	45		<b>\$14918</b>
K902SHP54G	16 x 92 x 55	125	329	42		<b>\$13903</b>
K842SHP54G	16 x 86 x 55	125	307	39		<b>\$12885</b>
K782SHP54G	16 x 80 x 55	125	285	37		<b>\$11873</b>
K722SHP54G	16 x 74 x 55	125	263	34		<b>\$10860</b>
K662SHP54G	16 x 68 x 55	125	241	34		<b>\$10469</b>
K602SHP54G	16 x 62 x 55	125	219	28		<b>\$10002</b>

Aluminum framed glass doors. Hutches between 98" and 86" have 6 doors; hutches less than 86" have 4 doors. One adjustable shelf.

Required Specifications

Finish  
Edge

Optional Specifications

Handles\* (wood doors only)

## HUTCHES & WALL MOUNTED STORAGE

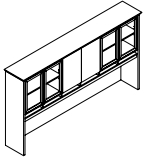

**54" H Storage Hutch w/Doors & Pigeon-Holes**

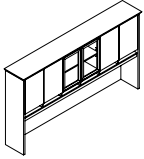

**54" H Storage Hutch w/Doors &\* Pigeon-Holes**

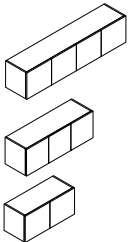

**Wall Mount Storage w/Wood Doors\***

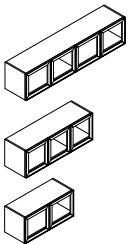

**Wall Mount Storage w/Glass Doors**

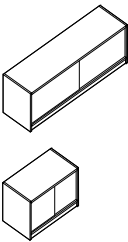

**Wall Mount Storage w/Sliding Glass Doors**

MODEL#	DIMENSIONS D x W x H	FREIGHT CLASS	WT/LBS.	CUBIC FT.	LIST PRICE
K962SHP54GDG	16 x 98 x 55	125	351	45	<b>\$12656</b>
K902SHP54GDG	16 x 92 x 55	125	329	42	<b>\$11926</b>
K842SHP54GDG	16 x 86 x 55	125	307	39	<b>\$11193</b>

Wood doors in the center and Aluminum framed glass doors on left and right. One adjustable shelf.

K962SHP54DGD	16 x 98 x 55	125	351	45	<b>\$13645</b>
K902SHP54DGD	16 x 92 x 55	125	329	42	<b>\$12916</b>
K842SHP54DGD	16 x 86 x 55	125	307	39	<b>\$12184</b>

Aluminum framed glass doors in the center and wood doors on left and right. One adjustable shelf.

CSF72	15.5 x 72 x 16.5	92.5	100	10	<b>\$2270</b>
CSF66	15.5 x 66 x 16.5	100	83	9	<b>\$2082</b>
CSF60	15.5 x 60 x 16.5	100	75	8	<b>\$1887</b>
CSF54	15.5 x 54 x 16.5	100	68	7	<b>\$1701</b>
CSF48	15.5 x 48 x 16.5	100	60	7	<b>\$1512</b>
CSF42	15.5 x 42 x 16.5	100	55	6	<b>\$1390</b>
CSF36	15.5 x 36 x 16.5	92.5	50	5	<b>\$1364</b>
CSF30	15.5 x 30 x 16.5	92.5	45	4	<b>\$1341</b>

CSF72G	15.5 x 72 x 16.5	92.5	100	10	<b>\$4776</b>
CSF66G	15.5 x 66 x 16.5	100	83	9	<b>\$4436</b>
CSF60G	15.5 x 60 x 16.5	100	75	8	<b>\$4158</b>
CSF54G	15.5 x 54 x 16.5	100	68	7	<b>\$3725</b>
CSF48G	15.5 x 48 x 16.5	100	60	7	<b>\$3291</b>
CSF42G	15.5 x 42 x 16.5	100	55	6	<b>\$2921</b>
CSF36G	15.5 x 36 x 16.5	92.5	50	5	<b>\$2700</b>
CSF30G	15.5 x 30 x 16.5	92.5	45	4	<b>\$2621</b>

Aluminum framed glass doors.

CSF72GSL	18 x 72 x 16.5	92.5	100	10	<b>\$4776</b>
CSF66GSL	18 x 66 x 16.5	100	83	9	<b>\$4436</b>
CSF60GSL	18 x 60 x 16.5	100	75	8	<b>\$4158</b>
CSF54GSL	18 x 54 x 16.5	100	68	7	<b>\$3725</b>
CSF48GSL	18 x 48 x 16.5	100	60	7	<b>\$3291</b>
CSF42GSL	18 x 42 x 16.5	100	55	6	<b>\$2921</b>
CSF36GSL	18 x 36 x 16.5	92.5	50	5	<b>\$2700</b>
CSF30GSL	18 x 30 x 16.5	92.5	45	4	<b>\$2621</b>

Frameless sliding glass doors.

### Required Specifications

Finish  
Edge

### Optional Specifications

Handles\* (wood doors only)

HUTCHES & WALL MOUNTED STORAGE

MODEL# DIMENSIONS FREIGHT CLASS WT./LBS. CUBIC FT. LIST PRICE

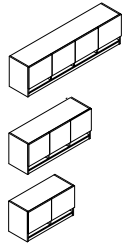

Wall Mount Storage w/Wood Doors &\* Pigeon-Holes

	D x W x H					
CSFP72	15.5 x 72 x 20	92.5	100	10		\$2720
CSFP66	15.5 x 66 x 20	100	83	9		\$2495
CSFP60	15.5 x 60 x 20	100	75	8		\$2270
CSFP54	15.5 x 54 x 20	100	68	7		\$2043
CSFP48	15.5 x 48 x 20	100	60	7		\$1813
CSFP42	15.5 x 42 x 20	100	55	6		\$1720
CSFP36	15.5 x 36 x 20	92.5	50	5		\$1637
CSFP30	15.5 x 30 x 20	92.5	45	4		\$1610

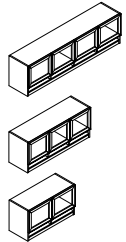

Wall Mount Storage w/Glass Doors & Pigeon-Holes

CSFP72G	15.5 x 72 x 20	100	100	12		\$5255
CSFP66G	15.5 x 66 x 20	125	83	11		\$5025
CSFP60G	15.5 x 60 x 20	125	75	10		\$4630
CSFP54G	15.5 x 54 x 20	125	68	9		\$4319
CSFP48G	15.5 x 48 x 20	125	60	8		\$3665
CSFP42G	15.5 x 42 x 20	125	55	7		\$3192
CSFP36G	15.5 x 36 x 20	100	50	6		\$3045
CSFP30G	15.5 x 30 x 20	100	45	5		\$2966

Aluminum framed glass doors.

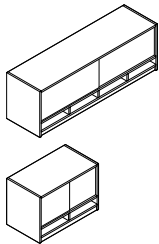

Wall Mount Storage w/Sliding Glass Doors & Pigeon-Holes

CSFP72GSL	18 x 72 x 20	100	100	12		\$5255
CSFP66GSL	18 x 66 x 20	125	83	11		\$5025
CSFP60GSL	18 x 60 x 20	125	75	10		\$4630
CSFP54GSL	18 x 54 x 20	125	68	9		\$4319
CSFP48GSL	18 x 48 x 20	125	60	8		\$3665
CSFP42GSL	18 x 42 x 20	125	55	7		\$3192
CSFP36GSL	18 x 36 x 20	100	50	6		\$3045
CSFP30GSL	18 x 30 x 20	100	45	5		\$2966

Frameless sliding glass doors.

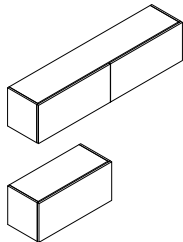

Wall Mount Storage w/Wood Flipper Doors

CSFF72	15.5 x 72 x 16.5	92.5	100	10		\$3346
CSFF66	15.5 x 66 x 16.5	100	83	9		\$3068
CSFF60	15.5 x 60 x 16.5	100	75	8		\$2787
CSFF54	15.5 x 54 x 16.5	100	68	7		\$2511
CSFF48	15.5 x 48 x 16.5	100	60	7		\$2232
CSFF42	15.5 x 42 x 16.5	100	55	6		\$2071
CSFF36	15.5 x 36 x 16.5	92.5	50	5		\$2033
CSFF30	15.5 x 30 x 16.5	92.5	45	4		\$2001

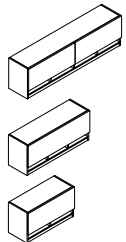

Wall Mount Storage w/Pigeon-Holes & Wood Flipper Doors

CSFFP72	15.5 x 72 x 20	100	100	12		\$4018
CSFFP66	15.5 x 66 x 20	125	83	11		\$3681
CSFFP60	15.5 x 60 x 20	125	75	10		\$3348
CSFFP54	15.5 x 54 x 20	125	68	9		\$3010
CSFFP48	15.5 x 48 x 20	125	60	8		\$2680
CSFFP42	15.5 x 42 x 20	125	55	7		\$2482
CSFFP36	15.5 x 36 x 20	100	50	6		\$2440
CSFFP30	15.5 x 30 x 20	100	45	5		\$2397

Required Specifications

Finish  
Edge

Optional Specifications

Handles\* (wood doors only)

**DESKS**

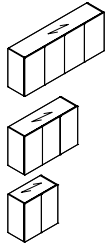

**Double High Wall Mount Storage\*  
w/Wood Doors**

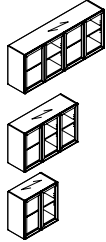

**Double High Wall Mount Storage  
w/Glass Doors**

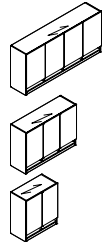

**Double High Wall Mount Storage\*  
w/Pigeon-Holes & Wood Doors**

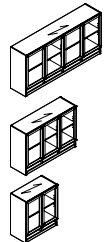

**Double High Wall Mount Storage  
w/Pigeon-Holes & Glass Doors**

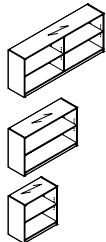

**Double High Open Wall Mount Storage**

MODEL#	DIMENSIONS D x W x H	FREIGHT CLASS	WT/LBS.	CUBIC FT.	LIST PRICE
CSF72H30	15.5 x 72 x 30	100	140	17	<b>\$5964</b>
CSF66H30	15.5 x 66 x 30	125	116	16	<b>\$5473</b>
CSF60H30	15.5 x 60 x 30	125	105	14	<b>\$4967</b>
CSF54H30	15.5 x 54 x 30	125	95	13	<b>\$4470</b>
CSF48H30	15.5 x 48 x 30	125	85	12	<b>\$3975</b>
CSF42H30	15.5 x 42 x 30	125	77	10	<b>\$3650</b>
CSF36H30	15.5 x 36 x 30	125	70	9	<b>\$3583</b>
CSF30H30	15.5 x 30 x 30	100	63	7	<b>\$3520</b>

CSF72H30G	15.5 x 72 x 30	100	140	17	<b>\$8675</b>
CSF66H30G	15.5 x 66 x 30	125	116	16	<b>\$8562</b>
CSF60H30G	15.5 x 60 x 30	60	1045	14	<b>\$8029</b>
CSF54H30G	15.5 x 54 x 30	125	95	13	<b>\$7190</b>
CSF48H30G	15.5 x 48 x 30	125	85	12	<b>\$6352</b>
CSF42H30G	15.5 x 42 x 30	125	77	10	<b>\$5642</b>
CSF36H30G	15.5 x 36 x 30	125	70	9	<b>\$5213</b>
CSF30H30G	15.5 x 30 x 30	100	63	7	<b>\$5059</b>

Aluminum framed glass doors.

CSFP72H34	15.5 x 72 x 34	100	140	17	<b>\$6487</b>
CSFP66H34	15.5 x 66 x 34	125	116	16	<b>\$5949</b>
CSFP60H34	15.5 x 60 x 34	125	105	14	<b>\$5414</b>
CSFP54H34	15.5 x 54 x 34	125	95	13	<b>\$4868</b>
CSFP48H34	15.5 x 48 x 34	125	85	12	<b>\$4323</b>
CSFP42H34	15.5 x 42 x 34	125	77	10	<b>\$4108</b>
CSFP36H34	15.5 x 36 x 34	125	70	9	<b>\$3897</b>
CSFP30H34	15.5 x 30 x 34	100	63	7	<b>\$3833</b>

CSFP72H34G	15.5 x 72 x 34	100	140	17	<b>\$9202</b>
CSFP66H34G	15.5 x 66 x 34	125	116	16	<b>\$8797</b>
CSFP60H34G	15.5 x 60 x 34	125	105	14	<b>\$8102</b>
CSFP54H34G	15.5 x 54 x 34	125	95	13	<b>\$7557</b>
CSFP48H34G	15.5 x 48 x 34	125	85	12	<b>\$6417</b>
CSFP42H34G	15.5 x 42 x 34	125	77	10	<b>\$5588</b>
CSFP36H34G	15.5 x 36 x 34	125	70	9	<b>\$5588</b>
CSFP30H34G	15.5 x 30 x 34	100	63	7	<b>\$5188</b>

Aluminum framed glass doors.

CSFO72H30	15.5 x 72 x 30	100	140	17	<b>\$4845</b>
CSFO66H30	15.5 x 66 x 30	125	116	16	<b>\$4448</b>
CSFO60H30	15.5 x 60 x 30	125	105	14	<b>\$4040</b>
CSFO54H30	15.5 x 54 x 30	125	95	13	<b>\$3644</b>
CSFO48H30	15.5 x 48 x 30	125	85	12	<b>\$3241</b>
CSFO42H30	15.5 x 42 x 30	125	77	10	<b>\$2984</b>
CSFO36H30	15.5 x 36 x 30	125	70	9	<b>\$2948</b>
CSFO30H30	15.5 x 30 x 30	100	63	7	<b>\$2893</b>

**Required Specifications**

Finish  
Edge

**Optional Specifications**

Handles\* (wood doors only)

DESKS

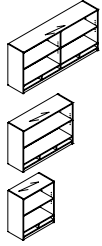

Double High Open Wall Mount Storage w/Pigeon-Holes

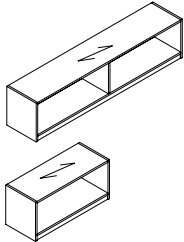

Open Wall Mount Storage

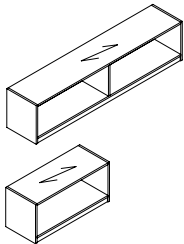

16\"/>

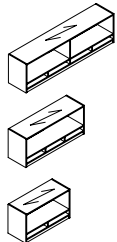

Open Wall Mount Storage w/Pigeon-Holes

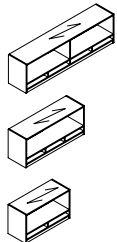

16\"/>

MODEL# DIMENSIONS FREIGHT CLASS WT./LBS. CUBIC FT. LIST PRICE

D x W x H

CSFOP72H34	15.5 x 72 x 34	100	140	17	\$5275
CSFOP66H34	15.5 x 66 x 34	125	116	16	\$4836
CSFOP60H34	15.5 x 60 x 34	125	105	14	\$4396
CSFOP54H34	15.5 x 54 x 34	125	95	13	\$3962
CSFOP48H34	15.5 x 48 x 34	125	85	12	\$3514
CSFOP42H34	15.5 x 42 x 34	125	77	10	\$3297
CSFOP36H34	15.5 x 36 x 34	125	70	9	\$3200
CSFOP30H34	15.5 x 30 x 34	100	63	7	\$3153

CSFO72	14.5 x 72 x 16.5	92.5	100	10	\$1840
CSFO66	14.5 x 66 x 16.5	100	83	9	\$1689
CSFO60	14.5 x 60 x 16.5	100	75	8	\$1540
CSFO54	14.5 x 54 x 16.5	100	68	7	\$1390
CSFO48	14.5 x 48 x 16.5	100	60	7	\$1235
CSFO42	14.5 x 42 x 16.5	100	55	6	\$1138
CSFO36	14.5 x 36 x 16.5	92.5	50	5	\$1121
CSFO30	14.5 x 30 x 16.5	92.5	45	4	\$1099

CSFO72D16	16 x 72 x 16.5	92.5	100	10	\$2792
CSFO66D16	16 x 66 x 16.5	100	83	9	\$2592
CSFO60D16	16 x 60 x 16.5	100	75	8	\$2389
CSFO54D16	16 x 54 x 16.5	100	68	7	\$2189
CSFO48D16	16 x 48 x 16.5	100	60	7	\$1987
CSFO42D16	16 x 42 x 16.5	100	55	6	\$1858
CSFO36D16	16 x 36 x 16.5	92.5	50	5	\$1840
CSFO30D16	16 x 30 x 16.5	92.5	45	4	\$1810

CSFOP72	14.5 x 72 x 19.5	92.5	100	10	\$2210
CSFOP66	14.5 x 66 x 19.5	100	83	9	\$2030
CSFOP60	14.5 x 60 x 19.5	100	75	8	\$1844
CSFOP54	14.5 x 54 x 19.5	100	68	7	\$1663
CSFOP48	14.5 x 48 x 19.5	100	60	7	\$1473
CSFOP42	14.5 x 42 x 19.5	100	55	6	\$1385
CSFOP36	14.5 x 36 x 19.5	92.5	50	5	\$1346
CSFOP30	14.5 x 30 x 19.5	92.5	45	4	\$1326

CSFOP72D16	16 x 72 x 19.5	100	100	12	\$3379
CSFOP66D16	16 x 66 x 19.5	125	83	11	\$3128
CSFOP60D16	16 x 60 x 19.5	125	75	10	\$2878
CSFOP54D16	16 x 54 x 19.5	125	68	9	\$2629
CSFOP48D16	16 x 48 x 19.5	125	60	8	\$2374
CSFOP42D16	16 x 42 x 19.5	125	55	7	\$2253
CSFOP36D16	16 x 36 x 19.5	100	50	6	\$2194
CSFOP30D16	16 x 30 x 19.5	100	45	5	\$2166

Required Specifications

Finish  
Edge

## FREESTANDING STORAGE NOTES

**NOTE:** Arrow indicates direction of grain

### Pedestals

- All units are shipped assembled.
- Standard face locking.

### Combination Storage

- All units are shipped assembled.
- No modifications accepted for this unit.
- Box drawers do not lock.
- Standard face locking.

### Storage Cabinets

- Units include adjustable shelves.
- If Handle is specified:
  - Black and Brass handle = Black Lock & Grommet
  - Silver, Nickel and Tungsten handle = Tungsten Lock & Grommet

Edge options - must specify:

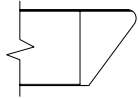

K16

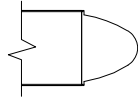

K18

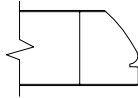

K21

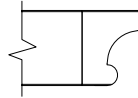

K22

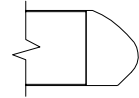

K29

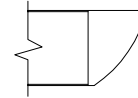

K30

FREESTANDING STORAGE	MODEL#	DIMENSIONS	FREIGHT CLASS	WT./LBS.	CUBIC FT.	LIST PRICE
		D x W x H				

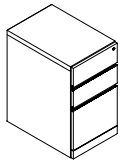

**Freestanding Pedestal**

KWDB	19.8 x 15.5 x 28	85	70	5	<b>\$2348</b>
KWWDB	23.8 x 15.5 x 28	85	75	6	<b>\$2703</b>

Box/box/file.

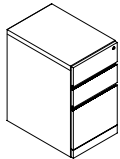

**Freestanding Mobile Pedestal**

KWDM	19.8 x 15.5 x 28	85	70	5	<b>\$2525</b>
KWWDM	23.8 x 15.5 x 28	85	75	6	<b>\$2906</b>

Box/box/file.

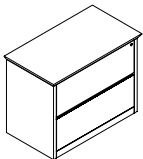

**Lateral File - 2 high**

KF3622	23 x 38 x 29	85	170	13	<b>\$4377</b>
KF3620	21 x 38 x 29	85	159	12	<b>\$3980</b>
KN3022	23 x 32.9 x 29	85	142	11	<b>\$3831</b>
KN3020	21 x 32.9 x 29	85	131	10	<b>\$3481</b>

Two lateral file drawers.

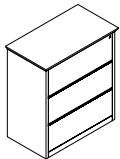

**Lateral File - 3 high**

KF36223	23 x 38 x 42	92.5	212	19	<b>\$5344</b>
KF36203	21 x 38 x 42	92.5	193	18	<b>\$4992</b>
KN30223	23 x 32.9 x 42	92.5	176	16	<b>\$4675</b>
KN30203	21 x 32.9 x 42	92.5	160	15	<b>\$4365</b>

Three lateral file drawers.

#### Required Specifications

Finish  
Edge

#### Optional Specifications

Handles

**FREESTANDING STORAGE**

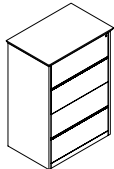

**Lateral File - 4 high**

MODEL#	DIMENSIONS D x W x H	FREIGHT CLASS	WT/LBS.	CUBIC FT.	LIST PRICE
KF36224	23 x 38 x 54	92.5	270	25	<b>\$6509</b>
KF36204	21 x 38 x 54	92.5	259	23	<b>\$6184</b>
KN30224	23 x 32.9 x 54	92.5	225	21	<b>\$5698</b>
KN30204	21 x 32.9 x 54	92.5	214	19	<b>\$5414</b>

Four lateral file drawers.

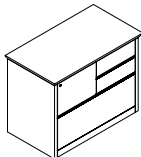

**Combination Storage - Left**

KZL3622	23 x 38 x 29	85	170	13	<b>\$4744</b>
KZL3620	21 x 38 x 29	85	160	12	<b>\$4518</b>

With 1 lateral file, 2 box drawers in the top right, and 1 file drawer in the top left.

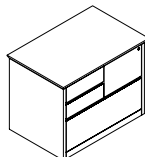

**Combination Storage - Right**

KZR3622	23 x 38 x 29	85	170	13	<b>\$4744</b>
KZR3620	21 x 38 x 29	85	160	12	<b>\$4518</b>

With 1 lateral file, 2 box drawers in the top left, and 1 file drawer in the top right.

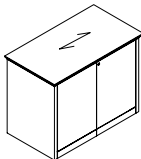

**Storage Cabinet w/Doors**

KBD3622	23 x 38 x 29	92.5	140	13	<b>\$2979</b>
KBD3620	21 x 38 x 29	92.5	129	12	<b>\$2837</b>
KBD3022	23 x 32.9 x 29	92.5	117	11	<b>\$2609</b>
KBD3020	21 x 32.9 x 29	92.5	106	10	<b>\$2479</b>

Storage with 1 adjustable shelf. For Aluminum framed glass door option, contact Customer Care.

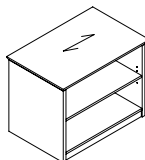

**Open Storage Cabinet**

KOB3622	23 x 38.75 x 29	100	115	13	<b>\$2393</b>
KOB3620	21 x 38.75 x 29	100	104	12	<b>\$2277</b>
KOB3022	23 x 33.63 x 29	100	96	11	<b>\$2089</b>
KOB3020	21 x 33.63 x 29	100	85	10	<b>\$1987</b>

Storage with 1 adjustable shelf.

**Required Specifications**

Finish  
Edge

**Optional Specifications**

Handles



## FREESTANDING STORAGE

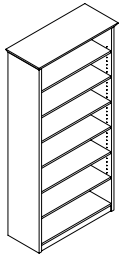

**Open Bookcase**

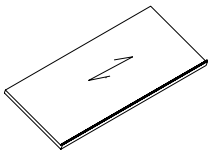

**Additional Shelf**

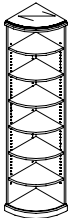

**Quarter Round Open Bookcase**

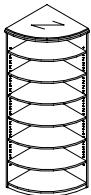

**Quarter Round Open Bookcase**

MODEL#	DIMENSIONS D x W x H	FREIGHT CLASS	WT/LBS.	CUBIC FT.	LIST PRICE
KB73615	16 x 38 x 78	100	228	24	<b>\$3717</b>
KB63615	16 x 38 x 72	100	210	23	<b>\$3432</b>
KB53615	16 x 38 x 65	100	188	21	<b>\$3161</b>
KB43615	16 x 38 x 48	100	140	15	<b>\$2602</b>
KB23615	16 x 38 x 29	92.5	90	9	<b>\$2086</b>
KB73015	16 x 32.9 x 78	92.5	228	20	<b>\$3254</b>
KB63015	16 x 32.9 x 72	92.5	210	19	<b>\$3002</b>
KB53015	16 x 32.9 x 65	92.5	188	17	<b>\$2768</b>
KB43015	16 x 32.9 x 48	92.5	140	13	<b>\$2277</b>
KB23015	16 x 32.9 x 29	92.5	90	8	<b>\$1826</b>

78" high models have 6 adjustable shelves, 72" has 5 adjustable shelves, 65" has 4 adjustable shelves, 48" has 3 adjustable shelves, 29" has 1 adjustable shelves.

KMAG3624	24 x 36 x 1	92.5	112	10	<b>\$225</b>
KMAG3622	22 x 36 x 1	92.5	104	10	<b>\$204</b>
KMAG3620	20 x 36 x 1	92.5	92	9	<b>\$184</b>
KMAG3615	15 x 36 x 1	92.5	81	8	<b>\$162</b>
KMAG3024	24 x 30 x 1	92.5	94	9	<b>\$189</b>
KMAG3022	22 x 30 x 1	100	87	9	<b>\$172</b>
KMAG3020	20 x 30 x 1	100	76	8	<b>\$152</b>
KMAG3015	15 x 30 x 1	100	67	8	<b>\$134</b>

**For use with open bookcase.** Can be specified for each shelf in an open bookcase.

KB7R1515	16 x 16 x 78	100	95	10	<b>\$2928</b>
KB6R1515	16 x 16 x 72	100	83	9	<b>\$2700</b>
KB5R1515	16 x 16 x 65	100	81	9	<b>\$2486</b>
KB4R1515	16 x 16 x 48	100	59	6	<b>\$2046</b>
KB2R1515	16 x 16 x 29	100	37	4	<b>\$1646</b>

84" and 78" high models have 6 adjustable shelves, 72" has 5 adjustable shelves, 65" has 4 adjustable shelves, 48" has 3 adjustable shelves, 29" has 1 adjustable shelf.

KB7R2222H84	23 x 23 x 84	100	191	23	<b>\$5036</b>
KB7R2222H72	23 x 23 x 72	100	171	20	<b>\$4319</b>
KB7R2222H65	23 x 23 x 65	100	157	18	<b>\$5037</b>
KB7R2020H84	21 x 21 x 84	100	163	19	<b>\$4798</b>
KB7R2020H72	21 x 21 x 72	100	142	17	<b>\$4112</b>
KB7R2020H65	21 x 21 x 65	100	130	15	<b>\$4798</b>

84" high models have 6 adjustable shelves, 72" has 5 adjustable shelves, and 65" has 4 adjustable shelves

### Required Specifications

Finish  
Edge

### Optional Specifications

Handles

FREESTANDING STORAGE

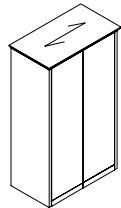

Storage Cabinet w/Wood Doors

MODEL# DIMENSIONS FREIGHT CLASS WT/LBS. CUBIC FT. LIST PRICE

D x W x H

K1D22W36H84	23 x 38 x 84	125	304	42	\$6993
K1D22W36H72	23 x 38 x 72	100	283	33	\$5995
K1D22W36H65	23 x 38 x 65	100	259	30	\$5493
K1D22W30H84	23 x 32.9 x 84	125	304	42	\$6118
K1D22W30H72	23 x 32.9 x 72	100	283	33	\$5245
K1D22W30H65	23 x 32.9 x 65	100	259	30	\$4810
K1D22W24H84	23 x 26 x 84	92.5	320	28	\$5242
K1D22W24H72	23 x 26 x 72	92.5	255	24	\$4494
K1D22W24H65	23 x 26 x 65	125	173	22	\$4128

K1D20W36H84	21 x 38 x 84	100	297	35	\$6664
K1D20W36H72	21 x 38 x 72	100	269	30	\$5712
K1D20W36H65	21 x 38 x 65	100	245	28	\$5236
K1D20W30H84	21 x 32.9 x 84	100	257	29	\$5550
K1D20W30H72	21 x 32.9 x 72	100	233	25	\$4758
K1D20W30H65	21 x 32.9 x 65	100	202	23	\$4361
K1D20W24H84	21 x 26 x 84	100	198	23	\$4442
K1D20W24H72	21 x 26 x 72	100	179	20	\$3806
K1D20W24H65	21 x 26 x 65	100	163	18	\$3485

84" high models have 6 adjustable shelves, 72" has 5 adjustable shelves, 65" has 4 adjustable shelves. For Aluminum framed glass door option, please contact customer care.

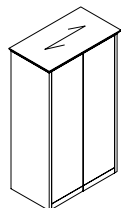

Wardrobe Cabinet

K2D22W36H84	23 x 38 x 84	125	304	42	\$6067
K2D22W36H72	23 x 38 x 72	100	283	33	\$5202
K2D22W36H65	23 x 38 x 65	100	259	30	\$4769
K2D22W30H84	23 x 32.9 x 84	125	304	42	\$5310
K2D22W30H72	23 x 32.9 x 72	100	283	33	\$4550
K2D22W30H65	23 x 32.9 x 65	100	259	30	\$4169
K2D22W24H84	23 x 26 x 84	92.5	320	28	\$4550
K2D22W24H72	23 x 26 x 72	92.5	255	24	\$3902
K2D22W24H65	23 x 26 x 65	125	173	22	\$3574

K2D20W36H84	21 x 38 x 84	100	297	35	\$5779
K2D20W36H72	21 x 38 x 72	100	269	30	\$4954
K2D20W36H65	21 x 38 x 65	100	245	28	\$4541
K2D20W30H84	21 x 32.9 x 84	100	257	29	\$4816
K2D20W30H72	21 x 32.9 x 72	100	233	25	\$4129
K2D20W30H65	21 x 32.9 x 65	100	202	23	\$3783
K2D20W24H84	21 x 26 x 84	100	198	23	\$3853
K2D20W24H72	21 x 26 x 72	100	179	20	\$3299
K2D20W24H65	21 x 26 x 65	100	163	18	\$3025

Doors, coat rack and hat shelf. 84" high models have 6 adjustable shelves, 72" has 5 adjustable shelves, 65" has 4 adjustable shelves. For Aluminum framed glass door option, please contact customer care.

Required Specifications

Finish  
Edge

Optional Specifications

Handles

## FREESTANDING STORAGE

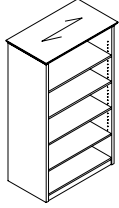

**Open Bookcase**

MODEL#	DIMENSIONS D x W x H	FREIGHT CLASS	WT/LBS.	CUBIC FT.	LIST PRICE
K7D22W36H84	23 x 38 x 84	125	331	43	<b>\$5596</b>
K7D22W36H72	23 x 38 x 72	100	306	36	<b>\$4798</b>
K7D22W36H65	23 x 38 x 65	100	281	33	<b>\$4398</b>
K7D22W30H84	23 x 32.9 x 84	125	280	36	<b>\$4895</b>
K7D22W30H72	23 x 32.9 x 72	100	255	30	<b>\$4263</b>
K7D22W30H65	23 x 32.9 x 65	100	234	28	<b>\$3847</b>
<hr/>					
K7D20W36H84	21 x 38 x 84	125	282	36	<b>\$5332</b>
K7D20W36H72	21 x 38 x 72	100	257	30	<b>\$4572</b>
K7D20W36H65	21 x 38 x 65	100	234	28	<b>\$4190</b>
K7D20W30H84	21 x 32.9 x 84	100	248	29	<b>\$4441</b>
K7D20W30H72	21 x 32.9 x 72	100	223	25	<b>\$3805</b>
K7D20W30H65	21 x 32.9 x 65	100	193	23	<b>\$3487</b>

84" high models have 6 adjustable shelves, 72" has 5 adjustable shelves, 65" has 4 adjustable shelves.

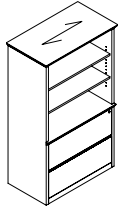

**Open Cabinet**

K12D22W36H84	23 x 38 x 84	92.5	364	36	<b>\$7593</b>
K12D22W36H72	23 x 38 x 72	92.5	336	33	<b>\$6508</b>
K12D22W36H65	23 x 38 x 65	92.5	308	30	<b>\$5970</b>
K12D22W30H84	23 x 32.9 x 84	92.5	330	31	<b>\$6643</b>
K12D22W30H72	23 x 32.9 x 72	92.5	294	28	<b>\$5698</b>
K12D22W30H65	23 x 32.9 x 65	92.5	257	25	<b>\$5221</b>
<hr/>					
K12D20W36H84	21 x 38 x 84	92.5	348	33	<b>\$7234</b>
K12D20W36H72	21 x 38 x 72	92.5	322	30	<b>\$6199</b>
K12D20W36H65	21 x 38 x 65	92.5	294	28	<b>\$5682</b>
K12D20W30H84	21 x 32.9 x 84	92.5	317	28	<b>\$6329</b>
K12D20W30H72	21 x 32.9 x 72	92.5	280	25	<b>\$5422</b>
K12D20W30H65	21 x 32.9 x 65	92.5	243	23	<b>\$4738</b>

Above two lateral file drawers. 84" high models have 6 adjustable shelves, 72" has 5 adjustable shelves, 65" has 4 adjustable shelves.

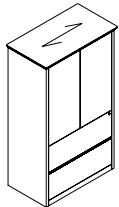

**Storage Cabinet w/Doors**

K13D22W36H84	23 x 38 x 84	92.5	364	36	<b>\$8654</b>
K13D22W36H72	23 x 38 x 72	92.5	341	33	<b>\$7417</b>
K13D22W36H65	23 x 38 x 65	92.5	313	30	<b>\$6801</b>
K13D22W30H84	23 x 32.9 x 84	92.5	330	31	<b>\$7572</b>
K13D22W30H72	23 x 32.9 x 72	92.5	299	28	<b>\$6490</b>
K13D22W30H65	23 x 32.9 x 65	92.5	261	25	<b>\$5950</b>
<hr/>					
K13D20W36H84	21 x 38 x 84	92.5	365	35	<b>\$8242</b>
K13D20W36H72	21 x 38 x 72	92.5	327	30	<b>\$7064</b>
K13D20W36H65	21 x 38 x 65	92.5	299	28	<b>\$6472</b>
K13D20W30H84	21 x 32.9 x 84	92.5	305	29	<b>\$6870</b>
K13D20W30H72	21 x 32.9 x 72	92.5	285	25	<b>\$5891</b>
K13D20W30H65	21 x 32.9 x 65	92.5	247	23	<b>\$5396</b>

Above two lateral file drawers. 84" high models have 6 adjustable shelves, 72" has 5 adjustable shelves, 65" has 4 adjustable shelves. For Aluminum framed glass door option, please contact customer care.

### Required Specifications

Finish  
Edge

### Optional Specifications

Handles

FREESTANDING STORAGE

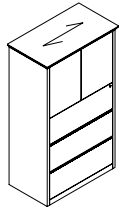

Storage Cabinet w/Doors

MODEL# DIMENSIONS FREIGHT CLASS WT/LBS. CUBIC FT. LIST PRICE

D x W x H

K14D22W36H84	23 x 38 x 84	100	340	42	<b>\$9303</b>
K14D22W36H72	23 x 38 x 72	100	312	33	<b>\$7974</b>
K14D22W36H65	23 x 38 x 65	100	286	30	<b>\$7312</b>
K14D22W30H84	23 x 32.9 x 84	100	308	35	<b>\$8138</b>
K14D22W30H72	23 x 32.9 x 72	100	273	28	<b>\$6977</b>
K14D22W30H65	23 x 32.9 x 65	100	238	25	<b>\$6396</b>

K14D20W36H84	21 x 38 x 84	100	330	35	<b>\$8860</b>
K14D20W36H72	21 x 38 x 72	100	298	30	<b>\$7596</b>
K14D20W36H65	21 x 38 x 65	100	272	28	<b>\$6963</b>
K14D20W30H84	21 x 32.9 x 84	92.5	298	29	<b>\$7384</b>
K14D20W30H72	21 x 32.9 x 72	92.5	259	25	<b>\$6330</b>
K14D20W30H65	21 x 32.9 x 65	100	224	23	<b>\$5802</b>

Above three lateral file drawers. 84" high models have 2 adjustable shelves, 72" and 65" have 1 adjustable shelf. For Aluminum framed glass door option, please contact customer care.

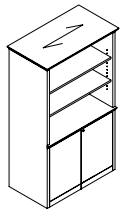

Open Storage

K22D22W36H84	23 x 38 x 84	125	325	42	<b>\$6373</b>
K22D22W36H72	23 x 38 x 72	100	300	33	<b>\$5460</b>
K22D22W36H65	23 x 38 x 65	100	275	30	<b>\$5008</b>
K22D22W30H84	23 x 32.9 x 84	100	304	35	<b>\$5577</b>
K22D22W30H72	23 x 32.9 x 72	100	279	28	<b>\$4781</b>
K22D22W30H65	23 x 32.9 x 65	100	243	25	<b>\$4383</b>

K22D20W36H84	21 x 38 x 84	100	327	33	<b>\$6067</b>
K22D20W36H72	21 x 38 x 72	92.5	305	30	<b>\$5202</b>
K22D20W36H65	21 x 38 x 65	100	278	28	<b>\$4769</b>
K22D20W30H84	21 x 32.9 x 84	92.5	301	28	<b>\$5063</b>
K22D20W30H72	21 x 32.9 x 72	92.5	265	25	<b>\$4339</b>
K22D20W30H65	21 x 32.9 x 65	100	229	23	<b>\$3973</b>

Above storage cabinet. 84" high models have 4 adjustable shelves, 72" has 3 adjustable shelves, 65" has 3 adjustable shelves. For Aluminum framed glass door option, please contact customer care.

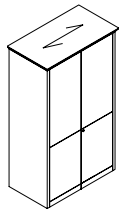

Closed Storage Cabinet

K23D22W36H84	23 x 38 x 84	100	340	42	<b>\$7469</b>
K23D22W36H72	23 x 38 x 72	100	319	33	<b>\$6401</b>
K23D22W36H65	23 x 38 x 65	100	292	30	<b>\$5862</b>
K23D22W30H84	23 x 32.9 x 84	100	308	33	<b>\$6221</b>
K23D22W30H72	23 x 32.9 x 72	100	279	28	<b>\$5332</b>
K23D22W30H65	23 x 32.9 x 65	100	243	25	<b>\$4891</b>

K23D20W36H84	21 x 38 x 84	100	330	35	<b>\$7111</b>
K23D20W36H72	21 x 38 x 72	92.5	305	30	<b>\$6096</b>
K23D20W36H65	21 x 38 x 65	100	278	28	<b>\$5586</b>
K23D20W30H84	21 x 32.9 x 84	92.5	298	29	<b>\$5925</b>
K23D20W30H72	21 x 32.9 x 72	92.5	265	25	<b>\$5080</b>
K23D20W30H65	21 x 32.9 x 65	100	229	23	<b>\$4657</b>

With upper and lower split doors. 1 fixed shelf and 2 adjustable shelves. For Aluminum framed glass door option, please contact customer care.

Required Specifications

Finish  
Edge

Optional Specifications

Handles

## FREESTANDING STORAGE

**MODEL# DIMENSIONS FREIGHT CLASS WT/LBS. CUBIC FT. LIST PRICE**

**D x W x H**

K25D22W36H84	23 x 38 x 84	100	348	42	<b>\$7843</b>
K25D22W36H72	23 x 38 x 72	100	319	33	<b>\$6726</b>
K25D22W36H65	23 x 38 x 65	100	292	30	<b>\$6164</b>
K25D22W30H84	23 x 32.9 x 84	100	307	35	<b>\$6862</b>
K25D22W30H72	23 x 32.9 x 72	100	279	28	<b>\$5884</b>
K25D22W30H65	23 x 32.9 x 65	100	243	25	<b>\$5392</b>
K25D22W24H84	23 x 26 x 84	100	254	28	<b>\$5882</b>
K25D22W24H72	23 x 26 x 72	100	213	24	<b>\$5041</b>
K25D22W24H65	23 x 26 x 65	100	195	22	<b>\$4617</b>

K25D20W36H84	21 x 38 x 84	100	330	35	<b>\$7468</b>
K25D20W36H72	21 x 38 x 72	92.5	305	30	<b>\$6398</b>
K25D20W36H65	21 x 38 x 65	100	278	28	<b>\$5865</b>
K25D20W30H84	21 x 32.9 x 84	92.5	300	29	<b>\$6222</b>
K25D20W30H72	21 x 32.9 x 72	92.5	265	25	<b>\$5333</b>
K25D20W30H65	21 x 32.9 x 65	100	229	23	<b>\$4891</b>
K25D20W24H84	21 x 26 x 84	100	235	28	<b>\$4980</b>
K25D20W24H72	21 x 26 x 72	100	203	24	<b>\$4268</b>
K25D20W24H65	21 x 26 x 65	100	185	22	<b>\$3916</b>

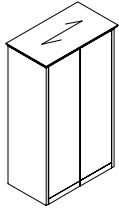

**Cabinet w/Doors and Storage**

Wardrobe with coat rack and hat shelf on left. Storage with adjustable shelves on right. 84" high models have 5 adjustable shelves, 72" and 65" have 4 adjustable shelves. For Aluminum framed glass door option, please contact customer care.

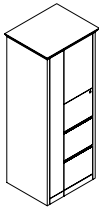

**Tower Unit - Left**

K27D22W24H84L	23 x 26 x 84	125	167	24	<b>\$9287</b>
K27D22W24H72L	23 x 26 x 72	125	154	22	<b>\$7960</b>
K27D22W24H65L	23 x 26 x 65	125	141	20	<b>\$7303</b>

K27D20W24H84L	21 x 26 x 84	125	152	22	<b>\$8846</b>
K27D20W24H72L	21 x 26 x 72	125	140	20	<b>\$7585</b>
K27D20W24H65L	21 x 26 x 65	125	128	18	<b>\$6952</b>

Wardrobe with coat rack and hat shelf on left. Three file drawers and storage with adjustable shelf on right. 84" high models have 2 adjustable shelves, 72" and 65" have 1 adjustable shelf. For Aluminum framed glass door option on right, please contact customer care.

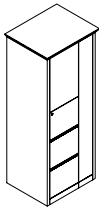

**Tower Unit - Right**

K27D22W24H84R	23 x 26 x 84	125	167	24	<b>\$9287</b>
K27D22W24H72R	23 x 26 x 72	125	154	22	<b>\$7960</b>
K27D22W24H65R	23 x 26 x 65	125	141	20	<b>\$7303</b>

K27D20W24H84R	21 x 26 x 84	125	152	22	<b>\$8846</b>
K27D20W24H72R	21 x 26 x 72	125	140	20	<b>\$7585</b>
K27D20W24H65R	21 x 26 x 65	125	128	18	<b>\$6952</b>

Wardrobe with coat rack and hat shelf on right. Three file drawers and storage with adjustable shelf on left. 84" high models have 2 adjustable shelves, 72" and 65" have 1 adjustable shelf. For Aluminum framed glass door option on left, please contact customer care.

**Required Specifications**

Finish  
Edge

**Optional Specifications**

Handles

MODESTY PANELS

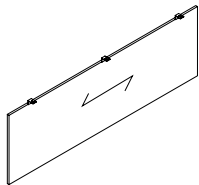

Veneer Modesty Panel\*

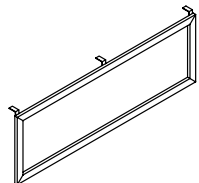

Glass Modesty Panel

MODEL# DIMENSIONS FREIGHT CLASS WT/LBS. CUBIC FT. LIST PRICE

D x W x H

CMP72W	0.75 x 67 x 18	--	20	1	\$1622
CMP66W	0.75 x 61 x 18	--	18	1	\$1570
CMP60W	0.75 x 55 x 18	--	16	1	\$1546
CMP54W	0.75 x 49 x 18	--	14	1	\$1520
CMP48W	0.75 x 43 x 18	--	13	1	\$1496

Straight modesty panel. Attaches to underside of worksurface. **Cannot be retrofitted in the field. Not sold individually - to be ordered as an upgrade option only.**

- CMP72W - Specify on 96" Piano desk: Boat, D or P
- CMP66W - Specify on 84" Piano desk: Boat or D
- CMP60W - For use on 84" Piano desk: P
- CMP54W - For use on 72" Piano desk: Boat or D/D table desk
- CMP48W - For use on 66" and 60" Piano desk: D or P/D table desk

CMP72G	0.75 x 67 x 18	--	20	1	\$2485
CMP66G	0.75 x 61 x 18	--	18	1	\$2351
CMP60G	0.75 x 55 x 18	--	16	1	\$2149
CMP54G	0.75 x 49 x 18	--	14	1	\$2001
CMP48G	0.75 x 43 x 18	--	13	1	\$1911

Straight modesty panel. Translucent, screened glass. Aluminum box frame construction in Tungsten Only. Attaches to underside of worksurface. **Cannot be retrofitted in the field. Not sold individually - to be ordered as an upgrade option only.**

- CMP72G - Specify on 96" Piano desk: Boat, D or P
- CMP66G - Specify on 84" Piano desk: Boat or D
- CMP60G - For use on 84" Piano desk: P
- CMP54G - For use on 72" Piano desk: Boat or D/D table desk
- CMP48G - For use on 66" and 60" Piano desk: D or P/D table desk
- Tungsten finish on the aluminum box frame closely resembles the existing Tungsten finish.

ACCESSORIES

MODEL# DIMENSIONS FREIGHT CLASS WT/LBS. CUBIC FT. LIST PRICE

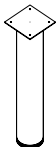

Metal Post Upgrade

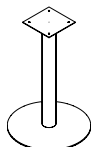

Metal Flat Plate Base Upgrade

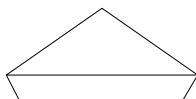

Corner Filler Top

SM06	6 x 6 x 28	--	--	--	\$1037
SM04	4 x 4 x 28	--	--	--	\$572
SM03	3 x 3 x 28	--	--	--	\$407

Must specify at time of order. **Cannot be retrofitted in the field.**  
Available in Black (E), Tungsten (K) and Brushed Chrome (P).

F3P18	18 x 18 x 28	--	--	--	\$1538
-------	--------------	----	----	----	--------

Must specify at time of order. **Can not be retrofitted in the field.**  
Available in Black (E), Tungsten (K) and Brushed Chrome (P).

KV1212CT	12 x 12 x 1.5	150	5	1	\$981
----------	---------------	-----	---	---	-------

Required Specifications

Finish\*

## TACKBOARDS FOR HUTCHES

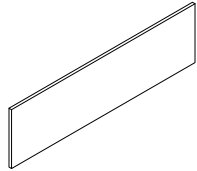

**Tackboard for 36" H  
Non-Pigeon Hole Hutches**

MODEL#	DIMENSIONS D x W x H	FREIGHT CLASS	WT/LBS.	CUBIC FT.	GR.1-3	GR. 4-5
KTS108	1 x 105 x 20	92.5	23	2	\$1232	\$1480
KTS102	1 x 99 x 20	100	19	2	\$1166	\$1402
KTS96	1 x 93 x 20	70	15	1	\$1097	\$1319
KTS90	1 x 87 x 20	70	15	1	\$1030	\$1238
KTS84	1 x 81 x 20	85	14	1	\$965	\$1161
KTS78	1 x 75 x 20	85	13	1	\$893	\$1073
KTS72	1 x 69 x 20	85	12	1	\$821	\$986
KTS66	1 x 63 x 20	92.5	11	1	\$751	\$902
KTS60	1 x 57 x 20	92.5	10	1	\$688	\$827
KTS36	1 x 33 x 20	60	6	0.01	\$412	\$496
KTS30	1 x 27 x 20	60	4	0.01	\$343	\$414

Factory installed hutch tackboard.

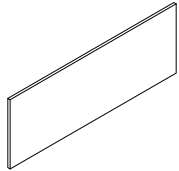

**Tackboard for 42" H & 54" H  
Pigeon-Hole Hutches**

KTSP108H23	1 x 105 x 23	70	30	2	\$1393	\$1673
KTSP102H23	1 x 99 x 23	85	24	2	\$1328	\$1595
KTSP96H23	1 x 93 x 23	92.5	20	2	\$1240	\$1490
KTSP90H23	1 x 87 x 23	70	20	1	\$1162	\$1396
KTSP84H23	1 x 81 x 23	70	18	1	\$1085	\$1303
KTSP78H23	1 x 75 x 23	70	17	1	\$1008	\$1211
KTSP72H23	1 x 69 x 23	70	16	1	\$937	\$1126
KTSP66H23	1 x 63 x 23	85	14	1	\$852	\$1024
KTSP60H23	1 x 57 x 23	85	13	1	\$779	\$938
KTSP36H23	1 x 33 x 23	60	8	0.01	\$466	\$561
KTSP30H23	1 x 27 x 23	60	5	0.01	\$388	\$469

Factory installed hutch tackboard.

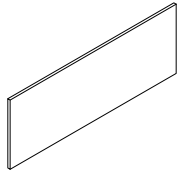

**Tackboard for 42" H & 54" H  
Non-Pigeon Hole Hutches**

KTS108H26	1 x 105 x 26	70	30	2	\$1611	\$1935
KTS102H26	1 x 99 x 26	85	24	2	\$1518	\$1823
KTS96H26	1 x 93 x 26	92.5	20	2	\$1427	\$1715
KTS90H26	1 x 87 x 26	92.5	20	2	\$1344	\$1614
KTS84H26	1 x 81 x 26	100	18	2	\$1249	\$1500
KTS78H26	1 x 75 x 26	100	17	2	\$1160	\$1394
KTS72H26	1 x 69 x 26	70	16	1	\$1071	\$1287
KTS66H26	1 x 63 x 26	85	14	1	\$982	\$1180
KTS60H26	1 x 57 x 26	85	13	1	\$893	\$1073
KTS36H26	1 x 33 x 26	60	8	0.01	\$538	\$647
KTS30H26	1 x 27 x 26	60	5	0.01	\$447	\$538

Factory installed hutch tackboard.

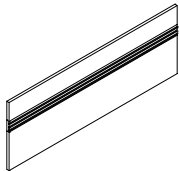

**Tackboard w/Rail for 36" H  
Non-Pigeon Hole Hutches\***

KTSAS108	1 x 105 x 20	92.5	23	2	\$2187	\$2626
KTSAS102	1 x 99 x 20	100	19	2	\$1973	\$2369
KTSAS96	1 x 93 x 20	70	15	1	\$1942	\$2333
KTSAS90	1 x 87 x 20	70	15	1	\$1826	\$2193
KTSAS84	1 x 81 x 20	85	14	1	\$1702	\$2045
KTSAS78	1 x 75 x 20	85	13	1	\$1582	\$1900
KTSAS72	1 x 69 x 20	85	12	1	\$1457	\$1749
KTSAS66	1 x 63 x 20	92.5	11	1	\$1335	\$1603
KTSAS60	1 x 57 x 20	92.5	10	1	\$1218	\$1486
KTSAS36	1 x 33 x 20	60	6	0.01	\$728	\$876
KTSAS30	1 x 27 x 20	60	4	0.01	\$607	\$731

Factory installed hutch tackboard.

- Specify Black (**E**), Tungsten (**K**), or Designer White (**DWT**) accessory rail finish.

### Required Specifications

Fabric  
Metal finish\*

TACKBOARDS FOR HUTCHES

MODEL#	DIMENSIONS	FREIGHT CLASS	WT/LBS.	CUBIC FT.	GR.1-3	GR. 4-5
	<b>D x W x H</b>					
KTSPAS108H23	1 x 105 x 23	70	30	2	\$2374	\$2850
KTSPAS102H23	1 x 99 x 23	85	24	2	\$2258	\$2734
KTSPAS96H23	1 x 93 x 23	92.5	20	2	\$2120	\$2546
KTSPAS90H23	1 x 87 x 23	92.5	20	2	\$1985	\$2384
KTSPAS84H23	1 x 81 x 23	100	18	2	\$1851	\$2223
KTSPAS78H23	1 x 75 x 23	100	17	2	\$1719	\$2064
KTSPAS72H23	1 x 69 x 23	70	16	1	\$1586	\$1904
KTSPAS66H23	1 x 63 x 23	85	14	1	\$1454	\$1746
KTSPAS60H23	1 x 57 x 23	85	13	1	\$1322	\$1588
KTSPAS36H23	1 x 33 x 23	100	8	1	\$795	\$956
KTSPAS30H23	1 x 27 x 23	150	5	1	\$667	\$802

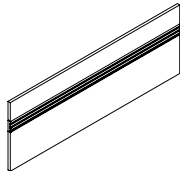

**Tackboard w/Rail for 42" H & 54" H\*  
Pigeon-Hole Hutch**

Factory installed hutch tackboard.

- Specify Black (E), Tungsten (K), or Designer White (DWT) accessory rail finish.

KTSAS108H26	1 x 105 x 26	92.5	23	2	\$2635	\$3165
KTSAS102H26	1 x 99 x 26	100	19	2	\$2480	\$2978
KTSAS96H26	1 x 93 x 26	70	15	1	\$2335	\$2804
KTSAS90H26	1 x 87 x 26	70	15	1	\$2198	\$2640
KTSAS84H26	1 x 81 x 26	85	14	1	\$2023	\$2429
KTSAS78H26	1 x 75 x 26	85	13	1	\$1898	\$2279
KTSAS72H26	1 x 69 x 26	85	12	1	\$1723	\$2069
KTSAS66H26	1 x 63 x 26	92.5	11	1	\$1611	\$1935
KTSAS60H26	1 x 57 x 26	92.5	10	1	\$1458	\$1752
KTSAS36H26	1 x 33 x 26	60	6	0.01	\$875	\$1053
KTSAS30H26	1 x 27 x 26	60	4	0.01	\$735	\$884

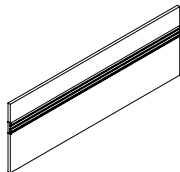

**Tackboard w/Rail for 42" H & 54" H\*  
Non-Pigeon Hole Hutch**

Factory installed hutch tackboard.

- Specify Black (E), Tungsten (K), or Designer White (DWT) accessory rail finish.

TS120	1 x 120 x 19.2	70	26	2	\$1522	\$1902
TS114	1 x 114 x 19.2	70	25	2	\$1449	\$1814
TS108	1 x 108 x 19.2	70	23	2	\$1370	\$1713
TS102	1 x 102 x 19.2	85	19	2	\$1298	\$1623
TS96	1 x 96 x 19.2	70	17	1	\$1214	\$1520
TS90	1 x 90 x 19.2	70	15	1	\$1141	\$1428
TS84	1 x 84 x 19.2	70	14	1	\$1069	\$1335
TS78	1 x 78 x 19.2	70	13	1	\$990	\$1238
TS72	1 x 72 x 19.2	70	12	1	\$557	\$698
TS66	1 x 66 x 19.2	85	11	1	\$512	\$644
TS60	1 x 60 x 19.2	85	10	1	\$471	\$592
TS54	1 x 54 x 19.2	85	10	1	\$427	\$537
TS48	1 x 48 x 19.2	85	10	1	\$382	\$479
TS42	1 x 42 x 19.2	85	10	1	\$338	\$425
TS36	1 x 36 x 19.2	100	8	1	\$302	\$383
TS30	1 x 30 x 19.2	150	5	1	\$251	\$316

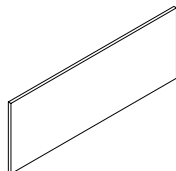

**Tackboard for 65" H Non-Pigeon Hole  
Wall Mount Cabinets**

Factory installed tackboard for wall mount cabinets.

**Required Specifications**

- Fabric
- Metal finish\*



## TACKBOARDS FOR WALL MOUNT CABINETS

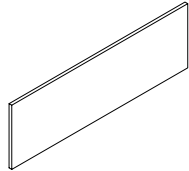

**Tackboard for 72" H Pigeon-Hole Wall Mount Cabinets**

MODEL#	DIMENSIONS D x W x H	FREIGHT CLASS	WT./LBS.	CUBIC FT.	GR. 1-3	GR. 4-5
TSP120H23	1 x 120 x 23	70	34	2	\$1718	\$2148
TSP114H23	1 x 114 x 23	70	32	2	\$1632	\$2039
TSP108H23	1 x 108 x 23	70	30	2	\$1600	\$1920
TSP102H23	1 x 102 x 23	85	24	2	\$1525	\$1831
TSP96H23	1 x 96 x 23	92.5	20	2	\$1377	\$1720
TSP90H23	1 x 90 x 23	92.5	20	1	\$1286	\$1609
TSP84H23	1 x 84 x 23	70	18	1	\$1201	\$1501
TSP78H23	1 x 78 x 23	70	17	1	\$983	\$1195
TSP72H23	1 x 72 x 23	70	16	1	\$913	\$1147
TSP66H23	1 x 66 x 23	85	14	1	\$830	\$1041
TSP60H23	1 x 60 x 23	85	13	1	\$601	\$755
TSP54H23	1 x 54 x 23	85	13	1	\$762	\$955
TSP48H23	1 x 48 x 23	85	13	1	\$602	\$613
TSP42H23	1 x 42 x 23	85	13	1	\$530	\$538
TSP36H23	1 x 36 x 23	100	8	1	\$458	\$474
TSP30H23	1 x 30 x 23	150	5	1	\$379	\$403

Factory installed tackboard for wall mount cabinets.

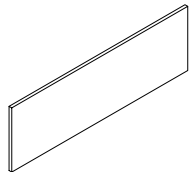

**Tackboard for 72" H Non-Pigeon-Hole Wall Mount Cabinets**

TS120H26	1 x 120 x 26	70	34	2	\$1979	\$2474
TS114H26	1 x 114 x 26	70	32	2	\$1880	\$2351
TS108H26	1 x 108 x 26	70	30	2	\$1782	\$2229
TS102H26	1 x 102 x 26	85	24	2	\$1678	\$2098
TS96H26	1 x 96 x 26	92.5	22	2	\$1587	\$1986
TS90H26	1 x 90 x 26	92.5	20	2	\$1488	\$1859
TS84H26	1 x 84 x 26	100	18	2	\$1383	\$1729
TS78H26	1 x 78 x 26	100	17	2	\$1286	\$1609
TS72H26	1 x 72 x 26	70	16	1	\$714	\$897
TS66H26	1 x 66 x 26	85	14	1	\$658	\$825
TS60H26	1 x 60 x 26	85	13	1	\$601	\$755
TS54H26	1 x 54 x 26	85	13	1	\$552	\$692
TS48H26	1 x 48 x 26	85	13	1	\$488	\$613
TS42H26	1 x 42 x 26	85	13	1	\$433	\$538
TS36H26	1 x 36 x 26	100	8	1	\$378	\$475
TS30H26	1 x 30 x 26	150	5	1	\$317	\$401

Factory installed tackboard for wall mount cabinets.

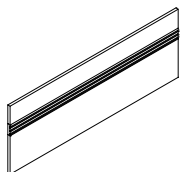

**Tackboard w/Rail for 65" H\* Non-Pigeon Hole Wall Mount Cabinets**

TSAS120	1 x 120 x 19.2	85	26	1	\$2353	\$2942
TSAS114	1 x 114 x 19.2	85	25	2	\$2239	\$2799
TSAS108	1 x 108 x 19.2	92.5	23	2	\$2120	\$2653
TSAS102	1 x 102 x 19.2	100	19	2	\$2007	\$2505
TSAS96	1 x 96 x 19.2	70	17	1	\$1880	\$2355
TSAS90	1 x 90 x 19.2	70	15	1	\$1765	\$2209
TSAS84	1 x 84 x 19.2	85	14	1	\$1646	\$2060
TSAS78	1 x 78 x 19.2	85	13	1	\$1533	\$1918
TSAS72	1 x 72 x 19.2	85	12	1	\$1412	\$1769
TSAS66	1 x 66 x 19.2	92.5	11	1	\$1298	\$1627
TSAS60	1 x 60 x 19.2	92.5	10	1	\$1177	\$1473
TSAS54	1 x 54 x 19.2	92.5	10	1	\$1064	\$1329
TSAS48	1 x 48 x 19.2	92.5	10	1	\$945	\$1180
TSAS42	1 x 42 x 19.2	92.5	10	1	\$825	\$1030
TSAS36	1 x 36 x 19.2	100	8	1	\$706	\$880
TSAS30	1 x 30 x 19.2	150	5	1	\$548	\$687

Factory installed tackboard for wall mount cabinets.

- Specify Black (E), Tungsten (K), or Designer White (DWT) accessory rail finish.

### Required Specifications

Fabric  
Metal finish\*

TACKBOARDS FOR WALL MOUNT CABINETS

MODEL#	DIMENSIONS	FREIGHT CLASS	WT./LBS.	CUBIC FT.	GR. 1-3	GR. 4-5
	<b>D x W x H</b>					
TSPAS120H23	1 x 120 x 22.3	70	34	2	\$2554	\$3193
TSPAS114H23	1 x 114 x 22.3	70	32	2	\$2429	\$3038
TSPAS108H23	1 x 108 x 22.3	70	30	2	\$2297	\$2874
TSPAS102H23	1 x 102 x 22.3	85	24	2	\$2182	\$2731
TSPAS96H23	1 x 96 x 22.3	70	22	1	\$2051	\$2567
TSPAS90H23	1 x 90 x 22.3	70	20	1	\$1917	\$2399
TSPAS84H23	1 x 84 x 22.3	70	18	1	\$1791	\$2244
TSPAS78H23	1 x 78 x 22.3	70	17	1	\$1664	\$2081
TSPAS72H23	1 x 72 x 22.3	70	16	1	\$1539	\$1927
TSPAS66H23	1 x 66 x 22.3	85	14	1	\$1412	\$1769
TSPAS60H23	1 x 60 x 22.3	85	13	1	\$1279	\$1600
TSPAS54H23	1 x 54 x 22.3	85	13	1	\$1133	\$1417
TSPAS48H23	1 x 48 x 22.3	85	13	1	\$1027	\$1286
TSPAS42H23	1 x 42 x 22.3	85	13	1	\$901	\$1125
TSPAS36H23	1 x 36 x 22.3	100	8	1	\$640	\$803
TSPAS30H23	1 x 30 x 22.3	150	5	1	\$624	\$777

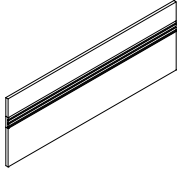

Tackboard w/Rail for 72" H\*  
Pigeon-Hole Wall Mount Cabinets

Factory installed tackboard for wall mount cabinets.

- Specify Black (E), Tungsten (K), or Designer White (DWT) accessory rail finish.

TSAS120H26	1 x 120 x 26	70	34	2	\$2826	\$3533
TSAS114H26	1 x 114 x 26	70	32	2	\$2679	\$3351
TSAS108H26	1 x 108 x 26	70	30	2	\$2549	\$3187
TSAS102H26	1 x 102 x 26	85	24	2	\$2403	\$3005
TSAS96H26	1 x 96 x 26	92.5	22	2	\$2258	\$2826
TSAS90H26	1 x 90 x 26	92.5	20	2	\$2126	\$2660
TSAS84H26	1 x 84 x 26	100	18	2	\$1961	\$2451
TSAS78H26	1 x 78 x 26	100	17	2	\$1835	\$2295
TSAS72H26	1 x 72 x 26	70	16	1	\$1670	\$2090
TSAS66H26	1 x 66 x 26	85	14	1	\$1559	\$1945
TSAS60H26	1 x 60 x 26	85	13	1	\$1412	\$1769
TSAS54H26	1 x 54 x 26	85	13	1	\$1273	\$1590
TSAS48H26	1 x 48 x 26	85	13	1	\$1133	\$1417
TSAS42H26	1 x 42 x 26	85	13	1	\$996	\$1242
TSAS36H26	1 x 36 x 26	100	8	1	\$851	\$1067
TSAS30H26	1 x 30 x 26	150	5	1	\$711	\$892

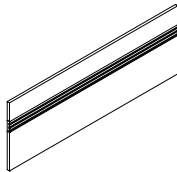

Tackboard w/Rail for 72" H\*  
Non-Pigeon-Hole Wall Mount Cabinets

Factory installed tackboard for wall mount cabinets.

- Specify Black (E), Tungsten (K), or Designer White (DWT) accessory rail finish.

TSP120H21	1 x 120 x 21	70	35	2	\$1656	\$1989
TSP114H21	1 x 114 x 21	70	32	2	\$1573	\$1890
TSP108H21	1 x 108 x 21	70	30	2	\$1489	\$1789
TSP102H21	1 x 102 x 21	85	24	2	\$1411	\$1694
TSP96H21	1 x 96 x 21	92.5	20	2	\$1322	\$1588
TSP90H21	1 x 90 x 21	70	1	1	\$1243	\$1493
TSP84H21	1 x 84 x 21	70	18	1	\$1162	\$1396
TSP78H21	1 x 78 x 21	70	17	1	\$1074	\$1291
TSP72H21	1 x 72 x 21	70	16	1	\$992	\$1193
TSP66H21	1 x 66 x 21	85	14	1	\$907	\$1091
TSP60H21	1 x 60 x 21	85	13	1	\$829	\$996
TSP54H21	1 x 54 x 21	85	13	1	\$747	\$898
TSP48H21	1 x 48 x 21	85	13	1	\$667	\$802
TSP42H21	1 x 42 x 21	125	6	1	\$582	\$701
TSP36H21	1 x 36 x 21	150	4	1	\$498	\$600
TSP30H21	1 x 30 x 21	250	3	1	\$417	\$502

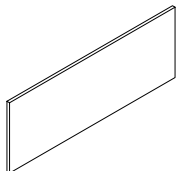

Tackboard for 84" H Double Height  
Pigeon-Hole Wall Mount Cabinets

Factory installed tackboard for wall mount cabinets.

**Required Specifications**

- Fabric
- Metal finish\*

## TACKBOARDS

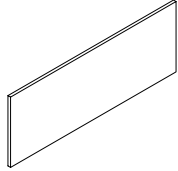

**Tackboard for 84" H Double Height Non Pigeon-Hole Wall Mount Cabinets**

MODEL#	DIMENSIONS D x W x H	FREIGHT CLASS	WT/LBS.	CUBIC FT.	GR. 3	GR. 4-5
TS120H25	1 x 120 x 25	85	27	2	\$1975	\$2371
TS114H25	1 x 114 x 25	85	25	2	\$1878	\$2256
TS108H25	1 x 108 x 25	92.5	23	2	\$1509	\$1884
TS102H25	1 x 102 x 25	100	19	2	\$1418	\$1776
TS96H25	1 x 96 x 25	70	17	1	\$1337	\$1668
TS90H25	1 x 90 x 25	70	15	1	\$1253	\$1569
TS84H25	1 x 84 x 25	85	14	1	\$1173	\$1468
TS78H25	1 x 78 x 25	85	13	1	\$1083	\$1355
TS72H25	1 x 72 x 25	85	12	1	\$1001	\$1256
TS66H25	1 x 66 x 25	92.5	11	1	\$920	\$1151
TS60H25	1 x 60 x 25	92.5	10	1	\$838	\$1051
TS54H25	1 x 54 x 25	92.5	10	1	\$889	\$1069
TS48H25	1 x 48 x 25	92.5	10	1	\$787	\$947
TS42H25	1 x 42 x 25	92.5	10	1	\$690	\$830
TS36H25	1 x 36 x 25	125	6	1	\$591	\$711
TS30H25	1 x 30 x 25	150	4	1	\$495	\$596

Factory installed tackboard for wall mount cabinets.

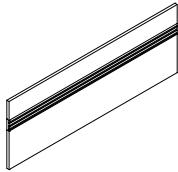

**Tackboard w/Rail for 84" H Double Ht.\* Pigeon-Hole Wall Mount Cabinets**

TSPAS120H21	1 x 120 x 21	70	33	2	\$2912	\$3495
TSPAS114H21	1 x 114 x 21	70	32	2	\$2769	\$3325
TSPAS108H21	1 x 108 x 21	70	30	2	\$2622	\$3147
TSPAS102H21	1 x 102 x 21	85	24	2	\$2485	\$2984
TSPAS96H21	1 x 96 x 21	70	20	1	\$2329	\$2796
TSPAS90H21	1 x 90 x 21	70	20	1	\$2192	\$2632
TSPAS84H21	1 x 84 x 21	70	18	1	\$2043	\$2454
TSPAS78H21	1 x 78 x 21	70	17	1	\$1897	\$2278
TSPAS72H21	1 x 72 x 21	70	16	1	\$1748	\$2100
TSPAS66H21	1 x 66 x 21	85	14	1	\$1604	\$1926
TSPAS60H21	1 x 60 x 21	85	13	1	\$1457	\$1748
TSPAS54H21	1 x 54 x 21	85	13	1	\$1317	\$1583
TSPAS48H21	1 x 48 x 21	85	13	1	\$1172	\$1409
TSPAS42H21	1 x 42 x 21	85	13	1	\$1022	\$1228
TSPAS36H21	1 x 36 x 21	60	6	0.01	\$872	\$1047
TSPAS30H21	1 x 30 x 21	60	4	0.01	\$677	\$815

Factory installed tackboard for wall mount cabinets.

- Specify Black (E), Tungsten (K), or Designer White (DWT) accessory rail finish.

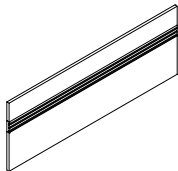

**Tackboard w/Rail for 84" H Double Ht.\* Non Pigeon-Hole Wall Mount Cabinets**

TSAS120H25	1 x 120 x 25	85	27	2	\$3332	\$4000
TSAS114H25	1 x 114 x 25	85	25	2	\$3163	\$3797
TSAS108H25	1 x 108 x 25	92.5	23	2	\$2455	\$3070
TSAS102H25	1 x 102 x 25	100	19	2	\$2307	\$2887
TSAS96H25	1 x 96 x 25	70	17	1	\$2169	\$2716
TSAS90H25	1 x 90 x 25	70	15	1	\$2043	\$2557
TSAS84H25	1 x 84 x 25	85	14	1	\$1885	\$2357
TSAS78H25	1 x 78 x 25	85	13	1	\$1765	\$2209
TSAS72H25	1 x 72 x 25	85	12	1	\$1602	\$2006
TSAS66H25	1 x 66 x 25	92.5	11	1	\$1500	\$1880
TSAS60H25	1 x 60 x 25	92.5	10	1	\$1363	\$1706
TSAS54H25	1 x 54 x 25	92.5	10	1	\$1504	\$1807
TSAS48H25	1 x 48 x 25	92.5	10	1	\$1341	\$1610
TSAS42H25	1 x 42 x 25	92.5	10	1	\$1175	\$1412
TSAS36H25	1 x 36 x 25	60	6	0.01	\$1004	\$1207
TSAS30H25	1 x 30 x 25	60	4	0.01	\$838	\$1008

Factory installed tackboard for wall mount cabinets.

- Specify Black (E), Tungsten (K), or Designer White (DWT) accessory rail finish.

### Required Specifications

Fabric  
Metal finish\*

ACCESSORIES

MODEL# DIMENSIONS FREIGHT CLASS WT/LBS. CUBIC FT. LIST PRICE

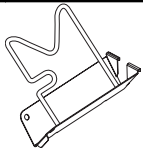

Flip Sorter

	D x W x H				
BAFS01	9.25 x 2.75 x 9.25	70	0.6	0.14	\$54

Load bar/accessory rail mounted metal flip sorter. Comes with chrome wire.  
 • Specify Black (E), Tungsten (K), or Designer White (DWT) accessory finish.

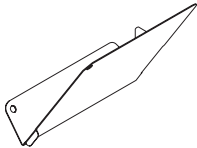

Slant Sorter

BASS01L (Left)	10.25 x 5 x 9.5	70	1	0.28	\$44
BASS01R (Right)	10.25 x 5 x 9.5	70	1	0.28	\$44

Load bar/accessory rail mounted metal slant sorter.  
 • Specify Black (E), Tungsten (K), or Designer White (DWT) accessory finish.

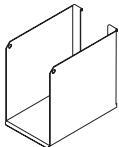

Binder Bin

BABB01	10.25 x 4 x 9	70	1.85	0.21	\$70
--------	---------------	----	------	------	------

Load bar/accessory rail mounted metal binder bin.  
 • Specify Black (E), Tungsten (K), or Designer White (DWT) accessory finish.

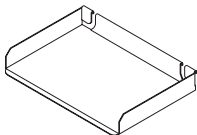

Letter Tray

BALTO1	9.25 x 13.5 x 2	70	0.5	0.15	\$58
--------	-----------------	----	-----	------	------

Load bar/accessory rail mounted metal letter tray.  
 • Specify Black (E), Tungsten (K), or Designer White (DWT) accessory finish.

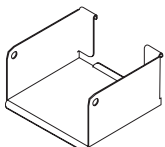

Media Bin

BAMB01	5.25 x 5.75 x 3	70	1.85	0.21	\$58
--------	-----------------	----	------	------	------

Load bar/accessory rail mounted metal media bin.  
 • Specify Black (E), Tungsten (K), or Designer White (DWT) accessory finish.

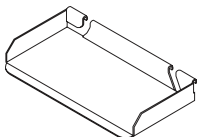

Utility Tray

BAUT01	3.75 x 5.75 x 3	70	0.5	0.02	\$38
--------	-----------------	----	-----	------	------

Load bar/accessory rail mounted metal utility tray.  
 • Specify Black (E), Tungsten (K), or Designer White (DWT) accessory finish.

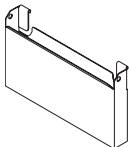

Mail Box

BAPP01	2.75 x 16 x 9	100	2	0.25	\$88
--------	---------------	-----	---	------	------

Load bar/accessory rail mounted metal mail box.  
 • Specify Black (E), Tungsten (K), or Designer White (DWT) accessory finish.

Required Specifications

Fabric  
 Metal finish\*



## ACCESSORIES

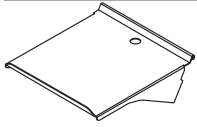

**Telephone Holder**

MODEL#	DIMENSIONS D x W x H	FREIGHT CLASS	WT./LBS.	CUBIC FT.	LIST PRICE
BATH01	10 x 9 x 2	125	2	0.26	<b>\$85</b>

Load bar/accessory rail mounted metal telephone holder.

- Specify Black (**E**), Tungsten (**K**), or Designer White (**DWT**) accessory finish.

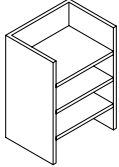

**Paper Organizer, Letter & Legal Format**

KCPH161226	12 x 16 x 27	125	20	3	<b>\$981</b>
KCPH161223	12 x 16 x 23	125	18	3	<b>\$829</b>
KCPH161219	12 x 16 x 20	125	15	2	<b>\$632</b>
KCPH131226	12 x 13 x 27	100	16	2	<b>\$795</b>
KCPH131223	12 x 13 x 23	125	15	2	<b>\$675</b>
KCPH131219	12 x 13 x 20	125	12	2	<b>\$512</b>

- Specify Black (**E**), Tungsten (**K**), or Designer White (**DWT**) accessory finish.

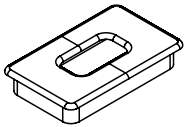

**Grommet**

GM5C	2 x 3.5 x --	70	--	--	<b>\$107</b>
------	--------------	----	----	----	--------------

Rectangular grommet in metal, tungsten finish.

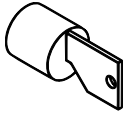

**Lock Assembly**

Black:					
LO	--	70	--	--	<b>\$106</b>

Tungsten:					
LO/C	--	70	--	--	<b>\$106</b>

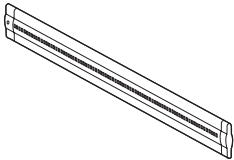

**LED Task Light**

PLED30	1.5 x 15.5 x .5	150	2	0.5	<b>\$494</b>
PLED50	1.5 x 23.5 x .5	150	2	0.5	<b>\$569</b>
PLED100	1.5 x 43.5 x .5	125	3	0.5	<b>\$660</b>

Energy efficient LED. Ultra slim design. Suitable for hanging under Hutch or Wallhung units. 6' power cord.

**Required Specifications**

Metal finish

# lufton





GLOBAL is pleased to introduce the **LUFTON** wood veneer series. This contemporary collection features an all wood veneer construction with a variety of features that emphasize a modern approach to the private office.

1" worksurfaces include a choice of four ¼" hardwood edges to choose from – Flat (L10), Radius (L20), Fluted (L30) and Soft Tail (L40). A black 5mm PVC inlay between the worksurface and gable provides a striking visual detail. Drawers and storage items feature eight handle options to choose from (where applicable) – storage options are available in 29", 66" and 72" heights. Various models include different types of storage configurations.

New 23" height credenzas allow for different visual planes – combined with a spacer unit, worksurfaces can be supported over this credenza.

Above worksurface storage selections include overhead storage and hutches with or without pigeon-hole storage. Hutch doors are available in a choice of veneer or glass with an aluminum frame. Tackboards are offered in all fabric or with a built-in accessory rail for organizing folders, binders, CDs and more!



**Features and Benefits**

- Choice of eight handle options for every door/drawer that features handles.
- Modesty panel options include metal (in Black or Tungsten), veneer, and glass.
- Base upgrades to replace standard monopost on islands are available in four styles.
- Drawers are standard vinyl wrapped construction with black drawer slides and bottom.
- 75 lb. box – 150 lb. file drawer weight capacity with full height sides – pencil tray included in box drawer.
- Lateral file drawers can accommodate legal or letter documents.
- Box drawers mounted on ¾ extension premium ball bearing slides.
- Power/Data accessories are available to be factory installed on any LUFTON unit, including Boardroom Tables to meet all today's technological requirements.
- A full array of complementary Boardroom and Reception area furnishings are available to coordinate the entire office.

**GENERAL INFORMATION**

- Lufton is a veneer desking system composed of hundreds of models, capable of furnishing executive suites, boardrooms and reception areas.
- 1" worksurfaces with 1/4" solid Wood Edge all around.
- 5MM Black PVC inlay between top and gables
- **Level 3 Certified**

**FINISHES**

- Conversion varnish (similar to catalyzed lacquer, but tougher), 35 to 40 degree sheen. Finishes are not buffed or rubbed.
- All Global wood casegood products are veneered and finished on the back sides (3600 finishing), except modular under-surface storage - tops and backs are unfinished.
- Touch up kits available, includes a touch up marker and fill crayon. Order **VTOUCHUPKIT, \$164** list. Specify finish when ordering.
- Global standard finish, on oak and walnut, is open pore and on cherry and maple is semi-closed pore. If a full finish is required for walnut, cherry, anigre and maple tops, add the suffix **"2"** to the finish code and add 5% to the base pricing for each product. Custom finish on standard veneer is available. Add 15% to the base pricing for each product.
- High Pressure laminate inlays are available at no upcharge. Contact Customer Care for specification information.
- Hanging file rails are pre-installed on file drawer perimeters and accommodate both legal and letter size filing. Legal filing can be achieved either as side-to-side or front-to-back. Letter filing can be achieved as front-to-back filing only.

**WORKSURFACE TOP & DRAWER/DOOR FRONTS, BODY FINISHES**

**(INCLUDING PEDESTALS) - VENEER**

Code	Finish	Veneer Type	Cut
AMW	Almond Cherry	Cherry	Flat Sliced
ACW	Amber Cherry	Cherry	Flat Sliced
BTW	Biscotti	White Oak	Rift
CAW	Cocoa Walnut	Walnut	Flat Sliced
CRW	Coral	White Oak	Rift
DCW	Dark Cherry	Cherry	Flat Sliced
DWW	Dark Walnut	Walnut	Flat Sliced
EWW	Espresso Walnut	Walnut	Flat Sliced
EVW	Evening Oak	White Oak	Rift
GRW	Grey on Oak	White Oak	Rift
HAW	Hazelnut	Maple	Flat Sliced
JAW	Java	White Oak	Rift
LTW	Latte Walnut	Walnut	Flat Sliced
MHW	Mahogany on Walnut	Walnut	Flat Sliced
MTW	Milestone	White Oak	Rift
MPW	Natural Maple	Maple	Flat Sliced
NLW	Natural Walnut	Walnut	Flat Sliced
RCW	Red Cherry	Cherry	Flat Sliced
VNW	Vintage Cherry	Cherry	Flat Sliced
ULW	Umber Walnut	Walnut	Flat Sliced
WLW	Walnut	Walnut	Flat Sliced
WCW	Warm Cherry	Cherry	Flat Sliced
WNW	White Maple	Maple	Flat Sliced

**EDGES**

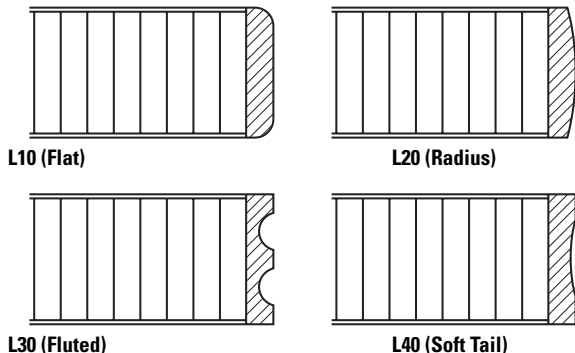

**HANDLES**

- Handles are standard on most drawers/storage modules. Each handle is identified by letters: **PL33, PL34, PL64, PL66, PL92, PL93, PL94, PL95, PL96, PL97, PL98, PL99, PLS7, and PLS8**. To specify a handle, specify the code after the model number and finish selections.

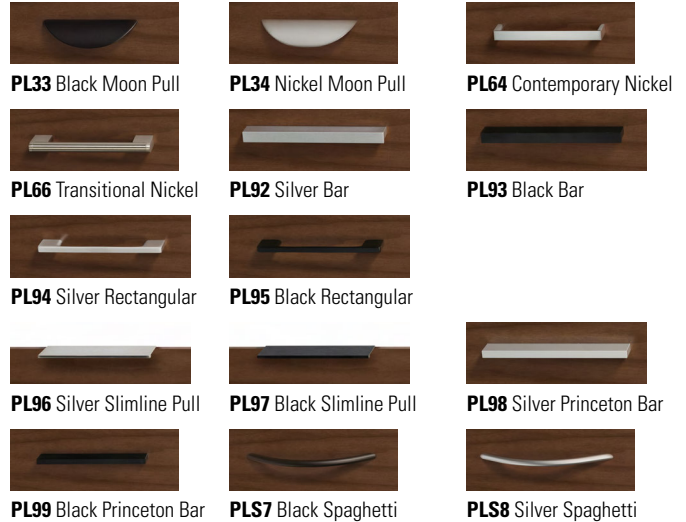

**GROMMETS**

- Standard grommet on all components is **GM5P**. Grommet is included with products where shown in line drawings in price book.
- Optional grommets may be ordered in standard worksurface locations (left, center or right). Order as **GM5PTL, GM5PTC or GM5PTR**. Add \$96.
- Grommet hole dimensions are 3.5" x 2".
- To order a grommet cover only, specify **GM5EP** for Black or **GM5KP** for Tungsten. Add \$57.
- Color of grommet will be automatically coordinated with handle color where applicable
- Components that come standard with grommet may be ordered without a grommet. Order as RSG - Add \$53.

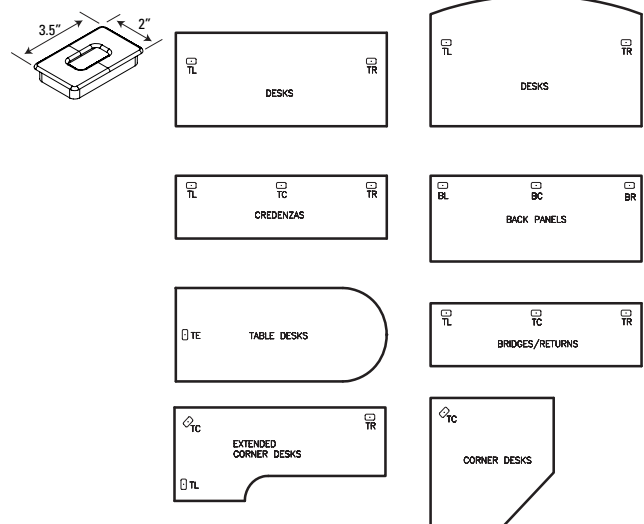



## DOUBLE PEDESTAL DESKS

MODEL#

DIMENSIONS

FREIGHT CLASS

WT/LBS.

CUBIC FT.

LIST PRICE

- Can be ordered as a shell or with pedestals.
- Grommets are available as an option on Desks and most Credenzas.
- Hand of Rectangular Desk is determined by location of pedestal from user side.
- Hand of "D" Island is determined by outward orientation of conference end from user projection.

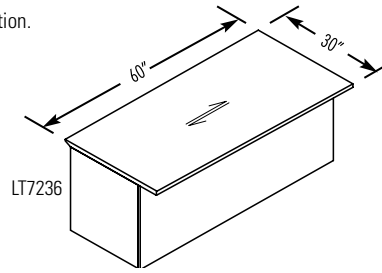
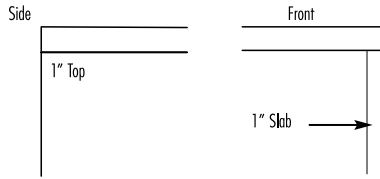
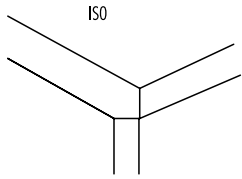

### MODESTY PANEL CLEARANCE:

LT7236

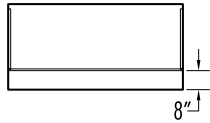

LT7230

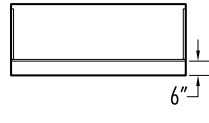

LMT7242

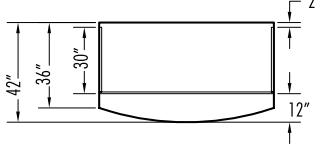

LMT7236

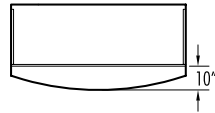

LISR7236D

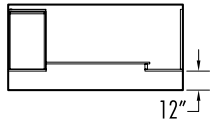

LISR7230D

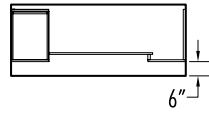

LDD7230

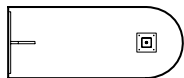

LDDBE7230

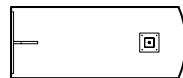

### DESK MODESTY OPTIONS:

#### Standard Full Modesty



#### Breakfront

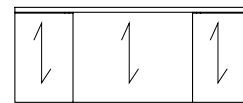

**NOTE:** Arrow indicates direction of grain.

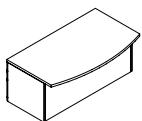
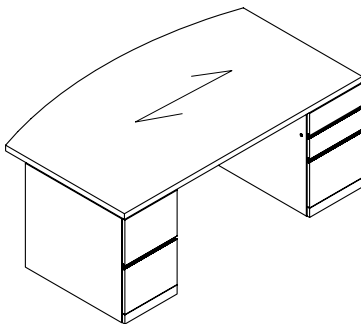

Flush Modesty

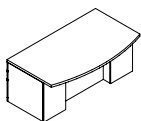

Breakfront

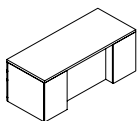

Recessed Modesty

**DOUBLE PEDESTAL DESKS - RECESSED FRONT MODESTY MODEL#**      **DIMENSIONS**      **FREIGHT CLASS**      **WT/LBS.**      **CUBIC FT.**      **LIST PRICE**

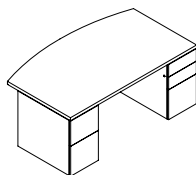

**Double Pedestal Bow Top Desk**

	<b>D x W x H</b>				
LMD8442ED	42 x 84 x 29	125	443	59	<b>\$6949</b>
LMD7842ED	42 x 78 x 29	125	412	55	<b>\$6456</b>
LMD7242ED	42 x 72 x 29	125	380	51	<b>\$5956</b>
LMD6636ED	36 x 66 x 29	125	240	40	<b>\$5780</b>

Standard with full to floor **file/file** pedestal on **left** and **box/box/file** pedestal on **right**. Bow top. Pedestals lock. One pencil tray. Refer to the Desks and Credenzas Notes Section above for overhang dimensions.

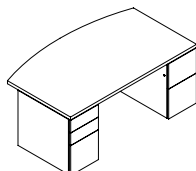

**Double Pedestal Bow Top Desk**

LMD8442DE	42 x 84 x 29	125	443	59	<b>\$6949</b>
LMD7842DE	42 x 78 x 29	125	412	55	<b>\$6456</b>
LMD7242DE	42 x 72 x 29	125	380	51	<b>\$5956</b>
LMD6636DE	36 x 66 x 29	125	240	40	<b>\$5780</b>

Standard with full to floor **box/box/file** pedestal on **left** and **file/file** pedestal on **right**. Bow top. Pedestals lock. One pencil tray. Refer to the Desks and Credenzas Notes Section on previous page for overhang dimensions.

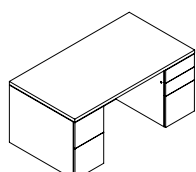

**Double Pedestal Desk**

LD8436ED	36 x 84 x 29	125	432	59	<b>\$5907</b>
LD7236ED	36 x 72 x 29	100	370	44	<b>\$5064</b>
LD7230ED	30 x 72 x 29	100	349	36	<b>\$4990</b>
LD6636ED	36 x 66 x 29	100	339	40	<b>\$4990</b>
LD6630ED	30 x 66 x 29	100	320	33	<b>\$4910</b>

Standard with full to floor **file/file** pedestal on **left** and **box/box/file** pedestal on **right**. Pedestals lock. Refer to the Desks and Credenzas Notes Section on previous page for overhang dimensions.

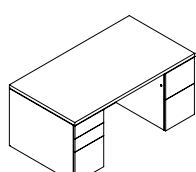

**Double Pedestal Desk**

LD8436DE	36 x 84 x 29	125	432	59	<b>\$5907</b>
LD7236DE	36 x 72 x 29	100	370	44	<b>\$5064</b>
LD7230DE	30 x 72 x 29	100	349	36	<b>\$4990</b>
LD6636DE	36 x 66 x 29	100	339	40	<b>\$4990</b>
LD6630DE	30 x 66 x 29	100	320	33	<b>\$4910</b>

Standard with full to floor **box/box/file** pedestal on **left** and **file/file** pedestal on **right**. Pedestals lock. Refer to the Desks and Credenzas Notes Section on previous page for overhang dimensions.

**DOUBLE PEDESTAL DESKS - BREAKFRONT STYLE**      **MODEL#**      **DIMENSIONS**      **FREIGHT CLASS**      **WT/LBS.**      **CUBIC FT.**      **LIST PRICE**

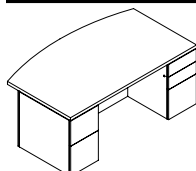

**Double Pedestal Bow Top Desk  
Breakfront Style**

LMID8442ED	42 x 84 x 29	125	443	59	<b>\$7772</b>
LMID7842ED	42 x 78 x 29	125	412	55	<b>\$7232</b>
LMID7242ED	42 x 72 x 29	125	380	51	<b>\$6687</b>
LMID6636ED	36 x 66 x 29	125	240	40	<b>\$6437</b>

Standard with full to floor **file/file** pedestal on **left** and **box/box/file** pedestal on **right**. Bow top. Pedestals lock. One pencil tray. Refer to the Desks and Credenzas Notes Section on previous page for overhang dimensions.

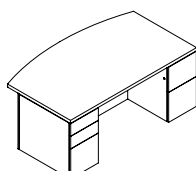

**Double Pedestal Bow Top Desk  
Breakfront Style**

LMID8442DE	42 x 84 x 29	125	443	59	<b>\$7772</b>
LMID7842DE	42 x 78 x 29	125	412	55	<b>\$7232</b>
LMID7242DE	42 x 72 x 29	125	380	51	<b>\$6687</b>
LMID6636DE	36 x 66 x 29	125	240	40	<b>\$6437</b>

Standard with full to floor **box/box/file** pedestal on **left** and **file/file** pedestal on **right**. Bow top. Pedestals lock. One pencil tray. Refer to the Desks and Credenzas Notes Section on previous page for overhang dimensions.

**Required Specifications**  
Veneer Finish  
Edge

**Optional Specifications**  
Grommet

## DOUBLE PEDESTAL DESKS - BREAKFRONT STYLE

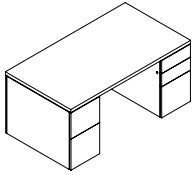

**Double Pedestal Desk, Breakfront Style**

MODEL#	DIMENSIONS D x W x H	FREIGHT CLASS	WT/LBS.	CUBIC FT.	LIST PRICE
LID8436ED	36 x 84 x 29	125	432	59	<b>\$6099</b>
LID7236ED	36 x 72 x 29	100	370	44	<b>\$5662</b>
LID7230ED	30 x 72 x 29	100	349	36	<b>\$5574</b>
LID6636ED	36 x 66 x 29	100	339	40	<b>\$5574</b>
LID6630ED	30 x 66 x 29	100	320	33	<b>\$5489</b>

Standard with full to floor **file/file** pedestal on **left** and **box/box/file** pedestal on **right**. Pedestals lock. Refer to the Desks and Credenzas Notes Section on previous page for overhang dimensions.

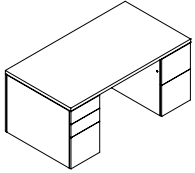

**Double Pedestal Desk, Breakfront Style**

LID8436DE	36 x 84 x 29	125	432	59	<b>\$6099</b>
LID7236DE	36 x 72 x 29	100	370	44	<b>\$5662</b>
LID7230DE	30 x 72 x 29	100	349	36	<b>\$5574</b>
LID6636DE	36 x 66 x 29	100	339	40	<b>\$5574</b>
LID6630DE	30 x 66 x 29	100	320	33	<b>\$5489</b>

Standard with full to floor **box/box/file** pedestal on **left** and **file/file** pedestal on **right**. Pedestals lock. Refer to the Desks and Credenzas Notes Section on page 268 for overhang dimensions.

## SINGLE PEDESTAL DESKS

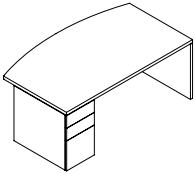

**Single Pedestal Bow Top Desk - LEFT**

MODEL#	DIMENSIONS	FREIGHT CLASS	WT/LBS.	CUBIC FT.	LIST PRICE
LMSL8442D	42 x 84 x 29	125	432	59	<b>\$6654</b>
LMSL7842D	42 x 78 x 29	125	401	55	<b>\$6175</b>
LMSL7242D	42 x 72 x 29	125	370	51	<b>\$5707</b>
LMSL6636D	36 x 66 x 29	150	230	40	<b>\$5489</b>

Standard with full to floor **box/box/file** pedestal on **left**. Bow top. Pedestal locks. Refer to the Desks and Credenzas Notes Section on page 268 for overhang dimensions.

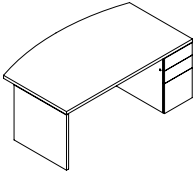

**Single Pedestal Bow Top Desk - RIGHT**

LMSR8442D	42 x 84 x 29	125	432	59	<b>\$6654</b>
LMSR7842D	42 x 78 x 29	125	401	55	<b>\$6175</b>
LMSR7242D	42 x 72 x 29	125	370	51	<b>\$5707</b>
LMSR6636D	36 x 66 x 29	150	230	40	<b>\$5489</b>

Standard with full to floor **box/box/file** pedestal on **right**. Bow top. Pedestal locks. Refer to the Desks and Credenzas Notes Section on page 268 for overhang dimensions.

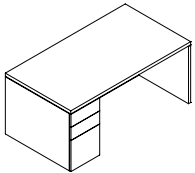

**Single Pedestal Desk - LEFT**

LSL8436D	42 x 84 x 29	125	463	59	<b>\$4507</b>
LSL7236D	36 x 72 x 29	125	340	44	<b>\$3864</b>
LSL7230D	30 x 72 x 29	125	283	36	<b>\$3690</b>
LSL6636D	36 x 66 x 29	125	312	40	<b>\$3690</b>
LSL6630D	30 x 66 x 29	100	295	33	<b>\$3526</b>

Standard with full to floor **box/box/file** pedestal on **left**. Pedestal locks. Refer to the Desks and Credenzas Notes Section on page 268 for overhang dimensions.

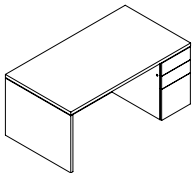

**Single Pedestal Desk - RIGHT**

LSR8436D	36 x 84 x 29	125	463	59	<b>\$4507</b>
LSR7236D	36 x 72 x 29	125	340	44	<b>\$3864</b>
LSR7230D	30 x 72 x 29	125	283	36	<b>\$3690</b>
LSR6636D	36 x 66 x 29	125	312	40	<b>\$3690</b>
LSR6630D	30 x 66 x 29	100	295	33	<b>\$3526</b>

Standard with full to floor **box/box/file** pedestal on **right**. Pedestal locks. Refer to the Desks and Credenzas Notes Section on page 268 for overhang dimensions.

### Required Specifications

Veneer Finish  
Edge

### Optional Specifications

Grommet

ELECTRIC HEIGHT ADJUSTABLE UNITS	MODEL#	DIMENSIONS	FREIGHT CLASS	WT./LBS.	CUBIC FT.	LIST PRICE
----------------------------------	--------	------------	---------------	----------	-----------	------------

D x W x H

- All Height Adjustable (HA) units are shipped fully assembled.
- Simple Up / Down function enables the height adjustment of the worksurface.
- The height adjustment range for desks is 29" to 45", for table and bridge top 26" to 43" (including worksurface).
- Single stage HA mechanism with an electric motor in each column is used.
- The height adjustable mechanism operates at 1.5" per second.
- Max. weight / lift is 265 lbs.
- All columns are integrated into fully functional pedestals, or pedestal bases with the exception of the HA table and the HA bridge top.
- Height adjustable bases are available in three colors: **Black (BLK)**, **Tungsten (TUN)**, and **Designer White (DWT)**
- All desks include two (2) PVC wire management channels (L & R side) allowing for cabling through the pedestals.
- Hanging wood modesty panel on desk is standard.
- To avoid risk of pinching:
  - 4.9" / 124mm gap is kept between the pedestal and the lowest point of the worksurface.
  - Wood spacer HASP must be used to attach height adjustable unit in the "U" or "L" configuration. See assembly instructions.
  - 2" gap is required between the worksurfaces when using the HA Table or the HA Bridge Top.
  - Includes collision detector
- Optional grommet locations: **TL** - Top Left or **TR** - Top Right

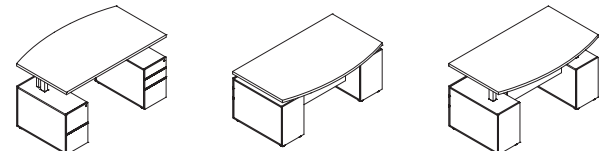
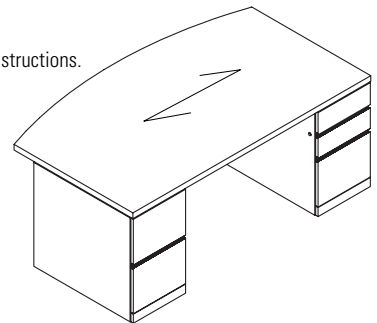

Note: Arrow indicates direction of grain.

HEIGHT ADJUSTABLE DOUBLE PEDESTAL DESKS	MODEL#	DIMENSIONS	FREIGHT CLASS	WT./LBS.	CUBIC FT.	LIST PRICE
---	--------	------------	---------------	----------	-----------	------------

D x W x H

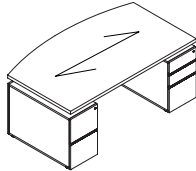

Height Adj. Double Ped. Bow Top Desk Breakfront Style

LHAMID8442ED	42 x 84 x 29	150	450	78	<b>\$13691</b>
LHAMID7842ED	42 x 78 x 29	150	430	72	<b>\$13112</b>
LHAMID7242ED	42 x 72 x 29	150	410	69	<b>\$12534</b>
LHAMID6636ED	36 x 66 x 29	125	390	54	<b>\$11889</b>

Built-in electric height adjustable double pedestal, standard with full to floor **box/box/file** pedestal on **right** and **file/file** pedestal on **left**. Bow top. Pedestals lock. One pencil tray. Refer to the Desks and Credenzas Notes Section on page 268 for overhang dimensions.

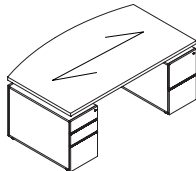

Height Adj. Double Ped. Bow Top Desk Breakfront Style

LHAMID8442DE	42 x 84 x 29	150	450	78	<b>\$13691</b>
LHAMID7842DE	42 x 78 x 29	150	430	72	<b>\$13112</b>
LHAMID7242DE	42 x 72 x 29	150	410	69	<b>\$12534</b>
LHAMID6636DE	36 x 66 x 29	125	390	54	<b>\$11889</b>

Built-in electric height adjustable double pedestal, standard with full to floor **box/box/file** pedestal on **left** and **file/file** pedestal on **right**. Bow top. Pedestals lock. One pencil tray. Refer to the Desks and Credenzas Notes Section on page 268 for overhang dimensions.

**Required Specifications**

- Top finish
- Edge
- Base finish
- Handle style

**Optional Specifications**

- Grommet
- Glass modesty

## HEIGHT ADJUSTABLE DOUBLE PEDESTAL DESKS

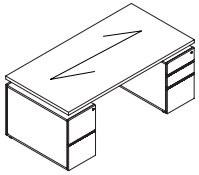

**Height Adj. Double Ped. Desk  
Breakfront Style**

MODEL#	DIMENSIONS D x W x H	FREIGHT CLASS	WT/LBS.	CUBIC FT.	LIST PRICE
LHAID8436ED	36 x 84 x 29	125	440	68	<b>\$11657</b>
LHAID7836ED	36 x 78 x 29	125	420	63	<b>\$11579</b>
LHAID7236ED	36 x 72 x 29	125	400	58	<b>\$11495</b>
LHAID7230ED	30 x 72 x 29	125	390	49	<b>\$11410</b>
LHAID6630ED	30 x 66 x 29	100	380	46	<b>\$11251</b>

Built-in electric height adjustable double pedestal, standard with full to floor **box/box/file** pedestal on **right** and **file/file** pedestal on **left**. Pedestals lock. One pencil tray. Refer to the Desks and Credenzas Notes Section on page 268 for overhang dimensions.

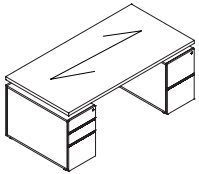

**Height Adj. Double Ped. Desk  
Breakfront Style**

LHAID8436DE	36 x 84 x 29	125	440	68	<b>\$11657</b>
LHAID7836DE	36 x 78 x 29	125	420	63	<b>\$11579</b>
LHAID7236DE	36 x 72 x 29	125	400	58	<b>\$11495</b>
LHAID7230DE	30 x 72 x 29	125	390	49	<b>\$11410</b>
LHAID6630DE	30 x 66 x 29	100	380	46	<b>\$11251</b>

Built-in electric height adjustable double pedestal, standard with full to floor **box/box/file** pedestal on **left** and **file/file** pedestal on **right**. Pedestals lock. One pencil tray. Refer to the Desks and Credenzas Notes Section on page 268 for overhang dimensions.

## HEIGHT ADJUSTABLE SINGLE PEDESTAL DESKS

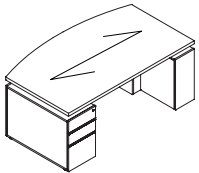

**Height Adj. Single Ped. Bow Top Desk  
Breakfront Style - LEFT**

MODEL#	DIMENSIONS	FREIGHT CLASS	WT/LBS.	CUBIC FT.	LIST PRICE
LHAMISL8442D	42 x 84 x 29	150	440	81	<b>\$12006</b>
LHAMISL7842D	42 x 78 x 29	150	420	72	<b>\$11554</b>
LHAMISL7242D	42 x 72 x 29	150	400	67	<b>\$11101</b>
LHAMISL6636D	36 x 66 x 29	125	390	54	<b>\$10535</b>

Built-in electric height adjustable single pedestal bow top desk. Standard with full to floor locking **box/box/file** pedestal on **left** and support pedestal on **right**. Refer to the Desks and Credenzas Notes Section on page 268 for overhang dimensions.

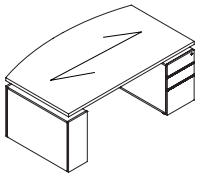

**Height Adj. Single Ped. Bow Top Desk  
Breakfront Style - RIGHT**

LHAMISR8442D	42 x 84 x 29	150	440	81	<b>\$12006</b>
LHAMISR7842D	42 x 78 x 29	150	420	72	<b>\$11554</b>
LHAMISR7242D	42 x 72 x 29	150	400	67	<b>\$11101</b>
LHAMISR6636D	36 x 66 x 29	125	390	54	<b>\$10535</b>

Built-in electric height adjustable single pedestal bow top desk. Standard with full to floor locking **box/box/file** pedestal on **right** and support pedestal on **left**. Refer to the Desks and Credenzas Notes Section on page 268 for overhang dimensions.

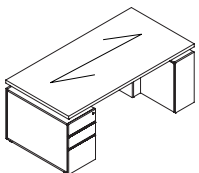

**Height Adjustable Single Ped. Desk  
Breakfront Style - LEFT**

LHAISL8436D	36 x 84 x 29	125	430	68	<b>\$10257</b>
LHAISL7836D	36 x 78 x 29	125	410	63	<b>\$10218</b>
LHAISL7236D	36 x 72 x 29	125	390	58	<b>\$10093</b>
LHAISL7230D	30 x 72 x 29	125	380	49	<b>\$9897</b>
LHAISL6630D	30 x 66 x 29	125	360	46	<b>\$9639</b>
LHAISL6030D	30 x 60 x 29	100	340	42	<b>\$9456</b>

Built-in electric height adjustable single pedestal desk. Standard with full to floor locking **box/box/file** pedestal on **left** and support pedestal on **right**. Refer to the Desks and Credenzas Notes Section on page 268 for overhang dimensions.

### Required Specifications

Top finish  
Edge  
Base finish  
Handle style

### Optional Specifications

Grommet  
Glass modesty

HEIGHT ADJUSTABLE SINGLE PEDESTAL DESKS

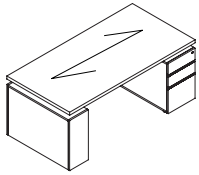

**Height Adjustable Single Ped. Desk\***  
**Breakfront Style - RIGHT**

MODEL#	DIMENSIONS	FREIGHT CLASS	WT/LBS.	CUBIC FT.	LIST PRICE
<b>D x W x H</b>					
LHAISR8436D	36 x 84 x 29	125	430	68	<b>\$10257</b>
LHAISR7836D	36 x 78 x 29	125	410	63	<b>\$10218</b>
LHAISR7236D	36 x 72 x 29	125	390	58	<b>\$10093</b>
LHAISR7230D	30 x 72 x 29	125	380	49	<b>\$9897</b>
LHAISR6630D	30 x 66 x 29	125	360	46	<b>\$9639</b>
LHAISR6030D	30 x 60 x 29	100	340	42	<b>\$9456</b>

Built-in electric height adjustable single pedestal desk. Standard with full to floor locking **box/box/file** pedestal on **right** and support pedestal on **left**. Refer to the Desks and Credenzas Notes Section on page 268 for overhang dimensions.

HEIGHT ADJUSTABLE DESK SHELLS

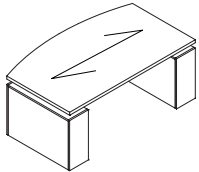

**Height Adjustable Bow Top Desk Shell**  
**Breakfront Style**

MODEL#	DIMENSIONS	FREIGHT CLASS	WT/LBS.	CUBIC FT.	LIST PRICE
LHAMIT8442	42 x 84 x 29	150	350	81	<b>\$11632</b>
LHAMIT7842	42 x 78 x 29	150	330	72	<b>\$11382</b>
LHAMIT7242	42 x 72 x 29	150	310	67	<b>\$11127</b>
LHAMIT6636	36 x 66 x 29	150	280	54	<b>\$10041</b>

Built-in electric height adjustable bow top desk shell.  
Refer to the Desks and Credenzas Notes Section on page 268 for overhang dimensions.

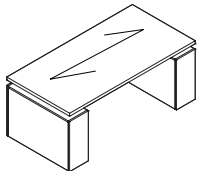

**Height Adjustable Desk Shell**  
**Breakfront Style**

LHAIT8436	36 x 84 x 29	150	330	68	<b>\$10349</b>
LHAIT7836	36 x 78 x 29	150	310	63	<b>\$10158</b>
LHAIT7236	36 x 72 x 29	150	290	58	<b>\$9954</b>
LHAIT7230	30 x 72 x 29	150	280	49	<b>\$9332</b>
LHAIT6636	36 x 66 x 29	150	260	54	<b>\$9561</b>
LHAIT6630	30 x 66 x 29	150	250	46	<b>\$9332</b>
LHAIT6030	30 x 60 x 29	150	240	42	<b>\$9166</b>

Built-in electric height adjustable desk shell.  
Refer to the Desks and Credenzas Notes Section on page 268 for overhang dimensions.

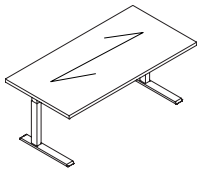

**Height Adjustable Table**

LHA8436	36 x 84 x 29	250	160	68	<b>\$8376</b>
LHA7836	36 x 78 x 29	250	150	63	<b>\$8187</b>
LHA7236	36 x 72 x 29	250	140	58	<b>\$7982</b>
LHA7230	30 x 72 x 29	250	130	49	<b>\$7356</b>
LHA6636	36 x 66 x 29	250	140	54	<b>\$7587</b>
LHA6630	30 x 66 x 29	250	120	46	<b>\$7356</b>
LHA6030	30 x 60 x 29	250	115	42	<b>\$7193</b>

Electric height adjustable table.

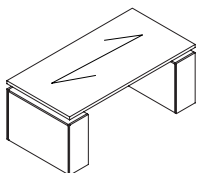

**Height Adjustable Desk**

LHA8436TP	36 x 84 x 29	150	320	68	<b>\$10021</b>
LHA7836TP	36 x 78 x 29	150	300	63	<b>\$9830</b>
LHA7236TP	36 x 72 x 29	150	280	58	<b>\$9627</b>
LHA7230TP	30 x 72 x 29	150	270	49	<b>\$9001</b>
LHA6636TP	36 x 66 x 29	150	250	54	<b>\$9233</b>
LHA6630TP	30 x 66 x 29	150	240	46	<b>\$9001</b>
LHA6030TP	30 x 60 x 29	150	230	42	<b>\$8837</b>

Built-in electric height adjustable desk on TP bases.

**Required Specifications**

Top finish  
Edge  
Base finish  
Handle style\*

**Optional Specifications**

Grommet  
Glass modesty

## HEIGHT ADJUSTABLE UNITS

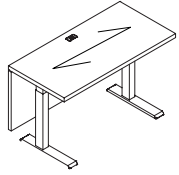

**Height Adjustable Bridge Top**

MODEL#	DIMENSIONS D x W x H	FREIGHT CLASS	WT/LBS.	CUBIC FT.	LIST PRICE
LHABT6024	24 x 60 x 29	150	150	35	<b>\$7805</b>
LHABT5424	24 x 54 x 29	150	140	31	<b>\$7574</b>
LHABT4824	24 x 48 x 29	150	130	28	<b>\$7343</b>
LHABT4224	24 x 42 x 29	150	120	26	<b>\$7105</b>

Electric height adjustable executive bridge top. Grommet in worksurface.

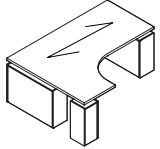

**Height Adj. Right Extended Corner Desk\***

LHAEKR60842436	24-36 x 60-84 x 29	150	450	108	<b>\$15519</b>
LHAEKR60782436	24-36 x 60-78 x 29	150	430	100	<b>\$15481</b>
LHAEKR60722436	24-36 x 60-72 x 29	150	410	93	<b>\$15139</b>
LHAEKR60662436	24-36 x 60-66 x 29	150	390	86	<b>\$14698</b>
LHAEKR60602436	24-36 x 60-60 x 29	150	370	79	<b>\$14258</b>

Built-in electric height adjustable right extended corner table desk with a 24" return connection. Extended worksurface on **right. Full end panel on right, narrow end panel on left.** Connects to Linking Bridges, Extended Corners and Connectable Tables.

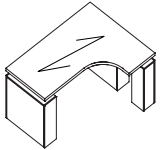

**Height Adj. Left Extended Corner Desk\***

LHAEKL84603624	24-36 x 60-84 x 29	150	450	108	<b>\$15519</b>
LHAEKL78603624	24-36 x 60-78 x 29	150	430	100	<b>\$15481</b>
LHAEKL72603624	24-36 x 60-72 x 29	150	410	93	<b>\$15139</b>
LHAEKL66603624	24-36 x 60-66 x 29	150	390	86	<b>\$14698</b>
LHAEKL60603624	24-36 x 60-60 x 29	150	370	79	<b>\$14258</b>

Built-in electric height adjustable right extended corner table desk with a 24" return connection. Extended worksurface on **left. Full end panel on left, narrow end panel on right.** Connects to Linking Bridges, Extended Corners and Connectable Tables.



**Spacer**

LHASP	2 x 8 x 23	70	15	.75	<b>\$561</b>
-------	------------	----	----	-----	--------------

Connects height adjustable desks with linking bridges and returns.

### Required Specifications

Top finish  
Edge  
Base finish

### Optional Specifications

Grommet\*  
Glass modesty

MODESTY PANEL OPTIONS

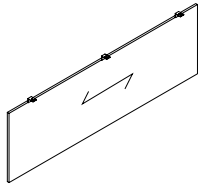

Veneer Modesty Panel Upgrade\*

MODEL#	DIMENSIONS D x W x H	FREIGHT CLASS	WT./LBS.	CUBIC FT.	LIST PRICE
CMP72W	0.75 x 67 x 18	--	20	1	\$1622
CMP66W	0.75 x 61 x 18	--	18	1	\$1570
CMP60W	0.75 x 55 x 18	--	16	1	\$1546
CMP54W	0.75 x 49 x 18	--	14	1	\$1520
CMP48W	0.75 x 43 x 18	--	13	1	\$1496

Straight modesty panel. Attaches to underside of worksurface. **Can not be retrofitted in the field *Not sold individually - to be ordered as an upgrade option only.***

- CMP72W - Specify on "P" Top Islands or 96" x 48" Islands for Piano Desks.
- CMP66W - Specify on 84" x 36" "D" Top Islands.
- CMP60W - Specify on 84" x 42" "P" Top Islands or 84" x 48" Islands for Piano Desks.
- CMP54W - Specify on 72" x 30" "D" Top Islands.
- CMP48W - Specify on 66" x 36" , 60" x 30" "D" Top Islands, 72" x 42" "P" Top Islands or 72" x 48" Islands for Piano Desks.

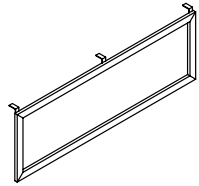

Glass Modesty Panel Upgrade

CMP72G	0.75 x 67 x 18	--	20	1	\$2485
CMP66G	0.75 x 61 x 18	--	18	1	\$2351
CMP60G	0.75 x 55 x 18	--	16	1	\$2149
CMP54G	0.75 x 49 x 18	--	14	1	\$2001
CMP48G	0.75 x 43 x 18	--	13	1	\$1911

Straight modesty panel. Translucent, screened glass. Aluminum box frame construction in Tungsten Only. Attaches to underside of worksurface. **Can not be retrofitted in the field. *Not sold individually - to be ordered as an upgrade option only.***

- CMP72G - Specify on "P" Top Islands or 96" x 48" Islands for Piano Desks.
- CMP66G - Specify on 84" x 36" "D" Top Islands.
- CMP60G - Specify on 84" x 42" "P" Top Islands or 84" x 48" Islands for Piano Desks.
- CMP54G - Specify on 72" x 30" "D" Top Islands.
- CMP48G - Specify on 66" x 36" , 60" x 30" "D" Top Islands, 72" x 42" "P" Top Islands or 72" x 48" Islands for Piano Desks.
- Tungsten finish on the aluminum box frame closely resembles the existing Tungsten finish.

SINGLE PEDESTAL DESKS - BREAKFRONT STYLE

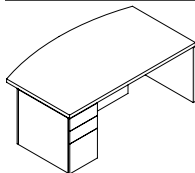

Single Pedestal Bow Top Desk - LEFT Breakfront Style\*

MODEL#	DIMENSIONS	FREIGHT CLASS	WT./LBS.	CUBIC FT.	LIST PRICE
LMISL8442D	42 x 84 x 29	125	432	59	\$6790
LMISL7842D	42 x 78 x 29	125	401	55	\$6313
LMISL7242D	42 x 72 x 29	125	370	51	\$5847
LMISL6636D	36 x 66 x 29	150	230	40	\$5574

Standard with full to floor **box/box/file** pedestal on **left**. Bow top. Pedestal locks. Refer to the Desks and Credenzas Notes Section on page 268 for overhang dimensions.

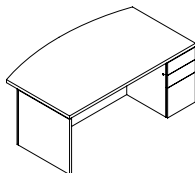

Single Pedestal Bow Top Desk - RIGHT Breakfront Style\*

LMISR8442D	42 x 84 x 29	125	432	59	\$6790
LMISR7842D	42 x 78 x 29	125	401	55	\$6313
LMISR7242D	42 x 72 x 29	125	370	51	\$5847
LMISR6636D	36 x 66 x 29	150	230	40	\$5574

Standard with full to floor **box/box/file** pedestal on **right**. Bow top. Pedestal locks. Refer to the Desks and Credenzas Notes Section on page 268 for overhang dimensions.

Required Specifications

Finish  
Veneer finish\*  
Edge\*

Optional Specifications

Grommet\*



## SINGLE PEDESTAL DESKS - BREAKFRONT STYLE

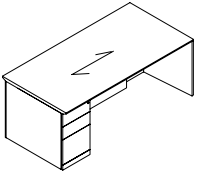

**Single Pedestal Desk - LEFT  
Breakfront Style**

MODEL#	DIMENSIONS	FREIGHT CLASS	WT/LBS.	CUBIC FT.	LIST PRICE
LISL8436D	36 x 84 x 29	125	463	59	<b>\$5923</b>
LISL7236D	36 x 72 x 29	125	340	44	<b>\$5045</b>
LISL7230D	30 x 72 x 29	125	283	36	<b>\$4153</b>
LISL6636D	36 x 66 x 29	125	312	40	<b>\$4153</b>
LISL6630D	30 x 66 x 29	100	295	33	<b>\$3967</b>

Standard with full to floor **box/box/file** pedestal on **left**. Pedestal locks. Refer to the Desks and Credenzas Notes Section on page 268 for overhang dimensions.

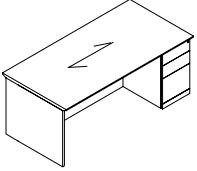

**Single Pedestal Desk - RIGHT  
Breakfront Style**

LISR8436D	42 x 84 x 29	125	463	59	<b>\$5923</b>
LISR7236D	36 x 72 x 29	125	340	44	<b>\$5045</b>
LISR7230D	30 x 72 x 29	125	283	36	<b>\$4153</b>
LISR6636D	36 x 66 x 29	125	312	40	<b>\$4153</b>
LISR6630D	30 x 66 x 29	100	295	33	<b>\$3967</b>

Standard with full to floor **box/box/file** pedestal on **right**. Pedestal locks. Refer to the Desks and Credenzas Notes Section on page 268 for overhang dimensions.

## DESK SHELLS

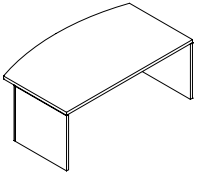

**Bow Top Desk Shell**

MODEL#	DIMENSIONS	FREIGHT CLASS	WT/LBS.	CUBIC FT.	LIST PRICE
LMT8442	42 x 84 x 29	125	380	59	<b>\$5114</b>
LMT7842	42 x 78 x 29	125	353	55	<b>\$4744</b>
LMT7242	42 x 72 x 29	125	331	51	<b>\$4391</b>
LMT6636	36 x 66 x 29	125	287	40	<b>\$4178</b>

Bow top and recessed modesty panel. Refer to the Desks and Credenzas Notes Section on page 268 for overhang dimensions.

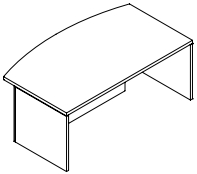

**Bow Top Desk Shell, Breakfront Style**

LMIT8442	42 x 84 x 29	125	380	59	<b>\$5254</b>
LMIT7842	42 x 78 x 29	125	353	55	<b>\$4952</b>
LMIT7242	42 x 72 x 29	125	331	51	<b>\$4651</b>
LMIT6636	36 x 66 x 29	125	287	40	<b>\$4482</b>

Bow top and recessed modesty panel. Refer to the Desks and Credenzas Notes Section on page 268 for overhang dimensions.

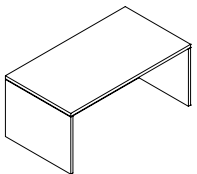

**Desk Shell**

LT8436	36 x 84 x 29	150	362	51	<b>\$3678</b>
LT7236	36 x 72 x 29	125	315	44	<b>\$3498</b>
LT7230	30 x 72 x 29	125	271	36	<b>\$3297</b>
LT6636	36 x 66 x 29	100	271	40	<b>\$3297</b>
LT6630	30 x 66 x 29	100	265	33	<b>\$3090</b>

Recessed modesty panel. Refer to the Desks and Credenzas Notes Section on page 268 for overhang dimensions.

### Required Specifications

Veneer Finish  
Edge

### Optional Specifications

Grommet

RETURNS	MODEL#	DIMENSIONS D x W x H	FREIGHT CLASS	WT./LBS.	CUBIC FT.	LIST PRICE
---------	--------	-------------------------	---------------	----------	-----------	------------

- An Executive Return is used to attach to a Single Pedestal Desk, Single Pedestal Credenza, Desk Shell or Credenza Shell.
- Grommets are available as an option.
- Hand of Executive Return is determined by location of full end panel from user side.
- Hand of Desk or Credenza is determined by location of pedestal from user side.
- To remove cross grain veneer pattern on top, delete suffix "CG" from the model number. Available as a special - no upcharge.

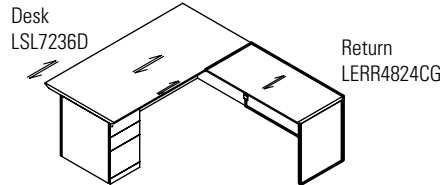
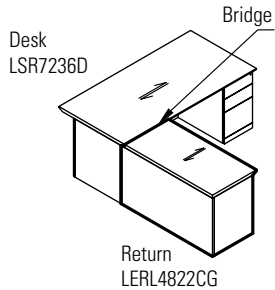

RETURNS	MODEL#	DIMENSIONS D x W x H	FREIGHT CLASS	WT./LBS.	CUBIC FT.	LIST PRICE
---------	--------	-------------------------	---------------	----------	-----------	------------

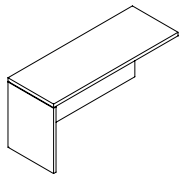

**Flush Return - LEFT 24" Deep**

LERL7224CG	24 x 72 x 29	150	135	29	<b>\$2681</b>
LERL6624CG	24 x 66 x 29	150	127	27	<b>\$2505</b>
LERL6024CG	24 x 60 x 29	150	120	24	<b>\$2323</b>
LERL5424CG	24 x 54 x 29	150	112	22	<b>\$2149</b>
LERL4824CG	24 x 48 x 29	150	105	19	<b>\$1969</b>
LERL4224CG	24 x 42 x 29	150	97	17	<b>\$1787</b>

Return has **no pedestal**. For use with right handed single pedestal desks, credenzas, desk shells, credenza shells, "D" islands or "P" islands.

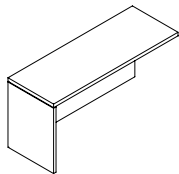

**Flush Return - LEFT 20" Deep**

LERL7220CG	20 x 72 x 29	150	130	27	<b>\$1947</b>
LERL6620CG	20 x 66 x 29	150	122	24	<b>\$1787</b>
LERL6020CG	20 x 60 x 29	150	115	22	<b>\$1624</b>
LERL5420CG	20 x 54 x 29	150	105	20	<b>\$1466</b>
LERL4820CG	20 x 48 x 29	150	100	18	<b>\$1302</b>
LERL4220CG	20 x 42 x 29	150	90	16	<b>\$1142</b>

Return has **no pedestal**. For use with right handed single pedestal desks, credenzas, desk shells, credenza shells, "D" islands or "P" islands.

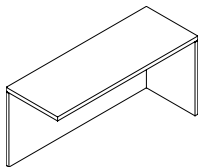

**Flush Return - RIGHT 24" Deep**

LERR7224CG	24 x 72 x 29	150	135	29	<b>\$2681</b>
LERR6624CG	24 x 66 x 29	150	127	27	<b>\$2505</b>
LERR6024CG	24 x 60 x 29	150	120	24	<b>\$2323</b>
LERR5424CG	24 x 54 x 29	150	112	22	<b>\$2149</b>
LERR4824CG	24 x 48 x 29	150	105	19	<b>\$1969</b>
LERR4224CG	24 x 42 x 29	150	97	17	<b>\$1787</b>

Return has **no pedestal**. For use with left handed single pedestal desks, credenzas, desk shells, credenza shells, "D" islands or "P" islands.

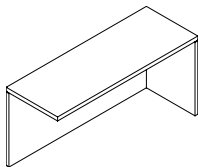

**Flush Return - RIGHT 20" Deep**

LERR7220CG	20 x 72 x 29	150	130	27	<b>\$1947</b>
LERR6620CG	20 x 66 x 29	150	122	24	<b>\$1787</b>
LERR6020CG	20 x 60 x 29	150	115	22	<b>\$1624</b>
LERR5420CG	20 x 54 x 29	150	105	20	<b>\$1466</b>
LERR4820CG	20 x 48 x 29	150	100	18	<b>\$1302</b>
LERR4220CG	20 x 42 x 29	150	90	16	<b>\$1142</b>

Return has **no pedestal**. For use with left handed single pedestal desks, credenzas, desk shells, credenza shells, "D" islands or "P" islands.

**Required Specifications**

Veneer Finish  
Edge

**Optional Specifications**

Grommet

## RETURNS

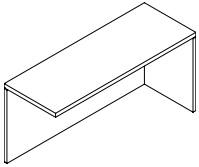

**Non-Handed Return**

MODEL#	DIMENSIONS D x W x H	FREIGHT CLASS	WT/LBS.	CUBIC FT.	LIST PRICE
LERR-L4824CG	24 x 48 x 29	150	105	19	<b>\$2556</b>
LERR-L4224CG	24 x 42 x 29	150	97	17	<b>\$2313</b>
LERR-L4820CG	20 x 48 x 29	150	100	19	<b>\$1693</b>
LERR-L4220CG	20 x 42 x 29	150	90	17	<b>\$1483</b>

Return has **no pedestal**. For use with left or right handed single pedestal desks, credenzas, desk shells, credenza shells, "D" islands or "P" islands.

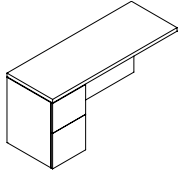

**Flush Return - LEFT 24" Deep**

LERL7224ECG	24 x 72 x 29	100	250	29	<b>\$4474</b>
LERL6624ECG	24 x 66 x 29	100	236	27	<b>\$4326</b>
LERL6024ECG	24 x 60 x 29	100	227	24	<b>\$3973</b>
LERL5424ECG	24 x 54 x 29	100	205	22	<b>\$3842</b>
LERL4824ECG	24 x 48 x 29	100	185	19	<b>\$3462</b>
LERL4224ECG	24 x 42 x 29	92.5	178	17	<b>\$3347</b>

Return has **file/file** pedestal on the **left**. Pedestal locks. For use with right handed single pedestal desks, credenzas, desk shells, credenza shells, "D" islands or "P" islands.

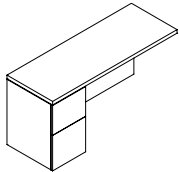

**Flush Return - LEFT 20" Deep**

LERL7220ECG	20 x 72 x 29	100	240	29	<b>\$3470</b>
LERL6620ECG	20 x 66 x 29	100	231	27	<b>\$3342</b>
LERL6020ECG	20 x 60 x 29	100	222	24	<b>\$3038</b>
LERL5420ECG	20 x 54 x 29	100	200	22	<b>\$2929</b>
LERL4820ECG	20 x 48 x 29	100	180	18	<b>\$2609</b>
LERL4220ECG	20 x 42 x 29	92.5	173	16	<b>\$2505</b>

Return has **file/file** pedestal on the **left**. Pedestal locks. For use with right handed single pedestal desks, credenzas, desk shells, credenza shells, "D" islands or "P" islands.

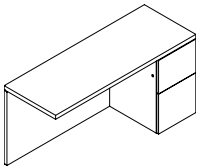

**Flush Return - RIGHT 24" Deep**

LERR7224ECG	24 x 72 x 29	100	250	29	<b>\$4474</b>
LERR6624ECG	24 x 66 x 29	100	236	27	<b>\$4326</b>
LERR6024ECG	24 x 60 x 29	100	227	24	<b>\$3973</b>
LERR5424ECG	24 x 54 x 29	100	205	22	<b>\$3842</b>
LERR4824ECG	24 x 48 x 29	100	185	19	<b>\$3462</b>
LERR4224ECG	24 x 42 x 29	92.5	178	17	<b>\$3347</b>

Return has **file/file** pedestal on the **right**. Pedestal locks. For use with left handed single pedestal desks, credenzas, desk shells, credenza shells, "D" islands or "P" islands.

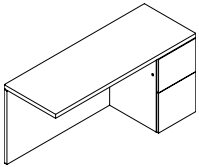

**Flush Return - RIGHT 20" Deep**

LERR7220ECG	20 x 72 x 29	100	240	29	<b>\$3470</b>
LERR6620ECG	20 x 66 x 29	100	231	27	<b>\$3342</b>
LERR6020ECG	20 x 60 x 29	100	222	24	<b>\$3038</b>
LERR5420ECG	20 x 54 x 29	100	200	22	<b>\$2929</b>
LERR4820ECG	20 x 48 x 29	100	180	18	<b>\$2609</b>
LERR4220ECG	20 x 42 x 29	92.5	173	16	<b>\$2505</b>

Return has **file/file** pedestal on the **right**. Pedestal locks. For use with left handed single pedestal desks, credenzas, desk shells, credenza shells, "D" islands or "P" islands.

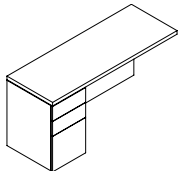

**Flush Return - LEFT 24" Deep**

LERL7224DCG	24 x 72 x 29	100	250	29	<b>\$4474</b>
LERL6624DCG	24 x 66 x 29	100	236	27	<b>\$4326</b>
LERL6024DCG	24 x 60 x 29	100	227	24	<b>\$3973</b>
LERL5424DCG	24 x 54 x 29	100	205	22	<b>\$3842</b>
LERL4824DCG	24 x 48 x 29	100	185	19	<b>\$3462</b>
LERL4224DCG	24 x 42 x 29	92.5	178	17	<b>\$3347</b>

Return has **box/box/file** pedestal on the **left**. Pedestal locks. For use with right handed single pedestal desks, credenzas, desk shells, credenza shells, "D" islands or "P" islands.

### Required Specifications

Veneer Finish  
Edge

### Optional Specifications

Grommet

**RETURNS**      **MODEL#**      **DIMENSIONS**      **FREIGHT CLASS**      **WT./LBS.**      **CUBIC FT.**      **LIST PRICE**

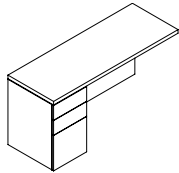

**Flush Return - LEFT 20" Deep**

MODEL#	DIMENSIONS D x W x H	FREIGHT CLASS	WT./LBS.	CUBIC FT.	LIST PRICE
LERL7220DCG	20 x 72 x 29	100	240	27	<b>\$3470</b>
LERL6620DCG	20 x 66 x 29	100	231	24	<b>\$3342</b>
LERL6020DCG	20 x 60 x 29	100	222	22	<b>\$3038</b>
LERL5420DCG	20 x 54 x 29	100	200	20	<b>\$2929</b>
LERL4820DCG	20 x 48 x 29	100	180	18	<b>\$2609</b>
LERL4220DCG	20 x 42 x 29	92.5	173	16	<b>\$2505</b>

Return has **box/box/file** pedestal on the **left**. Pedestal locks. For use with right handed single pedestal desks, credenzas, desk shells, credenza shells, "D" islands or "P" islands.

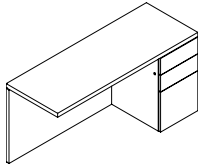

**Flush Return - RIGHT 24" Deep**

LERR7224DCG	24 x 72 x 29	100	250	29	<b>\$4474</b>
LERR6624DCG	24 x 66 x 29	100	236	27	<b>\$4326</b>
LERR6024DCG	24 x 60 x 29	100	227	24	<b>\$3973</b>
LERR5424DCG	24 x 54 x 29	100	205	22	<b>\$3842</b>
LERR4824DCG	24 x 48 x 29	100	185	19	<b>\$3462</b>
LERR4224DCG	24 x 42 x 29	92.5	178	17	<b>\$3347</b>

Return has **box/box/file** pedestal on the **right**. Pedestal locks. For use with left handed single pedestal desks, credenzas, desk shells, credenza shells, "D" islands or "P" islands.

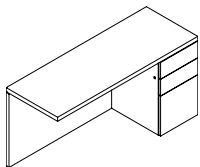

**Flush Return - RIGHT 20" Deep**

LERR7220DCG	20 x 72 x 29	100	240	27	<b>\$3470</b>
LERR6620DCG	20 x 66 x 29	100	231	24	<b>\$3342</b>
LERR6020DCG	20 x 60 x 29	100	222	22	<b>\$3038</b>
LERR5420DCG	20 x 54 x 29	100	200	20	<b>\$2929</b>
LERR4820DCG	20 x 48 x 29	100	180	18	<b>\$2609</b>
LERR4220DCG	20 x 42 x 29	92.5	173	16	<b>\$2505</b>

Return has **box/box/file** pedestal on the **right**. Pedestal locks. For use with left handed single pedestal desks, credenzas, desk shells, credenza shells, "D" islands or "P" islands.

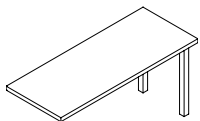

**Return**

LR8430CG	30 x 84 x 29	150	130	29	<b>\$1947</b>
LR7230CG	30 x 72 x 29	150	122	27	<b>\$1720</b>
LR6630CG	30 x 66 x 29	150	115	24	<b>\$1620</b>
LR6030CG	30 x 60 x 29	150	105	22	<b>\$1509</b>

Return has **no pedestal**. For use with single pedestal desks, credenzas, desk shells, credenza shells, "D" islands or "P" islands.

**BRIDGES - EXECUTIVE**

- An Executive Bridge is used to connect a Desk to a Credenza.
- Not to be used with Corner Components or Piano Desks,
- Three Modesty Panel options - Full Modesty, 8" Modesty and No Modesty (Flush Bridge Top).
- Modesty panel flush with end panels of Desk and Credenza.
- Includes GM1 grommet in the top center position.
- Both connecting sides of executive bridges feature a reverse profile edge

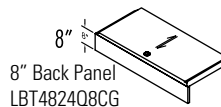
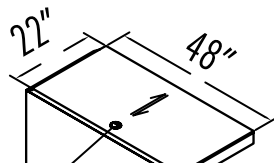
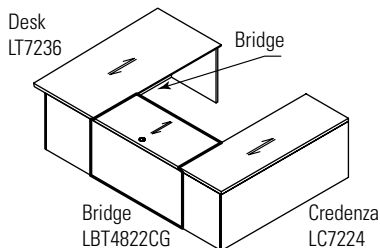

**Required Specifications**

Veneer Finish  
Edge

**Optional Specifications**

Grommet

## BRIDGES - LINKING

## MODEL#

## DIMENSIONS

## FREIGHT CLASS

## WT/LBS.

## CUBIC FT.

## LIST PRICE

D x W x H

- A linking bridge is used to connect corner components to a single pedestal desk, HA desk, single pedestal credenza, desk shell or credenza shell.
- When connecting HA desk, must specify LHASP spacer.
- Two modesty panel options - full modesty and 8" modesty.
- Includes GM1 grommet in the top center position.
- Hand of linking bridge is determined by location of half end panel from user side.
- Linking bridges are handed **left and right** (handedness is determined by connecting side with the self edge). The opposite connecting side features a reverse profile edge.

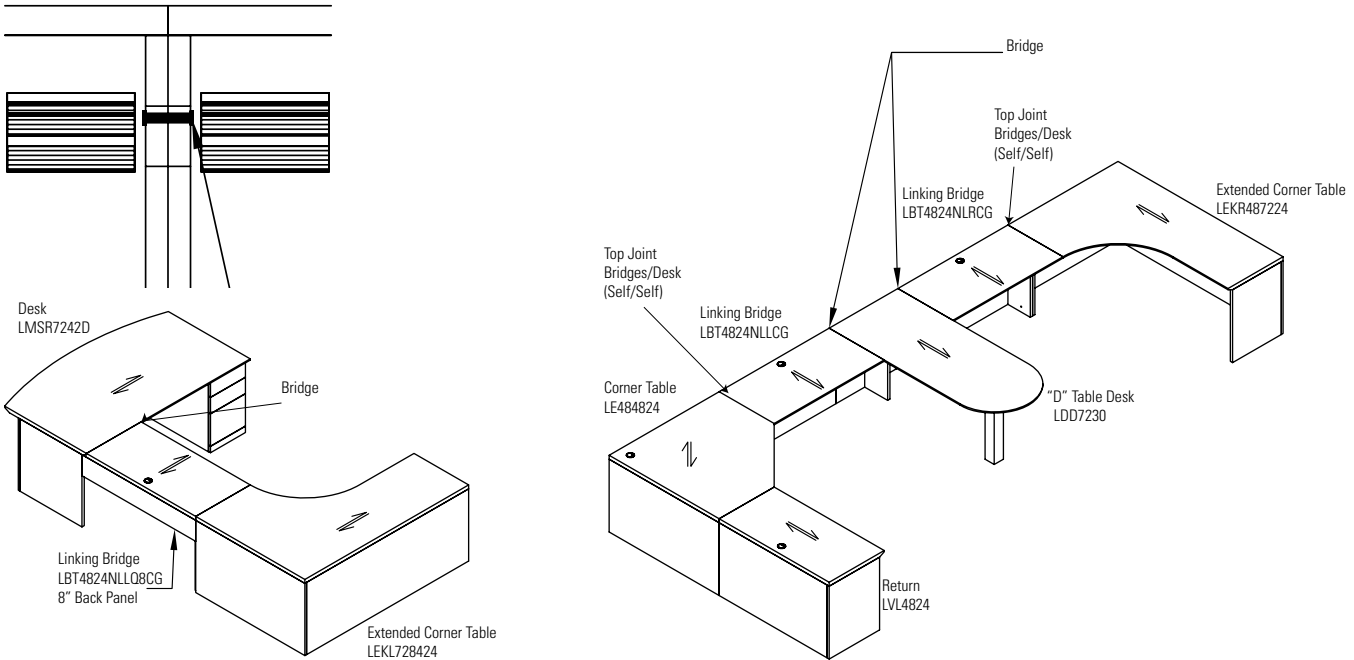

## BRIDGES

## MODEL#

## DIMENSIONS

## FREIGHT CLASS

## WT/LBS.

## CUBIC FT.

## LIST PRICE

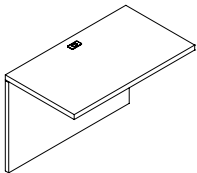

Flush Bridge

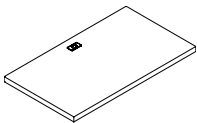

Flush Bridge Top

LBT6024CG	24 x 60 x 29	85	144	10	<b>\$1894</b>
LBT5424CG	24 x 54 x 29	85	129	9	<b>\$1705</b>
LBT4824CG	24 x 48 x 29	70	120	8	<b>\$1520</b>
LBT4224CG	24 x 42 x 29	70	105	7	<b>\$1329</b>
LBT6020CG	20 x 60 x 29	70	131	8	<b>\$1558</b>
LBT5420CG	20 x 54 x 29	85	118	8	<b>\$1402</b>
LBT4820CG	20 x 48 x 29	70	110	7	<b>\$1243</b>
LBT4220CG	20 x 42 x 29	70	96	6	<b>\$1067</b>

Top surface, back panel and hardware to create a "U" configuration with a single pedestal desk or credenza. **Cannot be used with corners.** Grommet in worksurface. Shipped RTA (ready to assemble).

- If linking to bookcase or open storage, add **/S** to end of model number

LBT5424TCG	24 x 54 x --	85	129	9	<b>\$1335</b>
LBT4824TCG	24 x 48 x --	70	120	8	<b>\$1201</b>
LBT4224TCG	24 x 42 x --	70	105	7	<b>\$1056</b>
LBT5420TCG	20 x 54 x --	85	118	8	<b>\$982</b>
LBT4820TCG	20 x 48 x --	70	110	7	<b>\$875</b>
LBT4220TCG	20 x 42 x --	70	96	6	<b>\$745</b>

Top surface only to create a "U" configuration with a single pedestal desk or credenza. **Cannot be used with corners.** Grommet in worksurface. Shipped RTA (ready to assemble).

- If linking to bookcase or open storage, add **/S** to end of model number

### Required Specifications

Veneer Finish  
Edge

### Optional Specifications

Grommet

BRIDGES

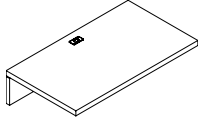

Flush Bridge Top, 8" Modesty Panel

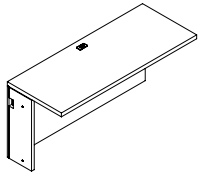

Linking Bridge - LEFT

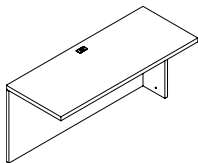

Linking Bridge - RIGHT

MODEL# DIMENSIONS FREIGHT CLASS WT/LBS. CUBIC FT. LIST PRICE

D x W x H

LBT6024Q8CG	24 x 60 x --	85	144	10	<b>\$1701</b>
LBT5424Q8CG	24 x 54 x --	85	129	9	<b>\$1540</b>
LBT4824Q8CG	24 x 48 x --	70	120	8	<b>\$1369</b>
LBT4224Q8CG	24 x 42 x --	70	105	7	<b>\$1196</b>

LBT6020Q8CG	20 x 60 x --	70	131	8	<b>\$1402</b>
LBT5420Q8CG	20 x 54 x --	85	118	8	<b>\$1260</b>
LBT4820Q8CG	20 x 48 x --	70	110	7	<b>\$1121</b>
LBT4220Q8CG	20 x 42 x --	70	96	6	<b>\$959</b>

Top surface with 8" modesty panel for utility access. Create a "U" configuration with a single pedestal desk or credenza.

**Cannot be used with corners.** Grommet in worksurface. Shipped RTA (ready to assemble).

- If linking to bookcase or open storage, add **/S** to end of model number

LBT6024NLLCG	24 x 60 x 29	125	145	24	1879
LBT5424NLLCG	24 x 54 x 29	150	131	22	<b>\$1689</b>
LBT4824NLLCG	24 x 48 x 29	125	116	19	<b>\$1502</b>
LBT4224NLLCG	24 x 42 x 29	125	102	17	<b>\$1218</b>
LBT3624NLLCG	24 x 36 x 29	150	87	15	<b>\$1108</b>
LBT3024NLLCG	24 x 30 x 29	125	73	12	<b>\$1077</b>

LBT6020NLLCG	22 x 60 x 29	150	131	22	<b>\$1705</b>
LBT5420NLLCG	22 x 54 x 29	150	118	20	<b>\$1534</b>
LBT4820NLLCG	22 x 48 x 29	125	110	18	1369
LBT4220NLLCG	22 x 42 x 29	150	95	16	1108
LBT3620NLLCG	22 x 36 x 29	125	80	13	1007
LBT3020NLLCG	22 x 30 x 29	150	65	11	982

Top surface, back panel and hardware. **Left side** connects to a 5-Sided Corner, Extended Corner or Connectable Table. Right side connects to a single pedestal desk or credenza, "D" island, Boat shaped island, "P" island and Delta island with a "T" base. Grommet in worksurface.

LBT6024NLRCG	24 x 60 x 29	125	145	24	<b>\$1879</b>
LBT5424NLRCG	24 x 54 x 29	150	131	22	<b>\$1689</b>
LBT4824NLRCG	24 x 48 x 29	125	116	19	<b>\$1502</b>
LBT4224NLRCG	24 x 42 x 29	125	102	17	<b>\$1218</b>
LBT3624NLRCG	24 x 36 x 29	150	87	15	<b>\$1108</b>
LBT3024NLRCG	24 x 30 x 29	125	73	12	<b>\$1077</b>

LBT6020NLRCG	22 x 60 x 29	150	131	22	<b>\$1705</b>
LBT5420NLRCG	22 x 54 x 29	150	118	20	<b>\$1534</b>
LBT4820NLRCG	22 x 48 x 29	125	110	18	<b>\$1369</b>
LBT4220NLRCG	22 x 42 x 29	150	95	16	<b>\$1108</b>
LBT3620NLRCG	22 x 36 x 29	125	80	13	<b>\$1007</b>
LBT3020NLRCG	22 x 30 x 29	150	65	11	<b>\$982</b>

Top surface, back panel and hardware. **Right side** connects to a 5-Sided Corner, Extended Corner or Connectable Table. Right side connects to a single pedestal desk or credenza, "D" island, Boat shaped island, "P" island and Delta island with a "T" base. Grommet in worksurface.

Required Specifications

Veneer Finish  
Edge

Optional Specifications

Grommet

**BRIDGES**

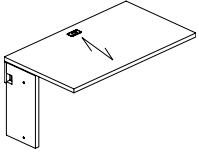

**Linking Bridge, 8" Modesty Panel - LEFT**

MODEL#	DIMENSIONS D x W x H	FREIGHT CLASS	WT/LBS.	CUBIC FT.	LIST PRICE
LBT6024NLLQ8CG	24 x 60 x 29	125	145	24	<b>\$2072</b>
LBT5424NLLQ8CG	24 x 54 x 29	150	131	22	<b>\$1863</b>
LBT4824NLLQ8CG	24 x 48 x 29	125	116	19	<b>\$1637</b>
LBT4224NLLQ8CG	24 x 42 x 29	125	102	17	<b>\$1452</b>
LBT3624NLLQ8CG	24 x 36 x 29	150	87	15	<b>\$1201</b>
LBT3024NLLQ8CG	24 x 30 x 29	125	73	12	<b>\$1175</b>
LBT6020NLLQ8CG	20 x 60 x 29	150	131	22	<b>\$1534</b>
LBT5420NLLQ8CG	20 x 54 x 29	150	118	20	<b>\$1385</b>
LBT4820NLLQ8CG	20 x 48 x 29	125	110	18	<b>\$1235</b>
LBT4220NLLQ8CG	20 x 42 x 29	150	95	16	<b>\$998</b>
LBT3620NLLQ8CG	20 x 36 x 29	125	80	13	<b>\$906</b>
LBT3020NLLQ8CG	20 x 30 x 29	150	65	11	<b>\$893</b>

Top surface with 8" modesty panel for utility access and hardware. **Left side** connects to a 5-Sided Corner, Extended Corner or Connectable Table. Right side connects to a single pedestal desk or credenza, "D" island, Boat shaped island, "P" island and Delta island with a "T" base. Grommet in worksurface. Shipped RTA (ready to assemble).

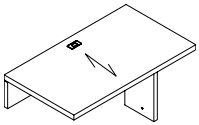

**Linking Bridge, 8" Modesty Panel - RIGHT**

LBT6024NLRQ8CG	24 x 60 x 29	125	145	24	<b>\$2072</b>
LBT5424NLRQ8CG	24 x 54 x 29	150	131	22	<b>\$1863</b>
LBT4824NLRQ8CG	24 x 48 x 29	125	116	19	<b>\$1637</b>
LBT4224NLRQ8CG	24 x 42 x 29	125	102	17	<b>\$1452</b>
LBT3624NLRQ8CG	24 x 36 x 29	150	87	15	<b>\$1201</b>
LBT3024NLRQ8CG	24 x 30 x 29	125	73	12	<b>\$1175</b>
LBT6020NLRQ8CG	20 x 60 x 29	150	131	22	<b>\$1534</b>
LBT5420NLRQ8CG	20 x 54 x 29	150	118	20	<b>\$1385</b>
LBT4820NLRQ8CG	20 x 48 x 29	125	110	18	<b>\$1235</b>
LBT4220NLRQ8CG	20 x 42 x 29	150	95	16	<b>\$998</b>
LBT3620NLRQ8CG	20 x 36 x 29	125	80	13	<b>\$906</b>
LBT3020NLRQ8CG	20 x 30 x 29	150	65	11	<b>\$893</b>

Top surface with 8" modesty panel for utility access and hardware. **Right side** connects to a 5-Sided Corner, Extended Corner or Connectable Table. Right side connects to a single pedestal desk or credenza, "D" island, Boat shaped island, "P" island and Delta island with a "T" base. Grommet in worksurface. Shipped RTA (ready to assemble).

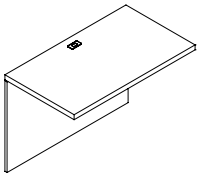

**Bridge - Hinged Modesty**

LHBT6024CG	24 x 60 x 29	85	144	10	<b>\$1894</b>
LHBT5424CG	24 x 54 x 29	85	129	9	<b>\$1705</b>
LHBT4824CG	24 x 48 x 29	70	120	8	<b>\$1520</b>
LHBT4224CG	24 x 42 x 29	70	105	7	<b>\$1329</b>
LHBT6020CG	20 x 60 x 29	70	131	8	<b>\$1558</b>
LHBT5420CG	20 x 54 x 29	85	118	8	<b>\$1402</b>
LHBT4820CG	20 x 48 x 29	70	110	7	<b>\$1243</b>
LHBT4220CG	20 x 42 x 29	70	96	6	<b>\$1067</b>

Executive Bridge Top and **Hinged Back Panel** to create a "U" configuration with a single pedestal desk or credenza. **Cannot be used with corners.** Grommet in worksurface. Shipped RTA (ready to assemble).

**Required Specifications**

Veneer Finish  
Edge

**Optional Specifications**

Grommet

CRENZAS

MODEL# DIMENSIONS FREIGHT CLASS WT/LBS. CUBIC FT. LIST PRICE

D x W x H

LC10824	24 x 108 x 29	125	348	44	\$4245
LC10224	24 x 102 x 29	100	329	41	\$4047
LC9624	24 x 96 x 29	125	309	39	\$3832
LC9024	24 x 90 x 29	100	290	36	\$3633
LC8424	24 x 84 x 29	125	271	34	\$3429
LC7824	24 x 78 x 29	100	251	31	\$3215
LC7224	24 x 72 x 29	100	232	29	\$3016
LC6624	24 x 66 x 29	125	213	27	\$2919
LC6024	24 x 60 x 29	100	193	24	\$2704

LC10820	20 x 108 x 29	100	309	36	\$3386
LC10220	20 x 102 x 29	100	291	34	\$3211
LC9620	20 x 96 x 29	100	273	32	\$3025
LC9020	20 x 90 x 29	100	255	30	\$2844
LC8420	20 x 84 x 29	100	237	28	\$2667
LC7820	20 x 78 x 29	100	219	26	\$2483
LC7220	20 x 72 x 29	100	206	24	\$2303
LC6620	20 x 66 x 29	100	188	22	\$2222
LC6020	20 x 60 x 29	100	169	20	\$2033

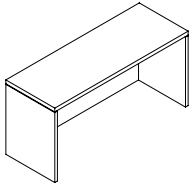

Credenza Shell

Standard with **no pedestals**. Flush full modesty panel. 96" w and larger includes a center support leg. If using storage component shells underneath to support the worksurface, **no more than 72" may be left unsupported**.

LCK8424EE	24 x 84 x 29	92.5	348	34	\$6420
LCK7824EE	24 x 78 x 29	92.5	319	31	\$6214
LCK7224EE	24 x 72 x 29	100	280	29	\$5780
LCK6624EE	24 x 66 x 29	100	261	27	\$5313
LCK6024EE	24 x 60 x 29	100	238	24	\$5257

LCK8420EE	20 x 84 x 29	92.5	320	34	\$6363
LCK7820EE	20 x 78 x 29	92.5	298	31	\$6536
LCK7220EE	20 x 72 x 29	92.5	280	29	\$5344
LCK6620EE	20 x 66 x 29	92.5	257	27	\$5257
LCK6020EE	20 x 60 x 29	92.5	233	24	\$5195

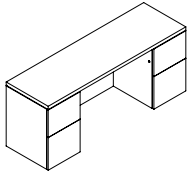

Kneespace Credenza

Standard with full to floor **file/file** pedestals on **left and right**. **Center is open** Pedestals lock.

LCK8424DD	24 x 84 x 29	92.5	348	34	\$6420
LCK7824DD	24 x 78 x 29	92.5	319	31	\$6214
LCK7224DD	24 x 72 x 29	100	280	29	\$5407
LCK6624DD	24 x 66 x 29	100	261	27	\$5313
LCK6024DD	24 x 60 x 29	100	238	24	\$5257

LCK8420DD	20 x 84 x 29	92.5	307	28	\$6660
LCK7820DD	20 x 78 x 29	92.5	285	26	\$6536
LCK7220DD	20 x 72 x 29	92.5	267	24	\$5344
LCK6620DD	20 x 66 x 29	92.5	244	22	\$5257
LCK6020DD	20 x 60 x 29	92.5	220	20	\$5195

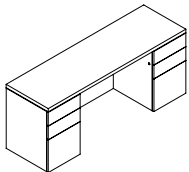

Kneespace Credenza

Standard with full to floor **box/box/file** pedestals on **left and right**. **Center is open** Pedestals lock.

Required Specifications

Veneer Finish  
Edge

Optional Specifications

Grommet



## CREDENZAS

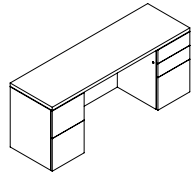

**Kneespace Credenza**

MODEL#	DIMENSIONS D x W x H	FREIGHT CLASS	WT/LBS.	CUBIC FT.	LIST PRICE
LCK8424ED	24 x 84 x 29	92.5	348	34	<b>\$6420</b>
LCK7824ED	24 x 78 x 29	92.5	319	31	<b>\$6214</b>
LCK7224ED	24 x 72 x 29	100	280	29	<b>\$5780</b>
LCK6624ED	24 x 66 x 29	100	261	27	<b>\$5313</b>
LCK6024ED	24 x 60 x 29	100	238	24	<b>\$5257</b>
LCK8420ED	20 x 84 x 29	92.5	307	28	<b>\$6363</b>
LCK7820ED	20 x 78 x 29	92.5	285	26	<b>\$6536</b>
LCK7220ED	20 x 72 x 29	92.5	267	24	<b>\$5344</b>
LCK6620ED	20 x 66 x 29	92.5	244	22	<b>\$5257</b>
LCK6020ED	20 x 60 x 29	92.5	220	20	<b>\$5195</b>

Standard with full to floor **file/file** pedestal on **left** and **box/box/file** pedestal on **right**. **Center is open** Pedestals lock. One pencil tray.

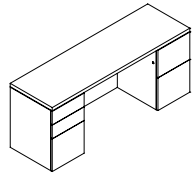

**Kneespace Credenza**

LCK8424DE	24 x 84 x 29	92.5	348	34	<b>\$6420</b>
LCK7824DE	24 x 78 x 29	92.5	319	31	<b>\$6214</b>
LCK7224DE	24 x 72 x 29	100	280	29	<b>\$5407</b>
LCK6624DE	24 x 66 x 29	100	261	27	<b>\$5313</b>
LCK6024DE	24 x 60 x 29	100	238	24	<b>\$5257</b>
LCK8420DE	20 x 84 x 29	92.5	307	28	<b>\$6363</b>
LCK7820DE	20 x 78 x 29	92.5	285	26	<b>\$6536</b>
LCK7220DE	20 x 72 x 29	92.5	267	24	<b>\$5344</b>
LCK6620DE	20 x 66 x 29	92.5	244	22	<b>\$5257</b>
LCK6020DE	20 x 60 x 29	92.5	220	20	<b>\$5195</b>

Standard with full to floor **box/box/file** pedestal on **left** and **file/file** pedestal on **right**. **Center is open** Pedestals lock. One pencil tray.

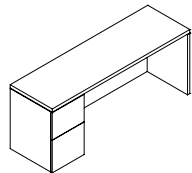

**Single Pedestal Credenza - LEFT**

LCL8424E	24 x 84 x 29	100	315	34	<b>\$5156</b>
LCL7824E	24 x 78 x 29	100	292	31	<b>\$4823</b>
LCL7224E	24 x 72 x 29	100	270	29	<b>\$4496</b>
LCL6624E	24 x 66 x 29	100	247	27	<b>\$4351</b>
LCL6024E	24 x 60 x 29	100	225	24	<b>\$4009</b>
LCL8420E	20 x 84 x 29	100	273	28	<b>\$4589</b>
LCL7820E	20 x 78 x 29	100	252	26	<b>\$4912</b>
LCL7220E	20 x 72 x 29	100	237	24	<b>\$3986</b>
LCL6620E	20 x 66 x 29	100	216	22	<b>\$3842</b>
LCL6020E	20 x 60 x 29	100	195	20	<b>\$3547</b>

Standard with full to floor **file/file** pedestal on **left**. Pedestal locks.

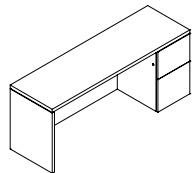

**Single Pedestal Credenza - RIGHT**

LCR8424E	24 x 84 x 29	100	315	34	<b>\$5156</b>
LCR7824E	24 x 78 x 29	100	292	31	<b>\$4823</b>
LCR7224E	24 x 72 x 29	100	270	29	<b>\$4496</b>
LCR6624E	24 x 66 x 29	100	247	27	<b>\$4351</b>
LCR6024E	24 x 60 x 29	100	225	24	<b>\$4009</b>
LCR8420E	20 x 84 x 29	100	273	28	<b>\$4589</b>
LCR7820E	20 x 78 x 29	100	252	26	<b>\$4912</b>
LCR7220E	20 x 72 x 29	100	237	24	<b>\$3986</b>
LCR6620E	20 x 66 x 29	100	216	22	<b>\$3842</b>
LCR6020E	20 x 60 x 29	100	195	20	<b>\$3547</b>

Standard with full to floor **file/file** pedestal on **right**. Pedestal locks.

### Required Specifications

Veneer Finish  
Edge

### Optional Specifications

Grommet

CREDENZAS

MODEL# DIMENSIONS FREIGHT CLASS WT/LBS. CUBIC FT. LIST PRICE

D x W x H

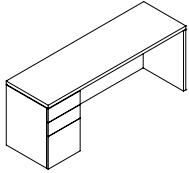

Single Pedestal Credenza - LEFT

LCL8424D	24 x 84 x 29	100	315	34	\$5156
LCL7824D	24 x 78 x 29	100	292	31	\$4823
LCL7224D	24 x 72 x 29	100	270	29	\$4496
LCL6624D	24 x 66 x 29	100	247	27	\$4351
LCL6024D	24 x 60 x 29	100	225	24	\$4009
LCL8420D	20 x 84 x 29	100	273	28	\$4589
LCL7820D	20 x 78 x 29	100	252	26	\$4912
LCL7220D	20 x 72 x 29	100	237	24	\$3986
LCL6620D	20 x 66 x 29	100	216	22	\$3842
LCL6020D	20 x 60 x 29	100	195	20	\$3547

Standard with full to floor **box/box/file** pedestal on **left**. Pedestal locks.

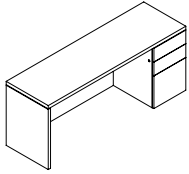

Single Pedestal Credenza - RIGHT

LCR8424D	24 x 84 x 29	100	315	34	\$5156
LCR7824D	24 x 78 x 29	100	292	31	\$4823
LCR7224D	24 x 72 x 29	100	270	29	\$4496
LCR6624D	24 x 66 x 29	100	247	27	\$4351
LCR6024D	24 x 60 x 29	100	225	24	\$4009
LCR8420D	20 x 84 x 29	100	273	28	\$4589
LCR7820D	20 x 78 x 29	100	252	26	\$4912
LCR7220D	20 x 72 x 29	100	237	24	\$3986
LCR6620D	20 x 66 x 29	100	216	22	\$3842
LCR6020D	20 x 60 x 29	100	195	20	\$3547

Standard with full to floor **box/box/file** pedestal on **right**. Pedestal locks.

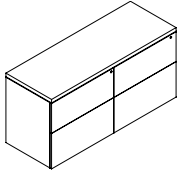

Lateral File Credenza

LC7224FF	24 x 72 x 29	92.5	328	29	\$6910
LC7220FF	20 x 72 x 29	92.5	287	24	\$6097
LC6024NN	24 x 60 x 29	92.5	273	24	\$6380
LC6020NN	20 x 60 x 29	92.5	205	20	\$5405

Two 2-drawer lateral files side-by-side. Locking drawers. Anti-lock tilt suspension. **Not for stacking materials on lateral file drawer bottom.**

- "FF" models use two 36" wide lateral files, "NN" models use 30" wide.

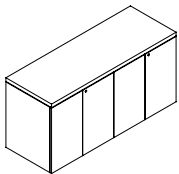

Storage Cabinet Credenza

LC7224GG	24 x 72 x 29	92.5	300	29	\$5285
LC7220GG	20 x 72 x 29	92.5	253	24	\$4673
LC6024MM	24 x 60 x 29	92.5	254	24	\$4877
LC6020MM	20 x 60 x 29	92.5	209	20	\$4164

Two 2-door storage cabinets side-by-side. Locking doors. Self-closing hinged doors cover one adjustable shelf.

- "GG" models use two 36" wide storage cabinets, "MM" models use 30" wide.

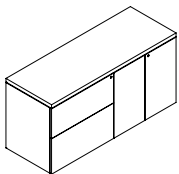

Lateral File/Storage Cabinet Credenza

LCF7224	24 x 72 x 29	92.5	305	29	\$5527
LCF7220	20 x 72 x 29	92.5	272	24	\$4893
LCF6024	24 x 60 x 29	92.5	254	24	\$4695
LCF6020	20 x 60 x 29	92.5	220	20	\$4164

One 2-drawer lateral file and one storage cabinet. Locking door/drawers. Storage cabinet includes one adjustable shelf. Anti-lock tilt suspension. **Not for stacking materials on lateral file drawer bottom.**

Required Specifications

Veneer Finish  
Edge

Optional Specifications

Grommet

## CREDENZAS

MODEL#	DIMENSIONS	FREIGHT CLASS	WT/LBS.	CUBIC FT.	LIST PRICE
--------	------------	---------------	---------	-----------	------------

D x W x H

LCL8424F	24 x 84 x 29	100	305	34	\$5386
LCL7824F	24 x 78 x 29	100	285	31	\$4994
LCL7224F	24 x 72 x 29	100	261	29	\$4620
LCL6624F	24 x 66 x 29	100	239	27	\$4448
LCL6024F	24 x 60 x 29	100	218	24	\$4034
LCL8420F	20 x 84 x 29	100	273	28	\$4706
LCL7820F	20 x 78 x 29	100	252	26	\$4364
LCL7220F	20 x 72 x 29	100	237	24	\$4031
LCL6620F	20 x 66 x 29	100	216	22	\$3883
LCL6020F	20 x 60 x 29	100	195	20	\$3526

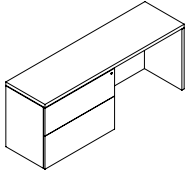

**Kneespace Lateral File Credenza - LEFT**

One 2-drawer lateral file on the **left**. Locking drawers. Anti-lock tilt suspension. **Not for stacking materials on lateral file drawer bottom.**

LCR8424F	24 x 84 x 29	100	305	34	\$5386
LCR7824F	24 x 78 x 29	100	285	31	\$4994
LCR7224F	24 x 72 x 29	100	261	29	\$4620
LCR6624F	24 x 66 x 29	100	239	27	\$4448
LCR6024F	24 x 60 x 29	100	218	24	\$4034
LCR8420F	20 x 84 x 29	100	273	28	\$4706
LCR7820F	20 x 78 x 29	100	252	26	\$4364
LCR7220F	20 x 72 x 29	100	237	24	\$4031
LCR6620F	20 x 66 x 29	100	216	22	\$3883
LCR6020F	20 x 60 x 29	100	195	20	\$3526

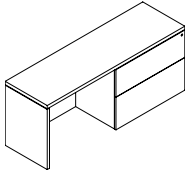

**Kneespace Lateral File Credenza - RIGHT**

One 2-drawer lateral file on the **right**. Locking drawers. Anti-lock tilt suspension. **Not for stacking materials on lateral file drawer bottom.**

LCL8424Z	24 x 84 x 29	100	338	34	\$6418
LCL7824Z	24 x 78 x 29	100	314	31	\$5994
LCL7224Z	24 x 72 x 29	100	290	29	\$5581
LCL6624Z	24 x 66 x 29	100	266	27	\$5386
LCL6024Z	24 x 60 x 29	100	242	24	\$4405
LCL8420Z	20 x 84 x 29	100	273	28	\$5682
LCL7820Z	20 x 78 x 29	100	252	26	\$5323
LCL7220Z	20 x 72 x 29	100	237	24	\$4952
LCL6620Z	20 x 66 x 29	100	216	22	\$4785
LCL6020Z	20 x 60 x 29	100	195	20	\$4405

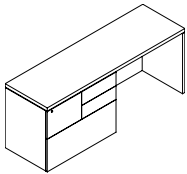

**Mixed Storage Credenza - LEFT**

Standard with two box drawers, one file drawer, and one 36"W lateral file drawer on the **left**. File drawer and lateral file drawer lock. **Not for stacking materials on lateral file drawer bottom.**

LCR8424Z	24 x 84 x 29	100	338	34	\$6418
LCR7824Z	24 x 78 x 29	100	314	31	\$5994
LCR7224Z	24 x 72 x 29	100	290	29	\$5581
LCR6624Z	24 x 66 x 29	100	266	27	\$5386
LCR6024Z	24 x 60 x 29	100	242	24	\$4405
LCR8420Z	20 x 84 x 29	100	273	28	\$5682
LCR7820Z	20 x 78 x 29	100	252	26	\$5323
LCR7220Z	20 x 72 x 29	100	237	24	\$4952
LCR6620Z	20 x 66 x 29	100	216	22	\$4785
LCR6020Z	20 x 60 x 29	100	195	20	\$4405

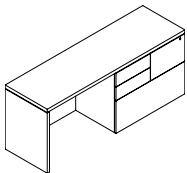

**Mixed Storage Credenza - RIGHT**

Standard with two box drawers, one file drawer, and one 36"W lateral file drawer on the **right**. File drawer and lateral file drawer lock. **Not for stacking materials on lateral file drawer bottom.**

### Required Specifications

Veneer Finish  
Edge

### Optional Specifications

Grommet

CREDENZAS

MODEL# DIMENSIONS FREIGHT CLASS WT/LBS. CUBIC FT. LIST PRICE

D x W x H

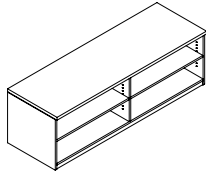

Credenza

LCO7224H23	24 x 72 x 23	92.5	305	29	<b>\$3579</b>
LCO7220H23	20 x 72 x 23	92.5	272	24	<b>\$3128</b>
LCO6024H23	24 x 60 x 23	92.5	254	24	<b>\$2985</b>
LCO6020H23	20 x 60 x 23	92.5	220	20	<b>\$2609</b>

Standard with open storage on **both sides**.

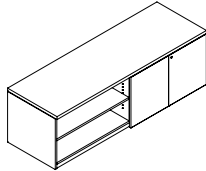

Credenza

LCOG7224H23	24 x 72 x 23	92.5	328	29	<b>\$3605</b>
LCOG7220H23	20 x 72 x 23	92.5	287	24	<b>\$3154</b>
LCOM6024H23	24 x 60 x 23	92.5	273	24	<b>\$3313</b>
LCOM6020H23	20 x 60 x 23	92.5	205	20	<b>\$2758</b>

Standard with open storage on the **left** and one storage cabinet on the **right**. Storage cabinet includes one adjustable shelf.

- "G" model uses 36" wide storage cabinets, "M" model uses 30" wide.

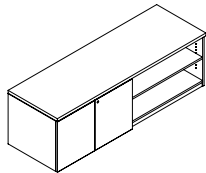

Credenza

LCG07224H23	24 x 72 x 23	92.5	328	29	<b>\$3605</b>
LCG07220H23	20 x 72 x 23	92.5	287	24	<b>\$3154</b>
LCM06024H23	24 x 60 x 23	92.5	273	24	<b>\$3313</b>
LCM06020H23	20 x 60 x 23	92.5	205	20	<b>\$2758</b>

Standard with open storage on the **right** and one storage cabinet on the **left**. Storage cabinet includes one adjustable shelf.

- "G" model uses 36" wide storage cabinets, "M" model uses 30" wide.

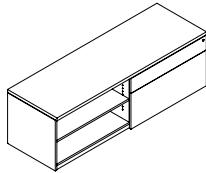

Credenza

LCOF7224H23	24 x 72 x 23	92.5	300	29	<b>\$4391</b>
LCOF7220H23	20 x 72 x 23	92.5	253	24	<b>\$3832</b>
LCON6024H23	24 x 60 x 23	92.5	254	24	<b>\$3836</b>
LCON6020H23	20 x 60 x 23	92.5	209	20	<b>\$3347</b>

Standard with one **box/file** drawer on **right** and open storage on the **left**. File drawer and lateral file drawer lock. Front-to-back and side-to-side filing. **Not for stacking materials on lateral file drawer bottom.**

- "F" models use 36" wide lateral files, "N" models use 30" wide.

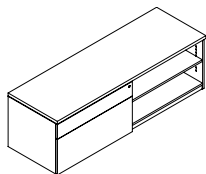

Credenza

LCF07224H23	24 x 72 x 23	92.5	300	29	<b>\$4391</b>
LCF07220H23	20 x 72 x 23	92.5	253	24	<b>\$3832</b>
LCN06024H23	24 x 60 x 23	92.5	254	24	<b>\$3836</b>
LCN06020H23	20 x 60 x 23	92.5	209	20	<b>\$3347</b>

Standard with one **box/file** drawer on **left** and open storage on the **right**. File drawer and lateral file drawer lock. Front-to-back and side-to-side filing. **Not for stacking materials on lateral file drawer bottom.**

- "F" models use 36" wide lateral files, "N" models use 30" wide.

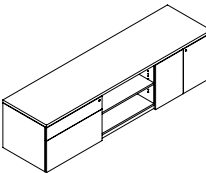

Credenza

LCNOM9024H23	24 x 90 x 23	92.5	300	29	<b>\$7667</b>
LCNOM9020H23	20 x 90 x 23	92.5	300	29	<b>\$7280</b>

Standard with one **box/file** drawer on **left**, open storage in the **center**, and one storage cabinet on the **right**. Storage cabinet includes one adjustable shelf. File drawer and lateral file drawer lock. Front-to-back and side-to-side filing. **Not for stacking materials on lateral file drawer bottom.**

Required Specifications

Veneer Finish  
Edge

Optional Specifications

Grommet

## CREDENZAS

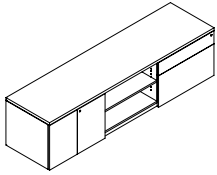

**Credenza**

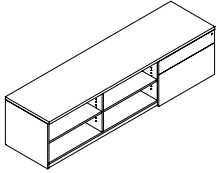

**Credenza**

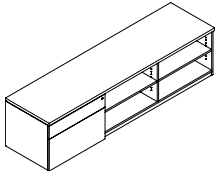

**Credenza**

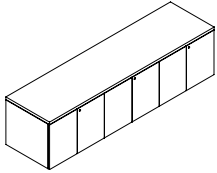

**Credenza**

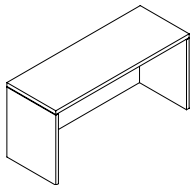

**Credenza Shell**

MODEL#	DIMENSIONS	FREIGHT CLASS	WT/LBS.	CUBIC FT.	LIST PRICE
LCMON9024H23	24 x 90 x 23	92.5	300	29	<b>\$7667</b>
LCMON9020H23	20 x 90 x 23	92.5	300	29	<b>\$7280</b>

Standard with one **box/file** drawer on **right**, open storage in the **center**, and one storage cabinet on the **left**. Storage cabinet includes one adjustable shelf. File drawer and lateral file drawer lock. Front-to-back and side-to-side filing. **Not for stacking materials on lateral file drawer bottom.**

LCOON9024H23	24 x 90 x 23	92.5	300	29	<b>\$7384</b>
LCOON9020H23	20 x 90 x 23	92.5	300	29	<b>\$6993</b>

Standard with one **box/file** drawer on **right** and open storage in the **center** and **left**. File drawer and lateral file drawer lock. Front-to-back and side-to-side filing. **Not for stacking materials on lateral file drawer bottom.**

LCN009024H23	24 x 90 x 23	92.5	300	29	<b>\$7384</b>
LCN009020H23	20 x 90 x 23	92.5	300	29	<b>\$6993</b>

Standard with one **box/file** drawer on **left** and open storage in the **center** and **right**. File drawer and lateral file drawer lock. Front-to-back and side-to-side filing. **Not for stacking materials on lateral file drawer bottom.**

LCMMM9024H23	24 x 90 x 23	92.5	300	29	<b>\$7100</b>
LCMMM9020H23	20 x 90 x 23	92.5	300	29	<b>\$5916</b>

Standard with **three** storage cabinets. Storage cabinets include one adjustable shelf per cabinet.

LC10824H23	24 x 108 x 23	125	348	44	<b>\$4056</b>
LC10224H23	24 x 102 x 23	100	329	41	<b>\$3857</b>
LC9624H23	24 x 96 x 23	125	309	39	<b>\$3644</b>
LC9024H23	24 x 90 x 23	100	290	36	<b>\$3445</b>
LC8424H23	24 x 84 x 23	125	271	34	<b>\$3240</b>
LC7824H23	24 x 78 x 23	100	251	31	<b>\$3025</b>
LC7224H23	24 x 72 x 23	100	232	29	<b>\$2826</b>
LC6624H23	24 x 66 x 23	125	213	27	<b>\$2730</b>
LC6024H23	24 x 60 x 23	100	193	24	<b>\$2515</b>
LC10820H23	20 x 108 x 23	100	309	36	<b>\$3197</b>
LC10220H23	20 x 102 x 23	100	291	34	<b>\$3020</b>
LC9620H23	20 x 96 x 23	100	273	32	<b>\$2841</b>
LC9020H23	20 x 90 x 23	100	255	30	<b>\$2656</b>
LC8420H23	20 x 84 x 23	100	237	28	<b>\$2480</b>
LC7820H23	20 x 78 x 23	100	219	26	<b>\$2297</b>
LC7220H23	20 x 72 x 23	100	206	24	<b>\$2112</b>
LC6620H23	20 x 66 x 23	100	188	22	<b>\$2033</b>
LC6020H23	20 x 60 x 23	100	169	20	<b>\$1844</b>

Standard with **no pedestals**. Flush full modesty panel. 96" w and larger includes a center support leg. If using storage component shells underneath to support the worksurface, **no more than 72" may be left unsupported.**

### Required Specifications

Veneer Finish  
Edge

### Optional Specifications

Grommet

CORNERS	MODEL#	DIMENSIONS D x W x H	FREIGHT CLASS	WT./LBS.	CUBIC FT.	LIST PRICE
---------	--------	-------------------------	---------------	----------	-----------	------------

- A Corner Desk is used to connect to a Linking Bridge and Linking Credenza, or Connectable Table
- Cable management tray is included.
- Full Modesty Panel option.
- 5-Sided Corners include a GM1 grommet in the top center position. Grommets are available as an option on Extended Corners.
- Hand of Linking Credenza is determined by location of full end panel from user side.
- Hand of Extended Corner is determined by location of long narrow end from user side.
- Connecting sides feature a self edge.

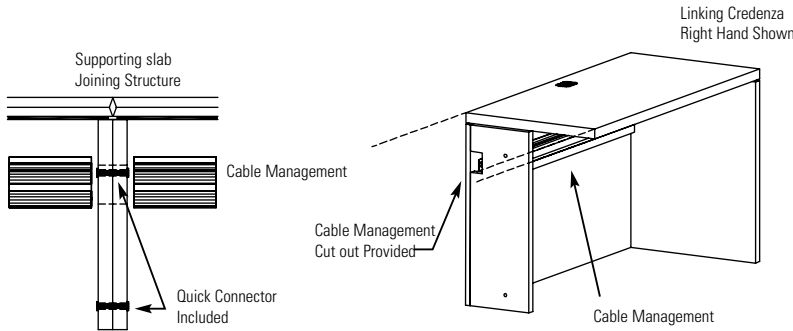

Code dimensions are actual

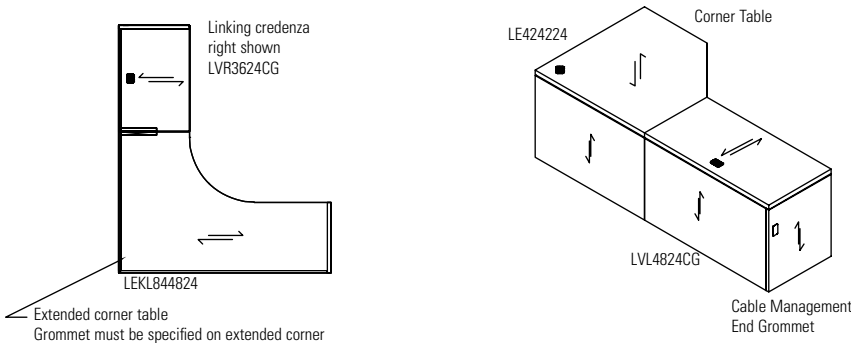

5-SIDED CORNERS	MODEL#	DIMENSIONS D x W x H	FREIGHT CLASS	WT./LBS.	CUBIC FT.	LIST PRICE
	LE484824	48 x 48 x 29	150	201	39	<b>\$3203</b>
	LE424224	42 x 42 x 29	150	155	30	<b>\$2552</b>
	LE363624	36 x 36 x 29	125	135	22	<b>\$2441</b>

5-Sided Corner

Connects to **24" D** connectables, returns, extended corners, storage/lateral file credenzas, credenzas and bridges. Includes grommet and installed horizontal wire management. Narrow end panels on left and right.

- *Not freestanding*

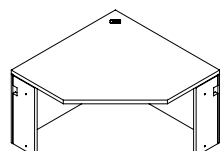

5-Sided Corner

LE484820	48 x 48 x 29	150	196	39	<b>\$3203</b>
LE424220	42 x 42 x 29	150	150	30	<b>\$2552</b>
LE363620	36 x 36 x 29	150	130	22	<b>\$2441</b>

Connects to **20" D** connectables, returns, extended corners, storage/lateral file credenzas, credenzas and bridges. Includes grommet and installed horizontal wire management. Narrow end panels on left and right.

- *Not freestanding*

**Required Specifications**

Veneer Finish  
Edge

**Optional Specifications**

Grommet

## LEFT EXTENDED CORNERS

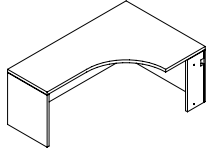

Left Extended Corner

MODEL#	DIMENSIONS	FREIGHT CLASS	WT/LBS.	CUBIC FT.	LIST PRICE
--------	------------	---------------	---------	-----------	------------

D x W x H

LEKL844824	24-48 x 84 x 29	150	338	68	<b>\$4727</b>
LEKL784824	24-48 x 78 x 29	150	314	63	<b>\$4663</b>
LEKL724824	24-48 x 72 x 29	150	290	58	<b>\$4398</b>
LEKL664824	24-48 x 66 x 29	150	266	52	<b>\$4178</b>
LEKL604824	24-48 x 60 x 29	150	242	48	<b>\$3904</b>
LEKL844820	20-48 x 84 x 29	150	338	68	<b>\$4651</b>
LEKL784820	20-48 x 78 x 29	150	314	63	<b>\$4554</b>
LEKL724820	20-48 x 72 x 29	150	290	58	<b>\$4293</b>
LEKL664820	20-48 x 66 x 29	150	266	52	<b>\$4073</b>
LEKL604820	20-48 x 60 x 29	150	242	48	<b>\$3800</b>

Extended worksurface on **left**. **Full end panel on left, narrow end panel on right**. Connects to Linking Bridges, Extended Corners and Connectable Tables.

## RIGHT EXTENDED CORNERS

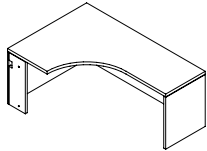

Right Extended Corner

MODEL#	DIMENSIONS	FREIGHT CLASS	WT/LBS.	CUBIC FT.	LIST PRICE
--------	------------	---------------	---------	-----------	------------

LEKR488424	24-48 x 84 x 29	150	338	68	<b>\$4727</b>
LEKR487824	24-48 x 78 x 29	150	314	63	<b>\$4663</b>
LEKR487224	24-48 x 72 x 29	150	290	58	<b>\$4398</b>
LEKR486624	24-48 x 66 x 29	150	266	52	<b>\$4178</b>
LEKR486024	24-48 x 60 x 29	150	242	48	<b>\$3904</b>
LEKR488420	20-48 x 84 x 29	150	338	68	<b>\$4651</b>
LEKR487820	20-48 x 78 x 29	150	314	63	<b>\$4554</b>
LEKR487220	20-48 x 72 x 29	150	290	58	<b>\$4293</b>
LEKR486620	20-48 x 66 x 29	150	266	52	<b>\$4073</b>
LEKR486020	20-48 x 60 x 29	150	242	48	<b>\$3800</b>

Extended worksurface on **right**. **Full end panel on right, narrow end panel on left**. Connects to Linking Bridges, Extended Corners and Connectable Tables.

## CONNECTABLE TABLES - LEFT

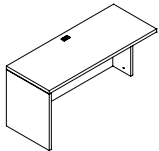

24" Deep Connectable Table - LEFT

MODEL#	DIMENSIONS	FREIGHT CLASS	WT/LBS.	CUBIC FT.	LIST PRICE
--------	------------	---------------	---------	-----------	------------

LVL9624CG	24 x 96 x 29	150	200	39	<b>\$3476</b>
LVL9024CG	24 x 90 x 29	150	187	36	<b>\$3277</b>
LVL8424CG	24 x 84 x 29	150	174	34	<b>\$3090</b>
LVL7824CG	24 x 78 x 29	150	162	31	<b>\$2892</b>
LVL7224CG	24 x 72 x 29	150	149	29	<b>\$2704</b>
LVL6624CG	24 x 66 x 29	150	141	27	<b>\$2566</b>
LVL6024CG	24 x 60 x 29	150	132	24	<b>\$2425</b>
LVL5424CG	24 x 54 x 29	150	121	22	<b>\$2306</b>
LVL4824CG	24 x 48 x 29	125	115	19	<b>\$2200</b>
LVL4224CG	24 x 42 x 29	150	99	17	<b>\$1916</b>
LVL3624CG	24 x 36 x 29	150	83	15	<b>\$1863</b>
LVL3024CG	24 x 30 x 29	125	77	12	<b>\$1835</b>
LVL2424CG	24 x 24 x 29	125	61	10	<b>\$1603</b>

**Full end panel on left.** Right narrow end panel connects to **24"D** center/right connectable table; **24"D** extended corners; **24"D** 5-sided corners; Grommet in worksurface.

- To remove cross grain veneer pattern on top, **delete suffix "CG"** from the model number. Available as a special - no upcharge.

### Required Specifications

Veneer Finish  
Edge

### Optional Specifications

Grommet

CONNECTABLE TABLES - LEFT

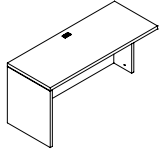

20" Deep Connectable Table - LEFT

MODEL#	DIMENSIONS	FREIGHT CLASS	WT./LBS.	CUBIC FT.	LIST PRICE
--------	------------	---------------	----------	-----------	------------

D x W x H					
LVL9620CG	20 x 96 x 29	150	187	39	\$2826
LVL9020CG	20 x 90 x 29	150	175	36	\$2649
LVL8420CG	20 x 84 x 29	150	163	34	\$2474
LVL7820CG	20 x 78 x 29	150	152	31	\$2297
LVL7220CG	20 x 72 x 29	150	140	29	\$2120
LVL6620CG	20 x 66 x 29	150	133	27	\$1989
LVL6020CG	20 x 60 x 29	150	125	24	\$1863
LVL5420CG	20 x 54 x 29	150	113	22	\$1755
LVL4820CG	20 x 48 x 29	150	110	19	\$1646
LVL4220CG	20 x 42 x 29	150	95	17	\$1393
LVL3620CG	20 x 36 x 29	150	80	15	\$1341
LVL3020CG	20 x 30 x 29	125	75	12	\$1319
LVL2420CG	20 x 24 x 29	125	60	10	\$1104

**Full end panel on left.** Right narrow end panel connects to 20"D center/right connectable table; 20"D 5-sided corners; Grommet in worksurface.

- To remove cross grain veneer pattern on top, delete suffix "CG" from the model number. Available as a special - no upcharge.

CONNECTABLE TABLES - RIGHT

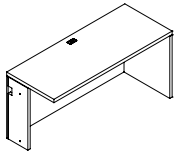

24" Deep Connectable Table - RIGHT

MODEL#	DIMENSIONS	FREIGHT CLASS	WT./LBS.	CUBIC FT.	LIST PRICE
--------	------------	---------------	----------	-----------	------------

LVR9624CG	24 x 96 x 29	150	200	39	\$3476
LVR9024CG	24 x 90 x 29	150	187	36	\$3277
LVR8424CG	24 x 84 x 29	150	174	34	\$3090
LVR7824CG	24 x 78 x 29	150	162	31	\$2892
LVR7224CG	24 x 72 x 29	150	149	29	\$2704
LVR6624CG	24 x 66 x 29	150	141	27	\$2566
LVR6024CG	24 x 60 x 29	150	132	24	\$2425
LVR5424CG	24 x 54 x 29	150	121	22	\$2306
LVR4824CG	24 x 48 x 29	125	115	19	\$2200
LVR4224CG	24 x 42 x 29	150	99	17	\$1916
LVR3624CG	24 x 36 x 29	150	83	15	\$1863
LVR3024CG	24 x 30 x 29	125	77	12	\$1835
LVR2424CG	24 x 24 x 29	125	61	10	\$1603

**Full end panel on right.** Left narrow end panel connects to 24"D center/left connectable table; 24"D extended corners, 24"D 5-sided corners; Grommet in worksurface.

- To remove cross grain veneer pattern on top, delete suffix "CG" from the model number. Available as a special - no upcharge.

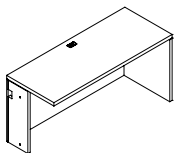

20" Deep Connectable Table - RIGHT

LVR9620CG	20 x 96 x 29	150	187	39	\$2826
LVR9020CG	20 x 90 x 29	150	175	36	\$2649
LVR8420CG	20 x 84 x 29	150	163	34	\$2474
LVR7820CG	20 x 78 x 29	150	152	31	\$2297
LVR7220CG	20 x 72 x 29	150	140	29	\$2120
LVR6620CG	20 x 66 x 29	150	133	27	\$1989
LVR6020CG	20 x 60 x 29	150	125	24	\$1863
LVR5420CG	20 x 54 x 29	150	113	22	\$1755
LVR4820CG	20 x 48 x 29	150	110	19	\$1646
LVR4220CG	20 x 42 x 29	150	95	17	\$1393
LVR3620CG	20 x 36 x 29	150	80	15	\$1341
LVR3020CG	20 x 30 x 29	125	75	12	\$1319
LVR2420CG	20 x 24 x 29	125	60	10	\$1104

**Full end panel on right.** Left narrow end panel connects to 20"D center/left connectable table; 20"D 5-sided corners; Grommet in worksurface.

- To remove cross grain veneer pattern on top, delete suffix "CG" from the model number. Available as a special - no upcharge.

**Required Specifications**

Veneer Finish  
Edge  
Monopost Finish - D Islands

**Optional Specifications**

Grommet  
Modesty Upgrade  
Modesty Panel  
Monopost (Base) Upgrade - D Islands



## CONNECTABLE TABLES

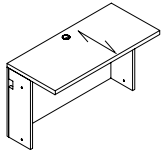

**24" Deep Connectable Table**

MODEL#	DIMENSIONS D x W x H	FREIGHT CLASS	WT/LBS.	CUBIC FT.	LIST PRICE
LV6024CG	24 x 60 x 29	150	132	24	<b>\$2356</b>
LV5424CG	24 x 54 x 29	150	121	22	<b>\$2222</b>
LV4824CG	24 x 48 x 29	125	115	19	<b>\$2087</b>
LV4224CG	24 x 42 x 29	150	99	17	<b>\$1747</b>
LV3624CG	24 x 36 x 29	150	83	15	<b>\$1803</b>
LV3024CG	24 x 30 x 29	125	77	12	<b>\$1652</b>
LV2424CG	24 x 24 x 29	125	61	10	<b>\$1385</b>

**Narrow end panels on left and right** connects to **24"D** connectable table; **24"D** extended corners, **24"D** 5-sided corners; Grommet in worksurface.

- To remove cross grain veneer pattern on top, **delete suffix "CG"** from the model number. Available as a special - no upcharge.

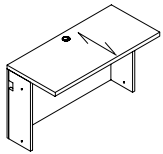

**22" Deep Connectable Table**

LV6020CG	20 x 60 x 29	150	125	24	<b>\$1813</b>
LV5420CG	20 x 54 x 29	150	113	22	<b>\$1705</b>
LV4820CG	20 x 48 x 29	150	110	19	<b>\$1599</b>
LV4220CG	20 x 42 x 29	150	95	17	<b>\$1335</b>
LV3620CG	20 x 36 x 29	150	80	15	<b>\$1293</b>
LV3020CG	20 x 30 x 29	125	75	12	<b>\$1268</b>
LV2420CG	20 x 24 x 29	125	60	10	<b>\$1067</b>

**Narrow end panels on left and right** connects to **22"D** connectable table; **22"D** extended corners, **22"D** 5-sided corners; Grommet in worksurface.

- To remove cross grain veneer pattern on top, **delete suffix "CG"** from the model number. Available as a special - no upcharge.

## "D" ISLANDS

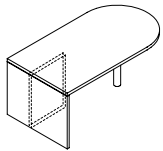

**"D" Island - Full End Panel (T-Base) & Monopost**

MODEL#	DIMENSIONS	FREIGHT CLASS	WT/LBS.	CUBIC FT.	LIST PRICE
LDD8430	30 x 84 x 29	125	343	51	<b>\$5254</b>
LDD7230	30 x 72 x 29	125	264	36	<b>\$4174</b>
LDD6630	30 x 66 x 29	125	245	40	<b>\$4174</b>
LDD6030	30 x 60 x 29	125	225	30	<b>\$4020</b>

Connects to Linking Bridges or Executive Returns. Attaching hardware included. **Not freestanding.**

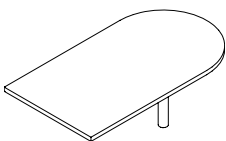

**"D" Island with Monopost**

LRD8430	30 x 84 x 29	125	135	51	<b>\$3750</b>
LRD7230	30 x 72 x 29	125	99	36	<b>\$2985</b>
LRD6630	30 x 66 x 29	125	99	40	<b>\$2985</b>
LRD6030	30 x 60 x 29	125	83	30	<b>\$2870</b>

Attaches to edge of worksurfaces with molding edge. Attaching hardware included. Shipped RTA (ready to assemble).

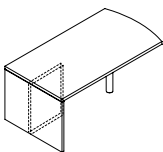

**"D" Island - Full End Panel (T-Base) & Monopost, Bow End**

LDDBE8430	30 x 84 x 29	125	343	51	<b>\$5254</b>
LDDBE7230	30 x 72 x 29	125	264	36	<b>\$4174</b>
LDDBE6630	30 x 66 x 29	125	245	40	<b>\$4174</b>
LDDBE6030	30 x 60 x 29	125	225	30	<b>\$4014</b>

Connects to Linking Bridges or Executive Returns. Attaching hardware included. **Not freestanding.**

### Required Specifications

Veneer Finish  
Edge  
Monopost Finish

### Optional Specifications

Grommet  
Monopost (Base) Upgrade

**"D" ISLANDS**

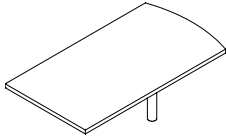

**"D" Island with Monopost, Bow End**

MODEL#	DIMENSIONS	FREIGHT CLASS	WT/LBS.	CUBIC FT.	LIST PRICE
<b>D x W x H</b>					
LRDBE8430	30 x 84 x 29	125	135	51	<b>\$3750</b>
LRDBE7230	30 x 72 x 29	125	99	36	<b>\$2985</b>
LRDBE6630	30 x 66 x 29	125	99	40	<b>\$2985</b>
LRDBE6030	30 x 60 x 29	125	83	30	<b>\$2870</b>

Attaches to edge of worksurfaces with molding edge. Attaching hardware included. Shipped RTA (ready to assemble).

**PIANO DESKS**

- Can be ordered as a shell or with pedestals.
- Components include a GM1 grommet in the top center position.
- Hand of Rectangular Desk is determined by location of pedestal from user side.
- Hand of "D" Top is determined by outward orientation of curved end from user projection.
- Hand of "P" Top is determined by outward orientation of conference end from user projection.
- Connectable Tables and Bridges - To remove cross grain veneer pattern on top, delete suffix "CG" from the model number. Available as a special - no upcharge.

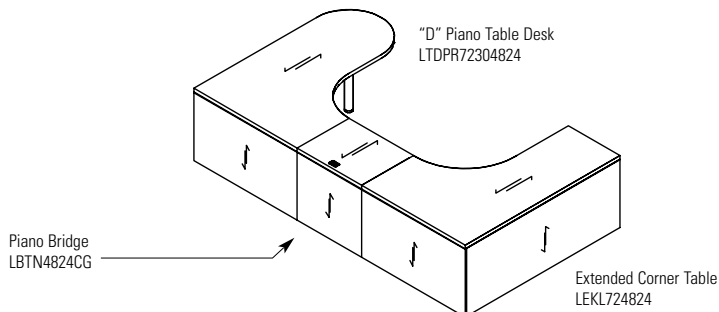
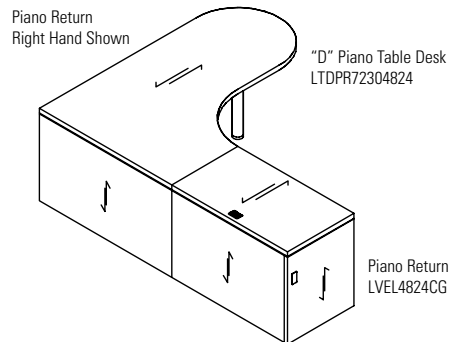
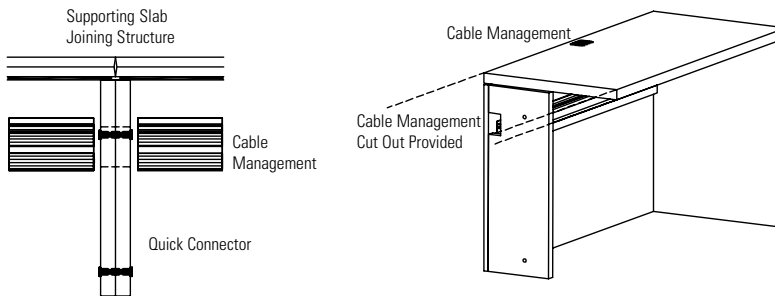

**Required Specifications**

- Veneer Finish
- Edge
- Monopost Finish

**Optional Specifications**

- Grommet
- Monopost (Base) Upgrade

## PIANO DESKS

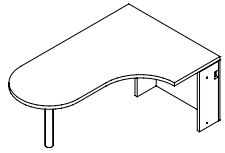

**"D" Island LEFT - Full End Panel & Monopost, Piano Desk**

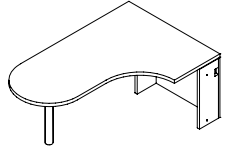

**"D" Island LEFT - Full End Panel & Monopost, Piano Desk**

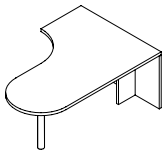

**"D" Island RIGHT - Full End Panel & Monopost, Piano Desk**

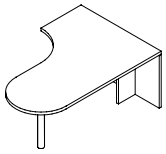

**"D" Island RIGHT - Full End Panel & Monopost, Piano Desk**

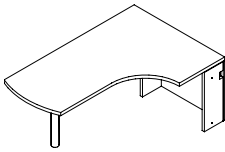

**"D" Island LEFT - Full End Panel & Monopost, Piano Desk - Bow End**

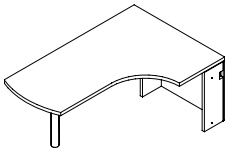

**"D" Island LEFT - Full End Panel & Monopost, Piano Desk - Bow End**

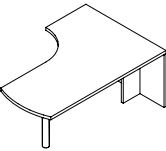

**"D" Island RIGHT - Full End Panel & Monopost, Piano Desk - Bow End**

MODEL#	DIMENSIONS D x W x H	FREIGHT CLASS	WT/LBS.	CUBIC FT.	LIST PRICE
LTDPL84304824	48 x 84 x 29	150	406	68	<b>\$4351</b>
LTDPL72304824	48 x 72 x 29	125	348	58	<b>\$3815</b>

Extended island worksurface on the **left**. Narrow end panel on right connects to **24"D** returns or bridges **for Piano Desks Only** (see pg. 107). **Not freestanding**. Includes installed horizontal wire management.

LTDPL84304820	48 x 84 x 29	150	406	68	<b>\$4245</b>
LTDPL72304820	48 x 72 x 29	125	348	58	<b>\$3706</b>

Extended island worksurface on the **left**. Narrow end panel on right connects to **20"D** returns or bridges **for Piano Desks Only** (see pg. 107). **Not freestanding**. Includes installed horizontal wire management.

LTDPR84304824	48 x 84 x 29	150	406	68	<b>\$4351</b>
LTDPR72304824	48 x 72 x 29	125	348	58	<b>\$3815</b>

Extended island worksurface on the **right**. Narrow end panel on left connects to **24"D** returns or bridges **for Piano Desks Only** (see pg. 107). **Not freestanding**. Includes installed horizontal wire management.

LTDPR84304820	48 x 84 x 29	150	406	68	<b>\$4245</b>
LTDPR72304820	48 x 72 x 29	125	348	58	<b>\$3706</b>

Extended island worksurface on the **right**. Narrow end panel on left connects to **20"D** returns or bridges **for Piano Desks Only** (see pg. 107). **Not freestanding**. Includes installed horizontal wire management.

LDBEPL84304824	48 x 84 x 29	150	406	68	<b>\$4351</b>
LDBEPL72304824	48 x 72 x 29	125	348	58	<b>\$3815</b>

Extended island worksurface on the **left**. Narrow end panel on right connects to **24"D** returns or bridges **for Piano Desks Only** (see pg. 107). **Not freestanding**. Includes installed horizontal wire management.

LDBEPL84304820	48 x 84 x 29	150	406	68	<b>\$4245</b>
LDBEPL72304820	48 x 72 x 29	125	348	58	<b>\$3706</b>

Extended island worksurface on the **left**. Narrow end panel on right connects to **20"D** returns or bridges **for Piano Desks Only** (see pg. 107). **Not freestanding**. Includes installed horizontal wire management.

LDBEPR84304824	48 x 84 x 29	150	406	68	<b>\$4351</b>
LDBEPR72304824	48 x 72 x 29	125	348	58	<b>\$3815</b>

Extended island worksurface on the **right**. Narrow end panel on left connects to **24"D** returns or bridges **for Piano Desks Only** (see pg. 107). **Not freestanding**. Includes installed horizontal wire management.

### Required Specifications

Veneer Finish  
Edge  
Monopost Finish - Piano Desk

### Optional Specifications

Grommet  
Monopost (Base) Upgrade - Piano Desk

PIANO DESK

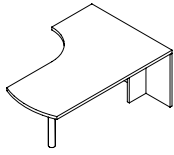

**"D" Island RIGHT - Full End Panel & Monopost, Piano Desk - Bow End**

MODEL#	DIMENSIONS D x W x H	FREIGHT CLASS	WT/LBS.	CUBIC FT.	LIST PRICE
LDBEPR84304820	48 x 84 x 29	150	406	68	\$4245
LDBEPR72304820	48 x 72 x 29	125	348	58	\$3706

Extended island worksurface on the **right**. Narrow end panel on left connects to **20"D** returns or bridges **for Piano Desks Only** (see pg. 107). **Not freestanding**. Includes installed horizontal wire management.

CONNECTABLE TABLES - FOR PIANO DESKS

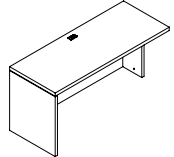

**24" Deep Connectable Table - LEFT For Piano Desk**

MODEL#	DIMENSIONS	FREIGHT CLASS	WT/LBS.	CUBIC FT.	LIST PRICE
LVEL8424CG	24 x 84 x 29	150	174	34	\$3197
LVEL7824CG	24 x 78 x 29	150	162	31	\$2995
LVEL7224CG	24 x 72 x 29	150	149	29	\$2801
LVEL6624CG	24 x 66 x 29	150	141	27	\$2649
LVEL6024CG	24 x 60 x 29	150	132	24	\$2505
LVEL5424CG	24 x 54 x 29	150	121	22	\$2382
LVEL4824CG	24 x 48 x 29	125	115	19	\$2270
LVEL4224CG	24 x 42 x 29	150	99	17	\$1975
LVEL3624CG	24 x 36 x 29	150	83	15	\$1920

**Full end panel on left.** Right narrow end panel connects to **24"D** right connectable table, "D" islands, Boat shaped islands, "P" islands or Delta islands with "T" bases **for Piano Desks Only**. Grommet in worksurface. Shipped RTA (ready to assemble).

- To remove cross grain veneer pattern on top, **delete suffix "CG"** from the model number. Available as a special - no upcharge.

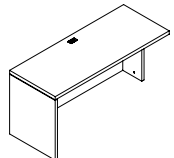

**20" Deep Connectable Table - LEFT For Piano Desk**

LVEL8420CG	20 x 84 x 29	150	174	34	\$2474
LVEL7820CG	20 x 78 x 29	150	162	31	\$2297
LVEL7220CG	20 x 72 x 29	150	149	29	\$2120
LVEL6620CG	20 x 66 x 29	150	141	27	\$1989
LVEL6020CG	20 x 60 x 29	150	132	24	\$1863
LVEL5420CG	20 x 54 x 29	150	121	22	\$1755
LVEL4820CG	20 x 48 x 29	125	115	19	\$1646
LVEL4220CG	20 x 42 x 29	150	99	17	\$1393
LVEL3620CG	20 x 36 x 29	150	83	15	\$1341

**Full end panel on left.** Right narrow end panel connects to **20"D** right connectable table, "D" islands, Boat shaped islands, "P" islands or Delta islands with "T" bases **for Piano Desks Only**. Grommet in worksurface. Shipped RTA (ready to assemble).

- To remove cross grain veneer pattern on top, **delete suffix "CG"** from the model number. Available as a special - no upcharge.

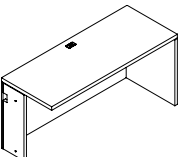

**24" Deep Connectable Table - RIGHT For Piano Desk**

LVER8424CG	24 x 84 x 29	150	174	34	\$3197
LVER7824CG	24 x 78 x 29	150	162	31	\$2995
LVER7224CG	24 x 72 x 29	150	149	29	\$2801
LVER6624CG	24 x 66 x 29	150	141	27	\$2649
LVER6024CG	24 x 60 x 29	150	132	24	\$2505
LVER5424CG	24 x 54 x 29	150	121	22	\$2382
LVER4824CG	24 x 48 x 29	125	115	19	\$2270
LVER4224CG	24 x 42 x 29	150	99	17	\$1975
LVER3624CG	24 x 36 x 29	150	83	15	\$1920

**Full end panel on right.** Left narrow end panel connects to **24"D** left connectable table, "D" islands, Boat shaped islands, "P" islands or Delta islands with "T" bases **for Piano Desks Only**. Grommet in worksurface. Shipped RTA (ready to assemble).

- To remove cross grain veneer pattern on top, **delete suffix "CG"** from the model number. Available as a special - no upcharge.

**Required Specifications**

Veneer Finish  
Edge  
Monopost Finish - Piano Desk

**Optional Specifications**

Grommet  
Monopost (Base) Upgrade - Piano Desk

## CONNECTABLE TABLES - FOR PIANO DESKS

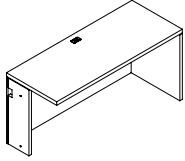

**20" Deep Connectable Table - RIGHT  
For Piano Desk**

MODEL#	DIMENSIONS D x W x H	FREIGHT CLASS	WT/LBS.	CUBIC FT.	LIST PRICE
LVER8420CG	20 x 84 x 29	150	174	34	<b>\$2474</b>
LVER7820CG	20 x 78 x 29	150	162	31	<b>\$2297</b>
LVER7220CG	20 x 72 x 29	150	149	29	<b>\$2120</b>
LVER6620CG	20 x 66 x 29	150	141	27	<b>\$1989</b>
LVER6020CG	20 x 60 x 29	150	132	24	<b>\$1863</b>
LVER5420CG	20 x 54 x 29	150	121	22	<b>\$1755</b>
LVER4820CG	20 x 48 x 29	125	115	19	<b>\$1646</b>
LVER4220CG	20 x 42 x 29	150	99	17	<b>\$1393</b>
LVER3620CG	20 x 36 x 29	150	83	15	<b>\$1341</b>

**Full end panel on right.** Left narrow end panel connects to **20"D** left connectable table, "D" islands, Boat shaped islands, "P" islands or Delta islands with "T" bases **for Piano Desks Only**. Grommet in worksurface. Shipped RTA (ready to assemble).

- To remove cross grain veneer pattern on top, **delete suffix "CG"** from the model number. Available as a special - no upcharge.

## BRIDGES - FOR PIANO DESKS

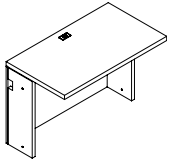

**Flush Bridge**

MODEL#	DIMENSIONS	FREIGHT CLASS	WT/LBS.	CUBIC FT.	LIST PRICE
LBTN4824CG	24 x 48 x 29	125	116	19	<b>\$2008</b>
LBTN4224CG	24 x 42 x 29	125	102	17	<b>\$1747</b>
LBTN3624CG	24 x 36 x 29	150	87	15	<b>\$1694</b>
LBTN3024CG	24 x 30 x 29	125	73	12	<b>\$1663</b>
LBTN2424CG	24 x 24 x 29	150	58	10	<b>\$1466</b>
LBTN1824CG	24 x 18 x 29	150	43	8	<b>\$1201</b>
LBTN1224CG	24 x 12 x 29	150	29	5	<b>\$932</b>

**Full end panel on both sides** connects to **24"D** worksurfaces, "D" islands, Boat shaped islands, "P" islands or Delta islands with "T" bases **for Piano Desks Only**. Grommet in worksurface. Shipped RTA (ready to assemble).

- To remove cross grain veneer pattern on top, **delete suffix "CG"** from the model number. Available as a special - no upcharge.

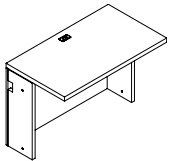

**Flush Bridge**

LBTN4820CG	20 x 48 x 29	125	116	19	<b>\$1599</b>
LBTN4220CG	20 x 42 x 29	125	102	17	<b>\$1335</b>
LBTN3620CG	20 x 36 x 29	150	87	15	<b>\$1293</b>
LBTN3020CG	20 x 30 x 29	125	73	12	<b>\$1268</b>
LBTN2420CG	20 x 24 x 29	150	58	10	<b>\$1067</b>
LBTN1820CG	20 x 18 x 29	150	43	8	<b>\$1015</b>
LBTN1220CG	20 x 12 x 29	150	29	5	<b>\$944</b>

**Full end panel on both sides** connects to **20"D** worksurfaces, "D" islands, Boat shaped islands, "P" islands or Delta islands with "T" bases **for Piano Desks Only**. Grommet in worksurface. Shipped RTA (ready to assemble).

- To remove cross grain veneer pattern on top, **delete suffix "CG"** from the model number. Available as a special - no upcharge.

### Required Specifications

Veneer Finish  
Edge  
Metal Finish - Modesty Panel

### Optional Specifications

Grommet

MODESTY PANEL OPTIONS

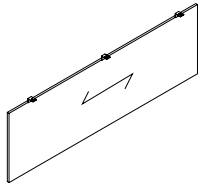

Veneer Modesty Panel Upgrade\*

MODEL#	DIMENSIONS	FREIGHT CLASS	WT/LBS.	CUBIC FT.	LIST PRICE
CMP72W	0.75 x 67 x 18	--	20	1	<b>\$1622</b>
CMP66W	0.75 x 61 x 18	--	18	1	<b>\$1570</b>
CMP60W	0.75 x 55 x 18	--	16	1	<b>\$1546</b>
CMP54W	0.75 x 49 x 18	--	14	1	<b>\$1520</b>
CMP48W	0.75 x 43 x 18	--	13	1	<b>\$1496</b>

Straight modesty panel. Attaches to underside of worksurface. **Can not be retrofitted in the field. Not sold individually - to be ordered as an upgrade option only.**

- CMP72W - Specify on "P" Top Islands or 96" x 48" Islands for Piano Desks.
- CMP66W - Specify on 84" x 36" "D" Top Islands.
- CMP60W - Specify on 84" x 42" "P" Top Islands or 84" x 48" Islands for Piano Desks.
- CMP54W - Specify on 72" x 30" "D" Top Islands.
- CMP48W - Specify on 66" x 36" , 60" x 30" "D" Top Islands, 72" x 42" "P" Top Islands or 72" x 48" Islands for Piano Desks.

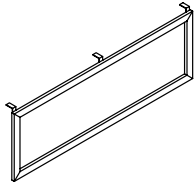

Glass Modesty Panel Upgrade

CMP72G	0.75 x 67 x 18	--	20	1	<b>\$2485</b>
CMP66G	0.75 x 61 x 18	--	18	1	<b>\$2351</b>
CMP60G	0.75 x 55 x 18	--	16	1	<b>\$2149</b>
CMP54G	0.75 x 49 x 18	--	14	1	<b>\$2001</b>
CMP48G	0.75 x 43 x 18	--	13	1	<b>\$1911</b>

Straight modesty panel. Translucent, screened glass. Aluminum box frame construction in Tungsten Only. Attaches to underside of worksurface. **Can not be retrofitted in the field. Not sold individually - to be ordered as an upgrade option only.**

- CMP72G - Specify on "P" Top Islands or 96" x 48" Islands for Piano Desks.
- CMP66G - Specify on 84" x 36" "D" Top Islands.
- CMP60G - Specify on 84" x 42" "P" Top Islands or 84" x 48" Islands for Piano Desks.
- CMP54G - Specify on 72" x 30" "D" Top Islands.
- CMP48G - Specify on 66" x 36" , 60" x 30" "D" Top Islands, 72" x 42" "P" Top Islands or 72" x 48" Islands for Piano Desks.
- Tungsten finish on the aluminum box frame closely resembles the existing Tungsten finish.

**Required Specifications**

Metal finish

**SIDE-BY-SIDE COMPONENTS      MODEL#      DIMENSIONS      FREIGHT CLASS      WT/LBS.      CUBIC FT.      LIST PRICE**

D x W x H

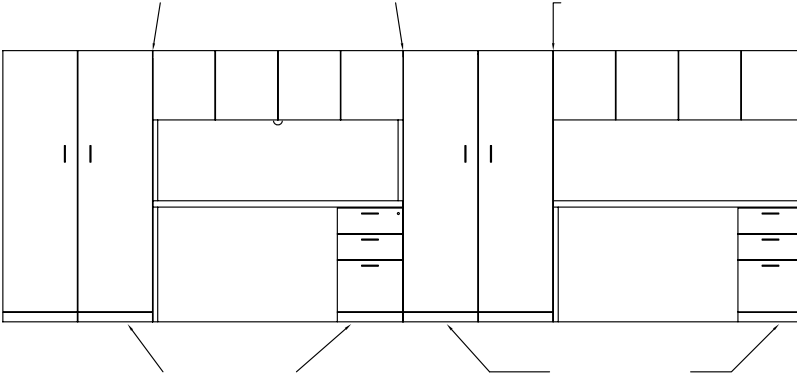

**MODULAR PEDESTALS**

- When using Storage Shells, laminate gables will show.
- Credenza shell cannot be completely filled up with storage shells to create a full storage credenza.
- Handle style must be specified.

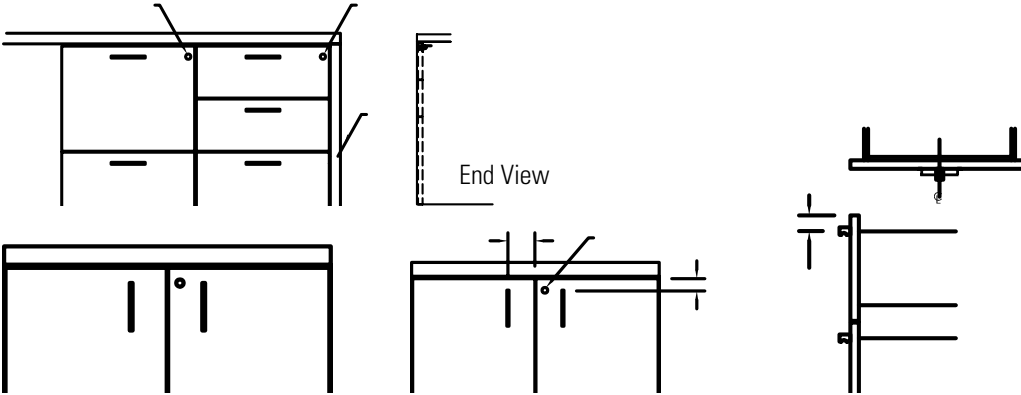

**STORAGE SHELLS      MODEL#      DIMENSIONS      FREIGHT CLASS      WT/LBS.      CUBIC FT.      LIST PRICE**

D x W x H

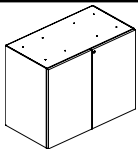

**Storage Shell**

LWG	18 x 35 x 28	92.5	115	11	<b>\$1777</b>
LWM	18 x 30 x 28	92.5	96	9	<b>\$1599</b>
LWG.5	18 x 34 x 28	92.5	115	11	<b>\$1777</b>

For use **under a freestanding worksurface (22", 24", 30" or 36"D)**. Top drilled to attach to worksurface. One adjustable shelf. Standard with lock.

- **Specify LWG and LWM for kneespace applications**
- **Unfinished top and back**

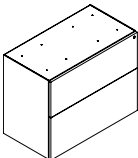

**File/File Shell - Lateral**

LWF	18 x 35 x 28	92.5	115	11	<b>\$2505</b>
LWN	18 x 30 x 28	92.5	96	9	<b>\$2178</b>
LWF.5	18 x 34 x 28	92.5	115	11	<b>\$2505</b>
LWN.5	18 x 29 x 28	92.5	96	9	<b>\$2178</b>

For use **under a freestanding worksurface (22", 24", 30" or 36"D)**. Top drilled to attach to worksurface. **Two lateral file drawers**. Lock secures all drawers. Side-to-side file bars included.

- **Specify LWF and LWN for kneespace applications**
- **Unfinished top and back**

**Required Specifications**

Veneer Finish  
Edge

STORAGE MODULES - FREESTANDING

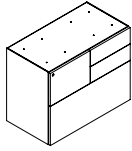

Mixed Storage Shell - LEFT

MODEL#	DIMENSIONS D x W x H	FREIGHT CLASS	WT/LBS.	CUBIC FT.	LIST PRICE
LWZL	18 x 35 x 28	92.5	115	11	\$2870
LWZL.5	18 x 34 x 28	92.5	115	11	\$2870

For use **under a freestanding worksurface (22", 24", 30" or 36"D)**. Top drilled to attach to worksurface. One file drawer on **left**, two box drawers on **right** and one lateral file drawer on bottom. File drawer and lateral file drawer lock. One pencil tray. **Not for stacking materials on lateral file drawer bottom.**

- Specify LWZL for kneespace applications
- Unfinished top and back

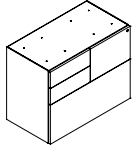

Mixed Storage Shell - RIGHT

LWZR	18 x 35 x 28	92.5	115	11	\$2870
LWZR.5	18 x 34 x 28	92.5	115	11	\$2870

For use **under a freestanding worksurface (22", 24", 30" or 36"D)**. Top drilled to attach to worksurface. One file drawer on **right**, two box drawers on **left** and one lateral file drawer on bottom. File drawer and lateral file drawer lock. One pencil tray. **Not for stacking materials on lateral file drawer bottom.**

- Specify LWZR for kneespace applications
- Unfinished top and back

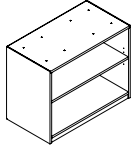

Open Shelving Shell

LWOB36	18 x 35 x 28	100	92	11	\$1372
LWOB30	18 x 30 x 28	100	77	9	\$1235

For use **under a freestanding worksurface (22", 24", 30" or 36"D)**. Top drilled to attach to worksurface. One adjustable veneer shelf.

- Unfinished top and back

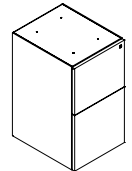

File/File Shell - Vertical

LETTER					
LWWE	23 x 16 x 28	92.5	72	6	\$2001
LWE	18 x 16 x 28	92.5	70	5	\$1777
LEGAL					
LWWLE	23 x 19 x 28	92.5	85	7	\$2339
LWLE	18 x 19 x 28	92.5	83	6	\$2072

For use **under a freestanding worksurface (22", 24", 30" or 36"D)**. Top drilled to attach to worksurface. **Two file drawers.** Lock secures all drawers.

- For 22" or 24"D worksurface, order **LWE or LWLE**. For 30" or 36"D worksurface, order **LWWE or LWWLE**.
- Unfinished top and back

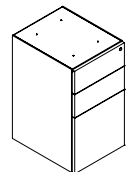

Box/Box/File Shell

LETTER					
LWWD	23 x 16 x 28	92.5	72	6	\$2001
LWD	19.1 x 16 x 28	92.5	70	5	\$1777
LEGAL					
LWWLD	23 x 19 x 28	92.5	85	7	\$2339
LWLD	19.1 x 19 x 28	92.5	83	6	\$2072

For use **under a freestanding worksurface (22", 24", 30" or 36"D)**. Top drilled to attach to worksurface. **Two box and one file drawers.** One pencil tray. Lock secures all drawers.

- For 22" or 24"D worksurface, order **LWD or LWLD**. For 30" or 36"D worksurface, order **LWWD or LWWLD**.
- Unfinished top and back

Required Specifications

Veneer Finish  
Edge



## STORAGE MODULES - FREESTANDING

MODEL# DIMENSIONS FREIGHT CLASS WT/LBS. CUBIC FT. LIST PRICE

D x W x H

LWBM	18 x 16 x 21	85	70	5	<b>\$1481</b>
LWWBM	24 x 16 x 21	85	75	6	<b>\$1738</b>

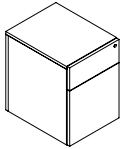

**Box/File Freestanding Pedestal**

**One box and one file drawer.** One pencil tray. Lock secures all drawers. Finished back.

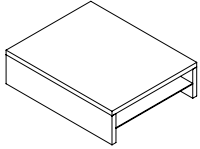

**Spacer**

LSPBOX1620	20 x 16 x 4.8	125	15	2	<b>\$525</b>
------------	---------------	-----	----	---	--------------

For use with 23"high credenzas to support an overlapping return. Includes shelf for paper management.

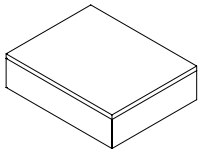

**Spacer, Closed**

LSPBOX1620C	20 x 16 x 4.8	125	15	2	<b>\$580</b>
-------------	---------------	-----	----	---	--------------

For use with 23"high credenzas to support an overlapping return.

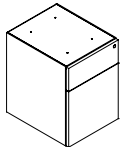

**Box/File Pedestal**

LWB15	18 x 16 x 19.5	70	50	3	<b>\$1268</b>
-------	----------------	----	----	---	---------------

**One box and one file drawer.** One pencil tray. Lock secures all drawers. Finished back. **For use with 23"high credenza shell.**

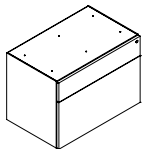

**Box/Lateral File Pedestal**

LWB36	18 x 36 x 19.5	92.5	115	11	<b>\$2306</b>
LWB30	18 x 30 x 19.5	92.5	96	9	<b>\$2017</b>

**One box and one lateral file drawer.** One pencil tray. Lock secures all drawers. Finished back. **For use with 23"high credenza shell.**

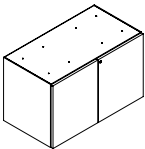

**Storage Cabinet w/Doors**

LWMH19.5	20 x 36 x 29	92.5	130	12	<b>\$1427</b>
LWGH19.5	20 x 30 x 29	92.5	107	10	<b>\$1610</b>

Includes one adjustable shelf. Standard with lock. **For use with 23"high credenza shell.**

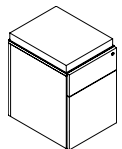

**Box/File Freestanding Pedestal Mobile, with Cushion**

LWBMCU	18 x 16 x 24	85	70	5	<b>\$2228</b>
LWWBMCU	24 x 16 x 24	85	75	6	<b>\$2543</b>

**One box and one file drawer.** One pencil tray. Lock secures all drawers. Casters.

**Required Specifications**

Veneer Finish  
Edge

STORAGE MODULES - FREESTANDING

MODEL# DIMENSIONS FREIGHT CLASS WT/LBS. CUBIC FT. LIST PRICE

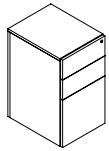

Box/Box/File Freestanding Pedestal

D x W x H						
LWDB	18 x 16 x 28	85	70	5		<b>\$1777</b>
LWWDB	24 x 16 x 28	85	75	6		<b>\$2043</b>

**Two box and one file drawer.** One pencil tray. Lock secures all drawers. Finished back.

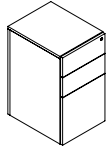

Box/Box/File Module, Mobile

LWDM	18 x 16 x 28	85	70	5		<b>\$1911</b>
LWWDM	24 x 16 x 28	85	75	6		<b>\$2194</b>

**Two box and one file drawer.** One pencil tray. Lock secures all drawers. Casters.

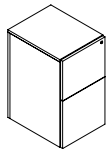

File/File Module, Mobile

LWEM	18 x 16 x 28	85	70	5		<b>\$2072</b>
LWWEM	24 x 16 x 28	85	75	6		<b>\$2227</b>

**Two file drawer.** Lock secures all drawers. Casters.

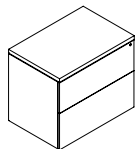

File/File Module, Lateral

LF3624	24 x 36 x 29	85	184	15		<b>\$3277</b>
LN3024	24 x 30 x 29	85	153	12		<b>\$2870</b>
LF3620	20 x 36 x 29	85	159	12		<b>\$2461</b>
LN3020	20 x 30 x 29	85	131	10		<b>\$2152</b>

**Two lateral file drawers.** Lock secures all drawers.

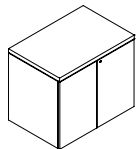

Storage Cabinet w/Doors

LBD3624	24 x 36 x 29	92.5	152	15		<b>\$2230</b>
LBD3024	24 x 30 x 29	92.5	127	12		<b>\$1958</b>
LBD3620	20 x 36 x 29	92.5	130	12		<b>\$1760</b>
LBD3020	20 x 30 x 29	92.5	107	10		<b>\$1534</b>

Includes one adjustable shelf. Standard with lock.

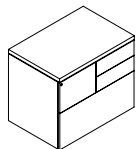

Mixed Storage Cabinet - LEFT

LZL3624	24 x 36 x 29	85	184	15		<b>\$3559</b>
LZL3620	20 x 36 x 29	85	170	13		<b>\$2796</b>

One file drawer on the **left**, two box drawers on the **right** and one lateral file drawer on the bottom. File drawer and lateral file drawer lock. One pencil tray. **Not for stacking materials on lateral file drawer bottom.**

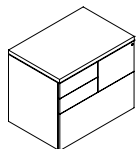

Mixed Storage Cabinet - RIGHT

LZR3624	24 x 36 x 29	85	184	15		<b>\$3559</b>
LZR3620	20 x 36 x 29	85	170	13		<b>\$2796</b>

One file drawer on the **right**, two box drawers on the **left** and one lateral file drawer on the bottom. File drawer and lateral file drawer lock. One pencil tray. **Not for stacking materials on lateral file drawer bottom.**

**Required Specifications**

Veneer Finish  
Edge

## FREESTANDING STORAGE

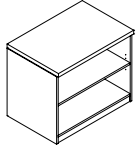

**Open Storage Cabinet**

MODEL#	DIMENSIONS D x W x H	FREIGHT CLASS	WT/LBS.	CUBIC FT.	LIST PRICE
LOB3624	24 x 36 x 29	100	123	15	<b>\$1792</b>
LOB3024	24 x 30 x 29	100	103	12	<b>\$1566</b>
LOB3620	20 x 36 x 29	100	115	13	<b>\$1411</b>
LOB3020	20 x 30 x 29	100	96	11	<b>\$1228</b>

One fixed and **one** adjustable veneer shelf. Shelves are ¾" thick.

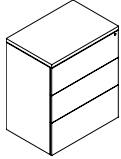

**Three File Module**

LF36243	24 x 36 x 42	92.5	231	21	<b>\$4009</b>
LN30243	24 x 30 x 42	92.5	193	18	<b>\$3505</b>
LF36203	20 x 36 x 42	92.5	212	19	<b>\$3429</b>
LN30203	20 x 30 x 42	92.5	176	16	<b>\$2999</b>

**Three lateral file drawers.** Lock secures all drawers.

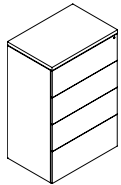

**Four File Module**

LF36244	24 x 36 x 54	92.5	297	27	<b>\$4884</b>
LN30244	24 x 30 x 54	92.5	248	23	<b>\$4271</b>
LF36204	20 x 36 x 54	92.5	270	25	<b>\$4250</b>
LN30204	20 x 30 x 54	92.5	225	21	<b>\$3718</b>

**Four lateral file drawers.** Lock secures all drawers.

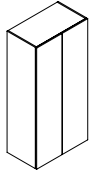

**Storage Cabinet w/Doors**

L1D24H72	24 x 35 x 72	100	324	36	<b>\$4266</b>
L1D24W30H72	24 x 30 x 72	100	270	30	<b>\$3725</b>
L1D24W24H72	24 x 24 x 72	100	216	24	<b>\$3182</b>
L1H72	20 x 35 x 72	100	269	30	<b>\$3725</b>
L1W30H72	20 x 30 x 72	100	233	25	<b>\$3108</b>
L1W24H72	20 x 24 x 72	100	179	20	<b>\$2483</b>
L1D24	24 x 35 x 65	100	297	33	<b>\$3912</b>
L1D24W30	24 x 30 x 65	100	248	28	<b>\$3424</b>
L1D24W24	24 x 24 x 65	100	198	22	<b>\$2936</b>
L1W35	20 x 35 x 65	100	245	28	<b>\$3417</b>
L1W30	20 x 30 x 65	100	202	23	<b>\$2848</b>
L1W24	20 x 24 x 65	100	163	18	<b>\$2281</b>

Includes four adjustable shelves. Standard with lock.

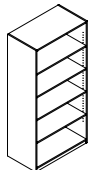

**Open Storage Cabinet**

L7D24H72	24 x 35 x 72	100	306	36	<b>\$3417</b>
L7D24W30H72	24 x 30 x 72	100	255	30	<b>\$2989</b>
L7H72	20 x 35 x 72	100	257	30	<b>\$2985</b>
L7W30H72	20 x 30 x 72	100	223	25	<b>\$2483</b>
L7D24	24 x 35 x 65	100	281	33	<b>\$3135</b>
L7D24W30	24 x 30 x 65	100	234	28	<b>\$2741</b>
L7	20 x 35 x 65	100	234	28	<b>\$2736</b>
L7W30	20 x 30 x 65	100	193	23	<b>\$2281</b>

Includes one fixed and **four** adjustable veneer shelves. Shelves are ¾" thick.

### Required Specifications

Veneer Finish  
Edge (file modules)

FREESTANDING STORAGE

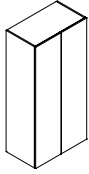

Wardrobe Cabinet

MODEL# DIMENSIONS FREIGHT CLASS WT/LBS. CUBIC FT. LIST PRICE

D x W x H

L2D24H72	24 x 35 x 72	100	324	36	\$3636
L2D24W30H72	24 x 30 x 72	100	270	30	\$3181
L2D24W24H72	24 x 24 x 72	100	216	24	\$2724
L2H72	20 x 35 x 72	100	269	30	\$3178
L2W30H72	20 x 30 x 72	100	233	25	\$2700
L2W24H72	20 x 24 x 72	100	179	20	\$2155

L2D24	24 x 35 x 65	100	297	33	\$3333
L2D24W30	24 x 30 x 65	100	246	28	\$2918
L2D24W24	24 x 24 x 65	100	198	22	\$2503
L2	20 x 35 x 65	100	245	28	\$2962
L2W30	20 x 30 x 65	100	202	23	\$2474
L2W24	20 x 24 x 65	100	163	18	\$1980

Includes full length hanging rod and fixed hat shelf.

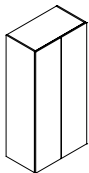

Wardrobe Cabinet/Shelving Combo

L25D24H72	24 x 35 x 72	100	324	36	\$4785
L25D24W30H72	24 x 30 x 72	100	270	30	\$4187
L25D24W24H72	24 x 24 x 72	100	216	24	\$3690
L25H72	20 x 35 x 72	100	269	30	\$4174
L25W30H72	20 x 30 x 72	100	233	25	\$3483
L25W24H72	20 x 24 x 72	100	179	20	\$2790

L25D24	24 x 35 x 65	100	297	33	\$4391
L25D24W30	24 x 30 x 65	100	246	28	\$3836
L25D24W24	24 x 24 x 65	100	198	22	\$3289
L25	20 x 35 x 65	100	245	28	\$3826
L25W30	20 x 30 x 65	100	202	23	\$3193
L25W24	20 x 24 x 65	100	163	18	\$2559

Wardrobe compartment on **left** includes hanging rod and fixed hat shelf. Storage compartment on **right** includes three adjustable shelves.

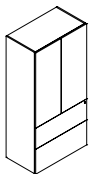

Two File Module w/Doors

L13D24H72	24 x 35 x 72	100	324	36	\$5279
L13D24W30H72	24 x 30 x 72	100	270	30	\$4620
L13H72	20 x 35 x 72	100	269	30	\$4611
L13W30H72	20 x 30 x 72	100	233	25	\$3846

L13D24	24 x 35 x 65	100	297	33	\$4842
L13D24W30	24 x 30 x 65	100	248	28	\$4232
L13	20 x 35 x 65	100	245	28	\$4228
L13W30	20 x 30 x 65	100	202	23	\$3526

Two lateral file drawers on bottom. Includes **two** adjustable shelves. Upper lock secures storage compartment. Lower lock secures two file drawers. **Not for stacking materials on lateral file drawer bottom.**

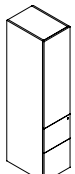

Two File Module w/Door - LEFT

L17D24H72L	24 x 16 x 72	125	99	15	\$3633
L17H72L	20 x 16 x 72	125	90	13	\$3090
L17D24L	24 x 16 x 65	125	91	13	\$3369
L17L	20 x 16 x 65	125	83	12	\$2833

Two file drawers on bottom. Includes two adjustable shelves. Upper lock secures storage compartment. Lower lock secures two file drawers. Handle is on the **right**, door opens to the **left**.

Required Specifications

Veneer Finish

**FREESTANDING STORAGE**

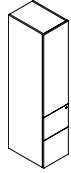

**Two File Module w/Door - RIGHT**

MODEL#	DIMENSIONS D x W x H	FREIGHT CLASS	WT/LBS.	CUBIC FT.	LIST PRICE
L17D24H72R	24 x 16 x 72	125	99	15	<b>\$3633</b>
L17H72R	20 x 16 x 72	125	90	13	<b>\$3090</b>
L17D24R	24 x 16 x 65	125	91	13	<b>\$3369</b>
L17R	20 x 16 x 65	125	83	12	<b>\$2833</b>

Two file drawers on bottom. Includes two adjustable shelves. Upper lock secures storage compartment. Lower lock secures two file drawers. Handle is on the **left**, door opens to the **right**.

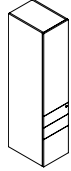

**Box/Box/File Module w/Door - LEFT**

L18D24H72L	24 x 16 x 72	125	99	15	<b>\$3633</b>
L18H72L	20 x 16 x 72	125	90	13	<b>\$3090</b>
L18D24L	24 x 16 x 65	125	91	13	<b>\$3369</b>
L18L	20 x 16 x 65	125	83	12	<b>\$2833</b>

Two box drawers and one file drawer on bottom. Includes two adjustable shelves. Upper lock secures storage compartment. Lower lock secures all drawers. Handle is on the **right**, door opens to the **left**.

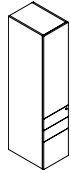

**Box/Box/File Module w/Door - RIGHT**

L18D24H72R	24 x 16 x 72	125	99	15	<b>\$3633</b>
L18H72R	20 x 16 x 72	125	90	13	<b>\$3090</b>
L18D24R	24 x 16 x 65	125	91	13	<b>\$3369</b>
L18R	20 x 16 x 65	125	83	12	<b>\$2833</b>

Two box drawers and one file drawer on bottom. Includes two adjustable shelves. Upper lock secures storage compartment. Lower lock secures all drawers. Handle is on the **left**, door opens to the **right**.

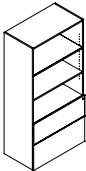

**Two File Module w/Open Shelves**

L12D24H72	24 x 35 x 72	100	324	36	<b>\$4637</b>
L12D24W30H72	24 x 30 x 72	100	270	30	<b>\$4056</b>
L12H72	20 x 35 x 72	100	269	30	<b>\$4047</b>
L12W30H72	20 x 30 x 72	100	233	25	<b>\$3541</b>
L12D24	24 x 35 x 65	100	297	33	<b>\$4250</b>
L12D24W30	24 x 30 x 65	100	248	28	<b>\$3718</b>
L12	20 x 35 x 65	100	245	28	<b>\$3706</b>
L12W30	20 x 30 x 65	100	239	23	<b>\$3096</b>

Three open veneer shelves and two lateral file drawers on bottom. Includes two adjustable shelves. Lock secures all drawers. Front-to-back and side-to-side filing. **Not for stacking materials on lateral file drawer bottom.**

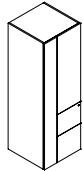

**Personal Tower - LEFT**

L29D24W24H72L	24 x 24 x 72	125	168	24	<b>\$5405</b>
L29W24H72L	20 x 24 x 72	125	140	20	<b>\$4418</b>
L29D24W24L	24 x 24 x 65	125	154	22	<b>\$4851</b>
L29W24L	20 x 24 x 65	125	128	18	<b>\$4002</b>

**Two file** drawers on bottom. Wardrobe compartment on **left** includes hanging rod. Storage compartment on **right** includes one adjustable shelf. Upper lock secures storage and wardrobe compartments. Lower lock secures all drawers.

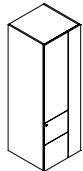

**Personal Tower - RIGHT**

L29D24W24H72R	24 x 24 x 72	125	168	24	<b>\$5405</b>
L29W24H72R	20 x 24 x 72	125	140	20	<b>\$4418</b>
L29D24W24R	24 x 24 x 65	125	154	22	<b>\$4851</b>
L29W24R	20 x 24 x 65	125	128	18	<b>\$4002</b>

**Two file** drawers on bottom. Wardrobe compartment on **right** includes hanging rod. Storage compartment on **left** includes one adjustable shelf. Upper lock secures storage and wardrobe compartments. Lower lock secures all drawers.

**Required Specifications**

Veneer Finish

FREESTANDING STORAGE

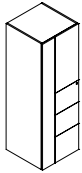

Personal Tower - LEFT

MODEL#	D x W x H	DIMENSIONS	FREIGHT CLASS	WT/LBS.	CUBIC FT.	LIST PRICE
L27D24W24H72L	24 x 24 x 72	24 x 24 x 72	125	168	24	\$5961
L27W24H72L	20 x 24 x 72	20 x 24 x 72	125	140	20	\$5212
L27D24W24L	24 x 24 x 65	24 x 24 x 65	125	154	22	\$5469
L27W24L	20 x 24 x 65	20 x 24 x 65	125	128	18	\$4774

Three file drawers on bottom. Wardrobe compartment on **left** includes hanging rod. Storage compartment on **right** includes one adjustable shelf. Upper lock secures storage and wardrobe compartments. Lower lock secures all drawers.

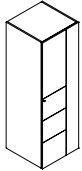

Personal Tower - RIGHT

L27D24W24H72R	24 x 24 x 72	24 x 24 x 72	125	168	24	\$5961
L27W24H72R	20 x 24 x 72	20 x 24 x 72	125	140	20	\$5212
L27D24W24R	24 x 24 x 65	24 x 24 x 65	125	154	22	\$5469
L27W24R	20 x 24 x 65	20 x 24 x 65	125	128	18	\$4774

Three file drawers on bottom. Wardrobe compartment on **right** includes hanging rod. Storage compartment on **left** includes one adjustable shelf. Upper lock secures storage and wardrobe compartments. Lower lock secures all drawers.

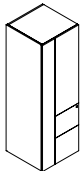

Personal Tower w/Open Bookcase - LEFT

L30D24W24H72L	24 x 24 x 72	24 x 24 x 72	125	168	24	\$5405
L30W24H72L	20 x 24 x 72	20 x 24 x 72	125	140	20	\$4418
L30D24W24L	24 x 24 x 65	24 x 24 x 65	125	154	22	\$4851
L30W24L	20 x 24 x 65	20 x 24 x 65	125	128	18	\$4002

Two file drawers on bottom. Wardrobe compartment on **left** includes hanging rod. Storage compartment on **right** includes one adjustable shelf. Open bookcase on **right** includes two adjustable shelves. Upper lock secures storage and wardrobe compartments. Lower lock secures all drawers.

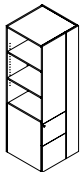

Personal Tower w/Open Bookcase - RIGHT

L30D24W24H72R	24 x 24 x 72	24 x 24 x 72	125	168	24	\$5405
L30W24H72R	20 x 24 x 72	20 x 24 x 72	125	140	20	\$4418
L30D24W24R	24 x 24 x 65	24 x 24 x 65	125	154	22	\$4851
L30W24R	20 x 24 x 65	20 x 24 x 65	125	128	18	\$4002

Two file drawers on bottom. Wardrobe compartment on **right** includes hanging rod. Storage compartment on **left** includes one adjustable shelf. Open bookcase on **left** includes two adjustable shelves. Upper lock secures storage and wardrobe compartments. Lower lock secures all drawers.

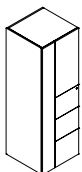

Personal Tower w/Open Bookcase - LEFT

L26D24W24H72L	24 x 24 x 72	24 x 24 x 72	125	168	24	\$5961
L26W24H72L	20 x 24 x 72	20 x 24 x 72	125	140	20	\$5901
L26D24W24L	24 x 24 x 65	24 x 24 x 65	125	154	22	\$5469
L26W24L	20 x 24 x 65	20 x 24 x 65	125	128	18	\$5452

Three file drawers on bottom. Wardrobe compartment on **left** includes hanging rod. Storage compartment on **right** includes one adjustable shelf. Open bookcase on **right** includes one adjustable shelf. Upper lock secures storage and wardrobe compartments. Lower lock secures all drawers.

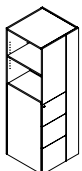

Personal Tower w/Open Bookcase - RIGHT

L26D24W24H72R	24 x 24 x 72	24 x 24 x 72	125	168	24	\$5961
L26W24H72R	20 x 24 x 72	20 x 24 x 72	125	140	20	\$5901
L26D24W24R	24 x 24 x 65	24 x 24 x 65	125	154	22	\$5469
L26W24R	20 x 24 x 65	20 x 24 x 65	125	128	18	\$5452

Three file drawers on bottom. Wardrobe compartment on **right** includes hanging rod. Storage compartment on **left** includes one adjustable shelf. Open bookcase on **left** includes one adjustable shelf. Upper lock secures storage and wardrobe compartments. Lower lock secures all drawers.

Required Specifications

Veneer Finish

## FREESTANDING STORAGE

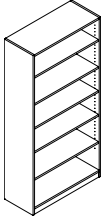

**Bookcase**



**End Shelf - 72" High - Square**

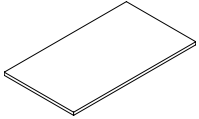

**Shelf for Bookcase**

MODEL#	DIMENSIONS D x W x H	FREIGHT CLASS	WT/LBS.	CUBIC FT.	LIST PRICE
LB73615	15 x 35 x 78	100	228	24	<b>\$2431</b>
LB63615	15 x 35 x 72	100	210	23	<b>\$2243</b>
LB53615	15 x 35 x 65	100	210	23	<b>\$2065</b>
LB73015	15 x 30 x 78	92.5	228	20	<b>\$2126</b>
LB63015	15 x 30 x 72	92.5	210	19	<b>\$1958</b>
LB53015	15 x 30 x 65	92.5	188	17	<b>\$1807</b>

Includes **adjustable** shelves. Shelf is 3/4" thick.

LB7S1515	15 x 15 x 78	100	95	10	<b>\$1916</b>
LB6S1515	15 x 15 x 72	100	83	9	<b>\$1764</b>
LB5S1515	15 x 15 x 65	100	81	9	<b>\$1624</b>
LB4S1515	15 x 15 x 48	100	59	6	<b>\$1341</b>

For use at end of **storage modules, wardrobe cabinets or personal towers**. Includes **adjustable** veneer shelves. Shipped RTA (ready to assemble).

MAG3624	24 x 35 x 1	92.5	112	10	<b>\$171</b>
MAG3620	20 x 35 x 1	92.5	92	9	<b>\$146</b>
MAG3615	15 x 35 x 1	92.5	81	8	<b>\$123</b>
MAG3024	24 x 30 x 1	92.5	94	9	<b>\$146</b>
MAG3020	20 x 30 x 1	100	76	8	<b>\$116</b>
MAG3015	15 x 30 x 1	100	67	8	<b>\$102</b>

**Required Specifications**

Veneer finish

FLOATING SHELVES

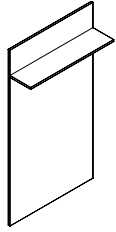

Wall Mounted Panel,  
One Floating Shelf

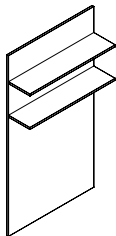

Wall Mounted Panel,  
Two Floating Shelves



End Cap

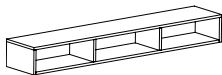

Wall Mounted Open Storage

MODEL# DIMENSIONS FREIGHT CLASS WT/LBS. CUBIC FT. LIST PRICE

D x W x H

TWF1S2466	11 x 24 x 66	250	42	13	<b>\$1508</b>
TWF1S3066	11 x 30 x 66	250	50	16	<b>\$1759</b>
TWF1S3666	11 x 36 x 66	250	58	19	<b>\$2034</b>
TWF1S4266	11 x 42 x 66	250	66	22	<b>\$2337</b>
TWF1S2472	11 x 24 x 72	250	45	14	<b>\$1605</b>
TWF1S3072	11 x 30 x 72	250	53	17	<b>\$1889</b>
TWF1S3672	11 x 36 x 72	250	62	20	<b>\$2151</b>
TWF1S4272	11 x 42 x 72	250	71	23	<b>\$2463</b>

Standard with pre-mounted "J" bracket for wall mount applications. End cap required at the end of a run of floating shelves. End cap sold separately.

**NOTE:** Care should be taken to mount the units. Units should be mounted to wall studs using correct fasteners. Failure to do so may result in collapse of the unit and subsequent personal injury. **Fastening hardware not included.** Mounting hardware used should be based on wall material. Consult an installation professional for proper wall mounting.

TWF2S2466	11 x 24 x 66	250	46	13	<b>\$1544</b>
TWF2S3066	11 x 30 x 66	250	56	16	<b>\$1811</b>
TWF2S3666	11 x 36 x 66	250	65	19	<b>\$2083</b>
TWF2S4266	11 x 42 x 66	250	74	21	<b>\$2409</b>
TWF2S2472	11 x 24 x 72	250	49	14	<b>\$1648</b>
TWF2S3072	11 x 30 x 72	250	59	17	<b>\$1952</b>
TWF2S3672	11 x 36 x 72	250	69	20	<b>\$2200</b>
TWF2S4272	11 x 42 x 72	250	79	23	<b>\$2532</b>

Standard with pre-mounted "J" bracket for wall mount applications. End cap required at the end of a run of floating shelves. End cap sold separately.

**NOTE:** Care should be taken to mount the units. Units should be mounted to wall studs using correct fasteners. Failure to do so may result in collapse of the unit and subsequent personal injury. **Fastening hardware not included.** Mounting hardware used should be based on wall material. Consult an installation professional for proper wall mounting.

ENDCAP66	.75 x 66 x 3	60	6	0.04	<b>\$819</b>
ENDCAP72	.75 x 72 x 3	60	8	0.05	<b>\$884</b>

For use with wall mounted panels.

CBYFO96D12H8	12 x 96 x 8	125	78	10	<b>\$2688</b>
CBYFO64D12H8	12 x 64 x 8	125	50	8	<b>\$1758</b>
CBYFO32D12H8	12 x 32 x 8	100	35	4	<b>\$1593</b>

To be used as a stand alone unit.

Required Specifications

Veneer finish



## WALLMOUNT STORAGE

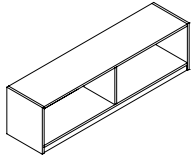

**Open Front Overhead Storage**

MODEL#	DIMENSIONS D x W x H	FREIGHT CLASS	WT/LBS.	CUBIC FT.	LIST PRICE
CSF072	15 x 72 x 17	92.5	100	10	<b>\$1840</b>
CSF066	15 x 66 x 17	100	83	9	<b>\$1689</b>
CSF060	15 x 60 x 17	100	75	8	<b>\$1540</b>
CSF054	15 x 54 x 17	100	68	7	<b>\$1390</b>
CSF048	15 x 48 x 17	100	60	7	<b>\$1235</b>
CSF042	15 x 42 x 17	100	55	6	<b>\$1138</b>
CSF036	15 x 36 x 17	92.5	50	5	<b>\$1121</b>
CSF030	15 x 30 x 17	92.5	45	4	<b>\$1099</b>

Includes pre-mounted "J" brackets for wall mount applications.

- **NOTE:** Care should be taken to mount the units. Units should be mounted to wall studs using correct fasteners. Failure to do so may result in collapse of the unit and subsequent personal injury. **Mounting hardware not included.** Mounting hardware used should be based on wall material. Consult an installation professional for proper wall mounting.

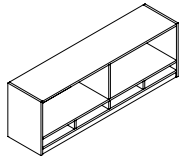

**Open Front Overhead Storage - Pigeon-Hole Storage**

CSFOP72	15 x 72 x 20	92.5	100	12	<b>\$2210</b>
CSFOP66	15 x 66 x 20	100	83	11	<b>\$2030</b>
CSFOP60	15 x 60 x 20	100	75	10	<b>\$1844</b>
CSFOP54	15 x 54 x 20	100	68	9	<b>\$1663</b>
CSFOP48	15 x 48 x 20	100	60	8	<b>\$1473</b>
CSFOP42	15 x 42 x 20	100	55	7	<b>\$1385</b>
CSFOP36	15 x 36 x 20	92.5	50	6	<b>\$1346</b>
CSFOP30	15 x 30 x 20	92.5	45	5	<b>\$1326</b>

Includes pre-mounted "J" brackets for wall mount applications. Horizontal pigeon-hole storage on bottom of overhead.

- **NOTE:** Care should be taken to mount the units. Units should be mounted to wall studs using correct fasteners. Failure to do so may result in collapse of the unit and subsequent personal injury. **Mounting hardware not included.** Mounting hardware used should be based on wall material. Consult an installation professional for proper wall mounting.

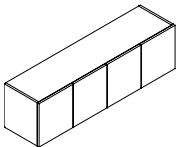

**Closed Front Overhead Storage with Hinge Doors**

CSF72	15 x 72 x 17	92.5	100	10	<b>\$2270</b>
CSF66	15 x 66 x 17	100	83	9	<b>\$2082</b>
CSF60	15 x 60 x 17	100	75	8	<b>\$1887</b>
CSF54	15 x 54 x 17	100	68	7	<b>\$1701</b>
CSF48	15 x 48 x 17	100	60	7	<b>\$1512</b>
CSF42	15 x 42 x 17	100	55	6	<b>\$1390</b>
CSF36	15 x 36 x 17	92.5	50	5	<b>\$1364</b>
CSF30	15 x 30 x 17	92.5	45	4	<b>\$1341</b>

Includes pre-mounted "J" brackets for wall mount applications.

- **NOTE:** Care should be taken to mount the units. Units should be mounted to wall studs using correct fasteners. Failure to do so may result in collapse of the unit and subsequent personal injury. **Mounting hardware not included.** Mounting hardware used should be based on wall material. Consult an installation professional for proper wall mounting.

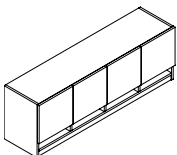

**Closed Front Overhead Storage with Hinge Doors & Pigeon-Hole Storage**

CSFP72	15 x 72 x 20	92.5	100	12	<b>\$2720</b>
CSFP66	15 x 66 x 20	100	83	11	<b>\$2495</b>
CSFP60	15 x 60 x 20	100	75	10	<b>\$2270</b>
CSFP54	15 x 54 x 20	100	68	9	<b>\$2043</b>
CSFP48	15 x 48 x 20	100	60	8	<b>\$1813</b>
CSFP42	15 x 42 x 20	100	55	7	<b>\$1720</b>
CSFP36	15 x 36 x 20	92.5	50	6	<b>\$1637</b>
CSFP30	15 x 30 x 20	92.5	45	5	<b>\$1610</b>

Includes pre-mounted "J" brackets for wall mount applications. Horizontal pigeon-hole storage on bottom of overhead.

- **NOTE:** Care should be taken to mount the units. Units should be mounted to wall studs using correct fasteners. Failure to do so may result in collapse of the unit and subsequent personal injury. **Mounting hardware not included.** Mounting hardware used should be based on wall material. Consult an installation professional for proper wall mounting.

### Required Specifications

Veneer finish

HUTCHES

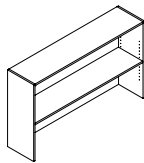

Open Hutch with Closed Back

MODEL# DIMENSIONS FREIGHT CLASS WT/LBS. CUBIC FT. LIST PRICE

D x W x H

L72CL36	14 x 72 x 36	125	155	23	\$2060
L66CL36	14 x 66 x 36	125	140	21	\$1911
L60CL36	14 x 60 x 36	125	130	19	\$1694
L48CL36	14 x 48 x 36	125	110	15	\$1615
L42CL36	14 x 42 x 36	125	95	13	\$1466
L36CL36	14 x 36 x 36	125	80	11	\$1369
L30CL36	14 x 30 x 36	125	67	9	\$1142

One adjustable shelf. Closed back. All hutches shipped pre-assembled.

- **A Tackboard cannot be used with this hutch.**

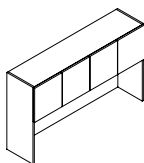

Closed Hutch w/Veneer Doors 36" High

L108SH36	15 x 108 x 36	125	268	34	\$5011
L102SH36	15 x 102 x 36	125	254	32	\$4733
L96SH36	15 x 96 x 36	100	241	30	\$4452
L90SH36	15 x 90 x 36	100	227	28	\$4174
L84SH36	15 x 84 x 36	100	214	26	\$3900
L78SH36	15 x 78 x 36	100	200	24	\$3622
L72SH36	15 x 72 x 36	100	187	23	\$3342
L66SH36	15 x 66 x 36	100	173	21	\$3218
L60SH36	15 x 60 x 36	100	160	19	\$3063
L36SH36	15 x 36 x 36	100	94	11	\$2090
L30SH36	15 x 30 x 36	100	78	9	\$1831

One fixed shelf. Closed back features one grommet. All hutches shipped pre-assembled.

- Models 108" w have three fixed shelf dividers.
- Models 84" w- 102" w have two fixed shelf dividers.
- Models 60" w - 78" w have one fixed shelf divider.
- Clearance from worksurface to valance is 19.5".

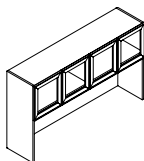

Closed Hutch w/Glass Doors 36" High

L108SH36G	15 x 108 x 36	125	268	34	\$7320
L102SH36G	15 x 102 x 36	125	254	32	\$6606
L96SH36G	15 x 96 x 36	100	241	30	\$6299
L90SH36G	15 x 90 x 36	100	227	28	\$5973
L84SH36G	15 x 84 x 36	100	214	26	\$5665
L78SH36G	15 x 78 x 36	100	200	24	\$5360
L72SH36G	15 x 72 x 36	100	187	23	\$4679
L66SH36G	15 x 66 x 36	100	173	21	\$4482
L60SH36G	15 x 60 x 36	100	160	19	\$4275
L36SH36G	15 x 36 x 36	100	94	11	\$2736
L30SH36G	15 x 30 x 36	100	78	9	\$2441

One fixed shelf. Closed back features one grommet. Aluminum frame available in Tungsten finish only. All hutches shipped pre-assembled. Translucent, screened glass.

- Models 108" w have three fixed shelf dividers.
- Models 84" w- 102" w have two fixed shelf dividers.
- Models 60" w - 78" w have one fixed shelf divider.
- Clearance from worksurface to valance is 19.5".
- **Locks are not available on hutches with Glass Doors.**

Required Specifications

Veneer finish

HUTCHES

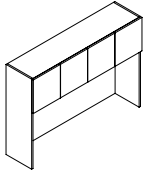

Closed Hutch w/Veneer Doors 42" H

MODEL#	DIMENSIONS D x W x H	FREIGHT CLASS	WT/LBS.	CUBIC FT.	LIST PRICE
L108SH42	15 x 108 x 42	125	307	39	\$5844
L102SH42	15 x 102 x 42	125	290	37	\$5515
L96SH42	15 x 96 x 42	100	273	35	\$5195
L90SH42	15 x 90 x 42	100	256	33	\$4867
L84SH42	15 x 84 x 42	100	239	31	\$4545
L78SH42	15 x 78 x 42	100	222	38	\$4223
L72SH42	15 x 72 x 42	100	205	26	\$3897
L66SH42	15 x 66 x 42	100	188	24	\$3756
L60SH42	15 x 60 x 42	100	171	22	\$3572
L36SH42	15 x 36 x 42	100	102	13	\$2435
L30SH42	15 x 30 x 42	100	85	11	\$2134

One fixed shelf. Closed back features one grommet. All hutches shipped pre-assembled.

- Models 108" w have three fixed shelf dividers.
- Models 84" w- 102" w have two fixed shelf dividers.
- Models 60" w - 78" w have one fixed shelf divider.
- Clearance from worksurface to valance is 19.5".

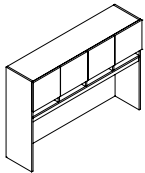

Closed Hutch w/Veneer Doors Pigeon-Hole Storage, 42" High

L108SHP42	15 x 108 x 42	125	307	39	\$7012
L102SHP42	15 x 102 x 42	125	290	37	\$6622
L96SHP42	15 x 96 x 42	100	273	35	\$6231
L90SHP42	15 x 90 x 42	100	256	33	\$5844
L84SHP42	15 x 84 x 42	100	239	31	\$5452
L78SHP42	15 x 78 x 42	100	222	38	\$5064
L72SHP42	15 x 72 x 42	100	205	26	\$4673
L66SHP42	15 x 66 x 42	100	188	24	\$4501
L60SHP42	15 x 60 x 42	100	171	22	\$4288
L36SHP42	15 x 36 x 42	100	102	13	\$2923
L30SHP42	15 x 30 x 42	100	85	11	\$2559

One fixed shelf. Closed back features one grommet. Horizontal pigeon-hole storage top mounted to hutch. All hutches shipped pre-assembled.

- Models 120" w- 108" w have three fixed shelf dividers.
- Models 84" w- 102" w have two fixed shelf dividers.
- Models 60" w - 78" w have one fixed shelf divider.
- Clearance from worksurface to valance is 21.5".

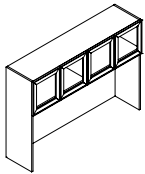

Closed Hutch w/Glass Doors 42" High

L108SH42G	15 x 108 x 42	125	307	39	\$7711
L102SH42G	15 x 102 x 42	125	290	37	\$6960
L96SH42G	15 x 96 x 42	100	273	35	\$6626
L90SH42G	15 x 90 x 42	100	256	33	\$6294
L84SH42G	15 x 84 x 42	100	239	31	\$5961
L78SH42G	15 x 78 x 42	100	222	38	\$5634
L72SH42G	15 x 72 x 42	100	205	26	\$4861
L66SH42G	15 x 66 x 42	100	188	24	\$4695
L60SH42G	15 x 60 x 42	100	171	22	\$4524
L36SH42G	15 x 36 x 42	100	102	13	\$2892
L30SH42G	15 x 30 x 42	100	85	11	\$2571

One fixed shelf. Closed back features one grommet. Aluminum frame available in Tungsten finish only. All hutches shipped pre-assembled. Translucent, screened glass.

- Models 120" w- 108" w have three fixed shelf dividers.
- Models 84" w- 102" w have two fixed shelf dividers.
- Models 60" w - 78" w have one fixed shelf divider.
- Clearance from worksurface to valance is 25.5".
- Locks are not available on hutches with Glass Doors.

Required Specifications

Veneer Finish

HUTCHES

MODEL# DIMENSIONS FREIGHT CLASS WT/LBS. CUBIC FT. LIST PRICE

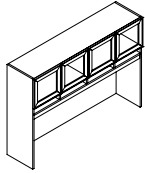

**Closed Hutch w/Glass Doors  
Pigeon-Hole Storage, 42" High**

MODEL#	D x W x H	FREIGHT CLASS	WT/LBS.	CUBIC FT.	LIST PRICE
L108SHP42G	15 x 108 x 42	125	307	39	<b>\$8773</b>
L102SHP42G	15 x 102 x 42	125	290	37	<b>\$7963</b>
L96SHP42G	15 x 96 x 42	100	273	35	<b>\$7589</b>
L90SHP42G	15 x 90 x 42	100	256	33	<b>\$7706</b>
L84SHP42G	15 x 84 x 42	100	239	31	<b>\$6778</b>
L78SHP42G	15 x 78 x 42	100	222	38	<b>\$6391</b>
L72SHP42G	15 x 72 x 42	100	205	26	<b>\$5571</b>
L66SHP42G	15 x 66 x 42	100	188	24	<b>\$5386</b>
L60SHP42G	15 x 60 x 42	100	171	22	<b>\$5136</b>
L36SHP42G	15 x 36 x 42	100	102	13	<b>\$3336</b>
L30SHP42G	15 x 30 x 42	100	85	11	<b>\$2977</b>

One fixed shelf. Closed back features one grommet. Aluminum frame available in Tungsten finish only. Horizontal pigeon-hole storage top mounted to hutch. All hutches shipped pre-assembled. Translucent, screened glass.

- Models 120"w- 108"w have three fixed shelf dividers.
- Models 84"w- 102"w have two fixed shelf dividers.
- Models 60"w - 78"w have one fixed shelf divider.
- *Clearance from worksurface to valance is 21.5".*
- **Locks are not available on hutches with Glass Doors.**

**Required Specifications**

Veneer Finish

## TACKBOARDS FOR OVERHEAD STORAGE

MODEL#	DIMENSIONS D x W x H	FREIGHT CLASS	WT/LBS.	CUBIC FT.	GR. 1-3	GR. 4-5
--------	-------------------------	---------------	---------	-----------	---------	---------

**TACKBOARD Notes:** Tackboards can be upholstered in all of the following fabrics:

**Grade 1:** Jenny, Quilt, Terrace, Urban, Waterfall

**Grade 2:** Imprint, Lola

**Grade 3:** Anchorage, Merge

LTS108	1 x 108 x 20	92.5	23	2	<b>\$893</b>	<b>\$1120</b>
LTS102	1 x 102 x 20	100	19	2	<b>\$843</b>	<b>\$1056</b>
LTS96	1 x 96 x 20	70	17	1	<b>\$795</b>	<b>\$998</b>
LTS90	1 x 90 x 20	70	15	1	<b>\$745</b>	<b>\$935</b>
LTS84	1 x 84 x 20	85	14	1	<b>\$698</b>	<b>\$877</b>
LTS78	1 x 78 x 20	85	13	1	<b>\$642</b>	<b>\$806</b>
LTS72	1 x 72 x 20	85	12	1	<b>\$597</b>	<b>\$750</b>
LTS66	1 x 66 x 20	92.5	11	1	<b>\$539</b>	<b>\$677</b>
LTS60	1 x 60 x 20	92.5	10	1	<b>\$499</b>	<b>\$627</b>
LTS36	1 x 36 x 20	125	8	1	<b>\$302</b>	<b>\$383</b>
LTS30	1 x 30 x 20	150	5	1	<b>\$252</b>	<b>\$317</b>

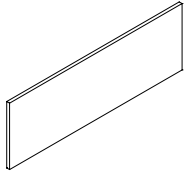

Tackboard for Hutch

For use on **36" H** hutches (**L\_SH36, L\_SH36G**). **Factory installed**, with velcro tape. Please specify hutch to be installed on. See "tackboard notes" exact fabric availability.

• **Not for use on non-Lufton hutches.**

LTS108H26	1 x 108 x 26	70	30	2	<b>\$1158</b>	<b>\$1450</b>
LTS102H26	1 x 102 x 26	85	24	2	<b>\$1095</b>	<b>\$1373</b>
LTS96H26	1 x 96 x 26	92.5	22	2	<b>\$1030</b>	<b>\$1291</b>
LTS90H26	1 x 90 x 26	92.5	20	2	<b>\$971</b>	<b>\$1216</b>
LTS84H26	1 x 84 x 26	100	18	2	<b>\$901</b>	<b>\$1129</b>
LTS78H26	1 x 78 x 26	100	17	2	<b>\$834</b>	<b>\$1046</b>
LTS72H26	1 x 72 x 26	70	16	1	<b>\$774</b>	<b>\$971</b>
LTS66H26	1 x 66 x 26	85	14	1	<b>\$707</b>	<b>\$887</b>
LTS60H26	1 x 60 x 26	85	13	1	<b>\$642</b>	<b>\$806</b>
LTS36H26	1 x 36 x 26	100	8	1	<b>\$391</b>	<b>\$493</b>
LTS30H26	1 x 30 x 26	150	5	1	<b>\$327</b>	<b>\$412</b>

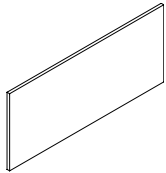

Tackboard for Hutch

For use on **42" H** hutches (**L\_SH42, L\_SH42**). **Factory installed**, with velcro tape. Please specify hutch to be installed on. See "tackboard notes" exact fabric availability.

• **Not for use on non-Lufton hutches.**

LTSP108H23	1 x 108 x 23	70	30	2	<b>\$1001</b>	<b>\$1256</b>
LTSP102H23	1 x 102 x 23	85	24	2	<b>\$959</b>	<b>\$1201</b>
LTSP96H23	1 x 96 x 23	92.5	20	2	<b>\$897</b>	<b>\$1124</b>
LTSP90H23	1 x 90 x 23	92.5	20	1	<b>\$843</b>	<b>\$1056</b>
LTSP84H23	1 x 84 x 23	70	18	1	<b>\$781</b>	<b>\$979</b>
LTSP78H23	1 x 78 x 23	70	17	1	<b>\$729</b>	<b>\$914</b>
LTSP72H23	1 x 72 x 23	70	16	1	<b>\$676</b>	<b>\$847</b>
LTSP66H23	1 x 66 x 23	85	14	1	<b>\$615</b>	<b>\$774</b>
LTSP60H23	1 x 60 x 23	85	13	1	<b>\$578</b>	<b>\$710</b>
LTSP36H23	1 x 36 x 23	100	8	1	<b>\$338</b>	<b>\$425</b>
LTSP30H23	1 x 30 x 23	150	5	1	<b>\$285</b>	<b>\$358</b>

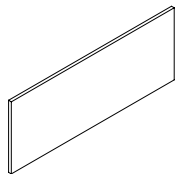

Tackboard for Hutch

For use on **42" H** hutches (**L\_SHP42, L\_SHP42G**) with Pigeon-Hole Storage. **Factory installed**, with velcro tape. Please specify hutch to be installed on. See "tackboard notes" exact fabric availability.

• **Not for use on non-Lufton hutches.**

### Required Specifications

Fabric

TACKBOARDS FOR OVERHEAD STORAGE

MODEL#	DIMENSIONS	FREIGHT CLASS	WT/LBS.	CUBIC FT.	GR. 1-3	GR. 4-5
	<b>D x W x H</b>					
LTSAS108	1 x 108 x 20	92.5	23	2	\$1578	\$1977
LTSAS102	1 x 102 x 20	100	19	2	\$1422	\$1780
LTSAS96	1 x 96 x 20	70	15	1	\$1402	\$1757
LTSAS90	1 x 90 x 20	70	15	1	\$1315	\$1648
LTSAS84	1 x 84 x 20	85	14	1	\$1228	\$1539
LTSAS78	1 x 78 x 20	85	13	1	\$1142	\$1431
LTSAS72	1 x 72 x 20	85	12	1	\$1050	\$1316
LTSAS66	1 x 66 x 20	92.5	11	1	\$966	\$1210
LTSAS60	1 x 60 x 20	92.5	10	1	\$879	\$1102
LTSAS36	1 x 36 x 20	125	6	1	\$525	\$660
LTSAS30	1 x 30 x 20	150	4	1	\$439	\$552

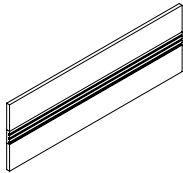

Tackboard for Hutch - Accessory Rail

For use on **36" H** hutches (**L\_SH36, L\_SH36G**). **Factory installed**, with velcro tape. Please specify hutch to be installed on. See "tackboard notes" exact fabric availability.

- **Must Specify Black (E) or Tungsten (K) Accessory Rail finish.**
- **Not for use on non-Lufton hutches.**

LTSAS108H26	1 x 108 x 26	70	23	2	\$1898	\$2377
LTSAS102H26	1 x 102 x 26	85	19	2	\$1787	\$2237
LTSAS96H26	1 x 96 x 26	92.5	15	1	\$1686	\$2112
LTSAS90H26	1 x 90 x 26	92.5	15	1	\$1584	\$1985
LTSAS84H26	1 x 84 x 26	100	14	1	\$1461	\$1828
LTSAS78H26	1 x 78 x 26	100	13	1	\$1369	\$1713
LTSAS72H26	1 x 72 x 26	70	12	1	\$1243	\$1557
LTSAS66H26	1 x 66 x 26	85	11	1	\$1158	\$1450
LTSAS60H26	1 x 60 x 26	85	10	1	\$1050	\$1316
LTSAS36H26	1 x 36 x 26	100	6	1	\$632	\$794
LTSAS30H26	1 x 30 x 26	150	4	1	\$532	\$668

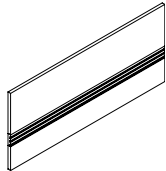

Tackboard for Hutch - Accessory Rail

For use on **42" H** hutches (**L\_SH42, L\_SH42G**). **Factory installed**, with velcro tape. Please specify hutch to be installed on. See "tackboard notes" exact fabric availability.

- **Must Specify Black (E) or Tungsten (K) Accessory Rail finish.**
- **Not for use on non-Lufton hutches.**

LTSPAS108H23	1 x 108 x 23	92.5	30	2	\$1712	\$2144
LTSPAS102H23	1 x 102 x 23	100	24	2	\$2134	\$2670
LTSPAS96H23	1 x 96 x 23	70	20	2	\$1523	\$1907
LTSPAS90H23	1 x 90 x 23	70	20	2	\$1433	\$1793
LTSPAS84H23	1 x 84 x 23	85	18	2	\$1335	\$1673
LTSPAS78H23	1 x 78 x 23	85	17	2	\$1239	\$1552
LTSPAS72H23	1 x 72 x 23	85	16	1	\$1142	\$1431
LTSPAS66H23	1 x 66 x 23	92.5	14	1	\$1050	\$1316
LTSPAS60H23	1 x 60 x 23	92.5	13	1	\$955	\$1196
LTSPAS36H23	1 x 36 x 23	125	6	1	\$575	\$722
LTSPAS30H23	1 x 30 x 23	150	4	1	\$482	\$605

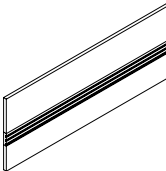

Tackboard for Hutch - Accessory Rail

For use on **42" H** hutches (**L\_SHP42, L\_SHP42G**) with Pigeon-Hole Storage. **Factory installed**, with velcro tape. Please specify hutch to be installed on. See "tackboard notes" exact fabric availability. List Price shown applies for all fabric grades.

- **Must Specify Black (E) or Tungsten (K) Accessory Rail finish.**
- **Not for use on non-Lufton hutches.**

**Required Specifications**

Fabric

WALLMOUNT TACKBOARDS

MODEL#	DIMENSIONS D x W x H	FREIGHT CLASS	WT/LBS.	CUBIC FT.	GR. 1-3	GR. 4-5
TS108	1 x 106 x 19	70	23	2	\$1370	\$1713
TS102	1 x 100 x 19	85	19	2	\$1298	\$1623
TS96	1 x 94 x 19	70	15	1	\$1214	\$1520
TS90	1 x 88 x 19	70	15	1	\$1141	\$1428
TS84	1 x 82 x 19	70	14	1	\$1069	\$1335
TS78	1 x 76 x 19	70	13	1	\$990	\$1238
TS72	1 x 70 x 19	70	12	1	\$557	\$698
TS66	1 x 64 x 19	85	11	1	\$512	\$644
TS60	1 x 58 x 19	85	10	1	\$471	\$592
TS36	1 x 34 x 19	100	6	1	\$302	\$383
TS30	1 x 28 x 19	150	4	1	\$251	\$316

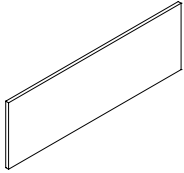

Tackboard - Wallmounted

For use on **16.5"H** overhead storage (CSFO\_, CSF\_, CSFF\_) at a finished height of 66". See "tackboard notes" exact fabric availability. List Price shown applies for all fabric grades.

- **NOTE:** Care should be taken to mount the units. Units should be mounted to wall studs using correct fasteners. Failure to do so may result in collapse of the unit and subsequent personal injury. **Mounting hardware not included.** Mounting hardware used should be based on wall material. Consult an installation professional for proper wall mounting.

TS108H26	1 x 106 x 26	70	30	2	\$1782	\$2229
TS102H26	1 x 100 x 26	85	24	2	\$1678	\$2098
TS96H26	1 x 94 x 26	92.5	20	2	\$1587	\$1986
TS90H26	1 x 88 x 26	92.5	20	2	\$1488	\$1859
TS84H26	1 x 82 x 26	100	18	2	\$1383	\$1729
TS78H26	1 x 76 x 26	100	17	2	\$1286	\$1609
TS72H26	1 x 70 x 26	70	16	1	\$714	\$897
TS66H26	1 x 64 x 26	85	14	1	\$658	\$825
TS60H26	1 x 58 x 26	85	13	1	\$601	\$755
TS36H26	1 x 34 x 26	100	8	1	\$378	\$475
TS30H26	1 x 28 x 26	150	5	1	\$317	\$401

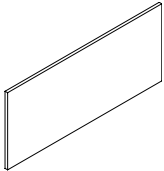

Tackboard - Wallmounted

For use on **16.5"H** overhead storage (CSFO\_, CSF\_) at a finished height of 72". See "tackboard notes" exact fabric availability. List Price shown applies for all fabric grades.

- **NOTE:** Care should be taken to mount the units. Units should be mounted to wall studs using correct fasteners. Failure to do so may result in collapse of the unit and subsequent personal injury. **Mounting hardware not included.** Mounting hardware used should be based on wall material. Consult an installation professional for proper wall mounting.

TSP108H23	1 x 106 x 23	70	30	2	\$1600	\$1920
TSP102H23	1 x 100 x 23	85	24	2	\$1525	\$1831
TSP96H23	1 x 94 x 23	92.5	20	2	\$1377	\$1720
TSP90H23	1 x 88 x 23	92.5	20	1	\$1286	\$1609
TSP84H23	1 x 82 x 23	70	18	1	\$1201	\$1501
TSP78H23	1 x 76 x 23	70	17	1	\$983	\$1195
TSP72H23	1 x 70 x 23	70	16	1	\$913	\$1147
TSP66H23	1 x 64 x 23	85	14	1	\$830	\$1041
TSP60H23	1 x 58 x 23	85	13	1	\$601	\$755
TSP36H23	1 x 34 x 23	100	8	1	\$458	\$474
TSP30H23	1 x 28 x 23	150	5	1	\$379	\$403

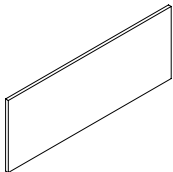

Tackboard - Wallmounted

For use on **19.5"H** overhead storage (CSFOP\_, CSFP\_) with Pigeon-Hole Storage at a finished height of 72". See "tackboard notes" exact fabric availability. List Price shown applies for all fabric grades.

- **NOTE:** Care should be taken to mount the units. Units should be mounted to wall studs using correct fasteners. Failure to do so may result in collapse of the unit and subsequent personal injury. **Mounting hardware not included.** Mounting hardware used should be based on wall material. Consult an installation professional for proper wall mounting.

**Required Specifications**  
Fabric

WALLMOUNT TACKBOARDS

MODEL#	DIMENSIONS D x W x H	FREIGHT CLASS	WT/LBS.	CUBIC FT.	GR. 1-3	GR. 4-5
TSAS108	1 x 106 x 20	92.5	23	2	\$2120	\$2653
TSAS102	1 x 100 x 20	100	19	2	\$2007	\$2505
TSAS96	1 x 94 x 20	70	15	1	\$1880	\$2355
TSAS90	1 x 88 x 20	70	15	1	\$1765	\$2209
TSAS84	1 x 82 x 20	85	14	1	\$1646	\$2060
TSAS78	1 x 76 x 20	85	13	1	\$1533	\$1918
TSAS72	1 x 70 x 20	85	12	1	\$1412	\$1769
TSAS66	1 x 64 x 20	92.5	11	1	\$1298	\$1627
TSAS60	1 x 58 x 20	92.5	10	1	\$1177	\$1473
TSAS36	1 x 34 x 20	125	6	1	\$706	\$880
TSAS30	1 x 28 x 20	150	4	1	\$548	\$687

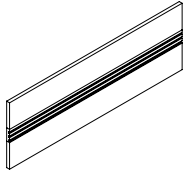

Tackboard - Accessory Rail, Wallmounted

For use on **16.5"H** overhead storage (**CSFO\_**, **CSF\_**) at a finished height of **66"**. See "tackboard notes" exact fabric availability. List Price shown applies for all fabric grades.

- **Must Specify Black (E) or Tungsten (K) Accessory Rail finish.**
- **NOTE:** Care should be taken to mount the units. Units should be mounted to wall studs using correct fasteners. Failure to do so may result in collapse of the unit and subsequent personal injury. **Mounting hardware not included.** Mounting hardware used should be based on wall material. Consult an installation professional for proper wall mounting.

TSAS108H26	1 x 106 x 26	70	23	2	\$2549	\$3187
TSAS102H26	1 x 100 x 26	85	19	2	\$2403	\$3005
TSAS96H26	1 x 94 x 26	92.5	15	1	\$2258	\$2826
TSAS90H26	1 x 88 x 26	92.5	15	1	\$2126	\$2660
TSAS78H26	1 x 76 x 26	100	13	1	\$1835	\$2295
TSAS72H26	1 x 70 x 26	70	12	1	\$1670	\$2090
TSAS66H26	1 x 64 x 26	85	11	1	\$1559	\$1945
TSAS60H26	1 x 58 x 26	85	10	1	\$1412	\$1769
TSAS36H26	1 x 34 x 26	100	6	1	\$851	\$1067
TSAS30H26	1 x 28 x 26	150	4	1	\$711	\$892

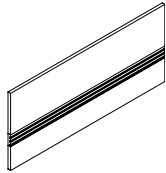

Tackboard - Accessory Rail, Wallmounted

For use on **16.5"H** overhead storage (**CSFO\_**, **CSF\_**) at a finished height of **72"**. See "tackboard notes" exact fabric availability. List Price shown applies for all fabric grades.

- **Must Specify Black (E) or Tungsten (K) Accessory Rail finish.**
- **NOTE:** Care should be taken to mount the units. Units should be mounted to wall studs using correct fasteners. Failure to do so may result in collapse of the unit and subsequent personal injury. **Mounting hardware not included.** Mounting hardware used should be based on wall material. Consult an installation professional for proper wall mounting.

TSPAS108H23	1 x 106 x 23	92.5	30	2	\$2297	\$2874
TSPAS102H23	1 x 100 x 23	100	24	2	\$2182	\$2731
TSPAS96H23	1 x 94 x 23	70	20	2	\$2051	\$2567
TSPAS90H23	1 x 88 x 23	70	20	2	\$1917	\$2399
TSPAS84H23	1 x 82 x 23	85	18	2	\$1791	\$2244
TSPAS78H23	1 x 76 x 23	85	17	2	\$1664	\$2081
TSPAS72H23	1 x 70 x 23	85	16	1	\$1539	\$1927
TSPAS66H23	1 x 64 x 23	92.5	14	1	\$1412	\$1769
TSPAS60H23	1 x 58 x 23	92.5	13	1	\$1279	\$1600
TSPAS36H23	1 x 34 x 23	125	8	1	\$640	\$803
TSPAS30H23	1 x 28 x 23	150	5	1	\$624	\$777

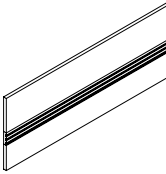

Tackboard - Accessory Rail, Wallmounted

For use on **19.5"H** overhead storage (**CSFOP\_**, **CSFP\_**) with Pigeon-Hole Storage at a finished height of **72"**. See "tackboard notes" exact fabric availability. List Price shown applies for all fabric grades.

- **Must Specify Black (E) or Tungsten (K) Accessory Rail finish.**
- **NOTE:** Care should be taken to mount the units. Units should be mounted to wall studs using correct fasteners. Failure to do so may result in collapse of the unit and subsequent personal injury. **Mounting hardware not included.** Mounting hardware used should be based on wall material. Consult an installation professional for proper wall mounting.

**Required Specifications**

Fabric



WALLMOUNT TACKBOARDS

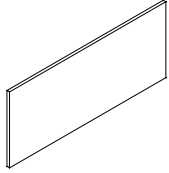

Tackboard - Wallmounted

MODEL#	DIMENSIONS D x W x H	FREIGHT CLASS	WT/LBS.	CUBIC FT.	GR. 1-3	GR. 4-5
TS108H25	1 x 106 x 25	92.5	23	2	\$1509	\$1884
TS102H25	1 x 100 x 25	100	19	2	\$1418	\$1776
TS96H25	1 x 94 x 25	70	17	1	\$1337	\$1668
TS90H25	1 x 88 x 25	70	15	1	\$1253	\$1569
TS84H25	1 x 82 x 25	85	14	1	\$1173	\$1468
TS78H25	1 x 76 x 25	85	13	1	\$1083	\$1355
TS72H25	1 x 70 x 25	85	12	1	\$1001	\$1256
TS66H25	1 x 64 x 25	92.5	11	1	\$920	\$1151
TS60H25	1 x 58 x 25	92.5	10	1	\$838	\$1051

For use on 16.5"H overhead storage (CSFO\_, CSF\_) mounted above 23"H credenzas for a finished height of 66". See "tackboard notes" exact fabric availability. List Price shown applies for all fabric grades

- **NOTE:** Care should be taken to mount the units. Units should be mounted to wall studs using correct fasteners. Failure to do so may result in collapse of the unit and subsequent personal injury. **Mounting hardware not included.** Mounting hardware used should be based on wall material. Consult an installation professional for proper wall mounting.

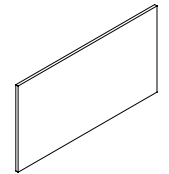

Tackboard - Wallmounted

TS108H32	1 x 106 x 32	70	30	2	\$1931	\$2409
TS102H32	1 x 100 x 32	85	24	2	\$1817	\$2274
TS96H32	1 x 94 x 32	92.5	20	2	\$1715	\$2148
TS90H32	1 x 88 x 32	92.5	20	2	\$1609	\$2014
TS84H32	1 x 82 x 32	100	18	2	\$1494	\$1873
TS78H32	1 x 76 x 32	100	17	2	\$1386	\$1736
TS72H32	1 x 70 x 32	70	16	1	\$1279	\$1600
TS66H32	1 x 64 x 32	85	14	1	\$1177	\$1473
TS60H32	1 x 58 x 32	85	13	1	\$1073	\$1342

For use on 16.5"H overhead storage (CSFO\_, CSF\_) mounted above 23"H credenzas for a finished height of 72". See "tackboard notes" exact fabric availability. List Price shown applies for all fabric grades

- **NOTE:** Care should be taken to mount the units. Units should be mounted to wall studs using correct fasteners. Failure to do so may result in collapse of the unit and subsequent personal injury. **Mounting hardware not included.** Mounting hardware used should be based on wall material. Consult an installation professional for proper wall mounting.

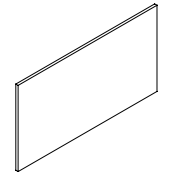

Tackboard - Wallmounted

TSP108H29	1 x 106 x 29	70	30	2	\$1745	\$2184
TSP102H29	1 x 100 x 29	85	24	2	\$1646	\$2060
TSP96H29	1 x 94 x 29	70	20	2	\$1550	\$1941
TSP90H29	1 x 88 x 29	70	20	2	\$1456	\$1821
TSP84H29	1 x 82 x 29	70	18	2	\$1355	\$1696
TSP78H29	1 x 76 x 29	70	17	2	\$1262	\$1573
TSP72H29	1 x 70 x 29	70	16	1	\$1160	\$1452
TSP66H29	1 x 64 x 29	85	14	1	\$1073	\$1342
TSP60H29	1 x 58 x 29	85	13	1	\$970	\$1215

For use on 16.5"H overhead storage (CSFO\_, CSF\_) mounted above 23"H credenzas for a finished height of 72". See "tackboard notes" exact fabric availability. List Price shown applies for all fabric grades

- **NOTE:** Care should be taken to mount the units. Units should be mounted to wall studs using correct fasteners. Failure to do so may result in collapse of the unit and subsequent personal injury. **Mounting hardware not included.** Mounting hardware used should be based on wall material. Consult an installation professional for proper wall mounting.

Required Specifications

Fabric

WALLMOUNT TACKBOARDS

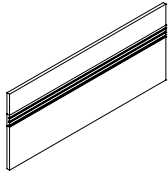

Tackboard - Accessory Rail, Wallmounted

MODEL#	DIMENSIONS D x W x H	FREIGHT CLASS	WT/LBS.	CUBIC FT.	GR. 1-3	GR. 4-5
TSAS108H25	1 x 106 x 25	92.5	23	2	\$2455	\$3070
TSAS102H25	1 x 100 x 25	100	19	2	\$2307	\$2887
TSAS96H25	1 x 94 x 25	70	15	1	\$2169	\$2716
TSAS90H25	1 x 88 x 25	70	15	1	\$2043	\$2557
TSAS78H25	1 x 76 x 25	85	13	1	\$1765	\$2209
TSAS72H25	1 x 70 x 25	85	12	1	\$1602	\$2006
TSAS66H25	1 x 64 x 25	92.5	11	1	\$1500	\$1880
TSAS60H25	1 x 58 x 25	92.5	10	1	\$1363	\$1706

For use on 16.5"H overhead storage (CSFO\_, CSF\_) mounted above 23"H credenzas for a finished height of 66". See "tackboard notes" exact fabric availability. List Price shown applies for all fabric grades

- **Must Specify Black (E) or Tungsten (K) Accessory Rail finish.**
- **NOTE:** Care should be taken to mount the units. Units should be mounted to wall studs using correct fasteners. Failure to do so may result in collapse of the unit and subsequent personal injury. **Mounting hardware not included.** Mounting hardware used should be based on wall material. Consult an installation professional for proper wall mounting.

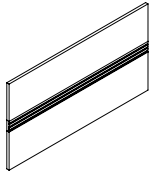

Tackboard - Accessory Rail, Wallmounted

TSAS108H32	1 x 106 x 32	70	23	2	\$3137	\$3923
TSAS102H32	1 x 100 x 32	85	19	2	\$2951	\$3690
TSAS96H32	1 x 94 x 32	92.5	15	1	\$2781	\$3480
TSAS90H32	1 x 88 x 32	92.5	15	1	\$2620	\$3272
TSAS78H32	1 x 76 x 32	100	13	1	\$2258	\$2826
TSAS72H32	1 x 70 x 32	70	12	1	\$2051	\$2567
TSAS66H32	1 x 64 x 32	85	11	1	\$1917	\$2399
TSAS60H32	1 x 58 x 32	85	10	1	\$1741	\$2178

For use on 16.5"H overhead storage (CSFO\_, CSF\_) mounted above 23"H credenzas for a finished height of 72". See "tackboard notes" exact fabric availability. List Price shown applies for all fabric grades

- **Must Specify Black (E) or Tungsten (K) Accessory Rail finish.**
- **NOTE:** Care should be taken to mount the units. Units should be mounted to wall studs using correct fasteners. Failure to do so may result in collapse of the unit and subsequent personal injury. **Mounting hardware not included.** Mounting hardware used should be based on wall material. Consult an installation professional for proper wall mounting.

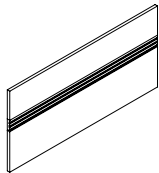

Tackboard - Accessory Rail, Wallmounted

TSPAS108H29	1 x 106 x 29	70	30	2	\$2846	\$3559
TSPAS102H29	1 x 100 x 29	85	24	2	\$2675	\$3341
TSPAS96H29	1 x 94 x 29	70	20	2	\$2518	\$3145
TSPAS90H29	1 x 88 x 29	70	20	2	\$2371	\$2968
TSPAS78H29	1 x 76 x 29	70	17	2	\$2051	\$2567
TSPAS72H29	1 x 70 x 29	70	16	1	\$1859	\$2328
TSPAS66H29	1 x 64 x 29	85	14	1	\$1741	\$2178
TSPAS60H29	1 x 58 x 29	85	13	1	\$1575	\$1974

For use on 16.5"H overhead storage (CSFO\_, CSF\_) mounted above 23"H credenzas for a finished height of 72". See "tackboard notes" exact fabric availability. List Price shown applies for all fabric grades

- **Must Specify Black (E) or Tungsten (K) Accessory Rail finish.**
- **NOTE:** Care should be taken to mount the units. Units should be mounted to wall studs using correct fasteners. Failure to do so may result in collapse of the unit and subsequent personal injury. **Mounting hardware not included.** Mounting hardware used should be based on wall material. Consult an installation professional for proper wall mounting.

Required Specifications

Fabric

## PIGEON-HOLE STORAGE

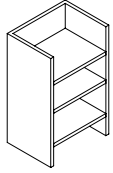

**Vertical Pigeon-Hole Storage\***

MODEL#	DIMENSIONS D x W x H	FREIGHT CLASS	WT/LBS.	CUBIC FT.	GR. 1-3	GR. 4-5
CPH161226	12 x 16 x 26	125	20	3	<b>\$707</b>	
CPH161223	12 x 16 x 23	125	18	3	<b>\$600</b>	
CPH161219	12 x 16 x 19	125	15	2	<b>\$456</b>	
CPH131226	12 x 13 x 26	100	16	2	<b>\$575</b>	
CPH131223	12 x 13 x 23	125	15	2	<b>\$488</b>	
CPH131219	12 x 13 x 19	125	12	2	<b>\$368</b>	

Used in conjunction with overhead storage units and hutches that incorporate horizontal pigeon-hole storage. Not freestanding. Shipped RTA (ready to assemble).

## ACCESSORY RAIL/PANEL ORGANIZERS

**Available Finishes:**

BLK	Black	SIL	Silver
CHR	Charcoal	TPE	Taupe
DWT	Designer White	TUN	Tungsten
NEV	Nevada		

## ACCESSORIES

MODEL#	DIMENSIONS	FREIGHT CLASS	WT/LBS.	CUBIC FT.	LIST PRICE
--------	------------	---------------	---------	-----------	------------

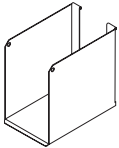

**Binder Bin\*\***

BABB01	10.25 x 4 x 9	100	2	.21	<b>\$70</b>
--------	---------------	-----	---	-----	-------------

Load bar/accessory rail mounted metal binder bin.

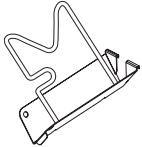

**Flip Sorter\*\***

BAFS01	9.25 x 2.75 x 9.25	70	.06	.14	<b>\$54</b>
--------	--------------------	----	-----	-----	-------------

Load bar/accessory rail mounted metal flip sorter. Comes with chrome wire.

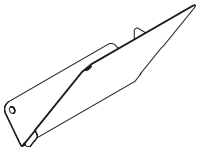

**Slant Sorter**

BASS01L (Left)	10.25 x 5 x 9.5	70	1	.28	<b>\$44</b>
BASS01R (Right)	10.25 x 5 x 9.5	70	1	.28	<b>\$44</b>

Load bar/accessory rail mounted metal slant sorter.

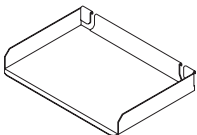

**Letter Tray**

BALTO1	9.25 x 13.5 x 2	70	.50	.15	<b>\$58</b>
--------	-----------------	----	-----	-----	-------------

Load bar/accessory rail mounted metal letter tray.

**Required Specifications**

- Fabric
- Veneer finish\*
- Metal finish\*\*

**ACCESSORY RAIL/ PANEL ORGANIZERS**      **MODEL#**      **DIMENSIONS**      **FREIGHT CLASS**      **WT/LBS.**      **CUBIC FT.**      **LIST PRICE**

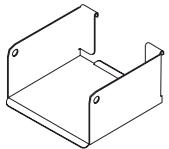

**Media Bin**

D x W x H						
BAMB01	5.25 x 5.75 x 3	70	.08	.05		<b>\$58</b>

Load bar/accessory rail mounted metal media bin.

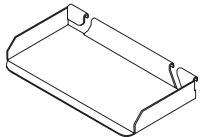

**Utility Tray**

BAUT01	3.75 x 5.75 x 3	70	.05	.02		<b>\$38</b>
--------	-----------------	----	-----	-----	--	-------------

Load bar/accessory rail mounted metal utility tray.

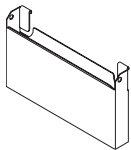

**Mail Box**

BAPP01	2.75 x 16 x 9	100	2	.25		<b>\$88</b>
--------	---------------	-----	---	-----	--	-------------

Load bar/accessory rail mounted metal mail box.

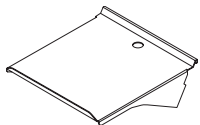

**Telephone Holder**

BATH01	10 x 9 x 2	125	2	.26		<b>\$85</b>
--------	------------	-----	---	-----	--	-------------

Load bar/accessory rail mounted metal telephone holder.

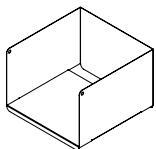

**Elevated Shelf Binder Bin**

BRTSBBIN	12 x 12 x 8	100	6	.66		<b>\$181</b>
----------	-------------	-----	---	-----	--	--------------

Load bar/accessory rail mounted elevated shelf binder bin.

**Required Specifications**  
Metal finish

## RECEPTION DESKS

### MODEL#

### DIMENSIONS

### FREIGHT CLASS

### WT./LBS.

### CUBIC FT.

### LIST PRICE

D x W x H

- To add storage use storage shells. See page 298 .
- Includes GM1 grommet.
- Transaction tops to be specified separately, handed by square edge from user side.
- Decorative Front Panels should be specified separately. Size chosen should be 12" less than desk dimensions. Available in Reverse Diamond, Vertical Rib, Vertical Grain and Horizontal Grain Patterns.

### OPTION DETAILS

Decorative Front Panel (Reverse Diamond Pattern)  
GFDP5430F

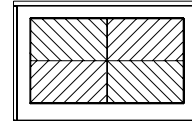

Decorative Front Panel (Vertical Rib Pattern)  
GFDP5430RIB

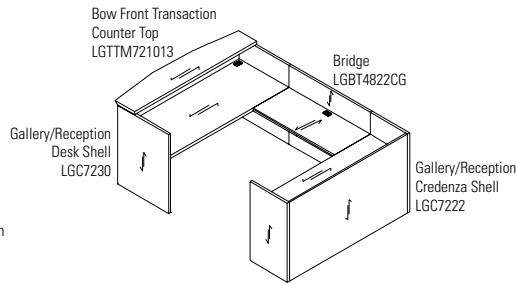
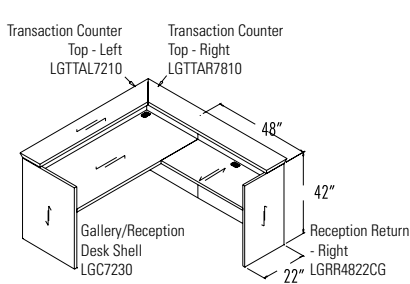
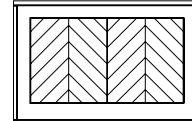

## RECEPTION DESKS

### MODEL#

### DIMENSIONS

### FREIGHT CLASS

### WT./LBS.

### CUBIC FT.

### LIST PRICE

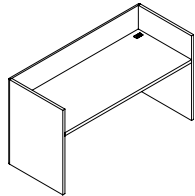

**Gallery/Reception Desk Shell**

LGC10836	36 x 108 x 42	150	533	95	<b>\$7449</b>
LGC10236	36 x 102 x 42	150	503	89	<b>\$7035</b>
LGC9636	36 x 96 x 42	150	473	84	<b>\$6622</b>
LGC9036	36 x 90 x 42	150	444	79	<b>\$6208</b>
LGC8436	36 x 84 x 42	150	414	74	<b>\$5796</b>
LGC7236	36 x 72 x 42	150	355	63	<b>\$4968</b>
LGC7230	30 x 72 x 42	150	315	53	<b>\$4809</b>
LGC6630	30 x 66 x 42	125	295	48	<b>\$4330</b>
LGC6030	30 x 60 x 42	125	275	44	<b>\$4690</b>

No pedestals. Two grommets in worksurface. For use with modular storage components.

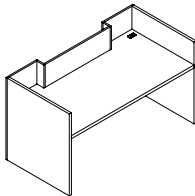

**Gallery/Reception Desk Shell  
Breakfront Style**

LGIC10836	36 x 108 x 42	150	533	95	<b>\$9161</b>
LGIC10236	36 x 102 x 42	150	503	89	<b>\$8643</b>
LGIC9636	36 x 96 x 42	150	473	84	<b>\$8145</b>
LGIC9036	36 x 90 x 42	150	444	79	<b>\$7631</b>
LGIC8436	36 x 84 x 42	150	414	74	<b>\$7131</b>
LGIC7236	36 x 72 x 42	150	355	63	<b>\$6100</b>
LGIC7230	30 x 72 x 42	150	315	53	<b>\$5907</b>
LGIC6630	30 x 66 x 42	125	295	48	<b>\$5757</b>
LGIC6030	30 x 60 x 42	125	275	44	<b>\$5426</b>

No pedestals. Two grommets in worksurface. For use with modular storage components.

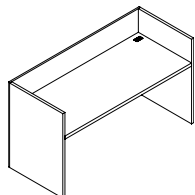

**Gallery/Reception Credenza Shell**

LGC10824	24 x 108 x 42	150	353	63	<b>\$5839</b>
LGC10224	24 x 102 x 42	150	333	60	<b>\$5522</b>
LGC9624	24 x 96 x 42	150	314	56	<b>\$5188</b>
LGC9024	24 x 90 x 42	150	294	53	<b>\$4861</b>
LGC8424	24 x 84 x 42	150	274	49	<b>\$4545</b>
LGC7224	24 x 72 x 42	150	235	42	<b>\$3900</b>
LGC6624	24 x 66 x 42	150	216	39	<b>\$3660</b>
LGC6024	24 x 60 x 42	150	196	35	<b>\$3429</b>

No pedestals. Two grommets in worksurface. For use with modular storage components.

### Required Specifications

Metal Finish (Accessories)  
Veneer Finish  
Edge

RECEPTION DESKS

MODEL# DIMENSIONS FREIGHT CLASS WT/LBS. CUBIC FT. LIST PRICE

D x W x H

LGBT5624CG	24 x 56 x 42	150	178	32	\$3272
LGBT5424CG	24 x 54 x 42	150	169	29	\$3272
LGBT5024CG	24 x 50 x 42	150	151	27	\$2902
LGBT4824CG	24 x 48 x 42	150	142	26	\$2902
LGBT4424CG	24 x 44 x 42	150	134	23	\$2549
LGBT4224CG	24 x 42 x 42	150	127	22	\$2549
LGBT3824CG	24 x 38 x 42	150	119	20	\$2291
LGBT3624CG	24 x 36 x 42	150	112	19	\$2291

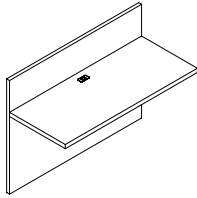

Bridge

Attaches between **Gallery Desk and Gallery Credenza Only**. One grommet in center of worksurface. Shipped RTA (ready to assemble).

- To remove cross-grain veneer pattern on top, **delete "CG"** from model number. Available as a special - no upcharge.

LGRL7224	24 x 72 x 42	125	273	42	\$4900
LGRL6624	24 x 66 x 42	125	250	39	\$4501
LGRL6024	24 x 60 x 42	125	228	35	\$4096
LGRL5424	24 x 54 x 42	125	205	32	\$3681
LGRL4824	24 x 48 x 42	125	182	28	\$3272
LGRL4224	24 x 42 x 42	125	159	25	\$2866
LGRL3624	24 x 36 x 42	125	137	21	\$2571

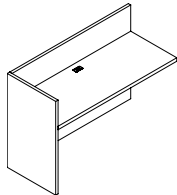

Reception Return - LEFT

No pedestal. One grommet in center of worksurface. For use with modular storage components.

LGRR7224	24 x 72 x 42	125	273	42	\$4900
LGRR6624	24 x 66 x 42	125	250	39	\$4501
LGRR6024	24 x 60 x 42	125	228	35	\$4096
LGRR5424	24 x 54 x 42	125	205	32	\$3681
LGRR4824	24 x 48 x 42	125	182	28	\$3272
LGRR4224	24 x 42 x 42	125	159	25	\$2866
LGRR3624	24 x 36 x 42	125	137	21	\$2571

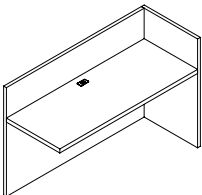

Reception Return - RIGHT

No pedestal. One grommet in center of worksurface. For use with modular storage components.

LGTT10810	10 x 108 x 1.50	100	78	8	\$1385
LGTT10210	10 x 102 x 1.50	92.5	72	7	\$1312
LGTT9610	10 x 96 x 1.50	100	66	7	\$1235
LGTT9010	10 x 90 x 1.50	92.5	60	6	\$1158
LGTT8410	10 x 84 x 1.50	100	54	6	\$1083
LGTT7210	10 x 72 x 1.50	100	48	5	\$918
LGTT6610	10 x 66 x 1.50	100	42	5	\$843
LGTT6010	10 x 60 x 1.50	100	36	4	\$766

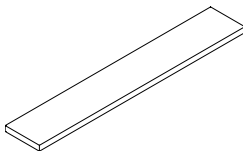

Transaction Counter Top

**Rectangular top** for main reception desk. Counter sits on top of Gallery panels. Does not overhang. **Factory installed - specify Gallery to be used on.** Size must match dimension of desk front or combined desk side and return length. Hardware included.

LGTTM1081013	10-13 x 108 x 1.50	125	78	10	\$2173
LGTTM1021013	10-13 x 102 x 1.50	100	72	9	\$2056
LGTTM961013	10-13 x 96 x 1.50	125	66	9	\$1932
LGTTM901013	10-13 x 90 x 1.50	125	60	8	\$1807
LGTTM841013	10-13 x 84 x 1.50	125	54	8	\$1689
LGTTM721013	10-13 x 72 x 1.50	125	48	7	\$1452
LGTTM661013	10-13 x 66 x 1.50	125	42	6	\$1329
LGTTM601013	10-13 x 60 x 1.50	125	36	5	\$1205

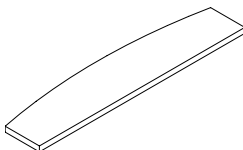

Bow Front Transaction Counter Top

**Bow top** for main reception desk. Counter sits on top of Gallery panels. Bow front overhangs 3". **Factory installed - specify Gallery to be used on.** Size must match dimension of desk front or combined desk side and return length. Hardware included.

**Required Specifications**

- Veneer Finish
- Edge

**RECEPTION DESKS**

**MODEL# DIMENSIONS FREIGHT CLASS WT/LBS. CUBIC FT. LIST PRICE**

**D x W x H**

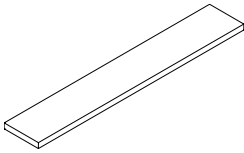

**Transaction Counter Top - Glass**

GTT10810G	10 x 108 x 1.50	100	78	8	<b>\$3161</b>
GTT10210G	10 x 102 x 1.50	92.5	72	7	<b>\$3043</b>
GTT9610G	10 x 96 x 1.50	100	66	7	<b>\$2923</b>
GTT9010G	10 x 90 x 1.50	92.5	60	6	<b>\$2805</b>
GTT8410G	10 x 84 x 1.50	100	54	6	<b>\$2689</b>
GTT7210G	10 x 72 x 1.50	100	48	5	<b>\$2515</b>
GTT6610G	10 x 66 x 1.50	100	42	5	<b>\$2398</b>
GTT6010G	10 x 60 x 1.50	100	36	4	<b>\$2281</b>

**Rectangular top** for main reception desk. Counter sits on top of Gallery panels. Does not overhang. **Factory installed - specify Gallery to be used on.** Size must match dimension of desk front or combined desk side and return length. Hardware included. 3/4" clear glass over wood subtop.

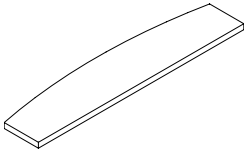

**Bow Front Transaction Counter Top - Glass**

GTTM1081013G	10-13 x 108 x 1.50	125	78	10	<b>\$3900</b>
GTTM1021013G	10-13 x 102 x 1.50	100	72	9	<b>\$3826</b>
GTTM961013G	10-13 x 96 x 1.50	125	66	9	<b>\$3788</b>
GTTM901013G	10-13 x 90 x 1.50	125	60	8	<b>\$3622</b>
GTTM841013G	10-13 x 84 x 1.50	125	54	8	<b>\$3445</b>
GTTM721013G	10-13 x 72 x 1.50	125	48	7	<b>\$3166</b>
GTTM661013G	10-13 x 66 x 1.50	125	42	6	<b>\$2989</b>
GTTM601013G	10-13 x 60 x 1.50	125	36	5	<b>\$2822</b>

**Bow top** for main reception desk. Counter sits on top of Gallery panels. Bow front overhangs 3". **Factory installed - specify Gallery to be used on.** Size must match dimension of desk front or combined desk side and return length. Hardware included. 3/4" clear glass over wood subtop.

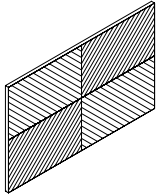

**Decorative Front Panel Reverse Diamond Pattern**

GFDP9630F	1 x 96 x 30	92.5	81	8	<b>\$1787</b>
GFDP9030F	1 x 90 x 30	100	78	8	<b>\$1674</b>
GFDP8430F	1 x 84 x 30	92.5	72	7	<b>\$1561</b>
GFDP7230F	1 x 72 x 30	100	66	7	<b>\$1341</b>
GFDP6030F	1 x 60 x 30	92.5	60	6	<b>\$1121</b>
GFDP5430F	1 x 54 x 30	100	54	6	<b>\$1007</b>
GFDP4830F	1 x 48 x 30	100	48	5	<b>\$897</b>

Raised decorative front panel for a reception desk. Size should be 12" less than desk dimensions. **Factory installed.** Hardware included.

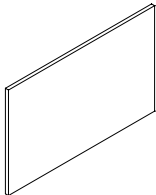

**Decorative Front Panel Vertical Grain Pattern**

GFDP9630V	1 x 96 x 30	92.5	81	8	<b>\$1558</b>
GFDP9030V	1 x 90 x 30	100	78	8	<b>\$1461</b>
GFDP8430V	1 x 84 x 30	92.5	72	7	<b>\$1364</b>
GFDP7230V	1 x 72 x 30	100	66	7	<b>\$1165</b>
GFDP6030V	1 x 60 x 30	92.5	60	6	<b>\$971</b>
GFDP5430V	1 x 54 x 30	100	54	6	<b>\$879</b>
GFDP4830V	1 x 48 x 30	100	48	5	<b>\$777</b>

Raised decorative front panel for a reception desk. Size should be 12" less than desk dimensions. **Factory installed.** Hardware included.

**Required Specifications**

- Metal Finish (Accessories)
- Veneer Finish
- Edge

RECEPTION DESKS - CURVED

MODEL# DIMENSIONS FREIGHT CLASS WT/LBS. CUBIC FT. LIST PRICE

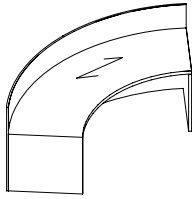

Gallery/Reception Curved Desk Shell\*\*

	D x W x H					
LGCCUS10630H36	30 x 106 x 36	100	647	72	\$13728	
LGCCUS10630H42	30 x 106 x 42	100	592	66	\$15788	

No pedestals. For use with modular storage components.

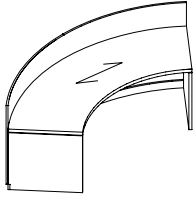

Gallery/Reception Curved Desk Shell\*\*

LGCKCUS10630H36	30 x 106 x 36	100	647	72	\$14413	
LGCKCUS10630H42	30 x 106 x 42	100	592	66	\$16577	

Includes recessed kick plate. No pedestals. For use with modular storage components.

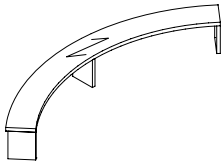

Wood Curved Transaction Counter\*

LGTTMCUS10610	10 x 106 x 1.5	150	84	19	\$6228	
---------------	----------------	-----	----	----	--------	--

Curved wood transaction top.

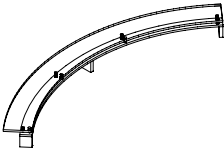

Glass Curved Transaction Counter

GCCCUS10610G	10 x 106 x 0.75	150	84	19	\$11423	
--------------	-----------------	-----	----	----	---------	--

3/4" clear glass bow front transaction counter over wood subtop.

Required Specifications

Veneer Finish\*  
Edge\*

Optional Specifications

Grommet\*



DESKS                      MODEL#                      DIMENSIONS                      FREIGHT CLASS                      WT./LBS.                      CUBIC FT.                      VENEER/LAMINATE                      ALL VENEER

D x W x H

**Required Specifications**

Veneer finish  
Edge  
Handle style

**Optional Specifications**

Grommet

# philadelphia





Philadelphia detailing is traditional with a 1" overhang on all edges. Solid walnut, cherry, maple, oak that bands worksurface perimeter is 1" wide by 1-3/8" thick for an overall thickness of 1-3/8". Philadelphia is a "top over pedestal" detailed series. Philadelphia is standard with a base. Floor storage unit bases (i.e. kick-plates on pedestals, lateral files, bookcases, etc.) are extended out over drawer faces and horizontally grained. Products that are normally positioned against walls, such as credenzas, have a self-edge veneered back edge detail. All primary faces have pin molding decorations.

This elegantly designed traditional furniture series employs state-of-the-art manufacturing to create traditional pieces for executive offices, conference rooms and reception areas. Philadelphia is characterized by solid-wood edge detailing with solid-wood moldings on the cases and brass hardware throughout. The finest clear hardwoods are hand-selected to ensure that the best quality and consistency is achieved. Each piece is protected with a catalyzed conversion varnish to provide one of the most durable finishes in the industry. Philadelphia makes a truly impressive statement for the discerning customer.



**Features and Benefits**

- Philadelphia is a traditional collection characterized by craftsmanship and elegance
- Solid-wood edge detailing with solid-wood moldings on the cases and brass hardware throughout
- Drawers are standard vinyl-wrapped construction with black drawer sides and bottom.
- Pedestals feature antique brass handles, profiled drawer fronts and maple drawer interiors.
- The base is profiled, with pin moldings on desk fronts and sides.
- Bronze glass is standard with clear glass available as an option.
- Modesty panel upgrades are available on select models.

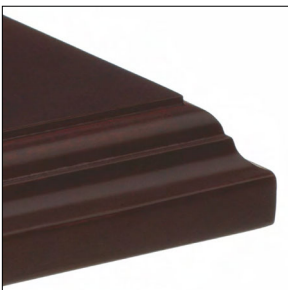

1-3/8" thick solid hardwood edge

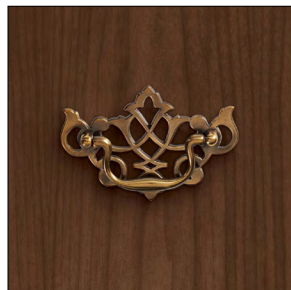

Antique brass pull (PL40)

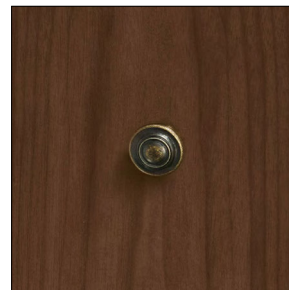

Knob on uppers (DK25)

## GENERAL INFORMATION

- Philadelphia is comprised of hundreds of models for the traditional executive suite and coordinating meeting areas.
- Solid wood is used on all perimeter worksurface edges, as well as end panel bottoms for mounting leveling glides
- 1" overhang with a traditional detailing is featured on all user and approach sides.
- Brass bulls exclusive to Philadelphia detail the traditional style of the product.
- GM5 grommets are standard on all designated worksurfaces.
- **Level certified**

## CONSTRUCTION

- Number One select, architectural grade "A" oak, American black walnut, American black cherry or maple. Wood worksurface molded edges are solid oak, walnut, cherry, or maple.
- Traditional detailing with 1" overhang on all edges.
- Solid walnut, cherry, maple, oak that bands worksurface perimeter is 1" wide by 1-3/8" thick for an overall thickness of 1-3/8".

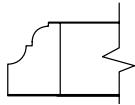

### Edge detail

- Top over pedestal design
- Products that are normally positioned against walls, such as credenzas, have a self-edge veneered back edge detail. All primary faces have pin molding decorations.

## FINISHES

- Conversion varnish (similar to catalyzed lacquer, but tougher), 25 degree sheen. Finishes are not buffed or rubbed.
- All Global wood casegood products are veneered and finished on the back sides (360° finishing), except modular under-surface storage - tops and backs are unfinished.
- Touch up kits available, includes a touch up marker and fill crayon. Order **VTOUCHUPKIT, \$164** list. Specify finish when ordering.
- Global standard finish, on oak and walnut, is open pore and on cherry and maple is semi-closed pore. If a full finish is required for walnut, cherry, anigre and maple tops, Add the suffix "2" to the finish code and Add 5% to the base pricing for each product.

### CUSTOM FINISH IS AVAILABLE.

## PEDESTALS

- Full-to-the-floor. Pedestals are fully assembled units that are either installed into desk and credenza shells, or available as modular units. Undersurface storage units include locks.
- Pedestal drawer suspensions are metal ball bearing type. Both box and file drawers are full extension.
- Drawers are standard vinyl-wrapped construction with black drawer sides and bottom.
- The drawer front is an applied element to a four sided drawer. Drawer fronts are veneered on all surfaces except the vertical edges, which are solid oak, walnut, cherry and maple then routed with series detailing. Drawer fronts can be removed or replaced in the field.
- Levelers have 1" range of adjustment.

## LOCKS

- Locks are standard on all below worksurface level drawer and door storage units, with the exception of pull-out tray units and single lateral file drawer combination tray/slot units.
- Combination storage unit comes with lock for file and lateral file drawer only; box drawers cannot lock.
- Lock color will match the handle option.
- Locks are optional on all above worksurface level closed storage

## HANDLES

- All drawer fronts come with traditional antique brass finished handles centered on drawer faces. All cabinet doors come with knobs in the same finish.



PL40 Brass Pull, 4.5"

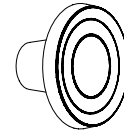

DK25 Knob on Uppers

## HARDWARE

- All necessary hardware items for attaching furniture items are included in the shipment. Actual wall attachment fasteners for wall cabinets, tackboards and visual boards are not included due to variation between site conditions.

## LEVELING GLIDES

- Shipped in a plastic bag attached to the bottom of the item or inside the pedestal. It is important to install leveling glides to ensure the unit is level. Levelers have a 1" range of adjustment.

## HANGING FILE RAILS

- Pre-installed on file drawer perimeters and accommodate both legal and letter size filing. Legal filing can be achieved either as side-to-side or front-to-back. Letter filing can be achieved as front-to-back filing only.

## FLAT PLATES

- Flat plates are used to attach bridges and returns to desks and are shipped pre-attached to the bottom of the bridge or return.
  - Mini flat plates for securing bridge back panels to desk or credenza end panels, and quick connectors for securing modular corner units to adjacent pieces, are shipped along with screws in a plastic bag attached to the bottom of the bridge or return.
- CAUTION:** Using screws other than those supplied by Global could result in damage to finished tops.

**WALL-MOUNTED CABINETS, TACKBOARDS AND VISUAL BOARDS**

- Pre-attached with horizontal wall rails to the back of each unit. The wall-side components must be detached from the unit and fastened to the wall accordingly.
- Wall fasteners are not included due to the variable site conditions. Securing the wall rail to a vertical structural member is the required manner of installation. The cabinet or visual board is then lowered on to the wall rail. It is important to level the wall rail before installation.
- Wall cabinets are equipped with levelers at the bottom of the back panels for proper cabinet alignment.
- Units with doors are equipped with adjustable European door hinges to assist in door alignment. It is required to use a #8 wood screw through the back of the cabinet and the wall-mounted rail, to further secure the wall attachment.
- Tackboards have vertical grooves in the back for tasklight wiring.
- Hutches and tackboards are installed with double faced tape applied to the bottom of the end panels. The tape is shipped in a plastic bag found in the hutch. Removal of the hutch requires moderate pressure to be applied on the top of the unit towards the wall for at least a minute for the pressure sensitive tape to release. Additional support may be added by installing flat plates along the outside back of the attached units. *These flat plates are not included in the shipment.*
- Hutch tackboards are factory-installed.
- Tackboards are standard in Grade 3 panel fabrics.

**MODULAR STORAGE UNITS**

- Pre-drilled holes through the unfinished tops for securing to the bottom of worksurfaces
- Screws and lock keys are included in a plastic bag fastened inside the pedestal. Installer should leave a 1/8" reveal between the Modular Storage Unit and the End panel. Disassemble the Modular Unit first before relocating the entire unit to avoid damage or bodily injuries.

**PEDESTAL SPACERS**

- Required if pedestals are placed side by side. A 1" gap is required between the modular pedestals to allow access to vertical fingerpulls. If required, order **SP700**.

**5-SIDED CORNER TABLES**

- Join bridge and credenza run-offs, using the supplied quick connectors.
- Recessed end-panels in these units are pre-drilled to accept quick-connectors for easy alignment
- Accurate leveling is critical for these units to align and connect properly.
- Flat-plates are pre-attached to the worksurface to secure to the desk unit.

## 1. SPECIFY MODEL NUMBER

## 2. SPECIFY FINISH

### WORKSURFACE TOP & DRAWER/DOOR FRONTS, BODY FINISHES (INCLUDING PEDESTALS) - VENEER

Code	Finish	Veneer Type	Cut
AMW	Almond Cherry	Cherry	Flat Sliced
ACW	Amber Cherry	Cherry	Flat Sliced
BTW	Biscotti	White Oak	Rift
CAW	Cocoa Walnut	Walnut	Flat Sliced
CRW	Coral	White Oak	Rift
DCW	Dark Cherry	Cherry	Flat Sliced
DWW	Dark Walnut	Walnut	Flat Sliced
EWV	Espresso Walnut	Walnut	Flat Sliced
EVW	Evening Oak	White Oak	Rift
GRW	Grey on Oak	White Oak	Rift
HAW	Hazelnut	Maple	Flat Sliced
JAW	Java	White Oak	Rift
LTW	Latte Walnut	Walnut	Flat Sliced
MHW	Mahogany on Walnut	Walnut	Flat Sliced
MTW	Milestone	White Oak	Rift
MPW	Natural Maple	Maple	Flat Sliced
NLW	Natural Walnut	Walnut	Flat Sliced
RCW	Red Cherry	Cherry	Flat Sliced
VNW	Vintage Cherry	Cherry	Flat Sliced
ULW	Umber Walnut	Walnut	Flat Sliced
WLW	Walnut	Walnut	Flat Sliced
WCW	Warm Cherry	Cherry	Flat Sliced
WMW	White Maple	Maple	Flat Sliced

### METAL FINISHES:

E	Black
K	Tungsten
DWT	Designer White
P	Brushed Chrome

### GLASS FINISH (for Glass Doors and Modesty Panels)

- Bronze Glass (standard)
- Clear Glass - contact Customer Care

## 3. SPECIFY OPTIONS

### GROMMETS

- Standard grommet on all components is **GM5**. Grommets are included with products where shown in product line drawings.
- Optional grommets may be ordered in standard worksurface locations (left, center or right). Order as **GM5L**, **GM5C** or **GM5R**. **Add \$96**.
- Grommet hole dimensions are 3.5" x 2". Specify **GM5E** for **Black** or **GM5K** for **Tungsten**.
- Color of grommet will be automatically coordinated with handle color where applicable

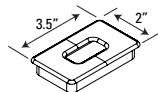

- Components that come standard with grommet may be ordered without a grommet. Order as RSG - **Add \$53**.
- View diagrams on the following pages for additional details.

### GROMMET LOCATIONS

- Grommets and Grommet Locations must be specified.
- Includes standard and optional grommet locations.
- For TEL & TER location please contact Customer Care.

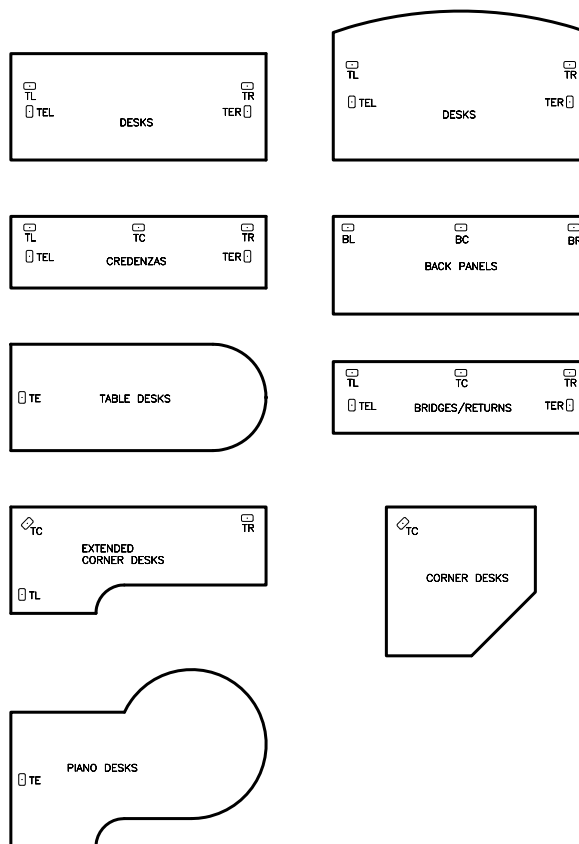

# P PHILADELPHIA - EDGE DETAILS

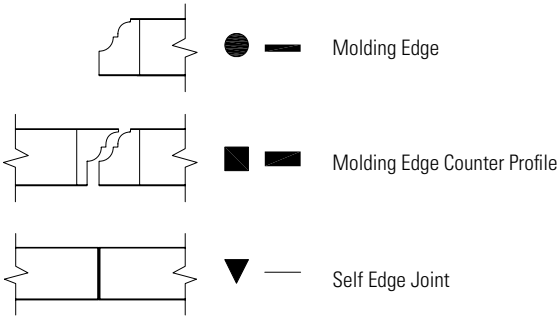

- D** - Desks and Credenzas
- B** - Executive Bridges
- E** - Executive Returns
- C** - Corner Components
- L** - Linking Bridges
- P** - Piano Desks

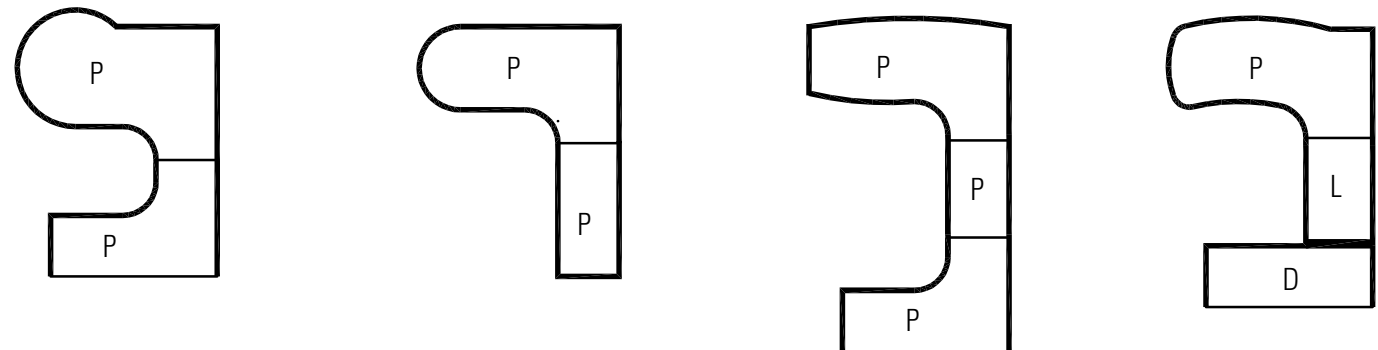
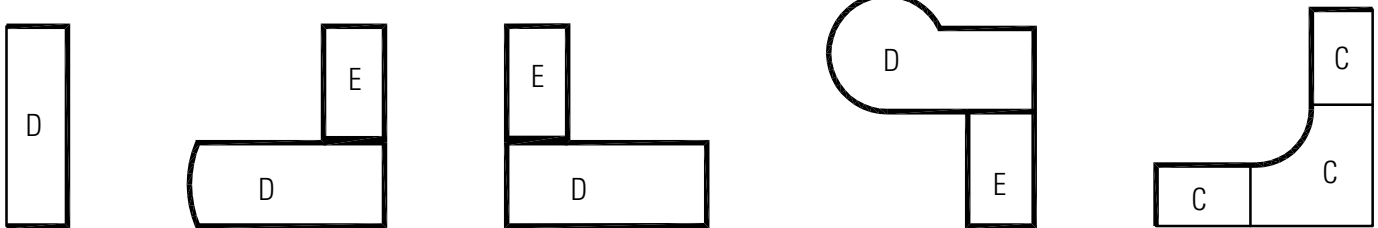
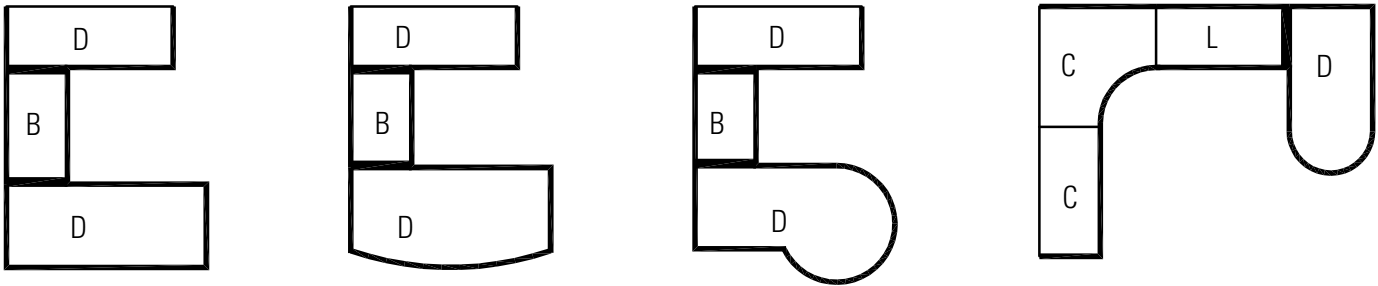
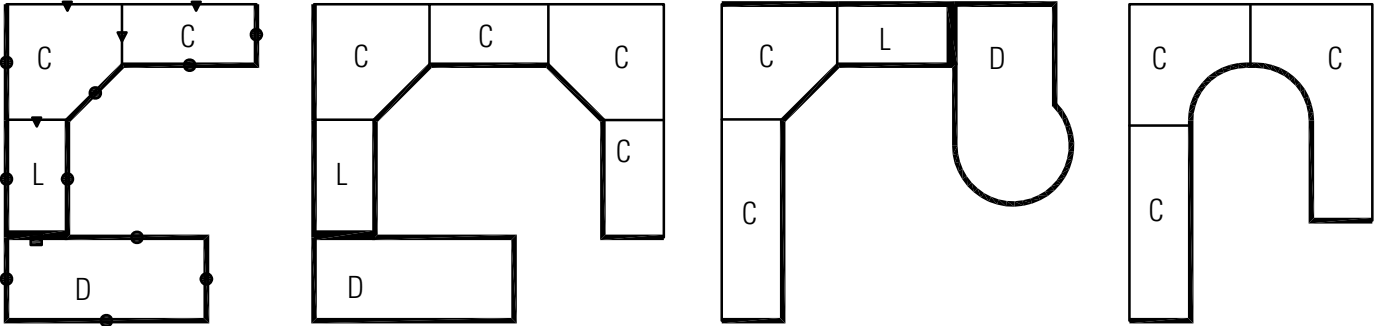

**DESK AND CREDENZA NOTES**

- Can be ordered as a shell or with pedestals
- Hand of Rectangular Desk is determined by location of pedestal from user side
- Hand of "D" Top is determined by outward orientation of curved end from user projection.
- Hand of "P" Top is determined by outward orientation of conference end from user projection.

Isometric View

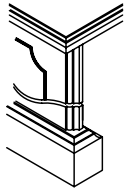

Side View  
1-3/8" Top

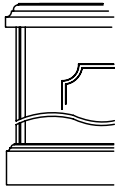

Front View  
1-3/16" Slab

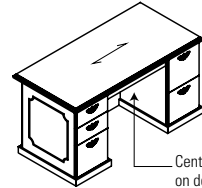
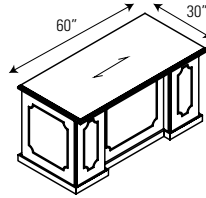
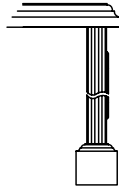

Center drawer standard on double pedestal desk

**MODESTY PANEL CLEARANCE**

PBID7236DE

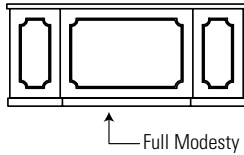

PBID7236 (7236 indicates top size)

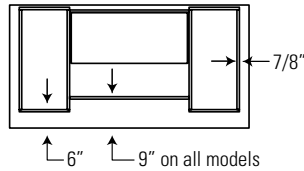

PBISR7230D

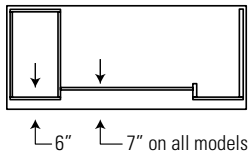

PBDDFL7230 (Left shown)

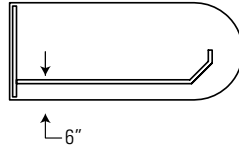

PBTPOL7242 (Left shown)

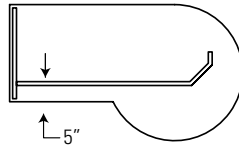

PBC7220

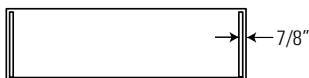



# P PHILADELPHIA - NOTES

## PIANO DESKS AND LINKING RETURNS

- All Desks are shipped assembled.
- Units include standard Grommets shown and installed horizontal wire management
- Unit is handed by Post Leg • Not for use with regular Corner Units

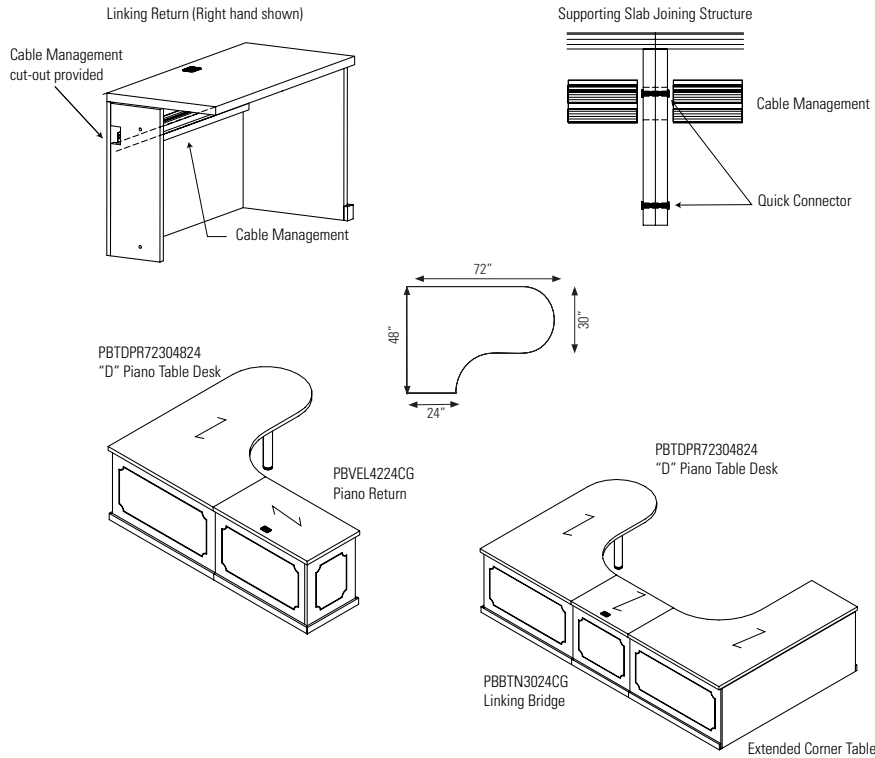

## EXECUTIVE BRIDGES

- Executive Bridge is used to connect a Desk to a Credenza.
- Not to be used with Corner Components or Piano Desks.
- Three Back Panel options
- Back panel flush with end panels of Desk and Credenza
- Includes GM5 Grommet Top Center
- The standard grain direction is cross grain (**CG**). To remove cross grain veneer pattern on top, delete suffix "**CG**" from the model number (no upcharge)

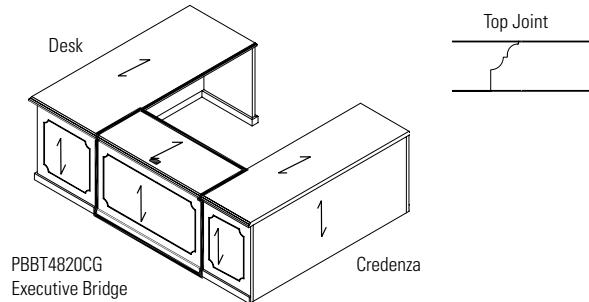

PBBT4820CG  
Dimensions are actual

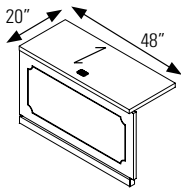

PBBT4820CG  
Full Back Panel

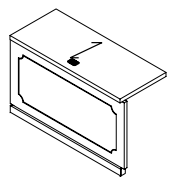

PBBT4820TCG  
Bridge Top only

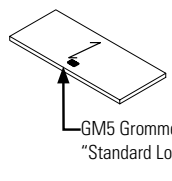

GM5 Grommet  
"Standard Location on Bridges"

PBBT4820Q8CG  
8" Back Panel

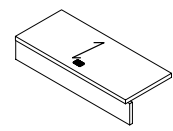

**EXECUTIVE RETURNS**

- Executive Return is used to attach to a Single Pedestal Desk, Single Pedestal Credenza, Desk Shell or Credenza Shell.
- Can be specified as a Shell or with a Pedestal.
- Back Panels are available as either full height or 8" from the underside of the worksurface.
- Hand of Executive Return is determined by location of full end panel from user side.
- Hand of Desk or Credenza is determined by location of pedestal from user side.
- The standard grain direction on return tops is cross grain (**CG**). To remove cross grain veneer pattern on top, delete suffix "**CG**" from the model number (no upcharge)

Executive Return attached to Desk or Credenza

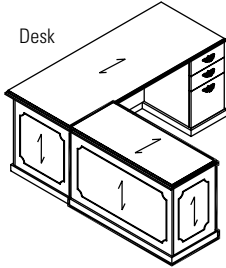

PBERL4822CG  
Executive Return

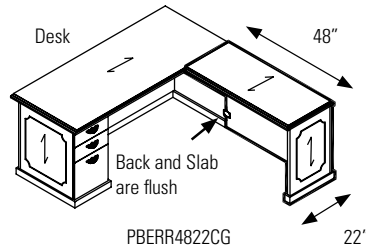

PBERR4822CG  
Executive Return

**CORNER COMPONENTS**

- Corner Table is used to connect to Linking Bridge and Linking Credenza.
- Cable management tray included.
- Back Panels are available as either full height or 8" from the underside of the worksurface.
- Hand of Linking Credenza is determined by location of full end panel from user side.
- Hand of Extended Corner is determined by location of long narrow end from user side
- The standard grain direction is cross grain (**CG**). To remove cross grain veneer pattern on top, delete suffix "**CG**" from the model number (no upcharge)

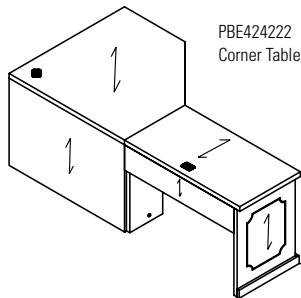

PBE424222  
Corner Table

PBEK424222  
Corner Table

PBEK424222  
Corner Table

Supporting Slab Joining Structure

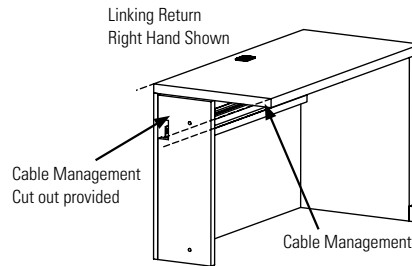
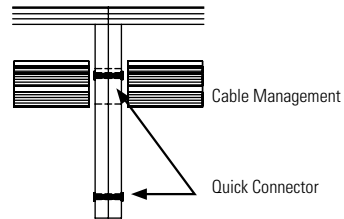

Linking Return  
Right Hand Shown

Cable Management  
Cut out provided

Cable Management

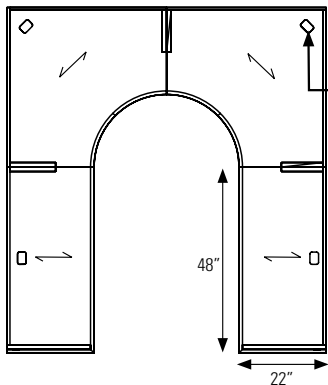

PBVL4822CG  
Linking Return

PBVR4822CG  
Linking Return

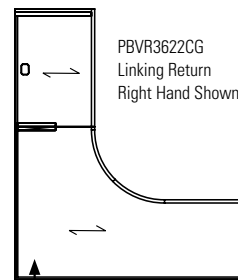

PBVR3622CG  
Linking Return  
Right Hand Shown

PBEKL724822  
Extended Corner Table

Grommet must be specified if required.

## LINKING BRIDGES

- Linking Bridge is used to connect Corner Components to Single Pedestal Desk, Single Pedestal Credenza, Desk Shell or Credenza Shell.
- Back panels are available as either full height or 8" from the underside of the worksurface.
- Includes GM5 Grommet Top Center
- Hand of Linking Bridge is determined by location of half end panel from user side
- The standard grain direction is cross grain (**CG**). To remove cross grain veneer pattern on top, delete suffix "**CG**" from the model number (no upcharge)

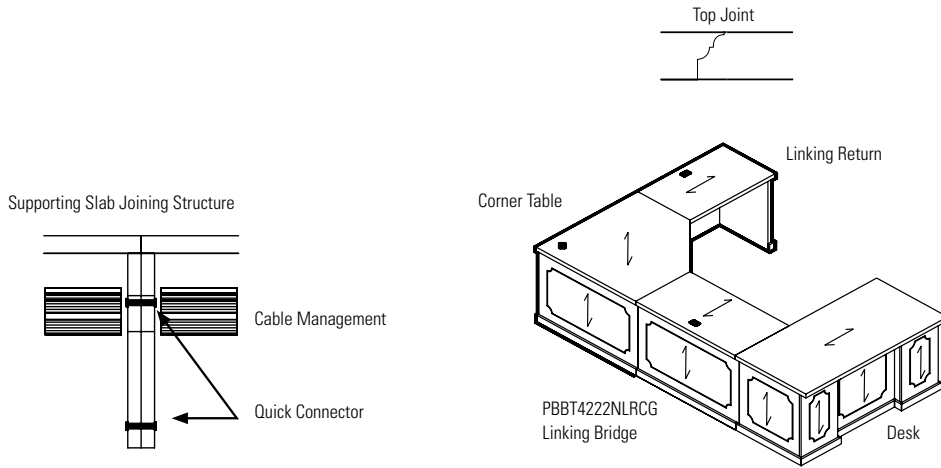

## COPING AND SELF-EDGE OPTIONS

- Coping option provides an undercut on hutches only so that storage cabinets placed next to the hutch fit flush.
  - Specify **COP** for coping on both sides, **COPR** for coping on the right side and **COPL** for coping on the left side. No upcharge.
- Self edge options provide a flush fit when storage units are placed next to one another.
  - Specify **SE** for self-edge on both sides, **SER** for self-edge on the right side and **SEL** for self-edge on the left side. When **SE**, **SER**, **SEL** are specified, the corresponding bottom base molding will also be removed. No upcharge.
  - Coping and self-edge handedness are from the users perspective. See diagram below.

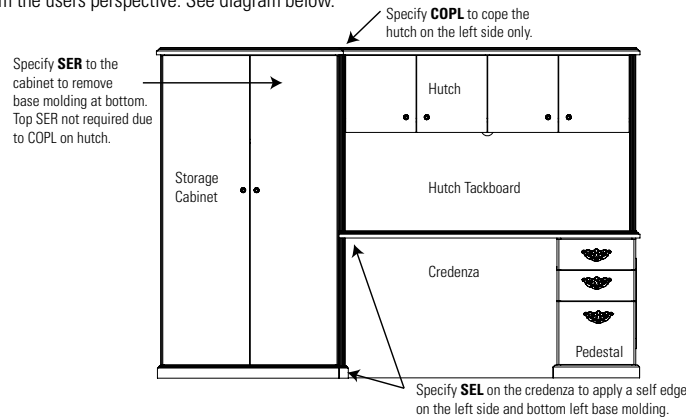

## MODULAR PEDESTALS AND HANDLES

- Modular Pedestal for Philadelphia using "C" components.
- SP700 spacer is required if two Modular Pedestals are placed side by side when there is no handles. Order as special.
- Credenza shell cannot be completely filled up with modular components to create a full storage credenza.

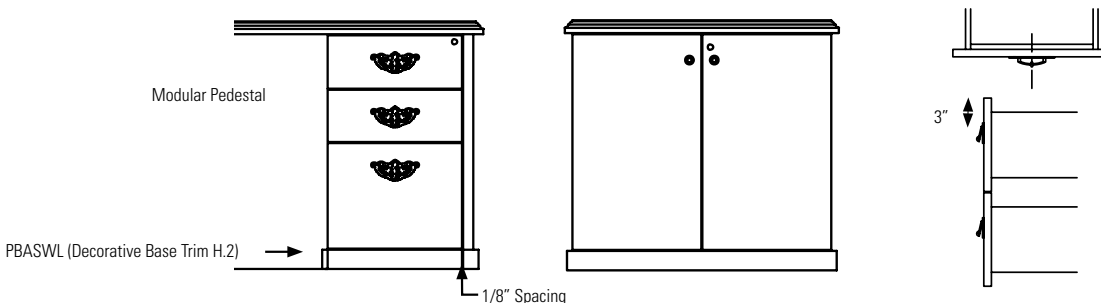

**LOCKING**

- Locks are standard on all below worksurface level drawer and door storage units with the exception of the pull-out tray units and single lateral file drawer combination tray/slot units.
- Locks are optional on all above worksurface level closed storage units.

**Standard Lock Positions**

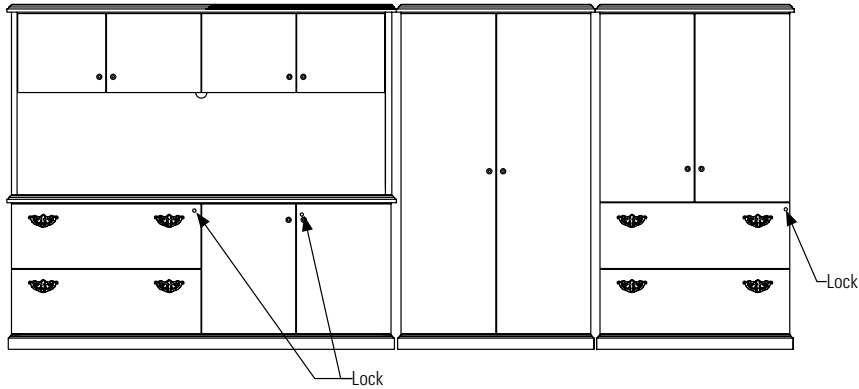

PBCF7222

Full Storage Credenza: Locks are on the front.

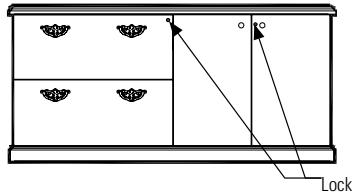

PB7236DE

Double Pedestal Desk/Credenza:

Lock for D and E Pedestals are on the inside Gable.

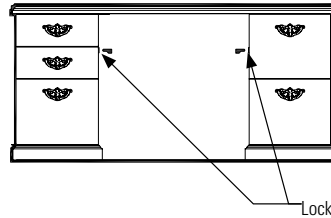

PBZR

Combination Storage Unit:

Lock for File and Lateral File Drawer only,  
Box Drawers do not lock.

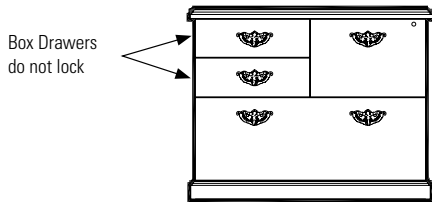

PBWF

Modular Furniture:  
Lock is on the front.

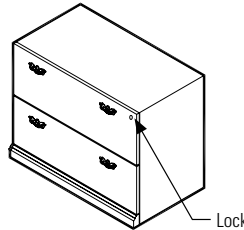

PBWD

Modular Furniture:  
Lock is on the front.

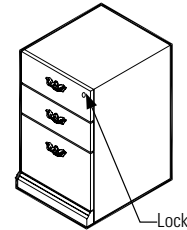

**HUTCH POSITIONING**

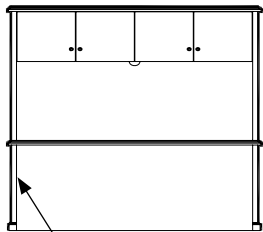

There must be an end panel  
under the hutch

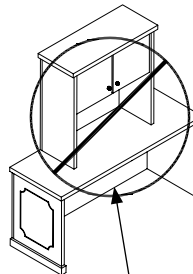
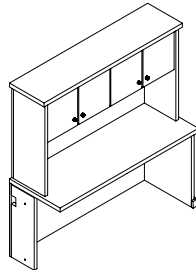

Missing Support  
NOT Recommended

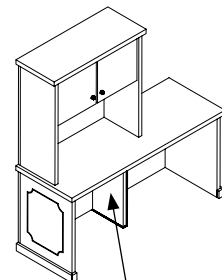

Add optional Support  
SLAB12 (as Special)

## TACKBOARDS

### Tackboards for Storage Huches

PB72SH36

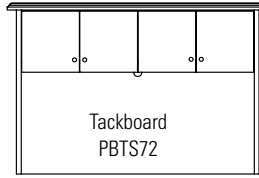

Tackboard  
PBTS72

PB72SHP42 and PB722SHP54

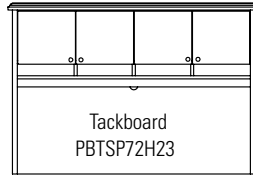

Tackboard  
PBTS72H23

PB72SH42 and PB722SH54

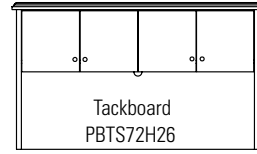

Tackboard  
PBTS72H26

### Tackboards with Accessory Rail

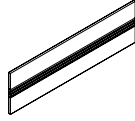

PBTSAS72

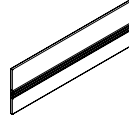

PBTSAS72H23

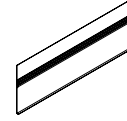

PBTSAS72H26

### Tackboards for Wall Mount Overheads

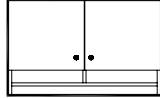

CSF36

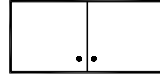

CSFP36

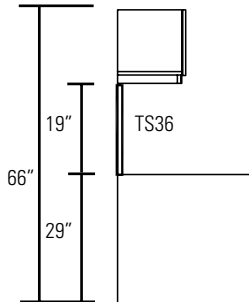

TS36

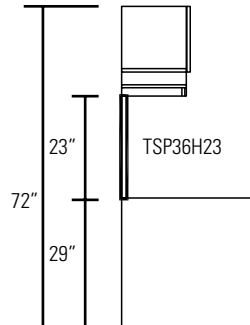

TSP36H23

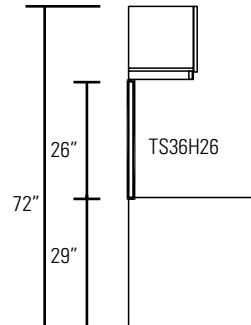

TS36H26

**LIGHTING**

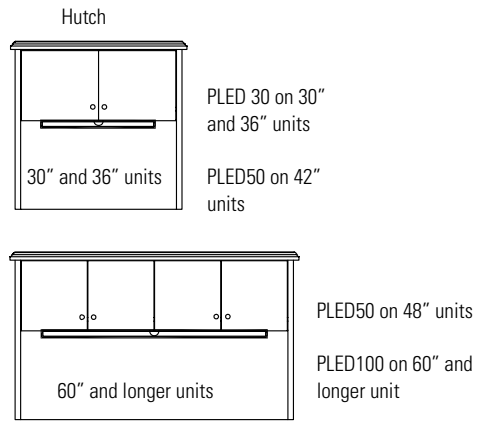
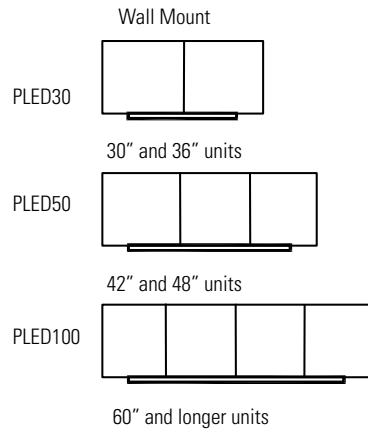

## DESKS - NOTES

**NOTE:** Arrow indicates direction of grain

#### Double Pedestal Desks

- Shipped assembled
- Kneewell locking standard and keyed alike
- Standard with center drawer
- For optional pull-out writing tray, specify **WTD**. Add **\$679**.

#### Single Pedestal Desks

- Shipped assembled
- Kneewell locking standard and keyed alike
- For optional pull-out writing tray, specify **WTS**. Add **\$343**.

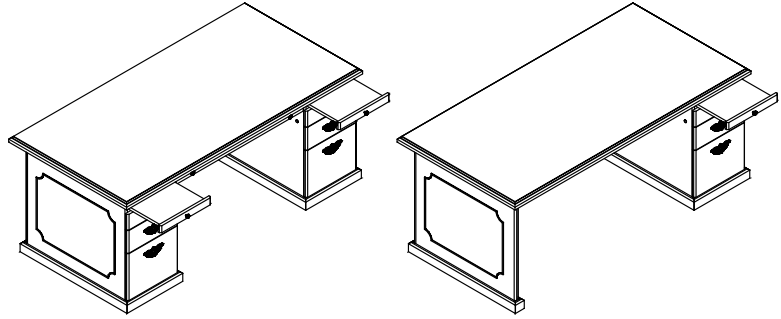

#### D and P shaped desks

- Shipped assembled.

#### D and P shaped connecting desks

- Shipped knocked down.
- The standard grain direction on D and P shaped connecting desks is cross grain (**CG**). To remove cross grain veneer pattern on top, delete suffix "**CG**" from the model number (no upcharge)
- Pedestals are handed:
  - Left pedestals have the handle offset from the center to the right, and the lock is placed on the right end panel
  - Right pedestals have the handle offset from the center to the left, and the lock is placed on the left end panel
- Modesty panels are available in wood or glass
- Grommets are available as an option on Desks and most Credenzas.

**DOUBLE PEDESTAL DESKS**      **MODEL#**      **DIMENSIONS**      **FREIGHT CLASS**      **WT/LBS.**      **CUBIC FT.**      **LIST PRICE**

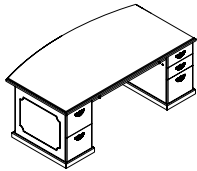

**Double Pedestal Bow Top Desk  
Breakfront Style**

	<b>D x W x H</b>					
PBMID8442ED	42 x 84 x 29	125	443	59		<b>\$12604</b>
PBMID7842ED	42 x 78 x 29	125	412	55		<b>\$11772</b>
PBMID7242ED	42 x 72 x 29	125	380	51		<b>\$10940</b>
PBMID6636ED	36 x 66 x 29	100	340	40		<b>\$10640</b>

Standard with full to floor **file/file** pedestal on **left** and **box/box/file** pedestal on **right**. Pedestals lock.  
Inset Full Height Modesty Panel.

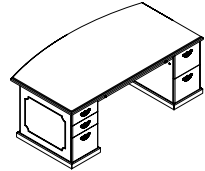

**Double Pedestal Bow Top Desk  
Breakfront Style**

PBMID8442DE	42 x 84 x 29	125	443	59		<b>\$12604</b>
PBMID7842DE	42 x 78 x 29	125	412	55		<b>\$11772</b>
PBMID7242DE	42 x 72 x 29	125	380	51		<b>\$10940</b>
PBMID6636DE	36 x 66 x 29	100	340	40		<b>\$10640</b>

Standard with full to floor **box/box/file** pedestal on **left** and **file/file** pedestal on **right**. Pedestals lock.  
Inset Full Height Modesty Panel.

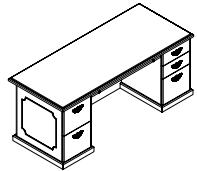

**Double Pedestal Desk  
Breakfront Style**

PBID8442ED	42 x 84 x 29	125	442	59		<b>\$10865</b>
PBID7842ED	42 x 78 x 29	125	421	55		<b>\$10156</b>
PBID7236ED	36 x 72 x 29	100	375	44		<b>\$9451</b>
PBID7230ED	30 x 72 x 29	100	345	36		<b>\$9322</b>
PBID6636ED	36 x 66 x 29	100	360	40		<b>\$9322</b>
PBID6630ED	30 x 66 x 29	92.5	315	30		<b>\$9192</b>
PBID6030ED	30 x 60 x 29	92.5	315	30		<b>\$8930</b>

Standard with full to floor **file/file** pedestal on **left** and **box/box/file** pedestal on **right**. Pedestals lock.  
Inset Full Height Modesty Panel.

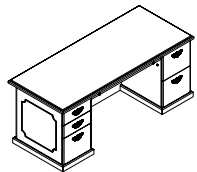

**Double Pedestal Desk  
Breakfront Style**

PBID8442DE	42 x 84 x 29	125	442	59		<b>\$10865</b>
PBID7842DE	42 x 78 x 29	125	421	55		<b>\$10156</b>
PBID7236DE	36 x 72 x 29	100	375	44		<b>\$9451</b>
PBID7230DE	30 x 72 x 29	100	345	36		<b>\$9322</b>
PBID6636DE	36 x 66 x 29	100	360	40		<b>\$9322</b>
PBID6630DE	30 x 66 x 29	92.5	315	30		<b>\$9192</b>
PBID6030DE	30 x 60 x 29	92.5	315	30		<b>\$8930</b>

Standard with full to floor **box/box/file** pedestal on **left** and **file/file** pedestal on **right**. Pedestals lock.  
Inset Full Height Modesty Panel.

**Required Specifications**

Finish

**Optional Specifications**

Grommet  
Modesty panel  
Pull-out writing tray



## SINGLE PEDESTAL DESKS

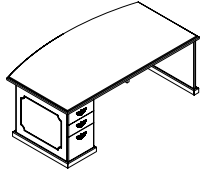

**Single Pedestal Bow Top Desk - Left\***  
*Breakfront Style*

MODEL#	DIMENSIONS D x W x H	FREIGHT CLASS	WT./LBS.	CUBIC FT.	LIST PRICE
PBMISL8442D	42 x 84 x 29	125	452	59	<b>\$9220</b>
PBMISL7842D	42 x 78 x 29	125	337	55	<b>\$8562</b>
PBMISL7242D	42 x 72 x 29	125	322	51	<b>\$7907</b>
PBMISL6636D	36 x 66 x 29	125	290	40	<b>\$7603</b>

Standard with full to floor **box/box/file** pedestal on **left**. Pedestals lock.  
Inset Full Height Modesty Panel.

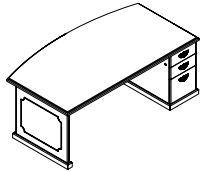

**Single Pedestal Bow Top Desk - Right\***  
*Breakfront Style*

PBMISR8442D	42 x 84 x 29	125	452	59	<b>\$9220</b>
PBMISR7842D	42 x 78 x 29	125	337	55	<b>\$8562</b>
PBMISR7242D	42 x 72 x 29	125	322	51	<b>\$7907</b>
PBMISR6636D	36 x 66 x 29	125	290	40	<b>\$7603</b>

Standard with full to floor **box/box/file** pedestal on **right**. Pedestals lock.  
Inset Full Height Modesty Panel.

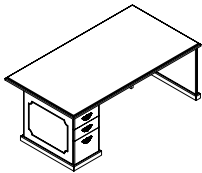

**Single Pedestal Desk - Left\***  
*Breakfront Style*

PBISL8442D	42 x 84 x 29	125	387	59	<b>\$8804</b>
PBISL7842D	42 x 78 x 29	125	366	55	<b>\$8173</b>
PBISL7236D	36 x 72 x 29	125	320	44	<b>\$6468</b>
PBISL7230D	30 x 70 x 29	100	290	36	<b>\$6180</b>
PBISL6636D	36 x 66 x 29	125	305	40	<b>\$6180</b>
PBISL6630D	30 x 66 x 29	100	275	33	<b>\$5898</b>
PBISL6030D	30 x 60 x 29	100	260	30	<b>\$5638</b>

Standard with full to floor **box/box/file** pedestal on **left**. Pedestals lock.  
Inset Full Height Modesty Panel.

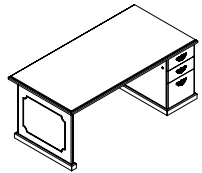

**Single Pedestal Desk - Right\***  
*Breakfront Style*

PBISR8442D	42 x 84 x 29	125	387	59	<b>\$8804</b>
PBISR7842D	42 x 78 x 29	125	366	55	<b>\$8173</b>
PBISR7236D	36 x 72 x 29	125	320	44	<b>\$6468</b>
PBISR7230D	30 x 70 x 29	100	290	36	<b>\$6180</b>
PBISR6636D	36 x 66 x 29	125	305	40	<b>\$6180</b>
PBISR6630D	30 x 66 x 29	100	275	33	<b>\$5898</b>
PBISR6030D	30 x 60 x 29	100	260	30	<b>\$5638</b>

Standard with full to floor **box/box/file** pedestal on **right**. Pedestals lock.  
Inset Full Height Modesty Panel.

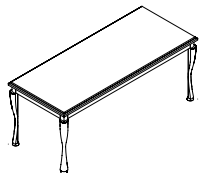

**Table Desk**  
*Queen Anne Style*

PBQATB8442	42 x 84 x 29	150	272	59	<b>\$10236</b>
PBQATB7842	42 x 78 x 29	150	253	55	<b>\$9598</b>
PBQATB7236	36 x 72 x 29	150	205	44	<b>\$7773</b>
PBQATB7230	30 x 70 x 29	150	192	36	<b>\$7002</b>
PBQATB6636	36 x 66 x 29	150	192	40	<b>\$7002</b>
PBQATB6630	30 x 66 x 29	150	188	33	<b>\$6160</b>
PBQATB6030	30 x 60 x 29	150	171	30	<b>\$5494</b>

Inset Full Height Modesty Panel.

### Required Specifications

Finish

### Optional Specifications

Additional grommet  
Modesty panel\*  
Pull-out writing tray\*

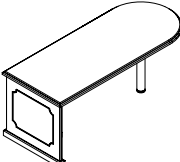
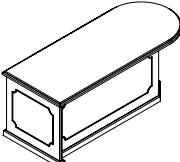
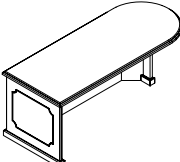
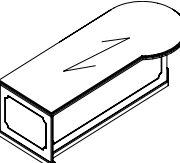
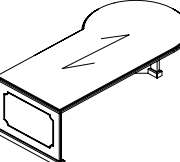
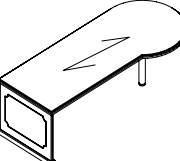
DESKS	MODEL#	DIMENSIONS	FREIGHT CLASS	WT/LBS.	CUBIC FT.	LIST PRICE
 <p><b>"D" Shaped Connecting Table Desk</b></p>	<b>D x W x H</b>					
	PBDD8436	36 x 84 x 29	125	343	51	<b>\$5750</b>
	PBDD7236	36 x 72 x 29	125	294	44	<b>\$4926</b>
	PBDD7230	30 x 72 x 29	125	264	36	<b>\$4578</b>
	PBDD6636	36 x 66 x 29	125	245	40	<b>\$4578</b>
	PBDD6030	30 x 60 x 29	125	225	30	<b>\$4398</b>
Wood column support and full end panel.						
 <p><b>"D" Shaped Table Desk - Left</b></p>	PBDDFL8436	36 x 84 x 29	125	367	51	<b>\$7062</b>
	PBDDFL7236	36 x 72 x 29	125	320	44	<b>\$6055</b>
	PBDDFL7230	30 x 72 x 29	100	290	36	<b>\$5711</b>
	PBDDFL6636	36 x 66 x 29	125	271	40	<b>\$5711</b>
	PBDDFL6030	30 x 60 x 29	100	247	30	<b>\$5527</b>
	With 45° angled modesty and end panel.					
 <p><b>"D" Shaped Table - Right</b></p>	PBDDFR8436	36 x 84 x 29	125	367	51	<b>\$7062</b>
	PBDDFR7236	36 x 72 x 29	125	320	44	<b>\$6055</b>
	PBDDFR7230	30 x 72 x 29	100	290	36	<b>\$5711</b>
	PBDDFR6636	36 x 66 x 29	125	271	40	<b>\$5711</b>
	PBDDFR6030	30 x 60 x 29	100	247	30	<b>\$5527</b>
	With 45° angled modesty and end panel.					
 <p><b>"P" Shaped Connecting Table - Left</b></p>	PBTPOL9642	42 x 96 x 29	150	317	68	<b>\$8470</b>
	PBTPOL8442	42 x 84 x 29	150	277	59	<b>\$7410</b>
	PBTPOL7242	42 x 72 x 29	150	211	51	<b>\$6859</b>
	With 45° angled modesty and end panel.					
 <p><b>"P" Shaped Connecting Table - Right</b></p>	PBTPOR9642	42 x 96 x 29	150	317	68	<b>\$8470</b>
	PBTPOR8442	42 x 84 x 29	150	277	59	<b>\$7410</b>
	PBTPOR7242	42 x 72 x 29	150	211	51	<b>\$6859</b>
	With 45° angled modesty and end panel.					
 <p><b>"P" Shaped Connecting Table - Left</b></p>	PBTPL9642	42 x 96 x 29	125	440	68	<b>\$7179</b>
	PBTPL8442	42 x 84 x 29	125	385	59	<b>\$6283</b>
	PBTPL7242	42 x 72 x 29	125	319	51	<b>\$5727</b>
	Wood column support and full end panel.					

**Required Specifications**  
Finish

**Optional Specifications**  
Additional grommet

**DESKS**

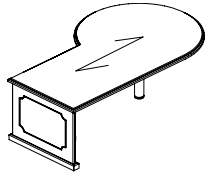

**"P" Shaped Connecting Table - Right**

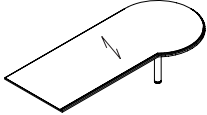

**"P" Shaped Connecting Table - Left**

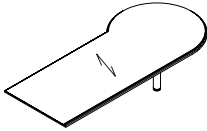

**"P" Shaped Connecting Table - Right**

MODEL#	DIMENSIONS	FREIGHT CLASS	WT/LBS.	CUBIC FT.	LIST PRICE
--------	------------	---------------	---------	-----------	------------

**D x W x H**

PBTPR9642	42 x 96 x 29	125	440	68	<b>\$7179</b>
PBTPR8442	42 x 84 x 29	125	385	59	<b>\$6283</b>
PBTPR7242	42 x 72 x 29	125	319	51	<b>\$5727</b>

Wood column support and full end panel.

PBRPL9642CG	42 x 96 x 29	250	239	68	<b>\$6807</b>
PBRPL8442CG	42 x 84 x 29	250	209	59	<b>\$5958</b>
PBRPL7242CG	42 x 72 x 29	250	143	51	<b>\$5104</b>

Wood column support. No end panel.

PBRPR9642CG	42 x 96 x 29	250	239	68	<b>\$6807</b>
PBRPR8442CG	42 x 84 x 29	250	209	59	<b>\$5958</b>
PBRPR7242CG	42 x 72 x 29	250	143	51	<b>\$5104</b>

Wood column support. No end panel.

**Required Specifications**

Finish

**Optional Specifications**

Additional grommet

**RETURNS - NOTES**

D x W x H

- All returns are shipped assembled
- Kneewell locking standard
- The standard grain direction on returns is cross grain (**CG**). To remove cross grain veneer pattern on top, delete suffix "**CG**" from the model number (no upcharge)
- **NOTE:** Arrow indicates direction of grain

RETURNS	MODEL#	DIMENSIONS	FREIGHT CLASS	WT/LBS.	CUBIC FT.	LIST PRICE
---------	--------	------------	---------------	---------	-----------	------------

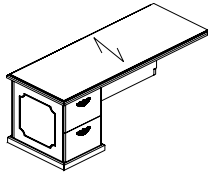

**Executive Return - Left**

PBERL7224ECG	24 x 72 x 29	100	250	29	<b>\$5816</b>
PBERL6624ECG	24 x 66 x 29	100	236	27	<b>\$5604</b>
PBERL6024ECG	24 x 60 x 29	100	227	24	<b>\$5098</b>
PBERL5424ECG	24 x 54 x 29	100	205	22	<b>\$4910</b>
PBERL4824ECG	24 x 48 x 29	100	185	19	<b>\$4364</b>
PBERL4224ECG	24 x 42 x 29	92.5	178	17	<b>\$4200</b>

Standard with full to floor **file/file** pedestal on **left**. Pedestal locks. Full height flush back panel.

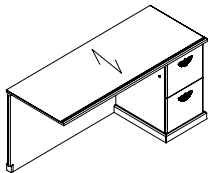

**Executive Return - Right**

PBERR7224ECG	24 x 72 x 29	100	250	29	<b>\$5816</b>
PBERR6624ECG	24 x 66 x 29	100	236	27	<b>\$5604</b>
PBERR6024ECG	24 x 60 x 29	100	227	24	<b>\$5098</b>
PBERR5424ECG	24 x 54 x 29	100	205	22	<b>\$4910</b>
PBERR4824ECG	24 x 48 x 29	100	185	19	<b>\$4364</b>
PBERR4224ECG	24 x 42 x 29	92.5	178	17	<b>\$4200</b>

Standard with full to floor **file/file** pedestal on **right**. Pedestal locks. Full height flush back panel.

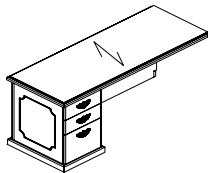

**Executive Return - Left**

PBERL7224DCG	24 x 72 x 29	100	250	29	<b>\$5816</b>
PBERL6624DCG	24 x 66 x 29	100	236	27	<b>\$5604</b>
PBERL6024DCG	24 x 60 x 29	100	227	24	<b>\$5098</b>
PBERL5424DCG	24 x 54 x 29	100	205	22	<b>\$4910</b>
PBERL4824DCG	24 x 48 x 29	100	185	19	<b>\$4364</b>
PBERL4224DCG	24 x 42 x 29	92.5	178	17	<b>\$4200</b>

Standard with full to floor **box/box/file** pedestal on **left**. Pedestal locks. Full height flush back panel.

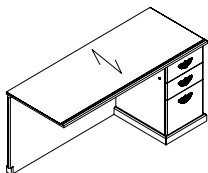

**Executive Return - Right**

PBERR7224DCG	24 x 72 x 29	100	250	29	<b>\$4200</b>
PBERR6624DCG	24 x 66 x 29	100	236	27	<b>\$5604</b>
PBERR6024DCG	24 x 60 x 29	100	227	24	<b>\$5098</b>
PBERR5424DCG	24 x 54 x 29	100	205	22	<b>\$4910</b>
PBERR4824DCG	24 x 48 x 29	100	185	19	<b>\$4364</b>
PBERR4224DCG	24 x 42 x 29	92.5	178	17	<b>\$4200</b>

Standard with full to floor **box/box/file** pedestal on **right**. Pedestal locks. Full height flush back panel.

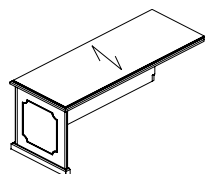

**Executive Return - Left**

PBERL7224CG	24 x 72 x 29	150	135	29	<b>\$3262</b>
PBERL6624CG	24 x 66 x 29	150	127	27	<b>\$2989</b>
PBERL6024CG	24 x 60 x 29	150	120	24	<b>\$2720</b>
PBERL5424CG	24 x 54 x 29	150	112	22	<b>\$2441</b>
PBERL4824CG	24 x 48 x 29	150	105	19	<b>\$2178</b>
PBERL4224CG	24 x 42 x 29	150	97	17	<b>\$1901</b>

Full height flush back panel.

**Required Specifications**  
Finish

**Optional Specifications**  
Grommet

**RETURNS**

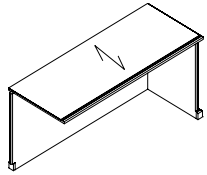

**Executive Return - Right**

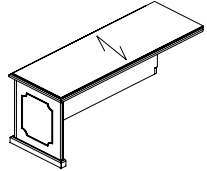

**Executive Return - Left**

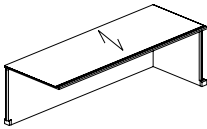

**Executive Return - Right**

**MODEL# DIMENSIONS FREIGHT CLASS WT/LBS. CUBIC FT. LIST PRICE**

**D x W x H**

PBERR7224CG	24 x 72 x 29	150	135	29	<b>\$3262</b>
PBERR6624CG	24 x 66 x 29	150	127	27	<b>\$2989</b>
PBERR6024CG	24 x 60 x 29	150	120	24	<b>\$2720</b>
PBERR5424CG	24 x 54 x 29	150	112	22	<b>\$2441</b>
PBERR4824CG	24 x 48 x 29	150	105	19	<b>\$2178</b>
PBERR4224CG	24 x 42 x 29	150	97	17	<b>\$1901</b>

Full height flush back panel.

PBERL7222CG	22 x 72 x 29	150	130	27	<b>\$3108</b>
PBERL6622CG	22 x 66 x 29	150	122	24	<b>\$2847</b>
PBERL6022CG	22 x 60 x 29	150	115	22	<b>\$2592</b>
PBERL5422CG	22 x 54 x 29	150	105	20	<b>\$2329</b>
PBERL4822CG	22 x 48 x 29	150	100	18	<b>\$2074</b>
PBERL4222CG	22 x 42 x 29	150	90	16	<b>\$1813</b>

Full height flush back panel.

PBERR7222CG	22 x 72 x 29	150	130	27	<b>\$3108</b>
PBERR6622CG	22 x 66 x 29	150	122	24	<b>\$2847</b>
PBERR6022CG	22 x 60 x 29	150	115	22	<b>\$2592</b>
PBERR5422CG	22 x 54 x 29	150	105	20	<b>\$2329</b>
PBERR4822CG	22 x 48 x 29	150	100	18	<b>\$2074</b>
PBERR4222CG	22 x 42 x 29	150	90	16	<b>\$1813</b>

Full height flush back panel.

**Required Specifications**  
Finish

**Optional Specifications**  
Additional grommet

**PIANO DESKS**

D x W x H

- All desks are shipped assembled
- Units include installed horizontal wire management
- Unit is handed by Post Leg
- Not for use with Regular Corner Units
- The standard grain direction on piano desks is cross grain (**CG**). To remove cross grain veneer pattern on top, delete suffix "**CG**" from the model number (no upcharge)
- If grommet color is not specified, Black is standard
- **NOTE:** Arrow indicates direction of grain

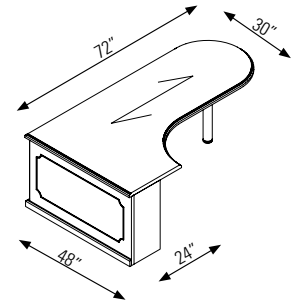

**PIANO DESKS**

**MODEL#      DIMENSIONS      FREIGHT CLASS      WT/LBS.      CUBIC FT.      LIST PRICE**

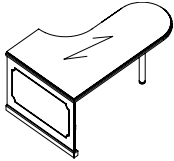

**D-shaped Piano Desk - Left**

PBTDPL96304824	48 x 96 x 29	125	464	77	<b>\$7468</b>
PBTDPL84304824	48 x 84 x 29	150	406	68	<b>\$6642</b>
PBTDPL72304824	48 x 72 x 29	125	348	58	<b>\$5817</b>

Wood column support and full end panel, 30"D worksurface extension and 24" return connection.

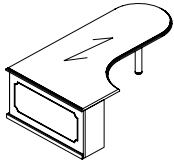

**D-shaped Piano Desk - Right**

PBT DPR96304824	48 x 96 x 29	125	464	77	<b>\$7468</b>
PBT DPR84304824	48 x 84 x 29	150	406	68	<b>\$6642</b>
PBT DPR72304824	48 x 72 x 29	125	348	58	<b>\$5817</b>

Wood column support and full end panel, 30"D worksurface extension and 24" return connection.

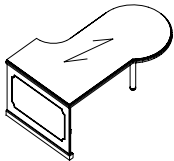

**P-shaped Piano Desk - Left**

PBTPPL96424824	54 x 96 x 29	150	580	97	<b>\$8521</b>
PBTPPL84424824	54 x 84 x 29	150	508	85	<b>\$7618</b>
PBTPPL72424824	54 x 72 x 29	150	435	73	<b>\$7064</b>

Wood column support and full end panel, 42"/30" worksurface and 24" return connection.

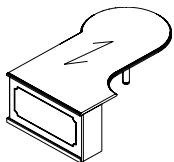

**P-shaped Piano Desk - Right**

PBT PPR96424824	54 x 96 x 29	150	580	97	<b>\$8521</b>
PBT PPR84424824	54 x 84 x 29	150	508	85	<b>\$7618</b>
PBT PPR72424824	54 x 72 x 29	150	435	73	<b>\$7064</b>

Wood column support and full end panel, 42"/30" worksurface and 24" return connection.

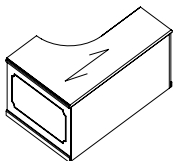

**Extended Corner Table Desk - Left**

PBEKL964824MR	48 x 96 x 29	150	387	77	<b>\$8113</b>
PBEKL904824MR	48 x 90 x 29	150	363	73	<b>\$7661</b>
PBEKL844824MR	48 x 84 x 29	150	338	68	<b>\$7571</b>
PBEKL784824MR	48 x 78 x 29	150	314	63	<b>\$7530</b>
PBEKL724824MR	48 x 72 x 29	150	290	58	<b>\$7157</b>
PBEKL664824MR	48 x 66 x 29	150	266	52	<b>\$6673</b>
PBEKL604824MR	48 x 60 x 29	150	242	48	<b>\$6184</b>

With 24" return connection.

**Required Specifications**

Finish

**Optional Specifications**

Additional grommet

## PIANO DESKS

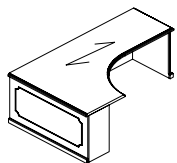

**Extended Corner Table Desk - Right**

MODEL#	DIMENSIONS D x W x H	FREIGHT CLASS	WT/LBS.	CUBIC FT.	LIST PRICE
PBEKR489624ML	48 x 96 x 29	150	387	77	<b>\$8113</b>
PBEKR489024ML	48 x 90 x 29	150	363	73	<b>\$7661</b>
PBEKR488424ML	48 x 84 x 29	150	338	68	<b>\$7571</b>
PBEKR487824ML	48 x 78 x 29	150	314	63	<b>\$7530</b>
PBEKR487224ML	48 x 72 x 29	150	290	58	<b>\$7157</b>
PBEKR486624ML	48 x 66 x 29	150	266	52	<b>\$6673</b>
PBEKR486024ML	48 x 60 x 29	150	242	48	<b>\$6184</b>

With 24" return connection.

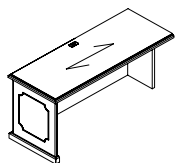

**Linking Return - Left**

PBVEL9624CG	24 x 96 x 29	150	200	39	<b>\$4931</b>
PBVEL9024CG	24 x 90 x 29	150	187	36	<b>\$4623</b>
PBVEL8424CG	24 x 84 x 29	150	174	34	<b>\$4315</b>
PBVEL7824CG	24 x 78 x 29	150	162	31	<b>\$4002</b>
PBVEL7224CG	24 x 72 x 29	150	149	29	<b>\$3699</b>
PBVEL6624CG	24 x 66 x 29	150	141	27	<b>\$3472</b>
PBVEL6024CG	24 x 60 x 29	150	132	24	<b>\$3245</b>
PBVEL5424CG	24 x 54 x 29	150	121	22	<b>\$3061</b>
PBVEL4824CG	24 x 48 x 29	125	115	19	<b>\$2878</b>
PBVEL4224CG	24 x 42 x 29	150	99	17	<b>\$2423</b>
PBVEL3624CG	24 x 36 x 29	150	83	15	<b>\$2340</b>
PBVEL3024CG	24 x 30 x 29	125	77	12	<b>\$2325</b>
PBVEL2424CG	24 x 24 x 29	125	61	10	<b>\$1928</b>

Used in conjunction with extended piano corner units or piano shaped desks.

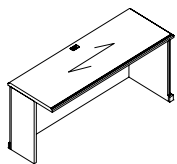

**Linking Return - Right**

PBVER9624CG	24 x 96 x 29	150	200	39	<b>\$4931</b>
PBVER9024CG	24 x 90 x 29	150	187	36	<b>\$4623</b>
PBVER8424CG	24 x 84 x 29	150	174	34	<b>\$4315</b>
PBVER7824CG	24 x 78 x 29	150	162	31	<b>\$4002</b>
PBVER7224CG	24 x 72 x 29	150	149	29	<b>\$3699</b>
PBVER6624CG	24 x 66 x 29	150	141	27	<b>\$3472</b>
PBVER6024CG	24 x 60 x 29	150	132	24	<b>\$3245</b>
PBVER5424CG	24 x 54 x 29	150	121	22	<b>\$3061</b>
PBVER4824CG	24 x 48 x 29	125	115	19	<b>\$2878</b>
PBVER4224CG	24 x 42 x 29	150	99	17	<b>\$2423</b>
PBVER3624CG	24 x 36 x 29	150	83	15	<b>\$2340</b>
PBVER3024CG	24 x 30 x 29	125	77	12	<b>\$2325</b>
PBVER2424CG	24 x 24 x 29	125	61	10	<b>\$1928</b>

Used in conjunction with extended piano corner units or piano shaped desks.

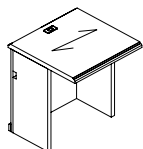

**Bridge**

PBBTN4824CG	24 x 48 x 29	150	110	19	<b>\$2791</b>
PBBTN4224CG	24 x 42 x 29	150	94	17	<b>\$2340</b>
PBBTN3624CG	24 x 36 x 29	150	79	15	<b>\$2253</b>
PBBTN3024CG	24 x 30 x 29	125	72	12	<b>\$2205</b>
PBBTN2424CG	24 x 24 x 29	150	56	10	<b>\$1854</b>
PBBTN1824CG	24 x 18 x 29	150	43	8	<b>\$1391</b>
PBBTN1224CG	24 x 12 x 29	150	29	5	<b>\$927</b>

For extended piano corner units or piano-shaped desks.

### Required Specifications

Finish

### Optional Specifications

Additional grommet

BRIDGES	MODEL#	DIMENSIONS	FREIGHT CLASS	WT/LBS.	CUBIC FT.	LIST PRICE
---------	--------	------------	---------------	---------	-----------	------------

D x W x H

- All bridges are shipped knockdown
- Not for use with Corner Units
- The standard grain direction is cross grain (**CG**). To remove cross grain veneer pattern on top, delete suffix “**CG**” from the model number (no upcharge)
- GM5 TC location is standard. If grommet color is not specified, Black is standard
- **NOTE:** Arrow indicates direction of grain

BRIDGES	MODEL#	DIMENSIONS	FREIGHT CLASS	WT/LBS.	CUBIC FT.	LIST PRICE
---------	--------	------------	---------------	---------	-----------	------------

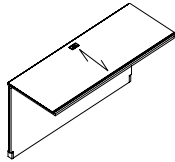

Executive Bridge Top

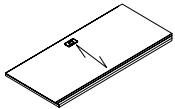

Executive Bridge Top

PBBT6022CG	22 x 60 x 29	92.5	108	10	<b>\$2879</b>
PBBT5422CG	22 x 54 x 29	92.5	99	9	<b>\$2598</b>
PBBT4822CG	22 x 48 x 29	92.5	90	8	<b>\$2307</b>
PBBT4222CG	22 x 42 x 29	92.5	81	7	<b>\$2018</b>
PBBT6020CG	20 x 60 x 29	85	105	8	<b>\$2361</b>
PBBT5420CG	20 x 54 x 29	85	96	8	<b>\$2125</b>
PBBT4820CG	20 x 48 x 29	85	87	7	<b>\$1890</b>
PBBT4220CG	20 x 42 x 29	85	78	6	<b>\$1617</b>

With full back panel.

PBBT5422TCG	22 x 54 x 1.3	125	64	9	<b>\$1559</b>
PBBT4822TCG	22 x 48 x 1.3	125	55	8	<b>\$1383</b>
PBBT4222TCG	22 x 42 x 1.3	125	46	7	<b>\$1214</b>
PBBT5420TCG	20 x 54 x 1.3	125	61	8	<b>\$1273</b>
PBBT4820TCG	20 x 48 x 1.3	125	52	7	<b>\$1137</b>
PBBT4220TCG	20 x 42 x 1.3	125	43	6	<b>\$974</b>

**Required Specifications**  
Finish

**Optional Specifications**  
Additional grommet



# P PHILADELPHIA

CRENZAS	MODEL#	DIMENSIONS	FREIGHT CLASS	WT./LBS.	CUBIC FT.	LIST PRICE
---------	--------	------------	---------------	----------	-----------	------------

D x W x H

- All credenzas are shipped assembled
- All storage cabinets include one adjustable shelf per set of doors
- **F** and **G** depict 36". **M** and **N** depict 30".
- **F** and **N** indicate lateral file drawers. **G** and **M** indicate storage cabinets with doors.
- Credenza shells accept modular storage. Use modular storage for top support allowing no more than 72" unsupported.
- Credenza shells with a width of 96" and more will have a 12" middle support gable.
- For PBCF7220 and PBCF6020, standard face locking for cabinet and lateral file.
- Grommets are available as an option on Desks and most Credenzas.
- **NOTE:** Arrow indicates direction of grain

CRENZAS	MODEL#	DIMENSIONS	FREIGHT CLASS	WT./LBS.	CUBIC FT.	LIST PRICE
---------	--------	------------	---------------	----------	-----------	------------

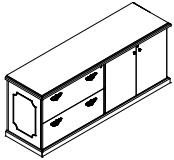

Full Storage Credenza

PBCF7220FG	20 x 72 x 29	92.5	272	24	<b>\$6644</b>
PBCF6020NM	20 x 60 x 29	92.5	220	20	<b>\$5536</b>

Lateral file on **left** and storage cabinet on **right**.

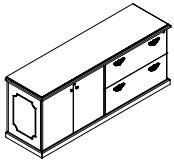

Full Storage Credenza

PBCF7220GF	20 x 72 x 29	92.5	272	24	<b>\$6644</b>
PBCF6020MN	20 x 60 x 29	92.5	220	20	<b>\$5536</b>

Storage cabinet on **left** and lateral file on **right**.

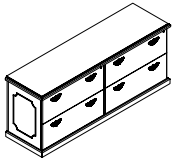

Full Storage Credenza

PBC7220FF	20 x 72 x 29	92.5	287	24	<b>\$8500</b>
PBC6020NN	20 x 60 x 29	92.5	205	20	<b>\$7439</b>

Lateral files on **left** and **right**.

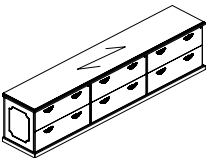

Full Storage Credenza

PBC10820FFF	20 x 108 x 29	92.5	412	36	<b>\$14272</b>
PBC9020NNN	20 x 90 x 29	92.5	337	30	<b>\$11896</b>

Lateral files on **left**, **center**, and **right**.

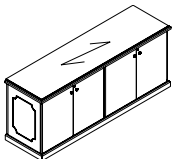

Full Storage Credenza

PBC7220GG	20 x 72 x 29	92.5	253	24	<b>\$6308</b>
PBC6020MM	20 x 60 x 29	92.5	209	20	<b>\$5519</b>

Storage cabinets on **left** and **right**.

**Required Specifications**  
Finish

**Optional Specifications**  
Additional grommet

**CRENZAS**

**MODEL# DIMENSIONS FREIGHT CLASS WT/LBS. CUBIC FT. LIST PRICE**

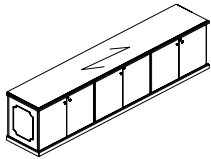

**Full Storage Credenza**

	<b>D x W x H</b>				
PBC10820GGG	20 x 108 x 29	125	278	36	<b>\$11374</b>
PBC9020MMM	20 x 90 x 29	125	228	30	<b>\$9481</b>

Storage cabinets on **left, center,** and **right.**

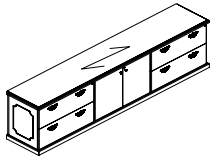

**Full Storage Credenza**

PBC10824FGF	24 x 108 x 29	92.5	479	44	<b>\$16002</b>
PBC9024NNM	24 x 90 x 29	92.5	399	36	<b>\$13331</b>
PBC10820FGF	20 x 108 x 29	92.5	388	36	<b>\$13307</b>
PBC9020NNM	20 x 90 x 29	92.5	321	30	<b>\$11087</b>

Lateral files on **left** and **right**; storage cabinet in **center.**

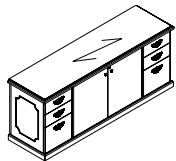

**Full Storage Credenza**

PBC7224DGD	24 x 72 x 29	92.5	319	29	<b>\$9837</b>
PBC6024DGD	24 x 60 x 29	92.5	266	24	<b>\$9016</b>
PBC7220DGD	20 x 72 x 29	85	298	24	<b>\$8571</b>
PBC6020DGD	20 x 60 x 29	85	246	20	<b>\$7500</b>

Box/box/file on **left** and **right**; storage cabinet in **center.**

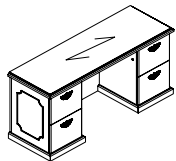

**Double Pedestal Credenza**

PBCK8424EE	24 x 84 x 29	92.5	348	34	<b>\$9345</b>
PBCK7824EE	24 x 78 x 29	92.5	319	31	<b>\$8682</b>
PBCK7224EE	24 x 72 x 29	100	280	29	<b>\$8019</b>
PBCK6624EE	24 x 66 x 29	100	261	27	<b>\$7894</b>
PBCK6024EE	24 x 60 x 29	100	238	24	<b>\$7345</b>

PBCK8420EE	20 x 84 x 29	92.5	307	28	<b>\$8149</b>
PBCK7820EE	20 x 78 x 29	92.5	285	26	<b>\$7566</b>
PBCK7220EE	20 x 72 x 29	92.5	267	24	<b>\$6984</b>
PBCK6620EE	20 x 66 x 29	92.5	244	22	<b>\$6398</b>
PBCK6020EE	20 x 60 x 29	92.5	220	20	<b>\$5821</b>

File/file pedestals on **left** and **right**. Full height back panel. Kneespace in center.

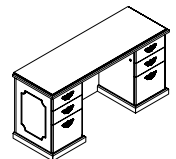

**Double Pedestal Credenza**

PBCK8424DD	24 x 84 x 29	92.5	348	34	<b>\$9345</b>
PBCK7824DD	24 x 78 x 29	92.5	319	31	<b>\$8682</b>
PBCK7224DD	24 x 72 x 29	100	280	29	<b>\$8019</b>
PBCK6624DD	24 x 66 x 29	100	261	27	<b>\$7894</b>
PBCK6024DD	24 x 60 x 29	100	238	24	<b>\$7345</b>

PBCK8420DD	20 x 84 x 29	92.5	307	28	<b>\$8149</b>
PBCK7820DD	20 x 78 x 29	92.5	285	26	<b>\$7566</b>
PBCK7220DD	20 x 72 x 29	92.5	267	24	<b>\$6984</b>
PBCK6620DD	20 x 66 x 29	92.5	244	22	<b>\$6398</b>
PBCK6020DD	20 x 60 x 29	92.5	220	20	<b>\$5821</b>

Box/box/file pedestals on **left** and **right**. Full height back panel. Kneespace in center.

**Required Specifications**

Finish

**Optional Specifications**

Additional grommet

**CREDENZAS**

**MODEL# DIMENSIONS FREIGHT CLASS WT/LBS. CUBIC FT. LIST PRICE**

**D x W x H**

PBCK8424ED	24 x 84 x 29	92.5	348	34	<b>\$9345</b>
PBCK7824ED	24 x 78 x 29	92.5	319	31	<b>\$8682</b>
PBCK7224ED	24 x 72 x 29	100	280	29	<b>\$8019</b>
PBCK6624ED	24 x 66 x 29	100	261	27	<b>\$7894</b>
PBCK6024ED	24 x 60 x 29	100	238	24	<b>\$7345</b>
PBCK8420ED	20 x 84 x 29	92.5	307	28	<b>\$8149</b>
PBCK7820ED	20 x 78 x 29	92.5	285	26	<b>\$7566</b>
PBCK7220ED	20 x 72 x 29	92.5	267	24	<b>\$6984</b>
PBCK6620ED	20 x 66 x 29	92.5	244	22	<b>\$6398</b>
PBCK6020ED	20 x 60 x 29	92.5	220	20	<b>\$5821</b>

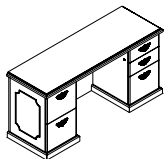

**Double Pedestal Credenza**

File/file pedestal on **left** and box/box/file pedestal on **right**. Full height back panel. Kneespace in center.

PBCK8424DE	24 x 84 x 29	92.5	348	34	<b>\$9345</b>
PBCK7824DE	24 x 78 x 29	92.5	319	31	<b>\$8682</b>
PBCK7224DE	24 x 72 x 29	100	280	29	<b>\$8019</b>
PBCK6624DE	24 x 66 x 29	100	261	27	<b>\$7894</b>
PBCK6024DE	24 x 60 x 29	100	238	24	<b>\$7345</b>
PBCK8420DE	20 x 84 x 29	92.5	307	28	<b>\$8149</b>
PBCK7820DE	20 x 78 x 29	92.5	285	26	<b>\$7566</b>
PBCK7220DE	20 x 72 x 29	92.5	267	24	<b>\$6984</b>
PBCK6620DE	20 x 66 x 29	92.5	244	22	<b>\$6398</b>
PBCK6020DE	20 x 60 x 29	92.5	220	20	<b>\$5821</b>

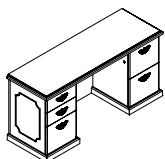

**Double Pedestal Credenza**

Box/box/file pedestal on **left** and file/file pedestal on **right**. Full height back panel. Kneespace in center.

PBCL8424E	24 x 84 x 29	100	315	34	<b>\$7066</b>
PBCL7824E	24 x 78 x 29	100	292	31	<b>\$6564</b>
PBCL7224E	24 x 72 x 29	100	270	29	<b>\$6057</b>
PBCL6624E	24 x 66 x 29	100	247	27	<b>\$5830</b>
PBCL6024E	24 x 60 x 29	100	225	24	<b>\$5301</b>
PBCL8420E	20 x 84 x 29	100	273	28	<b>\$6159</b>
PBCL7820E	20 x 78 x 29	100	252	26	<b>\$5719</b>
PBCL7220E	20 x 72 x 29	100	237	24	<b>\$5280</b>
PBCL6620E	20 x 66 x 29	100	216	22	<b>\$5082</b>
PBCL6020E	20 x 60 x 29	100	195	20	<b>\$4623</b>

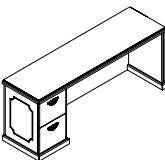

**Single Pedestal Credenza - Left**

File/file pedestal on **left**.

PBCR8424E	24 x 84 x 29	100	315	34	<b>\$7066</b>
PBCR7824E	24 x 78 x 29	100	292	31	<b>\$6564</b>
PBCR7224E	24 x 72 x 29	100	270	29	<b>\$6057</b>
PBCR6624E	24 x 66 x 29	100	247	27	<b>\$5830</b>
PBCR6024E	24 x 60 x 29	100	225	24	<b>\$5301</b>
PBCR8420E	20 x 84 x 29	100	273	28	<b>\$6159</b>
PBCR7820E	20 x 78 x 29	100	252	26	<b>\$5719</b>
PBCR7220E	20 x 72 x 29	100	237	24	<b>\$5280</b>
PBCR6620E	20 x 66 x 29	100	216	22	<b>\$5082</b>
PBCR6020E	20 x 60 x 29	100	195	20	<b>\$4623</b>

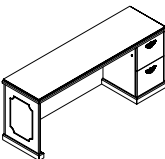

**Single Pedestal Credenza - Right**

File/file pedestal on **right**.

**Required Specifications**  
Finish

**Optional Specifications**  
Additional grommet

**CREDENZAS**      **MODEL#**      **DIMENSIONS**      **FREIGHT CLASS**      **WT/LBS.**      **CUBIC FT.**      **LIST PRICE**

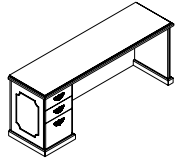

**Single Pedestal Credenza - Left**

	<b>D x W x H</b>					
PBCL8424D	24 x 84 x 29	100	315	34	<b>\$7066</b>	
PBCL7824D	24 x 78 x 29	100	292	31	<b>\$6564</b>	
PBCL7224D	24 x 72 x 29	100	270	29	<b>\$6057</b>	
PBCL6624D	24 x 66 x 29	100	247	27	<b>\$5830</b>	
PBCL6024D	24 x 60 x 29	100	225	24	<b>\$5301</b>	
PBCL8420D	20 x 84 x 29	100	273	28	<b>\$6159</b>	
PBCL7820D	20 x 78 x 29	100	252	26	<b>\$5719</b>	
PBCL7220D	20 x 72 x 29	100	237	24	<b>\$5280</b>	
PBCL6620D	20 x 66 x 29	100	216	22	<b>\$5082</b>	
PBCL6020D	20 x 60 x 29	100	195	20	<b>\$4623</b>	

Box/box/file pedestal on **left**.

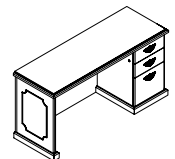

**Single Pedestal Credenza - Right**

PBCR8424D	24 x 84 x 29	100	315	34	<b>\$7066</b>	
PBCR7824D	24 x 78 x 29	100	292	31	<b>\$6564</b>	
PBCR7224D	24 x 72 x 29	100	270	29	<b>\$6057</b>	
PBCR6624D	24 x 66 x 29	100	247	27	<b>\$5830</b>	
PBCR6024D	24 x 60 x 29	100	225	24	<b>\$5301</b>	
PBCR8420D	20 x 84 x 29	100	273	28	<b>\$6159</b>	
PBCR7820D	20 x 78 x 29	100	252	26	<b>\$5719</b>	
PBCR7220D	20 x 72 x 29	100	237	24	<b>\$5280</b>	
PBCR6620D	20 x 66 x 29	100	216	22	<b>\$5082</b>	
PBCR6020D	20 x 60 x 29	100	195	20	<b>\$4623</b>	

Box/box/file pedestal on **right**.

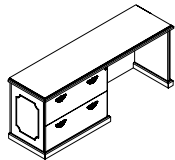

**Single Pedestal Credenza - Left**

PBCL8424F	24 x 84 x 29	100	305	34	<b>\$8214</b>	
PBCL7824F	24 x 78 x 29	100	285	31	<b>\$7623</b>	
PBCL7224F	24 x 72 x 29	100	261	29	<b>\$7042</b>	
PBCL6624F	24 x 66 x 29	100	239	27	<b>\$6836</b>	
PBCL6024F	24 x 60 x 29	100	218	24	<b>\$6153</b>	
PBCL8420F	20 x 84 x 29	100	253	28	<b>\$7160</b>	
PBCL7820F	20 x 78 x 29	100	233	26	<b>\$6643</b>	
PBCL7220F	20 x 72 x 29	100	218	24	<b>\$6132</b>	
PBCL6620F	20 x 66 x 29	100	197	22	<b>\$5905</b>	
PBCL6020F	20 x 60 x 29	100	176	20	<b>\$5362</b>	

36" lateral file on **left**.

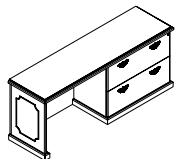

**Single Pedestal Credenza - Right**

PBCR8424F	24 x 84 x 29	100	305	34	<b>\$8214</b>	
PBCR7824F	24 x 78 x 29	100	285	31	<b>\$7623</b>	
PBCR7224F	24 x 72 x 29	100	261	29	<b>\$7042</b>	
PBCR6624F	24 x 66 x 29	100	239	27	<b>\$6836</b>	
PBCR6024F	24 x 60 x 29	100	218	24	<b>\$6153</b>	
PBCR8420F	20 x 84 x 29	100	253	28	<b>\$7160</b>	
PBCR7820F	20 x 78 x 29	100	233	26	<b>\$6643</b>	
PBCR7220F	20 x 72 x 29	100	218	24	<b>\$6132</b>	
PBCR6620F	20 x 66 x 29	100	197	22	<b>\$5905</b>	
PBCR6020F	20 x 60 x 29	100	176	20	<b>\$5362</b>	

36" lateral file on **right**.

**Required Specifications**  
Finish

**Optional Specifications**  
Additional grommet

## CREDENZAS

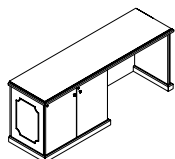

**Single Pedestal Credenza - Left**

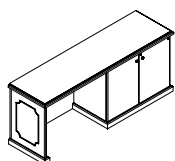

**Single Pedestal Credenza - Right**

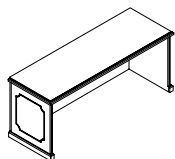

**Credenza Shell**

MODEL#	DIMENSIONS D x W x H	FREIGHT CLASS	WT/LBS.	CUBIC FT.	LIST PRICE
PBCL8424G	24 x 84 x 29	100	338	34	<b>\$7378</b>
PBCL7824G	24 x 78 x 29	92.5	314	31	<b>\$6848</b>
PBCL7224G	24 x 72 x 29	92.5	290	29	<b>\$6341</b>
PBCL6624G	24 x 66 x 29	100	266	27	<b>\$6086</b>
PBCL6024G	24 x 60 x 29	92.5	242	24	<b>\$5533</b>
PBCL8420G	20 x 84 x 29	92.5	290	28	<b>\$6429</b>
PBCL7820G	20 x 78 x 29	92.5	272	26	<b>\$5969</b>
PBCL7220G	20 x 72 x 29	92.5	252	24	<b>\$5511</b>
PBCL6620G	20 x 66 x 29	92.5	230	22	<b>\$5296</b>
PBCL6020G	20 x 60 x 29	92.5	208	20	<b>\$4823</b>

36" storage cabinet on **left**.

PBCR8424G	24 x 84 x 29	100	338	34	<b>\$7378</b>
PBCR7824G	24 x 78 x 29	92.5	314	31	<b>\$6848</b>
PBCR7224G	24 x 72 x 29	92.5	290	29	<b>\$6341</b>
PBCR6624G	24 x 66 x 29	100	266	27	<b>\$6086</b>
PBCR6024G	24 x 60 x 29	92.5	242	24	<b>\$5533</b>
PBCR8420G	20 x 84 x 29	92.5	290	28	<b>\$6429</b>
PBCR7820G	20 x 78 x 29	92.5	272	26	<b>\$5969</b>
PBCR7220G	20 x 72 x 29	92.5	252	24	<b>\$5511</b>
PBCR6620G	20 x 66 x 29	92.5	230	22	<b>\$5296</b>
PBCR6020G	20 x 60 x 29	92.5	208	20	<b>\$4823</b>

36" storage cabinet on **right**.

PBC12024	24 x 120 x 29	100	387	48	<b>\$6294</b>
PBC11424	24 x 114 x 29	125	367	46	<b>\$5983</b>
PBC10824	24 x 108 x 29	125	348	44	<b>\$5667</b>
PBC10224	24 x 102 x 29	100	329	41	<b>\$5346</b>
PBC9624	24 x 96 x 29	125	309	39	<b>\$5035</b>
PBC9024	24 x 90 x 29	100	290	36	<b>\$4718</b>
PBC8424	24 x 84 x 29	125	271	34	<b>\$4407</b>
PBC7824	24 x 78 x 29	100	251	31	<b>\$4089</b>
PBC7224	24 x 72 x 29	100	232	29	<b>\$3778</b>
PBC6624	24 x 66 x 29	125	213	27	<b>\$3644</b>
PBC6024	24 x 60 x 29	100	193	24	<b>\$3307</b>
PBC5424	24 x 54 x 29	125	174	22	<b>\$3128</b>
PBC4824	24 x 48 x 29	100	155	19	<b>\$2957</b>
PBC4224	24 x 42 x 29	125	135	17	<b>\$2506</b>

With full back panel.

### Required Specifications

Finish

### Optional Specifications

Additional grommet

**CORNERS - NOTES**

**NOTE:** Arrow indicates direction of grain

D x W x H

**Corners**

- All units are shipped assembled
- Unit includes grommets shown and installed horizontal wire management
- Corner units and extended corner units must be used exclusively with linking bridges and linking returns
- **Linking bridges** are handed by recessed end panel
- **Extended corner tables** have no molding on back side. Grommets are not included and must be specified.
- **Linking returns** include grommets shown and installed horizontal wire management. Handed by full end panel.
- **Tables** include grommets shown and installed horizontal wire management.

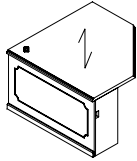
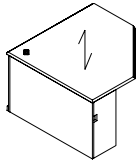
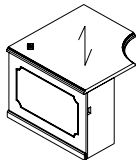
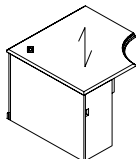
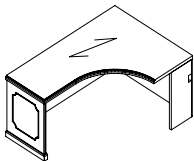
CORNERS AND COMPONENTS	MODEL#	DIMENSIONS	FREIGHT CLASS	WT/LBS.	CUBIC FT.	LIST PRICE
 <p><b>Corner Table - Left</b></p>	PBE484824ML	48 x 48 x 29	150	196	35	<b>\$4399</b>
	PBE424224ML	42 x 42 x 29	150	150	30	<b>\$3384</b>
	PBE363624ML	36 x 36 x 29	150	130	22	<b>\$3216</b>
With 2 recessed end panels.						
 <p><b>Corner Table - Right</b></p>	PBE484824MR	48 x 48 x 29	150	196	35	<b>\$4399</b>
	PBE424224MR	42 x 42 x 29	150	150	30	<b>\$3384</b>
	PBE363624MR	36 x 36 x 29	150	130	22	<b>\$3216</b>
With 2 recessed end panels.						
 <p><b>Corner Table - Left</b></p>	PBEK484824ML	48 x 48 x 29	150	196	39	<b>\$5059</b>
	PBEK424224ML	42 x 42 x 29	150	150	30	<b>\$3893</b>
	PBEK363624ML	36 x 36 x 29	150	130	22	<b>\$3698</b>
With 2 recessed end panels and inner curve.						
 <p><b>Corner Table - Right</b></p>	PBEK484824MR	48 x 48 x 29	150	196	39	<b>\$5059</b>
	PBEK424224MR	42 x 42 x 29	150	150	30	<b>\$3893</b>
	PBEK363624MR	36 x 36 x 29	150	130	22	<b>\$3698</b>
With 2 recessed end panels and inner curve.						
 <p><b>Extended Corner Table - Left</b></p>	PBEKL964824	96 x 48 x 29	150	387	77	<b>\$7375</b>
	PBEKL904824	90 x 48 x 29	150	363	73	<b>\$6963</b>
	PBEKL844824	84 x 48 x 29	150	338	68	<b>\$6878</b>
	PBEKL784824	78 x 48 x 29	150	314	63	<b>\$6844</b>
	PBEKL724824	72 x 48 x 29	150	290	58	<b>\$6504</b>
	PBEKL664824	66 x 48 x 29	150	266	52	<b>\$6061</b>
	PBEKL604824	60 x 48 x 29	150	242	48	<b>\$5625</b>
With full back panel.						

**Required Specifications**  
Finish

**Optional Specifications**  
Additional grommet

## CORNERS AND COMPONENTS

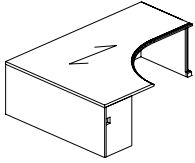

**Extended Corner Table - Right**

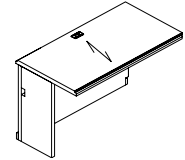

**Linking Bridge - Left**

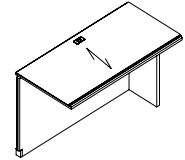

**Linking Bridge - Right**

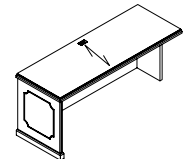

**Linking Return - Left**

MODEL#	DIMENSIONS	FREIGHT CLASS	WT/LBS.	CUBIC FT.	LIST PRICE
--------	------------	---------------	---------	-----------	------------

**D x W x H**

PBEKR489624	96 x 48 x 29	150	387	77	<b>\$7375</b>
PBEKR489024	90 x 48 x 29	150	363	73	<b>\$6963</b>
PBEKR488424	84 x 48 x 29	150	338	68	<b>\$6878</b>
PBEKR487824	78 x 48 x 29	150	314	63	<b>\$6844</b>
PBEKR487224	72 x 48 x 29	150	290	58	<b>\$6504</b>
PBEKR486624	66 x 48 x 29	150	266	52	<b>\$6061</b>
PBEKR486024	60 x 48 x 29	150	242	48	<b>\$5625</b>

With full back panel.

PBBT6024NLLCG	24 x 60 x 29	125	145	24	<b>\$2865</b>
PBBT5424NLLCG	24 x 54 x 29	150	131	22	<b>\$2577</b>
PBBT4824NLLCG	24 x 48 x 29	125	116	19	<b>\$2291</b>
PBBT4224NLLCG	24 x 42 x 29	125	102	17	<b>\$1856</b>
PBBT3624NLLCG	24 x 36 x 29	150	87	15	<b>\$1686</b>
PBBT3024NLLCG	24 x 30 x 29	125	73	12	<b>\$1647</b>

To join corner worksurface to desk or credenza. Full back panel.

PBBT6024NLR CG	24 x 60 x 29	125	145	24	<b>\$2865</b>
PBBT5424NLR CG	24 x 54 x 29	150	131	22	<b>\$2577</b>
PBBT4824NLR CG	24 x 48 x 29	125	116	19	<b>\$2291</b>
PBBT4224NLR CG	24 x 42 x 29	125	102	17	<b>\$1856</b>
PBBT3624NLR CG	24 x 36 x 29	150	87	15	<b>\$1686</b>
PBBT3024NLR CG	24 x 30 x 29	125	73	12	<b>\$1647</b>

To join corner worksurface to desk or credenza. Full back panel.

PBVL9624CG	24 x 96 x 29	150	200	39	<b>\$4745</b>
PBVL9024CG	24 x 90 x 29	150	187	36	<b>\$4448</b>
PBVL8424CG	24 x 84 x 29	150	174	34	<b>\$4153</b>
PBVL7824CG	24 x 78 x 29	150	162	31	<b>\$3857</b>
PBVL7224CG	24 x 72 x 29	150	149	29	<b>\$3559</b>
PBVL6624CG	24 x 66 x 29	150	141	27	<b>\$3340</b>
PBVL6024CG	24 x 60 x 29	150	132	24	<b>\$3122</b>
PBVL5424CG	24 x 54 x 29	150	121	22	<b>\$2947</b>
PBVL4824CG	24 x 48 x 29	125	115	19	<b>\$2768</b>
PBVL4224CG	24 x 42 x 29	150	99	17	<b>\$2335</b>
PBVL3624CG	24 x 36 x 29	150	83	15	<b>\$2250</b>
PBVL3024CG	24 x 30 x 29	125	77	12	<b>\$2210</b>
PBVL2424CG	24 x 24 x 29	125	61	10	<b>\$1854</b>

To be used with corner unit.

**Required Specifications**

Finish

**Optional Specifications**

Additional grommet

**CORNERS AND COMPONENTS**

**MODEL# DIMENSIONS FREIGHT CLASS WT/LBS. CUBIC FT. LIST PRICE**

**D x W x H**

PBVR9624CG	24 x 96 x 29	150	200	39	<b>\$4745</b>
PBVR9024CG	24 x 90 x 29	150	187	36	<b>\$4448</b>
PBVR8424CG	24 x 84 x 29	150	174	34	<b>\$4153</b>
PBVR7824CG	24 x 78 x 29	150	162	31	<b>\$3857</b>
PBVR7224CG	24 x 72 x 29	150	149	29	<b>\$3559</b>
PBVR6624CG	24 x 66 x 29	150	141	27	<b>\$3340</b>
PBVR6024CG	24 x 60 x 29	150	132	24	<b>\$3122</b>
PBVR5424CG	24 x 54 x 29	150	121	22	<b>\$2947</b>
PBVR4824CG	24 x 48 x 29	125	115	19	<b>\$2768</b>
PBVR4224CG	24 x 42 x 29	150	99	17	<b>\$2335</b>
PBVR3624CG	24 x 36 x 29	150	83	15	<b>\$2250</b>
PBVR3024CG	24 x 30 x 29	125	77	12	<b>\$2210</b>
PBVR2424CG	24 x 24 x 29	125	61	10	<b>\$1854</b>

To be used with corner unit.

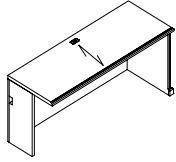

**Linking Return - Right**

PBVT9624	24 x 96 x 29	150	213	39	<b>\$4848</b>
PBVT9024	24 x 90 x 29	150	199	36	<b>\$4545</b>
PBVT8424	24 x 84 x 29	150	186	34	<b>\$4243</b>
PBVT7824	24 x 78 x 29	150	173	31	<b>\$3934</b>
PBVT7224	24 x 72 x 29	150	160	29	<b>\$3637</b>
PBVT6624	24 x 66 x 29	150	146	27	<b>\$3418</b>
PBVT6024	24 x 60 x 29	150	133	24	<b>\$3204</b>
PBVT5424	24 x 54 x 29	150	128	22	<b>\$3024</b>
PBVT4824	24 x 48 x 29	125	120	19	<b>\$2847</b>
PBVT4224	24 x 42 x 29	125	104	17	<b>\$2409</b>
PBVT3624	24 x 36 x 29	150	88	15	<b>\$2329</b>
PBVT3024	24 x 30 x 29	125	82	12	<b>\$2284</b>
PBVT2424	24 x 24 x 29	125	65	10	<b>\$1921</b>

Full end panels.

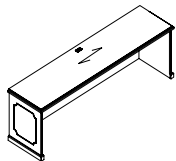

**Freestanding Table**

PBV1212CT	12 x 12 x 1.3	150	5	1	<b>\$974</b>
-----------	---------------	-----	---	---	--------------



**Corner Filler Top**

**Required Specifications**  
Finish

**Optional Specifications**  
Additional grommet



MODULAR STORAGE - NOTES

D x W x H

- All storage components are shipped assembled
- Components 28" high are intended for use with a desk, credenza or return shell
- Backs on 28" high pedestals and cabinets are unfinished. If finished back is required, see page 357.
- If a profiled top is required, please see "Freestanding Storage" section.

MODULAR STORAGE	MODEL#	DIMENSIONS	FREIGHT CLASS	WT/LBS.	CUBIC FT.	LIST PRICE
-----------------	--------	------------	---------------	---------	-----------	------------

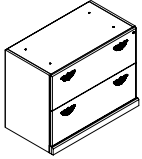

Modular Lateral File

PBWF	19.1 x 35.1 x 28	92.5	115	11	<b>\$3962</b>
PBWN	19.1 x 30 x 28	92.5	96	9	<b>\$3468</b>

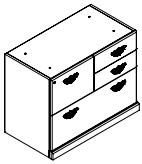

Modular Combination Storage

PBWZL	19.1 x 35.1 x 28	92.5	115	11	<b>\$3894</b>
-------	------------------	------	-----	----	---------------

With 1 lateral file, 2 box drawers in the top right, and 1 file drawer in the top left.

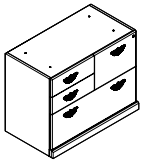

Modular Combination Storage

PBWZR	19.1 x 35.1 x 28	92.5	115	11	<b>\$3894</b>
-------	------------------	------	-----	----	---------------

With 1 lateral file, 2 box drawers in the top left, and 1 file drawer in the top right.

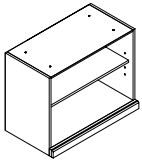

Modular Open Storage

PBWOB36	19.1 x 35.1 x 28	100	92	11	<b>\$1955</b>
PBWOB30	19.1 x 30 x 28	100	77	9	<b>\$1733</b>

Storage with 1 adjustable shelf.

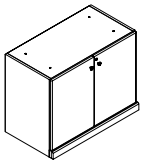

Modular Storage Cabinet w/Doors

PBWG	19.1 x 35.1 x 28	92.5	115	11	<b>\$2441</b>
PBWM	19.1 x 30 x 28	92.5	96	9	<b>\$2164</b>

Storage with 1 adjustable shelf.

Required Specifications

Finish

**MODULAR STORAGE**      **MODEL#**      **DIMENSIONS**      **FREIGHT CLASS**      **WT./LBS.**      **CUBIC FT.**      **LIST PRICE**

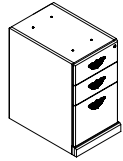

**Modular Pedestal**

**D x W x H**

Letter width:

PBWWD	23 x 15.6 x 28	85	72	6	<b>\$3058</b>
PBWD	19 x 15.6 x 28	85	70	5	<b>\$2661</b>

Legal width:

PBWWLD	23 x 18.5 x 28	85	85	7	<b>\$3669</b>
PBWLD	19 x 18.5 x 28	85	83	6	<b>\$3193</b>

Box/box/file pedestal.

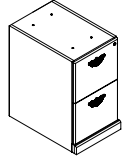

**Modular Pedestal**

Letter width:

PBWWLE	23 x 15.6 x 28	85	72	6	<b>\$3058</b>
PBWE	19 x 15.6 x 28	85	70	5	<b>\$2661</b>

Legal width:

PBWWLE	23 x 18.5 x 28	85	85	7	<b>\$3669</b>
PBWLE	19 x 18.5 x 28	85	83	6	<b>\$3193</b>

File/file pedestal.

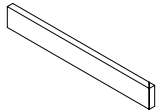

**Decorative Base Trim - Left**

PBAS-WL	1 x 19 x 2.5	70	1	0.01	<b>\$299</b>
PBAS-WWL	1 x 23 x 2.5	70	1	0.01	<b>\$368</b>

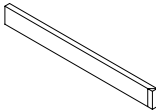

**Decorative Base Trim - Right**

PBAS-WR	1 x 19 x 2.5	70	1	0.01	<b>\$299</b>
PBAS-WWR	1 x 23 x 2.5	70	1	0.01	<b>\$368</b>

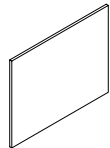

**Finished Back**

PBBA36	0.8 x 35 x 27.5	125	18	3	<b>\$467</b>
PBBA30	0.8 x 30 x 27.5	150	15	3	<b>\$388</b>
PBBA18	0.8 x 18.5 x 27.5	150	10	2	<b>\$226</b>
PBBA15	0.8 x 15.5 x 27.5	150	8	2	<b>\$196</b>

For modular pedestals.

**Required Specifications**

Finish

## HUTCHES & WALL MOUNTED STORAGE NOTES

D x W x H

**NOTE:** Arrow indicates direction of grain

### Hutches

- All hutches are shipped assembled
- Bronze glass door is standard. Clear glass is available, please contact customer care.

### Closed pigeon hole storage hutch

- 42" unit has 21.5" of clearance
- Hutches longer than 102" have 8 doors, hutches between 102" and 84" have 6 doors, and hutches less than 84" have 4 doors.

### Closed storage hutch

- 36" unit has 19.5" of clearance.
- 42" and 54" units have 25.5" of clearance
- Hutches longer than 102" have 8 doors, hutches between 102" and 84" have 6 doors, and hutches less than 84" have 4 doors.

### Tasklight

- For proper size see page 337.

HUTCHES & WALL MOUNTED STORAGE	MODEL#	DIMENSIONS	FREIGHT CLASS	WT/LBS.	CUBIC FT.	LIST PRICE
--------------------------------	--------	------------	---------------	---------	-----------	------------

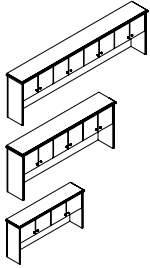

**36" H Storage Hutch w/Wood Doors**

PB108SH36	15 x 108 x 36	125	268	34	<b>\$7627</b>
PB102SH36	15 x 102 x 36	125	254	32	<b>\$7202</b>
PB96SH36	15 x 96 x 36	100	241	30	<b>\$6775</b>
PB90SH36	15 x 90 x 36	100	227	28	<b>\$6353</b>
PB84SH36	15 x 84 x 36	100	214	26	<b>\$5931</b>
PB78SH36	15 x 78 x 36	100	200	24	<b>\$5510</b>
PB72SH36	15 x 72 x 36	100	187	23	<b>\$5084</b>
PB66SH36	15 x 66 x 36	100	173	21	<b>\$4891</b>
PB60SH36	15 x 60 x 36	100	160	19	<b>\$4663</b>

Hutches longer than 102" have 8 doors, hutches between 102" and 84" have 6 doors, and hutches less than 84" have 4 doors.

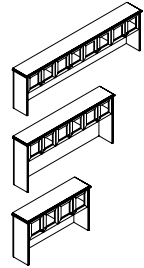

**36" H Storage Hutch w/Glass Doors**

PB108SH36G	15 x 108 x 36	125	268	34	<b>\$10639</b>
PB102SH36G	15 x 102 x 36	125	254	32	<b>\$9598</b>
PB96SH36G	15 x 96 x 36	100	241	30	<b>\$9133</b>
PB90SH36G	15 x 90 x 36	100	227	28	<b>\$8682</b>
PB84SH36G	15 x 84 x 36	100	214	26	<b>\$8221</b>
PB78SH36G	15 x 78 x 36	100	200	24	<b>\$7771</b>
PB72SH36G	15 x 72 x 36	100	187	23	<b>\$6704</b>
PB66SH36G	15 x 66 x 36	100	173	21	<b>\$6461</b>
PB60SH36G	15 x 60 x 36	100	160	19	<b>\$6188</b>

Wood framed glass doors. Hutches longer than 102" have 8 doors, hutches between 102" and 84" have 6 doors, and hutches less than 84" have 4 doors.

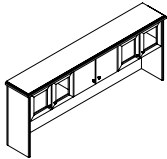

**36" H Storage Hutch w/Doors**

PB102SH36GDG	15 x 102 x 36	125	254	32	<b>\$8850</b>
PB96SH36GDG	15 x 96 x 36	100	241	30	<b>\$8388</b>
PB90SH36GDG	15 x 90 x 36	100	227	28	<b>\$7936</b>
PB84SH36GDG	15 x 84 x 36	100	214	26	<b>\$7476</b>

Wood doors in the center and wood framed glass doors on left and right.

### Required Specifications

Finish

### Optional Specifications

Additional grommet

HUTCHES & WALL MOUNTED STORAGE

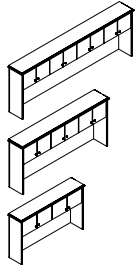

42" H Storage Hutch w/Wood Doors

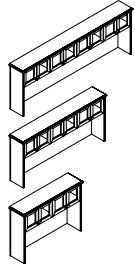

42" H Storage Hutch w/Glass Doors

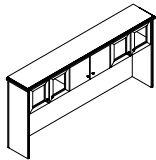

42" H Storage Hutch w/Doors

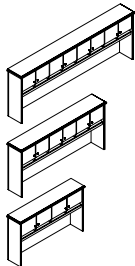

42" H Storage Hutch w/Wood Doors & Pigeon-Holes

MODEL#	DIMENSIONS	FREIGHT CLASS	WT/LBS.	CUBIC FT.	LIST PRICE
--------	------------	---------------	---------	-----------	------------

	D x W x H				
PB108SH42	15 x 108 x 42	125	307	39	\$8892
PB102SH42	15 x 102 x 42	125	290	37	\$8399
PB96SH42	15 x 96 x 42	125	273	35	\$7907
PB90SH42	15 x 90 x 42	125	256	33	\$7410
PB84SH42	15 x 84 x 42	125	239	31	\$6916
PB78SH42	15 x 78 x 42	150	222	38	\$6422
PB72SH42	15 x 72 x 42	125	205	26	\$5931
PB66SH42	15 x 66 x 42	125	188	24	\$5712
PB60SH42	15 x 60 x 42	125	171	22	\$5437

Hutches longer than 102" have 8 doors, hutches between 102" and 84" have 6 doors, and hutches less than 84" have 4 doors.

PB108SH42G	15 x 108 x 42	125	307	39	\$11843
PB102SH42G	15 x 102 x 42	125	290	37	\$10794
PB96SH42G	15 x 96 x 42	125	273	35	\$10266
PB90SH42G	15 x 90 x 42	125	256	33	\$9734
PB84SH42G	15 x 84 x 42	125	239	31	\$9210
PB78SH42G	15 x 78 x 42	150	222	38	\$8686
PB72SH42G	15 x 72 x 42	125	205	26	\$7549
PB66SH42G	15 x 66 x 42	125	188	24	\$7280
PB60SH42G	15 x 60 x 42	125	171	22	\$6960

Wood framed glass doors. Hutches longer than 102" have 8 doors, hutches between 102" and 84" have 6 doors, and hutches less than 84" have 4 doors.

PB102SH42GDG	15 x 102 x 42	125	290	37	\$10047
PB96SH42GDG	15 x 96 x 42	125	273	35	\$9518
PB90SH42GDG	15 x 90 x 42	125	256	33	\$8990
PB84SH42GDG	15 x 84 x 42	125	239	31	\$8464

Wood doors in the center and wood framed glass doors on left and right.

PB108SHP42	15 x 108 x 42	125	307	39	\$10667
PB102SHP42	15 x 102 x 42	125	290	37	\$10078
PB96SHP42	15 x 96 x 42	125	273	35	\$9487
PB90SHP42	15 x 90 x 42	125	256	33	\$8892
PB84SHP42	15 x 84 x 42	125	239	31	\$8296
PB78SHP42	15 x 78 x 42	150	222	38	\$7708
PB72SHP42	15 x 72 x 42	125	205	26	\$7119
PB66SHP42	15 x 66 x 42	125	241	31	\$7340
PB60SHP42	15 x 60 x 42	125	171	22	\$6523

Hutches longer than 102" have 8 doors, hutches between 102" and 84" have 6 doors, and hutches less than 84" have 4 doors.

**Required Specifications**  
Finish

**Optional Specifications**  
Additional grommet

## HUTCHES & WALL MOUNTED STORAGE

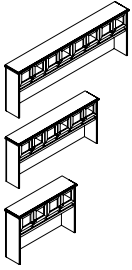

**42" H Storage Hutch w/Glass Doors & Pigeon-Holes**

MODEL#	DIMENSIONS D x W x H	FREIGHT CLASS	WT/LBS.	CUBIC FT.	LIST PRICE
PB108SHP42G	15 x 108 x 42	125	307	39	<b>\$13612</b>
PB102SHP42G	15 x 102 x 42	125	290	37	<b>\$12410</b>
PB96SHP42G	15 x 96 x 42	125	273	35	<b>\$11818</b>
PB90SHP42G	15 x 90 x 42	125	256	33	<b>\$11184</b>
PB84SHP42G	15 x 84 x 42	125		31	
PB78SHP42G	15 x 78 x 42	150	222	38	<b>\$9908</b>
PB72SHP42G	15 x 72 x 42	125	205	26	<b>\$8695</b>
PB66SHP42G	15 x 66 x 42	125	188	24	<b>\$8409</b>
PB60SHP42G	15 x 60 x 42	125	171	22	<b>\$8001</b>

Wood framed glass doors. Hutches longer than 102" have 8 doors, hutches between 102" and 84" have 6 doors, and hutches less than 84" have 4 doors.

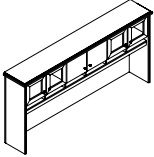

**42" H Storage Hutch w/Doors & Pigeon-Holes**

PB102SHP42GDG	15 x 102 x 42	125	290	37	<b>\$11664</b>
PB96SHP42GDG	15 x 96 x 42	125	273	35	<b>\$11069</b>
PB90SHP42GDG	15 x 90 x 42	125	256	33	<b>\$10438</b>
PB84SHP42GDG	15 x 84 x 42	125	239	31	<b>\$9774</b>

Wood doors in the center and wood framed glass doors on left and right.

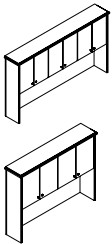

**54" H Storage Hutch w/Wood Doors**

PB962SH54	15 x 96 x 55	125	351	45	<b>\$10158</b>
PB902SH54	15 x 90 x 55	125	329	42	<b>\$9526</b>
PB842SH54	15 x 84 x 55	125	309	39	<b>\$8892</b>
PB782SH54	15 x 78 x 55	125	285	37	<b>\$8257</b>
PB722SH54	15 x 72 x 55	125	263	34	<b>\$7626</b>
PB662SH54	15 x 66 x 55	125	241	31	<b>\$7340</b>
PB602SH54	15 x 60 x 55	125	219	28	<b>\$6985</b>

Hutches between 96" and 84" have 6 doors; hutches less than 84" have 4 doors. One adjustable shelf.

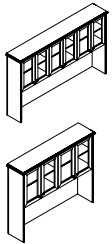

**54" H Storage Hutch w/Glass Doors**

PB962SH54G	15 x 96 x 55	125	351	45	<b>\$13114</b>
PB902SH54G	15 x 90 x 55	125	329	42	<b>\$12224</b>
PB842SH54G	15 x 84 x 55	125	307	39	<b>\$11326</b>
PB782SH54G	15 x 78 x 55	125	285	37	<b>\$10434</b>
PB722SH54G	15 x 72 x 55	125	263	34	<b>\$9544</b>
PB662SH54G	15 x 66 x 55	125	241	31	<b>\$9196</b>
PB602SH54G	15 x 60 x 55	125	219	28	<b>\$8781</b>

Wood framed glass doors. Hutches between 96" and 84" have 6 doors; hutches less than 84" have 4 doors. One adjustable shelf.

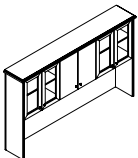

**54" H Storage Hutch w/Doors**

PB962SH54GDG	15 x 96 x 55	125	351	45	<b>\$12182</b>
PB902SH54GDG	15 x 90 x 55	125	329	42	<b>\$11294</b>
PB842SH54GDG	15 x 84 x 55	125	307	39	<b>\$10394</b>

Wood doors in the center and wood framed glass doors on left and right. One adjustable shelf.

### Required Specifications

Finish

**HUTCHES & WALL MOUNTED STORAGE**

**MODEL#      DIMENSIONS      FREIGHT CLASS      WT/LBS.      CUBIC FT.      LIST PRICE**

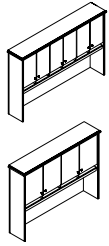

**54" H Storage Hutch w/Wood Doors & Pigeon-Holes**

	<b>D x W x H</b>					
PB962SHP54	15 x 96 x 55	125	351	45	<b>\$12195</b>	
PB902SHP54	15 x 90 x 55	125	329	42	<b>\$11434</b>	
PB842SHP54	15 x 84 x 55	125	307	39	<b>\$10667</b>	
PB782SHP54	15 x 78 x 55	125	285	37	<b>\$9908</b>	
PB722SHP54	15 x 72 x 55	125	263	34	<b>\$9146</b>	
PB662SHP54	15 x 66 x 55	125	241	31	<b>\$8806</b>	
PB602SHP54	15 x 60 x 55	125	219	28	<b>\$8381</b>	

Hutches between 96" and 84" have 6 doors; hutches less than 84" have 4 doors. One adjustable shelf.

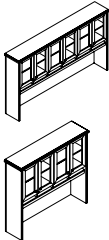

**54" H Storage Hutch w/Glass Doors & Pigeon-Holes**

PB962SHP54	15 x 96 x 55	125	351	45	<b>\$12195</b>	
PB902SHP54	15 x 90 x 55	125	329	42	<b>\$11434</b>	
PB842SHP54	15 x 84 x 55	125	307	39	<b>\$10667</b>	
PB782SHP54	15 x 78 x 55	125	285	37	<b>\$9908</b>	
PB722SHP54	15 x 72 x 55	125	263	34	<b>\$9146</b>	
PB662SHP54	15 x 66 x 55	125	241	31	<b>\$8806</b>	
PB602SHP54	15 x 60 x 55	125	219	28	<b>\$8381</b>	

Wood framed glass doors. Hutches between 96" and 84" have 6 doors; hutches less than 84" have 4 doors. One adjustable shelf.

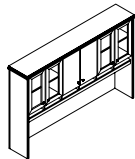

**54" H Storage Hutch w/Doors & Pigeon-Holes**

PB962SHP54GDG	15 x 96 x 55	125	351	45	<b>\$14218</b>	
PB902SHP54GDG	15 x 90 x 55	125	329	42	<b>\$13456</b>	
PB842SHP54GDG	15 x 84 x 55	125	307	39	<b>\$12355</b>	

Wood doors in the center and wood framed glass doors on left and right. One adjustable shelf.

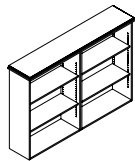

**Open Hutch**

PB720B54	15 x 72 x 55	125	260	35	<b>\$6995</b>	
PB360B54	15 x 36.75 x 55	125	130	18	<b>\$3507</b>	

Four adjustable shelves.

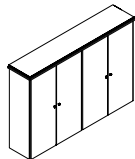

**Hutch w/Wood Doors**

PB72BD54	15 x 72 x 55	100	320	35	<b>\$9008</b>	
PB36BD54	15 x 36.75 x 55	100	160	18	<b>\$4512</b>	

Four adjustable shelves.

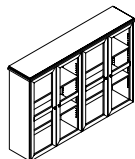

**Hutch w/Glass Doors**

PB72BG54	15 x 72 x 55	100	320	35	<b>\$10213</b>	
PB36BG54	15 x 36.75 x 55	100	160	18	<b>\$5109</b>	

Wood framed glass doors. Four adjustable shelves.

**Required Specifications**  
Finish

**Optional Specifications**  
Additional grommet

**HUTCHES & WALL MOUNTED STORAGE**

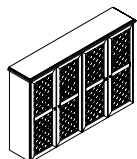

**Hutch w/Wire Mesh Doors**

MODEL#	DIMENSIONS D x W x H	FREIGHT CLASS	WT/LBS.	CUBIC FT.	LIST PRICE
PB72BW54	15 x 72 x 55	100	320	35	<b>\$11421</b>
PB36BW54	15 x 36.75 x 55	100	160	18	<b>\$5860</b>

Antique Brass wire mesh wood framed doors. Four adjustable shelves.

**FREESTANDING STORAGE NOTES**

**NOTE:** Arrow indicates direction of grain

**Pedestals**

- All units are shipped assembled.
- Standard face locking.

**Combination Storage**

- All units are shipped assembled.
- No modifications accepted for this unit.
- Box drawers do not lock.
- Standard face locking.

**Storage Cabinets**

- All units are shipped assembled.
- Units include adjustable shelves.
- Standard face locking.

**TV Cabinets**

- All units are shipped assembled.
- Units include 170° hinges, grommet on fixed shelf and adjustable shelf in lower cabinet.
- Standard face locking for lower cabinet.
- To add lock for upper cabinet, specify "LO".

**FREESTANDING STORAGE**

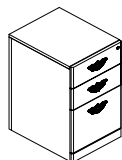

**Freestanding Pedestal**

MODEL#	DIMENSIONS D x W x H	FREIGHT CLASS	WT/LBS.	CUBIC FT.	LIST PRICE
PBWDB	19.8 x 15.5 x 28	85	70	5	<b>\$2701</b>
PBWWDB	23.8 x 15.5 x 28	85	75	6	<b>\$3111</b>

Box/box/file.

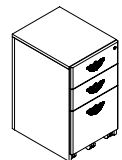

**Freestanding Mobile Pedestal**

PBWDM	19.8 x 15.5 x 28	85	70	5	<b>\$2906</b>
PBWWDM	23.8 x 15.5 x 28	85	75	6	<b>\$3339</b>

Box/box/file.

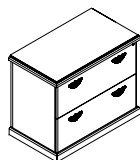

**Lateral File - 2 high**

PBF3624	24 x 36.75 x 29	85	184	15	<b>\$5000</b>
PBF3620	20 x 36.75 x 29	85	159	12	<b>\$4158</b>
PBN3024	24 x 31.63 x 29	85	153	12	<b>\$4375</b>
PBN3020	20 x 31.63 x 29	85	131	10	<b>\$3638</b>

Two lateral file drawers.

**Required Specifications**  
Finish

**Optional Specifications**  
Additional grommet

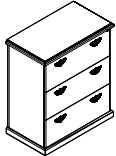
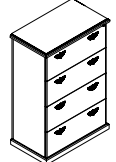
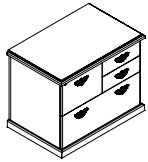
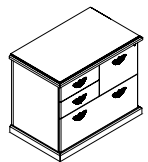
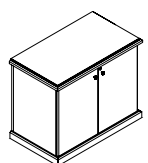
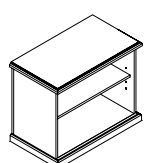
FREESTANDING STORAGE	MODEL#	DIMENSIONS	FREIGHT CLASS	WT/LBS.	CUBIC FT.	LIST PRICE
 <p><b>Lateral File - 3 high</b></p>		<b>D x W x H</b>				
	PBF36243	24 x 36.75 x 42	92.5	231	21	<b>\$6112</b>
	PBF36203	20 x 36.75 x 42	92.5	193	18	<b>\$5217</b>
	PBN30243	24 x 31.63 x 42	92.5	193	18	<b>\$5343</b>
	PBN30203	20 x 31.63 x 42	92.5	160	15	<b>\$4564</b>
Three lateral file drawers.						
 <p><b>Lateral File - 4 high</b></p>	PBF36244	24 x 36.75 x 54	92.5	297	27	<b>\$7443</b>
	PBF36204	20 x 36.75 x 54	92.5	259	23	<b>\$6466</b>
	PBN30244	24 x 31.63 x 54	92.5	248	23	<b>\$6508</b>
	PBN30204	20 x 31.63 x 54	92.5	214	19	<b>\$5656</b>
Four lateral file drawers.						
 <p><b>Combination Storage - Left</b></p>	PBZL3624	24 x 36.75 x 29	85	184	15	<b>\$5418</b>
	PBZL3620	20 x 36.75 x 29	85	160	12	<b>\$4375</b>
With 1 lateral file, 2 box drawers in the top right, and 1 file drawer in the top left.						
 <p><b>Combination Storage - Right</b></p>	PBZR3624	24 x 36.75 x 29	85	184	15	<b>\$5418</b>
	PBZR3620	20 x 36.75 x 29	85	160	12	<b>\$4375</b>
With 1 lateral file, 2 box drawers in the top left, and 1 file drawer in the top right.						
 <p><b>Storage Cabinet w/Doors</b></p>	PBBD3624	24 x 36.75 x 29	92.5	152	15	<b>\$3405</b>
	PBBD3620	20 x 36.75 x 29	92.5	129	12	<b>\$2966</b>
	PBBD3024	24 x 31.63 x 29	92.5	127	12	<b>\$2981</b>
	PBBD3020	20 x 31.63 x 29	92.5	106	10	<b>\$2592</b>
Storage with 1 adjustable shelf.						
 <p><b>Open Storage Cabinet</b></p>	PBOB3624	24 x 36.75 x 29	100	123	15	<b>\$2732</b>
	PBOB3620	20 x 36.75 x 29	100	104	12	<b>\$2380</b>
	PBOB3024	24 x 31.63 x 29	100	103	12	<b>\$2385</b>
	PBOB3020	20 x 31.63 x 29	100	85	10	<b>\$2075</b>
Storage with 1 adjustable shelf.						

**Required Specifications**  
Finish

**Optional Specifications**  
Additional grommet



## FREESTANDING STORAGE

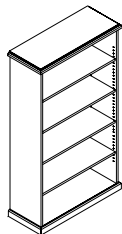

**Open Bookcase**

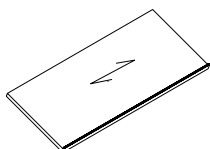

**Additional Shelf**

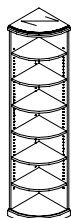

**Quarter Round Open Bookcase**

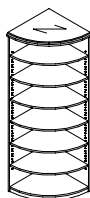

**Quarter Round Open Bookcase**

MODEL#	DIMENSIONS D x W x H	FREIGHT CLASS	WT/LBS.	CUBIC FT.	LIST PRICE
PBB83615	15 x 36.75 x 84	100	246	26	<b>\$4186</b>
PBB73615	15 x 36.75 x 78	100	228	24	<b>\$3887</b>
PBB63615	15 x 36.75 x 72	100	210	23	<b>\$3588</b>
PBB53615	15 x 36.75 x 65	100	188	21	<b>\$3302</b>
PBB43615	15 x 36.75 x 48	100	140	15	<b>\$2720</b>
PBB23615	15 x 36.75 x 29	92.5	90	8	<b>\$2180</b>
PBB23015	15 x 31.63 x 29	92.5	90	8	<b>\$1909</b>
PBB83615	15 x 31.63 x 84	100	246	26	<b>\$4186</b>
PBB73615	15 x 31.63 x 78	100	228	24	<b>\$3887</b>
PBB63615	15 x 31.63 x 72	100	210	23	<b>\$3588</b>
PBB53615	15 x 31.63 x 65	100	188	21	<b>\$3302</b>
PBB43615	15 x 31.63 x 48	100	140	15	<b>\$2720</b>

84" and 78" high models have 6 adjustable shelves, 72" has 5 adjustable shelves, 65" has 4 adjustable shelves, 48" has 3 adjustable shelves, 29" has 1 adjustable shelves.

PBAG3624	24 x 36 x 1	92.5	112	10	<b>\$225</b>
PBAG3622	22 x 36 x 1	92.5	104	10	<b>\$204</b>
PBAG3620	20 x 36 x 1	92.5	92	9	<b>\$184</b>
PBAG3615	15 x 36 x 1	92.5	81	8	<b>\$162</b>
PBAG3024	24 x 30 x 1	92.5	94	9	<b>\$189</b>
PBAG3022	22 x 30 x 1	100	87	9	<b>\$172</b>
PBAG3020	20 x 30 x 1	100	76	8	<b>\$152</b>
PBAG3015	15 x 30 x 1	100	67	8	<b>\$134</b>

**For use with open bookcase.** Can be specified for each shelf in an open bookcase.

PB8R1515	15 x 15 x 84	125	142	22	<b>\$3295</b>
PB7R1515	15 x 15 x 78	100	95	10	<b>\$3061</b>
PB6R1515	15 x 15 x 72	100	83	9	<b>\$2825</b>
PB5R1515	15 x 15 x 65	100	81	9	<b>\$2604</b>
PB4R1515	15 x 15 x 48	100	59	6	<b>\$2142</b>
PB2R1515	15 x 15 x 29	100	37	4	<b>\$1719</b>

84" and 78" high models have 6 adjustable shelves, 72" has 5 adjustable shelves, 65" has 4 adjustable shelves, 48" has 3 adjustable shelves, 29" has 1 adjustable shelf.

PBB7R2424H84	24 x 24 x 84	100	234	28	<b>\$5752</b>
PBB7R2424H72	24 x 24 x 72	125	204	28	<b>\$4933</b>
PBB7R2424H65	24 x 24 x 65	100	187	22	<b>\$4524</b>
PBB7R2020H84	20 x 20 x 84	100	163	19	<b>\$5027</b>
PBB7R2020H72	20 x 20 x 72	100	142	17	<b>\$4307</b>
PBB7R2020H65	20 x 20 x 65	100	130	15	<b>\$4039</b>

84" high models have 6 adjustable shelves, 72" has 5 adjustable shelves, and 65" has 4 adjustable shelves

### Required Specifications

Finish

**FREESTANDING STORAGE**

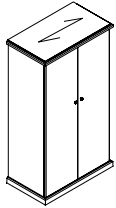

**Storage Cabinet w/Wood Doors**

**MODEL# DIMENSIONS FREIGHT CLASS WT/LBS. CUBIC FT. LIST PRICE**

**D x W x H**

PB1D24W36H84	24 x 36.75 x 84	125	304	42	<b>\$7990</b>
PB1D24W36H72	24 x 36.75 x 72	100	283	33	<b>\$6848</b>
PB1D24W36H65	24 x 36.75 x 65	100	259	30	<b>\$6276</b>
PB1D24W30H84	24 x 30.63 x 84	125	304	42	<b>\$6981</b>
PB1D24W30H72	24 x 30.63 x 72	100	283	33	<b>\$5983</b>
PB1D24W30H65	24 x 30.63 x 65	100	259	30	<b>\$5495</b>
PB1D24W24H84	24 x 24 x 84	92.5	320	28	<b>\$5964</b>
PB1D24W24H72	24 x 24 x 72	92.5	255	24	<b>\$5113</b>
PB1D24W24H65	24 x 24 x 65	125	173	22	<b>\$4712</b>
PB1D20W36H84	20 x 36.75 x 84	100	297	35	<b>\$6981</b>
PB1D20W36H72	20 x 36.75 x 72	100	269	30	<b>\$5983</b>
PB1D20W36H65	20 x 36.75 x 65	100	245	28	<b>\$5485</b>
PB1D20W30H84	20 x 30.63 x 84	100	257	29	<b>\$5816</b>
PB1D20W30H72	20 x 30.63 x 72	100	233	25	<b>\$4987</b>
PB1D20W30H65	20 x 30.63 x 65	100	202	23	<b>\$4571</b>
PB1D20W24H84	20 x 24 x 84	100	198	23	<b>\$4656</b>
PB1D20W24H72	20 x 24 x 72	100	179	20	<b>\$3990</b>
PB1D20W24H65	20 x 24 x 65	100	163	18	<b>\$3651</b>

84" high models have 6 adjustable shelves, 72" has 5 adjustable shelves, 65" has 4 adjustable shelves. For wood framed glass door option, please contact customer care.

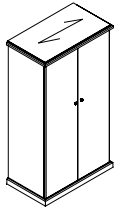

**Wardrobe Cabinet**

PB2D24W36H84	24 x 36.75 x 84	100	356	42	<b>\$6933</b>
PB2D24W36H72	24 x 36.75 x 72	100	324	36	<b>\$5945</b>
PB2D24W36H65	24 x 36.75 x 65	100	297	33	<b>\$5449</b>
PB2D24W30H84	24 x 30.63 x 84	100	296	35	<b>\$6070</b>
PB2D24W30H72	24 x 30.63 x 72	100	270	30	<b>\$5202</b>
PB2D24W30H65	24 x 30.63 x 65	100	248	28	<b>\$4768</b>
PB2D24W24H84	24 x 24 x 84	100	238	28	<b>\$5202</b>
PB2D24W24H72	24 x 24 x 72	100	216	24	<b>\$4459</b>
PB2D24W24H65	24 x 24 x 65	100	198	22	<b>\$4087</b>
PB2D20W36H84	20 x 36.75 x 84	100	297	35	<b>\$6054</b>
PB2D20W36H72	20 x 36.75 x 72	100	269	30	<b>\$5180</b>
PB2D20W36H65	20 x 36.75 x 65	100	245	28	<b>\$4745</b>
PB2D20W30H84	20 x 30.63 x 84	100	257	29	<b>\$5047</b>
PB2D20W30H72	20 x 30.63 x 72	100	233	25	<b>\$4318</b>
PB2D20W30H65	20 x 30.63 x 65	100	202	23	<b>\$3958</b>
PB2D20W24H84	20 x 24 x 84	100	198	23	<b>\$4034</b>
PB2D20W24H72	20 x 24 x 72	100	179	20	<b>\$3450</b>
PB2D20W24H65	20 x 24 x 65	100	163	18	<b>\$3166</b>

Doors, coat rack and hat shelf. 84" high models have 6 adjustable shelves, 72" has 5 adjustable shelves, 65" has 4 adjustable shelves. For wood framed glass door option, please contact customer care.

**Required Specifications**

Finish

## FREESTANDING STORAGE

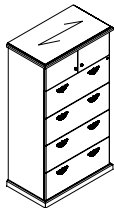

**Storage Cupboard**

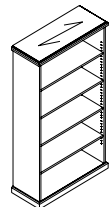

**Open Bookcase**

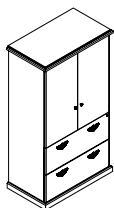

**Storage Cabinet w/Doors**

MODEL#	DIMENSIONS D x W x H	FREIGHT CLASS	WT/LBS.	CUBIC FT.	LIST PRICE
PB6D24W36H84	24 x 36.75 x 84	92.5	449	42	<b>\$11681</b>
PB6D24W36H72	24 x 36.75 x 72	92.5	414	36	<b>\$10015</b>
PB6D24W36H65	24 x 36.75 x 65	92.5	380	33	<b>\$9181</b>
PB6D24W30H84	24 x 30.63 x 84	92.5	375	35	<b>\$10226</b>
PB6D24W30H72	24 x 30.63 x 72	92.5	345	30	<b>\$8766</b>
PB6D24W30H65	24 x 30.63 x 65	92.5	316	28	<b>\$8034</b>
PB6D20W36H84	20 x 36.75 x 84	92.5	382	35	<b>\$10200</b>
PB6D20W36H72	20 x 36.75 x 72	92.5	351	30	<b>\$8726</b>
PB6D20W36H65	20 x 36.75 x 65	92.5	321	28	<b>\$7995</b>
PB6D20W30H84	20 x 30.63 x 84	92.5	347	29	<b>\$8500</b>
PB6D20W30H72	20 x 30.63 x 72	85	306	25	<b>\$7274</b>
PB6D20W30H65	20 x 30.63 x 65	92.5	265	23	<b>\$6668</b>

Above lateral file cabinet with 4 drawers. 84" high model has 1 adjustable shelf. For wood framed glass door option, please contact customer care.

PB7D24W36H84	24 x 36.75 x 84	125	331	43	<b>\$6396</b>
PB7D24W36H72	24 x 36.75 x 72	100	306	36	<b>\$5485</b>
PB7D24W36H65	24 x 36.75 x 65	100	281	33	<b>\$5027</b>
PB7D24W30H84	24 x 30.63 x 84	125	280	36	<b>\$5597</b>
PB7D24W30H72	24 x 30.63 x 72	100	255	30	<b>\$4785</b>
PB7D24W30H65	24 x 30.63 x 65	100	234	28	<b>\$4391</b>
PB7D20W36H84	20 x 36.75 x 84	100	282	35	<b>\$5584</b>
PB7D20W36H72	20 x 36.75 x 72	100	257	30	<b>\$4785</b>
PB7D20W36H65	20 x 36.75 x 65	100	234	28	<b>\$4391</b>
PB7D20W30H84	20 x 30.63 x 84	100	248	29	<b>\$4651</b>
PB7D20W30H72	20 x 30.63 x 72	100	223	25	<b>\$3988</b>
PB7D20W30H65	20 x 30.63 x 65	100	193	23	<b>\$3654</b>

84" high models have 6 adjustable shelves, 72" has 5 adjustable shelves, and 65" has 4 adjustable shelves.

PB13D24W36H84	24 x 36.75 x 84	100	407	42	<b>\$9889</b>
PB13D24W36H72	24 x 36.75 x 72	92.5	387	36	<b>\$8477</b>
PB13D24W36H65	24 x 36.75 x 65	92.5	347	33	<b>\$7772</b>
PB13D24W30H84	24 x 30.63 x 84	92.5	350	35	<b>\$8654</b>
PB13D24W30H72	24 x 30.63 x 72	92.5	315	30	<b>\$7417</b>
PB13D24W30H65	24 x 30.63 x 65	92.5	289	28	<b>\$6798</b>
PB13D20W36H84	20 x 36.75 x 84	92.5	365	35	<b>\$8632</b>
PB13D20W36H72	20 x 36.75 x 72	92.5	327	30	<b>\$7385</b>
PB13D20W36H65	20 x 36.75 x 65	92.5	299	28	<b>\$6770</b>
PB13D20W30H84	20 x 30.63 x 84	92.5	305	29	<b>\$7197</b>
PB13D20W30H72	20 x 30.63 x 72	92.5	285	25	<b>\$6157</b>
PB13D20W30H65	20 x 30.63 x 65	92.5	247	23	<b>\$5641</b>

Above two lateral file drawers. 84" high models have 3 adjustable shelves, 72" has 2 adjustable shelves, and 65" has 1 adjustable shelf. For wood framed glass door option, please contact customer care.

### Required Specifications

Finish

### Optional Specifications

Additional grommet

**FREESTANDING STORAGE**

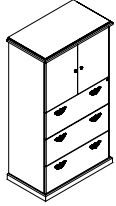

**Storage Cabinet w/Doors**

**MODEL# DIMENSIONS FREIGHT CLASS WT/LBS. CUBIC FT. LIST PRICE**

**D x W x H**

PB14D24W36H84	24 x 36.75 x 84	100	390	42	<b>\$10632</b>
PB14D24W36H72	24 x 36.75 x 72	92.5	360	36	<b>\$9114</b>
PB14D24W36H65	24 x 36.75 x 65	92.5	330	33	<b>\$8353</b>
PB14D24W30H84	24 x 30.63 x 84	100	325	35	<b>\$9305</b>
PB14D24W30H72	24 x 30.63 x 72	92.5	300	30	<b>\$7870</b>
PB14D24W30H65	24 x 30.63 x 65	100	275	28	<b>\$7311</b>

PB14D20W36H84	20 x 36.75 x 84	100	330	35	<b>\$9281</b>
PB14D20W36H72	20 x 36.75 x 72	92.5	305	30	<b>\$7940</b>
PB14D20W36H65	20 x 36.75 x 65	100	278	28	<b>\$7280</b>
PB14D20W30H84	20 x 30.63 x 84	92.5	298	29	<b>\$7735</b>
PB14D20W30H72	20 x 30.63 x 72	92.5	265	25	<b>\$6616</b>
PB14D20W30H65	20 x 30.63 x 65	100	229	23	<b>\$6067</b>

Above three lateral file drawers. 84" high models have 2 adjustable shelves, 72" and 65" have 1 adjustable shelf. For wood framed glass door option, please contact customer care.

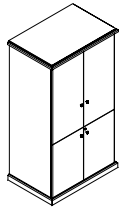

**Closed Storage Cabinet**

PB23D24W36H84	24 x 36.75 x 84	100	390	42	<b>\$8534</b>
PB23D24W36H72	24 x 36.75 x 72	92.5	360	36	<b>\$7314</b>
PB23D24W36H65	24 x 36.75 x 65	92.5	330	33	<b>\$6704</b>
PB23D24W30H84	24 x 30.63 x 84	100	325	35	<b>\$7089</b>
PB23D24W30H72	24 x 30.63 x 72	92.5	300	30	<b>\$6079</b>
PB23D24W30H65	24 x 30.63 x 65	100	275	28	<b>\$5586</b>

PB23D20W36H84	20 x 36.75 x 84	100	330	35	<b>\$7449</b>
PB23D20W36H72	20 x 36.75 x 72	92.5	305	30	<b>\$6376</b>
PB23D20W36H65	20 x 36.75 x 65	100	278	28	<b>\$5840</b>
PB23D20W30H84	20 x 30.63 x 84	92.5	298	29	<b>\$6207</b>
PB23D20W30H72	20 x 30.63 x 72	92.5	265	25	<b>\$5309</b>
PB23D20W30H65	20 x 30.63 x 65	100	229	23	<b>\$4869</b>

With upper and lower split doors. 1 fixed shelf and 2 adjustable shelves. For wood framed glass door option, please contact customer care.

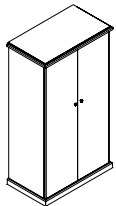

**Cabinet w/Doors and Storage**

PB25D24W36H84	24 x 36.75 x 84	100	390	42	<b>\$8965</b>
PB25D24W36H72	24 x 36.75 x 72	92.5	360	36	<b>\$7682</b>
PB25D24W36H65	24 x 36.75 x 65	92.5	330	33	<b>\$7042</b>
PB25D24W30H84	24 x 30.63 x 84	100	325	35	<b>\$7842</b>
PB25D24W30H72	24 x 30.63 x 72	92.5	300	30	<b>\$6719</b>
PB25D24W30H65	24 x 30.63 x 65	100	275	28	<b>\$6164</b>
PB25D24W24H84	24 x 24 x 84	100	260	28	<b>\$6713</b>
PB25D24W24H72	24 x 24 x 72	92.5	240	24	<b>\$5752</b>
PB25D24W24H65	24 x 24 x 65	92.5	220	22	<b>\$5280</b>

PB25D20W36H84	20 x 36.75 x 84	100	330	35	<b>\$7821</b>
PB25D20W36H72	20 x 36.75 x 72	92.5	305	30	<b>\$6692</b>
PB25D20W36H65	20 x 36.75 x 65	100	278	28	<b>\$6129</b>
PB25D20W30H84	20 x 30.63 x 84	92.5	300	29	<b>\$6520</b>
PB25D20W30H72	20 x 30.63 x 72	92.5	265	25	<b>\$5575</b>
PB25D20W30H65	20 x 30.63 x 65	100	229	23	<b>\$5111</b>
PB25D20W24H84	20 x 24 x 84	92.5	235	23	<b>\$5219</b>
PB25D20W24H72	20 x 24 x 72	92.5	203	20	<b>\$4466</b>
PB25D20W24H65	20 x 24 x 65	92.5	185	18	<b>\$4095</b>

Wardrobe with coat rack and hat shelf on left. Storage with adjustable shelves on right. 84" high models have 5 adjustable shelves, 72" and 65" have 4 adjustable shelves. For wood framed glass door option, please contact customer care.

**Required Specifications**

Finish

**Optional Specifications**

Additional grommet

## RECEPTION DESKS

### MODEL#

### DIMENSIONS

### FREIGHT CLASS

### WT./LBS.

### CUBIC FT.

### LIST PRICE

D x W x H

- To add storage use modular components. See page 356.
- Includes GM5 grommet.
- Transaction tops to be specified separately, handed by square edge from user side.

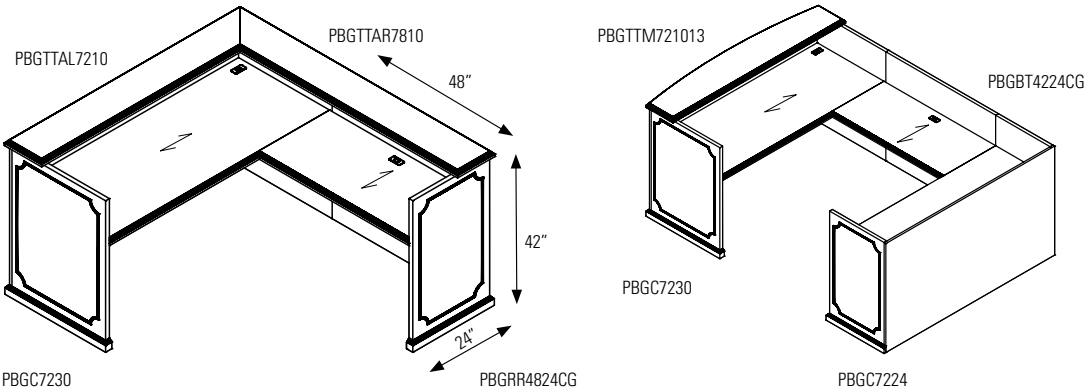

## RECEPTION DESKS

### MODEL#

### DIMENSIONS

### FREIGHT CLASS

### WT./LBS.

### CUBIC FT.

### LIST PRICE

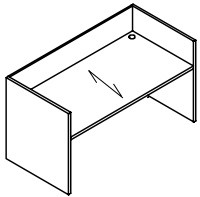

**Gallery/Reception Desk Shell\***

PBGC12036	36 x 120 x 42	150	592	105	<b>\$12272</b>
PBGC10836	36 x 108 x 42	150	533	95	<b>\$11044</b>
PBGC10236	36 x 102 x 42	150	503	89	<b>\$10431</b>
PBGC9636	36 x 96 x 42	150	473	84	<b>\$9815</b>
PBGC9036	36 x 90 x 42	150	444	79	<b>\$9205</b>
PBGC8436	36 x 84 x 42	150	414	74	<b>\$8587</b>
PBGC7236	36 x 72 x 42	150	355	63	<b>\$7368</b>
PBGC7230	30 x 72 x 42	150	315	53	<b>\$7124</b>
PBGC6630	30 x 66 x 42	125	295	48	<b>\$6947</b>
PBGC6030	30 x 60 x 42	125	275	44	<b>\$6552</b>

No pedestals. Two grommets in worksurface. For use with modular storage components. Pin molding included.

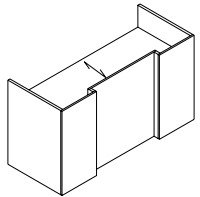

**Gallery/Reception Desk Shell  
Breakfront Style**

PBGIC12036	36 x 120 x 42	150	592	105	<b>\$13497</b>
PBGIC10836	36 x 108 x 42	150	533	95	<b>\$12145</b>
PBGIC10236	36 x 102 x 42	150	503	89	<b>\$11473</b>
PBGIC9636	36 x 96 x 42	150	473	84	<b>\$10796</b>
PBGIC9036	36 x 90 x 42	150	444	79	<b>\$10126</b>
PBGIC8436	36 x 84 x 42	150	414	74	<b>\$9446</b>
PBGIC7236	36 x 72 x 42	150	355	63	<b>\$8099</b>
PBGIC7230	30 x 72 x 42	150	315	53	<b>\$7838</b>
PBGIC6630	30 x 66 x 42	125	295	48	<b>\$7641</b>
PBGIC6030	30 x 60 x 42	125	275	44	<b>\$7207</b>

No pedestals. Two grommets in worksurface. For use with modular storage components. Pin molding included.

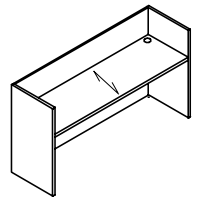

**Gallery/Reception Credenza Shell\***

PBGC12024	24 x 120 x 42	150	392	70	<b>\$9627</b>
PBGC10824	24 x 108 x 42	150	353	63	<b>\$8654</b>
PBGC10224	24 x 102 x 42	150	333	60	<b>\$8177</b>
PBGC9624	24 x 96 x 42	150	314	56	<b>\$7693</b>
PBGC9024	24 x 90 x 42	150	294	53	<b>\$7213</b>
PBGC8424	24 x 84 x 42	150	274	49	<b>\$6735</b>
PBGC7224	24 x 72 x 42	150	235	42	<b>\$5774</b>
PBGC6624	24 x 66 x 42	150	216	39	<b>\$5425</b>
PBGC6024	24 x 60 x 42	150	196	35	<b>\$5083</b>

**No pedestals.** Two grommets in worksurface. For use with modular storage components. Pin molding included.

### Required Specifications

Finish

### Optional Specifications

Additional grommet

RECEPTION DESKS

MODEL# DIMENSIONS FREIGHT CLASS WT/LBS. CUBIC FT. LIST PRICE

D x W x H

PBGBT5624CG	24 x 56 x 42	150	178	32	\$5183
PBGBT5424CG	24 x 54 x 42	150	169	29	\$5183
PBGBT5024CG	24 x 50 x 42	150	151	27	\$4606
PBGBT4824CG	24 x 48 x 42	150	142	26	\$4606
PBGBT4424CG	24 x 44 x 42	150	134	23	\$4029
PBGBT4224CG	24 x 42 x 42	150	127	22	\$4029
PBGBT3824CG	24 x 38 x 42	150	119	20	\$3629
PBGBT3624CG	24 x 36 x 42	150	112	19	\$3629

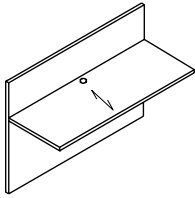

Bridge

Attaches between **Gallery Desk and Gallery Credenza Only**. One grommet in center of worksurface. Shipped RTA (ready to assemble). Pin molding included.

- To remove cross-grain veneer pattern on top, **delete "CG"** from model number. Available as a special - no upcharge.

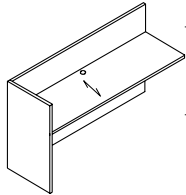

Reception Return - LEFT

PBGRL7224CG	24 x 72 x 42	125	273	42	\$7266
PBGRL6624CG	24 x 66 x 42	125	250	39	\$6664
PBGRL6024CG	24 x 60 x 42	125	228	35	\$6060
PBGRL5424CG	24 x 54 x 42	125	205	32	\$5458
PBGRL4824CG	24 x 48 x 42	125	182	28	\$4844
PBGRL4224CG	24 x 42 x 42	125	159	25	\$4243
PBGRL3624CG	24 x 36 x 42	125	137	21	\$3817

**No pedestal.** One grommet in center of worksurface. For use with modular storage components. Pin molding included.

- To remove cross-grain veneer pattern on top, **delete "CG"** from model number. Available as a special - no upcharge.

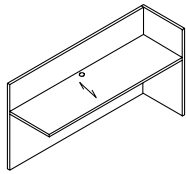

Reception Return - RIGHT

PBGRR7224CG	24 x 72 x 42	125	273	42	\$7266
PBGRR6624CG	24 x 66 x 42	125	250	39	\$6664
PBGRR6024CG	24 x 60 x 42	125	228	35	\$6060
PBGRR5424CG	24 x 54 x 42	125	205	32	\$5458
PBGRR4824CG	24 x 48 x 42	125	182	28	\$4844
PBGRR4224CG	24 x 42 x 42	125	159	25	\$4243
PBGRR3624CG	24 x 36 x 42	125	137	21	\$3817

**No pedestal.** One grommet in center of worksurface. For use with modular storage components. Pin molding included.

- To remove cross-grain veneer pattern on top, **delete "CG"** from model number. Available as a special - no upcharge.

Required Specifications

Finish

Optional Specifications

Additional grommet

## TRANSACTION COUNTERS

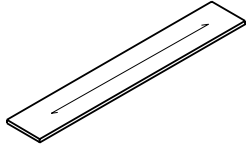

**Transaction Counter Top**

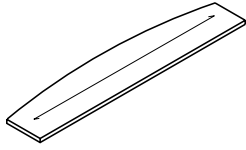

**Bow Front Transaction Counter Top**

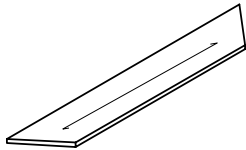

**Trapezoid Transaction Counter Top**

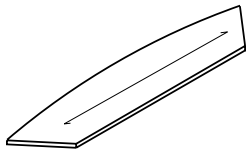

**Bow Front Trapezoid Transaction Counter Top**

MODEL#	DIMENSIONS	FREIGHT CLASS	WT/LBS.	CUBIC FT.	LIST PRICE
--------	------------	---------------	---------	-----------	------------

**D x W x H**

PBGTT12010	10 x 120 x 1.50	92.5	84	8	<b>\$2055</b>
PBGTT10810	10 x 108 x 1.50	100	78	8	<b>\$1852</b>
PBGTT10210	10 x 102 x 1.50	92.5	72	7	<b>\$1751</b>
PBGTT9610	10 x 96 x 1.50	100	66	7	<b>\$1648</b>
PBGTT9010	10 x 90 x 1.50	92.5	60	6	<b>\$1543</b>
PBGTT8410	10 x 84 x 1.50	100	54	6	<b>\$1436</b>
PBGTT7210	10 x 72 x 1.50	100	48	5	<b>\$1232</b>
PBGTT6610	10 x 66 x 1.50	100	42	5	<b>\$1130</b>
PBGTT6010	10 x 60 x 1.50	100	36	4	<b>\$1030</b>

**Rectangular top** for main reception desk. Counter sits on top of Gallery panels. Does not overhang. **Factory installed - specify Gallery to be used on.** Size must match dimension of desk front or combined desk side and return length. Hardware included.

PBGTTM1081013	10-13 x 108 x 1.50	125	78	10	<b>\$2768</b>
PBGTTM1021013	10-13 x 102 x 1.50	100	72	9	<b>\$2666</b>
PBGTTM961013	10-13 x 96 x 1.50	125	66	9	<b>\$2566</b>
PBGTTM901013	10-13 x 90 x 1.50	125	60	8	<b>\$2461</b>
PBGTTM841013	10-13 x 84 x 1.50	125	54	8	<b>\$2352</b>
PBGTTM721013	10-13 x 72 x 1.50	125	48	7	<b>\$2150</b>
PBGTTM661013	10-13 x 66 x 1.50	125	42	6	<b>\$2048</b>
PBGTTM601013	10-13 x 60 x 1.50	125	36	5	<b>\$1946</b>

**Bow top** for main reception desk. Counter sits on top of Gallery panels. Bow front overhangs 3". **Factory installed - specify Gallery to be used on.** Size must match dimension of desk front or combined desk side and return length. Hardware included.

PBGTTA10810	10 x 108 x 1.50	100	78	8	<b>\$2100</b>
PBGTTA10210	10 x 102 x 1.50	92.5	72	7	<b>\$1996</b>
PBGTTA9610	10 x 96 x 1.50	100	66	7	<b>\$1893</b>
PBGTTA9010	10 x 90 x 1.50	92.5	60	6	<b>\$1791</b>
PBGTTA8410	10 x 84 x 1.50	100	54	6	<b>\$1686</b>
PBGTTA7210	10 x 72 x 1.50	100	48	5	<b>\$1481</b>
PBGTTA6610	10 x 66 x 1.50	100	42	5	<b>\$1379</b>
PBGTTA6010	10 x 60 x 1.50	100	36	4	<b>\$1277</b>

**Trapezoid top** for main reception desk. 45° mitered ends on left and right. For use with left and right 45° mitered return transaction counters. Counter sits on top of Gallery panels. Does not overhang. **Factory installed - specify Gallery to be used on.** Width must match dimension of desk front. Hardware included.

PBGTTMA1081013	10-13 x 108 x 1.50	125	78	10	<b>\$2884</b>
PBGTTMA1021013	10-13 x 102 x 1.50	100	72	9	<b>\$2779</b>
PBGTTMA961013	10-13 x 96 x 1.50	125	66	9	<b>\$2679</b>
PBGTTMA901013	10-13 x 90 x 1.50	125	60	8	<b>\$2573</b>
PBGTTMA841013	10-13 x 84 x 1.50	125	54	8	<b>\$2470</b>
PBGTTMA721013	10-13 x 72 x 1.50	125	48	7	<b>\$2265</b>
PBGTTMA661013	10-13 x 66 x 1.50	125	42	6	<b>\$2158</b>
PBGTTMA601013	10-13 x 60 x 1.50	125	36	5	<b>\$2059</b>

**Trapezoid bow top** for main reception desk. 45° mitered ends on left and right. For use with left and right 45° mitered return transaction counters. Counter sits on top of Gallery panels. Bow front overhangs 3". **Factory installed - specify Gallery to be used on.** Width must match dimension of desk front. Hardware included.

**Required Specifications**

Finish

**Optional Specifications**

Additional grommet

**TRANSACTION COUNTERS**      **MODEL#**      **DIMENSIONS**      **FREIGHT CLASS**      **WT/LBS.**      **CUBIC FT.**      **LIST PRICE**

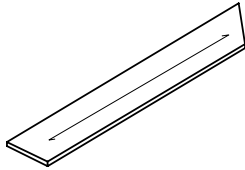

**Transaction Counter Top - LEFT**

	<b>D x W x H</b>					
PBGTTAL12010	10 x 120 x 1.50	92.5	84	8		<b>\$2218</b>
PBGTTAL11410	10 x 114 x 1.50	92.5	81	8		<b>\$2109</b>
PBGTTAL10810	10 x 108 x 1.50	100	78	8		<b>\$2011</b>
PBGTTAL10210	10 x 102 x 1.50	92.5	72	7		<b>\$1911</b>
PBGTTAL9610	10 x 96 x 1.50	100	66	7		<b>\$1808</b>
PBGTTAL9010	10 x 90 x 1.50	92.5	60	6		<b>\$1706</b>
PBGTTAL8410	10 x 84 x 1.50	100	54	6		<b>\$1600</b>
PBGTTAL7210	10 x 72 x 1.50	100	48	5		<b>\$1396</b>
PBGTTAL6610	10 x 66 x 1.50	100	42	5		<b>\$1290</b>
PBGTTAL6010	10 x 60 x 1.50	100	36	4		<b>\$1191</b>
PBGTTAL3610	10 x 36 x 1.50	100	24	3		<b>\$715</b>
PBGTTAL3010	10 x 30 x 1.50	92.5	20	2		<b>\$594</b>
PBGTTAL2410	10 x 24 x 1.50	100	16	2		<b>\$478</b>

**Rectangular top** for main reception desk with 45° mitered end on **left**. For use with rectangular or bow front transaction counters with miters at both ends. Width must match dimension of Gallery Desk end and Return width. Counter sits on top of Gallery panels. Does not overhang. **Factory installed - specify Gallery to be used on.** Hardware included.

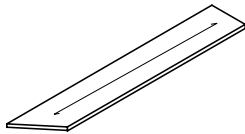

**Transaction Counter Top - RIGHT**

PBGTTAR12010	10 x 120 x 1.50	92.5	84	8		<b>\$2218</b>
PBGTTAR11410	10 x 114 x 1.50	92.5	81	8		<b>\$2109</b>
PBGTTAR10810	10 x 108 x 1.50	100	78	8		<b>\$2011</b>
PBGTTAR10210	10 x 102 x 1.50	92.5	72	7		<b>\$1911</b>
PBGTTAR9610	10 x 96 x 1.50	100	66	7		<b>\$1808</b>
PBGTTAR9010	10 x 90 x 1.50	92.5	60	6		<b>\$1706</b>
PBGTTAR8410	10 x 84 x 1.50	100	54	6		<b>\$1600</b>
PBGTTAR7210	10 x 72 x 1.50	100	48	5		<b>\$1396</b>
PBGTTAR6610	10 x 66 x 1.50	100	42	5		<b>\$1290</b>
PBGTTAR6010	10 x 60 x 1.50	100	36	4		<b>\$1191</b>
PBGTTAR3610	10 x 36 x 1.50	100	24	3		<b>\$715</b>
PBGTTAR3010	10 x 30 x 1.50	92.5	20	2		<b>\$594</b>
PBGTTAR2410	10 x 24 x 1.50	100	16	2		<b>\$478</b>

**Rectangular top** for main reception desk with 45° mitered end on **right**. For use with rectangular or bow front transaction counters with miters at both ends. Width must match dimension of Gallery Desk end and Return width. Counter sits on top of Gallery panels. Does not overhang. **Factory installed - specify Gallery to be used on.** Hardware included.

**Required Specifications**  
Finish

**Optional Specifications**  
Additional grommet



## TACKBOARDS FOR HUTCHES & ACCESSORIES

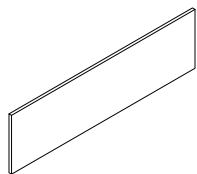

**Tackboard for 36"H\*  
Non-Pigeon Hole Hutches**

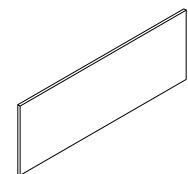

**Tackboard for 42"H & 54"H\*  
Pigeon Hole Hutches**

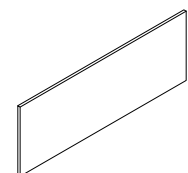

**Tackboard for 42"H & 54"H\*  
Non-Pigeon Hole Hutches**

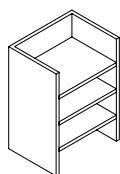

**Paper Organizer, Letter & Legal Format**

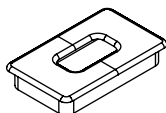

**Grommet**

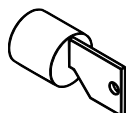

**Lock Assembly**

MODEL#	DIMENSIONS D x W x H	FREIGHT CLASS	WT/LBS.	CUBIC FT.	LIST PRICE
PBTS108	1 x 104.5 x 20	92.5	23	2	<b>\$1232</b>
PBTS102	1 x 98.5 x 20	100	19	2	<b>\$1166</b>
PBTS96	1 x 92.5 x 20	70	17	1	<b>\$1097</b>
PBTS90	1 x 86.5 x 20	70	15	1	<b>\$1030</b>
PBTS84	1 x 80.5 x 20	85	14	1	<b>\$967</b>
PBTS78	1 x 74.5 x 20	85	13	1	<b>\$894</b>
PBTS72	1 x 68.5 x 20	85	12	1	<b>\$825</b>
PBTS66	1 x 62.5 x 20	92.5	11	1	<b>\$753</b>
PBTS60	1 x 56.5 x 20	92.5	10	1	<b>\$688</b>

Factory installed hutch tackboard.

PBTSP108H23	1 x 104.5 x 23	70	30	2	<b>\$1394</b>
PBTSP102H23	1 x 98.5 x 23	85	24	2	<b>\$1328</b>
PBTSP96H23	1 x 92.5 x 23	92.5	22	2	<b>\$1240</b>
PBTSP90H23	1 x 86.5 x 23	70	20	1	<b>\$1162</b>
PBTSP84H23	1 x 80.5 x 23	70	18	1	<b>\$1085</b>
PBTSP78H23	1 x 74.5 x 23	70	17	1	<b>\$1008</b>
PBTSP72H23	1 x 68.5 x 23	70	16	1	<b>\$937</b>
PBTSP66H23	1 x 62.5 x 23	85	14	1	<b>\$852</b>
PBTSP60H23	1 x 56.5 x 23	85	13	1	<b>\$779</b>

Factory installed hutch tackboard.

PBTS108H26	1 x 104.5 x 26	70	30	2	<b>\$1611</b>
PBTS102H26	1 x 98.5 x 26	85	24	2	<b>\$1518</b>
PBTS102H26	1 x 92.5 x 26	85	24	2	<b>\$1518</b>
PBTS90H26	1 x 86.5 x 26	92.5	20	2	<b>\$1344</b>
PBTS84H26	1 x 80.5 x 26	100	18	2	<b>\$1160</b>
PBTS78H26	1 x 74.5 x 26	100	17	2	<b>\$982</b>
PBTS72H26	1 x 68.5 x 26	70	16	1	<b>\$894</b>
PBTS66H26	1 x 62.5 x 26	85	14	1	<b>\$802</b>
PBTS60H26	1 x 56.5 x 26	85	13	1	<b>\$621</b>

Factory installed hutch tackboard.

PBCPH161226	12 x 16 x 27	125	20	3	<b>\$981</b>
PBCPH161223	12 x 16 x 23	125	18	3	<b>\$1335</b>
PBCPH161219	12 x 16 x 20	125	15	2	<b>\$632</b>
PBCPH131226	12 x 13 x 27	100	16	2	<b>\$795</b>
PBCPH131223	12 x 13 x 23	125	15	2	<b>\$675</b>
PBCPH131219	12 x 13 x 20	125	12	2	<b>\$512</b>

GM5C	2 x 3.5 x --	70	--	--	<b>\$107</b>
------	--------------	----	----	----	--------------

Rectangular grommet in metal, tungsten finish.

LO/C	--	70	--	--	<b>\$106</b>
------	----	----	----	----	--------------

Tungsten.

### Required Specifications

Fabric\*

# boardroom tables



# T BOARDROOM TABLES - NOTES

## 1. SPECIFY MODEL NUMBER

## 2. SPECIFY FINISH

### TOP FINISH - WOOD VENEER

Code	Finish	Veneer Type	Cut
AMW	Almond Cherry	Cherry	Flat Sliced
ACW	Amber Cherry	Cherry	Flat Sliced
BTW	Biscotti	White Oak	Rift
CAW	Cocoa Walnut	Walnut	Flat Sliced
CRW	Coral	White Oak	Rift
DCW	Dark Cherry	Cherry	Flat Sliced
DWW	Dark Walnut	Walnut	Flat Sliced
EWV	Espresso Walnut	Walnut	Flat Sliced
EVW	Evening Oak	White Oak	Rift
GRW	Grey on Oak	White Oak	Rift
HAW	Hazelnut	Maple	Flat Sliced
JAW	Java	White Oak	Rift
LTW	Latte Walnut	Walnut	Flat Sliced
MHW	Mahogany on Walnut	Walnut	Flat Sliced
MTW	Milestone	White Oak	Rift
MPW	Natural Maple	Maple	Flat Sliced
NLW	Natural Walnut	Walnut	Flat Sliced
RCW	Red Cherry	Cherry	Flat Sliced
VNW	Vintage Cherry	Cherry	Flat Sliced
ULW	Umber Walnut	Walnut	Flat Sliced
WLW	Walnut	Walnut	Flat Sliced
WCW	Warm Cherry	Cherry	Flat Sliced
WMW	White Maple	Maple	Flat Sliced

### BASE FINISH (refer to specific model for availability):

K	Black
E	Tungsten

**3. SPECIFY OPTIONS**

**Boardroom Tops**

- Tops 120" and under ship in one piece
- Tops over 120" ship in two pieces
- Veneer wood grain will run with the **length** of the table and align at the seam

**Grommets**

- Optional grommets may be ordered in standard table top locations (left, center or right). Order as **GM1TL, GM1TC or GM1TR. Add \$96.**
- Grommet hole dimensions are 2 3/4" in diameter. Specify **GM1** for **Black** or **GM1K** for **Tungsten. Standard Grommet Locations:**

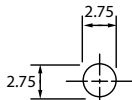

**Grommet Locations - Boardroom Tables**

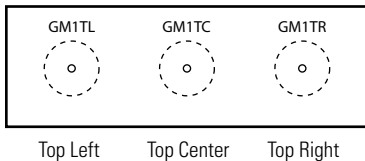

**Power/Data Accessories**

- Match power block desired with cut-out code and location from grid below.
- Please specify location in top as left, center or right (**TL/x, TC/x, or TR/x**) as per line drawing below. Location must be specified on product to be placed on at the time of the order. Please note orientation of power/data accessories on Boardroom Table tops as is shown in drawings below. **Add \$300** for each cut-out.
- When an "M" cut-out is ordered, certain bases will be notched to allow clearance for the Oasis Mini.

**PRODUCT CODE    DIAGRAM**

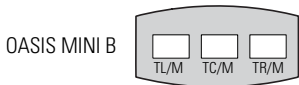
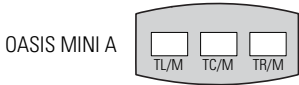
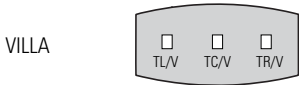
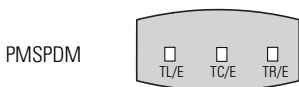

**PRODUCT CODE    DIAGRAM**

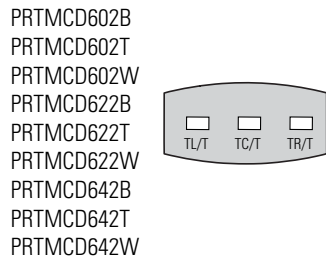
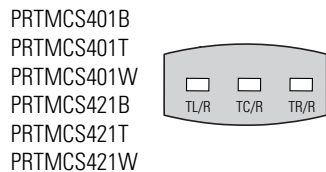

**Custom Cut-out**

- Optional custom sized cut-out available in standard locations - **CCUTL** (left), **CCUTC** (center) and **CCUTR** (right) for all boardroom table tops. Submit appropriate form (beginning on page 402) with order. **Add \$300** for each cut-out.

# T BOARDROOM TABLES

## BOARDROOM TABLE TOP AND BASE GUIDE

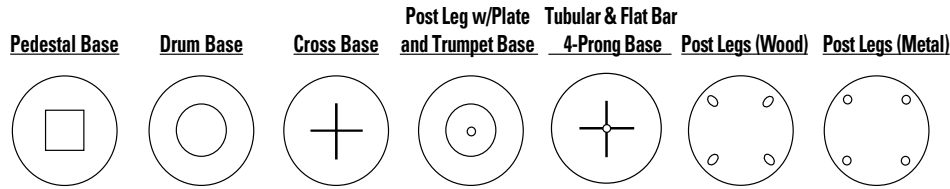

Requires 1 of the following: Pedestal, Drum, Cross, Post Leg w/Plate, Tubular and Flat Bar 4-Prong base, Trumpet Column Base

Requires 4 of the following: Wood Post Legs or Metal Post Legs.

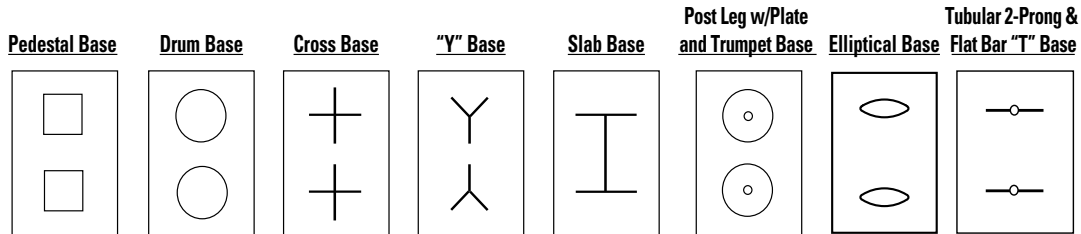

**3-Prong Tubular or**

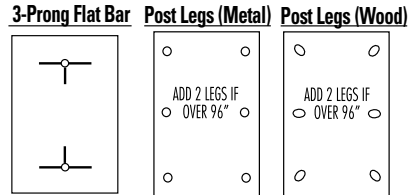
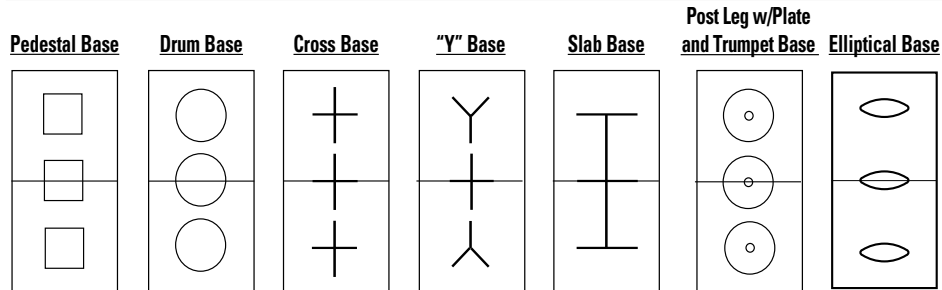

Table Tops up to 120" are in one section and require (2) bases.

Tubular, 2-Prong Base - Table Tops up to 84" require (2) bases.

Tubular and Flat Bar "T" Base - Table Tops up to 120" require (2) bases.

Post Legs - Table Tops up to 96" are in one section and require (4) legs. Tops 108" to 168" require (6) legs.



**3-Prong Tubular or**

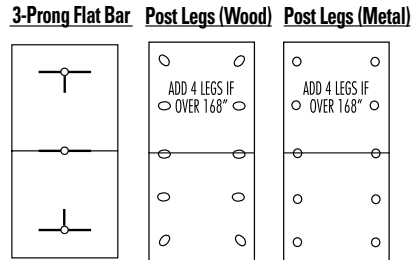

Table Tops 144" and over are in two sections and require (3) bases.

"Y" Base - Require (2) "Y" bases and (1) Cross base in the center.

Slab Base - Require (3) Slab bases.

Tubular and Flat Bar 3-Prong Base - Require (2) 3-Prong bases and (1) 2-Prong base in the center.

Post Legs - Table Tops 180" to 240" require (10) legs.

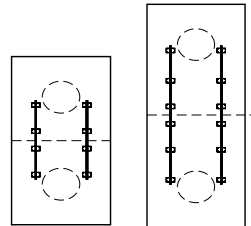

If design considerations or dimension requirements dictate an unsupported table joint, use metal table support rail.

*Top section must not exceed 72" to use metal supports.*

**BOARDROOM TABLES - TOPS WITH DUFFERIN EDGE**

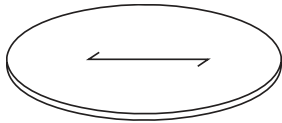

**Round Top**

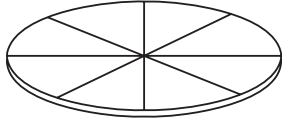

**Round Top - Sunburst Veneer Pattern**

MODEL#	DIMENSIONS D x W x H	FREIGHT CLASS	WT./LBS.	CUBIC FT.	LIST PRICE
RO60D	60 x 60 x 1.37	85	150	11	<b>\$2942</b>
RO48D	48 x 48 x 1.37	85	96	7	<b>\$2353</b>
RO42D	42 x 42 x 1.37	85	74	6	<b>\$2128</b>
RO36D	36 x 36 x 1.37	85	54	4	<b>\$1807</b>
RO30D	30 x 30 x 1.37	85	38	3	<b>\$1265</b>

For use with Drum Base, Pedestal Base, Cross Base, Wood Post Legs, Metal Post Legs, 4 Prong Base, Post leg w/Flat Plate, Flat Square Column Base, Trumpet Column base, Flat Bar "X" Base", Square Panel Base.

RO60SD	60 x 60 x 1.37	85	150	11	<b>\$3185</b>
RO48SD	48 x 48 x 1.37	85	96	7	<b>\$2694</b>
RO42SD	42 x 42 x 1.37	85	74	6	<b>\$2304</b>
RO36SD	36 x 36 x 1.37	85	54	4	<b>\$1983</b>
RO30SD	30 x 30 x 1.37	85	38	3	<b>\$1647</b>

For use with Drum Base, Pedestal Base, "X" Shape Slab Base, Wood Post Legs, Metal Post Legs, 4 Prong Base, Post leg w/Flat Plate, Flat Square Column Base, Trumpet Column base, Flat Bar "X" Base", Square Panel Base.

RE24054D	54 x 240 x 1.37	85	540	39	<b>\$9421</b>
RE21654D	54 x 216 x 1.37	85	486	35	<b>\$8479</b>
RE19254D	54 x 192 x 1.37	85	432	31	<b>\$7277</b>
RE5454D	54 x 54 x 1.37	85	121	9	<b>\$2071</b>
RE16848D	48 x 168 x 1.37	85	336	25	<b>\$5417</b>
RE14448D	48 x 144 x 1.37	85	288	21	<b>\$4081</b>
RE12048D	48 x 120 x 1.37	85	240	18	<b>\$3634</b>
RE9648D	48 x 96 x 1.37	85	192	14	<b>\$2681</b>
RE4848D	48 x 48 x 1.37	85	96	7	<b>\$1473</b>
RE8442D	42 x 84 x 1.37	85	147	11	<b>\$2471</b>
RE7242D	42 x 72 x 1.37	85	126	9	<b>\$2112</b>
RE4242D	42 x 42 x 1.37	85	74	5	<b>\$1378</b>
RE8436D	36 x 84 x 1.37	85	126	9	<b>\$2357</b>
RE7236D	36 x 72 x 1.37	85	108	8	<b>\$2021</b>
RE6636D	36 x 66 x 1.37	85	99	7	<b>\$1549</b>
RE3636D	36 x 36 x 1.37	85	54	4	<b>\$846</b>
RE8430D	30 x 84 x 1.37	85	105	8	<b>\$1967</b>
RE7230D	30 x 72 x 1.37	85	90	7	<b>\$1687</b>
RE6630D	30 x 66 x 1.37	85	83	6	<b>\$1549</b>
RE6030D	30 x 60 x 1.37	85	75	6	<b>\$1407</b>
RE5430D	30 x 54 x 1.37	85	68	5	<b>\$1270</b>
RE3030D	30 x 30 x 1.37	85	38	3	<b>\$709</b>
RE8424D	24 x 84 x 1.37	85	84	6	<b>\$1716</b>
RE7224D	24 x 72 x 1.37	85	72	5	<b>\$1471</b>
RE6624D	24 x 66 x 1.37	85	66	5	<b>\$1352</b>
RE6024D	24 x 60 x 1.37	70	60	4	<b>\$1228</b>
RE5424D	24 x 54 x 1.37	85	55	4	<b>\$1104</b>
RE4824D	24 x 48 x 1.37	70	48	3	<b>\$1064</b>
RE2424D	24 x 24 x 1.37	125	21	3	<b>\$489</b>
RE8422D	22 x 84 x 1.37	85	77	6	<b>\$1575</b>
RE7222D	22 x 72 x 1.37	85	66	5	<b>\$1352</b>
RE6622D	22 x 66 x 1.37	85	61	5	<b>\$1237</b>
RE6022D	22 x 60 x 1.37	85	55	4	<b>\$1126</b>
RE5422D	22 x 54 x 1.37	85	50	4	<b>\$1018</b>
RE4822D	22 x 48 x 1.37	85	44	3	<b>\$975</b>
RE2222D	22 x 22 x 1.37	92.5	20	2	<b>\$449</b>

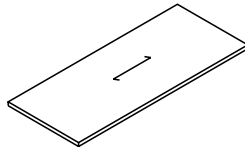

**Rectangular Top**

Grain runs the **length** of the worksurface. Tops 120" and under are shipped in one piece and require 2 bases. Tops 144" and over are shipped in two pieces and require 3 bases.

**Required Specifications**

Veneer Finish

**Optional Specifications**

Boardroom Table Base  
Grommet (not available on Round Tops)  
Custom cut-out

# T BOARDROOM TABLES - DUFFERIN

## BOARDROOM TABLES - TOPS

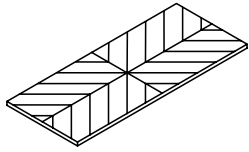

**Rectangular Top -  
Reverse Diamond Pattern**

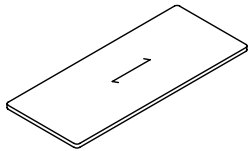

**Rectangular Top Radius Corners**

MODEL#	DIMENSIONS D x W x H	FREIGHT CLASS	WT./LBS.	CUBIC FT.	LIST PRICE
RE24054FD	54 x 240 x 1.37	85	540	39	<b>\$10797</b>
RE21654FD	54 x 216 x 1.37	85	486	35	<b>\$9762</b>
RE19254FD	54 x 192 x 1.37	85	432	31	<b>\$8437</b>
RE5454FD	54 x 54 x 1.37	85	119	9	<b>\$2363</b>
RE16848FD	48 x 168 x 1.37	85	336	25	<b>\$6393</b>
RE14448FD	48 x 144 x 1.37	85	288	21	<b>\$4925</b>
RE12048FD	48 x 120 x 1.37	85	240	18	<b>\$4287</b>
RE9648FD	48 x 96 x 1.37	85	192	14	<b>\$3241</b>
RE4848FD	48 x 48 x 1.37	85	98	7	<b>\$1729</b>
RE8442FD	42 x 84 x 1.37	85	147	11	<b>\$2966</b>
RE7242FD	42 x 72 x 1.37	85	126	9	<b>\$2577</b>
RE4242FD	42 x 42 x 1.37	85	74	5	<b>\$1624</b>
RE8436FD	36 x 84 x 1.37	85	126	9	<b>\$2774</b>
RE7236FD	36 x 72 x 1.37	85	108	8	<b>\$2384</b>
RE6636FD	36 x 66 x 1.37	85	99	7	<b>\$1817</b>
RE3636FD	36 x 36 x 1.37	85	54	4	<b>\$1160</b>
RE8430FD	30 x 84 x 1.37	85	105	8	<b>\$2308</b>
RE7230FD	30 x 72 x 1.37	85	90	7	<b>\$2063</b>
RE6630FD	30 x 66 x 1.37	85	83	6	<b>\$1987</b>
RE6030FD	30 x 60 x 1.37	85	75	6	<b>\$1817</b>
RE5430FD	30 x 54 x 1.37	85	68	5	<b>\$1488</b>
RE3030FD	30 x 30 x 1.37	85	38	3	<b>\$825</b>

Tops 120" and under are shipped in one piece and require 2 bases. Tops 144" and over are shipped in two pieces and require 3 bases.

RRE24054D	54 x 240 x 1.37	85	540	39	<b>\$11486</b>
RRE21654D	54 x 216 x 1.37	85	486	35	<b>\$10400</b>
RRE19254D	54 x 192 x 1.37	85	432	31	<b>\$9020</b>
RRE5454D	54 x 54 x 1.37	85	119	9	<b>\$2515</b>
RRE16848D	48 x 168 x 1.37	85	336	25	<b>\$6882</b>
RRE14448D	48 x 144 x 1.37	85	288	21	<b>\$5344</b>
RRE12048D	48 x 120 x 1.37	85	240	18	<b>\$4613</b>
RRE9648D	48 x 96 x 1.37	85	192	14	<b>\$3519</b>
RRE4848D	48 x 48 x 1.37	85	98	7	<b>\$1851</b>
RRE8442D	42 x 84 x 1.37	85	147	11	<b>\$3216</b>
RRE7242D	42 x 72 x 1.37	85	126	9	<b>\$2805</b>
RRE4242D	42 x 42 x 1.37	85	74	5	<b>\$1741</b>
RRE8436D	36 x 84 x 1.37	85	126	9	<b>\$2987</b>
RRE7236D	36 x 72 x 1.37	85	108	8	<b>\$2562</b>
RRE6636D	36 x 66 x 1.37	85	99	7	<b>\$1954</b>
RRE3636D	36 x 36 x 1.37	85	54	4	<b>\$1073</b>
RRE8430D	30 x 84 x 1.37	85	105	8	<b>\$2485</b>
RRE7230D	30 x 72 x 1.37	85	90	7	<b>\$2130</b>
RRE6630D	30 x 66 x 1.37	85	83	6	<b>\$1954</b>
RRE6030D	30 x 60 x 1.37	85	75	6	<b>\$1782</b>
RRE5430D	30 x 54 x 1.37	85	68	5	<b>\$1598</b>
RRE3030D	30 x 30 x 1.37	85	38	3	<b>\$894</b>

Grain runs the **length** of the worksurface. Tops 120" and under are shipped in one piece and require 2 bases. Tops 144" and over are shipped in two pieces and require 3 bases.

**Required Specifications**  
Veneer Finish

**Optional Specifications**  
Boardroom Table Base  
Grommet  
Custom cut-out

## BOARDROOM TABLES - TOPS

MODEL#      DIMENSIONS      FREIGHT CLASS      WT/LBS.      CUBIC FT.      LIST PRICE

**D x W x H**

REBE24054D	54 x 240 x 1.37	85	540	39	<b>\$10659</b>
REBE21654D	54 x 216 x 1.37	85	486	35	<b>\$9683</b>
REBE19254D	54 x 192 x 1.37	85	432	31	<b>\$8451</b>
REBE16848D	48 x 168 x 1.37	85	336	25	<b>\$6487</b>
REBE14448D	48 x 144 x 1.37	85	288	21	<b>\$5135</b>
REBE12048D	48 x 120 x 1.37	85	240	18	<b>\$4361</b>
REBE9648D	48 x 96 x 1.37	85	192	14	<b>\$3384</b>
REBE8442D	42 x 84 x 1.37	85	147	11	<b>\$3084</b>
REBE7242D	42 x 72 x 1.37	85	126	9	<b>\$2714</b>
REBE8436D	36 x 84 x 1.37	85	126	9	<b>\$2714</b>
REBE7236D	36 x 72 x 1.37	85	108	8	<b>\$2323</b>
REBE6636D	36 x 66 x 1.37	85	99	7	<b>\$1777</b>
REBE8430D	30 x 84 x 1.37	85	105	8	<b>\$2261</b>
REBE7230D	30 x 72 x 1.37	85	90	7	<b>\$1940</b>
REBE6630D	30 x 66 x 1.37	85	83	6	<b>\$1777</b>
REBE6030D	30 x 60 x 1.37	85	75	6	<b>\$1611</b>
REBE5430D	30 x 54 x 1.37	85	68	5	<b>\$1455</b>

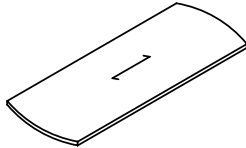

**Rectangular Top - Bow Ends**

Grain runs the **length** of the worksurface. Tops 120" and under are shipped in one piece and require 2 bases. Tops 144" and over are shipped in two pieces and require 3 bases.

RA24054D	54 x 240 x 1.37	85	540	39	<b>\$12978</b>
RA21654D	54 x 216 x 1.37	85	486	35	<b>\$10963</b>
RA19254D	54 x 192 x 1.37	85	432	31	<b>\$10369</b>
RA16848D	48 x 168 x 1.37	85	336	25	<b>\$7763</b>
RA14448D	48 x 144 x 1.37	85	288	21	<b>\$6099</b>
RA12048D	48 x 120 x 1.37	85	240	18	<b>\$5411</b>
RA9648D	48 x 96 x 1.37	85	192	14	<b>\$4297</b>
RA8442D	42 x 84 x 1.37	85	147	11	<b>\$3892</b>
RA7242D	42 x 72 x 1.37	85	126	9	<b>\$3417</b>
RA8436D	36 x 84 x 1.37	85	126	9	<b>\$3533</b>
RA7236D	36 x 72 x 1.37	85	108	8	<b>\$3027</b>
RA6636D	36 x 66 x 1.37	85	99	7	<b>\$2315</b>
RA8430D	30 x 84 x 1.37	85	105	8	<b>\$2945</b>
RA7230D	30 x 72 x 1.37	85	90	7	<b>\$2528</b>
RA6630D	30 x 66 x 1.37	85	83	6	<b>\$2315</b>
RA6030D	30 x 60 x 1.37	85	75	6	<b>\$2105</b>
RA5430D	30 x 54 x 1.37	85	68	5	<b>\$1898</b>
RA8422D	22 x 84 x 1.37	85	77	6	<b>\$2357</b>
RA7222D	22 x 72 x 1.37	85	66	5	<b>\$2021</b>
RA6622D	22 x 66 x 1.37	85	61	5	<b>\$1851</b>
RA6022D	22 x 60 x 1.37	85	55	4	<b>\$1687</b>
RA5422D	22 x 54 x 1.37	85	50	4	<b>\$1516</b>
RA4822D	22 x 48 x 1.37	85	44	3	<b>\$1462</b>

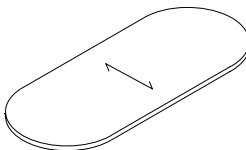

**Racetrack Top - Cross Grain**

Grain runs the **depth** of the worksurface. Tops 120" and under are shipped in one piece and require 2 bases. Tops 144" and over are shipped in two pieces and require 3 bases.

**Required Specifications**

Veneer Finish

**Optional Specifications**

Boardroom Table Base  
Grommet  
Custom cut-out



# T BOARDROOM TABLES - DUFFERIN

## BOARDROOM TABLES - TOPS

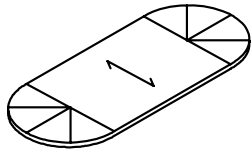

**Racetrack Top Cross Grain Center,  
Sunburst Veneer Pattern on Left & Right**

MODEL#	DIMENSIONS D x W x H	FREIGHT CLASS	WT/LBS.	CUBIC FT.	LIST PRICE
RA24054SD	54 x 240 x 1.37	85	540	39	<b>\$13984</b>
RA21654SD	54 x 216 x 1.37	85	486	35	<b>\$11952</b>
RA19254SD	54 x 192 x 1.37	85	432	31	<b>\$11351</b>
RA16848SD	48 x 168 x 1.37	85	336	25	<b>\$8718</b>
RA14448SD	48 x 144 x 1.37	85	288	21	<b>\$7035</b>
RA12048SD	48 x 120 x 1.37	85	240	18	<b>\$6050</b>
RA9648SD	48 x 96 x 1.37	85	192	14	<b>\$4931</b>
RA8442SD	42 x 84 x 1.37	85	147	11	<b>\$4389</b>
RA7242SD	42 x 72 x 1.37	85	126	9	<b>\$3964</b>
RA8436SD	36 x 84 x 1.37	85	126	9	<b>\$3964</b>
RA7236SD	36 x 72 x 1.37	85	108	8	<b>\$3396</b>
RA6636SD	36 x 66 x 1.37	85	99	7	<b>\$2596</b>
RA8430SD	30 x 84 x 1.37	85	105	8	<b>\$3300</b>
RA7230SD	30 x 72 x 1.37	85	90	7	<b>\$2835</b>
RA6630SD	30 x 66 x 1.37	85	83	6	<b>\$2596</b>
RA6030SD	30 x 60 x 1.37	85	75	6	<b>\$2363</b>
RA5430SD	30 x 54 x 1.37	85	68	5	<b>\$2126</b>
RA8422SD	22 x 84 x 1.37	85	77	6	<b>\$2646</b>
RA7222SD	22 x 72 x 1.37	85	66	5	<b>\$2268</b>
RA6622SD	22 x 66 x 1.37	85	61	5	<b>\$2084</b>
RA6022SD	22 x 60 x 1.37	85	55	4	<b>\$1891</b>
RA5422SD	22 x 54 x 1.37	85	50	4	<b>\$1701</b>
RA4822SD	22 x 48 x 1.37	85	44	3	<b>\$1639</b>

Grain runs the **depth** of the worksurface. Tops 120" and under are shipped in one piece and require 2 bases. Tops 144" and over are shipped in two pieces and require 3 bases.

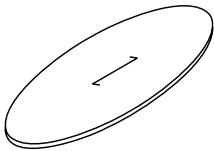

**Oval Top**

OV24054D	54 x 240 x 1.37	85	540	39	<b>\$16223</b>
OV21654D	54 x 216 x 1.37	85	486	35	<b>\$13703</b>
OV19254D	54 x 192 x 1.37	85	432	31	<b>\$12960</b>
OV16848D	48 x 168 x 1.37	85	336	25	<b>\$9700</b>
OV14448D	48 x 144 x 1.37	85	288	21	<b>\$7625</b>
OV12048D	48 x 120 x 1.37	85	240	18	<b>\$6763</b>
OV9648D	48 x 96 x 1.37	85	192	14	<b>\$5370</b>
OV8442D	42 x 84 x 1.37	85	147	11	<b>\$4865</b>
OV7242D	42 x 72 x 1.37	85	126	9	<b>\$4270</b>
OV8436D	36 x 84 x 1.37	85	126	9	<b>\$4270</b>
OV7236D	36 x 72 x 1.37	85	108	8	<b>\$3661</b>
OV6636D	36 x 66 x 1.37	85	99	7	<b>\$2797</b>
OV8430D	30 x 84 x 1.37	85	105	8	<b>\$3684</b>
OV7230D	30 x 72 x 1.37	85	90	7	<b>\$3159</b>
OV6630D	30 x 66 x 1.37	85	83	6	<b>\$2898</b>
OV6030D	30 x 60 x 1.37	85	75	6	<b>\$2629</b>
OV5430D	30 x 54 x 1.37	85	68	5	<b>\$2370</b>
OV8422D	22 x 84 x 1.37	85	77	6	<b>\$2945</b>
OV7222D	22 x 72 x 1.37	85	66	5	<b>\$2528</b>
OV6622D	22 x 66 x 1.37	85	61	5	<b>\$2315</b>
OV6022D	22 x 60 x 1.37	85	55	4	<b>\$2105</b>
OV5422D	22 x 54 x 1.37	85	50	4	<b>\$1898</b>
OV4822D	22 x 48 x 1.37	85	44	3	<b>\$1824</b>

Grain runs the **length** of the worksurface. Tops 120" and under are shipped in one piece and require 2 bases. Tops 144" and over are shipped in two pieces and require 3 bases.

### Required Specifications

Veneer Finish

### Optional Specifications

Boardroom Table Base  
Grommet  
Custom cut-out

## BOARDROOM TABLES - TOPS

MODEL#	DIMENSIONS	FREIGHT CLASS	WT/LBS.	CUBIC FT.	LIST PRICE
--------	------------	---------------	---------	-----------	------------

**D x W x H**

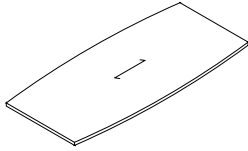

**Boat Shape Top**

B024054D	54 x 240 x 1.37	85	540	39	<b>\$10559</b>
B021654D	54 x 216 x 1.37	85	486	35	<b>\$9491</b>
B019254D	54 x 192 x 1.37	85	432	31	<b>\$8419</b>
B016848D	48 x 168 x 1.37	85	336	25	<b>\$6708</b>
B014448D	48 x 144 x 1.37	85	288	21	<b>\$5429</b>
B012048D	48 x 120 x 1.37	85	240	18	<b>\$4546</b>
B09648D	48 x 96 x 1.37	85	192	14	<b>\$3690</b>
B08442D	42 x 84 x 1.37	85	147	11	<b>\$3405</b>
B07242D	42 x 72 x 1.37	85	126	9	<b>\$2999</b>

Grain runs the **length** of the worksurface. Tops 120" and under are shipped in one piece and require 2 bases. Tops 144" and over are shipped in two pieces and require 3 bases.

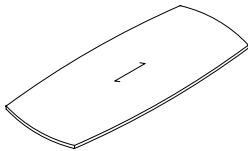

**Boat Shape Top - Bow Ends**

BOBE24054D	54 x 240 x 1.37	85	540	39	<b>\$12138</b>
BOBE21654D	54 x 216 x 1.37	85	486	35	<b>\$10914</b>
BOBE19254D	54 x 192 x 1.37	85	432	31	<b>\$9683</b>
BOBE5454D	54 x 54 x 1.37	85	121	9	<b>\$2726</b>
BOBE16848D	48 x 168 x 1.37	85	336	25	<b>\$7713</b>
BOBE14448D	48 x 144 x 1.37	85	288	21	<b>\$6236</b>
BOBE12048D	48 x 120 x 1.37	85	240	18	<b>\$5231</b>
BOBE9648D	48 x 96 x 1.37	85	192	14	<b>\$4245</b>
BOBE4848D	48 x 48 x 1.37	85	96	7	<b>\$2303</b>
BOBE8442D	42 x 84 x 1.37	85	147	11	<b>\$3918</b>
BOBE7242D	42 x 72 x 1.37	85	126	9	<b>\$3453</b>
BOBE4242D	42 x 42 x 1.37	85	74	5	<b>\$2009</b>

Grain runs the **length** of the worksurface. Tops 120" and under are shipped in one piece and require 2 bases. Tops 144" and over are shipped in two pieces and require 3 bases.

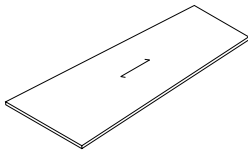

**Wedge Shape Top**

WE2405442D	54 - 42 x 240 x 1.37	85	540	39	<b>\$9272</b>
WE2165442D	54 - 42 x 216 x 1.37	85	486	35	<b>\$8419</b>
WE1925442D	54 - 42 x 192 x 1.37	85	432	31	<b>\$7351</b>
WE1684836D	48 - 36 x 168 x 1.37	85	336	25	<b>\$5640</b>
WE1444836D	48 - 36 x 144 x 1.37	85	288	21	<b>\$4464</b>
WE1204836D	48 - 36 x 120 x 1.37	85	240	18	<b>\$3793</b>
WE964836D	48 - 36 x 96 x 1.37	85	192	14	<b>\$2941</b>
WE844230D	42 - 30 x 84 x 1.37	85	147	11	<b>\$2678</b>
WE724230D	42 - 30 x 72 x 1.37	85	126	9	<b>\$2357</b>
WE843624D	36 - 24 x 84 x 1.37	85	126	9	<b>\$2357</b>
WE723624D	36 - 24 x 72 x 1.37	85	108	8	<b>\$2021</b>
WE663624D	36 - 24 x 66 x 1.37	85	99	7	<b>\$1549</b>

Grain runs the **length** of the worksurface. Tops 120" and under are shipped in one piece and require 2 bases. Tops 144" and over are shipped in two pieces and require 3 bases.

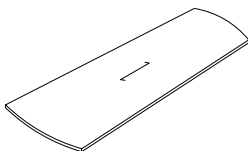

**Wedge Shape Top - Bow Ends**

WEBE2405442D	54 - 42 x 240 x 1.37	85	540	39	<b>\$10659</b>
WEBE2165442D	54 - 42 x 216 x 1.37	85	486	35	<b>\$9683</b>
WEBE1925442D	54 - 42 x 192 x 1.37	85	432	31	<b>\$8451</b>
WEBE1684836D	48 - 36 x 168 x 1.37	85	336	25	<b>\$6487</b>
WEBE1444836D	48 - 36 x 144 x 1.37	85	288	21	<b>\$5135</b>
WEBE1204836D	48 - 36 x 120 x 1.37	85	240	18	<b>\$4361</b>
WEBE964836D	48 - 36 x 96 x 1.37	85	192	14	<b>\$3384</b>
WEBE844230D	42 - 30 x 84 x 1.37	85	147	11	<b>\$3084</b>
WEBE724230D	42 - 30 x 72 x 1.37	85	126	9	<b>\$2714</b>
WEBE843624D	36 - 24 x 84 x 1.37	85	126	9	<b>\$2714</b>
WEBE723624D	36 - 24 x 72 x 1.37	85	108	8	<b>\$2323</b>
WEBE663624D	36 - 24 x 66 x 1.37	85	99	7	<b>\$1777</b>

Grain runs the **length** of the worksurface. Tops 120" and under are shipped in one piece and require 2 bases. Tops 144" and over are shipped in two pieces and require 3 bases.

**Required Specifications**

Veneer Finish

**Optional Specifications**

Boardroom Table Base  
Grommet  
Custom cut-out

# T BOARDROOM TABLES - LUFTON

## BOARDROOM TABLES - TOPS WITH LUFTON EDGE

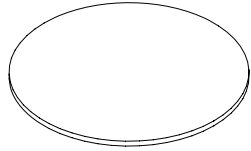

**Round Top**

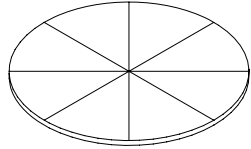

**Round Top - Sunburst Veneer Pattern**

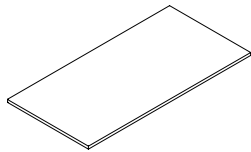

**Rectangular Top**

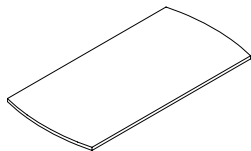

**Rectangular Top - Bow Ends**

MODEL#	DIMENSIONS D x W x H	FREIGHT CLASS	WT./LBS.	CUBIC FT.	LIST PRICE
RO60L	60 x 60 x 1.37	85	150	11	<b>\$2870</b>
RO48L	48 x 48 x 1.37	85	96	7	<b>\$2291</b>
RO42L	42 x 42 x 1.37	85	74	6	<b>\$2065</b>
RO36L	36 x 36 x 1.37	85	54	4	<b>\$1840</b>
RO30L	30 x 30 x 1.37	85	38	3	<b>\$1228</b>

For use with Drum Base, Pedestal Base, Cross Base, Wood Post Legs, Metal Post Legs, 4 Prong Base, Post leg w/Flat Plate, Flat Square Column Base, Trumpet Column base, Flat Bar "X" Base", Square Panel Base.

RO60SL	60 x 60 x 1.37	85	150	11	<b>\$3149</b>
RO48SL	48 x 48 x 1.37	85	96	7	<b>\$2591</b>
RO42SL	42 x 42 x 1.37	85	74	6	<b>\$2243</b>
RO36SL	36 x 36 x 1.37	85	54	4	<b>\$2021</b>
RO30SL	30 x 30 x 1.37	85	38	3	<b>\$1787</b>

For use with Drum Base, Pedestal Base, Cross Base, Wood Post Legs, Metal Post Legs, 4 Prong Base, Post leg w/Flat Plate, Flat Square Column Base, Trumpet Column base, Flat Bar "X" Base", Square Panel Base.

RE24054L	54 x 240 x 1.37	85	540	39	<b>\$8936</b>
RE21654L	54 x 216 x 1.37	85	486	35	<b>\$8110</b>
RE19254L	54 x 192 x 1.37	85	432	31	<b>\$7079</b>
RE16848L	48 x 168 x 1.37	85	336	25	<b>\$5430</b>
RE14448L	48 x 144 x 1.37	85	288	21	<b>\$4298</b>
RE12048L	48 x 120 x 1.37	300	240	18	<b>\$3654</b>
RE9648L	48 x 96 x 1.37	85	192	14	<b>\$2833</b>
RE8442L	42 x 84 x 1.37	85	147	11	<b>\$2581</b>
RE7242L	42 x 72 x 1.37	85	126	9	<b>\$2270</b>
RE8436L	36 x 84 x 1.37	85	126	9	<b>\$2270</b>
RE7236L	36 x 72 x 1.37	85	108	8	<b>\$1947</b>
RE6636L	36 x 66 x 1.37	92.5	99	7	<b>\$1492</b>
RE8430L	30 x 84 x 1.37	85	105	8	<b>\$1894</b>
RE7230L	30 x 72 x 1.37	85	90	7	<b>\$1624</b>
RE6630L	30 x 66 x 1.37	85	83	6	<b>\$1492</b>
RE6030L	30 x 60 x 1.37	85	75	6	<b>\$1357</b>
RE5430L	30 x 54 x 1.37	85	68	5	<b>\$1218</b>
RE4830L	30 x 48 x 1.37	85	44	3	<b>\$1192</b>

Grain runs the **length** of the worksurface. Tops 120" and under are shipped in one piece and require 2 bases. Tops 144" and over are shipped in two pieces and require 3 bases.

REBE24054L	54 x 240 x 1.37	85	540	39	<b>\$10271</b>
REBE21654L	54 x 216 x 1.37	85	486	35	<b>\$9321</b>
REBE19254L	54 x 192 x 1.37	85	432	31	<b>\$8140</b>
REBE16848L	48 x 168 x 1.37	85	336	25	<b>\$6246</b>
REBE14448L	48 x 144 x 1.37	85	288	21	<b>\$4943</b>
REBE12048L	48 x 120 x 1.37	300	240	18	<b>\$4201</b>
REBE9648L	48 x 96 x 1.37	85	192	14	<b>\$3258</b>
REBE8442L	42 x 84 x 1.37	85	147	11	<b>\$2967</b>
REBE7242L	42 x 72 x 1.37	85	126	9	<b>\$2613</b>
REBE8436L	36 x 84 x 1.37	85	126	9	<b>\$2613</b>
REBE7236L	36 x 72 x 1.37	85	108	8	<b>\$2238</b>

Grain runs the **length** of the worksurface. Tops 120" and under are shipped in one piece and require 2 bases. Tops 144" and over are shipped in two pieces and require 3 bases.

### Required Specifications

Veneer Finish

### Optional Specifications

Boardroom Table Base  
Grommet  
Custom cut-out

## BOARDROOM TABLES - TOPS W/LUFTON EDGE

**MODEL#      DIMENSIONS      FREIGHT CLASS      WT/LBS.      CUBIC FT.      LIST PRICE**

**D x W x H**

RA24054L	54 x 240 x 1.37	85	540	39	<b>\$12021</b>
RA21654L	54 x 216 x 1.37	85	486	35	<b>\$10271</b>
RA19254L	54 x 192 x 1.37	85	432	31	<b>\$9755</b>
RA16848L	48 x 168 x 1.37	85	336	25	<b>\$7491</b>
RA14448L	48 x 144 x 1.37	85	288	21	<b>\$6048</b>
RA12048L	48 x 120 x 1.37	300	240	18	<b>\$5200</b>
RA9648L	48 x 96 x 1.37	85	192	14	<b>\$4232</b>
RA8442L	42 x 84 x 1.37	85	147	11	<b>\$3815</b>
RA7242L	42 x 72 x 1.37	85	126	9	<b>\$3408</b>
RA8436L	36 x 84 x 1.37	85	126	9	<b>\$3408</b>
RA7236L	36 x 72 x 1.37	85	108	8	<b>\$2919</b>
RA6636L	36 x 66 x 1.37	92.5	99	7	<b>\$2230</b>

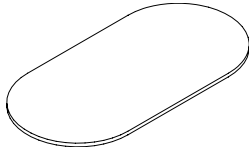

**Racetrack Top - Cross Grain**

Grain runs the **depth** of the worksurface. Tops 120" and under are shipped in one piece and require 2 bases. Tops 144" and over are shipped in two pieces and require 3 bases.

B024054L	54 x 240 x 1.37	85	540	39	<b>\$10162</b>
B021654L	54 x 216 x 1.37	85	486	35	<b>\$9138</b>
B019254L	54 x 192 x 1.37	85	432	31	<b>\$8110</b>
B016848L	48 x 168 x 1.37	85	336	25	<b>\$6462</b>
B014448L	48 x 144 x 1.37	85	288	21	<b>\$5220</b>
B012048L	48 x 120 x 1.37	85	240	18	<b>\$4378</b>
B09648L	48 x 96 x 1.37	85	192	14	<b>\$3559</b>
B08442L	42 x 84 x 1.37	85	147	11	<b>\$3277</b>
B07242L	42 x 72 x 1.37	85	126	9	<b>\$2892</b>

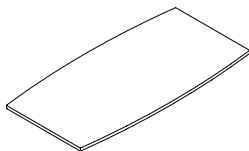

**Boat Shape Top**

Grain runs the **length** of the worksurface. Tops 120" and under are shipped in one piece and require 2 bases. Tops 144" and over are shipped in two pieces and require 3 bases.

BOBE24054L	54 x 240 x 1.37	85	540	39	<b>\$11692</b>
BOBE21654L	54 x 216 x 1.37	85	486	35	<b>\$10512</b>
BOBE19254L	54 x 192 x 1.37	85	432	31	<b>\$9321</b>
BOBE5454L	54 x 54 x 1.37	85	121	9	<b>\$2624</b>
BOBE16848L	48 x 168 x 1.37	85	336	25	<b>\$7427</b>
BOBE14448L	48 x 144 x 1.37	85	288	21	<b>\$6011</b>
BOBE12048L	48 x 120 x 1.37	85	240	18	<b>\$5035</b>
BOBE9648L	48 x 96 x 1.37	85	192	14	<b>\$3090</b>
BOBE4848L	48 x 48 x 1.37	85	96	7	<b>\$2222</b>
BOBE8442L	42 x 84 x 1.37	85	147	11	<b>\$3438</b>
BOBE7242L	42 x 72 x 1.37	85	126	9	<b>\$3320</b>
BOBE4242L	42 x 42 x 1.37	85	74	5	<b>\$1941</b>

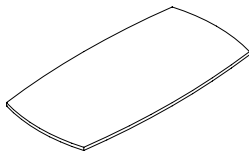

**Boat Shape Top - Bow Ends**

Grain runs the **length** of the worksurface. Tops 120" and under are shipped in one piece and require 2 bases. Tops 144" and over are shipped in two pieces and require 3 bases.

**Required Specifications**

Veneer Finish

**Optional Specifications**

Boardroom Table Base  
Grommet  
Custom cut-out

# T BOARDROOM TABLES - LUFTON

## BOARDROOM TABLES - TOPS W/LUFTON EDGE

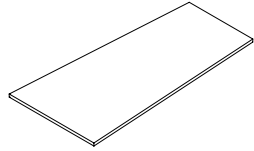

**Wedge Shape Top**

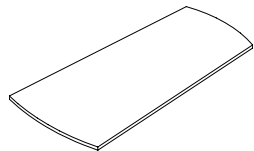

**Wedge Shape Top - Bow Ends**

MODEL#	DIMENSIONS D x W x H	FREIGHT CLASS	WT/LBS.	CUBIC FT.	LIST PRICE
WE2405442L	54 - 42 x 240 x 1.37	85	540	39	<b>\$8936</b>
WE2165442L	54 - 42 x 216 x 1.37	85	486	35	<b>\$8110</b>
WE1925442L	54 - 42 x 192 x 1.37	85	432	31	<b>\$7079</b>
WE1684836L	48 - 36 x 168 x 1.37	85	336	25	<b>\$5430</b>
WE1444836L	48 - 36 x 144 x 1.37	85	288	21	<b>\$4298</b>
WE1204836L	48 - 36 x 120 x 1.37	85	240	18	<b>\$3654</b>
WE964836L	48 - 36 x 96 x 1.37	85	192	14	<b>\$3541</b>
WE844230L	42 - 30 x 84 x 1.37	85	147	11	<b>\$2581</b>
WE724230L	42 - 30 x 72 x 1.37	85	126	9	<b>\$2270</b>

Grain runs the **length** of the worksurface. Tops 120" and under are shipped in one piece and require 2 bases. Tops 144" and over are shipped in two pieces and require 3 bases.

WEBE2405442L	54 - 42 x 240 x 1.37	85	540	39	<b>\$10271</b>
WEBE2165442L	54 - 42 x 216 x 1.37	85	486	35	<b>\$9321</b>
WEBE1925442L	54 - 42 x 192 x 1.37	85	432	31	<b>\$8140</b>
WEBE1684836L	48 - 36 x 168 x 1.37	85	336	25	<b>\$6246</b>
WEBE1444836L	48 - 36 x 144 x 1.37	85	288	21	<b>\$4943</b>
WEBE1204836L	48 - 36 x 120 x 1.37	85	240	18	<b>\$4201</b>
WEBE964836L	48 - 36 x 96 x 1.37	85	192	14	<b>\$3258</b>
WEBE844230L	42 - 30 x 84 x 1.37	85	147	11	<b>\$2967</b>
WEBE724230L	42 - 30 x 72 x 1.37	85	126	9	<b>\$2613</b>

Grain runs the **length** of the worksurface. Tops 120" and under are shipped in one piece and require 2 bases. Tops 144" and over are shipped in two pieces and require 3 bases.

### Required Specifications

Veneer Finish

### Optional Specifications

Boardroom Table Base

Grommet

Custom cut-out

**BOARDROOM TABLES - TOPS W/PHILADELPHIA EDGE**    **MODEL#**    **DIMENSIONS**    **FREIGHT CLASS**    **WT/LBS.**    **CUBIC FT.**    **LIST PRICE**

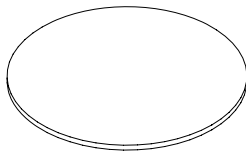

**Round Top**

	<b>D x W x H</b>				
RO60PB	60 x 60 x 1.5	85	150	11	<b>\$4958</b>
RO48PB	48 x 48 x 1.5	85	96	7	<b>\$3967</b>
RO42PB	42 x 42 x 1.5	85	74	6	<b>\$3563</b>
RO36PB	36 x 36 x 1.5	85	54	4	<b>\$3177</b>
RO30PB	30 x 30 x 1.5	85	38	3	<b>\$2649</b>

For use with Drum Base, Pedestal Base, Cross Base, Wood Post Legs, Metal Post Legs, 4 Prong Base, Post leg w/Flat Plate, Flat Square Column Base, Trumpet Column base, Flat Bar "X" Base", Square Panel Base.

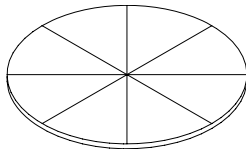

**Round Top - Sunburst Veneer Pattern**

RO60SPB	60 x 60 x 1.5	85	150	11	<b>\$5451</b>
RO48SPB	48 x 48 x 1.5	85	96	7	<b>\$4479</b>
RO42SPB	42 x 42 x 1.5	85	74	6	<b>\$3875</b>
RO36SPB	36 x 36 x 1.5	85	54	4	<b>\$3486</b>
RO30SPB	30 x 30 x 1.5	85	38	3	<b>\$3090</b>

For use with Drum Base, Pedestal Base, Cross Base, Wood Post Legs, Metal Post Legs, 4 Prong Base, Post leg w/Flat Plate, Flat Square Column Base, Trumpet Column base, Flat Bar "X" Base", Square Panel Base.

RE24054PB	54 x 240 x 1.5	85	540	39	<b>\$15450</b>
RE21654PB	54 x 216 x 1.5	85	486	35	<b>\$14026</b>
RE19254PB	54 x 192 x 1.5	85	432	31	<b>\$12243</b>
RE5454PB	54 x 54 x 1.5	85	121	9	<b>\$3443</b>
RE16848PB	48 x 168 x 1.5	85	336	25	<b>\$9393</b>
RE14448PB	48 x 144 x 1.5	85	288	21	<b>\$7435</b>
RE12048PB	48 x 120 x 1.5	85	240	18	<b>\$6319</b>
RE9648PB	48 x 96 x 1.5	85	192	14	<b>\$4899</b>
RE4848PB	48 x 48 x 1.5	85	96	7	<b>\$2447</b>
RE8442PB	42 x 84 x 1.5	85	147	11	<b>\$4461</b>
RE7242PB	42 x 72 x 1.5	85	126	9	<b>\$3925</b>
RE4242PB	42 x 42 x 1.5	85	74	5	<b>\$2293</b>
RE8436PB	36 x 84 x 1.5	85	126	9	<b>\$3991</b>
RE7236PB	36 x 72 x 1.5	85	108	8	<b>\$3370</b>
RE6636PB	36 x 66 x 1.5	85	99	7	<b>\$2573</b>
RE3636PB	36 x 36 x 1.5	85	54	4	<b>\$1402</b>
RE8430PB	30 x 84 x 1.5	85	105	8	<b>\$3273</b>
RE7230PB	30 x 72 x 1.5	85	90	7	<b>\$2810</b>
RE6630PB	30 x 66 x 1.5	85	83	6	<b>\$2573</b>
RE6030PB	30 x 60 x 1.5	85	75	6	<b>\$2335</b>
RE5430PB	30 x 54 x 1.5	85	68	5	<b>\$2110</b>
RE3030PB	30 x 30 x 1.5	85	38	3	<b>\$1170</b>
RE8424PB	24 x 84 x 1.5	No Match!	No Match!	No Match!	No Match!
RE7224PB	24 x 72 x 1.5	85	72	5	<b>\$2444</b>
RE6624PB	24 x 66 x 1.5	85	66	5	<b>\$2242</b>
RE6024PB	24 x 60 x 1.5	70	60	4	<b>\$2038</b>
RE5424PB	24 x 54 x 1.5	85	55	4	<b>\$1837</b>
RE4824PB	24 x 48 x 1.5	70	48	3	<b>\$1764</b>
RE2424PB	24 x 24 x 1.5	125	21	3	<b>\$814</b>
RE8422PB	22 x 84 x 1.5	85	77	6	<b>\$2622</b>
RE7222PB	22 x 72 x 1.5	85	66	5	<b>\$2242</b>
RE6622PB	22 x 66 x 1.5	85	61	5	<b>\$2058</b>
RE6022PB	22 x 60 x 1.5	85	55	4	<b>\$1873</b>
RE5422PB	22 x 54 x 1.5	85	50	4	<b>\$1680</b>
RE4822PB	22 x 48 x 1.5	85	44	3	<b>\$1620</b>
RE2222PB	22 x 22 x 1.5	92.5	20	2	<b>\$744</b>

Grain runs the **length** of the worksurface. Tops 120" and under are shipped in one piece and require 2 bases. Tops 144" and over are shipped in two pieces and require 3 bases.

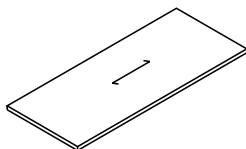

**Rectangular Top**

**Required Specifications**

Veneer Finish

**Optional Specifications**

Boardroom Table Base  
Grommet  
Custom cut-out

# T BOARDROOM TABLES - PHILADELPHIA

## BOARDROOM TABLES - TOPS W/PHILADELPHIA EDGE

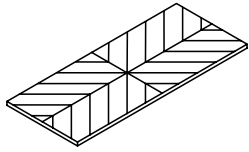

**Rectangular Top -  
Reverse Diamond Pattern**

MODEL#	DIMENSIONS D x W x H	FREIGHT CLASS	WT./LBS.	CUBIC FT.	LIST PRICE
RE24054FPB	54 x 240 x 1.5	85	540	39	<b>\$17513</b>
RE21654FPB	54 x 216 x 1.5	85	486	35	<b>\$15951</b>
RE19254FPB	54 x 192 x 1.5	85	432	31	<b>\$13985</b>
RE5454FPB	54 x 54 x 1.5	85	121	9	<b>\$3935</b>
RE16848FPB	48 x 168 x 1.5	85	336	25	<b>\$10857</b>
RE14448FPB	48 x 144 x 1.5	85	288	21	<b>\$8700</b>
RE12048FPB	48 x 120 x 1.5	85	240	18	<b>\$7299</b>
RE9648FPB	48 x 96 x 1.5	85	192	14	<b>\$5738</b>
RE4848FPB	48 x 48 x 1.5	85	96	7	<b>\$2867</b>
RE8442FPB	42 x 84 x 1.5	85	147	11	<b>\$3799</b>
RE7242FPB	42 x 72 x 1.5	85	126	9	<b>\$4620</b>
RE4242FPB	42 x 42 x 1.5	85	74	5	<b>\$2700</b>
RE8436FPB	36 x 84 x 1.5	85	126	9	<b>\$4620</b>
RE7236FPB	36 x 72 x 1.5	85	108	8	<b>\$3962</b>
RE6636FPB	36 x 66 x 1.5	85	99	7	<b>\$3028</b>
RE3636FPB	36 x 36 x 1.5	85	54	4	<b>\$1934</b>
RE8430FPB	30 x 84 x 1.5	85	105	8	<b>\$3847</b>
RE7230FPB	30 x 72 x 1.5	85	90	7	<b>\$3431</b>
RE6630FPB	30 x 66 x 1.5	85	83	6	<b>\$3303</b>
RE6030FPB	30 x 60 x 1.5	85	75	6	<b>\$3028</b>
RE5430FPB	30 x 54 x 1.5	85	68	5	<b>\$2477</b>
RE3030FPB	30 x 30 x 1.5	85	38	3	<b>\$1374</b>

Tops 120" and under are shipped in one piece and require 2 bases. Tops 144" and over are shipped in two pieces and require 3 bases.

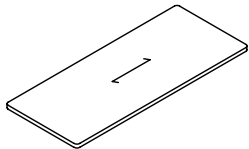

**Rectangular Top - Radius Corners**

RRE24054PB	54 x 240 x 1.5	85	540	39	<b>\$18553</b>
RRE21654PB	54 x 216 x 1.5	85	486	35	<b>\$16912</b>
RRE19254PB	54 x 192 x 1.5	85	432	31	<b>\$14865</b>
RRE5454PB	54 x 54 x 1.5	85	121	9	<b>\$4185</b>
RRE16848PB	48 x 168 x 1.5	85	336	25	<b>\$11587</b>
RRE14448PB	48 x 144 x 1.5	85	288	21	<b>\$9332</b>
RRE12048PB	48 x 120 x 1.5	85	240	18	<b>\$7794</b>
RRE9648PB	48 x 96 x 1.5	85	192	14	<b>\$6156</b>
RRE4848PB	48 x 48 x 1.5	85	96	7	<b>\$3076</b>
RRE8442PB	42 x 84 x 1.5	85	147	11	<b>\$5582</b>
RRE7242PB	42 x 72 x 1.5	85	126	9	<b>\$4971</b>
RRE4242PB	42 x 42 x 1.5	85	74	5	<b>\$2902</b>
RRE8436PB	36 x 84 x 1.5	85	126	9	<b>\$4971</b>
RRE7236PB	36 x 72 x 1.5	85	108	8	<b>\$4258</b>
RRE6636PB	36 x 66 x 1.5	85	99	7	<b>\$3254</b>
RRE3636PB	36 x 36 x 1.5	85	54	4	<b>\$1777</b>
RRE8430PB	30 x 84 x 1.5	85	105	8	<b>\$4144</b>
RRE7230PB	30 x 72 x 1.5	85	90	7	<b>\$3549</b>
RRE6630PB	30 x 66 x 1.5	85	83	6	<b>\$3254</b>
RRE6030PB	30 x 60 x 1.5	85	75	6	<b>\$2956</b>
RRE5430PB	30 x 54 x 1.5	85	68	5	<b>\$2666</b>
RRE3030PB	30 x 30 x 1.5	85	38	3	<b>\$1483</b>

Grain runs the **length** of the worksurface. Tops 120" and under are shipped in one piece and require 2 bases. Tops 144" and over are shipped in two pieces and require 3 bases.

**Required Specifications**  
Veneer Finish

**Optional Specifications**  
Boardroom Table Base  
Grommet  
Custom cut-out

**BOARDROOM TABLES - TOPS W/PHILADELPHIA EDGE MODEL# DIMENSIONS FREIGHT CLASS WT/LBS. CUBIC FT. LIST PRICE**

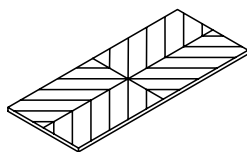

**Rectangular Top - Radius Corners  
Reverse Diamond Pattern**

	D x W x H					
RRE24054FPB	54 x 240 x 1.5	85	540	39	\$20926	
RRE21654FPB	54 x 216 x 1.5	85	486	35	\$19123	
RRE19254FPB	54 x 192 x 1.5	85	432	31	\$16867	
RRE5454FPB	54 x 54 x 1.5	85	121	9	\$4746	
RRE16848FPB	48 x 168 x 1.5	85	336	25	\$13267	
RRE14448FPB	48 x 144 x 1.5	85	288	21	\$10783	
RRE12048FPB	48 x 120 x 1.5	85	240	18	\$8919	
RRE9648FPB	48 x 96 x 1.5	85	192	14	\$7109	
RRE4848FPB	48 x 48 x 1.5	85	96	7	\$3560	
RRE8442FPB	42 x 84 x 1.5	85	147	11	\$6445	
RRE7242FPB	42 x 72 x 1.5	85	126	9	\$5766	
RRE4242FPB	42 x 42 x 1.5	85	74	5	\$3363	
RRE8436FPB	36 x 84 x 1.5	85	126	9	\$5766	
RRE7236FPB	36 x 72 x 1.5	85	108	8	\$4947	
RRE6636FPB	36 x 66 x 1.5	85	99	7	\$3779	
RRE3636FPB	36 x 36 x 1.5	85	54	4	\$2065	
RRE8430FPB	30 x 84 x 1.5	85	105	8	\$4804	
RRE7230FPB	30 x 72 x 1.5	85	90	7	\$4121	
RRE6630FPB	30 x 66 x 1.5	85	83	6	\$3779	
RRE6030FPB	30 x 60 x 1.5	85	75	6	\$3431	
RRE5430FPB	30 x 54 x 1.5	85	68	5	\$3092	
RRE3030FPB	30 x 30 x 1.5	85	38	3	\$1720	

Tops 120" and under are shipped in one piece and require 2 bases. Tops 144" and over are shipped in two pieces and require 3 bases.

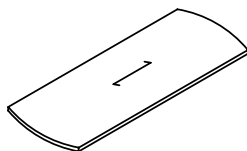

**Rectangular Top - Bow Ends**

REBE24054PB	54 x 240 x 1.5	85	540	39	\$17766	
REBE21654PB	54 x 216 x 1.5	85	486	35	\$16133	
REBE19254PB	54 x 192 x 1.5	85	432	31	\$14083	
REBE16848PB	48 x 168 x 1.5	85	336	25	\$10802	
REBE14448PB	48 x 144 x 1.5	85	288	21	\$8553	
REBE12048PB	48 x 120 x 1.5	85	240	18	\$7269	
REBE9648PB	48 x 96 x 1.5	85	192	14	\$5632	
REBE8442PB	42 x 84 x 1.5	85	147	11	\$5130	
REBE7242PB	42 x 72 x 1.5	85	126	9	\$4514	
REBE8436PB	36 x 84 x 1.5	85	126	9	\$4516	
REBE7236PB	36 x 72 x 1.5	85	108	8	\$3874	
REBE6636PB	36 x 66 x 1.5	85	99	7	\$2955	
REBE8430PB	30 x 84 x 1.5	85	105	8	\$3766	
REBE7230PB	30 x 72 x 1.5	85	90	7	\$3230	
REBE6630PB	30 x 66 x 1.5	85	83	6	\$2955	
REBE6030PB	30 x 60 x 1.5	85	75	6	\$2686	
REBE5430PB	30 x 54 x 1.5	85	68	5	\$2423	

Grain runs the **length** of the worksurface. Tops 120" and under are shipped in one piece and require 2 bases. Tops 144" and over are shipped in two pieces and require 3 bases.

**Required Specifications**  
Veneer Finish

**Optional Specifications**  
Boardroom Table Base  
Grommet  
Custom cut-out



# T BOARDROOM TABLES - PHILADELPHIA

## BOARDROOM TABLES - TOPS W/PHILADELPHIA EDGE MODEL# DIMENSIONS FREIGHT CLASS WT/LBS. CUBIC FT. LIST PRICE

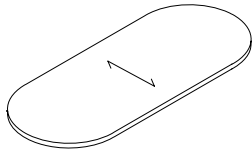

**Racetrack Top - Cross Grain**

	D x W x H					
RA24054PB	54 x 240 x 1.5	85	540	39		<b>\$20795</b>
RA21654PB	54 x 216 x 1.5	85	486	35		<b>\$17766</b>
RA19254PB	54 x 192 x 1.5	85	432	31		<b>\$16878</b>
RA16848PB	48 x 168 x 1.5	85	336	25		<b>\$12957</b>
RA14448PB	48 x 144 x 1.5	85	288	21		<b>\$10464</b>
RA12048PB	48 x 120 x 1.5	85	240	18		<b>\$8994</b>
RA9648PB	48 x 96 x 1.5	85	192	14		<b>\$7322</b>
RA8442PB	42 x 84 x 1.5	85	147	11		<b>\$6596</b>
RA7242PB	42 x 72 x 1.5	85	126	9		<b>\$5886</b>
RA8436PB	36 x 84 x 1.5	85	126	9		<b>\$5886</b>
RA7236PB	36 x 72 x 1.5	85	108	8		<b>\$5042</b>
RA6636PB	36 x 66 x 1.5	85	99	7		<b>\$3853</b>
RA8430PB	30 x 84 x 1.5	85	105	8		<b>\$4905</b>
RA7230PB	30 x 72 x 1.5	85	90	7		<b>\$4205</b>
RA6630PB	30 x 66 x 1.5	85	83	6		<b>\$3853</b>
RA6030PB	30 x 60 x 1.5	85	75	6		<b>\$3503</b>
RA5430PB	30 x 54 x 1.5	85	68	5		<b>\$3157</b>
RA8422PB	22 x 84 x 1.5	85	77	6		<b>\$3925</b>
RA7222PB	22 x 72 x 1.5	85	66	5		<b>\$3370</b>
RA6622PB	22 x 66 x 1.5	85	61	5		<b>\$3086</b>
RA6022PB	22 x 60 x 1.5	85	55	4		<b>\$2805</b>
RA5422PB	22 x 54 x 1.5	85	50	4		<b>\$2529</b>
RA4822PB	22 x 48 x 1.5	85	44	3		<b>\$2433</b>

Grain runs the **depth** of the worksurface. Tops 120" and under are shipped in one piece and require 2 bases. Tops 144" and over are shipped in two pieces and require 3 bases.

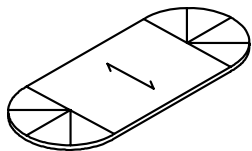

**Racetrack Top Cross Grain Center, Sunburst Veneer Pattern on Left & Right**

RA24054SPB	54 x 240 x 1.5	85	540	39		<b>\$23304</b>
RA21654SPB	54 x 216 x 1.5	85	486	35		<b>\$19912</b>
RA19254SPB	54 x 192 x 1.5	85	432	31		<b>\$18913</b>
RA16848SPB	48 x 168 x 1.5	85	336	25		<b>\$14519</b>
RA14448SPB	48 x 144 x 1.5	85	288	21		<b>\$11724</b>
RA12048SPB	48 x 120 x 1.5	85	240	18		<b>\$10080</b>
RA9648SPB	48 x 96 x 1.5	85	192	14		<b>\$8203</b>
RA8442SPB	42 x 84 x 1.5	85	147	11		<b>\$7313</b>
RA7242SPB	42 x 72 x 1.5	85	126	9		<b>\$6596</b>
RA8436SPB	36 x 84 x 1.5	85	126	9		<b>\$6596</b>
RA7236SPB	36 x 72 x 1.5	85	108	8		<b>\$5658</b>
RA6636SPB	36 x 66 x 1.5	85	99	7		<b>\$4321</b>
RA8430SPB	30 x 84 x 1.5	85	105	8		<b>\$5494</b>
RA7230SPB	30 x 72 x 1.5	85	90	7		<b>\$4714</b>
RA6630SPB	30 x 66 x 1.5	85	83	6		<b>\$4555</b>
RA6030SPB	30 x 60 x 1.5	85	75	6		<b>\$3932</b>
RA5430SPB	30 x 54 x 1.5	85	68	5		<b>\$3537</b>
RA8422SPB	22 x 84 x 1.5	No Match!	No Match!	No Match!		No Match!
RA7222SPB	22 x 72 x 1.5	85	66	5		<b>\$3771</b>
RA6622SPB	22 x 66 x 1.5	85	61	5		<b>\$3459</b>
RA6022SPB	22 x 60 x 1.5	85	55	4		<b>\$3144</b>
RA5422SPB	22 x 54 x 1.5	85	50	4		<b>\$2830</b>
RA4822SPB	22 x 48 x 1.5	85	44	3		<b>\$2724</b>

Grain runs the **depth** of the worksurface. Tops 120" and under are shipped in one piece and require 2 bases. Tops 144" and over are shipped in two pieces and require 3 bases.

**Required Specifications**  
Veneer Finish

**Optional Specifications**  
Boardroom Table Base  
Grommet  
Custom cut-out

BOARDROOM TABLES - TOPS W/PHILADELPHIA EDGE	MODEL#	DIMENSIONS	FREIGHT CLASS	WT/LBS.	CUBIC FT.	LIST PRICE
<b>D x W x H</b>						
	OV24054PB	54 x 240 x 1.5	85	540	39	<b>\$25995</b>
	OV21654PB	54 x 216 x 1.5	85	486	35	<b>\$22214</b>
	OV19254PB	54 x 192 x 1.5	85	432	31	<b>\$21092</b>
	OV16848PB	48 x 168 x 1.5	85	336	25	<b>\$16199</b>
	OV14448PB	48 x 144 x 1.5	85	288	21	<b>\$13077</b>
	OV12048PB	48 x 120 x 1.5	85	240	18	<b>\$11062</b>
	OV9648PB	48 x 96 x 1.5	85	192	14	<b>\$9153</b>
	OV8442PB	42 x 84 x 1.5	85	147	11	<b>\$8248</b>
	OV7242PB	42 x 72 x 1.5	85	126	9	<b>\$7361</b>
	OV8436PB	36 x 84 x 1.5	85	126	9	<b>\$7361</b>
	OV7236PB	36 x 72 x 1.5	85	108	8	<b>\$6306</b>
	OV6636PB	36 x 66 x 1.5	85	99	7	<b>\$4823</b>
	OV8430PB	30 x 84 x 1.5	85	105	8	<b>\$6131</b>
	OV7230PB	30 x 72 x 1.5	85	90	7	<b>\$5257</b>
	OV6630PB	30 x 66 x 1.5	85	83	6	<b>\$4823</b>
	OV6030PB	30 x 60 x 1.5	85	75	6	<b>\$4382</b>
	OV5430PB	30 x 54 x 1.5	85	68	5	<b>\$3947</b>
	OV8422PB	22 x 84 x 1.5	85	77	6	<b>\$4905</b>
	OV7222PB	22 x 72 x 1.5	85	66	5	<b>\$4205</b>
	OV6622PB	22 x 66 x 1.5	85	61	5	<b>\$3853</b>
	OV6022PB	22 x 60 x 1.5	85	55	4	<b>\$3503</b>
	OV5422PB	22 x 54 x 1.5	85	50	4	<b>\$3157</b>
	OV4822PB	22 x 48 x 1.5	85	44	3	<b>\$3038</b>

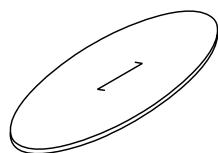

**Oval Top**

Grain runs the **length** of the worksurface. Tops 120" and under are shipped in one piece and require 2 bases. Tops 144" and over are shipped in two pieces and require 3 bases.

B024054PB	54 x 240 x 1.5	85	540	39	<b>\$17588</b>
B021654PB	54 x 216 x 1.5	85	486	35	<b>\$15809</b>
B019254PB	54 x 192 x 1.5	85	432	31	<b>\$14026</b>
B016848PB	48 x 168 x 1.5	85	336	25	<b>\$11172</b>
B014448PB	48 x 144 x 1.5	85	288	21	<b>\$9041</b>
B012048PB	48 x 120 x 1.5	85	240	18	<b>\$7570</b>
B09648PB	48 x 96 x 1.5	85	192	14	<b>\$6149</b>
B08442PB	42 x 84 x 1.5	85	147	11	<b>\$5673</b>
B07242PB	42 x 72 x 1.5	85	126	9	<b>\$4992</b>

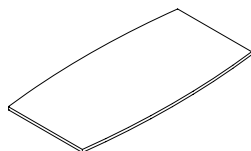

**Boat Shape Top**

Grain runs the **length** of the worksurface. Tops 120" and under are shipped in one piece and require 2 bases. Tops 144" and over are shipped in two pieces and require 3 bases.

BOBE24054PB	54 x 240 x 1.5	85	540	39	<b>\$20224</b>
BOBE21654PB	54 x 216 x 1.5	85	486	35	<b>\$18181</b>
BOBE19254PB	54 x 192 x 1.5	85	432	31	<b>\$16133</b>
BOBE5454PB	54 x 54 x 1.5	85	121	9	<b>\$4537</b>
BOBE16848PB	48 x 168 x 1.5	85	336	25	<b>\$12851</b>
BOBE14448PB	48 x 144 x 1.5	85	288	21	<b>\$10394</b>
BOBE12048PB	48 x 120 x 1.5	85	240	18	<b>\$8706</b>
BOBE9648PB	48 x 96 x 1.5	85	96	7	<b>\$7071</b>
BOBE4848PB	48 x 48 x 1.5	85	96	7	<b>\$3827</b>
BOBE8442PB	42 x 84 x 1.5	85	147	11	<b>\$6325</b>
BOBE7242PB	42 x 72 x 1.5	85	126	9	<b>\$5742</b>
BOBE4242PB	42 x 42 x 1.5	85	74	5	<b>\$3351</b>

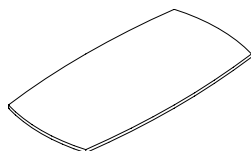

**Boat Shape Top - Bow Ends**

Grain runs the **length** of the worksurface. Tops 120" and under are shipped in one piece and require 2 bases. Tops 144" and over are shipped in two pieces and require 3 bases.

**Required Specifications**

Veneer Finish

**Optional Specifications**

Boardroom Table Base  
Grommet  
Custom cut-out

# T BOARDROOM TABLES - PHILADELPHIA

## BOARDROOM TABLES - TOPS W/PHILADELPHIA EDGE

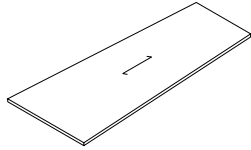

**Wedge Shape Top**

MODEL#	DIMENSIONS D x W x H	FREIGHT CLASS	WT/LBS.	CUBIC FT.	LIST PRICE
WE2405442PB	54 - 42 x 240 x 1.5	85	540	39	<b>\$15450</b>
WE2165442PB	54 - 42 x 216 x 1.5	85	486	35	<b>\$14026</b>
WE1925442PB	54 - 42 x 192 x 1.5	85	432	31	<b>\$12243</b>
WE1684836PB	48 - 36 x 168 x 1.5	85	336	25	<b>\$9393</b>
WE1444836PB	48 - 36 x 144 x 1.5	85	288	21	<b>\$7435</b>
WE1204836PB	48 - 36 x 120 x 1.5	85	240	18	<b>\$6319</b>
WE964836PB	48 - 36 x 96 x 1.5	85	192	14	<b>\$5511</b>
WE844230PB	42 - 30 x 84 x 1.5	85	147	11	<b>\$4461</b>
WE724230PB	42 - 30 x 72 x 1.5	85	126	9	<b>\$3925</b>
WE843624PB	36 - 24 x 84 x 1.5	85	126	9	<b>\$3925</b>
WE723624PB	36 - 24 x 72 x 1.5	85	108	8	<b>\$3370</b>
WE663624PB	36 - 24 x 66 x 1.5	85	99	7	<b>\$2573</b>

Grain runs the **length** of the worksurface. Tops 120" and under are shipped in one piece and require 2 bases. Tops 144" and over are shipped in two pieces and require 3 bases.

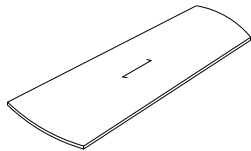

**Wedge Shape Top - Bow Ends**

WEBE2405442PB	54 - 42 x 240 x 1.5	85	540	39	<b>\$17766</b>
WEBE2165442PB	54 - 42 x 216 x 1.5	85	486	35	<b>\$16133</b>
WEBE1925442PB	54 - 42 x 192 x 1.5	85	432	31	<b>\$14081</b>
WEBE1684836PB	48 - 36 x 168 x 1.5	85	336	25	<b>\$10802</b>
WEBE1444836PB	48 - 36 x 144 x 1.5	85	288	21	<b>\$8553</b>
WEBE1204836PB	48 - 36 x 120 x 1.5	85	240	18	<b>\$7269</b>
WEBE964836PB	48 - 36 x 96 x 1.5	85	192	14	<b>\$5633</b>
WEBE844230PB	42 - 30 x 84 x 1.5	85	147	11	<b>\$5130</b>
WEBE724230PB	42 - 30 x 72 x 1.5	85	126	9	<b>\$4514</b>
WEBE843624PB	36 - 24 x 84 x 1.5	85	126	9	<b>\$4514</b>
WEBE723624PB	36 - 24 x 72 x 1.5	85	108	8	<b>\$3874</b>
WEBE663624PB	36 - 24 x 66 x 1.5	85	99	7	<b>\$2955</b>

Grain runs the **length** of the worksurface. Tops 120" and under are shipped in one piece and require 2 bases. Tops 144" and over are shipped in two pieces and require 3 bases.

### Required Specifications

Veneer Finish

### Optional Specifications

Boardroom Table Base  
Grommet  
Custom cut-out

## BOARDROOM TABLE BASES - ALL SERIES

MODEL# DIMENSIONS FREIGHT CLASS WT/LBS. CUBIC FT. LIST PRICE

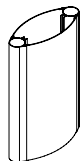

**Elliptical Base**

	D x W x H				
TE42	8 x 42 x 28	100	70	8	<b>\$1845</b>
TE36	7 x 36 x 28	92.5	60	6	<b>\$1845</b>
TE36	7 x 36 x 28	92.5	60	6	<b>\$1845</b>
TE30	6 x 30 x 28	85	50	4	<b>\$1787</b>
TE24	6 x 24 x 28	70	40	2	<b>\$1715</b>

**Not to be used with round table tops.** For tops up to 120", two Elliptical Bases must be ordered. For tops 144" and more, three Elliptical Bases must be ordered.

• **Plastic End Gables are available in a Tungsten (K) or Black (E) finish. Please Specify.**

- For 30" and 36" deep tops, order a 24" base (**TE24**).
- For 42" and 48" deep tops, order a 30" base (**TE30**).
- For 54" and 60" deep tops, order a 36" base (**TE36**) or 42" base (**TE42**).

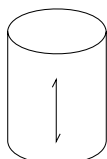

**Drum Base - Veneer**

TD30	30 x 30 x 28	125	93	15	<b>\$3011</b>
TD22	22 x 22 x 28	100	70	8	<b>\$1450</b>
TD18	18 x 18 x 28	85	62	5	<b>\$1263</b>

For tops up to 120", two Drum Bases must be ordered. For tops 144" and more, three Drum Bases must be ordered. Sand bag included to provide adequate stability.

- For 30", 36" and 42" deep tops, order a 18" base (**TD18**).
- For 48" and 54" deep tops, order a 22" base (**TD22**).
- For 60" deep tops, order a 30" base (**TD30**).

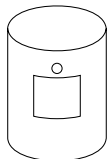

**Drum Base with Power Access Door - Veneer**

TD30J	30 x 30 x 28	125	93	15	<b>\$3764</b>
TD22J	22 x 22 x 28	100	70	8	<b>\$2206</b>
TD18J	18 x 18 x 28	85	62	5	<b>\$2017</b>

Access door and top and bottom cut-out to accommodate power/data grommet. For tops up to 120", two Drum Bases must be ordered. For tops 144" and more, three Drum Bases must be ordered. Sand bag included to provide adequate stability.

- Power access door is 12" x 12"
- For 30", 36" and 42" deep tops, order a 18" base (**TD18J**).
- For 48" and 54" deep tops, order a 22" base (**TD22J**).
- For 60" deep tops, order a 30" base (**TD30J**).

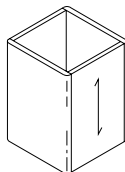

**Pedestal Base**

TP24	24 x 24 x 28	92.5	106	10	<b>\$1575</b>
TP20	20 x 20 x 28	85	89	7	<b>\$1513</b>
TP16	16 x 16 x 28	70	71	4	<b>\$1450</b>

For tops up to 120", two Pedestal Bases must be ordered. For tops 144" and more, three Pedestal Bases must be ordered.

- For 30", 36" and 42" deep tops, order a 16" base (**TP16**).
- For 48" and 54" deep tops, order a 20" base (**TP20**).
- For 60" deep tops, order a 24" base (**TP24**).

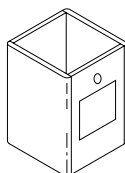

**Pedestal Base with Power Access Door**

TP24J	24 x 24 x 28	92.5	106	10	<b>\$2331</b>
TP20J	20 x 20 x 28	85	89	7	<b>\$2268</b>
TP16J	16 x 16 x 28	70	71	4	<b>\$2206</b>

Access door and top and bottom cut-out to accommodate power/data grommet. For tops up to 120", two Pedestal Bases must be ordered. For tops 144" and more, three Pedestal Bases must be ordered.

- Power access door is 12" x 12"
- For 30", 36" and 42" deep tops, order a 16" base (**TP16J**).
- For 48" and 54" deep tops, order a 20" base (**TP20J**).
- For 60" deep tops, order a 24" base (**TP24J**).

### Required Specifications

Veneer Finish

# T BOARDROOM TABLES

## BOARDROOM TABLE BASES - ALL SERIES

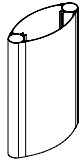

**Elliptical Base**

MODEL#	DIMENSIONS D x W x H	FREIGHT CLASS	WT/LBS.	CUBIC FT.	LIST PRICE	ALL VENEER
TE42	8 x 42 x 28	100	70	8	<b>\$1845</b>	
TE36	7 x 36 x 28	92.5	60	6	<b>\$1845</b>	
TE36	7 x 36 x 28	92.5	60	6	<b>\$1845</b>	
TE30	6 x 30 x 28	85	50	4	<b>\$1787</b>	
TE24	6 x 24 x 28	70	40	2	<b>\$1715</b>	

**Not to be used with round table tops.** For tops up to 120", two Elliptical Bases must be ordered. For tops 144" and more, three Elliptical Bases must be ordered.

• **Plastic End Gables are available in a Tungsten (K) or Black (E) finish. Please Specify.**

- For 30" and 36" deep tops, order a 24" base (**TE24**).
- For 42" and 48" deep tops, order a 30" base (**TE30**).
- For 54" and 60" deep tops, order a 36" base (**TE36**) or 42" base (**TE42**).

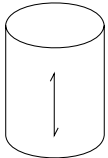

**Drum Base - Veneer**

TD30	30 x 30 x 28	125	93	15	<b>\$3011</b>	
TD22	22 x 22 x 28	100	70	8	<b>\$1450</b>	
TD18	18 x 18 x 28	85	62	5	<b>\$1263</b>	

For tops up to 120", two Drum Bases must be ordered. For tops 144" and more, three Drum Bases must be ordered. Sand bag included to provide adequate stability.

- For 30", 36" and 42" deep tops, order a 18" base (**TD18**).
- For 48" and 54" deep tops, order a 22" base (**TD22**).
- For 60" deep tops, order a 30" base (**TD30**).

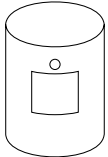

**Drum Base with Power Access Door - Veneer**

TD30J	30 x 30 x 28	125	93	15	<b>\$3764</b>	
TD22J	22 x 22 x 28	100	70	8	<b>\$2206</b>	
TD18J	18 x 18 x 28	85	62	5	<b>\$2017</b>	

Access door and top and bottom cut-out to accommodate power/data grommet. For tops up to 120", two Drum Bases must be ordered. For tops 144" and more, three Drum Bases must be ordered. Sand bag included to provide adequate stability.

- Power access door is 12" x 12"
- For 30", 36" and 42" deep tops, order a 18" base (**TD18J**).
- For 48" and 54" deep tops, order a 22" base (**TD22J**).
- For 60" deep tops, order a 30" base (**TD30J**).

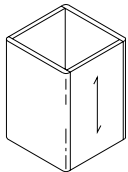

**Pedestal Base**

TP24	24 x 24 x 28	92.5	106	10	<b>\$1575</b>	
TP20	20 x 20 x 28	85	89	7	<b>\$1513</b>	
TP16	16 x 16 x 28	70	71	4	<b>\$1450</b>	

For tops up to 120", two Pedestal Bases must be ordered. For tops 144" and more, three Pedestal Bases must be ordered.

- For 30", 36" and 42" deep tops, order a 16" base (**TP16**).
- For 48" and 54" deep tops, order a 20" base (**TP20**).
- For 60" deep tops, order a 24" base (**TP24**).

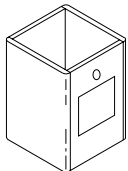

**Pedestal Base with Power Access Door**

TP24J	24 x 24 x 28	92.5	106	10	<b>\$2331</b>	
TP20J	20 x 20 x 28	85	89	7	<b>\$2268</b>	
TP16J	16 x 16 x 28	70	71	4	<b>\$2206</b>	

Access door and top and bottom cut-out to accommodate power/data grommet. For tops up to 120", two Pedestal Bases must be ordered. For tops 144" and more, three Pedestal Bases must be ordered.

- Power access door is 12" x 12"
- For 30", 36" and 42" deep tops, order a 16" base (**TP16J**).
- For 48" and 54" deep tops, order a 20" base (**TP20J**).
- For 60" deep tops, order a 24" base (**TP24J**).

### Required Specifications

Veneer Finish

\* Laminate Finish

## BOARDROOM TABLE BASES - ALL SERIES

MODEL#      DIMENSIONS      FREIGHT CLASS      WT/LBS.      CUBIC FT.      LIST PRICE

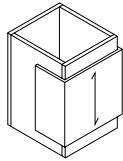

**Pedestal Base - Veneer  
Decorative Outside Panel\***

	D x W x H					
TPM24	24 x 24 x 28	92.5	106	10	<b>\$2440</b>	<b>\$2925</b>
TPM20	20 x 20 x 28	85	86	7	<b>\$2338</b>	<b>\$2804</b>
TPM16	16 x 16 x 28	70	71	4	<b>\$2246</b>	<b>\$2693</b>

For tops up to 120", two Pedestal Bases must be ordered. For tops 144" and more, three Pedestal Bases must be ordered.

- For 30", 36" and 42" deep tops, order a 16" base (**TPM16**).
- For 48" and 54" deep tops, order a 20" base (**TPM20**).
- For 60" deep tops, order a 24" base (**TPM24**).

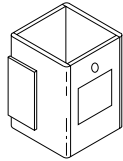

**Pedestal Base with Power Access Door  
Veneer Decorative Outside Panel\***

TPM24J	24 x 24 x 28	92.5	106	10	<b>\$2835</b>	<b>\$3405</b>
TPM20J	20 x 20 x 28	85	86	7	<b>\$2732</b>	<b>\$3281</b>
TPM16J	16 x 16 x 28	70	71	4	<b>\$2753</b>	<b>\$3306</b>

Access door and top and bottom cut-out to accommodate power/data grommet. For tops up to 120", two Pedestal Bases must be ordered. For tops 144" and more, three Pedestal Bases must be ordered.

- Power access door is 12" x 12"
- For 30", 36" and 42" deep tops, order a 16" base (**TPM16J**).
- For 48" and 54" deep tops, order a 20" base (**TPM20J**).
- For 60" deep tops, order a 24" base (**TPM24J**).

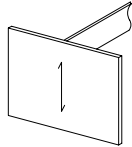

**Slab Base**

TH42	3 x 42 x 28	60	148	2	<b>\$2209</b>
TH36	3 x 36 x 28	60	127	2	<b>\$1993</b>
TH30	3 x 30 x 28	60	106	2	<b>\$1450</b>
TH22	3 x 22 x 28	60	89	2	<b>\$1256</b>

Not to be used with round table tops. For tops up to 120", two Slab Bases must be ordered. For tops 144" and more, three Slab Bases must be ordered.

- For 30" and 36" deep tops, order a 22" base (**TH22**).
- For 42" and 48" deep tops, order a 30" base (**TH30**).
- For 54" deep tops, order a 36" base (**TH36**).
- For 60" deep tops, order a 42" base (**TH42**).

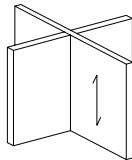

**Cross Base**

TX42	3 x 42 x 28	100	180	20	<b>\$2130</b>
TX36	3 x 36 x 28	100	155	17	<b>\$1993</b>
TX30	3 x 30 x 28	100	133	15	<b>\$1450</b>
TX22	3 x 22 x 28	100	97	11	<b>\$1256</b>

For tops up to 120", two Cross Bases must be ordered. For tops 144" and more, three Cross Bases must be ordered.

- For 30" and 36" deep tops, order a 22" base (**TX22**).
- For 42" and 48" deep tops, order a 30" base (**TX30**).
- For 54" deep tops, order a 36" base (**TX36**).
- For 60" deep tops, order a 42" base (**TX42**).

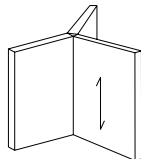

**"Y" Base**

TW42	4 x 42 x 28	125	140	20	<b>\$1845</b>
TW36	4 x 36 x 28	125	120	17	<b>\$1625</b>
TW30	4 x 30 x 28	125	100	15	<b>\$1335</b>
TW22	4 x 22 x 28	125	73	11	<b>\$1249</b>

**Not to be used with round table tops.** For tops up to 120", two "Y" Bases must be ordered. For tops 144" and more, two "Y" Bases and one Cross Base must be ordered.

- For 30" and 36" deep tops, order a 22" base (**TW22**).
- For 42" and 48" deep tops, order a 30" base (**TW30**).
- For 54" deep tops, order a 36" base (**TW36**).
- For 60" deep tops, order a 42" base (**TW42**).

### Required Specifications

Veneer Finish (Veneer Post Legs)  
Metal Finish (Metal Legs)

# T BOARDROOM TABLES

## BOARDROOM TABLE BASES - ALL SERIES

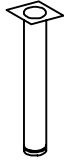

**Post Leg Veneer**

MODEL#	DIMENSIONS D x W x H	FREIGHT CLASS	WT/LBS.	CUBIC FT.	LIST PRICE
SN06	6 dia x 28	250	10	3	<b>\$1518</b>
SN04	4 dia x 28	125	7	1	<b>\$1169</b>
SN03	3 dia x 28	150	5	1	<b>\$737</b>

Available in 3", 4" and 6" diameters. Round tops and tops up to 96" require four legs. Tops 108" to 168" require six legs; tops 180" to 240" require ten legs.

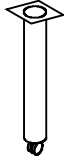

**Post Leg Veneer w/Caster**

SN06M	6 dia x 28	100	10	3	<b>\$1603</b>
SN04M	4 dia x 28	125	7	1	<b>\$1253</b>
SN03M	3 dia x 28	150	5	1	<b>\$824</b>

Available in 3", 4" and 6" diameters. Caster included. Round tops and tops up to 96" require four legs. Tops 108" to 168" require six legs; tops 180" to 240" require ten legs.

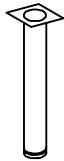

**Post Leg Metal**

SM06	6 dia x 28	100	10	3	<b>\$1037</b>
SM04	4 dia x 28	125	7	1	<b>\$572</b>
SM03	3 dia x 28	150	5	1	<b>\$407</b>

Available in 3", 4" and 6" diameters. Round tops and tops up to 96" require four legs. Tops 108" to 168" require six legs; tops 180" to 240" require ten legs.

• **Must Specify Black (E) or Tungsten (K) finish**

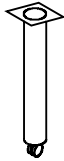

**Post Leg Metal w/Casters**

SM06M	6 dia x 28	100	10	3	<b>\$1125</b>
SM04M	4 dia x 28	125	7	1	<b>\$659</b>
SM03M	3 dia x 28	150	5	1	<b>\$495</b>

Available in 3", 4" and 6" diameters. Caster included. Round tops and tops up to 96" require four legs. Tops 108" to 168" require six legs; tops 180" to 240" require ten legs.

• **Must Specify Black (E) or Tungsten (K) finish**

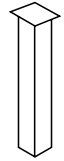

**Post Leg Metal, Square**

SMS4	4 x 4 x 28	125	7	1	<b>\$449</b>
------	------------	-----	---	---	--------------

Available in 4". Round tops and tops up to 96" require four legs. Tops 108" to 168" require six legs; tops 180" to 240" require ten legs.

• **Must Specify Black (E) or Tungsten (K) finish**

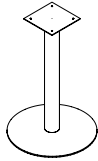

**Post Leg w/Flat Plate**

F6P36	36 x 36 x 28	150	100	22	<b>\$3562</b>
F4P30	30 x 30 x 28	150	80	15	<b>\$2169</b>
F4P24	24 x 24 x 28	125	60	10	<b>\$1733</b>
F3P18	18 x 18 x 28	100	45	5	<b>\$1538</b>

Round tops require a single base. For tops up to 120", two bases must be ordered. For tops 144" or more, three bases must be ordered.

• **Must Specify Black (E) or Tungsten (K) finish**

- For 30" deep tops, order a 18" base (**F3P18**).
- For 36" deep tops, order a 24" base (**F4P24**).
- For 42" and 48" deep tops, order a 30" base (**F4P30**).
- For 54" deep tops, order a 36" base (**F6P36**).

### Required Specifications

Metal Finish (Metal Legs)

## BOARDROOM TABLE BASES - ALL SERIES

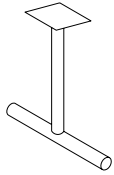

**Tubular 2-Prong Base**

MODEL#	DIMENSIONS	FREIGHT CLASS	WT/LBS.	CUBIC FT.	LIST PRICE
	<b>D x W x H</b>				
TTM36	36 x 36 x 28	100	28	22	<b>\$857</b>
TTM26	26 x 26 x 28	85	24	11	<b>\$822</b>

**Not to be used with round table tops.** Two square edged prongs. For tops up to 84", two Tubular 2-Prong Bases must be ordered. Used as a 3rd base to provide center support in conjunction with two 3-Prong bases on tops 144" or more.

- **Must Specify Black (E) or Tungsten (K) finish**
- For 30", 36" and 42" deep tops, order a 26" base (**TTM26**).
- For 48", 54" and 60" deep tops, order a 36" base (**TTM36**).

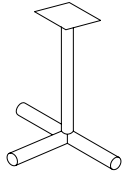

**Tubular 3-Prong Base**

TTE36	36 x 36 x 28	250	36	22	<b>\$913</b>
TTE26	26 x 26 x 28	85	32	11	<b>\$813</b>

**Not to be used with round table tops.** Three square edged prongs. For tops up to 120", two Tubular 3-Prong Bases must be ordered. For tops 144" and more, two Tubular 3-Prong Bases and one Tubular 2-Prong Base for the center must be ordered.

- **Must Specify Black (E) or Tungsten (K) finish**
- For 30", 36" and 42" deep tops, order a 26" base (**TTE26**).
- For 48", 54" and 60" deep tops, order a 36" base (**TTE36**).

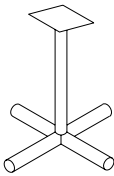

**Tubular 4-Prong Base**

TT36	36 x 36 x 28	300	40	22	<b>\$1369</b>
TT26	26 x 26 x 28	250	36	11	<b>\$943</b>

Four square edged prongs. For tops up to 120", two Tubular 4-Prong Bases must be ordered. For tops 144" and more, three Tubular 4-Prong Bases must be ordered.

- **Must Specify Black (E) or Tungsten (K) finish**
  - For 30", 36" and 42" deep tops, order a 26" base (**TT26**).
  - For 48" and 54" deep tops, order a 36" base (**TT36**)\*
- \* Maximum diameter for Round Tops is 54".

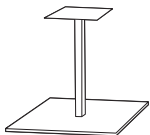

**Flat Square Column Base**

TTSQ23BH	23 x 23 x 41	150	75	14	<b>\$3413</b>
TTSQ18BH	18 x 18 x 41	125	65	10	<b>\$3161</b>
TTSQ30	30 x 30 x 28	150	80	14	<b>\$3540</b>
TTSQ23	23 x 23 x 28	150	55	12	<b>\$2908</b>
TTSQ18	18 x 18 x 28	150	45	8	<b>\$2655</b>

Round tops require a single base. For tops up to 120", two bases must be ordered. For tops 144" or more, three bases must be ordered.

- **Must Specify Black (E) or Tungsten (K) finish**
- For 30" deep tops, order a 18" base (**TTSQ18** or **TTSQ18BH**).
- For 36" deep tops, order a 24" base (**TTSQ23** or **TTSQ23BH**).
- For 42" and 48" deep tops, order a 30" base (**TTSQ30**).
  - Max diameter for round tops at standard height is 48".
  - Max diameter for round tops at bar height is 36".

### Required Specifications

Metal Finish



# T BOARDROOM TABLES

## BOARDROOM TABLE BASES

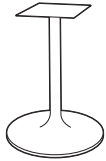

**Trumpet Column Base**

MODEL#	DIMENSIONS D x W x H	FREIGHT CLASS	WT/LBS.	CUBIC FT.	LIST PRICE
TRUM24BH	24 x 24 x 41	300	26	14	<b>\$1646</b>
TRUM18BH	18 x 18 x 41	300	24	16	<b>\$1520</b>
TRUM30	30 x 30 x 28	300	18	14	<b>\$1584</b>
TRUM24	24 x 24 x 28	300	16	12	<b>\$1141</b>
TRUM18	18 x 18 x 28	300	14	8	<b>\$1015</b>

Round tops require a single base. For tops up to 120", two bases must be ordered. For tops 144" or more, three bases must be ordered.

- **Must Specify Black (E) or Tungsten (K) finish**
- For 30" deep tops, order a 18" base (**TRUM18** or **TRUM18BH**).
- For 36" deep tops, order a 24" base (**TRUM24** or **TRUM24BH**).
- For 42" and 48" deep tops, order a 30" base (**TRUM30**).
  - Max diameter for round tops at standard height is 48".
  - Max diameter for round tops at bar height is 36".

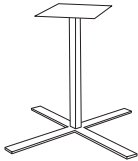

**Flat Bar "X" Column Base**

TTFLT36	36 x 36 x 28	300	18	14	<b>\$3161</b>
TTFLT30	30 x 30 x 28	300	16	12	<b>\$3036</b>
TTFLT22	22 x 22 x 28	300	15	10	<b>\$2794</b>

Round tops require a single base. For tops up to 120", two bases must be ordered. For tops 144" or more, three bases must be ordered.

- **Must Specify Black (E) or Tungsten (K) finish**
- For 30" and 36" deep tops, order a 22" base (**TTFLT22**).
- For 42" and 48" deep tops, order a 30" base (**TTFLT30**).
- For 54" deep tops, order a 36" base (**TTFLT36**).

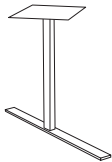

**Flat Bar "T" Column Base**

TTFLT36	36 x 36 x 28	150	14	3	<b>\$2655</b>
TTFLT24	24 x 24 x 28	150	10	2.50	<b>\$2403</b>

**Not to be used with round table tops.** For tops up to 84", two bases must be ordered. To be used as a 3rd base for center support in conjunction with two 3-prong bases on tops 144" or more.

- **Must Specify Black (E) or Tungsten (K) finish**
- For 30", 36" and 42" deep tops, order a 24" base (**TTFLT24**).
- For 48" and 54" deep tops, order a 36" base (**TTFLT36**).
- TTFLTxx bases are to be used as a middle base in combination with two TTFL3P bases



**Flat Bar 3 Prong Column Base**

TTFL3P36	36 x 36 x 28	400	16	22	<b>\$3036</b>
TTFL3P24	24 x 24 x 28	400	12	14	<b>\$2781</b>

**Not to be used with round table tops.** For tops up to 120", two bases must be ordered. For tops 144" or more, two 3-prong bases and one "T" column base must be ordered.

- **Must Specify Black (E) or Tungsten (K) finish**
- For 30", 36" and 42" deep tops, order a 24" base (**TTFL3P24**).
- For 48" and 54" deep tops, order a 36" base (**TTFL3P36**).
- When a third base is required, a TTFLTxx base may be used as the center base

### Required Specifications

Finish

## BOARDROOM TABLE BASES

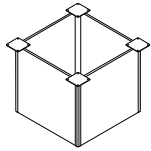

**Square Panel Base - Anodized Aluminum Radius Corner Detail**

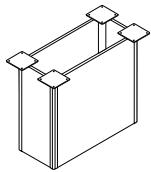

**Rectangular Panel Base - Anodized Aluminum Radius Corner Detail**

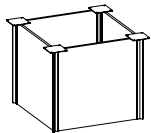

**Square Panel Base - Anodized Aluminum Rectangular Corner Detail**

MODEL#	DIMENSIONS	FREIGHT CLASS	WT/LBS.	CUBIC FT.	LIST PRICE
<b>D x W x H</b>					
TELS24J	24 x 24 x 28	100	75	8	<b>\$2554</b>
TELS20J	20 x 20 x 28	92.5	70	6	<b>\$2203</b>
TELS16J	16 x 16 x 28	70	65	4	<b>\$1999</b>
TELS24	24 x 24 x 28	100	75	8	<b>\$2239</b>
TELS20	20 x 20 x 28	92.5	70	6	<b>\$1885</b>
TELS16	16 x 16 x 28	70	65	4	<b>\$1685</b>

Round tops require a single base. For tops up to 120" two Square Panel bases must be ordered. For tops 144" or more, three bases must be ordered.

- **Model #'s with a "J" denote a power access door on one panel.**
- For 30", 36" and 42" deep tops, order a 16" base (**TELS16** or **TELS16J**).
- For 48" and 54" deep tops, order a 20" base (**TELS20** or **TELS20J**).
- For 60" deep tops, order a 24" base (**TELS24** or **TELS24J**).

TELR24J	12 x 24 x 28	100	65	8	<b>\$2429</b>
TELR20J	12 x 20 x 28	92.5	60	6	<b>\$2075</b>
TELR16J	12 x 16 x 28	85	50	4	<b>\$1873</b>
TELR24	12 x 24 x 28	100	65	8	<b>\$2112</b>
TELR20	12 x 20 x 28	92.5	60	6	<b>\$1760</b>
TELR16	12 x 16 x 28	85	50	4	<b>\$1559</b>

**Not to be used with round table tops.** For tops up to 96" two Rectangular Panel bases must be ordered. To be used as a 3rd base for center support in conjunction with two Square Panel bases on tops 144" or more.

- **Model #'s with a "J" denote a power access door on one panel.**
- For 30", 36" and 42" deep tops, order a 16" base (**TELR16** or **TELR16J**).
- For 48" and 54" deep tops, order a 20" base (**TELR20** or **TELR20J**).
- For 60" deep tops, order a 24" base (**TELR24** or **TELR24J**).

TELS24J	24 x 24 x 28	100	65	8	<b>\$2554</b>
TELS20J	20 x 20 x 28	92.5	60	6	<b>\$2203</b>
TELS16J	16 x 16 x 28	85	50	4	<b>\$1999</b>
TELS24	24 x 24 x 28	100	65	8	<b>\$2239</b>
TELS20	20 x 20 x 28	92.5	60	6	<b>\$1885</b>
TELS16	16 x 16 x 28	85	50	4	<b>\$1685</b>

Round tops require a single base. For tops up to 120" two Square Panel bases must be ordered. For tops 144" or more, three bases must be ordered.

- **Model #'s with a "J" denote a power access door on one panel.**
- For 30", 36" and 42" deep tops, order a 16" base (**TELS16** or **TELS16J**).
- For 48" and 54" deep tops, order a 20" base (**TELS20** or **TELS20J**).
- For 60" deep tops, order a 24" base (**TELS24** or **TELS24J**).

### Required Specifications

Finish

# T BOARDROOM TABLES

## BOARDROOM TABLE BASES

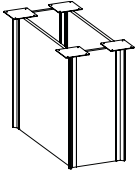

**Rectangular Panel Base - Anodized Aluminum Rectangular Corner Detail**

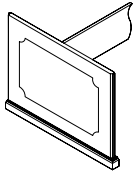

**Philadelphia Wood Slab Base and Stretcher**

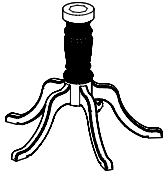

**Wood Queen Anne Base**

MODEL#	DIMENSIONS D x W x H	FREIGHT CLASS	WT./LBS.	CUBIC FT.	LIST PRICE
TELBR24J	12 x 24 x 28	100	65	8	<b>\$2429</b>
TELBR20J	12 x 20 x 28	92.5	60	6	<b>\$2075</b>
TELBR16J	12 x 16 x 28	85	50	4	<b>\$1873</b>
TELBR24	12 x 24 x 28	100	65	8	<b>\$2112</b>
TELBR20	12 x 20 x 28	92.5	60	6	<b>\$1760</b>
TELBR16	12 x 16 x 28	85	50	4	<b>\$1559</b>

**Not to be used with round table tops.** For tops up to 96" two Rectangular Panel bases must be ordered. To be used as a 3rd base for center support in conjunction with two Square Panel bases on tops 144" or more.

- **Model #'s with a "J" denote a power access door on one panel.**
- For 30", 36" and 42" deep tops, order a 16" base (**TELBR16** or **TELBR16J**).
- For 48" and 54" deep tops, order a 20" base (**TELBR20** or **TELBR20J**).
- For 60" deep tops, order a 24" base (**TELBR24** or **TELBR24J**).

PTH42PB	1 x 42 x 28	60	148	2	<b>\$3479</b>
PTH36PB	1 x 36 x 28	60	127	2	<b>\$3143</b>
PTH30PB	1 x 30 x 28	60	106	2	<b>\$2290</b>
PTH22PB	1 x 22 x 28	60	89	1	<b>\$1982</b>

**Need description**

- For 54" and 60" deep tops, order PTH36PB
- For 42" and 48" deep tops, order PTH30PB
- For 30" and 36" deep tops, order PTH22PB

PTQA30	30 x 30 x 28	150	73	15	<b>\$3558</b>
--------	--------------	-----	----	----	---------------

For use with 36", 42" and 48" deep tops.

**Required Specifications**

Finish

## BOARDROOM - ACCESSORIES

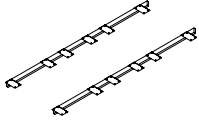

**Metal Support Rails**

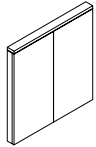

**Visual Board**

MODEL#	DIMENSIONS	FREIGHT CLASS	WT/LBS.	CUBIC FT.	LIST PRICE
	<b>D x W x H</b>				
TSUP102	1 x 102 x 2	70	0.10	0.10	<b>\$1163</b>
TSUP96	1 x 96 x 2	70	0.10	0.10	<b>\$1091</b>
TSUP90	1 x 90 x 2	70	0.10	0.10	<b>\$1009</b>
TSUP84	1 x 84 x 2	70	0.10	0.10	<b>\$932</b>
TSUP78	1 x 78 x 2	70	0.10	0.10	<b>\$854</b>
TSUP72	1 x 72 x 2	70	0.10	0.10	<b>\$777</b>
TSUP66	1 x 66 x 2	70	0.10	0.10	<b>\$702</b>
TSUP60	1 x 60 x 2	70	0.10	0.10	<b>\$626</b>
TSUP54	1 x 54 x 2	70	0.10	0.10	<b>\$575</b>

To be used when design considerations or dimension requirements dictate an unsupported table joint. Top section **MUST NOT** exceed 72" to use metal supports. **Sold in sets of two**

- Available in Black only.

VB4848E	5 x 48 x 48	70	115	7	<b>\$4263</b>
---------	-------------	----	-----	---	---------------

Includes porcelain on steel magnetic board and two side opening straight edge doors containing tackable fabric panels and 50-sheet paper writing pad that can be used on either door. Magnetic board can be used for projection. Set of 6 dry erase markers and eraser included. Interior fabric panels available in Anchorage. Specify color:

AN40 Birch	AN41 Green Apple	AN42 Lapis	AN43 Straw	AN44 Wolf
AN45 Goose	AN46 Angora	AN47 Cumin	AN48 Asteroid	AN49 Geranium
AN50 Thistle	AN51 Graphite	AN52 Slate	AN53 Quarry Blue	AN54 Onyx
AN55 Pumpkin	AN56 Red Delicious	AN57 Sunshine	AN59 Waterfall	AN61 Vanilla
AN62 Cobalt	AN64 Cloud			

- **NOTE:** Care should be taken to mount the units. Units should be mounted to wall studs using correct fasteners. Failure to do so may result in collapse of the unit and subsequent personal injury. **Mounting hardware not included.** Mounting hardware used should be based on wall material. Consult an installation professional for proper wall mounting.

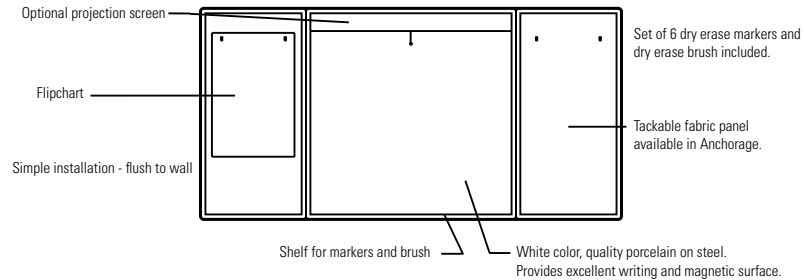

### Required Specifications

Finish  
Fabric

# T BOARDROOM TABLES

## BOARDROOM - ACCESSORIES

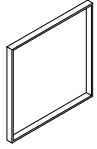

Visual Board, No Doors

MODEL#	DIMENSIONS D x W x H	FREIGHT CLASS	WT/LBS.	CUBIC FT.	LIST PRICE	ALL VENEER
VB48480	5 x 48 x 48	70	115	7	<b>\$2864</b>	

Includes porcelain on steel magnetic board. Magnetic board can be used for projection. Set of 6 dry erase markers and eraser included.

• **NOTE:** Care should be taken to mount the units. Units should be mounted to wall studs using correct fasteners. Failure to do so may result in collapse of the unit and subsequent personal injury. **Mounting hardware not included.** Mounting hardware used should be based on wall material. Consult an installation professional for proper wall mounting.

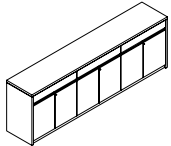

Credenza Buffet - Dufferin

DCB9022H36	22 x 90 x 36	92.5	440	44	<b>\$9140</b>	<b>\$10967</b>
DCB9020H36	20 x 90 x 36	92.5	400	40	<b>\$8309</b>	<b>\$9972</b>
DCB7222H36	22 x 72 x 36	92.5	330	33	<b>\$6206</b>	<b>\$7447</b>
DCB7220H36	20 x 72 x 36	92.5	300	30	<b>\$5529</b>	<b>\$6637</b>
DCB6022H36	22 x 60 x 36	100	275	28	<b>\$5323</b>	<b>\$6388</b>
DCB6020H36	20 x 60 x 36	92.5	250	25	<b>\$4838</b>	<b>\$5804</b>

90" w units have (3) two door storage cabinets with top drawer side-by-side. 72" w & 60" w units have (2) two door storage cabinets with top drawer side-by-side. Locking doors. Self-closing hinged doors cover one adjustable shelf.

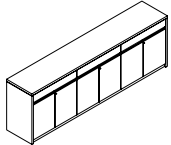

Credenza Buffet - Lufton

LCB9022H36	22 x 90 x 36	92.5	440	44	<b>\$9922</b>	
LCB9020H36	20 x 90 x 36	92.5	400	40	<b>\$9028</b>	
LCB7222H36	22 x 72 x 36	92.5	330	33	<b>\$6741</b>	
LCB7220H36	20 x 72 x 36	92.5	300	30	<b>\$6000</b>	
LCB6022H36	22 x 60 x 36	100	275	28	<b>\$5788</b>	
LCB6020H36	20 x 60 x 36	92.5	250	25	<b>\$5260</b>	

90" w units have (3) two door storage cabinets with top drawer side-by-side. 72" w & 60" w units have (2) two door storage cabinets with top drawer side-by-side. Locking doors. Self-closing hinged doors cover one adjustable shelf.

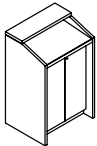

Lectern - Dufferin

DLEC3624	24 x 36 x 48	92.5	240	24	<b>\$4329</b>	<b>\$5195</b>
DLEC3024	24 x 30 x 48	92.5	200	20	<b>\$3610</b>	<b>\$4331</b>
DLEC2424	24 x 24 x 48	92.5	160	16	<b>\$2887</b>	<b>\$3463</b>

Features angled stand. Storage compartment with one adjustable and one fixed shelf. Locks optional.

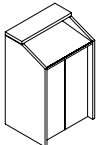

Lectern - Lufton

LEC3624L	24 x 36 x 48	92.5	240	24	<b>\$4910</b>	
LEC3024L	24 x 30 x 48	92.5	200	20	<b>\$4096</b>	
LEC2424L	24 x 24 x 48	92.5	160	16	<b>\$3263</b>	

Features angled stand. Storage compartment with one adjustable and one fixed shelf. Locks optional.

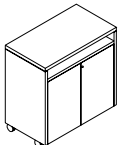



Utility Table - Dufferin

DTV3620M	20 x 36 x 34	85	121	10	<b>\$2620</b>	<b>\$3141</b>
----------	--------------	----	-----	----	---------------	---------------

Open shelf and storage compartment with one adjustable shelf. Locking doors. Casters.

### Required Specifications

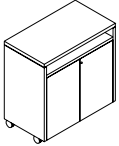
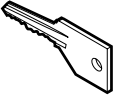
Finish

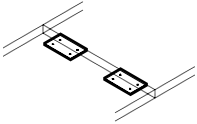
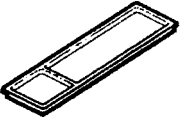
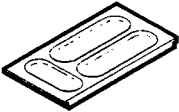
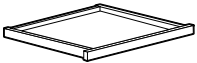
ACCESSORIES	MODEL#	DIMENSIONS	FREIGHT CLASS	WT/LBS.	CUBIC FT.	LIST PRICE
 <b>Utility Table - Lufton</b>	LTV3620M	D x W x H 20 x 36 x 34	85	121	10	<b>\$2838</b>
	Open shelf and storage compartment with one adjustable shelf. Locking doors. Casters.					
 <b>Extra Key</b>	LOCK	--	70	--	--	<b>\$43</b>
	Specify key #. Key range 400 - 500.					
 <b>Grommet Cover, Round</b>	GM1	2 dia x --	70	--	--	<b>\$65</b>
	GM1K	2 dia x --	70	--	--	<b>\$65</b>
	2.75" diameter. <ul style="list-style-type: none"> <li>• <b>Specify GM1 for Black or GM1K for Tungsten.</b></li> </ul>					
 <b>Mending Plates</b>	MP53	3 x 5 x 0.50	300	3	2	<b>\$61</b>
	Sold in sets of 2. <ul style="list-style-type: none"> <li>• <b>Available in Black Only.</b></li> </ul>					
 <b>Pencil Tray - Black Plastic</b>	PT	3 x 12.50 x 1	250	2	1	<b>\$21</b>
	Provides space for writing instruments and small items at the workspace. <ul style="list-style-type: none"> <li>• <b>Available in Black Only.</b></li> </ul>					
 <b>Pencil Tray - Veneer</b>	OPT	6 x 12.50 x 2	150	4	1	<b>\$171</b>
	Provides space for writing instruments and small items at the workspace. Solid oak finish.					
 <b>Center Drawer - Veneer</b>	CD	21 x 23 x 2	100	8	1	<b>\$698</b>
	Veneer drawer front is attached to a 4-sided frame. Must specify wood finish for drawer front.					

**Required Specifications**

Finish

# T BOARDROOM TABLES

## KEYBOARD DRAWERS

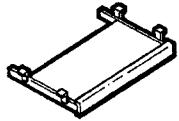

**Keyboard Drawer**

MODEL#	DIMENSIONS D x W x H	FREIGHT CLASS	WT/LBS.	CUBIC FT.	LIST PRICE
KD30	10 x 30 x 1	70	16	1	<b>\$938</b>
KD22	10 x 22 x 1	85	12	1	<b>\$838</b>
KD10	10 x 10 x 1	125	6	1	<b>\$424</b>

Pull-out veneer keyboard shelf. Clearance is 2 ¼". Must specify wood finish for drawer front.

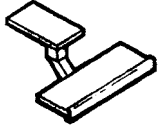

**Articulating Keyboard Drawer**

AKD30	10 x 30 x 1	65	24	1	<b>\$1295</b>
AKD22	10 x 22 x 1	70	18	1	<b>\$1199</b>

Adjustable pull-out keyboard shelf with articulating arm. Adjusts from flush with the worksurface to 5" below worksurface. Swivels 360° full arm rotation, angles -10° to +15°. Must specify wood finish for keyboard deck.

## WIRE MANAGEMENT



**Wire Management Cover**

MODEL#	DIMENSIONS	FREIGHT CLASS	WT/LBS.	CUBIC FT.	LIST PRICE
WH24	1 x 1 x 24	70	1	1	<b>\$74</b>

To conceal wires and cords. Plastic.

- **Available in Black Plastic Only.**



**Wire Management Track - Single**





C2M72	2 x 72 x 2	70	0.10	0.10	<b>\$83</b>
C2M60	2 x 60 x 2	70	0.10	0.10	<b>\$69</b>
C2M48	2 x 48 x 2	70	0.10	0.10	<b>\$57</b>
C2M36	2 x 36 x 2	70	0.10	0.10	<b>\$42</b>
C2M24	2 x 24 x 2	70	0.10	0.10	<b>\$31</b>
C2M12	2 x 12 x 2	70	0.10	0.10	<b>\$17</b>

To conceal and organize wires and cords. Attaches to Modesty Panel with double sided tape. Plastic.

- **Available in Black Plastic Only.**

### Required Specifications

Finish

POWER / DATA	MODEL#	DIMENSIONS	FREIGHT CLASS	WT/LBS.	CUBIC FT.	LIST PRICE
 <p><b>Single Sided Recessed Power Block</b></p>	<b>D x W x H</b>					
	PRTMCS401B	4.22 x 10.78 x 4.86	100	4.3	0.51	<b>\$456</b>
	PRTMCS401T	4.22 x 10.78 x 4.86	100	4.3	0.51	<b>\$456</b>
	PRTMCS401W	4.22 x 10.78 x 4.86	100	4.3	0.51	<b>\$456</b>
<p>Single-sided recessed power block with <b>one regular duplex and one telecom knockout on top; one power duplex on bottom</b>. 10' power cord with straight plug. Specify telecom options separately, see page 404. Available in Black (<b>B</b>), Tungsten (<b>T</b>) or Designer White (<b>W</b>) as indicated by the last letter of model number. Duplexes always Grey. Corresponding cut-out options are <b>R1, R2</b> or <b>R3</b>. Units are not approved for daisy chaining. UL listed: UL 1363.</p>						
 <p><b>Single Sided Recessed Power Block - USB-A + USB-C</b></p>	<b>D x W x H</b>					
	PRTMCS421B	4.22 x 10.78 x 4.86	100	4.3	0.51	<b>\$599</b>
	PRTMCS421T	4.22 x 10.78 x 4.86	100	4.3	0.51	<b>\$599</b>
	PRTMCS421W	4.22 x 10.78 x 4.86	100	4.3	0.51	<b>\$599</b>
<p>Single-sided recessed power block with <b>one power/USB-A/USB-C duplex and one telecom knockout on top; one power duplex on bottom</b>. USB-A port charges max 2.4 amps at 5V and USB-C port charges max 3 amps at 5V. 10' power cord with straight plug. Specify telecom options separately, see page 404. Available in Black (<b>B</b>), Tungsten (<b>T</b>) or Designer White (<b>W</b>) as indicated by the last letter of model number. Duplexes always Grey (duplex with USB ports is glossy finish). Corresponding cut-out options are <b>R1, R2</b> or <b>R3</b>. Units are not approved for daisy chaining. UL listed: UL 1363.</p>						
 <p><b>Double Sided Recessed Power Block</b></p>	<b>D x W x H</b>					
	PRTMCD602B	6.22 x 10.78 x 4.86	92.5	5.9	0.51	<b>\$521</b>
	PRTMCD602T	6.22 x 10.78 x 4.86	92.5	5.9	0.51	<b>\$521</b>
	PRTMCD602W	6.22 x 10.78 x 4.86	92.5	5.9	0.51	<b>\$521</b>
<p>Double-sided recessed power block with <b>two regular power duplexes and two telecom knockouts on top; one power duplex on bottom</b>. 10' power cord with straight plug. Specify telecom options separately, see page 404. Available in Black (<b>B</b>), Tungsten (<b>T</b>) or Designer White (<b>W</b>) as indicated by last letter of model number. Duplexes always Grey. Corresponding cut-out options are <b>T1, T2</b> or <b>T3</b>. Units are not approved for daisy chaining. UL listed: UL 1363.</p>						
 <p><b>Double Sided Recessed Power Block - USB-A + USB-C</b></p>	<b>D x W x H</b>					
	PRTMCD622B	6.22 x 10.78 x 4.86	92.5	6.1	0.51	<b>\$656</b>
	PRTMCD622T	6.22 x 10.78 x 4.86	92.5	6.1	0.51	<b>\$656</b>
	PRTMCD622W	6.22 x 10.78 x 4.86	92.5	6.1	0.51	<b>\$656</b>
<p>Double-sided recessed power block with <b>one regular power duplex, one power/USB-A/USB-C duplex and two telecom knockouts on top; one power duplex on bottom</b>. USB-A port charges max 2.4 amps at 5V and USB-C port charges max 3 amps at 5V. 10' power cord with straight plug. Specify telecom options separately, see page 404. Available in Black (<b>B</b>), Tungsten (<b>T</b>) or Designer White (<b>W</b>) as indicated by last letter of model number. Duplexes always Grey (duplex with USB ports is glossy finish). Corresponding cut-out options are <b>T1, T2</b> or <b>T3</b>. Units are not approved for daisy chaining. UL listed: UL 1363.</p>						
 <p><b>Double Sided Recessed Power Block - USB-A + USB-C</b></p>	<b>D x W x H</b>					
	PRTMCD642B	6.22 x 10.78 x 4.86	85	6.3	0.51	<b>\$790</b>
	PRTMCD642T	6.22 x 10.78 x 4.86	85	6.3	0.51	<b>\$790</b>
	PRTMCD642W	6.22 x 10.78 x 4.86	85	6.3	0.51	<b>\$790</b>
<p>Double-sided recessed power block with <b>two power/USB-A/USB-C duplexes and two telecom knockouts on top; one power duplex on bottom</b>. USB-A port charges max 2.4 amps at 5V and USB-C port charges max 3 amps at 5V. 10' power cord with straight plug. Specify telecom options separately, see page 404. Available in Black (<b>B</b>), Tungsten (<b>T</b>) or Designer White (<b>W</b>) as indicated by last letter of model number. Duplexes always Grey (duplex with USB ports is glossy finish). Corresponding cut-out options are <b>T1, T2</b> or <b>T3</b>. Units are not approved for daisy chaining. UL listed: UL 1363.</p>						

**Required Specifications**  
Finish



# T BOARDROOM TABLES

## TELECOM PLATES

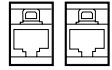

**Telecom Plate - 2 x 6**

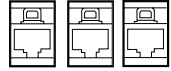

**Telecom Plate - 3 x 6**

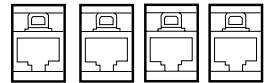

**Telecom Plate - 4 x 6**



**Telecom Plate - 3TSV**

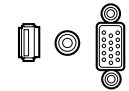

**Telecom Plate - 3SVH**

MODEL#	DIMENSIONS	FREIGHT CLASS	WT/LBS.	CUBIC FT.	LIST PRICE
--------	------------	---------------	---------	-----------	------------

D x W x H

PTELO1	- x - x -	70	0.01	0.05	<b>\$164</b>
--------	-----------	----	------	------	--------------

Includes 2 x RJ45 cat 6 data. Black telecom plate. To be hardwired by data contractor.

PTELO2	- x - x -	70	0.01	0.05	<b>\$222</b>
--------	-----------	----	------	------	--------------

Includes 2 x RJ45 cat 6 data and 1 RJ11 cat phone. Black telecom plate. To be hardwired by data contractor.

PTELO3	- x - x -	70	0.01	0.05	<b>\$340</b>
--------	-----------	----	------	------	--------------

Includes 4 x RJ45 cat 6 data. Black telecom plate. To be hardwired by data contractor.

PTELO4	- x - x -	70	0.01	0.05	<b>\$290</b>
--------	-----------	----	------	------	--------------



Includes 1 x RJ45 cat 6 data, mini stereo and 15 pin HD VGA. Black telecom plate. To be hardwired by data contractor.

PTELO5	- x - x -	70	0.01	0.05	<b>\$401</b>
--------	-----------	----	------	------	--------------

Includes mini stereo, 15 pin HD VGA and HDMI. Black telecom plate.

**Required Specifications**

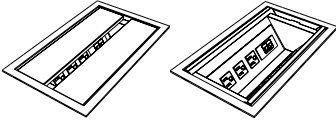
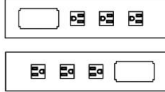
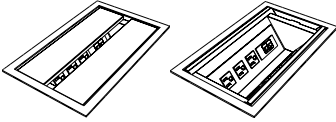
Finish

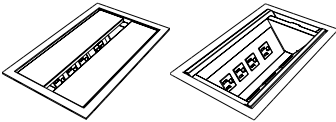
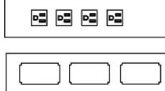
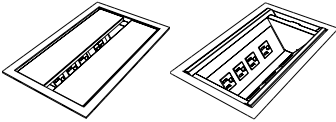
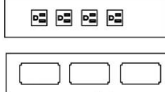
VILLA I SERIES CORDED UNITS		MODEL#	DIMENSIONS	FREIGHT CLASS	WT/LBS.	CUBIC FT.	LIST PRICE
 <p><b>Oasis Mini A, Corded</b></p>		OAM-A-PC-_ 	D x W x H 15 x 9 x 5.25	92.5	16	1.53	<b>\$1826</b>
	<p>Mini Oasis A unit. 15" Trough with six power receptacles, two telecom plate cut-outs (<b>telecom plates sold separate</b>, see page page 410) and two 108" 3-prong plugs. <b>M1, M2 or M3 cut-out(s) must be specified on conference table</b> (see product notes section for more details and cut-out upcharge). UL Listed.</p> <ul style="list-style-type: none"> <li>• <b>Cannot be daisy-chained.</b></li> <li>• Replace _ with <b>B</b> for <b>Black</b></li> <li>• Replace _ with <b>S</b> for <b>Silver Pearl</b></li> </ul>						
 <p><b>Oasis Mini A, DaisyLink Version</b></p>		OAM-A-PC-4-1-_ 	15 x 9 x 5.25	92.5	16	1.53	<b>\$2091</b>
	<p><b>For hardwire and daisy chain applications.</b> Mini Oasis A unit. 15" Trough with six power receptacles, two telecom plate cut-outs (<b>telecom plates sold separate</b>, see page page 410). <b>Power infeed sold separate</b> (see page page 412). <b>M1, M2 or M3 cut-out(s) must be specified on conference table</b> (see product notes section for more details and cut-out upcharge). For multiple circuit configurations, please contact customer service. <i>Please see our <b>Daisy-Chain guide</b> on page page 408 for appropriate cable lengths and important notes.</i> UL Listed.</p> <ul style="list-style-type: none"> <li>• Replace _ with <b>B</b> for <b>Black</b></li> <li>• Replace _ with <b>S</b> for <b>Silver Pearl</b></li> </ul>						
 <p><b>Oasis Mini B, Corded</b></p>		OAM-B-PC-_ 	15 x 9 x 5.25	92.5	16	1.53	<b>\$1826</b>
	<p>Mini Oasis B unit. 15" Trough with four power receptacles, three telecom plate cut-outs (<b>telecom plates sold separate</b>, see page page 410) and one 108" 3-prong plug. <b>M1, M2 or M3 cut-out(s) must be specified on conference table</b> (see product notes section for more details and cut-out upcharge). UL Listed.</p> <ul style="list-style-type: none"> <li>• <b>Cannot be daisy-chained.</b></li> <li>• Replace _ with <b>B</b> for <b>Black</b></li> <li>• Replace _ with <b>S</b> for <b>Silver Pearl</b></li> </ul>						
 <p><b>Oasis Mini B, DaisyLink Version</b></p>		OAM-B-PC-4-1-_ 	15 x 9 x 5.25	92.5	16	1.53	<b>\$2091</b>
	<p><b>For hardwire and daisy chain applications.</b> Mini Oasis B unit. 15" Trough with four power receptacles, three telecom plate cut-outs (<b>telecom plates sold separate</b>, see page page 410). <b>Power infeed sold separate</b> (see page page 412). <b>M1, M2 or M3 cut-out(s) must be specified on conference table</b> (see product notes section for more details and cut-out upcharge). For multiple circuit configurations, please contact customer service. <i>Please see our <b>Daisy-Chain guide</b> on page page 408 for appropriate cable lengths and important notes.</i> UL Listed.</p> <ul style="list-style-type: none"> <li>• Replace _ with <b>B</b> for <b>Black</b></li> <li>• Replace _ with <b>S</b> for <b>Silver Pearl</b></li> </ul>						

**Required Specifications**

- Finish
- Power infeed
- Cut-out location

# T BOARDROOM TABLES

OASIS MINI	MODEL#	DIMENSIONS	FREIGHT CLASS	WT/LBS.	CUBIC FT.	LIST PRICE
------------	--------	------------	---------------	---------	-----------	------------

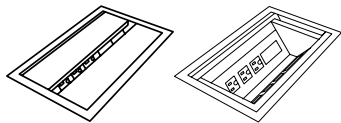

**Oasis Mini USB, Corded**

	D x W x H					
OAM-U-PC-__	15 x 9 x 5.25	92.5	16	1.53		<b>\$2044</b>

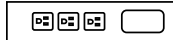
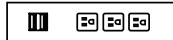

Mini Oasis USB unit. 15" trough with six power receptacles, two 2.1 AMP USB charging ports and one telecom plate cut-out (**telecom plates sold separate**, see page page 410) and two 108" 3-prong plugs. **M1, M2 or M3 cut-out(s) must be specified on conference table** (see product notes section for more details and cut-out upcharge). UL Listed.

- **Cannot be daisy-chained.**
- Replace \_\_ with **B** for **Black**
- Replace \_\_ with **S** for **Silver Pearl**

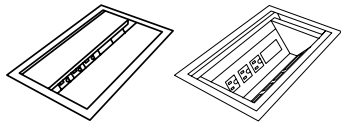

**Oasis Mini USB, DaisyLink Version**

OAM-U-PC-4-1-__	15 x 9 x 5.25	92.5	16	1.53		<b>\$2307</b>
-----------------	---------------	------	----	------	--	---------------

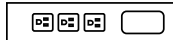
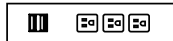

**For hardwire and daisy chain applications.** Mini Oasis USB unit. 15" trough with six power receptacles, two 2.1 AMP USB charging ports and one telecom plate cut-out (**telecom plates sold separate**, see page page 410). **Power infeed sold separate** (see page page 412). **M1, M2 or M3 cut-out(s) must be specified on conference table** (see product notes section for more details and cut-out upcharge). For multiple circuit configurations, please contact customer service. *Please see our **Daisy-Chain guide** on page page 408 for appropriate cable lengths and important notes.* UL Listed.

- Replace \_\_ with **B** for **Black**
- Replace \_\_ with **S** for **Silver Pearl**

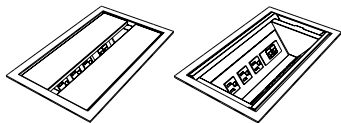

**Oasis Mini, Chicago Code**

GL-OAMPD_P72HW	15 x 9 x 5.25	92.5	16	1.53		<b>\$2490</b>
----------------	---------------	------	----	------	--	---------------

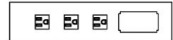
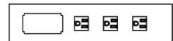

Mini Oasis for Chicago code includes electrical trough with (2) separate hardwire inserts. Each insert includes (3) simplex outlets and (1) telecom plate cut-out (**telecom plates sold separate**, see page page 410). **M1, M2 or M3 cut-out(s) must be specified on conference table** (see product notes section for more details and cut-out upcharge). Each component is UL listed.

- **Cannot be daisy-chained.**
- Replace \_\_ with **B** for **Black**
- Replace \_\_ with **S** for **Silver Pearl**

**Required Specifications**

- Finish
- Power infeed
- Cut-out location

OASIS MINI CUT OUT POSITIONS

D x W x H

**OASIS MINI A & B CABLE LENGTHS NEEDED FOR DAISY-CHAINING**

Model #	Oasis Mini A & Oasis Mini B	Oasis Mini A & Oasis Mini B	Oasis Mini A	Oasis Mini A	Oasis Mini B	Oasis Mini B
<b>Cut-out Positions</b>	TL/M & TR/M	TL/M & TR/M	TL/M, TC/M & TR/M	TL/M, TC/M & TR/M	TL/M, TC/M & TR/M	TL/M, TC/M & TR/M
<b>Infeed Position</b>	Left or Right	Center	Left or Right	Center	Left or Right	Center
<b>Reference</b>	Drawing 1A/1B	Drawing 2A/2B	Drawing 3	Drawing 4	Drawing 5	Drawing 6
<b>8' Dufferin &amp; Lufton Tables</b>	(1) 42FF-55 SPECIFY INFEED	(1) 42FF-29 (1) 42FM-29 (1) DAISY-T SPECIFY INFEED	N/A	N/A	N/A	N/A
<b>10' Dufferin &amp; Lufton Tables</b>	(1) 42FF-79 SPECIFY INFEED	(1) 42FF-41 (1) 42FM-41 (1) DAISY-T SPECIFY INFEED	(3) 42FF-37 SPECIFY INFEED	(3) 42FF-37 SPECIFY INFEED	(2) 42FF-37 SPECIFY INFEED	(2) 42FF-37 (1) 42FM-12 (1) DAISY-T SPECIFY INFEED
<b>12' Dufferin &amp; Lufton Tables</b>	(1) 42FF-103 SPECIFY INFEED	(1) 42FF-55 (1) 42FM-55 (1) DAISY-T SPECIFY INFEED	(3) 42FF-52 SPECIFY INFEED	(3) 42FF-52 SPECIFY INFEED	(2) 42FF-52 SPECIFY INFEED	(2) 42FF-52 (1) 42FM-12 (1) DAISY-T SPECIFY INFEED
<b>14' Dufferin &amp; Lufton Tables</b>	(1) 42FF-64 (1) 42FM-64 SPECIFY INFEED	1) 42FF-67 (1) 42FM-67 (1) DAISY-T SPECIFY INFEED	(3) 42FF-61 SPECIFY INFEED	(3) 42FF-61 SPECIFY INFEED	(2) 42FF-61 SPECIFY INFEED	(2) 42FF-61 (1) 42FM-12 (1) DAISY-T SPECIFY INFEED
<b>16' Dufferin &amp; Lufton Tables</b>	(1) 42FF-79 (1) 42FM-79 SPECIFY INFEED	1) 42FF-82 (1) 42FM-82 (1) DAISY-T SPECIFY INFEED	(3) 42FF-76 SPECIFY INFEED	(3) 42FF-76 SPECIFY INFEED	(2) 42FF-76 SPECIFY INFEED	(2) 42FF-76 (1) 42FM-12 (1) DAISY-T SPECIFY INFEED
<b>18' Dufferin &amp; Lufton Tables</b>	(1) 42FF-88 (1) 42FM-88 SPECIFY INFEED	1) 42FF-91 (1) 42FM-91 (1) DAISY-T SPECIFY INFEED	(3) 42FF-85 SPECIFY INFEED	(3) 42FF-85 SPECIFY INFEED	(2) 42FF-85 SPECIFY INFEED	(2) 42FF-85 (1) 42FM-12 (1) DAISY-T SPECIFY INFEED
<b>20' Dufferin &amp; Lufton Tables</b>	(1) 42FF-100 (1) 42FM-100 SPECIFY INFEED	1) 42FF-103 (1) 42FM-103 (1) DAISY-T SPECIFY INFEED	(3) 42FF-100 SPECIFY INFEED	(3) 42FF-100 SPECIFY INFEED	(2) 42FF-100 SPECIFY INFEED	(2) 42FF-100 (1) 42FM-12 (1) DAISY-T SPECIFY INFEED

**Interconnecting Cables - Common Cable Lengths (in inches)**

**Female/Female**

42FF-21 .....	\$108	42FF-94 .....	\$199	42FM-91 .....	\$201
42FF-29 .....	\$119	42FF-100 .....	\$205	42FM-94 .....	\$203
42FF-32 .....	\$121	42FF-103 .....	\$208	42FM-103 .....	\$216
42FF-37 .....	\$128	42FF-106 .....	\$211	42FM-106 .....	\$218
42FF-41 .....	\$133	42FF-112 .....	\$219	42FM-115 .....	\$230
42FF-46 .....	\$139	42FF-115 .....	\$225	42FM-118 .....	\$235
42FF-52 .....	\$147	42FF-118 .....	\$228		
42FF-55 .....	\$151				
42FF-58 .....	\$154	<b>Female/Male</b>			
42FF-61 .....	\$157	42FM-12 .....	\$104		
42FF-64 .....	\$161	42FM-21 .....	\$115		
42FF-67 .....	\$165	42FM-32 .....	\$128		
42FF-70 .....	\$168	42FM-46 .....	\$146		
42FF-76 .....	\$176	42FM-55 .....	\$156		
42FF-79 .....	\$180	42FM-58 .....	\$159		
42FF-82 .....	\$184	42FM-67 .....	\$170		
42FF-85 .....	\$187	42FM-70 .....	\$175		
42FF-88 .....	\$191	42FM-79 .....	\$186		
42FF-91 .....	\$195	42FM-82 .....	\$190		

# T BOARDROOM TABLES

## OASIS MINI NOTES

D x W x H

### DRAWING 1A - MINI OASIS A

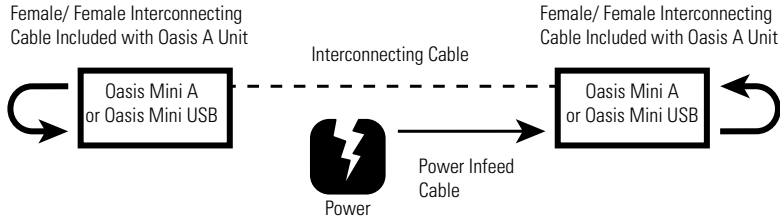

### DRAWING 1B - MINI OASIS B

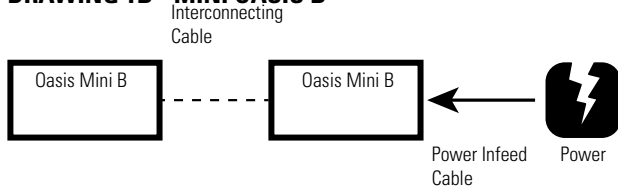

### DRAWING 2A - MINI OASIS A

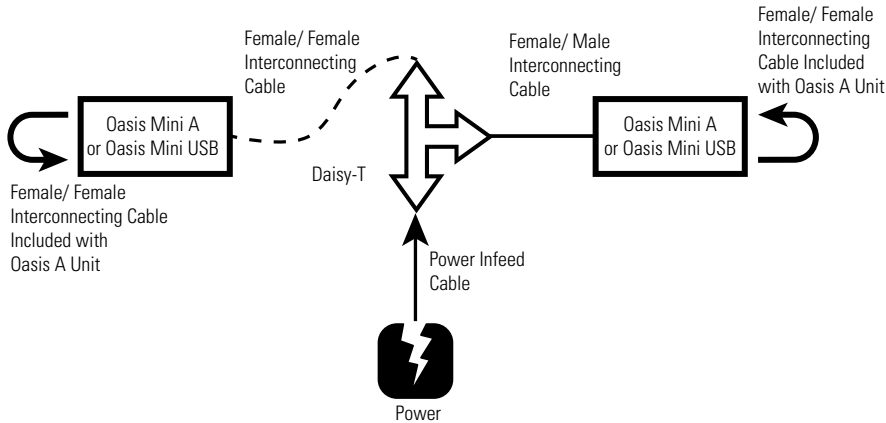

### DRAWING 2B - MINI OASIS B

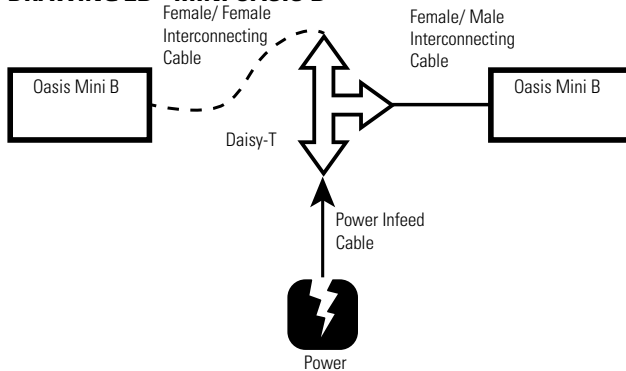

### DRAWING 3 - MINI OASIS A

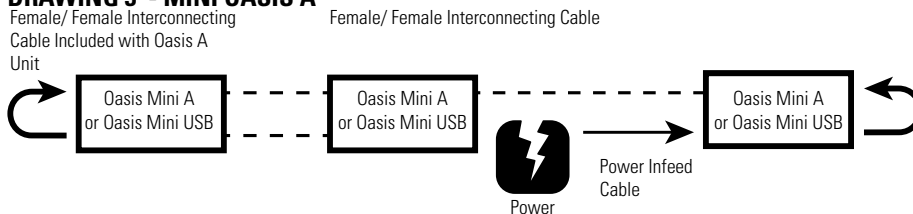

**OASIS MINI NOTES**

D x W x H

**DRAWING 4 - MINI OASIS A**

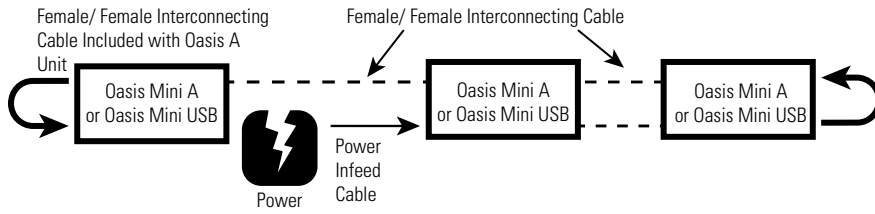

**DRAWING 5 - MINI OASIS B**

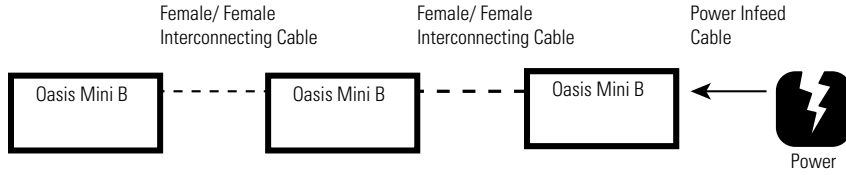



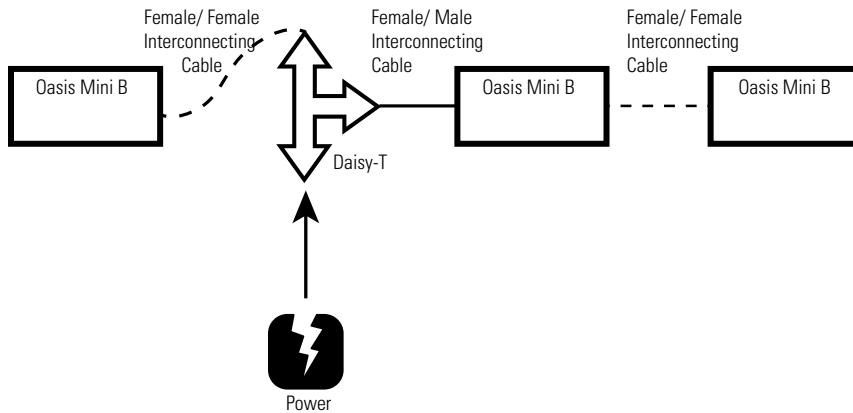







**DRAWING 6 - MINI OASIS B**

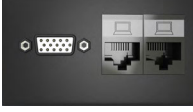

# T BOARDROOM TABLES

## TOP TELECOM PLATES

TOP TELECOM PLATE	MODEL	CONFIGURATION	D x W x H	LIST PRICE
	A-__-A-B	Telecom plate with RJ11 Cat 3 Phone and RJ45 Cat 6 Data		\$108
	A-__-B-B	(2) RJ45 Cat 6 Connectors		\$141
	A-__-B-B-B	(3) RJ45 Cat 6 Connectors		\$206
	A-__-B-B-B-B	(4) RJ45 Cat 6 Connectors		\$274
	A-__-B-C51-L	RJ45 Cat 6 Data, Mini-Stereo Inline and 15 pin HD VGA Female/Female with 72" patch cord attached.		\$244
	A-__-B-B-C51	(2) RJ45 Cat 6 Data and (1) 15 pin HD VGA Female/Female with 72" patch cord attached.		\$254
	A-__-A-B-102	RJ11 Cat 3 phone, RJ45 Cat 6 Data and USB with 72" patch cord attached.		\$244
	A-__-B	RJ45 Cat 6 Data		\$76
	A-__-C51-L	Mini Stereo Inline and 15 pin HD VGA Female/Female with 72" patch cord attached.		\$191
	A-__-CRDMINDER	Cordminder Plate - 2 5/8" holes and 1 7/8" holes		\$43
	A-__-C45-C51-L	HDMI Female/Female with 36" patch cord attached. Mini Stereo Inline and 15 Pin HD VGA Female/Female with 72" patch cord attached.		\$333

### Required Specifications

Finish  
Power infeed  
Cut-out location

TOP TELECOM PLATES		MODEL#	DIMENSIONS D x W x H	FREIGHT CLASS	WT/LBS.	CUBIC FT.	LIST PRICE
TOP TELECOM PLATE	MODEL	CONFIGURATION					LIST PRICE
	A-__-C45	HDMI Female/Female with 36" patch cord attached.					\$164
	A-__-A-B-B	(1) RJ11 Cat 3 Phone and (2) RJ45 Cat 6 data.					\$178
	A-__	Blank telecom plate					\$10
	A-__-102	USB with 72" patch cord attached.					\$76
	A-__-C51	15 pin HD VGA Female/Female with 72" patch cord attached.					\$123
<ul style="list-style-type: none"> <li>• Replace _ with <b>BL</b> for <b>Black</b></li> <li>• Replace _ with <b>GR</b> for <b>Grey</b></li> </ul>							

**Required Specifications**

Veneer Finish  
Laminate Finish  
Handle Style

**Optional Specifications**

Grommet



# T BOARDROOM TABLES

## POWER INFEEDS

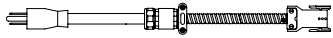

### Plug and Play Infeed

MODEL#	DIMENSIONS	FREIGHT CLASS	WT/LBS.	CUBIC FT.	LIST PRICE
--------	------------	---------------	---------	-----------	------------

D x W x H

42AP1-72	--	--	--	--	<b>\$245</b>
----------	----	----	----	----	--------------

Single Circuit 20 AMP Power Infeed with 72" 3-prong plug. Provides single power entry from floor or wall mounted standard power supply. Connects to Oasis Mini or Villa units that require a separate infeed. UL Listed.



### Multi-Circuit Hardwire Power Infeed

42SB2-108	--	--	--	--	<b>\$203</b>
42SB2-72	--	--	--	--	<b>\$158</b>
42SB2-36	--	--	--	--	<b>\$115</b>

Multi-Circuit Hardwire Infeed (up to 20 AMPS per circuit), two circuits. Provides single power entry from floor or wall located building power supply. Connects to Oasis Mini or Villa units that require a power infeed. **TO BE HARDWIRED BY A LICENSED ELECTRICIAN.** UL Listed.

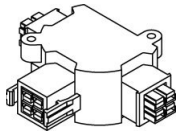

### 3 Way Power Splitter

DAISY-T	--	70	1	1	<b>\$187</b>
---------	----	----	---	---	--------------

Daisy-T power manager includes two male and one female connection. For use in splitting a power source two ways.

#### Required Specifications

Veneer Finish  
Laminate Finish  
Handle Style

#### Optional Specifications

Grommet

# textiles and finishes

## Care and Cleaning

### Textiles

**Fabrics:** To extend the life of your seating upholstered in fabric, regularly dust the chair to prevent airborne particles from penetrating the fabric surface.

For light soiling, use a damp cloth and blot the spot with very slight pressure, taking care never to soak the fabric. Dry with a clean cloth by blotting - never rub fabric. More intense stains can be treated the same way, but with a mild detergent. Always test fabric first in an unseen area before using any cleaning method.

**Leather:** For regular cleaning, simply use a soft damp cloth, taking care not to soak the leather. For more thorough treatment, soak a soft cloth in mild soap solution and wipe surface in a light circular motion. Repeat with clean water. Allow to dry and polish with a soft dry cloth. Do not use detergents, aerosol sprays or other polishes.

### Hard Surfaces

**Wood Veneer Finishes:** Waxing or polishing catalyzed finishes is not recommended because this will give a greasy, cloudy or uneven appearance to the product and could void your warranty. Global's conversion varnish is best cleaned by wiping the surface with a damp cloth, followed by a soft dry cloth in the direction of the grain. If the surfaces are heavily soiled, a gentle product like "Windex" can be used, following the same instructions as above.

**Laminate, painted & plated metal finishes, and solid surfaces:** Wipe the surface with a clean soft damp cloth; if needed, a mild soap solution can be used. To prevent streaks, dry the surface with a clean dry cloth moving in a circular motion.

- 
- **Water-Based Cleaner:** Spot clean, using the foam only from a water-based cleaning agent, such as a mild detergent or non-solvent upholstery shampoo product. Apply foam with a soft brush in a circular motion. Vacuum when dry. Pretest small area before proceeding.
  - **Solvent Cleaner:** Spot clean, using a mild water-free solvent or dry cleaning product. Clean only in a well-ventilated room and avoid any product containing carbon tetrachloride or other toxic materials. Pretest a small area before proceeding.
  - **Water/Solvent Cleaner:** Spot clean with a mild solvent, an upholstery shampoo, or the foam from a mild detergent. When using a solvent or dry cleaning product, follow instructions carefully and clean only in a well-ventilated room. Avoid any product that contains carbon tetrachloride or other toxic materials. With either method, pretest a small area before proceeding.
  - **Vacuum Only:** Clean this fabric only by vacuuming or light brushing to prevent accumulation of dust and grime. Water-based foam cleaning agents of any kind may cause excessive shrinking, staining, or distortion of the surface pile and therefore, should not be used.
  - **Crypton Cleaning:** Generally stains are removed with plain water and powdered enzyme detergent. Upholstery foam shampoo, water-based cleaning products and germicidal detergents can be used. Be sure to remove all residue from cleaning products with clean water. Do not use solvent-based cleaners or dry cleaning products.
  - These recommendations and codes were developed by fabric specialists. However, because of the various ways fabric can be stained or damaged, there is no guarantee that the results will be completely successful. Use suggested methods on your own responsibility. To help prevent overall soil, frequent vacuuming or light brushing to remove dust and grime is recommended. Use professional furniture cleaning service when overall soiled condition has been reached.

## Textile Price Grades - Global Textiles

Grade 1	Carrera, Dobby, Fusion, Illusion, Jenny, Quilt, Terrace, Trak, Urban, Waterfall, Wavelength
Grade 2	Allante FRee, Elevate, Etch, GC Linen, Imprint, Luxhide, Release
Grade 3	Non standard GLOBAL textiles
Grade 4	Non standard GLOBAL textiles
Grade 5	Non standard GLOBAL textiles
Grade 6	Novaro Genuine Leather, non standard GLOBAL textiles
Grade 7	Non standard GLOBAL textiles
Grade 8	Non standard GLOBAL textiles
Grade 9	Non standard GLOBAL textiles
Grade 11	Non standard GLOBAL textiles
Grade 10	Non standard GLOBAL textiles
Grade 12	Non standard GLOBAL textiles

Please refer to individual seating series for availability of a particular textile.

The charts above do not include Textiles offered by Alliance Partners: Arc-Com Fabrics, Architex, CF Stinson, Designtex, Knoll Textiles, Green Hides, LDI Interiors, Luum Textiles, Maharam, Mayer Fabrics, Momentum, and Ultrafabrics.

## Blend Seating Textiles

The grid below outlines the grade structure for using multiple textiles on select seating series. Blended textiles occur when one textile is chosen for one part of the chair and a different textile is selected for another part of the chair, resulting in a revised blended grade. For opportunities regarding more than two different textiles, please contact Global CustomerCare for approval process and grading.

		FIRST TEXTILE SELECTED																	
		1	2	3	4	5	6	7	8	9	10	11	12	13	14	15	16	17	18
SECOND TEXTILE SELECTED	1	1																	
	2	2	2																
	3	3	3	3															
	4	3	4	4	4														
	5	4	4	5	5	5													
	6	5	5	5	6	6	6												
	7	5	6	6	6	7	7	7											
	8	6	6	7	7	7	8	8	8										
	9	7	7	7	8	8	8	9	9	9									
	10	8	8	8	8	9	9	9	10	10	10								
	11	9	9	9	9	9	10	10	10	11	11	11							
	12	10	10	10	10	10	10	11	11	11	12	12	12						
	13	11	11	11	11	11	11	12	12	12	12	13	13	13					
	14	11	12	12	12	12	12	12	13	13	13	13	14	14	14				
	15	12	12	13	13	13	13	13	13	14	14	14	14	15	15	15			
	16	13	13	13	14	14	14	14	14	14	15	15	15	15	16	16	16		
	17	14	14	14	14	15	15	15	15	15	15	16	16	16	16	17	17	17	
	18	15	15	15	15	15	16	16	16	16	16	16	17	17	17	17	18	18	18

**TEXTILE AND COLOR LISTINGS**

**Grade 1**

**Carrera** 100% Polyester

CE84 Zest	CE85 Savannah	CE86 Slate	CE87 Rainforest	CE88 Aspen	CE89 Dune	CE90 Flannel
CE91 Azure	CE92 Chili	CE93 Jute	CE95 Ink	CE96 Sangria	CE97 Java	CE98 Charcoal

**Dobby** 96% Recycled Polyester / 4% Virgin Polyester

DB30 Snowcap	DB31 Bonsai	DB32 Cloud	DB33 Sand	DB34 Pewter	DB35 Santa Fe	DB36 Corfu
DB37 Medium Taupe	DB38 Charcoal	DB39 Berry	DB40 Royal	DB41 Titanium	DB42 Black	

**Fusion** 90% Virgin Polyester / 10% Post-Consumer Recycled Polyester

FU71 Tangerine	FU72 Fresh	FU73 Moss	FU74 Tomato	FU75 Aqua	FU76 Sandstone	FU77 Granite
FU78 Poppy	FU79 Cadet	FU80 Oasis	FU81 Graphite	FU82 Viola	FU83 Cobalt	FU84 Flax
FU85 Carbon						

**Illusion** 100% Virgin Polyester

II01 Cappuccino	II02 Paprika	II03 Tropic	II04 Wicker	II05 Hemp	II06 Cayenne	II07 Maui
II08 Dusk	II09 Smoke	II10 Currant	II11 Fiji	II12 Ozone	II13 Ebony	

**Jenny** 100% Polyester

JN01 Midnite	JN02 Ebony	JN03 Slate	JN07 Vermilion	JN08 Admiral	JN11 Charcoal	JN25 Silver Lining
JN26 Oatmeal	JN27 Sunflower	JN28 Cascade	JN29 Harvest	JN30 Melon	JN31 Berry	JN32 Green Grass
JN33 Roast						

**Quilt** 100% Polyester

QL10 Black	QL11 Charcoal Grey	QL14 Navy	QL16 Wine	QL19 Silver	QL20 Feather	QL21 Dune
QL22 Meadow	QL23 Cadet	QL24 Geranium	QL25 Daisy	QL26 Quest	QL27 Punch	QL28 Tangerine
QL29 Cocoa						

**Terrace** 70% Virgin Polyester / 30% Post-Consumer Recycled Polyester

TC61 Tigerlily	TC62 Shadow	TC63 Cobble	TC64 Cherry Blossom	TC65 Bluebell	TC66 Apple	TC67 Haze
TC68 Cerise	TC69 Twilight	TC70 Wintergreen	TC71 Ironwork	TC72 Pine Cone	TC73 Flirt	TC74 Echo
TC75 Glacier						

**Trak** 100% Recycled Polyester

TK40 Taupe	TK41 Mustard	TK42 Latte	TK43 Cement	TK44 Silver	TK45 Copper	TK46 Teal
TK47 Apple	TK48 Steel	TK49 Merlot	TK50 Midnight Sky	TK51 Mocha	TK52 Carbon	

**Urban** 62% Recycled Polyester / 32% Polyester

UR10 Red Rose	UR11 Ocean Blue	UR12 Blue Bayou	UR13 Green Grass	UR14 Sandcastle	UR15 Beach Day	UR16 Boardwalk
UR17 Earth	UR18 Brown Ridge	UR19 White Sand	UR20 Granite Rock	UR21 Gravel Road	UR22 Black Coal	

**Waterfall** 60% Virgin Polyester / 40% Post-Consumer Recycled Polyester

WA40 Trance	WA41 Tryst	WA42 Splash	WA43 Victoria	WA44 Imagine	WA45 Sky	WA46 Rainforest
WA47 Rumble	WA48 Prism	WA49 Tranquility	WA50 Grand	WA51 Rushing	WA52 Magestic	WA53 Pacific
WA54 Dance						

**Wavelength** 100% Virgin Polyester

WV01 Lime	WV02 Mint	WV03 Stone	WV04 Flame	WV05 Mykonos	WV06 Savannah	WV07 Mesa
WV08 Plasma	WV09 Cancun	WV10 Quartz	WV11 Moonrock	WV12 Rubine	WV13 Corfu	WV14 Bluejay
WV14 Panther						

**Grade 2**

**Elevate** 80% Post-Consumer Recycled Polyester / 20% Rayon

EL51 Halo	EL52 Dove	EL53 Safari	EL54 Sunglow	EL55 Margarita	EL56 Fiji	EL57 Mist
EL58 Blaze	EL59 Wasabi	EL60 Mystic	EL61 Mica	EL62 Cherry	EL63 Scuba	EL64 Lapis
EL65 Onyx						

**Etch** 80% Post-Consumer Recycled Polyester / 20% Rayon

ET81 Drift	ET82 Citron	ET83 Calypso	ET84 Mandarin	ET85 Crisp	ET86 Iris	ET87 Nickel
ET88 Paprika	ET89 Nutmeg	ET90 Marine	ET91 Magnet	ET92 Infrared	ET93 Espresso	ET94 Indigo
ET95 Anthracite						

**Imprint** 100% Post-Consumer Polyester

IM70 Almond	IM71 Cork	IM72 Sand	IM73 Currie	IM74 Candy Apple	IM75 Ocean	IM76 Navy
IM77 Green Tea	IM78 Celery	IM79 Oregon	IM80 Walnut	IM81 Paprika	IM82 Graphite	IM83 Slate
IM84 Licorice						

# T TEXTILES + FINISHES

**Grade 2 (Vinyl)** For availability of chair series in Vinyl, please contact a Global Sales Representative.

**Allante Free** 100% Vinyl Face / 100% Polyester Backing

A01F Illusion	A02F Bright White	A03F White Crush	A04F Ivory	A05F Ice	A06F Bleached Sand	A07F Taupe Fawn
A08F Warm Smoke	A09F Autumn Rain	A10F Cookie	A11F Sierra Brick	A12F Gibraltar	A13F Chateau Grey	A14F Garden Green
A15F Oasis Green	A16F Ink Black	A17F Purple Impulse	A18F Italian Rose	A19F Mountain Sky	A20F Old Navy	A21F Galaxy
A22F Red Truffle	A23F Chocolate Sundae	A24F Province Blue	A25F Eclipse			

**GC Linen** 100% Vinyl Face

LE50 Potters Clay	LE51 Pearl	LE52 Tan	LE53 Storm	LE54 Butter	LE55 Haystack	LE56 Ganache
LE57 Sunset	LE58 Burnt Orange	LE59 Cayenne	LE60 Navy	LE61 Bamboo	LE62 Gray	LE63 Charcoal
LE64 Moss						

**Luxhide** 100% Vinyl Face / Bonded Leather Backing

BL20 Black	BL22 Parchment	BL23 Saddle	BL24 Dark Brown	BL26 Burgundy	BL27 Charcoal	BL28 White
BL34 Light Grey						

**Release** 100% Vinyl Face

RL11 White	RL12 Chalk	RL13 Stone	RL14 Taupe	RL15 Orange	RL16 Country	RL17 Tuscan
RL18 Cottage	RL19 Yellow	RL21 Red Barn	RL22 Brave Red	RL23 Gypsy Red	RL24 Cajun	RL25 Vineyard
RL26 Olive	RL27 Bonsai	RL28 Summer's Dream	RL29 Calico	RL31 Green	RL32 Blue	RL33 Black
RL34 Cool Grey	RL35 Thunder Grey	RL36 Navy	RL37 Dark Chocolate	RL38 Espresso		

**Grade 6**

**Novaro Genuine Leather** 100% Leather

N050 Ash	N051 Asphalt	N052 Bison	N053 Blueberry	N054 Cloud	N055 Clove	N056 Cordovan
N057 Doe	N058 Linen	N059 Marina	N060 Phantom	N061 Pigeon	N062 Scarlet	N063 Turtle
N064 Wheat						

**PANEL/TACKBOARD FABRICS**

**GRADE 2**

**Lola** 100% Polyester.

LL11 Medium Taupe	LL12 Caramel Cream	LL14 Blue Mist	LL35 Spray	LL36 Granite	LL37 Cinder	LL38 Sandstone
-------------------	--------------------	----------------	------------	--------------	-------------	----------------

**GRADE 3**

**Anchorage** 65% Pre-consumer Polyester / 35% Post-consumer Polyester

AN40 Birch	AN41 Green Apple	AN42 Lapis	AN43 Straw	AN44 Wolf	AN45 Goose	AN46 Angora
AN47 Cumin	AN48 Asteroid	AN49 Geranium	AN50 Thistle	AN51 Graphite	AN52 Slate	AN53 Quarry Blue
AN54 Onyx	AN55 Pumpkin	AN56 Red Delicious	AN57 Sunshine	AN59 Waterfall	AN61 Vanilla	AN62 Cobalt
AN64 Cloud						

**Merge** 100% Polyester / 75% Post-consumer Recycled Polyester

MG20 Fawn	MG21 Marshmallow	MG22 Driftwood	MG23 Dove	MG24 Graphite	MG25 Slate	MG26 Eucalyptus
MG27 Fire Engine	MG28 Mediterranean	MG29 Midnight				

**FINISHES**

**Seating Finishes - Metal & Polymer:** *Please consult each Seating Series for finish availability.*

Black (BK)	Charcoal Grey (CHR)	Chrome (CHM)	Fog (FG)	Polished Aluminum (ALU)	Tungsten (TUN)
------------	---------------------	--------------	----------	-------------------------	----------------

**Seating Finishes - Plastic** (Duet, Popcorn, Sonic and Stream)

Buzz Blue (BZB)	Cactus (CCT)	Carrot (CRO)	Cloud (IVC)	Dijon (DJN)	Eggplant (EGP)	Fog (FOG)
Frost (FRO)	Ink (INK)	Latte (LAB)	Night (BLK)	Sand (SND)	Scarlet (SAR)	Shadow (SHW)

**Seating Finishes - Wood** Seating finishes will not necessarily match Casegoods finishes. This is due to the fact that Seating and Casegoods finishes use different wood species and are manufactured at multiple locations.

Absolute (AAM)	Black (BKM)	Cherry (ACM)	Espresso Cafe (ECM)	English Oak (EOM)	Fruitwood (TFM)	Gray (HGM)
Honey (AHM)	Mahogany (TMM)	Maple (AVM)	Medium Walnut (MWM)	Natural Walnut (NLW)	Night (ASM)	Noce Biondo (NBM)
Noce Grigio (NGM)	Noce Leggero (NEM)	Noce Medio (NMM)	Shaker Cherry (SKM)	Walnut (TWM)	WC Cream (WTM)	White (WHM)
Winter Cherry (WCM)						

**Desks, Workstations, Tables and Accessories - Laminate**

Absolute Acajou (ACJ)	Asian Night (ASN)	Avant Cherry (AWC)	Avant Honey (AWH)	Black (BLK)	Blizzard (BZD)	Brushed Cobalt (BRC)
Clear Maple (CMB)	Custom Grey (CGY)	Dark Espresso (DES)	Designer White (DWT)	Fashionista (FAS)	First Class (FCL)	Noce Biondo (NBL)
Noce Grigio (NGL)	Noce Leggero (NEL)	Noce Medio (NML)	Quartered Mahogany (QTM)	Sheer Beauty (SBY)	Stonedust (SDT)	Storm Grey (SOG)
Walnut Heights (WHE)	White Chocolate (WHC)	Winter Cherry (WCR)				

**Desks, Workstations, Tables and Accessories - Wood Veneer**

Almond Cherry (AMW)	Amber Cherry (ACW)	Biscotti (BTW)	Cocoa Walnut (CAW)	Coral (CRW)	Dark Cherry (DCW)	Dark Walnut (DWW)
Espresso Walnut (EWW)	Evening Oak (EVW)	Grey on Oak (GRW)	Hazelnut (HAW)	Java (JAW)	Latte Walnut (LTW)	Mahogany on Walnut (MHW)
Milestone (MTW)	Natural Maple (MPW)	Natural Walnut (NLW)	Red Cherry (RCW)	Umber Walnut (ULW)	Vintage Cherry (VNW)	Walnut (WLW)
Warm Cherry (WCW)	White Maple (WMM)					

**Metal Leg Finishes** *(check series for applicable finishes)*

Antique Copper (ACO)	Black (TBL)	Brushed Chrome (BCH)	Buzz Blue (TBZ)	Cactus (TCC)	Carrot (TCR)	Cloud (TIV)
Chrome (CHM)	Designer White (TDW)	Dijon (TDJ)	Eggplant (TEG)	Fog (TFO)	Frost (TFR)	Ink (TIN)
Kalua (TKA)	Latte (TLA)	Mocha (TMO)	Nevada (TNE)	Sand (TSN)	Satin Brass (SBR)	Scarlet (TSR)
Shadow (TSH)	Toast (TOA)	Tungsten (TTU)				

**Metal File + Storage Finishes**

Business Grey (BGR)	Black Coffee Textured (BKC)	Black (BLK)	Bone (BNE)	Blizzard Textured (BZD)	Charcoal (CHR)
Claret (CLT)	Dark Chocolate Textured (DCH)	Desert Putty (DPT)	Designer White (DWT)	Fog (FOG)	Grey (GRY)
Light Grey (LGR)	Ice (ICE)	Ivory (IVR)	Mocha Textured (MCH)	Metro (MET)	Moss (MOS)
Nevada (NEV)	Navy (NVY)	Oyster (OYS)	Stonedust Textured (SDT)	Storm Grey (SGR)	Silver (SIL)
Sky (SKY)	Stone (STN)	Taupe (TPE)	Tahiti Sand (TSA)	Tungsten (TUN)*	Willow (WIL)

\* 10% upcharge applies

# THIS FORM IS TO BE USED FOR NON-STANDARD CUT-OUT SIZES

Dufferin and Lufton tables up to 120" (Corby up to 84").

Model # \_\_\_\_\_ (please use one page for each model #)

Please check all that apply. Note: Base positions will vary based on style chosen. Outer cut-outs are approximately 18"-20" in from each end.

## CUT-OUT POSITION(S)

- Position 1 - near left base - use option code **CCUTL**
- Position 2 - center of table - use option code **CCUTC**
- Position 3 - near right base - use option code **CCUTR**
- Custom position(s) - indicate on diagram below w/dimensions to **center point** of cut-outs - use option code **CCUS**

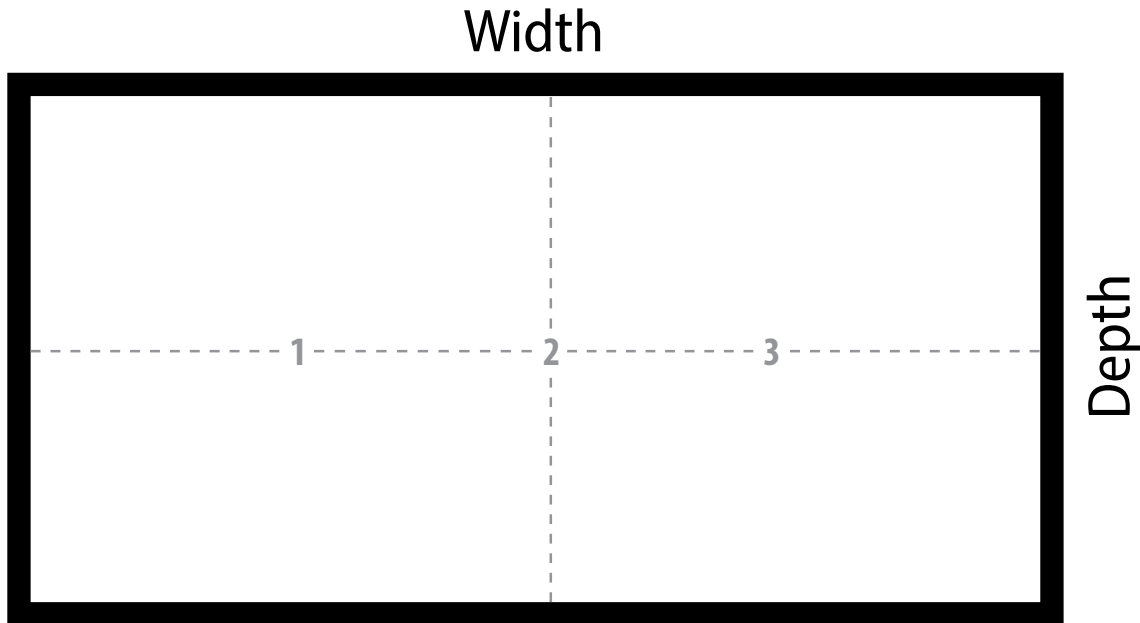

## CUT-OUT CRITERIA

All cut-outs require a minimum 8mm radius at each corner.

Cut-outs **must be centered** on the depth of each table due to wire management runners below the worksurface.

### Indicate cut-out size:

\_\_\_\_\_ " X dimension of cut-out runs the width of the table.

\_\_\_\_\_ " Y dimension of cut-out runs the depth of the table.

Y dimension not to exceed 14"

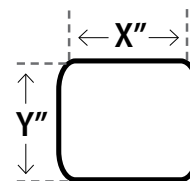

Dealer PO# \_\_\_\_\_

Internal use only

Global order# \_\_\_\_\_

Global trailer/load #: L \_\_\_\_\_ ID #: \_\_\_\_\_

# THIS FORM IS TO BE USED FOR NON-STANDARD CUT-OUT SIZES

Dufferin and Lufton tables 144" - 240".

Model # \_\_\_\_\_ (please use one page for each model #)

Please check all that apply. Note: Base positions will vary based on style chosen. Outer cutouts are approximately 18"-20" in from each end

## CUT-OUT POSITION(S)

- Position 1 - near left base - use option code **CCUTL**
- Position 2 - center of table - use option code **CCUTC**
- Position 3 - near right base - use option code **CCUTR**
- Custom position(s) - indicate on diagram below w/dimensions to **center point** of cut-outs - use option code **CCUS**

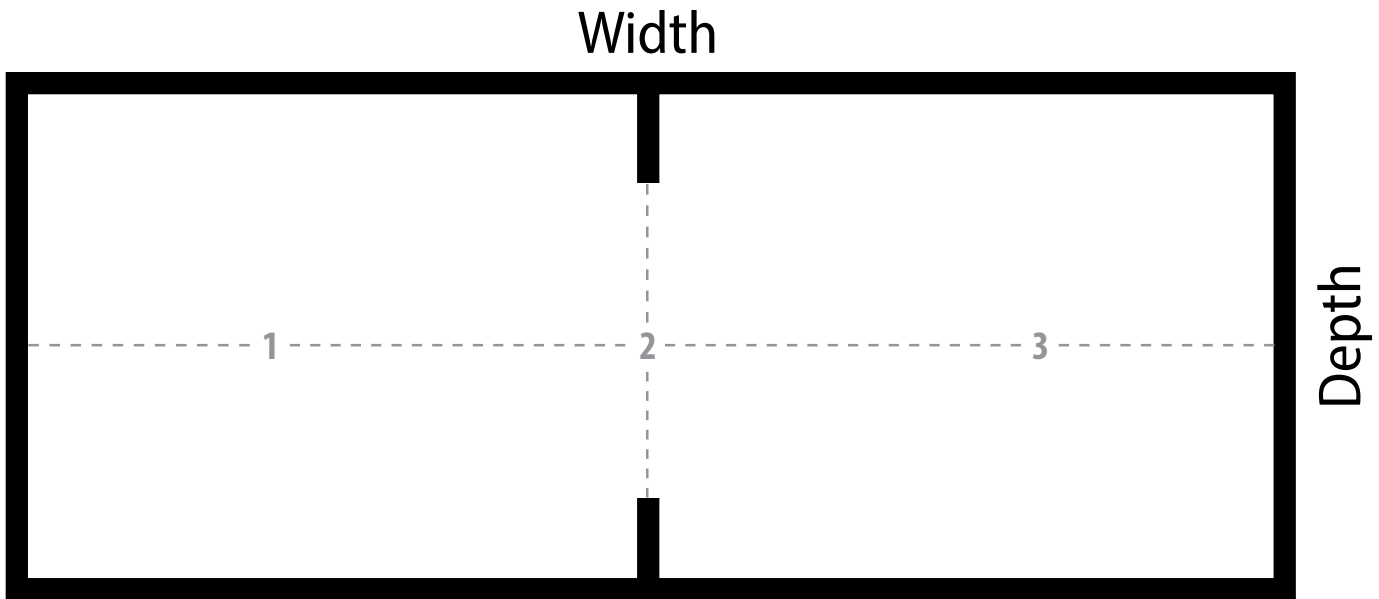

## CUT-OUT CRITERIA

All cut-outs require a minimum 8mm radius at each corner.

Cut-outs **must be centered** on the depth of each table due to wire management runners below the worksurface.

## Indicate cut-out size:

\_\_\_\_\_ " X dimension of cut-out runs the width of the table.

\_\_\_\_\_ " Y dimension of cut-out runs the depth of the table.  
Y dimension not to exceed 14"

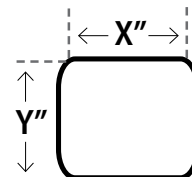

Dealer PO# \_\_\_\_\_

Internal use only

Global order# \_\_\_\_\_

Global trailer/load #: L \_\_\_\_\_ ID #: \_\_\_\_\_



# CUSTOM COLOR APPROVAL FORM - GLOBAL WOOD VENEER DESKS AND TABLES

## Corby, Dufferin, Kadin and Lufton series only

Dealer will be billed a matching fee of \$375 upon receipt of the match sample.  
All standard and special products with a custom stain receive a 15% upcharge.  
Please complete the form below and mail it, along with TWO samples (no smaller than 3" x 3") to:

Global Furniture Group  
ATTN: Casegoods - Custom Stain Match  
17 West Stow Road, PO Box 562  
Marlton, NJ 08053

### CONTACT INFORMATION

Date:	Project Name:		
A+D/Dealer/Company Name:	Contact Name:		
Billing Address:	Phone:		
City:	State:	Zip:	E-mail:

### CUSTOM STAIN INFORMATION

Manufacturer's Name:
Color Name:
Color Code:
Comments / Sample to be matched on (species):

**PLEASE FILL OUT THE SECTION BELOW ONCE SAMPLE HAS BEEN RECEIVED AND APPROVED. SUBMIT THIS PAPERWORK WITH THE ORDER.**

APPROVED:	YES	NO	DATE:
SIGNATURE			
PRINT NAME			
PO #			

### INTERNAL USE ONLY

Sample Received on:	VMID:
Special Finish Upcharge:	Color #:
Wood Species:	

## CARE AND MAINTENANCE GUIDE

**Wood Casegoods Care:** Global furniture is constructed to strict specifications to ensure years of satisfied use. As with all wood products, certain care requirements and periodic maintenance are necessary in order to maintain the original new appearance and function.

**Finishes:** Global veneers and solid woods are carefully selected for color, tone and grain. Since the distinctive characteristics and nature of wood cause variations, exact matches are not always possible. Wood veneer, being a natural material, will have shade differences between veneer leaves. This will be more apparent between flitches. Fading on wood veneers can be caused by exposure to UV rays / sunlight.

**Finish Protection:** All clear wood finishes are susceptible to scratches from rough and abrasive objects, such as staples, paper clips, ceramic coffee mugs, flower pots, picture frames, etc. Computer equipment with rubber feet can also cause discoloration and softening of the finish due to petroleum distillates in the rubber.

The most practical protection is the use of desk pads, paper management bins and coasters. Common sense, caution with rough items, and adding pressure sensitive felt to the feet or bottoms of any potentially destructive item will help to ensure a mar free surface.

**Finish Care:** Wax or polish should never be used on the finish; they will give a greasy, cloudy or uneven appearance to the product. Global's conversion varnish finish is best cleaned by wiping the surfaces with a damp cloth, followed by a soft dry cloth in the direction of the grain. If the surfaces are very dirty, use of a glass cleaning type of product is recommended. Touch-up of wood furniture should only be attempted by a qualified refinisher/touch-up technician. Contact your furniture dealer if this need should arise.

## GENERAL INSTALLATION AND HARDWARE

**Leveling wood office furniture properly is the most important procedure to ensure proper functioning and alignment of drawers, locks and doors.**

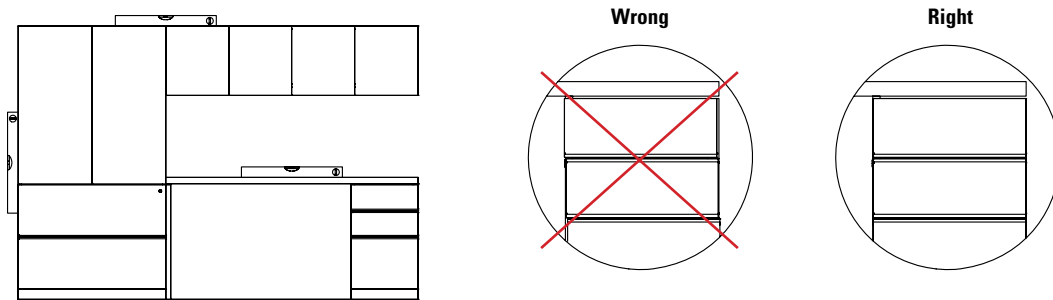

Hutch and wall cabinet doors may require field adjustment from time to time, due to shifting weight load factors inside the cabinet.

Modular furniture items, such as Desk Shells and Modular Pedestals **must be disassembled** prior to moving or relocating to avoid damage to the furniture.

Drawer suspensions are lubricated prior to shipment. Periodic lubrication may be applied to the ball bearing housing with a high quality lubricant found in most hardware stores.

**Hanging file rails:** Pre-installed on file drawer perimeters and accommodates both letter (front to back) and legal (side to side) size filing.

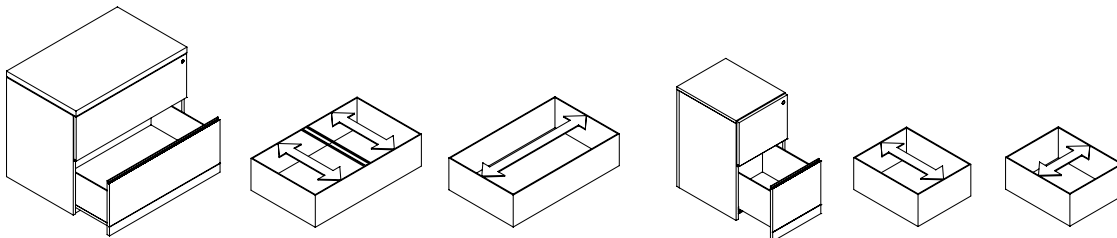

**ATTENTION: Always load the bottom drawer of Lateral Files and Freestanding Pedestals first!**

# TERMS & CONDITIONS

This illustrated price list has been designed to facilitate fast reference and easy use. Products are categorized into "seating", "desks", "files", "panels", or "tables", and are listed numerically within their categories. The line drawings match actual photographs (where possible) to aid in instant recognition of the total range within a series.

Sales of Global Furniture Group ("Global") products are made only on Global's standard Terms and Conditions of sale which are contained in this list price book. These standard terms and conditions may be modified or supplemented only by a separately written document signed by Global's authorized personnel at its head office in Marlton, NJ. Any term or condition contained in any purchase order or other form used by dealer/purchaser to order goods (including standard, printed language) which is different from, in addition to, or in any way inconsistent with Global's standard terms and conditions shall be of no force or effect whatsoever.

All illustrations, specifications and prices in this list price book are based on the latest product information available at time of publication. Global reserves the right to make changes at any time and without prior notice to prices, colors, materials, specifications and models offered.

## Description

Each product shown or described in this list price book is standard Global product. Available options are noted at the beginning of each series. Available options may require additional delivery time and cost, and may affect the warranty given. Sizes and weights shown are approximate and are subject to slight changes from time to time.

## Prices and Payment

The prices shown in this book, as well as those quoted by Global, are in United States dollars for orders shipped to destinations in the U.S. and Mexico.

If shipping date requested is more than 90 days from date of order, Global shall reserve right to use published list prices effective at the time of shipment.

Orders are invoiced at the time of shipment. Terms of payment are net 30 days from date of invoice (1% 15 days) unless otherwise stated. The Purchaser agrees that Global reserve the right to enforce a charge amounting to 1.5% per month (18% per year) on invoices outstanding more than 30 days.

If the Purchaser's most recent annual net volume is less than \$5,000.00, payment must be made in advance.

Any products sold by Global shall remain the personal property of Global until fully paid.

Prices are suggested list prices only and are subject to change without notice. Global will, however, attempt to keep dealer/purchasers up-to-date on all developments including price changes.

## Taxes

All prices shown in this book are exclusive of sales, use, excise and other applicable taxes and are the dealer/purchaser's responsibility as per the invoice issued by Global. If dealer/purchaser claims an exemption from such taxes, it shall be the dealer/purchaser's responsibility to furnish Global with an appropriate exemption certificate at time of order.

## Ordering Information

Global requires that all orders be submitted in writing and will be acknowledged on Global's acknowledgment forms governing the transaction.

The details appearing on this acknowledgment will describe the items to be shipped and the approximate shipping date. It is the Purchaser's responsibility to determine that the information in the acknowledgment is correct. In the event of an error, the Purchaser must notify their Global Customer Service representative immediately by telephone followed by written confirmation. Shipping dates are assigned to orders based on the items having the longest manufacturing lead time (unless instructed to partial ship).

At time of order, please provide the following information:

1. Account number (if possible)
2. PO number
3. "Bill to" and "Ship to" name and address
4. Complete model number and selected options including textiles/finishes
5. Special instructions and tag information
6. Shipping instructions, please indicate:
  - a. pick up
  - b. Global trailer program
  - c. common carrier, provide name of carrier, your account number
7. Special quote (SQ) # or MTM # (if applicable)
8. Customer's Own Material (COM), Global Purchased Material (GPM), Customer's Own Leather (COL), see below.
9. For specials and custom quoted product, please indicate the custom quote # on your PO. If changes are made to the quote a new quote must be issued prior to submitting the order. It is the Purchaser's responsibility to determine that the information on the quote is correct. Global will not be responsible for wrong product due to errors in the quote

The above points will be checked by Global for accuracy. Global will process orders using the codes provided by the Purchaser. Price discrepancy is the responsibility of the Purchaser. The Purchaser must notify Global prior to invoicing.

The Purchaser is responsible for providing correct information at time of order. If no option(s) are selected the system will default to standard feature(s). Orders with missing/incorrect information (finish, etc.) will be put on hold until all information is complete. Orders will be scheduled for manufacturing upon receipt of complete information.

## Changes and Cancellations

After the date of Global's acknowledgment of the Purchaser's order, the order may not be changed or canceled by the Purchaser without the written consent of Global. Special order items, C.O.M. and fabric-covered items already in production are not subject to change or cancellation under any circumstances. Textile-covered items are considered to be in production once the textile is scheduled for cutting. Other standard items already in production are subject to a minimum 35% cancellation charge.

## Errors and Omissions

All quotations, acknowledgements and invoices are subject to corrections for any errors and omissions.

## FINISHES

### Seating Finishes

Where painted frames are not a standard color, there is a one time charge of \$578.00 list price per-order for custom wood staining/color matching. Restrictions may apply. The customer must provide a 3" x 3" color chip/sample. Non-standard finishes must be approved by Global prior to acceptance of order.

## File Finishes

All non-standard finishes must be approved by Global prior to acceptance of order and may be subject to an upcharge.

Laminated Tops - Pricing for all non-standard finishes and sizes must be provided by Global Customer Service and may be subject to an upcharge.

## Desk Finishes

Because the distinctive characteristics and the nature of wood products cause variations, exact matches are not always possible.

Global has launched a finishes program between marketing companies within the Global Group to match products as best as possible when same finishes are specified.

## Customers Own Material (COM)

Use of COM must be approved by Global prior to acceptance of order. Please refer to back of the Seating List Price Book and fill out the Authorization Request Form. Photocopy and use this form as often as necessary. The customer must provide a 12" x 12" fabric sample and advise how the fabric is to be applied. **Textile yardage requirement will be advised by the factory, and additional yardage may be required if pattern requires matching.** Yardage shown in the List Price Book does not allow for pattern repeat/matching. Send to the address provided on shipping document upon approval from Global. If C.O.M. is difficult to apply or if product shall be modified, extra charges shall be made. Global reserves the right to cancel an order at any time if C.O.M. is inadequate for any reason. Customer's Own Material must be shipped freight and duties paid to our factory. Such shipment must be fully identified with purchaser's order number, RGA # provided by Global, and the item for which material is intended. Performance of C.O.M. when applied to product is the sole responsibility of the purchaser. Global's standard product warranty shall not apply to C.O.M. Use of C.O.M. will not reduce the published list price.

## Textile Grading

All products are priced according to their standard textile grade. Lower grade textiles may be available but at the same price as standard textile grade. See Textiles and Finishes section for graded textiles.

Combining two grades of textiles may result in a revised grade. Please refer to "Two Grades Combination Chart" in the Textiles and Finishes section. For more than two textiles a special quotation is required.

## Global Purchased Material, Customer Specified (GPM)

Global may purchase material specified by the customer. Use of GPM must be approved by Global prior to acceptance of order. If it is difficult to apply or if product is required to be modified, extra charges will apply. Global reserves the right to cancel an order at any time if GPM is inadequate for any reason. Performance of GPM when applied to product is the sole responsibility of the textile vendor. Global's standard warranty will not apply to GPM materials.

## Customer's Own Leather (COL)

Not all seating can be upholstered in leather. Please consult series notes for availability. COL price is the lowest published grade for the series (leather or fabric).

## Upholstery Coverings

Slight variations in color may occur between dye lots. Although Global attempts to minimize these variances, they do occur and must be accepted as normal and will not be considered defects.

## Leather is a Natural Product

Natural variations occur in the color, grain and texture of leather. As a result, a degree of variation should be expected. As leather is used it develops a patina. Its color changes slightly, it will get marked and it will stretch and pull, these are the hallmarks of genuine leather and are not considered defects.

## Yardage

Required yardage (ydg) is based on unmatched materials with widths of 54" for seating, 63" for panels. Yardage calculations are based on imperial measurements.

## Arms

A wide selection of arms are available for some series. See Arm Chart in the Seating price list for details.

## Delays

Global's order acknowledgement will state a shipping date which is Global's best estimate at the time the order is acknowledged. However, Global shall not incur any obligation or liability to Purchaser for failure to ship by specified date unless Global has agreed to an unequivocal shipping date in a separately signed written document executed by its authorized personnel at its head office. In addition, Global shall not be liable for any loss or damage resulting from any delay or failure in shipment or other failure to perform all or any part of the agreement between the parties with respect to the goods shown on the face of the order acknowledgement where such delay, failure, loss or damage is the proximate result of any act of any governmental authority or political subdivision thereof, revolution, riot, civil disorder or disturbance, delay or default in transportation, strike disputes among or between labor unions or other labor disputes, delay or inability in obtaining materials and facilities, fire, flood, act of God or any cause not within the reasonable control of the company, whether of the class of causes enumerated or otherwise.

## F.O.B.

F.O.B. point is Global's Factory, Downsview, Ontario, Canada, or any Global Regional Distribution Center.

## UPS Shipments

Seating products marked with a UPS symbol are packaged for UPS-able shipments.

## Handling

A \$25. net handling charge per shipment will be applied for non UPS-able orders of less than \$2000 list.

## Special Delivery Requirements

Global's delivered pricing provides for dock delivery during normal business hours (considered to be 8 am to 4 pm Monday through Friday) to customer/end user only. Additional delivery requirements such as inside delivery, lift gate, limited access sites, installations and weekend deliveries will incur an additional expense and will be the responsibility of the dealer.

## Service

Service requests are normally the responsibility of Global's authorized dealers. Where this cannot be accomplished on a local level, service problems should be referred to Global's Customer Service Department in the nearest distribution center.

## Returns

No returns of goods will be accepted without written consent and shipping instruction of Global. A minimum re-stocking charge of 35% is made on all authorized returns for credit or refund, provided goods are received by Global in the condition in which they left the factory. This may increase depending on the type of product. Global's Return Goods Authorization

(R.G.A.) numbers must appear prominently on all authorized returns. Global will not be responsible for freight costs. No credit will be given if goods cannot be reused as new. Special order items, non-stock items and C.O.M. products are in no event subject to return. All returns must be approved and authorized in writing by Global Customer Service. Global reserves the right to refuse delivery of any unauthorized returns.

## Claims

All goods are sold FOB plant or Global Distribution Center. Global is not responsible for damage which occurs in transit (or in storage). The carrier signs for all goods received in apparently good order. It is the Purchaser's responsibility to examine goods upon receipt and to file any claims with the carrier for losses or damage to the product occurring during transit, including concealed damage.

Any claims made against Global for apparent defects, errors or shortages must be made by the Purchaser, in writing, within 15 working days after any delivery. Failure by the dealer/purchaser to make any claim against Global within 15 days shall constitute acceptance of the goods and a waiver of any apparent defects, errors or shortages.

## Suspension

In the event that the dealer/purchaser defaults in the payment of any sum due to Global, or in the event the dealer/purchaser's financial condition becomes unsatisfactory to Global, Global shall have the right to defer or discontinue shipment of any goods until such time as the default is cured or the dealer/purchaser provides assurance of payment to Global.

## Copyright

All catalogs, photographs, drawings, price lists and other printed material are protected by copyright. All rights reserved.

## Trademarks

All trademarks are owned by Global Furniture Group other than OBUSFORME™ which is owned by OBUSFORME LTD. and are used under license. OBUSFORME® and the distinctive backrest design are registered trademarks of OBUSFORME LTD.

## Designs and Patents

Many of the products produced by Global are protected by design registrations, design patents and/or patents. Design and specifications are subject to change, discontinuance or additions without notice.

For a full listing of issued trademarks, please visit [globalfurnituregroup.com](http://globalfurnituregroup.com).

## Cubic Measure

The stated volume is an approximate cubic foot measure that may be used to calculate freight costs. The figure shown is the total shipping volume of a unit (e.g. if a part is sent in 2 cartons the volume indicated reflects both cartons together) and is subject to change without notice. It is most economical to purchase the specified number per carton.

## Combined Shipments

Global will make every effort to combine shipments and orders on written request. However, Global cannot be held responsible where such request is not complied with.

## Offer of Sale

Possession of this price list or any other literature shall not imply the company's willingness to sell to the holder and shall not be construed as a direct offer of sale.

*If a conflict arises between: (i) prices found in software support packages furnished to the customer by Global or by any other source on behalf of Global; and (ii) Global's current pricing found on Global's website, then the most current shall prevail.*

## Disclaimer

All dimensions are in inches. Prices shown are current manufacturer's suggested list prices at the time of printing. Updated pricing is available on Global's website. All applicable taxes are extra. Descriptions, specifications and prices are subject to change without notice. Errors and omissions are subject to correction.

## Testing Qualifications

Many Global products pass or exceed the most stringent industry testing standards.

## Flammability

The foam used in Global chairs meets the requirements of California TB117:2013. In addition to the foam, upholstery materials must also meet the California TB117 smolder resistant requirements. Please contact Customer Care to determine if a selected textile meets the California TB117 requirement.

## This list price book is effective as of January 1, 2023.

For periodic updates, please check the PDF at [globalfurnituregroup.com](http://globalfurnituregroup.com). Select Resources then Price Lists. From here you will have the option to select either the Seating, Desking + Tables or Metal Filing + Storage price list books. Global warrants that all commercial products are free from defects in material and workmanship, for the life of the product, to the original Purchaser.

# LIFETIME WARRANTY

Global will repair or replace, at Global's option, as the sole remedy for any defect covered by the warranty. The warranty applies to products manufactured after March 22, 2016.

Global makes no warranty that any of its products are suitable for any particular purpose and makes no other warranties, express or implied, other than those set out here. As codes and standards vary from one jurisdiction to another, references to compliance are solely for convenience and without any representation as to accuracy or suitability. Users must verify the suitability of such information or product for their specific application. In no event shall Global be liable in either tort or contract for any loss or direct, special, incidental, consequential, or exemplary damages. The warranty applies to single shift, standard commercial usage, defined as a standard eight (8) hour day, forty (40) hour week for users weighing up to 300 pounds.

## General Commercial Seating

Global's warranty for general commercial seating covers all chair components including pneumatic cylinders, bases, casters, glides, frames, arms, plastic seats, backs and other structural components.

Exceptions to the warranty for general commercial seating are as follows:

- Foam, textiles (as sampled on Global branded and textile program cards), mesh material and electrical devices, are warranted for five (5) Years
- Control mechanisms are warranted for twelve (12) Years
- Heavy duty seating and Indoor/Outdoor Furniture are not defined as General commercial seating (see below for warranty exceptions)

## Heavy Duty Seating

Global offers products designed for multiple shift applications (24 hours a day / 7 days a week) and larger individuals weighing up to 400, 500 and/or 600 pounds (depending on series and/or model). Global warrants these products for twelve (12) years to the original purchaser. All components (including control mechanisms, pneumatic cylinders, bases, casters, glides, frames, arms, plastic seats/backs, etc.) are covered for 24/7 applications under the warranty. The exceptions are foam, upholstery and textiles, which are covered for five (5) years. Fabric or upholstery material on these products must exceed 100,000 double rubs for the textile portion of the warranty to apply. Heavy Duty product series that apply under this warranty can be found in the Heavy Duty section of this list price book.

## Outdoor Furniture

Global offers products designed for use indoors or outdoors. Global warrants these products for three (3) years to the original purchaser. This warranty applies to single shift (eight (8) hour day, forty (40) hour week) for users weighing up to 275 pounds, unless noted otherwise. Outdoor furniture must be stored indoors during inclement or extreme weather such as extreme cold, extreme heat, or excessive wind.

Exceptions to the warranty for indoor/outdoor furniture is as follows:

- Only Global branded textiles and Alliance Partner carded textile program materials expressly identified for outdoor application are covered for three (3) years when used outdoors.

## Global's Warranty does not apply (for any product category) to the following:

- Products not purchased directly from authorized Global resellers
- Nominal or normal amount of wear and tear that can occur over time
- Failures which result from negligence, abuse, accident or misuse
- Failure to apply, install or maintain products according to Global's written instructions and warnings
- Modifications, attachments or repair methods not approved by Global
- Damage caused by a carrier in transit, or delivery/installation contractors
- The matching of colors, grains or textures (wood, leather, etc.) of natural materials
- Products exposed to extreme hot or cold temperatures or excessively dry or humid environments
- Colorfastness or the matching of color of textiles, dye lots of textile can vary
- Damage by markings or staining; damage by sharp objects or imprinting from instruments
- Damage to textiles or laminate and wood surfaces/edges from exposure to sunlight (including UV rays)
- Products used for rental purposes
- Purchased parts are warranted for one (1) year
- Failure to follow specific cleaning and disinfecting instructions posted on [globalfurnituregroup.com](http://globalfurnituregroup.com)

## Seating Warranty Summary

Seating Type	Components Warranty For Original Purchaser	Use Time For Warranty Coverage	Exceptions
General Commercial Seating	Lifetime	8 Hours/5 Days Per Week	Foam/Upholstery/Textiles/Mesh/Electrical Devices - 5 Years Control Mechanisms - 12 Years
Heavy Duty Seating	12 Years	24 Hours/7 Days Per Week	Foam/Upholstery/Textiles - 5 Years
Indoor/Outdoor Furniture	3 Years	8 Hours/5 Days Per Week	Outdoor Use Textiles – 3 Years

## Textiles

Global warrants Global branded textiles and Alliance Partner carded textile programs inclusive of fabrics, vinyls and leather products for five (5) years. Global does not warrant COM (Customer Own Materials) or graded-in materials (non-carded) and purchased by Global for a customer. For graded-in or COM products, please contact the textile supplier for performance information and warranty details. Please refer to our website at [globalfurnituregroup.com](http://globalfurnituregroup.com) for detailed information on cleaning and disinfecting procedures. Improper usage of disinfecting/cleaning products may void the warranty.

Global textiles and finishes are updated periodically to meet the demand and trends of the market. As a result, some textiles and finishes may be discontinued by Global or the manufacturer. In the event that a textile or finish is discontinued, Global will make every reasonable effort to provide an alternative product(s) of comparable function.

Global warrants that all commercial products are free from defects in material and workmanship, for the life of the product, to the original Purchaser.

Global will repair or replace, at Global's option, as the sole remedy for any defect covered by the warranty. The warranty applies to products manufactured after March 22, 2016.

Global makes no warranty that any of its products are suitable for any particular purpose and makes no other warranties, express or implied, other than those set out here. As codes and standards vary from one jurisdiction to another, references to compliance are solely for convenience and without any representation as to accuracy or suitability. Users must verify the suitability of such information or product for their specific application. In no event shall Global be liable in either tort or contract for any loss or direct, special, incidental, consequential, or exemplary damages.

## Files, Desks, Modular Furniture, Tables, Panels & Accessories

Global warrants all components of metal storage and filing, laminate and wood veneer desks, laminate and wood veneer tables, metal leg components and panels for the lifetime of the product to the original purchaser.

The warranty applies to single shift, standard commercial usage, defined as a standard eight (8) hour day, forty (40) hour week. Load restrictions apply, refer to individual product descriptions.

Exceptions to the warranty for files/desks/tables and panels are as follows:

- Electrical devices, panel and tackboard textiles, adjustable keyboard mechanisms, non-electrical table mechanisms, monitor arms, lecterns, coat trees and task lights - five (5) years
- Laminate folding tables - one (1) year
- Motorized electrical components - two (2) years
- Keyless lock options - two (2) years

## Files, Desks, Modular Furniture, Tables, Panels & Accessories Warranty Summary

Product Type	Components Warranty For Original Purchaser	Exceptions
Metal storage and filing	Lifetime	keyless lock options - 2 years
Laminate/wood veneer desks and modular furniture	Lifetime	tackboard textiles, electrical devices, task lights - 5 years
Boardroom, conference and training tables	Lifetime	electrical devices - 5 years moving parts - 5 years
Panels	Lifetime	panel textiles, electrical devices, task lights - 5 years
Coat racks and lecterns	5 years	none
Folding tables (laminate & molded)	1 year	none
Height adjustable tables	5 years	motorized parts (on electrical tables) - 2 years

## Global's Warranty does not apply (for any product category) to the following:

- Nominal or normal amount of wear and tear that can occur over time
- Failures which result from negligence, abuse, accident or misuse
- Failure to apply, install or maintain products according to Global's written instructions and warnings
- Modifications, attachments or repair methods not approved by Global
- Damage caused by a carrier in transit, or delivery/installation contractors
- The matching of colors, grains or textures (wood, leather, etc.) of natural materials
- Products exposed to extreme hot or cold temperatures or excessively dry or humid environments
- Colorfastness or the matching of color of textiles, dye lots of textile can vary
- Damage by markings or staining; damage by sharp objects or imprinting from instruments
- Damage to textiles or laminate and wood surfaces/edges from exposure to sunlight (including UV rays)
- Products used for rental purposes
- Purchased parts are warranted for one (1) year
- Failure to follow specific cleaning and disinfecting instructions posted on [globalfurnituregroup.com](http://globalfurnituregroup.com)

Global's warranty does not cover the costs of transportation or labor. Repair or replacement will be at Global's option.

Global makes no warranty that any of its products are suitable for any particular purpose and makes no other warranties, express or implied, other than those set out here. As codes and standards vary from one jurisdiction to another, references to compliance are solely for convenience and without any representation as to accuracy or suitability. Users must verify the suitability of such information or product for their specific application. In no event shall Global be liable in either tort or contract for any loss or direct, special, incidental, consequential, or exemplary damages.

Global's warranty applies to products sold within the United States of America, Mexico, the Commonwealth of Puerto Rico and Canada.

## Textiles and Finishes

Global textiles and finishes are updated periodically to meet the demand and trends of the market. As a result, some textiles and finishes may be discontinued by Global or the manufacturer. In the event that a textile or finish is discontinued, Global will make every reasonable effort to provide an alternative product(s) of comparable function.

## Global US Headquarters/Distribution Center

17 West Stow Road, P.O. Box 562  
Marlton, New Jersey U.S.A. 08053  
T (856) 596-3390  
T (800) 220-1900

---

### Showrooms

#### Atlanta

10 10th Street  
Suite 150  
Atlanta, GA 30309  
T (404) 879-0998

#### Boston

One Harbor Street  
Suite 104  
Boston, MA 02210  
T (617) 406-5435

#### Chicago

222 Merchandise  
Mart Plaza  
10th Floor, Suite 1035  
Chicago, IL 60654  
T (312) 755-0843

#### Miami

112 NE 41st Street  
6th floor  
Miami, FL 33137

#### New York City

386 Park Avenue South  
7th floor  
New York, NY 10016  
T (212) 545-9900

#### Philadelphia

1735 Market Street  
38th Floor  
Philadelphia PA, 19103  
T (215) 861-0963

#### New Jersey (Southern)

119 West Greentree Road  
Marlton, NJ 08053  
T (856) 596-3390

#### Phoenix

4675 E Cotton Center Blvd.  
Suite 165  
Phoenix, AZ 85040  
T (602) 426-0666  
T (602) 426-0777

#### Washington, DC

1130 Connecticut Avenue  
10th Floor, Suite 1000  
Washington, DC 20036  
T (202) 659-0230  
T (202) 659-0236

### Distribution Centers

#### Atlanta Area

6715 Maple Ave.  
Suite 100  
Buford, GA 30518  
T (678) 602-4130

#### Baltimore Area

Troy Hill  
Corporate Center  
7030 Troy Hill Drive  
Elkridge, MD 21075  
T (410) 379-8021

#### Chicago Area

27W501 North Ave.  
Suite 300  
West Chicago, IL 60185  
T (630) 681-2818

#### Cincinnati Area

8712 LeSaint Drive  
Fairfield, OH 45014  
T (513) 777-0009

#### Dallas Area

2025 West Beltline Road  
#100  
Carrollton, TX 75006  
T (972) 236-1366

#### Denver Area

16401 East 33rd Drive  
Suite 50  
Aurora, CO 80011  
T (303) 340-1617

#### Ft. Lauderdale Area

560 Sawgrass  
Corporate Pkwy  
Sunrise, FL 33325  
T (954) 846-8888

#### Houston Area

7865 Northcourt Road  
Suite 200  
Houston, TX 77040  
T (713) 695-5777

#### Los Angeles Area

3629 Workman Mill Road  
Whittier, CA 90601  
T (562) 484-9686

#### Seattle Area

Oakesdale Commerce Ctr.  
820 Southwest 34th Street  
Building W7, Suite A  
Renton, WA 98057  
T (425) 291-9282

#### Kansas City Area

11617 West 81st Street  
Lenexa, KS 66214  
T (913) 310-9963

#### Tampa Area

10351 Windhorst Road  
Tampa, FL 33619  
T (813) 621-6272



globalfurnituregroup.com

