

**Wood Veneer**

Effective July 14, 2025 – USA

Revised April 1, 2026



PRICE LIST  
**wood veneer**



# think global

## THE GLOBAL EDGE

### ERGONOMICS IN THE TOTAL OFFICE

- One stop shopping for a full range of office furniture.
- Seating, desks, tables, files, modular furniture, panels and accessories.
- Ergonomics, competitive pricing and built-in value.

### STRENGTH AND STABILITY

- Established in 1966.
- One of North America's largest office furniture manufacturers.
- Manufacturing and showrooms worldwide.

### QUICK SHIP - INSTOCK

- Hundreds of products in stock for immediate delivery.

### STRONG LOCAL REPRESENTATION

- Service and expert advice where you are, when you need it!

### MANUFACTURING CAPABILITY

- Vertical integration ensures "start to finish" control.
- Ongoing research and investment in new, innovative production technology.

### QUALITY ASSURANCE

- Quality Assurance Program is qualified by C.G.S.B. ISO9001 standards.
- On-site furniture testing facility.
- Product and components are tested to ANSI/BIFMA standards.

### ENVIRONMENTAL COMMITMENT

- Continuous development of "earth friendly" programs.
- One of the first molded foam manufacturers to create ozone-friendly, CFC and HFC-free process.
- Seat and back pans are made from recyclable plastics and wood waste, enabling little waste and cost effective products.

## SYMBOL IDENTIFICATION



Global's Certified Products are in compliance with the stringent emission guidelines set by the GREENGUARD Environmental Institute and include all Upholstered Seating. To obtain a GREENGUARD Certificate for any product, please go to the product page on our website [www.globaltotaloffice.com](http://www.globaltotaloffice.com) and click on "View GREENGUARD Certificate".



level™ certification, based on the ANSI/BIFMA e3-2012 furniture sustainability standard, sets furniture manufacturers on a path toward greater sustainability over time. Based on environmental and social criteria set forth in the standard, a product's entire supply chain is assessed.



Certification assessment includes an evaluation of specific corporate policies and guidelines and an assessment of associated company manufacturing facilities. Products must meet quantifiable milestones of environmental and social performance at every step of development.

The quantitative assessment addresses four categories: material use, energy and atmosphere impacts, human and ecosystem health and social responsibility.

Manufacturers earn points in each of the four categories. The level™ brand and its numeric rating of 1, 2 or 3 indicate what threshold of certification a product has achieved. level™ 3 is the highest rating.

## TABLE OF CONTENTS

### WOOD VENEER DESKS

Corby.....	4
Dufferin.....	62
Foundations.....	146
Kingston.....	208
Lufton.....	272
Philadelphia.....	334

### WOOD VENEER TABLES

Boardroom Tables.....	382
-----------------------	-----

### REFERENCE

Care and Maintenance Guide.....	435
Custom Grommet Location Forms.....	432
Terms + Conditions.....	436
Textiles + Finishes.....	428
Warranty.....	438

# WOOD VENEER DESK NOTES

The following applies to all VENEER Series - Corby, Dufferin, Foundations, Kingston, Lufton and Philadelphia (unless otherwise noted).

## CONSTRUCTION:

- "Number one select, architectural grade A" oak, American black walnut, American black cherry, and hard maple. Wood worksurface moulded edges are solid oak, walnut, cherry, or maple (except where square self-edges exist, i.e. credenza and computer worksurface back edges that are most commonly against walls).

## FINISH:

- Conversion varnish (similar to catalyzed lacquer, but tougher), 25 degree sheen. Finishes are not buffed or rubbed.
- All Global wood casegood products are veneered and finished on the back sides (360 degree finishing), except modular under-surface storage - tops and backs are unfinished.
- Touch up kits available, includes a touch up marker and fill crayon. Order **VTOUCHUPKIT, \$164** list. Specify finish when ordering.

## PEDESTALS:

- Pedestals are fully assembled units. Undersurface storage units provide standard locks.
- All drawers are standard as vinyl-wrapped black embossed with V-groove construction.
- Drawers are "5-sided". The drawer front is an applied element to a four-sided drawer. Drawer fronts can be removed or replaced in the field.
- Pedestal drawers and lateral file drawers are supported by steel ball bearing suspensions. All suspensions carry a full lifetime warranty against defects.
- All drawers have full extension.

## HARDWARE:

- All necessary hardware items for attaching furniture items are included in the shipment. Actual wall attachment fasteners for wall cabinets, tackboards and visualboards are not included due to variation between site conditions.
- **Leveling glides** are shipped installed on the unit. Levelers have a 1" range of adjustment.
- **Hanging file rails** are pre-installed on file drawer perimeters with additional front-to-back rails found in the bottom of the filing drawers. These rails hang onto plastic clips and do not require any tools to install. Legal filing can be achieved either as side-to-side or front-to-back. Letter filing can be achieved as front-to-back filing only.
- **Flat plates** for attaching bridge and return to desk are shipped pre-attached to the bottom of the bridge or return. **Mini flat plates** for securing bridge modesty panels to desk or credenza end panels, and **quick connectors** for securing modular corner units to adjacent pieces (Dufferin Series) are shipped along with screws in a plastic bag attached to the bottom of the bridge or return. CAUTION: using screws other than those supplied by Global could result in damage to finished tops.

## INSTALLATION:

**Wall-mounted cabinets and visual boards** are pre-attached with horizontal wall rails to the back of each unit. The wall-side components need to be detached from the unit and fastened to the wall accordingly. Wall fasteners are not included due to variation between site conditions. Securing the wall rail to a vertical structural member is the required manner of installation. The cabinet or visualboard is then lowered on to the wall rail. It is important to level the wall rail before installation. Wall cabinets are equipped with levelers at the bottoms of the side panels for proper cabinet alignment. It is recommended to use a single drywall screw through the back of the cabinet and the wall-mounted rail, to further secure the wall attachment.

**Wall-mounted tackboards** have vertical grooves in the back for tasklight wiring. Horizontal wall rails are provided. Fasteners are not included due to variation between site conditions. The site installer need to position the wall rail and determine the type of screw to be used for the application. The tackboard is hung on the wall rail. Using a level will also aid in the tackboard installation.

**Hutches** are installed with double-faced tape applied on the bottom of the end panels. Global utilizes a non-marring method of hutch attachment. The tape is shipped in a plastic bag found in the hutch. Removal of the hutch requires moderate pressure to be applied on the top of the unit towards the wall for at least a minute for the pressure-sensitive tape to release. At the dealer or installer's discretion, additional support may be added by installing flat plates along the back of the attached units. These flat plates are not included in the shipment.

**Hutch tackboards** are factory installed.

**Modular storage units** have pre-drilled holes through the tops for securing to the bottom of the worksurfaces. Disassemble the modular unit first before relocating the entire unit to avoid damage or body injuries.

**5-Sided corner tables** and adjoining bridge and credenza run-offs are attached with MP-53 mending plates. Accurate leveling is critical for these units to align and connect properly.

**NOTE: Leveling wood office furniture properly is the most important procedure to ensure proper functioning and alignment of drawers, locks and doors. Upon completing installation, wipe furniture with a damp cloth, followed with a dry soft cloth - always in the direction of the grain.**

# corby



global



Introducing the Corby Collection of wood veneer and laminate desks, tables and storage elements. Christopher Wright has reflected on the mid-century modern vernacular to design a unique series of workplace furnishings that reward a new generation of pioneers and nation builders.

Corby is suited for any office environment, private office, boardrooms, open desking and collaborative areas. Its timeless design is expressed in subtle details - flared legs that elevate storage off the floor, tapered aprons on the bottom of storage pieces which reflect the knife edge detail of the worksurface. Standard height and counter height tables combined with tiered storage pieces offer a reprieve from formal boardrooms and deliver a more casual style for meeting areas.

Corby is a fresh take on desking, blending the warmth and comfort of residential-style furniture with the features and long lasting quality you'd expect from Global.

**Features and Benefits**

- Tapered solid wood legs in two heights
- Modesty panel in two heights
- Drawers are standard vinyl-wrapped construction with black drawer sides and bottom.
- 75 lb box - 150 lb. file drawer weight capacity with full height sides with pencil tray included in box drawer
- Lateral file drawers can accommodate legal or letter documents
- Premium full extension progressive ball bearing slides on file drawers
- Box drawers mounted on 3/4 extension premium ball bearing slides.
- Power / data accessories are available to be factory installed
- Designed by Christopher Wright



Overlapping worksurface with knife edge



Pedestal with optional cushion (shown with low base)



Rectangular grommet in tungsten

**GENERAL INFORMATION**

- Corby detailing is new century modern with a knife edge on table tops.
- Solid walnut, cherry, oak and maple edging on 1-3/8" tops (veneer).
- 3mm matching PVC edge on laminate surfaces.
- Tapered, solid wood legs are used to support the peninsula, work, collaboration and occasional tables.
- Pedestal, credenza and bookcase bottoms include 1 3/8" thick painted, beveled profile and tapered solid wood legs (4"H or 11 1/2"H).
- Productivity Solutions by Global offers multiple desktop power options that can be retrofitted into grommets, or clamp mounting on the edge of worksurfaces. Under mount options provide a clean way to power accessories in storage cabinets.
- For environmental certifications, please visit [globalfurnituregroup.com](http://globalfurnituregroup.com).

**WORKSURFACES**

- Standard with 1 3/8" top thickness
- Veneer surfaces constructed from grade "A" veneers
- When laminate is specified, all surfaces constructed using high pressure laminate.
- Peninsula tables, freestanding work tables, collaboration tables and coffee tables feature a contemporary 2" overhang knife edge on all sides. All other surfaces feature a self-edge veneer.

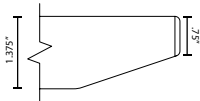
**CONSTRUCTION**

- "Number one select, architectural grade A" oak, American black walnut, American black cherry, and hard maple. Wood worksurface moulded edges are solid oak, walnut, cherry or maple (except where square self-edges exist, i.e. credenza and computer worksurface back edges that are most commonly against walls).
- Stack-on unit back panels are a solid thermally fused laminate color.
- When veneer is specified, tapered, solid wood legs (walnut, cherry, oak and maple) are used to support the Peninsula, Work, Collaboration and Occasional Tables.
- When laminate is specified, tapered, solid poplar legs are used to support the Peninsula, Work, Collaboration and Occasional Tables.
- Pedestal, Credenza and Bookcase bottoms include 1 3/8" thick painted, beveled profile and tapered solid wood legs.

**FINISHES**

- Conversion varnish (similar to catalyzed lacquer, but tougher), 25 degree sheen. Finishes are not buffed or rubbed.
- Global Corby Wood Veneer Desking products are veneered and finished on the back sides (360° finishing)
- Touch up kits available, includes a touch up marker and fill crayon. Order **VTOUCHUPKIT, \$175** list. Specify finish when ordering.
- Global standard finish, on oak and walnut, is open pore and on cherry and maple is semi-closed pore. If a full finish is required for walnut, cherry, anigre and maple tops, Add the suffix "2" to the finish code and Add 5% to the base pricing for each product.

**CUSTOM FINISH IS AVAILABLE.****PEDESTALS, STORAGE CABINETS, CREDENZAS AND BOOKCASES**

- All units are elevated 4" (xxLB = Low Base), or 11.5" (xxHB = High Base) off the floor by tapered, solid wood legs.

**HANDLES**

- All box and lateral drawers have one vertical handle PL89 (chrome finish) installed. Doors are equipped with touch latch mechanism with no handles.
- Handles can be purchased separately and installed in the field - no template is provided.

**STACK-ON BOOKCASES AND STORAGE CABINETS**

- Stack-on units are designed to be placed and installed on top of the credenzas with low and high base

**LOCKS**

- Front locking is standard on the Pedestals with box/file and file drawers, credenzas with box/lateral and lateral drawers. Box/box drawer units are non-locking. Optional locking on doors is available. Specify **LO, add \$429**.

**DRAWER SUSPENSIONS**

- Pedestal drawer suspensions are metal ball-bearing type. Both box and file drawers are full extension.

**HANGING FILE RAILS**

- Pre-installed on file drawer perimeters. The back rail in a lateral file drawer is designed for both legal and letter size filing. Legal filing can be achieved either as side-to-side or front-to-back. Letter filing can be achieved as front-to-back filing only.

**DRAWER CONSTRUCTION**

- Drawers are standard vinyl-wrapped construction with black drawer sides and bottom

**DRAWER FRONTS**

- The drawer front is an applied element to a four sided drawer. Drawer fronts are veneered on all surfaces. Drawer fronts can be removed or replaced in the field.

**LEVELING GLIDES**

- Levelers have a 1" range of adjustment

**HARDWARE**

- All necessary hardware for attaching furniture is included in the shipment

## 1. SPECIFY MODEL NUMBER

## 2. SPECIFY FINISH

### VENEER FINISHES - Top, Chassis, Doors and Fronts:

Code	Finish	Veneer Type	Cut
AMW	Almond Cherry	Cherry	Flat Sliced
ACW	Amber Cherry	Cherry	Flat Sliced
BTW	Biscotti	White Oak	Rift
CAW	Cocoa Walnut	Walnut	Flat Sliced
CRW	Coral	White Oak	Rift
DCW	Dark Cherry	Cherry	Flat Sliced
DWW	Dark Walnut	Walnut	Flat Sliced
EWV	Espresso Walnut	Walnut	Flat Sliced
EWL	Evening Oak	White Oak	Rift
GRW	Grey on Oak	White Oak	Rift
HAW	Hazelnut	Maple	Flat Sliced
JAW	Java	White Oak	Rift
LTW	Latte Walnut	Walnut	Flat Sliced
MHW	Mahogany on Walnut	Walnut	Flat Sliced
MTW	Milestone	White Oak	Rift
MPW	Natural Maple	Maple	Flat Sliced
NLW	Natural Walnut	Walnut	Flat Sliced
RCW	Red Cherry	Cherry	Flat Sliced
VNW	Vintage Cherry	Cherry	Flat Sliced
ULW	Umber Walnut	Walnut	Flat Sliced
WLW	Walnut	Walnut	Flat Sliced
WCW	Warm Cherry	Cherry	Flat Sliced
WMW	White Maple	Maple	Flat Sliced

### LAMINATE FINISHES - Top, Chassis, Doors and Fronts:

ACJ	Absolute Acajou	NBL	Noce Biondo
ASN	Asian Night	NGL	Noce Grigio
BLK	Black	NEL	Noce Leggero
BZD	Blizzard	NML	Noce Medio
CMB	Clear Maple	SBY	Sheer Beauty
CGY	Custom Grey	SDT	Stonedust
DES	Dark Espresso	SOG	Storm Grey
DWT	Designer White	WHE	Walnut Heights
FAS	Fashionista	WCR	Winter Cherry
FCL	First Class		

### LAMINATE FINISHES - Back Panel\*, Painted Legs and Base\*\*:

BLK	Black	BZD	Blizzard
CGY	Custom Grey	DWT	Designer White
SOG	Storm Grey	MSM	Moss
SDT	Stonedust	SEM	Sienna
SPM	Spice	SRM	Surf

\*Back panel only when unit is specified in veneer.

\*\*Back panel, painted legs + base when unit is specified in laminate.

## 3. SPECIFY OPTIONS

### Grommets

- Standard grommet on all components is GM5C. Grommet is included with products where shown in line drawings in price book.
- Optional grommets may be ordered along the centerline of Peninsula, Work and Collaboration tables. Order as GM5CTL, GM5CTC, GM5CTR. **Add \$103.**
- Grommet hole dimensions are 3.4" x 1.85". GM5C metal chrome grommet is available exclusively on Corby. Order as G5CTL, G5CTC, G5CTR. **Add \$103.**
- Components that come standard with grommet may be ordered without a grommet. Order as **RSG - Add \$57.**

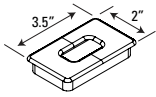

### Cushions

- Cushions are standard in Global Grade 2 seating textiles. Please refer to the website for the current offering at [globalfurnituregroup.com](http://globalfurnituregroup.com).

### Wood Back Panel

- For units that come with a laminate back panel (all stack-on and freestanding bookcases), an option is available for veneer back panel. Specify **WBP. Add \$732.**

### Custom Cut-out

- Optional custom sized cut-out available in standard locations - **CCUTL** (left), **CCUTC** (center) and **CCUTR** (right) for all CBYRTxxxx and CBYRTCxxxx tables. Submit appropriate form (beginning on page 432) with order. **Add \$320** for each cut-out.

**CUT-OUTS FOR GROMMETS**

**OPTIONAL GM5C GROMMET SPECIFICATION**



Work and Collaboration Table  
From 32" to 42" deep tops

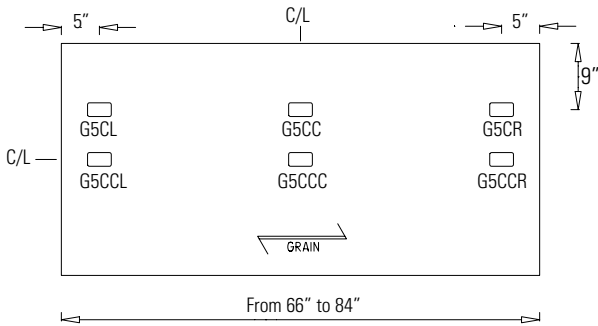

Peninsula Table  
For 32" deep tops

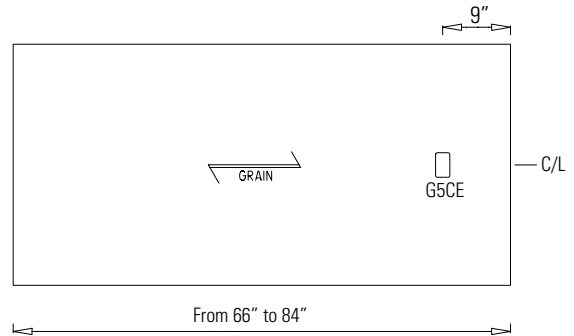

Executive Returns

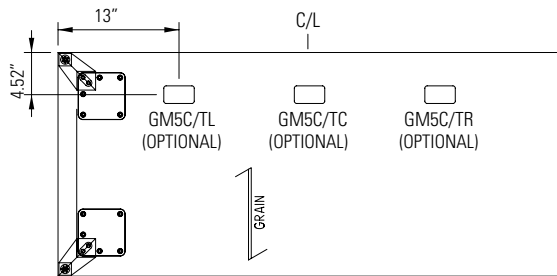

Executive Bridges

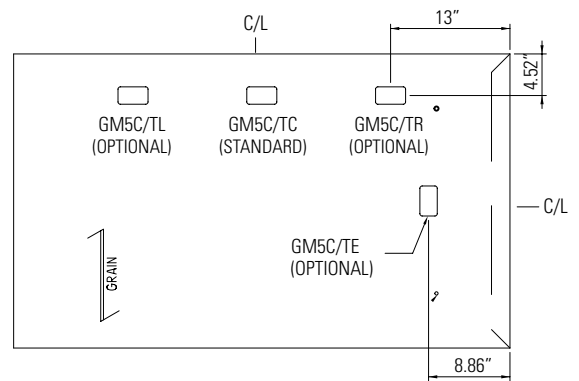

**CUT-OUTS FOR POWER BLOCKS**

Power Blocks sold separately, see page 57.

**PRTMCS401 / PRTMCS421**



**PRTMCD602 / PRTMCD622 / PRTMCD642**



Work and Collaboration Table  
From 32" to 42" deep tops

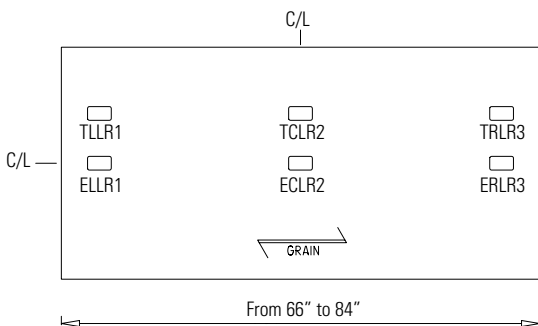

Work and Collaboration Table  
From 32" to 42" deep tops

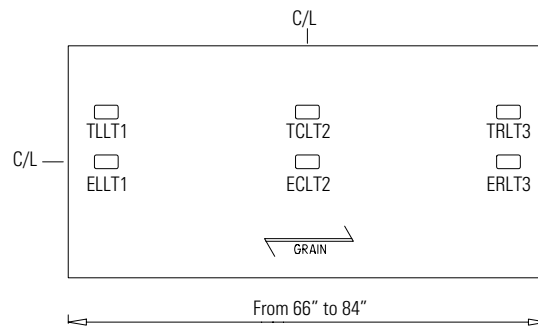

## CREDENZA WIRE MANAGEMENT CUT-OUT

- Option C275

### Cut-out Specification

- Available on all 27.5"H credenzas, above open positions only (not available on door or drawer positions).
- Use in conjunction with CBYRxxxx Peninsula Tops that have G5CE grommet specified to provide a means of wire management from the surface, thru the credenza top and out the credenza back.
- When specified, the C275 includes a 5.90" w x 3.90" d cut-out in the credenza top and a standard GM5C grommet in the back, upper section of the open cavity.
- Order as **C275L**, **C275C**, **C275R**. Add **\$429** list.

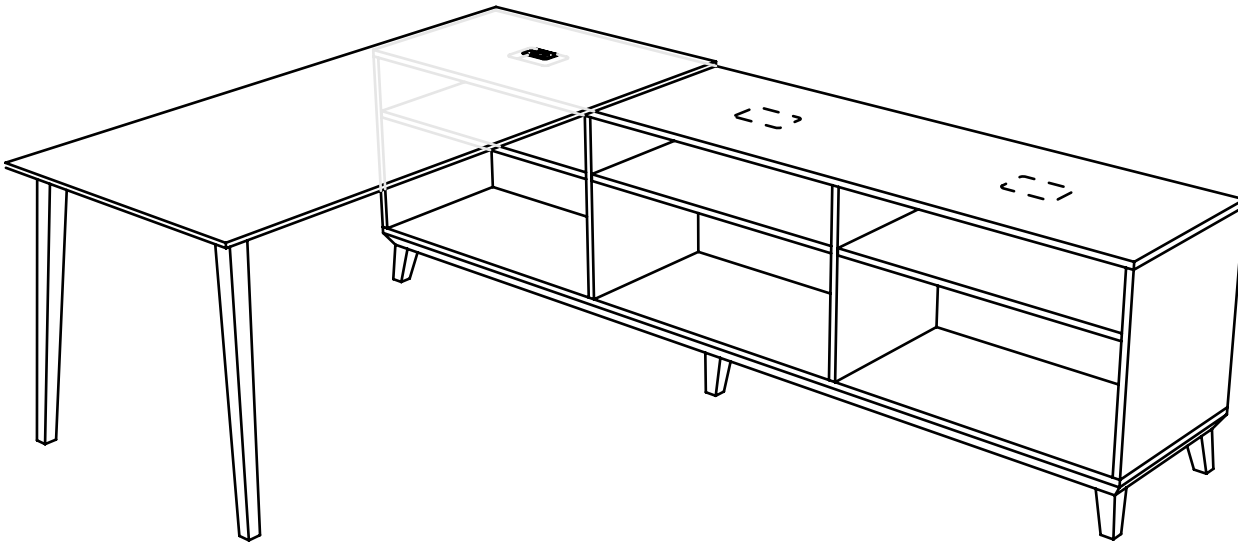
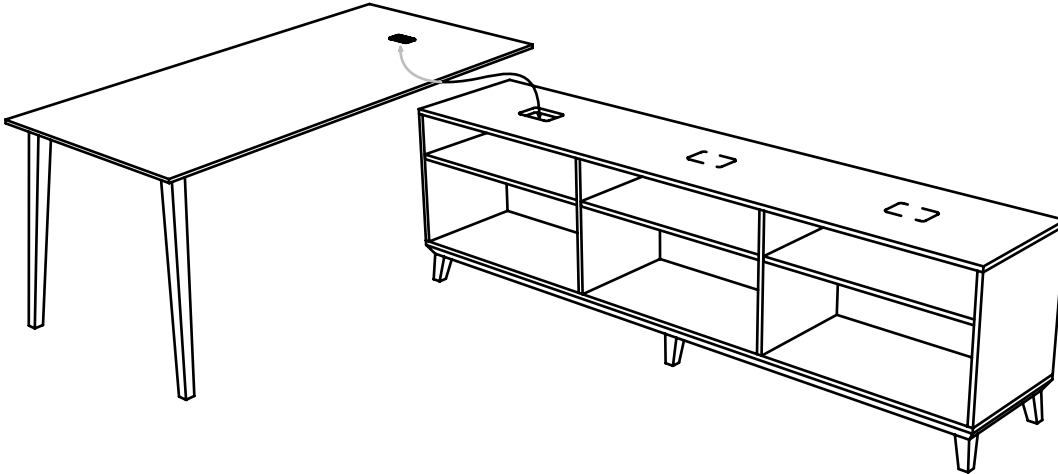

**MODESTY PANEL OPTIONS**

- Wood Modesty Panels are available in 15" and 22" height.
- To be used on Work Tables and on the Peninsula Table with and without the Riser Box.
- Recommended position for installation is 6" inset.

**PENINSULA TABLE WITH HIGH BASE PEDESTAL**MODESTY SIZES:

CBYCMPW44H15 - 44" x 15" x 0.75"

CBYCMPW50H15 - 50" x 15" x 0.75"

CBYCMPW56H15 - 56" x 15" x 0.75"

CBYCMPW62H15 - 62" x 15" x 0.75"

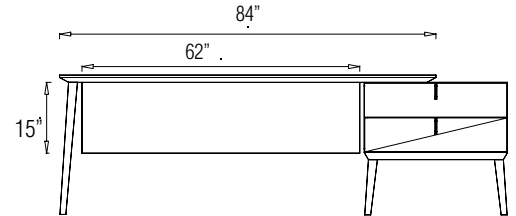
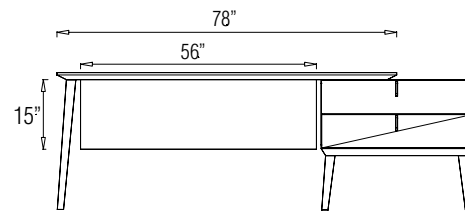
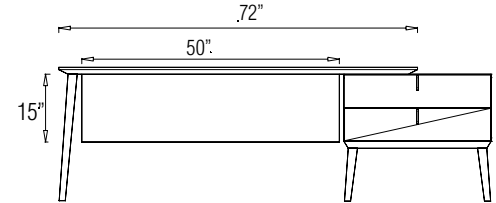
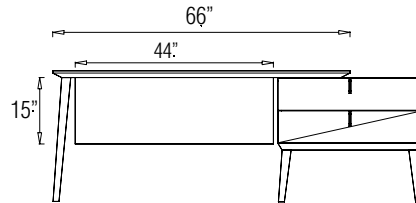
**PENINSULA TABLE WITH LOW BASE PEDESTAL**MODESTY SIZES:

CBYCMPW44H22 - 44" x 22" x 0.75"

CBYCMPW50H22 - 50" x 22" x 0.75"

CBYCMPW56H22 - 56" x 22" x 0.75"

CBYCMPW62H22 - 62" x 22" x 0.75"

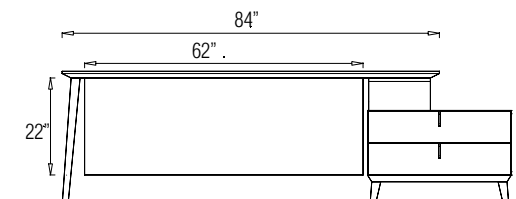
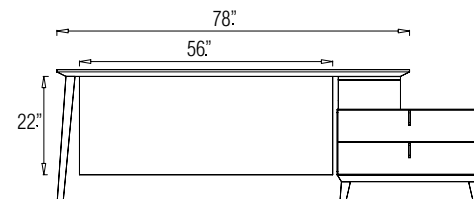
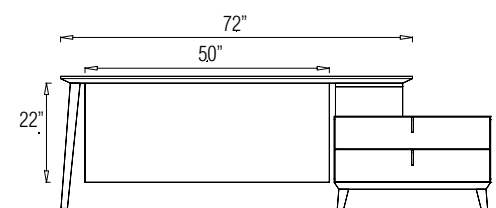
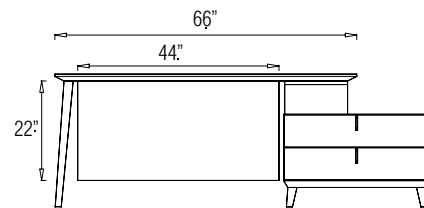
**PENINSULA TABLE WITH HIGH BASE CREDENZA**MODESTY SIZES:

CBYCMPW38H15 - 38" x 15" x 0.75"

CBYCMPW44H15 - 44" x 15" x 0.75"

CBYCMPW50H15 - 50" x 15" x 0.75"

CBYCMPW56H15 - 56" x 15" x 0.75"

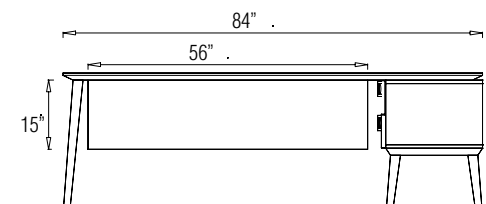
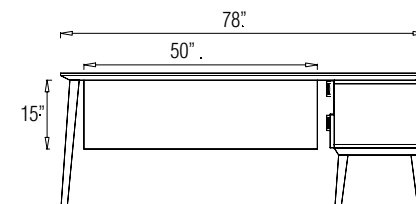
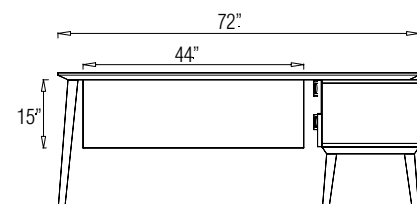
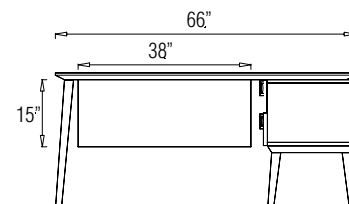

**MODESTY PANEL OPTIONS  
PENINSULA TABLE WITH  
LOW BASE CREDENZA**

**MODESTY SIZES:**

- CBYCMWP38H22 - 38" x 22" x 0.75"
- CBYCMWP44H22 - 44" x 22" x 0.75"
- CBYCMWP50H22 - 50" x 22" x 0.75"
- CBYCMWP56H22 - 56" x 22" x 0.75"

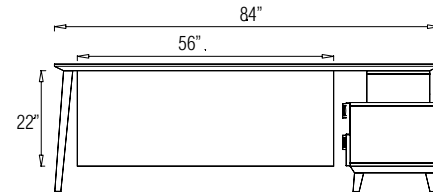
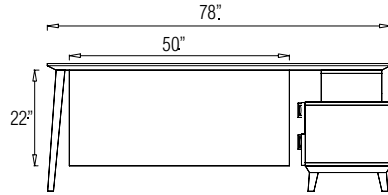
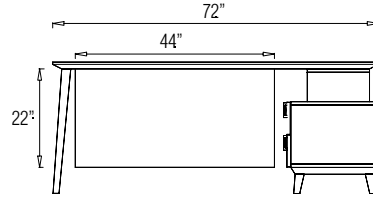
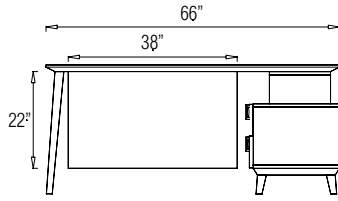

**FREESTANDING WORK TABLES  
& COLLABORATION TABLES**

**MODESTY SIZES:**

- CBYCMWP56H15 - 56" x 15" x 0.75"
- CBYCMWP62H15 - 62" x 15" x 0.75"
- CBYCMWP68H15 - 68" x 15" x 0.75"
- CBYCMWP74H15 - 74" x 15" x 0.75"

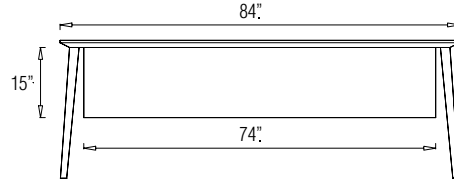
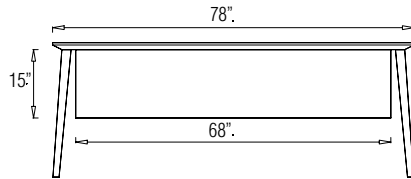
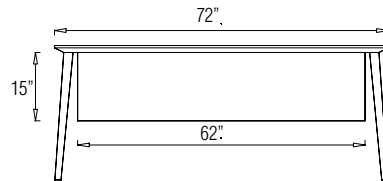
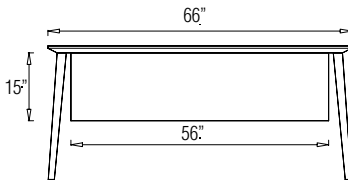

**RISER BOX**

- Riser Box is to be used as a spacer between the peninsula table and 20"H pedestals and credenzas
- CBYSPBOX2814 to be used with 32"D peninsula tables and executive bridges
- CBYSPBOX2014 to be used with 24"D executive bridges

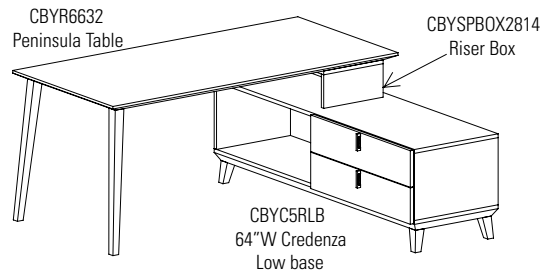
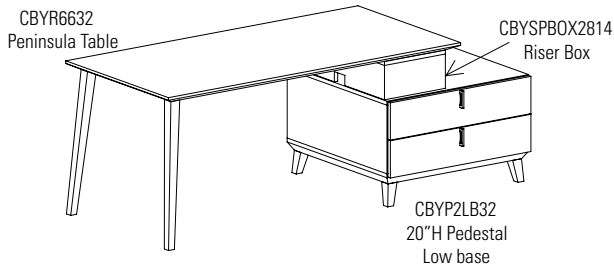

- On Peninsula Table, the Riser Box can be installed as below:

Riser Box opening is on the outside.

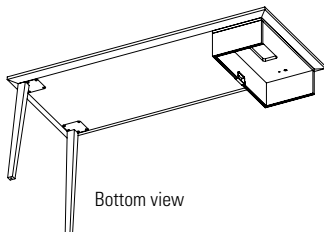

Riser Box opening is on the inside.

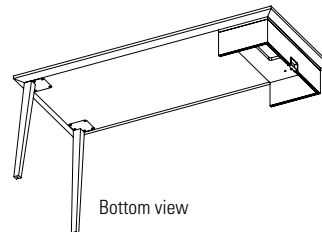

**HEIGHT GRID - FLOOR UNITS, LOW BASE**

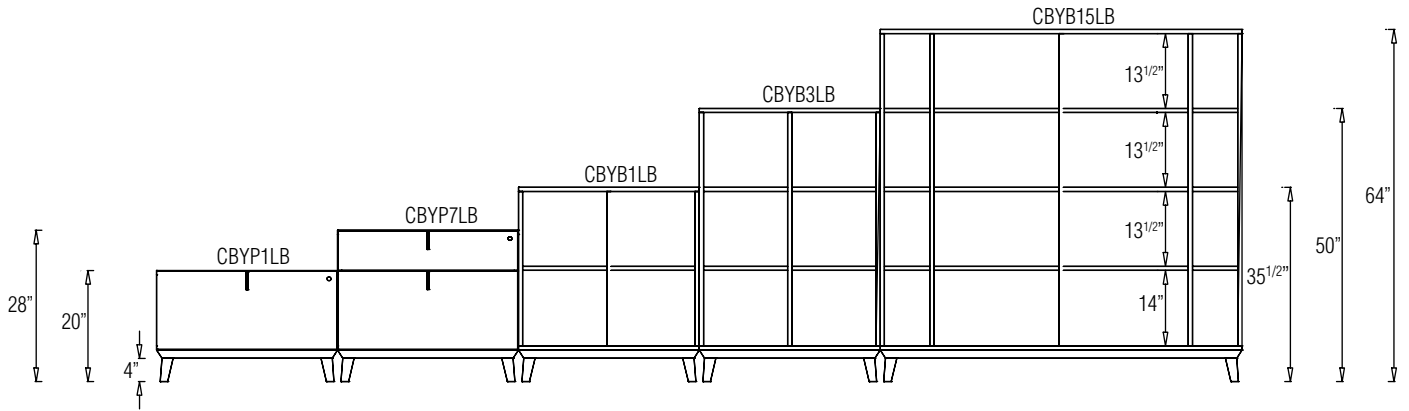

**HEIGHT GRID - FLOOR UNITS, HIGH BASE**

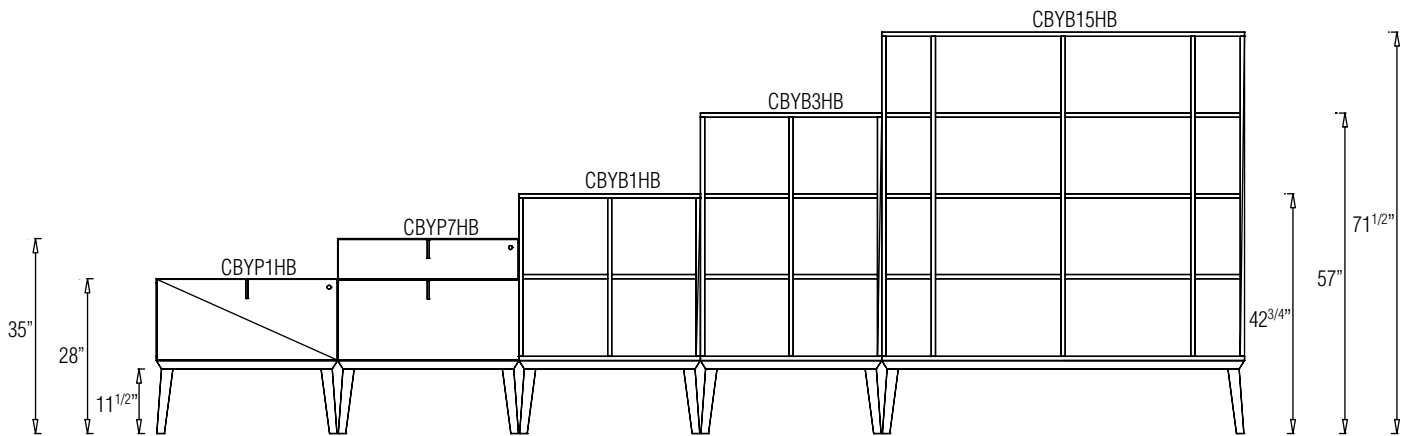

**HEIGHT GRID - STACK-ON UNITS**

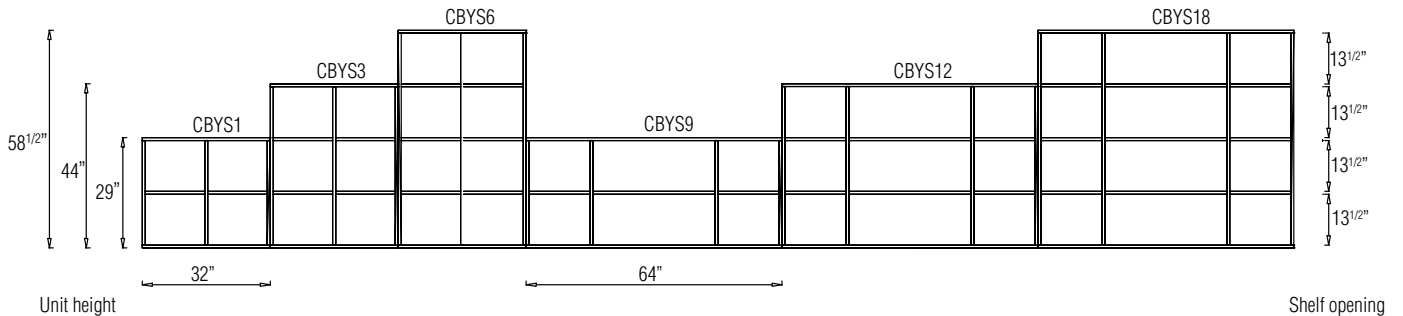

## TABLES

D x W x H

- All tables are shipped Knock Down (KD). Please see assembly instructions included with product.
- Available modesty panels are 15" and 22" height
- Peninsula table has metal inserts installed for quick assembly to the pedestal or pedestal with riser box

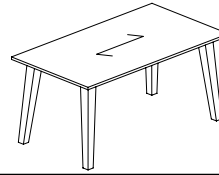

**Note** - Arrow indicates grain direction

### TABLES + RETURNS

MODEL#	DIMENSIONS	FREIGHT CLASS	WT/LBS.	CUBIC FT.	LAMINATE	VEENER
--------	------------	---------------	---------	-----------	----------	--------

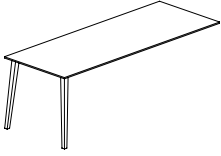

**Peninsula Table**

CBYR8432	32 x 84 x 29	100	119	12	<b>\$3141</b>	<b>\$3925</b>
CBYR7832	32 x 78 x 29	92.5	112	12	<b>\$2984</b>	<b>\$3731</b>
CBYR7232	32 x 72 x 29	100	105	11	<b>\$2843</b>	<b>\$3555</b>
CBYR6632	32 x 66 x 29	100	98	10	<b>\$2697</b>	<b>\$3373</b>

Table with two legs. Connects to 27.5"H storage. Must be supported by 32"D storage on one side (sold separately).



**Round Table**

CBY42H29	42 x 42 x 29	300	89	38	<b>\$4458</b>	<b>\$5574</b>
CBY36H29	36 x 36 x 29	300	77	31	<b>\$4204</b>	<b>\$5256</b>
CBY30H29	30 x 30 x 29	300	65	22	<b>\$3896</b>	<b>\$4872</b>

Round table with four legs.

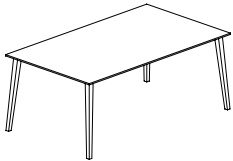

**Freestanding Work Table\***

CBYRT8442	42 x 84 x 29	65	170	15	<b>\$4867</b>	<b>\$6084</b>
CBYRT7842	42 x 78 x 29	92.5	161	14	<b>\$4663</b>	<b>\$5828</b>
CBYRT7242	42 x 72 x 29	65	152	13	<b>\$4478</b>	<b>\$5599</b>
CBYRT6642	42 x 66 x 29	70	142	13	<b>\$4291</b>	<b>\$5364</b>
CBYRT8432	32 x 84 x 29	65	139	12	<b>\$4229</b>	<b>\$5288</b>
CBYRT7832	32 x 78 x 29	92.5	132	12	<b>\$4074</b>	<b>\$5095</b>
CBYRT7232	32 x 72 x 29	65	125	11	<b>\$3930</b>	<b>\$4914</b>
CBYRT6632	32 x 66 x 29	65	118	10	<b>\$3791</b>	<b>\$4738</b>

Freestanding work table with four legs.



**Conference Tables\***

CBYRT16848	48 x 168 x 29	85	400	30	<b>\$23637</b>	<b>\$29546</b>
CBYRT14448	48 x 144 x 29	85	356	28	<b>\$21844</b>	<b>\$27305</b>
CBYRT12048	48 x 120 x 29	92.5	284	24	<b>\$20051</b>	<b>\$25063</b>
CBYRT9648	48 x 96 x 29	92.5	240	21	<b>\$18256</b>	<b>\$22821</b>
CBYRT16842	42 x 168 x 29	85	360	27	<b>\$22069</b>	<b>\$27585</b>
CBYRT14442	42 x 144 x 29	85	324	25	<b>\$20498</b>	<b>\$25623</b>
CBYRT12042	42 x 120 x 29	85	260	21	<b>\$18931</b>	<b>\$23663</b>
CBYRT9642	42 x 96 x 29	92.5	219	19	<b>\$17361</b>	<b>\$21701</b>
CBYRT16832	32 x 168 x 29	85	296	21	<b>\$19601</b>	<b>\$24502</b>
CBYRT14432	32 x 144 x 29	85	268	19	<b>\$18256</b>	<b>\$22821</b>
CBYRT12032	32 x 120 x 29	85	212	17	<b>\$17136</b>	<b>\$21420</b>
CBYRT9632	32 x 96 x 29	85	183	15	<b>\$15792</b>	<b>\$19738</b>

Freestanding conference table with six legs. 96" tables shipped in 4 cartons.

- 120", 144" and 168" tables are in two sections. Shipped in 5 cartons.

#### Required Specifications

Finish

#### Optional Specifications

Grommet  
Custom cut-out\*

## MODESTY PANELS

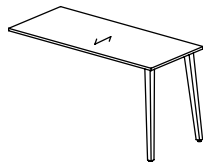
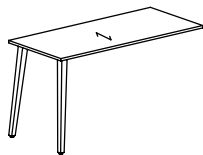
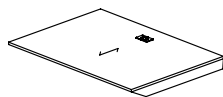
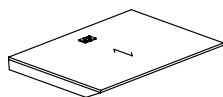
**Executive Return****Executive Bridge**

## MODEL#

## DIMENSIONS

## FREIGHT CLASS

## WT/LBS.

## CUBIC FT.

## LAMINATE

## VENEER

## D x W x H

**Left:**

CBYERL6024CG	24 x 60 x 29	70	56	3.30	<b>\$2312</b>	<b>\$2891</b>
CBYERL5424CG	24 x 54 x 29	70	50	3	<b>\$2197</b>	<b>\$2746</b>
CBYERL4824CG	24 x 48 x 29	70	45	2.60	<b>\$2080</b>	<b>\$2601</b>
CBYERL4224CG	24 x 42 x 29	70	39	2.30	<b>\$1964</b>	<b>\$2456</b>
CBYERL3624CG	24 x 36 x 29	70	34	2	<b>\$1850</b>	<b>\$2314</b>

**Right:**

CBYERR6024CG	24 x 60 x 29	70	56	3.30	<b>\$2312</b>	<b>\$2891</b>
CBYERR5424CG	24 x 54 x 29	70	50	3	<b>\$2197</b>	<b>\$2746</b>
CBYERR4824CG	24 x 48 x 29	70	45	2.60	<b>\$2080</b>	<b>\$2601</b>
CBYERR4224CG	24 x 42 x 29	70	39	2.30	<b>\$1964</b>	<b>\$2456</b>
CBYERR3624CG	24 x 36 x 29	70	34	2	<b>\$1850</b>	<b>\$2314</b>

Executive return with two legs. Coped edge on opposite side to connect to a freestanding work table, creating an "L" workstation. CBYERRxxxxCG has legs on right side. CBYERLxxxxCG has legs on left side.

**Left:**

CBY6024TLCG	24 x 60 x 29	70	56	3.30	<b>\$1646</b>	<b>\$2059</b>
CBY5424TLCG	24 x 54 x 29	70	50	3	<b>\$1487</b>	<b>\$1858</b>
CBY4824TLCG	24 x 48 x 29	70	45	2.60	<b>\$1321</b>	<b>\$1654</b>
CBY4224TLCG	24 x 42 x 29	70	39	2.30	<b>\$1159</b>	<b>\$1448</b>
CBY3624TLCG	24 x 36 x 29	70	34	2	<b>\$992</b>	<b>\$1241</b>

CBY6032TLCG	32 x 60 x 29	70	75	4.20	<b>\$2197</b>	<b>\$2746</b>
CBY5432TLCG	32 x 54 x 29	70	68	3.80	<b>\$1983</b>	<b>\$2479</b>
CBY4832TLCG	32 x 48 x 29	70	60	3.40	<b>\$1762</b>	<b>\$2203</b>
CBY4232TLCG	32 x 42 x 29	70	53	3	<b>\$1542</b>	<b>\$1928</b>
CBY3632TLCG	32 x 36 x 29	70	45	1	<b>\$1321</b>	<b>\$1654</b>

**Right:**

CBY6024TRCG	24 x 60 x 29	70	56	3.30	<b>\$1646</b>	<b>\$2059</b>
CBY5424TRCG	24 x 54 x 29	70	50	3	<b>\$1487</b>	<b>\$1858</b>
CBY4824TRCG	24 x 48 x 29	70	45	2.60	<b>\$1321</b>	<b>\$1654</b>
CBY4224TRCG	24 x 42 x 29	70	39	2.30	<b>\$1159</b>	<b>\$1448</b>
CBY3624TRCG	24 x 36 x 29	70	34	2	<b>\$992</b>	<b>\$1241</b>

CBY6032TRCG	32 x 60 x 29	70	75	4.20	<b>\$2197</b>	<b>\$2746</b>
CBY5432TRCG	32 x 54 x 29	70	68	3.80	<b>\$1983</b>	<b>\$2479</b>
CBY4832TRCG	32 x 48 x 29	70	60	3.40	<b>\$1762</b>	<b>\$2203</b>
CBY4232TRCG	32 x 42 x 29	70	53	3	<b>\$1542</b>	<b>\$1928</b>
CBY3632TRCG	32 x 36 x 29	70	45	1	<b>\$1321</b>	<b>\$1654</b>

Executive return with coped edge on one side to connect to a freestanding work table, overlapping a 27.5" h or 20" h storage piece (using "Riser Box", sold separately) on the opposite side. Standard with grommet.

- Available in 32" d to match cavity opening on credenzas and storage, or 24" d for a narrower workspace
- CBYxxxxTLCG units have a coped edge on the **left, forming a right return**
- CBYxxxxTRCG units have a coped edge on the **right, forming a left return**

**Required Specifications**

Finish

**Optional Specifications**Additional grommet  
Custom cut-out\*

**HEIGHT ADJUSTABLE TOPS**

MODEL#	DIMENSIONS	FREIGHT CLASS	WT/LBS.	CUBIC FT.	LAMINATE	veneer
D x W x H						
CBYRE8226T	26 x 82 x 1.5	85	105	8	<b>\$1911</b>	<b>\$2389</b>
CBYRE8026T	26 x 80 x 1.5	85	103	7.5	<b>\$1864</b>	<b>\$2330</b>
CBYRE7626T	26 x 76 x 1.5	85	98	7	<b>\$1773</b>	<b>\$2217</b>
CBYRE6426T	26 x 64 x 1.5	85	84	6	<b>\$1494</b>	<b>\$1867</b>
CBYRE5226T	26 x 52 x 1.5	85	70	5	<b>\$1215</b>	<b>\$1518</b>
CBYRE4626T	26 x 46 x 1.5	85	63	4.5	<b>\$1072</b>	<b>\$1340</b>
CBYRE4026T	26 x 40 x 1.5	85	56	4	<b>\$911</b>	<b>\$1168</b>
CBYRE8229T	29 x 82 x 1.5	85	116	9	<b>\$2131</b>	<b>\$2663</b>
CBYRE7629T	29 x 76 x 1.5	85	113	8.5	<b>\$1976</b>	<b>\$2470</b>
CBYRE6429T	29 x 64 x 1.5	85	93	6.5	<b>\$1667</b>	<b>\$2083</b>
CBYRE5229T	29 x 52 x 1.5	85	77	5.5	<b>\$1352</b>	<b>\$1690</b>
CBYRE4629T	29 x 46 x 1.5	85	70	5	<b>\$1198</b>	<b>\$1497</b>
CBYRE4029T	29 x 40 x 1.5	70	62	4	<b>\$1043</b>	<b>\$1303</b>
CBYRE8235T	35 x 82 x 1.5	85	138	10	<b>\$2574</b>	<b>\$3218</b>
CBYRE7635T	35 x 76 x 1.5	85	135	9.5	<b>\$2384</b>	<b>\$2980</b>
CBYRE6435T	35 x 64 x 1.5	85	110	8	<b>\$2011</b>	<b>\$2513</b>
CBYRE5235T	35 x 52 x 1.5	85	91	6.5	<b>\$1633</b>	<b>\$2040</b>
CBYRE4635T	35 x 46 x 1.5	85	82	6	<b>\$1441</b>	<b>\$1802</b>
CBYRE4035T	35 x 40 x 1.5	85	73	5	<b>\$1257</b>	<b>\$1571</b>

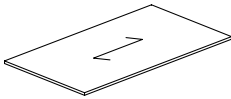

**Height Adjustable Top**

Corby tops with Corby edge on all sides, for use with FreeFit height adjustable table mechanisms, sold separately (FTxxxxx, see page 713 of the Desking price list for information).

- 26" deep tops accommodate FTxxxx24 mechanisms. Depth is exact to accommodate the Corby edge + the Freefit mechanism. *Cannot be made smaller.*
- 29" and 35" deep tops accommodate FTxxxx30 mechanisms



**HA Return Tops**

**Left:**

CBYRE6026CGCOPLT	26 x 60 x 1.5	85	80	5.5	<b>\$1399</b>	<b>\$1749</b>
CBYRE5426CGCOPLT	26 x 54 x 1.5	85	73	5	<b>\$1262</b>	<b>\$1577</b>
CBYRE4826CGCOPLT	26 x 48 x 1.5	85	66	4.5	<b>\$1120</b>	<b>\$1400</b>
CBYRE4226CGCOPLT	26 x 42 x 1.5	85	59	4	<b>\$978</b>	<b>\$1222</b>

**Right:**

CBYRE6026CGCOPRT	26 x 60 x 1.5	85	80	5.5	<b>\$1399</b>	<b>\$1749</b>
CBYRE5426CGCOPRT	26 x 54 x 1.5	85	73	5	<b>\$1262</b>	<b>\$1577</b>
CBYRE4826CGCOPRT	26 x 48 x 1.5	85	66	4.5	<b>\$1120</b>	<b>\$1400</b>
CBYRE4226CGCOPRT	26 x 42 x 1.5	85	59	4	<b>\$978</b>	<b>\$1222</b>

Corby return tops with Corby edge on three sides, for use with FreeFit height adjustable table mechanisms, sold separately (FTxxxxx, see page 713 of the Desking price list for information).

- 26" deep tops accommodate FTxxxx24 mechanisms. Depth is exact to accommodate the Corby edge + the Freefit mechanism. *Cannot be made smaller.*

**Required Specifications**  
Finish

**Optional Specifications**  
Grommet

## COLLABORATION TABLE

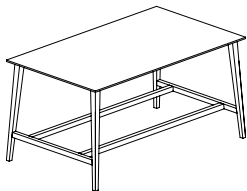

Freestanding Collaboration Table\*



Riser Box

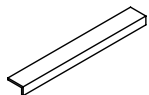

Footrest Cover

MODEL#	DIMENSIONS	FREIGHT CLASS	WT/LBS.	CUBIC FT.	LAMINATE	VENEER
--------	------------	---------------	---------	-----------	----------	--------

## D x W x H

CBYRTC8442	42 x 84 x 36	250	230	79	<b>\$5957</b>	<b>\$7448</b>
CBYRTC7842	42 x 78 x 36	250	211	73	<b>\$5759</b>	<b>\$7199</b>
CBYRTC7242	42 x 72 x 36	250	192	68	<b>\$5571</b>	<b>\$6965</b>
CBYRTC6642	42 x 66 x 36	250	172	62	<b>\$5382</b>	<b>\$6729</b>
CBYRTC8432	32 x 84 x 36	250	189	61	<b>\$5318</b>	<b>\$6649</b>
CBYRTC7832	32 x 78 x 36	250	172	56	<b>\$5161</b>	<b>\$6453</b>
CBYRTC7232	32 x 72 x 36	250	155	52	<b>\$5023</b>	<b>\$6279</b>
CBYRTC6632	32 x 66 x 36	250	138	48	<b>\$4882</b>	<b>\$6103</b>

Freestanding collaboration table with four legs and foot rests. Long footrests are steel and available in Brushed Chrome (**BCH**) or Black (**BLK**). Short footrests are wood and stained to match the veneer surface. Footrest covers are available as an option - please see page 15. Ships assembled.

CBYSPBOX2814	14 x 28 x 7.5	150	14	3	<b>\$236</b>	<b>\$296</b>
CBYSPBOX2014	14 x 20 x 7.5	250	2	1	<b>\$433</b>	<b>\$542</b>

Riser box for 20"H storage to support peninsula table. For wire pass through grommets, both top and back are included.

- CBYSPBOX2814 for use with 32"D peninsula tables and executive bridges.
- CBYSPBOX2014 for use with 24"D executive bridges

FRC8442	--	70	--	--	<b>\$1216</b>
FRC7842	--	70	--	--	<b>\$1148</b>
FRC7242	--	70	--	--	<b>\$1081</b>
FRC6642	--	70	--	--	<b>\$1014</b>
FRC8432	--	70	--	--	<b>\$1081</b>
FRC7832	--	70	--	--	<b>\$1014</b>
FRC7232	--	70	--	--	<b>\$947</b>
FRC6632	--	70	--	--	<b>\$879</b>

Factory installed.

## Required Specifications

Finish

## Optional Specifications

Lock\*  
Handles\*

**MODESTY PANELS**

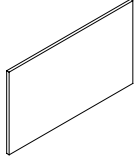

**Hanging Wood Modesty Panel**

MODEL#	DIMENSIONS D x W x H	FREIGHT CLASS	WT/LBS.	CUBIC FT.	LAMINATE	VENEER
CBYCMWP62H22	.75 x 62 x 22	100	28	3	<b>\$892</b>	<b>\$1116</b>
CBYCMWP56H22	.75 x 56 x 22	100	26	3	<b>\$831</b>	<b>\$1040</b>
CBYCMWP50H22	.75 x 50 x 22	100	24	3	<b>\$783</b>	<b>\$980</b>
CBYCMWP44H22	.75 x 44 x 22	92.5	22	2	<b>\$719</b>	<b>\$900</b>
CBYCMWP38H22	.75 x 38 x 22	92.5	20	2	<b>\$660</b>	<b>\$826</b>

22" hanging wood modesty panel.

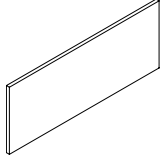

**Hanging Wood Modesty Panel**

CBYCMWP74H15	.75 x 74 x 15	100	24	3	<b>\$917</b>	<b>\$1148</b>
CBYCMWP68H15	.75 x 68 x 15	125	23	3	<b>\$864</b>	<b>\$1081</b>
CBYCMWP62H15	.75 x 62 x 15	92.5	21	2	<b>\$864</b>	<b>\$1081</b>
CBYCMWP56H15	.75 x 56 x 15	92.5	20	2	<b>\$805</b>	<b>\$1007</b>
CBYCMWP50H15	.75 x 50 x 15	100	18	2	<b>\$756</b>	<b>\$947</b>
CBYCMWP44H15	.75 x 44 x 15	100	17	2	<b>\$691</b>	<b>\$865</b>
CBYCMWP38H15	.75 x 38 x 15	125	15	2	<b>\$633</b>	<b>\$791</b>

15" hanging wood modesty panel.

**Required Specifications**

Veneer finish  
Long footrest finish\*

**Optional Specifications**

Additional grommet  
Custom cut-out\*

## COLLABORATION MEDIA TABLES

D x W x H

## COLLABORATION MEDIA TABLE (CBYxx32) AND WALL MOUNT MEDIA STORAGE (CBYFO-GM)

## 32" Wide, Wall Mount Media Storage

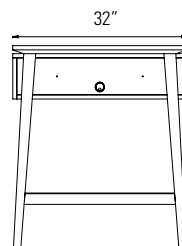
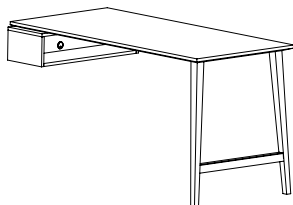

## 64" Wide, Wall Mount Media Storage

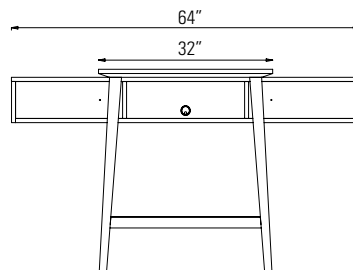
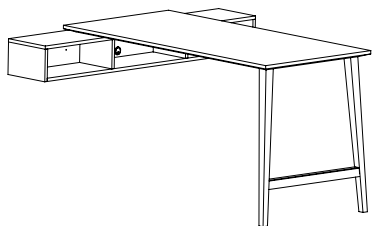

## 96" Wide, Wall Mount Media Storage

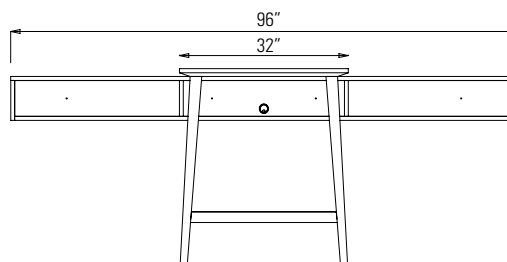
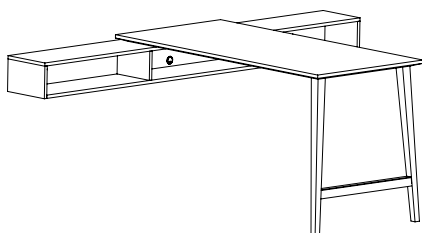

## COLLABORATION MEDIA TABLES

## MODEL#

## DIMENSIONS

## FREIGHT CLASS

## WT./LBS.

## CUBIC FT.

## LAMINATE

## VENEER

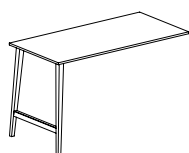

Collaboration Media Table

CBYRC8432	32 x 84 x 36	250	140	57	<b>\$4391</b>	<b>\$5490</b>
CBYRC7832	32 x 78 x 36	250	124	52	<b>\$4228</b>	<b>\$5286</b>
CBYRC7232	32 x 72 x 36	250	117	49	<b>\$4081</b>	<b>\$5103</b>
CBYRC6632	32 x 66 x 36	250	110	45	<b>\$3930</b>	<b>\$4914</b>

Table with two legs. To be used with Wall Mount Media Storage (CBYFOxxD12H8-GM).

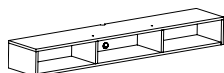

Wall Mounted Media Storage

CBYFO96D12H8-GM	12 x 96 x 8	125	78	10	<b>\$2373</b>	<b>\$2967</b>
CBYFO64D12H8-GM	12 x 64 x 8	125	50	8	<b>\$1582</b>	<b>\$1979</b>
CBYFO32D12H8-GM	12 x 32 x 8	100	35	4	<b>\$1447</b>	<b>\$1810</b>

To be used with Collaboration Media Table (CBYxx32). GM grommet on the back panel is included. For wire pass through, scoop cutouts on both top and bottom are included. Pre-drilled insert holes on top panel.

## Required Specifications

Veneer finish

**OCCASIONAL TABLES**

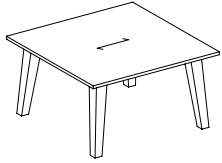

**Square Occasional Table**

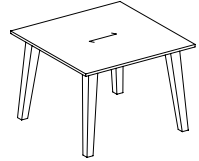

**Square Occasional Table**

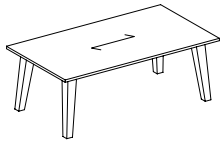

**Rectangular Occasional Table**

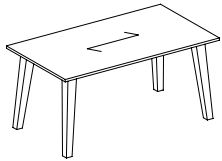

**Rectangular Occasional Table**



**Round Occasional Table**

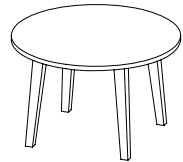

**Round Occasional Table**

MODEL#	DIMENSIONS D x W x H	FREIGHT CLASS	WT/LBS.	CUBIC FT.	LAMINATE	VENEER
CBYCT3636H13	36 x 36 x 13	125	73	8	<b>\$2545</b>	<b>\$3181</b>
CBYCT3030H13	30 x 30 x 13	125	59	6	<b>\$2245</b>	<b>\$2809</b>
CBYCT2424H13	24 x 24 x 13	125	47	5	<b>\$1999</b>	<b>\$2500</b>

13"H square occasional table.

CBYCT3636H17	36 x 36 x 17	150	78	9	<b>\$2855</b>	<b>\$3569</b>
CBYCT3030H17	30 x 30 x 17	150	64	7	<b>\$2557</b>	<b>\$3197</b>
CBYCT2424H17	24 x 24 x 17	125	52	6	<b>\$2312</b>	<b>\$2891</b>

17"H square occasional table.

CBYCT4820H13	48 x 20 x 13	125	61	7	<b>\$2295</b>	<b>\$2869</b>
CBYCT4220H13	42 x 20 x 13	125	57	6	<b>\$2190</b>	<b>\$2738</b>
CBYCT3620H13	36 x 20 x 13	125	52	6	<b>\$2107</b>	<b>\$2634</b>

13"H rectangular occasional table.

CBYCT4820H17	48 x 20 x 17	125	66	8	<b>\$2608</b>	<b>\$3260</b>
CBYCT4220H17	42 x 20 x 17	125	62	7	<b>\$2498</b>	<b>\$3124</b>
CBYCT3620H17	36 x 20 x 17	125	57	7	<b>\$2421</b>	<b>\$3026</b>

17"H rectangular occasional table.

CBYRO36H13	36 x 36 x 13	150	73	16	<b>\$3532</b>	<b>\$4417</b>
CBYRO30H13	30 x 30 x 13	150	59	12	<b>\$2901</b>	<b>\$3627</b>
CBYRO24H13	24 x 24 x 13	150	47	8	<b>\$2643</b>	<b>\$3304</b>

13"H round occasional table.

CBYRO36H17	36 x 36 x 17	250	78	20	<b>\$3811</b>	<b>\$4766</b>
CBYRO30H17	30 x 30 x 17	150	64	14	<b>\$3224</b>	<b>\$4030</b>
CBYRO24H17	24 x 24 x 17	150	52	10	<b>\$2967</b>	<b>\$3710</b>

17"H round occasional table.

**Required Specifications**

Veneer finish

## 32"W FREESTANDING PEDESTALS + STORAGE

D x W x H

- All pedestals and storage units are shipped assembled
- Freestanding Pedestals and Storage may be used as stand alone units or as the Peninsula Table Support (20" and 27.5" height units).
- To support the Peninsula Table with 20"H Pedestal, the Riser Box is required (see Tables / Accessories section).
- Pedestal and Storage units are available in two base heights: 4" (xxLB = Low Base) or 11.5" (xxHB = High Base)
- All drawer fronts have one vertical handle (PL89) installed.
- Front locking is standard on the Pedestals with box/file and file drawers.
- Optional locking on doors (Storage units) is available (see Accessories section).
- Optional Cushions (32" x 14") for Pedestal tops are available (see Accessories section).

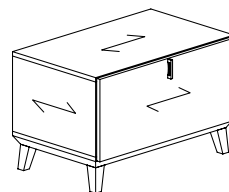
**Note** - Arrow indicates grain direction

## 32"W PEDESTALS - LOW BASE

MODEL#	DIMENSIONS	FREIGHT CLASS	WT/LBS.	CUBIC FT.	LAMINATE	veneer
--------	------------	---------------	---------	-----------	----------	--------

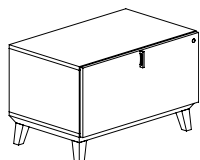
**Pedestal**

CBYP1LB	20 x 32 x 20	92.5	106	9	\$2530	\$3164
---------	--------------	------	-----	---	--------	--------

20"H freestanding pedestal with front locking lateral drawer. Low base.

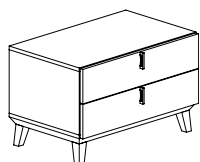
**Pedestal**

CBYP2LB	20 x 32 x 20	92.5	105	9	\$2514	\$3143
---------	--------------	------	-----	---	--------	--------

20"H freestanding pedestal with two box drawers. Low base.

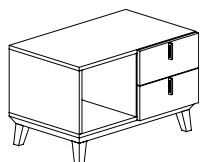
**Pedestal**

CBYP3LB	20 x 32 x 20	92.5	105	9	\$2672	\$3341
---------	--------------	------	-----	---	--------	--------

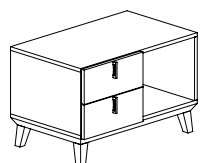
20"H freestanding pedestal with open cabinet on **left**, two box drawers on **right**. Low base.**Pedestal**

CBYP4LB	20 x 32 x 20	92.5	105	9	\$2672	\$3341
---------	--------------	------	-----	---	--------	--------

20"H freestanding pedestal with open cabinet on **right**, two box drawers on **left**. Low base.**Required Specifications**

Veneer finish

**32"W PEDESTALS - LOW BASE**

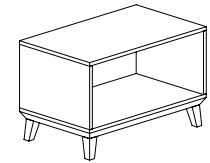

**Pedestal**

MODEL#	DIMENSIONS D x W x H	FREIGHT CLASS	WT/LBS.	CUBIC FT.	LAMINATE	veneer
CBYP5LB	20 x 32 x 20	100	86	9	<b>\$2190</b>	<b>\$2738</b>

20"H freestanding pedestal with open cabinet. Low base.

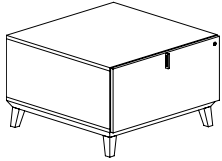

**Pedestal**

CBYP1LB32	32 x 32 x 20	100	136	14	<b>\$2687</b>	<b>\$3360</b>
-----------	--------------	-----	-----	----	---------------	---------------

20"H freestanding pedestal with front locking lateral drawer. Can be used to support peninsula table in conjunction with optional riser box ("CBYSPBOX2814"). Low base.

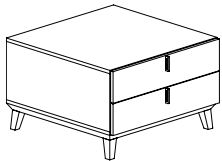

**Pedestal**

CBYP2LB32	32 x 32 x 20	100	135	14	<b>\$2672</b>	<b>\$3341</b>
-----------	--------------	-----	-----	----	---------------	---------------

20"H freestanding pedestal with two box drawers. Can be used to support peninsula table in conjunction with optional riser box ("CBYSPBOX2814"). Low base.

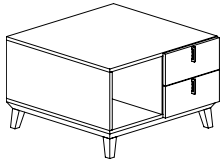

**Pedestal**

CBYP3LB32	32 x 32 x 20	100	135	14	<b>\$2826</b>	<b>\$3534</b>
-----------	--------------	-----	-----	----	---------------	---------------

20"H freestanding pedestal with open cabinet on **left**, two box drawers on **right**. Can be used to support peninsula table in conjunction with optional riser box ("CBYSPBOX2814"). Low base.

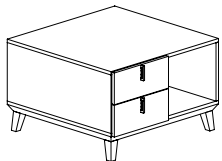

**Pedestal**

CBYP4LB32	32 x 32 x 20	100	135	14	<b>\$2826</b>	<b>\$3534</b>
-----------	--------------	-----	-----	----	---------------	---------------

20"H freestanding pedestal with open cabinet on **right**, two box drawers on **left**. Can be used to support peninsula table in conjunction with optional riser box ("CBYSPBOX2814"). Low base.

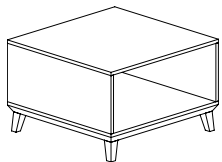

**Pedestal**

CBYP5LB32	32 x 32 x 20	100	135	14	<b>\$2342</b>	<b>\$2929</b>
-----------	--------------	-----	-----	----	---------------	---------------

20"H freestanding pedestal with open cabinet. Can be used to support peninsula table in conjunction with optional riser box ("CBYSPBOX2814"). Low base.

**Required Specifications**  
Veneer finish

**Optional Specifications**

## 32"W PEDESTALS - LOW BASE

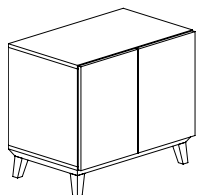

Pedestal\*

MODEL#	DIMENSIONS	FREIGHT CLASS	WT/LBS.	CUBIC FT.	LAMINATE	VENEER
--------	------------	---------------	---------	-----------	----------	--------

D x W x H

CBYP6LB	20 x 32 x 27.5	100	117	12	\$2655	\$3320
---------	----------------	-----	-----	----	--------	--------

27.5"H freestanding storage cabinet with two doors, one adjustable shelf. Low base.

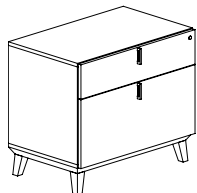

Pedestal

CBYP7LB	20 x 32 x 27.5	92.5	124	12	\$3388	\$4235
---------	----------------	------	-----	----	--------	--------

27.5"H freestanding pedestal with front locking lateral and box drawer. Low base.

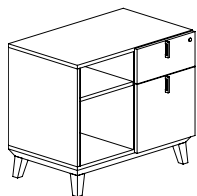

Pedestal

CBYP8LB	20 x 32 x 27.5	92.5	124	12	\$3541	\$4427
---------	----------------	------	-----	----	--------	--------

27.5"H freestanding pedestal with open fixed shelf on **left**, front locking box file drawer on **right**. Low base.

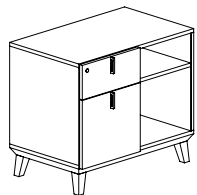

Pedestal

CBYP9LB	20 x 32 x 27.5	92.5	124	12	\$3541	\$4427
---------	----------------	------	-----	----	--------	--------

27.5"H freestanding pedestal with open fixed shelf on **right**, front locking box file drawer on **left**. Low base.

## 32"W PEDESTALS - HIGH BASE

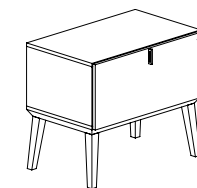

Pedestal

MODEL#	DIMENSIONS	FREIGHT CLASS	WT/LBS.	CUBIC FT.	LAMINATE	VENEER
--------	------------	---------------	---------	-----------	----------	--------

CBYP1HB	20 x 32 x 27.5	100	111	12	\$2843	\$3555
---------	----------------	-----	-----	----	--------	--------

27.5"H freestanding pedestal with front locking lateral drawer. High base.

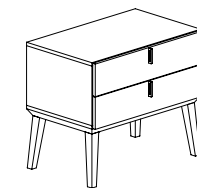

Pedestal

CBYP2HB	20 x 32 x 27.5	100	111	12	\$2826	\$3534
---------	----------------	-----	-----	----	--------	--------

27.5"H freestanding pedestal with two box drawers. High base.

**Required Specifications**

Veneer finish

**Optional Specifications**Lock\*  
Handles\*

**32"W PEDESTALS - HIGH BASE**

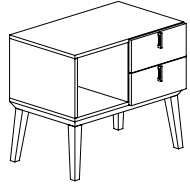

**Pedestal**

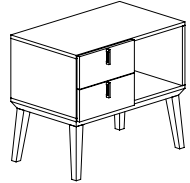

**Pedestal**

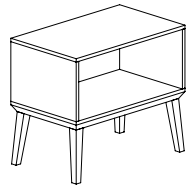

**Pedestal**

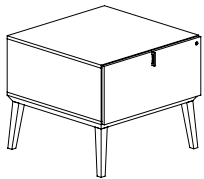

**Pedestal**

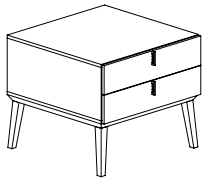

**Pedestal**

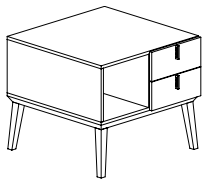

**Pedestal**

MODEL#	DIMENSIONS D x W x H	FREIGHT CLASS	WT/LBS.	CUBIC FT.	LAMINATE	veneer
CBYP3HB	20 x 32 x 27.5	100	111	12	<b>\$2672</b>	<b>\$3341</b>

27.5"H freestanding pedestal with open cabinet on **left**, two box drawers on **right**. High base.

CBYP4HB	20 x 32 x 27.5	100	110	12	<b>\$2672</b>	<b>\$3341</b>
---------	----------------	-----	-----	----	---------------	---------------

27.5"H freestanding pedestal with open cabinet on **right**, two box drawers on **left**. High base.

CBYP5HB	20 x 32 x 27.5	125	91	12	<b>\$2190</b>	<b>\$2738</b>
---------	----------------	-----	----	----	---------------	---------------

27.5"H freestanding pedestal with open cabinet. High base.

CBYP1HB32	32 x 32 x 27.5	125	141	18	<b>\$2998</b>	<b>\$3749</b>
-----------	----------------	-----	-----	----	---------------	---------------

27.5"H freestanding pedestal with front locking lateral drawer. Can be used to support peninsula table. High base.

CBYP2HB32	32 x 32 x 27.5	125	140	18	<b>\$2909</b>	<b>\$3731</b>
-----------	----------------	-----	-----	----	---------------	---------------

27.5"H freestanding pedestal with two box drawers. Can be used to support peninsula table. High base.

CBYP3HB32	32 x 32 x 27.5	125	140	18	<b>\$2826</b>	<b>\$3534</b>
-----------	----------------	-----	-----	----	---------------	---------------

27.5"H freestanding pedestal with open cabinet on **left**, two box drawers on **right**. Can be used to support peninsula table. High base.

**Required Specifications**  
Veneer finish

**Optional Specifications**

## 64"W AND 96"W FREESTANDING CREDENZAS

MODEL#	DIMENSIONS	FREIGHT CLASS	WT./LBS.	CUBIC FT.	LAMINATE	VENEER
	<b>D x W x H</b>					
CBYP4HB32	32 x 32 x 27.5	125	140	18	\$2826	\$3534
CBYP5HB32	32 x 32 x 27.5	125	121	18	\$2342	\$2929
CBYP6HB	20 x 32 x 35	100	129	15	\$2967	\$3710
CBYP7HB	20 x 32 x 35	100	129	15	\$3700	\$4625
CBYP8HB	20 x 32 x 35	100	132	15	\$3855	\$4819
CBYP9HB	20 x 32 x 35	100	132	15	\$3855	\$4819

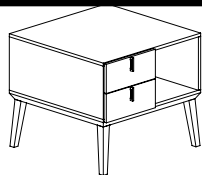
**Pedestal**

27.5"H freestanding pedestal with open cabinet on **right**, two box drawers on **left**. Can be used to support peninsula table. High base.

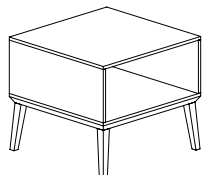
**Pedestal**

27.5"H freestanding pedestal with open cabinet. Can be used to support peninsula table. High base.

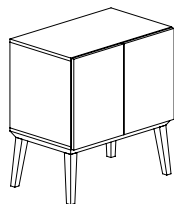
**Pedestal\***

35"H freestanding storage cabinet with two doors, one adjustable shelf. High base.

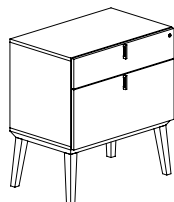
**Pedestal**

35"H freestanding pedestal with front locking lateral and box drawer. High base.

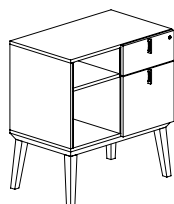
**Pedestal**

35"H freestanding pedestal open with fixed shelf on **left**, front locking box file drawer on **right**. High base.

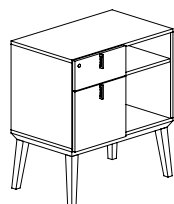
**Pedestal**

35"H freestanding pedestal open with fixed shelf on **right**, front locking box file drawer on **left**. High base.

**Required Specifications**

Veneer finish

**Optional Specifications**Lock\*  
Handles\*

## 64"W AND 96"W FREESTANDING CREDENZAS

D x W x H

- All Credenzas are shipped assembled.
- Freestanding Credenzas may be used as stand alone units or as the Peninsula Table Support (20" and 27.5" Height units)
- To support the Peninsula Table with 20"H Credenza, the Riser Box is required (see Tables or Accessories section).
- Credenza units are available in two base heights: 4" (xxLB = Low Base), or 11.5" (xxHB = High Base).
- All drawer fronts have vertical handle (PL89) installed where indicated.
- Front locking is standard on the Credenzas with box/lateral and lateral drawers.
- Optional locking on doors (Storage units) is available (see Accessories section).
- Optional Cushions (32" x 14") for Credenza tops are available (see Accessories section).

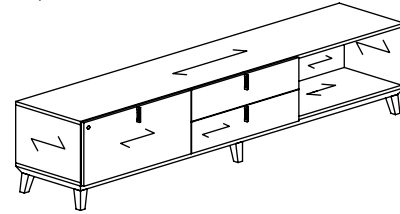

**Note** - Arrow indicates grain direction

### 64"W FREESTANDING CREDENZAS - LOW BASE

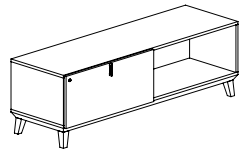

**Credenza**

MODEL#	DIMENSIONS	FREIGHT CLASS	WT/LBS.	CUBIC FT.	LAMINATE	VENEER
CBYC1LLB	20 x 64 x 20	125	161	17	\$4478	\$5599

Freestanding credenza with front locking lateral drawer on **left**, open on **right**. Low base.

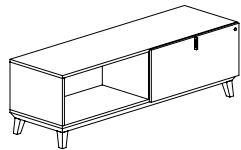

**Credenza**

CBYC1RLB	20 x 64 x 20	125	161	17	\$4478	\$5599
----------	--------------	-----	-----	----	--------	--------

Freestanding credenza with front locking lateral drawer on **right**, open on **left**. Low base.

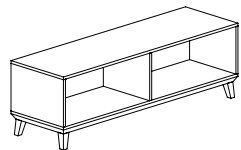

**Credenza**

CBYC2LB	20 x 64 x 20	100	141	17	\$3822	\$4779
---------	--------------	-----	-----	----	--------	--------

Freestanding credenza, open on left and right. Low base.

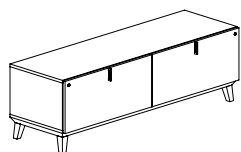

**Credenza**

CBYC3LB	20 x 64 x 20	92.5	180	17	\$4977	\$6224
---------	--------------	------	-----	----	--------	--------

Freestanding credenza, two front locking lateral drawers. Low base.

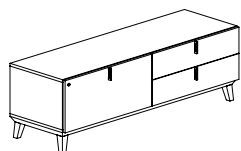

**Credenza**

CBYC4LLB	20 x 64 x 20	92.5	179	17	\$4964	\$6205
----------	--------------	------	-----	----	--------	--------

Freestanding credenza, front locking lateral drawer on **left**, two box drawers **right**. Low base.

#### Required Specifications

Veneer finish

#### Optional Specifications

## 64"W FREESTANDING CRENZAS - LOW BASE

MODEL#	DIMENSIONS	FREIGHT CLASS	WT/LBS.	CUBIC FT.	LAMINATE	VENEER
	<b>D x W x H</b>					
CBYC4RLB	20 x 64 x 20	92.5	179	17	\$4964	\$6205
CBYC5LLB	20 x 64 x 20	100	160	17	\$4478	\$5599
CBYC5RLB	20 x 64 x 20	100	160	17	\$4478	\$5599
CBYC6LB	20 x 64 x 20	92.5	179	17	\$4791	\$5990
CBYC7LB	20 x 64 x 27.5	100	213	23	\$6006	\$7509
CBYC8LLB	20 x 64 x 27.5	100	194	23	\$5337	\$6671

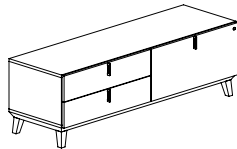
**Credenza**

Freestanding credenza, front locking lateral drawer on **right**, two box drawers **left**. Low base.

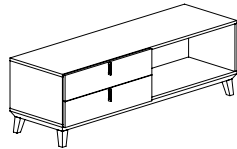
**Credenza**

Freestanding credenza, two box drawers on **left**, open on **right**. Low base.

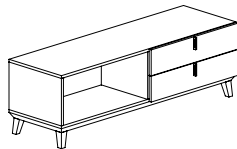
**Credenza**

Freestanding credenza, two box drawers on **right**, open on **left**. Low base.

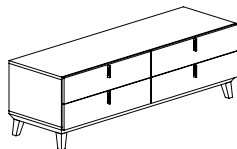
**Credenza**

Freestanding credenza, four box drawers. Low base.

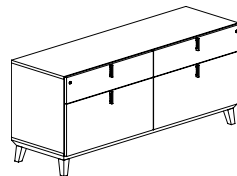
**Credenza**

Freestanding credenza, front locking lateral drawer with box drawer on left and right. Low base.

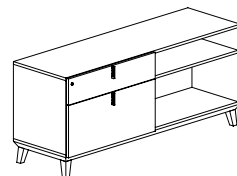
**Credenza\***

Freestanding credenza, front locking lateral drawer with box drawer on **left**, open with fixed shelf on **right**. Low base.

**Required Specifications**  
Veneer finish

**Optional Specifications**  
Wire management (C275)\*

**64"W FREESTANDING CREDENZAS - LOW BASE**

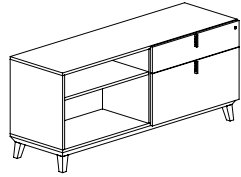

**Credenza\*\***

MODEL#	DIMENSIONS D x W x H	FREIGHT CLASS	WT/LBS.	CUBIC FT.	LAMINATE	VENEER
CBYC8RLB	20 x 64 x 27.5	100	194	23	<b>\$5337</b>	<b>\$6671</b>

Freestanding credenza, front locking lateral drawer with box drawer on **right**, open with fixed shelf on **left**. Low base.

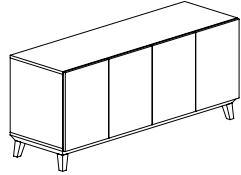

**Credenza\***

CBYC9LB	20 x 64 x 27.5	100	189	23	<b>\$5306</b>	<b>\$6635</b>
---------	----------------	-----	-----	----	---------------	---------------

Freestanding storage credenza, four doors with two adjustable shelves. Low base.

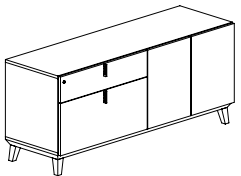

**Credenza\***

CBYC10LLB	20 x 64 x 27.5	100	206	23	<b>\$5644</b>	<b>\$7057</b>
-----------	----------------	-----	-----	----	---------------	---------------

Freestanding credenza, front locking lateral drawer with box drawer on **left**, two doors with adjustable shelf on **right**. Low base.

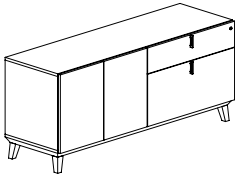

**Credenza\***

CBYC10RLB	20 x 64 x 27.5	100	206	23	<b>\$5644</b>	<b>\$7057</b>
-----------	----------------	-----	-----	----	---------------	---------------

Freestanding credenza, front locking lateral drawer with box drawer on **right**, two doors with adjustable shelf on **left**. Low base.

**64"W FREESTANDING CREDENZAS - HIGH BASE**

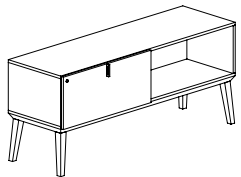

**Credenza\*\***

MODEL#	DIMENSIONS	FREIGHT CLASS	WT/LBS.	CUBIC FT.	LAMINATE	VENEER
CBYC1LHB	20 x 64 x 27.5	125	166	23	<b>\$4791</b>	<b>\$5990</b>

Freestanding credenza with front locking lateral drawer on **left**, open on **right**. High base.

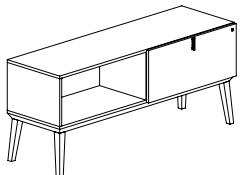

**Credenza\*\***

CBYC1RHB	20 x 64 x 27.5	125	166	23	<b>\$4791</b>	<b>\$5990</b>
----------	----------------	-----	-----	----	---------------	---------------

Freestanding credenza with front locking lateral drawer on **right**, open on **left**. High base.

**Required Specifications**  
Veneer finish

**Optional Specifications**  
Lock\*  
Handles\*  
Wire management (C275)\*\*

## 64"W FREESTANDING CREDENZAS - HIGH BASE

MODEL#	DIMENSIONS	FREIGHT CLASS	WT/LBS.	CUBIC FT.	LAMINATE	VENEER
	<b>D x W x H</b>					
CBYC2HB	20 x 64 x 27.5	125	146	23	\$4135	\$5170
CBYC3HB	20 x 64 x 27.5	100	185	23	\$5133	\$6418
CBYC4LHB	20 x 64 x 27.5	100	184	23	\$5120	\$6401
CBYC4RHB	20 x 64 x 27.5	100	184	23	\$5120	\$6401
CBYC5LHB	20 x 64 x 27.5	125	165	23	\$4791	\$5990
CBYC5RHB	20 x 64 x 27.5	125	165	23	\$4791	\$5990

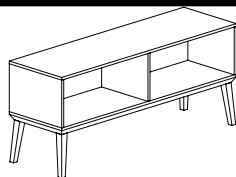

Credenza\*

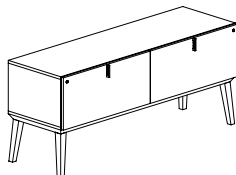
Freestanding credenza open on **left** and **right**. High base.

Credenza

Freestanding credenza, two front locking lateral drawers. High base.

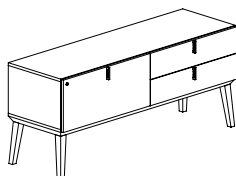

Credenza

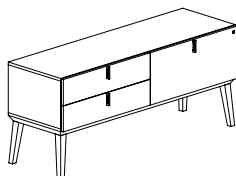
Freestanding credenza, front locking lateral drawer on **left**, two box drawers on **right**. High base.

Credenza

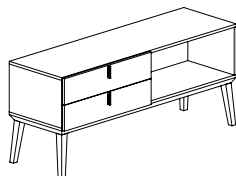
Freestanding credenza, front locking lateral drawer on **right**, two box drawers on **left**. High base.

Credenza\*

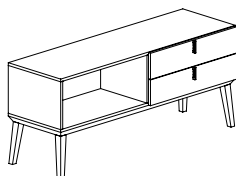
Freestanding credenza, two box drawers on **left**, open on **right**. High base.

Credenza\*

Freestanding credenza, two box drawers on **right**, open on **left**. High base.**Required Specifications**Veneer finish  
Laminate finish**Optional Specifications**Lock\*  
Handles\*

**64"W FREESTANDING CREDENZAS - HIGH BASE**

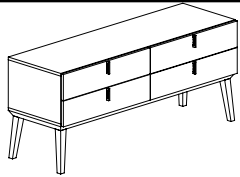

**Credenza**

MODEL#	DIMENSIONS D x W x H	FREIGHT CLASS	WT/LBS.	CUBIC FT.	LAMINATE	VENEER
CBYC6HB	20 x 64 x 27.5	100	184	23	<b>\$5104</b>	<b>\$6380</b>

Freestanding credenza with four box drawers. High base.

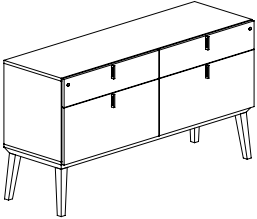

**Credenza**

CBYC7HB	20 x 64 x 35	125	218	29	<b>\$6320</b>	<b>\$7901</b>
---------	--------------	-----	-----	----	---------------	---------------

Freestanding credenza, front locking lateral drawer with box drawer on **left** and **right**. High base.

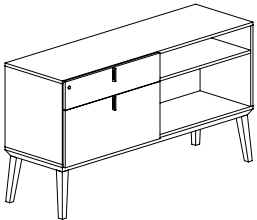

**Credenza**

CBYC8LHB	20 x 64 x 35	125	199	29	<b>\$5644</b>	<b>\$7057</b>
----------	--------------	-----	-----	----	---------------	---------------

Freestanding credenza, front locking lateral with box drawer on **left**, open with fixed shelf on **right**. High base.

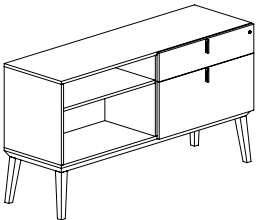

**Credenza**

CBYC8RHB	20 x 64 x 35	125	199	29	<b>\$5644</b>	<b>\$7057</b>
----------	--------------	-----	-----	----	---------------	---------------

Freestanding credenza, front locking lateral with box drawer on **right**, open with fixed shelf on **left**. High base.

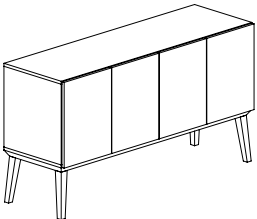

**Credenza\***

CBYC9HB	20 x 64 x 35	125	194	29	<b>\$5614</b>	<b>\$7017</b>
---------	--------------	-----	-----	----	---------------	---------------

Freestanding storage credenza, four doors with two adjustable shelves. High base.

**Required Specifications**

Veneer finish  
Laminate finish

**Optional Specifications**

Lock\*  
Handles\*

## 64"W FREESTANDING CREDENZAS - HIGH BASE

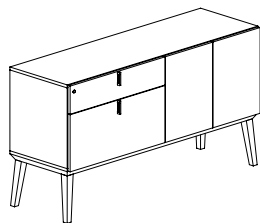

Credenza\*

MODEL#	DIMENSIONS D x W x H	FREIGHT CLASS	WT/LBS.	CUBIC FT.	LAMINATE	VENEER
CBYC10LHB	20 x 64 x 35	125	211	29	\$5957	\$7448

Freestanding credenza, front locking lateral with box drawer on **left**, two doors with adjustable shelf on **right**. High base.

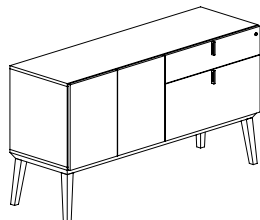

Credenza\*

CBYC10RHB	20 x 64 x 35	125	211	29	\$5957	\$7448
-----------	--------------	-----	-----	----	--------	--------

Freestanding credenza, front locking lateral with box drawer on **right**, two doors with adjustable shelf on **left**. High base.

## 96"W FREESTANDING CREDENZAS - LOW BASE

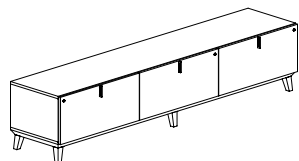

Credenza

MODEL#	DIMENSIONS	FREIGHT CLASS	WT/LBS.	CUBIC FT.	LAMINATE	VENEER
CBYC11LB	20 x 96 x 20	92.5	259	25	\$7427	\$9284

Freestanding credenza, three front locking lateral drawers. Low base.

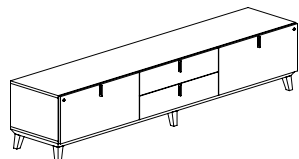

Credenza

CBYC12LB	20 x 96 x 20	92.5	258	25	\$7411	\$9265
----------	--------------	------	-----	----	--------	--------

Freestanding credenza, front locking lateral drawer on **left**, two box drawers **center**, and front locking lateral drawer on **right**. Low base.

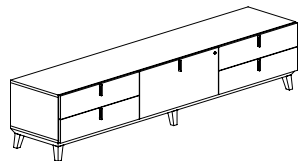

Credenza

CBYC13LB	20 x 96 x 20	92.5	258	25	\$7394	\$9243
----------	--------------	------	-----	----	--------	--------

Freestanding credenza, two box drawers on **left**, front locking lateral drawer **center**, and two box drawers on **right**. Low base.

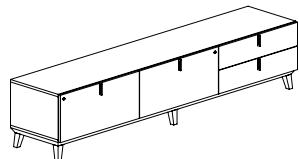

Credenza

CBYC14LB	20 x 96 x 20	92.5	258	25	\$7411	\$9265
----------	--------------	------	-----	----	--------	--------

Freestanding credenza, front locking lateral drawers **left** and **center**, and two box drawers on **right**. Low base.

**Required Specifications**

Veneer finish  
Laminate finish

**Optional Specifications**

Lock\*  
Handles\*

**96"W FREESTANDING CREDENZAS - LOW BASE**

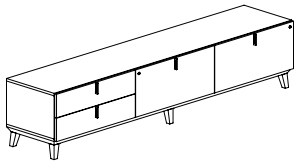

**Credenza**

MODEL#	DIMENSIONS D x W x H	FREIGHT CLASS	WT/LBS.	CUBIC FT.	LAMINATE	VENEER
CBYC15LB	20 x 96 x 20	92.5	258	25	<b>\$7411</b>	<b>\$9265</b>

Freestanding credenza, two box drawers on **left**, front locking lateral drawer **center** and **right**. Low base.

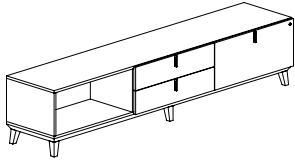

**Credenza**

CBYC16LB	20 x 96 x 20	100	239	25	<b>\$6911</b>	<b>\$8640</b>
----------	--------------	-----	-----	----	---------------	---------------

Freestanding credenza, open on **left**, two box drawers **center**, and front locking lateral drawer on **right**. Low base.

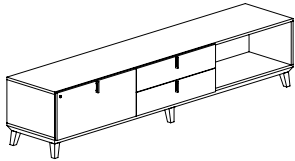

**Credenza**

CBYC17LB	20 x 96 x 20	100	239	25	<b>\$6911</b>	<b>\$8640</b>
----------	--------------	-----	-----	----	---------------	---------------

Freestanding credenza, front locking lateral drawer on **left**, two box drawers **center**, and open on **right**. Low base.

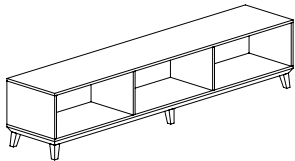

**Credenza**

CBYC18LB	20 x 96 x 20	100	201	25	<b>\$5927</b>	<b>\$7409</b>
----------	--------------	-----	-----	----	---------------	---------------

Freestanding credenza, open **left**, **center** and **right**. Low base.

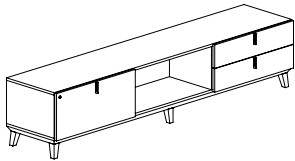

**Credenza**

CBYC19LB	20 x 96 x 20	100	239	25	<b>\$6911</b>	<b>\$8640</b>
----------	--------------	-----	-----	----	---------------	---------------

Freestanding credenza, front locking lateral drawer on **left**, open **center**, and two box drawers on **right**. Low base.

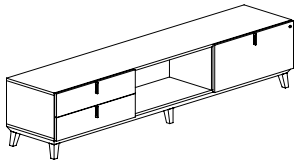

**Credenza**

CBYC20LB	20 x 96 x 20	100	239	25	<b>\$6911</b>	<b>\$8640</b>
----------	--------------	-----	-----	----	---------------	---------------

Freestanding credenza, two box drawers on **left**, open **center**, and front locking lateral drawer on **right**. Low base.

**Required Specifications**

- Veneer finish
- Laminate finish

## 96"W FREESTANDING CRENZAS - LOW BASE

MODEL#	DIMENSIONS	FREIGHT CLASS	WT/LBS.	CUBIC FT.	LAMINATE	VENEER
	<b>D x W x H</b>					
CBYC21LB	20 x 96 x 20	100	225	25	\$6549	\$8188
CBYC22LB	20 x 96 x 20	100	217	25	\$6393	\$7992
CBYC23LB	20 x 96 x 20	92.5	256	25	\$7377	\$9222
CBYC24LB	20 x 96 x 27.5	100	304	34	\$8158	\$10199
CBYC25LB	20 x 96 x 27.5	100	284	34	\$7411	\$9265
CBYC26LB	20 x 96 x 27.5	100	296	34	\$7566	\$9459

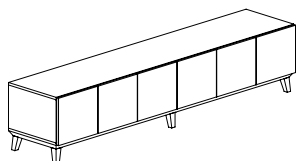

Credenza\*

Freestanding storage credenza with six doors. Low base.

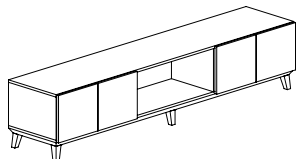

Credenza\*

Freestanding storage credenza with two doors on **left**, open **center**, and two doors on **right**. Low base.

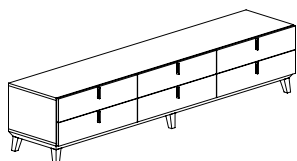

Credenza

Freestanding credenza with six box drawers. Low base.

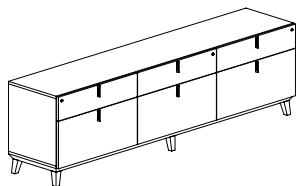

Credenza

Freestanding credenza, front locking lateral drawer with box drawer **left**, **center** and **right**. Low base.

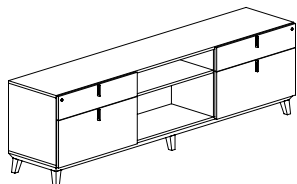

Credenza\*\*

Freestanding credenza, front locking lateral drawer with box drawer on **left**, open with fixed shelf **center**, and front locking lateral drawer with box drawer on **right**. Low base.

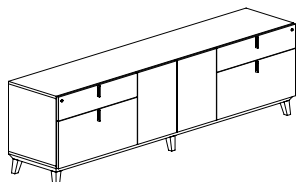

Credenza\*

Freestanding credenza, front locking lateral drawer with box drawer on **left**, two door storage with adjustable shelf **center**, and front locking lateral drawer with box drawer on **right**. Low base.

**Required Specifications**

Veneer finish  
Laminate finish

**Optional Specifications**

Lock  
Handles  
Wire management (C275)\*

96"W FREESTANDING CREDENZAS - LOW BASE

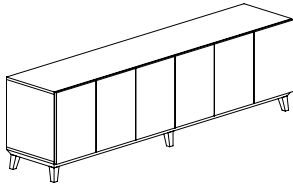

Credenza

MODEL#	DIMENSIONS D x W x H	FREIGHT CLASS	WT/LBS.	CUBIC FT.	LAMINATE	veneer
CBYC27LB	20 x 96 x 27.5	100	281	34	\$7018	\$8773

Freestanding storage credenza, six doors with three adjustable shelves. Low base.

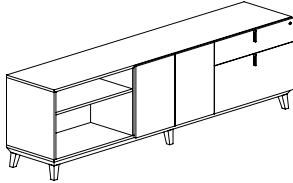

Credenza\*

CBYC28LB	20 x 96 x 27.5	100	277	34	\$6818	\$8524
----------	----------------	-----	-----	----	--------	--------

Freestanding credenza, open with fixed shelf on **left**, two door storage with adjustable shelf **center**, and front locking lateral drawer with box drawer on **right**. Low base.

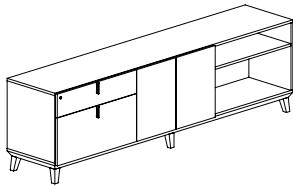

Credenza\*

CBYC29LB	20 x 96 x 27.5	100	277	34	\$6818	\$8524
----------	----------------	-----	-----	----	--------	--------

Freestanding credenza, front locking lateral drawer with box drawer on **left**, two door storage with adjustable shelf **center**, and open with fixed shelf on **right**. Low base.

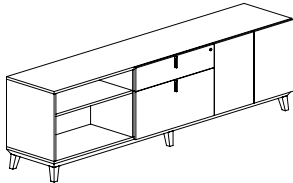

Credenza\*

CBYC30LB	20 x 96 x 27.5	100	277	34	\$6818	\$8524
----------	----------------	-----	-----	----	--------	--------

Freestanding credenza, open with fixed shelf on **left**, front locking lateral drawer with box drawer **center**, and two door storage with adjustable shelf on **right**. Low base.

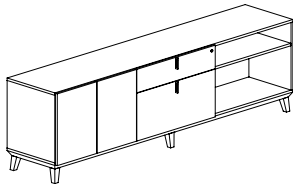

Credenza\*

CBYC31LB	20 x 96 x 27.5	100	277	34	\$6818	\$8524
----------	----------------	-----	-----	----	--------	--------

Freestanding credenza, two door storage with adjustable shelf on **left**, front locking lateral drawer with box drawer **center**, and open with fixed shelf on **right**. Low base.

**Required Specifications**

Veneer finish  
Laminate finish

**Optional Specifications**

Lock  
Handles  
Wire management (C275)\*

## 96"W FREESTANDING CREDENZAS - LOW BASE

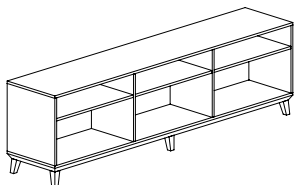

Credenza\*

MODEL#	DIMENSIONS	FREIGHT CLASS	WT/LBS.	CUBIC FT.	LAMINATE	VENEER
CBYC32LB	20 x 96 x 27.5	125	277	34	\$6549	\$8188

D x W x H

Freestanding credenza, open with fixed shelf **left, center** and **right**. Low base.

## 96"W FREESTANDING CREDENZAS - HIGH BASE

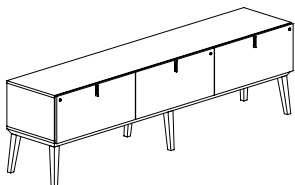

Credenza

MODEL#	DIMENSIONS	FREIGHT CLASS	WT/LBS.	CUBIC FT.	LAMINATE	VENEER
CBYC11HB	20 x 96 x 27.5	125	264	34	\$7739	\$9675

Freestanding credenza, three front locking lateral drawers. High base.

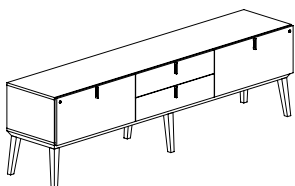

Credenza

CBYC12HB	20 x 96 x 27.5	125	263	34	\$7723	\$9654
----------	----------------	-----	-----	----	--------	--------

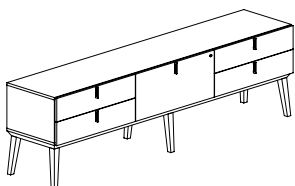
Freestanding credenza, front locking lateral drawer on **left**, two box drawers **center**, and front locking lateral drawer on **right**. High base.

Credenza

CBYC13HB	20 x 96 x 27.5	125	263	34	\$7706	\$9634
----------	----------------	-----	-----	----	--------	--------

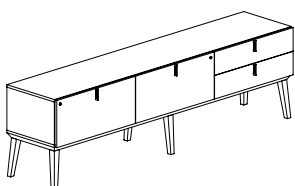
Freestanding credenza, two box drawers on **left**, front locking lateral drawer **center**, and two box drawers on **right**. High base.

Credenza

CBYC14HB	20 x 96 x 27.5	125	263	34	\$7723	\$9654
----------	----------------	-----	-----	----	--------	--------

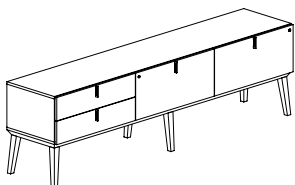
Freestanding credenza, front locking lateral drawer on **left** and **center**, two box drawers on **right**. High base.

Credenza

CBYC15HB	20 x 96 x 27.5	125	263	34	\$7723	\$9654
----------	----------------	-----	-----	----	--------	--------

Freestanding credenza, two box drawers on **left** and front locking lateral drawer **center** and **right**. High base.**Required Specifications**Veneer finish  
Laminate finish**Optional Specifications**

Wire management (C275)\*

96"W FREESTANDING CREDENZAS - HIGH BASE

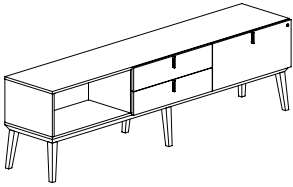

**Credenza\***

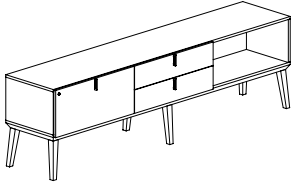

**Credenza\***

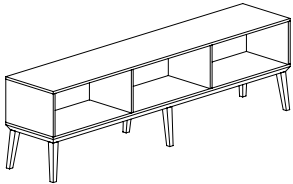

**Credenza\***

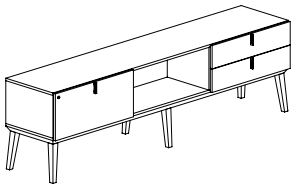

**Credenza\***

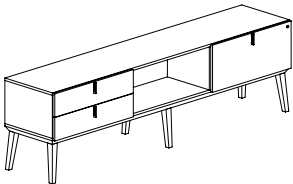

**Credenza\***

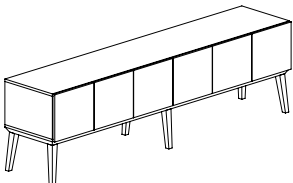

**Credenza\*\***

MODEL#	DIMENSIONS D x W x H	FREIGHT CLASS	WT/LBS.	CUBIC FT.	LAMINATE	ENEER
CBYC16HB	20 x 96 x 27.5	125	244	34	<b>\$7223</b>	<b>\$9030</b>
Freestanding credenza, open on <b>left</b> , two box drawers <b>center</b> , and front locking lateral drawer on <b>right</b> . High base.						
CBYC17HB	20 x 96 x 27.5	125	244	34	<b>\$7223</b>	<b>\$9030</b>
Freestanding credenza, front locking lateral drawer on <b>left</b> , two box drawers <b>center</b> , and open on <b>right</b> . High base.						
CBYC18HB	20 x 96 x 27.5	125	206	34	<b>\$6236</b>	<b>\$7797</b>
Freestanding credenza, open <b>left</b> , <b>center</b> and <b>right</b> . High base.						
CBYC19HB	20 x 96 x 27.5	125	244	34	<b>\$7223</b>	<b>\$9030</b>
Freestanding credenza, front locking lateral drawer on <b>left</b> , open <b>center</b> , and two box drawers on <b>right</b> . High base.						
CBYC20HB	20 x 96 x 27.5	125	244	34	<b>\$7223</b>	<b>\$9030</b>
Freestanding credenza, two box drawers on <b>left</b> , open <b>center</b> , and front locking lateral drawer on <b>right</b> . High base.						
CBYC21HB	20 x 96 x 27.5	125	230	34	<b>\$6863</b>	<b>\$8578</b>
Freestanding storage credenza, six doors. High base.						

**Required Specifications**

Veneer finish  
Laminate finish

**Optional Specifications**

Wire management (C275)\*  
Lock\*\*  
Handles\*\*

## 96"W FREESTANDING CREDENZAS - HIGH BASE

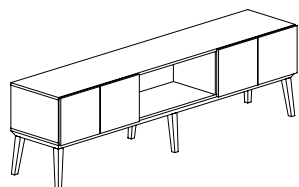

Credenza\*\*

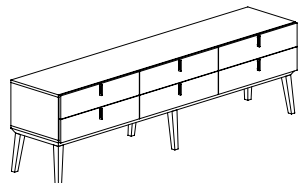

Credenza

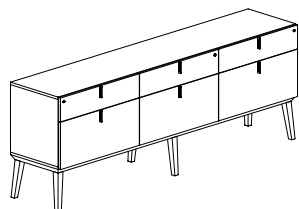

Credenza

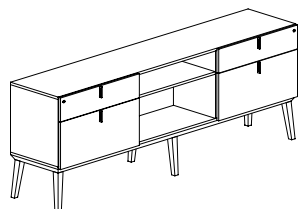

Credenza

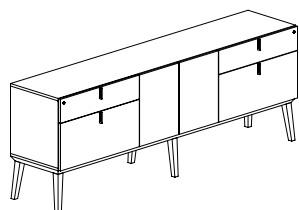

Credenza\*

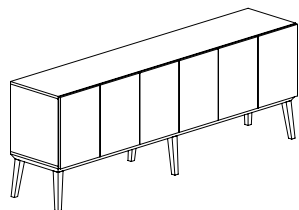

Credenza\*

MODEL#	DIMENSIONS	FREIGHT CLASS	WT/LBS.	CUBIC FT.	LAMINATE	VENEER
	<b>D x W x H</b>					
CBYC22HB	20 x 96 x 27.5	125	222	34	\$6705	\$8382
CBYC23HB	20 x 96 x 27.5	125	261	34	\$7690	\$9613
CBYC24HB	20 x 96 x 35	125	309	43	\$8469	\$10587
CBYC25HB	20 x 96 x 35	125	289	43	\$7723	\$9654
CBYC26HB	20 x 96 x 35	125	301	43	\$7876	\$9847
CBYC27HB	20 x 96 x 35	125	286	43	\$7331	\$9164

Freestanding storage credenza with two doors on **left**, open **center**, and two doors on **right**. High base.

Freestanding credenza with six box drawers. High base.

Freestanding credenza, front locking lateral drawer with box drawer **left**, **center** and **right**. High base.

Freestanding credenza, front locking lateral drawer with box drawer on **left**, open with fixed shelf **center**, and front locking lateral drawer with box drawer on **right**. High base.

Freestanding credenza, front locking lateral drawer with box drawer on **left**, two door storage with adjustable shelf **center**, and front locking lateral drawer with box drawer on **right**. High base.

Freestanding storage credenza, six doors with three adjustable shelves. High base.

**Required Specifications**

Veneer finish  
Laminate finish

**Optional Specifications**

Lock\*  
Handles\*  
Wire management (C275)\*\*

96"W FREESTANDING CRENZAS - HIGH BASE

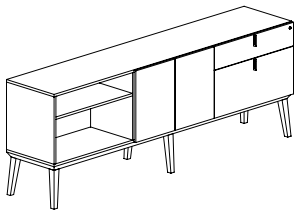

**Credenza\***

MODEL#	DIMENSIONS D x W x H	FREIGHT CLASS	WT/LBS.	CUBIC FT.	LAMINATE	VENEER
CBYC28HB	20 x 96 x 35	125	282	43	<b>\$7131</b>	<b>\$8915</b>

Freestanding credenza, open with fixed shelf on **left**, two door storage with adjustable shelf **center**, and front locking lateral drawer with box drawer on **right**. High base.

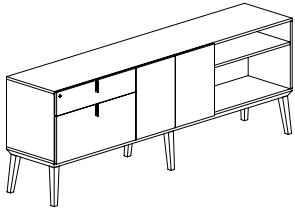

**Credenza\***

CBYC29HB	20 x 96 x 35	125	282	43	<b>\$7131</b>	<b>\$8915</b>
----------	--------------	-----	-----	----	---------------	---------------

Freestanding credenza, front locking lateral drawer with box drawer on **left**, two door storage with adjustable shelf **center**, and open with fixed shelf on **right**. High base.

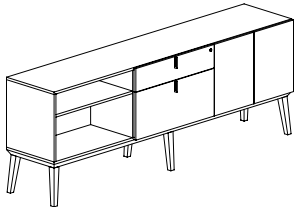

**Credenza\***

CBYC30HB	20 x 96 x 35	125	282	43	<b>\$7131</b>	<b>\$8915</b>
----------	--------------	-----	-----	----	---------------	---------------

Freestanding credenza, open with fixed shelf on **left**, front locking lateral drawer with box drawer **center**, and two door storage with adjustable shelf on **right**. High base.

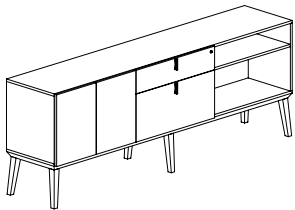

**Credenza\***

CBYC31HB	20 x 96 x 35	125	282	43	<b>\$7131</b>	<b>\$8915</b>
----------	--------------	-----	-----	----	---------------	---------------

Freestanding credenza, two door storage with adjustable shelf on **left**, front locking lateral drawer with box drawer **center**, and open with fixed shelf on **right**. High base.

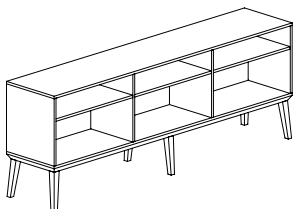

**Credenza**

CBYC32HB	20 x 96 x 35	150	250	43	<b>\$6862</b>	<b>\$8578</b>
----------	--------------	-----	-----	----	---------------	---------------

Freestanding credenza, open with fixed shelf **left, center** and **right**. High base.

**Required Specifications**

Veneer finish  
Laminate finish

**Optional Specifications**

Veneer back panel

## 32"W AND 64"W STACK-ON BOOKCASES AND STORAGE CABINETS

D x W x H

- All Stack-on Bookcases and Storage Cabinets are shipped assembled.
- Stack-on units are designed to be placed and installed on top of the Credenzas with Low or High Base.
- Stack on Units are available in three heights 29.5", 44" and 58.5". For the overall height, please see page A.7.
- Back Panels of the Stack-on units are made of LP solid color laminate.
- Optional locking on doors (Storage units) is available (see Accessories section)

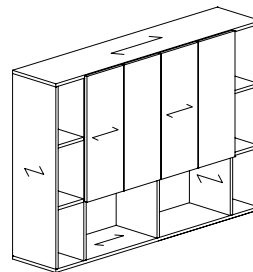

**Note** - Arrow indicates grain direction

## 32"W STACK-ON BOOKCASES

**MODEL#**      **DIMENSIONS**      **FREIGHT CLASS**      **WT/LBS.**      **CUBIC FT.**      **LAMINATE**      **VENEER**

D x W x H

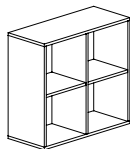

Stack-on Bookcase

CBYS1      14.5 x 32 x 29.5      125      69      9      **\$2107**      **\$2634**

Two-high stack-on bookcase with symmetrical 16" wide openings, fixed shelves. LP laminate back.

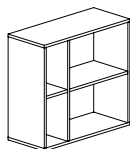

Stack-on Bookcase

CBYS2L      14.5 x 32 x 29.5      125      69      9      **\$2107**      **\$2634**

Two-high stack-on bookcase with asymmetrical openings - **8" left / 24" right**, fixed shelves. LP laminate back.

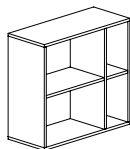

Stack-on Bookcase

CBYS2R      14.5 x 32 x 29.5      125      69      9      **\$2107**      **\$2634**

Two-high stack-on bookcase with asymmetrical openings - **24" left / 8" right**, fixed shelves. LP laminate back.

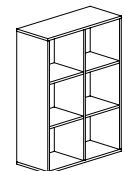

Stack-on Bookcase

CBYS3      14.5 x 32 x 44      125      95      14      **\$2886**      **\$3608**

Three-high stack-on bookcase with symmetrical 16" wide openings, fixed shelves. LP laminate back.

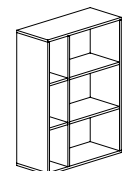

Stack-on Bookcase

CBYS4L      14.5 x 32 x 44      125      95      14      **\$2886**      **\$3608**

Three-high stack-on bookcase with asymmetrical openings - **8" left / 24" right**, fixed shelves. LP laminate back.

**Required Specifications**

Veneer finish  
Laminate finish

**Optional Specifications**

Veneer back panel

**32"W STACK-ON BOOKCASES**

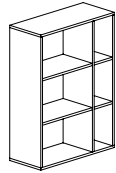

**Stack-on Bookcase**

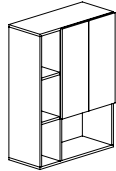

**Stack-on Bookcase\***

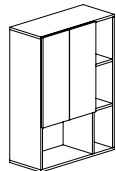

**Stack-on Bookcase\***

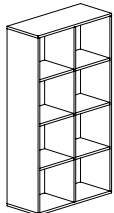

**Stack-on Bookcase**

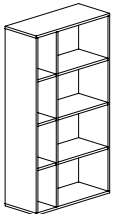

**Stack-on Bookcase**

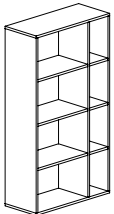

**Stack-on Bookcase**

MODEL#	DIMENSIONS	FREIGHT CLASS	WT/LBS.	CUBIC FT.	LAMINATE	VENEER
--------	------------	---------------	---------	-----------	----------	--------

	D x W x H					
CBYS4R	14.5 x 32 x 44	125	95	14	<b>\$2886</b>	<b>\$3608</b>

Three-high stack-on bookcase with asymmetrical openings - **24" left / 8" right**, fixed shelves. LP laminate back.

CBYS5L	14.5 x 32 x 44	125	106	14	<b>\$3417</b>	<b>\$4274</b>
--------	----------------	-----	-----	----	---------------	---------------

Three-high stack-on bookcase with asymmetrical openings - **8" left / 24" right**, fixed shelves, two door storage upper right with one adjustable shelf. LP laminate back.

CBYS5R	14.5 x 32 x 44	125	106	14	<b>\$3417</b>	<b>\$4274</b>
--------	----------------	-----	-----	----	---------------	---------------

Three-high stack-on bookcase with asymmetrical openings - **24" left / 8" right**, fixed shelves, two door storage upper left with one adjustable shelf. LP laminate back.

CBYS6	14.5 x 32 x 58.5	125	111	18	<b>\$3822</b>	<b>\$4779</b>
-------	------------------	-----	-----	----	---------------	---------------

Four-high stack-on bookcase with symmetrical 16" wide openings, fixed shelves. LP laminate back.

CBYS7L	14.5 x 32 x 58.5	125	111	18	<b>\$3822</b>	<b>\$4779</b>
--------	------------------	-----	-----	----	---------------	---------------

Four-high stack-on bookcase with asymmetrical openings - **8" left / 24" right**, fixed shelves. LP laminate back.

CBYS7R	14.5 x 32 x 58.5	125	111	18	<b>\$3822</b>	<b>\$4779</b>
--------	------------------	-----	-----	----	---------------	---------------

Four-high stack-on bookcase with asymmetrical openings - **24" left / 8" right**, fixed shelves. LP laminate back.

**Required Specifications**

Veneer finish  
Laminate finish

**Optional Specifications**

Lock\*  
Handles\*  
Veneer back panel

## 32"W STACK-ON BOOKCASES

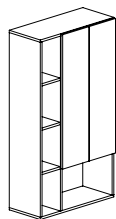

Stack-on Bookcase\*

MODEL#	DIMENSIONS	FREIGHT CLASS	WT/LBS.	CUBIC FT.	LAMINATE	VENEER
--------	------------	---------------	---------	-----------	----------	--------

D x W x H

CBYS8L	14.5 x 32 x 58.5	125	129	18	\$4634	\$5795
--------	------------------	-----	-----	----	--------	--------

Four-high stack-on bookcase with asymmetrical openings - **8" left / 24" right**, fixed shelves. two door storage upper right with two adjustable shelves. LP laminate back.

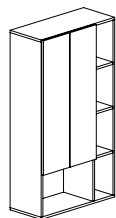

Stack-on Bookcase\*

CBYS8R	14.5 x 32 x 58.5	125	129	18	\$4634	\$5795
--------	------------------	-----	-----	----	--------	--------

Four-high stack-on bookcase with asymmetrical openings - **24" left / 8" right**, fixed shelves. two door storage upper left with two adjustable shelves. LP laminate back.

## 64"W STACK-ON BOOKCASES

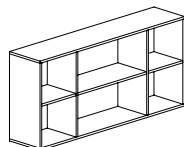

Stack-on Bookcase

MODEL#	DIMENSIONS	FREIGHT CLASS	WT/LBS.	CUBIC FT.	LAMINATE	VENEER
--------	------------	---------------	---------	-----------	----------	--------

CBYS9	14.5 x 64 x 29.5	125	119	18	\$3666	\$4584
-------	------------------	-----	-----	----	--------	--------

Two-high stack-on bookcase, 32" open fixed shelf center, 16" open fixed shelves on either side. LP laminate back.

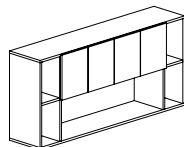

Stack-on Bookcase\*

CBYS10	14.5 x 64 x 29.5	125	134	18	\$4336	\$5422
--------	------------------	-----	-----	----	--------	--------

Two-high stack-on bookcase, four door storage upper center, 48" open fixed shelf lower center, and 8" open fixed shelves on either side. LP laminate back.

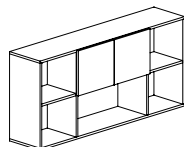

Stack-on Bookcase\*

CBYS11	14.5 x 64 x 29.5	125	127	18	\$4074	\$5095
--------	------------------	-----	-----	----	--------	--------

Two-high stack-on bookcase, two door storage upper center, 32" open fixed shelves center, and 16" open fixed shelves on either side. LP laminate back.

**Required Specifications**

Veneer finish  
Laminate finish

**Optional Specifications**

Lock\*  
Handles\*  
Veneer back panel

**64"W STACK-ON BOOKCASES**

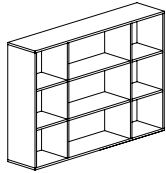

**Stack-on Bookcase**

MODEL#	DIMENSIONS D x W x H	FREIGHT CLASS	WT/LBS.	CUBIC FT.	LAMINATE	veneer
CBYS12	14.5 x 64 x 44	125	164	27	<b>\$5153</b>	<b>\$6441</b>

Three-high stack-on bookcase, 32" open fixed shelves center, 16" open fixed shelves on either side. LP laminate back.

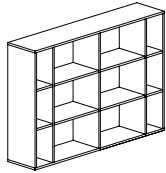

**Stack-on Bookcase**

CBYS13	14.5 x 64 x 44	125	174	27	<b>\$5433</b>	<b>\$6791</b>
--------	----------------	-----	-----	----	---------------	---------------

Three-high stack-on bookcase, two 24" open fixed shelves center, 8" open fixed shelves on either side. LP laminate back.

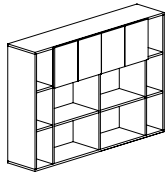

**Stack-on Bookcase\***

CBYS14	14.5 x 64 x 44	125	186	27	<b>\$6180</b>	<b>\$7725</b>
--------	----------------	-----	-----	----	---------------	---------------

Three-high stack-on bookcase, four door storage upper center, two 24" open fixed shelves lower center, 8" open fixed shelves on either side. LP laminate back.

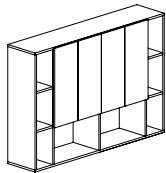

**Stack-on Bookcase\***

CBYS15	14.5 x 64 x 44	125	198	27	<b>\$6564</b>	<b>\$8207</b>
--------	----------------	-----	-----	----	---------------	---------------

Three-high stack-on bookcase, four door storage upper center, two 24" open fixed shelves lower center, 8" open fixed shelves on either side. LP laminate back.

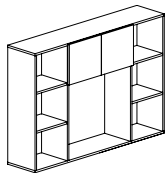

**Stack-on Bookcase\***

CBYS16	14.5 x 64 x 44	125	172	27	<b>\$5554</b>	<b>\$6944</b>
--------	----------------	-----	-----	----	---------------	---------------

Three-high stack-on bookcase, two door storage upper center, 32" open shelf lower center, 16" open fixed shelves on either side. LP laminate back.

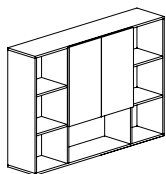

**Stack-on Bookcase\***

CBYS17	14.5 x 64 x 44	125	172	27	<b>\$5817</b>	<b>\$7273</b>
--------	----------------	-----	-----	----	---------------	---------------

Three-high stack-on bookcase, two door storage upper center with adjustable shelf, 32" open fixed shelf lower center, 16" open fixed shelves on either side. LP laminate back.

**Required Specifications**

Veneer finish  
Laminate finish

**Optional Specifications**

Lock\*  
Handles\*  
Veneer back panel

64"W STACK-ON BOOKCASES

MODEL# DIMENSIONS FREIGHT CLASS WT/LBS. CUBIC FT. LAMINATE VENEER

D x W x H

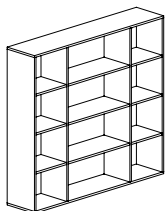

Stack-on Bookcase

CBYS18 14.5 x 64 x 58.5 150 208 35 \$6629 \$8288

Four-high stack-on bookcase, 32" open fixed shelves center, 16" open fixed shelves on either side. LP laminate back.

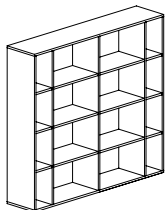

Stack-on Bookcase

CBYS19 14.5 x 64 x 58.5 125 222 35 \$7099 \$8874

Four-high stack-on bookcase, two 24" open fixed shelves center, 8" open fixed shelves on either side. LP laminate back.

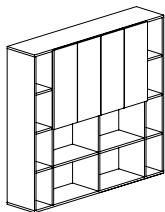

Stack-on Bookcase\*

CBYS20 14.5 x 64 x 58.5 125 245 35 \$8158 \$10199

Four-high stack-on bookcase, four door storage upper center, with adjustable shelves, two 24" open fixed shelves lower center, 8" open fixed shelves on either side. LP laminate back.

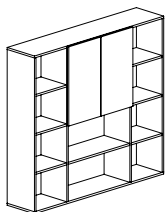

Stack-on Bookcase\*

CBYS21 14.5 x 64 x 58.5 125 224 35 \$7158 \$8948

Four-high stack-on bookcase, two door storage upper center, with adjustable shelf, 32" open fixed shelf lower center, 16" open fixed shelves on either side. LP laminate back.

Required Specifications

Veneer finish  
Laminate finish

Optional Specifications

Lock\*  
Handles\*  
Veneer back panel

## 32"W AND 64"W FREESTANDING BOOKCASES AND STORAGE CABINETS

D x W x H

- All Bookcases and Storage cabinets are shipped assembled.
- Bookcases and Storage cabinets are available in two base heights: 4" (xxLB = Low Base) or 11.5" (xxHB = High Base)
- Back Panels of the Bookcases and storage cabinets are made of LP solid color laminate.
- Optional locking on doors (Storage units) is available (see Accessories section).

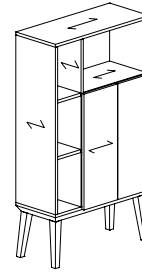

**Note** - Arrow indicates grain direction

### 32"W FREESTANDING BOOKCASES - LOW BASE

MODEL#	DIMENSIONS	FREIGHT CLASS	WT/LBS.	CUBIC FT.	LAMINATE	veneer
--------	------------	---------------	---------	-----------	----------	--------

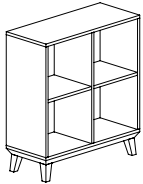

**Freestanding Bookcase**

CBYB1LB	14.5 x 32 x 35.5	100	101	11	<b>\$2731</b>	<b>\$3414</b>
---------	------------------	-----	-----	----	---------------	---------------

Freestanding two-high bookcase with symmetrical 16" wide openings, fixed shelves. Low base. LP Laminate back.

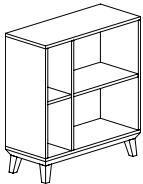

**Freestanding Bookcase**

CBYB2LLB	14.5 x 32 x 35.5	100	101	11	<b>\$2731</b>	<b>\$3414</b>
----------	------------------	-----	-----	----	---------------	---------------

Freestanding two-high bookcase with asymmetrical openings - **8" left / 24" right**, fixed shelves. Low base. LP laminate back.

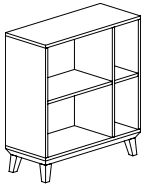

**Freestanding Bookcase**

CBYB2RLB	14.5 x 32 x 35.5	100	101	11	<b>\$2731</b>	<b>\$3414</b>
----------	------------------	-----	-----	----	---------------	---------------

Freestanding two-high bookcase with asymmetrical openings - **24" left / 8" right**, fixed shelves. Low base. LP laminate back.

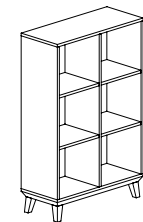

**Freestanding Bookcase**

CBYB3LB	14.5 x 32 x 50	125	119	15	<b>\$3512</b>	<b>\$4390</b>
---------	----------------	-----	-----	----	---------------	---------------

Freestanding three-high bookcase with symmetrical 16" wide openings, fixed shelves. Low base. LP Laminate back.

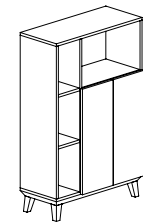

**Freestanding Bookcase\***

CBYB4LLB	14.5 x 32 x 50	100	138	15	<b>\$4044</b>	<b>\$5055</b>
----------	----------------	-----	-----	----	---------------	---------------

Freestanding three-high bookcase with asymmetrical openings - **8" left / 24" right**, fixed shelves, two door storage lower right with one adjustable shelf. Low base. LP Laminate back.

**Required Specifications**

Veneer finish  
Laminate finish

**Optional Specifications**

Lock\*  
Handles\*  
Veneer back panel

## 32"W FREESTANDING BOOKCASES - LOW BASE

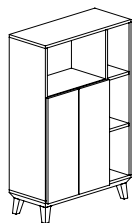

Freestanding Bookcase\*

MODEL#	DIMENSIONS	FREIGHT CLASS	WT/LBS.	CUBIC FT.	LAMINATE	VENEER
	<b>D x W x H</b>					
CBYB4RLB	14.5 x 32 x 50	100	138	15	\$4044	\$5055

Freestanding three-high bookcase with asymmetrical openings - **24" left / 8" right**, fixed shelves, two door storage lower left with one adjustable shelf. Low base. LP Laminate back.

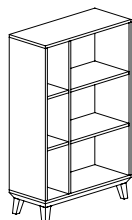

Freestanding Bookcase

CBYB5LLB	14.5 x 32 x 50	100	126	15	\$3512	\$4390
----------	----------------	-----	-----	----	--------	--------

Freestanding three-high bookcase with asymmetrical openings - **8" left / 24" right**, fixed shelves. Low base. LP Laminate back.

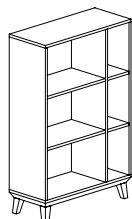

Freestanding Bookcase

CBYB5RLB	14.5 x 32 x 50	100	126	15	\$3512	\$4390
----------	----------------	-----	-----	----	--------	--------

Freestanding three-high bookcase with asymmetrical openings - **24" left / 8" right**, fixed shelves. Low base. LP Laminate back.

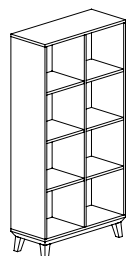

Freestanding Bookcase

CBYB6LB	14.5 x 32 x 64	125	152	20	\$4448	\$5559
---------	----------------	-----	-----	----	--------	--------

Freestanding four-high bookcase with symmetrical 16" wide openings, fixed shelves. Low base. LP Laminate back.

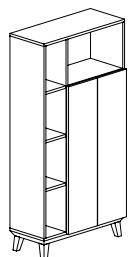

Freestanding Bookcase\*

CBYB7LLB	14.5 x 32 x 64	100	169	20	\$5259	\$6575
----------	----------------	-----	-----	----	--------	--------

Freestanding four-high bookcase with asymmetrical openings - **8" left / 24" right**, fixed shelves, two door storage lower right with two adjustable shelves. Low base. LP Laminate back.

**Required Specifications**

Veneer finish  
Laminate finish

**Optional Specifications**

Lock\*  
Handles\*  
Veneer back panel

**32"W FREESTANDING BOOKCASES - LOW BASE**

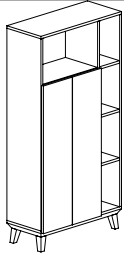

**Freestanding Bookcase\***

MODEL#	DIMENSIONS D x W x H	FREIGHT CLASS	WT/LBS.	CUBIC FT.	LAMINATE	VENEER
CBYB7RLB	14.5 x 32 x 64	100	169	20	<b>\$5259</b>	<b>\$6575</b>

Freestanding four-high bookcase with asymmetrical openings - **24" left / 8" right**, fixed shelves, two door storage lower left with two adjustable shelves. Low base. LP Laminate back.

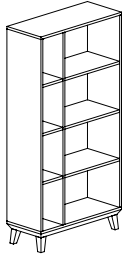

**Freestanding Bookcase**

CBYB8LLB	14.5 x 32 x 64	125	152	20	<b>\$4448</b>	<b>\$5559</b>
----------	----------------	-----	-----	----	---------------	---------------

Freestanding four-high bookcase with asymmetrical openings - **8" left / 24" right**, fixed shelves. Low base. LP Laminate back.

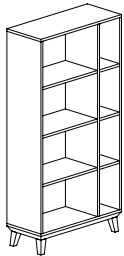

**Freestanding Bookcase**

CBYB8RLB	14.5 x 32 x 64	125	152	20	<b>\$4448</b>	<b>\$5559</b>
----------	----------------	-----	-----	----	---------------	---------------

Freestanding four-high bookcase with asymmetrical openings - **24" left / 8" right**, fixed shelves. Low base. LP Laminate back.

**32"W FREESTANDING BOOKCASES - HIGH BASE**

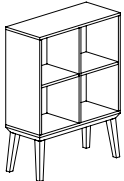

**Freestanding Bookcase**

MODEL#	DIMENSIONS	FREIGHT CLASS	WT/LBS.	CUBIC FT.	LAMINATE	VENEER
CBYB1HB	14.5 x 32 x 42.75	100	106	13	<b>\$3043</b>	<b>\$3804</b>

Freestanding two-high bookcase with symmetrical 16" wide openings, fixed shelves. High base. LP Laminate back.

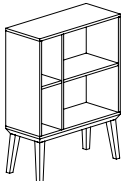

**Freestanding Bookcase**

CBYB2LHB	14.5 x 32 x 42.75	100	106	13	<b>\$3043</b>	<b>\$3804</b>
----------	-------------------	-----	-----	----	---------------	---------------

Freestanding two-high bookcase with asymmetrical openings - **8" left / 24" right**, fixed shelves. High base. LP laminate back.

**Required Specifications**

Veneer finish  
Laminate finish

**Optional Specifications**

Lock\*  
Handles\*  
Veneer back panel

## 32"W FREESTANDING BOOKCASES - HIGH BASE

## MODEL#

## DIMENSIONS

## FREIGHT CLASS

## WT/LBS.

## CUBIC FT.

## LAMINATE

## VENEER

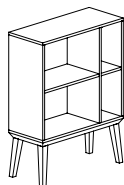

Freestanding Bookcase

	D x W x H						
CBYB2RHB	14.5 x 32 x 42.75	100	106	13	\$3043	\$3804	

Freestanding two-high bookcase with asymmetrical openings - **24" left / 8" right**, fixed shelves. High base. LP laminate back.

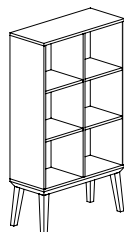

Freestanding Bookcase

CBYB3HB	14.5 x 32 x 57	125	119	18	\$3822	\$4779	
---------	----------------	-----	-----	----	--------	--------	--

Freestanding three-high bookcase with symmetrical 16" wide openings, fixed shelves. High base. LP Laminate back.

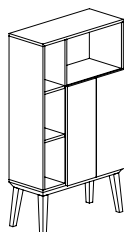

Freestanding Bookcase\*

CBYB4LHB	14.5 x 32 x 57	125	143	18	\$4355	\$5444	
----------	----------------	-----	-----	----	--------	--------	--

Freestanding three-high bookcase with asymmetrical openings - **8" left / 24" right**, fixed shelves, two door storage lower right with one adjustable shelf. High base. LP Laminate back.

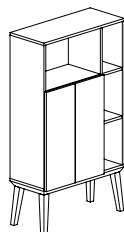

Freestanding Bookcase\*

CBYB4RHB	14.5 x 32 x 57	125	143	18	\$4355	\$5444	
----------	----------------	-----	-----	----	--------	--------	--

Freestanding three-high bookcase with asymmetrical openings - **24" left / 8" right**, fixed shelves, two door storage lower right with one adjustable shelf. High base. LP Laminate back.

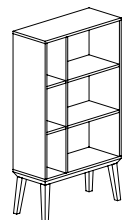

Freestanding Bookcase

CBYB5LHB	14.5 x 32 x 57	125	131	18	\$3822	\$4779	
----------	----------------	-----	-----	----	--------	--------	--

Freestanding three-high bookcase with asymmetrical openings - **8" left / 24" right**, fixed shelves. High base. LP Laminate back.

**Required Specifications**

Veneer finish  
Laminate finish

**Optional Specifications**

Lock\*  
Handles\*  
Veneer back panel

32"W FREESTANDING BOOKCASES - HIGH BASE

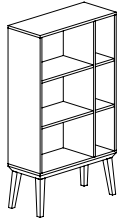

Freestanding Bookcase

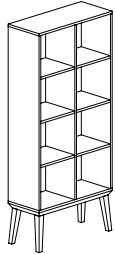

Freestanding Bookcase

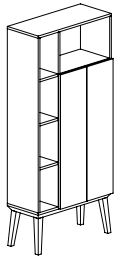

Freestanding Bookcase\*

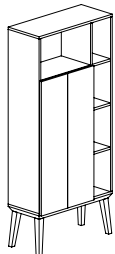

Freestanding Bookcase\*

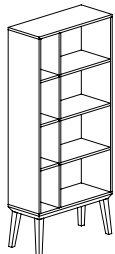

Freestanding Bookcase

MODEL#	DIMENSIONS	FREIGHT CLASS	WT/LBS.	CUBIC FT.	LAMINATE	veneer
--------	------------	---------------	---------	-----------	----------	--------

	D x W x H					
CBYB5RHB	14.5 x 32 x 57	125	131	18	\$3822	\$4779

Freestanding three-high bookcase with asymmetrical openings - **24" left / 8" right**, fixed shelves. High base. LP Laminate back.

CBYB6HB	14.5 x 32 x 71.5	125	157	22	\$4759	\$5949
---------	------------------	-----	-----	----	--------	--------

Freestanding four-high bookcase with symmetrical 16" wide openings, fixed shelves. High base. LP Laminate back.

CBYB7LHB	14.5 x 32 x 71.5	125	174	22	\$5571	\$6965
----------	------------------	-----	-----	----	--------	--------

Freestanding four-high bookcase with asymmetrical openings - **8" left / 24" right**, fixed shelves, two door storage lower right with two adjustable shelves. High base. LP Laminate back.

CBYB7RHB	14.5 x 32 x 71.5	125	174	22	\$5571	\$6965
----------	------------------	-----	-----	----	--------	--------

Freestanding four-high bookcase with asymmetrical openings - **24" left / 8" right**, fixed shelves, two door storage lower left with two adjustable shelves. High base. LP Laminate back.

CBYB8LHB	14.5 x 32 x 71.5	125	157	22	\$4759	\$5949
----------	------------------	-----	-----	----	--------	--------

Freestanding four-high bookcase with asymmetrical openings - **8" left / 24" right**, fixed shelves. High base. LP Laminate back.

**Required Specifications**

Veneer finish  
Laminate finish

**Optional Specifications**

Lock\*  
Handles\*  
Veneer back panel

## 32"W FREESTANDING BOOKCASES - HIGH BASE

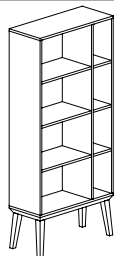

Freestanding Bookcase

## MODEL# DIMENSIONS FREIGHT CLASS WT/LBS. CUBIC FT. LAMINATE VENEER

MODEL#	DIMENSIONS D x W x H	FREIGHT CLASS	WT/LBS.	CUBIC FT.	LAMINATE	VENEER
CBYB8RHB	14.5 x 32 x 71.5	125	157	22	\$4759	\$5949

Freestanding four-high bookcase with asymmetrical openings - **24" left / 8" right**, fixed shelves. High base. LP Laminate back.

## 64"W FREESTANDING BOOKCASES - LOW BASE

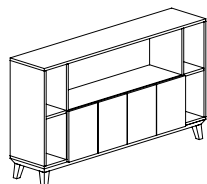

Freestanding Bookcase\*

## MODEL# DIMENSIONS FREIGHT CLASS WT/LBS. CUBIC FT. LAMINATE VENEER

CBYB9LB	14.5 x 64 x 35.5	100	177	21	\$4964	\$6205
---------	------------------	-----	-----	----	--------	--------

Freestanding two-high bookcase with four door storage lower center, 48" open fixed upper shelf and 8" open fixed shelves on either side. Low base. LP Laminate back.

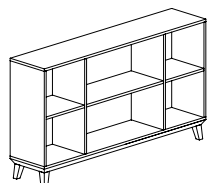

Freestanding Bookcase

CBYB10LB	14.5 x 64 x 35.5	125	162	21	\$4291	\$5364
----------	------------------	-----	-----	----	--------	--------

Freestanding two-high bookcase, 32" open fixed shelf center, and 16" open fixed shelves on either side. Low base. LP Laminate back.

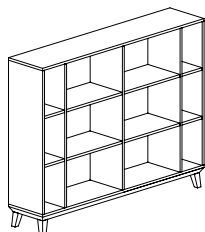

Freestanding Bookcase

CBYB11LB	14.5 x 64 x 50	125	217	30	\$4570	\$5713
----------	----------------	-----	-----	----	--------	--------

Freestanding three-high bookcase, two 24" open fixed shelves center, and 8" open fixed shelves on either side. Low base. LP Laminate back.

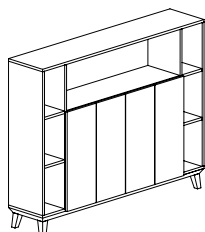

Freestanding Bookcase\*

CBYB12LB	14.5 x 64 x 50	125	237	30	\$7190	\$8988
----------	----------------	-----	-----	----	--------	--------

Freestanding three-high bookcase, four door storage lower center with adjustable shelves, 48" open fixed shelf upper, and 8" open fixed shelves on either side. Low base. LP Laminate back.

**Required Specifications**

Veneer finish  
Laminate finish

**Optional Specifications**

Lock\*  
Handles\*  
Veneer back panel

**64"W FREESTANDING BOOKCASES - LOW BASE**

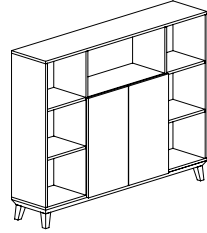

**Freestanding Bookcase\***

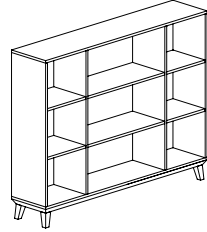

**Freestanding Bookcase**

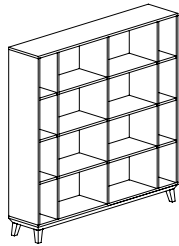

**Freestanding Bookcase**

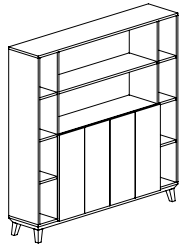

**Freestanding Bookcase\***

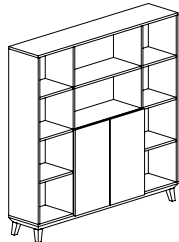

**Freestanding Bookcase\***

MODEL#	DIMENSIONS	FREIGHT CLASS	WT/LBS.	CUBIC FT.	LAMINATE	VENEER
--------	------------	---------------	---------	-----------	----------	--------

CBYB13LB	14.5 x 64 x 50	125	223	30	<b>\$6443</b>	<b>\$8054</b>
----------	----------------	-----	-----	----	---------------	---------------

Freestanding three-high bookcase, two door storage lower center with adjustable shelves, 32" open fixed shelf upper, and 16" open fixed shelves on either side. Low base. LP laminate back.

CBYB14LB	14.5 x 64 x 50	125	207	30	<b>\$5769</b>	<b>\$7213</b>
----------	----------------	-----	-----	----	---------------	---------------

Freestanding three-high bookcase, 32" open fixed shelves center, and 16" open fixed shelves on either side. Low base. LP laminate back.

CBYB15LB	14.5 x 64 x 64	125	265	38	<b>\$7723</b>	<b>\$9654</b>
----------	----------------	-----	-----	----	---------------	---------------

Freestanding four-high bookcase, two 24" open fixed shelves center, and 8" open fixed shelves on either side. Low base. LP laminate back.

CBYB16LB	14.5 x 64 x 64	125	281	38	<b>\$8780</b>	<b>\$10977</b>
----------	----------------	-----	-----	----	---------------	----------------

Freestanding four-high bookcase, four door storage lower center with adjustable shelves, 48" open fixed upper shelves, and 8" open fixed shelves on either side. Low base. LP laminate back.

CBYB17LB	14.5 x 64 x 64	125	267	38	<b>\$7780</b>	<b>\$9727</b>
----------	----------------	-----	-----	----	---------------	---------------

Freestanding four-high bookcase, two door storage lower center with adjustable shelves, 32" open fixed upper shelves, and 16" open fixed shelves on either side. Low base. LP laminate back.

**Required Specifications**

Veneer finish  
Laminate finish

**Optional Specifications**

Lock\*  
Handles\*  
Veneer back panel

## 64"W FREESTANDING BOOKCASES - LOW BASE

MODEL#	DIMENSIONS	FREIGHT CLASS	WT/LBS.	CUBIC FT.	LAMINATE	VENEER
--------	------------	---------------	---------	-----------	----------	--------

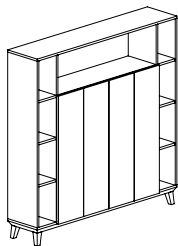

Freestanding Bookcase\*

	D x W x H					
CBYB18LB	14.5 x 64 x 64	125	295	38	\$8937	\$11172

Freestanding four-high bookcase, four door storage lower center with adjustable shelves, 48" open fixed upper shelf, and 8" open fixed shelves on either side. Low base. LP Laminate back.

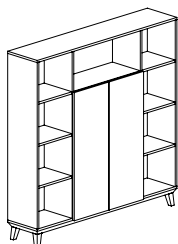

Freestanding Bookcase\*

CBYB19LB	14.5 x 64 x 64	125	275	38	\$7938	\$9923
----------	----------------	-----	-----	----	--------	--------

Freestanding four-high bookcase, four door storage lower center with adjustable shelves, 32" open fixed upper shelf, and 16" open fixed shelves on either side. Low base. LP Laminate back.

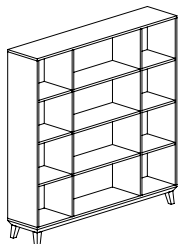

Freestanding Bookcase

CBYB20LB	14.5 x 64 x 64	125	251	38	\$7256	\$9070
----------	----------------	-----	-----	----	--------	--------

Freestanding four-high bookcase, 32" open fixed shelves center, and 16" open fixed shelves on either side. Low base. LP Laminate back.

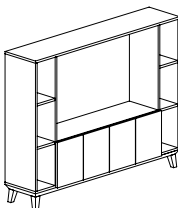

Freestanding Media Cabinet\*

CBYTV1LB	14.5 x 64 x 50	125	222	30	\$6803	\$8503
----------	----------------	-----	-----	----	--------	--------

Freestanding media cabinet, 48" wide two high opening can accommodate up to a 50" monitor, four door storage lower center, 8" open fixed shelf center on either side. Monitor mount is optional. Please see accessories. Low base. LP Laminate back.

## 64"W FREESTANDING BOOKCASES - HIGH BASE

MODEL#	DIMENSIONS	FREIGHT CLASS	WT/LBS.	CUBIC FT.	LAMINATE	VENEER
--------	------------	---------------	---------	-----------	----------	--------

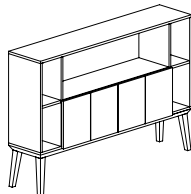

Freestanding Bookcase\*

CBYB9HB	14.5 x 64 x 42.75	125	182	26	\$5276	\$6595
---------	-------------------	-----	-----	----	--------	--------

Freestanding two-high bookcase with four door storage lower center, 48" open fixed upper shelf and 8" open fixed shelves on either side. High base. LP Laminate back.

**Required Specifications**

Veneer finish  
Laminate finish

**Optional Specifications**

Lock\*  
Handles\*  
Veneer back panel

**64"W FREESTANDING BOOKCASES - HIGH BASE**



**Freestanding Bookcase**

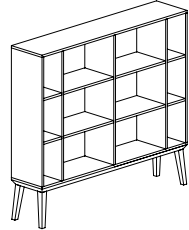

**Freestanding Bookcase**

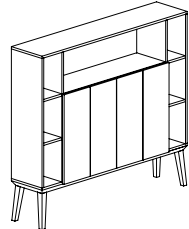

**Freestanding Bookcase\***

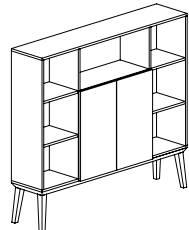

**Freestanding Bookcase\***

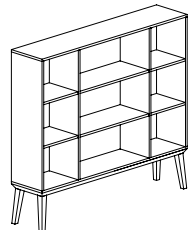

**Freestanding Bookcase**

MODEL#	DIMENSIONS	FREIGHT CLASS	WT/LBS.	CUBIC FT.	LAMINATE	VENEER
--------	------------	---------------	---------	-----------	----------	--------

**D x W x H**

CBYB10HB	14.5 x 64 x 42.75	125	167	26	<b>\$4603</b>	<b>\$5755</b>
----------	-------------------	-----	-----	----	---------------	---------------

Freestanding two-high bookcase, 32" open fixed shelf center, and 16" open fixed shelves on either side. High base. LP Laminate back.

CBYB11HB	14.5 x 64 x 57	125	222	34	<b>\$4882</b>	<b>\$6103</b>
----------	----------------	-----	-----	----	---------------	---------------

Freestanding three-high bookcase, two 24" open fixed shelves center, and 8" open fixed shelves on either side. High base. LP Laminate back.

CBYB12HB	14.5 x 64 x 57	125	242	34	<b>\$7502</b>	<b>\$9379</b>
----------	----------------	-----	-----	----	---------------	---------------

Freestanding three-high bookcase, four door storage lower center with adjustable shelves, 48" open fixed shelf upper, and 8" open fixed shelves on either side. High base. LP Laminate back.

CBYB13HB	14.5 x 64 x 57	125	228	34	<b>\$6753</b>	<b>\$8443</b>
----------	----------------	-----	-----	----	---------------	---------------

Freestanding three-high bookcase, two door storage lower center with adjustable shelves, 32" open fixed shelf upper, and 16" open fixed shelves on either side. High base. LP laminate back.

CBYB14HB	14.5 x 64 x 57	125	212	34	<b>\$6083</b>	<b>\$7604</b>
----------	----------------	-----	-----	----	---------------	---------------

Freestanding three-high bookcase, 32" open fixed shelves center, and 16" open fixed shelves on either side. High base. LP Laminate back.

**Required Specifications**

Veneer finish  
Laminate finish

**Optional Specifications**

Lock\*  
Handles\*  
Veneer back panel

## 64"W FREESTANDING BOOKCASES - HIGH BASE

## MODEL#

## DIMENSIONS

## FREIGHT CLASS

## WT/LBS.

## CUBIC FT.

## LAMINATE

## VENEER

## D x W x H

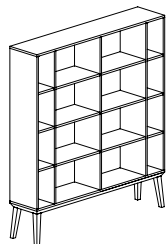

Freestanding Bookcase

MODEL#	DIMENSIONS	FREIGHT CLASS	WT/LBS.	CUBIC FT.	LAMINATE	VENEER
CBYB15HB	14.5 x 64 x 71.5	125	270	43	\$8035	\$10045

Freestanding four-high bookcase, two 24" open fixed shelves center, and 8" open fixed shelves on either side. High base. LP Laminate back.

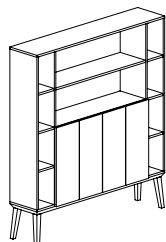

Freestanding Bookcase\*

CBYB16HB	14.5 x 64 x 71.5	125	286	43	\$9095	\$11369
----------	------------------	-----	-----	----	--------	---------

Freestanding four-high bookcase, four door storage lower center with adjustable shelves, 48" open fixed upper shelves, and 8" open fixed shelves on either side. High base. LP Laminate back.

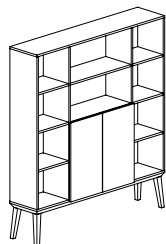

Freestanding Bookcase\*

CBYB17HB	14.5 x 64 x 71.5	125	272	43	\$8094	\$10118
----------	------------------	-----	-----	----	--------	---------

Freestanding four-high bookcase, two door storage lower center with adjustable shelves, 32" open fixed upper shelves, and 16" open fixed shelves on either side. High base. LP laminate back.

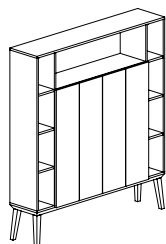

Freestanding Bookcase\*

CBYB18HB	14.5 x 64 x 71.5	125	300	43	\$9249	\$11563
----------	------------------	-----	-----	----	--------	---------

Freestanding four-high bookcase, four door storage lower center with adjustable shelves, 48" open fixed upper shelf, and 8" open fixed shelves on either side. High base. LP laminate back.

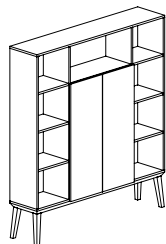

Freestanding Bookcase\*

CBYB19HB	14.5 x 64 x 71.5	125	280	43	\$8251	\$10314
----------	------------------	-----	-----	----	--------	---------

Freestanding four-high bookcase, four door storage lower center with adjustable shelves, 32" open fixed upper shelf, and 16" open fixed shelves on either side. High base. LP Laminate back.

**Required Specifications**

Veneer finish  
Laminate finish

**Optional Specifications**

Lock\*  
Handles\*  
Veneer back panel

64"W FREESTANDING BOOKCASES - HIGH BASE

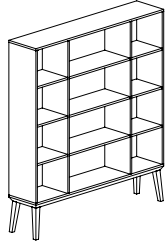

Freestanding Bookcase

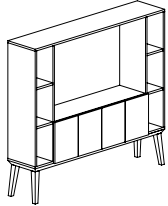

Freestanding Media Cabinet\*

MODEL#	DIMENSIONS	FREIGHT CLASS	WT/LBS.	CUBIC FT.	LAMINATE	VENEER
--------	------------	---------------	---------	-----------	----------	--------

D x W x H						
CBYB20HB	14.5 x 64 x 71.5	150	256	43	\$7566	\$9459

Freestanding four-high bookcase, 32" open fixed shelves center, and 16" open fixed shelves on either side. High base. LP Laminate back.

CBYTV1HB	14.5 x 64 x 57	125	227	34	\$7115	\$8892
----------	----------------	-----	-----	----	--------	--------

Freestanding media cabinet, 48" wide two high opening can accommodate up to a 50" monitor, four door storage lower center, 8" open fixed shelf center on either side. Monitor mount is optional. Please see accessories. High base. LP Laminate back.

ROOM DIVIDING BOOKCASES - LOW BASE

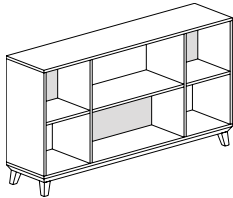

Freestanding Bookcase

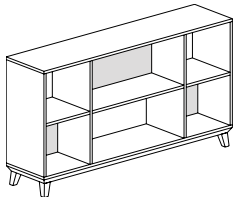

Freestanding Bookcase

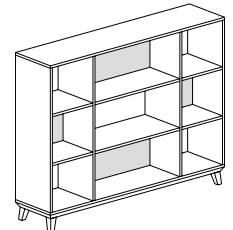

Freestanding Bookcase

MODEL#	DIMENSIONS	FREIGHT CLASS	WT/LBS.	CUBIC FT.	LAMINATE	VENEER
--------	------------	---------------	---------	-----------	----------	--------

CBYB28LB	15 x 64 x 35	125	162	21	\$6141	\$7678
----------	--------------	-----	-----	----	--------	--------

*Shaded areas indicate closed cavities.*

Freestanding two-high bookcase for use in open plan areas as space division. Low base. LP laminate back.

- Two 32" fixed shelves in center. Top cavity is open as a pass-through, bottom cavity is closed.
- 16" fixed shelves on either side. Top cavity is closed, bottom is open as a pass-through.

CBYB29LB	15 x 64 x 35	125	162	21	\$6141	\$7678
----------	--------------	-----	-----	----	--------	--------

*Shaded areas indicate closed cavities.*

Freestanding two-high bookcase for use in open plan areas as space division. Low base. LP laminate back.

- Two 32" fixed shelves in center. Top cavity is closed, bottom cavity is open as a pass-through.
- 16" fixed shelves on either side. Top cavity is open as a pass-through, bottom is closed.

CBYB26LB	15 x 64 x 49	125	217	30	\$7076	\$8847
----------	--------------	-----	-----	----	--------	--------

*Shaded areas indicate closed cavities.*

Freestanding three-high bookcase for use in open plan areas as space division. Low base. LP laminate back.

- Three 32" fixed shelves in center. Top and bottom cavities are closed, middle is open as a pass-through.
- Three 16" fixed shelves on either side. Top and bottom cavities are open as a pass-through, middle is closed.

**Required Specifications**

Veneer finish  
Laminate finish

**Optional Specifications**

Lock\*  
Handles\*  
Veneer back panel

## ROOM DIVIDING BOOKCASES - LOW BASE

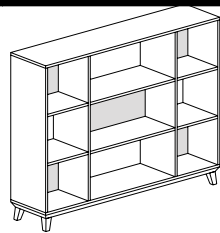

Freestanding Bookcase

MODEL#	DIMENSIONS	FREIGHT CLASS	WT/LBS.	CUBIC FT.	LAMINATE	VENEER
	<b>D x W x H</b>					
CBYB27LB	15 x 64 x 49	125	217	30	<b>\$7076</b>	<b>\$8847</b>

*Shaded areas indicate closed cavities.*

Freestanding three-high bookcase for use in open plan areas as space division. Low base. LP laminate back.

- Three 32" fixed shelves in center. Top and bottom cavities are open as a pass-through, middle is closed.
- Three 16" fixed shelves on either side. Top and bottom cavities are closed, middle is open as a pass-through.

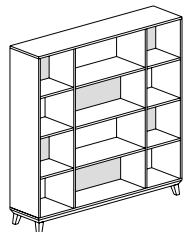

Freestanding Bookcase

CBYB22LB	15 x 64 x 64	125	265	38	<b>\$8921</b>	<b>\$11152</b>
----------	--------------	-----	-----	----	---------------	----------------

*Shaded areas indicate closed cavities.*

Freestanding four-high bookcase for use in open plan areas as space division. Low base. LP laminate back.

- Four 32" fixed shelves in center. Cavities alternate from top to bottom: open/closed/open/closed.
- Four 16" fixed shelves on either side. Cavities alternate from top to bottom: closed/open/closed/open.

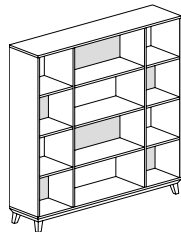

Freestanding Bookcase

CBYB23LB	15 x 64 x 64	125	265	38	<b>\$8921</b>	<b>\$11152</b>
----------	--------------	-----	-----	----	---------------	----------------

*Shaded areas indicate closed cavities.*

Freestanding four-high bookcase for use in open plan areas as space division. Low base. LP laminate back.

- Four 32" fixed shelves in center. Cavities alternate from top to bottom: closed/open/closed/open.
- Four 16" fixed shelves on either side. Cavities alternate from top to bottom: open/closed/open/closed.

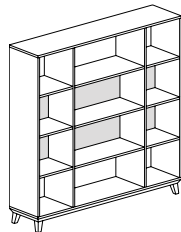

Freestanding Bookcase

CBYB24LB	15 x 64 x 64	125	265	38	<b>\$8921</b>	<b>\$11152</b>
----------	--------------	-----	-----	----	---------------	----------------

*Shaded areas indicate closed cavities.*

Freestanding four-high bookcase for use in open plan areas as space division. Low base. LP laminate back.

- Four 32" fixed shelves in center. Top and bottom cavities are open as a pass-through. Two middle cavities are closed.
- Four 16" fixed shelves on either side. Top and bottom cavities are closed. Two middle cavities are open as a pass-through.

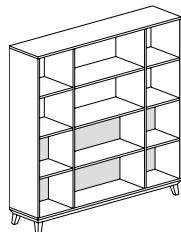

Freestanding Bookcase

CBYB25LB	15 x 64 x 64	125	265	38	<b>\$8921</b>	<b>\$11152</b>
----------	--------------	-----	-----	----	---------------	----------------

*Shaded areas indicate closed cavities.*

Freestanding four-high bookcase for use in open plan areas as space division. Low base. LP laminate back.

- Four 32" fixed shelves in center. Top two cavities are open as a pass-through. Bottom two cavities are closed.
- Four 16" fixed shelves on either side. Top two cavities are open as a pass-through. Bottom two cavities are closed.

**Required Specifications**

Veneer finish  
Laminate finish

**Optional Specifications**

Veneer back panel

ROOM DIVIDING BOOKCASES - HIGH BASE

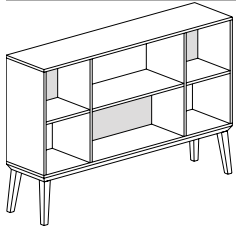

Freestanding Bookcase

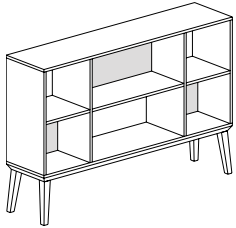

Freestanding Bookcase

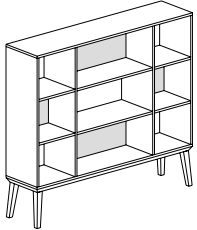

Freestanding Bookcase

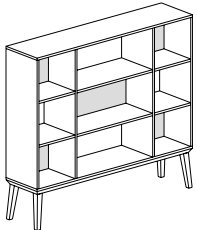

Freestanding Bookcase

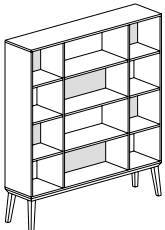

Freestanding Bookcase

MODEL#	DIMENSIONS D x W x H	FREIGHT CLASS	WT./LBS.	CUBIC FT.	LAMINATE	veneer
CBYB28HB	15 x 64 x 43	125	167	26	\$6443	\$8054

Shaded areas indicate closed cavities.

Freestanding two-high bookcase for use in open plan areas as space division. High base. LP laminate back.

- Two 32" fixed shelves in center. Top cavity is open as a pass-through, bottom cavity is closed.
- 16" fixed shelves on either side. Top cavity is closed, bottom is open as a pass-through.

CBYB29HB	15 x 64 x 43	125	167	26	\$6443	\$8054
----------	--------------	-----	-----	----	--------	--------

Shaded areas indicate closed cavities.

Freestanding two-high bookcase for use in open plan areas as space division. High base. LP laminate back.

- Two 32" fixed shelves in center. Top cavity is closed, bottom cavity is open as a pass-through.
- 16" fixed shelves on either side. Top cavity is open as a pass-through, bottom is closed.

CBYB26HB	15 x 64 x 57	125	222	34	\$7374	\$9219
----------	--------------	-----	-----	----	--------	--------

Shaded areas indicate closed cavities.

Freestanding three-high bookcase for use in open plan areas as space division. High base. LP laminate back.

- Three 32" fixed shelves in center. Top and bottom cavities are closed, middle is open as a pass-through.
- Three 16" fixed shelves on either side. Top and bottom cavities are open as a pass-through, middle is closed.

CBYB27HB	15 x 64 x 57	125	222	34	\$7374	\$9219
----------	--------------	-----	-----	----	--------	--------

Shaded areas indicate closed cavities.

Freestanding three-high bookcase for use in open plan areas as space division. High base. LP laminate back.

- Three 32" fixed shelves in center. Top and bottom cavities are open as a pass-through, middle is closed.
- Three 16" fixed shelves on either side. Top and bottom cavities are closed, middle is open as a pass-through.

CBYB22HB	15 x 64 x 72	125	270	43	\$9281	\$11603
----------	--------------	-----	-----	----	--------	---------

Shaded areas indicate closed cavities.

Freestanding four-high bookcase for use in open plan areas as space division. High base. LP laminate back.

- Four 32" fixed shelves in center. Cavities alternate from top to bottom: open/closed/open/closed.
- Four 16" fixed shelves on either side. Cavities alternate from top to bottom: closed/open/closed/open.

Required Specifications

Veneer finish  
Laminate finish

Optional Specifications

Veneer back panel

## ROOM DIVIDING BOOKCASES - HIGH BASE

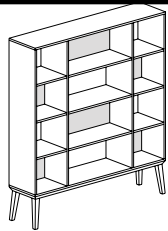

Freestanding Bookcase

MODEL#	DIMENSIONS	FREIGHT CLASS	WT/LBS.	CUBIC FT.	LAMINATE	VENEER
--------	------------	---------------	---------	-----------	----------	--------

	D x W x H					
CBYB23HB	15 x 64 x 72	125	270	43	\$9281	\$11603

*Shaded areas indicate closed cavities.*

Freestanding four-high bookcase for use in open plan areas as space division. High base. LP laminate back.

- Four 32" fixed shelves in center. Cavities alternate from top to bottom: closed/open/closed/open.
- Four 16" fixed shelves on either side. Cavities alternate from top to bottom: open/closed/open/closed.

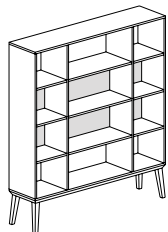

Freestanding Bookcase

CBYB24HB	15 x 64 x 72	125	270	43	\$9281	\$11603
----------	--------------	-----	-----	----	--------	---------

*Shaded areas indicate closed cavities.*

Freestanding four-high bookcase for use in open plan areas as space division. High base. LP laminate back.

- Four 32" fixed shelves in center. Top and bottom cavities are open as a pass-through. Two middle cavities are closed.
- Four 16" fixed shelves on either side. Top and bottom cavities are closed. Two middle cavities are open as a pass-through.

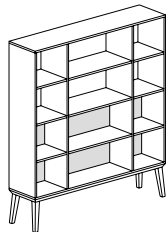

Freestanding Bookcase

CBYB25HB	15 x 64 x 72	125	270	43	\$9281	\$11603
----------	--------------	-----	-----	----	--------	---------

*Shaded areas indicate closed cavities.*

Freestanding four-high bookcase for use in open plan areas as space division. High base. LP laminate back.

- Four 32" fixed shelves in center. Top two cavities are open as a pass-through. Bottom two cavities are closed.
- Four 16" fixed shelves on either side. Top two cavities are open as a pass-through. Bottom two cavities are closed.

## FLOATING SHELF

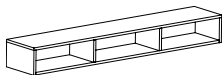

Wall Mounted Open Storage

MODEL#	DIMENSIONS	FREIGHT CLASS	WT/LBS.	CUBIC FT.	LAMINATE	VENEER
--------	------------	---------------	---------	-----------	----------	--------

CBYF096D12H8	12 x 96 x 8	125	78	10	\$2291	\$2863
CBYF064D12H8	12 x 64 x 8	125	50	8	\$1496	\$1873
CBYF032D12H8	12 x 32 x 8	100	35	4	\$1356	\$1697

To be used as a stand alone unit.

**Required Specifications**

Veneer finish  
Laminate finish

**Optional Specifications**

Veneer back panel

**ACCESSORIES**

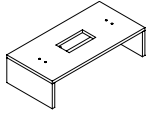

**Riser Box\***

MODEL#	DIMENSIONS D x W x H	FREIGHT CLASS	WT/LBS.	CUBIC FT.	LAMINATE	VENEER
CBYSPBOX2814	14 x 28 x 7.5	150	14	3	<b>\$236</b>	<b>\$296</b>
CBYSPBOX2014	14 x 20 x 7.5	250	2	1	<b>\$433</b>	<b>\$542</b>

Riser box for 20"H storage to support peninsula table. For wire pass through grommets, both top and back are included.

- CBYSPBOX2814 for use with 32"D peninsula tables and executive bridges.
- CBYSPBOX2014 for use with 24"D executive bridges

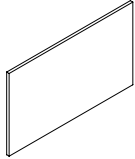

**Hanging Wood Modesty Panel\***

CBYCMWP62H22	.75 x 62 x 22	100	28	3	<b>\$892</b>	<b>\$1116</b>
CBYCMWP56H22	.75 x 56 x 22	100	26	3	<b>\$831</b>	<b>\$1040</b>
CBYCMWP50H22	.75 x 50 x 22	100	24	3	<b>\$783</b>	<b>\$980</b>
CBYCMWP44H22	.75 x 44 x 22	92.5	22	2	<b>\$719</b>	<b>\$900</b>
CBYCMWP38H22	.75 x 38 x 22	92.5	20	2	<b>\$660</b>	<b>\$826</b>

22" hanging wood modesty panel.

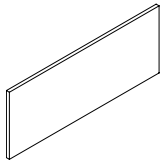

**Hanging Wood Modesty Panel\***

CBYCMWP74H15	.75 x 74 x 15	100	24	3	<b>\$917</b>	<b>\$1148</b>
CBYCMWP68H15	.75 x 68 x 15	125	23	3	<b>\$864</b>	<b>\$1081</b>
CBYCMWP62H15	.75 x 62 x 15	92.5	21	2	<b>\$864</b>	<b>\$1081</b>
CBYCMWP56H15	.75 x 56 x 15	92.5	20	2	<b>\$805</b>	<b>\$1007</b>
CBYCMWP50H15	.75 x 50 x 15	100	18	2	<b>\$756</b>	<b>\$947</b>
CBYCMWP44H15	.75 x 44 x 15	100	17	2	<b>\$691</b>	<b>\$865</b>
CBYCMWP38H15	.75 x 38 x 15	125	15	2	<b>\$633</b>	<b>\$791</b>

15" hanging wood modesty panel.

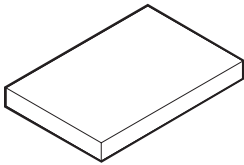

**Cushion\*\***

CU3020	20 x 30 x 2.5	150	6	1.30	1	<b>\$248</b>	7	<b>\$535</b>
	2				<b>\$294</b>	8	<b>\$634</b>	
	3				<b>\$325</b>	9	<b>\$711</b>	
	4				<b>\$374</b>	10	<b>\$794</b>	
	5				<b>\$440</b>	11	<b>\$967</b>	
	6				<b>\$474</b>	12	<b>\$1157</b>	

Cushion attaches with Velcro strips. For use on cabinets of coordinating size..

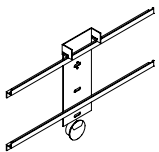

**Flat Screen Monitor Mount**

FVMED	2 x 28 x 17	70	14	.70	<b>\$783</b>
-------	-------------	----	----	-----	--------------

Flat screen monitor mount up to 50". To be used on CBYTV1LB and CBYTV1HB media cabinets. GM1K (tungsten) grommet on the back panel is included.

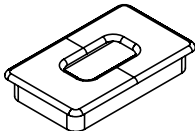

**Grommet**

GM5C	2 x 3.5 x --	70	--	--	<b>\$114</b>
------	--------------	----	----	----	--------------

Rectangular grommet in metal, tungsten finish.

**Required Specifications**

- Finish
- Fabric (cushion)\*\*

## POWER/DATA



**Single Sided Recessed Power Block**

MODEL#	DIMENSIONS	FREIGHT CLASS	WT/LBS.	CUBIC FT.	LIST PRICE
--------	------------	---------------	---------	-----------	------------

D x W x H					
-----------	--	--	--	--	--

PRTMCS401B	4.22 x 10.78 x 4.86	100	4.3	0.51	<b>\$486</b>
PRTMCS401T	4.22 x 10.78 x 4.86	100	4.3	0.51	<b>\$486</b>
PRTMCS401W	4.22 x 10.78 x 4.86	100	4.3	0.51	<b>\$486</b>

Single-sided recessed power block with **one regular duplex and one telecom knockout on top; one power duplex on bottom**. 10' power cord with straight plug. Specify telecom options separately, see page 58. Available in Black (**B**), Tungsten (**T**) or Designer White (**W**) as indicated by the last letter of model number. Duplexes always Grey. Corresponding cut-out options are **R1, R2** or **R3**. Units are not approved for daisy chaining. UL listed: UL 1363.



**Single Sided Recessed Power Block - USB-A + USB-C**

PRTMCS421B	4.22 x 10.78 x 4.86	100	4.3	0.51	<b>\$638</b>
PRTMCS421T	4.22 x 10.78 x 4.86	100	4.3	0.51	<b>\$638</b>
PRTMCS421W	4.22 x 10.78 x 4.86	100	4.3	0.51	<b>\$638</b>

Single-sided recessed power block with **one power/USB-A/USB-C duplex and one telecom knockout on top; one power duplex on bottom**. USB-A port charges max 2.4 amps at 5V and USB-C port charges max 3 amps at 5V. 10' power cord with straight plug. Specify telecom options separately, see page 58. Available in Black (**B**), Tungsten (**T**) or Designer White (**W**) as indicated by the last letter of model number. Duplexes always Grey (duplex with USB ports is glossy finish). Corresponding cut-out options are **R1, R2** or **R3**. Units are not approved for daisy chaining. UL listed: UL 1363.



**Double Sided Recessed Power Block**

PRTMCD602B	6.22 x 10.78 x 4.86	92.5	5.9	0.51	<b>\$555</b>
PRTMCD602T	6.22 x 10.78 x 4.86	92.5	5.9	0.51	<b>\$555</b>
PRTMCD602W	6.22 x 10.78 x 4.86	92.5	5.9	0.51	<b>\$555</b>

Double-sided recessed power block with **two regular power duplexes and two telecom knockouts on top; one power duplex on bottom**. 10' power cord with straight plug. Specify telecom options separately, see page 58. Available in Black (**B**), Tungsten (**T**) or Designer White (**W**) as indicated by last letter of model number. Duplexes always Grey. Corresponding cut-out options are **T1, T2** or **T3**. Units are not approved for daisy chaining. UL listed: UL 1363.



**Double Sided Recessed Power Block - USB-A + USB-C**

PRTMCD622B	6.22 x 10.78 x 4.86	92.5	6.1	0.51	<b>\$699</b>
PRTMCD622T	6.22 x 10.78 x 4.86	92.5	6.1	0.51	<b>\$699</b>
PRTMCD622W	6.22 x 10.78 x 4.86	92.5	6.1	0.51	<b>\$699</b>

Double-sided recessed power block with **one regular power duplex, one power/USB-A/USB-C duplex and two telecom knockouts on top; one power duplex on bottom**. USB-A port charges max 2.4 amps at 5V and USB-C port charges max 3 amps at 5V. 10' power cord with straight plug. Specify telecom options separately, see page 58. Available in Black (**B**), Tungsten (**T**) or Designer White (**W**) as indicated by last letter of model number. Duplexes always Grey (duplex with USB ports is glossy finish). Corresponding cut-out options are **T1, T2** or **T3**. Units are not approved for daisy chaining. UL listed: UL 1363.



**Double Sided Recessed Power Block - USB-A + USB-C**

PRTMCD642B	6.22 x 10.78 x 4.86	85	6.3	0.51	<b>\$842</b>
PRTMCD642T	6.22 x 10.78 x 4.86	85	6.3	0.51	<b>\$842</b>
PRTMCD642W	6.22 x 10.78 x 4.86	85	6.3	0.51	<b>\$842</b>

Double-sided recessed power block with **two power/USB-A/USB-C duplexes and two telecom knockouts on top; one power duplex on bottom**. USB-A port charges max 2.4 amps at 5V and USB-C port charges max 3 amps at 5V. 10' power cord with straight plug. Specify telecom options separately, see page 58. Available in Black (**B**), Tungsten (**T**) or Designer White (**W**) as indicated by last letter of model number. Duplexes always Grey (duplex with USB ports is glossy finish). Corresponding cut-out options are **T1, T2** or **T3**. Units are not approved for daisy chaining. UL listed: UL 1363.

**Required Specifications**

Finish

**POWER / DATA**

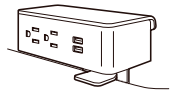

**Edge Mounted 2 Power/USB**

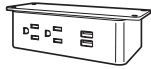

**Under Mounted 2 Power/USB\***

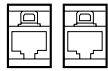

**Telecom Plate - 2 x 6**

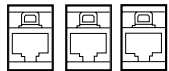

**Telecom Plate - 3 x 6**

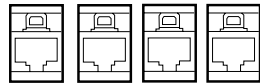

**Telecom Plate - 4 x 6**

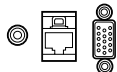

**Telecom Plate - 3TSV**

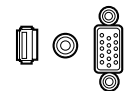

**Telecom Plate - 3SVH**

MODEL#	DIMENSIONS	FREIGHT CLASS	WT/LBS.	CUBIC FT.	LIST PRICE
--------	------------	---------------	---------	-----------	------------

**D x W x H**

PS305057	5.5 x 3.2 x 3	60	3.01	0.05	<b>\$412</b>
PS305002	5.5 x 3.2 x 3	60	3.01	0.05	<b>\$412</b>

Edge mounted power module with two power outlets and two 2.1 amp USB ports. Edge clamp accommodates worksurfaces 0.5" to 1.5" thick; fastened with thumb screws. 6' cord.

PS305057 - White module with Silver bracket. PS305002 - Black module with Silver bracket

PS305157	5.5 x 2.8 x 1.8	60	3.2	0.05	<b>\$357</b>
PS305102	5.5 x 2.8 x 1.8	60	3.2	0.05	<b>\$357</b>

Under mount power module with two power outlets and two 2.1 amp USB ports. Mountable under most worksurfaces. Installation template provided. 6' cord.

PS305157 - White module with Silver bracket. PS305102 - Black module with Silver bracket.

PTEL01	- x - x -	70	0.01	0.05	<b>\$175</b>
--------	-----------	----	------	------	--------------

Includes 2 x RJ45 cat 6 data. Black telecom plate. To be hardwired by data contractor.

PTEL02	- x - x -	70	0.01	0.05	<b>\$237</b>
--------	-----------	----	------	------	--------------

Includes 2 x RJ45 cat 6 data and 1 RJ11 cat phone. Black telecom plate. To be hardwired by data contractor.

PTEL03	- x - x -	70	0.01	0.05	<b>\$363</b>
--------	-----------	----	------	------	--------------

Includes 4 x RJ45 cat 6 data. Black telecom plate. To be hardwired by data contractor.

PTEL04	- x - x -	70	0.01	0.05	<b>\$309</b>
--------	-----------	----	------	------	--------------

Includes 1 x RJ45 cat 6 data, mini stereo and 15 pin HD VGA. Black telecom plate. To be hardwired by data contractor.

PTEL05	- x - x -	70	0.01	0.05	<b>\$428</b>
--------	-----------	----	------	------	--------------

Includes mini stereo, 15 pin HD VGA and HDMI. Black telecom plate.

**Required Specifications**

Finish\*

## ACCESSORIES

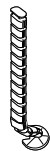

Cable Snake

MODEL#	DIMENSIONS	FREIGHT CLASS	WT/LBS.	CUBIC FT.	LIST PRICE
BRTCS	D x W x H 2 x 8 x 30	70	3	.19	<b>\$162</b>

Flexible cable management trough. Two pathways within the snake, one for data/communication and one for routing power cables. Translucent White finish only.

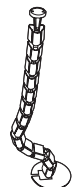

Cable Snake

PCSN01	-- x -- x --	92.5	2.10	.20	<b>\$144</b>
--------	--------------	------	------	-----	--------------

Flexible cable management. Provides access to power/data from floor to underside of worksurface where it attaches. Two pathways within Cable Snake. Length under desk is 31.25". Silver (SIL) plastic only.

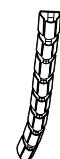

Cable Snake Extension

PCSN01E	- x - x -	92.5	2.1	0.2	<b>\$116</b>
---------	-----------	------	-----	-----	--------------

Extension kit to use with cable snake PCSN01. Additional 8 links extend cable snake up to 49" in length. Ideal for height adjustable tables. Silver plastic only.

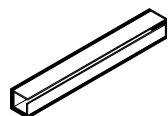

Wire Management Track - Single

C2M72	2 x 72 x 2	70	0.10	0.10	<b>\$89</b>
C2M60	2 x 60 x 2	70	0.10	0.10	<b>\$74</b>
C2M48	2 x 48 x 2	70	0.10	0.10	<b>\$61</b>
C2M36	2 x 36 x 2	70	0.10	0.10	<b>\$45</b>
C2M24	2 x 24 x 2	70	0.10	0.10	<b>\$34</b>
C2M12	2 x 12 x 2	70	0.10	0.10	<b>\$19</b>

To conceal and organize wires and cords. Attaches to Modesty Panel with double sided tape. Plastic.

• Available in Black Plastic Only.

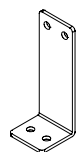

L Bracket

BAR526	--	70	.25	.10	<b>\$140</b>
--------	----	----	-----	-----	--------------

Set of two. For securing the stack-on units to the credenza.

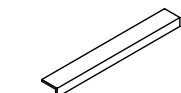

Foot Rest Cover

FRC8442	--	70	--	.10	<b>\$1216</b>
FRC7842	--	70	--	.10	<b>\$1148</b>
FRC7242	--	70	--	.10	<b>\$1081</b>
FRC6642	--	70	--	.10	<b>\$1014</b>
FRC8432	--	70	--	.10	<b>\$1081</b>
FRC7832	--	70	--	.10	<b>\$1014</b>
FRC7232	--	70	--	.10	<b>\$947</b>
FRC6632	--	70	--	.10	<b>\$879</b>

Factory installed.

**ACCESSORIES**

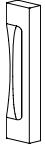

**Handle**

MODEL#	DIMENSIONS	FREIGHT CLASS	WT/LBS.	CUBIC FT.	LIST PRICE
--------	------------	---------------	---------	-----------	------------

**D x W x H**

PL89	--	70	--	--	<b>\$65</b>
------	----	----	----	----	-------------

Chrome finish.

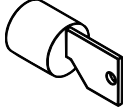

**Lock Assembly**

LO/C	--	70	--	--	<b>\$113</b>
------	----	----	----	----	--------------

Tungsten.

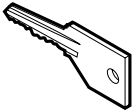

**Extra Key**

LOCK	--	70	--	--	<b>\$46</b>
------	----	----	----	----	-------------

Specify key #. Key range 401 - 420.

# dufferin



global



The **Dufferin** series is a unique entity in that it integrates wood veneer and laminate. Worksurfaces, drawer and cabinet fronts use genuine wood veneer while the chassis and cabinets are finished in your choice of laminate or wood veneer. The result is a rich, two tone appearance to coordinate with any contemporary business interior.

Key features include a two inch knife edge providing clean, crisp detailing, grommets, a reverse profile/self edge edge on connecting worksurfaces, square or round post leg on islands, base and modesty panel upgrades and endless electrical options.

Storage options are available in 29", 48", 54", 66", 72" and 84" heights. Various models include storage cabinets, file modules, mixed storage cabinets, open shelving, wardrobe cabinets and personal towers.

Above worksurface storage selections include overhead storage and hutches with or without pigeon-hole storage. Hutch doors are available in a choice of veneer or glass with an aluminum frame. Tackboards are offered in all fabric or with a built-in accessory rail for organizing folders, binders, cds and more!



Contemporary **two inch overhang knife edge** on user and guest sides. Self-edge veneer on ends and wall sides.



Optional **base upgrades** include a rectangular two tone base (shown) and elliptical base. Available on most islands.

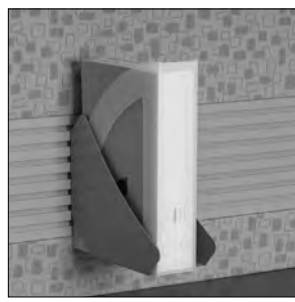

Tackboards with **accessory rails** accommodate letter trays, binder bins and file holders.



**Features and Benefits**

- Choice of ten handle options on every door/drawer that features handles
- Modesty panel options include veneer and straight glass (translucent) tungsten frame.
- Base upgrades to replace standard monopost on islands are available in four styles
- Drawers are standard vinyl-wrapped construction with black drawer sides and bottom.
- 75 lb box - 150 lb. file drawer weight capacity with full height sides with pencil tray included in box drawer
- Lateral file drawers can accommodate legal or letter documents
- Premium full extension progressive ball bearing slides on file drawers
- Box drawers mounted on 3/4 extension premium ball bearing slides.
- Power / Data accessories are available to be factory installed on any Dufferin unit, including Boardroom Tables, to meet all today's technological requirements
- A full array of complementary Boardroom and Reception area furnishings are available to coordinate the entire office

**GENERAL INFORMATION**

- Dufferin is a veneer and laminate desking system composed of hundreds of models, capable of furnishing executive suites, boardrooms and reception areas.
- 1 3/16" thick worksurfaces utilizing pedestal and panel construction with top over side panel design.
- Full modesty panels on desks are available in either a straight or breakfront style
- For environmental certification, please visit [globalfurnituregroup.com](http://globalfurnituregroup.com)

**WORKSURFACES**

- Standard with 1 3/16" top thickness
- All surfaces constructed from grade "A" veneers
- All top surfaces feature a contemporary 2" overhang knife edge on user and guest sides. Self-edge veneer on ends and wall sides.

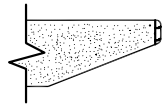

Contemporary 2" overhanging knife edge

**CONSTRUCTION**

- "Number one select, architectural grade A" oak, American black walnut, American black cherry, hard maple and lyptus. Wood worksurface molded edges are solid oak, walnut, cherry, maple or lyptus (except where square self-edges exist, i.e. credenza and computer worksurface back edges that are most commonly against walls).

**FINISHES**

- Conversion varnish (similar to catalyzed lacquer, but tougher), 35 to 40 degree sheen. Finishes are not buffed or rubbed.
- All Global wood casegood products are veneered and finished on the back sides (360° finishing), except modular under-surface storage - tops and backs are unfinished.
- Touch up kits available, includes a touch up marker and fill crayon. Order **VTUOUCHUPKIT, \$175** list. Specify finish when ordering.
- Global standard finish, on oak and walnut, is open pore and on cherry and maple is semi-closed pore. If a full finish is required for walnut, cherry, anigre and maple tops, Add the suffix "2" to the finish code and Add 5% to the base pricing for each product. **CUSTOM FINISH IS AVAILABLE.**
- High Pressure laminate inlays are available at no upcharge. Contact Customer Care for specification information.

**PEDESTALS**

- Black embossed vinyl-wrapped construction drawer sides and bottom are standard.
- All pedestals are full to floor and locking.
- Double pedestal models feature a choice of four drawer configurations: two file/file pedestals (EE), two box/box/file pedestals (DD), file/file on left, box/box/file on right (ED), or file/file on right, box/box/file on left (DE).
- Single pedestal models feature a choice of two drawer configurations: one file/file pedestal (E) or one box/box/file pedestal (D) on the left or right.

**HARDWARE**

- All necessary hardware items for attaching furniture items are included in the shipment. Actual wall attachment fasteners for wall cabinets, tackboards and visualboards are not included due to variation between site conditions.
- **Leveling glides** are shipped in a plastic bag attached to the bottom of the item or inside the pedestal. It is important to install leveling glides to ensure the unit is level. Levelers have a 1" range of adjustment.

- **Hanging file rails** are pre-installed on file drawer perimeters with additional front-to-back rails found in the bottom of the filing drawers. These rails hang onto plastic clips and do not require any tools to install. Legal filing can be achieved either as side-to-side or front-to-back. Letter filing can be achieved as front-to-back filing only.
- **Flat plates** for attaching bridge and return to desk are shipped pre-attached to the bottom of the bridge or return. **Mini flat plates** for securing bridge modesty panels to desk or credenza end panels, and quick connectors for securing modular corner units to adjacent pieces (Dufferin Series) are shipped along with screws in a plastic bag attached to the bottom of the bridge or return. **CAUTION:** using screws other than those supplied by Global could result in damage to finished tops.

**LOCKS**

- Locks are standard on all "below worksurface level" drawer and door storage units with the exception of the stationary organizer, pull-out tray units and single lateral file drawer combination tray/slot units. Combination storage unit comes with lock for file and lateral file drawer only, box drawers cannot lock.
- Optional locks may be ordered on all "above worksurface level" closed storage, Factory Installed. Please specify **LO, add \$143.**

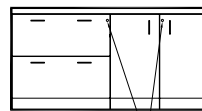
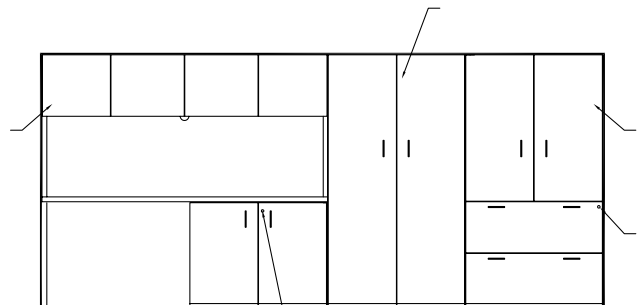

**DCF7224**

Style Credenza: File lock is on the inside gable behind the bookcase door. Lock for doors is on the front.

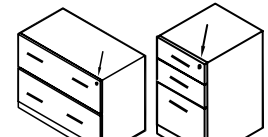

**DWF**

**DWD**

Modular Furniture: Lock is on the front

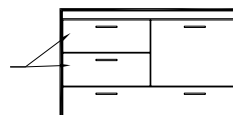

**DZ3622**

Combination storage unit Z comes with lock for file and lateral file drawer only, box drawers cannot lock.

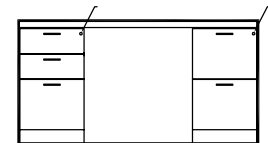

**DD7236DE**

Fully assembled furniture: Lock for D and E pedestals are inside the gable.

## 1. SPECIFY MODEL NUMBER

## 2. SPECIFY FINISH

### WORKSURFACE TOP & DRAWER/DOOR FRONTS, BODY FINISHES (including pedestals)

#### VENEER:

Code	Finish	Veneer Type	Cut
AMW	Almond Cherry	Cherry	Flat Sliced
ACW	Amber Cherry	Cherry	Flat Sliced
BTW	Biscotti	White Oak	Rift
CAW	Cocoa Walnut	Walnut	Flat Sliced
CRW	Coral	White Oak	Rift
DCW	Dark Cherry	Cherry	Flat Sliced
DWW	Dark Walnut	Walnut	Flat Sliced
EWV	Espresso Walnut	Walnut	Flat Sliced
EVW	Evening Oak	White Oak	Rift
GRW	Grey on Oak	White Oak	Rift
HAW	Hazelnut	Maple	Flat Sliced
JAW	Java	White Oak	Rift
LTW	Latte Walnut	Walnut	Flat Sliced
MHW	Mahogany on Walnut	Walnut	Flat Sliced
MTW	Milestone	White Oak	Rift
MPW	Natural Maple	Maple	Flat Sliced
NLW	Natural Walnut	Walnut	Flat Sliced
RCW	Red Cherry	Cherry	Flat Sliced
VNW	Vintage Cherry	Cherry	Flat Sliced
ULW	Umber Walnut	Walnut	Flat Sliced
WLW	Walnut	Walnut	Flat Sliced
WCW	Warm Cherry	Cherry	Flat Sliced
WMW	White Maple	Maple	Flat Sliced

#### BODY FINISHES (INCLUDING PEDESTALS) - LAMINATE:

BLK	Black
BZD	Blizzard
CGY	Custom Grey
DWT	Designer White
SDT	Stonedust
SOG	Storm Grey

#### MONOPOST FINISHES:

E	Black
K	Tungsten

## 3. SPECIFY OPTIONS

### Handles

- Handles are standard on most drawers/storage modules. Each handle is identified by letters: **PL33, PL34, PL64, PL66, PL92, PL93, PL94, PL95, PL96, PL97, PL98, PL99, PLS7, and PLS8**. To specify a handle, specify the code after the model number and finish selections.



**PL33** Black Moon Pull



**PL34** Nickel Moon Pull



**PL64** Contemporary Nickel



**PL66** Transitional Nickel



**PL92** Silver Bar



**PL93** Black Bar



**PL94** Silver Rectangular



**PL95** Black Rectangular

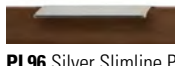

**PL96** Silver Slimline Pull

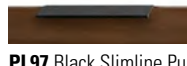

**PL97** Black Slimline Pull



**PL98** Silver Princeton Bar



**PL99** Black Princeton Bar



**PLS7** Black Spaghetti



**PLS8** Silver Spaghetti

### Grommets

- Standard grommet on all components is GM1. Grommet is included with products where shown in line drawings in price book.
- Optional grommets may be ordered in standard worksurface locations (left, center or right). Order as **GM1TL, GM1TC or GM1TR**. Add \$103.
- Grommet hole dimensions are 2.36" in diameter. Specify **GM1E** for **Black** or **GM1K** for **Tungsten**.



- Components that come standard with grommet may be ordered without a grommet. Order as RSG - Add \$57.

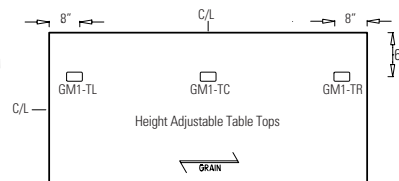
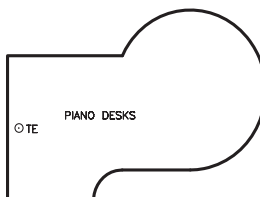
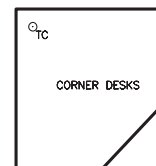
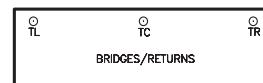
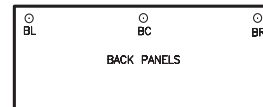
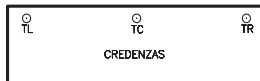
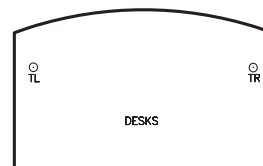

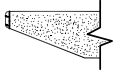

● Molding Edge

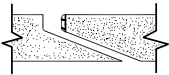

■ Reverse Profile / Molding Edge



▼ Self Edge Joint

- D - Desks and Credenzas
- B - Executive Bridges
- E - Executive Returns
- C - Corner Components
- L - Linking Bridges
- P - Piano Desks

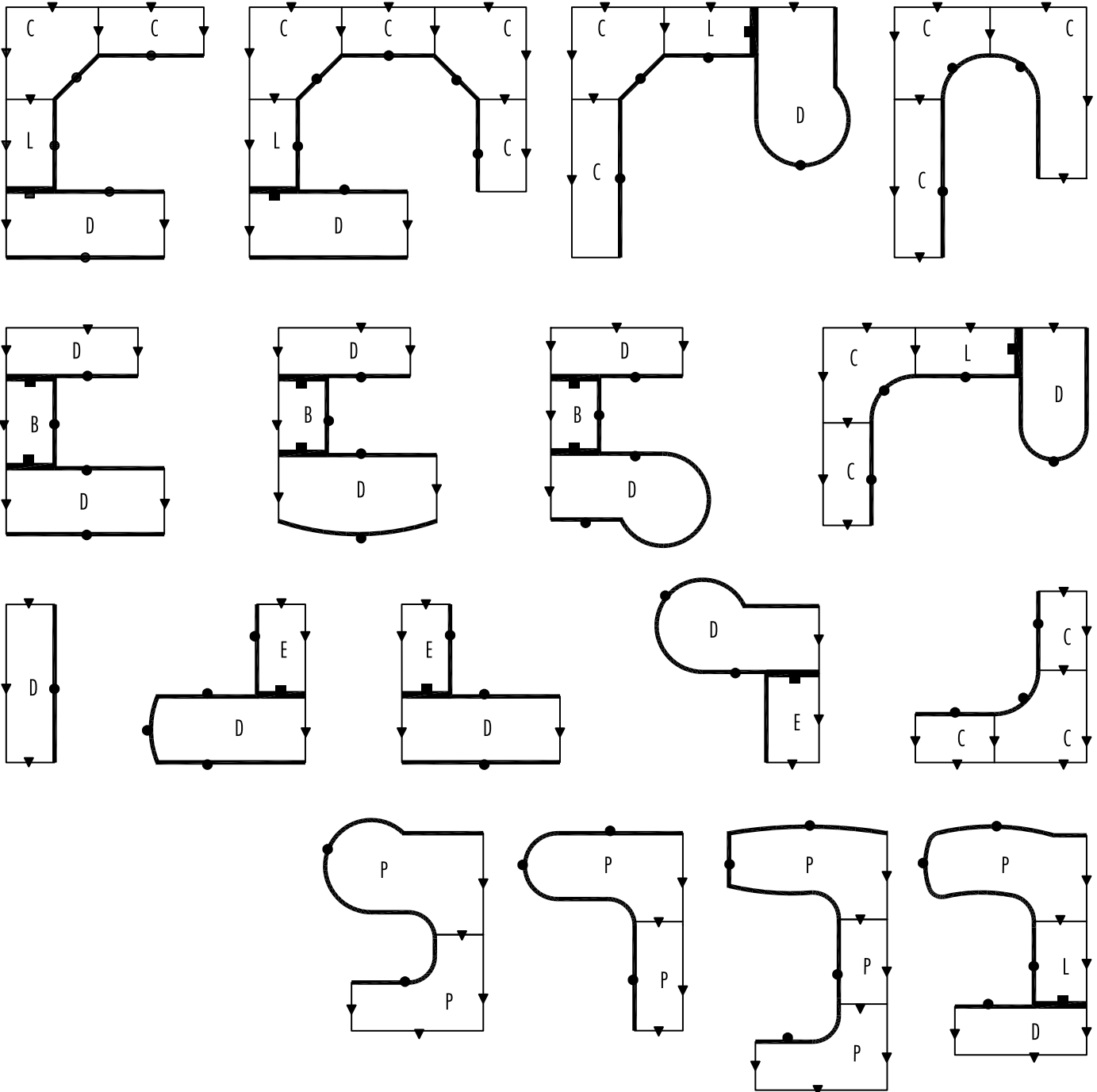

# D DUFFERIN

## DOUBLE PEDESTAL DESKS

### MODEL#

### DIMENSIONS

### FREIGHT CLASS

### WT/LBS.

### CUBIC FT.

### VENEER/LAMINATE

### ALL VENEER

D x W x H

- Can be ordered as a shell or with pedestals.
- Grommets are available an option on Desks and most Credenzas.
- Hand of Rectangular Desk is determined by location of pedestal from user side.
- Hand of "P" Top is determined by outward orientation of conference end from user projection.

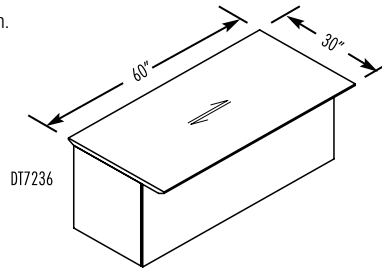
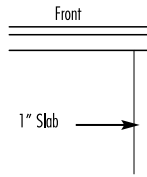
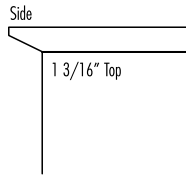
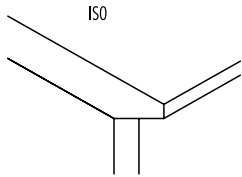

### MODESTY PANEL CLEARANCE:

DT7236

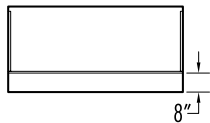

DT7230

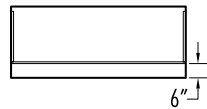

DMT7242

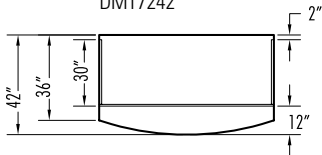

DMT6636

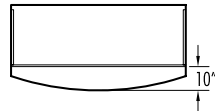

DISR8442D

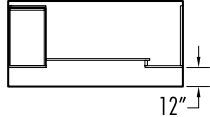

DISR7230D

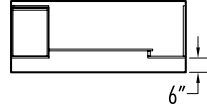

DDD7236

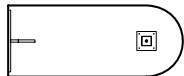

DDDBE7236



DDDBS7236



DTPL7242 (left shown)

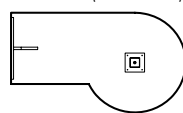

### DESK MODESTY OPTIONS:

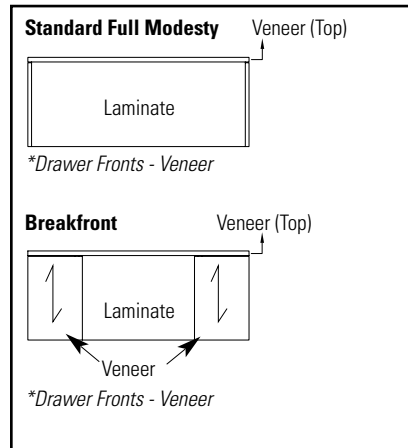

### Breakfront Style - Modesty

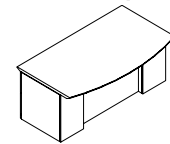

view from guest side

### Standard Full Modesty

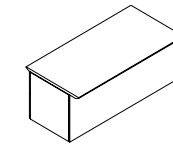

view from guest side

## DOUBLE PEDESTAL DESKS - RECESSED FRONT MODESTY

### DIMENSIONS

### FREIGHT CLASS

### WT/LBS.

### CUBIC FT.

### VENEER/LAMINATE

### ALL VENEER

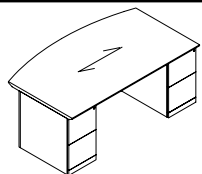

### Double Pedestal Bow Top Desk

MODEL#	DIMENSIONS	FREIGHT CLASS	WT/LBS.	CUBIC FT.	VENEER/LAMINATE	ALL VENEER
DMD8442EE	42 x 84 x 29	125	443	59	\$6531	\$7838
DMD7842EE	42 x 78 x 29	125	412	55	\$6061	\$7273
DMD7242EE	42 x 72 x 29	125	380	51	\$5598	\$6716
DMD6636EE	36 x 66 x 29	125	240	40	\$5430	\$6514

Standard with full to floor **file/file** pedestals on **left and right**. Bow top. Pedestals lock. Refer to the Desks and Credenzas Notes above for overhang dimensions. Shipped assembled in 1 carton.

### Required Specifications

Veneer Finish  
Laminate Finish  
Handle Style

### Optional Specifications

Grommet

**DOUBLE PEDESTAL DESKS**

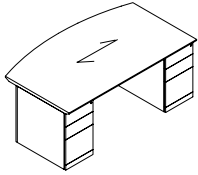

**Double Pedestal Bow Top Desk**

MODEL#	DIMENSIONS	FREIGHT CLASS	WT./LBS.	CUBIC FT.	VENEER/LAMINATE	ALL VENEER
<b>D x W x H</b>						
DMD8442DD	42 x 84 x 29	125	443	59	<b>\$6531</b>	<b>\$7838</b>
DMD7842DD	42 x 78 x 29	125	412	55	<b>\$6061</b>	<b>\$7273</b>
DMD7242DD	42 x 72 x 29	125	380	51	<b>\$5598</b>	<b>\$6716</b>
DMD6636DD	36 x 66 x 29	125	240	40	<b>\$5430</b>	<b>\$6514</b>

Standard with full to floor **box/box/file** pedestals on **left** and **right**. Bow top. Pedestals lock. One pencil tray. Refer to the Desks and Credenzas Notes Section on previous page for overhang dimensions. Shipped assembled in 1 carton.

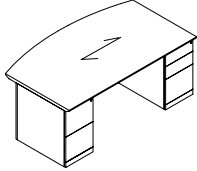

**Double Pedestal Bow Top Desk**

DMD8442ED	42 x 84 x 29	125	443	59	<b>\$6531</b>	<b>\$7838</b>
DMD7842ED	42 x 78 x 29	125	412	55	<b>\$6061</b>	<b>\$7273</b>
DMD7242ED	42 x 72 x 29	125	380	51	<b>\$5598</b>	<b>\$6716</b>
DMD6636ED	36 x 66 x 29	125	240	40	<b>\$5430</b>	<b>\$6514</b>

Standard with full to floor **file/file** pedestal on **left** and **box/box/file** pedestal on **right**. Bow top. Pedestals lock. One pencil tray. Refer to the Desks and Credenzas Notes Section on previous page for overhang dimensions. Shipped assembled in 1 carton.

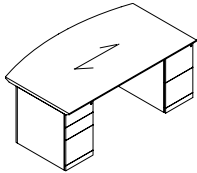

**Double Pedestal Bow Top Desk**

DMD8442DE	42 x 84 x 29	125	443	59	<b>\$6531</b>	<b>\$7838</b>
DMD7842DE	42 x 78 x 29	125	412	55	<b>\$6061</b>	<b>\$7273</b>
DMD7242DE	42 x 72 x 29	125	380	51	<b>\$5598</b>	<b>\$6716</b>
DMD6636DE	36 x 66 x 29	125	240	40	<b>\$5430</b>	<b>\$6514</b>

Standard with full to floor **box/box/file** pedestal on **left** and **file/file** pedestal on **right**. Bow top. Pedestals lock. One pencil tray. Refer to the Desks and Credenzas Notes Section on previous page for overhang dimensions. Shipped assembled in 1 carton.

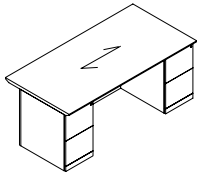

**Double Pedestal Desk**

DD8442EE	42 x 84 x 29	125	432	59	<b>\$5552</b>	<b>\$6662</b>
DD7842EE	42 x 78 x 29	125	401	55	<b>\$5158</b>	<b>\$6186</b>
DD7236EE	36 x 72 x 29	100	370	44	<b>\$4761</b>	<b>\$5711</b>
DD7230EE	30 x 72 x 29	100	349	36	<b>\$4685</b>	<b>\$5624</b>
DD6636EE	36 x 66 x 29	100	339	40	<b>\$4685</b>	<b>\$5624</b>
DD6630EE	30 x 66 x 29	100	320	33	<b>\$4612</b>	<b>\$5534</b>
DD6030EE	30 x 60 x 29	92.5	305	30	<b>\$4468</b>	<b>\$5363</b>

Standard with full to floor **file/file** pedestals on **left** and **right**. Pedestals lock. Refer to the Desks and Credenzas Notes Section on previous page for overhang dimensions. Shipped assembled in 1 carton.

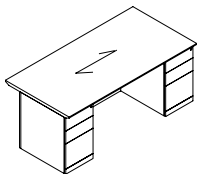

**Double Pedestal Desk**

DD8442DD	42 x 84 x 29	125	432	59	<b>\$5552</b>	<b>\$6662</b>
DD7842DD	42 x 78 x 29	125	401	55	<b>\$5158</b>	<b>\$6186</b>
DD7236DD	36 x 72 x 29	100	370	44	<b>\$4761</b>	<b>\$5711</b>
DD7230DD	30 x 72 x 29	100	349	36	<b>\$4685</b>	<b>\$5624</b>
DD6636DD	36 x 66 x 29	100	339	40	<b>\$4685</b>	<b>\$5624</b>
DD6630DD	30 x 66 x 29	100	320	33	<b>\$4612</b>	<b>\$5534</b>
DD6030DD	30 x 60 x 29	92.5	305	30	<b>\$4468</b>	<b>\$5363</b>

Standard with full to floor **box/box/file** pedestals on **left** and **right**. Pedestals lock. Refer to the Desks and Credenzas Notes Section on previous page for overhang dimensions. Shipped assembled in 1 carton.

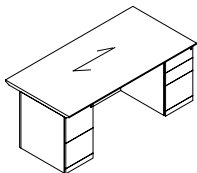

**Double Pedestal Desk**

DD8442ED	42 x 84 x 29	125	432	59	<b>\$5552</b>	<b>\$6662</b>
DD7842ED	42 x 78 x 29	125	401	55	<b>\$5158</b>	<b>\$6186</b>
DD7236ED	36 x 72 x 29	100	370	44	<b>\$4761</b>	<b>\$5711</b>
DD7230ED	30 x 72 x 29	100	349	36	<b>\$4685</b>	<b>\$5624</b>
DD6636ED	36 x 66 x 29	100	339	40	<b>\$4685</b>	<b>\$5624</b>
DD6630ED	30 x 66 x 29	100	320	33	<b>\$4612</b>	<b>\$5534</b>
DD6030ED	30 x 60 x 29	92.5	305	30	<b>\$4468</b>	<b>\$5363</b>

Standard with full to floor **file/file** pedestal on **left** and **box/box/file** pedestal on **right**. Pedestals lock. Refer to the Desks and Credenzas Notes Section on previous page for overhang dimensions. Shipped assembled in 1 carton.

**Required Specifications**

Veneer Finish  
Laminate Finish  
Handle Style

**Optional Specifications**

Grommet

DOUBLE PEDESTAL DESKS

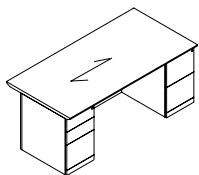

Double Pedestal Desk

MODEL#	DIMENSIONS D x W x H	FREIGHT CLASS	WT/LBS.	CUBIC FT.	VENEER/LAMINATE	ALL VENEER
DD8442DE	42 x 84 x 29	125	432	59	\$5552	\$6662
DD7842DE	42 x 78 x 29	125	401	55	\$5158	\$6186
DD7236DE	36 x 72 x 29	100	370	44	\$4761	\$5711
DD7230DE	30 x 72 x 29	100	349	36	\$4685	\$5624
DD6636DE	36 x 66 x 29	100	339	40	\$4685	\$5624
DD6630DE	30 x 66 x 29	100	320	33	\$4612	\$5534
DD6030DE	30 x 60 x 29	92.5	305	30	\$4468	\$5363

Standard with full to floor **box/box/file** pedestal on **left** and **file/file** pedestal on **right**. Pedestals lock. Refer to the Desks and Credenzas Notes Section on page 66 for overhang dimensions. Shipped assembled in 1 carton.

DOUBLE PEDESTAL DESKS - BREAKFRONT STYLE

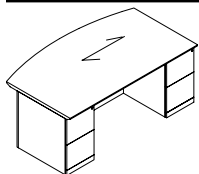

Double Pedestal Bow Top Desk Breakfront Style

MODEL#	DIMENSIONS	FREIGHT CLASS	WT/LBS.	CUBIC FT.	VENEER/LAMINATE	ALL VENEER
DMID8442EE	42 x 84 x 29	125	443	59	\$7753	\$9301
DMID7842EE	42 x 78 x 29	125	412	55	\$7198	\$8639
DMID7242EE	42 x 72 x 29	125	380	51	\$6647	\$7975
DMID6636EE	36 x 66 x 29	125	240	40	\$5974	\$7169

Standard with full to floor **file/file** pedestals on **left** and **right**. Bow top. Pedestals lock. Refer to the Desks and Credenzas Notes Section on page 66. for overhang dimensions. Shipped assembled in 1 carton.

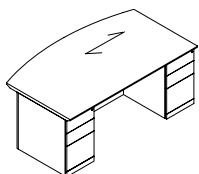

Double Pedestal Bow Top Desk Breakfront Style

DMID8442DD	42 x 84 x 29	125	443	59	\$7753	\$9301
DMID7842DD	42 x 78 x 29	125	412	55	\$7198	\$8639
DMID7242DD	42 x 72 x 29	125	380	51	\$6647	\$7975
DMID6636DD	36 x 66 x 29	125	240	40	\$5974	\$7169

Standard with full to floor **box/box/file** pedestals on **left** and **right**. Bow top. Pedestals lock. Refer to the Desks and Credenzas Notes Section on page 66. for overhang dimensions. Shipped assembled in 1 carton.

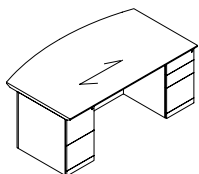

Double Pedestal Bow Top Desk Breakfront Style

DMID8442ED	42 x 84 x 29	125	443	59	\$7753	\$9301
DMID7842ED	42 x 78 x 29	125	412	55	\$7198	\$8639
DMID7242ED	42 x 72 x 29	125	380	51	\$6647	\$7975
DMID6636ED	36 x 66 x 29	125	240	40	\$5974	\$7169

Standard with full to floor **file/file** pedestal on **left** and **box/box/file** pedestal on **right**. Bow top. Pedestals lock. One pencil tray. Refer to the Desks and Credenzas Notes Section on page 66 for overhang dimensions. Shipped assembled in 1 carton.

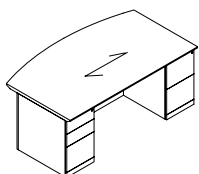

Double Pedestal Bow Top Desk Breakfront Style

DMID8442DE	42 x 84 x 29	125	443	59	\$7753	\$9301
DMID7842DE	42 x 78 x 29	125	412	55	\$7198	\$8639
DMID7242DE	42 x 72 x 29	125	380	51	\$6993	\$8394
DMID6636DE	36 x 66 x 29	125	240	40	\$5974	\$7169

Standard with full to floor **box/box/file** pedestal on **left** and **file/file** pedestal on **right**. Bow top. Pedestals lock. One pencil tray. Refer to the Desks and Credenzas Notes Section on page 66 for overhang dimensions. Shipped assembled in 1 carton.

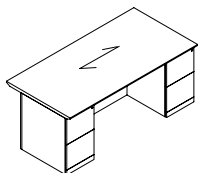

Double Pedestal Desk, Breakfront Style

DID8442EE	42 x 84 x 29	125	432	59	\$7626	\$9150
DID7842EE	42 x 78 x 29	125	401	55	\$7075	\$8494
DID7236EE	36 x 72 x 29	100	370	44	\$5654	\$6782
DID7230EE	30 x 72 x 29	100	349	36	\$5567	\$6677
DID6636EE	36 x 66 x 29	100	339	40	\$5567	\$6677
DID6630EE	30 x 66 x 29	100	320	33	\$5477	\$6572
DID6030EE	30 x 60 x 29	92.5	305	30	\$5306	\$6365

Standard with full to floor **file/file** pedestals on **left** and **right**. Pedestals lock. Refer to the Desks and Credenzas Notes Section on page 66 for overhang dimensions. Shipped assembled in 1 carton.

Required Specifications

Veneer Finish  
Laminate Finish  
Handle Style

Optional Specifications

Grommet

DOUBLE PEDESTAL DESKS - BREAKFRONT STYLE	MODEL#	DIMENSIONS	FREIGHT CLASS	WT./LBS.	CUBIC FT.	veneer/LAMINATE	ALL VENEER
		<b>D x W x H</b>					
	DID8442DD	42 x 84 x 29	125	432	59	<b>\$7626</b>	<b>\$9150</b>
	DID7842DD	42 x 78 x 29	125	401	55	<b>\$7075</b>	<b>\$8494</b>
	DID7236DD	36 x 72 x 29	100	370	44	<b>\$5654</b>	<b>\$6782</b>
	DID7230DD	30 x 72 x 29	100	349	36	<b>\$5567</b>	<b>\$6677</b>
	DID6636DD	36 x 66 x 29	100	339	40	<b>\$5567</b>	<b>\$6677</b>
	DID6630DD	30 x 66 x 29	100	320	33	<b>\$5477</b>	<b>\$6572</b>
DID6030DD	30 x 60 x 29	92.5	305	30	<b>\$5306</b>	<b>\$6365</b>	

**Double Pedestal Desk, Breakfront Style**

Standard with full to floor **box/box/file** pedestals on **left** and **right**. Pedestals lock. Refer to the Desks and Credenzas Notes Section on page 66 for overhang dimensions. Shipped assembled in 1 carton.

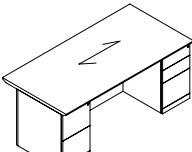
	DID8442ED	42 x 84 x 29	125	432	59	<b>\$7626</b>	<b>\$9150</b>
	DID7842ED	42 x 78 x 29	125	401	55	<b>\$7075</b>	<b>\$8494</b>
	DID7236ED	36 x 72 x 29	100	370	44	<b>\$5654</b>	<b>\$6782</b>
	DID7230ED	30 x 72 x 29	100	349	36	<b>\$5567</b>	<b>\$6677</b>
	DID6636ED	36 x 66 x 29	100	339	40	<b>\$5654</b>	<b>\$6782</b>
	DID6630ED	30 x 66 x 29	100	320	33	<b>\$5477</b>	<b>\$6572</b>
	DID6030ED	30 x 60 x 29	92.5	305	30	<b>\$5306</b>	<b>\$6365</b>

**Double Pedestal Desk, Breakfront Style**

Standard with full to floor **file/file** pedestal on **left** and **box/box/file** pedestal on **right**. Pedestals lock. Refer to the Desks and Credenzas Notes Section on page 66 for overhang dimensions. Shipped assembled in 1 carton.

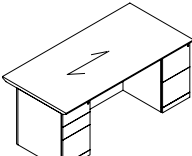
	DID8442DE	42 x 84 x 29	125	432	59	<b>\$7626</b>	<b>\$9150</b>
	DID7842DE	42 x 78 x 29	125	401	55	<b>\$7075</b>	<b>\$8494</b>
	DID7236DE	36 x 72 x 29	100	370	44	<b>\$5654</b>	<b>\$6782</b>
	DID7230DE	30 x 72 x 29	100	349	36	<b>\$5567</b>	<b>\$6677</b>
	DID6636DE	36 x 66 x 29	100	339	40	<b>\$5567</b>	<b>\$6677</b>
	DID6630DE	30 x 66 x 29	100	320	33	<b>\$5477</b>	<b>\$6572</b>
	DID6030DE	30 x 60 x 29	92.5	305	30	<b>\$5306</b>	<b>\$6365</b>

**Double Pedestal Desk, Breakfront Style**

Standard with full to floor **box/box/file** pedestal on **left** and **file/file** pedestal on **right**. Pedestals lock. Refer to the Desks and Credenzas Notes Section on page 66 for overhang dimensions. Shipped assembled in 1 carton.

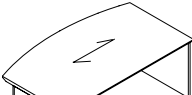
SINGLE PEDESTAL DESKS - RECESSED FRONT MODESTY		DIMENSIONS	FREIGHT CLASS	WT./LBS.	CUBIC FT.	veneer/LAMINATE	ALL VENEER
	DMSL8442E	42 x 84 x 29	125	432	59	<b>\$6144</b>	<b>\$7372</b>
	DMSL7842E	42 x 78 x 29	125	401	55	<b>\$5709</b>	<b>\$6853</b>
	DMSL7242E	42 x 72 x 29	125	370	51	<b>\$5270</b>	<b>\$6324</b>
	DMSL6636E	36 x 66 x 29	150	230	40	<b>\$5069</b>	<b>\$6080</b>

**Single Pedestal Bow Top Desk - LEFT**

Standard with full to floor **file/file** pedestal on **left**. Bow top. Pedestal locks. Refer to the Desks and Credenzas Notes Section on page 66 for overhang dimensions. Shipped assembled in 1 carton.

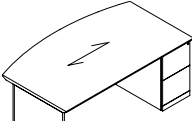
	DMSR8442E	42 x 84 x 29	125	432	59	<b>\$6144</b>	<b>\$7372</b>
	DMSR7842E	42 x 78 x 29	125	401	55	<b>\$5709</b>	<b>\$6853</b>
	DMSR7242E	42 x 72 x 29	125	370	51	<b>\$5270</b>	<b>\$6324</b>
	DMSR6636E	36 x 66 x 29	150	230	40	<b>\$5069</b>	<b>\$6080</b>

**Single Pedestal Bow Top Desk - RIGHT**

Standard with full to floor **file/file** pedestal on **right**. Bow top. Pedestal locks. Refer to the Desks and Credenzas Notes Section on page 66 for overhang dimensions. Shipped assembled in 1 carton.

**Required Specifications**

Veneer Finish  
Laminate Finish  
Handle Style

**Optional Specifications**

Grommet

SINGLE PEDESTAL DESKS

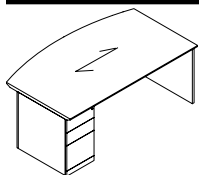

Single Pedestal Bow Top Desk - LEFT

MODEL#	DIMENSIONS D x W x H	FREIGHT CLASS	WT/LBS.	CUBIC FT.	VENEER/LAMINATE	ALL VENEER
DMSL8442D	42 x 84 x 29	125	432	59	\$6144	\$7372
DMSL7842D	42 x 78 x 29	125	401	55	\$5709	\$6853
DMSL7242D	42 x 72 x 29	125	370	51	\$5270	\$6324
DMSL6636D	36 x 66 x 29	150	230	40	\$5069	\$6080

Standard with full to floor **box/box/file** pedestal on **left**. Bow top. Pedestal locks. Refer to the Desks and Credenzas Notes Section on page 66 for overhang dimensions. Shipped assembled in 1 carton.

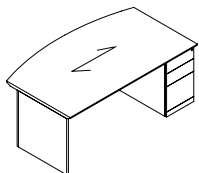

Single Pedestal Bow Top Desk - RIGHT

DMSR8442D	42 x 84 x 29	125	432	59	\$6144	\$7372
DMSR7842D	42 x 78 x 29	125	401	55	\$5709	\$6853
DMSR7242D	42 x 72 x 29	125	370	51	\$5270	\$6324
DMSR6636D	36 x 66 x 29	150	230	40	\$5069	\$6080

Standard with full to floor **box/box/file** pedestal on **right**. Bow top. Pedestal locks. Refer to the Desks and Credenzas Notes Section on page 66 for overhang dimensions. Shipped assembled in 1 carton.

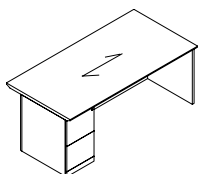

Single Pedestal Desk - LEFT

DSL8442E	42 x 84 x 29	125	463	59	\$4938	\$5923
DSL7842E	42 x 78 x 29	125	430	55	\$4584	\$5501
DSL7236E	36 x 72 x 29	125	340	44	\$3629	\$4352
DSL7230E	30 x 72 x 29	125	283	36	\$3470	\$4164
DSL6636E	36 x 66 x 29	125	312	40	\$3470	\$4164
DSL6630E	30 x 66 x 29	100	295	33	\$3312	\$3974
DSL6030E	30 x 60 x 29	100	265	30	\$3162	\$3795

Standard with full to floor **file/file** pedestal on **left**. Pedestal locks. Refer to the Desks and Credenzas Notes Section on page 66 for overhang dimensions. Shipped assembled in 1 carton.

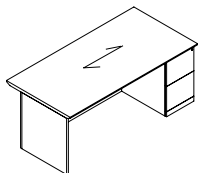

Single Pedestal Desk - RIGHT

DSR8442E	42 x 84 x 29	125	463	59	\$4938	\$5923
DSR7842E	42 x 78 x 29	125	430	55	\$4584	\$5501
DSR7236E	36 x 72 x 29	125	340	44	\$3629	\$4352
DSR7230E	30 x 72 x 29	125	283	36	\$3470	\$4164
DSR6636E	36 x 66 x 29	125	312	40	\$3470	\$4164
DSR6630E	30 x 66 x 29	100	295	33	\$3312	\$3974
DSR6030E	30 x 60 x 29	100	265	30	\$3162	\$3795

Standard with full to floor **file/file** pedestal on **right**. Pedestal locks. Refer to the Desks and Credenzas Notes Section on page 66 for overhang dimensions. Shipped assembled in 1 carton.

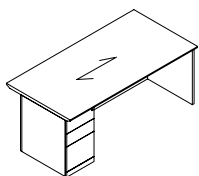

Single Pedestal Desk - LEFT

DSL8442D	42 x 84 x 29	125	463	59	\$4938	\$5923
DSL7842D	42 x 78 x 29	125	430	55	\$4584	\$5501
DSL7236D	36 x 72 x 29	125	340	44	\$3629	\$4352
DSL7230D	30 x 72 x 29	125	283	36	\$3470	\$4164
DSL6636D	36 x 66 x 29	125	312	40	\$3470	\$4164
DSL6630D	30 x 66 x 29	100	295	33	\$3312	\$3974
DSL6030D	30 x 60 x 29	100	265	30	\$3162	\$3795

Standard with full to floor **box/box/file** pedestal on **left**. Pedestal locks. Refer to the Desks and Credenzas Notes Section on page 66 for overhang dimensions. Shipped assembled in 1 carton.

Required Specifications

Veneer Finish  
Laminate Finish  
Handle Style

Optional Specifications

Grommet

SINGLE PEDESTAL DESKS	MODEL#	DIMENSIONS	FREIGHT CLASS	WT/LBS.	CUBIC FT.	VENEER/LAMINATE	ALL VENEER
		<b>D x W x H</b>					
	DSR8442D	42 x 84 x 29	125	463	59	\$4938	\$5923
	DSR7842D	42 x 78 x 29	125	430	55	\$4584	\$5501
	DSR7236D	36 x 72 x 29	125	340	44	\$3629	\$4352
	DSR7230D	30 x 72 x 29	125	283	36	\$3470	\$4164
	DSR6636D	36 x 66 x 29	125	312	40	\$3470	\$4164
	DSR6630D	30 x 66 x 29	100	295	33	\$3312	\$3974
DSR6030D	30 x 60 x 29	100	265	30	\$3162	\$3795	

**Single Pedestal Desk - RIGHT**

Standard with full to floor **box/box/file** pedestal on **right**. Pedestal locks. Refer to the Desks and Credenzas Notes Section on page 66 for overhang dimensions. Shipped assembled in 1 carton.

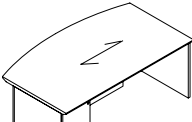
SINGLE PEDESTAL DESKS - BREAKFRONT STYLE	MODEL#	DIMENSIONS	FREIGHT CLASS	WT/LBS.	CUBIC FT.	VENEER/LAMINATE	ALL VENEER
	DMISL8442E	42 x 84 x 29	125	432	59	\$6144	\$7372
	DMISL7842E	42 x 78 x 29	125	401	55	\$5706	\$6847
	DMISL7242E	42 x 72 x 29	125	370	51	\$5268	\$6322
	DMISL6636E	36 x 66 x 29	150	230	40	\$5068	\$6078

**Single Pedestal Bow Top Desk - LEFT  
Breakfront Style**

Standard with full to floor **file/file** pedestal on **left**. Bow top. Pedestal locks. Refer to the Desks and Credenzas Notes Section on page 66 for overhang dimensions. Shipped assembled in 1 carton.

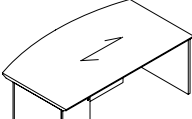
	DMISR8442E	42 x 84 x 29	125	432	59	\$6144	\$7372
	DMISR7842E	42 x 78 x 29	125	401	55	\$5706	\$6847
	DMISR7242E	42 x 72 x 29	125	370	51	\$5268	\$6322
	DMISR6636E	36 x 66 x 29	150	230	40	\$5068	\$6078

**Single Pedestal Bow Top Desk - RIGHT  
Breakfront Style**

Standard with full to floor **file/file** pedestal on **right**. Bow top. Pedestal locks. Refer to the Desks and Credenzas Notes Section on page 66 for overhang dimensions. Shipped assembled in 1 carton.

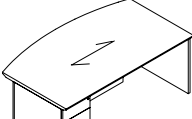
	DMISL8442D	42 x 84 x 29	125	432	59	\$6144	\$7372
	DMISL7842D	42 x 78 x 29	125	401	55	\$5706	\$6847
	DMISL7242D	42 x 72 x 29	125	370	51	\$5268	\$6322
	DMISL6636D	36 x 66 x 29	150	230	40	\$5068	\$6078

**Single Pedestal Bow Top Desk - LEFT  
Breakfront Style**

Standard with full to floor **box/box/file** pedestal on **left**. Bow top. Pedestal locks. Refer to the Desks and Credenzas Notes Section on page 66 for overhang dimensions. Shipped assembled in 1 carton.

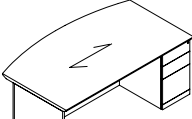
	DMISR8442D	42 x 84 x 29	125	432	59	\$6144	\$7372
	DMISR7842D	42 x 78 x 29	125	401	55	\$5706	\$6847
	DMISR7242D	42 x 72 x 29	125	370	51	\$5268	\$6322
	DMISR6636D	36 x 66 x 29	150	230	40	\$5068	\$6078

**Single Pedestal Bow Top Desk - RIGHT  
Breakfront Style**

Standard with full to floor **box/box/file** pedestal on **right**. Bow top. Pedestal locks. Refer to the Desks and Credenzas Notes Section on page 66 for overhang dimensions. Shipped assembled in 1 carton.

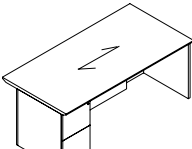
	DISL8442E	42 x 84 x 29	125	463	59	\$5862	\$7035
	DISL7842E	42 x 78 x 29	125	430	55	\$5444	\$6533
	DISL7236E	36 x 72 x 29	125	340	44	\$4311	\$5172
	DISL7230E	30 x 72 x 29	125	283	36	\$4119	\$4941
	DISL6636E	36 x 66 x 29	125	312	40	\$4119	\$4941
	DISL6630E	30 x 66 x 29	100	295	33	\$3930	\$4717
	DISL6030E	30 x 60 x 29	100	265	30	\$3758	\$4511

**Single Pedestal Desk - LEFT  
Breakfront Style**

Standard with full to floor **file/file** pedestal on **left**. Pedestal locks. Refer to the Desks and Credenzas Notes Section on page 66 for overhang dimensions. Shipped assembled in 1 carton.

**Required Specifications**

Veneer Finish  
Laminate Finish  
Handle Style

**Optional Specifications**

Grommet

## ELECTRIC HEIGHT ADJUSTABLE UNITS - NOTES

D x W x H

- All Height Adjustable (HA) units are shipped fully assembled.
- Simple Up / Down function enables the height adjustment of the worksurface.
- The height adjustment range for desks is 29" to 45", for table and bridge top 26" to 43" (including worksurface).
- Single stage HA mechanism with an electric motor in each column is used.
- The height adjustable mechanism operates at 1.5" per second.
- Max. weight / lift is 265 lbs.
- All columns are integrated into fully functional pedestals, or pedestal bases with the exception of the HA table and the HA bridge top.
- Height adjustable bases are available in three colors: **Black (BLK)**, **Tungsten (TUN)**, and **Designer White (DWT)**
- All desks include two (2) PVC wire management channels (L & R side) allowing for cabling through the pedestals.
- Hanging wood modesty panel on desk is standard. Hanging glass (aluminum framed) modesty panel is optional.
- To avoid risk of pinching:
  - 4.9" / 124mm gap is kept between the pedestal and the lowest point of the worksurface.
  - Wood spacer HASP must be used to attach height adjustable unit in the "U" or "L" configuration. See assembly instructions.
  - 2" gap is required between the worksurfaces when using the HA Table or the HA Bridge Top.
  - Includes collision detector
- Optional grommet locations: **TL** - Top Left or **TR** - Top Right

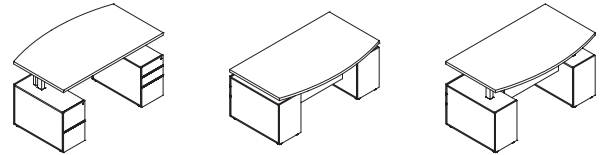
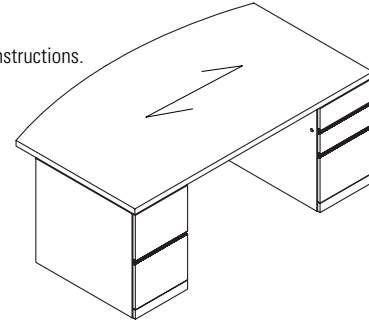

**Note:** Arrow indicates direction of grain.

HEIGHT ADJUSTABLE DOUBLE PEDESTAL DESKS	MODEL#	DIMENSIONS	FREIGHT CLASS	WT/LBS.	CUBIC FT.	VENEER/LAMINATE	ALL VENEER
---	--------	------------	---------------	---------	-----------	-----------------	------------

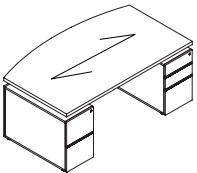

**Height Adj. Double Ped. Bow Top Desk  
Breakfront Style**

D x W x H							
DHAMID8442ED	42 x 84 x 29	150	450	81	<b>\$13124</b>	<b>\$14581</b>	
DHAMID7842ED	42 x 78 x 29	150	430	72	<b>\$12569</b>	<b>\$13965</b>	
DHAMID7242ED	42 x 72 x 29	125	410	67	<b>\$12015</b>	<b>\$13347</b>	
DHAMID6636ED	36 x 66 x 29	125	390	54	<b>\$11396</b>	<b>\$12662</b>	

Built-in electric height adjustable double pedestal, standard with full to floor **box/box/file** pedestal on **right** and **file/file** pedestal on **left**. Bow top. Pedestals lock. One pencil tray. Refer to the Desks and Credenzas Notes Section on page 66 for overhang dimensions. Shipped RTA (ready to assemble).

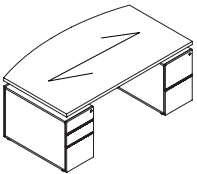

**Height Adj. Double Ped. Bow Top Desk  
Breakfront Style**

DHAMID8442DE	42 x 84 x 29	150	450	81	<b>\$13124</b>	<b>\$14581</b>	
DHAMID7842DE	42 x 78 x 29	150	430	72	<b>\$12569</b>	<b>\$13965</b>	
DHAMID7242DE	42 x 72 x 29	125	410	67	<b>\$12015</b>	<b>\$13347</b>	
DHAMID6636DE	36 x 66 x 29	125	390	54	<b>\$11396</b>	<b>\$12662</b>	

Built-in electric height adjustable double pedestal, standard with full to floor **box/box/file** pedestal on **left** and **file/file** pedestal on **right**. Bow top. Pedestals lock. One pencil tray. Refer to the Desks and Credenzas Notes Section on page 66 for overhang dimensions. Shipped RTA (ready to assemble).

**Required Specifications**

- Top Finish
- Edge
- Base finish
- Handle style

**Optional Specifications**

- Grommet
- Glass modesty

**HEIGHT ADJUSTABLE DOUBLE PEDESTAL DESKS**    **MODEL#**    **DIMENSIONS**    **FREIGHT CLASS**    **WT./LBS.**    **CUBIC FT.**    **VENEER/LAMINATE**    **ALL VENEER**

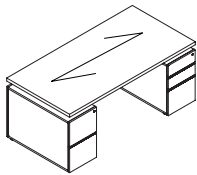

**Height Adj. Double Ped. Desk**  
**Breakfront Style**

	<b>D x W x H</b>						
DHAID8436ED	36 x 84 x 29	125	440	68	<b>\$11174</b>	<b>\$12416</b>	
DHAID7836ED	36 x 78 x 29	125	420	63	<b>\$11100</b>	<b>\$12332</b>	
DHAID7236ED	36 x 72 x 29	125	400	58	<b>\$11018</b>	<b>\$12243</b>	
DHAID7230ED	30 x 72 x 29	125	390	49	<b>\$10937</b>	<b>\$12152</b>	
DHAID6630ED	30 x 66 x 29	100	380	46	<b>\$10786</b>	<b>\$11983</b>	

Built-in electric height adjustable double pedestal, standard with full to floor **box/box/file** pedestal on **right** and **file/file** pedestal on **left**. Pedestals lock. One pencil tray. Refer to the Desks and Credenzas Notes Section on page 66 for overhang dimensions. Shipped RTA (ready to assemble).

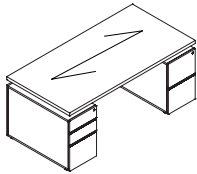

**Height Adj. Double Ped. Desk**  
**Breakfront Style**

DHAID8436DE	36 x 84 x 29	125	440	68	<b>\$11174</b>	<b>\$12416</b>	
DHAID7836DE	36 x 78 x 29	125	420	63	<b>\$11100</b>	<b>\$12332</b>	
DHAID7236DE	36 x 72 x 29	125	400	58	<b>\$11018</b>	<b>\$12243</b>	
DHAID7230DE	30 x 72 x 29	125	390	49	<b>\$10937</b>	<b>\$12152</b>	
DHAID6630DE	30 x 66 x 29	100	380	46	<b>\$10786</b>	<b>\$11983</b>	

Built-in electric height adjustable double pedestal, standard with full to floor **box/box/file** pedestal on **left** and **file/file** pedestal on **right**. Pedestals lock. One pencil tray. Refer to the Desks and Credenzas Notes Section on page 66 for overhang dimensions. Shipped RTA (ready to assemble).

**HEIGHT ADJUSTABLE SINGLE PEDESTAL DESKS**    **MODEL#**    **DIMENSIONS**    **FREIGHT CLASS**    **WT./LBS.**    **CUBIC FT.**    **VENEER/LAMINATE**    **ALL VENEER**

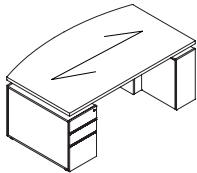

**Height Adj. Single Ped. Bow Top Desk**  
**Breakfront Style - LEFT**

DHAMISL8442D	42 x 84 x 29	150	440	59	<b>\$11511</b>	<b>\$12787</b>	
DHAMISL7842D	42 x 78 x 29	150	420	55	<b>\$11075</b>	<b>\$12306</b>	
DHAMISL7242D	42 x 72 x 29	150	400	51	<b>\$10638</b>	<b>\$11823</b>	
DHAMISL6636D	36 x 66 x 29	125	390	40	<b>\$10098</b>	<b>\$11220</b>	

Built-in electric height adjustable single pedestal bow top desk. Standard with full to floor locking **box/box/file** pedestal on **left** and support pedestal on **right**. Refer to the Desks and Credenzas Notes Section on page 66 for overhang dimensions. Shipped RTA (ready to assemble).

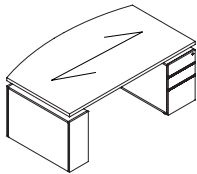

**Height Adj. Single Ped. Bow Top Desk**  
**Breakfront Style - RIGHT**

DHAMISR8442D	42 x 84 x 29	150	440	59	<b>\$11511</b>	<b>\$12787</b>	
DHAMISR7842D	42 x 78 x 29	150	420	55	<b>\$11075</b>	<b>\$12306</b>	
DHAMISR7242D	42 x 72 x 29	150	400	51	<b>\$10638</b>	<b>\$11823</b>	
DHAMISR6636D	36 x 66 x 29	125	390	40	<b>\$10098</b>	<b>\$11220</b>	

Built-in electric height adjustable single pedestal bow top desk. Standard with full to floor locking **box/box/file** pedestal on **right** and support pedestal on **left**. Refer to the Desks and Credenzas Notes Section on page 66 for overhang dimensions. Shipped RTA (ready to assemble).

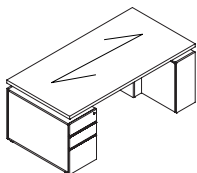

**Height Adjustable Single Ped. Desk**  
**Breakfront Style - LEFT**

DHAISL8436D	36 x 84 x 29	125	430	55	<b>\$9834</b>	<b>\$10924</b>	
DHAISL7836D	36 x 78 x 29	125	410	50	<b>\$9794</b>	<b>\$10883</b>	
DHAISL7236D	36 x 72 x 29	125	390	44	<b>\$9676</b>	<b>\$10751</b>	
DHAISL7230D	30 x 72 x 29	125	380	40	<b>\$9486</b>	<b>\$10684</b>	
DHAISL6630D	30 x 66 x 29	125	360	36	<b>\$9240</b>	<b>\$10266</b>	
DHAISL6030D	30 x 60 x 29	100	340	35	<b>\$9064</b>	<b>\$10071</b>	

Built-in electric height adjustable single pedestal desk. Standard with full to floor locking **box/box/file** pedestal on **left** and support pedestal on **right**. Refer to the Desks and Credenzas Notes Section on page 66 for overhang dimensions. Shipped RTA (ready to assemble).

**Required Specifications**

Top Finish  
Edge  
Base finish  
Handle style

**Optional Specifications**

Grommet  
Glass modesty

HEIGHT ADJUSTABLE SINGLE PEDESTAL DESKS

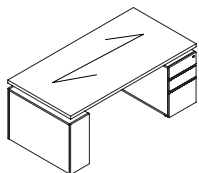

Height Adjustable Single Ped. Desk\*  
Breakfront Style - RIGHT

MODEL#	DIMENSIONS D x W x H	FREIGHT CLASS	WT/LBS.	CUBIC FT.	VENEER/LAMINATE	ALL VENEER
DHAISR8436D	36 x 84 x 29	125	430	55	\$9834	\$10924
DHAISR7836D	36 x 78 x 29	125	410	50	\$9794	\$10883
DHAISR7236D	36 x 72 x 29	125	390	44	\$9676	\$10751
DHAISR7230D	30 x 72 x 29	125	380	40	\$9486	\$10541
DHAISR6630D	30 x 66 x 29	125	360	36	\$9240	\$10266
DHAISR6030D	30 x 60 x 29	100	340	35	\$9064	\$10071

Built-in electric height adjustable single pedestal desk. Standard with full to floor locking **box/box/file** pedestal on **right** and support pedestal on **left**. Refer to the Desks and Credenzas Notes Section on page 66 for overhang dimensions. Shipped RTA (ready to assemble).

HEIGHT ADJUSTABLE DESK SHELLS

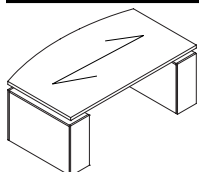

Height Adjustable Bow Top Desk Shell  
Breakfront Style

MODEL#	DIMENSIONS	FREIGHT CLASS	WT/LBS.	CUBIC FT.	VENEER/LAMINATE	ALL VENEER
DHAMIT8442	42 x 84 x 29	150	350	59	\$11151	\$12389
DHAMIT7842	42 x 78 x 29	150	330	55	\$10911	\$12122
DHAMIT7242	42 x 72 x 29	150	310	51	\$10665	\$11851
DHAMIT6636	36 x 66 x 29	150	280	40	\$9624	\$10694

Built-in electric height adjustable bow top desk shell. Shipped RTA (ready to assemble). Refer to the Desks and Credenzas Notes Section on page 66 for overhang dimensions.

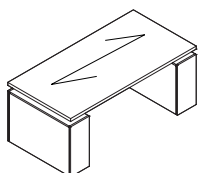

Height Adjustable Desk Shell  
Breakfront Style

DHAIT8436	36 x 84 x 29	150	330	68	\$9921	\$11022
DHAIT7836	36 x 78 x 29	150	310	63	\$9738	\$10819
DHAIT7236	36 x 72 x 29	150	290	44	\$9544	\$10605
DHAIT7230	30 x 72 x 29	150	280	40	\$8944	\$9939
DHAIT6636	36 x 66 x 29	150	260	36	\$9164	\$10183
DHAIT6630	30 x 66 x 29	150	250	35	\$8944	\$9939
DHAIT6030	30 x 60 x 29	150	240	42	\$8787	\$9762

Built-in electric height adjustable desk shell. Shipped RTA (ready to assemble). Refer to the Desks and Credenzas Notes Section on page 66 for overhang dimensions.

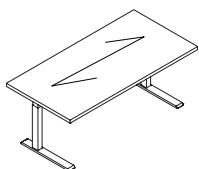

Height Adjustable Table

DHA8436	36 x 84 x 29	250	160	68	\$8030	\$8921
DHA7836	36 x 78 x 29	250	150	63	\$7847	\$8716
DHA7236	36 x 72 x 29	250	140	58	\$7649	\$8501
DHA7230	30 x 72 x 29	250	130	49	\$7052	\$7835
DHA6636	36 x 66 x 29	250	140	54	\$7273	\$8081
DHA6630	30 x 66 x 29	250	120	46	\$7052	\$7835
DHA6030	30 x 60 x 29	250	115	42	\$6895	\$7660

Electric height adjustable table. Shipped RTA (ready to assemble).

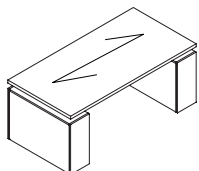

Height Adjustable Desk

DHA8436TP	36 x 84 x 29	150	320	68	\$9607	\$10688
DHA7836TP	36 x 78 x 29	150	300	63	\$9424	\$10469
DHA7236TP	36 x 72 x 29	150	280	58	\$9228	\$10253
DHA7230TP	30 x 72 x 29	150	270	49	\$8628	\$9587
DHA6636TP	36 x 66 x 29	150	250	54	\$8850	\$9832
DHA6630TP	30 x 66 x 29	150	240	46	\$8628	\$9587
DHA6030TP	30 x 60 x 29	150	230	42	\$8470	\$9412

Built-in electric height adjustable desk on TP bases. Shipped RTA (ready to assemble).

Required Specifications

- Top Finish
- Edge
- Base finish
- Handle style

Optional Specifications

- Grommet
- Glass modesty

**HEIGHT ADJUSTABLE**      **MODEL#**      **DIMENSIONS**      **FREIGHT CLASS**      **WT/LBS.**      **CUBIC FT.**       **veneer/LAMINATE**      **ALL VENEER**

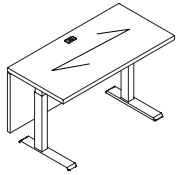

**Height Adjustable Bridge Top**

	<b>D x W x H</b>						
DHABT6024	24 x 60 x 29	150	150	35	<b>\$7482</b>	<b>\$8313</b>	
DHABT5424	24 x 54 x 29	150	140	31	<b>\$7260</b>	<b>\$8067</b>	
DHABT4824	24 x 48 x 29	150	130	28	<b>\$7040</b>	<b>\$7822</b>	
DHABT4224	24 x 42 x 29	300	29	26	<b>\$6812</b>	<b>\$7567</b>	

Electric height adjustable executive bridge top. Grommet in worksurface. Shipped RTA (ready to assemble).

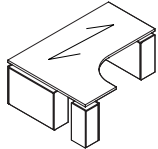

**Height Adj. Right Extended Corner Desk\***

DHAEKR60842436	24-36 x 60-84 x 29	150	450	108	<b>\$14875</b>	<b>\$16528</b>	
DHAEKR60782436	24-36 x 60-78 x 29	150	430	100	<b>\$14839</b>	<b>\$16488</b>	
DHAEKR60722436	24-36 x 60-72 x 29	150	410	93	<b>\$14512</b>	<b>\$16124</b>	
DHAEKR60662436	24-36 x 60-66 x 29	150	390	86	<b>\$14088</b>	<b>\$15655</b>	
DHAEKR60602436	24-36 x 60-60 x 29	150	370	79	<b>\$13667</b>	<b>\$15183</b>	

Built-in electric height adjustable right extended corner table desk with a 24" return connection. Extended worksurface on **right. Full end panel on right, narrow end panel on left.** Connects to Linking Bridges, Extended Corners and Connectable Tables. Shipped RTA (ready to assemble).

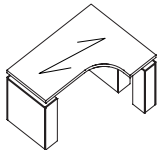

**Height Adj. Left Extended Corner Desk\***

DHAEKL84603624	24-36 x 60-84 x 29	150	450	108	<b>\$14875</b>	<b>\$16528</b>	
DHAEKL78603624	24-36 x 60-78 x 29	150	430	100	<b>\$14839</b>	<b>\$16488</b>	
DHAEKL72603624	24-36 x 60-72 x 29	150	410	93	<b>\$14512</b>	<b>\$16124</b>	
DHAEKL66603624	24-36 x 60-66 x 29	150	390	86	<b>\$14088</b>	<b>\$15655</b>	
DHAEKL60603624	24-36 x 60-60 x 29	150	370	79	<b>\$13667</b>	<b>\$15183</b>	

Built-in electric height adjustable right extended corner table desk with a 24" return connection. Extended worksurface on **left. Full end panel on left, narrow end panel on right.** Connects to Linking Bridges, Extended Corners and Connectable Tables. Shipped RTA (ready to assemble).



**Spacer**

DHASP	2 x 8 x 23	70	15	.75	<b>\$538</b>	<b>\$598</b>	
-------	------------	----	----	-----	--------------	--------------	--

Connects height adjustable desks with linking bridges and returns.

**Required Specifications**

Top Finish  
Edge  
Base finish

**Optional Specifications**

Grommet\*  
Glass modesty

HEIGHT ADJUSTABLE TOPS

MODEL# DIMENSIONS FREIGHT CLASS WT/LBS. CUBIC FT. LIST PRICE

D x W x H

DRE8226T	26 x 82 x 1.18	92.5	89	8	<b>\$2389</b>
DRE8026T	26 x 80 x 1.18	92.5	87	7.5	<b>\$2330</b>
DRE7626T	26 x 76 x 1.18	85	97	8	<b>\$2217</b>
DRE6426T	26 x 64 x 1.18	92.5	70	6	<b>\$1867</b>
DRE5226T	26 x 52 x 1.18	92.5	57	5.5	<b>\$1518</b>
DRE4626T	26 x 46 x 1.18	92.5	44	4	<b>\$1340</b>
DRE4026T	26 x 40 x 1.18	92.5	44	4	<b>\$1168</b>
DRE8229T	29 x 82 x 1.18	92.5	99	8.5	<b>\$2663</b>
DRE7629T	29 x 76 x 1.18	85	97	8	<b>\$2470</b>
DRE7029T	29 x 70 x 1.18	85	92	7.5	<b>\$2276</b>
DRE6429T	29 x 64 x 1.18	85	78	6.5	<b>\$2083</b>
DRE5229T	29 x 52 x 1.18	92.5	63	6	<b>\$1690</b>
DRE4629T	29 x 46 x 1.18	92.5	56	5	<b>\$1497</b>
DRE4029T	29 x 40 x 1.18	92.5	49	4.5	<b>\$1303</b>
DRE8235T	35 x 82 x 1.18	85	120	10	<b>\$3218</b>
DRE7635T	35 x 76 x 1.18	85	117	9.5	<b>\$2980</b>
DRE7235T	35 x 72 x 1.18	85	111	9	<b>\$2825</b>
DRE6435T	35 x 64 x 1.18	85	94	7.5	<b>\$2513</b>
DRE5235T	35 x 52 x 1.18	92.5	76	7	<b>\$2040</b>
DRE4635T	35 x 46 x 1.18	92.5	67	6	<b>\$1802</b>
DRE4035T	35 x 40 x 1.18	92.5	59	5	<b>\$1571</b>

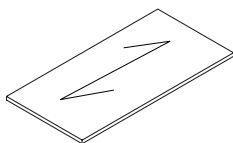

Height Adjustable Top

Dufferin tops with Dufferin edge on three sides, for use with FreeFit height adjustable table mechanisms, sold separately (FTxxxxx, see page 713 of the Desking price list for information).

- 26" deep tops accommodate FTxxxx24 mechanisms. Depth is exact to accommodate the Dufferin edge + the Freefit mechanism. *Cannot be made smaller.*
- 29" and 35" deep tops accommodate FTxxxx30 mechanisms.



HA Return Tops

**Left:**

DRE6026CGCOPLT	26 x 60 x 1.18	85	75	5.5	<b>\$1749</b>
DRE5426CGCOPLT	26 x 54 x 1.18	85	69	5	<b>\$1577</b>
DRE4826CGCOPLT	26 x 48 x 1.18	85	62	4.5	<b>\$1400</b>
DRE4226CGCOPLT	26 x 42 x 1.18	85	56	4	<b>\$1222</b>

**Right:**

DRE6026CGCOPRT	26 x 60 x 1.18	85	75	5.5	<b>\$1749</b>
DRE5426CGCOPRT	26 x 54 x 1.18	85	69	5	<b>\$1577</b>
DRE4826CGCOPRT	26 x 48 x 1.18	85	62	4.5	<b>\$1400</b>
DRE4226CGCOPRT	26 x 42 x 1.18	85	56	4	<b>\$1222</b>

Dufferin return tops with Dufferin edge on three sides, for use with FreeFit height adjustable table mechanisms, sold separately (FTxxxxx, see page 713 of the Desking price list for information).

- 26" deep tops accommodate FTxxxx24 mechanisms. Depth is exact to accommodate the Dufferin edge + the Freefit mechanism. *Cannot be made smaller.*

**Required Specifications**

Veneer finish  
Edge

**Optional Specifications**

Grommet

**MODESTY PANEL OPTIONS**

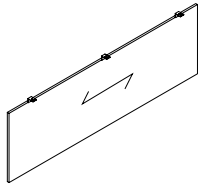

**Veneer Modesty Panel Upgrade\***

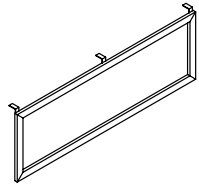

**Glass Modesty Panel Upgrade**

MODEL#	DIMENSIONS D x W x H	FREIGHT CLASS	WT/LBS.	CUBIC FT.	LIST PRICE
CMP72W	0.75 x 67 x 18	--	20	1	<b>\$1728</b>
CMP66W	0.75 x 61 x 18	--	18	1	<b>\$1673</b>
CMP60W	0.75 x 55 x 18	--	16	1	<b>\$1647</b>
CMP54W	0.75 x 49 x 18	--	14	1	<b>\$1619</b>
CMP48W	0.75 x 43 x 18	--	13	1	<b>\$1594</b>

Straight modesty panel. Attaches to underside of worksurface. **Cannot be retrofitted in the field *Not sold individually - to be ordered as an upgrade option only.***

- CMP72W - Specify on "P" Top Islands or 96" x 48" Islands for Piano Desks.
- CMP66W - Specify on 84" x 36" "D" Top Islands.
- CMP60W - Specify on 84" x 42" "P" Top Islands or 84" x 48" Islands for Piano Desks.
- CMP54W - Specify on 72" x 30" "D" Top Islands.
- CMP48W - Specify on 66" x 36" , 60" x 30" "D" Top Islands, 72" x 42" "P" Top Islands or 72" x 48" Islands for Piano Desks.

CMP72G	0.75 x 67 x 18	--	20	1	<b>\$2647</b>
CMP66G	0.75 x 61 x 18	--	18	1	<b>\$2504</b>
CMP60G	0.75 x 55 x 18	--	16	1	<b>\$2289</b>
CMP54G	0.75 x 49 x 18	--	14	1	<b>\$2132</b>
CMP48G	0.75 x 43 x 18	--	13	1	<b>\$2036</b>

Straight modesty panel. Translucent, screened glass. Aluminum box frame construction in Tungsten Only. Attaches to underside of worksurface. **Cannot be retrofitted in the field. *Not sold individually - to be ordered as an upgrade option only.***

- CMP72G - Specify on "P" Top Islands or 96" x 48" Islands for Piano Desks.
- CMP66G - Specify on 84" x 36" "D" Top Islands.
- CMP60G - Specify on 84" x 42" "P" Top Islands or 84" x 48" Islands for Piano Desks.
- CMP54G - Specify on 72" x 30" "D" Top Islands.
- CMP48G - Specify on 66" x 36" , 60" x 30" "D" Top Islands, 72" x 42" "P" Top Islands or 72" x 48" Islands for Piano Desks.
- Tungsten finish on the aluminum box frame closely resembles the existing Tungsten finish.

SINGLE PEDESTAL DESKS - BREAKFRONT STYLE

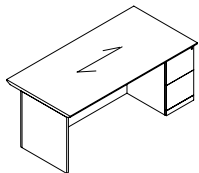

**Single Pedestal Desk - RIGHT  
Breakfront Style**

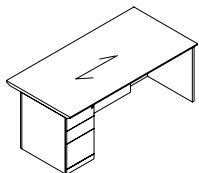

**Single Pedestal Desk - LEFT  
Breakfront Style**

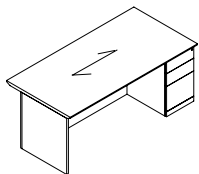

**Single Pedestal Desk - RIGHT  
Breakfront Style**

MODEL#	DIMENSIONS D x W x H	FREIGHT CLASS	WT/LBS.	CUBIC FT.	VENEER/LAMINATE	ALL VENEER
DISR8442E	42 x 84 x 29	125	463	59	<b>\$5862</b>	<b>\$7035</b>
DISR7842E	42 x 78 x 29	125	430	55	<b>\$5444</b>	<b>\$6533</b>
DISR7236E	36 x 72 x 29	125	340	44	<b>\$4311</b>	<b>\$5172</b>
DISR7230E	30 x 72 x 29	125	283	36	<b>\$4119</b>	<b>\$4941</b>
DISR6636E	36 x 66 x 29	125	312	40	<b>\$4119</b>	<b>\$4941</b>
DISR6630E	30 x 66 x 29	100	295	33	<b>\$3930</b>	<b>\$4717</b>
DISR6030E	30 x 60 x 29	100	265	30	<b>\$3758</b>	<b>\$4511</b>

Standard with full to floor **file/file** pedestal on **right**. Pedestal locks. Refer to the Desks and Credenzas Notes Section on page 66 for overhang dimensions. Shipped assembled in 1 carton.

DISL8442D	42 x 84 x 29	125	463	59	<b>\$5862</b>	<b>\$7035</b>
DISL7842D	42 x 78 x 29	125	430	55	<b>\$5444</b>	<b>\$6533</b>
DISL7236D	36 x 72 x 29	125	340	44	<b>\$4311</b>	<b>\$5172</b>
DISL7230D	30 x 72 x 29	125	283	36	<b>\$4119</b>	<b>\$4941</b>
DISL6636D	36 x 66 x 29	125	312	40	<b>\$4119</b>	<b>\$4941</b>
DISL6630D	30 x 66 x 29	100	295	33	<b>\$3930</b>	<b>\$4717</b>
DISL6030D	30 x 60 x 29	100	265	30	<b>\$3758</b>	<b>\$4511</b>

Standard with full to floor **box/box/file** pedestal on **left**. Pedestal locks. Refer to the Desks and Credenzas Notes Section on page 66 for overhang dimensions. Shipped assembled in 1 carton.

DISR8442D	42 x 84 x 29	125	463	59	<b>\$5862</b>	<b>\$7035</b>
DISR7842D	42 x 78 x 29	125	430	55	<b>\$5444</b>	<b>\$6533</b>
DISR7236D	36 x 72 x 29	125	340	44	<b>\$4311</b>	<b>\$5172</b>
DISR7230D	30 x 72 x 29	125	283	36	<b>\$4119</b>	<b>\$4941</b>
DISR6636D	36 x 66 x 29	125	312	40	<b>\$4119</b>	<b>\$4941</b>
DISR6630D	30 x 66 x 29	100	295	33	<b>\$3930</b>	<b>\$4717</b>
DISR6030D	30 x 60 x 29	100	265	30	<b>\$3758</b>	<b>\$4511</b>

Standard with full to floor **box/box/file** pedestal on **right**. Pedestal locks. Refer to the Desks and Credenzas Notes Section on page 66 for overhang dimensions. Shipped assembled in 1 carton.

**DESK SHELLS WITH RECESSED FRONT**

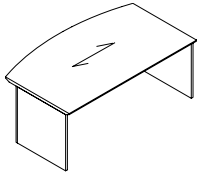

**Bow Top Desk Shell**

MODEL#	DIMENSIONS	FREIGHT CLASS	WT/LBS.	CUBIC FT.	veneer/LAMINATE	ALL VENEER
<b>D x W x H</b>						
DMT8442	42 x 84 x 29	125	380	59	<b>\$4725</b>	<b>\$5667</b>
DMT7842	42 x 78 x 29	125	353	55	<b>\$4385</b>	<b>\$5261</b>
DMT7242	42 x 72 x 29	125	331	51	<b>\$4051</b>	<b>\$4861</b>
DMT6636	36 x 66 x 29	125	287	40	<b>\$3862</b>	<b>\$4634</b>

Bow top and recessed modesty panel. Refer to the Desks and Credenzas Notes Section on page 66 for overhang dimensions. Shipped assembled in 1 carton.

DT8436	36 x 84 x 29	125	362	51	<b>\$3766</b>	<b>\$4520</b>
DT7836	36 x 78 x 29	125	336	47	<b>\$3498</b>	<b>\$4199</b>
DT7236	36 x 72 x 29	125	315	44	<b>\$3229</b>	<b>\$3874</b>
DT6636	36 x 66 x 29	125	271	40	<b>\$3041</b>	<b>\$3652</b>

DT7230	30 x 72 x 29	125	271	36	<b>\$3041</b>	<b>\$3652</b>
DT6630	30 x 66 x 29	100	265	33	<b>\$2855</b>	<b>\$3428</b>
DT6030	30 x 60 x 29	100	241	30	<b>\$2613</b>	<b>\$3136</b>

DT4824	24 x 48 x 29	125	123	20	<b>\$1720</b>	<b>\$2064</b>
DT4224	24 x 42 x 29	150	98	17	<b>\$1441</b>	<b>\$1729</b>
DT3624	24 x 36 x 29	150	82	14	<b>\$1387</b>	<b>\$1666</b>
DT3024	24 x 30 x 29	125	76	12	<b>\$1362</b>	<b>\$1634</b>

DT4822	22 x 48 x 29	150	105	18	<b>\$1578</b>	<b>\$1893</b>
DT4222	22 x 42 x 29	150	90	16	<b>\$1321</b>	<b>\$1585</b>
DT3622	22 x 36 x 29	150	75	13	<b>\$1275</b>	<b>\$1530</b>
DT3022	22 x 30 x 29	150	65	11	<b>\$1250</b>	<b>\$1499</b>

DT4820	20 x 48 x 29	125	105	18	<b>\$1435</b>	<b>\$1722</b>
DT4220	20 x 42 x 29	125	90	16	<b>\$1200</b>	<b>\$1439</b>
DT3620	20 x 36 x 29	125	75	13	<b>\$1162</b>	<b>\$1392</b>
DT3020	20 x 30 x 29	125	65	11	<b>\$1135</b>	<b>\$1362</b>

Recessed modesty panel. Refer to the Desks and Credenzas Notes Section on page 66 for overhang dimensions. Shipped assembled in 1 carton.

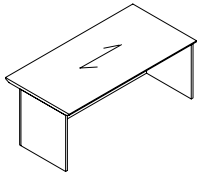

**Desk Shell**

**Required Specifications**

- Veneer Finish
- Laminate Finish
- Handle Style (Single Pedestal Desks)

**Optional Specifications**

- Grommet

# D DUFFERIN

## RETURNS

D x W x H

- An Executive Return is used to attach to a Single Pedestal Desk, Single Pedestal Credenza, Desk Shell or Credenza Shell.
- Grommets are available as an option.
- Hand of Executive Return is determined by location of full end panel from user side.
- Hand of Desk or Credenza is determined by location of pedestal from user side.
- To remove cross grain veneer pattern on top, delete suffix "CG" from the model number. Available as a special - no upcharge.

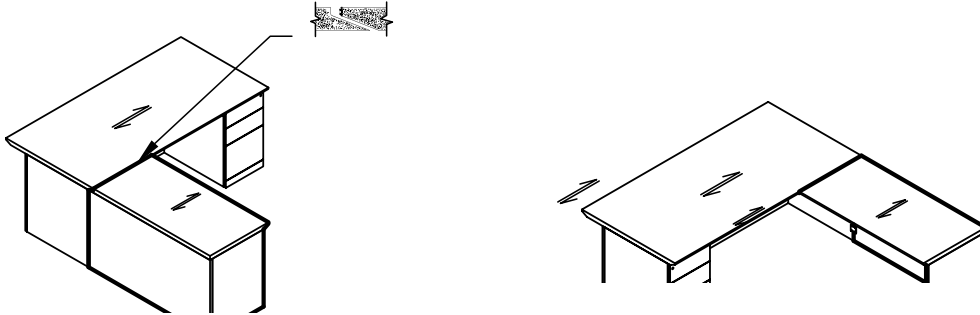

## RETURNS

MODEL# DIMENSIONS FREIGHT CLASS WT/LBS. CUBIC FT. VENEER/LAMINATE ALL VENEER

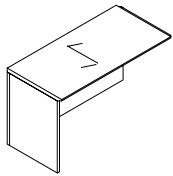

Flush Return - LEFT 24" Deep

DERL7224CG	24 x 72 x 29	150	135	29	\$2488	\$2986
DERL6624CG	24 x 66 x 29	150	127	27	\$2276	\$2733
DERL6024CG	24 x 60 x 29	150	120	24	\$2072	\$2487
DERL5424CG	24 x 54 x 29	150	112	22	\$1871	\$2246
DERL4824CG	24 x 48 x 29	150	105	19	\$1660	\$1990
DERL4224CG	24 x 42 x 29	150	97	17	\$1456	\$1746

Return has **no pedestal**. For use with right handed single pedestal desks, credenzas, desk shells, credenza shells, "D" islands or "P" islands. Shipped assembled in 1 carton.

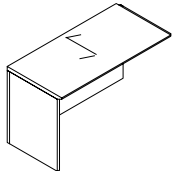

Flush Return - LEFT 22" Deep

DERL7222CG	22 x 72 x 29	150	130	27	\$2372	\$2846
DERL6622CG	22 x 66 x 29	150	122	24	\$1987	\$2384
DERL6022CG	22 x 60 x 29	150	115	22	\$1812	\$2172
DERL5422CG	22 x 54 x 29	150	105	20	\$1740	\$2086
DERL4822CG	22 x 48 x 29	150	100	18	\$1456	\$1746
DERL4222CG	22 x 42 x 29	150	90	16	\$1272	\$1528

Return has **no pedestal**. For use with right handed single pedestal desks, credenzas, desk shells, credenza shells, "D" islands or "P" islands. Shipped assembled in 1 carton.

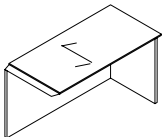

Flush Return - RIGHT 24" Deep

DERR7224CG	24 x 72 x 29	150	135	29	\$2488	\$2986
DERR6624CG	24 x 66 x 29	150	127	27	\$2276	\$2733
DERR6024CG	24 x 60 x 29	150	120	24	\$2072	\$2487
DERR5424CG	24 x 54 x 29	150	112	22	\$1871	\$2246
DERR4824CG	24 x 48 x 29	150	105	19	\$1660	\$1990
DERR4224CG	24 x 42 x 29	150	97	17	\$1456	\$1746

Return has **no pedestal**. For use with left handed single pedestal desks, credenzas, desk shells, credenza shells, "D" islands or "P" islands. Shipped assembled in 1 carton.

### Required Specifications

Veneer Finish  
Laminate Finish

### Optional Specifications

Grommet

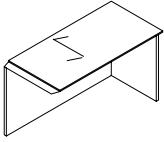
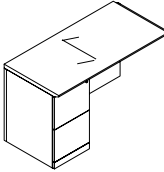
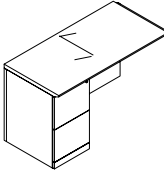
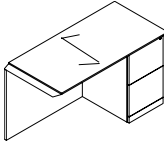
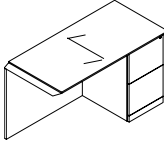
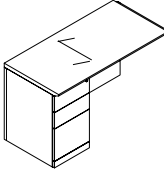
RETURNS	MODEL#	DIMENSIONS	FREIGHT CLASS	WT/LBS.	CUBIC FT.	VENEER/LAMINATE	ALL VENEER
 <p><b>Flush Return - RIGHT</b> <b>22" Deep</b></p>	<b>D x W x H</b>						
	DERR7222CG	22 x 72 x 29	150	130	27	<b>\$2372</b>	<b>\$2846</b>
	DERR6622CG	22 x 66 x 29	150	122	24	<b>\$1987</b>	<b>\$2384</b>
	DERR6022CG	22 x 60 x 29	150	115	22	<b>\$1812</b>	<b>\$2172</b>
	DERR5422CG	22 x 54 x 29	150	105	20	<b>\$1629</b>	<b>\$1955</b>
	DERR4822CG	22 x 48 x 29	150	100	18	<b>\$1448</b>	<b>\$1739</b>
DERR4222CG	22 x 42 x 29	150	90	16	<b>\$1266</b>	<b>\$1517</b>	
<p>Return has <b>no pedestal</b>. For use with left handed single pedestal desks, credenzas, desk shells, credenza shells, "D" islands or "P" islands. Shipped assembled in 1 carton.</p>							
 <p><b>Flush Return - LEFT*</b> <b>24" Deep</b></p>	DERL7224ECG	24 x 72 x 29	100	250	29	<b>\$4391</b>	<b>\$5268</b>
	DERL6624ECG	24 x 66 x 29	100	236	27	<b>\$4222</b>	<b>\$5068</b>
	DERL6024ECG	24 x 60 x 29	100	227	24	<b>\$3843</b>	<b>\$4611</b>
	DERL5424ECG	24 x 54 x 29	100	205	22	<b>\$3706</b>	<b>\$4446</b>
	DERL4824ECG	24 x 48 x 29	100	185	19	<b>\$3289</b>	<b>\$3946</b>
	DERL4224ECG	24 x 42 x 29	92.5	178	17	<b>\$3173</b>	<b>\$3807</b>
<p>Return has <b>file/file</b> pedestal on the <b>left</b>. Pedestal locks. For use with right handed single pedestal desks, credenzas, desk shells, credenza shells, "D" islands or "P" islands. Shipped assembled in 1 carton.</p>							
 <p><b>Flush Return - LEFT*</b> <b>22" Deep</b></p>	DERL7222ECG	22 x 72 x 29	100	240	27	<b>\$4222</b>	<b>\$5068</b>
	DERL6622ECG	22 x 66 x 29	100	231	24	<b>\$3726</b>	<b>\$4473</b>
	DERL6022ECG	22 x 60 x 29	92.5	222	22	<b>\$3393</b>	<b>\$4071</b>
	DERL5422ECG	22 x 54 x 29	92.5	200	20	<b>\$3268</b>	<b>\$3922</b>
	DERL4822ECG	22 x 48 x 29	92.5	180	18	<b>\$2905</b>	<b>\$3485</b>
	DERL4222ECG	22 x 42 x 29	92.5	173	16	<b>\$2795</b>	<b>\$3353</b>
<p>Return has <b>file/file</b> pedestal on the <b>left</b>. Pedestal locks. For use with right handed single pedestal desks, credenzas, desk shells, credenza shells, "D" islands or "P" islands. Shipped assembled in 1 carton.</p>							
 <p><b>Flush Return - RIGHT*</b> <b>24" Deep</b></p>	DERR7224ECG	24 x 72 x 29	100	250	29	<b>\$4391</b>	<b>\$5268</b>
	DERR6624ECG	24 x 66 x 29	100	236	27	<b>\$4222</b>	<b>\$5068</b>
	DERR6024ECG	24 x 60 x 29	100	227	24	<b>\$3843</b>	<b>\$4611</b>
	DERR5424ECG	24 x 54 x 29	100	205	22	<b>\$3706</b>	<b>\$4446</b>
	DERR4824ECG	24 x 48 x 29	100	185	19	<b>\$3289</b>	<b>\$3946</b>
	DERR4224ECG	24 x 42 x 29	92.5	178	17	<b>\$3173</b>	<b>\$3807</b>
<p>Return has <b>file/file</b> pedestal on the <b>right</b>. Pedestal locks. For use with right handed single pedestal desks, credenzas, desk shells, credenza shells, "D" islands or "P" islands. Shipped assembled in 1 carton.</p>							
 <p><b>Flush Return - RIGHT</b> <b>22" Deep</b></p>	DERR7222ECG	22 x 72 x 29	100	240	27	<b>\$4222</b>	<b>\$5068</b>
	DERR6622ECG	22 x 66 x 29	100	231	24	<b>\$3726</b>	<b>\$4473</b>
	DERR6022ECG	22 x 60 x 29	92.5	222	22	<b>\$3393</b>	<b>\$4071</b>
	DERR5422ECG	22 x 54 x 29	92.5	200	20	<b>\$3268</b>	<b>\$3922</b>
	DERR4822ECG	22 x 48 x 29	92.5	180	18	<b>\$2905</b>	<b>\$3485</b>
	DERR4222ECG	22 x 42 x 29	92.5	173	16	<b>\$2795</b>	<b>\$3353</b>
<p>Return has <b>file/file</b> pedestal on the <b>right</b>. Pedestal locks. For use with right handed single pedestal desks, credenzas, desk shells, credenza shells, "D" islands or "P" islands. Shipped assembled in 1 carton.</p>							
 <p><b>Flush Return - LEFT</b> <b>24" Deep</b></p>	DERL7224DCG	24 x 72 x 29	100	250	29	<b>\$4391</b>	<b>\$5268</b>
	DERL6624DCG	24 x 66 x 29	100	236	27	<b>\$4222</b>	<b>\$5068</b>
	DERL6024DCG	24 x 60 x 29	100	227	24	<b>\$3843</b>	<b>\$4611</b>
	DERL5424DCG	24 x 54 x 29	100	205	22	<b>\$3706</b>	<b>\$4446</b>
	DERL4824DCG	24 x 48 x 29	100	185	19	<b>\$3289</b>	<b>\$3946</b>
	DERL4224DCG	24 x 42 x 29	92.5	178	17	<b>\$3173</b>	<b>\$3807</b>
<p>Return has <b>box/box/file</b> pedestal on the <b>left</b>. Pedestal locks. For use with right handed single pedestal desks, credenzas, desk shells, credenza shells, "D" islands or "P" islands. Shipped assembled in 1 carton.</p>							

**Required Specifications**

Veneer Finish  
Laminate Finish  
Handle Style\*

**Optional Specifications**

Grommet

**RETURNS**

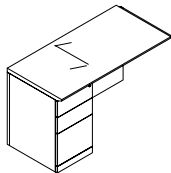

**Flush Return - LEFT**  
**22" Deep**

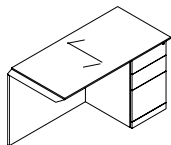

**Flush Return - RIGHT**  
**24" Deep**

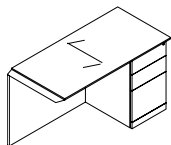

**Flush Return - RIGHT**  
**22" Deep**

MODEL#	DIMENSIONS D x W x H	FREIGHT CLASS	WT/LBS.	CUBIC FT.	VENEER/LAMINATE	ALL VENEER
DERL7222DCG	22 x 72 x 29	100	240	27	<b>\$4222</b>	<b>\$5068</b>
DERL6622DCG	22 x 66 x 29	100	231	24	<b>\$3726</b>	<b>\$4473</b>
DERL6022DCG	22 x 60 x 29	92.5	222	22	<b>\$3393</b>	<b>\$4071</b>
DERL5422DCG	22 x 54 x 29	92.5	200	20	<b>\$3268</b>	<b>\$3922</b>
DERL4822DCG	22 x 48 x 29	150	180	18	<b>\$2905</b>	<b>\$3485</b>
DERL4222DCG	22 x 42 x 29	92.5	173	16	<b>\$2795</b>	<b>\$3353</b>

Return has **box/box/file** pedestal on the **left**. Pedestal locks. For use with right handed single pedestal desks, credenzas, desk shells, credenza shells, "D" islands or "P" islands. Shipped assembled in 1 carton.

DERR7224DCG	24 x 72 x 29	100	250	29	<b>\$4391</b>	<b>\$5268</b>
DERR6624DCG	24 x 66 x 29	100	236	27	<b>\$4222</b>	<b>\$5068</b>
DERR6024DCG	24 x 60 x 29	100	227	24	<b>\$3843</b>	<b>\$4611</b>
DERR5424DCG	24 x 54 x 29	100	205	22	<b>\$3706</b>	<b>\$4446</b>
DERR4824DCG	24 x 48 x 29	100	185	19	<b>\$3289</b>	<b>\$3946</b>
DERR4224DCG	24 x 42 x 29	92.5	178	17	<b>\$3173</b>	<b>\$3807</b>

Return has **box/box/file** pedestal on the **right**. Pedestal locks. For use with right handed single pedestal desks, credenzas, desk shells, credenza shells, "D" islands or "P" islands. Shipped assembled in 1 carton.

DERR7222DCG	22 x 72 x 29	100	240	27	<b>\$4222</b>	<b>\$5068</b>
DERR6622DCG	22 x 66 x 29	100	231	24	<b>\$3726</b>	<b>\$4473</b>
DERR6022DCG	22 x 60 x 29	92.5	222	22	<b>\$3393</b>	<b>\$4071</b>
DERR5422DCG	22 x 54 x 29	92.5	200	20	<b>\$3268</b>	<b>\$3922</b>
DERR4822DCG	22 x 48 x 29	92.5	180	18	<b>\$2905</b>	<b>\$3485</b>
DERR4222DCG	22 x 42 x 29	92.5	173	16	<b>\$2795</b>	<b>\$3353</b>

Return has **box/box/file** pedestal on the **right**. Pedestal locks. For use with right handed single pedestal desks, credenzas, desk shells, credenza shells, "D" islands or "P" islands. Shipped assembled in 1 carton.

**Required Specifications**

Veneer Finish  
Laminate Finish  
Handle Style

**Optional Specifications**

Grommet

**BRIDGES - EXECUTIVE**      **MODEL#**      **DIMENSIONS**      **FREIGHT CLASS**      **WT/LBS.**      **CUBIC FT.**      **VENEER/LAMINATE**      **ALL VENEER**

D x W x H

- An Executive Bridge is used to connect a Desk to a Credenza.
- Not to be used with Corner Components or Piano Desks,
- Three Modesty Panel options - Full Modesty, 8" Modesty and No Modesty (Flush Bridge Top).
- Modesty panel flush with end panels of Desk and Credenza.
- Includes GM1 grommet in the top center position.
- Both connecting sides of executive bridges feature a reverse profile edge

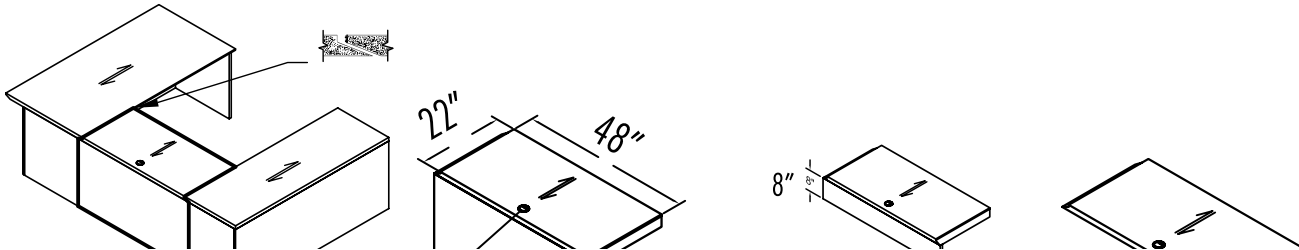

**BRIDGES - LINKING**

- A linking bridge is used to connect corner components to a single pedestal desk, HA desk, single pedestal credenza, desk shell or credenza shell.
- When connecting HA desk, must specify DHASP spacer.
- Two modesty panel options - full modesty and 8" modesty.
- Includes GM1 grommet in the top center position.
- Hand of linking bridge is determined by location of half end panel from user side.
- Linking bridges are handed **left and right** (handedness is determined by connecting side with the self edge). The opposite connecting side features a reverse profile edge.

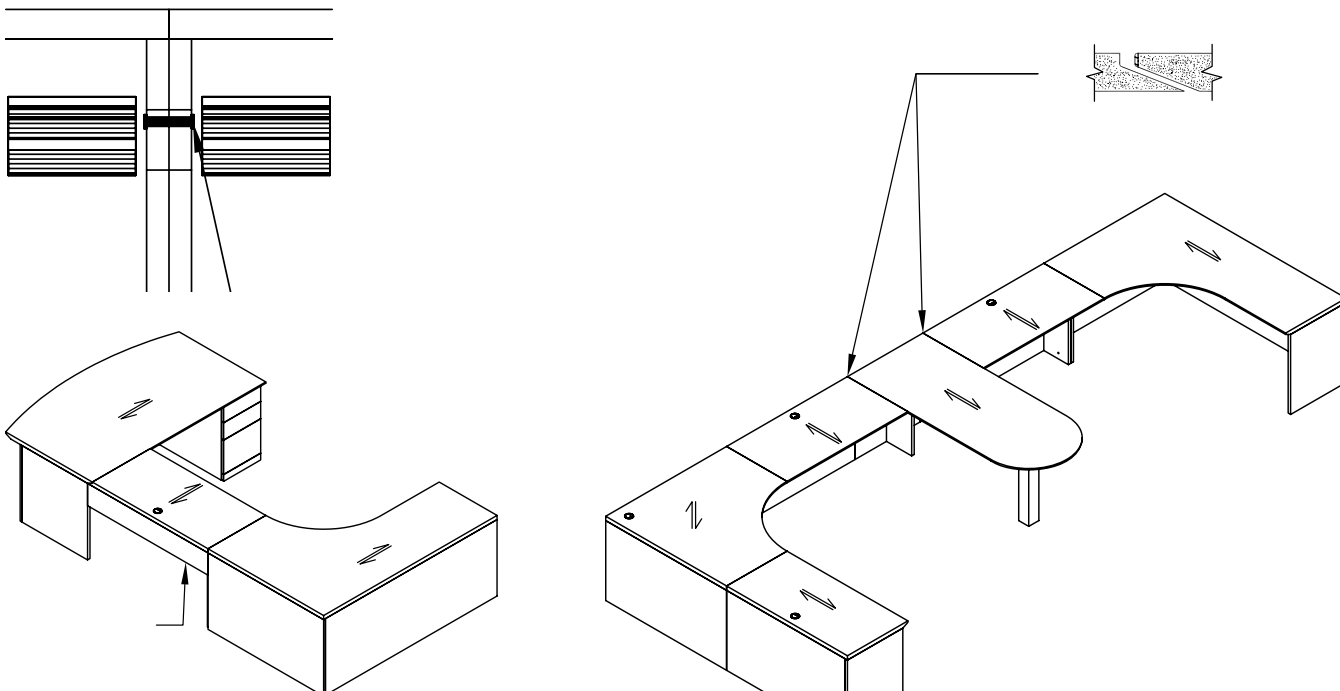

## BRIDGES - FLUSH

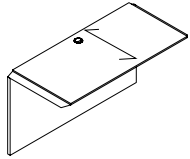

**Flush Bridge**

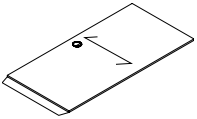

**Flush Bridge Top**

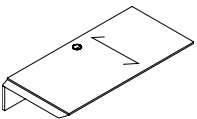

**Flush Bridge Top, 8" Modesty Panel**

MODEL#	DIMENSIONS D x W x H	FREIGHT CLASS	WT./LBS.	CUBIC FT.	VENEER/LAMINATE	ALL VENEER
DBT6024CG	24 x 60 x 29	70	144	10	<b>\$1779</b>	<b>\$2138</b>
DBT5424CG	24 x 54 x 29	70	129	9	<b>\$1608</b>	<b>\$1926</b>
DBT4824CG	24 x 48 x 29	70	120	8	<b>\$1425</b>	<b>\$1711</b>
DBT4224CG	24 x 42 x 29	85	105	7	<b>\$1249</b>	<b>\$1496</b>
DBT6022CG	22 x 60 x 29	70	138	9	<b>\$1458</b>	<b>\$1749</b>
DBT5422CG	22 x 54 x 29	70	124	8	<b>\$1444</b>	<b>\$1730</b>
DBT4822CG	22 x 48 x 29	85	115	7	<b>\$1281</b>	<b>\$1539</b>
DBT4222CG	22 x 42 x 29	85	101	6	<b>\$1124</b>	<b>\$1351</b>
DBT6020CG	20 x 60 x 29	70	131	8	<b>\$1458</b>	<b>\$1749</b>
DBT5420CG	20 x 54 x 29	85	118	8	<b>\$1316</b>	<b>\$1578</b>
DBT4820CG	20 x 48 x 29	85	110	7	<b>\$1169</b>	<b>\$1402</b>
DBT4220CG	20 x 42 x 29	85	96	6	<b>\$1004</b>	<b>\$1201</b>

Top surface, back panel and hardware to create a "U" configuration with a single pedestal desk or credenza. **Cannot be used with corners.** Grommet in worksurface. Shipped assembled in 1 carton.

- If linking to bookcase or open storage, add **/S** to end of model number

DBT5424TCG	24 x 54 x --	70	129	9	N/A	<b>\$1203</b>
DBT4824TCG	24 x 48 x --	70	120	8	N/A	<b>\$1070</b>
DBT4224TCG	24 x 42 x --	70	105	7	N/A	<b>\$937</b>
DBT5422TCG	22 x 54 x --	70	124	8	N/A	<b>\$966</b>
DBT4822TCG	22 x 48 x --	70	115	7	N/A	<b>\$860</b>
DBT4222TCG	22 x 42 x --	70	101	6	N/A	<b>\$753</b>
DBT5420TCG	20 x 54 x --	70	118	8	N/A	<b>\$883</b>
DBT4820TCG	20 x 48 x --	70	110	7	N/A	<b>\$783</b>
DBT4220TCG	20 x 42 x --	70	96	6	N/A	<b>\$674</b>

Top surface only to create a "U" configuration with a single pedestal desk or credenza. **Cannot be used with corners.** Grommet in worksurface. Shipped assembled in 1 carton.

- If linking to bookcase or open storage, add **/S** to end of model number

DBT6024Q8CG	24 x 60 x --	70	144	10	<b>\$1600</b>	<b>\$1921</b>
DBT5424Q8CG	24 x 54 x --	70	129	9	<b>\$1444</b>	<b>\$1730</b>
DBT4824Q8CG	24 x 48 x --	70	120	8	<b>\$1282</b>	<b>\$1540</b>
DBT4224Q8CG	24 x 42 x --	70	105	7	<b>\$1122</b>	<b>\$1350</b>
DBT6022Q8CG	22 x 60 x --	70	138	9	<b>\$1444</b>	<b>\$1730</b>
DBT5422Q8CG	22 x 54 x --	70	124	8	<b>\$1299</b>	<b>\$1559</b>
DBT4822Q8CG	22 x 48 x --	70	115	7	<b>\$1153</b>	<b>\$1381</b>
DBT4222Q8CG	22 x 42 x --	70	101	6	<b>\$1012</b>	<b>\$1216</b>
DBT6020Q8CG	20 x 60 x --	70	131	8	<b>\$1316</b>	<b>\$1578</b>
DBT5420Q8CG	20 x 54 x --	70	118	8	<b>\$1181</b>	<b>\$1418</b>
DBT4820Q8CG	20 x 48 x --	70	110	7	<b>\$1052</b>	<b>\$1263</b>
DBT4220Q8CG	20 x 42 x --	70	96	6	<b>\$901</b>	<b>\$1081</b>

Top surface with 8" modesty panel for utility access. Create a "U" configuration with a single pedestal desk or credenza. **Cannot be used with corners.** Grommet in worksurface. Shipped assembled in 1 carton.

- If linking to bookcase or open storage, add **/S** to end of model number

### Required Specifications

Veneer finish  
Laminate finish

### Optional Specifications

Additional grommet

**BRIDGES - LINKING**

**MODEL# DIMENSIONS FREIGHT CLASS WT/LBS. CUBIC FT. VENEER/LAMINATE ALL VENEER**

**D x W x H**

DBT6024NLLCG	24 x 60 x 29	125	145	24	<b>\$1766</b>	<b>\$2117</b>
DBT5424NLLCG	24 x 54 x 29	150	131	22	<b>\$1591</b>	<b>\$1908</b>
DBT4824NLLCG	24 x 48 x 29	125	116	19	<b>\$1414</b>	<b>\$1697</b>
DBT4224NLLCG	24 x 42 x 29	125	102	17	<b>\$1145</b>	<b>\$1374</b>
DBT3624NLLCG	24 x 36 x 29	150	87	15	<b>\$1042</b>	<b>\$1251</b>
DBT3024NLLCG	24 x 30 x 29	125	73	12	<b>\$1017</b>	<b>\$1219</b>

DBT6022NLLCG	22 x 60 x 29	150	131	22	<b>\$1681</b>	<b>\$2018</b>
DBT5422NLLCG	22 x 54 x 29	150	118	20	<b>\$1516</b>	<b>\$1821</b>
DBT4822NLLCG	22 x 48 x 29	125	110	18	<b>\$1346</b>	<b>\$1613</b>
DBT4222NLLCG	22 x 42 x 29	150	95	16	<b>\$1093</b>	<b>\$1310</b>
DBT3622NLLCG	22 x 36 x 29	125	80	13	<b>\$990</b>	<b>\$1189</b>
DBT3022NLLCG	22 x 30 x 29	150	65	11	<b>\$968</b>	<b>\$1163</b>

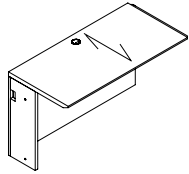

**Linking Bridge - LEFT**

Top surface, back panel and hardware. **Left side** connects to a 5-Sided Corner, Extended Corner or Connectable Table. Right side connects to a single pedestal desk or credenza, "D" island, Boat shaped island, "P" island and Delta island with a "T" base. Grommet in worksurface. Shipped assembled in 1 carton.

DBT6024NLRCG	24 x 60 x 29	125	145	24	<b>\$1766</b>	<b>\$2117</b>
DBT5424NLRCG	24 x 54 x 29	150	131	22	<b>\$1591</b>	<b>\$1908</b>
DBT4824NLRCG	24 x 48 x 29	125	116	19	<b>\$1414</b>	<b>\$1697</b>
DBT4224NLRCG	24 x 42 x 29	125	102	17	<b>\$1145</b>	<b>\$1374</b>
DBT3624NLRCG	24 x 36 x 29	150	87	15	<b>\$1042</b>	<b>\$1251</b>
DBT3024NLRCG	24 x 30 x 29	125	73	12	<b>\$1017</b>	<b>\$1219</b>

DBT6022NLRCG	22 x 60 x 29	150	131	22	<b>\$1681</b>	<b>\$2018</b>
DBT5422NLRCG	22 x 54 x 29	150	118	20	<b>\$1516</b>	<b>\$1821</b>
DBT4822NLRCG	22 x 48 x 29	125	110	18	<b>\$1346</b>	<b>\$1613</b>
DBT4222NLRCG	22 x 42 x 29	150	95	16	<b>\$1093</b>	<b>\$1310</b>
DBT3622NLRCG	22 x 36 x 29	125	80	13	<b>\$990</b>	<b>\$1189</b>
DBT3022NLRCG	22 x 30 x 29	150	65	11	<b>\$968</b>	<b>\$1163</b>

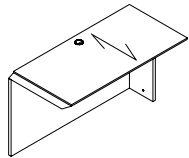

**Linking Bridge - RIGHT**

Top surface, back panel and hardware. **Right side** connects to a 5-Sided Corner, Extended Corner or Connectable Table. Left side connects to a single pedestal desk or credenza, "D" island, Boat shaped island, "P" island and Delta island with a "T" base. Grommet in worksurface. Shipped assembled in 1 carton.

DBT6024NLLQ8CG	24 x 60 x 29	125	145	24	<b>\$1943</b>	<b>\$2331</b>
DBT5424NLLQ8CG	24 x 54 x 29	150	131	22	<b>\$1752</b>	<b>\$2104</b>
DBT4824NLLQ8CG	24 x 48 x 29	125	116	19	<b>\$1558</b>	<b>\$1870</b>
DBT4224NLLQ8CG	24 x 42 x 29	125	102	17	<b>\$1401</b>	<b>\$1678</b>
DBT3624NLLQ8CG	24 x 36 x 29	150	87	15	<b>\$1145</b>	<b>\$1374</b>
DBT3024NLLQ8CG	24 x 30 x 29	125	73	12	<b>\$1121</b>	<b>\$1346</b>

DBT6022NLLQ8CG	22 x 60 x 29	150	131	22	<b>\$1851</b>	<b>\$2221</b>
DBT5422NLLQ8CG	22 x 54 x 29	150	118	20	<b>\$1667</b>	<b>\$2002</b>
DBT4822NLLQ8CG	22 x 48 x 29	125	110	18	<b>\$1482</b>	<b>\$1776</b>
DBT4222NLLQ8CG	22 x 42 x 29	150	95	16	<b>\$1199</b>	<b>\$1436</b>
DBT3622NLLQ8CG	22 x 36 x 29	125	80	13	<b>\$1090</b>	<b>\$1309</b>
DBT3022NLLQ8CG	22 x 30 x 29	150	65	11	<b>\$1065</b>	<b>\$1277</b>

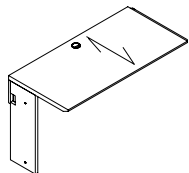

**Linking Bridge, 8" Modesty Panel - LEFT**

Top surface with 8" modesty panel for utility access and hardware. **Left side** connects to a 5-Sided Corner, Extended Corner or Connectable Table. Right side connects to a single pedestal desk or credenza, "D" island, Boat shaped island, "P" island and Delta island with a "T" base. Grommet in worksurface. Shipped assembled in 1 carton.

**Required Specifications**

Veneer finish  
Laminate finish

**Optional Specifications**

Additional grommet

## BRIDGES - LINKING

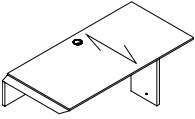

**Linking Bridge, 8" Modesty Panel - RIGHT**

MODEL#	DIMENSIONS	FREIGHT CLASS	WT/LBS.	CUBIC FT.	VENEER/LAMINATE	ALL VENEER
D x W x H						
DBT6024NLRQ8CG	24 x 60 x 29	125	145	24	<b>\$1943</b>	<b>\$2331</b>
DBT5424NLRQ8CG	24 x 54 x 29	150	131	22	<b>\$1752</b>	<b>\$2104</b>
DBT4824NLRQ8CG	24 x 48 x 29	125	116	19	<b>\$1558</b>	<b>\$1870</b>
DBT4224NLRQ8CG	24 x 42 x 29	125	102	17	<b>\$1401</b>	<b>\$1678</b>
DBT3624NLRQ8CG	24 x 36 x 29	150	87	15	<b>\$1145</b>	<b>\$1374</b>
DBT3024NLRQ8CG	24 x 30 x 29	125	73	12	<b>\$1121</b>	<b>\$1346</b>
DBT6022NLRQ8CG	22 x 60 x 29	150	131	22	<b>\$1851</b>	<b>\$2221</b>
DBT5422NLRQ8CG	22 x 54 x 29	150	118	20	<b>\$1667</b>	<b>\$2002</b>
DBT4822NLRQ8CG	22 x 48 x 29	125	110	18	<b>\$1482</b>	<b>\$1776</b>
DBT4222NLRQ8CG	22 x 42 x 29	150	95	16	<b>\$1199</b>	<b>\$1436</b>
DBT3622NLRQ8CG	22 x 36 x 29	125	80	13	<b>\$1090</b>	<b>\$1309</b>
DBT3022NLRQ8CG	22 x 30 x 29	150	65	11	<b>\$1065</b>	<b>\$1277</b>

Top surface with 8" modesty panel for utility access and hardware. **Right side** connects to a 5-Sided Corner, Extended Corner or Connectable Table. Right side connects to a single pedestal desk or credenza, "D" island, Boat shaped island, "P" island and Delta island with a "T" base. Grommet in worksurface. Shipped assembled in 1 carton.

## CREDENZAS

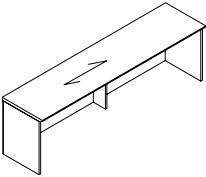

sizes 96" and larger

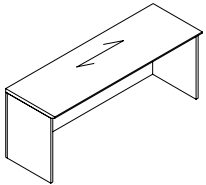

sizes less than 96"

**Credenza Shell\***

MODEL#	DIMENSIONS	FREIGHT CLASS	WT/LBS.	CUBIC FT.	VENEER/LAMINATE	ALL VENEER
DC12024	24 x 120 x 29	100	387	48	<b>\$4440</b>	<b>\$5329</b>
DC11424	24 x 114 x 29	125	367	46	<b>\$4218</b>	<b>\$5064</b>
DC10824	24 x 108 x 29	125	348	44	<b>\$3999</b>	<b>\$4795</b>
DC10224	24 x 102 x 29	100	329	41	<b>\$3776</b>	<b>\$4530</b>
DC9624	24 x 96 x 29	125	309	39	<b>\$3552</b>	<b>\$4262</b>
DC9024	24 x 90 x 29	100	290	36	<b>\$3332</b>	<b>\$3999</b>
DC8424	24 x 84 x 29	125	271	34	<b>\$3110</b>	<b>\$3733</b>
DC7824	24 x 78 x 29	100	251	31	<b>\$2888</b>	<b>\$3464</b>
DC7224	24 x 72 x 29	100	232	29	<b>\$2665</b>	<b>\$3198</b>
DC6624	24 x 66 x 29	125	213	27	<b>\$2565</b>	<b>\$3080</b>
DC6024	24 x 60 x 29	100	193	24	<b>\$2332</b>	<b>\$2798</b>
DC5424	24 x 54 x 29	125	174	22	<b>\$2211</b>	<b>\$2656</b>
DC4824	24 x 48 x 29	100	155	19	<b>\$2089</b>	<b>\$2506</b>
DC4224	24 x 42 x 29	125	135	17	<b>\$1769</b>	<b>\$2123</b>
DC12022	22 x 120 x 29	100	358	44	<b>\$4071</b>	<b>\$4884</b>
DC11422	22 x 114 x 29	100	340	42	<b>\$3866</b>	<b>\$4639</b>
DC10822	22 x 108 x 29	100	323	40	<b>\$3662</b>	<b>\$4397</b>
DC10222	22 x 102 x 29	100	305	38	<b>\$3456</b>	<b>\$4152</b>
DC9622	22 x 96 x 29	100	287	35	<b>\$3260</b>	<b>\$3910</b>
DC9022	22 x 90 x 29	100	269	33	<b>\$3055</b>	<b>\$3666</b>
DC8422	22 x 84 x 29	100	251	31	<b>\$2853</b>	<b>\$3426</b>
DC7822	22 x 78 x 29	100	233	29	<b>\$2646</b>	<b>\$3177</b>
DC7222	22 x 72 x 29	125	215	27	<b>\$2446</b>	<b>\$2934</b>
DC6622	22 x 66 x 29	100	197	24	<b>\$2357</b>	<b>\$2829</b>
DC6022	22 x 60 x 29	100	179	22	<b>\$2140</b>	<b>\$2565</b>
DC5422	22 x 54 x 29	100	161	20	<b>\$2027</b>	<b>\$2433</b>
DC4822	22 x 48 x 29	125	143	18	<b>\$1920</b>	<b>\$2303</b>
DC4222	22 x 42 x 29	125	125	16	<b>\$1621</b>	<b>\$1948</b>

Standard with **no pedestals**. Flush full modesty panel. 96"w and larger includes a center support leg. If using storage component shells underneath to support the worksurface, **no more than 72" may be left unsupported**. Shipped assembled in 1 carton.

### Required Specifications

Veneer finish  
Laminate finish

### Optional Specifications

Additional grommet

### Accessories

Modular Storage\*

**CREDENZAS**

**MODEL# DIMENSIONS FREIGHT CLASS WT/LBS. CUBIC FT. VENEER/LAMINATE ALL VENEER**

**D x W x H**

DCK8424EE	24 x 84 x 29	92.5	348	34	\$6580	\$7895
DCK7824EE	24 x 78 x 29	92.5	319	31	\$6114	\$7336
DCK7224EE	24 x 72 x 29	100	280	29	\$5646	\$6774
DCK6624EE	24 x 66 x 29	100	261	27	\$5560	\$6673
DCK6024EE	24 x 60 x 29	100	238	24	\$5172	\$6205

DCK8422EE	22 x 84 x 29	92.5	320	34	\$6032	\$7238
DCK7822EE	22 x 78 x 29	92.5	298	31	\$5605	\$6724
DCK7222EE	22 x 72 x 29	92.5	280	29	\$5173	\$6206
DCK6622EE	22 x 66 x 29	92.5	257	27	\$5095	\$6116
DCK6022EE	22 x 60 x 29	92.5	233	24	\$4739	\$5687

Standard with full to floor **file/file** pedestals on **left** and **right**. **Center is open** Pedestals lock. Shipped assembled in 1 carton.

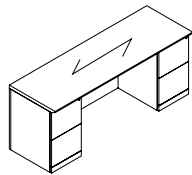

**Kneespace Credenza**

DCK8424DD	24 x 84 x 29	92.5	348	34	\$6580	\$7895
DCK7824DD	24 x 78 x 29	92.5	319	31	\$6114	\$7336
DCK7224DD	24 x 72 x 29	100	280	29	\$5646	\$6774
DCK6624DD	24 x 66 x 29	100	261	27	\$5560	\$6673
DCK6024DD	24 x 60 x 29	100	238	24	\$5172	\$6205

DCK8422DD	22 x 84 x 29	92.5	320	34	\$6032	\$7238
DCK7822DD	22 x 78 x 29	92.5	298	31	\$5605	\$6724
DCK7222DD	22 x 72 x 29	92.5	280	29	\$5173	\$6206
DCK6622DD	22 x 66 x 29	92.5	257	27	\$5095	\$6116
DCK6022DD	22 x 60 x 29	92.5	233	24	\$4739	\$5687

Standard with full to floor **box/box/file** pedestals on **left** and **right**. **Center is open** Pedestals lock. One pencil tray. Shipped assembled in 1 carton.

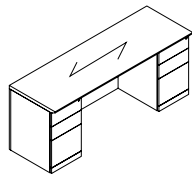

**Kneespace Credenza**

DCK8424ED	24 x 84 x 29	92.5	348	34	\$6580	\$7895
DCK7824ED	24 x 78 x 29	92.5	319	31	\$6114	\$7336
DCK7224ED	24 x 72 x 29	100	280	29	\$5646	\$6774
DCK6624ED	24 x 66 x 29	100	261	27	\$5560	\$6673
DCK6024ED	24 x 60 x 29	100	238	24	\$5172	\$6205

DCK8422ED	22 x 84 x 29	92.5	320	34	\$6032	\$7238
DCK7822ED	22 x 78 x 29	92.5	298	31	\$5605	\$6724
DCK7222ED	22 x 72 x 29	92.5	280	29	\$5173	\$6206
DCK6622ED	22 x 66 x 29	92.5	257	27	\$5095	\$6116
DCK6022ED	22 x 60 x 29	92.5	233	24	\$4739	\$5687

Standard with full to floor **file/file** pedestal on **left** and **box/box/file** pedestal on **right**. **Center is open** Pedestals lock. One pencil tray. Shipped assembled in 1 carton.

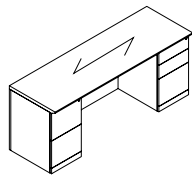

**Kneespace Credenza**

DCK8424DE	24 x 84 x 29	92.5	348	34	\$6580	\$7895
DCK7824DE	24 x 78 x 29	92.5	319	31	\$6114	\$7336
DCK7224DE	24 x 72 x 29	100	280	29	\$5646	\$6774
DCK6624DE	24 x 66 x 29	100	261	27	\$5560	\$6673
DCK6024DE	24 x 60 x 29	100	238	24	\$5172	\$6205

DCK8422DE	22 x 84 x 29	92.5	320	34	\$6032	\$7238
DCK7822DE	22 x 78 x 29	92.5	298	31	\$5605	\$6724
DCK7222DE	22 x 72 x 29	92.5	280	29	\$5173	\$6206
DCK6622DE	22 x 66 x 29	92.5	257	27	\$5095	\$6116
DCK6022DE	22 x 60 x 29	92.5	233	24	\$4739	\$5687

Standard with full to floor **box/box/file** pedestal on **left** and **file/file** pedestal on **right**. **Center is open** Pedestals lock. One pencil tray. Shipped assembled in 1 carton.

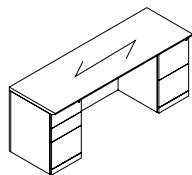

**Kneespace Credenza**

**Required Specifications**

- Veneer Finish
- Laminate Finish
- Handle style

**Optional Specifications**

- Grommet

CREENZAS	MODEL#	DIMENSIONS	FREIGHT CLASS	WT/LBS.	CUBIC FT.	VENEER/LAMINATE	ALL VENEER
----------	--------	------------	---------------	---------	-----------	-----------------	------------

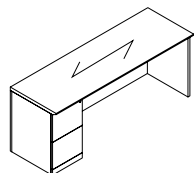

Single Pedestal Credenza - LEFT

	D x W x H						
DCL8424E	24 x 84 x 29	100	315	34	\$4977	\$5973	
DCL7824E	24 x 78 x 29	100	292	31	\$4623	\$5544	
DCL7224E	24 x 72 x 29	100	270	29	\$4268	\$5120	
DCL6624E	24 x 66 x 29	100	247	27	\$4108	\$4930	
DCL6024E	24 x 60 x 29	100	225	24	\$3735	\$4481	
DCL8422E	22 x 84 x 29	100	286	34	\$4563	\$5475	
DCL7822E	22 x 78 x 29	100	265	31	\$4239	\$5088	
DCL7222E	22 x 72 x 29	100	250	29	\$3915	\$4694	
DCL6622E	22 x 66 x 29	100	229	27	\$3767	\$4521	
DCL6022E	22 x 60 x 29	100	208	24	\$3426	\$4108	

Standard with full to floor **file/file** pedestal on **left**. Pedestal locks. Shipped assembled in 1 carton.

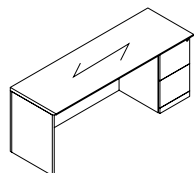

Single Pedestal Credenza - RIGHT

DCR8424E	24 x 84 x 29	100	315	34	\$4977	\$5973
DCR7824E	24 x 78 x 29	100	292	31	\$4623	\$5544
DCR7224E	24 x 72 x 29	100	270	29	\$4268	\$5120
DCR6624E	24 x 66 x 29	100	247	27	\$4108	\$4930
DCR6024E	24 x 60 x 29	100	225	24	\$3735	\$4481
DCR8422E	22 x 84 x 29	100	286	34	\$4563	\$5475
DCR7822E	22 x 78 x 29	100	265	31	\$4239	\$5088
DCR7222E	22 x 72 x 29	100	250	29	\$3915	\$4694
DCR6622E	22 x 66 x 29	100	229	27	\$3767	\$4521
DCR6022E	22 x 60 x 29	100	208	24	\$3426	\$4108

Standard with full to floor **file/file** pedestal on **right**. Pedestal locks. Shipped assembled in 1 carton.

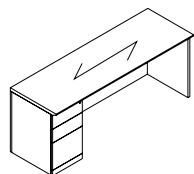

Single Pedestal Credenza - LEFT

DCL8424D	24 x 84 x 29	100	315	34	\$4977	\$5973
DCL7824D	24 x 78 x 29	100	292	31	\$4623	\$5544
DCL7224D	24 x 72 x 29	100	270	29	\$4268	\$5120
DCL6624D	24 x 66 x 29	100	247	27	\$4108	\$4930
DCL6024D	24 x 60 x 29	100	225	24	\$3735	\$4481
DCL8422D	22 x 84 x 29	100	286	34	\$4563	\$5475
DCL7822D	22 x 78 x 29	100	265	31	\$4239	\$5088
DCL7222D	22 x 72 x 29	100	250	29	\$3915	\$4694
DCL6622D	22 x 66 x 29	100	229	27	\$3767	\$4521
DCL6022D	22 x 60 x 29	100	208	24	\$3426	\$4108

Standard with full to floor **box/box/file** pedestal on **left**. Pedestal locks. Shipped assembled in 1 carton.

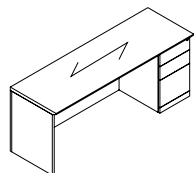

Single Pedestal Credenza - RIGHT

DCR8424D	24 x 84 x 29	100	315	34	\$4977	\$5973
DCR7824D	24 x 78 x 29	100	292	31	\$4623	\$5544
DCR7224D	24 x 72 x 29	100	270	29	\$4268	\$5120
DCR6624D	24 x 66 x 29	100	247	27	\$4108	\$4930
DCR6024D	24 x 60 x 29	100	225	24	\$3735	\$4481
DCR8422D	22 x 84 x 29	100	286	34	\$4563	\$5475
DCR7822D	22 x 78 x 29	100	265	31	\$4239	\$5088
DCR7222D	22 x 72 x 29	100	250	29	\$3915	\$4694
DCR6622D	22 x 66 x 29	100	229	27	\$3767	\$4521
DCR6022D	22 x 60 x 29	100	208	24	\$3426	\$4108

Standard with full to floor **box/box/file** pedestal on **right**. Pedestal locks. Shipped assembled in 1 carton.

**Required Specifications**

Veneer Finish  
Laminate Finish  
Handle style

**Optional Specifications**

Grommet

CREDENZAS

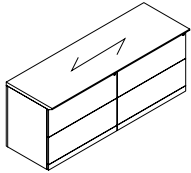

Lateral File Credenza

MODEL#	DIMENSIONS D x W x H	FREIGHT CLASS	WT/LBS.	CUBIC FT.	veneer/LAMINATE	ALL VENEER
DC7224FF	24 x 72 x 29	92.5	328	29	\$6864	\$8241
DC7222FF	22 x 72 x 29	92.5	300	27	\$6297	\$7553
DC6024NN	24 x 60 x 29	92.5	273	24	\$6296	\$7552
DC6022NN	22 x 60 x 29	100	218	22	\$5775	\$6932

Two 2-drawer lateral files side-by-side. Locking drawers. Anti-lock tilt suspension. **Not for stacking materials on lateral file drawer bottom.** Shipped assembled in 1 carton.

- "FF" models use two 36" wide lateral files, "NN" models use 30" wide.

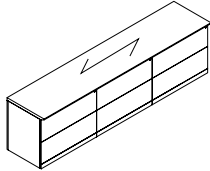

Lateral File Credenza

DC10824FFF	24 x 108 x 29	92.5	457	44	\$12077	\$14491
DC10822FFF	22 x 108 x 29	92.5	435	40	\$11069	\$13283
DC9024NNN	24 x 90 x 29	92.5	381	36	\$10067	\$12079
DC9022NNN	22 x 90 x 29	92.5	372	33	\$9230	\$11076

Three 2-drawer lateral files side-by-side. Locking drawers. Anti-lock tilt suspension. **Not for stacking materials on lateral file drawer bottom.** Shipped assembled in 1 carton.

- "FFF" models use two 36" wide lateral files, "NNN" models use 30" wide.

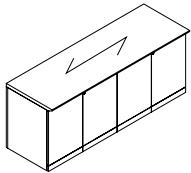

Storage Cabinet Credenza

DC7224GG	24 x 72 x 29	92.5	300	29	\$5097	\$6118
DC7222GG	22 x 72 x 29	92.5	277	27	\$4673	\$5607
DC6024MM	24 x 60 x 29	92.5	254	24	\$4673	\$5607
DC6022MM	22 x 60 x 29	92.5	232	22	\$4285	\$5142

Two 2-door storage cabinets side-by-side. Locking doors. Self-closing hinged doors cover one adjustable shelf. Shipped assembled in 1 carton.

- "GG" models use two 36" wide storage cabinets, "MM" models use 30" wide.

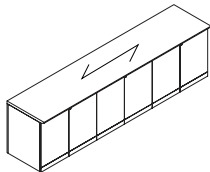

Storage Cabinet Credenza

DC10824GGG	24 x 108 x 29	100	392	44	\$9629	\$11555
DC10822GGG	22 x 108 x 29	100	348	40	\$8826	\$10591
DC9024MMM	24 x 90 x 29	100	326	36	\$8025	\$9630
DC9022MMM	22 x 90 x 29	100	302	33	\$7360	\$8830

Three 2-door storage cabinets side-by-side. Locking doors. Self-closing hinged doors cover one adjustable shelf. Shipped assembled in 1 carton.

- "GGG" models use two 36" wide storage cabinets, "MMM" models use 30" wide.

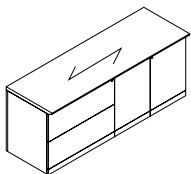

Lateral File/Storage Cabinet Credenza

DCF7224	24 x 72 x 29	92.5	305	29	\$5372	\$6447
DCF7222	22 x 72 x 29	92.5	285	27	\$4925	\$5911
DCF6024	24 x 60 x 29	92.5	254	24	\$4478	\$5372
DCF6022	22 x 60 x 29	92.5	233	22	\$4104	\$4923

One 2-drawer lateral file and one storage cabinet. Locking door/drawers. Storage cabinet includes one adjustable shelf. Anti-lock tilt suspension. **Not for stacking materials on lateral file drawer bottom.** Shipped assembled in 1 carton.

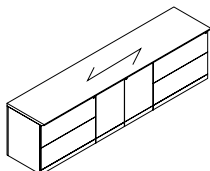

Lateral File/Storage Cabinet Credenza

DC10824FGF	24 x 108 x 29	92.5	392	44	\$11264	\$13517
DC10822FGF	22 x 108 x 29	92.5	348	40	\$10321	\$12388
DC9024NMN	24 x 90 x 29	92.5	326	36	\$9386	\$11264
DC9022NMN	22 x 90 x 29	92.5	302	33	\$8606	\$10327

One 2-drawer lateral file and one storage cabinet. Locking door/drawers. Storage cabinet includes one adjustable shelf. Anti-lock tilt suspension. **Not for stacking materials on lateral file drawer bottom.** Shipped assembled in 1 carton.

- "FGF" models use two 36" wide lateral files and one 36" wide storage cabinet, "NMN" models use 30" wide.

**Required Specifications**

- Veneer Finish
- Laminate Finish
- Handle style

CREDENZAS

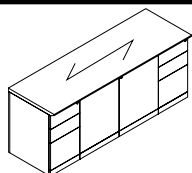

Vertical File/Storage Cabinet Credenza

MODEL#	DIMENSIONS D x W x H	FREIGHT CLASS	WT./LBS.	CUBIC FT.	VENEER/LAMINATE	ALL VENEER
DCD7224D	24 x 72 x 29	92.5	319	29	<b>\$6297</b>	<b>\$7553</b>
DCD7222D	22 x 72 x 29	92.5	298	24	<b>\$5775</b>	<b>\$6932</b>
DCD6024D	24 x 60 x 29	92.5	266	24	<b>\$5775</b>	<b>\$6932</b>
DCD6022D	22 x 60 x 29	92.5	246	20	<b>\$5292</b>	<b>\$6353</b>

Two box/box/file vertical files and one storage cabinet. Locking door/drawers. Storage cabinet includes one adjustable shelf. One pencil tray. Shipped assembled in 1 carton.

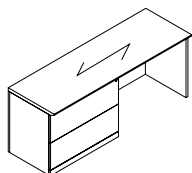

Kneespace Lateral File Credenza - LEFT\*

DCL8424F	24 x 84 x 29	100	305	34	<b>\$5782</b>	<b>\$6939</b>
DCL7824F	24 x 78 x 29	100	285	31	<b>\$5370</b>	<b>\$6446</b>
DCL7224F	24 x 72 x 29	100	261	29	<b>\$4956</b>	<b>\$5947</b>
DCL6624F	24 x 66 x 29	100	239	27	<b>\$4772</b>	<b>\$5725</b>
DCL6024F	24 x 60 x 29	100	218	24	<b>\$4335</b>	<b>\$5202</b>
DCL8422F	22 x 84 x 29	100	266	31	<b>\$5306</b>	<b>\$6365</b>
DCL7822F	22 x 78 x 29	100	245	29	<b>\$4923</b>	<b>\$5909</b>
DCL7222F	22 x 72 x 29	100	230	27	<b>\$4548</b>	<b>\$5458</b>
DCL6622F	22 x 66 x 29	100	209	24	<b>\$4377</b>	<b>\$5253</b>
DCL6022F	22 x 60 x 29	100	188	22	<b>\$3975</b>	<b>\$4769</b>

One 2-drawer lateral file on the **left**. Locking drawers. Anti-lock tilt suspension. **Not for stacking materials on lateral file drawer bottom.** Shipped assembled in 1 carton.

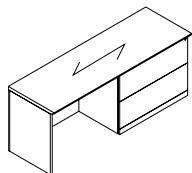

Kneespace Lateral File Credenza - RIGHT\*

DCR8424F	24 x 84 x 29	100	305	34	<b>\$5782</b>	<b>\$6939</b>
DCR7824F	24 x 78 x 29	100	285	31	<b>\$5370</b>	<b>\$6446</b>
DCR7224F	24 x 72 x 29	100	261	29	<b>\$4956</b>	<b>\$5947</b>
DCR6624F	24 x 66 x 29	100	239	27	<b>\$4772</b>	<b>\$5725</b>
DCR6024F	24 x 60 x 29	100	218	24	<b>\$4335</b>	<b>\$5202</b>
DCR8422F	22 x 84 x 29	100	266	31	<b>\$5306</b>	<b>\$6365</b>
DCR7822F	22 x 78 x 29	100	245	29	<b>\$4923</b>	<b>\$5909</b>
DCR7222F	22 x 72 x 29	100	230	27	<b>\$4548</b>	<b>\$5458</b>
DCR6622F	22 x 66 x 29	100	209	24	<b>\$4377</b>	<b>\$5253</b>
DCR6022F	22 x 60 x 29	100	188	22	<b>\$3975</b>	<b>\$4769</b>

One 2-drawer lateral file on the **right**. Locking drawers. Anti-lock tilt suspension. **Not for stacking materials on lateral file drawer bottom.** Shipped assembled in 1 carton.

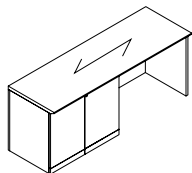

Kneespace Storage Cabinet \* Credenza - LEFT

DCL8424G	24 x 84 x 29	100	338	34	<b>\$5189</b>	<b>\$6229</b>
DCL7824G	24 x 78 x 29	92.5	314	31	<b>\$4822</b>	<b>\$5787</b>
DCL7224G	24 x 72 x 29	92.5	290	29	<b>\$4450</b>	<b>\$5340</b>
DCL6624G	24 x 66 x 29	100	266	27	<b>\$4284</b>	<b>\$5140</b>
DCL6024G	24 x 60 x 29	92.5	242	24	<b>\$3897</b>	<b>\$4677</b>
DCL8422G	22 x 84 x 29	100	266	31	<b>\$4765</b>	<b>\$5720</b>
DCL7822G	22 x 78 x 29	100	245	29	<b>\$4423</b>	<b>\$5310</b>
DCL7222G	22 x 72 x 29	100	230	27	<b>\$4082</b>	<b>\$4896</b>
DCL6622G	22 x 66 x 29	92.5	209	24	<b>\$3927</b>	<b>\$4712</b>
DCL6022G	22 x 60 x 29	92.5	188	22	<b>\$3576</b>	<b>\$4288</b>

One storage cabinet on **left**. Locking doors. Storage cabinet has one adjustable shelf. Shipped assembled in 1 carton.

**Required Specifications**

Veneer Finish  
Laminate Finish  
Handle style

**Optional Specifications**

Grommet\*

**CREDENZAS**

MODEL#	DIMENSIONS	FREIGHT CLASS	WT/LBS.	CUBIC FT.	VENEER/LAMINATE	ALL VENEER
--------	------------	---------------	---------	-----------	-----------------	------------

**D x W x H**

DCR8424G	24 x 84 x 29	100	338	34	<b>\$5189</b>	<b>\$6229</b>
DCR7824G	24 x 78 x 29	92.5	314	31	<b>\$4822</b>	<b>\$5787</b>
DCR7224G	24 x 72 x 29	92.5	290	29	<b>\$4450</b>	<b>\$5340</b>
DCR6624G	24 x 66 x 29	100	266	27	<b>\$4284</b>	<b>\$5140</b>
DCR6024G	24 x 60 x 29	92.5	242	24	<b>\$3897</b>	<b>\$4677</b>

DCR8422G	22 x 84 x 29	100	266	31	<b>\$4765</b>	<b>\$5720</b>
DCR7822G	22 x 78 x 29	100	245	29	<b>\$4423</b>	<b>\$5310</b>
DCR7222G	22 x 72 x 29	100	230	27	<b>\$4082</b>	<b>\$4896</b>
DCR6622G	22 x 66 x 29	92.5	209	24	<b>\$3927</b>	<b>\$4712</b>
DCR6022G	22 x 60 x 29	92.5	188	22	<b>\$3576</b>	<b>\$4288</b>

One storage cabinet on **right**. Locking doors. Storage cabinet has one adjustable shelf. Shipped assembled in 1 carton.

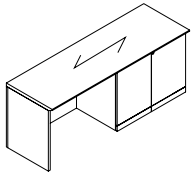

**Kneespace Storage Cabinet Credenza - RIGHT**

DCL8424Z	24 x 84 x 29	100	338	34	<b>\$6315</b>	<b>\$7579</b>
DCL7824Z	24 x 78 x 29	92.5	314	31	<b>\$5864</b>	<b>\$7036</b>
DCL7224Z	24 x 72 x 29	92.5	290	29	<b>\$5415</b>	<b>\$6496</b>
DCL6624Z	24 x 66 x 29	100	266	27	<b>\$5212</b>	<b>\$6254</b>
DCL6024Z	24 x 60 x 29	92.5	242	24	<b>\$4737</b>	<b>\$5682</b>

DCL8422Z	22 x 84 x 29	92.5	309	31	<b>\$5788</b>	<b>\$6947</b>
DCL7822Z	22 x 78 x 29	100	287	29	<b>\$5376</b>	<b>\$6451</b>
DCL7222Z	22 x 72 x 29	92.5	270	27	<b>\$4964</b>	<b>\$5956</b>
DCL6622Z	22 x 66 x 29	92.5	248	24	<b>\$4778</b>	<b>\$5732</b>
DCL6022Z	22 x 60 x 29	92.5	225	22	<b>\$4343</b>	<b>\$5212</b>

Standard with two box drawers, one file drawer, and one 36"W lateral file drawer on the **left**. File drawer and lateral file drawer lock. Front-to-back and side-to-side filing. **Not for stacking materials on lateral file drawer bottom.** Shipped assembled in 1 carton.

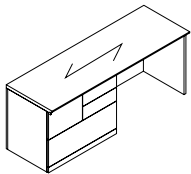

**Mixed Storage Credenza - LEFT**

DCR8424Z	24 x 84 x 29	100	338	34	<b>\$6315</b>	<b>\$7579</b>
DCR7824Z	24 x 78 x 29	92.5	314	31	<b>\$5864</b>	<b>\$7036</b>
DCR7224Z	24 x 72 x 29	92.5	290	29	<b>\$5415</b>	<b>\$6496</b>
DCR6624Z	24 x 66 x 29	100	266	27	<b>\$5212</b>	<b>\$6254</b>
DCR6024Z	24 x 60 x 29	92.5	242	24	<b>\$4737</b>	<b>\$5682</b>

DCR8422Z	22 x 84 x 29	92.5	309	31	<b>\$5788</b>	<b>\$6947</b>
DCR7822Z	22 x 78 x 29	100	287	29	<b>\$5377</b>	<b>\$6452</b>
DCR7222Z	22 x 72 x 29	92.5	270	27	<b>\$4964</b>	<b>\$5956</b>
DCR6622Z	22 x 66 x 29	92.5	248	24	<b>\$4778</b>	<b>\$5732</b>
DCR6022Z	22 x 60 x 29	92.5	225	22	<b>\$4343</b>	<b>\$5212</b>

Standard with two box drawers, one file drawer, and one 36"W lateral file drawer on the **right**. File drawer and lateral file drawer lock. Front-to-back and side-to-side filing. **Not for stacking materials on lateral file drawer bottom.** Shipped assembled in 1 carton.

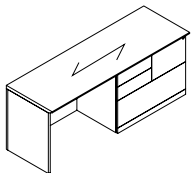

**Mixed Storage Credenza - RIGHT**

**Required Specifications**

Veneer Finish  
Laminate Finish  
Handle style

**Optional Specifications**

Grommet

# D DUFFERIN

## CORNERS

## MODEL#

## DIMENSIONS

## FREIGHT CLASS

## WT./LBS.

## CUBIC FT.

## VENEER/LAMINATE

## ALL VENEER

D x W x H

- A Corner Desk is used to connect to a Linking Bridge and Linking Credenza, or Connectable Table
- Cable management tray is included.
- Full Modesty Panel option.
- 5-Sided Corners include a GM1 grommet in the top center position. Grommets are available as an option on Extended Corners.
- Hand of Linking Credenza is determined by location of full end panel from user side.
- Hand of Extended Corner is determined by location of long narrow end from user side.
- Connecting sides feature a self edge.

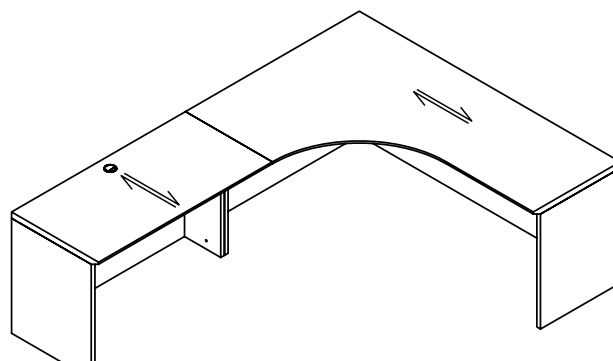
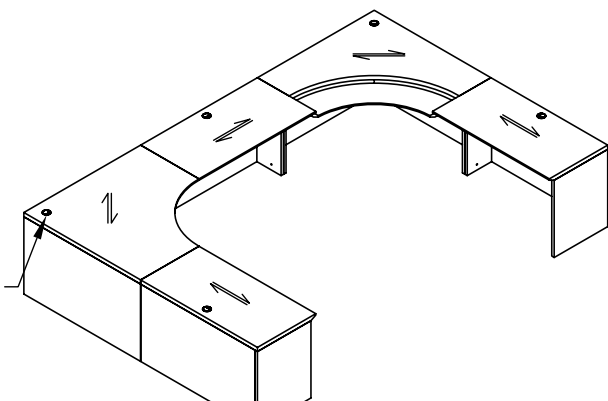
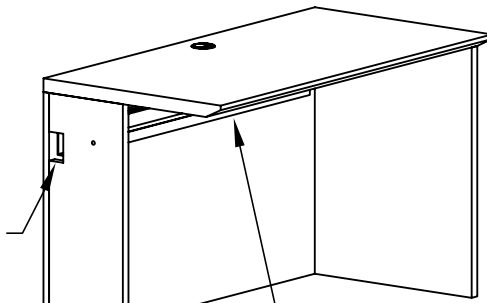
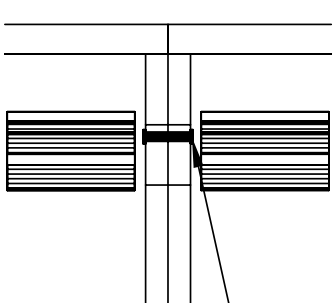

## 5-SIDED CORNERS

## MODEL#

## DIMENSIONS

## FREIGHT CLASS

## WT./LBS.

## CUBIC FT.

## VENEER/LAMINATE

## ALL VENEER

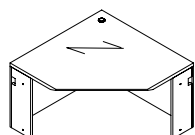

5-Sided Corner

DE484824	48 x 48 x 29	150	201	39	<b>\$3017</b>	<b>\$3619</b>
DE424224	42 x 42 x 29	150	155	30	<b>\$2314</b>	<b>\$2774</b>
DE363624	36 x 36 x 29	125	135	22	<b>\$2199</b>	<b>\$2639</b>

Connects to **24"D** connectables, returns, extended corners, storage/lateral file credenzas, credenzas and bridges. Includes grommet and installed horizontal wire management. Narrow end panels on left and right. Shipped assembled in 1 carton.

- *Not freestanding*

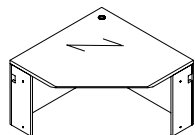

5-Sided Corner

DE484822	48 x 48 x 29	150	196	39	<b>\$3017</b>	<b>\$3619</b>
DE424222	42 x 42 x 29	150	150	30	<b>\$2314</b>	<b>\$2774</b>
DE363622	36 x 36 x 29	150	130	22	<b>\$2199</b>	<b>\$2639</b>

Connects to **22"D** connectables, returns, extended corners, storage/lateral file credenzas, credenzas and bridges. Includes grommet and installed horizontal wire management. Narrow end panels on left and right. Shipped assembled in 1 carton.

- *Not freestanding*

### Required Specifications

Veneer Finish  
Laminate Finish

### Optional Specifications

Additional grommet

**LEFT EXTENDED CORNERS**

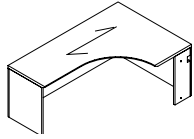

**Left Extended Corner**

MODEL#	DIMENSIONS	FREIGHT CLASS	WT./LBS.	CUBIC FT.	veneer/LAMINATE	ALL VENEER
<b>D x W x H</b>						
DEKL964824	24-48 x 96 x 29	150	387	77	<b>\$5021</b>	<b>\$6022</b>
DEKL904824	24-48 x 90 x 29	150	363	73	<b>\$4669</b>	<b>\$5602</b>
DEKL844824	24-48 x 84 x 29	150	338	68	<b>\$4663</b>	<b>\$5597</b>
DEKL784824	24-48 x 78 x 29	150	314	63	<b>\$4589</b>	<b>\$5505</b>
DEKL724824	24-48 x 72 x 29	150	290	58	<b>\$4302</b>	<b>\$5163</b>
DEKL664824	24-48 x 66 x 29	150	266	52	<b>\$4069</b>	<b>\$4881</b>
DEKL604824	24-48 x 60 x 29	150	242	48	<b>\$3770</b>	<b>\$4522</b>

Extended worksurface on **left. Full end panel on left, narrow end panel on right.** Connects to Linking Bridges, Extended Corners and Connectable Tables. Shipped assembled in 1 carton.

**RIGHT EXTENDED CORNERS**

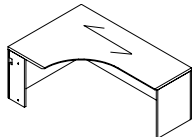

**Right Extended Corner**

MODEL#	DIMENSIONS	FREIGHT CLASS	WT./LBS.	CUBIC FT.	veneer/LAMINATE	ALL VENEER
DEKR489624	24-48 x 96 x 29	150	387	77	<b>\$5021</b>	<b>\$6022</b>
DEKR489024	24-48 x 90 x 29	150	363	73	<b>\$4669</b>	<b>\$5602</b>
DEKR488424	24-48 x 84 x 29	150	338	68	<b>\$4663</b>	<b>\$5597</b>
DEKR487824	24-48 x 78 x 29	150	314	63	<b>\$4589</b>	<b>\$5505</b>
DEKR487224	24-48 x 72 x 29	150	290	58	<b>\$4302</b>	<b>\$5163</b>
DEKR486624	24-48 x 66 x 29	150	266	52	<b>\$4069</b>	<b>\$4881</b>
DEKR486024	24-48 x 60 x 29	150	242	48	<b>\$3770</b>	<b>\$4522</b>

Extended worksurface on **right. Full end panel on right, narrow end panel on left.** Connects to Linking Bridges, Extended Corners and Connectable Tables. Shipped assembled in 1 carton.

**FREESTANDING TABLES**

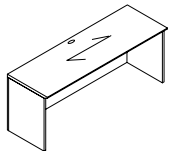

**24" Deep Freestanding Table**

MODEL#	DIMENSIONS	FREIGHT CLASS	WT./LBS.	CUBIC FT.	veneer/LAMINATE	ALL VENEER
DVT9624	24 x 96 x 29	150	213	39	<b>\$2993</b>	<b>\$3591</b>
DVT9024	24 x 90 x 29	150	199	36	<b>\$2805</b>	<b>\$3366</b>
DVT8424	24 x 84 x 29	150	186	34	<b>\$2619</b>	<b>\$3143</b>
DVT7824	24 x 78 x 29	150	173	31	<b>\$2433</b>	<b>\$2920</b>
DVT7224	24 x 72 x 29	150	160	29	<b>\$2246</b>	<b>\$2693</b>
DVT6624	24 x 66 x 29	150	146	27	<b>\$2111</b>	<b>\$2534</b>
DVT6024	24 x 60 x 29	150	133	24	<b>\$1977</b>	<b>\$2372</b>
DVT5424	24 x 54 x 29	150	128	22	<b>\$1870</b>	<b>\$2242</b>
DVT4824	24 x 48 x 29	125	120	19	<b>\$1757</b>	<b>\$2109</b>
DVT4224	24 x 42 x 29	125	104	17	<b>\$1488</b>	<b>\$1788</b>
DVT3624	24 x 36 x 29	150	88	15	<b>\$1441</b>	<b>\$1729</b>
DVT3024	24 x 30 x 29	125	82	12	<b>\$1414</b>	<b>\$1697</b>
DVT2424	24 x 24 x 29	125	65	10	<b>\$1188</b>	<b>\$1425</b>

Two full end panels. **Cannot be connected on left or right side.** Shipped assembled in 1 carton.

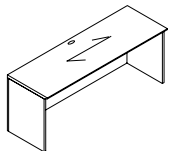

**22" Deep Freestanding Table**

DVT9622	22 x 96 x 29	150	193	35	<b>\$2852</b>	<b>\$3423</b>
DVT9022	22 x 90 x 29	150	181	33	<b>\$2670</b>	<b>\$3207</b>
DVT8422	22 x 84 x 29	150	169	31	<b>\$2498</b>	<b>\$2996</b>
DVT7822	22 x 78 x 29	150	157	29	<b>\$2316</b>	<b>\$2779</b>
DVT7222	22 x 72 x 29	150	145	27	<b>\$2140</b>	<b>\$2565</b>
DVT6622	22 x 66 x 29	150	138	24	<b>\$2010</b>	<b>\$2411</b>
DVT6022	22 x 60 x 29	150	130	22	<b>\$1883</b>	<b>\$2261</b>
DVT5422	22 x 54 x 29	125	123	20	<b>\$1777</b>	<b>\$2137</b>
DVT4822	22 x 48 x 29	125	115	18	<b>\$1676</b>	<b>\$2013</b>
DVT4222	22 x 42 x 29	125	100	16	<b>\$1418</b>	<b>\$1702</b>
DVT3622	22 x 36 x 29	125	85	13	<b>\$1374</b>	<b>\$1647</b>
DVT3022	22 x 30 x 29	125	80	11	<b>\$1346</b>	<b>\$1613</b>
DVT2422	22 x 24 x 29	125	64	9	<b>\$1130</b>	<b>\$1357</b>

Two full end panels. **Cannot be connected on left or right side.** Shipped assembled in 1 carton.

**Required Specifications**

Veneer Finish  
Laminate Finish

**Optional Specifications**

Grommet

## CONNECTABLE TABLES

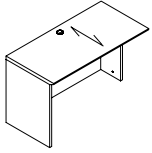

**24" Deep Connectable Table - LEFT**

MODEL#	DIMENSIONS D x W x H	FREIGHT CLASS	WT./LBS.	CUBIC FT.	VENEER/LAMINATE	ALL VENEER
DVL9624CG	24 x 96 x 29	150	200	39	\$3312	\$3974
DVL9024CG	24 x 90 x 29	150	187	36	\$3101	\$3721
DVL8424CG	24 x 84 x 29	150	174	34	\$2896	\$3476
DVL7824CG	24 x 78 x 29	150	162	31	\$2686	\$3221
DVL7224CG	24 x 72 x 29	150	149	29	\$2482	\$2978
DVL6624CG	24 x 66 x 29	150	141	27	\$2328	\$2794
DVL6024CG	24 x 60 x 29	150	132	24	\$2176	\$2613
DVL5424CG	24 x 54 x 29	150	121	22	\$2054	\$2460
DVL4824CG	24 x 48 x 29	125	115	19	\$1928	\$2315
DVL4224CG	24 x 42 x 29	150	99	17	\$1629	\$1955
DVL3624CG	24 x 36 x 29	150	83	15	\$1569	\$1886
DVL3024CG	24 x 30 x 29	125	77	12	\$1542	\$1850
DVL2424CG	24 x 24 x 29	125	61	10	\$1296	\$1553

**Full end panel on left.** Right narrow end panel connects to **24"D** center/right connectable table; **24"D** extended corners, **24"D** 5-sided corners; Grommet in worksurface. Shipped assembled in 1 carton.

- To remove cross grain veneer pattern on top, **delete suffix "CG"** from the model number. Available as a special - no upcharge.

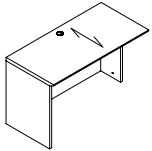

**22" Deep Connectable Table - LEFT**

DVL9622CG	22 x 96 x 29	150	187	39	\$3151	\$3780
DVL9022CG	22 x 90 x 29	150	175	36	\$2957	\$3549
DVL8422CG	22 x 84 x 29	150	163	34	\$2760	\$3312
DVL7822CG	22 x 78 x 29	150	152	31	\$2560	\$3070
DVL7222CG	22 x 72 x 29	150	140	29	\$2364	\$2836
DVL6622CG	22 x 66 x 29	150	133	27	\$2221	\$2664
DVL6022CG	22 x 60 x 29	150	125	24	\$2074	\$2490
DVL5422CG	22 x 54 x 29	150	113	22	\$1960	\$2351
DVL4822CG	22 x 48 x 29	125	110	19	\$1842	\$2209
DVL4222CG	22 x 42 x 29	150	95	17	\$1555	\$1863
DVL3622CG	22 x 36 x 29	125	80	15	\$1495	\$1795
DVL3022CG	22 x 30 x 29	125	75	12	\$1469	\$1766
DVL2422CG	22 x 24 x 29	125	60	10	\$1236	\$1483

**Full end panel on left.** Right narrow end panel connects to **22"D** center/right connectable table; **22"D** 5-sided corners; Grommet in worksurface. Shipped assembled in 1 carton.

- To remove cross grain veneer pattern on top, **delete suffix "CG"** from the model number. Available as a special - no upcharge.

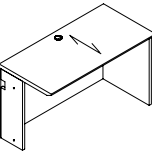

**24" Deep Connectable Table - RIGHT**

DVR9624CG	24 x 96 x 29	150	200	39	\$3312	\$3974
DVR9024CG	24 x 90 x 29	150	187	36	\$3101	\$3721
DVR8424CG	24 x 84 x 29	150	174	34	\$2896	\$3476
DVR7824CG	24 x 78 x 29	150	162	31	\$2686	\$3221
DVR7224CG	24 x 72 x 29	150	149	29	\$2482	\$2978
DVR6624CG	24 x 66 x 29	150	141	27	\$2328	\$2794
DVR6024CG	24 x 60 x 29	150	132	24	\$2173	\$2609
DVR5424CG	24 x 54 x 29	150	121	22	\$2054	\$2460
DVR4824CG	24 x 48 x 29	125	115	19	\$1930	\$2316
DVR4224CG	24 x 42 x 29	150	99	17	\$1629	\$1955
DVR3624CG	24 x 36 x 29	150	83	15	\$1569	\$1886
DVR3024CG	24 x 30 x 29	125	77	12	\$1542	\$1850
DVR2424CG	24 x 24 x 29	125	61	10	\$1296	\$1553

**Full end panel on right.** Left narrow end panel connects to **24"D** center/left connectable table; **24"D** extended corners, **24"D** 5-sided corners; Grommet in worksurface. Shipped assembled in 1 carton.

- To remove cross grain veneer pattern on top, **delete suffix "CG"** from the model number. Available as a special - no upcharge.

### Required Specifications

Veneer Finish  
Laminate Finish

### Optional Specifications

Additional grommet

CONNECTABLE TABLES

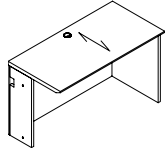

22" Deep Connectable Table - RIGHT

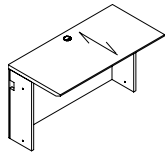

24" Deep Connectable Table

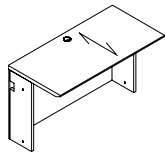

22" Deep Connectable Table

MODEL#	DIMENSIONS D x W x H	FREIGHT CLASS	WT./LBS.	CUBIC FT.	veneer/LAMINATE	ALL VENEER
DVR9622CG	22 x 96 x 29	150	187	39	\$3151	\$3780
DVR9022CG	22 x 90 x 29	150	175	36	\$2957	\$3549
DVR8422CG	22 x 84 x 29	150	163	34	\$2760	\$3312
DVR7822CG	22 x 78 x 29	150	152	31	\$2560	\$3070
DVR7222CG	22 x 72 x 29	150	140	29	\$2364	\$2836
DVR6622CG	22 x 66 x 29	150	133	27	\$2221	\$2664
DVR6022CG	22 x 60 x 29	150	125	24	\$2074	\$2490
DVR5422CG	22 x 54 x 29	150	113	22	\$1960	\$2351
DVR4822CG	22 x 48 x 29	125	110	19	\$1842	\$2209
DVR4222CG	22 x 42 x 29	150	95	17	\$1555	\$1863
DVR3622CG	22 x 36 x 29	125	80	15	\$1495	\$1795
DVR3022CG	22 x 30 x 29	125	75	12	\$1469	\$1766
DVR2422CG	22 x 24 x 29	125	60	10	\$1236	\$1483

**Full end panel on right.** Left narrow end panel connects to 22"D center/left connectable table; 22"D 5-sided corners; Grommet in worksurface. Shipped assembled in 1 carton.

- To remove cross grain veneer pattern on top, delete suffix "CG" from the model number. Available as a special - no upcharge.

DV9624CG	24 x 96 x 29	150	197	39	\$3233	\$3877
DV9024CG	24 x 90 x 29	150	185	36	\$3034	\$3641
DV8424CG	24 x 84 x 29	150	173	34	\$2831	\$3398
DV7824CG	24 x 78 x 29	150	160	31	\$2629	\$3154
DV7224CG	24 x 72 x 29	150	145	29	\$2424	\$2908
DV6624CG	24 x 66 x 29	150	136	27	\$2453	\$2945
DV6024CG	24 x 60 x 29	150	123	24	\$2117	\$2539
DV5424CG	24 x 54 x 29	150	119	22	\$1992	\$2392
DV4824CG	24 x 48 x 29	150	107	19	\$1871	\$2246
DV4224CG	24 x 42 x 29	150	91	17	\$1569	\$1886
DV3624CG	24 x 36 x 29	150	76	15	\$1514	\$1815
DV3024CG	24 x 30 x 29	150	70	12	\$1483	\$1777
DV2424CG	24 x 24 x 29	150	53	10	\$1245	\$1494

**Narrow end panels on left and right** connects to 24"D connectable table; 24"D extended corners, 24"D 5-sided corners; Grommet in worksurface. Shipped assembled in 1 carton.

- To remove cross grain veneer pattern on top, delete suffix "CG" from the model number. Available as a special - no upcharge.

DV9622CG	22 x 96 x 29	150	181	35	\$3079	\$3694
DV9022CG	22 x 90 x 29	150	169	33	\$2891	\$3468
DV8422CG	22 x 84 x 29	150	157	31	\$2693	\$3233
DV7822CG	22 x 78 x 29	150	145	29	\$2503	\$3004
DV7222CG	22 x 72 x 29	150	133	27	\$2305	\$2767
DV6622CG	22 x 66 x 29	150	126	24	\$2162	\$2594
DV6022CG	22 x 60 x 29	150	118	22	\$2022	\$2428
DV5422CG	22 x 54 x 29	150	111	20	\$1898	\$2276
DV4822CG	22 x 48 x 29	150	103	18	\$1780	\$2139
DV4222CG	22 x 42 x 29	150	88	16	\$1490	\$1790
DV3622CG	22 x 36 x 29	150	73	13	\$1440	\$1728
DV3022CG	22 x 30 x 29	125	68	11	\$1412	\$1693
DV2422CG	22 x 24 x 29	150	52	9	\$1184	\$1420

**Narrow end panels on left and right** connects to 22"D connectable table; 22"D extended corners, 22"D 5-sided corners; Grommet in worksurface. Shipped assembled in 1 carton.

- To remove cross grain veneer pattern on top, delete suffix "CG" from the model number. Available as a special - no upcharge.

**Required Specifications**

Veneer Finish  
Laminate Finish

**Optional Specifications**

Additional grommet

# DUFFERIN

**"D" ISLANDS**

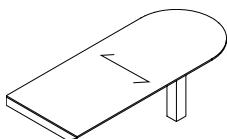

**"D" Island with Monopost**

MODEL#	DIMENSIONS D x W x H	FREIGHT CLASS	WT./LBS.	CUBIC FT.	VENEER/LAMINATE	ALL VENEER
DRD8436CG	36 x 84 x 29	250	135	51	N/A	<b>\$3052</b>
DRD7236CG	36 x 72 x 29	250	121	44	N/A	<b>\$2613</b>
DRD7230CG	30 x 72 x 29	250	99	36	N/A	<b>\$2446</b>
DRD6636CG	36 x 66 x 29	250	99	40	N/A	<b>\$2446</b>
DRD6030CG	30 x 60 x 29	250	83	30	N/A	<b>\$2276</b>

Attaches to edge of worksurfaces with Dufferin knife (molding) edge. Attaching hardware included. Shipped RTA (ready to assemble).

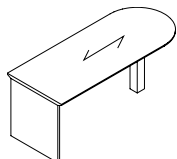

**"D" Island - Full End Panel\* (T-Base) & Monopost**

DDD8436	36 x 84 x 29	125	343	51	<b>\$4843</b>	<b>\$5813</b>
DDD7236	36 x 72 x 29	125	294	44	<b>\$4151</b>	<b>\$4978</b>
DDD7230	30 x 72 x 29	125	264	36	<b>\$3858</b>	<b>\$4628</b>
DDD6636	36 x 66 x 29	125	245	40	<b>\$3858</b>	<b>\$4628</b>
DDD6030	30 x 60 x 29	125	225	30	<b>\$3709</b>	<b>\$4448</b>

Connects to Linking Bridges or Executive Returns. Attaching hardware included. **Not freestanding.** Shipped RTA (ready to assemble).

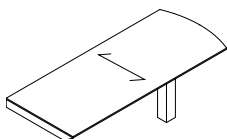

**"D" Island with Monopost, Bow End**

DRDBE8436CG	36 x 84 x 29	250	135	51	N/A	<b>\$3052</b>
DRDBE7236CG	36 x 72 x 29	250	121	44	N/A	<b>\$2613</b>
DRDBE7230CG	30 x 72 x 29	250	99	36	N/A	<b>\$2446</b>
DRDBE6636CG	36 x 66 x 29	250	99	40	N/A	<b>\$2446</b>
DRDBE6030CG	30 x 60 x 29	250	83	30	N/A	<b>\$2276</b>

Attaches to edge of worksurfaces with Dufferin knife (molding) edge. Attaching hardware included. Shipped RTA (ready to assemble).

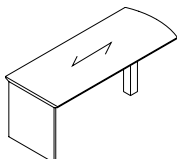

**"D" Island - Full End Panel, Bow End (T-Base) & Monopost**

DRDBE8436	36 x 84 x 29	125	343	51	<b>\$4842</b>	<b>\$5810</b>
DRDBE7236	36 x 72 x 29	125	294	44	<b>\$4151</b>	<b>\$4978</b>
DRDBE7230	30 x 72 x 29	125	264	36	<b>\$3857</b>	<b>\$4627</b>
DRDBE6636	36 x 66 x 29	125	245	40	<b>\$3857</b>	<b>\$4627</b>
DRDBE6030	30 x 60 x 29	125	225	30	<b>\$3706</b>	<b>\$4446</b>

Connects to Linking Bridges or Executive Returns. Attaching hardware included. **Not freestanding.** Shipped RTA (ready to assemble).

**BOAT SHAPED ISLANDS**

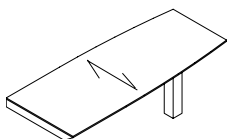

**Boat Shaped Island with Monopost**

MODEL#	DIMENSIONS	FREIGHT CLASS	WT./LBS.	CUBIC FT.	VENEER/LAMINATE	ALL VENEER
DRDBS8442CG	42 x 84 x 29	250	179	59	N/A	<b>\$3552</b>
DRDBS8436CG	36 x 84 x 29	250	155	51	N/A	<b>\$3052</b>
DRDBS7236CG	36 x 72 x 29	250	141	44	N/A	<b>\$2613</b>
DRDBS7230CG	30 x 72 x 29	250	119	36	N/A	<b>\$2446</b>
DRDBS6636CG	36 x 66 x 29	250	119	40	N/A	<b>\$2446</b>
DRDBS6030CG	30 x 60 x 29	250	103	30	N/A	<b>\$2276</b>

Attaches to edge of worksurfaces with Dufferin knife (molding) edge. Attaching hardware included. Shipped RTA (ready to assemble).

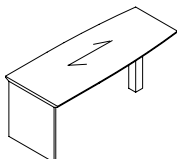

**Boat Shaped Island - Full End Panel\* (T-Base) & Monopost**

DRDBS8442	42 x 84 x 29	125	414	59	<b>\$5732</b>	<b>\$6880</b>
DRDBS8436	36 x 84 x 29	125	343	51	<b>\$4842</b>	<b>\$5810</b>
DRDBS7236	36 x 72 x 29	125	314	44	<b>\$4151</b>	<b>\$4978</b>
DRDBS7230	30 x 72 x 29	125	284	36	<b>\$3857</b>	<b>\$4627</b>
DRDBS6636	36 x 66 x 29	125	265	40	<b>\$3857</b>	<b>\$4627</b>
DRDBS6030	30 x 60 x 29	100	245	30	<b>\$3706</b>	<b>\$4446</b>

Connects to Linking Bridges or Executive Returns. Attaching hardware included. **Not freestanding.** Shipped RTA (ready to assemble).

**Required Specifications**

- Veneer finish
- Laminate finish\*
- Monopost finish

**Optional Specifications**

- Grommet
- Modesty panel
- Monopost (Base) upgrade

**"P" ISLANDS**

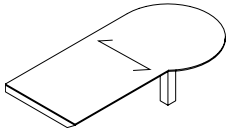

**"P" Island - LEFT with Monopost**

MODEL#	DIMENSIONS D x W x H	FREIGHT CLASS	WT./LBS.	CUBIC FT.	veneer/LAMINATE	ALL VENEER
DRPL9642CG	42 x 96 x 29	250	239	68	N/A	<b>\$4695</b>
DRPL8442CG	42 x 84 x 29	250	209	59	N/A	<b>\$4106</b>
DRPL7242CG	42 x 72 x 29	250	143	51	N/A	<b>\$3525</b>

Attaches to edge of worksurfaces with Dufferin knife (molding) edge. Attaching hardware included. Shipped RTA (ready to assemble).

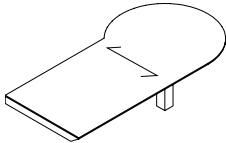

**"P" Island - RIGHT with Monopost**

DRPR9642CG	42 x 96 x 29	250	239	68	N/A	<b>\$4695</b>
DRPR8442CG	42 x 84 x 29	250	209	59	N/A	<b>\$4106</b>
DRPR7242CG	42 x 72 x 29	250	143	51	N/A	<b>\$3525</b>

Attaches to edge of worksurfaces with Dufferin knife (molding) edge. Attaching hardware included. Shipped RTA (ready to assemble).

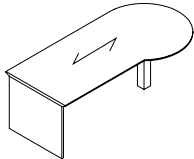

**"P" Island - LEFT with Monopost (T-Base) & Monopost\***

DTPL9642	42 x 96 x 29	125	440	68	<b>\$4434</b>	<b>\$5318</b>
DTPL8442	42 x 84 x 29	125	385	59	<b>\$3878</b>	<b>\$4656</b>
DTPL7242	42 x 72 x 29	125	319	51	<b>\$3535</b>	<b>\$4241</b>

Connects to Linking Bridges or Executive Returns. Attaching hardware included. **Not freestanding.** Shipped RTA (ready to assemble).

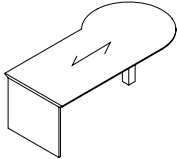

**"P" Island - RIGHT with Monopost (T-Base) & Monopost\***

DTPR9642	42 x 96 x 29	125	440	68	<b>\$4434</b>	<b>\$5318</b>
DTPR8442	42 x 84 x 29	125	385	59	<b>\$3878</b>	<b>\$4656</b>
DTPR7242	42 x 72 x 29	125	319	51	<b>\$3535</b>	<b>\$4241</b>

Connects to Linking Bridges or Executive Returns. Attaching hardware included. **Not freestanding.** Shipped RTA (ready to assemble).

**Required Specifications**

Veneer finish  
Laminate finish\*  
Monopost finish

**Optional Specifications**

Grommet  
Modesty panel  
Monopost (Base) upgrade

# D DUFFERIN

## PIANO DESKS

### MODEL#

### DIMENSIONS

### FREIGHT CLASS

### WT./LBS.

### CUBIC FT.

### VENEER/LAMINATE

### ALL VENEER

D x W x H

- Can be ordered as a shell or with pedestals.
- Components include a GM1 grommet in the top center position.
- Hand of Rectangular Desk is determined by location of pedestal from user side.
- Hand of "D" Top is determined by outward orientation of curved end from user projection.
- Hand of "P" Top is determined by outward orientation of conference end from user projection.
- Connectable Tables and Bridges - To remove cross grain veneer pattern on top, delete suffix "CG" from the model number. Available as a special - no upcharge.

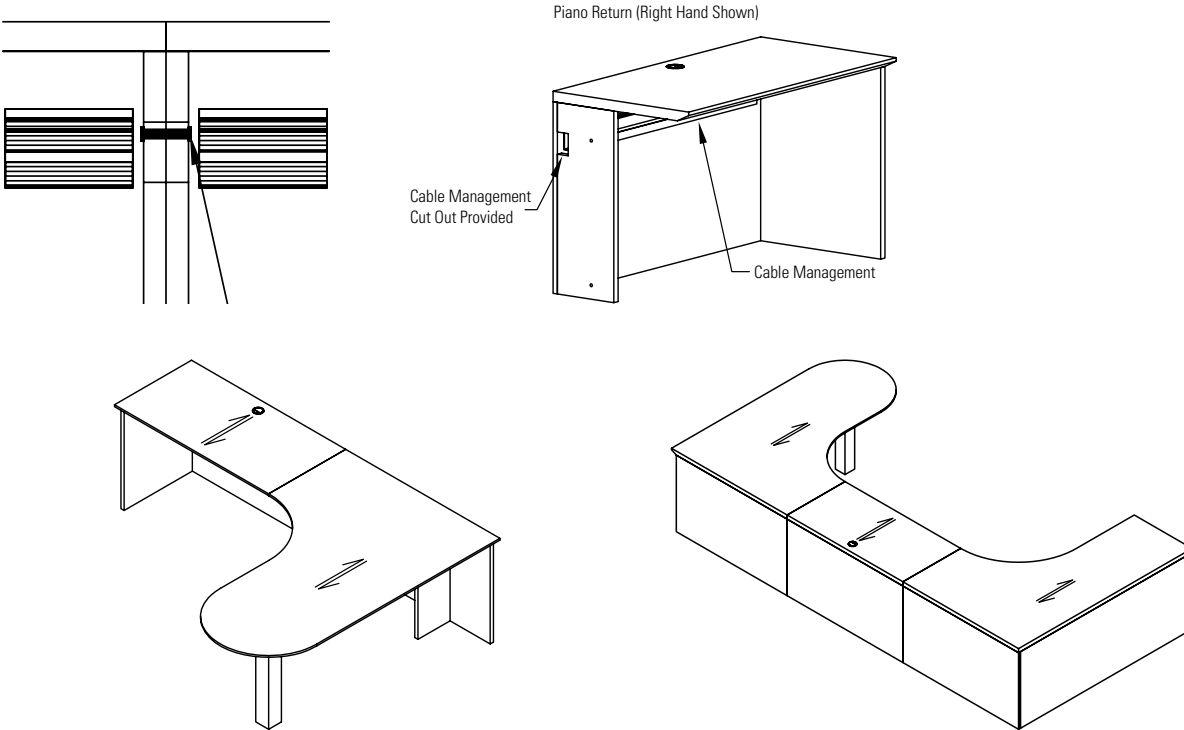

## "D" ISLANDS (PIANO DESKS)

### MODEL#

### DIMENSIONS

### FREIGHT CLASS

### WT./LBS.

### CUBIC FT.

### VENEER/LAMINATE

### ALL VENEER

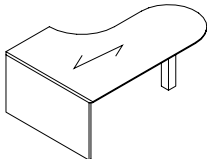

**"D" Island LEFT - Full End Panel & Monopost, Piano Desk**

DTDPL96304824	48 x 96 x 29	125	464	77	<b>\$4598</b>	<b>\$5516</b>
DTDPL84304824	48 x 84 x 29	150	406	68	<b>\$4093</b>	<b>\$4913</b>
DTDPL72304824	48 x 72 x 29	125	348	58	<b>\$3585</b>	<b>\$4302</b>

Extended island worksurface on the **left**. Narrow end panel on right connects to **24"D** returns or bridges **for Piano Desks Only** (see above). **Not freestanding**. Includes installed horizontal wire management. Shipped RTA (ready to assemble).

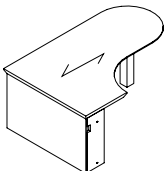

**"D" Island RIGHT - Full End Panel & Monopost, Piano Desk**

DTDPR96304824	48 x 96 x 29	125	464	77	<b>\$4598</b>	<b>\$5516</b>
DTDPR84304824	48 x 84 x 29	150	406	68	<b>\$4093</b>	<b>\$4913</b>
DTDPR72304824	48 x 72 x 29	125	348	58	<b>\$3585</b>	<b>\$4302</b>

Extended island worksurface on the **right**. Narrow end panel on left connects to **24"D** returns or bridges **for Piano Desks Only** (see above). **Not freestanding**. Includes installed horizontal wire management. Shipped RTA (ready to assemble).

#### Required Specifications

Veneer finish  
Laminate finish  
Monopost finish

#### Optional Specifications

Grommet  
Modesty panel  
Monopost (Base) upgrade

BOAT SHAPED ISLANDS (PIANO DESKS)	MODEL#	DIMENSIONS	FREIGHT CLASS	WT./LBS.	CUBIC FT.	VENEER/LAMINATE	ALL VENEER
		<b>D x W x H</b>					
	DTBPL96304824	48 x 96 x 29	125	522	87	<b>\$5465</b>	<b>\$6558</b>
	DTBPL84304824	48 x 84 x 29	125	457	76	<b>\$5465</b>	<b>\$6558</b>
	DTBPL72304824	48 x 72 x 29	125	392	65	<b>\$4772</b>	<b>\$5725</b>

**Boat Shaped Island LEFT - Full End Panel & Monopost, Piano Desk**

Extended island worksurface on the **left**. Narrow end panel on right connects to **24"D** returns or bridges **for Piano Desks Only** (see pg. 35). **Not freestanding**. Includes installed horizontal wire management. Shipped RTA (ready to assemble).

	DTBPR96304824	48 x 96 x 29	125	522	87	<b>\$5465</b>	<b>\$6558</b>
	DTBPR84304824	48 x 84 x 29	125	457	76	<b>\$5465</b>	<b>\$6558</b>
	DTBPR72304824	48 x 72 x 29	125	392	65	<b>\$4769</b>	<b>\$5724</b>

**Boat Shaped Island RIGHT - Full End Panel & Monopost, Piano Desk**

Extended island worksurface on the **right**. Narrow end panel on left connects to **24"D** returns or bridges **for Piano Desks Only** (see pg. 35). **Not freestanding**. Includes installed horizontal wire management. Shipped RTA (ready to assemble).

"P" ISLANDS (PIANO DESKS)	MODEL#	DIMENSIONS	FREIGHT CLASS	WT./LBS.	CUBIC FT.	VENEER/LAMINATE	ALL VENEER
	DTPPL96424824	60 x 96 x 29	150	580	97	<b>\$5245</b>	<b>\$6296</b>
	DTPPL84424824	60 x 84 x 29	150	508	85	<b>\$4692</b>	<b>\$5629</b>
	DTPPL72424824	60 x 72 x 29	150	435	73	<b>\$4350</b>	<b>\$5220</b>

**"P" Shaped Island LEFT - Full End Panel & Monopost, Piano Desk**

Extended island worksurface on the **left**. Narrow end panel on right connects to **24"D** returns or bridges **for Piano Desks Only** (see pg. 35). **Not freestanding**. Includes installed horizontal wire management. Shipped RTA (ready to assemble).

	DTPPR96424824	60 x 96 x 29	150	580	97	<b>\$5241</b>	<b>\$6289</b>
	DTPPR84424824	60 x 84 x 29	150	508	85	<b>\$4692</b>	<b>\$5629</b>
	DTPPR72424824	60 x 72 x 29	150	435	73	<b>\$4350</b>	<b>\$5220</b>

**Boat Shaped Island RIGHT - Full End Panel & Monopost, Piano Desk**

Extended island worksurface on the **right**. Narrow end panel on left connects to **24"D** returns or bridges **for Piano Desks Only** (see pg. 35). **Not freestanding**. Includes installed horizontal wire management. Shipped RTA (ready to assemble).

DELTA ISLANDS (PIANO DESKS)	MODEL#	DIMENSIONS	FREIGHT CLASS	WT./LBS.	CUBIC FT.	VENEER/LAMINATE	ALL VENEER
	DBTHPL96304824	54 x 96 x 29	125	531	87	<b>\$4973</b>	<b>\$5968</b>
	DBTHPL84304824	54 x 84 x 29	125	464	76	<b>\$4421</b>	<b>\$5306</b>
	DBTHPL72304824	54 x 72 x 29	125	398	65	<b>\$4081</b>	<b>\$4894</b>

**Delta Island LEFT - Full End Panel & Monopost, Piano Desk**

Extended island worksurface on the **left**. Narrow end panel on right connects to **24"D** returns or bridges **for Piano Desks Only** (see pg. 35). **Not freestanding**. Includes installed horizontal wire management. Shipped RTA (ready to assemble).

	DBTHPR96304824	54 x 96 x 29	125	531	87	<b>\$4973</b>	<b>\$5968</b>
	DBTHPR84304824	54 x 84 x 29	125	464	76	<b>\$4421</b>	<b>\$5306</b>
	DBTHPR72304824	54 x 72 x 29	125	398	65	<b>\$4081</b>	<b>\$4894</b>

**Delta Island RIGHT - Full End Panel & Monopost, Piano Desk**

Extended island worksurface on the **right**. Narrow end panel on left connects to **24"D** returns or bridges **for Piano Desks Only** (see pg. 35). **Not freestanding**. Includes installed horizontal wire management. Shipped RTA (ready to assemble).

**Required Specifications**

Veneer finish  
Laminate finish  
Monopost finish

**Optional Specifications**

Grommet  
Modesty panel  
Monopost (Base) upgrade

CONNECTABLE TABLES - LEFT (FOR PIANO DESKS)

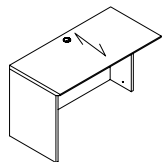

24" Deep Connectable Table - LEFT  
For Piano Desk

MODEL#	DIMENSIONS D x W x H	FREIGHT CLASS	WT/LBS.	CUBIC FT.	veneer/LAMINATE	ALL VENEER
DVEL9624CG	24 x 96 x 29	150	200	39	\$3436	\$4124
DVEL9024CG	24 x 90 x 29	150	187	36	\$3224	\$3871
DVEL8424CG	24 x 84 x 29	150	174	34	\$3006	\$3607
DVEL7824CG	24 x 78 x 29	150	162	31	\$2795	\$3353
DVEL7224CG	24 x 72 x 29	150	149	29	\$2583	\$3100
DVEL6624CG	24 x 66 x 29	150	141	27	\$2416	\$2900
DVEL6024CG	24 x 60 x 29	150	132	24	\$2265	\$2716
DVEL5424CG	24 x 54 x 29	150	121	22	\$2132	\$2559
DVEL4824CG	24 x 48 x 29	125	115	19	\$2008	\$2410
DVEL4224CG	24 x 42 x 29	150	99	17	\$1690	\$2025
DVEL3624CG	24 x 36 x 29	150	83	15	\$1638	\$1963
DVEL3024CG	24 x 30 x 29	125	77	12	\$1752	\$2104
DVEL2424CG	24 x 24 x 29	125	61	10	\$1346	\$1613

**Full end panel on left.** Right narrow end panel connects to 24"D right connectable table, "D" islands, Boat shaped islands, "P" islands or Delta islands with "T" bases **for Piano Desks Only.** Grommet in worksurface. Shipped assembled in 1 carton.

- To remove cross grain veneer pattern on top, **delete suffix "CG"** from the model number. Available as a special - no upcharge.

CONNECTABLE TABLES - RIGHT (FOR PIANO DESKS)

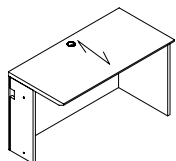

24" Deep Connectable Table - RIGHT  
For Piano Desk

MODEL#	DIMENSIONS	FREIGHT CLASS	WT/LBS.	CUBIC FT.	veneer/LAMINATE	ALL VENEER
DVER9624CG	24 x 96 x 29	150	200	39	\$3436	\$4124
DVER9024CG	24 x 90 x 29	150	187	36	\$3224	\$3871
DVER8424CG	24 x 84 x 29	150	174	34	\$3006	\$3607
DVER7824CG	24 x 78 x 29	150	162	31	\$2795	\$3353
DVER7224CG	24 x 72 x 29	150	149	29	\$2583	\$3100
DVER6624CG	24 x 66 x 29	150	141	27	\$2416	\$2900
DVER6024CG	24 x 60 x 29	150	132	24	\$2265	\$2716
DVER5424CG	24 x 54 x 29	150	121	22	\$2132	\$2559
DVER4824CG	24 x 48 x 29	125	115	19	\$2008	\$2410
DVER4224CG	24 x 42 x 29	150	99	17	\$1690	\$2025
DVER3624CG	24 x 36 x 29	150	83	15	\$1638	\$1963
DVER3024CG	24 x 30 x 29	125	77	12	\$1621	\$1948
DVER2424CG	24 x 24 x 29	125	61	10	\$1346	\$1613

**Full end panel on right.** Left narrow end panel connects to 24"D left connectable table, "D" islands, Boat shaped islands, "P" islands or Delta islands with "T" bases **for Piano Desks Only.** Grommet in worksurface. Shipped assembled in 1 carton..

- To remove cross grain veneer pattern on top, **delete suffix "CG"** from the model number. Available as a special - no upcharge.

BRIDGES (FOR PIANO DESKS)

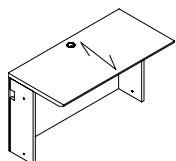

Flush Bridge

MODEL#	DIMENSIONS	FREIGHT CLASS	WT/LBS.	CUBIC FT.	veneer/LAMINATE	ALL VENEER
DBTN4824CG	24 x 48 x 29	125	116	19	\$1723	\$2068
DBTN4224CG	24 x 42 x 29	92.5	102	17	\$1448	\$1739
DBTN3624CG	24 x 36 x 29	150	87	15	\$1387	\$1666
DBTN3024CG	24 x 30 x 29	125	73	12	\$1359	\$1633
DBTN2424CG	24 x 24 x 29	150	58	10	\$1143	\$1371
DBTN1824CG	24 x 18 x 29	150	43	8	\$858	\$1029
DBTN1224CG	24 x 12 x 29	150	29	5	\$572	\$690

**Full end panel on both sides** connects to 24"D worksurfaces, "D" islands, Boat shaped islands, "P" islands or Delta islands with "T" bases **for Piano Desks Only.** Grommet in worksurface. Shipped assembled in 1 carton.

- To remove cross grain veneer pattern on top, **delete suffix "CG"** from the model number. Available as a special - no upcharge.

Required Specifications

Veneer finish  
Laminate finish

Optional Specifications

Additional grommet

TABLE DESK	MODEL#	DIMENSIONS	FREIGHT CLASS	WT/LBS.	CUBIC FT.	VENEER/LAMINATE	ALL VENEER
		<b>D x W x H</b>					
	DTB8442	42 x 84 x 29	150	272	59	N/A	<b>\$8189</b>
	DTB7842	42 x 78 x 29	150	253	55	N/A	<b>\$7606</b>
	DTB7236	36 x 72 x 29	150	205	44	N/A	<b>\$6019</b>
	DTB7230	30 x 72 x 29	150	192	36	N/A	<b>\$5905</b>
	DTB6636	36 x 66 x 29	150	192	40	N/A	<b>\$5905</b>
	DTB6630	30 x 66 x 29	150	188	33	N/A	<b>\$5790</b>
DTB6030	30 x 60 x 29	150	171	30	N/A	<b>\$5517</b>	

**Table Desk\*\***

Four 4" square metal legs. Includes centered pencil drawer. Shipped RTA (ready to assemble).

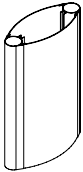
MONOPOST (BASE) UPGRADES	MODEL#	DIMENSIONS	FREIGHT CLASS	WT/LBS.	CUBIC FT.	VENEER/LAMINATE	ALL VENEER
	TE18	5 x 18 x 28	70	30	2	N/A	<b>\$1375</b>

**Elliptical Base Upgrade**

To replace one standard monopost on Islands ONLY. Must specify at time of order. **Cannot be retrofitted in the field.**

	TPML18	8 x 18 x 28	70	36	2	N/A	<b>\$1440</b>
---	--------	-------------	----	----	---	-----	---------------

**Rectangular Base Upgrade**

To replace one standard monopost on Islands ONLY. Must specify at time of order. **Cannot be retrofitted in the field. Not sold individually - to be ordered as an upgrade option only.**

**Required Specifications**

Veneer Finish  
Laminate Finish  
Metal finish\*

**Optional Specifications**

Lock\*\*  
Veneer top\*\*

# DUFFERIN

## MODESTY PANEL OPTIONS

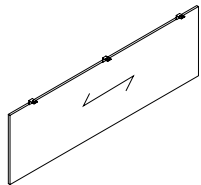

Veneer Modesty Panel Upgrade\*

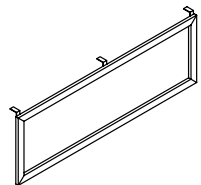

Glass Modesty Panel Upgrade

MODEL#	DIMENSIONS D x W x H	FREIGHT CLASS	WT/LBS.	CUBIC FT.	LIST PRICE
CMP72W	0.75 x 67 x 18	--	20	1	<b>\$1728</b>
CMP66W	0.75 x 61 x 18	--	18	1	<b>\$1673</b>
CMP60W	0.75 x 55 x 18	--	16	1	<b>\$1647</b>
CMP54W	0.75 x 49 x 18	--	14	1	<b>\$1619</b>
CMP48W	0.75 x 43 x 18	--	13	1	<b>\$1594</b>

Straight modesty panel. Attaches to underside of worksurface. **Cannot be retrofitted in the field *Not sold individually - to be ordered as an upgrade option only.***

- CMP72W - Specify on "P" Top Islands or 96" x 48" Islands for Piano Desks.
- CMP66W - Specify on 84" x 36" "D" Top Islands.
- CMP60W - Specify on 84" x 42" "P" Top Islands or 84" x 48" Islands for Piano Desks.
- CMP54W - Specify on 72" x 30" "D" Top Islands.
- CMP48W - Specify on 66" x 36" , 60" x 30" "D" Top Islands, 72" x 42" "P" Top Islands or 72" x 48" Islands for Piano Desks.

CMP72G	0.75 x 67 x 18	--	20	1	<b>\$2647</b>
CMP66G	0.75 x 61 x 18	--	18	1	<b>\$2504</b>
CMP60G	0.75 x 55 x 18	--	16	1	<b>\$2289</b>
CMP54G	0.75 x 49 x 18	--	14	1	<b>\$2132</b>
CMP48G	0.75 x 43 x 18	--	13	1	<b>\$2036</b>

Straight modesty panel. Translucent, screened glass. Aluminum box frame construction in Tungsten Only. Attaches to underside of worksurface. **Cannot be retrofitted in the field. *Not sold individually - to be ordered as an upgrade option only.***

- CMP72G - Specify on "P" Top Islands or 96" x 48" Islands for Piano Desks.
- CMP66G - Specify on 84" x 36" "D" Top Islands.
- CMP60G - Specify on 84" x 42" "P" Top Islands or 84" x 48" Islands for Piano Desks.
- CMP54G - Specify on 72" x 30" "D" Top Islands.
- CMP48G - Specify on 66" x 36" , 60" x 30" "D" Top Islands, 72" x 42" "P" Top Islands or 72" x 48" Islands for Piano Desks.
- Tungsten finish on the aluminum box frame closely resembles the existing Tungsten finish.

## SIDE BY SIDE COMPONENTS

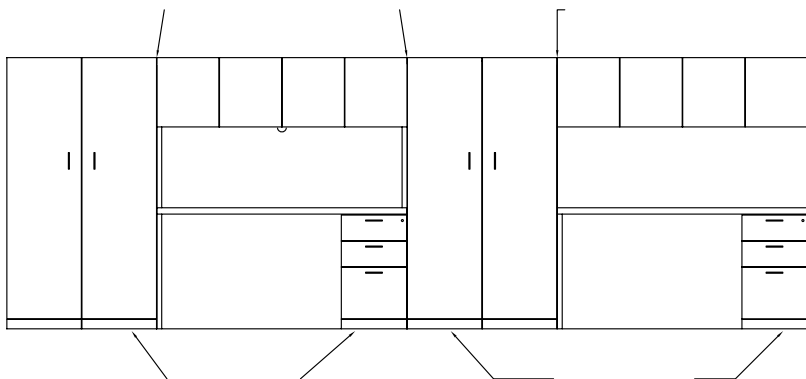

### Required Specifications

Veneer finish

**STORAGE SHELLS - NOTES**

D x W x H

- When using Storage Shells, laminate gables will show.
- Credenza shell cannot be completely filled up with storage shells to create a full storage credenza.
- Handle style must be specified.

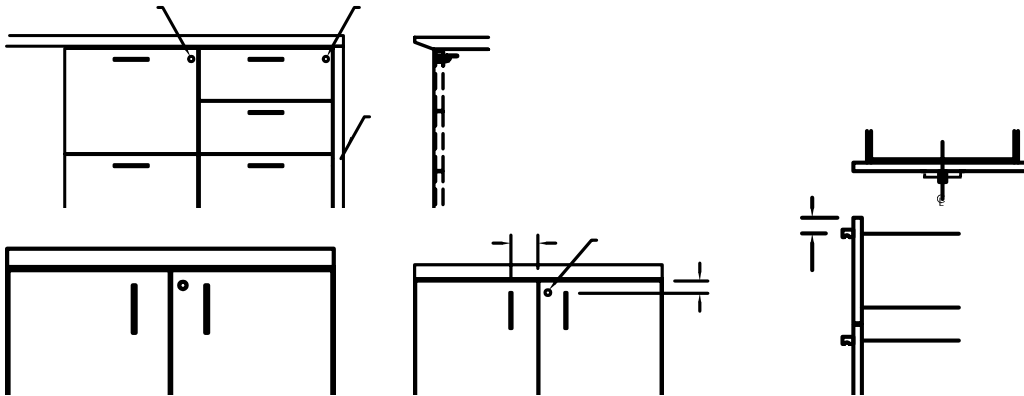

STORAGE SHELLS	MODEL#	DIMENSIONS	FREIGHT CLASS	WT./LBS.	CUBIC FT.	VENEER/LAMINATE	ALL VENEER
----------------	--------	------------	---------------	----------	-----------	-----------------	------------

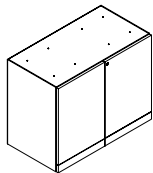

**Storage Shell**

DWG	19.1 x 36.75 x 28	92.5	115	11	<b>\$1685</b>	<b>\$2020</b>
DWM	19.1 x 31.625 x 28	92.5	96	9	<b>\$1490</b>	<b>\$1790</b>

For use **under a freestanding worksurface (22", 24", 30" or 36"D)**. Top drilled to attach to worksurface. One adjustable shelf. **Standard with lock**. Shipped assembled in 1 carton.

- **Unfinished top and back**

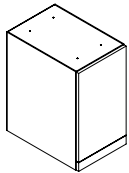

**Storage Shell - LEFT**

DWWIL	23 x 15.6 x 28	100	53	6	<b>\$1498</b>	<b>\$1797</b>
DWIL	19.1 x 15.6 x 28	100	45	5	<b>\$1238</b>	<b>\$1484</b>

For use **under a freestanding worksurface (22", 24", 30" or 36"D)**. Top drilled to attach to worksurface. One adjustable shelf. Handle is on the **right**, door opens to the **left**. Shipped assembled in 1 carton.

- For 22" or 24"D worksurface, order **DWIL**. For 30" or 36"D worksurface, order **DWWIL**.

- **Unfinished top and back**

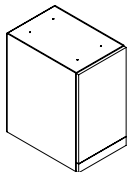

**Storage Shell - RIGHT**

DWWIR	23 x 15.6 x 28	100	53	6	<b>\$1498</b>	<b>\$1797</b>
DWIR	19.1 x 15.6 x 28	100	45	5	<b>\$1238</b>	<b>\$1484</b>

For use **under a freestanding worksurface (22", 24", 30" or 36"D)**. Top drilled to attach to worksurface. One adjustable shelf. Handle is on the **left**, door opens to the **right**. Shipped assembled in 1 carton.

- For 22" or 24"D worksurface, order **DWIR**. For 30" or 36"D worksurface, order **DWWIR**.

- **Unfinished top and back**

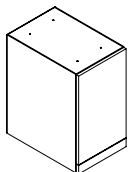

**Storage Shell - LEFT**  
**Eight Storage Slot Shelves**

DWWIL8S	23 x 15.6 x 28	125	45	6	<b>\$2047</b>	<b>\$2456</b>
DWIL8S	19.1 x 15.6 x 28	125	37	5	<b>\$1779</b>	<b>\$2138</b>

For use **under a freestanding worksurface (22", 24", 30" or 36"D)**. Top drilled to attach to worksurface. Eight adjustable storage slot shelves. Handle is on the **right**, door opens to the **left**. Shipped assembled in 1 carton.

- For 22" or 24"D worksurface, order **DWIL8S**. For 30" or 36"D worksurface, order **DWWIL8S**.

- **Unfinished top and back**

**Required Specifications**

Veneer Finish (doors)  
Laminate Finish (body)  
Handle Style

**Optional Specifications**

Lock

STORAGE SHELLS

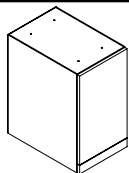

**Storage Shell - RIGHT**  
*Eight Storage Slot Shelves*

MODEL#	DIMENSIONS D x W x H	FREIGHT CLASS	WT/LBS.	CUBIC FT.	VENEER/LAMINATE	ALL VENEER
DWWIR8S	23 x 15.6 x 28	125	45	6	<b>\$2047</b>	<b>\$2456</b>
DWIR8S	19.1 x 15.6 x 28	125	37	5	<b>\$1779</b>	<b>\$2138</b>

For use **under a freestanding worksurface (22", 24", 30" or 36"D)**. Top drilled to attach to worksurface. Eight adjustable storage slot shelves. Handle is on the **left**, door opens to the **right**. Shipped assembled in 1 carton.

- For 22" or 24"D worksurface, order **DWIR8S**. For 30" or 36"D worksurface, order **DWWIR8S**.
- **Unfinished top and back**

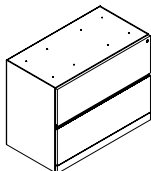

**File/File Shell - Lateral**

DWF	19.1 x 36.75 x 28	92.5	115	11	<b>\$2412</b>	<b>\$2896</b>
DWN	19.1 x 31.625 x 28	92.5	96	9	<b>\$2112</b>	<b>\$2535</b>

For use **under a freestanding worksurface (22", 24", 30" or 36"D)**. Top drilled to attach to worksurface. **Two lateral file drawers**. Lock secures all drawers. Side-to-side file bars included. Shipped assembled in 1 carton.

- **Unfinished top and back**

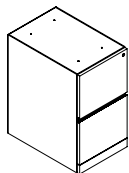

**File/File Shell - Vertical\***

**LETTER**

DWWE	23 x 15.6 x 28	85	72	6	<b>\$1859</b>	<b>\$2233</b>
DWE	19.1 x 15.6 x 28	85	70	5	<b>\$1620</b>	<b>\$1944</b>

**LEGAL**

DWWLE	23 x 18.5 x 28	85	85	7	<b>\$2235</b>	<b>\$2682</b>
DWLE	19.1 x 18.5 x 28	85	83	6	<b>\$1944</b>	<b>\$2332</b>

For use **under a freestanding worksurface (22", 24", 30" or 36"D)**. Top drilled to attach to worksurface. **Two file drawers**. Lock secures all drawers. Shipped assembled in 1 carton.

- For 22" or 24"D worksurface, order **DWE or DWLE**. For 30" or 36"D worksurface, order **DWWE or DWWLE**.
- **Unfinished top and back**

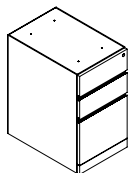

**Box/Box/File Shell - Vertical\***

**LETTER**

DWWD	23 x 15.6 x 28	85	72	6	<b>\$1859</b>	<b>\$2233</b>
DWD	19.1 x 15.6 x 28	85	70	5	<b>\$1620</b>	<b>\$1944</b>

**LEGAL**

DWWLD	23 x 18.5 x 28	85	85	7	<b>\$2235</b>	<b>\$2682</b>
DWLD	19.1 x 18.5 x 28	85	83	6	<b>\$1944</b>	<b>\$2332</b>

For use **under a freestanding worksurface (22", 24", 30" or 36"D)**. Top drilled to attach to worksurface. **Two box and one file drawers**. One pencil tray. Lock secures all drawers. Shipped assembled in 1 carton.

- For 22" or 24"D worksurface, order **DWD or DWLD**. For 30" or 36"D worksurface, order **DWWD or DWWLD**.
- **Unfinished top and back**

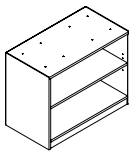

**Open Shelving Shell**

DWOB36	19.1 x 36.75 x 28	100	92	11	<b>\$1274</b>	<b>\$1529</b>
DWOB30	19.1 x 31.625 x 28	100	77	9	<b>\$1128</b>	<b>\$1354</b>

For use **under a freestanding worksurface (22", 24", 30" or 36"D)**. Top drilled to attach to worksurface. One adjustable veneer shelf. Shipped assembled in 1 carton.

- **Unfinished top and back**

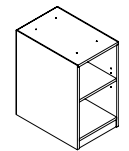

**Open Shelving Shell**

DWWQ	23 x 15.6 x 28	125	45	6	<b>\$1319</b>	<b>\$1581</b>
DWQ	19.1 x 15.6 x 28	125	37	5	<b>\$1090</b>	<b>\$1309</b>

For use **under a freestanding worksurface (22", 24", 30" or 36"D)**. Top drilled to attach to worksurface. One adjustable veneer shelf. Shipped assembled in 1 carton.

- For 22" or 24"D worksurface, order **DWQ**. For 30" or 36"D worksurface, order **DWWQ**.
- **Unfinished top and back**

**Required Specifications**

Veneer Finish (doors, drawer fronts, open shelves)  
Laminate Finish (body)  
Handle Style

**Optional Specifications**

Additional Lock\*

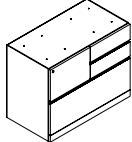
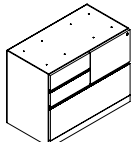
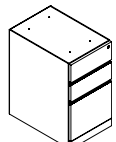
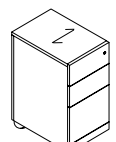
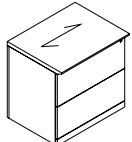
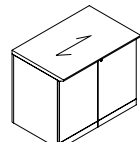
STORAGE SHELLS	MODEL#	DIMENSIONS	FREIGHT CLASS	WT/LBS.	CUBIC FT.	veneer/LAMINATE	ALL VENEER
 <b>Mixed Storage Shell - LEFT</b>		<b>D x W x H</b>					
	DWZL	19.1 x 36.75 x 28	92.5	115	11	<b>\$2800</b>	<b>\$3362</b>
<p>For use <b>under a freestanding worksurface (22", 24", 30" or 36"D)</b>. Top drilled to attach to worksurface. One file drawer on <b>left</b>, two box drawers on <b>right</b> and one lateral file drawer on bottom. File drawer and lateral file drawer lock. One pencil tray. <b>Not for stacking materials on lateral file drawer bottom</b>. Shipped assembled in 1 carton.</p> <p>• <b>Unfinished top and back</b></p>							
 <b>Mixed Storage Shell - RIGHT</b>		<b>D x W x H</b>					
	DWZR	19.1 x 36.75 x 28	92.5	115	11	<b>\$2800</b>	<b>\$3362</b>
<p>For use <b>under a freestanding worksurface (22", 24", 30" or 36"D)</b>. Top drilled to attach to worksurface. One file drawer on <b>right</b>, two box drawers on <b>left</b> and one lateral file drawer on bottom. File drawer and lateral file drawer lock. One pencil tray. <b>Not for stacking materials on lateral file drawer bottom</b>. Shipped assembled in 1 carton.</p> <p>• <b>Unfinished top and back</b></p>							
STORAGE MODULES - (FREESTANDING)	MODEL#	DIMENSIONS	FREIGHT CLASS	WT/LBS.	CUBIC FT.	veneer/LAMINATE	ALL VENEER
 <b>Box/Box/File Freestanding Pedestal</b>	DWDB	19.8 x 15.5 x 28	85	70	5	<b>\$1756</b>	<b>\$2108</b>
	DWWDB	23.8 x 15.5 x 28	300	75	6	<b>\$2022</b>	<b>\$2428</b>
<p><b>Two box and one file drawer.</b> One pencil tray. Lock secures all drawers. Finished back. Shipped assembled in 1 carton.</p>							
 <b>Box/Box/File Module, Mobile</b>	DWDM	19.8 x 15.5 x 28	85	70	5	<b>\$1890</b>	<b>\$2267</b>
	DWWDM	23.8 x 15.5 x 28	300	75	6	<b>\$2171</b>	<b>\$2607</b>
<p><b>Two box and one file drawer.</b> One pencil tray. Lock secures all drawers. Casters. Shipped assembled in 1 carton.</p>							
 <b>File/File Module, Lateral</b>	DF3624	24 x 36 x 29	85	184	15	<b>\$3358</b>	<b>\$4029</b>
	DN3024	24 x 30 x 29	85	153	12	<b>\$2941</b>	<b>\$3530</b>
	DF3622	22 x 36 x 29	85	170	13	<b>\$3078</b>	<b>\$3693</b>
	DN3022	22 x 30 x 29	85	142	11	<b>\$2697</b>	<b>\$3237</b>
	<p><b>Two lateral file drawers.</b> Lock secures all drawers. Side-to-side file bars included. Shipped assembled in 1 carton.</p>						
 <b>Storage Cabinet w/Doors</b>	DBD3624	24 x 36 x 29	92.5	152	15	<b>\$2101</b>	<b>\$2519</b>
	DBD3024	24 x 30 x 29	92.5	127	12	<b>\$1838</b>	<b>\$2203</b>
	DBD3622	22 x 36 x 29	92.5	140	13	<b>\$1924</b>	<b>\$2306</b>
	DBD3022	22 x 30 x 29	92.5	117	11	<b>\$1685</b>	<b>\$2020</b>
<p>Includes one adjustable shelf. Standard with lock. Shipped assembled in 1 carton.</p>							

**Required Specifications**

Veneer Finish (doors, drawer fronts, open shelves)  
 Laminate Finish (top/body)  
 Handle Style

STORAGE MODULES - FREESTANDING

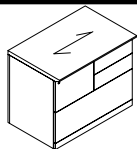

Mixed Storage Cabinet - LEFT

MODEL#	DIMENSIONS D x W x H	FREIGHT CLASS	WT/LBS.	CUBIC FT.	VENEER/LAMINATE	ALL VENEER
DZL3624	24 x 36 x 29	85	184	15	\$3342	\$4009
DZL3622	22 x 36 x 29	85	170	13	\$3063	\$3678

One file drawer on the **left**, two box drawers on the **right** and one lateral file drawer on the bottom. File drawer and lateral file drawer lock. One pencil tray. Not for stacking materials on lateral file drawer bottom. Shipped assembled in 1 carton.

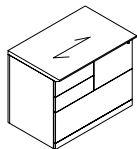

Mixed Storage Cabinet - RIGHT

DZR3624	24 x 36 x 29	85	184	15	\$3342	\$4009
DZR3622	22 x 36 x 29	85	170	13	\$3063	\$3678

One file drawer on the **right**, two box drawers on the **left** and one lateral file drawer on the bottom. File drawer and lateral file drawer lock. One pencil tray. Not for stacking materials on lateral file drawer bottom. Shipped assembled in 1 carton.

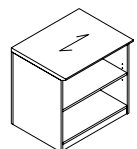

Open Storage Cabinet

DOB3624	24 x 36 x 29	100	123	15	\$1620	\$1944
DOB3024	24 x 30 x 29	100	103	12	\$1420	\$1703
DOB3622	22 x 36 x 29	100	115	13	\$1488	\$1788
DOB3022	22 x 30 x 29	100	96	11	\$1303	\$1563

One fixed and **one** adjustable veneer shelf. Shelves are 3/4" thick. Shipped assembled in 1 carton.

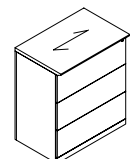

Three File Module

DF36243	24 x 36 x 42	92.5	231	21	\$4057	\$4871
DN30243	24 x 30 x 42	92.5	193	18	\$3559	\$4271
DF36223	22 x 36 x 42	92.5	212	19	\$3757	\$4507
DN30223	22 x 30 x 42	92.5	176	16	\$3297	\$3954

**Three lateral file drawers.** Lock secures all drawers. Shipped assembled in 1 carton.

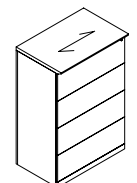

Four File Module

DF36244	24 x 36 x 54	92.5	297	27	\$5369	\$6443
DN30244	24 x 30 x 54	92.5	248	23	\$4584	\$5501
DF36224	22 x 36 x 54	92.5	270	25	\$4577	\$5492
DN30224	22 x 30 x 54	92.5	225	21	\$4010	\$4814

**Four lateral file drawers.** Lock secures all drawers. Shipped assembled in 1 carton.

STORAGE MODULES - 48" HIGH (FREESTANDING)

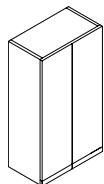

Storage Cabinet w/Doors\*

MODEL#	DIMENSIONS	FREIGHT CLASS	WT/LBS.	CUBIC FT.	VENEER/LAMINATE	ALL VENEER
D1D22H48	22 x 36 x 48	150	107	22	\$3238	\$3885
D1D22W30H48	22 x 30 x 48	150	90	19	\$3162	\$3795
D1D22W24H48	22 x 24 x 48	150	72	15	\$3101	\$3721
D1D20H48	20 x 36 x 48	150	97	20	\$2946	\$3533
D1D20W30H48	20 x 30 x 48	150	81	17	\$2882	\$3456
D1D20W24H48	20 x 24 x 48	150	63	13	\$2820	\$3382

Includes four adjustable shelves. Optional lock available. Shipped assembled in 1 carton.

**Required Specifications**

Veneer finish  
Laminate finish (body)  
Handle Style

**Optional Specifications**

Lock\*  
Veneer Top\*

**STORAGE MODULES - 48" HIGH (FREESTANDING)    MODEL#    DIMENSIONS    FREIGHT CLASS    WT/LBS.    CUBIC FT.    VENEER/LAMINATE    ALL VENEER**

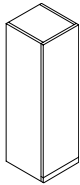

**Storage Cabinet w/Door - LEFT\***

	D x W x H						
D1D22W18H48L	22 x 18 x 48	150	60	11	<b>\$2044</b>	<b>\$2454</b>	
D1D22W16H48L	22 x 16 x 48	150	54	10	<b>\$1818</b>	<b>\$2184</b>	
D1D20W18H48L	20 x 18 x 48	125	60	10	<b>\$1861</b>	<b>\$2236</b>	
D1D20W16H48L	20 x 16 x 48	125	54	9	<b>\$1650</b>	<b>\$1980</b>	

Includes three adjustable shelves. Handle is on the **right**, door opens to the **left**. Optional lock available. Shipped assembled in 1 carton.

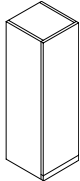

**Storage Cabinet w/Door - RIGHT\***

D1D22W18H48R	22 x 18 x 48	150	60	11	<b>\$2044</b>	<b>\$2454</b>	
D1D22W16H48R	22 x 16 x 48	150	54	10	<b>\$1818</b>	<b>\$2184</b>	
D1D20W18H48R	20 x 18 x 48	125	60	10	<b>\$1861</b>	<b>\$2236</b>	
D1D20W16H48R	20 x 16 x 48	125	54	9	<b>\$1650</b>	<b>\$1980</b>	

Includes three adjustable shelves. Handle is on the **left**, door opens to the **right**. Optional lock available. Shipped assembled in 1 carton.

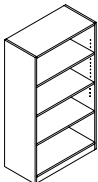

**Open Storage Cabinet**

D7D22W36H48	22 x 36 x 48	150	118	22	<b>\$2554</b>	<b>\$3066</b>	
D7D22W30H48	22 x 30 x 48	150	98	19	<b>\$1898</b>	<b>\$2276</b>	
D7D22W24H48	22 x 24 x 48	150	78	15	<b>\$1514</b>	<b>\$1815</b>	
D7D22W18H48	22 x 18 x 48	150	59	11	<b>\$1272</b>	<b>\$1528</b>	
D7D20W36H48	20 x 36 x 48	150	108	20	<b>\$2322</b>	<b>\$2787</b>	
D7D20W30H48	20 x 30 x 48	150	90	17	<b>\$1723</b>	<b>\$2068</b>	
D7D20W24H48	20 x 24 x 48	100	72	13	<b>\$1687</b>	<b>\$2022</b>	
D7D20W18H48	20 x 18 x 48	150	54	10	<b>\$1215</b>	<b>\$1457</b>	

One fixed and **three** adjustable veneer shelves. Shelves are 3/4" thick. Shipped assembled in 1 carton.

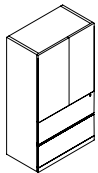

**Two File Module w/Doors\***

D13D22H48	22 x 36 x 48	150	117	23	<b>\$3450</b>	<b>\$4138</b>	
D13D22W30H48	22 x 30 x 48	150	101	19	<b>\$3123</b>	<b>\$3746</b>	
D13H48	20 x 36 x 48	150	107	23	<b>\$3304</b>	<b>\$3968</b>	
D13W30H48	20 x 30 x 48	150	91	19	<b>\$4040</b>	<b>\$4846</b>	

Two lateral file drawers on bottom. Includes two adjustable shelves. Lower lock secures two file drawers. Optional lock available for upper storage. **Not for stacking materials on lateral file drawer bottom.** Shipped assembled in 1 carton.

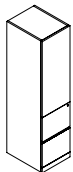

**Two File Module w/Door - LEFT\***

D17D22H48L	22 x 16 x 48	125	97	13	<b>\$2561</b>	<b>\$3073</b>	
D17D20H48L	20 x 16 x 48	125	88	13	<b>\$2336</b>	<b>\$2803</b>	

Two file drawers on bottom. Includes two adjustable shelves. Lower lock secures two file drawers. Optional lock available for upper storage. Handle is on the right, door opens to the left. Shipped assembled in 1 carton.

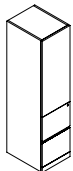

**Two File Module w/Door - RIGHT\***

D17D22H48R	22 x 16 x 48	125	97	13	<b>\$2561</b>	<b>\$3073</b>	
D17D20H48R	20 x 16 x 48	125	88	13	<b>\$2336</b>	<b>\$2803</b>	

Two file drawers on bottom. Includes two adjustable shelves. Lower lock secures two file drawers. Optional lock available for upper storage. Handle is on the left, door opens to the right. Shipped assembled in 1 carton.

**Required Specifications**

Veneer finish (doors, drawer fronts)  
Laminate finish (top/body)  
Handle Style\*

**Optional Specifications**

Lock\*  
Veneer top

STORAGE MODULES - 48" HIGH (FREESTANDING)		MODEL#	DIMENSIONS	FREIGHT CLASS	WT/LBS.	CUBIC FT.	VENEER/LAMINATE	ALL VENEER
			<b>D x W x H</b>					
		D18D22H48L	22 x 16 x 48	125	64	9	<b>\$2561</b>	<b>\$3073</b>
	D18D20H48L	20 x 16 x 48	125	59	9	<b>\$2336</b>	<b>\$2803</b>	
<b>Box/Box/File Module w/Door - LEFT*</b>		Two box drawers and one file drawer on bottom. Includes two adjustable shelves. Lower lock secures all drawers. Optional lock available for upper storage. Handle is on the <b>right</b> , door opens to the <b>left</b> . Shipped assembled in 1 carton.						
		D18D22H48R	22 x 16 x 48	125	64	9	<b>\$2561</b>	<b>\$3073</b>
	D18D20H48R	20 x 16 x 48	125	59	9	<b>\$2336</b>	<b>\$2803</b>	
<b>Box/Box/File Module w/Door - RIGHT*</b>		Two box drawers and one file drawer on bottom. Includes two adjustable shelves. Lower lock secures all drawers. Optional lock available for upper storage. Handle is on the <b>left</b> , door opens to the <b>right</b> . Shipped assembled in 1 carton.						
		D12D22H48	22 x 36 x 48	150	117	23	<b>\$3239</b>	<b>\$3888</b>
		D12D22W30H48	22 x 30 x 48	150	101	19	<b>\$2800</b>	<b>\$3362</b>
		D12H48	20 x 36 x 48	150	107	23	<b>\$3109</b>	<b>\$3731</b>
	D12W30H48	20 x 30 x 48	150	91	19	<b>\$3793</b>	<b>\$4550</b>	
<b>Two File Module w/Open Shelf</b>		Two open veneer shelves and two lateral file drawers on bottom. Includes one adjustable shelf. Lock secures all drawers. <b>Not for stacking materials on lateral file drawer bottom.</b> Shipped assembled in 1 carton.						
		D22D22H48	22 x 36 x 48	150	117	23	<b>\$2924</b>	<b>\$3506</b>
		D22D22W30H48	22 x 30 x 48	150	101	19	<b>\$2002</b>	<b>\$2400</b>
		D22D20H48	20 x 36 x 48	150	107	23	<b>\$2301</b>	<b>\$2760</b>
	D22D20W30H48	20 x 30 x 48	150	91	19	<b>\$1912</b>	<b>\$2295</b>	
<b>Storage Module w/Open Shelf</b>		Two open veneer shelves and storage cabinet on bottom. Includes one adjustable shelf in upper compartment and one adjustable shelf in storage cabinet. Lock secures storage cabinet. Shipped assembled in 1 carton.						

WARDROBE CABINETS - 48" HIGH		MODEL#	DIMENSIONS	FREIGHT CLASS	WT/LBS.	CUBIC FT.	VENEER/LAMINATE	ALL VENEER
		D2D22H48	22 x 36 x 48	150	107	22	<b>\$2647</b>	<b>\$3181</b>
		D2D22W30H48	22 x 30 x 48	150	107	19	<b>\$2592</b>	<b>\$3109</b>
		D2D22W24H48	22 x 24 x 48	150	85	15	<b>\$3101</b>	<b>\$3721</b>
		D2H48	20 x 36 x 48	150	102	20	<b>\$2408</b>	<b>\$2891</b>
		D2W30H48	20 x 30 x 48	150	89	17	<b>\$2357</b>	<b>\$2829</b>
		D2W24H48	20 x 24 x 48	150	72	13	<b>\$2305</b>	<b>\$2767</b>
<b>Wardrobe Cabinet*</b>		Includes full length hanging rod and fixed hat shelf. Optional lock available. Shipped assembled in 1 carton.						
		D2D22W24H48L	22 x 24 x 48	150	80	15	<b>\$2539</b>	<b>\$3051</b>
		D2D22W18H48L	22 x 18 x 48	150	60	11	<b>\$2044</b>	<b>\$2454</b>
		D2D22W12H48L	22 x 12 x 48	150	40	7	<b>\$1952</b>	<b>\$2342</b>
		D2D20W24H48L	20 x 24 x 48	150	72	13	<b>\$2305</b>	<b>\$2767</b>
		D2D20W18H48L	20 x 18 x 48	150	54	10	<b>\$1861</b>	<b>\$2236</b>
	D2D20W12H48L	20 x 12 x 48	125	36	7	<b>\$2165</b>	<b>\$2596</b>	
<b>Wardrobe Cabinet - LEFT*</b>		Includes full length hanging rod and fixed hat shelf. Handle is on the <b>right</b> , door opens to the <b>left</b> . Optional lock available. Shipped assembled in 1 carton.						

**Required Specifications**

Veneer Finish (doors, drawer fronts)  
Laminate Finish (top/body)  
Handle Style

**Optional Specifications**

Lock\*  
Veneer Top

**WARDROBE CABINETS - 48" HIGH**

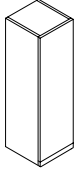

**Wardrobe Cabinet - RIGHT\***

MODEL#	DIMENSIONS D x W x H	FREIGHT CLASS	WT/LBS.	CUBIC FT.	VENEER/LAMINATE	ALL VENEER
D2D22W24H48R	22 x 24 x 48	150	80	15	\$2539	\$3051
D2D22W18H48R	22 x 18 x 48	150	60	11	\$2044	\$2454
D2D22W12H48R	22 x 12 x 48	150	40	7	\$1952	\$2342
D2D20W24H48R	20 x 24 x 48	150	72	13	\$2305	\$2767
D2D20W18H48R	20 x 18 x 48	150	54	10	\$1861	\$2236
D2D20W12H48R	20 x 12 x 48	125	36	7	\$2165	\$2596

Includes full length hanging rod and fixed hat shelf. Handle is on the **left**, door opens to the **right**. Optional lock available. Shipped assembled in 1 carton.

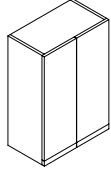

**Wardrobe Cabinet/Shelving Combo\***

D25D22H48	22 x 36 x 48	150	117	23	\$2818	\$3381
D25D22W30H48	22 x 30 x 48	150	101	19	\$2765	\$3318
D25D20H48	20 x 36 x 48	150	107	23	\$2699	\$3239
D25D20W30H48	20 x 30 x 48	60	91	19	\$2647	\$3181

Wardrobe compartment on **left** includes hanging rod and fixed hat shelf. Storage compartment on **right** includes three adjustable shelves. Optional lock available. Shipped assembled in 1 carton.

**STORAGE MODULES - 54" HIGH (FREESTANDING)**

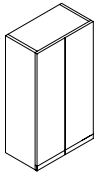

**Storage Cabinet w/Doors\***

MODEL#	DIMENSIONS	FREIGHT CLASS	WT/LBS.	CUBIC FT.	VENEER/LAMINATE	ALL VENEER
D1D22H54	22 x 36 x 54	150	120	22	\$2867	\$3442
D1D22W30H54	22 x 30 x 54	150	102	19	\$2853	\$3426
D1D22W24H54	22 x 24 x 54	150	81	17	\$3485	\$4185
D1D20H54	20 x 36 x 54	150	110	20	\$2709	\$3248
D1D20W30H54	20 x 30 x 54	150	92	17	\$2647	\$3181
D1D20W24H54	20 x 24 x 54	150	71	13	\$2599	\$3116

Includes four adjustable shelves. Optional lock available. Shipped assembled in 1 carton.

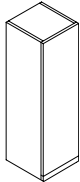

**Storage Cabinet w/Door - LEFT\***

D1D22W18H54L	22 x 18 x 54	150	68	12	\$2305	\$2767
D1D22W16H54L	22 x 16 x 54	150	61	11	\$2044	\$2454
D1D20W18H54L	20 x 18 x 54	125	68	11	\$2089	\$2506
D1D20W16H54L	20 x 16 x 54	125	61	10	\$1861	\$2236

Includes three adjustable shelves. Handle is on the **right**, door opens to the **left**. Optional lock available. Shipped assembled in 1 carton.

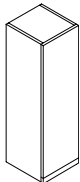

**Storage Cabinet w/Door - RIGHT\***

D1D22W18H54R	22 x 18 x 54	150	68	12	\$2305	\$2767
D1D22W16H54R	22 x 16 x 54	150	61	11	\$2044	\$2454
D1D20W18H54R	20 x 18 x 54	125	68	11	\$2089	\$2506
D1D20W16H54R	20 x 16 x 54	125	61	10	\$1861	\$2236

Includes three adjustable shelves. Handle is on the **left**, door opens to the **right**. Optional lock available. Shipped assembled in 1 carton.

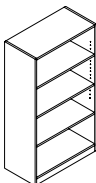

**Open Storage Cabinet**

D7D22W36H54	22 x 36 x 54	150	132	25	\$2876	\$3450
D7D22W30H54	22 x 30 x 54	150	110	21	\$2132	\$2559
D7D22W24H54	22 x 24 x 54	150	88	17	\$1711	\$2054
D7D22W18H54	22 x 18 x 54	150	67	12	\$1336	\$1608
D7D20W36H54	20 x 36 x 54	150	122	23	\$2613	\$3136
D7D20W30H54	20 x 30 x 54	150	102	19	\$1943	\$2331
D7D20W24H54	20 x 24 x 54	150	81	15	\$1550	\$1858
D7D20W18H54	20 x 18 x 54	150	61	11	\$1257	\$1510

One fixed and **three** adjustable veneer shelves. Shelves are 3/4" thick. Shipped assembled in 1 carton.

**Required Specifications**

Veneer Finish (doors)  
Laminate Finish (top/body)  
Handle Style\*

**Optional Specifications**

Lock\*  
Veneer Top

STORAGE MODULES - 54" HIGH (FREESTANDING)    MODEL#    DIMENSIONS    FREIGHT CLASS    WT/LBS.    CUBIC FT.    VENEER/LAMINATE    ALL VENEER

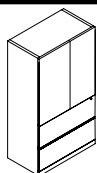

Two File Module w/Doors

	D x W x H						
D13D22H54	22 x 36 x 54	150	130	24	<b>\$4739</b>	<b>\$5687</b>	
D13D22W30H54	22 x 30 x 54	150	112	20	<b>\$3508</b>	<b>\$4212</b>	
D13H54	20 x 36 x 54	125	120	19	<b>\$3721</b>	<b>\$4466</b>	
D13W30H54	20 x 30 x 54	150	102	21	<b>\$3365</b>	<b>\$4035</b>	

Two lateral file drawers on bottom. Includes two adjustable shelves. Lower lock secures two file drawers. Optional lock available for upper storage. Front-to-back and side-to-side filing. **Not for stacking materials on lateral file drawer bottom.** Shipped assembled in 1 carton.



Two File Module w/Door - LEFT

D17D22H54L	22 x 16 x 54	100	110	13	<b>\$2891</b>	<b>\$3468</b>	
D17D20H54L	20 x 16 x 54	125	99	13	<b>\$2629</b>	<b>\$3154</b>	

Two file drawers on bottom. Includes two adjustable shelves. Lower lock secures two file drawers. Optional lock available for upper storage. Handle is on the right, door opens to the left. Shipped assembled in 1 carton.



Two File Module w/Door - RIGHT

D17D22H54R	22 x 16 x 54	100	110	13	<b>\$2891</b>	<b>\$3468</b>	
D17D20H54R	20 x 16 x 54	125	99	13	<b>\$2629</b>	<b>\$3154</b>	

Two file drawers on bottom. Includes two adjustable shelves. Lower lock secures two file drawers. Optional lock available for upper storage. Handle is on the left, door opens to the right. Shipped assembled in 1 carton.

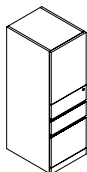

Box/Box/File Module w/Door - LEFT

D18D22H54L	22 x 16 x 54	125	71	10	<b>\$2891</b>	<b>\$3468</b>	
D18D20H54L	20 x 16 x 54	125	66	10	<b>\$2629</b>	<b>\$3154</b>	

Two box drawers and one file drawer on bottom. Includes two adjustable shelves. Lower lock secures all drawers. Optional lock available for upper storage. Handle is on the **right**, door opens to the **left**. Shipped assembled in 1 carton.

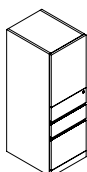

Box/Box/File Module w/Door - RIGHT

D18D22H54R	22 x 16 x 54	125	71	10	<b>\$2891</b>	<b>\$3468</b>	
D18D20H54R	20 x 16 x 54	125	66	10	<b>\$2629</b>	<b>\$3154</b>	

Two box drawers and one file drawer on bottom. Includes two adjustable shelves. Lower lock secures all drawers. Optional lock available for upper storage. Handle is on the **left**, door opens to the **right**. Shipped assembled in 1 carton.

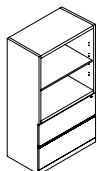

Two File Module w/Open Shelf

D12D22H54	22 x 36 x 54	150	130	24	<b>\$3878</b>	<b>\$4656</b>	
D12D22W30H54	22 x 30 x 54	150	112	20	<b>\$3151</b>	<b>\$3780</b>	
D12H54	20 x 36 x 54	125	120	19	<b>\$3878</b>	<b>\$4656</b>	
D12W30H54	20 x 30 x 54	150	102	21	<b>\$3020</b>	<b>\$3627</b>	

Two open veneer shelves and two lateral file drawers on bottom. Includes one adjustable shelf. Lock secures all drawers. Front-to-back and side-to-side filing. **Not for stacking materials on lateral file drawer bottom.** Shipped assembled in 1 carton.

**Required Specifications**

Veneer Finish (doors, drawer fronts, open shelves)  
Laminate Finish (top/body)  
Handle Style

**Optional Specifications**

Additional Lock (storage compartments)  
Veneer Top

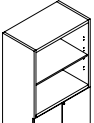
STORAGE MODULES - 54" HIGH (FREESTANDING)	MODEL#	DIMENSIONS	FREIGHT CLASS	WT/LBS.	CUBIC FT.	VENEER/LAMINATE	ALL VENEER
		<b>D x W x H</b>					
	D22D22H54	22 x 36 x 54	150	130	24	\$2693	\$3233
	D22D22W30H54	22 x 30 x 54	150	112	20	\$2248	\$2698
	D22D20H54	20 x 36 x 54	150	120	24	\$2583	\$3100
	D22D20W30H54	20 x 30 x 54	150	102	20	\$2153	\$2585

**Storage Module w/Open Shelf**

Two open veneer shelves and storage cabinet on bottom. Includes one adjustable shelf in upper compartment and one adjustable shelf in storage cabinet. Lock secures storage cabinet. Shipped assembled in 1 carton.

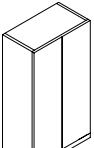
WARDROBE CABINETS - 54" HIGH	MODEL#	DIMENSIONS	FREIGHT CLASS	WT/LBS.	CUBIC FT.	VENEER/LAMINATE	ALL VENEER
	D2D22H54	22 x 36 x 54	150	120	25	\$2867	\$3442
	D2D22W30H54	22 x 30 x 54	150	120	21	\$2853	\$3426
	D2D22W24H54	22 x 24 x 54	150	95	17	\$3485	\$4185
	D2H54	20 x 36 x 54	150	119	23	\$2709	\$3248
	D2W30H54	20 x 30 x 54	150	101	19	\$2647	\$3181
	D2W24H54	20 x 24 x 54	150	81	15	\$2599	\$3116

**Wardrobe Cabinet\***

Includes full length hanging rod and fixed hat shelf. Optional lock available. Shipped assembled in 1 carton.

	D2D22W24H54L	22 x 24 x 54	150	90	17	\$2853	\$3426
	D2D22W18H54L	22 x 18 x 54	150	68	12	\$2301	\$2760
	D2D22W12H54L	22 x 12 x 54	150	45	8	\$2190	\$2629
	D2D20W24H54L	20 x 24 x 54	150	81	15	\$3168	\$3804
	D2D20W18H54L	20 x 18 x 54	150	61	11	\$2089	\$2506
	D2D20W12H54L	20 x 12 x 54	150	41	8	\$2435	\$2922

**Wardrobe Cabinet - LEFT\***

Includes full length hanging rod and fixed hat shelf. Handle is on the **right**, door opens to the **left**. Optional lock available. Shipped assembled in 1 carton.

	D2D22W24H54R	22 x 24 x 54	150	90	17	\$2853	\$3426
	D2D22W18H54R	22 x 18 x 54	150	68	12	\$2301	\$2760
	D2D22W12H54R	22 x 12 x 54	150	45	8	\$2190	\$2629
	D2D20W24H54R	20 x 24 x 54	150	81	15	\$3168	\$3804
	D2D20W18H54R	20 x 18 x 54	150	61	11	\$2089	\$2506
	D2D20W12H54R	20 x 12 x 54	150	41	8	\$2435	\$2922

**Wardrobe Cabinet - RIGHT\***

Includes full length hanging rod and fixed hat shelf. Handle is on the **left**, door opens to the **right**. Optional lock available. Shipped assembled in 1 carton.

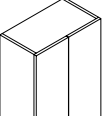
	D25D22H54	22 x 36 x 54	150	130	24	\$3166	\$3798
	D25D22W30H54	22 x 30 x 54	150	112	20	\$3109	\$3731
	D25D20H54	20 x 36 x 54	150	120	24	\$3034	\$3641
	D25D20W30H54	20 x 30 x 54	150	102	20	\$2985	\$3580

**Wardrobe Cabinet/Shelving Combo\***

Wardrobe compartment on **left** includes hanging rod and fixed hat shelf. Storage compartment on **right** includes three adjustable shelves. Optional lock available. Shipped assembled in 1 carton.

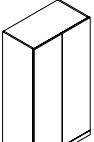
STORAGE MODULES - 66" HIGH (FREESTANDING)	MODEL#	DIMENSIONS	FREIGHT CLASS	WT/LBS.	CUBIC FT.	VENEER/LAMINATE	ALL VENEER
	D1D22	22 x 36 x 66	100	259	30	\$3545	\$4252
	D1D22W30	22 x 30 x 66	100	259	25	\$3104	\$3724
	D1D22W24	22 x 24 x 66	125	173	22	\$2664	\$3197
	D1	20 x 36 x 66	100	245	28	\$3380	\$4053
	D1W30	20 x 30 x 66	100	202	23	\$2818	\$3381
	D1W24	20 x 24 x 66	125	163	18	\$2249	\$2699

**Storage Cabinet w/Doors\***

Includes four adjustable shelves. Optional lock available. Shipped assembled in 1 carton.

**Required Specifications**

Veneer Finish (doors, drawer fronts, open shelves)  
Laminate Finish (top/body)  
Handle Style

**Optional Specifications**

Lock\*  
Veneer Top

STORAGE MODULES - 66" HIGH (FREESTANDING)    MODEL#    DIMENSIONS    FREIGHT CLASS    WT/LBS.    CUBIC FT.    VENEER/LAMINATE    ALL VENEER

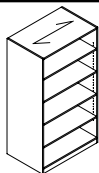

Open Storage Cabinet

	D x W x H						
D7D24	24 x 36 x 66	100	281	33	<b>\$3262</b>	<b>\$3915</b>	
D7D24W30	24 x 30 x 66	100	234	28	<b>\$2853</b>	<b>\$3426</b>	
D7	20 x 36 x 66	100	234	28	<b>\$2703</b>	<b>\$3244</b>	
D7W30	20 x 30 x 66	100	193	23	<b>\$2372</b>	<b>\$2846</b>	

Includes one fixed and **four** adjustable veneer shelves. Shelves are ¾" thick. Shipped assembled in 1 carton.

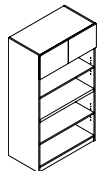

Open Storage Cabinet w/Doors\*

D9D22	22 x 36 x 66	92.5	308	30	<b>\$3052</b>	<b>\$3660</b>	
D9D22W30	22 x 30 x 66	92.5	257	25	<b>\$2669</b>	<b>\$3205</b>	
D9	20 x 36 x 66	92.5	294	28	<b>\$2904</b>	<b>\$3484</b>	
D9W30	20 x 30 x 66	92.5	243	23	<b>\$2424</b>	<b>\$2908</b>	

Storage compartment with fixed shelf. One fixed and **two** adjustable veneer shelves. Fixed shelf is at 29" high. Shelves are ¾" thick. Optional lock available for upper storage. Shipped assembled in 1 carton.

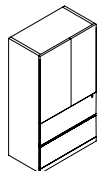

Two File Module w/Doors\*

D13D22	22 x 36 x 66	92.5	313	30	<b>\$4386</b>	<b>\$5264</b>	
D13D22W30	22 x 30 x 66	92.5	261	25	<b>\$3843</b>	<b>\$4611</b>	
D13	20 x 36 x 66	92.5	299	28	<b>\$4178</b>	<b>\$5015</b>	
D13W30	20 x 30 x 66	92.5	247	23	<b>\$3484</b>	<b>\$4181</b>	

Two lateral file drawers on bottom. Includes **two** adjustable shelves. Lower lock secures two file drawers. Optional lock available for upper storage. Front-to-back and side-to-side filing. **Not for stacking materials on lateral file drawer bottom.** Shipped assembled in 1 carton.



Two File Module w/Door - LEFT\*

D17D22L	22 x 16 x 66	125	91	13	<b>\$3052</b>	<b>\$3660</b>	
D17D20L	20 x 16 x 66	125	83	12	<b>\$2772</b>	<b>\$3326</b>	

Two file drawers on bottom. Includes two adjustable shelves. Lower lock secures two file drawers. Optional lock available for upper storage. Handle is on the **right**, door opens to the **left**. Shipped assembled in 1 carton.



Two File Module w/Door - RIGHT\*

D17D22R	22 x 16 x 66	125	91	13	<b>\$3052</b>	<b>\$3660</b>	
D17D20R	20 x 16 x 66	125	83	12	<b>\$2772</b>	<b>\$3326</b>	

Two file drawers on bottom. Includes two adjustable shelves. Lower lock secures two file drawers. Optional lock available for upper storage. Handle is on the **left**, door opens to the **right**. Shipped assembled in 1 carton.

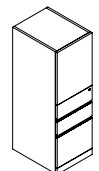

Box/Box/File Module w/Door - LEFT\*

D18D22L	22 x 16 x 66	125	91	13	<b>\$3052</b>	<b>\$3660</b>	
D18D20L	20 x 16 x 66	125	83	12	<b>\$2772</b>	<b>\$3326</b>	

Two box drawers and one file drawer on bottom. Includes two adjustable shelves. Lower lock secures all drawers. Optional lock available for upper storage. Handle is on the **right**, door opens to the **left**. Shipped assembled in 1 carton.

**Required Specifications**

Veneer Finish (doors, drawer fronts, open shelves)  
Laminate Finish (top/body)  
Handle Style

**Optional Specifications**

Lock\*  
Veneer Top

**PERSONAL TOWERS - 66" HIGH (FREESTANDING) MODEL# DIMENSIONS FREIGHT CLASS WT./LBS. CUBIC FT. VENEER/LAMINATE ALL VENEER**

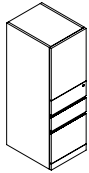

**Box/Box/File Module w/Door - RIGHT\***

	D x W x H						
D18D22R	22 x 16 x 66	125	91	13	<b>\$3052</b>	<b>\$3660</b>	
D18D20R	20 x 16 x 66	125	83	12	<b>\$2772</b>	<b>\$3326</b>	

Two box drawers and one file drawer on bottom. Includes two adjustable shelves. Lower lock secures all drawers. Optional lock available for upper storage. Handle is on the left, door opens to the right. Shipped assembled in 1 carton.

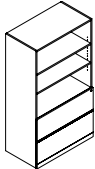

**Two File Module w/Open Shelves**

D12D22	22 x 36 x 66	92.5	303	30	<b>\$3850</b>	<b>\$4625</b>	
D12D22W30	22 x 30 x 66	92.5	253	25	<b>\$3372</b>	<b>\$4049</b>	
D12	20 x 36 x 66	92.5	289	28	<b>\$3666</b>	<b>\$4398</b>	
D12W30	20 x 30 x 66	92.5	239	23	<b>\$3058</b>	<b>\$3673</b>	

Three open veneer shelves and two lateral file drawers on bottom. Includes two adjustable shelves. Lock secures all drawers. Front-to-back and side-to-side filing. **Not for stacking materials on lateral file drawer bottom.** Shipped assembled in 1 carton.

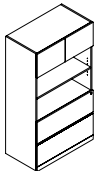

**Two File Module w/Doors\* and Open Shelves**

D10D22	22 x 36 x 66	92.5	308	30	<b>\$4262</b>	<b>\$5116</b>	
D10D22W30	22 x 30 x 66	92.5	257	25	<b>\$3733</b>	<b>\$4478</b>	
D10	20 x 36 x 66	92.5	294	28	<b>\$4056</b>	<b>\$4870</b>	
D10W30	20 x 30 x 66	92.5	243	23	<b>\$3384</b>	<b>\$4059</b>	

Storage compartment with fixed shelf. Two open veneer shelves and two lateral file drawers on bottom. Includes one adjustable shelf. Lock secures all drawers. Optional lock available for upper storage. Front-to-back and side-to-side filing. **Not for stacking materials on lateral file drawer bottom.** Shipped assembled in 1 carton.

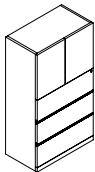

**Three File Module w/Doors\***

D14D22	22 x 36 x 66	100	286	30	<b>\$4717</b>	<b>\$5662</b>	
D14D22W30	22 x 30 x 66	100	238	25	<b>\$4132</b>	<b>\$4958</b>	
D14	20 x 36 x 66	100	272	28	<b>\$4495</b>	<b>\$5393</b>	
D14W30	20 x 30 x 66	100	224	23	<b>\$3743</b>	<b>\$4494</b>	

Three lateral file drawers on bottom. Includes one adjustable shelf. Lock secures all drawers. Optional lock available for upper storage. Front-to-back and side-to-side filing. **Not for stacking materials on lateral file drawer bottom.** Shipped assembled in 1 carton.

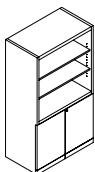

**Storage Module w/Open Shelves**

D22D22	22 x 36 x 66	100	275	30	<b>\$3233</b>	<b>\$3877</b>	
D22D22W30	22 x 30 x 66	100	243	25	<b>\$2828</b>	<b>\$3394</b>	
D22	20 x 36 x 66	100	278	28	<b>\$3080</b>	<b>\$3695</b>	
D22W30	20 x 30 x 66	100	229	23	<b>\$2563</b>	<b>\$3078</b>	

Three open veneer shelves and storage cabinet on bottom. Includes two adjustable shelves in upper compartment and one adjustable shelf in storage cabinet. Lock secures storage cabinet. Shipped assembled in 1 carton.

**WARDROBE CABINETS - 66" HIGH (FREESTANDING) MODEL# DIMENSIONS FREIGHT CLASS WT./LBS. CUBIC FT. VENEER/LAMINATE ALL VENEER**

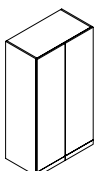

**Wardrobe Cabinet\***

D2D22	22 x 36 x 66	100	259	30	<b>\$3080</b>	<b>\$3695</b>	
D2D22W30	22 x 30 x 66	100	216	30	<b>\$2693</b>	<b>\$3233</b>	
D2D22W24	22 x 24 x 66	100	198	22	<b>\$2307</b>	<b>\$2769</b>	
D2	20 x 36 x 66	100	245	28	<b>\$2932</b>	<b>\$3521</b>	
D2W30	20 x 30 x 66	100	202	23	<b>\$2443</b>	<b>\$2931</b>	
D2W24	20 x 24 x 66	125	163	18	<b>\$1955</b>	<b>\$2347</b>	

Includes full length hanging rod and fixed hat shelf. Optional lock available. Shipped assembled in 1 carton.

**Required Specifications**

Veneer Finish (doors, drawer fronts)  
Laminate Finish (top/body)  
Handle Style

**Optional Specifications**

Lock\*  
Veneer Top

**WARDROBE CABINETS - 66" HIGH (FREESTANDING) MODEL# DIMENSIONS FREIGHT CLASS WT/LBS. CUBIC FT. VENEER/LAMINATE ALL VENEER**

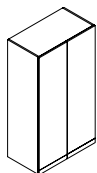

**Wardrobe Cabinet/Shelving Combo\***

	D x W x H						
D25D22	22 x 36 x 66	100	292	30	<b>\$3977</b>	<b>\$4772</b>	
D25D22W30	22 x 30 x 66	100	243	25	<b>\$3480</b>	<b>\$4176</b>	
D25D22W24	22 x 24 x 66	100	195	22	<b>\$2981</b>	<b>\$3578</b>	
D25	20 x 36 x 66	100	278	28	<b>\$3784</b>	<b>\$4543</b>	
D25W30	20 x 30 x 66	100	229	23	<b>\$3157</b>	<b>\$3789</b>	
D25W24	20 x 24 x 66	100	185	18	<b>\$2526</b>	<b>\$3031</b>	

Wardrobe compartment on **left** includes hanging rod and fixed hat shelf. Storage compartment on **right** includes three adjustable shelves. Optional lock available. Shipped assembled in 1 carton.

**PERSONAL TOWERS - 66" HIGH (FREESTANDING) MODEL# DIMENSIONS FREIGHT CLASS WT/LBS. CUBIC FT. VENEER/LAMINATE ALL VENEER**

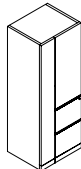

**Personal Tower - LEFT**

D29D22W24L	22 x 24 x 66	125	141	20	<b>\$4140</b>	<b>\$4971</b>	
D29W24L	20 x 24 x 66	125	128	18	<b>\$3924</b>	<b>\$4709</b>	

**Two file** drawers on bottom. Wardrobe compartment on **left** includes hanging rod. Storage compartment on **right** includes one adjustable shelf. Lower lock secures all drawers. Optional lock available for upper storage and wardrobe. Shipped assembled in 1 carton.

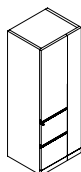

**Personal Tower - RIGHT**

D29D22W24R	22 x 24 x 66	125	141	20	<b>\$4140</b>	<b>\$4971</b>	
D29W24R	20 x 24 x 66	125	128	18	<b>\$3924</b>	<b>\$4709</b>	

**Two file** drawers on bottom. Wardrobe compartment on **right** includes hanging rod. Storage compartment on **left** includes one adjustable shelf. Lower lock secures all drawers. Optional lock available for upper storage and wardrobe. Shipped assembled in 1 carton.

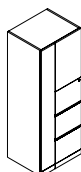

**Personal Tower - LEFT**

D27D22W24L	22 x 24 x 66	125	141	20	<b>\$4710</b>	<b>\$5654</b>	
D27W24L	20 x 24 x 66	125	128	18	<b>\$4485</b>	<b>\$5382</b>	

**Three file** drawers on bottom. Wardrobe compartment on **left** includes hanging rod. Storage compartment on **right** includes one adjustable shelf. Lower lock secures all drawers. Optional lock available for upper storage and wardrobe. Shipped assembled in 1 carton.

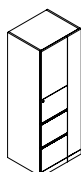

**Personal Tower - RIGHT**

D27D22W24R	22 x 24 x 66	125	141	20	<b>\$4710</b>	<b>\$5654</b>	
D27W24R	20 x 24 x 66	125	128	18	<b>\$4485</b>	<b>\$5382</b>	

**Three file** drawers on bottom. Wardrobe compartment on **right** includes hanging rod. Storage compartment on **left** includes one adjustable shelf. Lower lock secures all drawers. Optional lock available for upper storage and wardrobe. Shipped assembled in 1 carton.

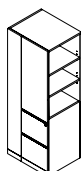

**Personal Tower w/Open Bookcase - LEFT**

D30D22W24L	22 x 24 x 66	125	141	20	<b>\$4140</b>	<b>\$4971</b>	
D30W24L	20 x 24 x 66	125	128	18	<b>\$3924</b>	<b>\$4709</b>	

**Two file drawers** on bottom. Wardrobe compartment on **left** includes hanging rod. Storage compartment on **right** includes one adjustable shelf. Open bookcase on **right** includes two adjustable shelves. Lower lock secures all drawers. Optional lock available for wardrobe. Shipped assembled in 1 carton.

**Required Specifications**

Veneer Finish (doors, drawer fronts)  
Laminate Finish (top/body)  
Handle Style

**Optional Specifications**

Lock  
Veneer Top

**PERSONAL TOWERS - 66" HIGH (FREESTANDING)    MODEL#    DIMENSIONS    FREIGHT CLASS    WT/LBS.    CUBIC FT.    VENEER/LAMINATE    ALL VENEER**

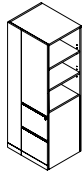

**Personal Tower w/Open Bookcase RIGHT\***

	D x W x H						
D30D22W24R	22 x 24 x 66	125	141	20	<b>\$4140</b>	<b>\$4971</b>	
D30W24R	20 x 24 x 66	125	128	18	<b>\$3924</b>	<b>\$4709</b>	

**Two file drawers** on bottom. Wardrobe compartment on **right** includes hanging rod. Storage compartment on **left** includes one adjustable shelf. Open bookcase on **left** includes two adjustable shelves. Lower lock secures all drawers. Optional lock available for wardrobe. Shipped assembled in 1 carton.

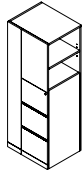

**Personal Tower w/Open Bookcase LEFT\***

D26D22W24L	22 x 24 x 66	125	141	20	<b>\$5705</b>	<b>\$6845</b>	
D26W24L	20 x 24 x 66	125	128	18	<b>\$5434</b>	<b>\$6520</b>	

**Three file drawers** on bottom. Wardrobe compartment on **left** includes hanging rod. Storage compartment on **right** includes one adjustable shelf. Open bookcase on **right** includes one adjustable shelf. Lower lock secures all drawers. Optional lock available for wardrobe. Shipped assembled in 1 carton.

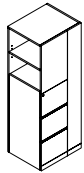

**Personal Tower w/Open Bookcase RIGHT\***

D26D22W24R	22 x 24 x 66	125	141	20	<b>\$5705</b>	<b>\$6845</b>	
D26W24R	20 x 24 x 66	125	128	18	<b>\$5434</b>	<b>\$6520</b>	

**Three file drawers** on bottom. Wardrobe compartment on **right** includes hanging rod. Storage compartment on **left** includes one adjustable shelf. Open bookcase on **left** includes one adjustable shelf. Lower lock secures all drawers. Optional lock available for wardrobe. Shipped assembled in 1 carton.

**STORAGE MODULES - 72" HIGH (FREESTANDING)    MODEL#    DIMENSIONS    FREIGHT CLASS    WT/LBS.    CUBIC FT.    VENEER/LAMINATE    ALL VENEER**

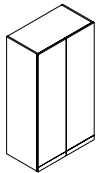

**Storage Cabinet w/Doors\***

D1D22H72	22 x 36 x 72	100	283	33	<b>\$3870</b>	<b>\$4643</b>	
D1D22W30H72	22 x 30 x 72	100	283	28	<b>\$3384</b>	<b>\$4059</b>	
D1D22W24H72	22 x 24 x 72	125	255	24	<b>\$2902</b>	<b>\$3482</b>	
D1H72	20 x 36 x 72	100	269	30	<b>\$3686</b>	<b>\$4422</b>	
D1W30H72	20 x 30 x 72	100	233	25	<b>\$3070</b>	<b>\$3684</b>	
D1W24H72	20 x 24 x 72	125	179	20	<b>\$2457</b>	<b>\$2949</b>	

Includes four adjustable shelves. Optional lock available. Shipped assembled in 1 carton.

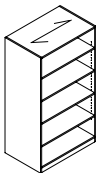

**Open Storage Cabinet**

D7D24H72	24 x 36 x 72	100	306	36	<b>\$3559</b>	<b>\$4271</b>	
D7D24W30H72	24 x 30 x 72	100	255	30	<b>\$3113</b>	<b>\$3738</b>	
D7H72	20 x 36 x 72	100	257	30	<b>\$2951</b>	<b>\$3543</b>	
D7W30H72	20 x 30 x 72	100	223	25	<b>\$2459</b>	<b>\$2952</b>	

Includes one fixed and **four** adjustable veneer shelves. Shelves are ¾" thick. Shipped assembled in 1 carton.

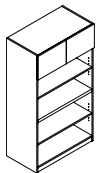

**Open Storage Cabinet w/Doors\***

D9D22H72	22 x 36 x 72	92.5	336	33	<b>\$3326</b>	<b>\$3993</b>	
D9D22W30H72	22 x 30 x 72	92.5	294	28	<b>\$2910</b>	<b>\$3495</b>	
D9H72	20 x 36 x 72	92.5	322	30	<b>\$3166</b>	<b>\$3798</b>	
D9W30H72	20 x 30 x 72	92.5	280	25	<b>\$2642</b>	<b>\$3168</b>	

Storage compartment with fixed shelf. One fixed and **two** adjustable veneer shelves. Fixed shelf is at 29" high. Shelves are ¾" thick. Optional lock available on upper storage. Shipped assembled in 1 carton.

**Required Specifications**

Veneer Finish (doors, drawer fronts, open shelves)  
Laminate Finish (top/body)  
Handle Style

**Optional Specifications**

Lock\*  
Veneer Top

STORAGE MODULES - 72" HIGH (FREESTANDING)    MODEL#    DIMENSIONS    FREIGHT CLASS    WT/LBS.    CUBIC FT.    VENEER/LAMINATE    ALL VENEER

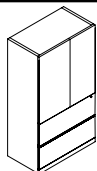

Two File Module w/Doors\*

	D x W x H						
D13D22H72	22 x 36 x 72	92.5	341	33	<b>\$4789</b>	<b>\$5747</b>	
D13D22W30H72	22 x 30 x 72	125	299	28	<b>\$4188</b>	<b>\$5024</b>	
D13H72	20 x 36 x 72	92.5	327	30	<b>\$4560</b>	<b>\$5470</b>	
D13W30H72	20 x 30 x 72	92.5	285	25	<b>\$3798</b>	<b>\$4560</b>	

Two lateral file drawers on bottom. Includes **two** adjustable shelves. Lower lock secures two file drawers. Optional lock available on upper storage. Front-to-back and side-to-side filing. **Not for stacking materials on lateral file drawer bottom.** Shipped assembled in 1 carton.



Two File Module w/Door - LEFT\*

D17D22H72L	22 x 16 x 72	125	99	15	<b>\$3333</b>	<b>\$4001</b>	
D17D20H72L	20 x 16 x 72	125	90	13	<b>\$3029</b>	<b>\$3634</b>	

Two file drawers on bottom. Includes two adjustable shelves. Lower lock secures two file drawers. Optional lock available on upper storage. Handle is on the **right**, door opens to the **left**. Shipped assembled in 1 carton.



Two File Module w/Door - RIGHT\*

D17D22H72R	22 x 16 x 72	125	99	15	<b>\$3333</b>	<b>\$4001</b>	
D17D20H72R	20 x 16 x 72	125	90	13	<b>\$3029</b>	<b>\$3634</b>	

Two file drawers on bottom. Includes two adjustable shelves. Lower lock secures two file drawers. Optional lock available on upper storage. Handle is on the **left**, door opens to the **right**. Shipped assembled in 1 carton.

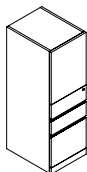

Box/Box/File Module w/Door - LEFT\*

D18D22H72L	22 x 16 x 72	125	99	15	<b>\$3333</b>	<b>\$4001</b>	
D18D20H72L	20 x 16 x 72	125	90	13	<b>\$3029</b>	<b>\$3634</b>	

Two box drawers and one file drawer on bottom. Includes two adjustable shelves. Lower lock secures all drawers. Optional lock available on upper storage. Handle is on the **right**, door opens to the **left**. Shipped assembled in 1 carton.

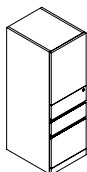

Box/Box/File Module w/Door - RIGHT\*

D18D22H72R	22 x 16 x 72	125	99	15	<b>\$3333</b>	<b>\$4001</b>	
D18D20H72R	20 x 16 x 72	125	90	13	<b>\$3029</b>	<b>\$3634</b>	

Two box drawers and one file drawer on bottom. Includes two adjustable shelves. Lower lock secures all drawers. Optional lock available on upper storage. Handle is on the **left**, door opens to the **right**. Shipped assembled in 1 carton.

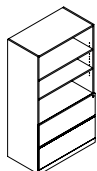

Two File Module w/Open Shelves

D12D22H72	22 x 36 x 72	92.5	331	33	<b>\$4204</b>	<b>\$5044</b>	
D12D22W30H72	22 x 30 x 72	92.5	289	28	<b>\$3678</b>	<b>\$4413</b>	
D12H72	20 x 36 x 72	92.5	317	30	<b>\$4002</b>	<b>\$4802</b>	
D12W30H72	20 x 30 x 72	92.5	275	25	<b>\$3502</b>	<b>\$4202</b>	

Three open veneer shelves and two lateral file drawers on bottom. Includes two adjustable shelves. Lock secures all drawers. Front-to-back and side-to-side filing. **Not for stacking materials on lateral file drawer bottom.** Shipped assembled in 1 carton.

**Required Specifications**

Veneer Finish (doors, drawer fronts, open shelves)  
Laminate Finish (top/body)  
Handle Style

**Optional Specifications**

Lock\*  
Veneer Top

**STORAGE MODULES - 72" HIGH (FREESTANDING)    MODEL#    DIMENSIONS    FREIGHT CLASS    WT/LBS.    CUBIC FT.    VENEER/LAMINATE    ALL VENEER**

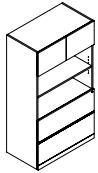

**Two File Module w/Doors\* and Open Shelves**

	D x W x H						
D10D22H72	22 x 36 x 72	92.5	336	33	\$4649	\$5579	
D10D22W30H72	22 x 30 x 72	92.5	294	28	\$4069	\$4881	
D10H72	20 x 36 x 72	92.5	322	30	\$4425	\$5311	
D10W30H72	20 x 30 x 72	92.5	280	25	\$3689	\$4426	

Storage compartment with fixed shelf. Two open veneer shelves and two lateral file drawers on bottom. Includes one adjustable shelf. Lower lock secures all drawers. Optional lock available on upper storage. Front-to-back and side-to-side filing. **Not for stacking materials on lateral file drawer bottom.** Shipped assembled in 1 carton.

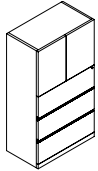

**Three File Module w/Doors\***

D14D22H72	22 x 36 x 72	100	312	33	\$5147	\$6174
D14D22W30H72	22 x 30 x 72	100	273	28	\$4503	\$5405
D14H72	20 x 36 x 72	100	298	30	\$4899	\$5881
D14W30H72	20 x 30 x 72	92.5	259	25	\$4085	\$4901

Three lateral file drawers on bottom. Includes one adjustable shelf. Lower lock secures all drawers. Optional lock available on upper storage. Front-to-back and side-to-side filing. **Not for stacking materials on lateral file drawer bottom.**

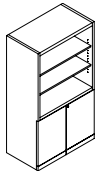

**Storage Module w/Open Shelves**

D22D22H72	22 x 36 x 72	100	300	33	\$3529	\$4233
D22D22W30H72	22 x 30 x 72	100	279	28	\$3088	\$3706
D22H72	20 x 36 x 72	100	305	30	\$3354	\$4026
D22W30H72	20 x 30 x 72	100	265	25	\$2798	\$3358

Three open veneer shelves and storage cabinet on bottom. Includes two adjustable shelves in upper compartment and one adjustable shelf in storage cabinet. Lower lock secures storage cabinet. Optional lock available on upper storage. Shipped assembled in 1 carton.

**WARDROBE CABINETS - 72" HIGH (FREESTANDING)    MODEL#    DIMENSIONS    FREIGHT CLASS    WT/LBS.    CUBIC FT.    VENEER/LAMINATE    ALL VENEER**

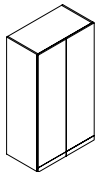

**Wardrobe Cabinet\***

D2D22H72	22 x 36 x 72	100	283	33	\$3354	\$4026
D2D22W30H72	22 x 30 x 72	100	247	33	\$2936	\$3525
D2D22W24H72	22 x 24 x 72	125	216	24	\$2494	\$2992
D2H72	20 x 36 x 72	100	269	30	\$3197	\$3838
D2W30H72	20 x 30 x 72	100	233	25	\$2664	\$3197
D2W24H72	20 x 24 x 72	125	179	20	\$2132	\$2559

Includes full length hanging rod and fixed hat shelf. Optional lock available. Shipped assembled in 1 carton.

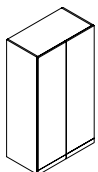

**Wardrobe Cabinet/ Shelving Combo\***

D25D22H72	22 x 36 x 72	100	319	33	\$4339	\$5206
D25D22W30H72	22 x 30 x 72	100	279	28	\$3794	\$4552
D25D22W24H72	22 x 24 x 72	100	213	24	\$3253	\$3902
D25H72	20 x 36 x 72	92.5	305	30	\$5053	\$6061
D25W30H72	20 x 30 x 72	92.5	265	25	\$3447	\$4134
D25W24H72	20 x 24 x 72	100	203	20	\$2757	\$3306

Wardrobe compartment on **left** includes hanging rod and fixed hat shelf. Storage compartment on **right** includes three adjustable shelves. Optional lock available. Shipped assembled in 1 carton.

**PERSONAL TOWERS - 72" HIGH (FREESTANDING)    MODEL#    DIMENSIONS    FREIGHT CLASS    WT/LBS.    CUBIC FT.    VENEER/LAMINATE    ALL VENEER**

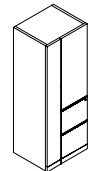

**Personal Tower - LEFT\***

D29D22W24H72L	22 x 24 x 72	125	154	22	\$4566	\$5477
D29W24H72L	20 x 24 x 72	125	140	20	\$5283	\$6338

**Two file** drawers on bottom. Wardrobe compartment on **left** includes hanging rod. Storage compartment on **right** includes one adjustable shelf. Lower lock secures all drawers. Optional lock available on upper storage and wardrobe. Shipped assembled in 1 carton.

**Required Specifications**

Veneer Finish (doors, drawer fronts, open shelves)  
Laminate Finish (top/body)  
Handle Style

**Optional Specifications**

Lock\*  
Veneer Top

PERSONAL TOWERS - 72" HIGH (FREESTANDING)	MODEL#	DIMENSIONS	FREIGHT CLASS	WT/LBS.	CUBIC FT.	VENEER/LAMINATE	ALL VENEER
---	--------	------------	---------------	---------	-----------	-----------------	------------

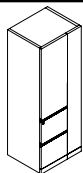

Personal Tower - RIGHT\*

	D x W x H						
D29D22W24H72R	22 x 24 x 72	125	154	22	<b>\$4566</b>	<b>\$5477</b>	
D29W24H72R	20 x 24 x 72	125	140	20	<b>\$4323</b>	<b>\$5188</b>	

**Two file** drawers on bottom. Wardrobe compartment on **right** includes hanging rod. Storage compartment on **left** includes one adjustable shelf. Lower lock secures all drawers. Optional lock available on upper storage and wardrobe. Shipped assembled in 1 carton.

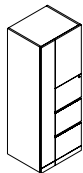

Personal Tower - LEFT\*

D27D22W24H72L	22 x 24 x 72	125	154	22	<b>\$5136</b>	<b>\$6165</b>	
D27W24H72L	20 x 24 x 72	125	140	20	<b>\$4894</b>	<b>\$5873</b>	

**Three file** drawers on bottom. Wardrobe compartment on **left** includes hanging rod. Storage compartment on **right** includes one adjustable shelf. Lower lock secures all drawers. Optional lock available on upper storage and wardrobe. Shipped assembled in 1 carton.

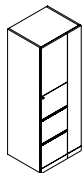

Personal Tower - RIGHT\*

D27D22W24H72R	22 x 24 x 72	125	154	22	<b>\$5136</b>	<b>\$6165</b>	
D27W24H72R	20 x 24 x 72	125	140	20	<b>\$4894</b>	<b>\$5873</b>	

**Three file** drawers on bottom. Wardrobe compartment on **right** includes hanging rod. Storage compartment on **left** includes one adjustable shelf. Lower lock secures all drawers. Optional lock available on upper storage and wardrobe. Shipped assembled in 1 carton.

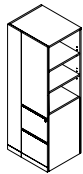

Personal Tower w/Open Bookcase - LEFT

D30D22W24H72L	22 x 24 x 72	125	154	22	<b>\$4566</b>	<b>\$5477</b>	
D30W24H72L	20 x 24 x 72	125	140	20	<b>\$4323</b>	<b>\$5188</b>	

**Two file drawers** on bottom. Wardrobe compartment on **left** includes hanging rod. Storage compartment on **right** includes one adjustable shelf. Open bookcase on **right** includes two adjustable shelves. Lower lock secures all drawers. Shipped assembled in 1 carton.

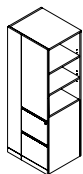

Personal Tower w/Open Bookcase - RIGHT

D30D22W24H72R	22 x 24 x 72	125	154	22	<b>\$4566</b>	<b>\$5477</b>	
D30W24H72R	20 x 24 x 72	125	140	20	<b>\$4323</b>	<b>\$5188</b>	

**Two file drawers** on bottom. Wardrobe compartment on **right** includes hanging rod. Storage compartment on **left** includes one adjustable shelf. Open bookcase on **left** includes two adjustable shelves. Lower lock secures all drawers. Shipped assembled in 1 carton.

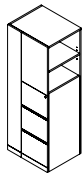

Personal Tower w/Open Bookcase - LEFT

D26D22W24H72L	22 x 24 x 72	125	154	22	<b>\$5089</b>	<b>\$6106</b>	
D26W24H72L	20 x 24 x 72	125	140	20	<b>\$5924</b>	<b>\$7109</b>	

**Three file drawers** on bottom. Wardrobe compartment on **left** includes hanging rod. Storage compartment on **right** includes one adjustable shelf. Open bookcase on **right** includes one adjustable shelf. Lower lock secures all drawers. Shipped assembled in 1 carton.

**Required Specifications**

Veneer Finish (doors, drawer fronts, open shelves)  
Laminate Finish (top/body)  
Handle Style

**Optional Specifications**

Lock\*  
Veneer Top

**PERSONAL TOWERS - 72" HIGH (FREESTANDING)    MODEL#    DIMENSIONS    FREIGHT CLASS    WT/LBS.    CUBIC FT.    VENEER/LAMINATE    ALL VENEER**

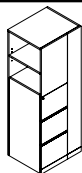

**Personal Tower w/Open Bookcase RIGHT\***

	D x W x H						
D26D22W24H72R	22 x 24 x 72	125	154	22	<b>\$5089</b>	<b>\$6106</b>	
D26W24H72R	20 x 24 x 72	125	140	20	<b>\$5924</b>	<b>\$7109</b>	

**Three file drawers** on bottom. Wardrobe compartment on **right** includes hanging rod. Storage compartment on **left** includes one adjustable shelf. Open bookcase on **left** includes one adjustable shelf. Lower lock secures all drawers. Optional lock available on wardrobe. Shipped assembled in 1 carton.

**STORAGE MODULES - 84" HIGH (FREESTANDING)    MODEL#    DIMENSIONS    FREIGHT CLASS    WT/LBS.    CUBIC FT.    VENEER/LAMINATE    ALL VENEER**

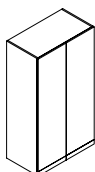

**Storage Cabinet w/Doors\***

D1D22H84	22 x 36 x 84	125	304	42	<b>\$4470</b>	<b>\$5364</b>	
D1D22W30H84	22 x 30 x 84	100	304	35	<b>\$3908</b>	<b>\$4691</b>	
D1D22W24H84	22 x 24 x 84	92.5	320	28	<b>\$3347</b>	<b>\$4016</b>	
D1H84	20 x 36 x 84	100	297	35	<b>\$4259</b>	<b>\$5108</b>	
D1W30H84	20 x 30 x 84	100	257	29	<b>\$3545</b>	<b>\$4252</b>	
D1W24H84	20 x 24 x 84	100	198	23	<b>\$2840</b>	<b>\$3405</b>	

Includes four adjustable shelves. Optional lock available. Shipped assembled in 1 carton.

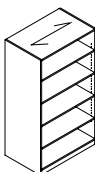

**Open Storage Cabinet**

D7D24H84	24 x 36 x 84	125	331	43	<b>\$4151</b>	<b>\$4978</b>	
D7D24W30H84	24 x 30 x 84	125	280	36	<b>\$3632</b>	<b>\$4362</b>	
D7H84	20 x 36 x 84	100	282	35	<b>\$3627</b>	<b>\$4350</b>	
D7W30H84	20 x 30 x 84	100	248	29	<b>\$3020</b>	<b>\$3627</b>	

Includes one fixed and **four** adjustable veneer shelves. Shelves are 3/4" thick. Shipped assembled in 1 carton.

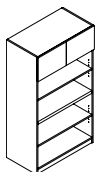

**Open Storage Cabinet w/Doors\***

D9D22H84	22 x 36 x 84	92.5	364	36	<b>\$3878</b>	<b>\$4656</b>	
D9D22W30H84	22 x 30 x 84	92.5	330	31	<b>\$3400</b>	<b>\$4081</b>	
D9H84	20 x 36 x 84	92.5	348	33	<b>\$3690</b>	<b>\$4427</b>	
D9W30H84	20 x 30 x 84	92.5	317	28	<b>\$3079</b>	<b>\$3694</b>	

Storage compartment with fixed shelf. One fixed and **two** adjustable veneer shelves. Fixed shelf is at 29" high. Shelves are 3/4" thick. Optional lock available on upper storage. Shipped assembled in 1 carton.

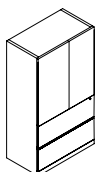

**Two File Module w/Doors\***

D13D22H84	22 x 36 x 84	92.5	364	36	<b>\$5533</b>	<b>\$6640</b>	
D13D22W30H84	22 x 30 x 84	92.5	330	31	<b>\$4842</b>	<b>\$5810</b>	
D13H84	20 x 36 x 84	92.5	365	35	<b>\$5265</b>	<b>\$6317</b>	
D13W30H84	20 x 30 x 84	92.5	305	29	<b>\$4807</b>	<b>\$5764</b>	

Two lateral file drawers on bottom. Includes **two** adjustable shelves. Lower lock secures two file drawers. Optional lock available on upper storage. Front-to-back and side-to-side filing. **Not for stacking materials on lateral file drawer bottom.** Shipped assembled in 1 carton.



**Two File Module w/Door - LEFT\***

D17D22H84L	22 x 16 x 84	125	116	17	<b>\$3999</b>	<b>\$4795</b>	
D17D20H84L	20 x 16 x 84	125	105	15	<b>\$3632</b>	<b>\$4362</b>	

Two file drawers on bottom. Includes two adjustable shelves. Lower lock secures two file drawers. Optional lock available on upper storage. Handle is on the **right**, door opens to the **left**. Shipped assembled in 1 carton.

**Required Specifications**

Veneer Finish (doors, drawer fronts, open shelves)  
Laminate Finish (top/body)  
Handle Style

**Optional Specifications**

Lock\*  
Veneer Top

**STORAGE MODULES - 84" HIGH (FREESTANDING)    MODEL#    DIMENSIONS    FREIGHT CLASS    WT/LBS.    CUBIC FT.    VENEER/LAMINATE    ALL VENEER**

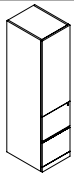

**Two File Module w/Door - RIGHT**

	D x W x H						
D17D22H84R	22 x 16 x 84	125	116	17	<b>\$3999</b>	<b>\$4795</b>	
D17D20H84R	20 x 16 x 84	125	105	15	<b>\$3632</b>	<b>\$4362</b>	

Two file drawers on bottom. Includes two adjustable shelves. Lower lock secures two file drawers. Handle is on the **left**, door opens to the **right**. Shipped assembled in 1 carton.

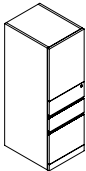

**Box/Box/File Module w/Door - LEFT**

D18D22H84L	22 x 16 x 84	125	116	17	<b>\$3999</b>	<b>\$4795</b>	
D18D20H84L	20 x 16 x 84	125	105	15	<b>\$3632</b>	<b>\$4362</b>	

Two box drawers and one file drawer on bottom. Includes two adjustable shelves. Lower lock secures all drawers. Handle is on the **right**, door opens to the **left**. Shipped assembled in 1 carton.

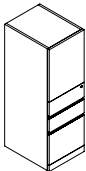

**Box/Box/File Module w/Door - RIGHT**

D18D22H84R	22 x 16 x 84	125	116	17	<b>\$3999</b>	<b>\$4795</b>	
D18D20H84R	20 x 16 x 84	125	105	15	<b>\$3632</b>	<b>\$4362</b>	

Two box drawers and one file drawer on bottom. Includes two adjustable shelves. Lower lock secures all drawers. Handle is on the **left**, door opens to the **right**. Shipped assembled in 1 carton.

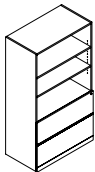

**Two File Module w/Open Shelves**

D12D22H84	22 x 36 x 84	92.5	364	36	<b>\$4858</b>	<b>\$5828</b>	
D12D22W30H84	22 x 30 x 84	92.5	330	31	<b>\$4252</b>	<b>\$5103</b>	
D12H84	20 x 36 x 84	92.5	348	33	<b>\$4675</b>	<b>\$5608</b>	
D12W30H84	20 x 30 x 84	92.5	317	28	<b>\$4049</b>	<b>\$4858</b>	

Three open veneer shelves and two lateral file drawers on bottom. Includes two adjustable shelves. Lock secures all drawers. Front-to-back and side-to-side filing. **Not for stacking materials on lateral file drawer bottom**. Shipped assembled in 1 carton.

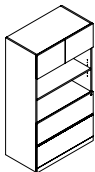

**Two File Module w/Doors and Open Shelves**

D10D22H84	22 x 36 x 84	92.5	364	36	<b>\$5373</b>	<b>\$6449</b>	
D10D22W30H84	22 x 30 x 84	92.5	330	31	<b>\$4706</b>	<b>\$5646</b>	
D10H84	20 x 36 x 84	92.5	348	33	<b>\$5118</b>	<b>\$6141</b>	
D10W30H84	20 x 30 x 84	92.5	317	28	<b>\$4268</b>	<b>\$5120</b>	

Storage compartment with fixed shelf. Two open veneer shelves and two lateral file drawers on bottom. Includes one adjustable shelf. Lock secures all drawers. Front-to-back and side-to-side filing. **Not for stacking materials on lateral file drawer bottom**. Shipped assembled in 1 carton.

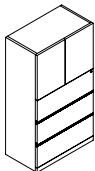

**Three File Module w/Doors**

D14D22H84	22 x 36 x 84	100	340	42	<b>\$5970</b>	<b>\$7166</b>	
D14D22W30H84	22 x 30 x 84	100	308	35	<b>\$5206</b>	<b>\$6249</b>	
D14H84	20 x 36 x 84	100	330	35	<b>\$5665</b>	<b>\$6799</b>	
D14W30H84	20 x 30 x 84	92.5	298	29	<b>\$4725</b>	<b>\$5667</b>	

Three lateral file drawers on bottom. Includes one adjustable shelf. Lock secures all drawers. Front-to-back and side-to-side filing. **Not for stacking materials on lateral file drawer bottom**. Shipped assembled in 1 carton.

**Required Specifications**

Veneer Finish (doors, drawer fronts, open shelves)  
Laminate Finish (top/body)  
Handle Style

**Optional Specifications**

Additional Lock (storage compartments)  
Veneer Top

**STORAGE MODULES - 84" HIGH (FREESTANDING) MODEL# DIMENSIONS FREIGHT CLASS WT/LBS. CUBIC FT. VENEER/LAMINATE ALL VENEER**

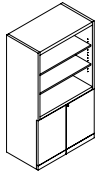

**Storage Module w/Open Shelves**

	D x W x H						
D22D22H84	22 x 36 x 84	125	325	42	<b>\$4076</b>	<b>\$4891</b>	
D22D22W30H84	22 x 30 x 84	100	304	35	<b>\$3565</b>	<b>\$4281</b>	
D22H84	20 x 36 x 84	100	327	33	<b>\$3878</b>	<b>\$4656</b>	
D22W30H84	20 x 30 x 84	92.5	301	28	<b>\$3239</b>	<b>\$3888</b>	

Three open veneer shelves and storage cabinet on bottom. Includes two adjustable shelves in upper compartment and one adjustable shelf in storage cabinet. Lock secures storage cabinet.

**WARDROBE CABINETS - 84" HIGH (FREESTANDING) MODEL# DIMENSIONS FREIGHT CLASS WT/LBS. CUBIC FT. VENEER/LAMINATE ALL VENEER**

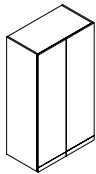

**Wardrobe Cabinet\***

D2D22H84	22 x 36 x 84	125	307	42	<b>\$3878</b>	<b>\$4656</b>	
D2D22W30H84	22 x 30 x 84	125	260	42	<b>\$3400</b>	<b>\$4081</b>	
D2D22W24H84	22 x 24 x 84	100	242	28	<b>\$2910</b>	<b>\$3495</b>	
D2H84	20 x 36 x 84	100	297	35	<b>\$3690</b>	<b>\$4427</b>	
D2W30H84	20 x 30 x 84	100	257	29	<b>\$3079</b>	<b>\$3694</b>	
D2W24H84	20 x 24 x 84	100	198	23	<b>\$2466</b>	<b>\$2958</b>	

Includes full length hanging rod and fixed hat shelf. Optional lock available. Shipped assembled in 1 carton.

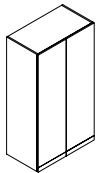

**Wardrobe Cabinet/Shelving Combo\***

D25D22H84	22 x 36 x 84	100	348	42	<b>\$5019</b>	<b>\$6020</b>	
D25D22W30H84	22 x 30 x 84	100	307	35	<b>\$4382</b>	<b>\$5259</b>	
D25D22W24H84	22 x 24 x 84	100	254	28	<b>\$3757</b>	<b>\$4507</b>	
D25H84	20 x 36 x 84	100	330	35	<b>\$4776</b>	<b>\$5731</b>	
D25W30H84	20 x 30 x 84	92.5	300	29	<b>\$3981</b>	<b>\$4778</b>	
D25W24H84	20 x 24 x 84	92.5	235	23	<b>\$3190</b>	<b>\$3825</b>	

Wardrobe compartment on **left** includes hanging rod and fixed hat shelf. Storage compartment on **right** includes three adjustable shelves. Optional lock available. Shipped assembled in 1 carton.

**PERSONAL TOWERS - 84" HIGH (FREESTANDING) MODEL# DIMENSIONS FREIGHT CLASS WT/LBS. CUBIC FT. VENEER/LAMINATE ALL VENEER**

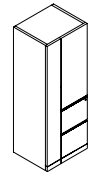

**Personal Tower - LEFT\***

D29D22W24H84L	22 x 24 x 84	125	167	24	<b>\$5417</b>	<b>\$6498</b>	
D29W24H84L	20 x 24 x 84	125	152	22	<b>\$5132</b>	<b>\$6158</b>	

**Two file** drawers on bottom. Wardrobe compartment on **left** includes hanging rod. Storage compartment on **right** includes one adjustable shelf. Lower lock secures all drawers. Optional lock available on upper storage and wardrobe. Shipped assembled in 1 carton.

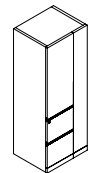

**Personal Tower - RIGHT\***

D29D22W24H84R	22 x 24 x 84	125	167	24	<b>\$5417</b>	<b>\$6498</b>	
D29W24H84R	20 x 24 x 84	125	152	22	<b>\$5132</b>	<b>\$6158</b>	

**Two file** drawers on bottom. Wardrobe compartment on **right** includes hanging rod. Storage compartment on **left** includes one adjustable shelf. Lower lock secures all drawers. Optional lock available on upper storage and wardrobe. Shipped assembled in 1 carton.

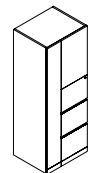

**Personal Tower - LEFT\***

D27D22W24H84L	22 x 24 x 84	125	167	24	<b>\$7258</b>	<b>\$8712</b>	
D27W24H84L	20 x 24 x 84	125	152	22	<b>\$6910</b>	<b>\$8293</b>	

**Three file** drawers on bottom. Wardrobe compartment on **left** includes hanging rod. Storage compartment on **right** includes one adjustable shelf. Lower lock secures all drawers. Optional lock available on upper storage and wardrobe. Shipped assembled in 1 carton.

**Required Specifications**

Veneer Finish (doors, drawer fronts, open shelves)  
Laminate Finish (top/body)  
Handle Style

**Optional Specifications**

Lock\*  
Veneer Top

PERSONAL TOWERS - 84" HIGH (FREESTANDING)    MODEL#    DIMENSIONS    FREIGHT CLASS    WT/LBS.    CUBIC FT.    VENEER/LAMINATE    ALL VENEER

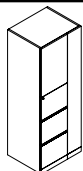

Personal Tower - RIGHT

	D x W x H						
D27D22W24H84R	22 x 24 x 84	125	167	24	<b>\$7258</b>	<b>\$8712</b>	
D27W24H84R	20 x 24 x 84	125	152	22	<b>\$6910</b>	<b>\$8293</b>	

**Three file** drawers on bottom. Wardrobe compartment on **right** includes hanging rod. Storage compartment on **left** includes one adjustable shelf. Lower lock secures all drawers. Optional lock available on upper storage and wardrobe. Shipped assembled in 1 carton.

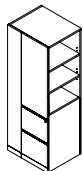

Personal Tower w/Open Bookcase - LEFT

D30D22W24H84L	22 x 24 x 84	125	167	24	<b>\$5417</b>	<b>\$6498</b>	
D30W24H84L	20 x 24 x 84	125	152	22	<b>\$5132</b>	<b>\$6158</b>	

**Two file drawers** on bottom. Wardrobe compartment on **left** includes hanging rod. Storage compartment on **right** includes one adjustable shelf. Open bookcase on **right** includes two adjustable shelves. Lower lock secures all drawers. Optional lock available on wardrobe. Shipped assembled in 1 carton.

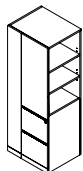

Personal Tower w/Open Bookcase - RIGHT

D30D22W24H84R	22 x 24 x 84	125	167	24	<b>\$5417</b>	<b>\$6498</b>	
D30W24H84R	20 x 24 x 84	125	152	22	<b>\$5132</b>	<b>\$6158</b>	

**Two file drawers** on bottom. Wardrobe compartment on **right** includes hanging rod. Storage compartment on **left** includes one adjustable shelf. Open bookcase on **left** includes two adjustable shelves. Lower lock secures all drawers. Optional lock available on wardrobe. Shipped assembled in 1 carton.

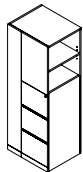

Personal Tower w/Open Bookcase - LEFT

D26D22W24H84L	22 x 24 x 84	125	167	24	<b>\$7258</b>	<b>\$8712</b>	
D26W24H84L	20 x 24 x 84	125	152	22	<b>\$6910</b>	<b>\$8293</b>	

**Three file drawers** on bottom. Wardrobe compartment on **left** includes hanging rod. Storage compartment on **right** includes one adjustable shelf. Open bookcase on **right** includes one adjustable shelf. Lower lock secures all drawers. Optional lock available on wardrobe. Shipped assembled in 1 carton.

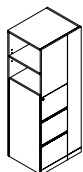

Personal Tower w/Open Bookcase - RIGHT

D26D22W24H84R	22 x 24 x 84	125	167	24	<b>\$7258</b>	<b>\$8712</b>	
D26W24H84R	20 x 24 x 84	125	152	22	<b>\$6910</b>	<b>\$8293</b>	

**Three file drawers** on bottom. Wardrobe compartment on **right** includes hanging rod. Storage compartment on **left** includes one adjustable shelf. Open bookcase on **left** includes one adjustable shelf. Lower lock secures all drawers. Optional lock available on wardrobe. Shipped assembled in 1 carton.

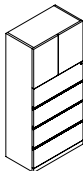

Four File Module w/Doors

D6W30H84	20 x 30 x 84	85	351	29	<b>\$5757</b>	<b>\$6906</b>	
----------	--------------	----	-----	----	---------------	---------------	--

Four lateral file drawers on bottom. Includes one adjustable shelf. Lock secures all drawers. Optional lock available on upper storage. Front-to-back and side-to-side filing. **Not for stacking materials on lateral file drawer bottom.** Shipped assembled in 1 carton.

**Required Specifications**

Veneer Finish (doors, drawer fronts, open shelves)  
Laminate Finish (top/body)  
Handle Style

**Optional Specifications**

Lock\*  
Veneer Top

TOPS FOR STORAGE MODELS

MODEL#	DIMENSIONS	FREIGHT CLASS	WT./LBS.	CUBIC FT.	VENEER/LAMINATE	ALL VENEER
D x W x H						
D12024T	24 x 120 x 1	60	115	2	N/A	\$2453
D11824T	24 x 118 x 1	60	109	2	N/A	\$2416
D11624T	24 x 116 x 1	60	107	2	N/A	\$2381
D11424T	24 x 114 x 1	60	105	2	N/A	\$2350
D11224T	24 x 112 x 1	60	103	2	N/A	\$2292
D11024T	24 x 110 x 1	60	102	2	N/A	\$2248
D10824T	24 x 108 x 1	60	100	2	N/A	\$2206
D10624T	24 x 106 x 1	60	98	2	N/A	\$2167
D10424T	24 x 104 x 1	60	96	2	N/A	\$2124
D10224T	24 x 102 x 1	60	94	2	N/A	\$2089
D10024T	24 x 100 x 1	60	92	2	N/A	\$2044
D9824T	24 x 98 x 1	60	90	2	N/A	\$2002
D9624T	24 x 96 x 1	60	88	2	N/A	\$1963
D9424T	24 x 94 x 1	60	86	2	N/A	\$1921
D9224T	24 x 92 x 1	60	85	2	N/A	\$1883
D9024T	24 x 90 x 1	60	83	2	N/A	\$1842
D8824T	24 x 88 x 1	60	81	2	N/A	\$1804
D8624T	24 x 86 x 1	60	80	2	N/A	\$1760
D8424T	24 x 84 x 1	60	78	2	N/A	\$1716
D8224T	24 x 82 x 1	60	75	2	N/A	\$1678
D8024T	24 x 80 x 1	60	74	2	N/A	\$1638
D7824T	24 x 78 x 1	60	72	2	N/A	\$1615
D7624T	24 x 76 x 1	60	70	2	N/A	\$1558
D7424T	24 x 74 x 1	60	69	2	N/A	\$1518
D7224T	24 x 72 x 1	60	66	2	N/A	\$1477
D7024T	24 x 70 x 1	60	64	2	N/A	\$1433
D6824T	24 x 68 x 1	60	62	2	N/A	\$1399
D6624T	24 x 66 x 1	60	61	2	N/A	\$1353
D6424T	24 x 64 x 1	60	59	1	N/A	\$1308
D6224T	24 x 62 x 1	60	57	1	N/A	\$1272
D6024T	24 x 60 x 1	60	55	1	N/A	\$1227
D5824T	24 x 58 x 1	60	54	1	N/A	\$1184
D5624T	24 x 56 x 1	60	52	1	N/A	\$1148
D5424T	24 x 54 x 1	60	50	1	N/A	\$1106
D5224T	24 x 52 x 1	60	48	1	N/A	\$1067
D5024T	24 x 50 x 1	60	46	1	N/A	\$1024
D4824T	24 x 48 x 1	60	44	1	N/A	\$981
D4224T	24 x 42 x 1	60	39	1	N/A	\$953
D4024T	24 x 40 x 1	60	37	1	N/A	\$909
D3824T	24 x 38 x 1	60	35	1	N/A	\$864
D3624T	24 x 36 x 1	60	33	1	N/A	\$813
D3424T	24 x 34 x 1	60	31	1	N/A	\$761
D3224T	24 x 32 x 1	65	29	1	N/A	\$719
D3024T	24 x 30 x 1	65	28	1	N/A	\$616
D2424T	24 x 24 x 1	65	23	1	N/A	\$616
D1824T	24 x 18 x 1	70	17	1	N/A	\$448
D1624T	24 x 16 x 1	70	15	1	N/A	\$434
D1224T	24 x 12 x 1	92.5	11	1	N/A	\$325

EXAMPLE:

(1) D9024T  
Veneer Top

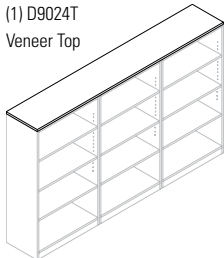

(3) D7D22W30H48 - Open Storage Cabinet

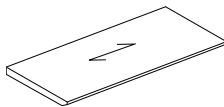

Tops - 24" Deep

For use with 22" deep units. Tops are 1" thick.

- **This is an OPTION for Storage Modules, Wardrobe Cabinets and Personal Towers.**  
Specify a Veneer Top from the listing above (either a single model or straight run).

Required Specifications

Veneer finish

TOPS FOR STORAGE MODELS

MODEL#	DIMENSIONS	FREIGHT CLASS	WT/LBS.	CUBIC FT.	VENEER/LAMINATE	ALL VENEER
D x W x H						
D12022T	22 x 120 x 1	60	101	2	N/A	\$2248
D11822T	22 x 118 x 1	60	100	2	N/A	\$2211
D11622T	22 x 116 x 1	60	97	2	N/A	\$2173
D11422T	22 x 114 x 1	60	96	2	N/A	\$2140
D11222T	22 x 112 x 1	60	95	2	N/A	\$2104
D11022T	22 x 110 x 1	60	92	2	N/A	\$2059
D10822T	22 x 108 x 1	60	91	2	N/A	\$2022
D10622T	22 x 106 x 1	60	89	2	N/A	\$1987
D10422T	22 x 104 x 1	60	87	2	N/A	\$1952
D10222T	22 x 102 x 1	60	86	2	N/A	\$1912
D10022T	22 x 100 x 1	60	84	2	N/A	\$1877
D9822T	22 x 98 x 1	60	83	2	N/A	\$1832
D9622T	22 x 96 x 1	60	81	2	N/A	\$1797
D9422T	22 x 94 x 1	60	79	2	N/A	\$1760
D9222T	22 x 92 x 1	60	77	2	N/A	\$1723
D9022T	22 x 90 x 1	60	76	2	N/A	\$1723
D8822T	22 x 88 x 1	60	74	2	N/A	\$1650
D8622T	22 x 86 x 1	60	73	2	N/A	\$1615
D8422T	22 x 84 x 1	60	71	2	N/A	\$1578
D8222T	22 x 82 x 1	60	69	2	N/A	\$1542
D8022T	22 x 80 x 1	60	67	2	N/A	\$1499
D7822T	22 x 78 x 1	60	66	2	N/A	\$1461
D7622T	22 x 76 x 1	60	65	2	N/A	\$1425
D7422T	22 x 74 x 1	60	63	2	N/A	\$1387
D7222T	22 x 72 x 1	60	61	2	N/A	\$1387
D7022T	22 x 70 x 1	65	59	2	N/A	\$1318
D6822T	22 x 68 x 1	65	57	2	N/A	\$1280
D6622T	22 x 66 x 1	65	55	2	N/A	\$1245
D6422T	22 x 64 x 1	65	54	1	N/A	\$1200
D6222T	22 x 62 x 1	60	52	1	N/A	\$1166
D6022T	22 x 60 x 1	60	50	1	N/A	\$1125
D5822T	22 x 58 x 1	60	49	1	N/A	\$1089
D5622T	22 x 56 x 1	60	47	1	N/A	\$1055
D5422T	22 x 54 x 1	60	46	1	N/A	\$1018
D5222T	22 x 52 x 1	60	44	1	N/A	\$981
D5022T	22 x 50 x 1	60	42	1	N/A	\$937
D4822T	22 x 48 x 1	60	40	1	N/A	\$901
D4222T	22 x 42 x 1	60	36	1	N/A	\$873
D4022T	22 x 40 x 1	60	34	1	N/A	\$828
D3822T	22 x 38 x 1	60	32	1	N/A	\$791
D3622T	22 x 36 x 1	60	30	1	N/A	\$749
D3422T	22 x 34 x 1	65	28	1	N/A	\$703
D3222T	22 x 32 x 1	65	27	1	N/A	\$662
D3022T	22 x 30 x 1	65	25	1	N/A	\$616
D2422T	22 x 24 x 1	70	20	1	N/A	\$594
D1822T	22 x 18 x 1	70	15	1	N/A	\$448
D1622T	22 x 16 x 1	85	14	1	N/A	\$397
D1222T	22 x 12 x 1	92.5	10	1	N/A	\$298

EXAMPLE:

(1) D9022T  
Veneer Top

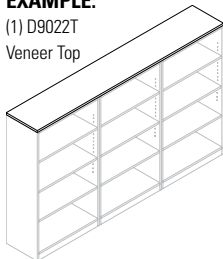

(3) D7D20W30H48 - Open Storage Cabinet

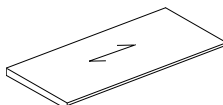

Tops - 22" Deep

For use with 20" deep units. Tops are 1" thick.

• **This is an OPTION for Storage Modules, Wardrobe Cabinets and Personal Towers.**  
Specify a Veneer Top from the listing above (either a single model or straight run).

FLOATING SHELF

MODEL#	DIMENSIONS	FREIGHT CLASS	WT/LBS.	CUBIC FT.	LIST PRICE
CBYF096D12H8	12 x 96 x 8	125	78	10	\$2863
CBYF064D12H8	12 x 64 x 8	125	50	8	\$1873
CBYF032D12H8	12 x 32 x 8	100	35	4	\$1697

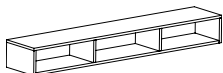

Wall Mounted Open Storage\*

To be used as a stand alone unit. Shipped assembled in 1 carton.

Required Specifications

Veneer finish

OVERHEAD STORAGE

MODEL#	DIMENSIONS	FREIGHT CLASS	WT./LBS.	CUBIC FT.	VENEER/LAMINATE	ALL VENEER
--------	------------	---------------	----------	-----------	-----------------	------------

sizes 48" and larger

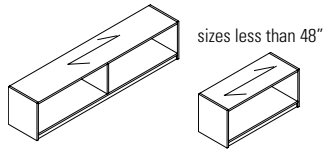

Open Front Overhead Storage

	D x W x H					
DCSF072	14.5 x 72 x 16.5	125	100	10	\$1733	\$2082
DCSF066	14.5 x 66 x 16.5	125	83	9	\$1592	\$1909
DCSF060	14.5 x 60 x 16.5	100	75	8	\$1446	\$1733
DCSF054	14.5 x 54 x 16.5	100	68	7	\$1303	\$1563
DCSF048	14.5 x 48 x 16.5	100	60	7	\$1159	\$1390
DCSF042	14.5 x 42 x 16.5	100	55	6	\$1071	\$1283
DCSF036	14.5 x 36 x 16.5	100	50	5	\$1060	\$1270
DCSF030	14.5 x 30 x 16.5	100	45	4	\$1036	\$1245

Includes pre-mounted "J" brackets for wall mount applications. Shipped assembled in 1 carton.

- **NOTE:** Care should be taken to mount the units. Units should be mounted to wall studs using correct fasteners. Failure to do so may result in collapse of the unit and subsequent personal injury. **Mounting hardware not included.** Mounting hardware used should be based on wall material. Consult an installation professional for proper wall mounting.

sizes 48" and larger

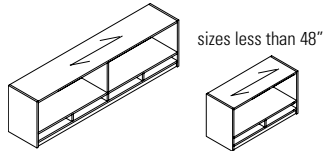

Open Front Overhead Storage - Pigeon-Hole Storage

DCSFOP72	14.5 x 72 x 19.5	125	100	12	\$2082	\$2498
DCSFOP66	14.5 x 66 x 19.5	125	83	11	\$1908	\$2290
DCSFOP60	14.5 x 60 x 19.5	125	75	10	\$1733	\$2082
DCSFOP54	14.5 x 54 x 19.5	125	68	9	\$1565	\$1878
DCSFOP48	14.5 x 48 x 19.5	125	60	8	\$1386	\$1664
DCSFOP42	14.5 x 42 x 19.5	125	55	7	\$1303	\$1563
DCSFOP36	14.5 x 36 x 19.5	125	50	6	\$1263	\$1515
DCSFOP30	14.5 x 30 x 19.5	125	45	5	\$1248	\$1495

Includes pre-mounted "J" brackets for wall mount applications. Horizontal pigeon-hole storage on bottom of overhead.

- **NOTE:** Care should be taken to mount the units. Units should be mounted to wall studs using correct fasteners. Failure to do so may result in collapse of the unit and subsequent personal injury. **Mounting hardware not included.** Mounting hardware used should be based on wall material. Consult an installation professional for proper wall mounting. Shipped assembled in 1 carton.

sizes 48" and larger

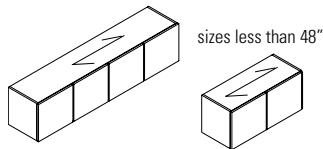

Closed Front Overhead Storage with Hinge Doors\*

DSF72	14.5 x 72 x 16.5	92.5	100	10	\$2242	\$2690
DSF66	14.5 x 66 x 16.5	100	83	9	\$2059	\$2471
DSF60	14.5 x 60 x 16.5	100	75	8	\$1871	\$2246
DSF54	14.5 x 54 x 16.5	100	68	7	\$1678	\$2014
DSF48	14.5 x 48 x 16.5	60	60	7	\$1650	\$1980
DSF42	14.5 x 42 x 16.5	100	55	6	\$1375	\$1649
DSF36	14.5 x 36 x 16.5	92.5	50	5	\$1346	\$1613
DSF30	14.5 x 30 x 16.5	92.5	45	4	\$1322	\$1588

Includes pre-mounted "J" brackets for wall mount applications. Shipped assembled in 1 carton.

- **NOTE:** Care should be taken to mount the units. Units should be mounted to wall studs using correct fasteners. Failure to do so may result in collapse of the unit and subsequent personal injury. **Mounting hardware not included.** Mounting hardware used should be based on wall material. Consult an installation professional for proper wall mounting.

sizes 48" and larger

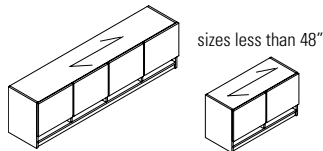

Closed Front Overhead Storage with Hinge Doors & Pigeon-Hole Storage\*

DSFP72	14.5 x 72 x 19.5	100	100	12	\$2693	\$3233
DSFP66	14.5 x 66 x 19.5	125	83	11	\$2466	\$2958
DSFP60	14.5 x 60 x 19.5	125	75	10	\$2248	\$2698
DSFP54	14.5 x 54 x 19.5	125	68	9	\$2022	\$2428
DSFP48	14.5 x 48 x 19.5	125	60	8	\$1791	\$2146
DSFP42	14.5 x 42 x 19.5	125	55	7	\$1711	\$2054
DSFP36	14.5 x 36 x 19.5	100	50	6	\$1615	\$1938
DSFP30	14.5 x 30 x 19.5	100	45	5	\$1593	\$1910

Includes pre-mounted "J" brackets for wall mount applications. Horizontal pigeon-hole storage on bottom of overhead. Shipped assembled in 1 carton.

- **NOTE:** Care should be taken to mount the units. Units should be mounted to wall studs using correct fasteners. Failure to do so may result in collapse of the unit and subsequent personal injury. **Mounting hardware not included.** Mounting hardware used should be based on wall material. Consult an installation professional for proper wall mounting.

Required Specifications

Veneer Finish  
Laminate Finish (top/body)

Optional Specifications

Lock\*  
Handle style\*

OVERHEAD STORAGE

sizes 48" and larger

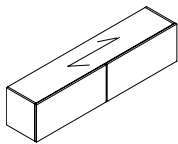

sizes less than 48"

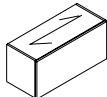

**Closed Front Overhead Storage - with Flipper Doors**

sizes 48" and larger

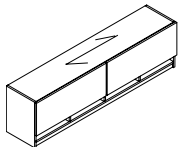

sizes less than 48"

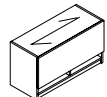

**Closed Front Overhead Storage with Flipper Doors & Pigeon-Hole Storage**

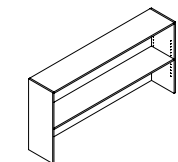

**Open Hutch with Closed Back**

MODEL# DIMENSIONS FREIGHT CLASS WT/LBS. CUBIC FT. VENEER/LAMINATE ALL VENEER

D x W x H

DSFF72	14.5 x 72 x 16.5	92.5	100	10	\$2431	\$2916
DSFF66	14.5 x 66 x 16.5	100	83	9	\$2225	\$2670
DSFF60	14.5 x 60 x 16.5	100	75	8	\$2022	\$2428
DSFF54	14.5 x 54 x 16.5	100	68	7	\$1826	\$2191
DSFF48	14.5 x 48 x 16.5	100	60	7	\$1621	\$1948
DSFF42	14.5 x 42 x 16.5	100	55	6	\$1506	\$1805
DSFF36	14.5 x 36 x 16.5	92.5	50	5	\$1477	\$1773
DSFF30	14.5 x 30 x 16.5	92.5	45	4	\$1456	\$1746

Includes pre-mounted "J" brackets for wall mount applications. Horizontal pigeon-hole storage on bottom of overhead. Shipped assembled in 1 carton.

- **NOTE:** Care should be taken to mount the units. Units should be mounted to wall studs using correct fasteners. Failure to do so may result in collapse of the unit and subsequent personal injury. **Mounting hardware not included.** Mounting hardware used should be based on wall material. Consult an installation professional for proper wall mounting.

DSFFP72	14.5 x 72 x 19.5	100	100	12	\$3187	\$3824
DSFFP66	14.5 x 66 x 19.5	125	83	11	\$2669	\$3205
DSFFP60	14.5 x 60 x 19.5	125	75	10	\$2431	\$2916
DSFFP54	14.5 x 54 x 19.5	125	68	9	\$2185	\$2618
DSFFP48	14.5 x 48 x 19.5	125	60	8	\$1943	\$2331
DSFFP42	14.5 x 42 x 19.5	125	55	7	\$1804	\$2165
DSFFP36	14.5 x 36 x 19.5	100	50	6	\$1768	\$2121
DSFFP30	14.5 x 30 x 19.5	100	45	5	\$1740	\$2086

Includes pre-mounted "J" brackets for wall mount applications. Horizontal pigeon-hole storage on bottom of overhead. Shipped assembled in 1 carton.

- **NOTE:** Care should be taken to mount the units. Units should be mounted to wall studs using correct fasteners. Failure to do so may result in collapse of the unit and subsequent personal injury. **Mounting hardware not included.** Mounting hardware used should be based on wall material. Consult an installation professional for proper wall mounting.

D72CL36	16 x 72 x 36	125	155	23	\$1936	\$2322
D66CL36	16 x 66 x 36	125	140	21	\$1795	\$2152
D60CL36	16 x 60 x 36	125	130	19	\$1593	\$1910
D48CL36	16 x 48 x 36	125	110	15	\$1516	\$1821
D42CL36	16 x 42 x 36	125	95	13	\$1375	\$1649
D36CL36	16 x 36 x 36	125	80	11	\$1293	\$1550
D30CL36	16 x 30 x 36	125	67	9	\$1074	\$1293

One adjustable shelf. Closed back. Shipped assembled in 1 carton.

- **A Tackboard cannot be used with this hutch.**

CLOSED HUTCHES

sizes 120"-108"w

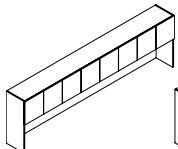

sizes 102"-84"w

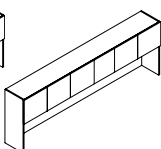

sizes 78"-60"w

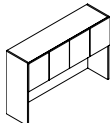

sizes 36"-30"w

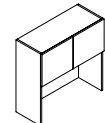

**Closed Hutch w/Veneer Doors 36" High\***

MODEL# DIMENSIONS FREIGHT CLASS WT/LBS. CUBIC FT. VENEER/LAMINATE ALL VENEER

D120SH36	16 x 120 x 36	125	295	38	\$5230	\$6277
D114SH36	16 x 114 x 36	125	281	36	\$4967	\$5960
D108SH36	16 x 108 x 36	125	268	34	\$4707	\$5647
D102SH36	16 x 102 x 36	125	254	32	\$4446	\$5335
D96SH36	16 x 96 x 36	100	241	30	\$4186	\$5022
D90SH36	16 x 90 x 36	100	227	28	\$3922	\$4707
D84SH36	16 x 84 x 36	100	214	26	\$3660	\$4393
D78SH36	16 x 78 x 36	100	200	24	\$3400	\$4081
D72SH36	16 x 72 x 36	125	187	23	\$3139	\$3767
D66SH36	16 x 66 x 36	100	173	21	\$3025	\$3628
D60SH36	16 x 60 x 36	100	160	19	\$2877	\$3452
D36SH36	16 x 36 x 36	100	94	11	\$1964	\$2358
D30SH36	16 x 30 x 36	100	78	9	\$1718	\$2061

One fixed shelf. Closed back features one grommet. Shipped assembled in 1 carton.

- Models 120"w- 108"w have three fixed shelf dividers.
- Models 84"w- 102"w have two fixed shelf dividers.
- Models 60"w - 78"w have one fixed shelf divider.
- *Clearance from worksurface to valance is 19.5".*

**Required Specifications**

Veneer Finish  
Laminate Finish (top/body)

**Optional Specifications**

Lock (models with doors)  
Handle Style (models with doors)

**Accessories**

Tackboard\*  
Tasklight\*

**CLOSED HUTCHES**

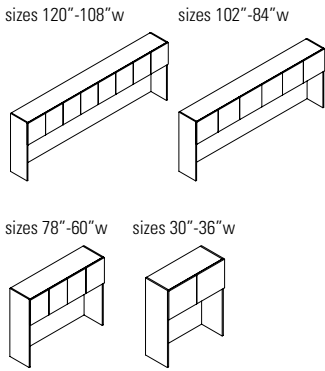

**Closed Hutch w/Veneer Doors 42" H**

MODEL#	DIMENSIONS	FREIGHT CLASS	WT./LBS.	CUBIC FT.	veneer/LAMINATE	ALL VENEER
<b>D x W x H</b>						
D120SH42	16 x 120 x 42	125	341	44	<b>\$6100</b>	<b>\$7318</b>
D114SH42	16 x 114 x 42	125	324	42	<b>\$5791</b>	<b>\$6951</b>
D108SH42	16 x 108 x 42	125	307	39	<b>\$5766</b>	<b>\$6920</b>
D102SH42	16 x 102 x 42	125	290	37	<b>\$5184</b>	<b>\$6221</b>
D96SH42	16 x 96 x 42	125	273	35	<b>\$4880</b>	<b>\$5856</b>
D90SH42	16 x 90 x 42	125	256	33	<b>\$4575</b>	<b>\$5490</b>
D84SH42	16 x 84 x 42	125	239	31	<b>\$4485</b>	<b>\$5382</b>
D78SH42	16 x 78 x 42	125	222	38	<b>\$3968</b>	<b>\$4760</b>
D72SH42	16 x 72 x 42	125	205	26	<b>\$3660</b>	<b>\$4393</b>
D66SH42	16 x 66 x 42	125	188	24	<b>\$3526</b>	<b>\$4232</b>
D60SH42	16 x 60 x 42	125	171	22	<b>\$3354</b>	<b>\$4026</b>
D36SH42	16 x 36 x 42	125	102	13	<b>\$2291</b>	<b>\$2747</b>
D30SH42	16 x 30 x 42	125	85	11	<b>\$2006</b>	<b>\$2406</b>

One fixed shelf. Closed back features one grommet. Shipped assembled in 1 carton.

- Models 120" w- 108" w have three fixed shelf dividers.
- Models 84" w- 102" w have two fixed shelf dividers.
- Models 60" w - 78" w have one fixed shelf divider.
- *Clearance from worksurface to valance is 19.5"*.

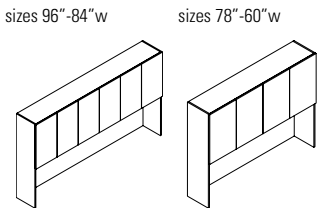

**Closed Hutch w/Veneer Doors 54" H**

D962SH54	15 x 96 x 54	125	351	45	<b>\$6268</b>	<b>\$7522</b>
D902SH54	15 x 90 x 54	125	329	42	<b>\$5881</b>	<b>\$7056</b>
D842SH54	15 x 84 x 54	125	307	39	<b>\$5488</b>	<b>\$6582</b>
D782SH54	15 x 78 x 54	125	285	37	<b>\$5095</b>	<b>\$6116</b>
D722SH54	15 x 72 x 54	300	263	34	<b>\$4706</b>	<b>\$5646</b>
D662SH54	15 x 66 x 54	125	241	31	<b>\$4530</b>	<b>\$5436</b>
D602SH54	15 x 60 x 54	125	219	28	<b>\$4315</b>	<b>\$5176</b>

One fixed shelf and one adjustable shelf (per compartment). Closed back features one grommet. Shipped assembled in 1 carton.

- *Clearance from worksurface to valance is 25.5"*.

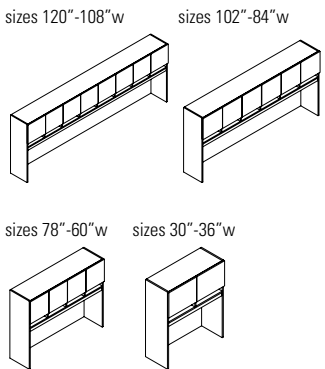

**Closed Hutch w/Veneer Doors Pigeon-Hole Storage, 42" High**

D120SHP42	15 x 120 x 42	125	341	44	<b>\$7318</b>	<b>\$8782</b>
D114SHP42	15 x 114 x 42	125	324	42	<b>\$6952</b>	<b>\$8344</b>
D108SHP42	15 x 108 x 42	125	307	39	<b>\$6590</b>	<b>\$7904</b>
D102SHP42	15 x 102 x 42	125	290	37	<b>\$6221</b>	<b>\$7465</b>
D96SHP42	15 x 96 x 42	125	273	35	<b>\$5856</b>	<b>\$7026</b>
D90SHP42	15 x 90 x 42	125	256	33	<b>\$5490</b>	<b>\$6590</b>
D84SHP42	15 x 84 x 42	125	239	31	<b>\$5124</b>	<b>\$6148</b>
D78SHP42	15 x 78 x 42	125	222	38	<b>\$4759</b>	<b>\$5709</b>
D72SHP42	15 x 72 x 42	125	205	26	<b>\$4599</b>	<b>\$5517</b>
D66SHP42	15 x 66 x 42	125	188	24	<b>\$4440</b>	<b>\$5329</b>
D60SHP42	15 x 60 x 42	125	171	22	<b>\$4232</b>	<b>\$5077</b>
D36SHP42	15 x 36 x 42	125	102	13	<b>\$2747</b>	<b>\$3298</b>
D30SHP42	15 x 30 x 42	125	85	11	<b>\$2406</b>	<b>\$2889</b>

One fixed shelf. Closed back features one grommet. Horizontal pigeon-hole storage top mounted to hutch. Shipped assembled in 1 carton.

- Models 120" w- 108" w have three fixed shelf dividers.
- Models 84" w- 102" w have two fixed shelf dividers.
- Models 60" w - 78" w have one fixed shelf divider.
- *Clearance from worksurface to valance is 21.5"*.

**Required Specifications**

Veneer Finish (doors)  
Laminate Finish (top/body)

**Optional Specifications**

Lock  
Handle Style

**Accessories**

Tackboard  
Tasklight

CLOSED HUTCHES

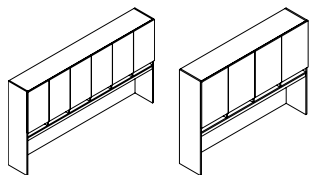

**Closed Hutch w/Veneer Doors**  
**Pigeon-Hole Storage, 54" H\***

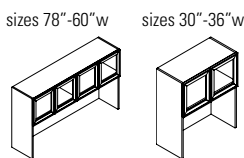
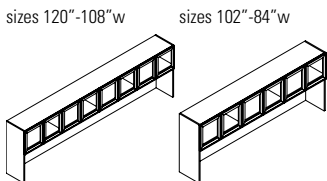

**Closed Hutch w/Glass Doors 36" H\*\***

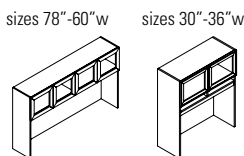
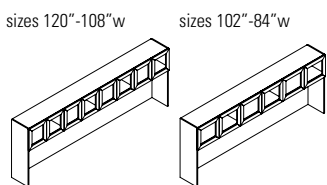

**Closed Hutch w/Glass Doors 42" H\*\***

MODEL#	DIMENSIONS	FREIGHT CLASS	WT./LBS.	CUBIC FT.	VENEER/LAMINATE	ALL VENEER
	<b>D x W x H</b>					
D962SHP54	15 x 96 x 54	125	351	45	<b>\$7527</b>	<b>\$9033</b>
D902SHP54	15 x 90 x 54	125	329	42	<b>\$7053</b>	<b>\$8462</b>
D842SHP54	15 x 84 x 54	125	307	39	<b>\$6580</b>	<b>\$7895</b>
D782SHP54	15 x 78 x 54	125	285	37	<b>\$6114</b>	<b>\$7336</b>
D722SHP54	15 x 72 x 54	125	263	34	<b>\$5646</b>	<b>\$6774</b>
D662SHP54	15 x 66 x 54	125	241	31	<b>\$5434</b>	<b>\$6520</b>
D602SHP54	15 x 60 x 54	125	219	28	<b>\$5174</b>	<b>\$6208</b>

One fixed shelf and one adjustable shelf (per compartment). Closed back features one grommet. Horizontal pigeon-hole storage top mounted to hutch. Shipped assembled in 1 carton.

- Clearance from worksurface to valance is 21.5".

D120SH36G	15 x 120 x 36	125	295	38	<b>\$7822</b>	<b>\$9384</b>
D114SH36G	15 x 114 x 36	125	281	36	<b>\$7508</b>	<b>\$9009</b>
D108SH36G	15 x 108 x 36	125	268	34	<b>\$7202</b>	<b>\$8642</b>
D102SH36G	15 x 102 x 36	125	254	32	<b>\$6466</b>	<b>\$7759</b>
D96SH36G	15 x 96 x 36	85	241	30	<b>\$6168</b>	<b>\$7401</b>
D90SH36G	15 x 90 x 36	100	227	28	<b>\$5862</b>	<b>\$7035</b>
D84SH36G	15 x 84 x 36	100	214	26	<b>\$5563</b>	<b>\$6675</b>
D78SH36G	15 x 78 x 36	85	200	24	<b>\$5271</b>	<b>\$6326</b>
D72SH36G	15 x 72 x 36	100	187	23	<b>\$4580</b>	<b>\$5495</b>
D66SH36G	15 x 66 x 36	100	173	21	<b>\$4382</b>	<b>\$5259</b>
D60SH36G	15 x 60 x 36	100	160	19	<b>\$4187</b>	<b>\$5023</b>
D36SH36G	15 x 36 x 36	100	94	11	<b>\$2663</b>	<b>\$3194</b>
D30SH36G	15 x 30 x 36	100	78	9	<b>\$2381</b>	<b>\$2854</b>

One fixed shelf. Closed back features one grommet. Aluminum frame available in Tungsten finish only. Shipped assembled in 1 carton. Translucent, screened glass.

- Models 120" w- 108" w have three fixed shelf dividers.
- Models 84" w- 102" w have two fixed shelf dividers.
- Models 60" w - 78" w have one fixed shelf divider.
- Clearance from worksurface to valance is 19.5".
- **Locks are not available on hutches with Glass Doors.**

D120SH42G	15 x 120 x 42	125	341	44	<b>\$8222</b>	<b>\$9868</b>
D114SH42G	15 x 114 x 42	125	324	42	<b>\$7887</b>	<b>\$9464</b>
D108SH42G	15 x 108 x 42	125	307	39	<b>\$7560</b>	<b>\$9071</b>
D102SH42G	15 x 102 x 42	125	290	37	<b>\$6814</b>	<b>\$8180</b>
D96SH42G	15 x 96 x 42	125	273	35	<b>\$6495</b>	<b>\$7793</b>
D90SH42G	15 x 90 x 42	125	256	33	<b>\$6254</b>	<b>\$7506</b>
D84SH42G	15 x 84 x 42	125	239	31	<b>\$5840</b>	<b>\$7008</b>
D78SH42G	15 x 78 x 42	150	222	38	<b>\$5518</b>	<b>\$6622</b>
D72SH42G	15 x 72 x 42	125	205	26	<b>\$4763</b>	<b>\$5713</b>
D66SH42G	15 x 66 x 42	125	188	24	<b>\$4595</b>	<b>\$5514</b>
D60SH42G	15 x 60 x 42	125	171	22	<b>\$4434</b>	<b>\$5318</b>
D36SH42G	15 x 36 x 42	125	102	13	<b>\$3462</b>	<b>\$4154</b>
D30SH42G	15 x 30 x 42	125	85	11	<b>\$2517</b>	<b>\$3025</b>

One fixed shelf. Closed back features one grommet. Aluminum frame available in Tungsten finish only. Shipped assembled in 1 carton. Translucent, screened glass.

- Models 120" w- 108" w have three fixed shelf dividers.
- Models 84" w- 102" w have two fixed shelf dividers.
- Models 60" w - 78" w have one fixed shelf divider.
- Clearance from worksurface to valance is 25.5".
- **Locks are not available on hutches with Glass Doors.**

**Required Specifications**

Veneer finish\*  
Laminate finish (body)\*\*  
Handle Style

**Optional Specifications**

Lock\*  
Veneer top\*

**Accessories**

Tackboard  
Tasklight

**CLOSED HUTCHES**

sizes 96"-84"w

sizes 78"-60"w

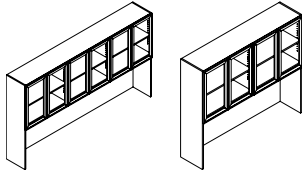

**Closed Hutch w/Glass Doors 54"H**

MODEL#	DIMENSIONS	FREIGHT CLASS	WT./LBS.	CUBIC FT.	veneer/LAMINATE	ALL VENEER
<b>D x W x H</b>						
D962SH54G	15 x 96 x 54	125	351	45	<b>\$8295</b>	<b>\$9953</b>
D902SH54G	15 x 90 x 54	125	329	42	<b>\$7697</b>	<b>\$9238</b>
D842SH54G	15 x 84 x 54	125	307	39	<b>\$7151</b>	<b>\$8582</b>
D782SH54G	15 x 78 x 54	125	285	37	<b>\$6575</b>	<b>\$7891</b>
D722SH54G	15 x 72 x 54	125	263	34	<b>\$6007</b>	<b>\$7207</b>
D662SH54G	15 x 66 x 54	125	241	31	<b>\$5797</b>	<b>\$6957</b>
D602SH54G	15 x 60 x 54	125	219	28	<b>\$5541</b>	<b>\$6649</b>

One fixed shelf and one adjustable shelf (per compartment). Closed back features one grommet. Aluminum frame available in Tungsten finish only. Shipped assembled in 1 carton. Translucent, screened glass.

- Clearance from worksurface to valance is 25.5".
- Locks are not available on hutches with Glass Doors.

sizes 120"-108"w

sizes 102"-84"w

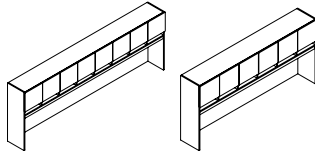

sizes 78"-60"w

sizes 30"-36"w

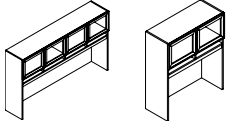

**Closed Hutch w/Glass Doors Pigeon-Hole Storage, 42"H**

D120SHP42G	15 x 120 x 42	125	341	44	<b>\$9371</b>	<b>\$11247</b>
D114SHP42G	15 x 114 x 42	125	324	42	<b>\$8967</b>	<b>\$10758</b>
D108SHP42G	15 x 108 x 42	125	307	39	<b>\$8593</b>	<b>\$10313</b>
D102SHP42G	15 x 102 x 42	125	290	37	<b>\$7798</b>	<b>\$9359</b>
D96SHP42G	15 x 96 x 42	125	273	35	<b>\$7436</b>	<b>\$8924</b>
D90SHP42G	15 x 90 x 42	125	256	33	<b>\$7413</b>	<b>\$8896</b>
D84SHP42G	15 x 84 x 42	125	239	31	<b>\$6642</b>	<b>\$7967</b>
D78SHP42G	15 x 78 x 42	150	222	38	<b>\$6262</b>	<b>\$7513</b>
D72SHP42G	15 x 72 x 42	125	205	26	<b>\$5462</b>	<b>\$6552</b>
D66SHP42G	15 x 66 x 42	125	188	24	<b>\$5286</b>	<b>\$6344</b>
D60SHP42G	15 x 60 x 42	125	171	22	<b>\$5030</b>	<b>\$6037</b>
D36SHP42G	15 x 36 x 42	125	102	13	<b>\$3268</b>	<b>\$3922</b>
D30SHP42G	15 x 30 x 42	125	85	11	<b>\$2918</b>	<b>\$3502</b>

One fixed shelf. Closed back features one grommet. Aluminum frame available in Tungsten finish only. Horizontal pigeon-hole storage top mounted to hutch. Shipped assembled in 1 carton. Translucent, screened glass.

- Models 120"w- 108"w have three fixed shelf dividers.
- Models 84"w- 102"w have two fixed shelf dividers.
- Models 60"w - 78"w have one fixed shelf divider.
- Clearance from worksurface to valance is 21.5".
- Locks are not available on hutches with Glass Doors.

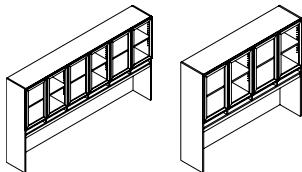

**Closed Hutch w/Glass Doors Pigeon-Hole Storage, 54"H**

D962SHP54G	15 x 96 x 54	125	351	45	<b>\$9532</b>	<b>\$11441</b>
D902SHP54G	15 x 90 x 54	125	329	42	<b>\$8885</b>	<b>\$10661</b>
D842SHP54G	15 x 84 x 54	125	307	39	<b>\$8235</b>	<b>\$9884</b>
D782SHP54G	15 x 78 x 54	125	285	37	<b>\$7589</b>	<b>\$9105</b>
D722SHP54G	15 x 72 x 54	125	263	34	<b>\$6940</b>	<b>\$8328</b>
D662SHP54G	15 x 66 x 54	125	241	31	<b>\$6692</b>	<b>\$8028</b>
D602SHP54G	15 x 60 x 54	125	219	28	<b>\$6393</b>	<b>\$7673</b>

One fixed shelf and one adjustable shelf (per compartment). Closed back features one grommet. Aluminum frame available in Tungsten finish only. Horizontal pigeon-hole storage top mounted to hutch. Shipped assembled in 1 carton. Translucent, screened glass.

- Clearance from worksurface to valance is 21.5".
- Locks are not available on hutches with Glass Doors.

**Required Specifications**  
Laminate Finish (body)

**Accessories**  
Tackboard  
Task Light

**CLOSED HUTCHES**

MODEL#	DIMENSIONS	FREIGHT CLASS	WT/LBS.	CUBIC FT.	GR. 1-3	GR. 4-5
--------	------------	---------------	---------	-----------	---------	---------

D x W x H

**TACKBOARD** Notes: Tackboards can be upholstered in all of the following fabrics:

**Grade 1:** Jenny, Quilt, Terrace, Urban, Waterfall

**Grade 2:** Imprint, Lola

**Grade 3:** Anchorage, Merge

**WALL MOUNTED TACKBOARDS FOR OVERHEAD STORAGE**

GR. 1-3	GR. 4-5
---------	---------

TS120	1 x 120 x 20	70	26	2	\$1621	\$2026
TS114	1 x 114 x 20	70	25	2	\$1544	\$1932
TS108	1 x 108 x 20	70	23	2	\$1460	\$1825
TS102	1 x 102 x 20	85	19	2	\$1383	\$1729
TS96	1 x 96 x 20	70	17	1	\$1293	\$1619
TS90	1 x 90 x 20	70	15	1	\$1216	\$1521
TS84	1 x 84 x 20	70	14	1	\$1139	\$1422
TS78	1 x 78 x 20	70	13	1	\$1055	\$1319
TS72	1 x 72 x 20	70	12	1	\$594	\$744
TS66	1 x 66 x 20	85	11	1	\$546	\$686
TS60	1 x 60 x 20	85	10	1	\$502	\$631
TS54	1 x 54 x 20	85	10	1	\$455	\$572
TS48	1 x 48 x 20	85	10	1	\$407	\$511
TS42	1 x 42 x 20	85	10	1	\$360	\$453
TS36	1 x 36 x 20	100	8	1	\$322	\$408
TS30	1 x 30 x 20	150	5	1	\$268	\$337

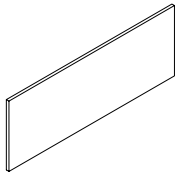

Tackboard

For use on **16.5" H** overhead storage (**DCSFO\_**, **DSF\_**, **DSFF\_**) at a finished height of **66"**. See Tackboard Notes above for exact fabric availability. List Price shown applies for all fabric grades.

- **NOTE:** Care should be taken to mount the units. Units should be mounted to wall studs using correct fasteners. Failure to do so may result in collapse of the unit and subsequent personal injury. **Mounting hardware not included.** Mounting hardware used should be based on wall material. Consult an installation professional for proper wall mounting.

TS120H26	1 x 120 x 26	70	34	2	\$2108	\$2635
TS114H26	1 x 114 x 26	70	32	2	\$2003	\$2504
TS108H26	1 x 108 x 26	70	30	2	\$1898	\$2374
TS102H26	1 x 102 x 26	85	24	2	\$1788	\$2235
TS96H26	1 x 96 x 26	92.5	22	2	\$1691	\$2116
TS90H26	1 x 90 x 26	92.5	20	2	\$1585	\$1980
TS84H26	1 x 84 x 26	100	18	2	\$1473	\$1842
TS78H26	1 x 78 x 26	100	17	2	\$1370	\$1714
TS72H26	1 x 72 x 26	70	16	1	\$761	\$956
TS66H26	1 x 66 x 26	85	14	1	\$701	\$879
TS60H26	1 x 60 x 26	85	13	1	\$641	\$805
TS54H26	1 x 54 x 26	85	13	1	\$588	\$737
TS48H26	1 x 48 x 26	85	13	1	\$520	\$653
TS42H26	1 x 42 x 26	85	13	1	\$462	\$573
TS36H26	1 x 36 x 26	100	8	1	\$403	\$506
TS30H26	1 x 30 x 26	150	5	1	\$338	\$428

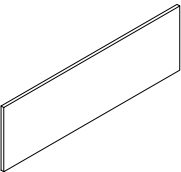

Tackboard

For use on **16.5" H** overhead storage (**DCSFO\_**, **DSF\_**, **DSFF\_**) at a finished height of **72"**. See Tackboard Notes above for exact fabric availability. List Price shown applies for all fabric grades.

- **NOTE:** Care should be taken to mount the units. Units should be mounted to wall studs using correct fasteners. Failure to do so may result in collapse of the unit and subsequent personal injury. **Mounting hardware not included.** Mounting hardware used should be based on wall material. Consult an installation professional for proper wall mounting.

**Required Specifications**

Fabric

TACKBOARDS FOR OVERHEAD STORAGE & HUTCHES MODEL# DIMENSIONS FREIGHT CLASS WT/LBS. CUBIC FT. GR. 1-3 GR. 4-5

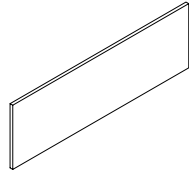

Tackboard

	D x W x H						
TSP120H23	1 x 120 x 23	70	34	2	\$1830	\$2288	
TSP114H23	1 x 114 x 23	70	32	2	\$1739	\$2172	
TSP108H23	1 x 108 x 23	70	30	2	\$1704	\$2045	
TSP102H23	1 x 102 x 23	85	24	2	\$1625	\$1951	
TSP96H23	1 x 96 x 23	92.5	20	2	\$1467	\$1832	
TSP90H23	1 x 90 x 23	92.5	20	1	\$1370	\$1714	
TSP84H23	1 x 84 x 23	70	18	1	\$1280	\$1599	
TSP78H23	1 x 78 x 23	70	17	1	\$1047	\$1273	
TSP72H23	1 x 72 x 23	70	16	1	\$973	\$1222	
TSP66H23	1 x 66 x 23	85	14	1	\$884	\$1109	
TSP60H23	1 x 60 x 23	85	13	1	\$641	\$805	
TSP54H23	1 x 54 x 23	85	13	1	\$812	\$1018	
TSP48H23	1 x 48 x 23	85	13	1	\$642	\$653	
TSP42H23	1 x 42 x 23	85	13	1	\$565	\$573	
TSP36H23	1 x 36 x 23	100	8	1	\$488	\$505	
TSP30H23	1 x 30 x 23	150	5	1	\$404	\$430	

For use on 19.5"H overhead storage (DCSFOP\_, DSFP\_, DSFFP\_) with Pigeon-Hole Storage at a finished height of 72". See Tackboard Notes above for exact fabric availability. List Price shown applies for all fabric grades.

- **NOTE:** Care should be taken to mount the units. Units should be mounted to wall studs using correct fasteners. Failure to do so may result in collapse of the unit and subsequent personal injury. **Mounting hardware not included.** Mounting hardware used should be based on wall material. Consult an installation professional for proper wall mounting.

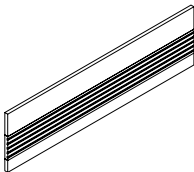

Tackboard - Accessory Rail

TSA120	1 x 120 x 20	85	26	2	\$2854	\$3567
TSA114	1 x 114 x 20	85	25	2	\$2715	\$3395
TSA108	1 x 108 x 20	92.5	23	2	\$2569	\$3210
TSA102	1 x 102 x 20	100	19	2	\$2436	\$3045
TSA96	1 x 96 x 20	70	15	1	\$2283	\$2854
TSA90	1 x 90 x 20	70	15	1	\$2142	\$2678
TSA84	1 x 84 x 20	85	14	1	\$1996	\$2498
TSA78	1 x 78 x 20	85	13	1	\$1857	\$2322
TSA72	1 x 72 x 20	85	12	1	\$1711	\$2139
TSA66	1 x 66 x 20	92.5	11	1	\$1570	\$1964
TSA60	1 x 60 x 20	92.5	10	1	\$1425	\$1783
TSA54	1 x 54 x 20	92.5	10	1	\$1286	\$1610
TSA48	1 x 48 x 20	92.5	10	1	\$1146	\$1434
TSA42	1 x 42 x 20	92.5	10	1	\$999	\$1250
TSA36	1 x 36 x 20	125	6	1	\$854	\$1070
TSA30	1 x 30 x 20	150	4	1	\$665	\$831

For use on 16.5"H overhead storage (DCSFO\_, DSF\_, DSFF\_) at a finished height of 66". See Tackboard Notes above for exact fabric availability. List Price shown applies for all fabric grades.

- **Must Specify Black (E) or Tungsten (K) Accessory Rail finish.**
- **NOTE:** Care should be taken to mount the units. Units should be mounted to wall studs using correct fasteners. Failure to do so may result in collapse of the unit and subsequent personal injury. **Mounting hardware not included.** Mounting hardware used should be based on wall material. Consult an installation professional for proper wall mounting.

**Required Specifications**

- Fabric
- Accessory Rail Finish

**WALL MOUNTED TACKBOARDS FOR OVERHEAD STORAGE MODEL# DIMENSIONS FREIGHT CLASS WT/LBS. CUBIC FT. GR. 1-3 GR. 4-5**

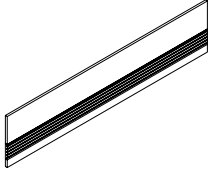

**Tackboard - Accessory Rail**

	D x W x H						
TSA120H26	1 x 120 x 26	85	26	2	\$3427	\$4283	
TSA114H26	1 x 114 x 26	85	25	2	\$3252	\$4065	
TSA108H26	1 x 108 x 26	92.5	23	2	\$3092	\$3864	
TSA102H26	1 x 102 x 26	100	19	2	\$2916	\$3647	
TSA96H26	1 x 96 x 26	70	15	1	\$2582	\$3229	
TSA90H26	1 x 90 x 26	70	15	1	\$2576	\$3221	
TSA84H26	1 x 84 x 26	85	14	1	\$2373	\$2967	
TSA78H26	1 x 78 x 26	85	13	1	\$2226	\$2785	
TSA72H26	1 x 72 x 26	85	12	1	\$2025	\$2533	
TSA66H26	1 x 66 x 26	92.5	11	1	\$1893	\$2365	
TSA60H26	1 x 60 x 26	92.5	10	1	\$1711	\$2139	
TSA54H26	1 x 54 x 26	92.5	10	1	\$1544	\$1932	
TSA48H26	1 x 48 x 26	92.5	10	1	\$1376	\$1720	
TSA42H26	1 x 42 x 26	92.5	10	1	\$1210	\$1511	
TSA36H26	1 x 36 x 26	125	6	1	\$1028	\$1286	
TSA30H26	1 x 30 x 26	150	4	1	\$860	\$1076	

For use on **16.5" H** overhead storage (**DCSF0\_**, **DSF\_**, **DSFF\_**) at a finished height of **72"**. See *Tackboard Notes* above for exact fabric availability. List Price shown applies for all fabric grades.

- **Must Specify Black (E) or Tungsten (K) Accessory Rail finish.**
- **NOTE:** Care should be taken to mount the units. Units should be mounted to wall studs using correct fasteners. Failure to do so may result in collapse of the unit and subsequent personal injury. **Mounting hardware not included.** Mounting hardware used should be based on wall material. Consult an installation professional for proper wall mounting.

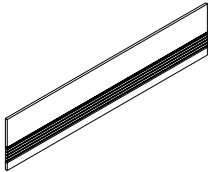

**Tackboard - Accessory Rail**

TSPA120H23	1 x 120 x 23	70	34	2	\$3120	\$3899
TSPA114H23	1 x 114 x 23	70	32	2	\$2952	\$3694
TSPA108H23	1 x 108 x 23	70	30	2	\$2784	\$3482
TSPA102H23	1 x 102 x 23	85	24	2	\$2652	\$3315
TSPA96H23	1 x 96 x 23	92.5	20	2	\$2484	\$3108
TSPA90H23	1 x 90 x 23	70	20	2	\$2332	\$2915
TSPA84H23	1 x 84 x 23	100	18	2	\$2171	\$2714
TSPA78H23	1 x 78 x 23	100	17	2	\$2019	\$2525
TSPA72H23	1 x 72 x 23	70	16	1	\$1863	\$2331
TSPA66H23	1 x 66 x 23	85	14	1	\$1711	\$2139
TSPA60H23	1 x 60 x 23	85	13	1	\$1551	\$1940
TSPA54H23	1 x 54 x 23	85	13	1	\$1370	\$1714
TSPA48H23	1 x 48 x 23	85	13	1	\$1242	\$1555
TSPA42H23	1 x 42 x 23	85	13	1	\$1090	\$1364
TSPA36H23	1 x 36 x 23	100	6	1	\$937	\$1170
TSPA30H23	1 x 30 x 23	150	4	1	\$777	\$973

For use on **19.5" H** overhead storage (**DCSF0P\_**, **DSFP\_**, **DSFFP\_**) with Pigeon-Hole Storage at a finished height of **72"**. See *Tackboard Notes* above for exact fabric availability. List Price shown applies for all fabric grades.

- **Must Specify Black (E) or Tungsten (K) Accessory Rail finish.**
- **NOTE:** Care should be taken to mount the units. Units should be mounted to wall studs using correct fasteners. Failure to do so may result in collapse of the unit and subsequent personal injury. **Mounting hardware not included.** Mounting hardware used should be based on wall material. Consult an installation professional for proper wall mounting.

**Required Specifications**

- Fabric
- Accessory Rail Finish

**WALL MOUNTED TACKBOARDS FOR OVERHEAD STORAGE**    **MODEL#**    **DIMENSIONS**    **FREIGHT CLASS**    **WT/LBS.**    **CUBIC FT.**    **GR. 1-3**    **GR. 4-5**

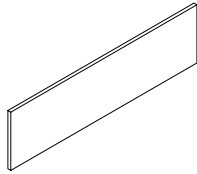

**Tackboard**

	<b>D x W x H</b>						
DTS120	1 x 118 x 20	70	26	2	\$963	\$1207	
DTS114	1 x 112 x 20	70	25	2	\$914	\$1145	
DTS108	1 x 106 x 20	70	23	2	\$870	\$1091	
DTS102	1 x 100 x 20	85	19	2	\$824	\$1032	
DTS96	1 x 94 x 20	70	15	1	\$776	\$973	
DTS90	1 x 88 x 20	70	15	1	\$734	\$924	
DTS84	1 x 82 x 20	70	14	1	\$690	\$864	
DTS78	1 x 76 x 20	70	13	1	\$641	\$805	
DTS72	1 x 70 x 20	70	12	1	\$594	\$744	
DTS66	1 x 64 x 20	85	11	1	\$546	\$686	
DTS60	1 x 58 x 20	85	10	1	\$502	\$631	
DTS36	1 x 34 x 20	100	6	1	\$322	\$408	
DTS30	1 x 28 x 20	150	4	1	\$268	\$337	

For use on **36" H** hutches (**D\_SH36, D\_SH36G, D\_SH36DGD, D\_SH36GDG**). **Factory installed**, with velcro tape. Please specify hutch to be installed on. *See Tackboard Notes above for exact fabric availability.* List Price shown applies for all fabric grades.

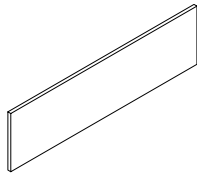

**Tackboard**

DTS120H26	1 x 118 x 26	70	34	2	\$1245	\$1559
DTS114H26	1 x 112 x 26	70	32	2	\$1184	\$1483
DTS108H26	1 x 106 x 26	70	30	2	\$1122	\$1405
DTS102H26	1 x 100 x 26	85	24	2	\$1063	\$1335
DTS96H26	1 x 94 x 26	92.5	20	2	\$1005	\$1259
DTS90H26	1 x 88 x 26	92.5	20	2	\$941	\$1181
DTS84H26	1 x 82 x 26	100	18	2	\$882	\$1107
DTS78H26	1 x 76 x 26	100	17	2	\$824	\$1032
DTS72H26	1 x 70 x 26	70	16	1	\$761	\$956
DTS66H26	1 x 64 x 26	85	14	1	\$701	\$879
DTS60H26	1 x 58 x 26	85	13	1	\$641	\$805
DTS36H26	1 x 34 x 26	100	8	1	\$403	\$506
DTS30H26	1 x 28 x 26	150	5	1	\$338	\$428

For use on **42" H and 54" H** hutches (**D\_SH42/54, D\_SH42/54G, D\_SH42/54DGD, D\_SH42/54GDG**). **Factory installed**, with velcro tape. Please specify hutch to be installed on. *See Tackboard Notes above for exact fabric availability.* List Price shown applies for all fabric grades.

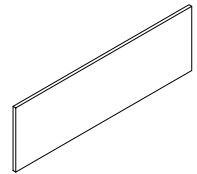

**Tackboard**

DTSP120H23	1 x 118 x 23	70	34	2	\$1245	\$1559
DTSP114H23	1 x 112 x 23	70	32	2	\$1184	\$1483
DTSP108H23	1 x 106 x 23	70	30	2	\$1122	\$1405
DTSP102H23	1 x 100 x 23	85	24	2	\$1063	\$1335
DTSP96H23	1 x 94 x 23	92.5	20	2	\$1005	\$1259
DTSP90H23	1 x 88 x 23	92.5	20	1	\$941	\$1181
DTSP84H23	1 x 82 x 23	70	18	1	\$882	\$1107
DTSP78H23	1 x 76 x 23	70	17	1	\$824	\$1032
DTSP72H23	1 x 70 x 23	70	16	1	\$761	\$956
DTSP66H23	1 x 64 x 23	85	14	1	\$701	\$879
DTSP60H23	1 x 58 x 23	85	13	1	\$641	\$805
DTSP54H23	1 x 52 x 23	85	13	1	\$588	\$737
DTSP48H23	1 x 46 x 23	85	13	1	\$520	\$653
DTSP42H23	1 x 40 x 23	85	13	1	\$462	\$581
DTSP36H23	1 x 34 x 23	100	8	1	\$403	\$506
DTSP30H23	1 x 28 x 23	150	5	1	\$338	\$428

For use on **42" H and 54" H** hutches (**D\_SHP42/54, D\_SHP42/54G, D\_SHP42/54DGD, D\_SHP42/54GDG**) with Pigeon-Hole Storage. **Factory installed**, with velcro tape. Please specify hutch to be installed on. *See Tackboard Notes above for exact fabric availability.* List Price shown applies for all fabric grades.

**Required Specifications**

Fabric

TACKBOARDS FOR HUTCHES

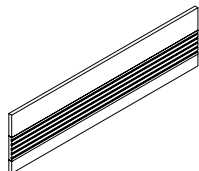

Tackboard - Accessory Rail

MODEL#	DIMENSIONS	FREIGHT CLASS	WT/LBS.	CUBIC FT.	GR. 1-3	GR. 4-5
D x W x H						
DTSA120	1 x 118 x 20	85	26	2	\$1678	\$2103
DTSA114	1 x 112 x 20	85	25	2	\$1599	\$2004
DTSA108	1 x 106 x 20	92.5	23	2	\$1511	\$1892
DTSA102	1 x 100 x 20	100	19	2	\$1432	\$1793
DTSA96	1 x 94 x 20	70	15	1	\$1346	\$1684
DTSA90	1 x 88 x 20	70	15	1	\$1271	\$1594
DTSA84	1 x 82 x 20	85	14	1	\$1184	\$1483
DTSA78	1 x 76 x 20	85	13	1	\$1105	\$1384
DTSA72	1 x 70 x 20	85	12	1	\$1023	\$1281
DTSA66	1 x 64 x 20	92.5	11	1	\$936	\$1173
DTSA60	1 x 58 x 20	92.5	10	1	\$856	\$1074
DTSA54	1 x 52 x 20	92.5	10	1	\$776	\$973
DTSA48	1 x 46 x 20	92.5	10	1	\$695	\$871
DTSA42	1 x 40 x 20	92.5	10	1	\$615	\$773
DTSA36	1 x 34 x 20	125	6	1	\$528	\$664
DTSA30	1 x 28 x 20	150	4	1	\$445	\$561

For use on 36" H hutches (D\_SH36, D\_SH36G, D\_SH36DGD, D\_SH36GDG). Factory installed, with velcro tape. Please specify hutch to be installed on. See Tackboard Notes above for exact fabric availability. List Price shown applies for all fabric grades.

- Must Specify Black (E) or Tungsten (K) Accessory Rail finish.

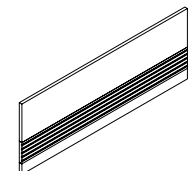

Tackboard - Accessory Rail

DTSA120H26	1 x 118 x 26	85	26	2	\$2007	\$2513
DTSA114H26	1 x 112 x 26	85	25	2	\$1908	\$2390
DTSA108H26	1 x 106 x 26	92.5	23	2	\$1813	\$2272
DTSA102H26	1 x 100 x 26	100	19	2	\$1714	\$2145
DTSA96H26	1 x 94 x 26	70	15	1	\$1612	\$2019
DTSA90H26	1 x 88 x 26	70	15	1	\$1518	\$1900
DTSA78H26	1 x 76 x 26	85	13	1	\$1319	\$1652
DTSA72H26	1 x 70 x 26	85	12	1	\$1198	\$1501
DTSA66H26	1 x 64 x 26	92.5	11	1	\$1122	\$1405
DTSA60H26	1 x 58 x 26	92.5	10	1	\$1023	\$1281
DTSA54H26	1 x 52 x 26	92.5	10	1	\$924	\$1157
DTSA48H26	1 x 46 x 26	92.5	10	1	\$828	\$1039
DTSA42H26	1 x 40 x 26	92.5	10	1	\$729	\$913
DTSA36H26	1 x 34 x 26	125	6	1	\$627	\$785
DTSA30H26	1 x 28 x 26	150	4	1	\$534	\$671

For use on 42" H and 54" H hutches (D\_SH42/54, D\_SH42/54G, D\_SH42/54DGD, D\_SH42/54GDG). Factory installed, with velcro tape. Please specify hutch to be installed on. See Tackboard Notes above for exact fabric availability. List Price shown applies for all fabric grades.

- Must Specify Black (E) or Tungsten (K) Accessory Rail finish.

**Required Specifications**

Fabric  
Accessory Rail finish

**TACKBOARDS FOR HUTCHES**

MODEL#	DIMENSIONS	FREIGHT CLASS	WT/LBS.	CUBIC FT.	GR. 1-3	GR. 4-5
	<b>D x W x H</b>					
DTSPA120H23	1 x 118 x 23	70	34	2	<b>\$2088</b>	<b>\$2612</b>
DTSPA114H23	1 x 112 x 23	70	32	2	<b>\$1988</b>	<b>\$2489</b>
DTSPA108H23	1 x 106 x 23	70	30	2	<b>\$1879</b>	<b>\$2351</b>
DTSPA102H23	1 x 100 x 23	85	24	2	<b>\$1795</b>	<b>\$2249</b>
DTSPA96H23	1 x 94 x 23	92.5	20	2	<b>\$1678</b>	<b>\$2103</b>
DTSPA90H23	1 x 88 x 23	92.5	20	2	<b>\$1580</b>	<b>\$1981</b>
DTSPA84H23	1 x 82 x 23	100	18	2	<b>\$1472</b>	<b>\$1845</b>
DTSPA78H23	1 x 76 x 23	100	17	2	<b>\$1373</b>	<b>\$1720</b>
DTSPA72H23	1 x 70 x 23	70	16	1	<b>\$1271</b>	<b>\$1594</b>
DTSPA66H23	1 x 64 x 23	85	14	1	<b>\$1166</b>	<b>\$1462</b>
DTSPA60H23	1 x 58 x 23	85	13	1	<b>\$1063</b>	<b>\$1335</b>
DTSPA54H23	1 x 52 x 23	85	13	1	<b>\$963</b>	<b>\$1207</b>
DTSPA48H23	1 x 46 x 23	85	13	1	<b>\$856</b>	<b>\$1074</b>
DTSPA42H23	1 x 40 x 23	85	13	1	<b>\$756</b>	<b>\$948</b>
DTSPA36H23	1 x 34 x 23	100	8	1	<b>\$653</b>	<b>\$823</b>
DTSPA30H23	1 x 28 x 23	150	5	1	<b>\$555</b>	<b>\$698</b>

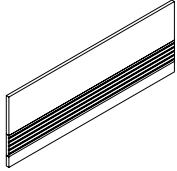

**Tackboard - Accessory Rail\***

For use on **42"H** and **54"H** hutches (**D\_SHP42/54, D\_SHP42/54G, D\_SHP42/54DGD, D\_SHP42/54GDG**) with Pigeon-Hole Storage. **Factory installed**, with velcro tape. Please specify hutch to be installed on. See *Tackboard Notes above* for exact fabric availability. List Price shown applies for all fabric grades.

- **Must Specify Black (E) or Tungsten (K) Accessory Rail finish.**

**HUTCH ACCESSORIES**

MODEL#	DIMENSIONS	FREIGHT CLASS	WT/LBS.	CUBIC FT.	veneer/LAMINATE	ALL VENEER
DCPH131226	12 x 13 x 26	100	16	2	<b>\$613</b>	<b>\$733</b>
DCPH131223	12 x 13 x 23	125	15	2	<b>\$520</b>	<b>\$625</b>
DCPH131219	12 x 13 x 19	125	12	2	<b>\$392</b>	<b>\$472</b>

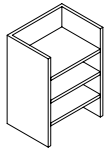

**Vertical Pigeon-Hole Storage, Letter\*\***

Used in conjunction with overhead storage units and hutches that incorporate horizontal pigeon-hole storage. Not freestanding. Shipped RTA (ready to assemble).

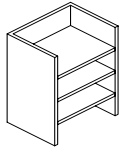

**Vertical Pigeon-Hole Storage, Legal\*\***

DCPH161226	12 x 16 x 26	125	20	3	<b>\$753</b>	<b>\$906</b>
DCPH161223	12 x 16 x 23	125	18	3	<b>\$638</b>	<b>\$766</b>
DCPH161219	12 x 16 x 19	125	15	2	<b>\$485</b>	<b>\$579</b>

Used in conjunction with overhead storage units and hutches that incorporate horizontal pigeon-hole storage. Not freestanding. Shipped RTA (ready to assemble).



**Required Specifications**

- Fabric\*
- Accessory Rail finish\*
- Veneer finish\*\*
- Laminate finish\*\*

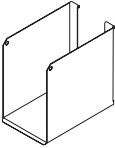
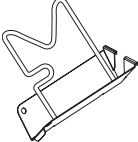
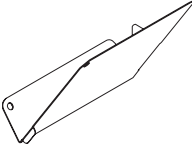
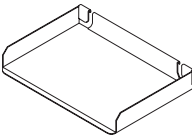
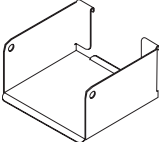
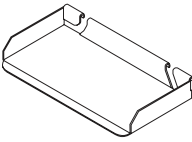
ACCESSORY RAIL/PANEL ORGANIZERS	MODEL#	DIMENSIONS		FREIGHT CLASS	WT/LBS.	CUBIC FT.	LIST PRICE
<b>Available Finishes:</b>		<b>D x W x H</b>					
	BLK	Black	SIL	Silver			
	CHR	Charcoal	TPE	Taupe			
	DWT	Designer White	TUN	Tungsten			
	NEV	Nevada					

	MODEL#	DIMENSIONS	FREIGHT CLASS	WT/LBS.	CUBIC FT.	LIST PRICE
 <p><b>Binder Bin</b></p>	BABB01	10.25 x 4 x 9	100	2	.21	<b>\$75</b>
Load bar/accessory rail mounted metal binder bin.						
 <p><b>Flip Sorter</b></p>	BAFS01	9.25 x 2.75 x 9.25	70	.06	.14	<b>\$58</b>
Load bar/accessory rail mounted metal flip sorter. Comes with chrome wire.						
 <p><b>Slant Sorter</b></p>	BASS01L (Left)	10.25 x 5 x 9.5	70	1	.28	<b>\$47</b>
	BASS01R (Right)	10.25 x 5 x 9.5	70	1	.28	<b>\$47</b>
Load bar/accessory rail mounted metal slant sorter.						
 <p><b>Letter Tray</b></p>	BALTO1	9.25 x 13.5 x 2	70	.50	.15	<b>\$62</b>
Load bar/accessory rail mounted metal letter tray.						
 <p><b>Media Bin</b></p>	BAMB01	5.25 x 5.75 x 3	70	.08	.05	<b>\$62</b>
Load bar/accessory rail mounted metal media bin.						
 <p><b>Utility Tray</b></p>	BAUT01	3.75 x 5.75 x 3	70	.05	.02	<b>\$41</b>
Load bar/accessory rail mounted metal utility tray.						

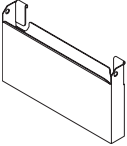
**Required Specifications**  
Metal finish

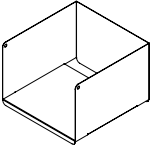
ACCESSORY RAIL/PANEL ORGANIZERS	MODEL#	DIMENSIONS	FREIGHT CLASS	WT./LBS.	CUBIC FT.	LIST PRICE	
 <b>Mail Box*</b>	BAPP01	<b>D x W x H</b> 2.75 x 16 x 9	100	2	.25	<b>\$94</b>	
	Load bar/accessory rail mounted metal mail box.						
	 <b>Telephone Holder*</b>	BATH01	10 x 9 x 2	125	2	.26	<b>\$91</b>
Load bar/accessory rail mounted metal telephone holder.							
 <b>Elevated Shelf Binder Bin*</b>	BRTESBBIN	12 x 12 x 8	100	6	.66	<b>\$193</b>	
	Load bar/accessory rail mounted elevated shelf binder bin.						

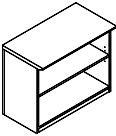
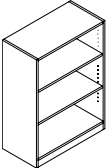
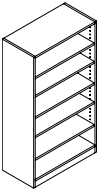
BOOKCASES	MODEL#	DIMENSIONS	FREIGHT CLASS	WT./LBS.	CUBIC FT.	VENEER/LAMINATE	ALL VENEER
 <b>Bookcase - 29" High**</b>	DB23615	15 x 36 x 29	92.5	90	9	<b>\$1350</b>	<b>\$1617</b>
	DB23015	15 x 30 x 29	92.5	90	8	<b>\$1179</b>	<b>\$1416</b>
Includes <b>one adjustable</b> veneer shelf. Shelf is 3/4" thick. Shipped assembled in 1 carton.							
 <b>Bookcase - 48" High**</b>	DB43615	15 x 36 x 48	100	140	15	<b>\$1684</b>	<b>\$2019</b>
	DB43015	15 x 30 x 48	92.5	140	13	<b>\$1474</b>	<b>\$1768</b>
Includes <b>two adjustable</b> veneer shelves. Shelf is 3/4" thick. Shipped assembled in 1 carton.							
 <b>Bookcase - 66" High**</b>	DB53615	15 x 36 x 66	100	188	21	<b>\$2042</b>	<b>\$2451</b>
	DB53015	15 x 30 x 66	92.5	188	17	<b>\$1788</b>	<b>\$2143</b>
Includes <b>five adjustable</b> veneer shelves. Shelf is 3/4" thick. Shipped assembled in 1 carton.							

**Required Specifications**

- Metal finish\*
- Veneer finish (shelves)\*\*
- Laminate finish (top/body)\*\*

BOOKCASES

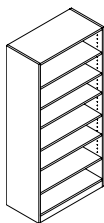

Bookcase - 72" High

MODEL#	DIMENSIONS D x W x H	FREIGHT CLASS	WT/LBS.	CUBIC FT.	VENEER/LAMINATE	ALL VENEER
DB63615	15 x 36 x 72	100	210	23	\$2214	\$2658
DB63015	15 x 30 x 72	92.5	210	19	\$1939	\$2326

Includes **six adjustable** veneer shelves. Shelf is 3/4" thick. Shipped assembled in 1 carton.

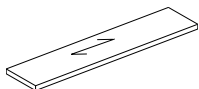

Tops 15" Deep

DT3617D	17 x 36 x 1	65	27	1	N/A	\$663
DT3017D	17 x 30 x 1	65	23	1	N/A	\$551

For use with 15" deep bookcases. Tops are 1" thick. Shipped assembled in 1 carton.

END SHELVES

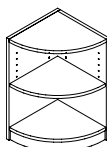

End Shelf - 29" High

MODEL#	DIMENSIONS	FREIGHT CLASS	WT/LBS.	CUBIC FT.	VENEER/LAMINATE	ALL VENEER
DB2R1515	15 x 15 x 29	100	37	4	\$1063	\$1275

For use at end of **worksurfaces or storage modules**. Includes one adjustable veneer shelf. Shipped assembled in 1 carton..

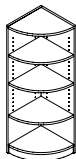

End Shelf - 48" High

DB4R1515	15 x 15 x 48	100	59	6	\$1323	\$1589
----------	--------------	-----	----	---	--------	--------

For use at end of **storage modules or wardrobe cabinets**. Includes **three adjustable** veneer shelves. Shipped assembled in 1 carton.

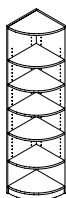

End Shelf - 66" High

DB5R1515	15 x 15 x 66	100	81	9	\$1610	\$1930
----------	--------------	-----	----	---	--------	--------

For use at end of **storage modules, wardrobe cabinets or personal towers**. Includes **five adjustable** veneer shelves. Shipped assembled in 1 carton.

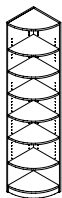

End Shelf - 72" High

DB6R1515	15 x 15 x 72	100	83	9	\$1748	\$2096
----------	--------------	-----	----	---	--------	--------

For use at end of **storage modules, wardrobe cabinets or personal towers**. Includes **six adjustable** veneer shelves. Shipped assembled in 1 carton.

Required Specifications

- Veneer finish (shelves)
- Laminate finish (top/body)

**END SHELVES**      **MODEL#**      **DIMENSIONS**      **FREIGHT CLASS**      **WT/LBS.**      **CUBIC FT.**       **veneer/LAMINATE**      **ALL VENEER**

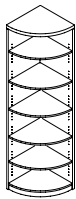

**End Shelf - 66" High**

	<b>D x W x H</b>						
DB7R2424	24 x 24 x 66	100	187	22	<b>\$2934</b>	<b>\$3522</b>	
DB7R2222	22 x 22 x 66	100	157	18	<b>\$2554</b>	<b>\$3066</b>	
DB7R2020	20 x 20 x 66	100	130	15	<b>\$2436</b>	<b>\$2925</b>	

For use at end of **storage modules, wardrobe cabinets or personal towers**. Includes **five adjustable** veneer shelves. Shipped assembled in 1 carton.

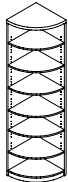

**End Shelf - 72" High**

DB7R2424H72	24 x 24 x 72	125	204	28	<b>\$3203</b>	<b>\$3843</b>	
DB7R2222H72	22 x 22 x 72	100	171	20	<b>\$2791</b>	<b>\$3346</b>	
DB7R2020H72	20 x 20 x 72	100	142	17	<b>\$2658</b>	<b>\$3190</b>	

For use at end of **storage modules, wardrobe cabinets or personal towers**. Includes **six adjustable** veneer shelves. Shipped assembled in 1 carton.

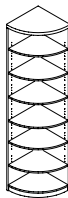

**End Shelf - 84" High**

DB7R2424H84	24 x 24 x 84	100	234	28	<b>\$3735</b>	<b>\$4481</b>	
DB7R2222H84	22 x 22 x 84	100	189	20	<b>\$3423</b>	<b>\$4106</b>	
DB7R2020H84	20 x 20 x 84	100	163	19	<b>\$3262</b>	<b>\$3915</b>	

For use at end of **storage modules, wardrobe cabinets or personal towers**. Includes **seven adjustable** veneer shelves. Shipped assembled in 1 carton.

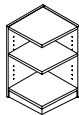

**End Shelf - 29" High - Square**

DB2S1515	15 x 15 x 29	100	37	4	<b>\$1119</b>	<b>\$1345</b>	
----------	--------------	-----	----	---	---------------	---------------	--

For use at end of **worksurfaces or storage modules**. Includes **one adjustable** veneer shelf. Shipped assembled in 1 carton.

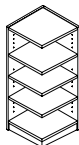

**End Shelf - 48" High - Square**

DB4S1515	15 x 15 x 48	100	59	6	<b>\$1399</b>	<b>\$1674</b>	
----------	--------------	-----	----	---	---------------	---------------	--

For use at end of **storage modules or wardrobe cabinets**. Includes **three adjustable** veneer shelves. Shipped assembled in 1 carton.

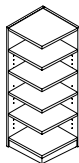

**End Shelf - 66" High - Square**

DB5S1515	15 x 15 x 66	100	81	9	<b>\$1695</b>	<b>\$2035</b>	
----------	--------------	-----	----	---	---------------	---------------	--

For use at end of **storage modules, wardrobe cabinets or personal towers**. Includes **five adjustable** veneer shelves. Shipped assembled in 1 carton.

**Required Specifications**

- Veneer finish (shelves)
- Laminate finish (top/body)

# D DUFFERIN

## END SHELVES

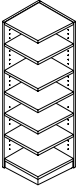

**End Shelf - 72" High - Square**

MODEL#	DIMENSIONS D x W x H	FREIGHT CLASS	WT./LBS.	CUBIC FT.	VENEER/LAMINATE	ALL VENEER
DB6S1515	15 x 15 x 72	100	83	9	<b>\$1842</b>	<b>\$2209</b>

For use at end of **storage modules, wardrobe cabinets or personal towers**. Includes **six adjustable** veneer shelves. Shipped assembled in 1 carton.

## RECEPTION DESKS

- To add storage use storage shells. See pages 40-42.
- Includes GM1 grommet.
- Transaction tops to be specified separately, handed by square edge from user side.
- Decorative Front Panels should be specified separately. Size chosen should be 12" less than desk dimensions. Available in Reverse Diamond, Vertical Rib, Vertical Grain and Horizontal Grain Patterns.

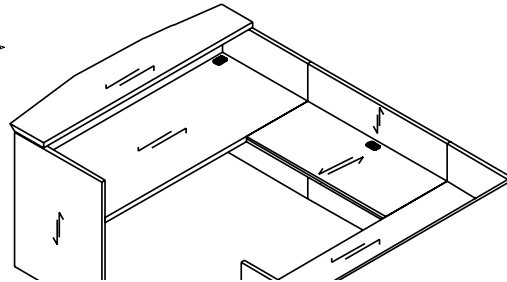
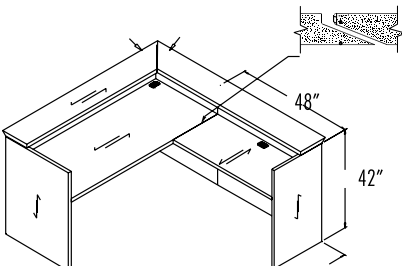

### OPTION DETAILS

Decorative Front Panel (Reverse Diamond Pattern)  
DGFDP5430F

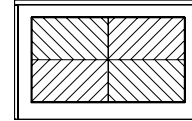

Decorative Front Panel (Vertical Rib Pattern)  
DGFDP5430RIB

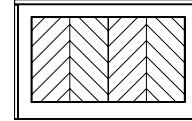

MODEL#	DIMENSIONS	FREIGHT CLASS	WT./LBS.	CUBIC FT.	VENEER/LAMINATE	ALL VENEER
DGC10836	36 x 108 x 42	150	533	95	<b>\$6883</b>	<b>\$8257</b>
DGC10236	36 x 102 x 42	150	503	89	<b>\$6498</b>	<b>\$7798</b>
DGC9636	36 x 96 x 42	150	473	84	<b>\$6118</b>	<b>\$7340</b>
DGC9036	36 x 90 x 42	150	444	79	<b>\$5736</b>	<b>\$6884</b>
DGC8436	36 x 84 x 42	150	414	74	<b>\$5352</b>	<b>\$6420</b>
DGC7236	36 x 72 x 42	150	355	63	<b>\$4589</b>	<b>\$5505</b>
DGC7230	30 x 72 x 42	150	315	53	<b>\$4439</b>	<b>\$5327</b>
DGC6630	30 x 66 x 42	125	295	48	<b>\$4001</b>	<b>\$4799</b>
DGC6030	30 x 60 x 42	125	275	44	<b>\$4329</b>	<b>\$5192</b>

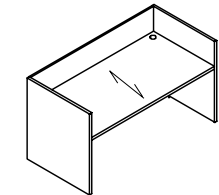

**Gallery/Reception Desk Shell\***

No pedestals. Two grommets in worksurface. For use with modular storage components. Shipped assembled in 1 carton.

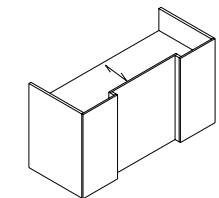

**Gallery/Reception Desk Shell  
Breakfront Style**

DGIC10836	36 x 108 x 42	150	533	95	<b>\$8454</b>	<b>\$10146</b>
DGIC10236	36 x 102 x 42	150	503	89	<b>\$7986</b>	<b>\$9582</b>
DGIC9636	36 x 96 x 42	150	473	84	<b>\$7517</b>	<b>\$9020</b>
DGIC9036	36 x 90 x 42	150	444	79	<b>\$7048</b>	<b>\$8457</b>
DGIC8436	36 x 84 x 42	150	414	74	<b>\$6578</b>	<b>\$7894</b>
DGIC7236	36 x 72 x 42	150	355	63	<b>\$5640</b>	<b>\$6768</b>
DGIC7230	30 x 72 x 42	150	315	53	<b>\$5455</b>	<b>\$6545</b>
DGIC6630	30 x 66 x 42	125	295	48	<b>\$5318</b>	<b>\$6383</b>
DGIC6030	30 x 60 x 42	125	275	44	<b>\$5019</b>	<b>\$6020</b>

No pedestals. Two grommets in worksurface. For use with modular storage components. Shipped assembled in 1 carton.

### Required Specifications

Veneer Finish  
Laminate Finish

### Optional Specifications

Additional Grommet (Reception Desks)  
Decorative Panel\*

### Accessories

Storage Shells (Reception Desks)

RECEPTION DESKS

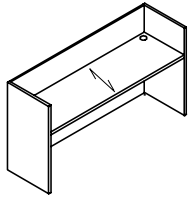

Gallery/Reception Credenza Shell\*

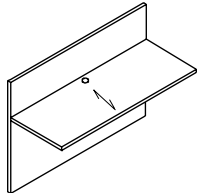

Bridge

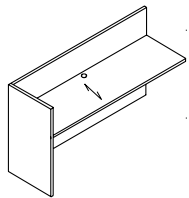

Reception Return - LEFT

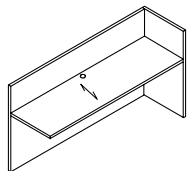

Reception Return - RIGHT

MODEL#	DIMENSIONS D x W x H	FREIGHT CLASS	WT/LBS.	CUBIC FT.	VENEER/LAMINATE	ALL VENEER
DGC10824	24 x 108 x 42	150	353	63	\$5394	\$6473
DGC10224	24 x 102 x 42	150	333	60	\$5095	\$6116
DGC9624	24 x 96 x 42	150	314	56	\$4794	\$5755
DGC9024	24 x 90 x 42	150	294	53	\$4495	\$5393
DGC8424	24 x 84 x 42	150	274	49	\$4193	\$5035
DGC7224	24 x 72 x 42	150	235	42	\$3599	\$4317
DGC6624	24 x 66 x 42	150	216	39	\$3382	\$4057
DGC6024	24 x 60 x 42	150	196	35	\$3167	\$3801

**No pedestals.** Two grommets in worksurface. For use with modular storage components. Shipped assembled in 1 carton.

DGBT5624CG	24 x 56 x 42	150	178	32	\$3018	\$3625
DGBT5424CG	24 x 54 x 42	150	169	29	\$3018	\$3625
DGBT5024CG	24 x 50 x 42	150	151	27	\$2682	\$3217
DGBT4824CG	24 x 48 x 42	150	142	26	\$2682	\$3217
DGBT4424CG	24 x 44 x 42	150	134	23	\$2348	\$2815
DGBT4224CG	24 x 42 x 42	150	127	22	\$2348	\$2815
DGBT3824CG	24 x 38 x 42	150	119	20	\$2115	\$2537
DGBT3624CG	24 x 36 x 42	150	112	19	\$2115	\$2537

Attaches between **Gallery Desk and Gallery Credenza Only**. One grommet in center of worksurface. Shipped assembled in 1 carton.

- To remove cross-grain veneer pattern on top, **delete "CG"** from model number. Available as a special - no upcharge.

DGRL7224	24 x 72 x 42	125	273	42	\$4530	\$5436
DGRL6624	24 x 66 x 42	125	250	39	\$4153	\$4984
DGRL6024	24 x 60 x 42	125	228	35	\$3778	\$4531
DGRL5424	24 x 54 x 42	125	205	32	\$3400	\$4081
DGRL4824	24 x 48 x 42	125	182	28	\$3025	\$3628
DGRL4224	24 x 42 x 42	125	159	25	\$2644	\$3173
DGRL3624	24 x 36 x 42	125	137	21	\$2381	\$2854

**No pedestal.** One grommet in center of worksurface. For use with modular storage components. Shipped assembled in 1 carton.

DGRR7224	24 x 72 x 42	125	273	42	\$4530	\$5436
DGRR6624	24 x 66 x 42	125	250	39	\$4153	\$4984
DGRR6024	24 x 60 x 42	125	228	35	\$3778	\$4531
DGRR5424	24 x 54 x 42	125	205	32	\$3400	\$4081
DGRR4824	24 x 48 x 42	125	182	28	\$3025	\$3628
DGRR4224	24 x 42 x 42	125	159	25	\$2644	\$3173
DGRR3624	24 x 36 x 42	125	137	21	\$2381	\$2854

**No pedestal.** One grommet in center of worksurface. For use with modular storage components. Shipped assembled in 1 carton.

**Required Specifications**

Veneer Finish  
Laminate Finish

**Optional Specifications**

Additional grommet\*  
Decorative panel\*

**Accessories**

Storage shells\*

TRANSACTION TOPS

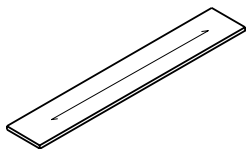

Transaction Counter Top

MODEL#	DIMENSIONS D x W x H	FREIGHT CLASS	WT./LBS.	CUBIC FT.	VENEER/LAMINATE	ALL VENEER
DGTT10810	10 x 108 x 1.50	100	78	8	N/A	<b>\$1276</b>
DGTT10210	10 x 102 x 1.50	92.5	72	7	N/A	<b>\$1207</b>
DGTT9610	10 x 96 x 1.50	100	66	7	N/A	<b>\$1137</b>
DGTT9010	10 x 90 x 1.50	92.5	60	6	N/A	<b>\$1065</b>
DGTT8410	10 x 84 x 1.50	100	54	6	N/A	<b>\$994</b>
DGTT7210	10 x 72 x 1.50	100	48	5	N/A	<b>\$854</b>
DGTT6610	10 x 66 x 1.50	100	42	5	N/A	<b>\$780</b>
DGTT6010	10 x 60 x 1.50	100	36	4	N/A	<b>\$712</b>

**Rectangular top** for main reception desk. Counter sits on top of Gallery panels. Does not overhang. **Factory installed - specify Gallery to be used on.** Size must match dimension of desk front or combined desk side and return length. Hardware included.

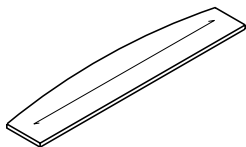

Bow Front Transaction Counter Top

DGTTM1081013	10-13 x 108 x 1.50	125	78	10	N/A	<b>\$2551</b>
DGTTM1021013	10-13 x 102 x 1.50	100	72	9	N/A	<b>\$2831</b>
DGTTM961013	10-13 x 96 x 1.50	125	66	9	N/A	<b>\$2268</b>
DGTTM901013	10-13 x 90 x 1.50	125	60	8	N/A	<b>\$2126</b>
DGTTM841013	10-13 x 84 x 1.50	125	54	8	N/A	<b>\$1986</b>
DGTTM721013	10-13 x 72 x 1.50	125	48	7	N/A	<b>\$1702</b>
DGTTM661013	10-13 x 66 x 1.50	125	42	6	N/A	<b>\$1562</b>
DGTTM601013	10-13 x 60 x 1.50	125	36	5	N/A	<b>\$1418</b>

**Bow top** for main reception desk. Counter sits on top of Gallery panels. Bow front overhangs 3". **Factory installed - specify Gallery to be used on.** Size must match dimension of desk front or combined desk side and return length. Hardware included.

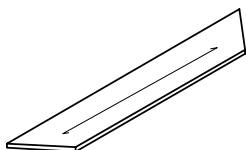

Trapezoid Transaction Counter Top

DGTTA10810	10 x 108 x 1.50	100	78	8	N/A	<b>\$1449</b>
DGTTA10210	10 x 102 x 1.50	92.5	72	7	N/A	<b>\$1378</b>
DGTTA9610	10 x 96 x 1.50	100	66	7	N/A	<b>\$1307</b>
DGTTA9010	10 x 90 x 1.50	92.5	60	6	N/A	<b>\$1236</b>
DGTTA8410	10 x 84 x 1.50	100	54	6	N/A	<b>\$1168</b>
DGTTA7210	10 x 72 x 1.50	100	48	5	N/A	<b>\$1024</b>
DGTTA6610	10 x 66 x 1.50	100	42	5	N/A	<b>\$956</b>
DGTTA6010	10 x 60 x 1.50	100	36	4	N/A	<b>\$882</b>

**Trapezoid top** for main reception desk. 45° mitered ends on left and right. For use with left and right 45° mitered return transaction counters. Counter sits on top of Gallery panels. Does not overhang. **Factory installed - specify Gallery to be used on.** Width must match dimension of desk front. Hardware included.

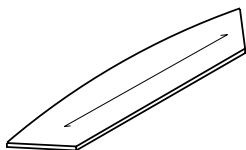

Bow Front Trapezoid Transaction Counter Top

DGTTMA1081013	10-13 x 108 x 1.50	125	78	10	N/A	<b>\$2718</b>
DGTTMA1021013	10-13 x 102 x 1.50	100	72	9	N/A	<b>\$2578</b>
DGTTMA961013	10-13 x 96 x 1.50	125	66	9	N/A	<b>\$2437</b>
DGTTMA901013	10-13 x 90 x 1.50	125	60	8	N/A	<b>\$2296</b>
DGTTMA841013	10-13 x 84 x 1.50	125	54	8	N/A	<b>\$2158</b>
DGTTMA721013	10-13 x 72 x 1.50	125	48	7	N/A	<b>\$1872</b>
DGTTMA661013	10-13 x 66 x 1.50	125	42	6	N/A	<b>\$1729</b>
DGTTMA601013	10-13 x 60 x 1.50	125	36	5	N/A	<b>\$1591</b>

**Trapezoid bow top** for main reception desk. 45° mitered ends on left and right. For use with left and right 45° mitered return transaction counters. Counter sits on top of Gallery panels. Bow front overhangs 3". **Factory installed - specify Gallery to be used on.** Width must match dimension of desk front. Hardware included.

**Required Specifications**  
Veneer Finish

TRANSACTION TOPS	MODEL#	DIMENSIONS	FREIGHT CLASS	WT/LBS.	CUBIC FT.	VENEER/LAMINATE	ALL VENEER
		<b>D x W x H</b>					
	DGTTAL12010	10 x 120 x 1.50	92.5	84	8	N/A	<b>\$1531</b>
	DGTTAL11410	10 x 114 x 1.50	92.5	81	8	N/A	<b>\$1455</b>
	DGTTAL10810	10 x 108 x 1.50	100	78	8	N/A	<b>\$1390</b>
	DGTTAL10210	10 x 102 x 1.50	92.5	72	7	N/A	<b>\$1321</b>
	DGTTAL9610	10 x 96 x 1.50	100	66	7	N/A	<b>\$1251</b>
	DGTTAL9010	10 x 90 x 1.50	92.5	60	6	N/A	<b>\$1178</b>
	DGTTAL8410	10 x 84 x 1.50	100	54	6	N/A	<b>\$1110</b>
	DGTTAL7210	10 x 72 x 1.50	100	48	5	N/A	<b>\$966</b>
	DGTTAL6610	10 x 66 x 1.50	100	42	5	N/A	<b>\$898</b>
	DGTTAL6010	10 x 60 x 1.50	100	36	4	N/A	<b>\$827</b>
	DGTTAL3610	10 x 36 x 1.50	100	24	3	N/A	<b>\$497</b>
	DGTTAL3010	10 x 30 x 1.50	92.5	20	2	N/A	<b>\$417</b>
	DGTTAL2410	10 x 24 x 1.50	100	16	2	N/A	<b>\$366</b>

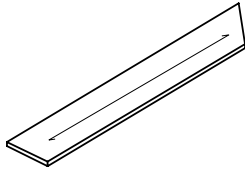

**Transaction Counter Top - LEFT**

**Rectangular top** for main reception desk with 45° mitered end on **left**. For use with rectangular or bow front transaction counters with miters at both ends. Width must match dimension of Gallery Desk end and Return width. Counter sits on top of Gallery panels. Does not overhang. **Factory installed - specify Gallery to be used on.** Hardware included.

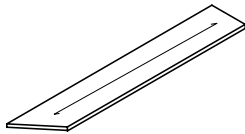

**Transaction Counter Top - RIGHT**

DGTTAR12010	10 x 120 x 1.50	92.5	84	8	N/A	<b>\$1531</b>
DGTTAR11410	10 x 114 x 1.50	92.5	81	8	N/A	<b>\$1455</b>
DGTTAR10810	10 x 108 x 1.50	100	78	8	N/A	<b>\$1390</b>
DGTTAR10210	10 x 102 x 1.50	92.5	72	7	N/A	<b>\$1321</b>
DGTTAR9610	10 x 96 x 1.50	100	66	7	N/A	<b>\$1251</b>
DGTTAR9010	10 x 90 x 1.50	92.5	60	6	N/A	<b>\$1178</b>
DGTTAR8410	10 x 84 x 1.50	100	54	6	N/A	<b>\$1110</b>
DGTTAR7210	10 x 72 x 1.50	100	48	5	N/A	<b>\$966</b>
DGTTAR6610	10 x 66 x 1.50	100	42	5	N/A	<b>\$898</b>
DGTTAR6010	10 x 60 x 1.50	100	36	4	N/A	<b>\$827</b>
DGTTAR3610	10 x 36 x 1.50	100	24	3	N/A	<b>\$497</b>
DGTTAR3010	10 x 30 x 1.50	92.5	20	2	N/A	<b>\$417</b>
DGTTAR2410	10 x 24 x 1.50	100	16	2	N/A	<b>\$366</b>

**Rectangular top** for main reception desk with 45° mitered end on **right**. For use with rectangular or bow front transaction counters with miters at both ends. Width must match dimension of Gallery Desk end and Return width. Counter sits on top of Gallery panels. Does not overhang. **Factory installed - specify Gallery to be used on.** Hardware included.

**Required Specifications**

Veneer Finish

RECEPTION DESKS

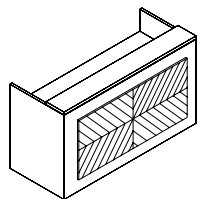

**Decorative Front Panel  
Reverse Diamond Pattern**

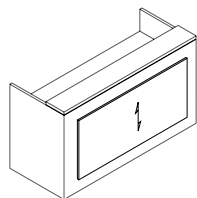

**Decorative Front Panel  
Vertical Grain Pattern**

MODEL#	DIMENSIONS D x W x H	FREIGHT CLASS	WT./LBS.	CUBIC FT.	VENEER/LAMINATE	ALL VENEER
DGFDP9630F	1 x 96 x 30	92.5	81	8	N/A	<b>\$2539</b>
DGFDP9030F	1 x 90 x 30	100	78	8	N/A	<b>\$2377</b>
DGFDP8430F	1 x 84 x 30	92.5	72	7	N/A	<b>\$2222</b>
DGFDP7230F	1 x 72 x 30	100	66	7	N/A	<b>\$1904</b>
DGFDP6030F	1 x 60 x 30	92.5	60	6	N/A	<b>\$1591</b>
DGFDP5430F	1 x 54 x 30	100	54	6	N/A	<b>\$1429</b>
DGFDP4830F	1 x 48 x 30	100	48	5	N/A	<b>\$1272</b>

Raised decorative front panel for a reception desk. Size should be 12" less than desk dimensions. **Factory installed.** Hardware included.

DGFDP9630V	1 x 96 x 30	92.5	81	8	N/A	<b>\$2210</b>
DGFDP9030V	1 x 90 x 30	100	78	8	N/A	<b>\$2069</b>
DGFDP8430V	1 x 84 x 30	92.5	72	7	N/A	<b>\$1936</b>
DGFDP7230V	1 x 72 x 30	100	66	7	N/A	<b>\$1657</b>
DGFDP6030V	1 x 60 x 30	92.5	60	6	N/A	<b>\$1381</b>
DGFDP5430V	1 x 54 x 30	100	54	6	N/A	<b>\$1249</b>
DGFDP4830V	1 x 48 x 30	100	48	5	N/A	<b>\$1105</b>

Raised decorative front panel for a reception desk. Size should be 12" less than desk dimensions. **Factory installed.** Hardware included.

**Required Specifications**

Veneer finish

# foundations





Contemporary. Minimal. Inspirational. **Foundations** desking draws upon a contemporary minimal aesthetic, paring down furniture structure and surface to its essence to reveal an architecture of simple horizontal and vertical planar elements.

Each piece is designed to serve the needs of a changing office landscape, elevating the look and function of the private office and taking into account the diverse uses of meeting rooms in the modern work environment. Designed by Christopher Wright.

Foundations components for the private office include modular desks, credenzas and wall storage units punctuated by niches set into the vertical plane of the unit. Personal items or work tools can be stored in niches, desks and storage components that combine to suit individual work styles.

#### Features and Benefits

- Workwalls support configurations or function as display backdrops
- Niches are designed to accept tackboards, remote-controlled LED lighting and flat screen monitors
- Wall units can be specified with LED lighting.
- Power, data and cable management accessories are available on any Foundations unit, including boardroom tables to meet exact requirements.
- A full array of complementary conference room furnishings are available to coordinate the entire office.



Open frame leg

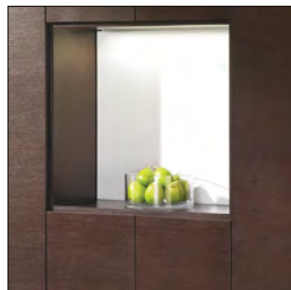

Workwall niche offers a surface, storage or display.

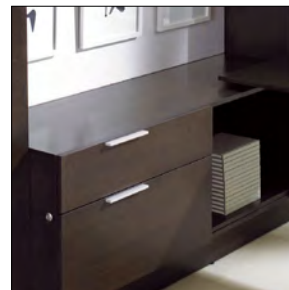

Workwall with integrated storage credenza.

**GENERAL INFORMATION**

- Foundations includes workwalls, single- and double-pedestal desks and executive desk extensions, bridges and transaction counters
- Storage components include credenzas, bench storage, wall-mounted and freestanding storage
- Two- or three-tone finish options allow for a distinctive aesthetic
- Executive desk extensions are supported by an open frame leg or elevated pedestals
- Modular wall units, pedestals and credenzas allow for scalable storage solutions; components accommodate L- and U-shaped configurations, as well as desk and workwall/credenza combinations.
- For environmental certification, please visit [globalfurnituregroup.com](http://globalfurnituregroup.com)

**CONSTRUCTION**

- Engineered veneer is real wood that through a manufacturing process of slicing, dyeing, gluing and re-slicing achieves consistent wood grain and color structure.
- Veneer is purchased by the block and sliced into a rift cut slip matched pattern to a thickness of 0.6mm (1/42"). Global lays up rift cut veneers in a slip match method.

**FINISHES**

- Conversion varnish (similar to catalyzed lacquer, but tougher), 25 degree sheen. Finishes are not buffed or rubbed.
- All Global wood casegood products are veneered and finished on the back sides (360° finishing), except modular under-surface storage - tops and backs are unfinished.
- Touch up kits available, includes a touch up marker and fill crayon. Order **VTOUCHUPKIT, \$175** list. Specify finish when ordering.
- Global standard finish, on oak and walnut, is open pore and on cherry and maple is semi-closed pore. If a full finish is required for walnut, cherry, anigre and maple tops, Add the suffix "2" to the finish code and Add 5% to the base pricing for each product.

**CUSTOM FINISH IS AVAILABLE.****PEDESTALS AND CREDENZAS**

- Suspended 7.5" off the floor by an open framed aluminum leg
- Locks are always located on the side panel.
- Handle placement is offset from the center, towards the lock
- Overall height is 26.5"
- Pedestal drawer suspensions are metal ball bearing type. Both box and file drawers are full extension.
- Hanging file rails are pre-installed on file drawer perimeters. The back rail in a lateral file drawer is designed for both letter and legal size filing.
- Drawer sides and bottoms are wrapped black vinyl.
- Drawer front is an applied element to a four sided drawer. Drawer fronts are veneered on all surfaces. Drawer fronts can be removed or replaced in the field.
- Leveling glides have 1" range of adjustment.

**HARDWARE**

- All necessary hardware to assemble the furniture is included in the shipment. Actual wall-attachment fasteners for wall cabinets and tackboards are not included due to variable site conditions.
- Hanging file rails are pre-installed on file drawer perimeters and accommodate both legal and letter size filing. Legal filing can be achieved either as side-to-side or front-to-back. Letter filing can be achieved as front-to-back filing only.
- Connecting brackets are used to attached bridges and returns to desk, and are shipped pre-attached to the bottom of the bridge or return. Additional screws are shipped in a plastic bag.

**INSTALLATION**

- **Wall-mounted cabinets and tackboards** are shipped with preattached horizontal wall rails at the back of each unit. The wall-side components must be detached from the unit and fastened to the wall accordingly. Wall fasteners are not included due to the variable site conditions. Securing the wall rail to a vertical structural member is the required manner of installation. The cabinet or tackboard is then lowered on to the wall rail. It is important to level the wall rail before installation. Wall cabinets are equipped with levelers at the bottom of the back panels for proper cabinet alignment. Units with doors are equipped with adjustable European door hinges to assist in door alignment. It is required to use a #8 wood screw through the back of the cabinet and the wall-mounted rail, to further secure the wall attachment. Tackboards have vertical grooves in the back for tasklight wiring.
- **Transaction counter and decorative panels** are shipped knock down. To assemble it follow the assembly instruction sheet included. To secure the transaction counter to the desk, double sided tape is applied to the bottom of the end panels. Included screws must be used to attach the decorative panel to the desk.
- **Modular storage units:** Have pre-drilled holes through the tops for securing to the bottom of the work surfaces. Screws and lock keys are included in a plastic bag fastened inside the pedestal. Pedestals may be installed flush or offset. Disassemble the modular unit first before relocating the entire unit to avoid damage or bodily injuries.
- **Work Walls:** Incorporate storage units, credenzas and niches of different sizes, attached to the base with connecting bolts. Upper units are installed with plastic dowels. Small connectors are supplied to secure the units thru the side panels. Complete assembly instruction is included with the wall unit. All necessary connectors and dowels are shipped in a plastic bag.
- **Credenza backpanels and display walls:** Optional credenza backpanels and display walls are attached to the units with supplied quick connectors. To assemble the display wall follow the assembly instructions included. All connectors and screws are shipped in a plastic bag.
- **Tables:** All table components are shipped in multiple boxes. Screws and table connectors are packed in a separate box identified with the label "Hardware Enclosed". Assembly instructions for specific tables are included.

# F FOUNDATIONS - HOW TO SPECIFY

## 1. SPECIFY MODEL NUMBER

## 2. SPECIFY FINISH

### WORKSURFACE TOP & DRAWER/DOOR FRONTS, BODY FINISHES (INCLUDING PEDESTALS) - VENEER

#### Foundations Engineered Veneer Finishes (Horizontal Grain Standard):

Code	Finish	Veneer Type	Cut
NTF	Natural	Maple Reconstituted	Rift
TLF	Twilight	Maple Reconstituted	Rift
CIF	Chai	White Oak Reconstituted	Rift
FGF	Fig	White Oak Reconstituted	Rift
STF	Sumatra	White Oak Reconstituted	Rift
MTF	Metro	White Oak Reconstituted	Rift
MSF	Mesa	White Oak Reconstituted	Rift
CHF	Cashmere	White Oak Reconstituted	Rift
SNF	Sienna	White Oak Reconstituted	Rift
WIF	Winter	White Oak Reconstituted	Rift

#### METAL LEG FINISH (Casegoods):

SGR Silver Glimmer

#### METAL LEG FINISHES (Conference Tables):

BLKT Black Textured  
 TUNT Tungsten Textured  
 DWTT Designer White Textured

## 3. SPECIFY OPTIONS

### Handle

- Handles are standard on most drawers/storage modules.

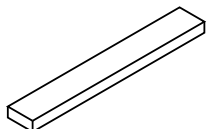

PL83 Anodized Aluminum, 7.2"

### Edges

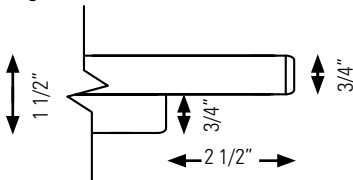

Edge Detail - Casegoods

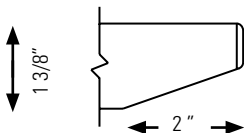

Edge Detail - Conference Tables

### Grommets

- Standard grommet on all components is **GM5**. Grommets are included with products where shown in product line drawings.
- Optional grommets may be ordered in standard worksurface locations (left, center or right). Order as **GM5L, GM5C or GM5R**. **Add \$103.**
- Grommet hole dimensions are 3.5" x 2"
- Grommets available in Tungsten only

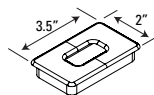

- Components that come standard with grommet may be ordered without a grommet. Order as **RSG** - **Add \$57.**
- View diagrams on the following pages for additional details.

For tops up to 24"D

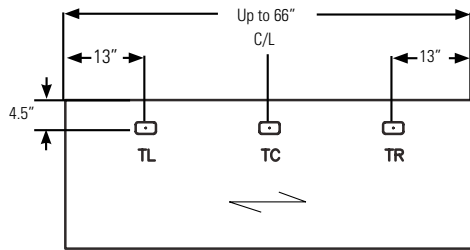
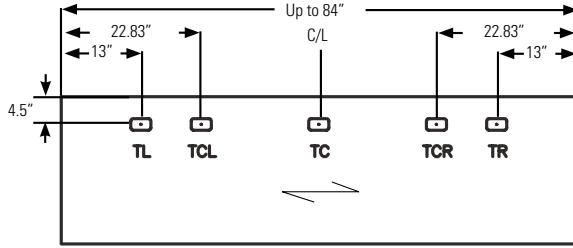

For tops 30" to 36"D

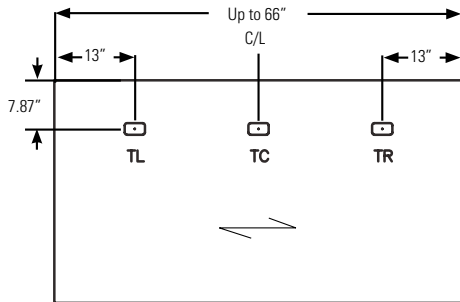
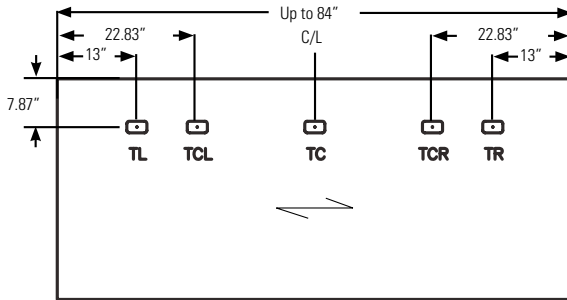

# F FOUNDATIONS - NOTES

## Optional Grommet Locations on Work Walls

Grommets and Grommet Locations must be specified.

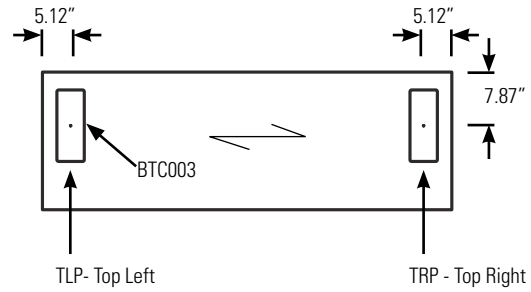
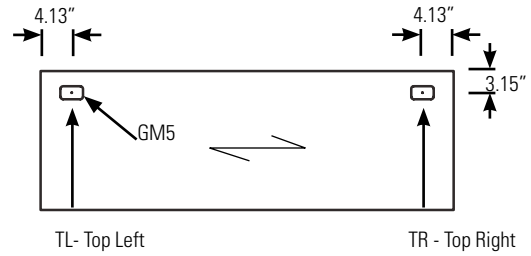
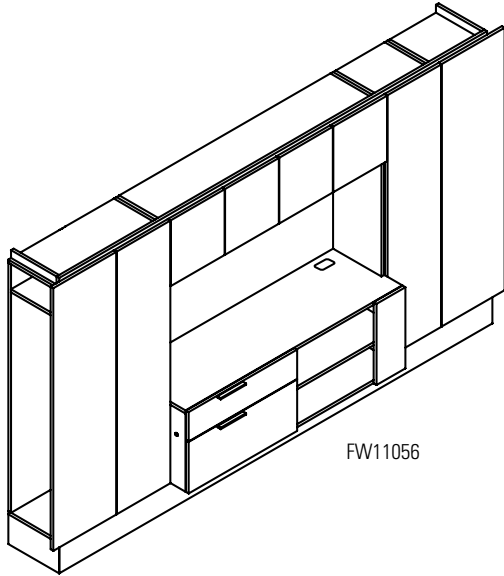

## Standard Grommet Locations on Work Walls

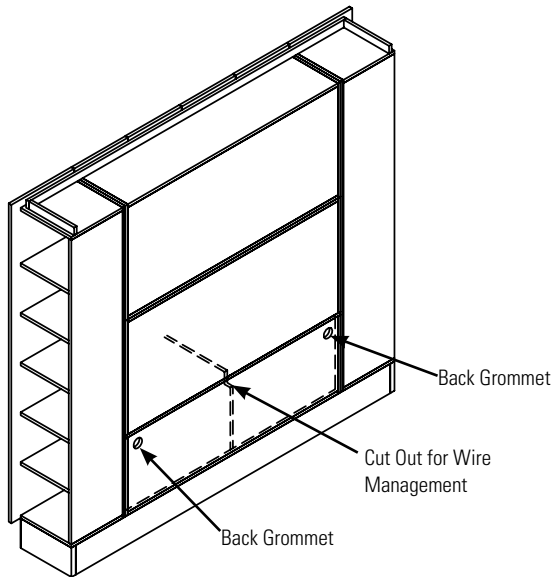

FW9570-IR Back View

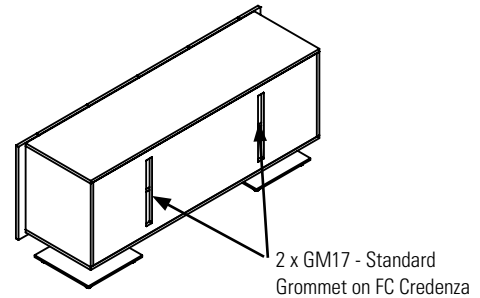
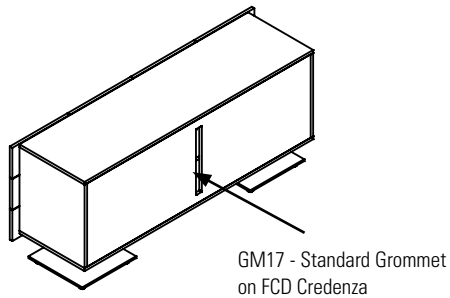
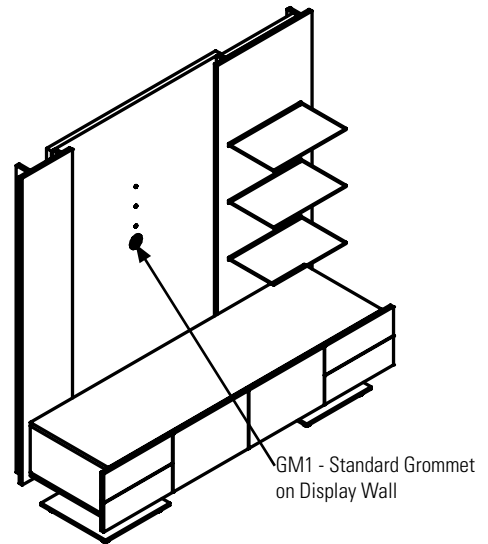

**Work Wall Display Niches**

- Available widths 15", 30", 45", 60" wide.
- Available heights 14", 28", 42" high.
- Maximum niche dimension 60" wide is 42" high.
- Maximum niche dimension 75" wide is 28" high.

When a niche is placed on 20" cantilevered storage there is no bottom. When a niche is placed between storage components it always has a bottom.

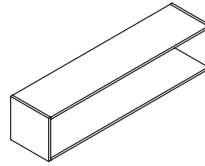
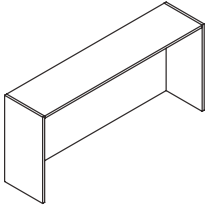

**Work Wall Lighting**

- LED lights for niches must be specified at time of manufacture. When more than one LED light is required in a work wall configuration, a single remote switch is included. Up to four LED lights can work off a single transformer.

Four sided niche with routed upper panel for LED light.

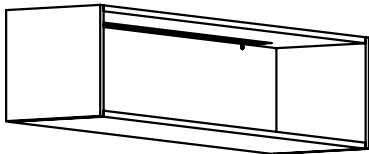

Niche is routed on inside top panel & back is drilled for wire pass through.

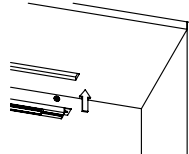

Open bottom niche with routed upper panel for LED light.

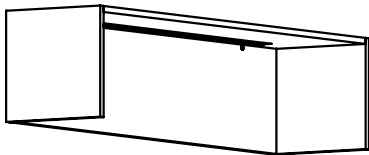

LED lights available in 12", 24", 36" and 48" widths.

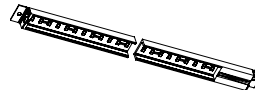

# F FOUNDATIONS - NOTES

## CONFERENCE TABLES DETAILS

### Optional Grommet Locations for Conference Table Tops

Grommets and Grommet Locations must be specified.

For tables that are 48" wide and 96", 120", 144" or 168" long:

**TCL** - Top Center Left

**TCR** - Top Left

**TC** - Top Center

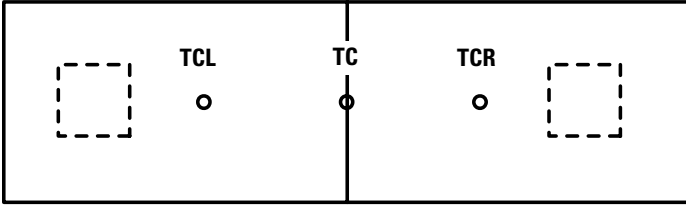

For tables that are 48" wide and 192" or 216" long and tables that are 60" wide and 168", 192", 216" or 240" long:

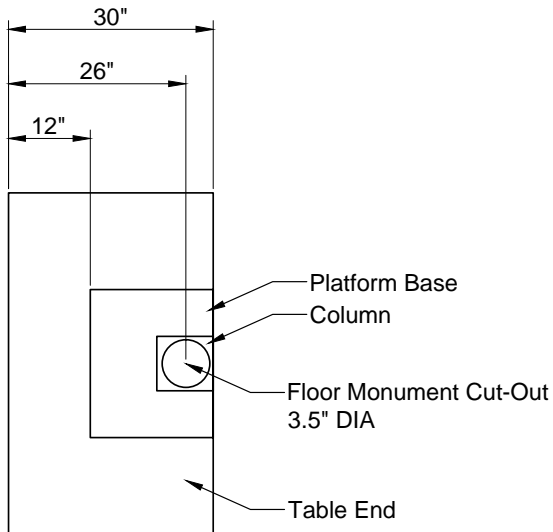
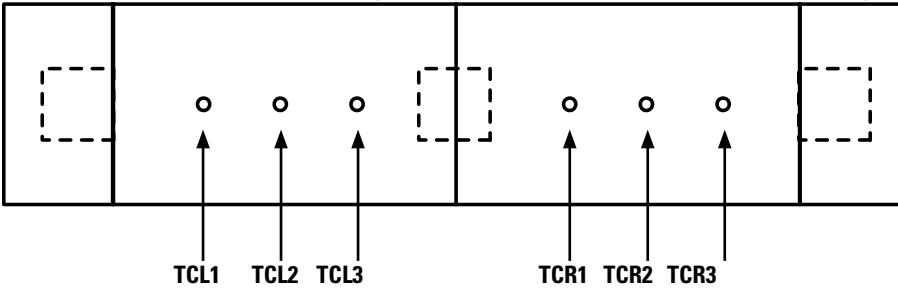

**Conference Table Top and Base Guide**

**Conference Table, two piece Top with 3 Bases**

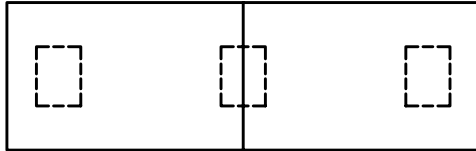

**Sectional Conference Table with 3 Bases**

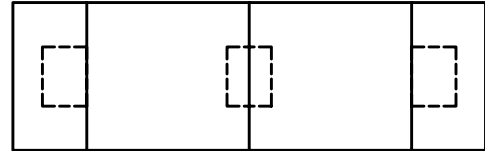

**Conference Table, two piece Top with 2 Bases**

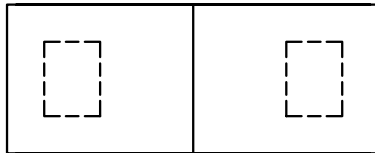

**Sectional Conference Table with 2 Bases**



**Conference Table, one piece Top with 2 Bases**



**Square Table Top with Mono Base**

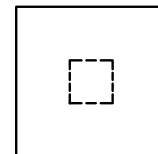

**Sectional Conference Table with Technology Trough and 3 Bases**

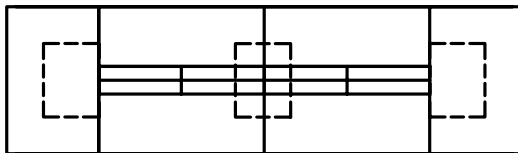

**Round Table Top with Mono Base**

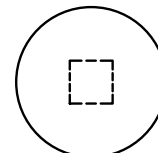

**Sectional Conference Table with Technology Trough and 2 Bases**

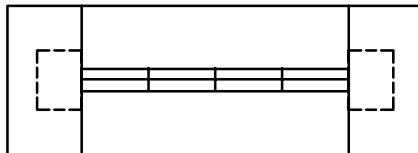

**Sectional Conference Table with Technology Trough and 2 Bases**



**Note:** Different Table Shapes are available.

## Technology Trough Details

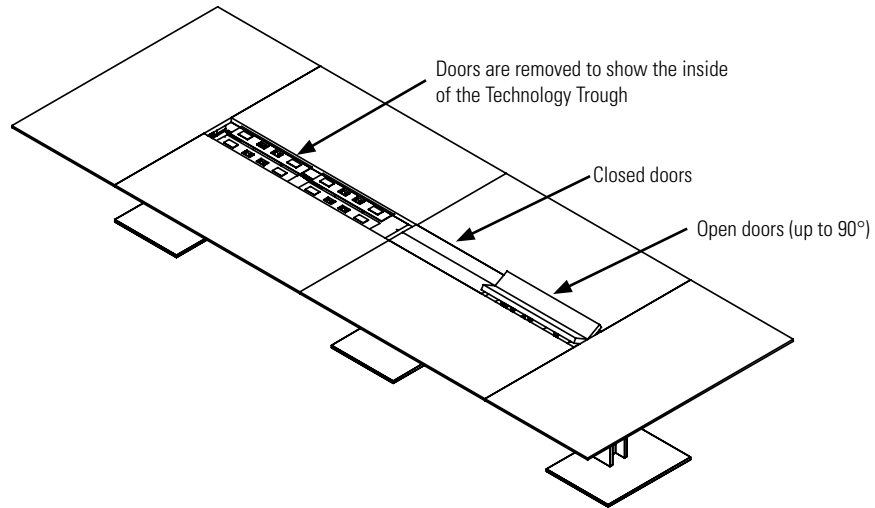

**Side View**

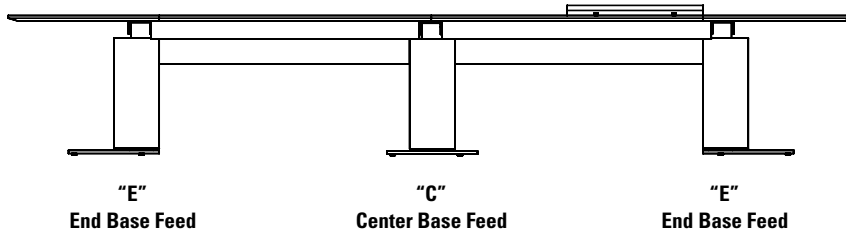

**End View**

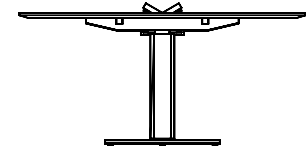

Power kits are included.  
 Two power receptacles and two telecom knockouts per door are standard.  
 Telecom plates will be shipped separately.  
 If no telecom plate is specified, blank coverplate will be included.

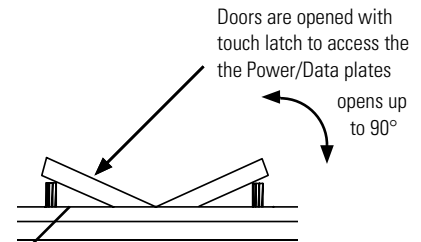
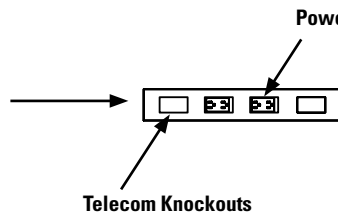

**End View Detail**

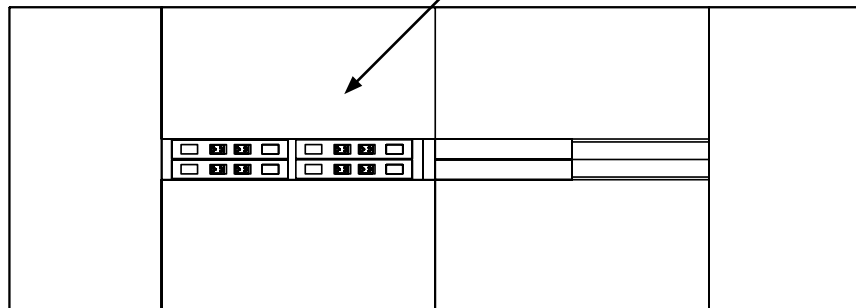

**FINISH SPECIFICATIONS**

**Double and Single Pedestal Desks**

- For desks two finishes can be specified.
- The first finish in the product string, indicated as #1.
- The second finish in the product string indicated as #2.
- If only one finish is indicated, the entire unit will be monotone.
- **Note:** Horizontal grain direction is standard on all engineered finishes. If natural veneer is required, the grain direction will be vertical. Arrow indicates direction of grain.

**User Side**

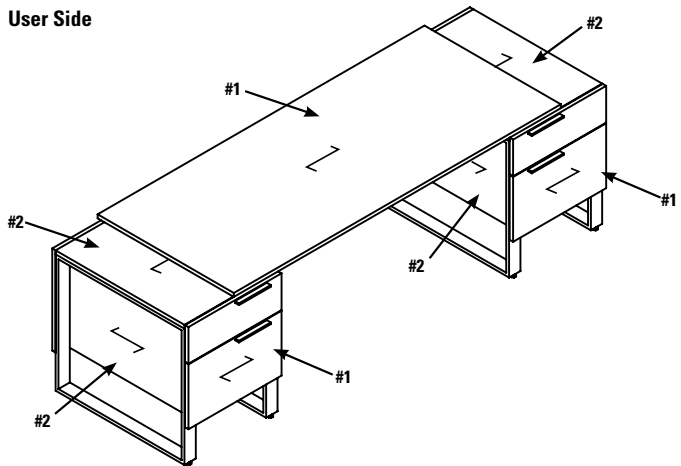

**Back View**

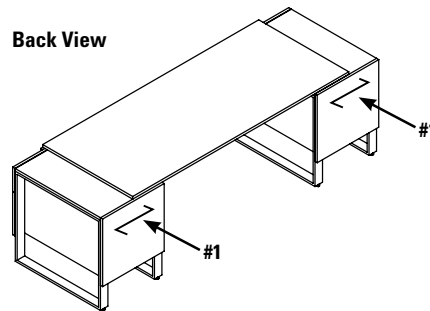

**Transaction Counter and Decorative Panel**

- For Transaction Counter and Decorative Panel, only one finish can be specified.
- Arrow indicates direction of grain

**User Side**

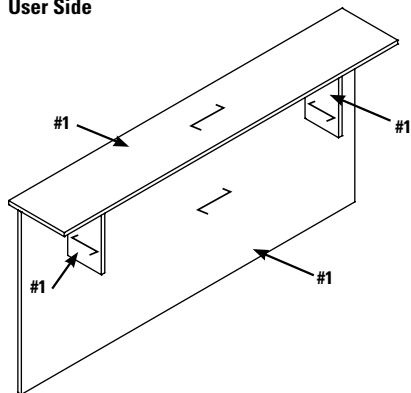

**Back View**

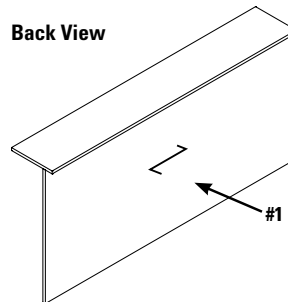

**Pedestals**

- For Pedestals, two finishes can be specified.
- The first finish in the product string, indicated as #1.
- The second finish in the product string indicated as #2.
- If only one finish is indicated, the entire unit will be monotone.

**User Side**

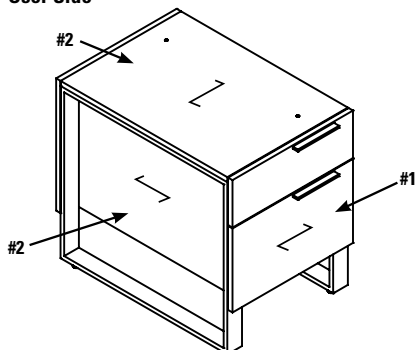

**Back View**

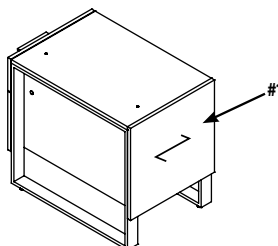

# F FOUNDATIONS - NOTES

## Lateral Files

- For Lateral Files two finishes can be specified.
- The first finish in the product string, indicated as **#1**.
- The second finish in the product string indicated as **#2**.
- If only one finish is indicated, the entire unit will be monotone.
- Arrow indicates direction of grain

### User Side

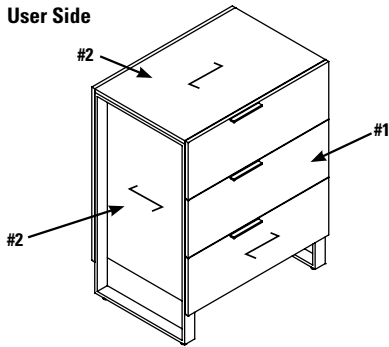

### Back View

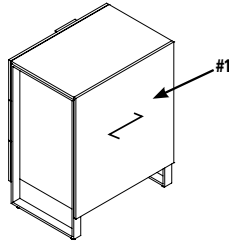

## Mobile Pedestals

- For Mobile Pedestals, two finishes can be specified.
- The first finish in the product string, indicated as **#1**.
- The second finish in the product string indicated as **#2**.
- If only one finish is indicated, the entire unit will be monotone.
- Arrow indicates direction of grain

### User Side

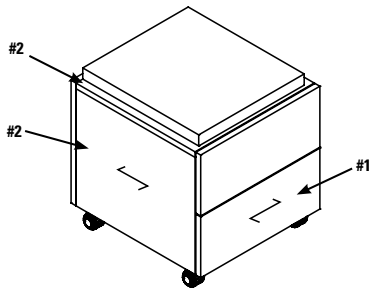

### Back View

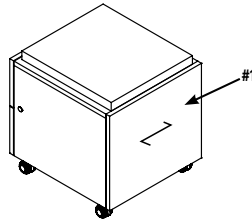

## Benches

- For Benches, two finishes can be specified.
- The first finish in the product string, indicated as **#1**.
- The second finish in the product string indicated as **#2**.
- If only one finish is indicated, the entire unit will be monotone.
- Arrow indicates direction of grain

### User Side

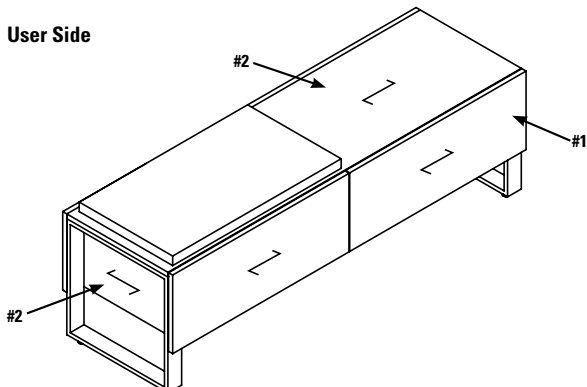

### Back View

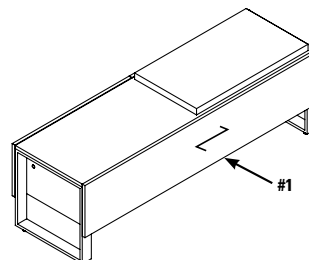

**Credenzas**

- For Credenzas, two finishes can be specified.
- The first finish in the product string, indicated as **#1**.
- The second finish in the product string indicated as **#2**.
- If only one finish is indicated, the entire unit will be monotone.
- Arrow indicates direction of grain

**User Side**

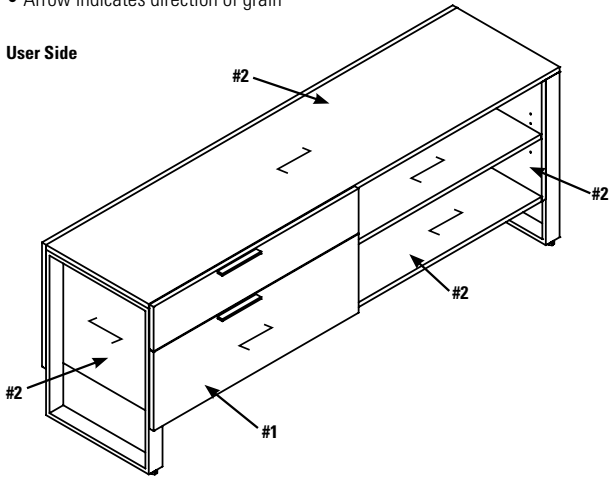

**Back View**

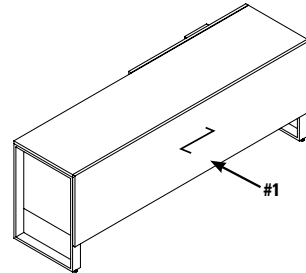

**Modular Tops**

- For Modular Tops, only one finish can be specified.
- Arrow indicates direction of grain

**Isometric View**

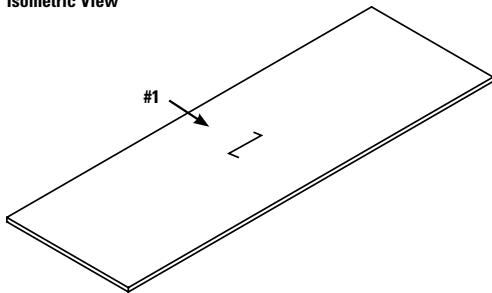

**End View**

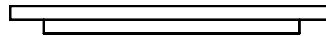

**Wall Mounted Overheads**

- For wall mounted overheads, two finishes can be specified.
- The first finish in the product string, indicated as **#1**.
- The second finish in the product string indicated as **#2**.
- If only one finish is indicated, the entire unit will be monotone.
- Arrow indicates direction of grain

**User Side**

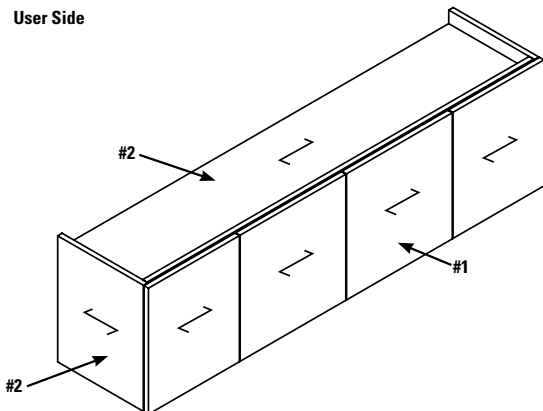

**Back View**

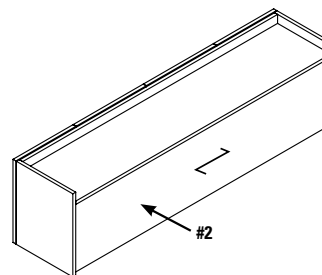

# F FOUNDATIONS - NOTES

## Work Wall Credenzas

- Two finishes can be specified.
- The first finish in the product string, indicated as **#1**.
- The second finish in the product string indicated as **#2**.
- If only one finish is indicated, the entire unit will be monotone.
- Arrow indicates direction of grain

User Side

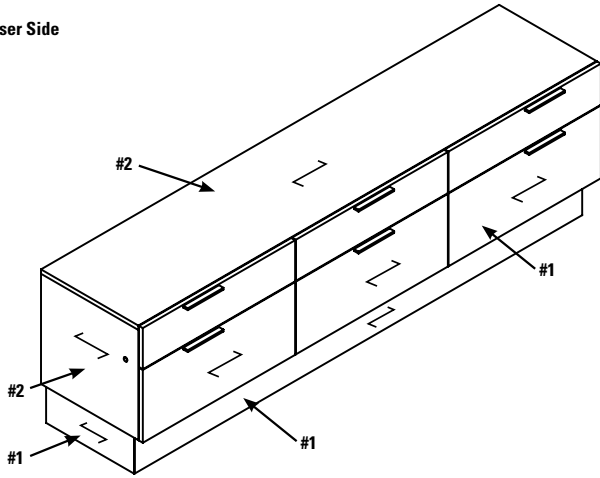

Back View

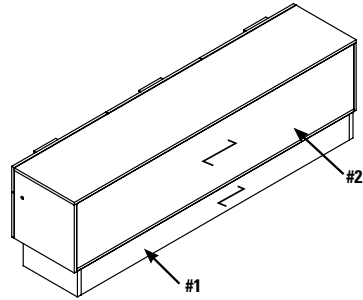

**Work Wall Credenzas**

- Three finishes can be specified.
- The first finish in the product string, indicated as **#1**.
- The second finish in the product string indicated as **#2**.
- The third finish in the product string indicated as **#3**.
- If only one finish is indicated, the entire unit will be monotone.
- Horizontal grain direction is standard on all engineered finishes. If natural veneer is required, the grain direction will be vertical. Arrow indicates direction of grain

**Front View**

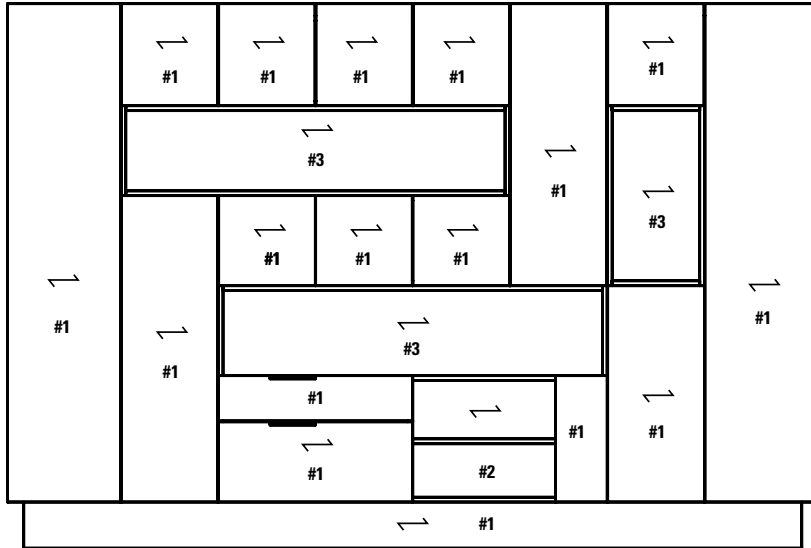

**Side View**

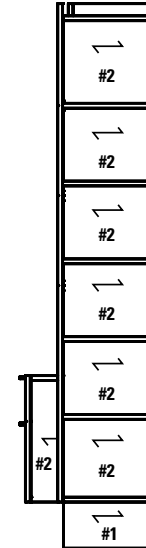

**Isometric View**

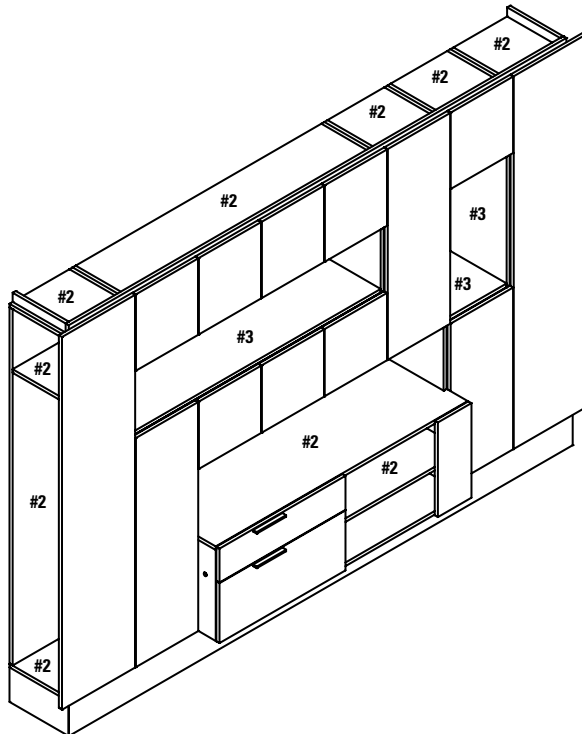

# F FOUNDATIONS - NOTES

## Sectional Top with two bases

- Two finishes can be specified.
- The first finish in the product string, indicated as #1.
- The second finish in the product string indicated as #2.
- If only one finish is indicated, the entire unit will be monotone.
- Arrow indicates direction of grain

Top View

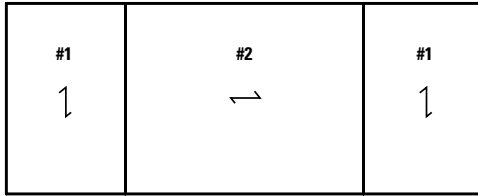

Side View

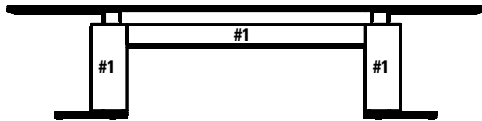

End View

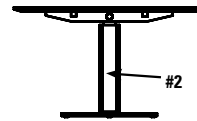

## Sectional Top with Technology Trough and bases

- Three finishes can be specified.
- The first finish in the product string, indicated as #1.
- The second finish in the product string indicated as #2.
- The third finish in the product string indicated as #3.
- If only one finish is indicated, the entire unit will be monotone.
- Arrow indicates direction of grain

Top View

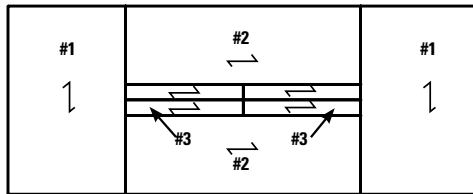

Side View

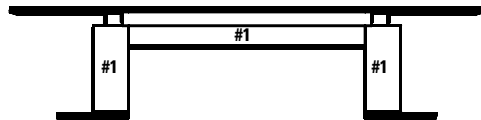

End View

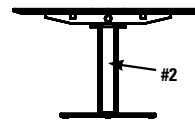

**Full Storage Credenza with two sets of Storage Cabinets and Display Wall**

- Two finishes can be specified.
- The first finish in the product string, indicated as #1.
- The second finish in the product string indicated as #2.
- If only one finish is indicated, the entire unit will be monotone.
- Arrow indicates direction of grain

Front View

Side View

Top View

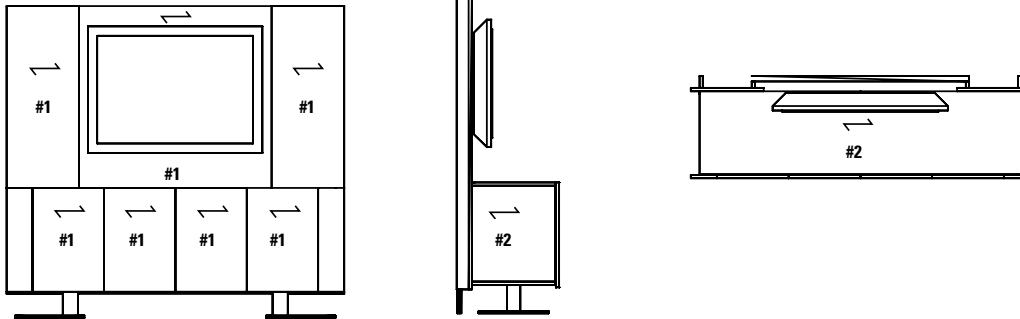

**Full Storage Credenza with BBB, Storage Cabinet, BBB and Display Wall**

- Two finishes can be specified.
- The first finish in the product string, indicated as #1.
- The second finish in the product string indicated as #2.
- If only one finish is indicated, the entire unit will be monotone.
- Arrow indicates direction of grain

Front View

Side View

Top View

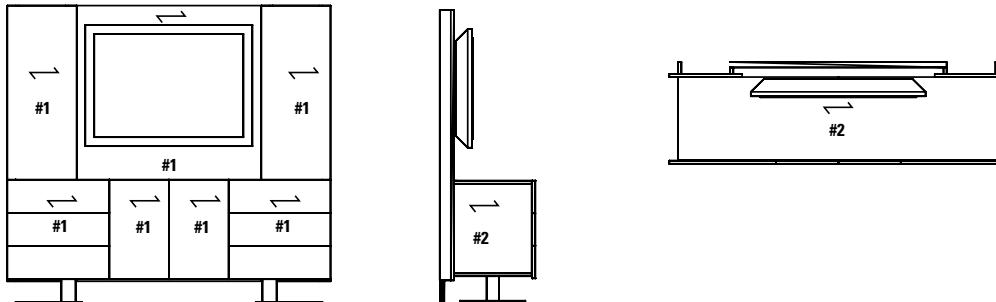

**Full Storage Credenza with BB, Storage Cabinet, BB and Display Wall**

- Two finishes can be specified.
- The first finish in the product string, indicated as #1.
- The second finish in the product string indicated as #2.
- If only one finish is indicated, the entire unit will be monotone.
- Arrow indicates direction of grain

Front View

Side View

Top View

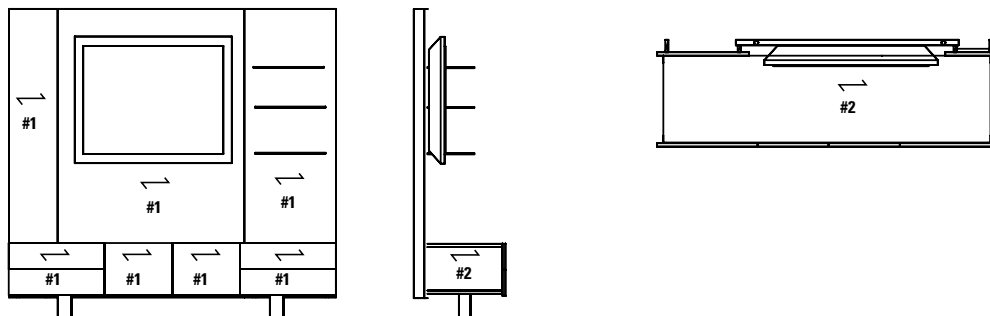

# F FOUNDATIONS - NOTES

## Lectern

- Two finishes can be specified.
- The first finish in the product string, indicated as **#1**.
- The second finish in the product string indicated as **#2**.
- If only one finish is indicated, the entire unit will be monotone.
- Arrow indicates direction of grain

### FLEC-36 Lectern

Front View

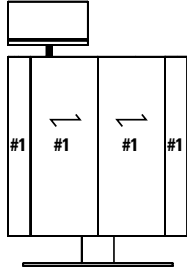

Side View

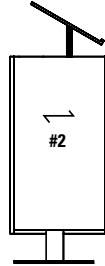

Top View

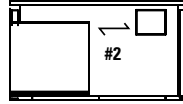

### FLEC-24 Lectern

Front View

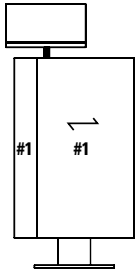

Side View

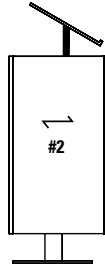

Top View

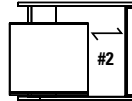

**Mobile Units**

- Two finishes can be specified.
- The first finish in the product string, indicated as **#1**.
- The second finish in the product string indicated as **#2**.
- If only one finish is indicated, the entire unit will be monotone.
- Arrow indicates direction of grain

**Mobile Lectern**

**Front View**

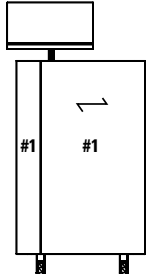

**Side View**

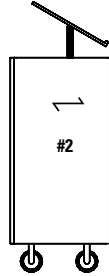

**Top View**

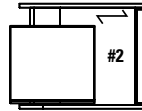

**Mobile Tech Cart**

**Front View**

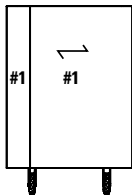

**Side View**

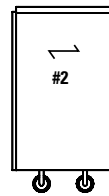

**Top View**

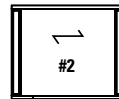

**Mobile Server**

**Front View**

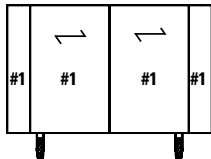

**Side View**

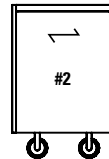

**Top View**

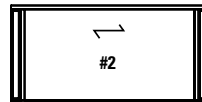

## DESKS - NOTES

- Horizontal grain direction is standard on all engineered finishes.
- Tops are constructed with two 3/4" thick panels, laminated together to create a total thickness of 1.5".
- All pedestals are suspended 7.5" off the floor by an open framed leg, and can be installed flush or offset
- Pedestals are handed:
  - Left pedestals have the handle offset from the center to the right, and the lock is placed on the right end panel
  - Right pedestals have the handle offset from the center to the left, and the lock is placed on the left end panel
- Modesty panels are available as an optional upgrade in wood or glass on Desks
- Grommets are available as an option on Desks and most Credenzas.
- **NOTE:** Arrow indicates direction of grain

Double Pedestal Desk with Box/File installed flush.

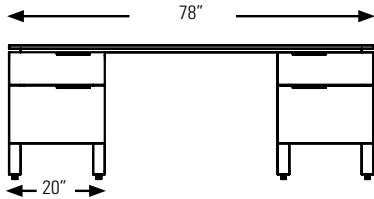

Double Pedestal Desk with Box/File installed offset.  
Add 20" to the overall width of the top.

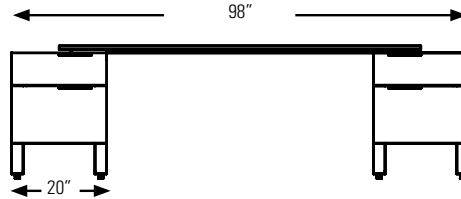

Single Pedestal Desk with Box/File installed flush.

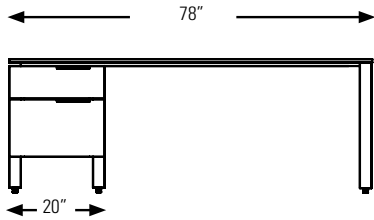

Single Pedestal Desk with Box/File installed offset.  
Add 10" to the overall width of the top.

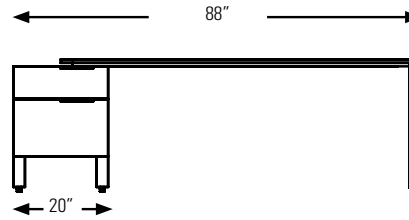

By adding a Transaction Counter Top with Decorative Front Panel (**FGTT**) to a Desk, the Desk can be used as a Reception Desk:

**User View**

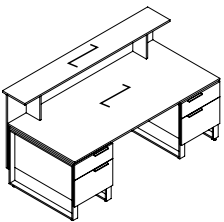

**Guest View**

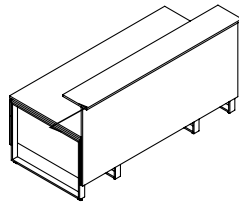

### Required Specifications

Veneer Finish  
Edge

### Optional Specifications

Grommet

## DOUBLE PEDESTAL DESKS

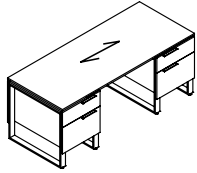

**Double Pedestal Desk**

MODEL#	DIMENSIONS	FREIGHT CLASS	WT./LBS.	CUBIC FT.	LIST PRICE
--------	------------	---------------	----------	-----------	------------

**D x W x H**

FD8436BB	36 x 84 x 28	85	201	15	<b>\$12195</b>
FD7836BB	36 x 78 x 28	85	192	15	<b>\$11957</b>
FD7236BB	36 x 72 x 28	92.5	177	15	<b>\$11660</b>
FD8430BB	30 x 84 x 28	85	184	15	<b>\$11587</b>
FD7830BB	30 x 78 x 28	92.5	176	15	<b>\$11397</b>
FD7230BB	30 x 72 x 28	92.5	163	14	<b>\$11125</b>

Standard with **flush box/file** pedestals on **left and right**.

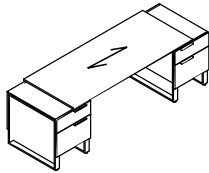

**Double Pedestal Desk**

FD8436BBOS	36 x 104 x 28	85	201	15	<b>\$12578</b>
FD7836BBOS	36 x 98 x 28	85	192	15	<b>\$12344</b>
FD7236BBOS	36 x 92 x 28	92.5	177	15	<b>\$12042</b>
FD8430BBOS	30 x 104 x 28	85	184	15	<b>\$11975</b>
FD7830BBOS	30 x 98 x 28	92.5	176	15	<b>\$11783</b>
FD7230BBOS	30 x 92 x 28	92.5	163	14	<b>\$11511</b>

Standard with **offset box/file** pedestals on **left and right**. Model # represents worksurface dimension only.

## SINGLE PEDESTAL DESKS

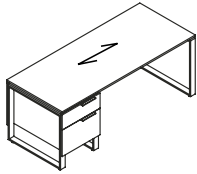

**Single Pedestal Desk - LEFT**

MODEL#	DIMENSIONS	FREIGHT CLASS	WT./LBS.	CUBIC FT.	LIST PRICE
--------	------------	---------------	----------	-----------	------------

FSL8436B	36 x 84 x 28	85	201	15	<b>\$8872</b>
FSL7836B	36 x 78 x 28	85	192	15	<b>\$8634</b>
FSL7236B	36 x 72 x 28	92.5	177	15	<b>\$8310</b>
FSL8430B	30 x 84 x 28	85	184	15	<b>\$8265</b>
FSL7830B	30 x 78 x 28	92.5	176	15	<b>\$8071</b>
FSL7230B	30 x 72 x 28	92.5	163	14	<b>\$7803</b>

Standard with **flush box/file** pedestal on **left**.

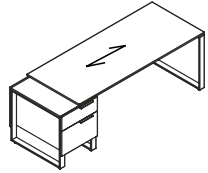

**Single Pedestal Desk - LEFT**

FSL8436BOS	36 x 94 x 28	85	201	15	<b>\$9259</b>
FSL7836BOS	36 x 88 x 28	85	192	15	<b>\$9020</b>
FSL7236BOS	36 x 82 x 28	92.5	177	15	<b>\$8693</b>
FSL8430BOS	30 x 94 x 28	85	184	15	<b>\$8650</b>
FSL7830BOS	30 x 88 x 28	92.5	176	15	<b>\$8461</b>
FSL7230BOS	30 x 82 x 28	92.5	163	14	<b>\$8188</b>

Standard with **offset box/file** pedestal on **left**. Model # represents worksurface dimension only.

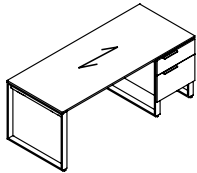

**Single Pedestal Desk - RIGHT**

FSR8436B	36 x 84 x 28	85	201	15	<b>\$8872</b>
FSR7836B	36 x 78 x 28	85	192	15	<b>\$8634</b>
FSR7236B	36 x 72 x 28	92.5	177	15	<b>\$8310</b>
FSR8430B	30 x 84 x 28	85	184	15	<b>\$8265</b>
FSR7830B	30 x 78 x 28	92.5	176	15	<b>\$8071</b>
FSR7230B	30 x 72 x 28	92.5	163	14	<b>\$7803</b>

Standard with **flush box/file** pedestal on **right**.

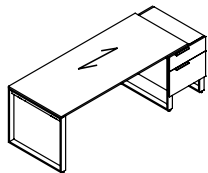

**Single Pedestal Desk - RIGHT**

FSR8436BOS	36 x 94 x 28	85	201	15	<b>\$9259</b>
FSR7836BOS	36 x 88 x 28	85	192	15	<b>\$9020</b>
FSR7236BOS	36 x 82 x 28	92.5	177	15	<b>\$8693</b>
FSR8430BOS	30 x 94 x 28	85	184	15	<b>\$8650</b>
FSR7830BOS	30 x 88 x 28	92.5	176	15	<b>\$8461</b>
FSR7230BOS	30 x 82 x 28	92.5	163	14	<b>\$8188</b>

Standard with **offset box/file** pedestal on **right**. Model # represents worksurface dimension only.

### Required Specifications

Top finish  
Body finish

### Optional Specifications

Grommet  
Modesty Panel

# F FOUNDATIONS

## DESK SHELL

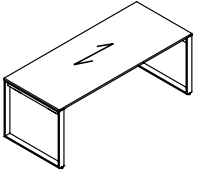

Desk Shell\*

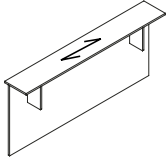

Transaction Counter

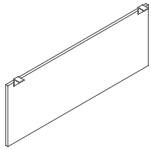

Hanging Wood Modesty Panel

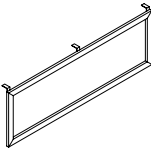

Hanging Glass Modesty Panel

MODEL#	DIMENSIONS	FREIGHT CLASS	WT/LBS.	CUBIC FT.	LIST PRICE
--------	------------	---------------	---------	-----------	------------

D x W x H

FT7236	36 x 72 x 28	85	201	15	\$5851
FT6636	36 x 66 x 28	85	192	15	\$5585
FT6036	36 x 60 x 28	92.5	177	15	\$5337
FT7230	30 x 72 x 28	85	184	15	\$5142
FT6630	30 x 66 x 28	92.5	176	15	\$4938
FT6030	30 x 60 x 28	92.5	163	14	\$4738

FGTT8412	12 x 84 x 42	250	73	21	\$3905
FGTT7812	12 x 78 x 42	250	68	19	\$3743
FGTT7212	12 x 72 x 42	250	63	18	\$3495

Rectangular transaction counter with decorative panel.

FCMP70W	0.75 x 70 x 18	--	25	1	\$1746
FCMP66W	0.75 x 66 x 18	--	24	1	\$1707
FCMP64W	0.75 x 64 x 18	--	23	1	\$1693
FCMP62W	0.75 x 62 x 18	--	22	1	\$1674
FCMP60W	0.75 x 60 x 18	--	22	1	\$1504
FCMP58W	0.75 x 58 x 18	--	21	1	\$1652
FCMP56W	0.75 x 56 x 18	--	20	1	\$1646
FCMP54W	0.75 x 54 x 18	--	20	1	\$1637
FCMP50W	0.75 x 50 x 18	--	18	1	\$1621
FCMP48W	0.75 x 48 x 18	--	18	1	\$1613
FCMP42W	0.75 x 42 x 18	--	16	1	\$1504
FCMP36W	0.75 x 36 x 18	--	14	1	\$1292
FCMP30W	0.75 x 30 x 18	--	12	1	\$1080

Hanging wood modesty panel. Attaches to underside of worksurface. **Cannot be retrofitted in the field.**

**Not sold individually - to be ordered as an upgrade option only.**

FCMP70G	0.75 x 70 x 18	--	25	1	\$2812
FCMP66G	0.75 x 66 x 18	--	24	1	\$2722
FCMP64G	0.75 x 64 x 18	--	23	1	\$2659
FCMP62G	0.75 x 62 x 18	--	22	1	\$2511
FCMP60G	0.75 x 60 x 18	--	22	1	\$2141
FCMP58G	0.75 x 58 x 18	--	21	1	\$2367
FCMP56G	0.75 x 56 x 18	--	20	1	\$2348
FCMP54G	0.75 x 54 x 18	--	20	1	\$2266
FCMP50G	0.75 x 50 x 18	--	18	1	\$2205
FCMP48G	0.75 x 48 x 18	--	18	1	\$2165
FCMP42G	0.75 x 42 x 18	--	16	1	\$2141
FCMP36G	0.75 x 36 x 18	--	14	1	\$2124
FCMP30G	0.75 x 30 x 18	--	12	1	\$2101

Aluminum framed glass modesty panel with frosted glass (standard). Attaches to underside of worksurface. **Cannot be retrofitted in the field. Not sold individually - to be ordered as an upgrade option only.**

- For white back painted glass, please contact Customer Care for pricing.

### Required Specifications

Top finish  
Body finish

### Optional Specifications

Grommet  
Modesty Panel\*

## CRENZAS - NOTES

D x W x H

- Horizontal grain direction is standard on all engineered finishes.
- Tops are constructed with two 3/4" thick panels, laminated together to create a total thickness of 1.5".
- All pedestals are suspended 7.5" off the floor by an open framed leg, and can be installed flush or offset
- Pedestals are handed:
  - Left pedestals have the handle offset from the center to the right, and the lock is placed on the right end panel
  - Right pedestals have the handle offset from the center to the left, and the lock is placed on the left end panel
- Modesty panels are available in wood or glass
- Grommets can be specified on Credenza Tops.
- **NOTE:** Arrow indicates direction of grain

Single Pedestal Credenza with 35" Lat. Box/File installed flush

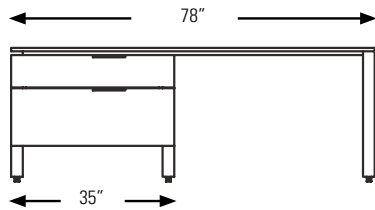

Single Pedestal Credenza with 35" Lat. Box/File installed offset  
Adds 10" to overall width

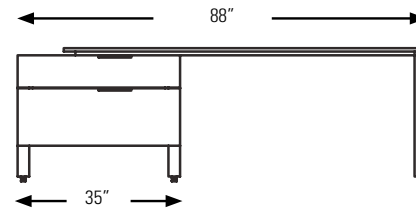

Single Pedestal Credenza with 40" Lat. Box/File installed flush.

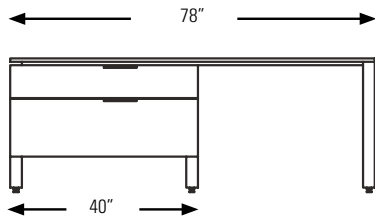

Double Pedestal Credenza with 40" Lat. Box/File installed offset.  
Adds 10" to overall width

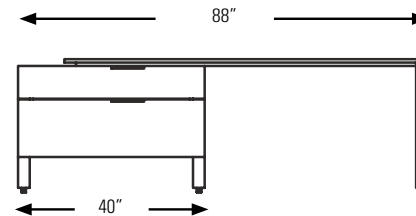

### SINGLE PEDESTAL CRENZAS

MODEL# DIMENSIONS FREIGHT CLASS WT/LBS. CUBIC FT. LIST PRICE

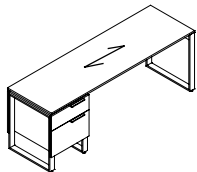

Single Pedestal Credenza - LEFT

FCCL7824B	24 x 78 x 28	85	160	12	<b>\$8009</b>
FCCL7224B	24 x 72 x 28	85	151	12	<b>\$7753</b>
FCCL7820B	20 x 78 x 28	85	153	11	<b>\$7520</b>
FCCL7220B	20 x 72 x 28	85	144	11	<b>\$7284</b>

Standard with **flush box/file** pedestal on **left**.

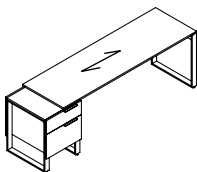

Single Pedestal Credenza - LEFT

FCCL7824BOS	24 x 88 x 28	85	160	12	<b>\$8059</b>
FCCL7224BOS	24 x 82 x 28	85	151	12	<b>\$7753</b>
FCCL7820BOS	20 x 88 x 28	85	153	11	<b>\$7573</b>
FCCL7220BOS	20 x 82 x 28	85	144	11	<b>\$7284</b>

Standard with **offset box/file** pedestal on **left**. Model # represents worksurface dimension only.

#### Required Specifications

Top finish  
Body finish

#### Optional Specifications

Grommet

## SINGLE PEDESTAL CREDENZAS

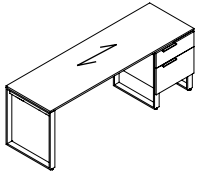

Single Pedestal Credenza - RIGHT

MODEL#	DIMENSIONS D x W x H	FREIGHT CLASS	WT./LBS.	CUBIC FT.	LIST PRICE
FCCR7824B	24 x 78 x 28	85	160	12	<b>\$8009</b>
FCCR7224B	24 x 72 x 28	85	151	12	<b>\$7753</b>
FCCR7820B	20 x 78 x 28	85	153	11	<b>\$7520</b>
FCCR7220B	20 x 72 x 28	85	144	11	<b>\$7284</b>

Standard with **flush box/file** pedestal on **right**.

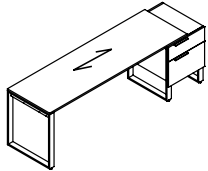

Single Pedestal Credenza - RIGHT

FCCR7824BOS	24 x 88 x 28	85	160	12	<b>\$8059</b>
FCCR7224BOS	24 x 82 x 28	85	151	12	<b>\$7753</b>
FCCR7820BOS	20 x 88 x 28	85	153	11	<b>\$7573</b>
FCCR7220BOS	20 x 82 x 28	85	144	11	<b>\$7284</b>

Standard with **offset box/file** pedestal on **right**. Model # represents worksurface dimension only.

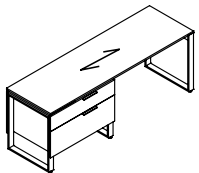

Single Pedestal Credenza - LEFT

FCC35L7824H	24 x 78 x 28	92.5	188	18	<b>\$8639</b>
FCC35L7224H	24 x 72 x 28	100	179	18	<b>\$8381</b>
FCC35L7820H	20 x 78 x 28	92.5	179	15	<b>\$8106</b>
FCC35L7220H	20 x 72 x 28	92.5	170	15	<b>\$7868</b>

Standard with **flush 35" lateral box/file** pedestal on **left**.

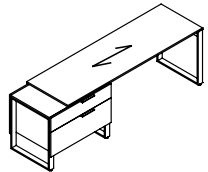

Single Pedestal Credenza - LEFT

FCC35L7824HOS	24 x 88 x 28	92.5	188	18	<b>\$8985</b>
FCC35L7224HOS	24 x 82 x 28	100	179	18	<b>\$8725</b>
FCC35L7820HOS	20 x 88 x 28	92.5	179	15	<b>\$8454</b>
FCC35L7220HOS	20 x 82 x 28	92.5	170	15	<b>\$8215</b>

Standard with **offset 35" lateral box/file** pedestal on **left**. Model # represents worksurface dimension only.

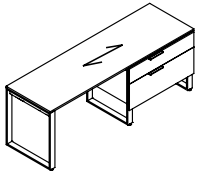

Single Pedestal Credenza - RIGHT

FCC35R7824H	24 x 78 x 28	92.5	188	18	<b>\$8639</b>
FCC35R7224H	24 x 72 x 28	100	179	18	<b>\$8381</b>
FCC35R7820H	20 x 78 x 28	92.5	179	15	<b>\$8106</b>
FCC35R7220H	20 x 72 x 28	92.5	170	15	<b>\$7868</b>

Standard with **flush 35" lateral box/file** pedestal on **right**.

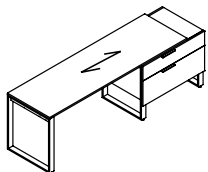

Single Pedestal Credenza - RIGHT

FCC35R7824HOS	24 x 88 x 28	92.5	188	18	<b>\$8985</b>
FCC35R7224HOS	24 x 82 x 28	100	179	18	<b>\$8725</b>
FCC35R7820HOS	20 x 88 x 28	92.5	179	15	<b>\$8454</b>
FCC35R7220HOS	20 x 82 x 28	92.5	170	15	<b>\$8215</b>

Standard with **offset 35" lateral box/file** pedestal on **right**. Model # represents worksurface dimension only.

### Required Specifications

Top finish  
Body finish

### Optional Specifications

Grommet

**SINGLE PEDESTAL CREDENZAS**

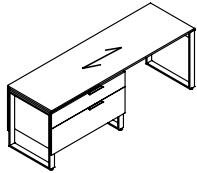

**Single Pedestal Credenza - LEFT**

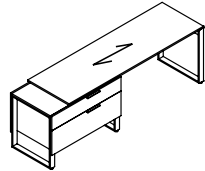

**Single Pedestal Credenza - LEFT**

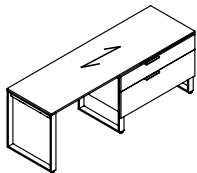

**Single Pedestal Credenza - RIGHT**

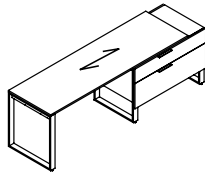

**Single Pedestal Credenza - RIGHT**

MODEL#	DIMENSIONS D x W x H	FREIGHT CLASS	WT/LBS.	CUBIC FT.	LIST PRICE
FCC40L7824H	24 x 78 x 28	100	198	20	<b>\$8939</b>
FCC40L7224H	24 x 72 x 28	100	189	20	<b>\$9029</b>
FCC40L7820H	20 x 78 x 28	92.5	188	17	<b>\$8493</b>
FCC40L7220H	20 x 72 x 28	92.5	179	17	<b>\$8252</b>

Standard with **flush 40" lateral box/file** pedestal on **left**.

FCC40L7824HOS	24 x 88 x 28	100	198	20	<b>\$9284</b>
FCC40L7224HOS	24 x 82 x 28	100	189	20	<b>\$9029</b>
FCC40L7820HOS	20 x 88 x 28	92.5	188	17	<b>\$8837</b>
FCC40L7220HOS	20 x 82 x 28	92.5	179	17	<b>\$8599</b>

Standard with **offset 40" lateral box/file** pedestal on **left**. Model # represents worksurface dimension only.

FCC40R7824H	24 x 78 x 28	100	198	20	<b>\$8939</b>
FCC40R7224H	24 x 72 x 28	100	189	20	<b>\$9029</b>
FCC40R7820H	20 x 78 x 28	92.5	188	17	<b>\$8493</b>
FCC40R7220H	20 x 72 x 28	92.5	179	17	<b>\$8252</b>

Standard with **flush 40" lateral box/file** pedestal on **right**.

FCC40R7824HOS	24 x 88 x 28	100	198	20	<b>\$9284</b>
FCC40R7224HOS	24 x 82 x 28	100	189	20	<b>\$9029</b>
FCC40R7820HOS	20 x 88 x 28	92.5	188	17	<b>\$8837</b>
FCC40R7220HOS	20 x 82 x 28	92.5	179	17	<b>\$8599</b>

Standard with **offset 40" lateral box/file** pedestal on **right**. Model # represents worksurface dimension only.

**Required Specifications**

Top finish  
Body finish

**Optional Specifications**

Grommet

## FULL STORAGE CREDENZAS - NOTES

D x W x H

- Horizontal grain direction is standard on all engineered finishes.
- Tops are 3/4" thick with flat edge.
- All pedestals are suspended 7.5" off the floor by an open framed leg, and can be installed flush or offset.
- Handles are standard on all drawer fronts.
- Doors will open with touch latch.
- Units placed on the left have the handle offset from the center to the left, and the lock is placed on the left side panel.
- Units placed on the right have the handle offset from the center to the right, and the lock is placed on the right side panel.
- Units intended to be used with overlapping bridges or returns.
- **NOTE:** Arrow indicates direction of grain

### FULL STORAGE CREDENZAS

MODEL# DIMENSIONS FREIGHT CLASS WT/LBS. CUBIC FT. LIST PRICE

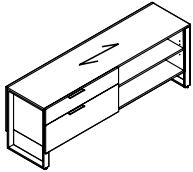

Storage Credenza

FCC7424HO	24 x 74.5 x 26.75	125	203	29	<b>\$7809</b>
FCC6424HO	24 x 64.5 x 26.75	125	186	25	<b>\$6884</b>
FCC7420HO	20 x 74.5 x 26.75	125	187	24	<b>\$7440</b>
FCC6420HO	20 x 64.5 x 26.75	100	171	21	<b>\$6545</b>

Standard with **lateral box/file** on **left** and **open storage** on **right**. Handle and lock on left.

- If using in a freestanding application, must specify modular top.

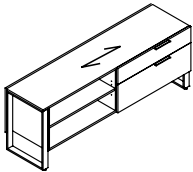

Storage Credenza

FCC7424OH	24 x 74.5 x 26.75	125	203	29	<b>\$7809</b>
FCC6424OH	24 x 64.5 x 26.75	125	186	25	<b>\$6884</b>
FCC7420OH	20 x 74.5 x 26.75	125	187	24	<b>\$7440</b>
FCC6420OH	20 x 64.5 x 26.75	100	171	21	<b>\$6545</b>

Standard with **open storage** on **left** and **lateral box/file** on **right**. Handle and lock on right.

- If using in a freestanding application, must specify modular top.

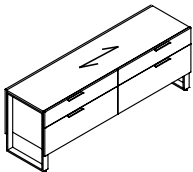

Storage Credenza

FCC7424HH	24 x 74.5 x 26.75	100	265	29	<b>\$8862</b>
FCC6424HH	24 x 64.5 x 26.75	100	238	25	<b>\$7765</b>
FCC7420HH	20 x 74.5 x 26.75	92.5	251	24	<b>\$8440</b>
FCC6420HH	20 x 64.5 x 26.75	92.5	226	21	<b>\$7399</b>

Standard with **lateral box/file** on **left** and **right**. Handles and locks on left and right.

- If using in a freestanding application, must specify modular top.

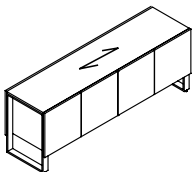

Storage Credenza

FCC7424GG	24 x 74.5 x 26.75	150	171	29	<b>\$7756</b>
FCC6424MM	24 x 64.5 x 26.75	125	152	25	<b>\$7028</b>
FCC7420GG	20 x 74.5 x 26.75	125	153	24	<b>\$7126</b>
FCC6420MM	20 x 64.5 x 26.75	125	136	21	<b>\$6463</b>

Standard with **four doors and adjustable shelves** on **left** and **right**.

- If using in a freestanding application, must specify modular top.

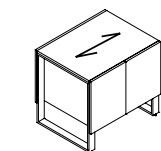

Storage Credenza

FCC3624G	24 x 36 x 26.75	150	171	29	<b>\$4849</b>
FCC3024M	24 x 30 x 26.75	125	152	25	<b>\$4042</b>
FCC3620G	20 x 36 x 26.75	125	153	24	<b>\$4334</b>
FCC3020M	20 x 30 x 26.75	125	136	21	<b>\$3612</b>

Standard with **two doors and adjustable shelves**.

- If using in a freestanding application, must specify modular top.

#### Required Specifications

Top finish  
Body finish

#### Optional Specifications

Grommet

## MODULAR STORAGE - NOTES

D x W x H

- Horizontal grain direction is standard on all engineered finishes.
- All pedestals are suspended 7.5" off the floor by an open framed leg, and can be installed flush or offset
- Pedestals are handed:
  - Left pedestals have the handle offset from the center to the right, and the lock is placed on the right gable
  - Right pedestals have the handle offset from the center to the left, and the lock is placed on the left gable
- All modular pedestals have pre-drilled holes on the top for easy connection to worksurface.
- **NOTE:** Arrow indicates direction of grain

MODULAR STORAGE	MODEL#	DIMENSIONS	FREIGHT CLASS	WT./LBS.	CUBIC FT.	LIST PRICE
-----------------	--------	------------	---------------	----------	-----------	------------

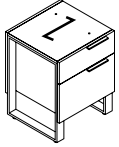

**Box/File Pedestal - LEFT**

F2036BL	36 x 20.5 x 26.75	100	99	11	<b>\$4669</b>
F2030BL	30 x 20.5 x 26.75	100	90	10	<b>\$4449</b>
F2024BL	24 x 20.5 x 26.75	92.5	83	8	<b>\$4192</b>
F2020BL	20 x 20.5 x 26.75	92.5	78	7	<b>\$3988</b>

For use under a freestanding desk or credenza. Top pre-drilled to attach to worksurface. One **box/file** drawer.

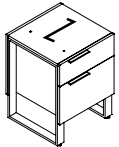

**Box/File Pedestal - RIGHT**

F2036BR	36 x 20.5 x 26.75	100	99	11	<b>\$4669</b>
F2030BR	30 x 20.5 x 26.75	100	90	10	<b>\$4449</b>
F2024BR	24 x 20.5 x 26.75	92.5	83	8	<b>\$4192</b>
F2020BR	20 x 20.5 x 26.75	92.5	78	7	<b>\$3988</b>

For use under a freestanding desk or credenza. Top pre-drilled to attach to worksurface. One **box/file** drawer.

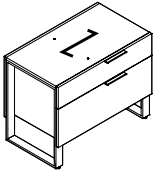

**Lateral Box/File Pedestal - LEFT**

F4024HL	24 x 40 x 26.75	125	121	16	<b>\$5490</b>
F3524HL	24 x 35 x 26.75	125	111	14	<b>\$5186</b>
F4020HL	20 x 40 x 26.75	100	113	13	<b>\$5325</b>
F3520HL	20 x 35 x 26.75	100	104	11	<b>\$4938</b>

For use under a freestanding desk or credenza. Top pre-drilled to attach to worksurface. One **lateral box/file** drawer.

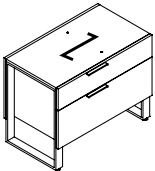

**Lateral Box/File Pedestal - RIGHT**

F4024HR	24 x 40 x 26.75	125	121	16	<b>\$5490</b>
F3524HR	24 x 35 x 26.75	125	111	14	<b>\$5186</b>
F4020HR	20 x 40 x 26.75	100	113	13	<b>\$5325</b>
F3520HR	20 x 35 x 26.75	100	104	11	<b>\$4938</b>

For use under a freestanding desk or credenza. Top pre-drilled to attach to worksurface. One **lateral box/file** drawer.

### Required Specifications

Front finish  
Top/body finish

### Optional Specifications

Grommet

# F FOUNDATIONS

## MODULAR STORAGE

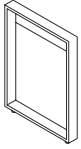

Frame Leg

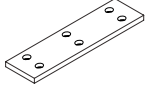

Top Connecting Bracket

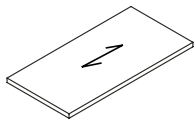

Modular Top\*

MODEL#	DIMENSIONS D x W x H	FREIGHT CLASS	WT/LBS.	CUBIC FT.	LIST PRICE
FLEG36	2.5 x 36 x 27.5	250	6	3	\$1260
FLEG30	2.5 x 30 x 27.5	250	6	3	\$1155
FLEG24	2.5 x 24 x 27.5	250	5	2	\$1070
FLEG20	2.5 x 20 x 27.5	250	5	2	\$979

FCON36	31 x 10 x .75	150	4	1	\$266
FCON30	25 x 10 x .75	150	4	1	\$245
FCON24	19 x 10 x .75	250	3	1	\$240
FCON20	15 x 10 x .75	250	3	1	\$222

F8436T	36 x 84 x 1.5	60	95	3	\$3463
F7836T	36 x 78 x 1.5	65	88	3	\$3222
F7236T	36 x 72 x 1.5	65	82	3	\$2973
F8430T	30 x 84 x 1.5	65	80	3	\$2897
F7830T	30 x 78 x 1.5	65	73	3	\$2701
F7230T	30 x 72 x 1.5	60	67	2	\$2472
F6630T	30 x 66 x 1.5	60	62	2	\$2289
F6030T	30 x 60 x 1.5	65	56	2	\$2088
F5430T	30 x 54 x 1.5	65	51	2	\$1887
F8424T	24 x 84 x 1.5	60	67	2	\$2575
F7824T	24 x 78 x 1.5	60	62	2	\$2390
F7424T	24 x 74 x 1.5	65	58	2	\$2268
F7224T	24 x 72 x 1.5	65	53	2	\$2136
F6624T	24 x 66 x 1.5	65	51	2	\$2055
F6424T	24 x 64 x 1.5	65	49	2	\$1925
F6024T	24 x 60 x 1.5	65	47	2	\$1799
F5424T	24 x 54 x 1.5	70	42	2	\$1668
F4824T	24 x 48 x 1.5	60	38	1	\$1542
F4224T	24 x 42 x 1.5	60	34	1	\$1352
F8420T	20 x 84 x 1.5	60	64	2	\$2371
F7820T	20 x 78 x 1.5	60	60	2	\$2199
F7420T	20 x 74 x 1.5	65	51	2	\$2088
F7220T	20 x 72 x 1.5	65	51	2	\$1961
F6620T	20 x 66 x 1.5	65	49	2	\$1898
F6420T	20 x 64 x 1.5	65	47	2	\$1790
F6020T	20 x 60 x 1.5	65	45	2	\$1663
F5420T	20 x 54 x 1.5	60	40	1	\$1538
F4820T	20 x 48 x 1.5	60	36	1	\$1415
F4220T	20 x 42 x 1.5	60	31	1	\$1239

3/4" top with flat edge. 3/4" subtop inset 2.5" all around. For crossgrain veneer pattern, add (CG) to the end of the product code. When connecting two tops together, a connecting bracket must be specified. Use the width of the smallest top to determine the correct bracket size (i.e. for a 20"D top, order FCON20). Optional grommet may be specified.



**Required Specifications**  
Top finish\*

**Optional Specifications**  
Grommet\*

## FREESTANDING STORAGE - NOTES

D x W x H

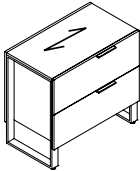
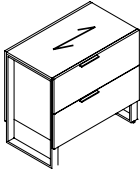
- Horizontal grain direction is standard on all engineered finishes.
- All pedestals are suspended 7.5" off the floor by an open framed leg, and can be installed flush or offset
- Pedestals are handed:
  - Left pedestals have the handle offset from the center to the right, and the lock is placed on the right gable
  - Right pedestals have the handle offset from the center to the left, and the lock is placed on the left gable
- Bench drawers do not come with a handle. They open by pulling the bottom edge of the drawer.
- Cushions will be field installed. On double width benches, the cushion can either be installed left or right.
- On mobile pedestals, the lock will be placed on the right gable.
- **NOTE:** Arrow indicates direction of grain

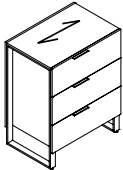
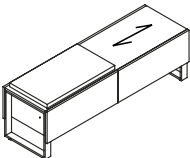
FREESTANDING STORAGE	MODEL#	DIMENSIONS	FREIGHT CLASS	WT./LBS.	CUBIC FT.	LIST PRICE
 <p><b>2H Lateral File Pedestal - LEFT</b></p>	FN3524L	24 x 35 x 32	100	152	17	<b>\$5696</b>
	FN3520L	20 x 35 x 32	100	144	15	<b>\$5420</b>
 <p><b>2H Lateral File Pedestal - RIGHT</b></p>	FN3524R	24 x 35 x 32	100	152	17	<b>\$5696</b>
	FN3520R	20 x 35 x 32	100	144	15	<b>\$5420</b>
 <p><b>3H Lateral File Pedestal - LEFT</b></p>	FN35243L	24 x 35 x 44.5	92.5	220	22	<b>\$7251</b>
	FN35203L	20 x 35 x 44.5	92.5	212	19	<b>\$6929</b>
 <p><b>3H Lateral File Pedestal - RIGHT</b></p>	FN35243R	24 x 35 x 44.5	92.5	220	22	<b>\$7251</b>
	FN35203R	20 x 35 x 44.5	92.5	212	19	<b>\$6929</b>
 <p><b>Bench, Two File Drawers w/Cushion*</b></p>	FBENKK6420	20 x 64.5 x 21	100	167	17	<b>\$6216</b>
<p>With <b>two file drawers</b> and <b>cushion</b>. Standard in grade 2 seating fabric. Locks on left and right.</p>						

### Required Specifications

Front finish  
 Top/body finish  
 Fabric\*

# F FOUNDATIONS

## FREESTANDING STORAGE

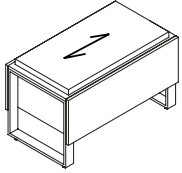

**Bench, One File Drawer w/Cushion**

MODEL#	DIMENSIONS	FREIGHT CLASS	WT/LBS.	CUBIC FT.	LIST PRICE
--------	------------	---------------	---------	-----------	------------

D x W x H

FBENK3520	20 x 35 x 21	92.5	99	9	<b>\$4515</b>
-----------	--------------	------	----	---	---------------

With **one file drawer** and **cushion**. Standard in grade 2 seating fabric. Lock on right.

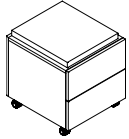

**Mobile Box/Box Pedestal w/Cushion**

F20BMCU	20 x 20.5 x 20.5	70	87	5	<b>\$3066</b>
---------	------------------	----	----	---	---------------

With **two box drawers** and **cushion**. Standard in grade 2 seating fabric. Lock on right. Casters are locking.

### Required Specifications

Front finish  
Top/body finish  
Fabric

## RETURNS - NOTES

D x W x H

- Horizontal grain direction is standard on all engineered finishes.
- Tops are constructed with two 3/4" thick panels, laminated together to create a total thickness of 1.5".
- Returns can be connected to wall credenzas and single pedestal desks
- All pedestals are suspended 7.5" off the floor by an open framed leg, and can be installed flush or offset
- Pedestals are handed:
  - Left pedestals have the handle offset from the center to the right, and the lock is placed on the left gable.
  - Right pedestals have the handle offset from the center to the left, and the lock is placed on the right gable.
- The standard grain direction on return tops is cross grain (**CG**). To remove cross grain veneer pattern on top, delete suffix "**CG**" from the model number (no upcharge)
- One Connecting Bracket is included.
- **NOTE:** Arrow indicates direction of grain

### RETURNS

#### MODEL#

#### DIMENSIONS

#### FREIGHT CLASS

#### WT./LBS.

#### CUBIC FT.

#### LIST PRICE

D x W x H

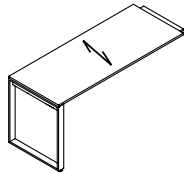

**Executive Return - LEFT**

FERL6624CG	24 x 66 x 28	85	59	4	<b>\$3838</b>
FERL6024CG	24 x 60 x 28	85	55	4	<b>\$3580</b>
FERL5424CG	24 x 54 x 28	85	50	4	<b>\$3384</b>
FERL4824CG	24 x 48 x 28	70	46	3	<b>\$3246</b>
FERL4224CG	24 x 42 x 28	85	42	3	<b>\$2675</b>
FERL6620CG	20 x 66 x 28	85	57	4	<b>\$3489</b>
FERL6020CG	20 x 60 x 28	85	53	4	<b>\$3255</b>
FERL5420CG	20 x 54 x 28	70	48	3	<b>\$3075</b>
FERL4820CG	20 x 48 x 28	85	44	3	<b>\$2951</b>
FERL4220CG	20 x 42 x 28	85	39	3	<b>\$2430</b>

Return has **no pedestal**. For use with right handed single pedestal desks, credenzas, or desk shells.

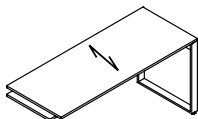

**Executive Return - RIGHT**

FERR6624CG	24 x 66 x 28	85	59	4	<b>\$3838</b>
FERR6024CG	24 x 60 x 28	85	55	4	<b>\$3580</b>
FERR5424CG	24 x 54 x 28	85	50	4	<b>\$3384</b>
FERR4824CG	24 x 48 x 28	70	46	3	<b>\$3246</b>
FERR4224CG	24 x 42 x 28	85	42	3	<b>\$2675</b>
FERR6620CG	20 x 66 x 28	85	57	4	<b>\$3489</b>
FERR6020CG	20 x 60 x 28	85	53	4	<b>\$3255</b>
FERR5420CG	20 x 54 x 28	70	48	3	<b>\$3075</b>
FERR4820CG	20 x 48 x 28	85	44	3	<b>\$2951</b>
FERR4220CG	20 x 42 x 28	85	39	3	<b>\$2430</b>

Return has **no pedestal**. For use with left handed single pedestal desks, credenzas, or desk shells.

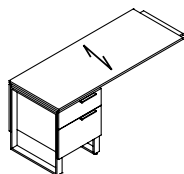

**Executive Return - LEFT**

FERL6624BCG	24 x 66 x 28	85	137	10	<b>\$6405</b>
FERL6024BCG	24 x 60 x 28	85	133	10	<b>\$6157</b>
FERL5424BCG	24 x 54 x 28	85	128	10	<b>\$6024</b>
FERL4824BCG	24 x 48 x 28	85	124	9	<b>\$5897</b>
FERL4224BCG	24 x 42 x 28	85	120	9	<b>\$5711</b>
FERL6620BCG	20 x 66 x 28	85	130	9	<b>\$6102</b>
FERL6020BCG	20 x 60 x 28	85	126	9	<b>\$5867</b>
FERL5420BCG	20 x 54 x 28	70	121	8	<b>\$5739</b>
FERL4820BCG	20 x 48 x 28	85	117	8	<b>\$5618</b>
FERL4220BCG	20 x 42 x 28	85	112	8	<b>\$5441</b>

Return has **flush box/file pedestal** on the **left**. For use with right handed single pedestal desks, credenzas, or desk shells.

#### Required Specifications

Top finish  
Body finish

#### Optional Specifications

Grommet

## EXECUTIVE RETURNS

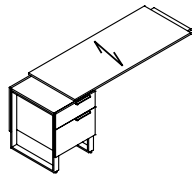

**Executive Return - LEFT**

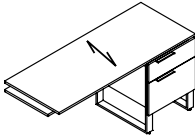

**Executive Return - RIGHT**

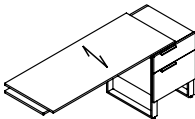

**Executive Return - RIGHT**

MODEL#	DIMENSIONS D x W x H	FREIGHT CLASS	WT/LBS.	CUBIC FT.	LIST PRICE
FERL6624BOSCG	24 x 76 x 28	85	137	10	<b>\$7094</b>
FERL6024BOSCG	24 x 70 x 28	85	133	10	<b>\$6157</b>
FERL5424BOSCG	24 x 64 x 28	85	128	10	<b>\$6024</b>
FERL4824BOSCG	24 x 58 x 28	85	124	9	<b>\$5897</b>
FERL4224BOSCG	24 x 52 x 28	85	120	9	<b>\$5711</b>
FERL6620BOSCG	20 x 76 x 28	85	130	9	<b>\$6447</b>
FERL6020BOSCG	20 x 70 x 28	85	126	9	<b>\$5867</b>
FERL5420BOSCG	20 x 64 x 28	70	121	8	<b>\$5739</b>
FERL4820BOSCG	20 x 58 x 28	85	117	8	<b>\$5618</b>
FERL4220BOSCG	20 x 52 x 28	85	112	8	<b>\$5441</b>

Return has **offset box/file pedestal** on the **left**. For use with right handed single pedestal desks, credenzas, or desk shells.  
Model # represents worksurface dimension only.

FERR6624BCG	24 x 66 x 28	85	137	10	<b>\$6405</b>
FERR6024BCG	24 x 60 x 28	85	133	10	<b>\$6157</b>
FERR5424BCG	24 x 54 x 28	85	128	10	<b>\$6024</b>
FERR4824BCG	24 x 48 x 28	85	124	9	<b>\$5897</b>
FERR4224BCG	24 x 42 x 28	85	120	9	<b>\$5711</b>
FERR6620BCG	20 x 66 x 28	85	130	9	<b>\$6102</b>
FERR6020BCG	20 x 60 x 28	85	126	9	<b>\$5867</b>
FERR5420BCG	20 x 54 x 28	70	121	8	<b>\$5739</b>
FERR4820BCG	20 x 48 x 28	85	117	8	<b>\$5618</b>
FERR4220BCG	20 x 42 x 28	85	112	8	<b>\$5441</b>

Return has **flush box/file pedestal** on the **right**. For use with left-handed single pedestal desks, credenzas, or desk shells.

FERR6624BOSCG	24 x 76 x 28	85	137	10	<b>\$7094</b>
FERR6024BOSCG	24 x 70 x 28	85	133	10	<b>\$6157</b>
FERR5424BOSCG	24 x 64 x 28	85	128	10	<b>\$6024</b>
FERR4824BOSCG	24 x 58 x 28	85	124	9	<b>\$5897</b>
FERR4224BOSCG	24 x 52 x 28	85	120	9	<b>\$5711</b>
FERR6620BOSCG	20 x 76 x 28	85	130	9	<b>\$6447</b>
FERR6020BOSCG	20 x 70 x 28	85	126	9	<b>\$5867</b>
FERR5420BOSCG	20 x 64 x 28	70	121	8	<b>\$5739</b>
FERR4820BOSCG	20 x 58 x 28	85	117	8	<b>\$5618</b>
FERR4220BOSCG	20 x 52 x 28	85	112	8	<b>\$5441</b>

Return has **offset box/file pedestal** on the **right**. For use with left-handed single pedestal desks, credenzas, or desk shells.  
Model # represents worksurface dimension only.

### Required Specifications

Top finish  
Body finish

### Optional Specifications

Grommet

DESKS	MODEL#	DIMENSIONS	FREIGHT CLASS	WT/LBS.	CUBIC FT.	LIST PRICE
-------	--------	------------	---------------	---------	-----------	------------

D x W x H

- Horizontal grain direction is standard on all engineered finishes.
- Tops are constructed with two 3/4" thick panels, laminated together to create a total thickness of 1.5".
- All pedestals are suspended 7.5" off the floor by an open framed leg, and can be installed flush or offset
- The standard grain direction on Bridge tops is cross grain (**CG**). To remove cross grain veneer pattern on top, delete suffix "**CG**" from the model number (no upcharge)
- Two Connecting Brackets are included.
- GM5K (Tungsten) TC grommet location is standard
- **NOTE:** Arrow indicates direction of grain

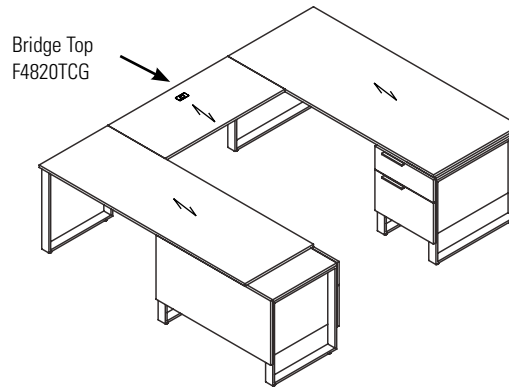

BRIDGES	MODEL#	DIMENSIONS	FREIGHT CLASS	WT/LBS.	CUBIC FT.	LIST PRICE
---------	--------	------------	---------------	---------	-----------	------------

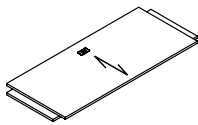

**Bridge Top**

FBT6624CG	24 x 66 x 1.5	65	57	2	<b>\$3067</b>
FBT6024CG	24 x 60 x 1.5	65	53	2	<b>\$2810</b>
FBT5424CG	24 x 54 x 1.5	65	48	2	<b>\$2665</b>
FBT4824CG	24 x 48 x 1.5	60	44	1	<b>\$2162</b>
FBT4224CG	24 x 42 x 1.5	60	40	1	<b>\$1960</b>
FBT6620CG	20 x 66 x 1.5	65	55	2	<b>\$2788</b>
FBT6020CG	20 x 60 x 1.5	65	51	2	<b>\$2552</b>
FBT5420CG	20 x 54 x 1.5	60	46	1	<b>\$2428</b>
FBT4820CG	20 x 48 x 1.5	60	42	1	<b>\$1960</b>
FBT4220CG	20 x 42 x 1.5	60	37	1	<b>\$1780</b>

Top surface only to create a "U" configuration with a single pedestal desk or credenza. **Cannot be used with corners.** Grommet in worksurface. Shipped RTA (ready to assemble).

**Required Specifications**  
Top finish

**Optional Specifications**  
Grommet

# F FOUNDATIONS

## WALL-MOUNTED STORAGE - NOTES

D x W x H

- Horizontal grain direction is standard on all engineered finishes.
- Wall Mount Overheads have a 2" deep valance on top and bottom and it can accommodate LED or T5 lighting in either location
- Tackboards are installed flush.
- Standard Heights for Tackboards are:
  - 19.2" (overall height above worksurface = 36.5")
  - 26" (overall height above worksurface = 42.5")
- **NOTE:** Arrow indicates direction of grain

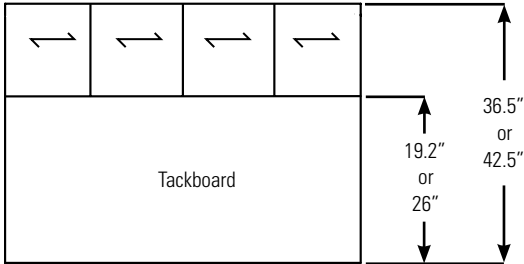

WALL-MOUNTED STORAGE	MODEL#	DIMENSIONS	FREIGHT CLASS	WT/LBS.	CUBIC FT.	LIST PRICE
----------------------	--------	------------	---------------	---------	-----------	------------

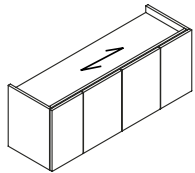

Wall Mount Storage w/Doors

FSF74	15 x 74.5 x 18.5	125	103	13	<b>\$4158</b>
FSF72	15 x 72 x 18.5	100	101	12	<b>\$3990</b>
FSF66	15 x 66 x 18.5	100	94	11	<b>\$3752</b>
FSF64	15 x 64.5 x 18.5	100	92	11	<b>\$3674</b>
FSF60	15 x 60 x 18.5	100	87	10	<b>\$3519</b>
FSF54	15 x 54 x 18.5	100	80	9	<b>\$3353</b>
FSF48	15 x 48 x 18.5	100	74	8	<b>\$3049</b>

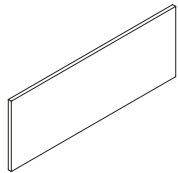

Wall Mount Tackboard\*

FTS74H26	.75 x 74.5 x 26	100	17	2	<b>\$1260</b>
FTS72H26	.75 x 72 x 26	70	16	1	<b>\$1163</b>
FTS66H26	.75 x 66 x 26	85	14	1	<b>\$1070</b>
FTS64H26	.75 x 64.5 x 26	85	13	1	<b>\$1036</b>
FTS60H26	.75 x 60 x 26	85	13	1	<b>\$969</b>
FTS54H26	.75 x 54 x 26	85	13	1	<b>\$874</b>
FTS48H26	.75 x 48 x 26	85	13	1	<b>\$777</b>
FTS74	.75 x 74.5 x 19.2	85	13	1	<b>\$968</b>
FTS72	.75 x 72 x 19.2	85	12	1	<b>\$894</b>
FTS66	.75 x 66 x 19.2	92.5	11	1	<b>\$815</b>
FTS64	.75 x 64.5 x 19.2	92.5	11	1	<b>\$774</b>
FTS60	.75 x 60 x 19.2	92.5	10	1	<b>\$745</b>
FTS54	.75 x 54 x 19.2	92.5	10	1	<b>\$675</b>
FTS48	.75 x 48 x 19.2	92.5	10	1	<b>\$601</b>

### Required Specifications

Front finish  
Top/body finish  
Fabric\*

## WORK WALLS - NOTES

D x W x H

- Horizontal grain direction is standard on all engineered finishes.
- Tackboards and tasklights must be specified
- When the tackboard option is specified, the price includes a tackboard for each niche of the Work Wall.
- When the Task Light option is specified, the price includes LED Tasklight installed in the top of each niche. If more than one niche is needed in the configuration, remote on/off switch is included for simultaneous operation.
- All Storage Doors open with touch latch
- Side access to open storage or wardrobe - front panels are fixed.
- Standard heights are 26.5", 56", 70" and 84"
- Walls are available in 15" increments starting at 95" (i.e. 110", 125" 140", 155")
- Wall credenzas are only available in 90" width
- Cantilevered storage units are side locking
- For modifications to the wall configurations, size or finish, please contact customer care.

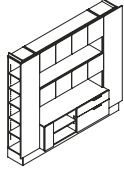
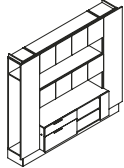
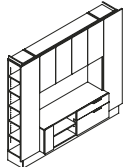
WORK WALLS - 84" H	MODEL#	DIMENSIONS	FREIGHT CLASS	WT/LBS.	CUBIC FT.	LIST PRICE
 <p><b>Work Wall - 95"W</b></p>	FW9584-1L	20 x 95 x 84	100	634	79	<b>\$27605</b>
		Vertical storage with 5 adjustable shelves, 60" wide wall credenza with adjustable shelf and box/file, 60" wide niche, 60" wide single height storage, 60" wide niche, 60" wide single height storage, wardrobe with coat hook and hat shelf.				<ul style="list-style-type: none"> <li>• To add tackboard to niche, add <b>TB</b> to end of product code. <b>Add \$2056</b> to list price for grades 1-3. Add <b>\$2467</b> for grades 4-5.</li> <li>• To add LED light to niche, add <b>LT</b> to end of product code. <b>Add \$2159</b> to list price.</li> </ul>
 <p><b>Work Wall - 95"W</b></p>	FW9584-1R	20 x 95 x 84	100	634	79	<b>\$27605</b>
		Wardrobe with coat hook and hat shelf, 60" wide wall credenza with box/file and adjustable shelf, 60" wide niche, 60" wide single height storage, 60" wide niche, 60" wide single height storage, vertical storage with 5 adjustable shelves.				<ul style="list-style-type: none"> <li>• To add tackboard to niche, add <b>TB</b> to end of product code. <b>Add \$2056</b> to list price for grades 1-3. Add <b>\$2467</b> for grades 4-5.</li> <li>• To add LED light to niche, add <b>LT</b> to end of product code. <b>Add \$2159</b> to list price.</li> </ul>
 <p><b>Work Wall - 95"W</b></p>	FW9584-2L	20 x 95 x 84	125	568	77	<b>\$24269</b>
		Vertical storage with 5 adjustable shelves, 60" wide wall credenza with adjustable shelf and box/file, 60" wide double height niche, 60" wide double height storage, wardrobe with coat hook and hat shelf.				<ul style="list-style-type: none"> <li>• To add tackboard to niche, add <b>TB</b> to end of product code. <b>Add \$1276</b> to list price for grades 1-3. Add <b>\$1532</b> for grades 4-5.</li> <li>• To add LED light to niche, add <b>LT</b> to end of product code. <b>Add \$873</b> to list price.</li> </ul>

### Required Specifications

Front finish  
Top/body finish  
Cubby interior finish

### Optional Specifications

Grommet  
LED light  
Tackboard

## WORK WALLS - 84"H

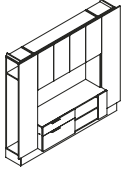

**Work Wall - 95\"/>**

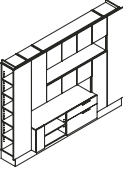

**Work Wall - 110\"/>**

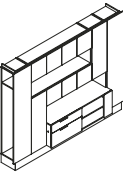

**Work Wall - 110\"/>**

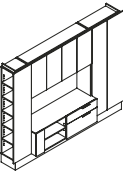

**Work Wall - 110\"/>**

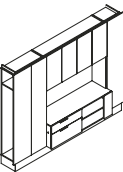

**Work Wall - 110\"/>**

MODEL#	DIMENSIONS	FREIGHT CLASS	WT/LBS.	CUBIC FT.	LIST PRICE
--------	------------	---------------	---------	-----------	------------

D x W x H

FW9584-2R	20 x 95 x 84	125	568	77	<b>\$24269</b>
-----------	--------------	-----	-----	----	----------------

Wardrobe with coat hook and hat shelf, 60" wide wall credenza with box/file and adjustable shelf, 60" wide double height niche, 60" wide double height storage, vertical storage with 5 adjustable shelves.

- To add tackboard to niche, add **TB** to end of product code. **Add \$1276** to list price for grades 1-3. Add **\$1532** for grades 4-5.
- To add LED light to niche, add **LT** to end of product code. **Add \$873** to list price.

FW11084-1L	20 x 110 x 84	100	741	91	<b>\$31430</b>
------------	---------------	-----	-----	----	----------------

Vertical storage with 5 adjustable shelves, 60" wide wall credenza with adjustable shelf and box/file, 60" wide niche, triple height storage, 45" wide single height storage, 60" wide niche, 60" wide single height storage, triple height storage, wardrobe with coat hook and hat shelf.

- To add tackboard to niche, add **TB** to end of product code. **Add \$2050** to list price for grades 1-3. Add **\$2460** for grades 4-5.
- To add LED light to niche, add **LT** to end of product code. **Add \$2162** to list price.

FW11084-1R	20 x 110 x 84	100	741	91	<b>\$31430</b>
------------	---------------	-----	-----	----	----------------

Wardrobe with coat hook and hat shelf, triple height storage, 60" wide niche, 60" wide single height storage, 60" wide wall credenza with box/file and adjustable shelf, 60" wide niche, 45" wide single height storage, triple height storage, vertical storage with 5 adjustable shelves.

- To add tackboard to niche, add **TB** to end of product code. **Add \$2050** to list price for grades 1-3. Add **\$2460** for grades 4-5.
- To add LED light to niche, add **LT** to end of product code. **Add \$2162** to list price.

FW11084-2L	20 x 110 x 84	125	628	88	<b>\$26823</b>
------------	---------------	-----	-----	----	----------------

Vertical storage with 5 adjustable shelves, 60" wide wall credenza with adjustable shelf and box/file, 60" wide double height niche, 60" wide double height storage, double depth wardrobe with coat rod and hat shelf.

- To add tackboard to niche, add **TB** to end of product code. **Add \$1274** to list price for grades 1-3. Add **\$1529** for grades 4-5.
- To add LED light to niche, add **LT** to end of product code. **Add \$873** to list price.

FW11084-2R	20 x 110 x 84	125	628	88	<b>\$26823</b>
------------	---------------	-----	-----	----	----------------

Double depth wardrobe with coat rod and hat shelf, 60" wide wall credenza with adjustable shelf and box/file, 60" wide double height niche, 60" wide double height storage, vertical storage with 5 adjustable shelves.

- To add tackboard to niche, add **TB** to end of product code. **Add \$1274** to list price for grades 1-3. Add **\$1529** for grades 4-5.
- To add LED light to niche, add **LT** to end of product code. **Add \$873** to list price.

### Required Specifications

Front finish  
Top/body finish  
Cubby interior finish

### Optional Specifications

Grommet  
LED light  
Tackboard

**WORK WALLS - 84"H**

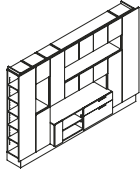

**Work Wall - 125"W**

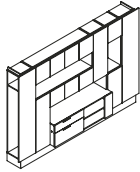

**Work Wall - 125"W**

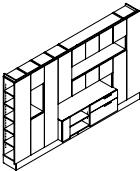

**Work Wall - 140"W**

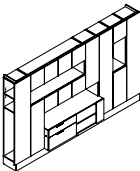

**Work Wall - 140"W**

MODEL#	DIMENSIONS	FREIGHT CLASS	WT/LBS.	CUBIC FT.	LIST PRICE
--------	------------	---------------	---------	-----------	------------

**D x W x H**

FW12584-1L	20 x 125 x 84	100	858	103	<b>\$35286</b>
------------	---------------	-----	-----	-----	----------------

Vertical storage with 5 adjustable shelves, 15" wide double height niche, single height storage, 60" wide wall credenza with adjustable shelf and box/file, 60" wide niche, triple height storage, 45" wide single height storage, 60" wide niche, 60" wide single height storage, triple height storage, wardrobe with coat hook and hat shelf.

- To add tackboard to niche, add **TB** to end of product code. **Add \$2503** to list price for grades 1-3. Add **\$3005** for grades 4-5.
- To add LED light to niche, add **LT** to end of product code. **Add \$2512** to list price.

FW12584-1R	20 x 125 x 84	100	858	103	<b>\$35286</b>
------------	---------------	-----	-----	-----	----------------

Wardrobe with coat hook and hat shelf, triple height storage, 60" wide niche, 60" wide single height storage, 60" wide wall credenza with box/file and adjustable shelf, 60" wide niche, 45" wide single height storage, triple height storage, 15" wide double height niche, single height storage, vertical storage with 5 adjustable shelves.

- To add tackboard to niche, add **TB** to end of product code. **Add \$2503** to list price for grades 1-3. Add **\$3005** for grades 4-5.
- To add LED light to niche, add **LT** to end of product code. **Add \$2512** to list price.

FW14084-1L	20 x 140 x 84	100	936	115	<b>\$38055</b>
------------	---------------	-----	-----	-----	----------------

Vertical storage with 5 adjustable shelves, triple height storage, 15" wide double height niche, single height storage, vertical storage with 5 adjustable shelves, 60" wide wall credenza with adjustable shelf and box/file, 60" wide niche, triple height storage cabinet, 45" wide single height storage, 60" wide niche, 60" wide single height storage, double depth wardrobe with coat rod and two shelves.

- To add tackboard to niche, add **TB** to end of product code. **Add \$2503** to list price for grades 1-3. Add **\$3005** for grades 4-5.
- To add LED light to niche, add **LT** to end of product code. **Add \$2511** to list price.

FW14084-1R	20 x 125 x 84	100	936	115	<b>\$38055</b>
------------	---------------	-----	-----	-----	----------------

Double depth wardrobe with coat rod and two shelves, 60" wide niche, 60" wide single height storage, 60" wide wall credenza with box/file and adjustable shelf, 60" wide niche, 45" wide single height storage, triple height storage, vertical storage with 5 adjustable shelves, triple height storage, 15" wide double height niche, single height storage, vertical storage with 5 adjustable shelves.

- To add tackboard to niche, add **TB** to end of product code. **Add \$2503** to list price for grades 1-3. Add **\$3005** for grades 4-5.
- To add LED light to niche, add **LT** to end of product code. **Add \$2511** to list price.

**Required Specifications**

Front finish  
Top/body finish  
Cubby interior finish

**Optional Specifications**

Grommet  
LED light  
Tackboard

## WORK WALLS - 70"H

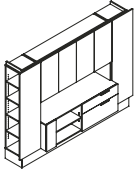

**Work Wall - 95"W**

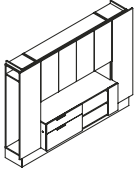

**Work Wall - 95"W**

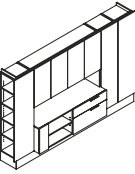

**Work Wall - 110"W**

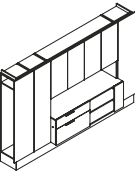

**Work Wall - 110"W**

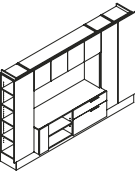

**Work Wall - 110"W**

MODEL#	DIMENSIONS	FREIGHT CLASS	WT./LBS.	CUBIC FT.	LIST PRICE
--------	------------	---------------	----------	-----------	------------

D x W x H

FW9570-1L	20 x 95 x 70	125	523	66	<b>\$23169</b>
-----------	--------------	-----	-----	----	----------------

Vertical storage with 4 adjustable shelves, 60" wide wall credenza with adjustable shelf and box/file, 60" wide niche, 60" wide double height storage, wardrobe with coat hook and hat shelf.

- To add tackboard to niche, add **TB** to end of product code. **Add \$1029** to list price for grades 1-3. Add **\$1236** for grades 4-5.
- To add LED light to niche, add **LT** to end of product code. **Add \$871** to list price.

FW9570-1R	20 x 95 x 70	125	523	66	<b>\$23169</b>
-----------	--------------	-----	-----	----	----------------

Wardrobe with coat hook and hat shelf, 60" wide wall credenza with box/file and adjustable shelf, 60" wide niche, 60" wide double height storage, vertical storage with 4 adjustable shelves.

- To add tackboard to niche, add **TB** to end of product code. **Add \$1029** to list price for grades 1-3. Add **\$1236** for grades 4-5.
- To add LED light to niche, add **LT** to end of product code. **Add \$871** to list price.

FW11070-1L	20 x 110 x 70	100	618	76	<b>\$25296</b>
------------	---------------	-----	-----	----	----------------

Vertical storage with 4 adjustable shelves, 60" wide wall credenza with adjustable shelf and box/file, 60" wide niche, 60" wide double height storage, vertical storage with 4 adjustable shelves, wardrobe with coat hook and hat shelf.

- To add tackboard to niche, add **TB** to end of product code. **Add \$1026** to list price for grades 1-3. Add **\$1231** for grades 4-5.
- To add LED light to niche, add **LT** to end of product code. **Add \$871** to list price.

FW11070-1R	20 x 110 x 70	100	618	76	<b>\$25296</b>
------------	---------------	-----	-----	----	----------------

Wardrobe with coat hook and hat shelf, vertical storage with 4 adjustable shelves, 60" wide wall credenza with box/file and adjustable shelf, 60" wide niche, 60" wide double height storage, vertical storage with 4 adjustable shelves.

- To add tackboard to niche, add **TB** to end of product code. **Add \$1026** to list price for grades 1-3. Add **\$1231** for grades 4-5.
- To add LED light to niche, add **LT** to end of product code. **Add \$871** to list price.

FW11070-2L	20 x 110 x 70	125	586	76	<b>\$23839</b>
------------	---------------	-----	-----	----	----------------

Vertical storage with 4 adjustable shelves, 60" wide wall credenza with adjustable shelf and box/file, 60" wide double height niche, 60" wide single height storage, vertical storage with 4 adjustable shelves, wardrobe with coat hook and hat shelf.

- To add tackboard to niche, add **TB** to end of product code. **Add \$1271** to list price for grades 1-3. Add **\$1526** for grades 4-5.
- To add LED light to niche, add **LT** to end of product code. **Add \$873** to list price.

### Required Specifications

Front finish  
Top/body finish  
Cubby interior finish

### Optional Specifications

Grommet  
LED light  
Tackboard

## WORK WALLS - 70"H

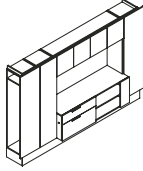

**Work Wall - 110"W**

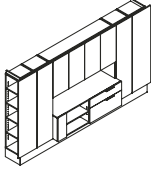

**Work Wall - 125"W**

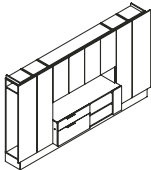

**Work Wall - 125"W**

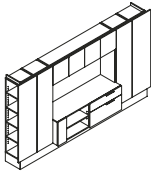

**Work Wall - 125"W**

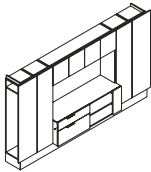

**Work Wall - 125"W**

MODEL#	DIMENSIONS	FREIGHT CLASS	WT/LBS.	CUBIC FT.	LIST PRICE
--------	------------	---------------	---------	-----------	------------

**D x W x H**

FW11070-2R	20 x 110 x 70	125	586	76	<b>\$23839</b>
------------	---------------	-----	-----	----	----------------

Wardrobe with coat hook and hat shelf, vertical storage with 4 adjustable shelves, 60" wide wall credenza with box/file and adjustable shelf, 60" wide double height niche, 60" wide single height storage, vertical storage with 4 adjustable shelves.

- To add tackboard to niche, add **TB** to end of product code. **Add \$1271** to list price for grades 1-3. Add **\$1526** for grades 4-5.
- To add LED light to niche, add **LT** to end of product code. **Add \$873** to list price.

FW12570-1L	20 x 125 x 70	100	713	85	<b>\$26578</b>
------------	---------------	-----	-----	----	----------------

Vertical storage with 4 adjustable shelves, vertical storage with 4 adjustable shelves, 60" wide wall credenza with adjustable shelf and box/file, 60" wide niche, 60" wide double height storage, vertical storage with 4 adjustable shelves, wardrobe with coat hook and hat shelf.

- To add tackboard to niche, add **TB** to end of product code. **Add \$1029** to list price for grades 1-3. Add **\$1236** for grades 4-5.
- To add LED light to niche, add **LT** to end of product code. **Add \$873** to list price.

FW12570-1R	20 x 125 x 70	100	713	85	<b>\$26578</b>
------------	---------------	-----	-----	----	----------------

Wardrobe with coat hook and hat shelf, vertical storage with 4 adjustable shelves, 60" wide wall credenza with box/file and adjustable shelf, 60" wide niche, 60" wide double height storage, vertical storage with 4 adjustable shelves, vertical storage with 4 adjustable shelves.

- To add tackboard to niche, add **TB** to end of product code. **Add \$1029** to list price for grades 1-3. Add **\$1236** for grades 4-5.
- To add LED light to niche, add **LT** to end of product code. **Add \$873** to list price.

FW12570-2L	20 x 125 x 70	100	681	85	<b>\$25117</b>
------------	---------------	-----	-----	----	----------------

Vertical storage with 4 adjustable shelves, vertical storage with 4 adjustable shelves, 60" wide wall credenza with adjustable shelf and box/file, 60" wide double height niche, 60" wide single height storage, vertical storage with 4 adjustable shelves, wardrobe with coat hook and hat shelf.

- To add tackboard to niche, add **TB** to end of product code. **Add \$1274** to list price for grades 1-3. Add **\$1529** for grades 4-5.
- To add LED light to niche, add **LT** to end of product code. **Add \$873** to list price.

FW12570-2R	20 x 125 x 70	100	681	85	<b>\$25117</b>
------------	---------------	-----	-----	----	----------------

Wardrobe with coat hook and hat shelf, vertical storage with 4 adjustable shelves, 60" wide wall credenza with box/file and adjustable shelf, 60" wide double height niche, 60" wide single height storage, vertical storage with 4 adjustable shelves, vertical storage with 4 adjustable shelves.

- To add tackboard to niche, add **TB** to end of product code. **Add \$1274** to list price for grades 1-3. Add **\$1529** for grades 4-5.
- To add LED light to niche, add **LT** to end of product code. **Add \$873** to list price.

**Required Specifications**

Front finish  
Top/body finish  
Cubby interior finish

**Optional Specifications**

Grommet  
LED light  
Tackboard

## WORK WALLS - 70"H

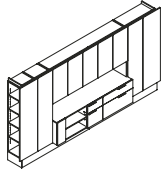

**Work Wall - 140"W**

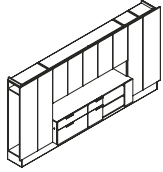

**Work Wall - 140"W**

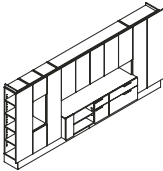

**Work Wall - 155"W**

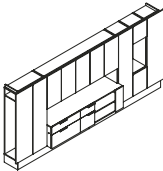

**Work Wall - 155"W**

MODEL#	DIMENSIONS	FREIGHT CLASS	WT/LBS.	CUBIC FT.	LIST PRICE
--------	------------	---------------	---------	-----------	------------

D x W x H

FW14070-1L	20 x 140 x 70	125	750	95	<b>\$28753</b>
------------	---------------	-----	-----	----	----------------

Vertical storage with 4 adjustable shelves, vertical storage with 4 adjustable shelves, 75" wide wall credenza with adjustable shelf, narrow box/file and box file, 75" wide single height niche, 75" wide double height storage, double depth wardrobe with coat rod and hat shelf.

- To add tackboard to niche, add **TB** to end of product code. **Add \$1289** to list price for grades 1-3. Add **\$1547** for grades 4-5.
- To add LED light to niche, add **LT** to end of product code. **Add \$1972** to list price.

FW14070-1R	20 x 140 x 70	125	750	95	<b>\$28753</b>
------------	---------------	-----	-----	----	----------------

Double depth wardrobe with coat rod and hat shelf, 75" wide wall credenza with box/file, narrow box/file and adjustable shelf, 75" wide single height niche, 75" wide double height storage, vertical storage with 4 adjustable shelves, vertical storage with 4 adjustable shelves.

- To add tackboard to niche, add **TB** to end of product code. **Add \$1289** to list price for grades 1-3. Add **\$1547** for grades 4-5.
- To add LED light to niche, add **LT** to end of product code. **Add \$1972** to list price.

FW15570-1L	20 x 155 x 70	125	849	107	<b>\$34732</b>
------------	---------------	-----	-----	-----	----------------

Vertical storage with 4 adjustable shelves, double height storage, 15" wide double height niche, single height storage, vertical storage with 4 adjustable shelves, 75" wide wall credenza with adjustable shelf, narrow box/file and box file, 75" wide niche, 75" wide double height storage, double depth wardrobe with coat rod and hat shelf.

- To add tackboard to niche, add **TB** to end of product code. **Add \$1736** to list price for grades 1-3. Add **\$2084** for grades 4-5.
- To add LED light to niche, add **LT** to end of product code. **Add \$2318** to list price.

FW15570-1R	20 x 155 x 70	125	849	107	<b>\$34732</b>
------------	---------------	-----	-----	-----	----------------

Double depth wardrobe with coat rod and hat shelf, 75" wide wall credenza with box/file, narrow box/file and adjustable shelf, 75" wide niche, 75" wide double height storage, vertical storage with 4 adjustable shelves, double height storage, 15" wide double height niche, single height storage, vertical storage with 4 adjustable shelves.

- To add tackboard to niche, add **TB** to end of product code. **Add \$1736** to list price for grades 1-3. Add **\$2084** for grades 4-5.
- To add LED light to niche, add **LT** to end of product code. **Add \$2318** to list price.

### Required Specifications

Front finish  
Top/body finish  
Cubby interior finish

### Optional Specifications

Grommet  
LED light  
Tackboard

## WORK WALLS - 56"H

MODEL#	DIMENSIONS	FREIGHT CLASS	WT/LBS.	CUBIC FT.	LIST PRICE
--------	------------	---------------	---------	-----------	------------

D x W x H

FW9556-1	20 x 95 x 56	100	488	55	<b>\$21467</b>
----------	--------------	-----	-----	----	----------------

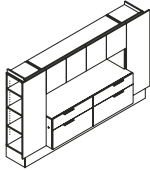

**Work Wall - 95"W**

Vertical storage with 3 adjustable shelves, 60" wide wall credenza with two box/files, 60" wide single height niche, 60" wide single height storage, vertical storage with 3 adjustable shelves.

- To add tackboard to niche, add **TB** to end of product code. **Add \$1028** to list price for grades 1-3. Add **\$1235** for grades 4-5.
- To add LED light to niche, add **LT** to end of product code. **Add \$871** to list price.

FW9556-2	20 x 95 x 56	125	420	55	<b>\$19338</b>
----------	--------------	-----	-----	----	----------------

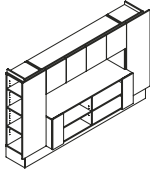

**Work Wall - 95"W**

Vertical storage with 3 adjustable shelves, 60" wide wall open credenza with two adjustable shelves, 60" wide single height niche, 60" wide single height storage, vertical storage with 3 adjustable shelves.

- To add tackboard to niche, add **TB** to end of product code. **Add \$1028** to list price for grades 1-3. Add **\$1235** for grades 4-5.
- To add LED light to niche, add **LT** to end of product code. **Add \$873** to list price.

FW11056-1L	20 x 110 x 56	100	533	63	<b>\$21040</b>
------------	---------------	-----	-----	----	----------------

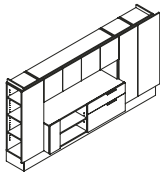

**Work Wall - 110"W**

Vertical storage with 3 adjustable shelves, 60" wide wall credenza with adjustable shelf and box/file, 60" wide niche, 60" wide single height storage, vertical storage with 3 adjustable shelves, wardrobe with coat hook and hat shelf.

- To add tackboard to niche, add **TB** to end of product code. **Add \$1028** to list price for grades 1-3. Add **\$1235** for grades 4-5.
- To add LED light to niche, add **LT** to end of product code. **Add \$871** to list price.

FW11056-1R	20 x 110 x 56	100	533	63	<b>\$21040</b>
------------	---------------	-----	-----	----	----------------

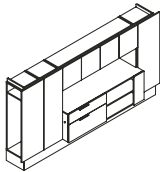

**Work Wall - 110"W**

Wardrobe with coat hook and hat shelf, vertical storage with 3 adjustable shelves, 60" wide wall credenza with box/file and adjustable shelf, 60" wide single height niche, 60" wide single height storage, vertical storage with 3 adjustable shelves.

- To add tackboard to niche, add **TB** to end of product code. **Add \$1028** to list price for grades 1-3. Add **\$1235** for grades 4-5.
- To add LED light to niche, add **LT** to end of product code. **Add \$871** to list price.

FW11056-2L	20 x 110 x 56	100	549	62	<b>\$23168</b>
------------	---------------	-----	-----	----	----------------

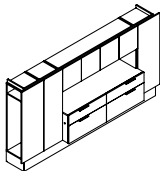

**Work Wall - 110"W**

Wardrobe with coat hook and hat shelf, vertical storage with 3 adjustable shelves, 60" wide wall credenza with two box/files, 60" wide niche, 60" wide single height storage, vertical storage with 3 adjustable shelves.

- To add tackboard to niche, add **TB** to end of product code. **Add \$1028** to list price for grades 1-3. Add **\$1236** for grades 4-5.
- To add LED light to niche, add **LT** to end of product code. **Add \$871** to list price.

### Required Specifications

Front finish  
Top/body finish  
Cubby interior finish

### Optional Specifications

Grommet  
LED light  
Tackboard

**WORK WALLS - 56"H**

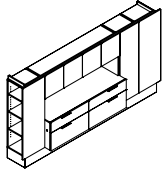

**Work Wall - 110"W\***

MODEL#	DIMENSIONS D x W x H	FREIGHT CLASS	WT/LBS.	CUBIC FT.	LIST PRICE
FW11056-2R	20 x 110 x 56	100	549	62	<b>\$23168</b>

Vertical storage with 3 adjustable shelves, 60" wide wall credenza with two box/files, 60" wide niche, 60" wide single height storage, vertical storage with 3 adjustable shelves, wardrobe with coat hook and hat shelf.

- To add tackboard to niche, add **TB** to end of product code. **Add \$1028** to list price for grades 1-3. Add **\$1236** for grades 4-5.
- To add LED light to niche, add **LT** to end of product code. **Add \$871** to list price.

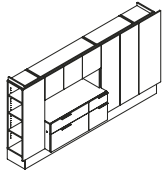

**Work Wall - 110"W\***

FW11056-3L	20 x 110 x 56	100	538	62	<b>\$22960</b>
------------	---------------	-----	-----	----	----------------

Vertical storage with 3 adjustable shelves, 45" wide wall credenza with box/file and narrow box/file, 45" wide niche, 45" wide single height storage, double width vertical storage with 3 adjustable shelves, wardrobe with coat hook and hat shelf.

- To add tackboard to niche, add **TB** to end of product code. **Add \$1031** to list price for grades 1-3. Add **\$1238** for grades 4-5.
- To add LED light to niche, add **LT** to end of product code. **Add \$708** to list price.

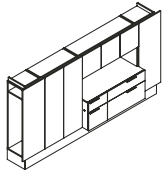

**Work Wall - 110"W\***

FW11056-3R	20 x 110 x 56	100	538	62	<b>\$22960</b>
------------	---------------	-----	-----	----	----------------

Wardrobe with coat hook and hat shelf, double width vertical storage with 3 adjustable shelves, 45" wide wall credenza with narrow box/file and box/file, 45" wide niche, 45" wide single height storage, vertical storage with 3 adjustable shelves.

- To add tackboard to niche, add **TB** to end of product code. **Add \$1031** to list price for grades 1-3. Add **\$1238** for grades 4-5.
- To add LED light to niche, add **LT** to end of product code. **Add \$708** to list price.

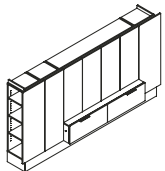

**Work Wall - 110"W**

FW11056-4L	20 x 110 x 56	100	530	61	<b>\$22036</b>
------------	---------------	-----	-----	----	----------------

Vertical storage with 3 adjustable shelves, vertical storage with 3 adjustable shelves, 60" wide single height wall credenza with two files, 60" wide triple height storage with 2 adjustable shelves, wardrobe with coat hook and hat shelf.

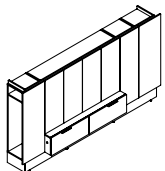

**Work Wall - 110"W**

FW11056-4R	20 x 110 x 56	100	530	61	<b>\$22036</b>
------------	---------------	-----	-----	----	----------------

Wardrobe with coat hook and hat shelf, single height 60" wide wall credenza with two files, 60" wide triple height storage with 2 adjustable shelves, vertical storage with 3 adjustable shelves, vertical storage with 3 adjustable shelves.

**Required Specifications**

Front finish  
Top/body finish  
Cubby interior finish

**Optional Specifications**

Grommet  
LED light\*  
Tackboard\*

## WORK WALLS - 84"H

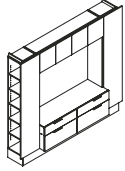

**Work Wall - 95"W**

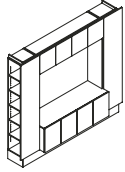

**Work Wall - 95"W**

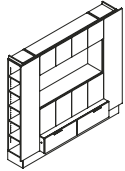

**Work Wall - 95"W**

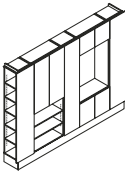

**Work Wall - 110"W**

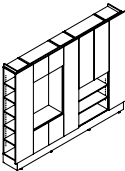

**Work Wall - 110"W**

MODEL#	DIMENSIONS	FREIGHT CLASS	WT/LBS.	CUBIC FT.	LIST PRICE
--------	------------	---------------	---------	-----------	------------

**D x W x H**

FW9584-20	20 x 95 x 84	125	565	77	<b>\$26820</b>
-----------	--------------	-----	-----	----	----------------

Vertical storage with 5 adjustable shelves, 60" wide wall credenza with two box/files, 60" wide triple height niche, 60" wide single height storage, vertical storage with 5 adjustable shelves.

- To add tackboard to niche, add **TB** to end of product code. **Add \$1910** to list price for grades 1-3. Add **\$2292** for grades 4-5.
- To add LED light to niche, add **LT** to end of product code. **Add \$871** to list price.

FW9584-21	20 x 95 x 84	125	512	77	<b>\$24690</b>
-----------	--------------	-----	-----	----	----------------

Vertical storage with 5 adjustable shelves, 60" wide wall credenza with two cabinets with adjustable shelves, 60" wide triple height niche, 60" wide single height storage, vertical storage with 5 adjustable shelves.

- To add tackboard to niche, add **TB** to end of product code. **Add \$1910** to list price for grades 1-3. Add **\$2292** for grades 4-5.
- To add LED light to niche, add **LT** to end of product code. **Add \$874** to list price.

FW9584-22	20 x 95 x 84	125	611	77	<b>\$25754</b>
-----------	--------------	-----	-----	----	----------------

Vertical storage with 5 adjustable shelves, 60" wide single height wall credenza with two files, 60" wide double height storage, 60" wide double height niche, 60" wide single height storage, vertical storage with 5 adjustable shelves.

- To add tackboard to niche, add **TB** to end of product code. **Add \$1271** to list price for grades 1-3. Add **\$1526** for grades 4-5.
- To add LED light to niche, add **LT** to end of product code. **Add \$871** to list price.

FW11084-20L	15 x 110 x 84	125	659	87	<b>\$25226</b>
-------------	---------------	-----	-----	----	----------------

Vertical storage with 5 adjustable shelves, 30" wide triple height open bookcase, 30" wide triple height double width storage, vertical storage with 5 adjustable shelves, 30" wide and double height storage, 30" triple height niche, 30" wide single height storage, vertical storage with 5 adjustable shelves.

- To add tackboard to niche, add **TB** to end of product code. **Add \$956** to list price for grades 1-3. Add **\$1146** for grades 4-5.
- To add LED light to niche, add **LT** to end of product code. **Add \$533** to list price.

FW11084-20R	15 x 110 x 84	125	659	87	<b>\$25226</b>
-------------	---------------	-----	-----	----	----------------

Vertical storage with 5 adjustable shelves, 30" wide double height storage, 30" wide triple height niche, 30" wide single height storage, vertical storage with 5 adjustable shelves, 30" wide triple height open bookcase, 30" wide triple height double width storage, vertical storage with 5 adjustable shelves.

- To add tackboard to niche, add **TB** to end of product code. **Add \$956** to list price for grades 1-3. Add **\$1146** for grades 4-5.
- To add LED light to niche, add **LT** to end of product code. **Add \$533** to list price.

**Required Specifications**

Front finish  
Top/body finish  
Cubby interior finish

**Optional Specifications**

Grommet  
LED light  
Tackboard

## WORK WALLS - 84"H

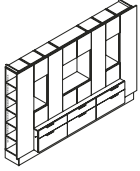

**Work Wall - 125"W**

MODEL#	DIMENSIONS D x W x H	FREIGHT CLASS	WT/LBS.	CUBIC FT.	LIST PRICE
FW12584-20	20 x 125 x 84	100	962	101	<b>\$38990</b>

Vertical storage with 5 adjustable shelves, 90" wide wall credenza with three box/files, single height storage, 15" wide double height niche, single height storage, four-fold height vertical storage with 3 adjustable shelves, double width single height storage, 30" wide double height niche, double width single height storage, fourfold height vertical storage with 3 adjustable shelves, single height storage, 15" wide double height niche, single height storage, vertical storage with 5 adjustable shelves.

- To add tackboard to niche, add **TB** to end of product code. **Add \$1736** to list price for grades 1-3. **Add \$2084** for grades 4-5.
- To add LED light to niche, add **LT** to end of product code. **Add \$1742** to list price.

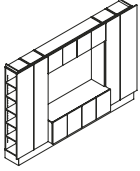

**Work Wall - 125"W**

FW12584-21	20 x 125 x 84	125	738	100	<b>\$29584</b>
------------	---------------	-----	-----	-----	----------------

Vertical storage with 5 adjustable shelves, vertical storage with 5 adjustable shelves, 60" wide wall credenza with two cabinets and adjustable shelf, 60" wide triple height niche, 60" wide single height storage, vertical storage with 5 adjustable shelves, vertical storage with 5 adjustable shelves.

- To add tackboard to niche, add **TB** to end of product code. **Add \$1905** to list price for grades 1-3. **Add \$2287** for grades 4-5.
- To add LED light to niche, add **LT** to end of product code. **Add \$873** to list price.

## WORK WALLS - 70"H

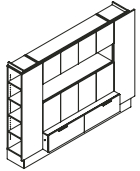

**Work Wall - 95"W**

MODEL#	DIMENSIONS	FREIGHT CLASS	WT/LBS.	CUBIC FT.	LIST PRICE
FW9570-20	20 x 95 x 70	100	563	66	<b>\$23169</b>

Vertical storage with 4 adjustable shelves, 60" wide single height wall credenza with two files, 60" wide double height storage, 60" wide niche, 60" wide single height storage, vertical storage with 4 adjustable shelves.

- To add tackboard to niche, add **TB** to end of product code. **Add \$1029** to list price for grades 1-3. **Add \$1236** for grades 4-5.
- To add LED light to niche, add **LT** to end of product code. **Add \$871** to list price.

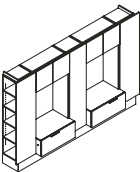

**Work Wall - 110"W**

FW11070-20	20 x 110 x 70	125	602	78	<b>\$26602</b>
------------	---------------	-----	-----	----	----------------

Vertical storage with 4 adjustable shelves, 30" wide single height wall credenza with file, 30" wide triple height niche, 30" wide single height storage, vertical storage with 4 adjustable shelves, 30" wide single height wall credenza with file, 30" wide triple height niche, 30" wide single height storage, vertical storage with 4 adjustable shelves.

- To add tackboard to niche, add **TB** to end of product code. **Add \$1908** to list price for grades 1-3. **Add \$2289** for grades 4-5.
- To add LED light to niche, add **LT** to end of product code. **Add \$1381** to list price.

### Required Specifications

Front finish  
Top/body finish  
Cubby interior finish

### Optional Specifications

Grommet  
LED light  
Tackboard

**WORK WALLS - 70"H**

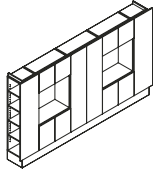

**Work Wall - 125"W**

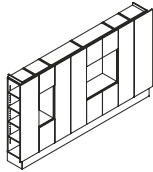

**Work Wall - 125"W**

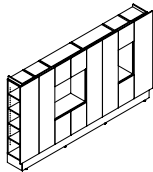

**Work Wall - 125"W**

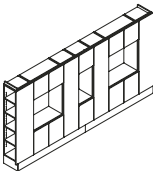

**Work Wall - 140"W**

MODEL#	DIMENSIONS	FREIGHT CLASS	WT/LBS.	CUBIC FT.	LIST PRICE
--------	------------	---------------	---------	-----------	------------

**D x W x H**

FW12570-20	20 x 125 x 70	125	645	84	<b>\$26823</b>
------------	---------------	-----	-----	----	----------------

Vertical storage with 4 adjustable shelves, 30" wide double height storage, 30" wide double height niche, 30" wide single height storage, double width vertical storage with 4 adjustable shelves, 30" wide double height storage, 30" wide double height niche, 30" wide single height storage, vertical storage with 4 adjustable shelves.

- To add tackboard to niche, add **TB** to end of product code. **Add \$1274** to list price for grades 1-3. Add **\$1529** for grades 4-5.
- To add LED light to niche, add **LT** to end of product code. **Add \$1380** to list price.

FW12570-21L	20 x 125 x 70	100	685	84	<b>\$28121</b>
-------------	---------------	-----	-----	----	----------------

Vertical storage with 4 adjustable shelves, 15" wide double height storage, 15" wide double height niche, 15" wide single height storage, double width vertical storage with 4 adjustable shelves, 30" wide double height storage, 30" wide double height niche, 30" wide single height storage, vertical storage with 4 adjustable shelves, vertical storage with 4 adjustable shelves.

- To add tackboard to niche, add **TB** to end of product code. **Add \$871** to list price for grades 1-3. Add **\$1045** for grades 4-5.
- To add LED light to niche, add **LT** to end of product code. **Add \$1045** to list price.

FW12570-21R	20 x 125 x 70	100	685	84	<b>\$28121</b>
-------------	---------------	-----	-----	----	----------------

Vertical storage with 4 adjustable shelves, vertical storage with 4 adjustable shelves, 30" wide double height storage, 30" wide double height niche, 30" wide single height storage, double width vertical storage with 4 adjustable shelves, 15" wide double height storage, 15" wide double height niche, 15" wide single height storage, vertical storage with 4 adjustable shelves.

- To add tackboard to niche, add **TB** to end of product code. **Add \$871** to list price for grades 1-3. Add **\$1045** for grades 4-5.
- To add LED light to niche, add **LT** to end of product code. **Add \$1045** to list price.

FW14070-20	20 x 140 x 70	100	779	96	<b>\$31741</b>
------------	---------------	-----	-----	----	----------------

Vertical storage with 4 adjustable shelves, 30" wide double height storage, 30" wide double height niche, 30" wide single height storage, vertical storage cabinet with 4 adjustable shelves, 15" wide double height storage, 15" wide double height niche, 15" wide single height storage, vertical storage with 4 adjustable shelves, 30" wide double height storage, 30" wide double height niche, 30" wide single height storage, vertical storage with 4 adjustable shelves.

- To add tackboard to niche, add **TB** to end of product code. **Add \$1722** to list price for grades 1-3. Add **\$2066** for grades 4-5.
- To add LED light to niche, add **LT** to end of product code. **Add \$1745** to list price.

**Required Specifications**

Front finish  
Top/body finish  
Cubby interior finish

**Optional Specifications**

Grommet  
LED light  
Tackboard

## WORK WALLS - 70"H

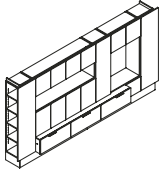

**Work Wall - 140"W**

MODEL#	DIMENSIONS D x W x H	FREIGHT CLASS	WT/LBS.	CUBIC FT.	LIST PRICE
FW14070-21L	20 x 140 x 70	100	832	96	<b>\$31741</b>

Vertical storage with 4 adjustable shelves, 60" wide double height storage, 60" wide niche, 60" wide single height storage, 15" wide triple height storage, 15" wide single height storage, 30" wide double height niche, 30" wide single height storage, 90" wide single height wall credenza with three files, vertical storage with 4 adjustable shelves.

- To add tackboard to niche, add **TB** to end of product code. **Add \$2025** to list price for grades 1-3. Add **\$2431** for grades 4-5.
- To add LED light to niche, add **LT** to end of product code. **Add \$1814** to list price.

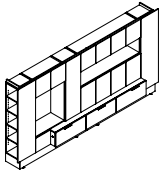

**Work Wall - 140"W**

FW14070-21R	20 x 140 x 70	100	832	96	<b>\$31741</b>
-------------	---------------	-----	-----	----	----------------

Vertical storage with 4 adjustable shelves, 15" wide single height storage, 30" wide double height niche, 30" wide single height storage, 90" wide single height wall credenza with three files, 15" wide triple height storage, 60" wide double height storage, 60" wide niche, 60" wide single height storage, vertical storage with 4 adjustable shelves.

- To add tackboard to niche, add **TB** to end of product code. **Add \$2025** to list price for grades 1-3. Add **\$2431** for grades 4-5.
- To add LED light to niche, add **LT** to end of product code. **Add \$1814** to list price.

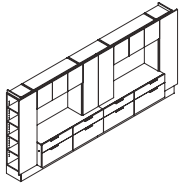

**Work Wall - 155"W**

FW15570-20	20 x 155 x 70	100	900	108	<b>\$31741</b>
------------	---------------	-----	-----	-----	----------------

Vertical storage with 4 adjustable shelves, 60" wide wall credenza with two box/files, 45" wide double height niche, 45" wide single height storage, 30" wide double width storage with 2 adj. shelves, 60" wide wall credenza with two box/files, 45" wide double height niche, 45" wide single height storage, vertical storage with 4 adjustable

- To add tackboard to niche, add **TB** to end of product code. **Add \$2595** to list price for grades 1-3. Add **\$3113** for grades 4-5.
- To add LED light to niche, add **LT** to end of product code. **Add \$1858** to list price.

## WORK WALLS - 84"H

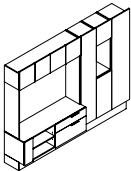

**Work Wall - 107"W**

MODEL#	DIMENSIONS	FREIGHT CLASS	WT/LBS.	CUBIC FT.	LIST PRICE
FW10784L	20 x 95 x 84	100	832	96	<b>\$29442</b>

60" wide wall credenza with adjustable shelf and box/file, 60" wide triple height niche, 60" wide single height storage, vertical storage with 5 adjustable shelves, triple height storage, 15" wide double height niche, single height storage, vertical storage with 5 adjustable shelves.

- To add tackboard to niche, add **TB** to end of product code. **Add \$1298** to list price for grades 1-3. Add **\$1558** for grades 4-5.
- To add LED light to niche, add **LT** to end of product code. **Add \$1298** to list price.

### Required Specifications

Front finish  
Top/body finish  
Cubby interior finish

### Optional Specifications

Grommet  
LED light  
Tackboard

## OPEN KNEE SPACE WORK WALLS

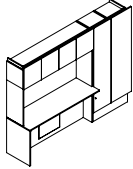

**Open Knee Space Work Wall - 92"W**

MODEL#	DIMENSIONS D x W x H	FREIGHT CLASS	WT/LBS.	CUBIC FT.	LIST PRICE
FW927002R	20 x 92.5 x 84	100	832	96	<b>\$17358</b>

60" wide worksurface wall credenza, 60" wide double height niche, 60" wide single height storage, vertical storage with 4 adjustable shelves, wardrobe with coat hook and hat shelf.

- To add tackboard to niche, add **TB** to end of product code. **Add \$1298** to list price for grades 1-3. Add **\$1558** for grades 4-5.
- To add LED light to niche, add **LT** to end of product code. **Add \$1298** to list price.

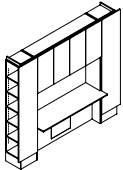

**Open Knee Space Work Wall - 95"W**

FW95840WR	20 x 95 x 84	100	832	96	<b>\$18129</b>
-----------	--------------	-----	-----	----	----------------

Vertical storage with 5 adjustable shelves, 60" wide worksurface wall credenza, 60" wide double height niche, 60" wide double height storage, wardrobe with coat hook and hat shelf.

- To add tackboard to niche, add **TB** to end of product code. **Add \$1298** to list price for grades 1-3. Add **\$1558** for grades 4-5.
- To add LED light to niche, add **LT** to end of product code. **Add \$889** to list price.

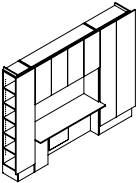

**Open Knee Space Work Wall - 110"W**

FW110840W2R	20 x 110 x 84	100	832	96	<b>\$20763</b>
-------------	---------------	-----	-----	----	----------------

Vertical storage with 5 adjustable shelves, 60" wide worksurface wall credenza, 60" wide double height niche, 60" wide double height storage, double depth wardrobe with coat rod and hat shelf.

- To add tackboard to niche, add **TB** to end of product code. **Add \$1299** to list price for grades 1-3. Add **\$1559** for grades 4-5.
- To add LED light to niche, add **LT** to end of product code. **Add \$894** to list price.

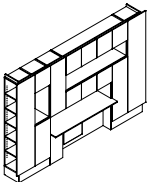

**Open Knee Space Work Wall - 125"W**

FW125840IL	20 x 110 x 84	100	832	96	<b>\$29257</b>
------------	---------------	-----	-----	----	----------------

Vertical storage with 5 adjustable shelves, triple height storage, 15" wide triple height storage, 15" wide double height niche, single high storage, 60" wide worksurface wall credenza, 60" wide single height niche, triple height storage, 45" wide single height storage, 60" wide single height niche, 60" wide single height storage, triple height storage, wardrobe with coat hook and hat shelf.

- To add tackboard to niche, add **TB** to end of product code. **Add \$2554** to list price for grades 1-3. Add **\$3067** for grades 4-5.
- To add LED light to niche, add **LT** to end of product code. **Add \$2563** to list price.

### Required Specifications

Front finish  
Top/body finish  
Cubby interior finish

### Optional Specifications

Grommet  
LED light  
Tackboard

# F FOUNDATIONS

## WORK WALL CREDENZAS

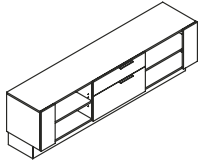

**Work Wall Credenza**

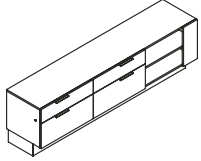

**Work Wall Credenza**

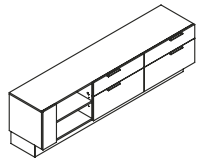

**Work Wall Credenza**

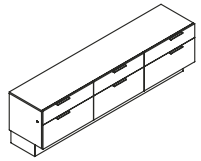

**Work Wall Credenza**

MODEL#	DIMENSIONS	FREIGHT CLASS	WT/LBS.	CUBIC FT.	LIST PRICE
--------	------------	---------------	---------	-----------	------------

**D x W x H**

FW9026-1	20 x 90 x 26	100	254	27	<b>\$10008</b>
----------	--------------	-----	-----	----	----------------

Standard with adjustable shelf, box/file and adjustable shelf.

FW9026-2	20 x 90 x 26	92.5	270	27	<b>\$10435</b>
----------	--------------	------	-----	----	----------------

Standard with box/file, box/file and adjustable shelf.

FW9026-3	20 x 90 x 26	92.5	270	27	<b>\$10735</b>
----------	--------------	------	-----	----	----------------

Standard with adjustable shelf, box/file and box/file.

FW9026-4	20 x 90 x 26	92.5	310	27	<b>\$11071</b>
----------	--------------	------	-----	----	----------------

Standard with three box/file drawers. Center pedestal does not lock.

**Required Specifications**

Front finish  
Top/body finish

**Optional Specifications**

Grommet

CONFERENCE ROOM FURNITURE - NOTES

D x W x H

- Horizontal grain direction is standard on all engineered finishes.
- Full Storage Credenza backs include GM17 vertical cut out
- Optional decorative credenza back panels (**FBP**) are available as a factory installed upgrade on FC/FCD models only.
- Doors open with touch latch
- To open the drawer, pull drawer front overhang - no handles available
- Display Wall can be purchased with optional monitor mount installed
- Mobile and stationary lecterns are available.
- Two Connecting Brackets are included.
- **Metal Leg finishes (conference furniture):**
  - BLKT Black Textured
  - TUNT Tungsten Textured
  - DWTT Designer White Textured
- **NOTE:** Arrow indicates direction of grain

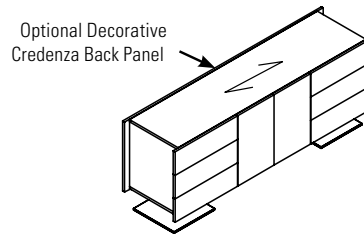

CONFERENCE ROOM FURNITURE      MODEL#      DIMENSIONS      FREIGHT CLASS      WT./LBS.      CUBIC FT.      LIST PRICE

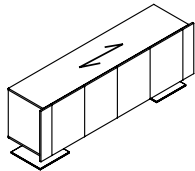

**Full Storage Credenza**

FC9020GG	20 x 90 x 29	125	241	36	<b>\$11284</b>
FC8420GG	20 x 84 x 29	125	232	33	<b>\$10837</b>
FC7820GG	20 x 78 x 29	125	223	31	<b>\$10059</b>
FC7220GG	20 x 72 x 29	125	213	29	<b>\$9787</b>
FC6020MM	20 x 60 x 29	125	194	26	<b>\$9083</b>

Standard with two sets of storage cabinets.

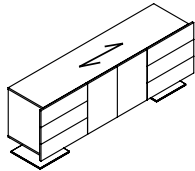

**Full Storage Credenza**

FCD9020A	20 x 90 x 29	125	249	36	<b>\$11956</b>
FCD8420A	20 x 84 x 29	125	240	33	<b>\$11512</b>
FCD7820A	20 x 78 x 29	125	230	31	<b>\$10689</b>
FCD7220A	20 x 72 x 29	125	221	29	<b>\$10459</b>
FCD6020A	20 x 60 x 29	125	202	26	<b>\$9763</b>

Standard with three box drawers on left, storage cabinets in center, and three box drawers on right.

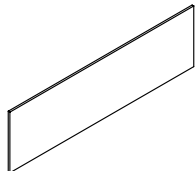

**Decorative Back Panel**

FBP9020	20 x 90 x 29	92.5	41	4	<b>\$1924</b>
FBP8420	20 x 84 x 29	100	38	4	<b>\$1827</b>
FBP7820	20 x 78 x 29	85	36	3	<b>\$1701</b>
FBP7220	20 x 72 x 29	92.5	33	3	<b>\$1482</b>
FBP6020	20 x 60 x 29	100	27	3	<b>\$1254</b>

For FC/FCD credenza models only. Not sold individually. Must be ordered as an upgrade option only.

**Required Specifications**

- Front finish
- Top/body finish
- Leg finish

## CONFERENCE ROOM FURNITURE

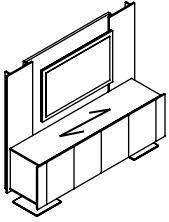

**Display Wall Storage Credenza**

MODEL#	DIMENSIONS D x W x H	FREIGHT CLASS	WT/LBS.	CUBIC FT.	LIST PRICE
FC9024GGTWH72	24 x 90 x 72	100	463	47	<b>\$17489</b>
FC8424GGTWH72	24 x 84 x 72	92.5	460	45	<b>\$16659</b>
FC7824GGTWH72	24 x 78 x 72	125	286	41	<b>\$15471</b>
FC7224GGTWH72	24 x 72 x 72	92.5	418	39	<b>\$15004</b>
FC9024GGTWH66	24 x 90 x 66	100	444	48	<b>\$16882</b>
FC8424GGTWH66	24 x 84 x 66	100	422	45	<b>\$16218</b>
FC7824GGTWH66	24 x 78 x 66	100	402	42	<b>\$15057</b>
FC7224GGTWH66	24 x 72 x 66	100	381	39	<b>\$14592</b>

With two sets of storage cabinets and display wall. Monitors and TV mounts are not included. Display wall includes GM1 grommet.

Monitor size chart based on display wall size:

Display Wall Width	Monitor Size
90"	54"
84"	50"
78"	46"
72"	42"

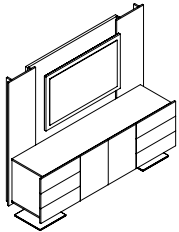

**Display Wall Storage Credenza**

FCD9024ATWH72	24 x 90 x 72	92.5	481	48	<b>\$17757</b>
FCD8424ATWH72	24 x 84 x 72	92.5	460	45	<b>\$16929</b>
FCD7824ATWH72	24 x 78 x 72	92.5	439	42	<b>\$14121</b>
FCD7224ATWH72	24 x 72 x 72	100	381	39	<b>\$15223</b>
FCD9024ATWH66	24 x 90 x 66	100	444	48	<b>\$17153</b>
FCD8424ATWH66	24 x 84 x 66	100	422	45	<b>\$16486</b>
FCD7824ATWH66	24 x 78 x 66	100	402	42	<b>\$15330</b>
FCD7224ATWH66	24 x 72 x 66	100	381	39	<b>\$14863</b>

With three box drawers on left, storage cabinets in center, and three box drawers on right, and display wall. Monitors and TV mounts are not included. Display wall includes GM1 grommet.

Monitor size chart based on display wall size:

Display Wall Width	Monitor Size
90"	54"
84"	50"
78"	46"
72"	42"

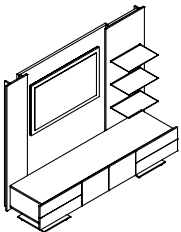

**Display Wall Storage Credenza**

FFTWA90WH72	24 x 90 x 72	92.5	482	41	<b>\$18588</b>
FFTWA84WH72	24 x 84 x 72	85	462	38	<b>\$17953</b>
FFTWA78WH72	24 x 78 x 72	85	442	35	<b>\$17026</b>
FFTWA72WH72	24 x 72 x 72	85	421	32	<b>\$16007</b>
FFTWA90WH66	24 x 90 x 66	92.5	462	40	<b>\$17985</b>
FFTWA84WH66	24 x 84 x 66	92.5	443	37	<b>\$17349</b>
FFTWA78WH66	24 x 78 x 66	85	424	34	<b>\$16458</b>
FFTWA72WH66	24 x 72 x 66	85	404	31	<b>\$15535</b>

With two box drawers on left, storage cabinets in center, and two box drawers on right, and display wall with shelves. Monitors and TV mounts are not included. Display wall includes GM1 grommet.

Monitor size chart based on display wall size:

Display Wall Width	Monitor Size
90"	54"
84"	50"
78"	46"
72"	42"

### Required Specifications

Front/wall finish  
Top/body finish  
Leg finish

## CONFERENCE ROOM ACCESSORIES

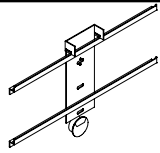

**Flat Screen Monitor Mount**

MODEL#	DIMENSIONS	FREIGHT CLASS	WT/LBS.	CUBIC FT.	LIST PRICE
FVMED	D x W x H 2 x 28 x 17	70	14	0.7	<b>\$783</b>

Flat screen monitor mount up to 50". To be used on Foundations display wall storage credenzas. GM1K (tungsten) grommet on the back panel is included.

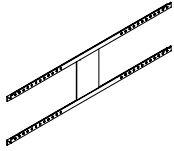

**Flat Screen Monitor Mount**

FVLRG	2 x 38 x 21	60	25	0.75	<b>\$651</b>
-------	-------------	----	----	------	--------------

Flat screen monitor mount for over 50". To be used on Foundations display wall storage credenzas.

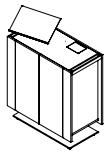

**Lectern**

FLEC36	20 x 36 x 42	125	166	22	<b>\$10800</b>
--------	--------------	-----	-----	----	----------------

With pop-up door to reveal concealed power/data monument (power duplex, 15 pin VGA, data and telephone connectors). Metal finish on base, book rest and handles must be specified. Includes 1 adjustable shelf.

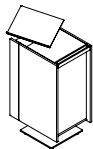

**Lectern**

FLEC24	20 x 24 x 42	100	135	15	<b>\$8911</b>
--------	--------------	-----	-----	----	---------------

With laptop pull-out tray to reveal concealed power/data monument (power duplex, 15 pin VGA, data and telephone connectors). Metal finish on base, book rest and handles must be specified. Includes 1 adjustable shelf.

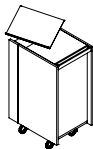

**Mobile Lectern**

FLEC24M	20 x 24 x 42	100	135	15	<b>\$6601</b>
---------	--------------	-----	-----	----	---------------

With laptop pull-out tray. Metal finish on base, book rest and handles must be specified. Includes 1 adjustable shelf. Locking casters (Tungsten only).

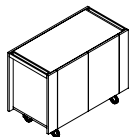

**Mobile Server**

FSM4020	20 x 40 x 30	150	108	21	<b>\$7192</b>
---------	--------------	-----	-----	----	---------------

With cutlery drawer and adjustable shelf. Metal finish on handles must be specified. Locking casters (Tungsten only).

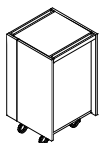

**Mobile Tech Cart**

FTCM2020H42	20 x 20 x 42	150	67	13.5	<b>\$5241</b>
FTCM2020H36	20 x 20 x 36	150	54	10.5	<b>\$4494</b>

Metal finish on handles must be specified. Includes 1 adjustable shelf. Locking casters (Tungsten only).

### Required Specifications

Front finish  
Top/body finish  
Metal finish\*

## BOARDROOM TABLES - NOTES

D x W x H

- Table tops are 1.5" thick with a 2" undercut knife edge.

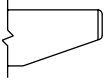

- All tops have a 1/8" (3mm) solid edge of walnut, cherry, maple and oak
- See notes section for optional grommet locations on tables without technology trough
- See "Technology Trough Details" on page 154
- For tables with 3 bases and technology trough, add **C** (for center base feed) or **E** (for end base feed) to the end of the model number (Example: FRESTCT19298**C**)
- Extended leveling capabilities below the top surface; interior column of base can be raised an additional 4" over the 0.5" of leveling glide adjustment at the floor if required. See installation instructions for further information.
- **NOTE:** Arrow indicates direction of grain

### BOARDROOM TABLES - RECTANGULAR

MODEL# DIMENSIONS FREIGHT CLASS WT/LBS. CUBIC FT. LIST PRICE

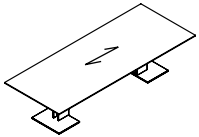

Rectangular Table

FRE12048	48 x 120 x 29	100	450	54	<b>\$15293</b>
FRE9648	48 x 96 x 29	125	390	49	<b>\$13847</b>

One piece top. Two bases.

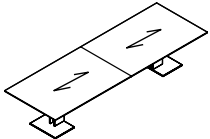

Rectangular Table

FRE16848	48 x 168 x 29	100	571	65	<b>\$18681</b>
FRE14448	48 x 144 x 29	100	511	60	<b>\$16913</b>
FRE12048-2	48 x 120 x 29	100	450	56	<b>\$15495</b>

Two piece top. Two bases.

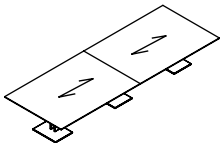

Rectangular Table

FRE24060	60 x 240 x 29	100	965	109	<b>\$29818</b>
FRE21660	60 x 216 x 29	100	893	104	<b>\$28146</b>
FRE19260	60 x 192 x 29	100	821	99	<b>\$26418</b>
FRE16860	60 x 168 x 29	100	748	93	<b>\$24710</b>
FRE21648	48 x 216 x 29	92.5	872	87	<b>\$25829</b>
FRE19248	48 x 192 x 29	100	744	82	<b>\$24295</b>

Two piece top. Three bases.

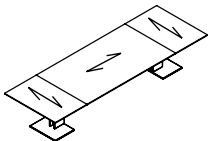

Rectangular Table, Sectional\*

FREST16848	48 x 168 x 29	100	571	65	<b>\$19037</b>
FREST14448	48 x 144 x 29	100	511	60	<b>\$17529</b>
FREST12048	48 x 120 x 29	100	450	54	<b>\$16009</b>

Three piece top. Two bases.

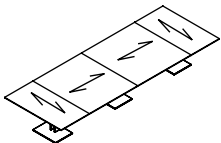

Rectangular Table, Sectional\*

FREST24060	60 x 240 x 29	100	965	109	<b>\$27693</b>
FREST21660	60 x 216 x 29	100	893	104	<b>\$28753</b>
FREST19260	60 x 192 x 29	100	821	99	<b>\$26836</b>
FREST16860	60 x 168 x 29	100	748	93	<b>\$25000</b>
FREST21648	48 x 216 x 29	92.5	872	87	<b>\$26533</b>
FREST19248	48 x 192 x 29	100	744	82	<b>\$24898</b>

Four piece top. Three bases.

- 168"W table - midsection is one piece

#### Required Specifications

Top finish/base side finish  
Base end finish  
Metal finish

#### Optional Specifications

Grommet

## BOARDROOM TABLES - RECTANGULAR

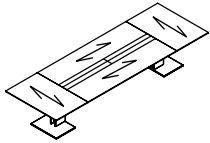

**Rectangular Table, Sectional**

MODEL#	DIMENSIONS	FREIGHT CLASS	WT/LBS.	CUBIC FT.	LIST PRICE
--------	------------	---------------	---------	-----------	------------

**D x W x H**

FRESTCT16848	48 x 168 x 29	100	659	69	<b>\$29049</b>
FRESTCT14448	48 x 144 x 29	100	584	63	<b>\$23273</b>
FRESTCT12048	48 x 120 x 29	100	508	57	<b>\$21576</b>

Four piece top. Two bases / power kit included.

- 168"W table includes technology trough with 8 doors
- 144"W and 120" tables include technology trough with 4 doors

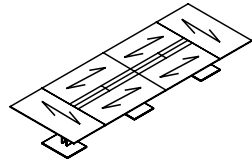

**Rectangular Table, Sectional**

FRESTCT24060	60 x 240 x 29	100	1113	116	<b>\$42464</b>
FRESTCT21660	60 x 216 x 29	100	1021	109	<b>\$40210</b>
FRESTCT19260	60 x 192 x 29	100	920	103	<b>\$37770</b>
FRESTCT16860	60 x 168 x 29	100	836	96	<b>\$35253</b>
FRESTCT21648	48 x 216 x 29	92.5	1000	92	<b>\$38096</b>
FRESTCT19248	48 x 192 x 29	100	843	87	<b>\$35881</b>

Six piece top. Three bases. Add **C** or **E** to end of model number to specify base feed location. Includes technology trough with 8 doors.

- 168"W table - midsection is one piece

## BOARDROOM TABLES - BOW END

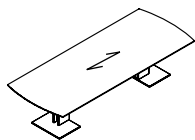

**Bow End Table**

MODEL#	DIMENSIONS	FREIGHT CLASS	WT/LBS.	CUBIC FT.	LIST PRICE
--------	------------	---------------	---------	-----------	------------

FREBE12048	48 x 120 x 29	100	450	54	<b>\$16056</b>
FREBE9648	48 x 96 x 29	125	390	49	<b>\$14539</b>

One piece top. Two bases.

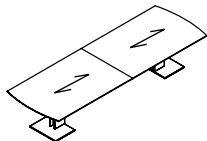

**Bow End Table**

FREBE16848	48 x 168 x 29	100	571	65	<b>\$19611</b>
FREBE14448	48 x 144 x 29	100	511	60	<b>\$17758</b>
FREBE12048-2	48 x 120 x 29	100	450	56	<b>\$16271</b>

Two piece top. Two bases.

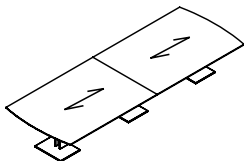

**Bow End Table**

FREBE24060	60 x 240 x 29	100	965	109	<b>\$31307</b>
FREBE21660	60 x 216 x 29	100	893	104	<b>\$29552</b>
FREBE19260	60 x 192 x 29	100	821	99	<b>\$27738</b>
FREBE16860	60 x 168 x 29	100	748	93	<b>\$25945</b>
FREBE21648	48 x 216 x 29	92.5	872	87	<b>\$27120</b>
FREBE19248	48 x 192 x 29	100	744	82	<b>\$25508</b>

Two piece top. Three bases.

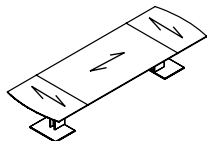

**Bow End Table, Sectional**

FREBEST16848	48 x 168 x 29	100	571	65	<b>\$19991</b>
FREBEST14448	48 x 144 x 29	100	511	60	<b>\$18405</b>
FREBEST12048	48 x 120 x 29	100	450	54	<b>\$16810</b>

Three piece top. Two bases.

### Required Specifications

Top finish/base side finish  
Base end finish  
Metal finish

### Optional Specifications

Grommet

# F FOUNDATIONS

## BOARDROOM TABLES - BOW END

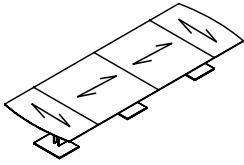

**Bow End Table, Sectional**

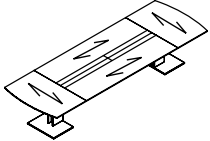

**Bow End Table, Sectional**

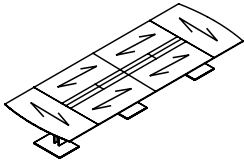

**Bow End Table, Sectional**

MODEL#	DIMENSIONS D x W x H	FREIGHT CLASS	WT/LBS.	CUBIC FT.	LIST PRICE
FREBEST24060	60 x 240 x 29	100	965	109	<b>\$31982</b>
FREBEST21660	60 x 216 x 29	100	893	104	<b>\$30192</b>
FREBEST19260	60 x 192 x 29	100	821	99	<b>\$28179</b>
FREBEST16860	60 x 168 x 29	100	748	93	<b>\$26248</b>
FREBEST21648	48 x 216 x 29	92.5	872	87	<b>\$27861</b>
FREBEST19248	48 x 192 x 29	100	744	82	<b>\$26141</b>

Four piece top. Three bases.  
 • 168"W table - midsection is one piece

FREBESTCT16848	48 x 168 x 29	100	659	69	<b>\$30502</b>
FREBESTCT14448	48 x 144 x 29	100	584	63	<b>\$24434</b>
FREBESTCT12048	48 x 120 x 29	100	508	57	<b>\$22654</b>

Four piece top. Two bases / power kit included.  
 • 168"W table includes technology trough with 8 doors  
 • 144"W and 120" tables include technology trough with 4 doors

FREBESTCT24060	60 x 240 x 29	100	1113	116	<b>\$44585</b>
FREBESTCT21660	60 x 216 x 29	100	1021	109	<b>\$42217</b>
FREBESTCT19260	60 x 192 x 29	100	920	103	<b>\$39659</b>
FREBESTCT16860	60 x 168 x 29	100	836	96	<b>\$37015</b>
FREBESTCT21648	48 x 216 x 29	92.5	1000	92	<b>\$40000</b>
FREBESTCT19248	48 x 192 x 29	100	843	87	<b>\$37673</b>

Six piece top. Three bases. Add **C** or **E** to end of model number to specify base feed location. Includes technology trough with 8 doors.  
 • 168"W table - midsection is one piece

## BOARDROOM TABLES - BOAT SHAPED

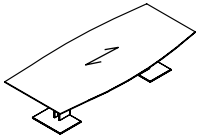

**Boat Shaped Table**

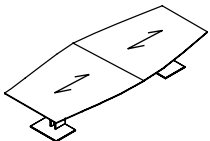

**Boat Shaped Table**

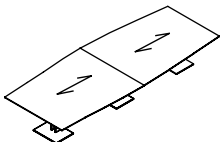

**Boat Shaped Table**

MODEL#	DIMENSIONS	FREIGHT CLASS	WT/LBS.	CUBIC FT.	LIST PRICE
FBO12048	48 x 120 x 29	100	450	54	<b>\$16856</b>
FBO9648	48 x 96 x 29	125	390	49	<b>\$15264</b>

One piece top. Two bases.

FBO16848	48 x 168 x 29	100	571	65	<b>\$20590</b>
FBO14448	48 x 144 x 29	100	511	60	<b>\$18644</b>
FBO12048-2	48 x 120 x 29	100	450	56	<b>\$17081</b>

Two piece top. Two bases.

FBO24060	60 x 240 x 29	100	965	109	<b>\$32871</b>
FBO21660	60 x 216 x 29	100	893	104	<b>\$31028</b>
FBO19260	60 x 192 x 29	100	821	99	<b>\$29124</b>
FBO16860	60 x 168 x 29	100	748	93	<b>\$27237</b>
FBO21648	48 x 216 x 29	92.5	872	87	<b>\$28473</b>
FBO19248	48 x 192 x 29	100	744	82	<b>\$26784</b>

Two piece top. Three bases.

### Required Specifications

Top finish/base side finish  
 Base end finish  
 Metal finish

### Optional Specifications

Grommet

## BOARDROOM TABLES - BOAT SHAPED

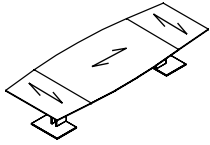

**Boat Shaped Table, Sectional**

MODEL#	DIMENSIONS	FREIGHT CLASS	WT./LBS.	CUBIC FT.	LIST PRICE
--------	------------	---------------	----------	-----------	------------

**D x W x H**

FBOST16848	48 x 168 x 29	100	571	65	<b>\$20991</b>
FBOST14448	48 x 144 x 29	100	511	60	<b>\$19325</b>
FBOST12048	48 x 120 x 29	100	450	54	<b>\$17650</b>

Three piece top. Two bases.

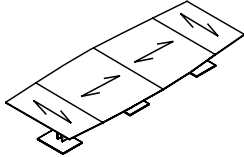

**Boat Shaped Table, Sectional**

FBOST24060	60 x 240 x 29	100	965	109	<b>\$33582</b>
FBOST21660	60 x 216 x 29	100	893	104	<b>\$31700</b>
FBOST19260	60 x 192 x 29	100	821	99	<b>\$29587</b>
FBOST16860	60 x 168 x 29	100	748	93	<b>\$27558</b>
FBOST21648	48 x 216 x 29	92.5	872	87	<b>\$29250</b>
FBOST19248	48 x 192 x 29	100	744	82	<b>\$27447</b>

Four piece top. Three bases.

- 168"W table - midsection is one piece

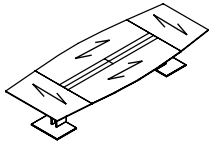

**Boat Shaped Table, Sectional**

FBOSTCT16848	48 x 168 x 29	100	659	69	<b>\$32027</b>
FBOSTCT14448	48 x 144 x 29	100	584	63	<b>\$25652</b>
FBOSTCT12048	48 x 120 x 29	100	508	57	<b>\$23787</b>

Four piece top. Two bases / power kit included.

- 168"W table includes technology trough with 8 doors
- 144"W and 120" tables include technology trough with 4 doors

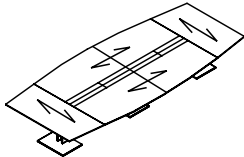

**Boat Shaped Table, Sectional**

FBOSTCT24060	60 x 240 x 29	100	1113	116	<b>\$46812</b>
FBOSTCT21660	60 x 216 x 29	92.5	1021	91	<b>\$44325</b>
FBOSTCT19260	60 x 192 x 29	100	920	103	<b>\$41641</b>
FBOSTCT16860	60 x 168 x 29	100	836	96	<b>\$38863</b>
FBOSTCT21648	48 x 216 x 29	92.5	1000	92	<b>\$41456</b>
FBOSTCT19248	48 x 192 x 29	100	843	87	<b>\$39556</b>

Six piece top. Three bases. Add **C** or **E** to end of model number to specify base feed location. Includes technology trough with 8 doors.

- 168"W table - midsection is one piece

## BOARDROOM TABLES - BOAT SHAPED, BOW END

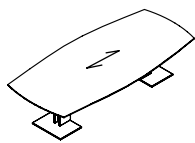

**Boat Shaped Table, Bow End**

MODEL#	DIMENSIONS	FREIGHT CLASS	WT./LBS.	CUBIC FT.	LIST PRICE
--------	------------	---------------	----------	-----------	------------

FBOBE12048	48 x 120 x 29	100	450	54	<b>\$17426</b>
FBOBE9648	48 x 96 x 29	125	390	49	<b>\$15757</b>

One piece top. Two bases.

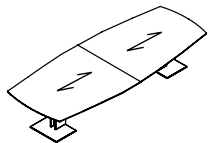

**Boat Shaped Table, Bow End**

FBOBE16848	48 x 168 x 29	100	571	65	<b>\$21347</b>
FBOBE14448	48 x 144 x 29	100	511	60	<b>\$19309</b>
FBOBE12048-2	48 x 120 x 29	100	450	56	<b>\$17664</b>

Two piece top. Two bases.

### Required Specifications

Top finish/base side finish  
Base end finish  
Metal finish

### Optional Specifications

Grommet

# F FOUNDATIONS

## BOARDROOM TABLES - BOAT SHAPED, BOW END

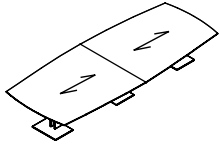

**Boat Shaped Table, Bow End**

MODEL#	DIMENSIONS D x W x H	FREIGHT CLASS	WT/LBS.	CUBIC FT.	LIST PRICE
FBOBE24060	60 x 240 x 29	100	965	109	<b>\$34246</b>
FBOBE21660	60 x 216 x 29	100	893	104	<b>\$32304</b>
FBOBE19260	60 x 192 x 29	100	821	99	<b>\$30309</b>
FBOBE16860	60 x 168 x 29	100	748	93	<b>\$28329</b>
FBOBE21648	48 x 216 x 29	92.5	872	87	<b>\$29622</b>
FBOBE19248	48 x 192 x 29	100	744	82	<b>\$27852</b>

Two piece top. Three bases.

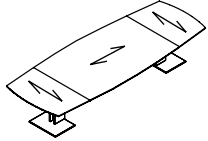

**Boat Shaped Table, Bow End, Sectional**

FBOBEST16848	48 x 168 x 29	100	571	65	<b>\$21767</b>
FBOBEST14448	48 x 144 x 29	100	511	60	<b>\$20020</b>
FBOBEST12048	48 x 120 x 29	100	450	54	<b>\$18249</b>

Three piece top. Two bases.

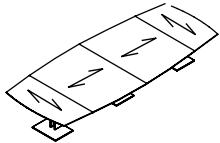

**Boat Shaped Table, Bow End, Sectional**

FBOBEST24060	60 x 240 x 29	100	965	109	<b>\$34992</b>
FBOBEST21660	60 x 216 x 29	100	893	104	<b>\$33011</b>
FBOBEST19260	60 x 192 x 29	100	821	99	<b>\$30513</b>
FBOBEST16860	60 x 168 x 29	100	748	93	<b>\$28667</b>
FBOBEST21648	48 x 216 x 29	92.5	872	87	<b>\$30444</b>
FBOBEST19248	48 x 192 x 29	100	744	82	<b>\$28545</b>

Four piece top. Three bases.

- 168"W table - midsection is one piece

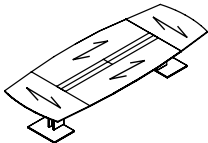

**Boat Shaped Table, Bow End, Sectional**

FBOBESTCT16848	48 x 168 x 29	100	659	69	<b>\$33356</b>
FBOBESTCT14448	48 x 144 x 29	100	584	63	<b>\$26666</b>
FBOBESTCT12048	48 x 120 x 29	100	508	57	<b>\$24704</b>

Four piece top. Two bases / power kit included.

- 168"W table includes technology trough with 8 doors
- 144"W and 120" tables include technology trough with 4 doors

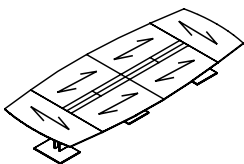

**Boat Shaped Table, Bow End, Sectional**

FBOBESTCT24060	60 x 240 x 29	100	1113	116	<b>\$48881</b>
FBOBESTCT21660	60 x 216 x 29	100	1021	109	<b>\$46270</b>
FBOBESTCT19260	60 x 192 x 29	100	920	103	<b>\$43449</b>
FBOBESTCT16860	60 x 168 x 29	100	836	96	<b>\$40550</b>
FBOBESTCT21648	48 x 216 x 29	92.5	1000	92	<b>\$43259</b>
FBOBESTCT19248	48 x 192 x 29	100	843	87	<b>\$41260</b>

Six piece top. Three bases. Add **C** or **E** to end of model number to specify base feed location. Includes technology trough with 8 doors.

- 168"W table - midsection is one piece

### Required Specifications

Top finish/base side finish  
Base end finish  
Metal finish

### Optional Specifications

Grommet

## BOARDROOM TABLES - RACETRACK

MODEL#	DIMENSIONS	FREIGHT CLASS	WT/LBS.	CUBIC FT.	LIST PRICE
--------	------------	---------------	---------	-----------	------------

D x W x H

FRA12048	48 x 120 x 29	100	450	54	<b>\$17700</b>
FRA9648	48 x 96 x 29	125	390	49	<b>\$16029</b>

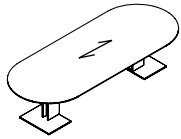

**Racetrack Table**

One piece top. Two bases.

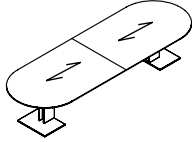

**Racetrack Table**

FRA16848	48 x 168 x 29	100	571	65	<b>\$21618</b>
FRA14448	48 x 144 x 29	100	511	60	<b>\$19575</b>
FRA12048-2	48 x 120 x 29	100	450	56	<b>\$17935</b>

Two piece top. Two bases.

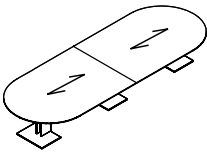

**Racetrack Table**

FRA24060	60 x 240 x 29	100	965	109	<b>\$34516</b>
FRA21660	60 x 216 x 29	100	893	104	<b>\$32576</b>
FRA19260	60 x 192 x 29	100	821	99	<b>\$30580</b>
FRA16860	60 x 168 x 29	100	748	93	<b>\$28597</b>
FRA21648	48 x 216 x 29	92.5	872	87	<b>\$29895</b>
FRA19248	48 x 192 x 29	100	744	82	<b>\$28121</b>

Two piece top. Three bases.

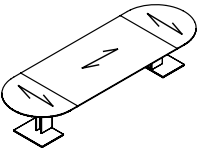

**Racetrack Table, Sectional**

FRAST16848	48 x 168 x 29	100	571	65	<b>\$22034</b>
FRAST14448	48 x 144 x 29	100	511	60	<b>\$20291</b>
FRAST12048	48 x 120 x 29	100	450	54	<b>\$18522</b>

Three piece top. Two bases.

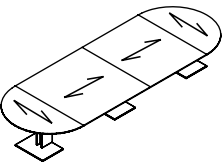

**Racetrack Table, Sectional**

FRAST24060	60 x 240 x 29	100	965	109	<b>\$35261</b>
FRAST21660	60 x 216 x 29	100	893	104	<b>\$33285</b>
FRAST19260	60 x 192 x 29	100	821	99	<b>\$30783</b>
FRAST16860	60 x 168 x 29	100	748	93	<b>\$28937</b>
FRAST21648	48 x 216 x 29	92.5	872	87	<b>\$30714</b>
FRAST19248	48 x 192 x 29	100	744	82	<b>\$28817</b>

Four piece top. Three bases.

- 168"W table - midsection is one piece

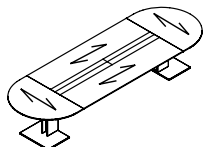

**Racetrack Table, Sectional**

FRASTCT16848	48 x 168 x 29	100	659	69	<b>\$33627</b>
FRASTCT14448	48 x 144 x 29	100	584	63	<b>\$26935</b>
FRASTCT12048	48 x 120 x 29	100	508	57	<b>\$24974</b>

Four piece top. Two bases / power kit included.

- 168"W table includes technology trough with 8 doors
- 144"W and 120" tables include technology trough with 4 doors

### Required Specifications

Top finish/base side finish  
Base end finish  
Metal finish

### Optional Specifications

Grommet

## BOARDROOM TABLES - RACETRACK

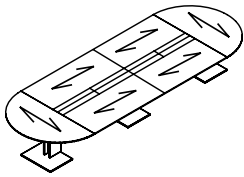

**Racetrack Table, Sectional**

MODEL#	DIMENSIONS D x W x H	FREIGHT CLASS	WT/LBS.	CUBIC FT.	LIST PRICE
FRASCT24060	60 x 240 x 29	100	1113	116	<b>\$49152</b>
FRASCT21660	60 x 216 x 29	100	1021	109	<b>\$46539</b>
FRASCT19260	60 x 192 x 29	100	920	103	<b>\$43721</b>
FRASCT16860	60 x 168 x 29	100	836	96	<b>\$40802</b>
FRASCT21648	48 x 216 x 29	92.5	1000	92	<b>\$43529</b>
FRASCT19248	48 x 192 x 29	100	843	87	<b>\$41533</b>

Six piece top. Three bases. Add **C** or **E** to end of model number to specify base feed location. Includes technology trough with 8 doors.

- 168"W table - midsection is one piece

## BOARDROOM TABLES - WEDGE

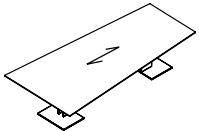

**Wedge Table**

MODEL#	DIMENSIONS	FREIGHT CLASS	WT/LBS.	CUBIC FT.	LIST PRICE
FWE1206048	60-48 x 120 x 29	100	511	60	<b>\$15560</b>

One piece top. Two bases.

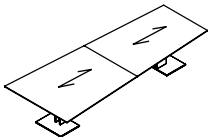

**Wedge Table**

FWE1446048	48 x 144 x 29	100	571	65	<b>\$18950</b>
FWE1206048-2	48 x 120 x 29	100	511	60	<b>\$17183</b>

Two piece top. Two bases.

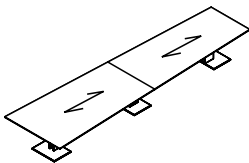

**Wedge Table**

FWE2406048	60-48 x 240 x 29	100	1037	114	<b>\$30089</b>
FWE2166048	60-48 x 216 x 29	100	965	109	<b>\$28414</b>
FWE1926048	60-48 x 192 x 29	100	893	104	<b>\$26687</b>
FWE1686048	60-48 x 168 x 29	100	630	70	<b>\$24977</b>

Two piece top. Three bases.

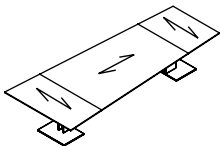

**Wedge Table, Sectional**

FWEST1446048	60-48 x 144 x 29	100	571	65	<b>\$19311</b>
FWEST1206048	60-48 x 120 x 29	100	511	60	<b>\$17803</b>

Three piece top. Two bases.

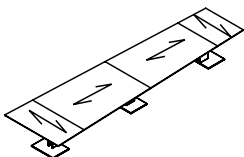

**Wedge Table, Sectional**

FWEST2406048	60-48 x 240 x 29	100	1037	114	<b>\$30194</b>
FWEST2166048	60-48 x 216 x 29	100	965	109	<b>\$29026</b>
FWEST1926048	60-48 x 192 x 29	100	893	104	<b>\$28179</b>
FWEST1686048	60-48 x 168 x 29	100	630	70	<b>\$25269</b>

Four piece top. Three bases.

- 168"W table - midsection is one piece

### Required Specifications

Top finish/base side finish  
Base end finish  
Metal finish

### Optional Specifications

Grommet

## BOARDROOM TABLES - WEDGE

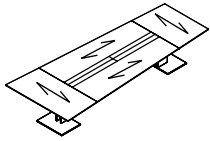

**Wedge Table, Sectional\***

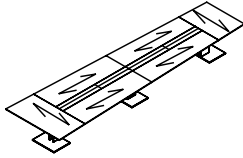

**Wedge Table, Sectional\***

MODEL#	DIMENSIONS	FREIGHT CLASS	WT/LBS.	CUBIC FT.	LIST PRICE
--------	------------	---------------	---------	-----------	------------

**D x W x H**

FWESTCT1446048	60-48 x 144 x 29	100	571	65	<b>\$29332</b>
FWESTCT1206048	60-48 x 120 x 29	100	511	60	<b>\$23542</b>

Four piece top. Two bases / power kit included. Includes technology trough with 4 doors

FWESTCT2406048	60 x 240 x 29	100	1037	114	<b>\$42734</b>
FWESTCT2166048	60 x 216 x 29	100	965	109	<b>\$40478</b>
FWESTCT1926048	60 x 192 x 29	100	893	104	<b>\$37770</b>
FWESTCT1686048	60 x 168 x 29	100	823	99	<b>\$35520</b>

Six piece top. Three bases. Add **C** or **E** to end of model number to specify base feed location. Includes technology trough with 8 doors.

- 168"W table - midsection is one piece

## BOARDROOM TABLES - SQUARE

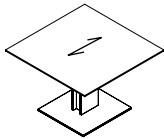

**Square Table**

MODEL#	DIMENSIONS	FREIGHT CLASS	WT/LBS.	CUBIC FT.	LIST PRICE
--------	------------	---------------	---------	-----------	------------

FRE6060	60 x 60 x 29	150	261	44	<b>\$9072</b>
FRE5454	54 x 54 x 29	150	233	42	<b>\$8467</b>
FRE4848	48 x 48 x 29	150	207	40	<b>\$7833</b>
FRE4242	42 x 42 x 29	150	185	39	<b>\$7355</b>

One base. No grommet option available.

## BOARDROOM TABLES - ROUND

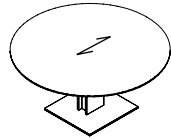

**Round Table**

MODEL#	DIMENSIONS	FREIGHT CLASS	WT/LBS.	CUBIC FT.	LIST PRICE
--------	------------	---------------	---------	-----------	------------

FRO60	60 x 60 x 29	150	261	44	<b>\$9525</b>
FRO54	54 x 54 x 29	150	233	42	<b>\$8891</b>
FRO48	48 x 48 x 29	150	207	40	<b>\$8223</b>
FRO42	42 x 42 x 29	150	185	39	<b>\$7724</b>

One base. No grommet option available.

**Required Specifications**

Top finish/base side finish  
Base end finish  
Metal finish

**Optional Specifications**

Grommet\*

POWER/DATA



Single Sided Recessed Power Block

MODEL#	DIMENSIONS D x W x H	FREIGHT CLASS	WT/LBS.	CUBIC FT.	LIST PRICE
PRTMCS401B	4.22 x 10.78 x 4.86	100	4.3	0.51	<b>\$486</b>
PRTMCS401T	4.22 x 10.78 x 4.86	100	4.3	0.51	<b>\$486</b>
PRTMCS401W	4.22 x 10.78 x 4.86	100	4.3	0.51	<b>\$486</b>

Single-sided recessed power block with **one regular duplex and one telecom knockout on top; one power duplex on bottom**. 10' power cord with straight plug. Specify telecom options separately. Available in Black (**B**), Tungsten (**T**) or Designer White (**W**) as indicated by the last letter of model number. Duplexes always Grey. Corresponding cut-out options are **R1**, **R2** or **R3**. Units are not approved for daisy chaining. UL listed: UL 1363.



Single Sided Recessed Power Block - USB-A + USB-C

PRTMCS421B	4.22 x 10.78 x 4.86	100	4.3	0.51	<b>\$638</b>
PRTMCS421T	4.22 x 10.78 x 4.86	100	4.3	0.51	<b>\$638</b>
PRTMCS421W	4.22 x 10.78 x 4.86	100	4.3	0.51	<b>\$638</b>

Single-sided recessed power block with **one power/USB-A/USB-C duplex and one telecom knockout on top; one power duplex on bottom**. USB-A port charges max 2.4 amps at 5V and USB-C port charges max 3 amps at 5V. 10' power cord with straight plug. Specify telecom options separately. Available in Black (**B**), Tungsten (**T**) or Designer White (**W**) as indicated by the last letter of model number. Duplexes always Grey (duplex with USB ports is glossy finish). Corresponding cut-out options are **R1**, **R2** or **R3**. Units are not approved for daisy chaining. UL listed: UL 1363.



Double Sided Recessed Power Block

PRTMCD602B	6.22 x 10.78 x 4.86	92.5	5.9	0.51	<b>\$555</b>
PRTMCD602T	6.22 x 10.78 x 4.86	92.5	5.9	0.51	<b>\$555</b>
PRTMCD602W	6.22 x 10.78 x 4.86	92.5	5.9	0.51	<b>\$555</b>

Double-sided recessed power block with **two regular power duplexes and two telecom knockouts on top; one power duplex on bottom**. 10' power cord with straight plug. Specify telecom options separately. Available in Black (**B**), Tungsten (**T**) or Designer White (**W**) as indicated by last letter of model number. Duplexes always Grey. Corresponding cut-out options are **T1**, **T2** or **T3**. Units are not approved for daisy chaining. UL listed: UL 1363.



Double Sided Recessed Power Block - USB-A + USB-C

PRTMCD622B	6.22 x 10.78 x 4.86	92.5	6.1	0.51	<b>\$699</b>
PRTMCD622T	6.22 x 10.78 x 4.86	92.5	6.1	0.51	<b>\$699</b>
PRTMCD622W	6.22 x 10.78 x 4.86	92.5	6.1	0.51	<b>\$699</b>

Double-sided recessed power block with **one regular power duplex, one power/USB-A/USB-C duplex and two telecom knockouts on top; one power duplex on bottom**. USB-A port charges max 2.4 amps at 5V and USB-C port charges max 3 amps at 5V. 10' power cord with straight plug. Specify telecom options separately. Available in Black (**B**), Tungsten (**T**) or Designer White (**W**) as indicated by last letter of model number. Duplexes always Grey (duplex with USB ports is glossy finish). Corresponding cut-out options are **T1**, **T2** or **T3**. Units are not approved for daisy chaining. UL listed: UL 1363.



Double Sided Recessed Power Block - USB-A + USB-C

PRTMCD642B	6.22 x 10.78 x 4.86	85	6.3	0.51	<b>\$842</b>
PRTMCD642T	6.22 x 10.78 x 4.86	85	6.3	0.51	<b>\$842</b>
PRTMCD642W	6.22 x 10.78 x 4.86	85	6.3	0.51	<b>\$842</b>

Double-sided recessed power block with **two power/USB-A/USB-C duplexes and two telecom knockouts on top; one power duplex on bottom**. USB-A port charges max 2.4 amps at 5V and USB-C port charges max 3 amps at 5V. 10' power cord with straight plug. Specify telecom options separately. Available in Black (**B**), Tungsten (**T**) or Designer White (**W**) as indicated by last letter of model number. Duplexes always Grey (duplex with USB ports is glossy finish). Corresponding cut-out options are **T1**, **T2** or **T3**. Units are not approved for daisy chaining. UL listed: UL 1363.

**Required Specifications**

Finish

**ACCESSORIES**

MODEL#	DIMENSIONS	FREIGHT CLASS	WT./LBS.	CUBIC FT.	LIST PRICE
--------	------------	---------------	----------	-----------	------------

D x W x H

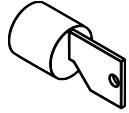

**Lock Assembly**

LO/C	--	70	--	--	<b>\$113</b>
------	----	----	----	----	--------------

Tungsten.

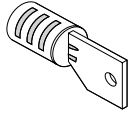

**Lock Drum with Key**

LOB/C	--	70	--	--	<b>\$47</b>
-------	----	----	----	----	-------------

Tungsten.

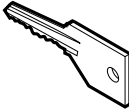

**Extra Key**

LOCK	--	70	--	--	<b>\$46</b>
------	----	----	----	----	-------------

Specify key #. Key range 401 - 420.



**Grommet Cover Round**

GM1	2 dia x --	70	--	--	<b>\$70</b>
GM1K	2 dia x --	70	--	--	<b>\$70</b>

2.75" diameter.

• **Specify GM1 for Black or GM1K for Tungsten.**

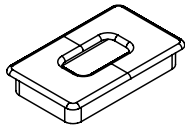

**Grommet**

GM5C	2 x 3.5 x --	70	--	--	<b>\$114</b>
------	--------------	----	----	----	--------------

Rectangular grommet in metal, tungsten finish.

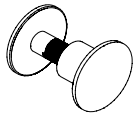

**Quick Connector**

QC50	--	70	.01	.01	<b>\$11</b>
QC30	--	70	.01	.01	<b>\$11</b>

**Required Specifications**

Top finish  
Body finish

**Optional Specifications**

Grommet  
Modesty Panel

# F FOUNDATIONS

ACCESSORIES

MODEL#

DIMENSIONS

FREIGHT CLASS

WT/LBS.

CUBIC FT.

LIST PRICE

D x W x H

# kingston





Kingston is a modern expression of old world craftsmanship. The classic proportion, attentive detailing, exquisite hand-matched veneers and solid wood edge details convey refined elegance with timeless beauty. Designed to highlight the warmth and majestic nature of real wood, Kingston offers an impressive array of storage components, fixed and freestanding worksurfaces that can be arranged to meet virtually any functional requirement.

Kingston detailing is contemporary with a 1" overhang on all edges. Solid walnut, cherry, maple, oak that bands worksurface perimeter is 1" wide by 1-3/8" thick for an overall thickness of 1-3/8". Kingston is a "top over pedestal" detailed series with a 1/4" reveal between the top and end panel. Tops have a 1" overhang. Floor storage unit bases are integrated in drawer faces. Products that are normally positioned against walls, such as credenzas, have a self-edge veneered back edge detail.

**Features and Benefits**

- Choice of 15 handle options for every door/drawer that features handles.
- Choice of six edge options
- Wide selection of storage components, fixed and freestanding worksurfaces.
- Sleek design



Interior veneer drawer edge

Edge options



K16



K18

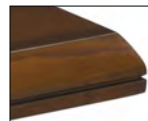

K21



K22



K29



K30

## GENERAL INFORMATION

- Distinguished by an elegant overhang detailed edge, Kingston pairs sleek European styling with functional design features that address the needs of today's dynamic and tech-savvy executive office.
- Kingston offers six distinctive edge shapes, as well as a multitude of drawer pull options.
- For environmental certification, please visit [globalfurnituregroup.com](http://globalfurnituregroup.com)

## CONSTRUCTION

- Number One select, architectural grade "A" oak, American black walnut, American black cherry or maple. Wood worksurface molded edges are solid oak, walnut, cherry, or maple.
- Contemporary detailing with 1" overhang on all edges.
- Solid walnut, cherry, maple, oak that bands worksurface perimeter is 1" wide by 1-3/8" thick for an overall thickness of 1-3/8".

## FINISHES

- Conversion varnish (similar to catalyzed lacquer, but tougher), 25 degree sheen. Finishes are not buffed or rubbed.
- All Global wood casegood products are veneered and finished on the back sides (360° finishing), except modular under-surface storage - tops and backs are unfinished.
- Touch up kits available, includes a touch up marker and fill crayon. Order **VTOUCHUPKIT, \$175** list. Specify finish when ordering.
- Global standard finish, on oak and walnut, is open pore and on cherry and maple is semi-closed pore. If a full finish is required for walnut, cherry, anigre and maple tops, Add the suffix "2" to the finish code and Add 5% to the base pricing for each product. **CUSTOM FINISH IS AVAILABLE.**

## PEDESTALS

- Full-to-the-floor. Pedestals are fully assembled units that are either installed into desk and credenza shells, or available as modular units. Undersurface storage units include locks.
- Pedestal drawer suspensions are metal ball bearing type. Both box and file drawers are full extension.
- Hanging file rails are pre-installed on file drawer perimeters and accommodate both legal and letter size filing. Legal filing can be achieved either as side-to-side or front-to-back. Letter filing can be achieved as front-to-back filing only.
- Drawers are standard vinyl-wrapped construction with black drawer sides and bottom.
- The drawer front is an applied element to a four sided drawer. Drawer fronts are veneered on all surfaces except the vertical edges, which are solid oak, walnut, cherry and maple then routed with series detailing. Drawer fronts can be removed or replaced in the field.
- Levelers have 1" range of adjustment.

## LOCKS

- Locks are standard on all below worksurface level drawer and door storage units, with the exception of pull-out tray units and single lateral file drawer combination tray/slot units.
- Combination storage unit comes with lock for file and lateral file drawer only; box drawers cannot lock.
- Lock color will match the handle option.
- Locks are optional on all above worksurface level closed storage.
- For optional lock, specify **LO. Add \$143** per lock.

## HANDLES

- If no handle is specified, there will be a routed finger pull in drawer fronts and touch latch mechanism for doors.
- See next page for options.

## 1. SPECIFY MODEL NUMBER

## 2. SPECIFY FINISH

### WORKSURFACE TOP & DRAWER/DOOR FRONTS, BODY FINISHES (INCLUDING PEDESTALS) - VENEER

Code	Finish	Veneer Type	Cut
AMW	Almond Cherry	Cherry	Flat Sliced
ACW	Amber Cherry	Cherry	Flat Sliced
BTW	Biscotti	White Oak	Rift
CAW	Cocoa Walnut	Walnut	Flat Sliced
CRW	Coral	White Oak	Rift
DCW	Dark Cherry	Cherry	Flat Sliced
DWW	Dark Walnut	Walnut	Flat Sliced
EWV	Espresso Walnut	Walnut	Flat Sliced
EVW	Evening Oak	White Oak	Rift
GRW	Grey on Oak	White Oak	Rift
HAW	Hazelnut	Maple	Flat Sliced
JAW	Java	White Oak	Rift
LTW	Latte Walnut	Walnut	Flat Sliced
MHW	Mahogany on Walnut	Walnut	Flat Sliced
MTW	Milestone	White Oak	Rift
MPW	Natural Maple	Maple	Flat Sliced
NLW	Natural Walnut	Walnut	Flat Sliced
RCW	Red Cherry	Cherry	Flat Sliced
VNW	Vintage Cherry	Cherry	Flat Sliced
ULW	Umber Walnut	Walnut	Flat Sliced
WLW	Walnut	Walnut	Flat Sliced
WCW	Warm Cherry	Cherry	Flat Sliced
WMW	White Maple	Maple	Flat Sliced

### METAL FINISHES (see model # notes for available finish):

E	Black
K	Tungsten
DWT	Designer White
P	Brushed Chrome

### GLASS FINISHES (for Glass Doors and Modesty Panels):

- Frosted Glass (standard)
- White back painted glass - contact customer care

## 3. SPECIFY OPTIONS

### EDGES

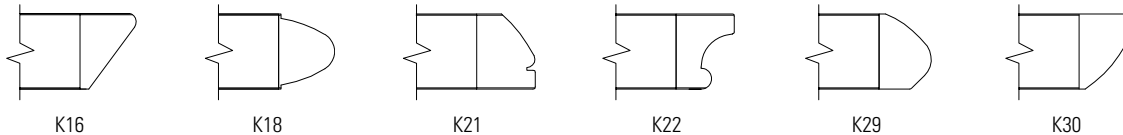

### HANDLES

- If Handle is not specified Routed Pull, Black Lock & Grommet are standard
- If Handle is specified:
  - Black and Brass handle = Black Lock & Grommet
  - Silver, Nickel and Tungsten handle = Tungsten Lock & Grommet
- Handles are standard on most drawers/storage modules. Each handle is identified by letters: **PL33, PL34, PL64, PL66, PL92, PL93, PL94, PL95, PL96, PL97, PL98, PL99, PLS7, and PLS8**. To specify a handle, specify the code after the model number and finish selections.



**PL33** Black Moon Pull, 4"



**PL34** Nickel Moon Pull, 4"



**PL64** Contemporary Nickel 5-3/8"



**PL66** Transitional Nickel, 6-3/4"



**PL92** Silver Bar, 5-3/8"



**PL93** Black Bar, 5-3/8"



**PL94** Silver Rectangular, 5-3/8"



**PL95** Black Rectangular, 5-3/8"



**PL96** Silver Slimline Pull, 5-3/8"



**PL97** Black Slimline Pull, 5-3/8"



**PL98** Silver Princeton Bar, 5-3/8"



**PL99** Black Princeton Bar, 5-3/8"



**PLS7** Black Spaghetti, 7-3/8"



**PLS8** Silver Spaghetti, 7-3/8"

**GROMMETS**

- Standard grommet on all components is **GM5**. Grommet is included with products where shown in line drawings in price book.
- Optional grommets may be ordered in standard worksurface locations (left, center or right). Order as **GM5TL, GM5TC or GM5TR**. Add \$103.
- Grommet hole dimensions are 3.5" x 2". Specify **GM5E** for Black or **GM5K** for Tungsten.
- To order a grommet cover only, Add \$61.
- Components that come standard with grommet may be ordered without a grommet. Order as RSG - Add \$57.

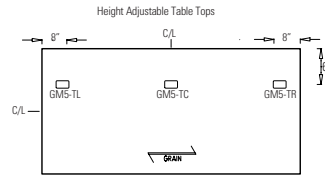
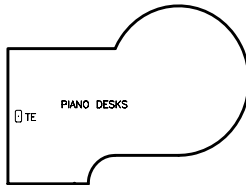
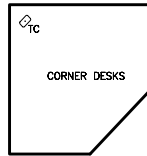
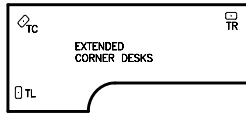
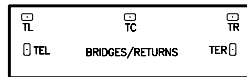
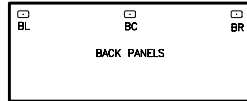
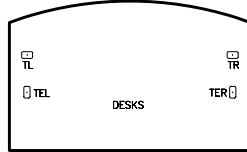
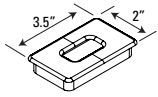

# K KINGSTON - EDGE DETAILS

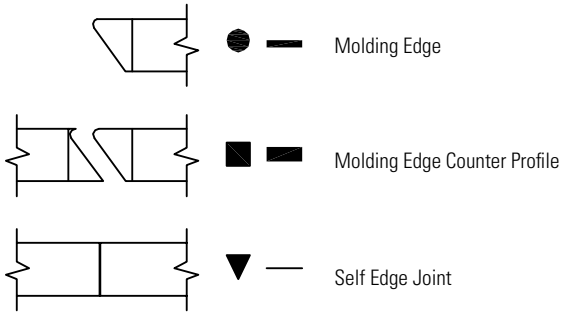

- D** - Desks and Credenzas
- B** - Executive Bridges
- E** - Executive Returns
- C** - Corner Components
- L** - Linking Bridges
- P** - Piano Desks

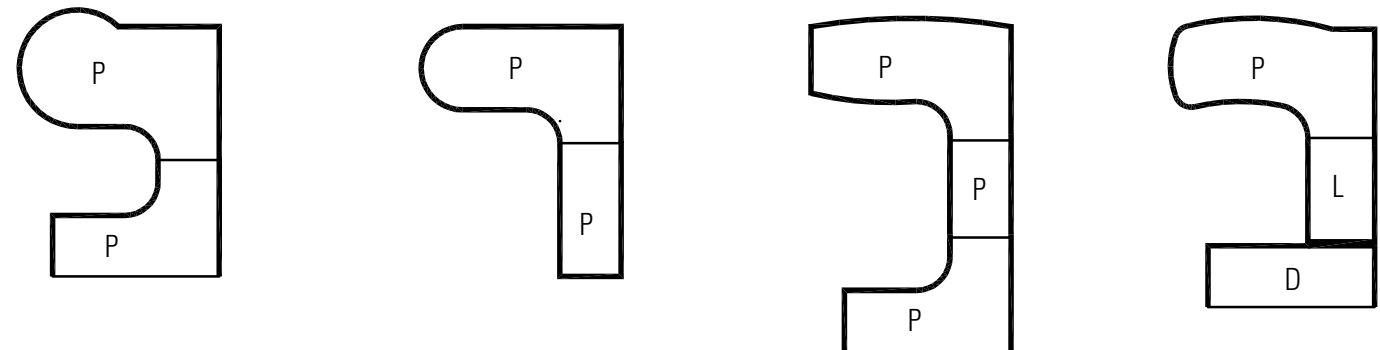
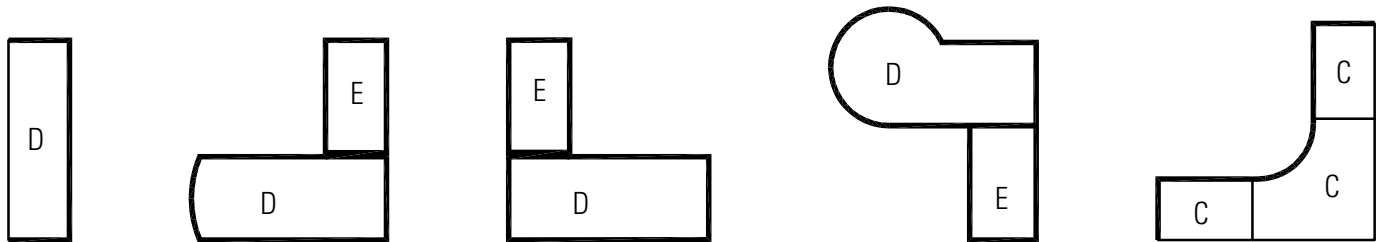
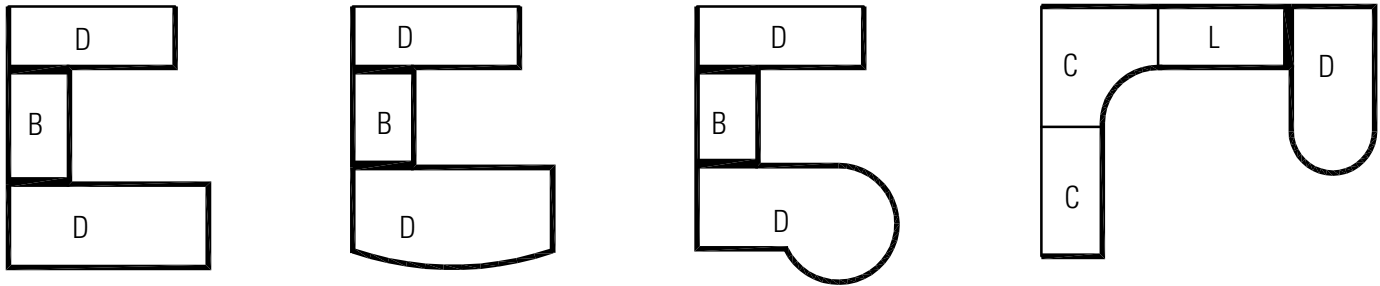
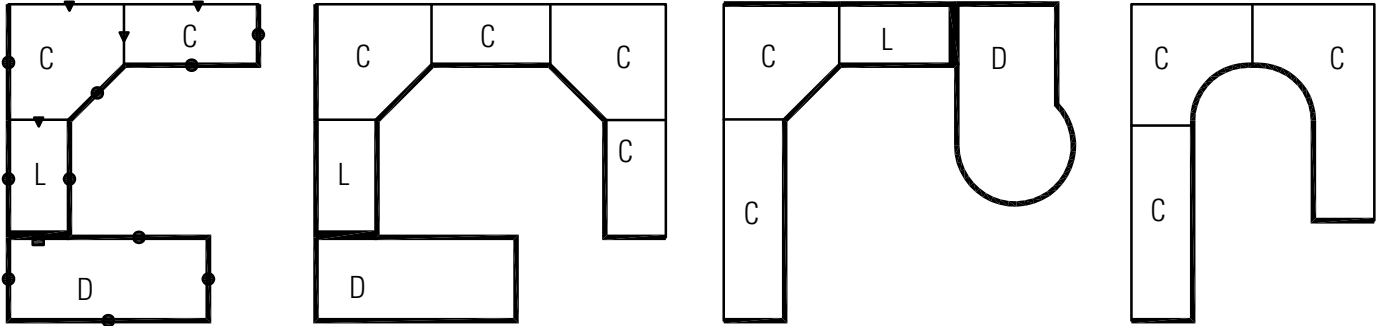

**DESK AND CREDENZA NOTES**

- Can be ordered as a shell or with pedestals
- Hand of Rectangular Desk is determined by location of pedestal from user side
- Hand of "D" Top is determined by outward orientation of curved end from user projection.
- Hand of "P" Top is determined by outward orientation of conference end from user projection.

Isometric View

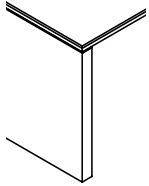

Side View  
1-3/8" Top

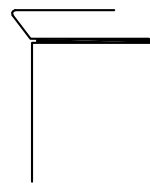

Front View  
1-3/16" Slab

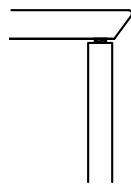

KT6030

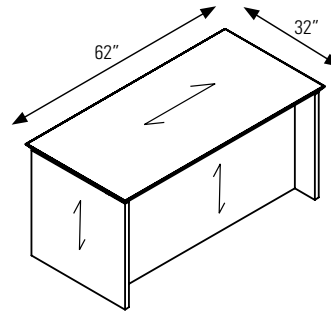

**MODESTY PANEL CLEARANCE**

KT7236

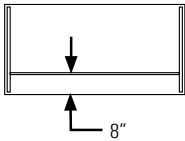

KMT7242

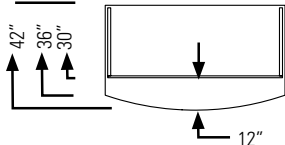

KiSR7230D

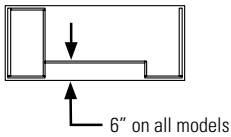

KDDCL7236

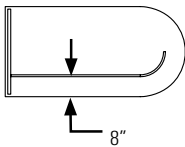

KT7236



Full Back Panel

KT7230

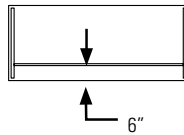

KMT7236

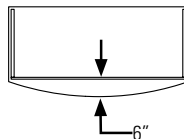

KDDF7230

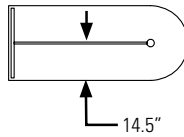

KDDCL7230

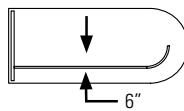

KTPL7242

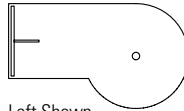

Left Shown

Field "punch out" to accommodate center drawer and keyboard

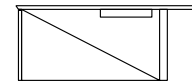

**MODESTY PANEL OPTIONS**

Standard Full Modesty

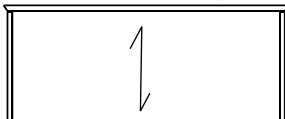

Glass Modesty

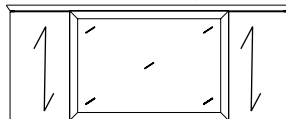

Breakfront

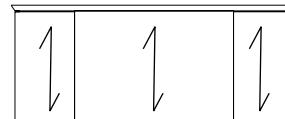

## PIANO DESKS AND LINKING RETURNS

- All Desks are shipped assembled.
- Units include standard Grommets shown and installed horizontal wire management
- Unit is handed by Post Leg
- Not for use with regular Corner Units
- The standard grain direction is cross grain (**CG**). To remove cross grain veneer pattern on top, delete suffix "**CG**" from the model number (no upcharge)

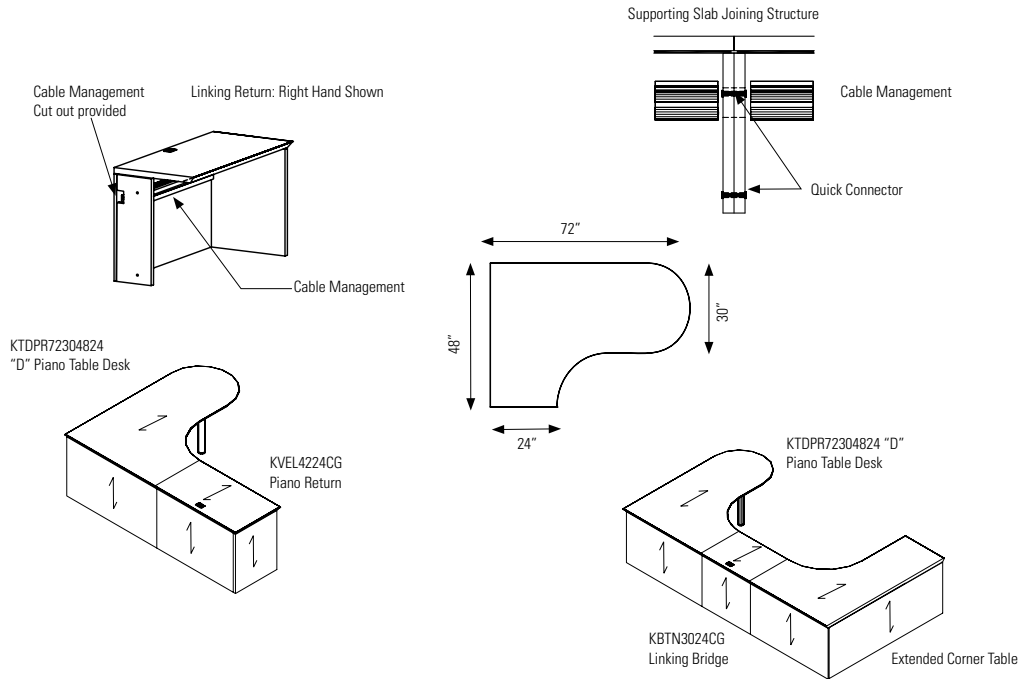

## EXECUTIVE BRIDGES

- Executive Bridge is used to connect a Desk to a Credenza.
- Not to be used with Corner Components or Piano Desks.
- Three Back Panel options
- Back panel flush with end panels of Desk and Credenza
- Includes GM5 Grommet Top Center
- The standard grain direction is cross grain (**CG**). To remove cross grain veneer pattern on top, delete suffix "**CG**" from the model number (no upcharge)

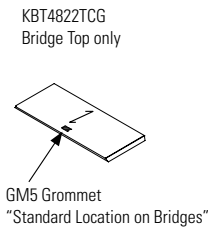
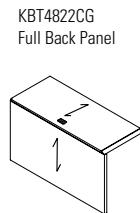
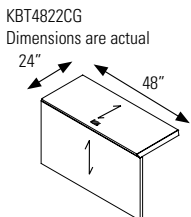
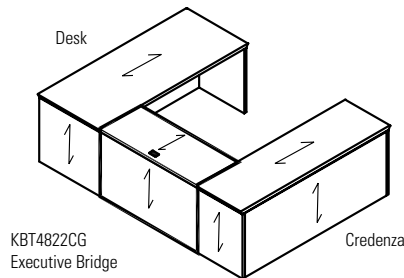

**EXECUTIVE RETURNS**

- Executive Return is used to attach to a Single Pedestal Desk, Single Pedestal Credenza, Desk Shell or Credenza Shell.
- Can be specified as a Shell or with a Pedestal.
- Back Panels are available as either full height or 8" from the underside of the worksurface.
- Hand of Executive Return is determined by location of full end panel from user side.
- Hand of Desk or Credenza is determined by location of pedestal from user side.
- The standard grain direction on return tops is cross grain (**CG**). To remove cross grain veneer pattern on top, delete suffix "**CG**" from the model number (no upcharge)

Executive Return attached to Desk or Credenza

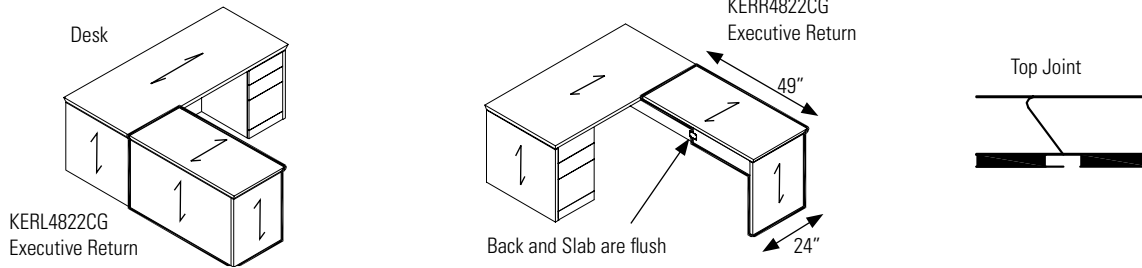

**CORNER COMPONENTS**

- Corner Table is used to connect to Linking Bridge and Linking Credenza.
- Cable management tray included.
- Back Panels are available as either full height or 8" from the underside of the worksurface.
- Hand of Linking Credenza is determined by location of full end panel from user side.
- Hand of Extended Corner is determined by location of long narrow end from user side
- The standard grain direction is cross grain (**CG**). To remove cross grain veneer pattern on top, delete suffix "**CG**" from the model number (no upcharge)

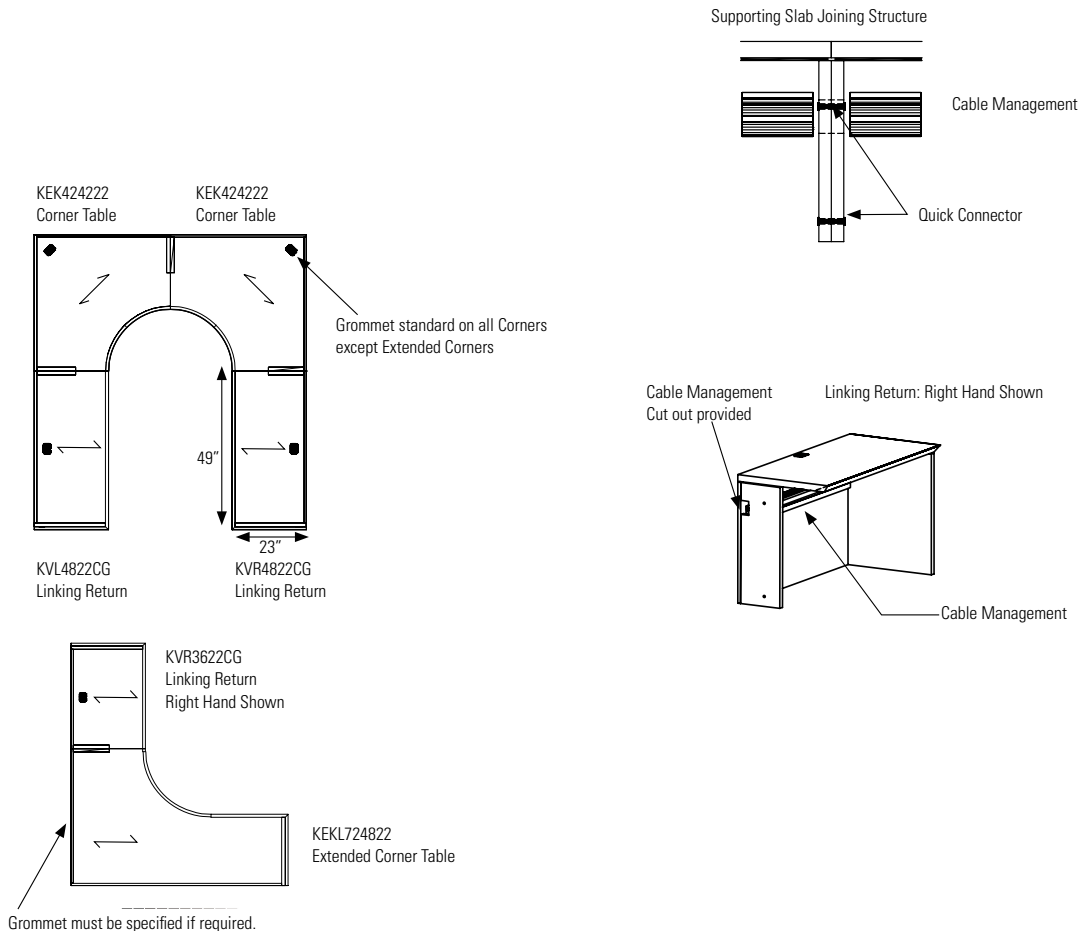

## LINKING BRIDGES

- Linking Bridge is used to connect Corner Components to Single Pedestal Desk, Single Pedestal Credenza, Desk Shell or Credenza Shell.
- Back panels are available as either full height or 8" from the underside of the worksurface.
- Includes GM5 Grommet Top Center
- Hand of Linking Bridge is determined by location of half end panel from user side
- The standard grain direction is cross grain (**CG**). To remove cross grain veneer pattern on top, delete suffix "**CG**" from the model number (no upcharge)

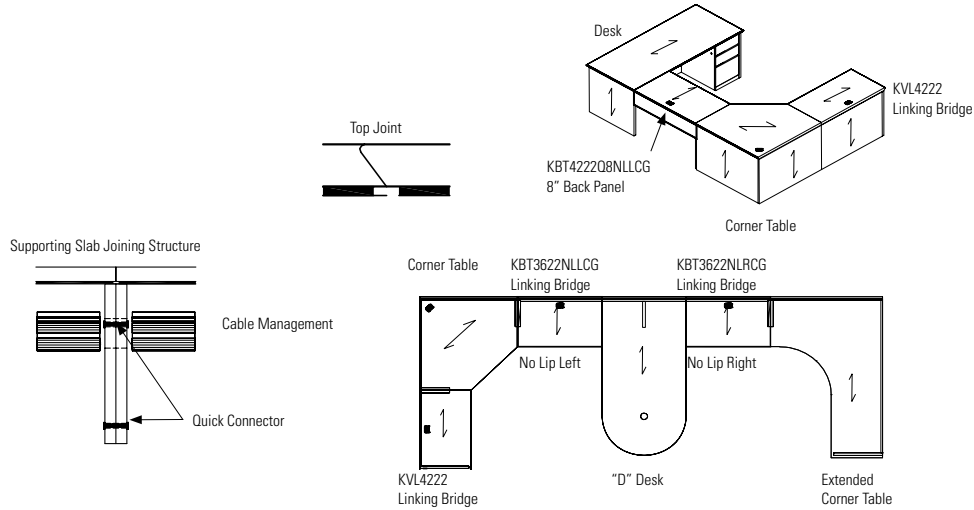

## MODULAR PEDESTALS AND HANDLES

- Modular Pedestal for Kingston.
- Credenza Shells can only be completely filled with modular components that end in ".5" to create a full storage credenza.

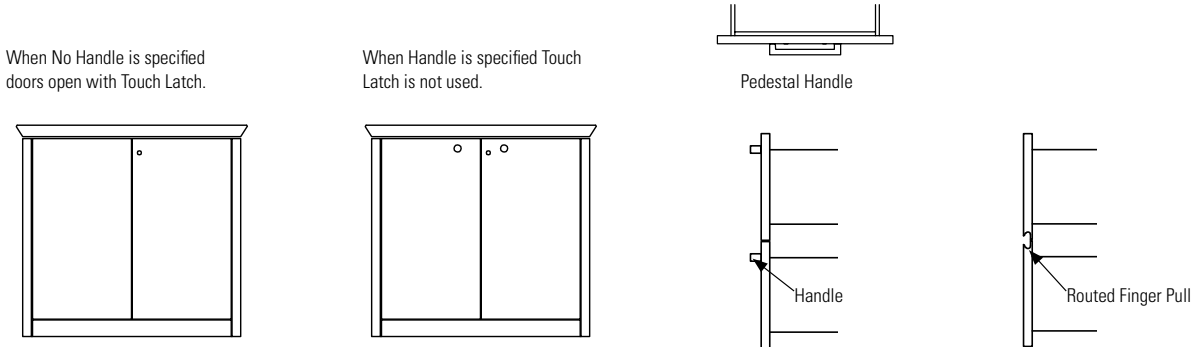

**COPING AND SELF-EDGE OPTIONS**

- Coping option provides an undercut on hutches only so that storage cabinets placed next to the hutch fit flush.
  - Specify **COP** for coping on both sides, **COPR** for coping on the right side and **COPL** for coping on the left side. No upcharge.
- Self edge options provide a flush fit when storage units are placed next to one another.
  - Specify **SE** for self-edge on both sides, **SER** for self-edge on the right side and **SEL** for self-edge on the left side. No upcharge.
  - Coping and self-edge handedness are from the users perspective. See diagram below.

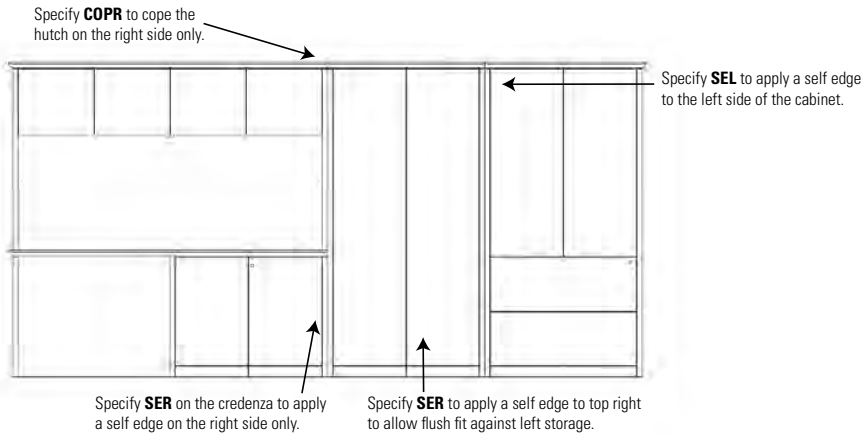

**LOCKING**

- Locks are standard on all below worksurface level drawer and door storage units with the exception of the pull-out tray units and single lateral file drawer combination tray/slot units.
- Locks are optional on all above worksurface level closed storage units. See Accessories Section (page 270) for lock specification details.

**Standard Lock Positions**

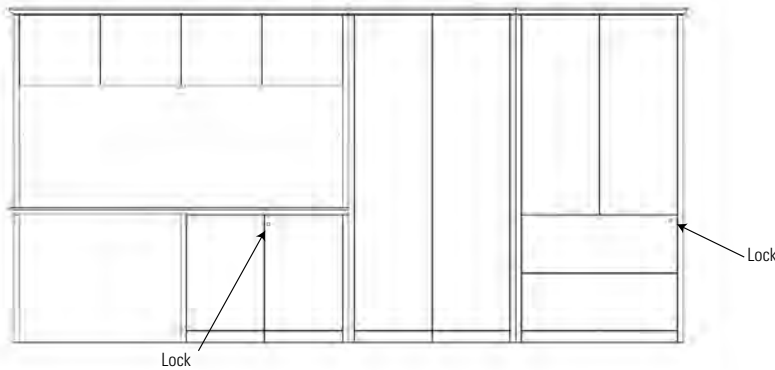

KZR  
Combination Storage Unit:  
Lock for File and Lateral File Drawer only,  
Box Drawers do not lock.

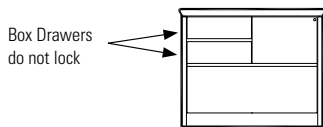

KD7236DE  
Double Pedestal Desk/Credenza:  
Lock for D and E Pedestals are on the inside Gable.

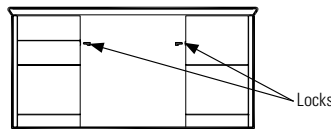

KCF7222  
Full Storage Credenza: Locks are on the front.

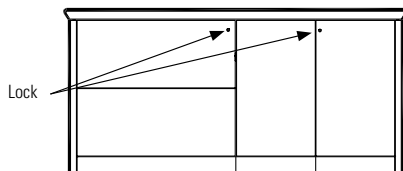

KWD  
Modular Furniture:  
Lock is on the front.

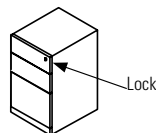

KWF  
Modular Furniture:  
Lock is on the front.

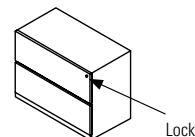

## HUTCH POSITIONING

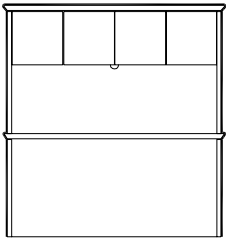

There must be an end panel under the hutch

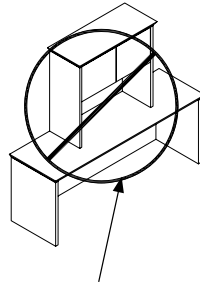
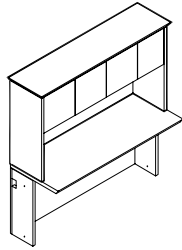

Missing Support  
NOT Recommended

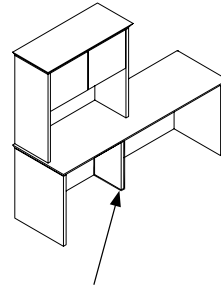

Add optional Support  
SLAB12 (as Special)

## TACKBOARDS

### Tackboards for Storage Hutches

K72SH36

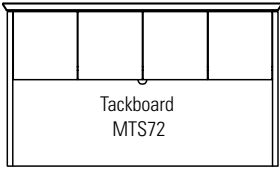

K72SHP42 and K72SHP42

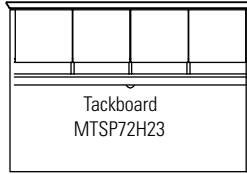

K72SH42 and K722SH54

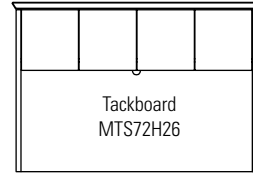

### Tackboards with Accessory Rail

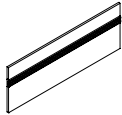

KTSAS72

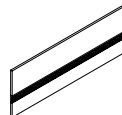

KTSPAS72H23

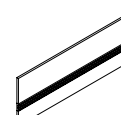

KTSAS72H26

### Tackboards for Wall Mount Overheads



CSF36

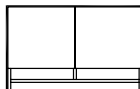

CSFP36

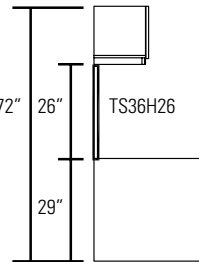
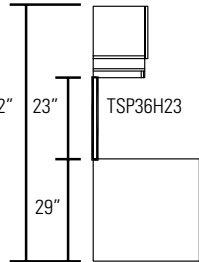
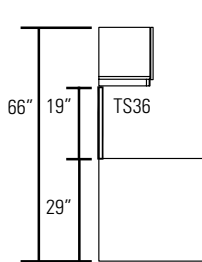

## LIGHTING

### For hutches and wall mount overheads

Wall Mount

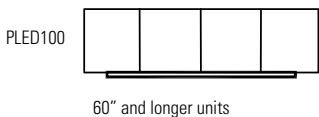
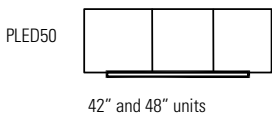
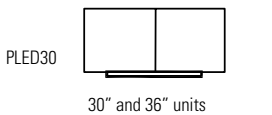

Hutch

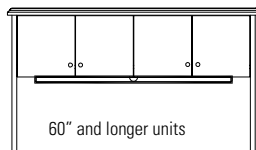
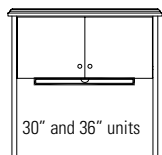

DESKS - NOTES

D x W x H

NOTE: Arrow indicates direction of grain

- All desks are shipped assembled
- Kneewell locking standard
- Desks available with a variety of modesty options: flush, breakfront, recessed and glass
- If Handle is not specified Routed Pull, Black Lock & Grommet are standard
- If Handle is specified:
  - Black and Brass handle = Black Lock & Grommet
  - Silver, Nickel and Tungsten handle = Tungsten Lock & Grommet
- Grommets are available as an option on Desks and most Credenzas.
- Edge options - must specify:

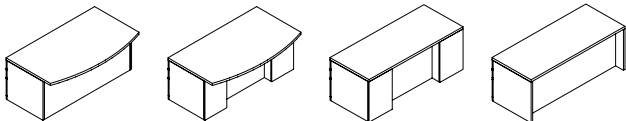
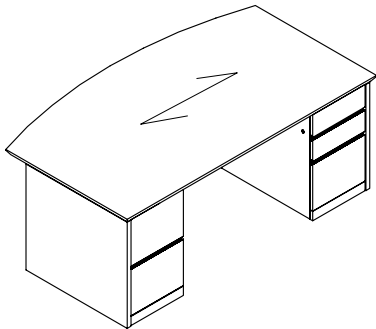
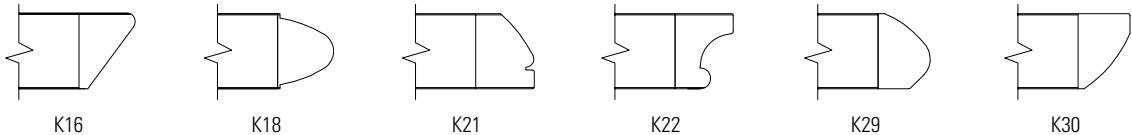

Flush Modesty                      Breakfront                      Recessed Modesty

## DOUBLE PEDESTAL DESKS

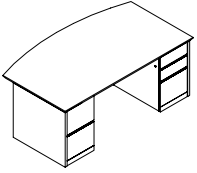

**Double Pedestal Bow Top Desk**

MODEL#	DIMENSIONS D x W x H	FREIGHT CLASS	WT/LBS.	CUBIC FT.	LIST PRICE
KMD8442ED	44 x 86 x 29	125	407	59	<b>\$10778</b>
KMD7842ED	44 x 80 x 29	125	392	55	<b>\$10009</b>
KMD7242ED	44 x 74 x 29	125	377	51	<b>\$9236</b>
KMD6636ED	38 x 68 x 29	100	340	40	<b>\$8959</b>

Standard with full to floor **file/file** pedestal on **left** and **box/box/file** pedestal on **right**. Pedestals lock. Full Height Modesty Panel.

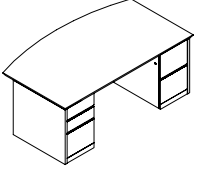

**Double Pedestal Bow Top Desk**

KMD8442DE	44 x 86 x 29	125	407	59	<b>\$10778</b>
KMD7842DE	44 x 80 x 29	125	392	55	<b>\$10009</b>
KMD7242DE	44 x 74 x 29	125	377	51	<b>\$9236</b>
KMD6636DE	38 x 68 x 29	100	340	40	<b>\$8959</b>

Standard with full to floor **file/file** pedestal on **right** and **box/box/file** pedestal on **left**. Pedestals lock. Full Height Modesty Panel.

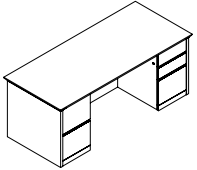

**Double Pedestal Desk**

KD8442ED	44 x 86 x 29	125	442	59	<b>\$9164</b>
KD7842ED	44 x 80 x 29	125	421	55	<b>\$8512</b>
KD7236ED	38 x 74 x 29	100	375	44	<b>\$7858</b>
KD7230ED	32 x 74 x 29	100	345	36	<b>\$7739</b>
KD6636ED	38 x 68 x 29	100	360	40	<b>\$7739</b>
KD6630ED	32 x 68 x 29	92.5	330	33	<b>\$7614</b>
KD6030ED	32 x 62 x 29	92.5	315	30	<b>\$7376</b>

Standard with full to floor **file/file** pedestal on **left** and **box/box/file** pedestal on **right**. Pedestals lock. Full height modesty panel.

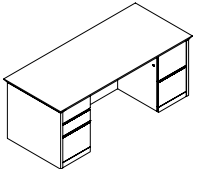

**Double Pedestal Desk**

KD8442DE	44 x 86 x 29	125	442	59	\$9164
KD7842DE	44 x 80 x 29	125	421	55	<b>\$8512</b>
KD7236DE	38 x 74 x 29	100	375	44	<b>\$7858</b>
KD7230DE	32 x 74 x 29	100	345	36	<b>\$7739</b>
KD6636DE	38 x 68 x 29	100	360	40	<b>\$7739</b>
KD6630DE	32 x 68 x 29	92.5	330	33	<b>\$7614</b>
KD6030DE	32 x 62 x 29	92.5	315	30	<b>\$7376</b>

Standard with full to floor **file/file** pedestal on **right** and **box/box/file** pedestal on **left**. Pedestals lock. Full height modesty panel.

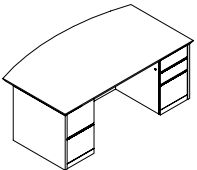

**Double Pedestal Bow Top Desk\*  
Breakfront Style**

KMID8442ED	44 x 86 x 29	125	407	59	\$11853
KMID7842ED	44 x 80 x 29	125	392	55	<b>\$11008</b>
KMID7242ED	44 x 74 x 29	125	377	51	<b>\$10165</b>
KMID6636ED	38 x 68 x 29	100	345	40	<b>\$9852</b>

Standard with full to floor **file/file** pedestal on **left** and **box/box/file** pedestal on **right**. Pedestals lock. Inset Full Height Modesty Panel.

- For Aluminum Framed Glass Modesty option on Breakfront Style add "G" to the end of the product code. Add **\$1892**.

### Required Specifications

Finish  
Edge

### Optional Specifications

Handles  
Additional grommet  
Glass modesty panel\*



## DESKS

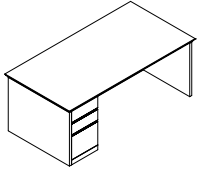

**Single Pedestal Desk**

MODEL#	DIMENSIONS D x W x H	FREIGHT CLASS	WT./LBS.	CUBIC FT.	LIST PRICE
KSL8442D	44 x 86 x 29	125	387	59	\$8031
KSL7842D	44 x 80 x 29	125	366	55	<b>\$7565</b>
KSL7236D	38 x 74 x 29	125	320	44	<b>\$5993</b>
KSL7230D	32 x 74 x 29	100	290	36	<b>\$5724</b>
KSL6636D	38 x 68 x 29	125	305	40	<b>\$5724</b>
KSL6630D	32 x 68 x 29	100	275	33	<b>\$5463</b>
KSL6030D	32 x 62 x 29	100	260	30	<b>\$5222</b>

Standard with full to floor **box/box/file** pedestal on **left**. Pedestals lock.  
Full Height Modesty Panel.

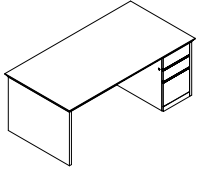

**Single Pedestal Desk**

KSR8442D	44 x 86 x 29	125	387	59	\$8031
KSR7842D	44 x 80 x 29	125	366	55	<b>\$7565</b>
KSR7236D	38 x 74 x 29	125	320	44	<b>\$5993</b>
KSR7230D	32 x 74 x 29	100	290	36	<b>\$5724</b>
KSR6636D	38 x 68 x 29	125	305	40	<b>\$5724</b>
KSR6630D	32 x 68 x 29	100	275	33	<b>\$5463</b>
KSR6030D	32 x 62 x 29	100	260	30	<b>\$5222</b>

Standard with full to floor **box/box/file** pedestal on **right**. Pedestals lock.  
Full Height Modesty Panel.

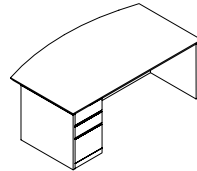

**Single Pedestal Desk - Left\*  
Breakfront Style**

KMISL8442D	44 x 86 x 29	125	452	59	\$9393
KMISL7842D	44 x 80 x 29	125	337	55	<b>\$8723</b>
KMISL7242D	44 x 74 x 29	125	322	51	<b>\$8055</b>
KMISL6636D	38 x 68 x 29	125	290	40	<b>\$7746</b>

Standard with full to floor **box/box/file** pedestal on **left**. Pedestals lock.  
Inset Full Height Modesty Panel.

- For Aluminum Framed Glass Modesty option on Breakfront Style add "G" to the end of the product code. Add **\$1892**.

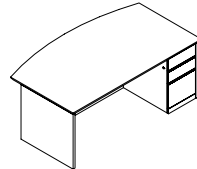

**Single Pedestal Desk - Right\*  
Breakfront Style**

KMISR8442D	44 x 86 x 29	125	452	59	\$9393
KMISR7842D	44 x 80 x 29	125	337	55	<b>\$8723</b>
KMISR7242D	44 x 74 x 29	125	322	51	<b>\$8055</b>
KMISR6636D	38 x 68 x 29	125	290	40	<b>\$7746</b>

Standard with full to floor **box/box/file** pedestal on **right**. Pedestals lock.  
Inset Full Height Modesty Panel.

- For Aluminum Framed Glass Modesty option on Breakfront Style add "G" to the end of the product code. Add **\$1892**.

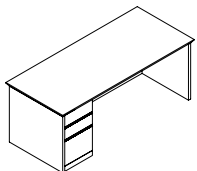

**Single Pedestal Desk - Left\*  
Breakfront Style**

KISL8442D	44 x 86 x 29	125	387	59	\$8969
KISL7842D	44 x 80 x 29	125	366	55	<b>\$8329</b>
KISL7236D	38 x 74 x 29	125	320	44	<b>\$6590</b>
KISL7230D	32 x 74 x 29	100	290	36	<b>\$6296</b>
KISL6636D	38 x 68 x 29	125	305	40	<b>\$6296</b>
KISL6630D	32 x 68 x 29	100	275	33	<b>\$6009</b>
KISL6030D	32 x 62 x 29	100	260	30	<b>\$5743</b>

Standard with full to floor **box/box/file** pedestal on **left**. Pedestals lock.  
Inset Full Height Modesty Panel.

- For Aluminum Framed Glass Modesty option on Breakfront Style add "G" to the end of the product code. Add **\$1892**.

### Required Specifications

Finish  
Edge

### Optional Specifications

Handles  
Additional grommet  
Glass modesty panel\*

DESKS

MODEL# DIMENSIONS FREIGHT CLASS WT/LBS. CUBIC FT. LIST PRICE

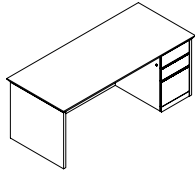

**Single Pedestal Desk - Right\*  
Breakfront Style**

	D x W x H				
KISR8442D	44 x 86 x 29	125	387	59	\$8969
KISR7842D	44 x 80 x 29	125	366	55	<b>\$8329</b>
KISR7236D	38 x 74 x 29	125	320	44	<b>\$6590</b>
KISR7230D	32 x 74 x 29	100	290	36	<b>\$6296</b>
KISR6636D	38 x 68 x 29	125	305	40	<b>\$6296</b>
KISR6630D	32 x 68 x 29	100	275	33	<b>\$6009</b>
KISR6030D	32 x 62 x 29	100	260	30	<b>\$5743</b>

Standard with full to floor **box/box/file** pedestal on **right**. Pedestals lock.  
Inset Full Height Modesty Panel.

- For Aluminum Framed Glass Modesty option on Breakfront Style add "G" to the end of the product code. Add **\$1892**.

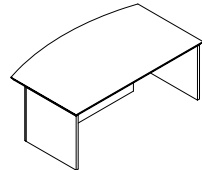

**Desk Shell, Bow Top  
Breakfront Style**

KMIT8442	44 x 86 x 29	125	380	59	\$7247
KMIT7842	44 x 80 x 29	125	353	55	<b>\$6775</b>
KMIT7242	44 x 74 x 29	125	331	51	<b>\$6308</b>
KMIT6636	38 x 68 x 29	125	287	40	<b>\$5985</b>

Inset Full Height Modesty Panel.

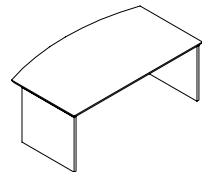

**Desk Shell, Bow Top**

KMT8442	44 x 86 x 29	150	297	59	\$6565
KMT7842	44 x 80 x 29	150	282	55	<b>\$6092</b>
KMT7242	44 x 74 x 29	150	267	51	<b>\$5627</b>
KMT6636	38 x 68 x 29	150	235	40	<b>\$5304</b>

Recessed Modesty Panel.

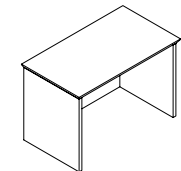

**Desk Shell**

KT8442	44 x 86 x 29	125	337	55	\$6103
KT7842	44 x 80 x 29	125	317	51	<b>\$5667</b>
KT8436	38 x 86 x 29	125	317	51	\$5233
KT7836	38 x 80 x 29	125	296	47	<b>\$4861</b>
KT7236	38 x 74 x 29	125	265	44	<b>\$4491</b>
KT7230	32 x 74 x 29	125	235	36	<b>\$4225</b>
KT6636	38 x 68 x 29	125	250	40	<b>\$4225</b>
KT6630	32 x 68 x 29	125	220	33	<b>\$3970</b>
KT6030	32 x 62 x 29	125	205	30	<b>\$3629</b>

Recessed Modesty Panel.

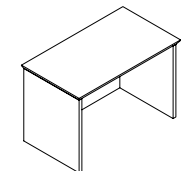

**Desk Shell**

KT4822	24 x 50 x 29	150	95	17	\$2599
KT4222	24 x 44 x 29	150	85	15	<b>\$2177</b>
KT3622	24 x 38 x 29	150	75	13	\$2101
KT3022	24 x 32 x 29	150	65	11	<b>\$2059</b>
KT4820	22 x 50 x 29	150	95	17	<b>\$2367</b>
KT4220	22 x 44 x 29	150	85	15	<b>\$1979</b>
KT3620	22 x 38 x 29	125	75	12	<b>\$1912</b>
KT3020	22 x 32 x 29	125	65	10	<b>\$1875</b>

Flush modesty panel.

**Required Specifications**

Finish  
Edge

**Optional Specifications**

Handles  
Additional grommet  
Glass modesty panel\*

## DESKS

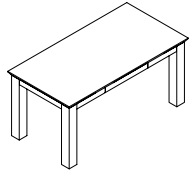

**Table Desk\***

MODEL#	DIMENSIONS D x W x H	FREIGHT CLASS	WT/LBS.	CUBIC FT.	LIST PRICE
KTB8442	44 x 86 x 29	150	272	59	\$11492
KTB7842	44 x 80 x 29	150	253	55	<b>\$10673</b>
KTB7236	38 x 74 x 29	150	205	44	<b>\$8441</b>
KTB7230	32 x 74 x 29	150	192	36	<b>\$8288</b>
KTB6636	38 x 68 x 29	150	192	40	<b>\$8288</b>
KTB6630	32 x 68 x 29	150	188	33	<b>\$8126</b>
KTB6030	32 x 62 x 29	150	171	30	<b>\$7740</b>

3" apron, center pencil drawer. 4" square legs.

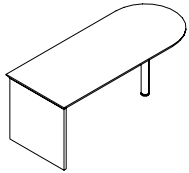

**"D" Shaped Connecting Table Desk\***

KDD8436	36 x 84 x 29	125	343	51	<b>\$5855</b>
KDD7236	36 x 72 x 29	125	294	44	<b>\$5015</b>
KDD7230	30 x 72 x 29	125	264	36	<b>\$4662</b>
KDD6636	36 x 66 x 29	125	245	40	<b>\$4662</b>
KDD6030	30 x 60 x 29	125	225	30	<b>\$4480</b>

3" wood post and full end panel.

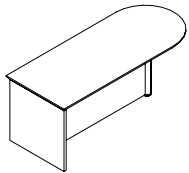

**"D" Shaped Connecting Table Desk**

KDDF8436	36 x 84 x 29	125	343	51	<b>\$7190</b>
KDDF7236	36 x 72 x 29	125	294	44	<b>\$6171</b>
KDDF7230	30 x 72 x 29	125	264	36	<b>\$5811</b>
KDDF6636	36 x 66 x 29	125	245	40	<b>\$5811</b>
KDDF6030	30 x 60 x 29	125	225	30	<b>\$5629</b>

3" wood post, full modesty panel, and full end panel.

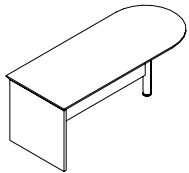

**"D" Shaped Connecting Table Desk**

KQDD8436	36 x 84 x 29	125	357	51	<b>\$6753</b>
KQDD7236	36 x 72 x 29	125	311	44	<b>\$5785</b>
KQDD7230	30 x 72 x 29	125	281	36	<b>\$5431</b>
KQDD6636	36 x 66 x 29	125	264	40	<b>\$5431</b>
KQDD6030	30 x 60 x 29	100	247	30	<b>\$5251</b>

3" wood post, 3/4 modesty panel, and full end panel.

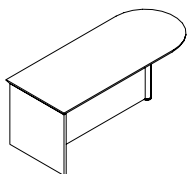

**"D" Shaped Connecting Table Desk - Left**

KDDCL8436	36 x 84 x 29	125	368	51	<b>\$7645</b>
KDDCL7236	36 x 72 x 29	125	320	44	<b>\$6552</b>
KDDCL7230	30 x 72 x 29	100	290	36	<b>\$6193</b>
KDDCL6636	36 x 66 x 29	125	270	40	<b>\$6193</b>
KDDCL6030	30 x 60 x 29	100	242	30	<b>\$6016</b>

Full height curved modesty panel, 3" wood post, and full end panel.

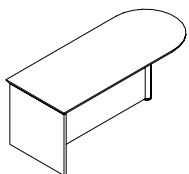

**"D" Shaped Connecting Table Desk - Right**

KDDCR8436	36 x 84 x 29	125	368	51	<b>\$7645</b>
KDDCR7236	36 x 72 x 29	125	320	44	<b>\$6552</b>
KDDCR7230	30 x 72 x 29	100	290	36	<b>\$6193</b>
KDDCR6636	36 x 66 x 29	125	270	40	<b>\$6193</b>
KDDCR6030	30 x 60 x 29	100	242	30	<b>\$6016</b>

Full height curved modesty panel, 3" wood post, and full end panel.

### Required Specifications

Finish  
Edge

### Optional Specifications

Additional grommet  
Base upgrade\* (see accessories for options)

DESKS

MODEL# DIMENSIONS FREIGHT CLASS WT/LBS. CUBIC FT. LIST PRICE

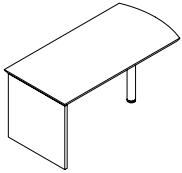

Connecting Bow End Table Desk\*

D x W x H						
KDDBE8436	36 x 84 x 29	125	343	51		\$5855
KDDBE7236	36 x 72 x 29	125	294	44		\$5015
KDDBE7230	30 x 72 x 29	125	264	36		\$4662
KDDBE6636	36 x 66 x 29	125	245	40		\$4662
KDDBE6030	30 x 60 x 29	125	225	30		\$4480

3" wood post and full end panel.

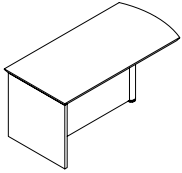

Connecting Bow End Table Desk

KDDBEF8436	36 x 84 x 29	125	368	51		\$7190
KDDBEF7236	36 x 72 x 29	125	320	44		\$6168
KDDBEF7230	30 x 72 x 29	100	290	36		\$5811
KDDBEF6636	36 x 66 x 29	125	271	40		\$5811
KDDBEF6030	30 x 60 x 29	100	247	30		\$5629

3" wood post, full modesty panel, and full end panel.

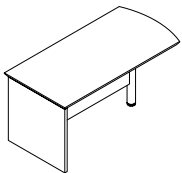

Connecting Bow End Table Desk

KQDDBE8436	36 x 84 x 29	125	357	51		\$6753
KQDDBE7236	36 x 72 x 29	125	311	44		\$5785
KQDDBE7230	30 x 72 x 29	125	281	36		\$5431
KQDDBE6636	36 x 66 x 29	125	264	40		\$5431
KQDDBE6030	30 x 60 x 29	100	247	30		\$5251

3" wood post, 3/4 modesty panel, and full end panel.

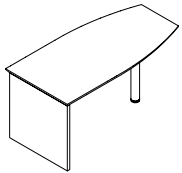

Connecting Boat Shaped Table Desk\*

KDDBS8442	42 x 84 x 29	125	414	59		\$6930
KDDBS8436	36 x 84 x 29	125	343	51		\$5855
KDDBS7236	36 x 72 x 29	125	314	44		\$5015
KDDBS7230	30 x 72 x 29	125	284	36		\$4662
KDDBS6636	36 x 66 x 29	125	265	40		\$4662
KDDBS6030	30 x 60 x 29	100	245	30		\$4480

3" wood post and full end panel.

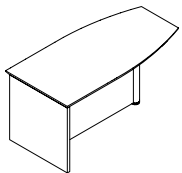

Connecting Boat Shaped Table Desk

KDDBSF8442	42 x 84 x 29	125	429	59		\$8392
KDDBSF8436	36 x 84 x 29	125	368	51		\$7190
KDDBSF7236	36 x 72 x 29	125	320	44		\$6168
KDDBSF7230	30 x 72 x 29	100	290	36		\$5811
KDDBSF6636	36 x 66 x 29	125	271	40		\$5811
KDDBSF6030	30 x 60 x 29	100	247	30		\$5629

3" wood post, full modesty panel, and full end panel.

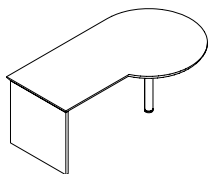

"P" Shaped Connecting Table - Left\*

KTPL9642	42 x 96 x 29	125	440	68		\$7314
KTPL8442	42 x 84 x 29	125	385	59		\$6399
KTPL7242	42 x 72 x 29	125	319	51		\$5837

3" wood post and full end panel.

Required Specifications

Finish  
Edge

Optional Specifications

Additional grommet  
Base upgrade\* (see accessories for options)

## P-SHAPED CONNECTING TABLES

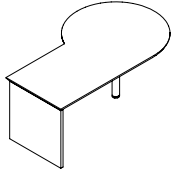

**"P" Shaped Connecting Table - Right\***

MODEL#	DIMENSIONS D x W x H	FREIGHT CLASS	WT/LBS.	CUBIC FT.	LIST PRICE
KTPR9642	42 x 96 x 29	125	440	68	<b>\$7314</b>
KTPR8442	42 x 84 x 29	125	385	59	<b>\$6399</b>
KTPR7242	42 x 72 x 29	125	319	51	<b>\$5837</b>

3" wood post and full end panel.

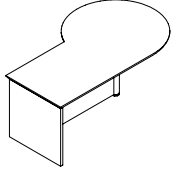

**"P" Shaped Connecting Table - Left**

KTPFL9642	42 x 96 x 29	150	317	68	<b>\$8629</b>
KTPFL8442	42 x 84 x 29	150	277	59	<b>\$6657</b>
KTPFL7242	42 x 72 x 29	150	211	51	<b>\$6989</b>

3" wood post, full height modesty panel, and full end panel.

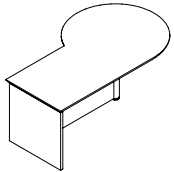

**"P" Shaped Connecting Table - Right**

KTPFR9642	42 x 96 x 29	150	317	68	<b>\$8629</b>
KTPFR8442	42 x 84 x 29	150	277	59	<b>\$6657</b>
KTPFR7242	42 x 72 x 29	150	211	51	<b>\$6989</b>

3" wood post, full height modesty panel, and full end panel.

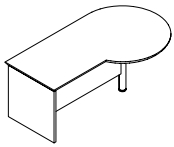

**"P" Shaped Connecting Table - Left**

KQTPL9642	42 x 96 x 29	150	291	68	<b>\$8191</b>
KQTPL8442	42 x 84 x 29	150	255	59	<b>\$7168</b>
KQTPL7242	42 x 72 x 29	250	189	51	<b>\$6601</b>

3" wood post, 3/4 height modesty panel, and full end panel.

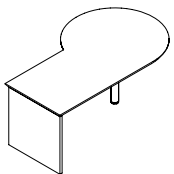

**"P" Shaped Connecting Table - Right**

KQTPR9642	42 x 96 x 29	150	291	68	<b>\$8191</b>
KQTPR8442	42 x 84 x 29	150	255	59	<b>\$7168</b>
KQTPR7242	42 x 72 x 29	250	189	51	<b>\$6601</b>

3" wood post, 3/4 height modesty panel, and full end panel.

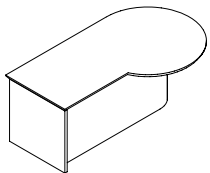

**"P" Shaped Connecting Table - Left**

KTPCL9642	42 x 96 x 29	150	317	68	<b>\$9063</b>
KTPCL8442	42 x 84 x 29	150	277	59	<b>\$7936</b>
KTPCL7242	42 x 72 x 29	150	211	51	<b>\$7020</b>

3" wood post, curved modesty panel, and full end panel.

### Required Specifications

Finish  
Edge

### Optional Specifications

Additional grommet  
Base upgrade\* (see accessories for options)

P-SHAPED CONNECTING TABLES

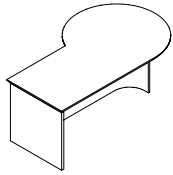

"P" Shaped Connecting Table - Right

MODEL#	DIMENSIONS	FREIGHT CLASS	WT/LBS.	CUBIC FT.	LIST PRICE
--------	------------	---------------	---------	-----------	------------

D x W x H					
KTPCR9642	42 x 96 x 29	150	317	68	\$9063
KTPCR8442	42 x 84 x 29	150	277	59	\$7936
KTPCR7242	42 x 72 x 29	150	211	51	\$7020

3" wood post, curved modesty panel, and full end panel.

HEIGHT ADJUSTABLE TOPS



Height Adjustable Top

MODEL#	DIMENSIONS	FREIGHT CLASS	WT/LBS.	CUBIC FT.	LIST PRICE
--------	------------	---------------	---------	-----------	------------

KRE8224T	24 x 82 x 1.18	92.5	85	7.7	\$2749
KRE8024T	24 x 80 x 1.18	92.5	84	7.5	\$2680
KRE7624T	24 x 76 x 1.18	92.5	80	7	\$2550
KRE6424T	24 x 64 x 1.18	92.5	69	6	\$2148
KRE5224T	24 x 52 x 1.18	92.5	58	5	\$1744
KRE4624T	24 x 46 x 1.18	92.5	53	4.5	\$1539
KRE4024T	24 x 40 x 1.18	100	37	4	\$1346
KRE8229T	29 x 82 x 1.18	92.5	101	9	\$3061
KRE7629T	29 x 76 x 1.18	92.5	99	8.5	\$2841
KRE7029T	29 x 70 x 1.18	92.5	94	8	\$2615
KRE6429T	29 x 64 x 1.18	92.5	81	7	\$2395
KRE5229T	29 x 52 x 1.18	92.5	68	6	\$1943
KRE4629T	29 x 46 x 1.18	85	61	5	\$1723
KRE4029T	29 x 40 x 1.18	85	55	4.5	\$1497
KRE8235T	35 x 82 x 1.18	92.5	120	10.5	\$3701
KRE7635T	35 x 76 x 1.18	92.5	117	10	\$3428
KRE7235T	35 x 72 x 1.18	300	12	9.5	\$3250
KRE6435T	35 x 64 x 1.18	92.5	96	9	\$2890
KRE5235T	35 x 52 x 1.18	85	80	6.5	\$2347
KRE4635T	35 x 46 x 1.18	85	72	6	\$2072
KRE4035T	35 x 40 x 1.18	85	64	5	\$1808

Kingston tops with Kingston edge on three sides, for use with FreeFit height adjustable table mechanisms, sold separately (FTxxxxx, see page 713 of the Desking price list for information).

- 26" deep tops accommodate FTxxxx24 mechanisms. Depth is exact to accommodate the Kingston edge + the Freefit mechanism. *Cannot be made smaller.*
- 29" and 35" deep tops accommodate FTxxxx30 mechanisms.

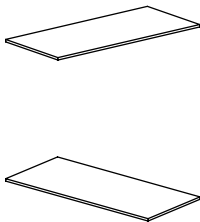

HA Return Tops

**Left:**

KRE6024CGCOPLT	24 x 60 x 1.18	92.5	65	5.5	\$2012
KRE5424CGCOPLT	24 x 54 x 1.18	85	60	5	\$1814
KRE4824CGCOPLT	24 x 48 x 1.18	85	54	4.5	\$1610
KRE4224CGCOPLT	24 x 42 x 1.18	85	49	4	\$1405

**Right:**

KRE6024CGCOPRT	24 x 60 x 1.18	92.5	65	5.5	\$2012
KRE5424CGCOPRT	24 x 54 x 1.18	85	60	5	\$1814
KRE4824CGCOPRT	24 x 48 x 1.18	85	54	4.5	\$1610
KRE4224CGCOPRT	24 x 42 x 1.18	85	49	4	\$1405

Kingston return tops with Kingston edge on three sides, for use with FreeFit height adjustable table mechanisms, sold separately (FTxxxxx, see page 713 of the Desking price list for information).

- 26" deep tops accommodate FTxxxx24 mechanisms. Depth is exact to accommodate the Kingston edge + the Freefit mechanism. *Cannot be made smaller.*

**Required Specifications**

Finish  
Edge

**Optional Specifications**

Handles\*  
Additional grommet

## RETURNS - NOTES

- All returns are shipped assembled
- Kneewell locking standard
- The standard grain direction on returns is cross grain (**CG**). To remove cross grain veneer pattern on top, delete suffix "**CG**" from the model number (no upcharge)
- If Handle is not specified Routed Pull, Black Lock & Grommet are standard
- If Handle is specified:
  - Black and Brass handle = Black Lock & Grommet
  - Silver, Nickel and Tungsten handle = Tungsten Lock & Grommet
- Grommets are available as an option on Desks and most Credenzas.
- Edge options - must specify:

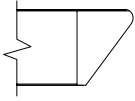

K16

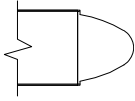

K18

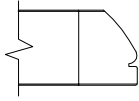

K21

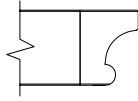

K22

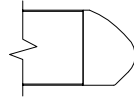

K29

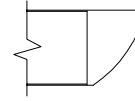

K30

- **NOTE:** Arrow indicates direction of grain

### EXECUTIVE RETURNS

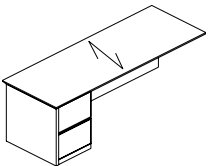

**Executive Return - Left\***

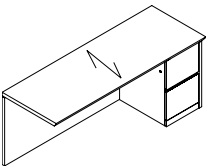

**Executive Return - Right\***

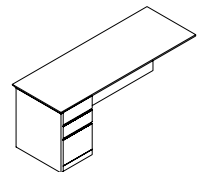

**Executive Return - Left\***

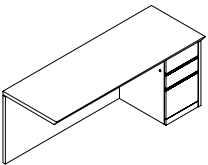

**Executive Return - Right\***

MODEL#	DIMENSIONS	FREIGHT CLASS	WT/LBS.	CUBIC FT.	LIST PRICE
KERL7222ECG	24 x 73 x 29	100	250	29	<b>\$5926</b>
KERL6622ECG	24 x 67 x 29	100	236	27	<b>\$5709</b>
KERL6022ECG	24 x 61 x 29	100	227	24	<b>\$5189</b>
KERL5422ECG	24 x 55 x 29	100	205	22	<b>\$5005</b>
KERL4822ECG	24 x 49 x 29	100	185	19	<b>\$4448</b>
KERL4222ECG	24 x 43 x 29	92.5	178	17	<b>\$4282</b>

Standard with full to floor **file/file** pedestal on **left**. Pedestal locks. Full height flush back panel.

KERR7222ECG	24 x 73 x 29	100	250	29	<b>\$5926</b>
KERR6622ECG	24 x 67 x 29	100	236	27	<b>\$5709</b>
KERR6022ECG	24 x 61 x 29	100	227	24	<b>\$5189</b>
KERR5422ECG	24 x 55 x 29	100	205	22	<b>\$5005</b>
KERR4822ECG	24 x 49 x 29	100	185	19	<b>\$4448</b>
KERR4222ECG	24 x 43 x 29	92.5	178	17	<b>\$4282</b>

Standard with full to floor **file/file** pedestal on **right**. Pedestal locks. Full height flush back panel.

KERL7222DCG	24 x 73 x 29	92.5	178	17	<b>\$5926</b>
KERL6622DCG	24 x 67 x 29	100	236	27	<b>\$5709</b>
KERL6022DCG	24 x 61 x 29	100	227	24	<b>\$5189</b>
KERL5422DCG	24 x 55 x 29	100	205	22	<b>\$5005</b>
KERL4822DCG	24 x 49 x 29	100	185	19	<b>\$4448</b>
KERL4222DCG	24 x 43 x 29	92.5	178	17	<b>\$4282</b>

Standard with full to floor **box/box/file** pedestal on **left**. Pedestal locks. Full height flush back panel.

KERR7222DCG	24 x 73 x 29	92.5	178	17	<b>\$5926</b>
KERR6622DCG	24 x 67 x 29	100	236	27	<b>\$5709</b>
KERR6022DCG	24 x 61 x 29	100	227	24	<b>\$5189</b>
KERR5422DCG	24 x 55 x 29	100	205	22	<b>\$5005</b>
KERR4822DCG	24 x 49 x 29	100	185	19	<b>\$4448</b>
KERR4222DCG	24 x 43 x 29	92.5	178	17	<b>\$4282</b>

Standard with full to floor **box/box/file** pedestal on **right**. Pedestal locks. Full height flush back panel.

#### Required Specifications

Finish  
Edge

#### Optional Specifications

Additional grommet  
Base upgrade\* (see accessories for options)

**EXECUTIVE RETURNS**      **MODEL#**      **DIMENSIONS**      **FREIGHT CLASS**      **WT/LBS.**      **CUBIC FT.**      **LIST PRICE**

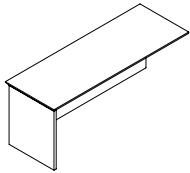

**Executive Return - Left**

	<b>D x W x H</b>					
KERL7222CG	24 x 73 x 29	150	135	29		<b>\$3326</b>
KERL6622CG	24 x 67 x 29	150	127	27		<b>\$3051</b>
KERL6022CG	24 x 61 x 29	150	120	24		<b>\$2772</b>
KERL5422CG	24 x 55 x 29	150	112	22		<b>\$2493</b>
KERL4822CG	24 x 49 x 29	150	105	19		<b>\$2219</b>
KERL4222CG	24 x 43 x 29	150	97	17		<b>\$1938</b>

Full height flush back panel.

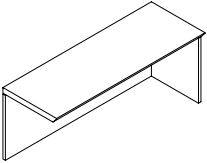

**Executive Return - Right**

KERR7222CG	24 x 73 x 29	150	135	29		<b>\$3326</b>
KERR6622CG	24 x 67 x 29	150	127	27		<b>\$3051</b>
KERR6022CG	24 x 61 x 29	150	120	24		<b>\$2772</b>
KERR5422CG	24 x 55 x 29	150	112	22		<b>\$2493</b>
KERR4822CG	24 x 49 x 29	150	105	19		<b>\$2219</b>
KERR4222CG	24 x 43 x 29	150	97	17		<b>\$1938</b>

Full height flush back panel.

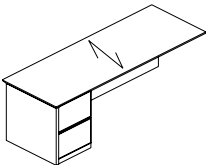

**Executive Return - Left\***

KERL7220ECG	22 x 73 x 29	100	240	27		<b>\$5643</b>
KERL6620ECG	22 x 67 x 29	100	231	24		<b>\$5435</b>
KERL6020ECG	22 x 61 x 29	92.5	222	22		<b>\$4942</b>
KERL5420ECG	22 x 55 x 29	92.5	200	20		<b>\$4764</b>
KERL4820ECG	22 x 49 x 29	92.5	180	18		<b>\$4234</b>
KERL4220ECG	22 x 43 x 29	92.5	173	16		<b>\$4081</b>

Standard with full to floor **file/file** pedestal on **left**. Pedestal locks. Full height flush back panel.

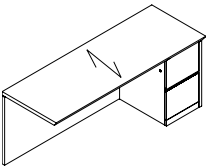

**Executive Return - Right\***

KERR7220ECG	22 x 73 x 29	100	240	27		<b>\$5643</b>
KERR6620ECG	22 x 67 x 29	100	231	24		<b>\$5435</b>
KERR6020ECG	22 x 61 x 29	92.5	222	22		<b>\$4942</b>
KERR5420ECG	22 x 55 x 29	92.5	200	20		<b>\$4764</b>
KERR4820ECG	22 x 49 x 29	92.5	180	18		<b>\$4234</b>
KERR4220ECG	22 x 43 x 29	92.5	173	16		<b>\$4081</b>

Standard with full to floor **file/file** pedestal on **right**. Pedestal locks. Full height flush back panel.

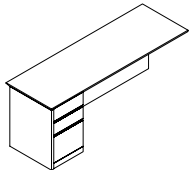

**Executive Return - Left\***

KERL7220DCG	22 x 73 x 29	100	240	27		<b>\$5643</b>
KERL6620DCG	22 x 67 x 29	100	231	24		<b>\$5435</b>
KERL6020DCG	22 x 61 x 29	92.5	222	22		<b>\$4942</b>
KERL5420DCG	22 x 55 x 29	92.5	200	20		<b>\$4764</b>
KERL4820DCG	22 x 49 x 29	92.5	180	18		<b>\$4234</b>
KERL4220DCG	22 x 43 x 29	92.5	173	16		<b>\$4081</b>

Standard with full to floor **box/box/file** pedestal on **left**. Pedestal locks. Full height flush back panel.

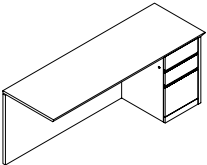

**Executive Return - Right\***

KERR7220DCG	22 x 73 x 29	100	240	27		<b>\$5643</b>
KERR6620DCG	22 x 67 x 29	100	231	24		<b>\$5435</b>
KERR6020DCG	22 x 61 x 29	92.5	222	22		<b>\$4942</b>
KERR5420DCG	22 x 55 x 29	92.5	200	20		<b>\$4764</b>
KERR4820DCG	22 x 49 x 29	92.5	180	18		<b>\$4234</b>
KERR4220DCG	22 x 43 x 29	92.5	173	16		<b>\$4081</b>

Standard with full to floor **box/box/file** pedestal on **right**. Pedestal locks. Full height flush back panel.

**Required Specifications**

Finish  
Edge

**Optional Specifications**

Handles\*  
Additional grommet

## EXECUTIVE RETURNS

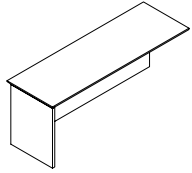

**Executive Return - Left**

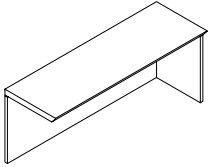

**Executive Return - Right**

MODEL#	DIMENSIONS	FREIGHT CLASS	WT/LBS.	CUBIC FT.	LIST PRICE
--------	------------	---------------	---------	-----------	------------

**D x W x H**

KERL7220CG	22 x 73 x 29	150	130	27	<b>\$3168</b>
KERL6620CG	22 x 67 x 29	150	122	24	<b>\$2906</b>
KERL6020CG	22 x 61 x 29	150	115	22	<b>\$2641</b>
KERL5420CG	22 x 55 x 29	150	105	20	<b>\$2374</b>
KERL4820CG	22 x 49 x 29	150	100	18	<b>\$2115</b>
KERL4220CG	22 x 43 x 29	150	90	16	<b>\$1846</b>

Full height flush back panel.

KERR7220CG	22 x 73 x 29	150	130	27	<b>\$3168</b>
KERR6620CG	22 x 67 x 29	150	122	24	<b>\$2906</b>
KERR6020CG	22 x 61 x 29	150	115	22	<b>\$2641</b>
KERR5420CG	22 x 55 x 29	150	105	20	<b>\$2374</b>
KERR4820CG	22 x 49 x 29	150	100	18	<b>\$2115</b>
KERR4220CG	22 x 43 x 29	150	90	16	<b>\$1846</b>

Full height flush back panel.

### Required Specifications

Finish  
Edge

### Optional Specifications

Handles\*  
Additional grommet

**PIANO DESKS - NOTES**

- All desks are shipped assembled
- Units include installed horizontal wire management
- Unit is handed by Post leg.
- Not for use with regular corner units
- If grommet (optional) color is not specified, Black grommet is standard.
- Grommets are available as an option on Desks and most Credenzas.
- Edge options - must specify:

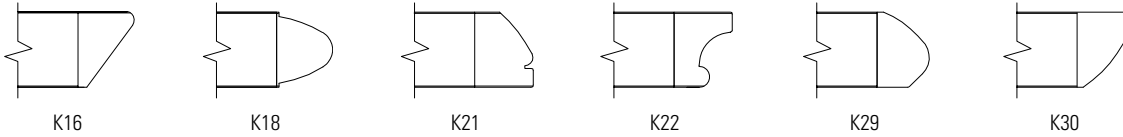

- **NOTE:** Arrow indicates direction of grain
- For cross grain veneer pattern on top, add **(CG)**.

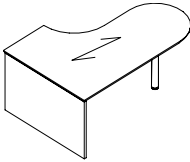
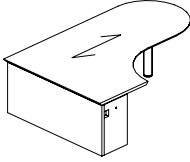
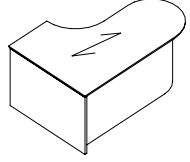
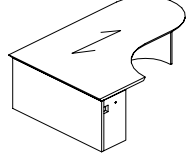
PIANO DESKS	MODEL#	DIMENSIONS	FREIGHT CLASS	WT/LBS.	CUBIC FT.	LIST PRICE
 <p><b>D-shaped Piano Desk - Left*</b></p>	KTDPPL96304822	48 x 96 x 29	125	464	77	<b>\$7591</b>
	KTDPPL84304822	48 x 84 x 29	150	406	68	<b>\$6756</b>
	KTDPPL72304822	48 x 72 x 29	125	348	58	<b>\$5916</b>
3" wood post and full end panel, 30"D worksurface and 24" return connection.						
 <p><b>D-shaped Piano Desk - Right*</b></p>	KTDPDR96304822	48 x 96 x 29	125	464	77	<b>\$7591</b>
	KTDPDR84304822	48 x 84 x 29	150	406	68	<b>\$6756</b>
	KTDPDR72304822	48 x 72 x 29	125	348	58	<b>\$5916</b>
3" wood post and full end panel, 30"D worksurface and 24" return connection.						
 <p><b>D-shaped Piano Desk - Left</b></p>	KTDPCL96304822	48 x 96 x 29	125	479	77	<b>\$9634</b>
	KTDPCL84304822	48 x 84 x 29	125	420	68	<b>\$8544</b>
	KTDPCL72304822	48 x 72 x 29	125	360	58	<b>\$7450</b>
Full height curved modesty panel, 3" wood post, and full end panel, 30"D worksurface and 24" return connection.						
 <p><b>D-shaped Piano Desk - Right</b></p>	KTDPDR96304822	48 x 96 x 29	125	479	77	<b>\$9634</b>
	KTDPDR84304822	48 x 84 x 29	125	420	68	<b>\$8544</b>
	KTDPDR72304822	48 x 72 x 29	125	360	58	<b>\$7450</b>
Full height curved modesty panel, 3" wood post, and full end panel, 30"D worksurface and 24" return connection.						

**Required Specifications**

Finish  
Edge

**Optional Specifications**

Handles\*  
Additional grommet

## PIANO DESKS - NOTES

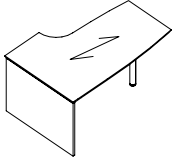

**Boat-shaped Piano Desk - Left\***

	D x W x H					
KTBPPL96364822	48 x 96 x 29	125	522	87		<b>\$8544</b>
KTBPPL84364822	48 x 84 x 29	125	457	76		<b>\$7596</b>
KTBPPL72364822	48 x 72 x 29	125	392	65		<b>\$6652</b>

3" wood post and full end panel, with 36"/30"D worksurface and 24" return connection.

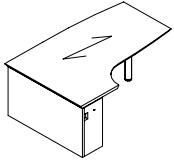

**Boat-shaped Piano Desk - Right\***

KTBPR96364822	48 x 96 x 29	125	522	87		<b>\$8544</b>
KTBPR84364822	48 x 84 x 29	125	457	76		<b>\$7596</b>
KTBPR72364822	48 x 72 x 29	125	392	65		<b>\$6652</b>

3" wood post and full end panel, with 36"/30"D worksurface and 24" return connection.

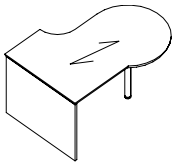

**P-shaped Piano Desk - Left\***

KTPLL96424822	48 x 96 x 29	150	580	97		<b>\$8662</b>
KTPLL84424822	48 x 84 x 29	150	508	85		<b>\$7749</b>
KTPLL72424822	48 x 72 x 29	150	435	73		<b>\$7181</b>

3" wood post and full end panel, with 42"/30"D worksurface and 24" return connection.

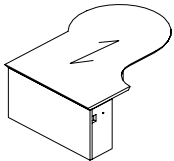

**P-shaped Piano Desk - Right\***

KTPPR96424822	48 x 96 x 29	150	580	97		<b>\$8662</b>
KTPPR84424822	48 x 84 x 29	150	508	85		<b>\$7749</b>
KTPPR72424822	48 x 72 x 29	150	435	73		<b>\$7181</b>

3" wood post and full end panel, with 42"/30"D worksurface and 24" return connection.

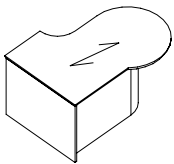

**P-shaped Piano Desk - Left**

KTPPCL96424822	48 x 96 x 29	125	590	97		<b>\$10409</b>
KTPPCL84424822	48 x 84 x 29	125	516	85		<b>\$9277</b>
KTPPCL72424822	48 x 72 x 29	125	442	73		<b>\$8720</b>

Full curved modesty panel, 3" wood post, and full end panel, with 42"/30"D worksurface and 24" return connection.

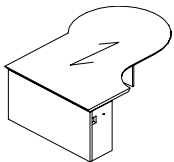

**P-shaped Piano Desk - Right**

KTPPCR96424822	48 x 96 x 29	125	590	97		<b>\$10409</b>
KTPPCR84424822	48 x 84 x 29	125	516	85		<b>\$9277</b>
KTPPCR72424822	48 x 72 x 29	125	442	73		<b>\$8720</b>

Full curved modesty panel, 3" wood post, and full end panel, with 42"/30"D worksurface and 24" return connection.

### Required Specifications

Finish  
Edge

### Optional Specifications

Additional grommet  
Base upgrade\* (see accessories for options)

**PIANO DESKS** **MODEL#** **DIMENSIONS** **FREIGHT CLASS** **WT/LBS.** **CUBIC FT.** **LIST PRICE**

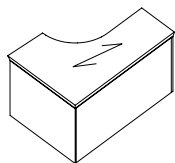

**Extended Corner Table - Right**

	<b>D x W x H</b>					
KEKL964822MR	98 x 48 x 29	150	387	77	<b>\$8248</b>	
KEKL904822MR	92 x 48 x 29	150	363	73	<b>\$7790</b>	
KEKL844822MR	86 x 48 x 29	150	338	68	<b>\$7695</b>	
KEKL784822MR	80 x 48 x 29	150	314	63	<b>\$7656</b>	
KEKL724822MR	74 x 48 x 29	150	290	58	<b>\$6613</b>	
KEKL664822MR	68 x 48 x 29	150	266	52	<b>\$6786</b>	
KEKL604822MR	62 x 48 x 29	150	242	48	<b>\$6285</b>	

Self edge on back edge, and 24" return connection.

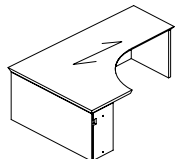

**Extended Corner Table - Right**

KEKR489622ML	98 x 48 x 29	150	387	77	<b>\$8248</b>	
KEKR489022ML	92 x 48 x 29	150	363	73	<b>\$7790</b>	
KEKR488422ML	86 x 48 x 29	150	338	68	<b>\$7695</b>	
KEKR487822ML	80 x 48 x 29	150	314	63	<b>\$7656</b>	
KEKR487222ML	74 x 48 x 29	150	290	58	<b>\$7274</b>	
KEKR486622ML	68 x 48 x 29	150	266	52	<b>\$6786</b>	
KEKR486022ML	62 x 48 x 29	150	242	48	<b>\$6285</b>	

Self edge on back edge, and 24" return connection.

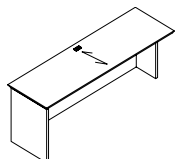

**Linking Return - Left**

KVEL9622CG	24 x 97 x 29	150	200	39	<b>\$5012</b>	
KVEL9022CG	24 x 91 x 29	150	187	36	<b>\$4698</b>	
KVEL8422CG	24 x 85 x 29	150	174	34	<b>\$4386</b>	
KVEL7822CG	24 x 79 x 29	150	162	31	<b>\$4072</b>	
KVEL7222CG	24 x 73 x 29	150	149	29	<b>\$3763</b>	
KVEL6622CG	24 x 67 x 29	150	141	27	<b>\$3532</b>	
KVEL6022CG	24 x 61 x 29	150	132	24	<b>\$3140</b>	
KVEL5422CG	24 x 55 x 29	150	121	22	<b>\$3115</b>	
KVEL4822CG	24 x 47 x 29	125	115	19	<b>\$2927</b>	
KVEL4222CG	24 x 43 x 29	150	99	17	<b>\$2463</b>	
KVEL3622CG	24 x 37 x 29	150	83	15	<b>\$2377</b>	
KVEL3022CG	24 x 31 x 29	125	77	12	<b>\$2365</b>	
KVEL2422CG	24 x 25 x 29	125	61	10	<b>\$1959</b>	

Used in conjunction with Extended Corner Units or Piano Table Desks

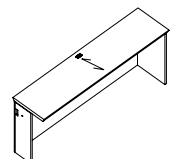

**Linking Return - Right**

KVER9622CG	24 x 97 x 29	150	200	39	<b>\$5012</b>	
KVER9022CG	24 x 91 x 29	150	187	36	<b>\$4698</b>	
KVER8422CG	24 x 85 x 29	150	174	34	<b>\$4386</b>	
KVER7822CG	24 x 79 x 29	150	162	31	<b>\$4072</b>	
KVER7222CG	24 x 73 x 29	150	149	29	<b>\$3763</b>	
KVER6622CG	24 x 67 x 29	150	141	27	<b>\$3532</b>	
KVER6022CG	24 x 61 x 29	150	132	24	<b>\$3140</b>	
KVER5422CG	24 x 55 x 29	150	121	22	<b>\$3115</b>	
KVER4822CG	24 x 47 x 29	125	115	19	<b>\$2927</b>	
KVER4222CG	24 x 43 x 29	150	99	17	<b>\$2463</b>	
KVER3622CG	24 x 37 x 29	150	83	15	<b>\$2377</b>	
KVER3022CG	24 x 31 x 29	125	77	12	<b>\$2365</b>	
KVER2422CG	24 x 25 x 29	125	61	10	<b>\$1959</b>	

Used in conjunction with Extended Corner Units or Piano Table Desks

**Required Specifications**

Finish  
Edge

**Optional Specifications**

Additional grommet  
Base upgrade\* (see accessories for options)

## EXTENDED CORNERS

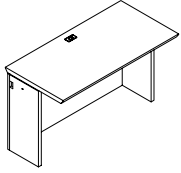

Bridge

MODEL#	DIMENSIONS	FREIGHT CLASS	WT./LBS.	CUBIC FT.	LIST PRICE
--------	------------	---------------	----------	-----------	------------

D x W x H

KBTN4822CG	24 x 48 x 29	125	116	19	<b>\$2836</b>
KBTN4222CG	24 x 42 x 29	125	102	17	<b>\$2377</b>
KBTN3622CG	24 x 36 x 29	150	87	15	<b>\$2292</b>
KBTN3022CG	24 x 30 x 29	125	73	12	<b>\$2244</b>
KBTN2422CG	24 x 24 x 29	150	58	10	<b>\$1883</b>
KBTN1822CG	24 x 18 x 29	150	43	8	<b>\$1417</b>
KBTN1222CG	24 x 12 x 29	150	29	5	<b>\$943</b>

For Extended Corner Units or Piano Table Desks, with full back panel and recessed end panels.

## BRIDGES

- All bridges are shipped knockdown.
- Not for use with corner units.
- The standard grain direction is cross grain (**CG**). To remove cross grain veneer pattern on top, delete suffix "**CG**" from the model number (no upcharge).
- GM5 TC location is standard. If grommet color is not specified, Black grommet is standard.
- Edge options - must specify:

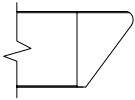

K16

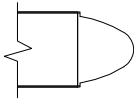

K18

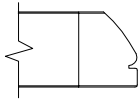

K21

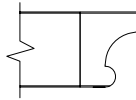

K22

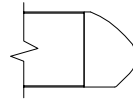

K29

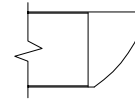

K30

- **NOTE:** Arrow indicates direction of grain

## BRIDGES

MODEL#	DIMENSIONS	FREIGHT CLASS	WT./LBS.	CUBIC FT.	LIST PRICE
--------	------------	---------------	----------	-----------	------------

KBT6022CG	24 x 60 x 29	85	108	9	<b>\$2641</b>
KBT5422CG	24 x 54 x 29	85	99	8	<b>\$2377</b>
KBT4822CG	24 x 48 x 29	85	90	7	<b>\$2115</b>
KBT4222CG	24 x 42 x 29	85	81	6	<b>\$1848</b>
KBT6020CG	22 x 60 x 29	85	105	8	<b>\$2405</b>
KBT5420CG	22 x 54 x 29	85	96	8	<b>\$2164</b>
KBT4820CG	22 x 48 x 29	85	87	7	<b>\$1922</b>
KBT4220CG	22 x 42 x 29	85	78	6	<b>\$1648</b>

With full back panel.

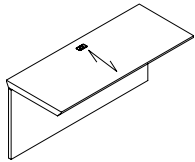

Executive Bridge Top

KBT6022Q8CG	24 x 60 x 9.5	100	83	9	<b>\$2377</b>
KBT5422Q8CG	24 x 54 x 9.5	100	74	8	<b>\$2141</b>
KBT4822Q8CG	24 x 48 x 9.5	100	65	7	<b>\$1896</b>
KBT4222Q8CG	24 x 42 x 9.5	100	56	6	<b>\$1663</b>

KBT6020Q8CG	22 x 60 x 9.5	92.5	80	8	<b>\$2164</b>
KBT5420Q8CG	22 x 54 x 9.5	100	71	8	<b>\$1953</b>
KBT4820Q8CG	22 x 48 x 9.5	100	62	7	<b>\$1736</b>
KBT4220Q8CG	22 x 42 x 9.5	100	53	6	<b>\$1484</b>

With 8" back panel.

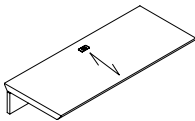

Executive Bridge Top

### Required Specifications

Finish  
Edge

### Optional Specifications

Additional grommet

EXTENDED CORNERS

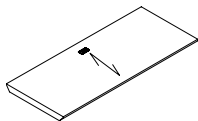

Executive Bridge Top

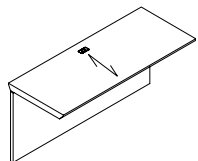

Executive Bridge Top

MODEL# DIMENSIONS FREIGHT CLASS WT/LBS. CUBIC FT. LIST PRICE

D x W x H

KBT5422TCG	24 x 54 x 1.5	100	64	8	\$1422
KBT4822TCG	24 x 48 x 1.5	125	55	7	\$1270
KBT4222TCG	24 x 42 x 1.5	125	46	6	\$1113
KBT5420TCG	22 x 54 x 1.5	125	61	8	\$1303
KBT4820TCG	22 x 48 x 1.5	125	52	7	\$1157
KBT4220TCG	22 x 42 x 1.5	125	43	6	\$991

No back panel.

KHBT6022CG	24 x 60 x 29	85	108	9	\$3034
KHBT5422CG	24 x 54 x 29	85	99	8	\$2777
KHBT4822CG	24 x 48 x 29	85	90	7	\$2512
KHBT4222CG	24 x 42 x 29	85	81	6	\$2246

KHBT6020CG	22 x 60 x 29	85	105	8	\$2803
KHBT5420CG	22 x 54 x 29	85	96	8	\$2562
KHBT4820CG	22 x 48 x 29	85	87	7	\$2322
KHBT4220CG	22 x 42 x 29	85	78	6	\$2045

With hinged back panel, for U configurations.

CREDENZA NOTES

- All credenzas are shipped assembled.
- All Storage Cabinets include one adjustable shelf per set of doors.
- "F" and "G" depict 36", and "M" and "N" depict 30".
- "F" and "N" indicate lateral file drawers and "G" and "M" indicate storage cabinets with doors.
- Credenza shells accept modular storage. Use modular storage for top support, allowing no more than 72" unsupported.
- Credenza shells with a width of 96" and more will have a 12" center support gable.
- Credenza shells can only be completely filled with modular storage units with ".5" at the end of the model number.
- If Handle is not specified Routed Pull, Black Lock & Grommet are standard
- If Handle is specified:
  - Black and Brass handle = Black Lock & Grommet
  - Silver, Nickel and Tungsten handle = Tungsten Lock & Grommet
- **NOTE:** Arrow indicates direction of grain
- Edge options - must specify:

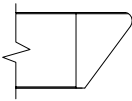
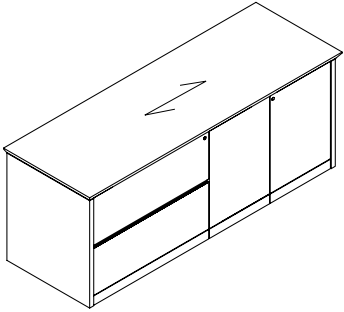

K16

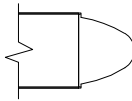

K18

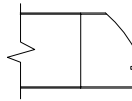

K21

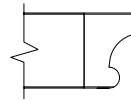

K22

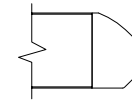

K29

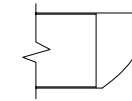

K30

CREDENZAS

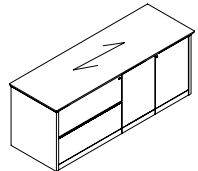

Full Storage Credenza\*

MODEL# DIMENSIONS FREIGHT CLASS WT/LBS. CUBIC FT. LIST PRICE

KC7222FG	23 x 74 x 29	92.5	285	27	\$7110
KC6022NM	23 x 62 x 29	92.5	233	22	\$5925
KC7220FG	21 x 74 x 29	92.5	272	24	\$6769
KC6020NM	21 x 62 x 29	92.5	220	20	\$5639

Standard with lateral box/file on left and storage cabinet on right.

- For Aluminum Framed Glass Door option, contact Customer Care.

Required Specifications

Finish  
Edge

Optional Specifications

Additional grommet

**DESKS**

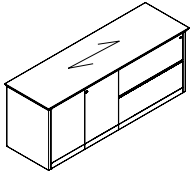

**Full Storage Credenza**

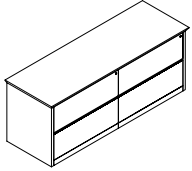

**Full Storage Credenza**

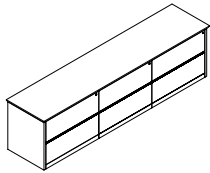

**Full Storage Credenza**

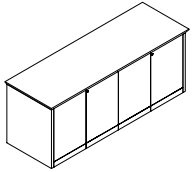

**Full Storage Credenza**

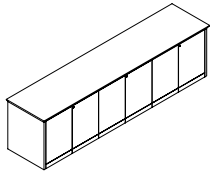

**Full Storage Credenza**

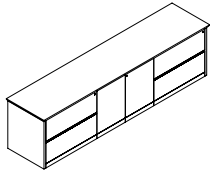

**Full Storage Credenza**

MODEL#	DIMENSIONS	FREIGHT CLASS	WT/LBS.	CUBIC FT.	LIST PRICE
--------	------------	---------------	---------	-----------	------------

**D x W x H**

KC7222GF	23 x 74 x 29	92.5	285	27	<b>\$7110</b>
KC6022MN	23 x 62 x 29	92.5	233	22	<b>\$5925</b>
KC7220GF	21 x 74 x 29	92.5	272	24	<b>\$6769</b>
KC6020MN	21 x 62 x 29	92.5	220	20	<b>\$5639</b>

Standard with **lateral box/file** on **right** and **storage cabinet** on **left**.

- For Aluminum Framed Glass Door option, contact Customer Care.

KC7222FF	23 x 74 x 29	92.5	300	27	<b>\$9090</b>
KC6022NN	23 x 62 x 29	100	218	22	<b>\$8337</b>
KC7220FF	21 x 74 x 29	92.5	287	24	<b>\$8657</b>
KC6020NN	21 x 62 x 29	92.5	205	20	<b>\$7582</b>

Standard with **lateral box/file** on **left** and **right**.

KC10822FFF	23 x 110 x 29	92.5	435	40	<b>\$15990</b>
KC9022NNN	23 x 92 x 29	92.5	372	33	<b>\$13326</b>
KC10820FFF	21 x 110 x 29	92.5	412	36	<b>\$14536</b>
KC9020NNN	21 x 92 x 29	92.5	337	30	<b>\$12116</b>

Standard with **lateral box/file** on **left, center** and **right**.

KC7222GG	23 x 74 x 29	92.5	277	27	<b>\$6747</b>
KC6022MM	23 x 62 x 29	92.5	232	22	<b>\$6186</b>
KC7220GG	21 x 74 x 29	92.5	253	24	<b>\$6427</b>
KC6020MM	21 x 62 x 29	92.5	209	20	<b>\$5624</b>

Standard with **storage cabinets** on **left** and **right**.

KC10822GGG	23 x 110 x 29	100	348	40	<b>\$12752</b>
KC9022MMM	23 x 92 x 29	100	302	33	<b>\$10626</b>
KC10820GGG	21 x 110 x 29	125	278	36	<b>\$11589</b>
KC9020MMM	21 x 92 x 29	125	228	30	<b>\$9597</b>

Standard with **storage cabinets** on **left, center** and **right**.

KC10822FGF	23 x 110 x 29	100	348	40	<b>\$14912</b>
KC9022NMN	23 x 92 x 29	100	302	33	<b>\$12428</b>
KC10820FGF	21 x 110 x 29	125	278	36	<b>\$13554</b>
KC9020NMN	21 x 92 x 29	125	228	30	<b>\$11296</b>

**Lateral files** on **left** and **right**; **storage cabinet** in **center**

**Required Specifications**

Finish  
Edge

**Optional Specifications**

Handles\*  
Additional grommet

CREDENZAS

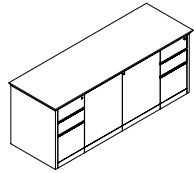

Full Storage Credenza

MODEL# DIMENSIONS FREIGHT CLASS WT/LBS. CUBIC FT. LIST PRICE

D x W x H

KC7222DGD	23 x 74 x 29	92.5	319	29	<b>\$8337</b>
KC6022DMD	23 x 62 x 29	92.5	266	24	<b>\$7643</b>
KC7220DGD	21 x 74 x 29	85	298	24	<b>\$7937</b>
KC6020DMD	21 x 62 x 29	85	246	20	<b>\$6947</b>

Standard with **box/box/file** on **left** and **right**; **storage cabinet** in **center**.

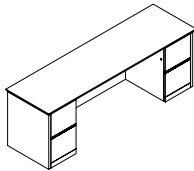

Double Pedestal Credenza

KCK8422EE	23 x 86 x 29	100	320	34	<b>\$8711</b>
KCK7822EE	23 x 80 x 29	100	298	31	<b>\$8090</b>
KCK7222EE	23 x 74 x 29	100	280	29	<b>\$7470</b>
KCK6622EE	23 x 68 x 29	100	257	27	<b>\$7356</b>
KCK6022EE	23 x 62 x 29	100	233	24	<b>\$6844</b>

KCK8420EE	21 x 86 x 29	92.5	307	28	<b>\$8302</b>
KCK7820EE	21 x 80 x 29	92.5	285	26	<b>\$7709</b>
KCK7220EE	21 x 74 x 29	92.5	267	24	<b>\$7114</b>
KCK6620EE	21 x 68 x 29	92.5	244	22	<b>\$6520</b>
KCK6020EE	21 x 62 x 29	92.5	220	20	<b>\$5928</b>

**File/file** pedestals on **left** and **right**. Full height back panel. Kneespace in center.

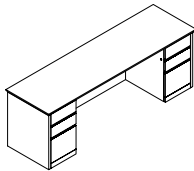

Double Pedestal Credenza

KCK8422DD	23 x 86 x 29	100	320	34	<b>\$8711</b>
KCK7822DD	23 x 80 x 29	100	298	31	<b>\$8090</b>
KCK7222DD	23 x 74 x 29	100	280	29	<b>\$7470</b>
KCK6622DD	23 x 68 x 29	100	257	27	<b>\$7356</b>
KCK6022DD	23 x 62 x 29	100	233	24	<b>\$6844</b>

KCK8420DD	21 x 86 x 29	92.5	307	28	<b>\$8302</b>
KCK7820DD	21 x 80 x 29	92.5	285	26	<b>\$7709</b>
KCK7220DD	21 x 74 x 29	92.5	267	24	<b>\$7114</b>
KCK6620DD	21 x 68 x 29	92.5	244	22	<b>\$6520</b>
KCK6020DD	21 x 62 x 29	92.5	220	20	<b>\$5928</b>

**Box/box/file** pedestals on **left** and **right**. Full height back panel. Kneespace in center.

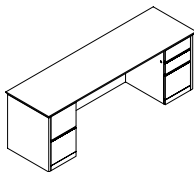

Double Pedestal Credenza

KCK8422ED	23 x 86 x 29	100	320	34	<b>\$8711</b>
KCK7822ED	23 x 80 x 29	100	298	31	<b>\$8090</b>
KCK7222ED	23 x 74 x 29	100	280	29	<b>\$7470</b>
KCK6622ED	23 x 68 x 29	100	257	27	<b>\$7356</b>
KCK6022ED	23 x 62 x 29	100	233	24	<b>\$6844</b>

KCK8420ED	21 x 86 x 29	92.5	307	28	<b>\$8302</b>
KCK7820ED	21 x 80 x 29	92.5	285	26	<b>\$7709</b>
KCK7220ED	21 x 74 x 29	92.5	267	24	<b>\$7114</b>
KCK6620ED	21 x 68 x 29	92.5	244	22	<b>\$6520</b>
KCK6020ED	21 x 62 x 29	92.5	220	20	<b>\$5928</b>

**File/file** pedestal on **left**, **box/box/file** pedestal on **right**. Full height back panel. Kneespace in center.

Required Specifications

Finish  
Edge

Optional Specifications

Handles  
Additional grommet

## CREDENZAS

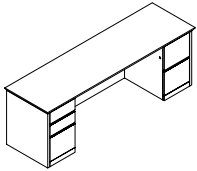

**Double Pedestal Credenza**

MODEL#	DIMENSIONS D x W x H	FREIGHT CLASS	WT./LBS.	CUBIC FT.	LIST PRICE
KCK8422DE	23 x 86 x 29	100	320	34	<b>\$8711</b>
KCK7822DE	23 x 80 x 29	100	298	31	<b>\$8090</b>
KCK7222DE	23 x 74 x 29	100	280	29	<b>\$7470</b>
KCK6622DE	23 x 68 x 29	100	257	27	<b>\$7356</b>
KCK6022DE	23 x 62 x 29	100	233	24	<b>\$6844</b>
KCK8420DE	21 x 86 x 29	92.5	307	28	<b>\$8302</b>
KCK7820DE	21 x 80 x 29	92.5	285	26	<b>\$7709</b>
KCK7220DE	21 x 74 x 29	92.5	267	24	<b>\$7114</b>
KCK6620DE	21 x 68 x 29	92.5	244	22	<b>\$6520</b>
KCK6020DE	21 x 62 x 29	92.5	220	20	<b>\$5928</b>

**Box/box/file** pedestal on **left** and **file/file** pedestal on **right**. Full height back panel. Kneespace in center.

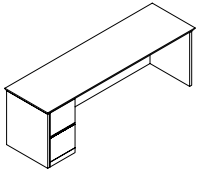

**Single Pedestal Credenza - Left**

KCL8422E	23 x 86 x 29	100	286	34	<b>\$6586</b>
KCL7822E	23 x 80 x 29	100	265	31	<b>\$6119</b>
KCL7222E	23 x 74 x 29	100	250	29	<b>\$5643</b>
KCL6622E	23 x 68 x 29	100	229	27	<b>\$5435</b>
KCL6022E	23 x 62 x 29	100	208	24	<b>\$4942</b>
KCL8420E	21 x 86 x 29	100	273	28	<b>\$6275</b>
KCL7820E	21 x 80 x 29	100	252	26	<b>\$5829</b>
KCL7220E	21 x 74 x 29	100	237	24	<b>\$5378</b>
KCL6620E	21 x 68 x 29	100	216	22	<b>\$5176</b>
KCL6020E	21 x 62 x 29	100	195	20	<b>\$4710</b>

**File/file** pedestal on **left**. Full height back panel.

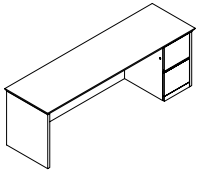

**Single Pedestal Credenza - Right**

KCR8422E	23 x 86 x 29	100	286	34	<b>\$6586</b>
KCR7822E	23 x 80 x 29	100	265	31	<b>\$6119</b>
KCR7222E	23 x 74 x 29	100	250	29	<b>\$5643</b>
KCR6622E	23 x 68 x 29	100	229	27	<b>\$5435</b>
KCR6022E	23 x 62 x 29	100	208	24	<b>\$4942</b>
KCR8420E	21 x 86 x 29	100	273	28	<b>\$6275</b>
KCR7820E	21 x 80 x 29	100	252	26	<b>\$5829</b>
KCR7220E	21 x 74 x 29	100	237	24	<b>\$5378</b>
KCR6620E	21 x 68 x 29	100	216	22	<b>\$5176</b>
KCR6020E	21 x 62 x 29	100	195	20	<b>\$4710</b>

**File/file** pedestal on **right**. Full height back panel.

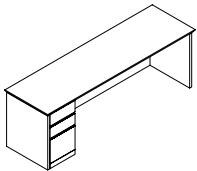

**Single Pedestal Credenza - Left**

KCL8422D	23 x 86 x 29	100	286	34	<b>\$6586</b>
KCL7822D	23 x 80 x 29	100	265	31	<b>\$6119</b>
KCL7222D	23 x 74 x 29	100	250	29	<b>\$5643</b>
KCL6622D	23 x 68 x 29	100	229	27	<b>\$5435</b>
KCL6022D	23 x 62 x 29	100	208	24	<b>\$4942</b>
KCL8420D	21 x 86 x 29	100	273	28	<b>\$6275</b>
KCL7820D	21 x 80 x 29	100	252	26	<b>\$5829</b>
KCL7220D	21 x 74 x 29	100	237	24	<b>\$5378</b>
KCL6620D	21 x 68 x 29	100	216	22	<b>\$5176</b>
KCL6020D	21 x 62 x 29	100	195	20	<b>\$4710</b>

**Box/box/file** pedestal on **left**. Full height back panel.

### Required Specifications

Finish  
Edge

### Optional Specifications

Handles  
Additional grommet

CREENZAS

MODEL# DIMENSIONS FREIGHT CLASS WT/LBS. CUBIC FT. LIST PRICE

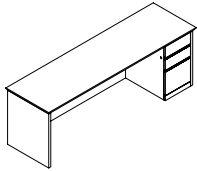

Single Pedestal Credenza - Right

	D x W x H				
KCR8422D	23 x 86 x 29	100	286	34	\$6586
KCR7822D	23 x 80 x 29	100	265	31	\$6119
KCR7222D	23 x 74 x 29	100	250	29	\$5643
KCR6622D	23 x 68 x 29	100	229	27	\$5435
KCR6022D	23 x 62 x 29	100	208	24	\$4942
KCR8420D	21 x 86 x 29	100	273	28	\$6275
KCR7820D	21 x 80 x 29	100	252	26	\$5829
KCR7220D	21 x 74 x 29	100	237	24	\$5378
KCR6620D	21 x 68 x 29	100	216	22	\$5176
KCR6020D	21 x 62 x 29	100	195	20	\$4710

Box/box/file pedestal on right. Full height back panel.

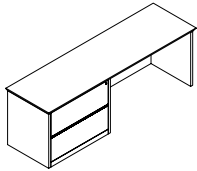

Single Pedestal Credenza - Left

KCL8422F	23 x 86 x 29	100	266	31	\$7656
KCL7822F	23 x 80 x 29	100	245	29	\$7108
KCL7222F	23 x 74 x 29	100	230	27	\$6565
KCL6622F	23 x 68 x 29	100	209	24	\$6319
KCL6022F	23 x 62 x 29	100	188	22	\$5736
KCL8420F	21 x 86 x 29	100	253	28	\$7289
KCL7820F	21 x 80 x 29	100	233	26	\$6766
KCL7220F	21 x 74 x 29	100	218	24	\$6247
KCL6620F	21 x 68 x 29	100	197	22	\$6017
KCL6020F	21 x 62 x 29	100	176	20	\$5463

36" lateral file pedestal on left. Full height back panel.

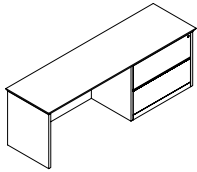

Single Pedestal Credenza - Right

KCR8422F	23 x 86 x 29	100	266	31	\$7656
KCR7822F	23 x 80 x 29	100	245	29	\$7108
KCR7222F	23 x 74 x 29	100	230	27	\$6565
KCR6622F	23 x 68 x 29	100	209	24	\$6319
KCR6022F	23 x 62 x 29	100	188	22	\$5736
KCR8420F	21 x 86 x 29	100	253	28	\$7289
KCR7820F	21 x 80 x 29	100	233	26	\$6766
KCR7220F	21 x 74 x 29	100	218	24	\$6247
KCR6620F	21 x 68 x 29	100	197	22	\$6017
KCR6020F	21 x 62 x 29	100	176	20	\$5463

36" lateral file pedestal on right. Full height back panel.

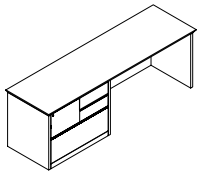

Single Pedestal Credenza - Left

KCL8422Z	23 x 86 x 29	100	309	31	\$8356
KCL7822Z	23 x 80 x 29	100	287	29	\$7762
KCL7222Z	23 x 74 x 29	92.5	270	27	\$7168
KCL6622Z	23 x 68 x 29	92.5	248	24	\$6893
KCL6022Z	23 x 62 x 29	92.5	225	22	\$6274
KCL8420Z	21 x 86 x 29	92.5	296	28	\$7964
KCL7820Z	21 x 80 x 29	92.5	274	26	\$7395
KCL7220Z	21 x 74 x 29	92.5	257	24	\$6501
KCL6620Z	21 x 68 x 29	92.5	235	22	\$6567
KCL6020Z	21 x 62 x 29	92.5	212	20	\$5971

Modular combination storage pedestal with 1 lateral file, 1 file drawer on top left, and two box drawers on top right.

Required Specifications

Finish  
Edge

Optional Specifications

Handles  
Additional grommet

## CREENZAS

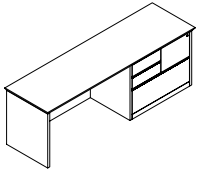

**Single Pedestal Credenza - Right**

96" and larger:

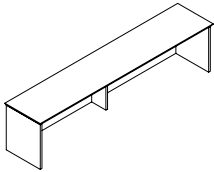

Less than 96":

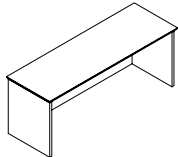

**Credenza Shell**

MODEL#	DIMENSIONS D x W x H	FREIGHT CLASS	WT./LBS.	CUBIC FT.	LIST PRICE
KCR8422Z	23 x 86 x 29	100	309	31	<b>\$8356</b>
KCR7822Z	23 x 80 x 29	100	287	29	<b>\$7762</b>
KCR7222Z	23 x 74 x 29	92.5	270	27	<b>\$7168</b>
KCR6622Z	23 x 68 x 29	92.5	248	24	<b>\$6893</b>
KCR6022Z	23 x 62 x 29	92.5	225	22	<b>\$6274</b>
KCR8420Z	21 x 86 x 29	92.5	296	28	<b>\$7964</b>
KCR7820Z	21 x 80 x 29	92.5	274	26	<b>\$7395</b>
KCR7220Z	21 x 74 x 29	92.5	257	24	<b>\$6501</b>
KCR6620Z	21 x 68 x 29	92.5	235	22	<b>\$6567</b>
KCR6020Z	21 x 62 x 29	92.5	212	20	<b>\$5971</b>

**Modular combination storage** pedestal with 1 lateral file, 1 file drawer on top right, and two box drawers on top left.

KC10822	23 x 108 x 29	125	320	41	<b>\$5290</b>
KC10222	23 x 104 x 29	100	305	38	<b>\$4997</b>
KC9622	23 x 98 x 29	100	287	35	<b>\$4705</b>
KC9022	23 x 92 x 29	100	269	33	<b>\$4199</b>
KC8422	23 x 86 x 29	100	251	31	<b>\$4118</b>
KC7822	23 x 80 x 29	100	233	29	<b>\$3822</b>
KC7222	23 x 74 x 29	125	215	27	<b>\$3532</b>
KC6622	23 x 68 x 29	100	197	24	<b>\$3397</b>
KC6022	23 x 62 x 29	100	179	22	<b>\$3091</b>
KC5422	23 x 56 x 29	100	161	20	<b>\$2927</b>
KC4822	23 x 50 x 29	125	143	18	<b>\$2767</b>
KC4222	23 x 44 x 29	125	125	16	<b>\$2341</b>
KC10820	21 x 108 x 29	100	310	36	<b>\$5042</b>
KC10220	21 x 104 x 29	100	291	34	<b>\$4763</b>
KC9620	21 x 98 x 29	100	273	32	<b>\$4482</b>
KC9020	21 x 92 x 29	100	255	30	<b>\$4205</b>
KC8420	21 x 86 x 29	100	237	28	<b>\$3924</b>
KC7820	21 x 80 x 29	100	219	26	<b>\$3641</b>
KC7220	21 x 74 x 29	100	206	24	<b>\$3358</b>
KC6620	21 x 68 x 29	100	188	22	<b>\$3234</b>
KC6020	21 x 62 x 29	100	169	20	<b>\$2944</b>
KC5420	21 x 56 x 29	100	147	18	<b>\$2784</b>
KC4820	21 x 50 x 29	125	101	16	<b>\$2633</b>
KC4220	21 x 44 x 29	125	86	14	<b>\$2231</b>

With full back panel.

### Required Specifications

Finish  
Edge

### Optional Specifications

Handles  
Additional grommet

CRENZAS MODEL# DIMENSIONS FREIGHT CLASS WT./LBS. CUBIC FT. LIST PRICE

NOTE: Arrow indicates direction of grain

**Corners**

- All units are shipped assembled
- Unit includes grommets shown and installed horizontal wire management
- Corner units and extended corner units must be used exclusively with linking bridges and linking returns
- Edge options - must specify:

- **Linking bridges** are handed by recessed end panel
- **Extended corner tables** have no molding on back side.
- **Linking returns** include grommets shown and installed horizontal wire management. Handed by full end panel.
- **Tables** include grommets shown and installed horizontal wire management.

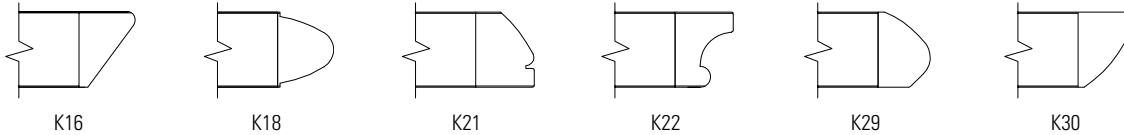

CORNERS AND COMPONENTS MODEL# DIMENSIONS FREIGHT CLASS WT./LBS. CUBIC FT. LIST PRICE

D x W x H

KBT6022NLLCG	24 x 60 x 29	125	145	24	<b>\$2911</b>
KBT5422NLLCG	24 x 54 x 29	150	131	22	<b>\$2623</b>
KBT4822NLLCG	24 x 48 x 29	125	116	19	<b>\$2332</b>
KBT4222NLLCG	24 x 42 x 29	125	102	17	<b>\$1886</b>
KBT3622NLLCG	24 x 36 x 29	150	87	15	<b>\$1716</b>
KBT3022NLLCG	24 x 30 x 29	125	73	12	<b>\$1673</b>
KBT6020NLLCG	22 x 60 x 29	150	131	22	<b>\$2772</b>
KBT5420NLLCG	22 x 54 x 29	150	118	20	<b>\$2496</b>
KBT4820NLLCG	22 x 48 x 29	125	110	18	<b>\$2219</b>
KBT4220NLLCG	22 x 42 x 29	150	95	16	<b>\$1796</b>
KBT3620NLLCG	22 x 36 x 29	125	80	13	<b>\$1631</b>
KBT3020NLLCG	22 x 30 x 29	150	65	11	<b>\$1593</b>

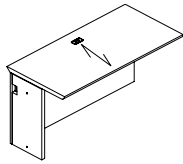

Linking Bridge - Left

To join corner worksurface to desk or credenza. Full back panel.

KBT6022NLRCG	24 x 60 x 29	125	145	24	<b>\$2911</b>
KBT5422NLRCG	24 x 54 x 29	150	131	22	<b>\$2623</b>
KBT4822NLRCG	24 x 48 x 29	125	116	19	<b>\$2332</b>
KBT4222NLRCG	24 x 42 x 29	125	102	17	<b>\$1886</b>
KBT3622NLRCG	24 x 36 x 29	150	87	15	<b>\$1716</b>
KBT3022NLRCG	24 x 30 x 29	125	73	12	<b>\$1673</b>
KBT6020NLRCG	22 x 60 x 29	150	131	22	<b>\$2772</b>
KBT5420NLRCG	22 x 54 x 29	150	118	20	<b>\$2496</b>
KBT4820NLRCG	22 x 48 x 29	125	110	18	<b>\$2219</b>
KBT4220NLRCG	22 x 42 x 29	150	95	16	<b>\$1796</b>
KBT3620NLRCG	22 x 36 x 29	125	80	13	<b>\$1631</b>
KBT3020NLRCG	22 x 30 x 29	150	65	11	<b>\$1593</b>

To join corner worksurface to desk or credenza. Full back panel.

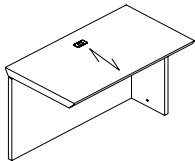

Linking Bridge - Right

**Required Specifications**

Finish  
Edge

**Optional Specifications**

Handles  
Additional grommet

## CORNERS - NOTES

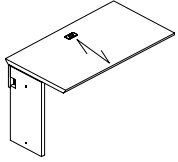

**Linking Bridge - Left**

	D x W x H				
KBT6022NLLQ8CG	24 x 60 x 9.5	125	145	24	<b>\$2623</b>
KBT5422NLLQ8CG	24 x 54 x 9.5	150	131	22	<b>\$2365</b>
KBT4822NLLQ8CG	24 x 48 x 9.5	125	116	19	<b>\$2101</b>
KBT4222NLLQ8CG	24 x 42 x 9.5	125	102	17	<b>\$1695</b>
KBT3622NLLQ8CG	24 x 36 x 9.5	150	87	15	<b>\$1544</b>
KBT3022NLLQ8CG	24 x 30 x 9.5	125	73	12	<b>\$1510</b>
KBT6020NLLQ8CG	22 x 60 x 9.5	150	131	22	<b>\$2496</b>
KBT5420NLLQ8CG	22 x 54 x 9.5	150	118	20	<b>\$2249</b>
KBT4820NLLQ8CG	22 x 48 x 9.5	125	110	18	<b>\$2000</b>
KBT4220NLLQ8CG	22 x 42 x 9.5	150	95	16	<b>\$1619</b>
KBT3620NLLQ8CG	22 x 36 x 9.5	125	80	13	<b>\$1470</b>
KBT3020NLLQ8CG	22 x 30 x 9.5	150	65	11	<b>\$1438</b>

To join corner worksurface to desk or credenza. 8" back panel.

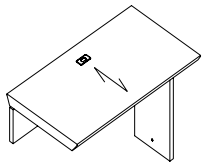

**Linking Bridge - Right**

KBT6022NLRQ8CG	24 x 60 x 9.5	125	145	24	<b>\$2623</b>
KBT5422NLRQ8CG	24 x 54 x 9.5	150	131	22	<b>\$2365</b>
KBT4822NLRQ8CG	24 x 48 x 9.5	125	116	19	<b>\$2101</b>
KBT4222NLRQ8CG	24 x 42 x 9.5	125	102	17	<b>\$1695</b>
KBT3622NLRQ8CG	24 x 36 x 9.5	150	87	15	<b>\$1544</b>
KBT3022NLRQ8CG	24 x 30 x 9.5	125	73	12	<b>\$1510</b>
KBT6020NLRQ8CG	22 x 60 x 9.5	150	131	22	<b>\$2496</b>
KBT5420NLRQ8CG	22 x 54 x 9.5	150	118	20	<b>\$2249</b>
KBT4820NLRQ8CG	22 x 48 x 9.5	125	110	18	<b>\$2000</b>
KBT4220NLRQ8CG	22 x 42 x 9.5	150	95	16	<b>\$1619</b>
KBT3620NLRQ8CG	22 x 36 x 9.5	125	80	13	<b>\$1470</b>
KBT3020NLRQ8CG	22 x 30 x 9.5	150	65	11	<b>\$1438</b>

To join corner worksurface to desk or credenza. 8" back panel.

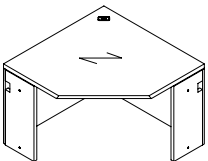

**Corner Table**

KE484822	48 x 48 x 29	150	201	39	<b>\$4188</b>
KE424222	42 x 42 x 29	150	155	30	<b>\$3215</b>
KE363622	36 x 36 x 29	125	135	22	<b>\$3053</b>
KE484820	48 x 48 x 29	150	196	39	<b>\$4188</b>
KE424220	42 x 42 x 29	150	150	30	<b>\$3215</b>
KE363620	36 x 36 x 29	150	130	22	<b>\$3053</b>

Connects to linking returns and linking bridges. 2 recessed end panels.

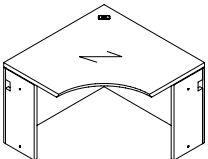

**Corner Table**

KEK484822	48 x 48 x 29	150	201	39	<b>\$4822</b>
KEK424222	42 x 42 x 29	150	155	30	<b>\$3690</b>
KEK363622	36 x 36 x 29	125	135	22	<b>\$3506</b>
KEK484820	48 x 48 x 29	150	196	39	<b>\$4822</b>
KEK424220	42 x 42 x 29	150	150	30	<b>\$3690</b>
KEK363620	36 x 36 x 29	150	130	22	<b>\$3506</b>

Connects to linking returns and linking bridges. 2 recessed end panels and inner curve.

### Required Specifications

Finish  
Edge

### Optional Specifications

Additional grommet

CORNER COMPONENTS

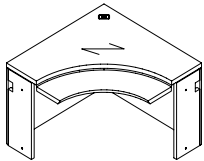

Corner Table

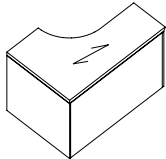

Extended Corner Table - Left

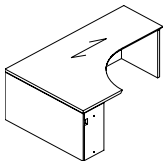

Extended Corner Table - Right

MODEL#	DIMENSIONS	FREIGHT CLASS	WT/LBS.	CUBIC FT.	LIST PRICE
<b>D x W x H</b>					
KEKS484822	48 x 48 x 29	150	201	39	<b>\$8005</b>
KEKS424222	42 x 42 x 29	150	155	30	<b>\$6706</b>
KEKS363622	36 x 36 x 29	125	135	22	<b>\$6493</b>
KEKS484820	48 x 48 x 29	150	196	39	<b>\$8005</b>
KEKS424220	42 x 42 x 29	150	150	30	<b>\$6706</b>
KEKS363620	36 x 36 x 29	150	130	22	<b>\$6493</b>

Connects to linking returns and linking bridges. 2 recessed end panels and inner curve. Adjustable keyboard tray and an articulating arm.

KEKL964822	48 x 97 x 29	150	387	77	<b>\$7497</b>
KEKL904822	48 x 91 x 29	150	363	73	<b>\$7076</b>
KEKL844822	48 x 85 x 29	150	338	68	<b>\$6993</b>
KEKL784822	48 x 79 x 29	150	314	63	<b>\$6959</b>
KEKL724822	48 x 73 x 29	150	290	58	<b>\$6612</b>
KEKL664822	48 x 67 x 29	150	266	52	<b>\$6166</b>
KEKL604822	48 x 61 x 29	150	242	48	<b>\$5446</b>

24" return connection.

KEKR489622	48 x 97 x 29	150	387	77	<b>\$7497</b>
KEKR489022	48 x 91 x 29	150	363	73	<b>\$7076</b>
KEKR488422	48 x 85 x 29	150	338	68	<b>\$6993</b>
KEKR487822	48 x 79 x 29	150	314	63	<b>\$6959</b>
KEKR487222	48 x 73 x 29	150	290	58	<b>\$6612</b>
KEKR486622	48 x 67 x 29	150	266	52	<b>\$6166</b>
KEKR486022	48 x 61 x 29	150	242	48	<b>\$5446</b>

24" return connection.

**Required Specifications**

Finish  
Edge

**Optional Specifications**

Additional grommet

## CORNER COMPONENTS

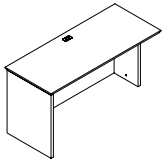

Linking Return - Left

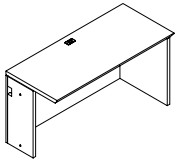

Linking Return - Right

MODEL#	DIMENSIONS	FREIGHT CLASS	WT./LBS.	CUBIC FT.	LIST PRICE
--------	------------	---------------	----------	-----------	------------

**D x W x H**

KVL9622CG	23 x 97 x 29	150	200	39	\$4827
KVL9022CG	23 x 91 x 29	150	187	36	\$4522
KVL8422CG	23 x 85 x 29	150	174	34	\$4222
KVL7822CG	23 x 79 x 29	150	162	31	\$3922
KVL7222CG	23 x 73 x 29	150	149	29	\$3619
KVL6622CG	23 x 67 x 29	150	141	27	\$3394
KVL6022CG	23 x 61 x 29	150	132	24	\$3174
KVL5422CG	23 x 55 x 29	150	121	22	\$2995
KVL4822CG	23 x 49 x 29	125	115	19	\$2814
KVL4222CG	23 x 43 x 29	150	99	17	\$2374
KVL3622CG	23 x 37 x 29	150	83	15	\$2290
KVL3022CG	23 x 31 x 29	125	77	12	\$2249
KVL2422CG	23 x 23 x 29	125	61	10	\$1883

KVL9620CG	21 x 97 x 29	150	187	39	\$4596
KVL9020CG	21 x 91 x 29	150	175	36	\$4307
KVL8420CG	21 x 85 x 29	150	163	34	\$4024
KVL7820CG	21 x 79 x 29	150	152	31	\$3734
KVL7220CG	21 x 73 x 29	150	140	29	\$3450
KVL6620CG	21 x 67 x 29	150	133	27	\$3234
KVL6020CG	21 x 61 x 29	150	125	24	\$3025
KVL5420CG	21 x 55 x 29	150	113	22	\$2853
KVL4820CG	21 x 49 x 29	150	110	19	\$2678
KVL4220CG	21 x 43 x 29	150	95	17	\$2261
KVL3620CG	21 x 37 x 29	150	80	15	\$2177
KVL3020CG	21 x 31 x 29	125	75	12	\$2141
KVL2420CG	21 x 23 x 29	125	60	10	\$1796

To be used with corner unit.

KVR9622CG	23 x 97 x 29	150	200	39	\$4827
KVR9022CG	23 x 91 x 29	150	187	36	\$4522
KVR8422CG	23 x 85 x 29	150	174	34	\$4222
KVR7822CG	23 x 79 x 29	150	162	31	\$3922
KVR7222CG	23 x 73 x 29	150	149	29	\$3619
KVR6622CG	23 x 67 x 29	150	141	27	\$3394
KVR6022CG	23 x 61 x 29	150	132	24	\$3174
KVR5422CG	23 x 55 x 29	150	121	22	\$2995
KVR4822CG	23 x 49 x 29	125	115	19	\$2814
KVR4222CG	23 x 43 x 29	150	99	17	\$2374
KVR3622CG	23 x 37 x 29	150	83	15	\$2290
KVR3022CG	23 x 31 x 29	125	77	12	\$2249
KVR2422CG	23 x 23 x 29	125	61	10	\$1883

KVR9620CG	21 x 97 x 29	150	187	39	\$4596
KVR9020CG	21 x 91 x 29	150	175	36	\$4307
KVR8420CG	21 x 85 x 29	150	163	34	\$4024
KVR7820CG	21 x 79 x 29	150	152	31	\$3734
KVR7220CG	21 x 73 x 29	150	140	29	\$3450
KVR6620CG	21 x 67 x 29	150	133	27	\$3234
KVR6020CG	21 x 61 x 29	150	125	24	\$3025
KVR5420CG	21 x 55 x 29	150	113	22	\$2853
KVR4820CG	21 x 49 x 29	150	110	19	\$2678
KVR4220CG	21 x 43 x 29	150	95	17	\$2261
KVR3620CG	21 x 37 x 29	150	80	15	\$2177
KVR3020CG	21 x 31 x 29	125	75	12	\$2141
KVR2420CG	21 x 23 x 29	125	60	10	\$1796

To be used with corner unit.

**Required Specifications**

Finish  
Edge

**Optional Specifications**

Additional grommet

LINKING RETURNS

MODEL# DIMENSIONS FREIGHT CLASS WT/LBS. CUBIC FT. LIST PRICE

D x W x H

KV9622CG	24 x 96 x 29	150	197	39	\$4714
KV9022CG	24 x 90 x 29	150	185	36	\$4422
KV8422CG	24 x 84 x 29	150	173	34	\$4123
KV7822CG	24 x 78 x 29	150	160	31	\$3826
KV7222CG	24 x 72 x 29	150	145	29	\$3534
KV6622CG	24 x 66 x 29	150	136	27	\$3314
KV6022CG	24 x 60 x 29	150	123	24	\$3093
KV5422CG	24 x 54 x 29	150	119	22	\$2911
KV4822CG	24 x 48 x 29	150	107	19	\$2732
KV4222CG	24 x 42 x 29	150	91	17	\$2517
KV3622CG	24 x 36 x 29	150	76	15	\$2290
KV3022CG	24 x 30 x 29	150	70	12	\$2160
KV2422CG	24 x 24 x 29	150	53	10	\$1815
KV9620CG	22 x 96 x 29	150	181	35	\$4494
KV9020CG	22 x 90 x 29	150	169	33	\$4214
KV8420CG	22 x 84 x 29	150	157	31	\$3929
KV7820CG	22 x 78 x 29	150	145	29	\$3648
KV7220CG	22 x 72 x 29	150	133	27	\$3367
KV6620CG	22 x 66 x 29	150	126	24	\$3157
KV6020CG	22 x 60 x 29	150	118	22	\$2947
KV5420CG	22 x 54 x 29	150	111	20	\$2772
KV4820CG	22 x 48 x 29	150	103	18	\$2599
KV4220CG	22 x 42 x 29	150	88	16	\$2177
KV3620CG	22 x 36 x 29	150	73	13	\$2101
KV3020CG	22 x 30 x 29	125	68	11	\$2059
KV2420CG	22 x 24 x 29	150	52	9	\$1728

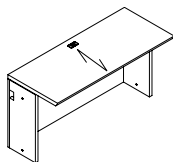

Center Surface\*

With recessed end panels.

Required Specifications

Finish  
Edge

Optional Specifications

Additional grommet

## MODULAR STORAGE - NOTES

- All storage components are shipped assembled
- Components 28" high are intended for use with a desk, credenza or return shell
- Backs on 28" high pedestals and cabinets are unfinished. If finished back is required, see page 247.
- If a profiled top is required, see "Freestanding Storage" on page 256.
- If Handle is not specified Routed Pull, Black Lock & Grommet are standard
- If Handle is specified:
  - Black and Brass handle = Black Lock & Grommet
  - Silver, Nickel and Tungsten handle = Tungsten Lock & Grommet

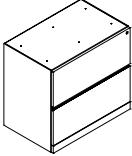
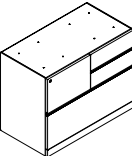
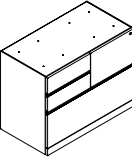
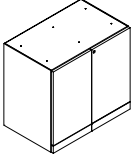
MODULAR STORAGE	MODEL#	DIMENSIONS	FREIGHT CLASS	WT/LBS.	CUBIC FT.	LIST PRICE
<b>D x W x H</b>						
 <p><b>Modular Lateral File**</b></p>	KWF	19 x 35.1 x 28	92.5	115	11	<b>\$3410</b>
	KWN	19 x 30 x 28	92.5	96	9	<b>\$2984</b>
	KWF.5	19 x 34.5 x 28	92.5	115	11	<b>\$3410</b>
Units with ".5" at end of code are intended to be used if a Full Storage Credenza is to be created. For Single Pedestal installations either style can be used.						
 <p><b>Modular Combination Storage - Left**</b></p>	KWZL	19 x 35.1 x 28	92.5	115	11	<b>\$3959</b>
	KWZL.5	19 x 34.5 x 28	92.5	115	11	<b>\$3959</b>
1 lateral file, 2 box drawers top right, and 1 file top left.						
• Units with ".5" at end of code are intended to be used if a Full Storage Credenza is to be created. For Single Pedestal installations either style can be used.						
 <p><b>Modular Combination Storage - Right**</b></p>	KWZR	19 x 35.1 x 28	92.5	115	11	<b>\$3959</b>
	KWZR.5	19 x 34.5 x 28	92.5	115	11	<b>\$3959</b>
1 lateral file, 2 box drawers top left, and 1 file top right.						
• Units with ".5" at end of code are intended to be used if a Full Storage Credenza is to be created. For Single Pedestal installations either style can be used.						
 <p><b>Modular Storage Cabinet w/Doors*</b></p>	KWG	19 x 35.1 x 28	92.5	115	11	<b>\$2377</b>
	KWM	19 x 30 x 28	92.5	96	9	<b>\$2004</b>
	KWG.5	19 x 34.5 x 28	92.5	115	11	<b>\$2377</b>
Storage with 1 adjustable shelf.						
• Units with ".5" at end of code are intended to be used if a Full Storage Credenza is to be created. For Single Pedestal installations either style can be used.						

### Required Specifications

Finish  
Edge\*

### Optional Specifications

Handles\*\*  
Additional grommet

MODULAR STORAGE

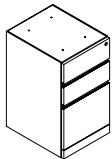

Modular Pedestal\*

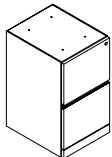

Modular Pedestal\*

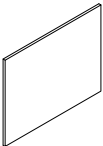

Finished Back

MODEL# DIMENSIONS FREIGHT CLASS WT./LBS. CUBIC FT. LIST PRICE

D x W x H

Letter width:

KWWD	23 x 15.6 x 28	85	72	6	<b>\$2633</b>
KWD	19 x 15.6 x 28	85	70	5	<b>\$2293</b>

Legal width:

KWWLD	23 x 18.5 x 28	85	85	7	<b>\$3160</b>
KWLD	19 x 18.5 x 28	85	83	6	<b>\$2749</b>

Box/box/file pedestal.

Letter width:

KWWE	23 x 15.6 x 28	85	72	6	<b>\$2633</b>
KWE	19 x 15.6 x 28	85	70	5	<b>\$2293</b>

Legal width:

KWWLE	23 x 18.5 x 28	85	85	7	<b>\$3160</b>
KWLE	19 x 18.5 x 28	85	83	6	<b>\$2749</b>

File/file pedestal.

KBA36	0.8 x 35 x 27.5	125	18	3	<b>\$498</b>
KBA30	0.8 x 30 x 27.5	150	15	3	<b>\$414</b>
KBA18	0.8 x 18.5 x 27.5	150	10	2	<b>\$241</b>
KBA15	0.8 x 15.5 x 27.5	150	8	2	<b>\$209</b>

For modular pedestals.

**Required Specifications**  
Finish

**Optional Specifications**  
Handles\*

## HUTCHES & WALL MOUNTED STORAGE NOTES

### Hutches

- All hutches are shipped assembled
- Handles can be specified for hutches with wood doors.
- Handles cannot be specified on Aluminum framed glass doors.
- Frosted glass door is standard. White back painted clear glass is available, please contact customer care.

### Closed pigeon hole storage hutch

- 42" unit has 21.5" of clearance

**NOTE:** Arrow indicates direction of grain

Edge options - must specify:

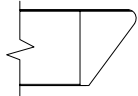

K16

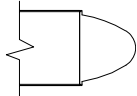

K18

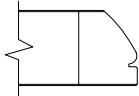

K21

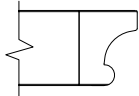

K22

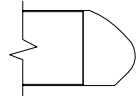

K29

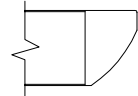

K30

### Closed storage hutch

- 36" unit has 19.5" of clearance.
- 42" and 54" units have 25.5" of clearance
- For lock option, see page 270

### Tasklight

- For proper size, see page 270.
- If Handle is specified:
  - Black and Brass handle = Black Lock & Grommet
  - Silver, Nickel and Tungsten handle = Tungsten Lock & Grommet

## HUTCHES & WALL MOUNTED STORAGE

### MODEL#

### DIMENSIONS

### FREIGHT CLASS

### WT/LBS.

### CUBIC FT.

### LIST PRICE

K108SH36	16 x 110 x 36	125	268	34	<b>\$7771</b>
K102SH36	16 x 104 x 36	125	254	32	<b>\$7339</b>
K96SH36	16 x 98 x 36	100	241	30	<b>\$6793</b>
K90SH36	16 x 92 x 36	100	227	28	<b>\$6474</b>
K84SH36	16 x 86 x 36	100	214	26	<b>\$6042</b>
K78SH36	16 x 80 x 36	100	200	24	<b>\$5612</b>
K72SH36	16 x 74 x 36	100	187	23	<b>\$5177</b>
K66SH36	16 x 68 x 36	100	173	21	<b>\$4982</b>
K60SH36	16 x 62 x 36	100	160	19	<b>\$4749</b>
K36SH36	16 x 38 x 36	100	94	11	<b>\$3238</b>
K30SH36	16 x 32 x 36	100	78	9	<b>\$2834</b>

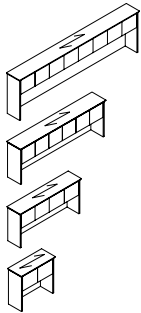

**36" H Storage Hutch w/Wood Doors\***

Hutches longer than 102" have 8 doors, hutches between 102" and 86" have 6 doors, hutches between 80" and 62" have 4 doors, and 32" and 38" hutches have 2 doors. Locks are optional.

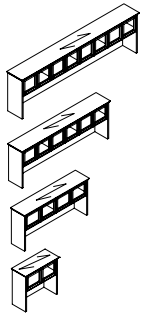

**36" H Storage Hutch w/Glass Doors**

K108SH36G	16 x 110 x 36	125	268	34	<b>\$11297</b>
K102SH36G	16 x 104 x 36	125	254	32	<b>\$10140</b>
K96SH36G	16 x 98 x 36	100	241	30	<b>\$9670</b>
K90SH36G	16 x 92 x 36	100	227	28	<b>\$9195</b>
K84SH36G	16 x 86 x 36	100	214	26	<b>\$8727</b>
K78SH36G	16 x 80 x 36	100	200	24	<b>\$8264</b>
K72SH36G	16 x 74 x 36	100	187	23	<b>\$7075</b>
K66SH36G	16 x 68 x 36	100	173	21	<b>\$6883</b>
K60SH36G	16 x 62 x 36	100	160	19	<b>\$6533</b>
K36SH36G	16 x 38 x 36	100	94	11	<b>\$4178</b>
K30SH36G	16 x 32 x 36	100	78	9	<b>\$3724</b>

Aluminum framed glass doors. Hutches longer than 102" have 8 doors, hutches between 102" and 86" have 6 doors, hutches between 80" and 62" have 4 doors, and 32" and 38" hutches have 2 doors. No lock option available.

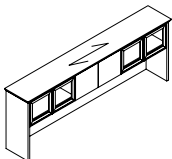

**36" H Storage Hutch w/Doors\***

K102SH36GDG	16 x 104 x 3	125	254	32	<b>\$9120</b>
K96SH36GDG	16 x 98 x 36	100	241	30	<b>\$8688</b>
K90SH36GDG	16 x 92 x 36	100	227	28	<b>\$8255</b>
K84SH36GDG	16 x 86 x 36	100	214	26	<b>\$7455</b>

Wood doors in the center and Aluminum framed glass doors on left and right. Locks are optional on wood doors.

### Required Specifications

Finish  
Edge

### Optional Specifications

Handles\* (wood doors only)  
Locks\* (wood doors only)

HUTCHES & WALL MOUNTED STORAGE

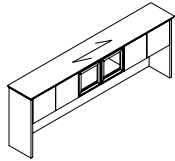

36" H Storage Hutch w/Doors\*

MODEL#	DIMENSIONS D x W x H	FREIGHT CLASS	WT/LBS.	CUBIC FT.	LIST PRICE
K102SH36DGD	16 x 104 x 3	125	254	32	<b>\$9120</b>
K96SH36DGD	16 x 98 x 36	100	241	30	<b>\$7567</b>
K90SH36DGD	16 x 92 x 36	100	227	28	<b>\$7360</b>
K84SH36DGD	16 x 86 x 36	100	214	26	<b>\$6930</b>

Aluminum framed glass doors in the center and wood doors on left and right. Locks are optional on wood doors.

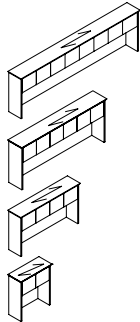

42" H Storage Hutch w/Wood Doors\*

K108SH42	16 x 110 x 43	125	307	39	<b>\$9060</b>
K102SH42	16 x 104 x 43	125	290	37	<b>\$8552</b>
K96SH42	16 x 98 x 43	125	273	35	<b>\$8055</b>
K90SH42	16 x 92 x 43	125	256	33	<b>\$7550</b>
K84SH42	16 x 86 x 43	125	239	31	<b>\$7044</b>
K78SH42	16 x 80 x 43	150	222	38	<b>\$6548</b>
K72SH42	16 x 74 x 43	125	205	26	<b>\$6042</b>
K66SH42	16 x 68 x 43	125	188	24	<b>\$5813</b>
K60SH42	16 x 62 x 43	125	171	22	<b>\$5538</b>
K36SH42	16 x 38 x 43	125	102	13	<b>\$3780</b>
K30SH42	16 x 32 x 43	125	85	11	<b>\$3307</b>

Hutches longer than 102" have 8 doors, hutches between 102" and 86" have 6 doors, hutches between 80" and 62" have 4 doors, and 32" and 38" hutches have 2 doors. Locks are optional.

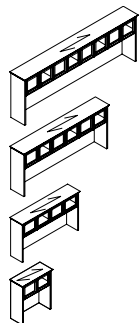

42" H Storage Hutch w/Glass Doors

K108SH42G	16 x 110 x 43	125	307	39	<b>\$12590</b>
K102SH42G	16 x 104 x 43	125	290	37	<b>\$11359</b>
K96SH42G	16 x 98 x 43	125	273	35	<b>\$10817</b>
K90SH42G	16 x 92 x 43	125	256	33	<b>\$10277</b>
K84SH42G	16 x 86 x 43	125	239	31	<b>\$9735</b>
K78SH42G	16 x 80 x 43	150	222	38	<b>\$9194</b>
K72SH42G	16 x 74 x 43	125	205	26	<b>\$7938</b>
K66SH42G	16 x 68 x 43	125	188	24	<b>\$7658</b>
K60SH42G	16 x 62 x 43	125	171	22	<b>\$7385</b>
K36SH42G	16 x 38 x 43	125	102	13	<b>\$4720</b>
K30SH42G	16 x 32 x 43	125	85	11	<b>\$4198</b>

Aluminum framed glass doors. Hutches longer than 102" have 8 doors, hutches between 102" and 86" have 6 doors, hutches between 80" and 62" have 4 doors, and 32" and 38" hutches have 2 doors. Lock option not available.

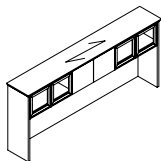

42" H Storage Hutch w/Doors\*

K102SH42GDG	16 x 104 x 43	125	290	37	<b>\$11850</b>
K96SH42GDG	16 x 98 x 43	125	273	35	<b>\$11153</b>
K90SH42GDG	16 x 92 x 43	125	256	33	<b>\$10458</b>
K84SH42GDG	16 x 86 x 43	125	239	31	<b>\$9759</b>

Wood doors in the center and Aluminum framed glass doors on left and right. Locks are optional on wood doors.

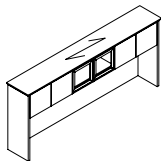

42" H Storage Hutch w/Doors\*

K102SH42DGD	16 x 104 x 43	125	290	37	<b>\$9919</b>
K96SH42DGD	16 x 98 x 43	125	273	35	<b>\$8942</b>
K90SH42DGD	16 x 92 x 43	125	256	33	<b>\$8438</b>
K84SH42DGD	16 x 86 x 43	125	239	31	<b>\$7938</b>

Aluminum framed glass doors in the center and wood doors on left and right. Locks are optional on wood doors.

**Required Specifications**

Finish  
Edge

**Optional Specifications**

Handles\* (wood doors only)  
Locks\* (wood doors only)

## HUTCHES & WALL MOUNTED STORAGE

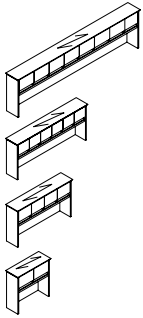

**42" H Storage Hutch w/Wood Doors & Pigeon-Holes**

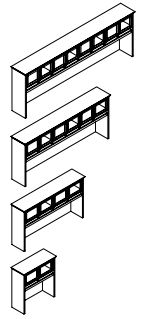

**42" H Storage Hutch w/Glass Doors & Pigeon-Holes**

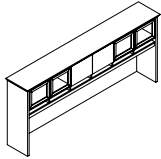

**42" H Storage Hutch w/Doors & Pigeon-Holes**

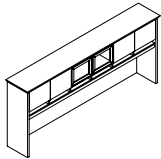

**42" H Storage Hutch w/Doors & Pigeon-Holes**

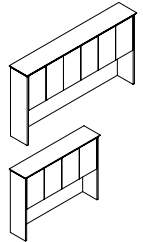

**54" H Storage Hutch w/Wood Doors\***

MODEL#	DIMENSIONS	FREIGHT CLASS	WT/LBS.	CUBIC FT.	LIST PRICE
--------	------------	---------------	---------	-----------	------------

**D x W x H**

K108SHP42	16 x 110 x 43	125	307	39	<b>\$10867</b>
K102SHP42	16 x 104 x 43	125	290	37	<b>\$10268</b>
K96SHP42	16 x 98 x 43	125	273	35	<b>\$9662</b>
K90SHP42	16 x 92 x 43	125	256	33	<b>\$9060</b>
K84SHP42	16 x 86 x 43	125	239	31	<b>\$8456</b>
K78SHP42	16 x 80 x 43	150	222	38	<b>\$7850</b>
K72SHP42	16 x 74 x 43	125	205	26	<b>\$7249</b>
K66SHP42	16 x 68 x 43	125	188	24	<b>\$6981</b>
K60SHP42	16 x 62 x 43	125	171	22	<b>\$6645</b>
K36SHP42	16 x 38 x 43	125	102	13	<b>\$4536</b>
K30SHP42	16 x 32 x 43	125	85	11	<b>\$3970</b>

Hutches longer than 102" have 8 doors, hutches between 102" and 86" have 6 doors, hutches between 80" and 62" have 4 doors, and 32" and 38" hutches have 2 doors. Locks are optional.

K108SHP42G	16 x 110 x 43	125	307	39	<b>\$14319</b>
K102SHP42G	16 x 104 x 43	125	290	37	<b>\$13002</b>
K96SHP42G	16 x 98 x 43	125	273	35	<b>\$12390</b>
K90SHP42G	16 x 92 x 43	125	256	33	<b>\$12352</b>
K84SHP42G	16 x 86 x 43	125	239	31	<b>\$11063</b>
K78SHP42G	16 x 80 x 43	150	222	38	<b>\$10429</b>
K72SHP42G	16 x 74 x 43	125	205	26	<b>\$9095</b>
K66SHP42G	16 x 68 x 43	125	188	24	<b>\$8807</b>
K60SHP42G	16 x 62 x 43	125	171	22	<b>\$8382</b>
K36SHP42G	16 x 38 x 43	125	102	13	<b>\$5446</b>
K30SHP42G	16 x 32 x 43	125	85	11	<b>\$4860</b>

Aluminum framed glass doors. Hutches longer than 102" have 8 doors, hutches between 102" and 86" have 6 doors, hutches between 80" and 62" have 4 doors, and 32" and 38" hutches have 2 doors. No lock option available.

K102SHP42GDG	16 x 104 x 43	125	290	37	<b>\$12002</b>
K96SHP42GDG	16 x 98 x 43	125	273	35	<b>\$11396</b>
K90SHP42GDG	16 x 92 x 43	125	256	33	<b>\$10799</b>
K84SHP42GDG	16 x 86 x 43	125	239	31	<b>\$9707</b>

Wood doors in the center and Aluminum framed glass doors on left and right. Locks are optional on wood doors.

K102SHP42DGD	16 x 104 x 43	125	290	37	<b>\$11159</b>
K96SHP42DGD	16 x 98 x 43	125	273	35	<b>\$10027</b>
K90SHP42DGD	16 x 92 x 43	125	256	33	<b>\$9562</b>
K84SHP42DGD	16 x 86 x 43	125	239	31	<b>\$9325</b>

Aluminum framed glass doors in the center and wood doors on left and right. Locks are optional on wood doors.

K962SH54	16 x 98 x 55	125	351	45	<b>\$10355</b>
K902SH54	16 x 92 x 55	125	329	42	<b>\$9707</b>
K842SH54	16 x 86 x 55	125	307	39	<b>\$9060</b>
K782SH54	16 x 80 x 55	125	285	37	<b>\$8412</b>
K722SH54	16 x 74 x 55	125	263	34	<b>\$7764</b>
K662SH54	16 x 68 x 55	125	241	31	<b>\$7474</b>
K602SH54	16 x 62 x 55	125	219	28	<b>\$7117</b>

Hutches between 98" and 86" have 6 doors; hutches less than 86" have 4 doors. One adjustable shelf. Locks are optional.

**Required Specifications**

Finish  
Edge

**Optional Specifications**

Handles\* (wood doors only)  
Locks\* (wood doors only)

**HUTCHES & WALL MOUNTED STORAGE**      **MODEL#**      **DIMENSIONS**      **FREIGHT CLASS**      **WT/LBS.**      **CUBIC FT.**      **LIST PRICE**

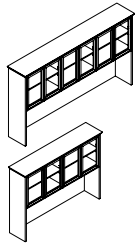

**54" H Storage Hutch w/Glass Doors**

D x W x H						
K962SH54G	16 x 98 x 55	125	351	45	<b>\$13816</b>	
K902SH54G	16 x 92 x 55	125	329	42	<b>\$12868</b>	
K842SH54G	16 x 86 x 55	125	307	39	<b>\$11915</b>	
K782SH54G	16 x 80 x 55	125	285	37	<b>\$10960</b>	
K722SH54G	16 x 74 x 55	125	263	34	<b>\$10014</b>	
K662SH54G	16 x 68 x 55	125	241	31	<b>\$9653</b>	
K602SH54G	16 x 62 x 55	125	219	28	<b>\$9227</b>	

Aluminum framed glass doors. Hutches between 98" and 86" have 6 doors; hutches less than 86" have 4 doors. One adjustable shelf. No lock option available.

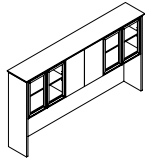

**54" H Storage Hutch w/Doors\***

K962SH54GDG	16 x 98 x 55	125	351	45	<b>\$12463</b>
K902SH54GDG	16 x 92 x 55	125	329	42	<b>\$11812</b>
K842SH54GDG	16 x 86 x 55	125	309	39	<b>\$11167</b>

Wood doors in the center and Aluminum framed glass doors on left and right. One adjustable shelf. Locks are optional on wood doors.

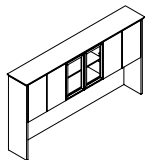

**54" H Storage Hutch w/Doors\***

K962SH54DGD	16 x 98 x 55	125	351	45	<b>\$11405</b>
K902SH54DGD	16 x 92 x 55	125	329	42	<b>\$10760</b>
K842SH54DGD	16 x 86 x 55	125	307	39	<b>\$10115</b>

Aluminum framed glass doors in the center and wood doors on left and right. One adjustable shelf. Locks are optional on wood doors.

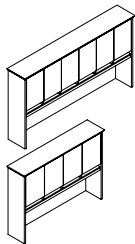

**54" H Storage Hutch w/Wood Doors & Pigeon-Holes**

K962SHP54	16 x 98 x 55	125	351	45	<b>\$12428</b>
K902SHP54	16 x 92 x 55	125	329	42	<b>\$11644</b>
K842SHP54	16 x 86 x 55	125	307	39	<b>\$10865</b>
K782SHP54	16 x 80 x 55	125	285	37	<b>\$10865</b>
K722SHP54	16 x 74 x 55	125	263	34	<b>\$9313</b>
K662SHP54	16 x 68 x 55	125	241	31	<b>\$8970</b>
K602SHP54	16 x 62 x 55	125	219	28	<b>\$8545</b>

Hutches between 98" and 86" have 6 doors; hutches less than 86" have 4 doors. One adjustable shelf. Locks are optional.

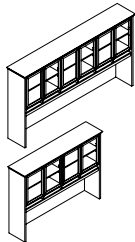

**54" H Storage Hutch w/Glass Doors & Pigeon-Holes**

K962SHP54G	16 x 98 x 55	125	351	45	<b>\$15888</b>
K902SHP54G	16 x 92 x 55	125	329	42	<b>\$14807</b>
K842SHP54G	16 x 86 x 55	125	307	39	<b>\$13723</b>
K782SHP54G	16 x 80 x 55	125	285	37	<b>\$12645</b>
K722SHP54G	16 x 74 x 55	125	263	34	<b>\$11566</b>
K662SHP54G	16 x 68 x 55	125	241	34	<b>\$11150</b>
K602SHP54G	16 x 62 x 55	125	219	28	<b>\$10653</b>

Aluminum framed glass doors. Hutches between 98" and 86" have 6 doors; hutches less than 86" have 4 doors. One adjustable shelf. No lock option available.

**Required Specifications**

Finish  
Edge

**Optional Specifications**

Handles\* (wood doors only)  
Locks\* (wood doors only)

## HUTCHES & WALL MOUNTED STORAGE

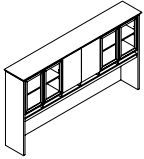

**54" H Storage Hutch w/Doors & Pigeon-Holes**

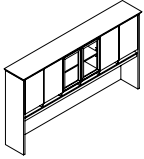

**54" H Storage Hutch w/Doors &\* Pigeon-Holes**

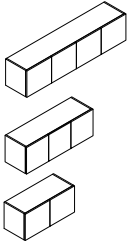

**Wall Mount Storage w/Wood Doors\***

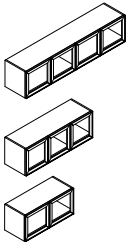

**Wall Mount Storage w/Glass Doors**

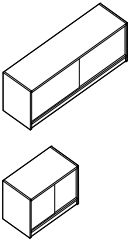

**Wall Mount Storage w/Sliding Glass Doors**

MODEL#	DIMENSIONS D x W x H	FREIGHT CLASS	WT/LBS.	CUBIC FT.	LIST PRICE
K962SHP54GDG	16 x 98 x 55	125	351	45	<b>\$13479</b>
K902SHP54GDG	16 x 92 x 55	125	329	42	<b>\$12702</b>
K842SHP54GDG	16 x 86 x 55	125	307	39	<b>\$11921</b>

Wood doors in the center and Aluminum framed glass doors on left and right. One adjustable shelf. Locks are optional on wood doors.

K962SHP54DGD	16 x 98 x 55	125	351	45	<b>\$14532</b>
K902SHP54DGD	16 x 92 x 55	125	329	42	<b>\$13756</b>
K842SHP54DGD	16 x 86 x 55	125	307	39	<b>\$12976</b>

Aluminum framed glass doors in the center and wood doors on left and right. One adjustable shelf. Locks are optional on wood doors.

CSF72	15.5 x 72 x 16.5	92.5	100	10	<b>\$2418</b>
CSF66	15.5 x 66 x 16.5	100	83	9	<b>\$2218</b>
CSF60	15.5 x 60 x 16.5	100	75	8	<b>\$2010</b>
CSF54	15.5 x 54 x 16.5	100	68	7	<b>\$1812</b>
CSF48	15.5 x 48 x 16.5	100	60	7	<b>\$1611</b>
CSF42	15.5 x 42 x 16.5	100	55	6	<b>\$1481</b>
CSF36	15.5 x 36 x 16.5	92.5	50	5	<b>\$1453</b>
CSF30	15.5 x 30 x 16.5	92.5	45	4	<b>\$1429</b>

Locks are optional.

CSF72G	15.5 x 72 x 16.5	92.5	100	10	<b>\$5087</b>
CSF66G	15.5 x 66 x 16.5	100	83	9	<b>\$4725</b>
CSF60G	15.5 x 60 x 16.5	100	75	8	<b>\$4429</b>
CSF54G	15.5 x 54 x 16.5	100	68	7	<b>\$3968</b>
CSF48G	15.5 x 48 x 16.5	100	60	7	<b>\$3505</b>
CSF42G	15.5 x 42 x 16.5	100	55	6	<b>\$3111</b>
CSF36G	15.5 x 36 x 16.5	92.5	50	5	<b>\$2876</b>
CSF30G	15.5 x 30 x 16.5	92.5	45	4	<b>\$2792</b>

Aluminum framed glass doors. No lock option available.

CSF72GSL	18 x 72 x 16.5	92.5	100	10	<b>\$5087</b>
CSF66GSL	18 x 66 x 16.5	100	83	9	<b>\$4725</b>
CSF60GSL	18 x 60 x 16.5	100	75	8	<b>\$4429</b>
CSF54GSL	18 x 54 x 16.5	100	68	7	<b>\$3968</b>
CSF48GSL	18 x 48 x 16.5	100	60	7	<b>\$3505</b>
CSF42GSL	18 x 42 x 16.5	100	55	6	<b>\$3111</b>
CSF36GSL	18 x 36 x 16.5	92.5	50	5	<b>\$2876</b>
CSF30GSL	18 x 30 x 16.5	92.5	45	4	<b>\$2792</b>

Frameless sliding glass doors. No lock option available.

### Required Specifications

Finish  
Edge

### Optional Specifications

Handles\* (wood doors only)  
Locks\* (wood doors only)

**HUTCHES & WALL MOUNTED STORAGE**

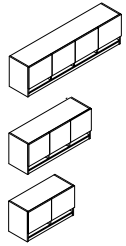

**Wall Mount Storage w/Wood Doors &\* Pigeon-Holes**

MODEL#	D x W x H	FREIGHT CLASS	WT./LBS.	CUBIC FT.	LIST PRICE
CSFP72	15.5 x 72 x 20	92.5	100	10	\$2897
CSFP66	15.5 x 66 x 20	100	83	9	\$2658
CSFP60	15.5 x 60 x 20	100	75	8	\$2418
CSFP54	15.5 x 54 x 20	100	68	7	\$2176
CSFP48	15.5 x 48 x 20	100	60	7	\$1931
CSFP42	15.5 x 42 x 20	100	55	6	\$1832
CSFP36	15.5 x 36 x 20	92.5	50	5	\$1744
CSFP30	15.5 x 30 x 20	92.5	45	4	\$1715

Locks are optional.

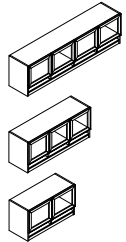

**Wall Mount Storage w/Glass Doors & Pigeon-Holes**

CSFP72G	15.5 x 72 x 20	100	100	12	\$5597
CSFP66G	15.5 x 66 x 20	125	83	11	\$5352
CSFP60G	15.5 x 60 x 20	125	75	10	\$4931
CSFP54G	15.5 x 54 x 20	125	68	9	\$4600
CSFP48G	15.5 x 48 x 20	125	60	8	\$3904
CSFP42G	15.5 x 42 x 20	125	55	7	\$3400
CSFP36G	15.5 x 36 x 20	100	50	6	\$3243
CSFP30G	15.5 x 30 x 20	100	45	5	\$3159

Aluminum framed glass doors. No lock option available.

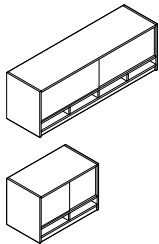

**Wall Mount Storage w/Sliding Glass Doors & Pigeon-Holes**

CSFP72GSL	18 x 72 x 20	100	100	12	\$5597
CSFP66GSL	18 x 66 x 20	125	83	11	\$5352
CSFP60GSL	18 x 60 x 20	125	75	10	\$4931
CSFP54GSL	18 x 54 x 20	125	68	9	\$4600
CSFP48GSL	18 x 48 x 20	125	60	8	\$3904
CSFP42GSL	18 x 42 x 20	125	55	7	\$3400
CSFP36GSL	18 x 36 x 20	100	50	6	\$3243
CSFP30GSL	18 x 30 x 20	100	45	5	\$3159

Frameless sliding glass doors. Locks are optional.

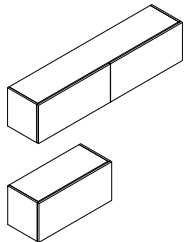

**Wall Mount Storage w/Wood Flipper Doors**

CSFF72	15.5 x 72 x 16.5	92.5	100	10	\$3564
CSFF66	15.5 x 66 x 16.5	100	83	9	\$3268
CSFF60	15.5 x 60 x 16.5	100	75	8	\$2969
CSFF54	15.5 x 54 x 16.5	100	68	7	\$2675
CSFF48	15.5 x 48 x 16.5	100	60	7	\$2378
CSFF42	15.5 x 42 x 16.5	100	55	6	\$2206
CSFF36	15.5 x 36 x 16.5	92.5	50	5	\$2166
CSFF30	15.5 x 30 x 16.5	92.5	45	4	\$2132

Locks are optional.

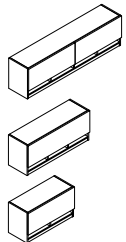

**Wall Mount Storage w/Pigeon-Holes & Wood Flipper Doors**

CSFFP72	15.5 x 72 x 20	100	100	12	\$4280
CSFFP66	15.5 x 66 x 20	125	83	11	\$3921
CSFFP60	15.5 x 60 x 20	125	75	10	\$3566
CSFFP54	15.5 x 54 x 20	125	68	9	\$3206
CSFFP48	15.5 x 48 x 20	125	60	8	\$2855
CSFFP42	15.5 x 42 x 20	125	55	7	\$2644
CSFFP36	15.5 x 36 x 20	100	50	6	\$2599
CSFFP30	15.5 x 30 x 20	100	45	5	\$2553

Locks are optional.

**Required Specifications**

Finish  
Edge

**Optional Specifications**

Handles\* (wood doors only)  
Locks\* (wood doors only)

## HUTCHES & WALL MOUNTED STORAGE

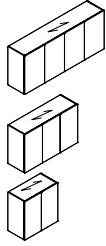

**Double High Wall Mount Storage\*  
w/Wood Doors**

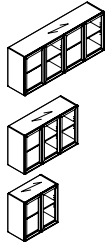

**Double High Wall Mount Storage  
w/Glass Doors**

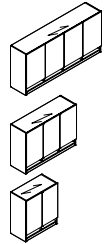

**Double High Wall Mount Storage\*  
w/Pigeon-Holes & Wood Doors**

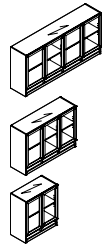

**Double High Wall Mount Storage  
w/Pigeon-Holes & Glass Doors**

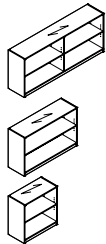

**Double High Open Wall Mount Storage**

MODEL#	DIMENSIONS D x W x H	FREIGHT CLASS	WT/LBS.	CUBIC FT.	LIST PRICE
CSF72H30	15.5 x 72 x 30	100	140	17	<b>\$6352</b>
CSF66H30	15.5 x 66 x 30	125	116	16	<b>\$5829</b>
CSF60H30	15.5 x 60 x 30	125	105	14	<b>\$5290</b>
CSF54H30	15.5 x 54 x 30	125	95	13	<b>\$4761</b>
CSF48H30	15.5 x 48 x 30	125	85	12	<b>\$4234</b>
CSF42H30	15.5 x 42 x 30	125	77	10	<b>\$3888</b>
CSF36H30	15.5 x 36 x 30	125	70	9	<b>\$3816</b>
CSF30H30	15.5 x 30 x 30	100	63	7	<b>\$3749</b>

Locks are optional.

CSF72H30G	15.5 x 72 x 30	100	140	17	<b>\$9239</b>
CSF66H30G	15.5 x 66 x 30	125	116	16	<b>\$9119</b>
CSF60H30G	15.5 x 60 x 30	60	1045	14	<b>\$8551</b>
CSF54H30G	15.5 x 54 x 30	125	95	13	<b>\$7658</b>
CSF48H30G	15.5 x 48 x 30	125	85	12	<b>\$6765</b>
CSF42H30G	15.5 x 42 x 30	125	77	10	<b>\$6009</b>
CSF36H30G	15.5 x 36 x 30	125	70	9	<b>\$5552</b>
CSF30H30G	15.5 x 30 x 30	100	63	7	<b>\$5388</b>

Aluminum framed glass doors. No lock option available.

CSFP72H34	15.5 x 72 x 34	100	140	17	<b>\$6909</b>
CSFP66H34	15.5 x 66 x 34	125	116	16	<b>\$6336</b>
CSFP60H34	15.5 x 60 x 34	125	105	14	<b>\$5766</b>
CSFP54H34	15.5 x 54 x 34	125	95	13	<b>\$5185</b>
CSFP48H34	15.5 x 48 x 34	125	85	12	<b>\$4604</b>
CSFP42H34	15.5 x 42 x 34	125	77	10	<b>\$4376</b>
CSFP36H34	15.5 x 36 x 34	125	70	9	<b>\$4151</b>
CSFP30H34	15.5 x 30 x 34	100	63	7	<b>\$4083</b>

Locks are optional.

CSFP72H34G	15.5 x 72 x 34	100	140	17	<b>\$9801</b>
CSFP66H34G	15.5 x 66 x 34	125	116	16	<b>\$9369</b>
CSFP60H34G	15.5 x 60 x 34	125	105	14	<b>\$8629</b>
CSFP54H34G	15.5 x 54 x 34	125	95	13	<b>\$8049</b>
CSFP48H34G	15.5 x 48 x 34	125	85	12	<b>\$6835</b>
CSFP42H34G	15.5 x 42 x 34	125	77	10	<b>\$5952</b>
CSFP36H34G	15.5 x 36 x 34	125	70	9	<b>\$5952</b>
CSFP30H34G	15.5 x 30 x 34	100	63	7	<b>\$5526</b>

Aluminum framed glass doors. No lock option available.

CSFO72H30	15.5 x 72 x 30	100	140	17	<b>\$5160</b>
CSFO66H30	15.5 x 66 x 30	125	116	16	<b>\$4738</b>
CSFO60H30	15.5 x 60 x 30	125	105	14	<b>\$4303</b>
CSFO54H30	15.5 x 54 x 30	125	95	13	<b>\$3881</b>
CSFO48H30	15.5 x 48 x 30	125	85	12	<b>\$3452</b>
CSFO42H30	15.5 x 42 x 30	125	77	10	<b>\$3178</b>
CSFO36H30	15.5 x 36 x 30	125	70	9	<b>\$3140</b>
CSFO30H30	15.5 x 30 x 30	100	63	7	<b>\$3082</b>

### Required Specifications

Finish  
Edge

### Optional Specifications

Handles\* (wood doors only)  
Locks\* (wood doors only)

**HUTCHES** **MODEL#** **DIMENSIONS** **FREIGHT CLASS** **WT./LBS.** **CUBIC FT.** **LIST PRICE**

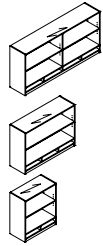

**Double High Open Wall Mount Storage w/Pigeon-Holes**

	<b>D x W x H</b>					
CSFOP72H34	15.5 x 72 x 34	100	140	17	<b>\$5618</b>	
CSFOP66H34	15.5 x 66 x 34	125	116	16	<b>\$5151</b>	
CSFOP60H34	15.5 x 60 x 34	125	105	14	<b>\$4682</b>	
CSFOP54H34	15.5 x 54 x 34	125	95	13	<b>\$4220</b>	
CSFOP48H34	15.5 x 48 x 34	125	85	12	<b>\$3743</b>	
CSFOP42H34	15.5 x 42 x 34	125	77	10	<b>\$3512</b>	
CSFOP36H34	15.5 x 36 x 34	125	70	9	<b>\$3408</b>	
CSFOP30H34	15.5 x 30 x 34	100	63	7	<b>\$3358</b>	

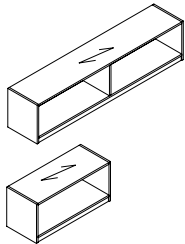

**Open Wall Mount Storage**

CSFO72	14.5 x 72 x 16.5	92.5	100	10	<b>\$1960</b>	
CSFO66	14.5 x 66 x 16.5	100	83	9	<b>\$1799</b>	
CSFO60	14.5 x 60 x 16.5	100	75	8	<b>\$1641</b>	
CSFO54	14.5 x 54 x 16.5	100	68	7	<b>\$1481</b>	
CSFO48	14.5 x 48 x 16.5	100	60	7	<b>\$1316</b>	
CSFO42	14.5 x 42 x 16.5	100	55	6	<b>\$1212</b>	
CSFO36	14.5 x 36 x 16.5	92.5	50	5	<b>\$1194</b>	
CSFO30	14.5 x 30 x 16.5	92.5	45	4	<b>\$1171</b>	

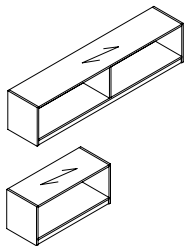

**16" D Open Wall Mount Storage**

CSFO72D16	16 x 72 x 16.5	92.5	100	10	<b>\$2974</b>	
CSFO66D16	16 x 66 x 16.5	100	83	9	<b>\$2761</b>	
CSFO60D16	16 x 60 x 16.5	100	75	8	<b>\$2545</b>	
CSFO54D16	16 x 54 x 16.5	100	68	7	<b>\$2332</b>	
CSFO48D16	16 x 48 x 16.5	100	60	7	<b>\$2117</b>	
CSFO42D16	16 x 42 x 16.5	100	55	6	<b>\$1979</b>	
CSFO36D16	16 x 36 x 16.5	92.5	50	5	<b>\$1960</b>	
CSFO30D16	16 x 30 x 16.5	92.5	45	4	<b>\$1928</b>	

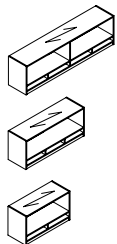

**Open Wall Mount Storage w/Pigeon-Holes**

CSFOP72	14.5 x 72 x 19.5	92.5	100	10	<b>\$2354</b>	
CSFOP66	14.5 x 66 x 19.5	100	83	9	<b>\$2162</b>	
CSFOP60	14.5 x 60 x 19.5	100	75	8	<b>\$1964</b>	
CSFOP54	14.5 x 54 x 19.5	100	68	7	<b>\$1772</b>	
CSFOP48	14.5 x 48 x 19.5	100	60	7	<b>\$1569</b>	
CSFOP42	14.5 x 42 x 19.5	100	55	6	<b>\$1476</b>	
CSFOP36	14.5 x 36 x 19.5	92.5	50	5	<b>\$1434</b>	
CSFOP30	14.5 x 30 x 19.5	92.5	45	4	<b>\$1413</b>	

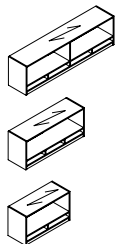

**16" D Open Wall Mount Storage w/Pigeon-Holes**

CSFOP72D16	16 x 72 x 19.5	100	100	12	<b>\$3599</b>	
CSFOP66D16	16 x 66 x 19.5	125	83	11	<b>\$3332</b>	
CSFOP60D16	16 x 60 x 19.5	125	75	10	<b>\$3066</b>	
CSFOP54D16	16 x 54 x 19.5	125	68	9	<b>\$2800</b>	
CSFOP48D16	16 x 48 x 19.5	125	60	8	<b>\$2529</b>	
CSFOP42D16	16 x 42 x 19.5	125	55	7	<b>\$2400</b>	
CSFOP36D16	16 x 36 x 19.5	100	50	6	<b>\$2337</b>	
CSFOP30D16	16 x 30 x 19.5	100	45	5	<b>\$2307</b>	

**Required Specifications**

Finish  
Edge

## FREESTANDING STORAGE NOTES

**NOTE:** Arrow indicates direction of grain

### Pedestals

- All units are shipped assembled.
- Standard face locking.

### Combination Storage

- All units are shipped assembled.
- No modifications accepted for this unit.
- Box drawers do not lock.
- Standard face locking.

Edge options - must specify:

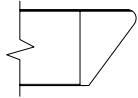

K16

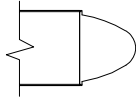

K18

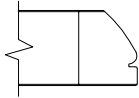

K21

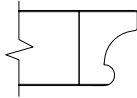

K22

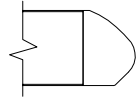

K29

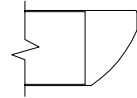

K30

### Storage Cabinets

- Units include adjustable shelves.
- If Handle is specified:
  - Black and Brass handle = Black Lock & Grommet
  - Silver, Nickel and Tungsten handle = Tungsten Lock & Grommet

## FREESTANDING STORAGE

### MODEL#

### DIMENSIONS

### FREIGHT CLASS

### WT/LBS.

### CUBIC FT.

### LIST PRICE

D x W x H

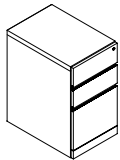

**Freestanding Pedestal**

KWDB	19.8 x 15.5 x 28	85	70	5	<b>\$2501</b>
KWWDB	23.8 x 15.5 x 28	85	75	6	<b>\$2879</b>

Box/box/file.

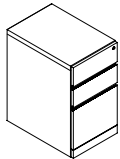

**Freestanding Mobile Pedestal**

KWDM	19.8 x 15.5 x 28	85	70	5	<b>\$2690</b>
KWWDM	23.8 x 15.5 x 28	85	75	6	<b>\$3095</b>

Box/box/file.

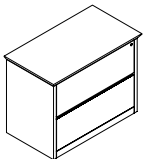

**Lateral File - 2 high**

KF3622	23 x 38 x 29	85	170	13	<b>\$4662</b>
KF3620	21 x 38 x 29	85	159	12	<b>\$4239</b>
KN3022	23 x 32.9 x 29	85	142	11	<b>\$4081</b>
KN3020	21 x 32.9 x 29	85	131	10	<b>\$3708</b>

Two lateral file drawers.

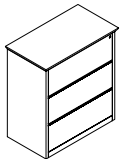

**Lateral File - 3 high**

KF36223	23 x 38 x 42	92.5	212	19	<b>\$5692</b>
KF36203	21 x 38 x 42	92.5	193	18	<b>\$5317</b>
KN30223	23 x 32.9 x 42	92.5	176	16	<b>\$4979</b>
KN30203	21 x 32.9 x 42	92.5	160	15	<b>\$4649</b>

Three lateral file drawers.

### Required Specifications

Finish  
Edge

### Optional Specifications

Handles

**FREESTANDING STORAGE**

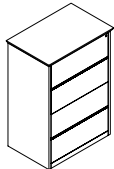

**Lateral File - 4 high**

MODEL#	DIMENSIONS D x W x H	FREIGHT CLASS	WT/LBS.	CUBIC FT.	LIST PRICE
KF36224	23 x 38 x 54	92.5	270	25	<b>\$6933</b>
KF36204	21 x 38 x 54	92.5	259	23	<b>\$6586</b>
KN30224	23 x 32.9 x 54	92.5	225	21	<b>\$6069</b>
KN30204	21 x 32.9 x 54	92.5	214	19	<b>\$5766</b>

Four lateral file drawers.

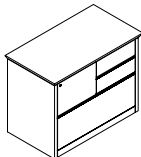

**Combination Storage - Left**

KZL3622	23 x 38 x 29	85	170	13	<b>\$5053</b>
KZL3620	21 x 38 x 29	85	160	12	<b>\$4812</b>

With 1 lateral file, 2 box drawers in the top right, and 1 file drawer in the top left.

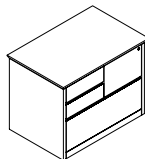

**Combination Storage - Right**

KZR3622	23 x 38 x 29	85	170	13	<b>\$5053</b>
KZR3620	21 x 38 x 29	85	160	12	<b>\$4812</b>

With 1 lateral file, 2 box drawers in the top left, and 1 file drawer in the top right.

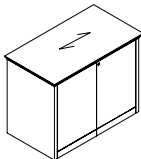

**Storage Cabinet w/Doors**

KBD3622	23 x 38 x 29	92.5	140	13	<b>\$3173</b>
KBD3620	21 x 38 x 29	92.5	129	12	<b>\$3022</b>
KBD3022	23 x 32.9 x 29	92.5	117	11	<b>\$2779</b>
KBD3020	21 x 32.9 x 29	92.5	106	10	<b>\$2641</b>

Storage with 1 adjustable shelf. For Aluminum framed glass door option, contact Customer Care.

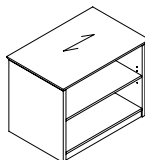

**Open Storage Cabinet**

KOB3622	23 x 38.75 x 29	100	115	13	<b>\$2549</b>
KOB3620	21 x 38.75 x 29	100	104	12	<b>\$2426</b>
KOB3022	23 x 33.63 x 29	100	96	11	<b>\$2225</b>
KOB3020	21 x 33.63 x 29	100	85	10	<b>\$2117</b>

Storage with 1 adjustable shelf.

**Required Specifications**

Finish  
Edge

**Optional Specifications**

Handles

## FREESTANDING STORAGE

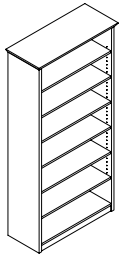

**Open Bookcase**

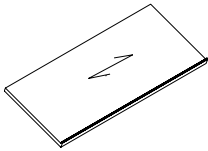

**Additional Shelf**

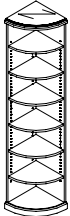

**Quarter Round Open Bookcase**

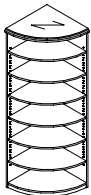

**Quarter Round Open Bookcase**

MODEL#	DIMENSIONS D x W x H	FREIGHT CLASS	WT/LBS.	CUBIC FT.	LIST PRICE
KB73615	16 x 38 x 78	100	228	24	<b>\$3959</b>
KB63615	16 x 38 x 72	100	210	23	<b>\$3656</b>
KB53615	16 x 38 x 65	100	188	21	<b>\$3367</b>
KB43615	16 x 38 x 48	100	140	15	<b>\$2772</b>
KB23615	16 x 38 x 29	92.5	90	9	<b>\$2222</b>
KB73015	16 x 32.9 x 78	92.5	228	20	<b>\$3466</b>
KB63015	16 x 32.9 x 72	92.5	210	19	<b>\$3198</b>
KB53015	16 x 32.9 x 65	92.5	188	17	<b>\$2948</b>
KB43015	16 x 32.9 x 48	92.5	140	13	<b>\$2426</b>
KB23015	16 x 32.9 x 29	92.5	90	8	<b>\$1945</b>

78" high models have 6 adjustable shelves, 72" has 5 adjustable shelves, 65" has 4 adjustable shelves, 48" has 3 adjustable shelves, 29" has 1 adjustable shelves.

KMAG3624	24 x 36 x 1	92.5	112	10	<b>\$240</b>
KMAG3622	22 x 36 x 1	92.5	104	10	<b>\$218</b>
KMAG3620	20 x 36 x 1	92.5	92	9	<b>\$196</b>
KMAG3615	15 x 36 x 1	92.5	81	8	<b>\$173</b>
KMAG3024	24 x 30 x 1	92.5	94	9	<b>\$202</b>
KMAG3022	22 x 30 x 1	100	87	9	<b>\$184</b>
KMAG3020	20 x 30 x 1	100	76	8	<b>\$162</b>
KMAG3015	15 x 30 x 1	100	67	8	<b>\$143</b>

**For use with open bookcase.** Can be specified for each shelf in an open bookcase.

KB7R1515	16 x 16 x 78	100	95	10	<b>\$3119</b>
KB6R1515	16 x 16 x 72	100	83	9	<b>\$2876</b>
KB5R1515	16 x 16 x 65	100	81	9	<b>\$2648</b>
KB4R1515	16 x 16 x 48	100	59	6	<b>\$2179</b>
KB2R1515	16 x 16 x 29	100	37	4	<b>\$1753</b>

84" and 78" high models have 6 adjustable shelves, 72" has 5 adjustable shelves, 65" has 4 adjustable shelves, 48" has 3 adjustable shelves, 29" has 1 adjustable shelf.

KB7R2222H84	23 x 23 x 84	100	191	23	<b>\$5364</b>
KB7R2222H72	23 x 23 x 72	100	171	20	<b>\$4600</b>
KB7R2222H65	23 x 23 x 65	100	157	18	<b>\$5365</b>
KB7R2020H84	21 x 21 x 84	100	163	19	<b>\$5110</b>
KB7R2020H72	21 x 21 x 72	100	142	17	<b>\$4380</b>
KB7R2020H65	21 x 21 x 65	100	130	15	<b>\$5110</b>

84" high models have 6 adjustable shelves, 72" has 5 adjustable shelves, and 65" has 4 adjustable shelves

### Required Specifications

Finish  
Edge

### Optional Specifications

Handles

FREESTANDING STORAGE

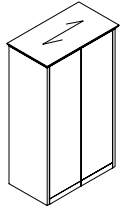

Storage Cabinet w/Wood Doors

MODEL# DIMENSIONS FREIGHT CLASS WT/LBS. CUBIC FT. LIST PRICE

	D x W x H				
K1D22W36H84	23 x 38 x 84	125	304	42	\$7448
K1D22W36H72	23 x 38 x 72	100	283	33	\$6385
K1D22W36H65	23 x 38 x 65	100	259	30	\$5851
K1D22W30H84	23 x 32.9 x 84	125	304	42	\$6516
K1D22W30H72	23 x 32.9 x 72	100	283	33	\$5586
K1D22W30H65	23 x 32.9 x 65	100	259	30	\$5123
K1D22W24H84	23 x 26 x 84	92.5	320	28	\$5583
K1D22W24H72	23 x 26 x 72	92.5	255	24	\$4787
K1D22W24H65	23 x 26 x 65	125	173	22	\$4397
K1D20W36H84	21 x 38 x 84	100	297	35	\$7098
K1D20W36H72	21 x 38 x 72	100	269	30	\$6084
K1D20W36H65	21 x 38 x 65	100	245	28	\$5577
K1D20W30H84	21 x 32.9 x 84	100	257	29	\$5911
K1D20W30H72	21 x 32.9 x 72	100	233	25	\$5068
K1D20W30H65	21 x 32.9 x 65	100	202	23	\$4645
K1D20W24H84	21 x 26 x 84	100	198	23	\$4731
K1D20W24H72	21 x 26 x 72	100	179	20	\$4054
K1D20W24H65	21 x 26 x 65	100	163	18	\$3712

84" high models have 6 adjustable shelves, 72" has 5 adjustable shelves, 65" has 4 adjustable shelves. For Aluminum framed glass door option, please contact customer care. Locks are optional.

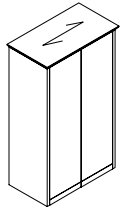

Wardrobe Cabinet

K2D22W36H84	23 x 38 x 84	125	304	42	\$6462
K2D22W36H72	23 x 38 x 72	100	283	33	\$5541
K2D22W36H65	23 x 38 x 65	100	259	30	\$5079
K2D22W30H84	23 x 32.9 x 84	125	304	42	\$5656
K2D22W30H72	23 x 32.9 x 72	100	283	33	\$4846
K2D22W30H65	23 x 32.9 x 65	100	259	30	\$4440
K2D22W24H84	23 x 26 x 84	92.5	320	28	\$4846
K2D22W24H72	23 x 26 x 72	92.5	255	24	\$4156
K2D22W24H65	23 x 26 x 65	125	173	22	\$3807
K2D20W36H84	21 x 38 x 84	100	297	35	\$6155
K2D20W36H72	21 x 38 x 72	100	269	30	\$5277
K2D20W36H65	21 x 38 x 65	100	245	28	\$4837
K2D20W30H84	21 x 32.9 x 84	100	257	29	\$5130
K2D20W30H72	21 x 32.9 x 72	100	233	25	\$4398
K2D20W30H65	21 x 32.9 x 65	100	202	23	\$4029
K2D20W24H84	21 x 26 x 84	100	198	23	\$4104
K2D20W24H72	21 x 26 x 72	100	179	20	\$3514
K2D20W24H65	21 x 26 x 65	100	163	18	\$3222

Doors, coat rack and hat shelf. 84" high models have 6 adjustable shelves, 72" has 5 adjustable shelves, 65" has 4 adjustable shelves. For Aluminum framed glass door option, please contact customer care. Locks are optional.

Required Specifications

Finish  
Edge

Optional Specifications

Handles  
Locks

## FREESTANDING STORAGE

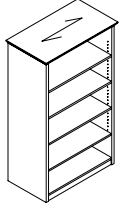

**Open Bookcase**

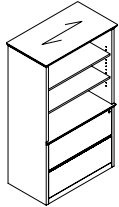

**Open Cabinet**

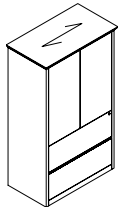

**Storage Cabinet w/Doors\***

MODEL#	DIMENSIONS	FREIGHT CLASS	WT/LBS.	CUBIC FT.	LIST PRICE
--------	------------	---------------	---------	-----------	------------

**D x W x H**

K7D22W36H84	23 x 38 x 84	125	331	43	<b>\$5960</b>
K7D22W36H72	23 x 38 x 72	100	306	36	<b>\$5110</b>
K7D22W36H65	23 x 38 x 65	100	281	33	<b>\$4684</b>
K7D22W30H84	23 x 32.9 x 84	125	280	36	<b>\$5214</b>
K7D22W30H72	23 x 32.9 x 72	100	255	30	<b>\$4541</b>
K7D22W30H65	23 x 32.9 x 65	100	234	28	<b>\$4098</b>
K7D20W36H84	21 x 38 x 84	125	282	36	<b>\$5679</b>
K7D20W36H72	21 x 38 x 72	100	257	30	<b>\$4870</b>
K7D20W36H65	21 x 38 x 65	100	234	28	<b>\$4463</b>
K7D20W30H84	21 x 32.9 x 84	100	248	29	<b>\$4730</b>
K7D20W30H72	21 x 32.9 x 72	100	223	25	<b>\$4053</b>
K7D20W30H65	21 x 32.9 x 65	100	193	23	<b>\$3714</b>

84" high models have 6 adjustable shelves, 72" has 5 adjustable shelves, 65" has 4 adjustable shelves.

K12D22W36H84	23 x 38 x 84	92.5	364	36	<b>\$8087</b>
K12D22W36H72	23 x 38 x 72	92.5	336	33	<b>\$6932</b>
K12D22W36H65	23 x 38 x 65	92.5	308	30	<b>\$6359</b>
K12D22W30H84	23 x 32.9 x 84	92.5	330	31	<b>\$7075</b>
K12D22W30H72	23 x 32.9 x 72	92.5	294	28	<b>\$6069</b>
K12D22W30H65	23 x 32.9 x 65	92.5	257	25	<b>\$5561</b>
K12D20W36H84	21 x 38 x 84	92.5	348	33	<b>\$7705</b>
K12D20W36H72	21 x 38 x 72	92.5	322	30	<b>\$6602</b>
K12D20W36H65	21 x 38 x 65	92.5	294	28	<b>\$6052</b>
K12D20W30H84	21 x 32.9 x 84	92.5	317	28	<b>\$6741</b>
K12D20W30H72	21 x 32.9 x 72	92.5	280	25	<b>\$5775</b>
K12D20W30H65	21 x 32.9 x 65	92.5	243	23	<b>\$5046</b>

Above two lateral file drawers. 84" high models have 6 adjustable shelves, 72" has 5 adjustable shelves, 65" has 4 adjustable shelves.

K13D22W36H84	23 x 38 x 84	92.5	364	36	<b>\$9217</b>
K13D22W36H72	23 x 38 x 72	92.5	341	33	<b>\$7900</b>
K13D22W36H65	23 x 38 x 65	92.5	313	30	<b>\$7244</b>
K13D22W30H84	23 x 32.9 x 84	92.5	330	31	<b>\$8065</b>
K13D22W30H72	23 x 32.9 x 72	92.5	299	28	<b>\$6912</b>
K13D22W30H65	23 x 32.9 x 65	92.5	261	25	<b>\$6337</b>
K13D20W36H84	21 x 38 x 84	92.5	365	35	<b>\$8778</b>
K13D20W36H72	21 x 38 x 72	92.5	327	30	<b>\$7524</b>
K13D20W36H65	21 x 38 x 65	92.5	299	28	<b>\$6893</b>
K13D20W30H84	21 x 32.9 x 84	92.5	305	29	<b>\$7317</b>
K13D20W30H72	21 x 32.9 x 72	92.5	285	25	<b>\$6274</b>
K13D20W30H65	21 x 32.9 x 65	92.5	247	23	<b>\$5747</b>

Above two lateral file drawers. 84" high models have 6 adjustable shelves, 72" has 5 adjustable shelves, 65" has 4 adjustable shelves. For Aluminum framed glass door option, please contact customer care. Lock for upper storage is optional.

**Required Specifications**

Finish  
Edge

**Optional Specifications**

Handles  
Lock\*

FREESTANDING STORAGE

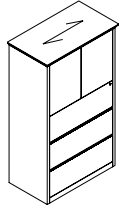

Storage Cabinet w/Doors\*

MODEL# DIMENSIONS FREIGHT CLASS WT/LBS. CUBIC FT. LIST PRICE

D x W x H

K14D22W36H84	23 x 38 x 84	100	340	42	<b>\$9908</b>
K14D22W36H72	23 x 38 x 72	100	312	33	<b>\$8493</b>
K14D22W36H65	23 x 38 x 65	100	286	30	<b>\$7788</b>
K14D22W30H84	23 x 32.9 x 84	100	308	35	<b>\$8667</b>
K14D22W30H72	23 x 32.9 x 72	100	273	28	<b>\$7431</b>
K14D22W30H65	23 x 32.9 x 65	100	238	25	<b>\$6812</b>

K14D20W36H84	21 x 38 x 84	100	330	35	<b>\$9436</b>
K14D20W36H72	21 x 38 x 72	100	298	30	<b>\$8090</b>
K14D20W36H65	21 x 38 x 65	100	272	28	<b>\$7416</b>
K14D20W30H84	21 x 32.9 x 84	92.5	298	29	<b>\$7864</b>
K14D20W30H72	21 x 32.9 x 72	92.5	259	25	<b>\$6742</b>
K14D20W30H65	21 x 32.9 x 65	100	224	23	<b>\$6180</b>

Above three lateral file drawers. 84" high models have 2 adjustable shelves, 72" and 65" have 1 adjustable shelf. For Aluminum framed glass door option, please contact customer care. Lock for upper storage is optional

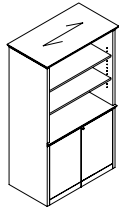

Open Storage\*

K22D22W36H84	23 x 38 x 84	125	325	42	<b>\$6788</b>
K22D22W36H72	23 x 38 x 72	100	300	33	<b>\$5815</b>
K22D22W36H65	23 x 38 x 65	100	275	30	<b>\$5334</b>
K22D22W30H84	23 x 32.9 x 84	100	304	35	<b>\$5940</b>
K22D22W30H72	23 x 32.9 x 72	100	279	28	<b>\$5092</b>
K22D22W30H65	23 x 32.9 x 65	100	243	25	<b>\$4668</b>

K22D20W36H84	21 x 38 x 84	100	327	33	<b>\$6462</b>
K22D20W36H72	21 x 38 x 72	92.5	305	30	<b>\$5541</b>
K22D20W36H65	21 x 38 x 65	100	278	28	<b>\$5079</b>
K22D20W30H84	21 x 32.9 x 84	92.5	301	28	<b>\$5393</b>
K22D20W30H72	21 x 32.9 x 72	92.5	265	25	<b>\$4622</b>
K22D20W30H65	21 x 32.9 x 65	100	229	23	<b>\$4232</b>

Above storage cabinet. 84" high models have 4 adjustable shelves, 72" has 3 adjustable shelves, 65" has 3 adjustable shelves. For Aluminum framed glass door option, please contact customer care.

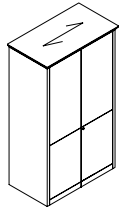

Closed Storage Cabinet\*

K23D22W36H84	23 x 38 x 84	100	340	42	<b>\$7955</b>
K23D22W36H72	23 x 38 x 72	100	319	33	<b>\$6818</b>
K23D22W36H65	23 x 38 x 65	100	292	30	<b>\$6244</b>
K23D22W30H84	23 x 32.9 x 84	100	308	33	<b>\$6626</b>
K23D22W30H72	23 x 32.9 x 72	100	279	28	<b>\$5679</b>
K23D22W30H65	23 x 32.9 x 65	100	243	25	<b>\$5209</b>

K23D20W36H84	21 x 38 x 84	100	330	35	<b>\$7574</b>
K23D20W36H72	21 x 38 x 72	92.5	305	30	<b>\$6493</b>
K23D20W36H65	21 x 38 x 65	100	278	28	<b>\$5950</b>
K23D20W30H84	21 x 32.9 x 84	92.5	298	29	<b>\$6311</b>
K23D20W30H72	21 x 32.9 x 72	92.5	265	25	<b>\$5411</b>
K23D20W30H65	21 x 32.9 x 65	100	229	23	<b>\$4960</b>

With upper and lower split doors. 1 fixed shelf and 2 adjustable shelves. Lock for upper storage is optional. For Aluminum framed glass door option, please contact customer care.

Required Specifications

Finish  
Edge

Optional Specifications

Handles  
Lock\*

## FREESTANDING STORAGE

**MODEL# DIMENSIONS FREIGHT CLASS WT/LBS. CUBIC FT. LIST PRICE**

**D x W x H**

K25D22W36H84	23 x 38 x 84	100	348	42	<b>\$8353</b>
K25D22W36H72	23 x 38 x 72	100	319	33	<b>\$7164</b>
K25D22W36H65	23 x 38 x 65	100	292	30	<b>\$6565</b>
K25D22W30H84	23 x 32.9 x 84	100	307	35	<b>\$7309</b>
K25D22W30H72	23 x 32.9 x 72	100	279	28	<b>\$6267</b>
K25D22W30H65	23 x 32.9 x 65	100	243	25	<b>\$5743</b>
K25D22W24H84	23 x 26 x 84	100	254	28	<b>\$6265</b>
K25D22W24H72	23 x 26 x 72	100	213	24	<b>\$5369</b>
K25D22W24H65	23 x 26 x 65	100	195	22	<b>\$4918</b>

K25D20W36H84	21 x 38 x 84	100	330	35	<b>\$7954</b>
K25D20W36H72	21 x 38 x 72	92.5	305	30	<b>\$6814</b>
K25D20W36H65	21 x 38 x 65	100	278	28	<b>\$6247</b>
K25D20W30H84	21 x 32.9 x 84	92.5	300	29	<b>\$6627</b>
K25D20W30H72	21 x 32.9 x 72	92.5	265	25	<b>\$5680</b>
K25D20W30H65	21 x 32.9 x 65	100	229	23	<b>\$5209</b>
K25D20W24H84	21 x 26 x 84	100	235	28	<b>\$5304</b>
K25D20W24H72	21 x 26 x 72	100	203	24	<b>\$4546</b>
K25D20W24H65	21 x 26 x 65	100	185	22	<b>\$4171</b>

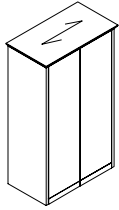

**Cabinet w/Doors and Storage**

Wardrobe with coat rack and hat shelf on left. Storage with adjustable shelves on right. 84" high models have 5 adjustable shelves, 72" and 65" have 4 adjustable shelves. For Aluminum framed glass door option, please contact customer care. Lock is optional.

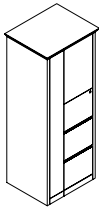

**Tower Unit - Left**

K27D22W24H84L	23 x 26 x 84	125	167	24	<b>\$9891</b>
K27D22W24H72L	23 x 26 x 72	125	154	22	<b>\$8478</b>
K27D22W24H65L	23 x 26 x 65	125	141	20	<b>\$7778</b>
K27D20W24H84L	21 x 26 x 84	125	152	22	<b>\$9421</b>
K27D20W24H72L	21 x 26 x 72	125	140	20	<b>\$8079</b>
K27D20W24H65L	21 x 26 x 65	125	128	18	<b>\$7404</b>

Wardrobe with coat rack and hat shelf on left. Three file drawers and storage with adjustable shelf on right. 84" high models have 2 adjustable shelves, 72" and 65" have 1 adjustable shelf. For Aluminum framed glass door option on right, please contact customer care. Lock for upper storage and wardrobe is optional.

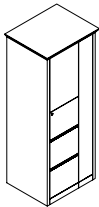

**Tower Unit - Right**

K27D22W24H84R	23 x 26 x 84	125	167	24	<b>\$9891</b>
K27D22W24H72R	23 x 26 x 72	125	154	22	<b>\$8478</b>
K27D22W24H65R	23 x 26 x 65	125	141	20	<b>\$7778</b>
K27D20W24H84R	21 x 26 x 84	125	152	22	<b>\$9421</b>
K27D20W24H72R	21 x 26 x 72	125	140	20	<b>\$8079</b>
K27D20W24H65R	21 x 26 x 65	125	128	18	<b>\$7404</b>

Wardrobe with coat rack and hat shelf on right. Three file drawers and storage with adjustable shelf on left. 84" high models have 2 adjustable shelves, 72" and 65" have 1 adjustable shelf. For Aluminum framed glass door option on left, please contact customer care. Lock for upper storage and wardrobe is optional.

**Required Specifications**

Finish  
Edge

**Optional Specifications**

Handles  
Locks

**MODESTY PANELS**

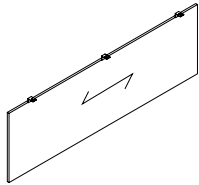

**Veneer Modesty Panel\***

MODEL#	DIMENSIONS D x W x H	FREIGHT CLASS	WT./LBS.	CUBIC FT.	LIST PRICE
CMP72W	0.75 x 67 x 18	--	20	1	<b>\$1728</b>
CMP66W	0.75 x 61 x 18	--	18	1	<b>\$1728</b>
CMP60W	0.75 x 55 x 18	--	16	1	<b>\$1728</b>
CMP54W	0.75 x 49 x 18	--	14	1	<b>\$1673</b>
CMP48W	0.75 x 43 x 18	--	13	1	<b>\$1619</b>

Straight modesty panel. Attaches to underside of worksurface. **Cannot be retrofitted in the field. Not sold individually - to be ordered as an upgrade option only.**

- CMP72W - Specify on 96" Piano desk: Boat, D or P
- CMP66W - Specify on 84" Piano desk: Boat or D
- CMP60W - For use on 84" Piano desk: P
- CMP54W - For use on 72" Piano desk: Boat or D/D table desk
- CMP48W - For use on 66" and 60" Piano desk: D or P/D table desk

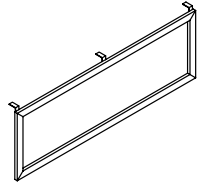

**Glass Modesty Panel**

CMP72G	0.75 x 67 x 18	--	20	1	<b>\$2647</b>
CMP66G	0.75 x 61 x 18	--	18	1	<b>\$2647</b>
CMP60G	0.75 x 55 x 18	--	16	1	<b>\$2647</b>
CMP54G	0.75 x 49 x 18	--	14	1	<b>\$2504</b>
CMP48G	0.75 x 43 x 18	--	13	1	<b>\$2132</b>

Straight modesty panel. Translucent, screened glass. Aluminum box frame construction in Tungsten Only. Attaches to underside of worksurface. **Cannot be retrofitted in the field. Not sold individually - to be ordered as an upgrade option only.**

- CMP72G - Specify on 96" Piano desk: Boat, D or P
- CMP66G - Specify on 84" Piano desk: Boat or D
- CMP60G - For use on 84" Piano desk: P
- CMP54G - For use on 72" Piano desk: Boat or D/D table desk
- CMP48G - For use on 66" and 60" Piano desk: D or P/D table desk
- Tungsten finish on the aluminum box frame closely resembles the existing Tungsten finish.

**ACCESSORIES**

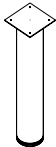

**Metal Post Upgrade**

MODEL#	DIMENSIONS	FREIGHT CLASS	WT./LBS.	CUBIC FT.	LIST PRICE
SM06	6 x 6 x 28	--	--	--	<b>\$1105</b>
SM04	4 x 4 x 28	--	--	--	<b>\$610</b>
SM03	3 x 3 x 28	--	--	--	<b>\$434</b>

Must specify at time of order. **Cannot be retrofitted in the field.**  
Available in Black (E), Tungsten (K) and Brushed Chrome (P).

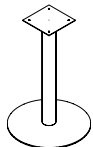

**Metal Flat Plate Base Upgrade**

F3P18	18 x 18 x 28	--	--	--	<b>\$1638</b>
-------	--------------	----	----	----	---------------

Must specify at time of order. **Can not be retrofitted in the field.**  
Available in Black (E), Tungsten (K) and Brushed Chrome (P).

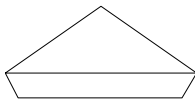

**Corner Filler Top**

KV1212CT	12 x 12 x 1.5	150	5	1	<b>\$1045</b>
----------	---------------	-----	---	---	---------------

**Required Specifications**

Finish\*

## TACKBOARDS FOR HUTCHES

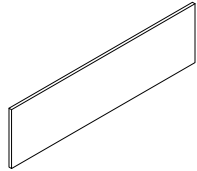

**Tackboard for 36" H  
Non-Pigeon Hole Hutches**

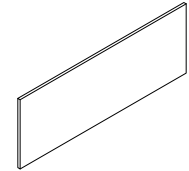

**Tackboard for 42" H & 54" H  
Pigeon-Hole Hutches**

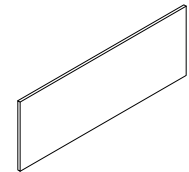

**Tackboard for 42" H & 54" H  
Non-Pigeon Hole Hutches**

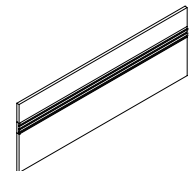

**Tackboard w/Rail for 36" H  
Non-Pigeon Hole Hutches\***

MODEL#	DIMENSIONS D x W x H	FREIGHT CLASS	WT/LBS.	CUBIC FT.	GR. 1-3	GR. 4-5
KTS108	1 x 105 x 20	92.5	23	2	\$1313	\$1578
KTS102	1 x 99 x 20	100	19	2	\$1242	\$1494
KTS96	1 x 93 x 20	70	15	1	\$1169	\$1406
KTS90	1 x 87 x 20	70	15	1	\$1097	\$1319
KTS84	1 x 81 x 20	85	14	1	\$1028	\$1237
KTS78	1 x 75 x 20	85	13	1	\$952	\$1144
KTS72	1 x 69 x 20	85	12	1	\$875	\$1051
KTS66	1 x 63 x 20	92.5	11	1	\$800	\$961
KTS60	1 x 57 x 20	92.5	10	1	\$733	\$882
KTS36	1 x 33 x 20	60	6	0.01	\$439	\$529
KTS30	1 x 27 x 20	60	4	0.01	\$366	\$442

Factory installed hutch tackboard.

KTSP108H23	1 x 105 x 23	70	30	2	\$1484	\$1783
KTSP102H23	1 x 99 x 23	85	24	2	\$1415	\$1700
KTSP96H23	1 x 93 x 23	92.5	20	2	\$1321	\$1588
KTSP90H23	1 x 87 x 23	70	20	1	\$1238	\$1488
KTSP84H23	1 x 81 x 23	70	18	1	\$1156	\$1389
KTSP78H23	1 x 75 x 23	70	17	1	\$1074	\$1291
KTSP72H23	1 x 69 x 23	70	16	1	\$998	\$1200
KTSP66H23	1 x 63 x 23	85	14	1	\$908	\$1092
KTSP60H23	1 x 57 x 23	85	13	1	\$830	\$1000
KTSP36H23	1 x 33 x 23	60	8	0.01	\$497	\$599
KTSP30H23	1 x 27 x 23	60	5	0.01	\$414	\$501

Factory installed hutch tackboard.

KTS108H26	1 x 105 x 26	70	30	2	\$1716	\$2062
KTS102H26	1 x 99 x 26	85	24	2	\$1617	\$1942
KTS96H26	1 x 93 x 26	92.5	20	2	\$1520	\$1827
KTS90H26	1 x 87 x 26	92.5	20	2	\$1432	\$1720
KTS84H26	1 x 81 x 26	100	18	2	\$1331	\$1599
KTS78H26	1 x 75 x 26	100	17	2	\$1236	\$1486
KTS72H26	1 x 69 x 26	70	16	1	\$1141	\$1372
KTS66H26	1 x 63 x 26	85	14	1	\$1046	\$1257
KTS60H26	1 x 57 x 26	85	13	1	\$952	\$1144
KTS36H26	1 x 33 x 26	60	8	0.01	\$573	\$690
KTS30H26	1 x 27 x 26	60	5	0.01	\$477	\$574

Factory installed hutch tackboard.

KTSAS108	1 x 105 x 20	92.5	23	2	\$2330	\$2798
KTSAS102	1 x 99 x 20	100	19	2	\$2102	\$2524
KTSAS96	1 x 93 x 20	70	15	1	\$2069	\$2486
KTSAS90	1 x 87 x 20	70	15	1	\$1945	\$2336
KTSAS84	1 x 81 x 20	85	14	1	\$1813	\$2179
KTSAS78	1 x 75 x 20	85	13	1	\$1685	\$2024
KTSAS72	1 x 69 x 20	85	12	1	\$1552	\$1863
KTSAS66	1 x 63 x 20	92.5	11	1	\$1422	\$1708
KTSAS60	1 x 57 x 20	92.5	10	1	\$1298	\$1584
KTSAS36	1 x 33 x 20	60	6	0.01	\$776	\$934
KTSAS30	1 x 27 x 20	60	4	0.01	\$647	\$780

Factory installed hutch tackboard.

- Specify Black (**E**), Tungsten (**K**), or Designer White (**DWT**) accessory rail finish.

### Required Specifications

Fabric  
Metal finish\*

TACKBOARDS FOR HUTCHES

MODEL#	DIMENSIONS	FREIGHT CLASS	WT./LBS.	CUBIC FT.	GR.1-3	GR. 4-5
	<b>D x W x H</b>					
KTSPAS108H23	1 x 105 x 23	70	30	2	\$2529	\$3036
KTSPAS102H23	1 x 99 x 23	85	24	2	\$2405	\$2912
KTSPAS96H23	1 x 93 x 23	92.5	20	2	\$2258	\$2712
KTSPAS90H23	1 x 87 x 23	92.5	20	2	\$2115	\$2540
KTSPAS84H23	1 x 81 x 23	100	18	2	\$1972	\$2369
KTSPAS78H23	1 x 75 x 23	100	17	2	\$1831	\$2199
KTSPAS72H23	1 x 69 x 23	70	16	1	\$1690	\$2029
KTSPAS66H23	1 x 63 x 23	85	14	1	\$1549	\$1860
KTSPAS60H23	1 x 57 x 23	85	13	1	\$1408	\$1692
KTSPAS36H23	1 x 33 x 23	100	8	1	\$847	\$1019
KTSPAS30H23	1 x 27 x 23	150	5	1	\$711	\$855

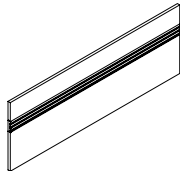

Tackboard w/Rail for 42”H & 54”H\*  
Pigeon-Hole Hutches

Factory installed hutch tackboard.  
 • Specify Black (E), Tungsten (K), or Designer White (DWT) accessory rail finish.

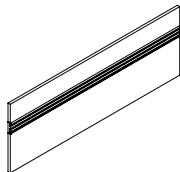

Tackboard w/Rail for 42”H & 54”H\*  
Non-Pigeon Hole Hutches

KTSAS108H26	1 x 105 x 26	92.5	23	2	\$2807	\$3372
KTSAS102H26	1 x 99 x 26	100	19	2	\$2642	\$3173
KTSAS96H26	1 x 93 x 26	70	15	1	\$2487	\$2987
KTSAS90H26	1 x 87 x 26	70	15	1	\$2341	\$2812
KTSAS84H26	1 x 81 x 26	85	14	1	\$2155	\$2588
KTSAS78H26	1 x 75 x 26	85	13	1	\$2022	\$2428
KTSAS72H26	1 x 69 x 26	85	12	1	\$1835	\$2204
KTSAS66H26	1 x 63 x 26	92.5	11	1	\$1716	\$2062
KTSAS60H26	1 x 57 x 26	92.5	10	1	\$1553	\$1867
KTSAS36H26	1 x 33 x 26	60	6	0.01	\$932	\$1122
KTSAS30H26	1 x 27 x 26	60	4	0.01	\$783	\$942

Factory installed hutch tackboard.  
 • Specify Black (E), Tungsten (K), or Designer White (DWT) accessory rail finish.

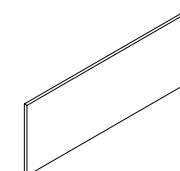

Tackboard for 65”H Non-Pigeon Hole  
Wall Mount Cabinets

TS120	1 x 120 x 19.2	70	26	2	\$1621	\$2026
TS114	1 x 114 x 19.2	70	25	2	\$1544	\$1932
TS108	1 x 108 x 19.2	70	23	2	\$1460	\$1825
TS102	1 x 102 x 19.2	85	19	2	\$1383	\$1729
TS96	1 x 96 x 19.2	70	17	1	\$1293	\$1619
TS90	1 x 90 x 19.2	70	15	1	\$1216	\$1521
TS84	1 x 84 x 19.2	70	14	1	\$1139	\$1422
TS78	1 x 78 x 19.2	70	13	1	\$1055	\$1319
TS72	1 x 72 x 19.2	70	12	1	\$594	\$744
TS66	1 x 66 x 19.2	85	11	1	\$546	\$686
TS60	1 x 60 x 19.2	85	10	1	\$502	\$631
TS54	1 x 54 x 19.2	85	10	1	\$455	\$572
TS48	1 x 48 x 19.2	85	10	1	\$407	\$511
TS42	1 x 42 x 19.2	85	10	1	\$360	\$453
TS36	1 x 36 x 19.2	100	8	1	\$322	\$408
TS30	1 x 30 x 19.2	150	5	1	\$268	\$337

Factory installed tackboard for wall mount cabinets.

**Required Specifications**

Fabric  
 Metal finish\*

## TACKBOARDS FOR WALL MOUNT CABINETS

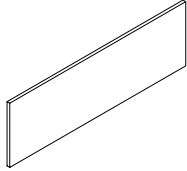

**Tackboard for 72" H Pigeon-Hole Wall Mount Cabinets**

MODEL#	DIMENSIONS D x W x H	FREIGHT CLASS	WT./LBS.	CUBIC FT.	GR. 1-3	GR. 4-5
TSP120H23	1 x 120 x 23	70	34	2	\$1830	\$2288
TSP114H23	1 x 114 x 23	70	32	2	\$1739	\$2172
TSP108H23	1 x 108 x 23	70	30	2	\$1704	\$2045
TSP102H23	1 x 102 x 23	85	24	2	\$1625	\$1951
TSP96H23	1 x 96 x 23	92.5	20	2	\$1467	\$1832
TSP90H23	1 x 90 x 23	92.5	20	1	\$1370	\$1714
TSP84H23	1 x 84 x 23	70	18	1	\$1280	\$1599
TSP78H23	1 x 78 x 23	70	17	1	\$1047	\$1273
TSP72H23	1 x 72 x 23	70	16	1	\$973	\$1222
TSP66H23	1 x 66 x 23	85	14	1	\$884	\$1109
TSP60H23	1 x 60 x 23	85	13	1	\$641	\$805
TSP54H23	1 x 54 x 23	85	13	1	\$812	\$1018
TSP48H23	1 x 48 x 23	85	13	1	\$642	\$653
TSP42H23	1 x 42 x 23	85	13	1	\$565	\$573
TSP36H23	1 x 36 x 23	100	8	1	\$488	\$505
TSP30H23	1 x 30 x 23	150	5	1	\$404	\$430

Factory installed tackboard for wall mount cabinets.

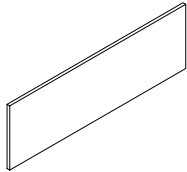

**Tackboard for 72" H Non-Pigeon-Hole Wall Mount Cabinets**

TS120H26	1 x 120 x 26	70	34	2	\$2108	\$2635
TS114H26	1 x 114 x 26	70	32	2	\$2003	\$2504
TS108H26	1 x 108 x 26	70	30	2	\$1898	\$2374
TS102H26	1 x 102 x 26	85	24	2	\$1788	\$2235
TS96H26	1 x 96 x 26	92.5	22	2	\$1691	\$2116
TS90H26	1 x 90 x 26	92.5	20	2	\$1585	\$1980
TS84H26	1 x 84 x 26	100	18	2	\$1473	\$1842
TS78H26	1 x 78 x 26	100	17	2	\$1370	\$1714
TS72H26	1 x 72 x 26	70	16	1	\$761	\$956
TS66H26	1 x 66 x 26	85	14	1	\$701	\$879
TS60H26	1 x 60 x 26	85	13	1	\$641	\$805
TS54H26	1 x 54 x 26	85	13	1	\$588	\$737
TS48H26	1 x 48 x 26	85	13	1	\$520	\$653
TS42H26	1 x 42 x 26	85	13	1	\$462	\$573
TS36H26	1 x 36 x 26	100	8	1	\$403	\$506
TS30H26	1 x 30 x 26	150	5	1	\$338	\$428

Factory installed tackboard for wall mount cabinets.

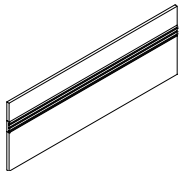

**Tackboard w/Rail for 65" H\* Non-Pigeon Hole Wall Mount Cabinets**

TSAS120	1 x 120 x 19.2	85	26	1	\$2506	\$3134
TSAS114	1 x 114 x 19.2	85	25	2	\$2385	\$2981
TSAS108	1 x 108 x 19.2	92.5	23	2	\$2258	\$2826
TSAS102	1 x 102 x 19.2	100	19	2	\$2138	\$2668
TSAS96	1 x 96 x 19.2	70	17	1	\$2003	\$2509
TSAS90	1 x 90 x 19.2	70	15	1	\$1880	\$2353
TSAS84	1 x 84 x 19.2	85	14	1	\$1753	\$2194
TSAS78	1 x 78 x 19.2	85	13	1	\$1633	\$2043
TSAS72	1 x 72 x 19.2	85	12	1	\$1504	\$1884
TSAS66	1 x 66 x 19.2	92.5	11	1	\$1383	\$1733
TSAS60	1 x 60 x 19.2	92.5	10	1	\$1254	\$1569
TSAS54	1 x 54 x 19.2	92.5	10	1	\$1134	\$1416
TSAS48	1 x 48 x 19.2	92.5	10	1	\$1007	\$1257
TSAS42	1 x 42 x 19.2	92.5	10	1	\$879	\$1097
TSAS36	1 x 36 x 19.2	100	8	1	\$752	\$938
TSAS30	1 x 30 x 19.2	150	5	1	\$584	\$732

Factory installed tackboard for wall mount cabinets.

- Specify Black (E), Tungsten (K), or Designer White (DWT) accessory rail finish.

### Required Specifications

Fabric  
Metal finish\*

TACKBOARDS FOR WALL MOUNT CABINETS

MODEL#	DIMENSIONS	FREIGHT CLASS	WT./LBS.	CUBIC FT.	GR. 1-3	GR. 4-5
	<b>D x W x H</b>					
TSPAS120H23	1 x 120 x 22.3	70	34	2	\$2721	\$3401
TSPAS114H23	1 x 114 x 22.3	70	32	2	\$2587	\$3236
TSPAS108H23	1 x 108 x 22.3	70	30	2	\$2447	\$3061
TSPAS102H23	1 x 102 x 22.3	85	24	2	\$2324	\$2909
TSPAS96H23	1 x 96 x 22.3	70	22	1	\$2185	\$2734
TSPAS90H23	1 x 90 x 22.3	70	20	1	\$2042	\$2555
TSPAS84H23	1 x 84 x 22.3	70	18	1	\$1908	\$2390
TSPAS78H23	1 x 78 x 22.3	70	17	1	\$1773	\$2217
TSPAS72H23	1 x 72 x 22.3	70	16	1	\$1640	\$2053
TSPAS66H23	1 x 66 x 22.3	85	14	1	\$1504	\$1884
TSPAS60H23	1 x 60 x 22.3	85	13	1	\$1363	\$1704
TSPAS54H23	1 x 54 x 22.3	85	13	1	\$1207	\$1510
TSPAS48H23	1 x 48 x 22.3	85	13	1	\$1094	\$1370
TSPAS42H23	1 x 42 x 22.3	85	13	1	\$960	\$1199
TSPAS36H23	1 x 36 x 22.3	100	8	1	\$682	\$856
TSPAS30H23	1 x 30 x 22.3	150	5	1	\$665	\$828

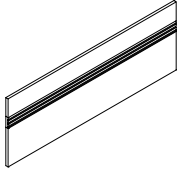

Tackboard w/Rail for 72"H\*  
Pigeon-Hole Wall Mount Cabinets

Factory installed tackboard for wall mount cabinets.

- Specify Black (E), Tungsten (K), or Designer White (DWT) accessory rail finish.

TSAS120H26	1 x 120 x 26	70	34	2	\$3010	\$3763
TSAS114H26	1 x 114 x 26	70	32	2	\$2854	\$3569
TSAS108H26	1 x 108 x 26	70	30	2	\$2715	\$3395
TSAS102H26	1 x 102 x 26	85	24	2	\$2560	\$3201
TSAS96H26	1 x 96 x 26	92.5	22	2	\$2405	\$3010
TSAS90H26	1 x 90 x 26	92.5	20	2	\$2265	\$2833
TSAS84H26	1 x 84 x 26	100	18	2	\$2089	\$2611
TSAS78H26	1 x 78 x 26	100	17	2	\$1955	\$2445
TSAS72H26	1 x 72 x 26	70	16	1	\$1779	\$2226
TSAS66H26	1 x 66 x 26	85	14	1	\$1661	\$2072
TSAS60H26	1 x 60 x 26	85	13	1	\$1504	\$1884
TSAS54H26	1 x 54 x 26	85	13	1	\$1356	\$1694
TSAS48H26	1 x 48 x 26	85	13	1	\$1207	\$1510
TSAS42H26	1 x 42 x 26	85	13	1	\$1061	\$1323
TSAS36H26	1 x 36 x 26	100	8	1	\$907	\$1137
TSAS30H26	1 x 30 x 26	150	5	1	\$758	\$950

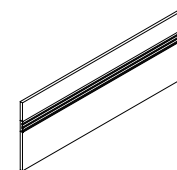

Tackboard w/Rail for 72"H\*  
Non-Pigeon-Hole Wall Mount Cabinets

Factory installed tackboard for wall mount cabinets.

- Specify Black (E), Tungsten (K), or Designer White (DWT) accessory rail finish.

TSP120H21	1 x 120 x 21	70	35	2	\$1764	\$2119
TSP114H21	1 x 114 x 21	70	32	2	\$1676	\$2013
TSP108H21	1 x 108 x 21	70	30	2	\$1586	\$1906
TSP102H21	1 x 102 x 21	85	24	2	\$1503	\$1805
TSP96H21	1 x 96 x 21	92.5	20	2	\$1408	\$1692
TSP90H21	1 x 90 x 21	70	1	1	\$1324	\$1591
TSP84H21	1 x 84 x 21	70	18	1	\$1238	\$1487
TSP78H21	1 x 78 x 21	70	17	1	\$1144	\$1375
TSP72H21	1 x 72 x 21	70	16	1	\$1057	\$1271
TSP66H21	1 x 66 x 21	85	14	1	\$966	\$1162
TSP60H21	1 x 60 x 21	85	13	1	\$883	\$1061
TSP54H21	1 x 54 x 21	85	13	1	\$796	\$957
TSP48H21	1 x 48 x 21	85	13	1	\$711	\$855
TSP42H21	1 x 42 x 21	125	6	1	\$620	\$747
TSP36H21	1 x 36 x 21	150	4	1	\$531	\$639
TSP30H21	1 x 30 x 21	250	3	1	\$445	\$535

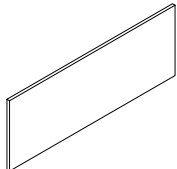

Tackboard for 84"H Double Height  
Pigeon-Hole Wall Mount Cabinets

Factory installed tackboard for wall mount cabinets.

**Required Specifications**

- Fabric
- Metal finish\*

## TACKBOARDS

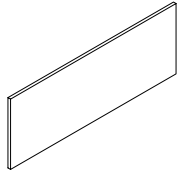

**Tackboard for 84" H Double Height Non Pigeon-Hole Wall Mount Cabinets**

MODEL#	DIMENSIONS D x W x H	FREIGHT CLASS	WT/LBS.	CUBIC FT.	GR. 3	GR. 4-5
TS120H25	1 x 120 x 25	85	27	2	\$2104	\$2526
TS114H25	1 x 114 x 25	85	25	2	\$2001	\$2403
TS108H25	1 x 108 x 25	92.5	23	2	\$1608	\$2007
TS102H25	1 x 102 x 25	100	19	2	\$1511	\$1892
TS96H25	1 x 96 x 25	70	17	1	\$1424	\$1777
TS90H25	1 x 90 x 25	70	15	1	\$1335	\$1671
TS84H25	1 x 84 x 25	85	14	1	\$1250	\$1564
TS78H25	1 x 78 x 25	85	13	1	\$1154	\$1444
TS72H25	1 x 72 x 25	85	12	1	\$1067	\$1338
TS66H25	1 x 66 x 25	92.5	11	1	\$980	\$1226
TS60H25	1 x 60 x 25	92.5	10	1	\$893	\$1120
TS54H25	1 x 54 x 25	92.5	10	1	\$947	\$1139
TS48H25	1 x 48 x 25	92.5	10	1	\$839	\$1009
TS42H25	1 x 42 x 25	92.5	10	1	\$735	\$884
TS36H25	1 x 36 x 25	125	6	1	\$630	\$758
TS30H25	1 x 30 x 25	150	4	1	\$528	\$635

Factory installed tackboard for wall mount cabinets.

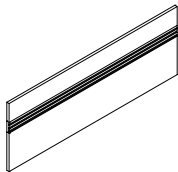

**Tackboard w/Rail for 84" H Double Ht.\* Pigeon-Hole Wall Mount Cabinets**

TSPAS120H21	1 x 120 x 21	70	33	2	\$3102	\$3723
TSPAS114H21	1 x 114 x 21	70	32	2	\$2949	\$3542
TSPAS108H21	1 x 108 x 21	70	30	2	\$2793	\$3352
TSPAS102H21	1 x 102 x 21	85	24	2	\$2647	\$3178
TSPAS96H21	1 x 96 x 21	70	20	1	\$2481	\$2978
TSPAS90H21	1 x 90 x 21	70	20	1	\$2335	\$2804
TSPAS84H21	1 x 84 x 21	70	18	1	\$2176	\$2614
TSPAS78H21	1 x 78 x 21	70	17	1	\$2021	\$2427
TSPAS72H21	1 x 72 x 21	70	16	1	\$1862	\$2237
TSPAS66H21	1 x 66 x 21	85	14	1	\$1709	\$2052
TSPAS60H21	1 x 60 x 21	85	13	1	\$1552	\$1862
TSPAS54H21	1 x 54 x 21	85	13	1	\$1403	\$1686
TSPAS48H21	1 x 48 x 21	85	13	1	\$1249	\$1501
TSPAS42H21	1 x 42 x 21	85	13	1	\$1089	\$1308
TSPAS36H21	1 x 36 x 21	60	6	0.01	\$929	\$1116
TSPAS30H21	1 x 30 x 21	60	4	0.01	\$722	\$868

Factory installed tackboard for wall mount cabinets.

- Specify Black (E), Tungsten (K), or Designer White (DWT) accessory rail finish.

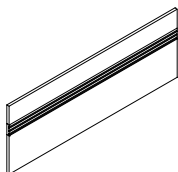

**Tackboard w/Rail for 84" H Double Ht.\* Non Pigeon-Hole Wall Mount Cabinets**

TSAS120H25	1 x 120 x 25	85	27	2	\$3549	\$4260
TSAS114H25	1 x 114 x 25	85	25	2	\$3369	\$4044
TSAS108H25	1 x 108 x 25	92.5	23	2	\$2615	\$3270
TSAS102H25	1 x 102 x 25	100	19	2	\$2457	\$3075
TSAS96H25	1 x 96 x 25	70	17	1	\$2310	\$2893
TSAS90H25	1 x 90 x 25	70	15	1	\$2176	\$2724
TSAS84H25	1 x 84 x 25	85	14	1	\$2008	\$2511
TSAS78H25	1 x 78 x 25	85	13	1	\$1880	\$2353
TSAS72H25	1 x 72 x 25	85	12	1	\$1707	\$2137
TSAS66H25	1 x 66 x 25	92.5	11	1	\$1598	\$2003
TSAS60H25	1 x 60 x 25	92.5	10	1	\$1452	\$1817
TSAS54H25	1 x 54 x 25	92.5	10	1	\$1602	\$1925
TSAS48H25	1 x 48 x 25	92.5	10	1	\$1429	\$1715
TSAS42H25	1 x 42 x 25	92.5	10	1	\$1252	\$1504
TSAS36H25	1 x 36 x 25	60	6	0.01	\$1070	\$1286
TSAS30H25	1 x 30 x 25	60	4	0.01	\$893	\$1074

Factory installed tackboard for wall mount cabinets.

- Specify Black (E), Tungsten (K), or Designer White (DWT) accessory rail finish.

### Required Specifications

Fabric  
Metal finish\*

ACCESSORIES

MODEL# DIMENSIONS FREIGHT CLASS WT/LBS. CUBIC FT. LIST PRICE

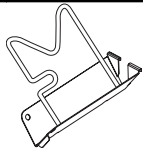

Flip Sorter

	D x W x H				
BAFS01	9.25 x 2.75 x 9.25	70	0.6	0.14	\$58

Load bar/accessory rail mounted metal flip sorter. Comes with chrome wire.  
 • Specify Black (E), Tungsten (K), or Designer White (DWT) accessory finish.

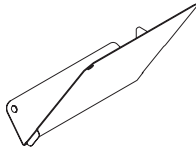

Slant Sorter

BASS01L (Left)	10.25 x 5 x 9.5	70	1	0.28	\$47
BASS01R (Right)	10.25 x 5 x 9.5	70	1	0.28	\$47

Load bar/accessory rail mounted metal slant sorter.  
 • Specify Black (E), Tungsten (K), or Designer White (DWT) accessory finish.

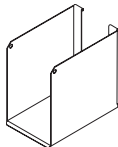

Binder Bin

BABB01	10.25 x 4 x 9	70	1.85	0.21	\$75
--------	---------------	----	------	------	------

Load bar/accessory rail mounted metal binder bin.  
 • Specify Black (E), Tungsten (K), or Designer White (DWT) accessory finish.

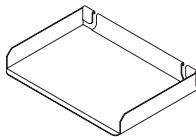

Letter Tray

BALTO1	9.25 x 13.5 x 2	70	0.5	0.15	\$62
--------	-----------------	----	-----	------	------

Load bar/accessory rail mounted metal letter tray.  
 • Specify Black (E), Tungsten (K), or Designer White (DWT) accessory finish.

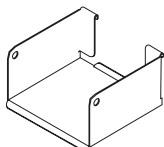

Media Bin

BAMB01	5.25 x 5.75 x 3	70	1.85	0.21	\$62
--------	-----------------	----	------	------	------

Load bar/accessory rail mounted metal media bin.  
 • Specify Black (E), Tungsten (K), or Designer White (DWT) accessory finish.

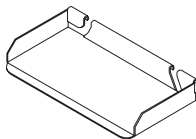

Utility Tray

BAUT01	3.75 x 5.75 x 3	70	0.5	0.02	\$41
--------	-----------------	----	-----	------	------

Load bar/accessory rail mounted metal utility tray.  
 • Specify Black (E), Tungsten (K), or Designer White (DWT) accessory finish.

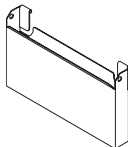

Mail Box

BAPP01	2.75 x 16 x 9	100	2	0.25	\$94
--------	---------------	-----	---	------	------

Load bar/accessory rail mounted metal mail box.  
 • Specify Black (E), Tungsten (K), or Designer White (DWT) accessory finish.

Required Specifications

Fabric  
 Metal finish\*

## ACCESSORIES

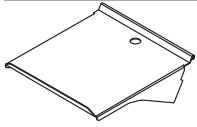

**Telephone Holder**

MODEL#	DIMENSIONS D x W x H	FREIGHT CLASS	WT./LBS.	CUBIC FT.	LIST PRICE
BATH01	10 x 9 x 2	125	2	0.26	<b>\$91</b>

Load bar/accessory rail mounted metal telephone holder.

- Specify Black (**E**), Tungsten (**K**), or Designer White (**DWT**) accessory finish.

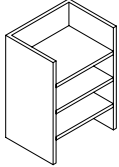

**Paper Organizer, Letter & Legal Format**

KCPH161226	12 x 16 x 27	125	20	3	<b>\$1045</b>
KCPH161223	12 x 16 x 23	125	18	3	<b>\$883</b>
KCPH161219	12 x 16 x 20	125	15	2	<b>\$674</b>
KCPH131226	12 x 13 x 27	100	16	2	<b>\$847</b>
KCPH131223	12 x 13 x 23	125	15	2	<b>\$719</b>
KCPH131219	12 x 13 x 20	125	12	2	<b>\$546</b>

- Specify Black (**E**), Tungsten (**K**), or Designer White (**DWT**) accessory finish.

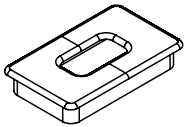

**Grommet**

GM5C	2 x 3.5 x --	70	--	--	<b>\$114</b>
------	--------------	----	----	----	--------------

Rectangular grommet in metal, tungsten finish.

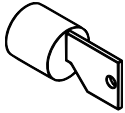

**Lock Assembly**

Black:					
LO	--	70	--	--	<b>\$113</b>
Tungsten:					
LO/C	--	70	--	--	<b>\$113</b>

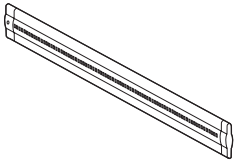

**LED Task Light**

PLED30	1.5 x 15.5 x .5	150	2	0.5	<b>\$522</b>
PLED50	1.5 x 23.5 x .5	150	2	0.5	<b>\$601</b>
PLED100	1.5 x 43.5 x .5	125	3	0.5	<b>\$697</b>

Energy efficient LED. Ultra slim design. Suitable for hanging under Hutch or Wallhung units. 6' power cord.

### Required Specifications

Metal finish

# lufton





GLOBAL is pleased to introduce the **LUFTON** wood veneer series. This contemporary collection features an all wood veneer construction with a variety of features that emphasize a modern approach to the private office.

1-3/16" worksurfaces include a choice of four 1/4" hardwood edges to choose from – Flat (L10), Radius (L20), Fluted (L30) and Soft Tail (L40). A black 5mm PVC inlay between the work surface and gable provides a striking visual detail.

Drawers and storage items feature eight handle options to choose from (where applicable) – storage options are available in 29", 66" and 72" heights. Various models include different types of storage configurations.

New 23" height credenzas allow for different visual planes – combined with a spacer unit, worksurfaces can be supported over this credenza.

Above work surface storage selections include overhead storage and hutches with or without pigeon-hole storage. Hutch doors are available in a choice of veneer or glass with an aluminum frame. Tackboards are offered in all fabric or with a built-in accessory rail for organizing folders, binders, CDs and more!



**Features and Benefits**

- Choice of eight handle options for every door/drawer that features handles.
- Modesty panel options include metal (in Black or Tungsten), veneer, and glass.
- Base upgrades to replace standard monopost on islands are available in four styles.
- Drawers are standard vinyl wrapped construction with black drawer slides and bottom.
- 75 lb. box – 150 lb. file drawer weight capacity with full height sides – pencil tray included in box drawer.
- Lateral file drawers can accommodate legal or letter documents.
- Box drawers mounted on 3/4 extension premium ball bearing slides.
- Power/Data accessories are available to be factory installed on any LUFTON unit, including Boardroom Tables to meet all today's technological requirements.
- A full array of complementary Boardroom and Reception area furnishings are available to coordinate the entire office.

**GENERAL INFORMATION**

- Lufton is a veneer desking system composed of hundreds of models, capable of furnishing executive suites, boardrooms and reception areas.
- 1-3/16" worksurfaces with 1/4" solid Wood Edge all around.
- 5MM Black PVC inlay between top and gables
- **Level 3 Certified**

**FINISHES**

- Conversion varnish (similar to catalyzed lacquer, but tougher), 35 to 40 degree sheen. Finishes are not buffed or rubbed.
- All Global wood casegood products are veneered and finished on the back sides (3600 finishing), except modular under-surface storage - tops and backs are unfinished.
- Touch up kits available, includes a touch up marker and fill crayon. Order **VTOUCHUPKIT**, **\$175** list. Specify finish when ordering.
- Global standard finish, on oak and walnut, is open pore and on cherry and maple is semi-closed pore. If a full finish is required for walnut, cherry, anigre and maple tops, add the suffix **"2"** to the finish code and add 5% to the base pricing for each product. Custom finish on standard veneer is available. Add 15% to the base pricing for each product.
- High Pressure laminate inlays are available at no upcharge. Contact Customer Care for specification information.
- Hanging file rails are pre-installed on file drawer perimeters and accommodate both legal and letter size filing. Legal filing can be achieved either as side-to-side or front-to-back. Letter filing can be achieved as front-to-back filing only.

**WORKSURFACE TOP & DRAWER/DOOR FRONTS, BODY FINISHES**

(INCLUDING PEDESTALS) - VENEER

Code	Finish	Veneer Type	Cut
AMW	Almond Cherry	Cherry	Flat Sliced
ACW	Amber Cherry	Cherry	Flat Sliced
BTW	Biscotti	White Oak	Rift
CAW	Cocoa Walnut	Walnut	Flat Sliced
CRW	Coral	White Oak	Rift
DCW	Dark Cherry	Cherry	Flat Sliced
DWW	Dark Walnut	Walnut	Flat Sliced
EWW	Espresso Walnut	Walnut	Flat Sliced
EVW	Evening Oak	White Oak	Rift
GRW	Grey on Oak	White Oak	Rift
HAW	Hazelnut	Maple	Flat Sliced
JAW	Java	White Oak	Rift
LTW	Latte Walnut	Walnut	Flat Sliced
MHW	Mahogany on Walnut	Walnut	Flat Sliced
MTW	Milestone	White Oak	Rift
MPW	Natural Maple	Maple	Flat Sliced
NLW	Natural Walnut	Walnut	Flat Sliced
RCW	Red Cherry	Cherry	Flat Sliced
VNW	Vintage Cherry	Cherry	Flat Sliced
ULW	Umber Walnut	Walnut	Flat Sliced
WLW	Walnut	Walnut	Flat Sliced
WCW	Warm Cherry	Cherry	Flat Sliced
WMW	White Maple	Maple	Flat Sliced

**EDGES**

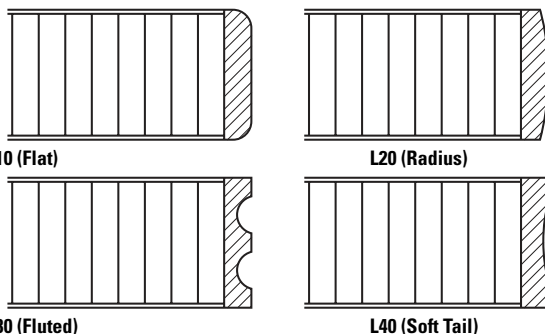

**LOCKS**

- Locks come standard on all storage beneath worksurface height. Above worksurface height locks are optional.
- For optional lock, specify **L0**. Add **\$143** per lock.

**HANDLES**

- Handles are standard on most drawers/storage modules. Each handle is identified by letters: **PL33, PL34, PL64, PL66, PL92, PL93, PL94, PL95, PL96, PL97, PL98, PL99, PLS7, and PLS8**. To specify a handle, specify the code after the model number and finish selections.



**GROMMETS**

- Standard grommet on all components is **GM5P**. Grommet is included with products where shown in line drawings in price book.
- Optional grommets may be ordered in standard worksurface locations (left, center or right). Order as **GM5PTL, GM5PTC or GM5PTR**. Add **\$103**.
- Grommet hole dimensions are 3.5" x 2".
- To order a grommet cover only, specify **GM5EP** for Black or **GM5KP** for Tungsten. Add **\$61**.
- Components that come standard with grommet may be ordered without a grommet. Order as RSG - Add **\$57**.

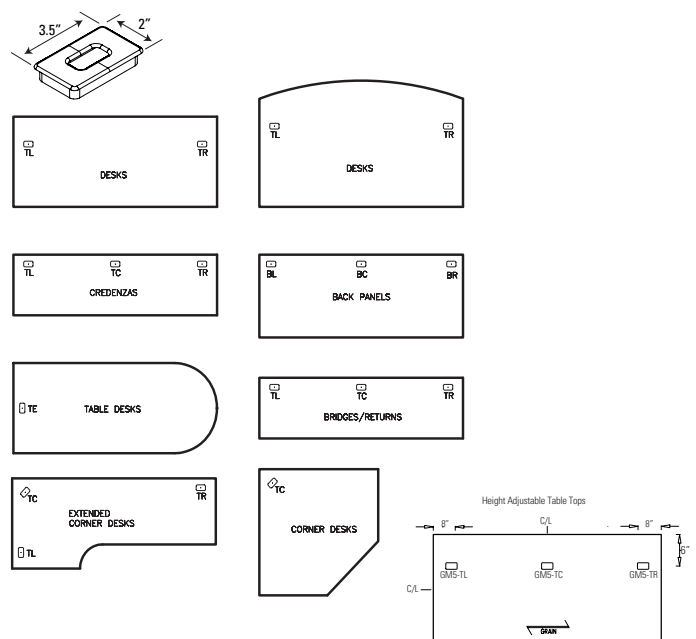

## DOUBLE PEDESTAL DESK NOTES

- Can be ordered as a shell or with pedestals.
- Grommets are available as an option on Desks and most Credenzas.
- Hand of Rectangular Desk is determined by location of pedestal from user side.
- Hand of "D" Island is determined by outward orientation of conference end from user projection.

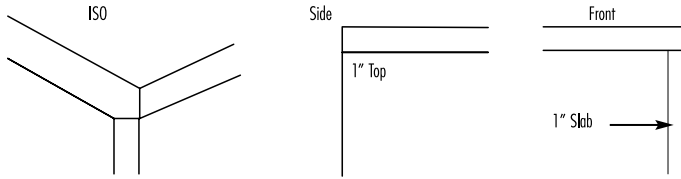

### MODESTY PANEL CLEARANCE:

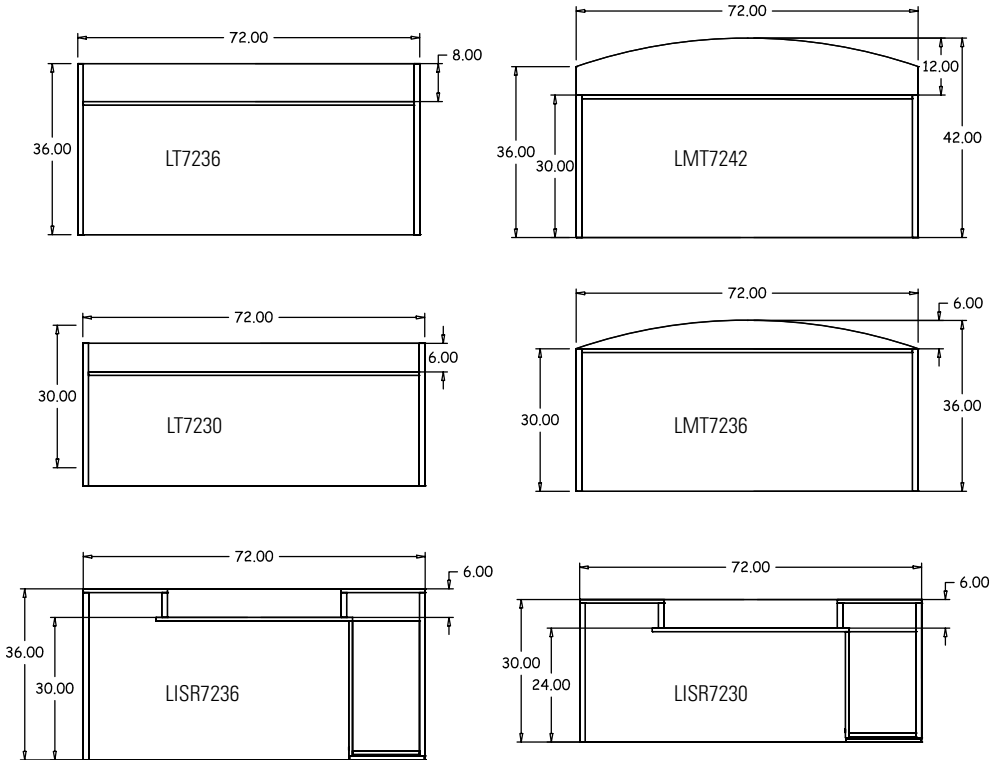

**NOTE:** Arrow indicates direction of grain.

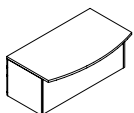
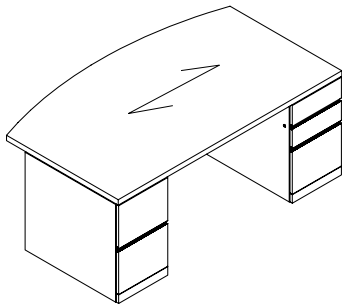

Flush Modesty

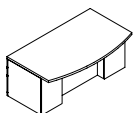

Breakfront

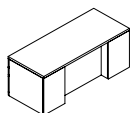

Recessed Modesty

### DESK MODESTY OPTIONS:

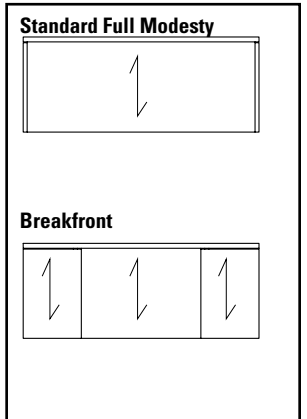

**DOUBLE PEDESTAL DESKS - RECESSED FRONT MODESTY MODEL#**      **DIMENSIONS**      **FREIGHT CLASS**      **WT/LBS.**      **CUBIC FT.**      **LIST PRICE**

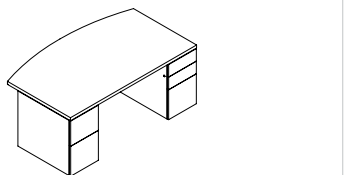

**Double Pedestal Bow Top Desk**

	<b>D x W x H</b>				
LMD8442ED	42 x 84 x 29	125	443	59	<b>\$7401</b>
LMD7842ED	42 x 78 x 29	125	412	55	<b>\$6876</b>
LMD7242ED	42 x 72 x 29	125	380	51	<b>\$6344</b>
LMD6636ED	36 x 66 x 29	125	240	40	<b>\$6156</b>

Standard with full to floor **file/file** pedestal on **left** and **box/box/file** pedestal on **right**. Bow top. Pedestals lock. One pencil tray. Refer to the Desks and Credenzas Notes Section above for overhang dimensions. Ships assembled in one carton.

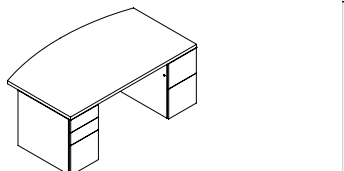

**Double Pedestal Bow Top Desk**

LMD8442DE	42 x 84 x 29	125	443	59	<b>\$7401</b>
LMD7842DE	42 x 78 x 29	125	412	55	<b>\$6876</b>
LMD7242DE	42 x 72 x 29	125	380	51	<b>\$6344</b>
LMD6636DE	36 x 66 x 29	125	240	40	<b>\$6156</b>

Standard with full to floor **box/box/file** pedestal on **left** and **file/file** pedestal on **right**. Bow top. Pedestals lock. One pencil tray. Refer to the Desks and Credenzas Notes Section on previous page for overhang dimensions. Ships assembled in one carton.

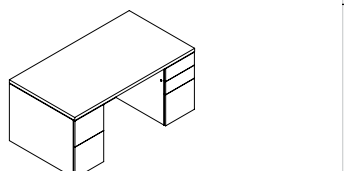

**Double Pedestal Desk**

LD8436ED	36 x 84 x 29	125	432	59	<b>\$6291</b>
LD7236ED	36 x 72 x 29	100	370	44	<b>\$5394</b>
LD7230ED	30 x 72 x 29	100	349	36	<b>\$5315</b>
LD6636ED	36 x 66 x 29	100	339	40	<b>\$5315</b>
LD6630ED	30 x 66 x 29	100	320	33	<b>\$5230</b>

Standard with full to floor **file/file** pedestal on **left** and **box/box/file** pedestal on **right**. Pedestals lock. Refer to the Desks and Credenzas Notes Section on previous page for overhang dimensions. Ships assembled in one carton.

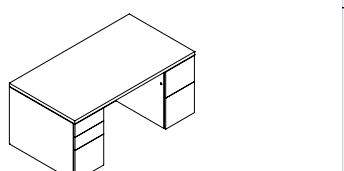

**Double Pedestal Desk**

LD8436DE	36 x 84 x 29	125	432	59	<b>\$6291</b>
LD7236DE	36 x 72 x 29	100	370	44	<b>\$5394</b>
LD7230DE	30 x 72 x 29	100	349	36	<b>\$5315</b>
LD6636DE	36 x 66 x 29	100	339	40	<b>\$5315</b>
LD6630DE	30 x 66 x 29	100	320	33	<b>\$5230</b>

Standard with full to floor **box/box/file** pedestal on **left** and **file/file** pedestal on **right**. Pedestals lock. Refer to the Desks and Credenzas Notes Section on previous page for overhang dimensions.

**DOUBLE PEDESTAL DESKS - BREAKFRONT STYLE**      **MODEL#**      **DIMENSIONS**      **FREIGHT CLASS**      **WT/LBS.**      **CUBIC FT.**      **LIST PRICE**

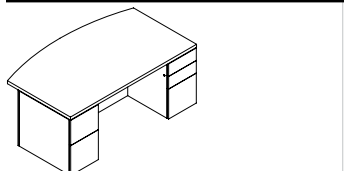

**Double Pedestal Bow Top Desk Breakfront Style**

LMID8442ED	42 x 84 x 29	125	443	59	<b>\$8278</b>
LMID7842ED	42 x 78 x 29	125	412	55	<b>\$7703</b>
LMID7242ED	42 x 72 x 29	125	380	51	<b>\$7122</b>
LMID6636ED	36 x 66 x 29	125	240	40	<b>\$6856</b>

Standard with full to floor **file/file** pedestal on **left** and **box/box/file** pedestal on **right**. Bow top. Pedestals lock. One pencil tray. Refer to the Desks and Credenzas Notes Section on previous page for overhang dimensions. Ships assembled in one carton.

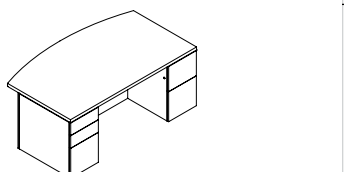

**Double Pedestal Bow Top Desk Breakfront Style**

LMID8442DE	42 x 84 x 29	125	443	59	<b>\$8278</b>
LMID7842DE	42 x 78 x 29	125	412	55	<b>\$7703</b>
LMID7242DE	42 x 72 x 29	125	380	51	<b>\$7122</b>
LMID6636DE	36 x 66 x 29	125	240	40	<b>\$6856</b>

Standard with full to floor **box/box/file** pedestal on **left** and **file/file** pedestal on **right**. Bow top. Pedestals lock. One pencil tray. Refer to the Desks and Credenzas Notes Section on previous page for overhang dimensions. Ships assembled in one carton.

**Required Specifications**

Veneer Finish  
Edge

**Optional Specifications**

Grommet

## DOUBLE PEDESTAL DESKS - BREAKFRONT STYLE

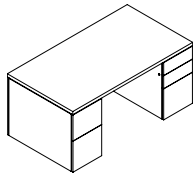

Double Pedestal Desk, Breakfront Style

MODEL#	DIMENSIONS D x W x H	FREIGHT CLASS	WT/LBS.	CUBIC FT.	LIST PRICE
LID8436ED	36 x 84 x 29	125	432	59	<b>\$6496</b>
LID7236ED	36 x 72 x 29	100	370	44	<b>\$6031</b>
LID7230ED	30 x 72 x 29	100	349	36	<b>\$5937</b>
LID6636ED	36 x 66 x 29	100	339	40	<b>\$5937</b>
LID6630ED	30 x 66 x 29	100	320	33	<b>\$5846</b>

Standard with full to floor **file/file** pedestal on **left** and **box/box/file** pedestal on **right**. Pedestals lock. Refer to the Desks and Credenzas Notes Section on previous page for overhang dimensions. Ships assembled in one carton.

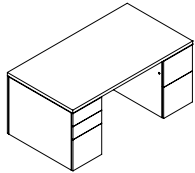

Double Pedestal Desk, Breakfront Style

LID8436DE	36 x 84 x 29	125	432	59	<b>\$6496</b>
LID7236DE	36 x 72 x 29	100	370	44	<b>\$6031</b>
LID7230DE	30 x 72 x 29	100	349	36	<b>\$5937</b>
LID6636DE	36 x 66 x 29	100	339	40	<b>\$5937</b>
LID6630DE	30 x 66 x 29	100	320	33	<b>\$5846</b>

Standard with full to floor **box/box/file** pedestal on **left** and **file/file** pedestal on **right**. Pedestals lock. Refer to the Desks and Credenzas Notes Section on page 274 for overhang dimensions. Ships assembled in one carton.

## SINGLE PEDESTAL DESKS

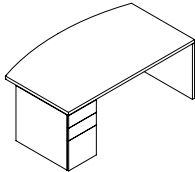

Single Pedestal Bow Top Desk - LEFT

MODEL#	DIMENSIONS	FREIGHT CLASS	WT/LBS.	CUBIC FT.	LIST PRICE
LMSL8442D	42 x 84 x 29	125	432	59	<b>\$7087</b>
LMSL7842D	42 x 78 x 29	125	401	55	<b>\$6577</b>
LMSL7242D	42 x 72 x 29	125	370	51	<b>\$6078</b>
LMSL6636D	36 x 66 x 29	150	230	40	<b>\$5846</b>

Standard with full to floor **box/box/file** pedestal on **left**. Bow top. Pedestal locks. Refer to the Desks and Credenzas Notes Section on page 274 for overhang dimensions. Ships assembled in one carton.

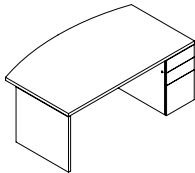

Single Pedestal Bow Top Desk - RIGHT

LMSR8442D	42 x 84 x 29	125	432	59	<b>\$7087</b>
LMSR7842D	42 x 78 x 29	125	401	55	<b>\$6577</b>
LMSR7242D	42 x 72 x 29	125	370	51	<b>\$6078</b>
LMSR6636D	36 x 66 x 29	150	230	40	<b>\$5846</b>

Standard with full to floor **box/box/file** pedestal on **right**. Bow top. Pedestal locks. Refer to the Desks and Credenzas Notes Section on page 274 for overhang dimensions. Ships assembled in one carton.

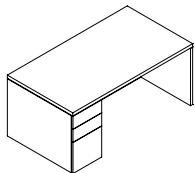

Single Pedestal Desk - LEFT

LSL8436D	42 x 84 x 29	125	463	59	<b>\$4800</b>
LSL7236D	36 x 72 x 29	125	340	44	<b>\$4116</b>
LSL7230D	30 x 72 x 29	125	283	36	<b>\$3930</b>
LSL6636D	36 x 66 x 29	125	312	40	<b>\$3930</b>
LSL6630D	30 x 66 x 29	100	295	33	<b>\$3756</b>

Standard with full to floor **box/box/file** pedestal on **left**. Pedestal locks. Refer to the Desks and Credenzas Notes Section on page 274 for overhang dimensions. Ships assembled in one carton.

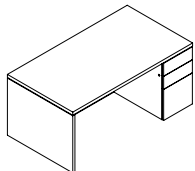

Single Pedestal Desk - RIGHT

LSR8436D	36 x 84 x 29	125	463	59	<b>\$4800</b>
LSR7236D	36 x 72 x 29	125	340	44	<b>\$4116</b>
LSR7230D	30 x 72 x 29	125	283	36	<b>\$3930</b>
LSR6636D	36 x 66 x 29	125	312	40	<b>\$3930</b>
LSR6630D	30 x 66 x 29	100	295	33	<b>\$3756</b>

Standard with full to floor **box/box/file** pedestal on **right**. Pedestal locks. Refer to the Desks and Credenzas Notes Section on page 274 for overhang dimensions. Ships assembled in one carton.

## Required Specifications

Veneer Finish  
Edge

## Optional Specifications

Grommet

**ELECTRIC HEIGHT ADJUSTABLE UNITS      MODEL#      DIMENSIONS      FREIGHT CLASS      WT/LBS.      CUBIC FT.      LIST PRICE**

**D x W x H**

- All Height Adjustable (HA) units are shipped fully assembled.
- Simple Up / Down function enables the height adjustment of the worksurface.
- The height adjustment range for desks is 29" to 45", for table and bridge top 26" to 43" (including worksurface).
- Single stage HA mechanism with an electric motor in each column is used.
- The height adjustable mechanism operates at 1.5" per second.
- Max. weight / lift is 265 lbs.
- All columns are integrated into fully functional pedestals, or pedestal bases with the exception of the HA table and the HA bridge top.
- Height adjustable bases are available in three colors: **Black (BLK)**, **Tungsten (TUN)**, and **Designer White (DWT)**
- All desks include two (2) PVC wire management channels (L & R side) allowing for cabling through the pedestals.
- Hanging wood modesty panel on desk is standard.
- To avoid risk of pinching:
  - 4.9" / 124mm gap is kept between the pedestal and the lowest point of the worksurface.
  - Wood spacer HASP must be used to attach height adjustable unit in the "U" or "L" configuration. See assembly instructions.
  - 2" gap is required between the worksurfaces when using the HA Table or the HA Bridge Top.
  - Includes collision detector
- Optional grommet locations: **TL** - Top Left or **TR** - Top Right

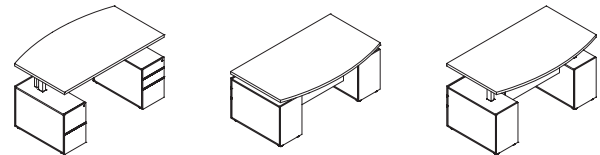
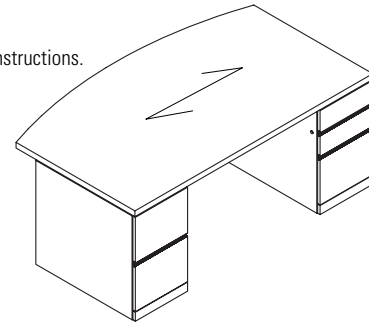

**Note:** Arrow indicates direction of grain.

**HEIGHT ADJUSTABLE DOUBLE PEDESTAL DESKS      MODEL#      DIMENSIONS      FREIGHT CLASS      WT/LBS.      CUBIC FT.      LIST PRICE**

**D x W x H**

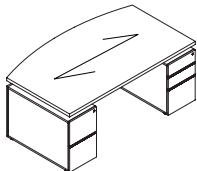

**Height Adj. Double Ped. Bow Top Desk  
Breakfront Style**

LHAMID8442ED	42 x 84 x 29	150	450	78	<b>\$14581</b>
LHAMID7842ED	42 x 78 x 29	150	430	72	<b>\$13965</b>
LHAMID7242ED	42 x 72 x 29	150	410	69	<b>\$13349</b>
LHAMID6636ED	36 x 66 x 29	125	390	54	<b>\$12662</b>

Built-in electric height adjustable double pedestal, standard with full to floor **box/box/file** pedestal on **right** and **file/file** pedestal on **left**. Bow top. Pedestals lock. One pencil tray. Refer to the Desks and Credenzas Notes Section on page 274 for overhang dimensions. Shipped RTA - ready to assemble.

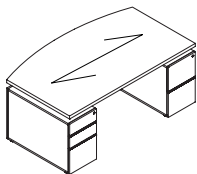

**Height Adj. Double Ped. Bow Top Desk  
Breakfront Style**

LHAMID8442DE	42 x 84 x 29	150	450	78	<b>\$14581</b>
LHAMID7842DE	42 x 78 x 29	150	430	72	<b>\$13965</b>
LHAMID7242DE	42 x 72 x 29	150	410	69	<b>\$13349</b>
LHAMID6636DE	36 x 66 x 29	125	390	54	<b>\$12662</b>

Built-in electric height adjustable double pedestal, standard with full to floor **box/box/file** pedestal on **left** and **file/file** pedestal on **right**. Bow top. Pedestals lock. One pencil tray. Refer to the Desks and Credenzas Notes Section on page 274 for overhang dimensions. Shipped RTA - ready to assemble.

**Required Specifications**

- Top finish
- Edge
- Base finish
- Handle style

**Optional Specifications**

- Grommet
- Glass modesty

## HEIGHT ADJUSTABLE DOUBLE PEDESTAL DESKS

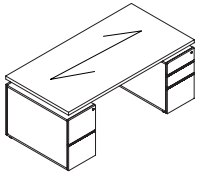

**Height Adj. Double Ped. Desk  
Breakfront Style**

MODEL#	DIMENSIONS D x W x H	FREIGHT CLASS	WT/LBS.	CUBIC FT.	LIST PRICE
LHAID8436ED	36 x 84 x 29	125	440	68	<b>\$12415</b>
LHAID7836ED	36 x 78 x 29	125	420	63	<b>\$12332</b>
LHAID7236ED	36 x 72 x 29	125	400	58	<b>\$12243</b>
LHAID7230ED	30 x 72 x 29	125	390	49	<b>\$12152</b>
LHAID6630ED	30 x 66 x 29	100	380	46	<b>\$11983</b>

Built-in electric height adjustable double pedestal, standard with full to floor **box/box/file** pedestal on **right** and **file/file** pedestal on **left**. Pedestals lock. One pencil tray. Refer to the Desks and Credenzas Notes Section on page 274 for overhang dimensions. Shipped RTA - ready to assemble.

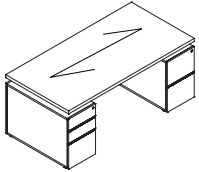

**Height Adj. Double Ped. Desk  
Breakfront Style**

LHAID8436DE	36 x 84 x 29	125	440	68	<b>\$12415</b>
LHAID7836DE	36 x 78 x 29	125	420	63	<b>\$12332</b>
LHAID7236DE	36 x 72 x 29	125	400	58	<b>\$12243</b>
LHAID7230DE	30 x 72 x 29	125	390	49	<b>\$12152</b>
LHAID6630DE	30 x 66 x 29	100	380	46	<b>\$11983</b>

Built-in electric height adjustable double pedestal, standard with full to floor **box/box/file** pedestal on **left** and **file/file** pedestal on **right**. Pedestals lock. One pencil tray. Refer to the Desks and Credenzas Notes Section on page 274 for overhang dimensions. Shipped RTA - ready to assemble.

## HEIGHT ADJUSTABLE SINGLE PEDESTAL DESKS

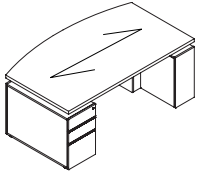

**Height Adj. Single Ped. Bow Top Desk  
Breakfront Style - LEFT**

MODEL#	DIMENSIONS	FREIGHT CLASS	WT/LBS.	CUBIC FT.	LIST PRICE
LHAMISL8442D	42 x 84 x 29	150	440	81	<b>\$12787</b>
LHAMISL7842D	42 x 78 x 29	150	420	72	<b>\$12306</b>
LHAMISL7242D	42 x 72 x 29	150	400	67	<b>\$11823</b>
LHAMISL6636D	36 x 66 x 29	125	390	54	<b>\$11220</b>

Built-in electric height adjustable single pedestal bow top desk. Standard with full to floor locking **box/box/file** pedestal on **left** and support pedestal on **right**. Refer to the Desks and Credenzas Notes Section on page 274 for overhang dimensions. Shipped RTA - ready to assemble.

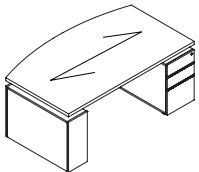

**Height Adj. Single Ped. Bow Top Desk  
Breakfront Style - RIGHT**

LHAMISR8442D	42 x 84 x 29	150	440	81	<b>\$12787</b>
LHAMISR7842D	42 x 78 x 29	150	420	72	<b>\$12306</b>
LHAMISR7242D	42 x 72 x 29	150	400	67	<b>\$11823</b>
LHAMISR6636D	36 x 66 x 29	125	390	54	<b>\$11220</b>

Built-in electric height adjustable single pedestal bow top desk. Standard with full to floor locking **box/box/file** pedestal on **right** and support pedestal on **left**. Refer to the Desks and Credenzas Notes Section on page 274 for overhang dimensions. Shipped RTA - ready to assemble.

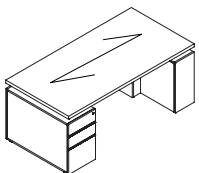

**Height Adjustable Single Ped. Desk  
Breakfront Style - LEFT**

LHAISL8436D	36 x 84 x 29	125	430	68	<b>\$10924</b>
LHAISL7836D	36 x 78 x 29	125	410	63	<b>\$10883</b>
LHAISL7236D	36 x 72 x 29	125	390	58	<b>\$10750</b>
LHAISL7230D	30 x 72 x 29	125	380	49	<b>\$10541</b>
LHAISL6630D	30 x 66 x 29	125	360	46	<b>\$10266</b>
LHAISL6030D	30 x 60 x 29	100	340	42	<b>\$10071</b>

Built-in electric height adjustable single pedestal desk. Standard with full to floor locking **box/box/file** pedestal on **left** and support pedestal on **right**. Refer to the Desks and Credenzas Notes Section on page 274 for overhang dimensions. Shipped RTA - ready to assemble.

### Required Specifications

Top finish  
Edge  
Base finish  
Handle style

### Optional Specifications

Grommet  
Glass modesty

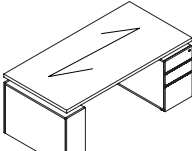
HEIGHT ADJUSTABLE SINGLE PEDESTAL DESKS	MODEL#	DIMENSIONS	FREIGHT CLASS	WT./LBS.	CUBIC FT.	LIST PRICE
<b>D x W x H</b>						
	LHAISR8436D	36 x 84 x 29	125	430	68	<b>\$10924</b>
	LHAISR7836D	36 x 78 x 29	125	410	63	<b>\$10883</b>
	LHAISR7236D	36 x 72 x 29	125	390	58	<b>\$10750</b>
	LHAISR7230D	30 x 72 x 29	125	380	49	<b>\$10541</b>
	LHAISR6630D	30 x 66 x 29	125	360	46	<b>\$10266</b>
	LHAISR6030D	30 x 60 x 29	100	340	42	<b>\$10071</b>

**Height Adjustable Single Ped. Desk\***  
**Breakfront Style - RIGHT**

Built-in electric height adjustable single pedestal desk. Standard with full to floor locking **box/box/file** pedestal on **right** and support pedestal on **left**. Refer to the Desks and Credenzas Notes Section on page 274 for overhang dimensions. Shipped RTA - ready to assemble.

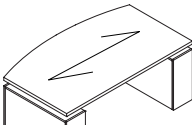
HEIGHT ADJUSTABLE DESK SHELLS	MODEL#	DIMENSIONS	FREIGHT CLASS	WT./LBS.	CUBIC FT.	LIST PRICE
	LHAMIT8442	42 x 84 x 29	150	350	81	<b>\$12389</b>
	LHAMIT7842	42 x 78 x 29	150	330	72	<b>\$12122</b>
	LHAMIT7242	42 x 72 x 29	150	310	67	<b>\$11851</b>
	LHAMIT6636	36 x 66 x 29	150	280	54	<b>\$10694</b>

**Height Adjustable Bow Top Desk Shell**  
**Breakfront Style**

Built-in electric height adjustable bow top desk shell. Refer to the Desks and Credenzas Notes Section on page 274 for overhang dimensions. Shipped RTA - ready to assemble.

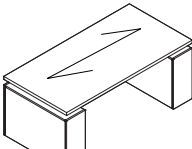
	LHAIT8436	36 x 84 x 29	150	330	68	<b>\$11022</b>
	LHAIT7836	36 x 78 x 29	150	310	63	<b>\$10819</b>
	LHAIT7236	36 x 72 x 29	150	290	58	<b>\$10602</b>
	LHAIT7230	30 x 72 x 29	150	280	49	<b>\$9939</b>
	LHAIT6636	36 x 66 x 29	150	260	54	<b>\$10183</b>
	LHAIT6630	30 x 66 x 29	150	250	46	<b>\$9939</b>
	LHAIT6030	30 x 60 x 29	150	240	42	<b>\$9762</b>

**Height Adjustable Desk Shell**  
**Breakfront Style**

Built-in electric height adjustable desk shell. Refer to the Desks and Credenzas Notes Section on page 274 for overhang dimensions. Shipped RTA - ready to assemble.

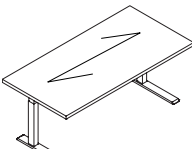
	LHA8436	36 x 84 x 29	250	160	68	<b>\$8921</b>
	LHA7836	36 x 78 x 29	250	150	63	<b>\$8720</b>
	LHA7236	36 x 72 x 29	250	140	58	<b>\$8501</b>
	LHA7230	30 x 72 x 29	250	130	49	<b>\$7835</b>
	LHA6636	36 x 66 x 29	250	140	54	<b>\$8081</b>
	LHA6630	30 x 66 x 29	250	120	46	<b>\$7835</b>
	LHA6030	30 x 60 x 29	250	115	42	<b>\$7661</b>

**Height Adjustable Table**

Electric height adjustable table. Shipped RTA - ready to assemble.

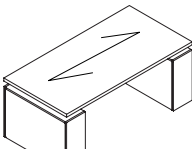
	LHA8436TP	36 x 84 x 29	150	320	68	<b>\$10673</b>
	LHA7836TP	36 x 78 x 29	150	300	63	<b>\$10469</b>
	LHA7236TP	36 x 72 x 29	150	280	58	<b>\$10253</b>
	LHA7230TP	30 x 72 x 29	150	270	49	<b>\$9587</b>
	LHA6636TP	36 x 66 x 29	150	250	54	<b>\$9834</b>
	LHA6630TP	30 x 66 x 29	150	240	46	<b>\$9587</b>
	LHA6030TP	30 x 60 x 29	150	230	42	<b>\$9412</b>

**Height Adjustable Desk**

Built-in electric height adjustable desk on TP bases. Shipped RTA - ready to assemble.

**Required Specifications**

Top finish  
Edge  
Base finish  
Handle style\*

**Optional Specifications**

Grommet  
Glass modesty

## HEIGHT ADJUSTABLE UNITS

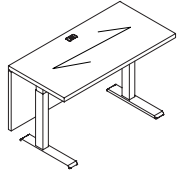

**Height Adjustable Bridge Top**

MODEL#	DIMENSIONS D x W x H	FREIGHT CLASS	WT/LBS.	CUBIC FT.	LIST PRICE
LHABT6024	24 x 60 x 29	150	150	35	<b>\$8313</b>
LHABT5424	24 x 54 x 29	150	140	31	<b>\$8067</b>
LHABT4824	24 x 48 x 29	150	130	28	<b>\$7821</b>
LHABT4224	24 x 42 x 29	150	120	26	<b>\$7567</b>

Electric height adjustable executive bridge top. Grommet in worksurface. Shipped RTA - ready to assemble.

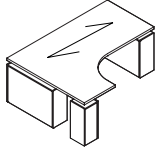

**Height Adj. Right Extended Corner Desk\***

LHAEKR60842436	24-36 x 60-84 x 29	150	450	108	<b>\$16528</b>
LHAEKR60782436	24-36 x 60-78 x 29	150	430	100	<b>\$16488</b>
LHAEKR60722436	24-36 x 60-72 x 29	150	410	93	<b>\$16124</b>
LHAEKR60662436	24-36 x 60-66 x 29	150	390	86	<b>\$15654</b>
LHAEKR60602436	24-36 x 60-60 x 29	150	370	79	<b>\$15185</b>

Built-in electric height adjustable right extended corner table desk with a 24" return connection. Extended worksurface on **right. Full end panel on right, narrow end panel on left.** Connects to Linking Bridges, Extended Corners and Connectable Tables. Shipped RTA - ready to assemble.

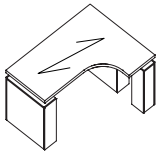

**Height Adj. Left Extended Corner Desk\***

LHAEKL84603624	24-36 x 60-84 x 29	150	450	108	<b>\$16528</b>
LHAEKL78603624	24-36 x 60-78 x 29	150	430	100	<b>\$16488</b>
LHAEKL72603624	24-36 x 60-72 x 29	150	410	93	<b>\$16124</b>
LHAEKL66603624	24-36 x 60-66 x 29	150	390	86	<b>\$15654</b>
LHAEKL60603624	24-36 x 60-60 x 29	150	370	79	<b>\$15185</b>

Built-in electric height adjustable right extended corner table desk with a 24" return connection. Extended worksurface on **left. Full end panel on left, narrow end panel on right.** Connects to Linking Bridges, Extended Corners and Connectable Tables. Shipped RTA - ready to assemble.



**Spacer**

LHASP	2 x 8 x 23	70	15	.75	<b>\$598</b>
-------	------------	----	----	-----	--------------

Connects height adjustable desks with linking bridges and returns.

### Required Specifications

Top finish  
Edge  
Base finish

### Optional Specifications

Grommet\*  
Glass modesty

**HEIGHT ADJUSTABLE TOPS**

MODEL#	DIMENSIONS	FREIGHT CLASS	WT/LBS.	CUBIC FT.	LIST PRICE
<b>D x W x H</b>					
LRE8223T	23 x 82 x 1.18	92.5	82	7	<b>\$1760</b>
LRE7623T	23 x 76 x 1.18	92.5	77	6.5	<b>\$1631</b>
LRE7023T	23 x 70 x 1.18	85	72	6	<b>\$1507</b>
LRE6423T	23 x 64 x 1.18	85	66	5.5	<b>\$1372</b>
LRE5223T	23 x 52 x 1.18	85	56	4.5	<b>\$1114</b>
LRE4623T	23 x 46 x 1.18	85	50	4	<b>\$991</b>
LRE4023T	23 x 40 x 1.18	85	45	3.5	<b>\$862</b>
LRE8229T	29 x 82 x 1.18	85	101	8	<b>\$2222</b>
LRE7629T	29 x 76 x 1.18	85	94	7.5	<b>\$2061</b>
LRE7029T	29 x 70 x 1.18	85	88	7	<b>\$1894</b>
LRE6429T	29 x 64 x 1.18	85	81	6.5	<b>\$1733</b>
LRE5229T	29 x 52 x 1.18	85	68	5.5	<b>\$1411</b>
LRE4629T	29 x 46 x 1.18	85	61	5	<b>\$1249</b>
LRE4029T	29 x 40 x 1.18	85	55	4.5	<b>\$1083</b>
LRE8235T	35 x 82 x 1.18	85	120	10	<b>\$2680</b>
LRE7635T	35 x 76 x 1.18	85	112	9	<b>\$2486</b>
LRE7235T	35 x 72 x 1.18	85	104	8.5	<b>\$2357</b>
LRE6435T	35 x 64 x 1.18	85	96	8	<b>\$2093</b>
LRE5235T	35 x 52 x 1.18	85	80	6.5	<b>\$1700</b>
LRE4635T	35 x 46 x 1.18	85	72	6	<b>\$1507</b>
LRE4035T	35 x 40 x 1.18	85	64	5	<b>\$1308</b>

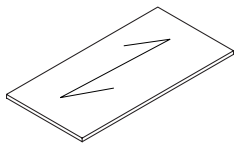

**Height Adjustable Top**

Lufton tops with Lufton edge on three sides, for use with FreeFit height adjustable table mechanisms, sold separately (FTxxxxx, see page 713 of the Desking price list for information).

- 23" deep tops accommodate FTxxxx24 mechanisms. Depth is exact to accommodate the Lufton edge + the Freefit mechanism. *Cannot be made smaller.*
- 29" and 35" deep tops accommodate FTxxxx30 mechanisms.

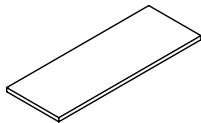

**HA Return Top**

LRE6024CGT	24 x 60 x 1.18	300	10	5.5	<b>\$1346</b>
LRE5424CGT	24 x 54 x 1.18	250	10	5	<b>\$1211</b>
LRE4824CGT	24 x 48 x 1.18	250	10	4.5	<b>\$1077</b>
LRE4224CGT	24 x 42 x 1.18	250	10	4	<b>\$942</b>

Lufton return tops with Lufton edge on three sides, for use with FreeFit height adjustable table mechanisms, sold separately (FTxxxxx, see page 713 of the Desking price list for information).

**Required Specifications**

Veneer finish  
Edge

**Optional Specifications**

Grommet

MODESTY PANEL OPTIONS

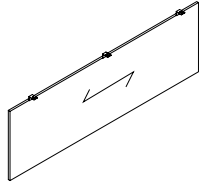

Veneer Modesty Panel Upgrade\*

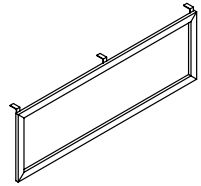

Glass Modesty Panel Upgrade

MODEL#	DIMENSIONS D x W x H	FREIGHT CLASS	WT/LBS.	CUBIC FT.	LIST PRICE
CMP72W	0.75 x 67 x 18	--	20	1	<b>\$1728</b>
CMP66W	0.75 x 61 x 18	--	18	1	<b>\$1673</b>
CMP60W	0.75 x 55 x 18	--	16	1	<b>\$1647</b>
CMP54W	0.75 x 49 x 18	--	14	1	<b>\$1619</b>
CMP48W	0.75 x 43 x 18	--	13	1	<b>\$1594</b>

Straight modesty panel. Attaches to underside of worksurface. **Can not be retrofitted in the field *Not sold individually - to be ordered as an upgrade option only.***

- CMP72W - Specify on "P" Top Islands or 96" x 48" Islands for Piano Desks.
- CMP66W - Specify on 84" x 36" "D" Top Islands.
- CMP60W - Specify on 84" x 42" "P" Top Islands or 84" x 48" Islands for Piano Desks.
- CMP54W - Specify on 72" x 30" "D" Top Islands.
- CMP48W - Specify on 66" x 36" , 60" x 30" "D" Top Islands, 72" x 42" "P" Top Islands or 72" x 48" Islands for Piano Desks.

CMP72G	0.75 x 67 x 18	--	20	1	<b>\$2647</b>
CMP66G	0.75 x 61 x 18	--	18	1	<b>\$2504</b>
CMP60G	0.75 x 55 x 18	--	16	1	<b>\$2289</b>
CMP54G	0.75 x 49 x 18	--	14	1	<b>\$2132</b>
CMP48G	0.75 x 43 x 18	--	13	1	<b>\$2036</b>

Straight modesty panel. Translucent, screened glass. Aluminum box frame construction in Tungsten Only. Attaches to underside of worksurface. **Can not be retrofitted in the field. *Not sold individually - to be ordered as an upgrade option only.***

- CMP72G - Specify on "P" Top Islands or 96" x 48" Islands for Piano Desks.
- CMP66G - Specify on 84" x 36" "D" Top Islands.
- CMP60G - Specify on 84" x 42" "P" Top Islands or 84" x 48" Islands for Piano Desks.
- CMP54G - Specify on 72" x 30" "D" Top Islands.
- CMP48G - Specify on 66" x 36" , 60" x 30" "D" Top Islands, 72" x 42" "P" Top Islands or 72" x 48" Islands for Piano Desks.
- Tungsten finish on the aluminum box frame closely resembles the existing Tungsten finish.

**Required Specifications**

Veneer finish  
Edge  
Handle style

**Optional Specifications**

Grommet

**SINGLE PEDESTAL DESKS - BREAKFRONT STYLE**    **MODEL#**    **DIMENSIONS**    **FREIGHT CLASS**    **WT/LBS.**    **CUBIC FT.**    **LIST PRICE**

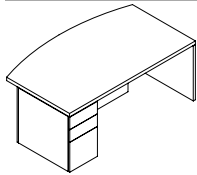

**Single Pedestal Bow Top Desk - LEFT Breakfront Style\***

	<b>D x W x H</b>					
LMISL8442D	42 x 84 x 29	125	432	59		<b>\$7232</b>
LMISL7842D	42 x 78 x 29	125	401	55		<b>\$6724</b>
LMISL7242D	42 x 72 x 29	125	370	51		<b>\$6228</b>
LMISL6636D	36 x 66 x 29	150	230	40		<b>\$5937</b>

Standard with full to floor **box/box/file** pedestal on **left**. Bow top. Pedestal locks. Refer to the Desks and Credenzas Notes Section on page 274 for overhang dimensions. Ships assembled in 1 carton.

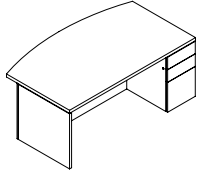

**Single Pedestal Bow Top Desk - RIGHT Breakfront Style\***

LMISR8442D	42 x 84 x 29	125	432	59		<b>\$7232</b>
LMISR7842D	42 x 78 x 29	125	401	55		<b>\$6724</b>
LMISR7242D	42 x 72 x 29	125	370	51		<b>\$6228</b>
LMISR6636D	36 x 66 x 29	150	230	40		<b>\$5937</b>

Standard with full to floor **box/box/file** pedestal on **right**. Bow top. Pedestal locks. Refer to the Desks and Credenzas Notes Section on page 274 for overhang dimensions. Ships assembled in 1 carton.

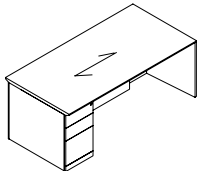

**Single Pedestal Desk - LEFT Breakfront Style**

LISL8436D	36 x 84 x 29	125	463	59		<b>\$6308</b>
LISL7236D	36 x 72 x 29	125	340	44		<b>\$5373</b>
LISL7230D	30 x 72 x 29	125	283	36		<b>\$4423</b>
LISL6636D	36 x 66 x 29	125	312	40		<b>\$4423</b>
LISL6630D	30 x 66 x 29	100	295	33		<b>\$4225</b>

Standard with full to floor **box/box/file** pedestal on **left**. Pedestal locks. Refer to the Desks and Credenzas Notes Section on page 274 for overhang dimensions. Ships assembled in 1 carton.

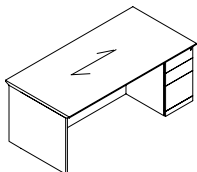

**Single Pedestal Desk - RIGHT Breakfront Style**

LISR8436D	42 x 84 x 29	125	463	59		<b>\$6308</b>
LISR7236D	36 x 72 x 29	125	340	44		<b>\$5373</b>
LISR7230D	30 x 72 x 29	125	283	36		<b>\$4423</b>
LISR6636D	36 x 66 x 29	125	312	40		<b>\$4423</b>
LISR6630D	30 x 66 x 29	100	295	33		<b>\$4225</b>

Standard with full to floor **box/box/file** pedestal on **right**. Pedestal locks. Refer to the Desks and Credenzas Notes Section on page 274 for overhang dimensions. Ships assembled in 1 carton.

**Required Specifications**

Veneer Finish  
Laminate Finish  
Handle Style

**Optional Specifications**

Grommet

## DESK SHELLS

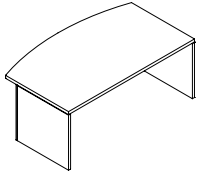

**Bow Top Desk Shell**

MODEL#	DIMENSIONS	FREIGHT CLASS	WT/LBS.	CUBIC FT.	LIST PRICE
LMT8442	42 x 84 x 29	125	380	59	<b>\$5447</b>
LMT7842	42 x 78 x 29	125	353	55	<b>\$5053</b>
LMT7242	42 x 72 x 29	125	331	51	<b>\$4677</b>
LMT6636	36 x 66 x 29	125	287	40	<b>\$4450</b>

Bow top and recessed modesty panel. Refer to the Desks and Credenzas Notes Section on page 274 for overhang dimensions. Ships assembled in 1 carton.

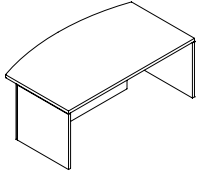

**Bow Top Desk Shell, Breakfront Style**

LMIT8442	42 x 84 x 29	125	380	59	<b>\$5596</b>
LMIT7842	42 x 78 x 29	125	353	55	<b>\$5274</b>
LMIT7242	42 x 72 x 29	125	331	51	<b>\$4954</b>
LMIT6636	36 x 66 x 29	125	287	40	<b>\$4774</b>

Bow top and recessed modesty panel. Refer to the Desks and Credenzas Notes Section on page 274 for overhang dimensions. Ships assembled in 1 carton.

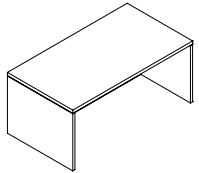

**Desk Shell**

LT8436	36 x 84 x 29	150	362	51	<b>\$3918</b>
LT7236	36 x 72 x 29	125	315	44	<b>\$3726</b>
LT7230	30 x 72 x 29	125	271	36	<b>\$3512</b>
LT6636	36 x 66 x 29	100	271	40	<b>\$3512</b>
LT6630	30 x 66 x 29	100	265	33	<b>\$3291</b>

Recessed modesty panel. Refer to the Desks and Credenzas Notes Section on page 274 for overhang dimensions. Ships assembled in 1 carton.

**Required Specifications**

Veneer Finish  
Edge

**Optional Specifications**

Grommet

RETURNS	MODEL#	DIMENSIONS	FREIGHT CLASS	WT/LBS.	CUBIC FT.	LIST PRICE
---------	--------	------------	---------------	---------	-----------	------------

D x W x H

- An Executive Return is used to attach to a Single Pedestal Desk, Single Pedestal Credenza, Desk Shell or Credenza Shell.
- Grommets are available as an option.
- Hand of Executive Return is determined by location of full end panel from user side.
- Hand of Desk or Credenza is determined by location of pedestal from user side.
- To remove cross grain veneer pattern on top, delete suffix "CG" from the model number. Available as a special - no upcharge.

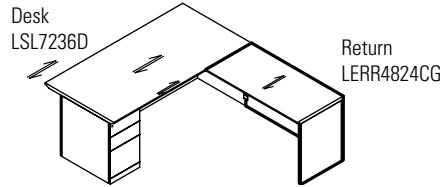
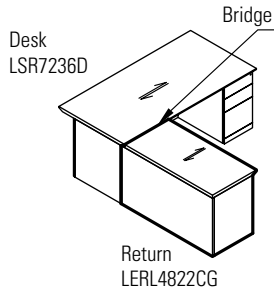

RETURNS	MODEL#	DIMENSIONS	FREIGHT CLASS	WT/LBS.	CUBIC FT.	LIST PRICE
---------	--------	------------	---------------	---------	-----------	------------

D x W x H

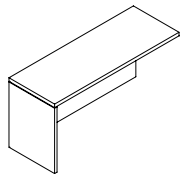

Flush Return - LEFT 24" Deep

LERL7224CG	24 x 72 x 29	150	135	29	<b>\$2856</b>
LERL6624CG	24 x 66 x 29	150	127	27	<b>\$2668</b>
LERL6024CG	24 x 60 x 29	150	120	24	<b>\$2474</b>
LERL5424CG	24 x 54 x 29	150	112	22	<b>\$2289</b>
LERL4824CG	24 x 48 x 29	150	105	19	<b>\$2097</b>
LERL4224CG	24 x 42 x 29	150	97	17	<b>\$1904</b>

Return has **no pedestal**. For use with right handed single pedestal desks, credenzas, desk shells, credenza shells, "D" islands or "P" islands.

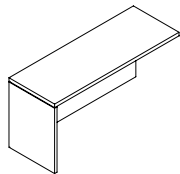

Flush Return - LEFT 20" Deep

LERL7220CG	20 x 72 x 29	150	130	27	<b>\$2074</b>
LERL6620CG	20 x 66 x 29	150	122	24	<b>\$1904</b>
LERL6020CG	20 x 60 x 29	150	115	22	<b>\$1730</b>
LERL5420CG	20 x 54 x 29	150	105	20	<b>\$1562</b>
LERL4820CG	20 x 48 x 29	150	100	18	<b>\$1387</b>
LERL4220CG	20 x 42 x 29	150	90	16	<b>\$1217</b>

Return has **no pedestal**. For use with right handed single pedestal desks, credenzas, desk shells, credenza shells, "D" islands or "P" islands.

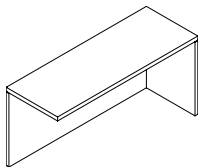

Flush Return - RIGHT 24" Deep

LERR7224CG	24 x 72 x 29	150	135	29	<b>\$2856</b>
LERR6624CG	24 x 66 x 29	150	127	27	<b>\$2668</b>
LERR6024CG	24 x 60 x 29	150	120	24	<b>\$2474</b>
LERR5424CG	24 x 54 x 29	150	112	22	<b>\$2289</b>
LERR4824CG	24 x 48 x 29	150	105	19	<b>\$2097</b>
LERR4224CG	24 x 42 x 29	150	97	17	<b>\$1904</b>

Return has **no pedestal**. For use with left handed single pedestal desks, credenzas, desk shells, credenza shells, "D" islands or "P" islands.

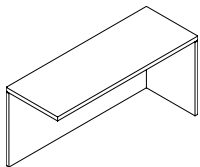

Flush Return - RIGHT 20" Deep

LERR7220CG	20 x 72 x 29	150	130	27	<b>\$2074</b>
LERR6620CG	20 x 66 x 29	150	122	24	<b>\$1904</b>
LERR6020CG	20 x 60 x 29	150	115	22	<b>\$1730</b>
LERR5420CG	20 x 54 x 29	150	105	20	<b>\$1562</b>
LERR4820CG	20 x 48 x 29	150	100	18	<b>\$1387</b>
LERR4220CG	20 x 42 x 29	150	90	16	<b>\$1217</b>

Return has **no pedestal**. For use with left handed single pedestal desks, credenzas, desk shells, credenza shells, "D" islands or "P" islands.

**Required Specifications**

Veneer Finish  
Edge

**Optional Specifications**

Grommet

**RETURNS**

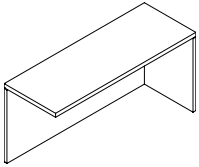

**Non-Handed Return**

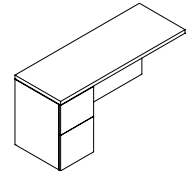

**Flush Return - LEFT 24" Deep**

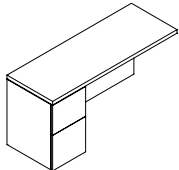

**Flush Return - LEFT 20" Deep**

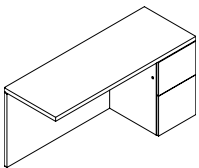

**Flush Return - RIGHT 24" Deep**

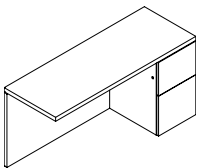

**Flush Return - RIGHT 20" Deep**

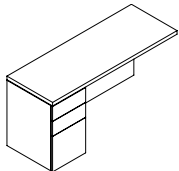

**Flush Return - LEFT 24" Deep**

MODEL#	DIMENSIONS D x W x H	FREIGHT CLASS	WT/LBS.	CUBIC FT.	LIST PRICE
LERR-L4824CG	24 x 48 x 29	150	105	19	<b>\$2723</b>
LERR-L4224CG	24 x 42 x 29	150	97	17	<b>\$2464</b>
LERR-L4820CG	20 x 48 x 29	150	100	19	<b>\$1804</b>
LERR-L4220CG	20 x 42 x 29	150	90	17	<b>\$1580</b>

Return has **no pedestal**. For use with left or right handed single pedestal desks, credenzas, desk shells, credenza shells, "D" islands or "P" islands. Ships assembled in 1 carton.

LERL7224ECG	24 x 72 x 29	100	250	29	<b>\$4765</b>
LERL6624ECG	24 x 66 x 29	100	236	27	<b>\$4608</b>
LERL6024ECG	24 x 60 x 29	100	227	24	<b>\$4232</b>
LERL5424ECG	24 x 54 x 29	100	205	22	<b>\$4092</b>
LERL4824ECG	24 x 48 x 29	100	185	19	<b>\$3688</b>
LERL4224ECG	24 x 42 x 29	92.5	178	17	<b>\$3565</b>

Return has **file/file** pedestal on the **left**. Pedestal locks. For use with right handed single pedestal desks, credenzas, desk shells, credenza shells, "D" islands or "P" islands. Ships assembled in 1 carton.

LERL7220ECG	20 x 72 x 29	100	240	29	<b>\$3696</b>
LERL6620ECG	20 x 66 x 29	100	231	27	<b>\$3560</b>
LERL6020ECG	20 x 60 x 29	100	222	24	<b>\$3236</b>
LERL5420ECG	20 x 54 x 29	100	200	22	<b>\$3120</b>
LERL4820ECG	20 x 48 x 29	100	180	18	<b>\$2779</b>
LERL4220ECG	20 x 42 x 29	92.5	173	16	<b>\$2668</b>

Return has **file/file** pedestal on the **left**. Pedestal locks. For use with right handed single pedestal desks, credenzas, desk shells, credenza shells, "D" islands or "P" islands. Ships assembled in 1 carton.

LERR7224ECG	24 x 72 x 29	100	250	29	<b>\$4765</b>
LERR6624ECG	24 x 66 x 29	100	236	27	<b>\$4608</b>
LERR6024ECG	24 x 60 x 29	100	227	24	<b>\$4232</b>
LERR5424ECG	24 x 54 x 29	100	205	22	<b>\$4092</b>
LERR4824ECG	24 x 48 x 29	100	185	19	<b>\$3688</b>
LERR4224ECG	24 x 42 x 29	92.5	178	17	<b>\$3565</b>

Return has **file/file** pedestal on the **right**. Pedestal locks. For use with left handed single pedestal desks, credenzas, desk shells, credenza shells, "D" islands or "P" islands. Ships assembled in 1 carton.

LERR7220ECG	20 x 72 x 29	100	240	29	<b>\$3696</b>
LERR6620ECG	20 x 66 x 29	100	231	27	<b>\$3560</b>
LERR6020ECG	20 x 60 x 29	100	222	24	<b>\$3236</b>
LERR5420ECG	20 x 54 x 29	100	200	22	<b>\$3120</b>
LERR4820ECG	20 x 48 x 29	100	180	18	<b>\$2779</b>
LERR4220ECG	20 x 42 x 29	92.5	173	16	<b>\$2668</b>

Return has **file/file** pedestal on the **right**. Pedestal locks. For use with left handed single pedestal desks, credenzas, desk shells, credenza shells, "D" islands or "P" islands. Ships assembled in 1 carton.

LERL7224DCG	24 x 72 x 29	100	250	29	<b>\$4765</b>
LERL6624DCG	24 x 66 x 29	100	236	27	<b>\$4608</b>
LERL6024DCG	24 x 60 x 29	100	227	24	<b>\$4232</b>
LERL5424DCG	24 x 54 x 29	100	205	22	<b>\$4092</b>
LERL4824DCG	24 x 48 x 29	100	185	19	<b>\$3688</b>
LERL4224DCG	24 x 42 x 29	92.5	178	17	<b>\$3565</b>

Return has **box/box/file** pedestal on the **left**. Pedestal locks. For use with right handed single pedestal desks, credenzas, desk shells, credenza shells, "D" islands or "P" islands. Ships assembled in 1 carton.

**Required Specifications**

Veneer Finish  
Edge

**Optional Specifications**

Grommet

**RETURNS**

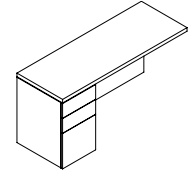

**Flush Return - LEFT 20" Deep**

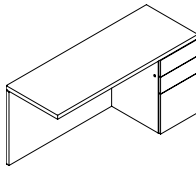

**Flush Return - RIGHT 24" Deep**

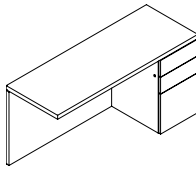

**Flush Return - RIGHT 20" Deep**

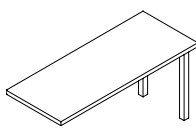

**Return**

MODEL#	DIMENSIONS D x W x H	FREIGHT CLASS	WT/LBS.	CUBIC FT.	LIST PRICE
LERL7220DCG	20 x 72 x 29	100	240	27	<b>\$3696</b>
LERL6620DCG	20 x 66 x 29	100	231	24	<b>\$3560</b>
LERL6020DCG	20 x 60 x 29	100	222	22	<b>\$3236</b>
LERL5420DCG	20 x 54 x 29	100	200	20	<b>\$3120</b>
LERL4820DCG	20 x 48 x 29	100	180	18	<b>\$2779</b>
LERL4220DCG	20 x 42 x 29	92.5	173	16	<b>\$2668</b>

Return has **box/box/file** pedestal on the **left**. Pedestal locks. For use with right handed single pedestal desks, credenzas, desk shells, credenza shells, "D" islands or "P" islands. Ships assembled in 1 carton.

LERR7224DCG	24 x 72 x 29	100	250	29	<b>\$4765</b>
LERR6624DCG	24 x 66 x 29	100	236	27	<b>\$4608</b>
LERR6024DCG	24 x 60 x 29	100	227	24	<b>\$4232</b>
LERR5424DCG	24 x 54 x 29	100	205	22	<b>\$4092</b>
LERR4824DCG	24 x 48 x 29	100	185	19	<b>\$3688</b>
LERR4224DCG	24 x 42 x 29	92.5	178	17	<b>\$3565</b>

Return has **box/box/file** pedestal on the **right**. Pedestal locks. For use with left handed single pedestal desks, credenzas, desk shells, credenza shells, "D" islands or "P" islands. Ships assembled in 1 carton.

LERR7220DCG	20 x 72 x 29	100	240	27	<b>\$3696</b>
LERR6620DCG	20 x 66 x 29	100	231	24	<b>\$3560</b>
LERR6020DCG	20 x 60 x 29	100	222	22	<b>\$3236</b>
LERR5420DCG	20 x 54 x 29	100	200	20	<b>\$3120</b>
LERR4820DCG	20 x 48 x 29	100	180	18	<b>\$2779</b>
LERR4220DCG	20 x 42 x 29	92.5	173	16	<b>\$2668</b>

Return has **box/box/file** pedestal on the **right**. Pedestal locks. For use with left handed single pedestal desks, credenzas, desk shells, credenza shells, "D" islands or "P" islands. Ships assembled in 1 carton.

LR8430CG	30 x 84 x 29	150	130	29	<b>\$2074</b>
LR7230CG	30 x 72 x 29	150	122	27	<b>\$1832</b>
LR6630CG	30 x 66 x 29	150	115	24	<b>\$1726</b>
LR6030CG	30 x 60 x 29	150	105	22	<b>\$1608</b>

Return has **no pedestal**. For use with single pedestal desks, credenzas, desk shells, credenza shells, "D" islands or "P" islands. Shipped RTA - ready to assemble.

**BRIDGES - EXECUTIVE**

- An Executive Bridge is used to connect a Desk to a Credenza.
- Not to be used with Corner Components or Piano Desks,
- Three Modesty Panel options - Full Modesty, 8" Modesty and No Modesty (Flush Bridge Top).
- Modesty panel flush with end panels of Desk and Credenza.
- Includes GM1 grommet in the top center position.
- Both connecting sides of executive bridges feature a reverse profile edge

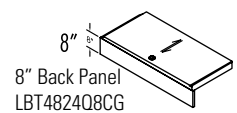
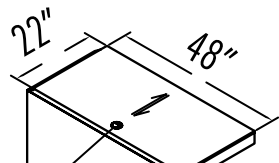
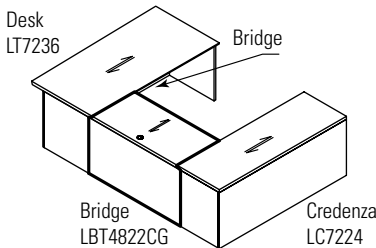

**Required Specifications**  
Veneer Finish  
Edge

**Optional Specifications**  
Grommet

BRIDGES - LINKING	MODEL#	DIMENSIONS D x W x H	FREIGHT CLASS	WT/LBS.	CUBIC FT.	LIST PRICE
-------------------	--------	-------------------------	---------------	---------	-----------	------------

- A linking bridge is used to connect corner components to a single pedestal desk, HA desk, single pedestal credenza, desk shell or credenza shell.
- When connecting HA desk, must specify LHASP spacer.
- Two modesty panel options - full modesty and 8" modesty.
- Includes GM1 grommet in the top center position.
- Hand of linking bridge is determined by location of half end panel from user side.
- Linking bridges are handed **left and right** (handedness is determined by connecting side with the self edge). The opposite connecting side features a reverse profile edge.

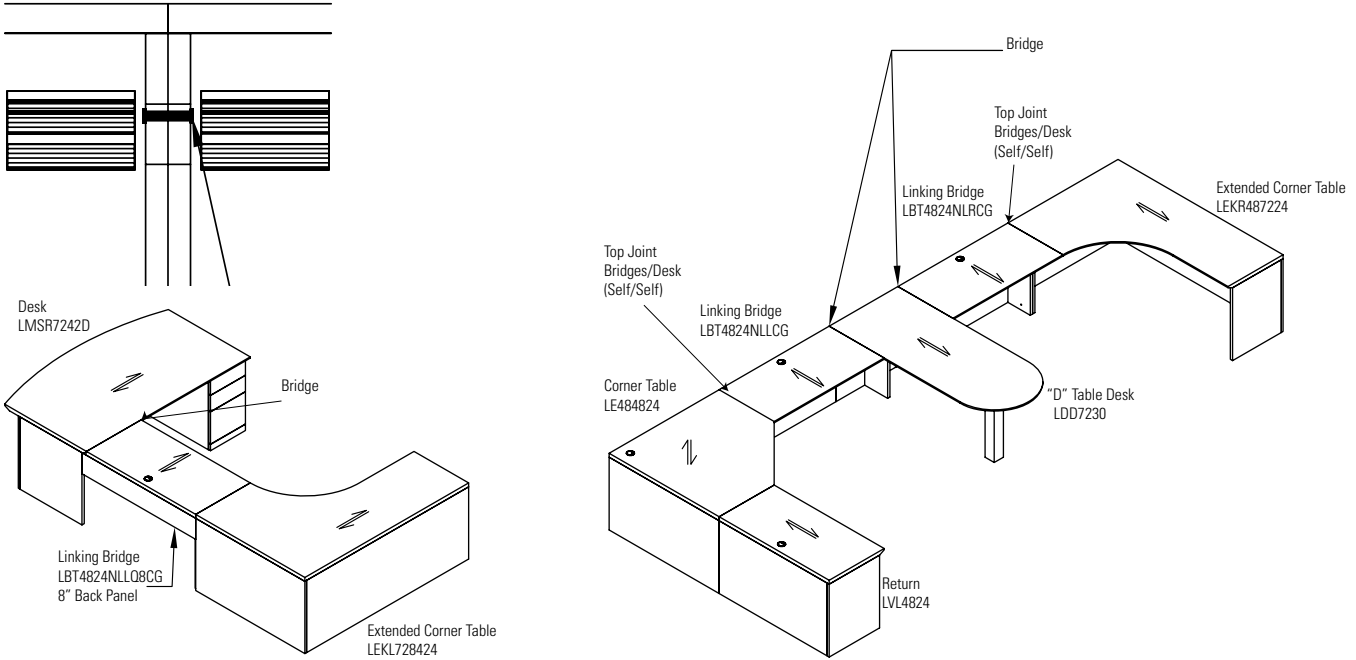

BRIDGES	MODEL#	DIMENSIONS	FREIGHT CLASS	WT/LBS.	CUBIC FT.	LIST PRICE
---------	--------	------------	---------------	---------	-----------	------------

LBT6024CG	24 x 60 x 29	85	144	10	<b>\$2018</b>
LBT5424CG	24 x 54 x 29	85	129	9	<b>\$1816</b>
LBT4824CG	24 x 48 x 29	70	120	8	<b>\$1619</b>
LBT4224CG	24 x 42 x 29	70	105	7	<b>\$1416</b>
LBT6020CG	20 x 60 x 29	70	131	8	<b>\$1660</b>
LBT5420CG	20 x 54 x 29	85	118	8	<b>\$1494</b>
LBT4820CG	20 x 48 x 29	70	110	7	<b>\$1324</b>
LBT4220CG	20 x 42 x 29	70	96	6	<b>\$1137</b>

**Flush Bridge**

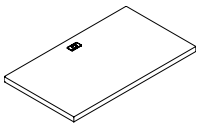

**Flush Bridge Top**

Top surface, back panel and hardware to create a "U" configuration with a single pedestal desk or credenza. **Cannot be used with corners.** Grommet in worksurface. Ships assembled in 1 carton.

- If linking to bookcase or open storage, add **/S** to end of model number

LBT5424TCG	24 x 54 x --	85	129	9	<b>\$1422</b>
LBT4824TCG	24 x 48 x --	70	120	8	<b>\$1280</b>
LBT4224TCG	24 x 42 x --	70	105	7	<b>\$1125</b>
LBT5420TCG	20 x 54 x --	85	118	8	<b>\$1046</b>
LBT4820TCG	20 x 48 x --	70	110	7	<b>\$932</b>
LBT4220TCG	20 x 42 x --	70	96	6	<b>\$794</b>

Top surface only to create a "U" configuration with a single pedestal desk or credenza. **Cannot be used with corners.** Grommet in worksurface. Ships assembled in 1 carton.

- If linking to bookcase or open storage, add **/S** to end of model number

**Required Specifications**

Veneer Finish  
Edge

**Optional Specifications**

Grommet

**BRIDGES**      **MODEL#**      **DIMENSIONS**      **FREIGHT CLASS**      **WT/LBS.**      **CUBIC FT.**      **LIST PRICE**

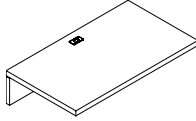

**Flush Bridge Top, 8" Modesty Panel**

	<b>D x W x H</b>					
LBT6024Q8CG	24 x 60 x --	85	144	10		<b>\$1812</b>
LBT5424Q8CG	24 x 54 x --	85	129	9		<b>\$1641</b>
LBT4824Q8CG	24 x 48 x --	70	120	8		<b>\$1458</b>
LBT4224Q8CG	24 x 42 x --	70	105	7		<b>\$1274</b>
LBT6020Q8CG	20 x 60 x --	70	131	8		<b>\$1494</b>
LBT5420Q8CG	20 x 54 x --	85	118	8		<b>\$1342</b>
LBT4820Q8CG	20 x 48 x --	70	110	7		<b>\$1194</b>
LBT4220Q8CG	20 x 42 x --	70	96	6		<b>\$1022</b>

Top surface with 8" modesty panel for utility access. Create a "U" configuration with a single pedestal desk or credenza. **Cannot be used with corners.** Grommet in worksurface. Ships assembled in 1 carton.

- If linking to bookcase or open storage, add **/S** to end of model number

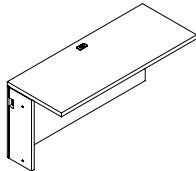

**Linking Bridge - LEFT**

LBT6024NLLCG	24 x 60 x 29	125	145	24	2002	
LBT5424NLLCG	24 x 54 x 29	150	131	22		<b>\$1799</b>
LBT4824NLLCG	24 x 48 x 29	125	116	19		<b>\$1600</b>
LBT4224NLLCG	24 x 42 x 29	125	102	17		<b>\$1298</b>
LBT3624NLLCG	24 x 36 x 29	150	87	15		<b>\$1181</b>
LBT3024NLLCG	24 x 30 x 29	125	73	12		<b>\$1148</b>
LBT6020NLLCG	22 x 60 x 29	150	131	22		<b>\$1816</b>
LBT5420NLLCG	22 x 54 x 29	150	118	20		<b>\$1634</b>
LBT4820NLLCG	22 x 48 x 29	125	110	18	1458	
LBT4220NLLCG	22 x 42 x 29	150	95	16	1181	
LBT3620NLLCG	22 x 36 x 29	125	80	13	1073	
LBT3020NLLCG	22 x 30 x 29	150	65	11	1046	

Top surface, back panel and hardware. **Left side** connects to a 5-Sided Corner, Extended Corner or Connectable Table. Right side connects to a single pedestal desk or credenza, "D" island, Boat shaped island, "P" island and Delta island with a "T" base. Grommet in worksurface. Ships assembled in 1 carton.

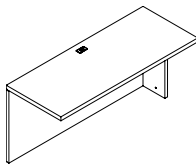

**Linking Bridge - RIGHT**

LBT6024NLRCG	24 x 60 x 29	125	145	24		<b>\$2002</b>
LBT5424NLRCG	24 x 54 x 29	150	131	22		<b>\$1799</b>
LBT4824NLRCG	24 x 48 x 29	125	116	19		<b>\$1600</b>
LBT4224NLRCG	24 x 42 x 29	125	102	17		<b>\$1298</b>
LBT3624NLRCG	24 x 36 x 29	150	87	15		<b>\$1181</b>
LBT3024NLRCG	24 x 30 x 29	125	73	12		<b>\$1148</b>
LBT6020NLRCG	22 x 60 x 29	150	131	22		<b>\$1816</b>
LBT5420NLRCG	22 x 54 x 29	150	118	20		<b>\$1634</b>
LBT4820NLRCG	22 x 48 x 29	125	110	18		<b>\$1458</b>
LBT4220NLRCG	22 x 42 x 29	150	95	16		<b>\$1181</b>
LBT3620NLRCG	22 x 36 x 29	125	80	13		<b>\$1073</b>
LBT3020NLRCG	22 x 30 x 29	150	65	11		<b>\$1046</b>

Top surface, back panel and hardware. **Right side** connects to a 5-Sided Corner, Extended Corner or Connectable Table. Right side connects to a single pedestal desk or credenza, "D" island, Boat shaped island, "P" island and Delta island with a "T" base. Grommet in worksurface. Ships assembled in 1 carton.

**Required Specifications**

Veneer Finish  
Edge

**Optional Specifications**

Grommet

## BRIDGES

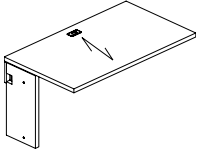

**Linking Bridge, 8" Modesty Panel - LEFT**

MODEL#	DIMENSIONS D x W x H	FREIGHT CLASS	WT/LBS.	CUBIC FT.	LIST PRICE
LBT6024NLLQ8CG	24 x 60 x 29	125	145	24	<b>\$2207</b>
LBT5424NLLQ8CG	24 x 54 x 29	150	131	22	<b>\$1985</b>
LBT4824NLLQ8CG	24 x 48 x 29	125	116	19	<b>\$1744</b>
LBT4224NLLQ8CG	24 x 42 x 29	125	102	17	<b>\$1547</b>
LBT3624NLLQ8CG	24 x 36 x 29	150	87	15	<b>\$1280</b>
LBT3024NLLQ8CG	24 x 30 x 29	125	73	12	<b>\$1252</b>
LBT6020NLLQ8CG	20 x 60 x 29	150	131	22	<b>\$1634</b>
LBT5420NLLQ8CG	20 x 54 x 29	150	118	20	<b>\$1476</b>
LBT4820NLLQ8CG	20 x 48 x 29	125	110	18	<b>\$1316</b>
LBT4220NLLQ8CG	20 x 42 x 29	150	95	16	<b>\$1063</b>
LBT3620NLLQ8CG	20 x 36 x 29	125	80	13	<b>\$965</b>
LBT3020NLLQ8CG	20 x 30 x 29	150	65	11	<b>\$952</b>

Top surface with 8" modesty panel for utility access and hardware. **Left side** connects to a 5-Sided Corner, Extended Corner or Connectable Table. Right side connects to a single pedestal desk or credenza, "D" island, Boat shaped island, "P" island and Delta island with a "T" base. Grommet in worksurface. Ships assembled in 1 carton.

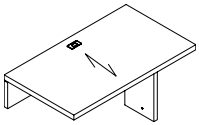

**Linking Bridge, 8" Modesty Panel - RIGHT**

LBT6024NLRQ8CG	24 x 60 x 29	125	145	24	<b>\$2207</b>
LBT5424NLRQ8CG	24 x 54 x 29	150	131	22	<b>\$1985</b>
LBT4824NLRQ8CG	24 x 48 x 29	125	116	19	<b>\$1744</b>
LBT4224NLRQ8CG	24 x 42 x 29	125	102	17	<b>\$1547</b>
LBT3624NLRQ8CG	24 x 36 x 29	150	87	15	<b>\$1280</b>
LBT3024NLRQ8CG	24 x 30 x 29	125	73	12	<b>\$1252</b>
LBT6020NLRQ8CG	20 x 60 x 29	150	131	22	<b>\$1634</b>
LBT5420NLRQ8CG	20 x 54 x 29	150	118	20	<b>\$1476</b>
LBT4820NLRQ8CG	20 x 48 x 29	125	110	18	<b>\$1316</b>
LBT4220NLRQ8CG	20 x 42 x 29	150	95	16	<b>\$1063</b>
LBT3620NLRQ8CG	20 x 36 x 29	125	80	13	<b>\$965</b>
LBT3020NLRQ8CG	20 x 30 x 29	150	65	11	<b>\$952</b>

Top surface with 8" modesty panel for utility access and hardware. **Right side** connects to a 5-Sided Corner, Extended Corner or Connectable Table. Right side connects to a single pedestal desk or credenza, "D" island, Boat shaped island, "P" island and Delta island with a "T" base. Grommet in worksurface. Ships assembled in 1 carton.

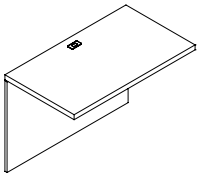

**Bridge - Hinged Modesty**

LHBT6024CG	24 x 60 x 29	85	144	10	<b>\$2018</b>
LHBT5424CG	24 x 54 x 29	85	129	9	<b>\$1816</b>
LHBT4824CG	24 x 48 x 29	70	120	8	<b>\$1619</b>
LHBT4224CG	24 x 42 x 29	70	105	7	<b>\$1416</b>
LHBT6020CG	20 x 60 x 29	70	131	8	<b>\$1660</b>
LHBT5420CG	20 x 54 x 29	85	118	8	<b>\$1494</b>
LHBT4820CG	20 x 48 x 29	70	110	7	<b>\$1324</b>
LHBT4220CG	20 x 42 x 29	70	96	6	<b>\$1137</b>

Executive Bridge Top and **Hinged Back Panel** to create a "U" configuration with a single pedestal desk or credenza. **Cannot be used with corners.** Grommet in worksurface. Ships assembled in 1 carton.

### Required Specifications

Veneer Finish  
Edge

### Optional Specifications

Grommet

**CREDENZAS**      **MODEL#**      **DIMENSIONS**      **FREIGHT CLASS**      **WT/LBS.**      **CUBIC FT.**      **LIST PRICE**

**D x W x H**

LC10824	24 x 108 x 29	125	348	44	<b>\$4521</b>
LC10224	24 x 102 x 29	100	329	41	<b>\$4311</b>
LC9624	24 x 96 x 29	125	309	39	<b>\$4082</b>
LC9024	24 x 90 x 29	100	290	36	<b>\$3870</b>
LC8424	24 x 84 x 29	125	271	34	<b>\$3652</b>
LC7824	24 x 78 x 29	100	251	31	<b>\$3424</b>
LC7224	24 x 72 x 29	100	232	29	<b>\$3213</b>
LC6624	24 x 66 x 29	125	213	27	<b>\$3109</b>
LC6024	24 x 60 x 29	100	193	24	<b>\$2880</b>

LC10820	20 x 108 x 29	100	309	36	<b>\$3607</b>
LC10220	20 x 102 x 29	100	291	34	<b>\$3420</b>
LC9620	20 x 96 x 29	100	273	32	<b>\$3222</b>
LC9020	20 x 90 x 29	100	255	30	<b>\$3029</b>
LC8420	20 x 84 x 29	100	237	28	<b>\$2841</b>
LC7820	20 x 78 x 29	100	219	26	<b>\$2645</b>
LC7220	20 x 72 x 29	100	206	24	<b>\$2453</b>
LC6620	20 x 66 x 29	100	188	22	<b>\$2367</b>
LC6020	20 x 60 x 29	100	169	20	<b>\$2166</b>

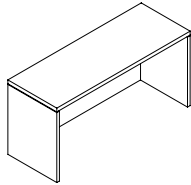

**Credenza Shell**

Standard with **no pedestals**. Flush full modesty panel. 96" w and larger includes a center support leg. If using storage component shells underneath to support the worksurface, **no more than 72" may be left unsupported**. Ships assembled in 1 carton.

LCK8424EE	24 x 84 x 29	92.5	348	34	<b>\$6838</b>
LCK7824EE	24 x 78 x 29	92.5	319	31	<b>\$6618</b>
LCK7224EE	24 x 72 x 29	100	280	29	<b>\$6156</b>
LCK6624EE	24 x 66 x 29	100	261	27	<b>\$5659</b>
LCK6024EE	24 x 60 x 29	100	238	24	<b>\$5599</b>

LCK8420EE	20 x 84 x 29	92.5	320	34	<b>\$6777</b>
LCK7820EE	20 x 78 x 29	92.5	298	31	<b>\$6961</b>
LCK7220EE	20 x 72 x 29	92.5	280	29	<b>\$5692</b>
LCK6620EE	20 x 66 x 29	92.5	257	27	<b>\$5599</b>
LCK6020EE	20 x 60 x 29	92.5	233	24	<b>\$5533</b>

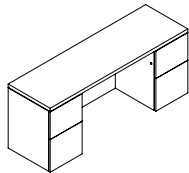

**Kneespace Credenza**

Standard with full to floor **file/file** pedestals on **left and right**. **Center is open**. Pedestals lock. Ships assembled in 1 carton.

LCK8424DD	24 x 84 x 29	92.5	348	34	<b>\$6838</b>
LCK7824DD	24 x 78 x 29	92.5	319	31	<b>\$6618</b>
LCK7224DD	24 x 72 x 29	100	280	29	<b>\$5759</b>
LCK6624DD	24 x 66 x 29	100	261	27	<b>\$5659</b>
LCK6024DD	24 x 60 x 29	100	238	24	<b>\$5599</b>

LCK8420DD	20 x 84 x 29	92.5	307	28	<b>\$7093</b>
LCK7820DD	20 x 78 x 29	92.5	285	26	<b>\$6961</b>
LCK7220DD	20 x 72 x 29	92.5	267	24	<b>\$5692</b>
LCK6620DD	20 x 66 x 29	92.5	244	22	<b>\$5599</b>
LCK6020DD	20 x 60 x 29	92.5	220	20	<b>\$5533</b>

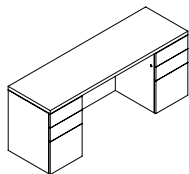

**Kneespace Credenza**

Standard with full to floor **box/box/file** pedestals on **left and right**. **Center is open**. Pedestals lock. Ships assembled in 1 carton.

**Required Specifications**

Veneer Finish  
Edge

**Optional Specifications**

Grommet

## CREDENZAS

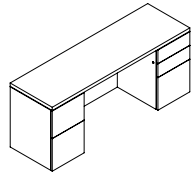

**Kneespace Credenza**

MODEL#	DIMENSIONS	FREIGHT CLASS	WT/LBS.	CUBIC FT.	LIST PRICE
--------	------------	---------------	---------	-----------	------------

D x W x H

LCK8424ED	24 x 84 x 29	92.5	348	34	<b>\$6838</b>
LCK7824ED	24 x 78 x 29	92.5	319	31	<b>\$6618</b>
LCK7224ED	24 x 72 x 29	100	280	29	<b>\$6156</b>
LCK6624ED	24 x 66 x 29	100	261	27	<b>\$5659</b>
LCK6024ED	24 x 60 x 29	100	238	24	<b>\$5599</b>
LCK8420ED	20 x 84 x 29	92.5	307	28	<b>\$6777</b>
LCK7820ED	20 x 78 x 29	92.5	285	26	<b>\$6961</b>
LCK7220ED	20 x 72 x 29	92.5	267	24	<b>\$5692</b>
LCK6620ED	20 x 66 x 29	92.5	244	22	<b>\$5599</b>
LCK6020ED	20 x 60 x 29	92.5	220	20	<b>\$5533</b>

Standard with full to floor **file/file** pedestal on **left** and **box/box/file** pedestal on **right**. **Center is open** Pedestals lock. One pencil tray. Ships assembled in 1 carton.

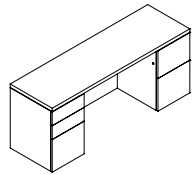

**Kneespace Credenza**

LCK8424DE	24 x 84 x 29	92.5	348	34	<b>\$6838</b>
LCK7824DE	24 x 78 x 29	92.5	319	31	<b>\$6618</b>
LCK7224DE	24 x 72 x 29	100	280	29	<b>\$5759</b>
LCK6624DE	24 x 66 x 29	100	261	27	<b>\$5659</b>
LCK6024DE	24 x 60 x 29	100	238	24	<b>\$5599</b>
LCK8420DE	20 x 84 x 29	92.5	307	28	<b>\$6777</b>
LCK7820DE	20 x 78 x 29	92.5	285	26	<b>\$6961</b>
LCK7220DE	20 x 72 x 29	92.5	267	24	<b>\$5692</b>
LCK6620DE	20 x 66 x 29	92.5	244	22	<b>\$5599</b>
LCK6020DE	20 x 60 x 29	92.5	220	20	<b>\$5533</b>

Standard with full to floor **box/box/file** pedestal on **left** and **file/file** pedestal on **right**. **Center is open** Pedestals lock. One pencil tray. Ships assembled in 1 carton.

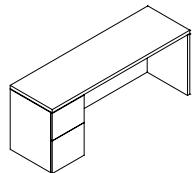

**Single Pedestal Credenza - LEFT**

LCL8424E	24 x 84 x 29	100	315	34	<b>\$5492</b>
LCL7824E	24 x 78 x 29	100	292	31	<b>\$5137</b>
LCL7224E	24 x 72 x 29	100	270	29	<b>\$4789</b>
LCL6624E	24 x 66 x 29	100	247	27	<b>\$4634</b>
LCL6024E	24 x 60 x 29	100	225	24	<b>\$4270</b>
LCL8420E	20 x 84 x 29	100	273	28	<b>\$4888</b>
LCL7820E	20 x 78 x 29	100	252	26	<b>\$5232</b>
LCL7220E	20 x 72 x 29	100	237	24	<b>\$4246</b>
LCL6620E	20 x 66 x 29	100	216	22	<b>\$4092</b>
LCL6020E	20 x 60 x 29	100	195	20	<b>\$3778</b>

Standard with full to floor **file/file** pedestal on **left**. Pedestal locks. Ships assembled in 1 carton.

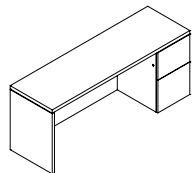

**Single Pedestal Credenza - RIGHT**

LCR8424E	24 x 84 x 29	100	315	34	<b>\$5492</b>
LCR7824E	24 x 78 x 29	100	292	31	<b>\$5137</b>
LCR7224E	24 x 72 x 29	100	270	29	<b>\$4789</b>
LCR6624E	24 x 66 x 29	100	247	27	<b>\$4634</b>
LCR6024E	24 x 60 x 29	100	225	24	<b>\$4270</b>
LCR8420E	20 x 84 x 29	100	273	28	<b>\$4888</b>
LCR7820E	20 x 78 x 29	100	252	26	<b>\$5232</b>
LCR7220E	20 x 72 x 29	100	237	24	<b>\$4246</b>
LCR6620E	20 x 66 x 29	100	216	22	<b>\$4092</b>
LCR6020E	20 x 60 x 29	100	195	20	<b>\$3778</b>

Standard with full to floor **file/file** pedestal on **right**. Pedestal locks. Ships assembled in 1 carton.

### Required Specifications

Veneer Finish  
Edge

### Optional Specifications

Grommet

**CRENZAS MODEL# DIMENSIONS FREIGHT CLASS WT/LBS. CUBIC FT. LIST PRICE**

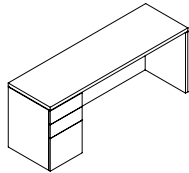

**Single Pedestal Credenza - LEFT**

	D x W x H					
LCL8424D	24 x 84 x 29	100	315	34		<b>\$5492</b>
LCL7824D	24 x 78 x 29	100	292	31		<b>\$5137</b>
LCL7224D	24 x 72 x 29	100	270	29		<b>\$4789</b>
LCL6624D	24 x 66 x 29	100	247	27		<b>\$4634</b>
LCL6024D	24 x 60 x 29	100	225	24		<b>\$4270</b>
LCL8420D	20 x 84 x 29	100	273	28		<b>\$4888</b>
LCL7820D	20 x 78 x 29	100	252	26		<b>\$5232</b>
LCL7220D	20 x 72 x 29	100	237	24		<b>\$4246</b>
LCL6620D	20 x 66 x 29	100	216	22		<b>\$4092</b>
LCL6020D	20 x 60 x 29	100	195	20		<b>\$3778</b>

Standard with full to floor **box/box/file** pedestal on **left**. Pedestal locks. Ships assembled in 1 carton.

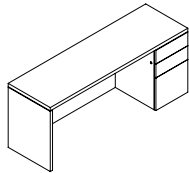

**Single Pedestal Credenza - RIGHT**

LCR8424D	24 x 84 x 29	100	315	34		<b>\$5492</b>
LCR7824D	24 x 78 x 29	100	292	31		<b>\$5137</b>
LCR7224D	24 x 72 x 29	100	270	29		<b>\$4789</b>
LCR6624D	24 x 66 x 29	100	247	27		<b>\$4634</b>
LCR6024D	24 x 60 x 29	100	225	24		<b>\$4270</b>
LCR8420D	20 x 84 x 29	100	273	28		<b>\$4888</b>
LCR7820D	20 x 78 x 29	100	252	26		<b>\$5232</b>
LCR7220D	20 x 72 x 29	100	237	24		<b>\$4246</b>
LCR6620D	20 x 66 x 29	100	216	22		<b>\$4092</b>
LCR6020D	20 x 60 x 29	100	195	20		<b>\$3778</b>

Standard with full to floor **box/box/file** pedestal on **right**. Pedestal locks. Ships assembled in 1 carton.

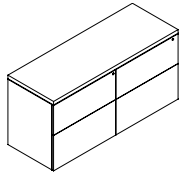

**Lateral File Credenza**

LC7224FF	24 x 72 x 29	92.5	328	29		<b>\$7360</b>
LC7220FF	20 x 72 x 29	92.5	287	24		<b>\$6494</b>
LC6024NN	24 x 60 x 29	92.5	273	24		<b>\$6795</b>
LC6020NN	20 x 60 x 29	92.5	205	20		<b>\$5757</b>

Two 2-drawer lateral files side-by-side. Locking drawers. Anti-lock tilt suspension. **Not for stacking materials on lateral file drawer bottom.** Ships assembled in 1 carton.

- "FF" models use two 36" wide lateral files, "NN" models use 30" wide.

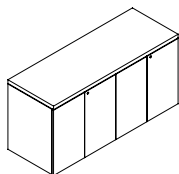

**Storage Cabinet Credenza**

LC7224GG	24 x 72 x 29	92.5	300	29		<b>\$5629</b>
LC7220GG	20 x 72 x 29	92.5	253	24		<b>\$4977</b>
LC6024MM	24 x 60 x 29	92.5	254	24		<b>\$5195</b>
LC6020MM	20 x 60 x 29	92.5	209	20		<b>\$4435</b>

Two 2-door storage cabinets side-by-side. Locking doors. Self-closing hinged doors cover one adjustable shelf. Ships assembled in 1 carton.

- "GG" models use two 36" wide storage cabinets, "MM" models use 30" wide.

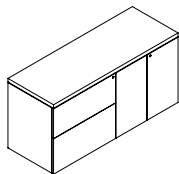

**Lateral File/Storage Cabinet Credenza**

LCF7224	24 x 72 x 29	92.5	305	29		<b>\$5887</b>
LCF7220	20 x 72 x 29	92.5	272	24		<b>\$5212</b>
LCF6024	24 x 60 x 29	92.5	254	24		<b>\$5001</b>
LCF6020	20 x 60 x 29	92.5	220	20		<b>\$4435</b>

One 2-drawer lateral file and one storage cabinet. Locking door/drawers. Storage cabinet includes one adjustable shelf. Anti-lock tilt suspension. **Not for stacking materials on lateral file drawer bottom.** Ships assembled in 1 carton.

**Required Specifications**

Veneer Finish  
Edge

**Optional Specifications**

Grommet

## CREDENZAS

MODEL#	DIMENSIONS	FREIGHT CLASS	WT/LBS.	CUBIC FT.	LIST PRICE
--------	------------	---------------	---------	-----------	------------

D x W x H

LCL8424F	24 x 84 x 29	100	305	34	<b>\$5737</b>
LCL7824F	24 x 78 x 29	100	285	31	<b>\$5319</b>
LCL7224F	24 x 72 x 29	100	261	29	<b>\$4921</b>
LCL6624F	24 x 66 x 29	100	239	27	<b>\$4738</b>
LCL6024F	24 x 60 x 29	100	218	24	<b>\$4297</b>
LCL8420F	20 x 84 x 29	100	273	28	<b>\$5012</b>
LCL7820F	20 x 78 x 29	100	252	26	<b>\$4648</b>
LCL7220F	20 x 72 x 29	100	237	24	<b>\$4294</b>
LCL6620F	20 x 66 x 29	100	216	22	<b>\$4136</b>
LCL6020F	20 x 60 x 29	100	195	20	<b>\$3756</b>

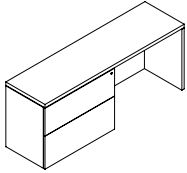

**Kneespace Lateral File Credenza - LEFT**

One 2-drawer lateral file on the **left**. Locking drawers. Anti-lock tilt suspension. **Not for stacking materials on lateral file drawer bottom.** Ships assembled in 1 carton.

LCR8424F	24 x 84 x 29	100	305	34	<b>\$5737</b>
LCR7824F	24 x 78 x 29	100	285	31	<b>\$5319</b>
LCR7224F	24 x 72 x 29	100	261	29	<b>\$4921</b>
LCR6624F	24 x 66 x 29	100	239	27	<b>\$4738</b>
LCR6024F	24 x 60 x 29	100	218	24	<b>\$4297</b>
LCR8420F	20 x 84 x 29	100	273	28	<b>\$5012</b>
LCR7820F	20 x 78 x 29	100	252	26	<b>\$4648</b>
LCR7220F	20 x 72 x 29	100	237	24	<b>\$4294</b>
LCR6620F	20 x 66 x 29	100	216	22	<b>\$4136</b>
LCR6020F	20 x 60 x 29	100	195	20	<b>\$3756</b>

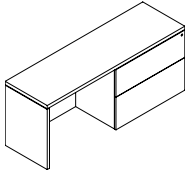

**Kneespace Lateral File Credenza - RIGHT**

One 2-drawer lateral file on the **right**. Locking drawers. Anti-lock tilt suspension. **Not for stacking materials on lateral file drawer bottom.** Ships assembled in 1 carton.

LCL8424Z	24 x 84 x 29	100	338	34	<b>\$6836</b>
LCL7824Z	24 x 78 x 29	100	314	31	<b>\$6384</b>
LCL7224Z	24 x 72 x 29	100	290	29	<b>\$5944</b>
LCL6624Z	24 x 66 x 29	100	266	27	<b>\$5737</b>
LCL6024Z	24 x 60 x 29	100	242	24	<b>\$4692</b>
LCL8420Z	20 x 84 x 29	100	273	28	<b>\$6052</b>
LCL7820Z	20 x 78 x 29	100	252	26	<b>\$5669</b>
LCL7220Z	20 x 72 x 29	100	237	24	<b>\$5274</b>
LCL6620Z	20 x 66 x 29	100	216	22	<b>\$5097</b>
LCL6020Z	20 x 60 x 29	100	195	20	<b>\$4692</b>

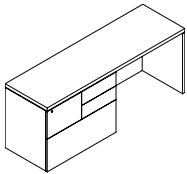

**Mixed Storage Credenza - LEFT**

Standard with two box drawers, one file drawer, and one 36"W lateral file drawer on the **left**. File drawer and lateral file drawer lock. **Not for stacking materials on lateral file drawer bottom.** Ships assembled in 1 carton.

LCR8424Z	24 x 84 x 29	100	338	34	<b>\$6836</b>
LCR7824Z	24 x 78 x 29	100	314	31	<b>\$6384</b>
LCR7224Z	24 x 72 x 29	100	290	29	<b>\$5944</b>
LCR6624Z	24 x 66 x 29	100	266	27	<b>\$5737</b>
LCR6024Z	24 x 60 x 29	100	242	24	<b>\$4692</b>
LCR8420Z	20 x 84 x 29	100	273	28	<b>\$6052</b>
LCR7820Z	20 x 78 x 29	100	252	26	<b>\$5669</b>
LCR7220Z	20 x 72 x 29	100	237	24	<b>\$5274</b>
LCR6620Z	20 x 66 x 29	100	216	22	<b>\$5097</b>
LCR6020Z	20 x 60 x 29	100	195	20	<b>\$4692</b>

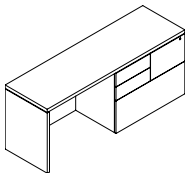

**Mixed Storage Credenza - RIGHT**

Standard with two box drawers, one file drawer, and one 36"W lateral file drawer on the **right**. File drawer and lateral file drawer lock. **Not for stacking materials on lateral file drawer bottom.** Ships assembled in 1 carton.

### Required Specifications

Veneer Finish  
Edge

### Optional Specifications

Grommet

**CREDENZAS**      **MODEL#**      **DIMENSIONS**      **FREIGHT CLASS**      **WT/LBS.**      **CUBIC FT.**      **LIST PRICE**

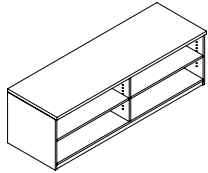

**Credenza**

	<b>D x W x H</b>					
LCO7224H23	24 x 72 x 23	92.5	305	29		<b>\$3812</b>
LCO7220H23	20 x 72 x 23	92.5	272	24		<b>\$3332</b>
LCO6024H23	24 x 60 x 23	92.5	254	24		<b>\$3180</b>
LCO6020H23	20 x 60 x 23	92.5	220	20		<b>\$2779</b>

Standard with open storage on **both sides**. Ships assembled in 1 carton.

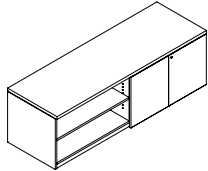

**Credenza**

LCOG7224H23	24 x 72 x 23	92.5	328	29		<b>\$3840</b>
LCOG7220H23	20 x 72 x 23	92.5	287	24		<b>\$3360</b>
LCOM6024H23	24 x 60 x 23	92.5	273	24		<b>\$3529</b>
LCOM6020H23	20 x 60 x 23	92.5	205	20		<b>\$2938</b>

Standard with open storage on the **left** and one storage cabinet on the **right**. Storage cabinet includes one adjustable shelf. Ships assembled in 1 carton.

- "G" model uses 36" wide storage cabinets, "M" model uses 30" wide.

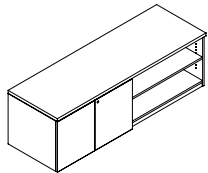

**Credenza**

LCG07224H23	24 x 72 x 23	92.5	328	29		<b>\$3840</b>
LCG07220H23	20 x 72 x 23	92.5	287	24		<b>\$3360</b>
LCM06024H23	24 x 60 x 23	92.5	273	24		<b>\$3529</b>
LCM06020H23	20 x 60 x 23	92.5	205	20		<b>\$2938</b>

Standard with open storage on the **right** and one storage cabinet on the **left**. Storage cabinet includes one adjustable shelf. Ships assembled in 1 carton.

- "G" model uses 36" wide storage cabinets, "M" model uses 30" wide.

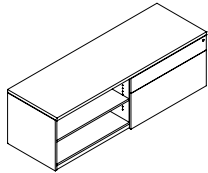

**Credenza**

LCOF7224H23	24 x 72 x 23	92.5	300	29		<b>\$4677</b>
LCOF7220H23	20 x 72 x 23	92.5	253	24		<b>\$4082</b>
LCN06024H23	24 x 60 x 23	92.5	254	24		<b>\$4086</b>
LCN06020H23	20 x 60 x 23	92.5	209	20		<b>\$3565</b>

Standard with one **box/file** drawer on **right** and open storage on the **left**. File drawer and lateral file drawer lock. Front-to-back and side-to-side filing. **Not for stacking materials on lateral file drawer bottom**. Ships assembled in 1 carton.

- "F" models use 36" wide lateral files, "N" models use 30" wide.

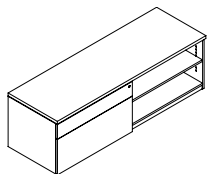

**Credenza**

LCF07224H23	24 x 72 x 23	92.5	300	29		<b>\$4677</b>
LCF07220H23	20 x 72 x 23	92.5	253	24		<b>\$4082</b>
LCN06024H23	24 x 60 x 23	92.5	254	24		<b>\$4086</b>
LCN06020H23	20 x 60 x 23	92.5	209	20		<b>\$3565</b>

Standard with one **box/file** drawer on **left** and open storage on the **right**. File drawer and lateral file drawer lock. Front-to-back and side-to-side filing. **Not for stacking materials on lateral file drawer bottom**. Ships assembled in 1 carton.

- "F" models use 36" wide lateral files, "N" models use 30" wide.

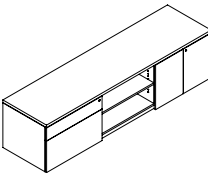

**Credenza**

LCNOM9024H23	24 x 90 x 23	92.5	300	29		<b>\$8166</b>
LCNOM9020H23	20 x 90 x 23	92.5	300	29		<b>\$7754</b>

Standard with one **box/file** drawer on **left**, open storage in the **center**, and one storage cabinet on the **right**. Storage cabinet includes one adjustable shelf. File drawer and lateral file drawer lock. Front-to-back and side-to-side filing. **Not for stacking materials on lateral file drawer bottom**. Ships assembled in 1 carton.

**Required Specifications**

Veneer Finish  
Edge

**Optional Specifications**

Grommet

## CREDENZAS

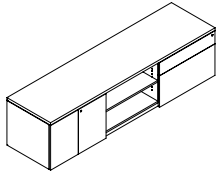

Credenza

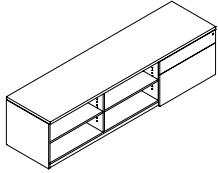

Credenza

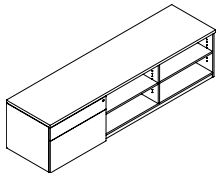

Credenza

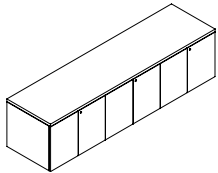

Credenza

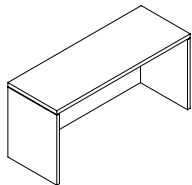

Credenza Shell

MODEL#	DIMENSIONS	FREIGHT CLASS	WT/LBS.	CUBIC FT.	LIST PRICE
LCMON9024H23	24 x 90 x 23	92.5	300	29	<b>\$8166</b>
LCMON9020H23	20 x 90 x 23	92.5	300	29	<b>\$7754</b>

Standard with one **box/file** drawer on **right**, open storage in the **center**, and one storage cabinet on the **left**. Storage cabinet includes one adjustable shelf. File drawer and lateral file drawer lock. Front-to-back and side-to-side filing. **Not for stacking materials on lateral file drawer bottom.** Ships assembled in 1 carton.

LCOON9024H23	24 x 90 x 23	92.5	300	29	<b>\$7864</b>
LCOON9020H23	20 x 90 x 23	92.5	300	29	<b>\$7448</b>

Standard with one **box/file** drawer on **right** and open storage in the **center** and **left**. File drawer and lateral file drawer lock. Front-to-back and side-to-side filing. **Not for stacking materials on lateral file drawer bottom.** Ships assembled in 1 carton.

LCN009024H23	24 x 90 x 23	92.5	300	29	<b>\$7864</b>
LCN009020H23	20 x 90 x 23	92.5	300	29	<b>\$7448</b>

Standard with one **box/file** drawer on **left** and open storage in the **center** and **right**. File drawer and lateral file drawer lock. Front-to-back and side-to-side filing. **Not for stacking materials on lateral file drawer bottom.** Ships assembled in 1 carton.

LCMMM9024H23	24 x 90 x 23	92.5	300	29	<b>\$7562</b>
LCMMM9020H23	20 x 90 x 23	92.5	300	29	<b>\$6301</b>

Standard with **three** storage cabinets. Storage cabinets include one adjustable shelf per cabinet. Ships assembled in 1 carton.

LC10824H23	24 x 108 x 23	125	348	44	<b>\$4320</b>
LC10224H23	24 x 102 x 23	100	329	41	<b>\$4108</b>
LC9624H23	24 x 96 x 23	125	309	39	<b>\$3881</b>
LC9024H23	24 x 90 x 23	100	290	36	<b>\$3669</b>
LC8424H23	24 x 84 x 23	125	271	34	<b>\$3451</b>
LC7824H23	24 x 78 x 23	100	251	31	<b>\$3222</b>
LC7224H23	24 x 72 x 23	100	232	29	<b>\$3010</b>
LC6624H23	24 x 66 x 23	125	213	27	<b>\$2908</b>
LC6024H23	24 x 60 x 23	100	193	24	<b>\$2679</b>
LC10820H23	20 x 108 x 23	100	309	36	<b>\$3405</b>
LC10220H23	20 x 102 x 23	100	291	34	<b>\$3217</b>
LC9620H23	20 x 96 x 23	100	273	32	<b>\$3026</b>
LC9020H23	20 x 90 x 23	100	255	30	<b>\$2829</b>
LC8420H23	20 x 84 x 23	100	237	28	<b>\$2642</b>
LC7820H23	20 x 78 x 23	100	219	26	<b>\$2447</b>
LC7220H23	20 x 72 x 23	100	206	24	<b>\$2250</b>
LC6620H23	20 x 66 x 23	100	188	22	<b>\$2166</b>
LC6020H23	20 x 60 x 23	100	169	20	<b>\$1964</b>

Standard with **no pedestals**. Flush full modesty panel. 96" w and larger includes a center support leg. If using storage component shells underneath to support the worksurface, **no more than 72" may be left unsupported.** Ships assembled in 1 carton.

### Required Specifications

Veneer Finish  
Edge

### Optional Specifications

Grommet

CORNERS	MODEL#	DIMENSIONS D x W x H	FREIGHT CLASS	WT./LBS.	CUBIC FT.	LIST PRICE
---------	--------	-------------------------	---------------	----------	-----------	------------

- A Corner Desk is used to connect to a Linking Bridge and Linking Credenza, or Connectable Table
- Cable management tray is included.
- Full Modesty Panel option.
- 5-Sided Corners include a GM1 grommet in the top center position. Grommets are available as an option on Extended Corners.
- Hand of Linking Credenza is determined by location of full end panel from user side.
- Hand of Extended Corner is determined by location of long narrow end from user side.
- Connecting sides feature a self edge.

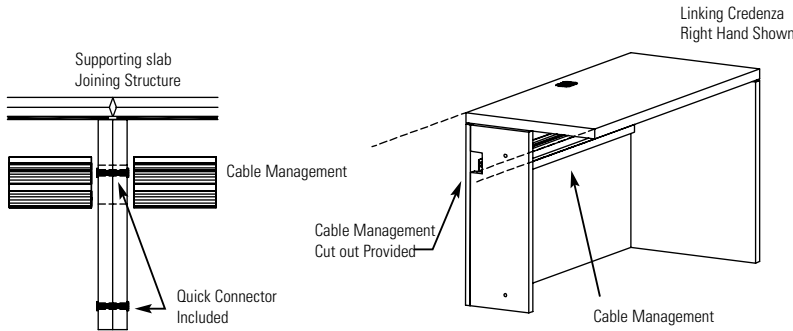

Code dimensions are actual

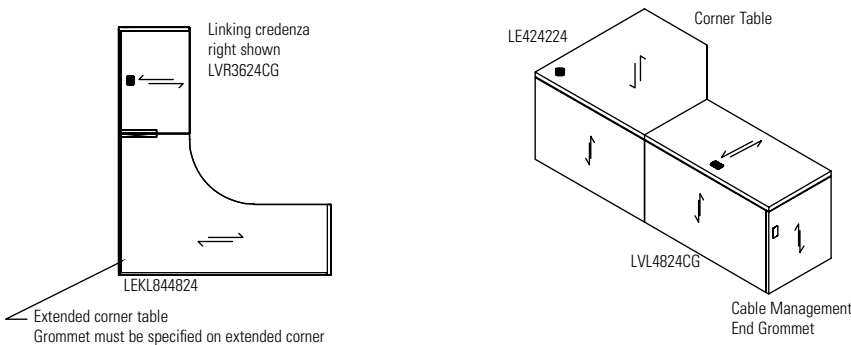

5-SIDED CORNERS	MODEL#	DIMENSIONS D x W x H	FREIGHT CLASS	WT./LBS.	CUBIC FT.	LIST PRICE
-----------------	--------	-------------------------	---------------	----------	-----------	------------

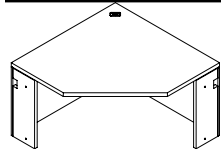

5-Sided Corner

LE484824	48 x 48 x 29	150	201	39	<b>\$3412</b>
LE424224	42 x 42 x 29	150	155	30	<b>\$2718</b>
LE363624	36 x 36 x 29	125	135	22	<b>\$2600</b>

Connects to **24" D** connectables, returns, extended corners, storage/lateral file credenzas, credenzas and bridges. Includes grommet and installed horizontal wire management. Narrow end panels on left and right. Ships assembled in 1 carton.

- *Not freestanding*

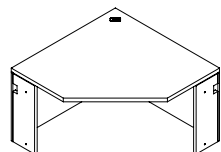

5-Sided Corner

LE484820	48 x 48 x 29	150	196	39	<b>\$3412</b>
LE424220	42 x 42 x 29	150	150	30	<b>\$2718</b>
LE363620	36 x 36 x 29	150	130	22	<b>\$2600</b>

Connects to **20" D** connectables, returns, extended corners, storage/lateral file credenzas, credenzas and bridges. Includes grommet and installed horizontal wire management. Narrow end panels on left and right. Ships assembled in 1 carton.

- *Not freestanding*

**Required Specifications**

Veneer Finish  
Edge

**Optional Specifications**

Grommet

## LEFT EXTENDED CORNERS

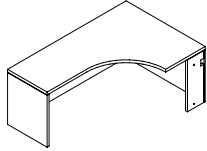

Left Extended Corner

MODEL#	DIMENSIONS	FREIGHT CLASS	WT/LBS.	CUBIC FT.	LIST PRICE
<b>D x W x H</b>					
LEKL844824	24-48 x 84 x 29	150	338	68	<b>\$5035</b>
LEKL784824	24-48 x 78 x 29	150	314	63	<b>\$4967</b>
LEKL724824	24-48 x 72 x 29	150	290	58	<b>\$4684</b>
LEKL664824	24-48 x 66 x 29	150	266	52	<b>\$4450</b>
LEKL604824	24-48 x 60 x 29	150	242	48	<b>\$4158</b>
LEKL844820	20-48 x 84 x 29	150	338	68	<b>\$4954</b>
LEKL784820	20-48 x 78 x 29	150	314	63	<b>\$4851</b>
LEKL724820	20-48 x 72 x 29	150	290	58	<b>\$4573</b>
LEKL664820	20-48 x 66 x 29	150	266	52	<b>\$4338</b>
LEKL604820	20-48 x 60 x 29	150	242	48	<b>\$4047</b>

Extended worksurface on **left**. **Full end panel on left, narrow end panel on right**. Connects to Linking Bridges, Extended Corners and Connectable Tables. Ships assembled in 1 carton.

## RIGHT EXTENDED CORNERS

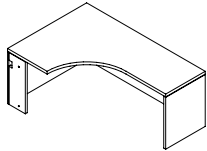

Right Extended Corner\*

MODEL#	DIMENSIONS	FREIGHT CLASS	WT/LBS.	CUBIC FT.	LIST PRICE
LEKR488424	24-48 x 84 x 29	150	338	68	<b>\$5035</b>
LEKR487824	24-48 x 78 x 29	150	314	63	<b>\$4967</b>
LEKR487224	24-48 x 72 x 29	150	290	58	<b>\$4684</b>
LEKR486624	24-48 x 66 x 29	150	266	52	<b>\$4450</b>
LEKR486024	24-48 x 60 x 29	150	242	48	<b>\$4158</b>
LEKR488420	20-48 x 84 x 29	150	338	68	<b>\$4954</b>
LEKR487820	20-48 x 78 x 29	150	314	63	<b>\$4851</b>
LEKR487220	20-48 x 72 x 29	150	290	58	<b>\$4573</b>
LEKR486620	20-48 x 66 x 29	150	266	52	<b>\$4338</b>
LEKR486020	20-48 x 60 x 29	150	242	48	<b>\$4047</b>

Extended worksurface on **right**. **Full end panel on right, narrow end panel on left**. Connects to Linking Bridges, Extended Corners and Connectable Tables. Ships assembled in 1 carton.

## CONNECTABLE TABLES - LEFT

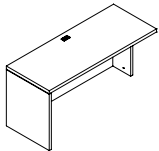

24" Deep Connectable Table - LEFT

MODEL#	DIMENSIONS	FREIGHT CLASS	WT/LBS.	CUBIC FT.	LIST PRICE
LVL9624CG	24 x 96 x 29	150	200	39	<b>\$3702</b>
LVL9024CG	24 x 90 x 29	150	187	36	<b>\$3491</b>
LVL8424CG	24 x 84 x 29	150	174	34	<b>\$3291</b>
LVL7824CG	24 x 78 x 29	150	162	31	<b>\$3080</b>
LVL7224CG	24 x 72 x 29	150	149	29	<b>\$2880</b>
LVL6624CG	24 x 66 x 29	150	141	27	<b>\$2733</b>
LVL6024CG	24 x 60 x 29	150	132	24	<b>\$2583</b>
LVL5424CG	24 x 54 x 29	150	121	22	<b>\$2456</b>
LVL4824CG	24 x 48 x 29	125	115	19	<b>\$2343</b>
LVL4224CG	24 x 42 x 29	150	99	17	<b>\$2041</b>
LVL3624CG	24 x 36 x 29	150	83	15	<b>\$1985</b>
LVL3024CG	24 x 30 x 29	125	77	12	<b>\$1955</b>
LVL2424CG	24 x 24 x 29	125	61	10	<b>\$1708</b>

**Full end panel on left**. Right narrow end panel connects to **24"D** center/right connectable table; **24"D** extended corners; **24"D** 5-sided corners; Grommet in worksurface. Ships assembled in 1 carton.

- To remove cross grain veneer pattern on top, **delete suffix "CG"** from the model number. Available as a special - no upcharge.

### Required Specifications

Veneer Finish  
Edge

### Optional Specifications

Grommet\*

**CONNECTABLE TABLES - LEFT**      **MODEL#**      **DIMENSIONS**      **FREIGHT CLASS**      **WT./LBS.**      **CUBIC FT.**      **LIST PRICE**

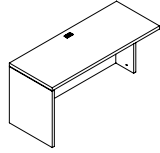

**20" Deep Connectable Table - LEFT**

	<b>D x W x H</b>					
LVL9620CG	20 x 96 x 29	150	187	39		<b>\$3010</b>
LVL9020CG	20 x 90 x 29	150	175	36		<b>\$2822</b>
LVL8420CG	20 x 84 x 29	150	163	34		<b>\$2635</b>
LVL7820CG	20 x 78 x 29	150	152	31		<b>\$2447</b>
LVL7220CG	20 x 72 x 29	150	140	29		<b>\$2258</b>
LVL6620CG	20 x 66 x 29	150	133	27		<b>\$2119</b>
LVL6020CG	20 x 60 x 29	150	125	24		<b>\$1985</b>
LVL5420CG	20 x 54 x 29	150	113	22		<b>\$1870</b>
LVL4820CG	20 x 48 x 29	150	110	19		<b>\$1753</b>
LVL4220CG	20 x 42 x 29	150	95	17		<b>\$1484</b>
LVL3620CG	20 x 36 x 29	150	80	15		<b>\$1429</b>
LVL3020CG	20 x 30 x 29	125	75	12		<b>\$1405</b>
LVL2420CG	20 x 24 x 29	125	60	10		<b>\$1176</b>

**Full end panel on left.** Right narrow end panel connects to **20"D** center/right connectable table; **20"D** 5-sided corners; Grommet in worksurface. Ships assembled in 1 carton.

- To remove cross grain veneer pattern on top, **delete suffix "CG"** from the model number. Available as a special - no upcharge.

**CONNECTABLE TABLES - RIGHT**      **MODEL#**      **DIMENSIONS**      **FREIGHT CLASS**      **WT./LBS.**      **CUBIC FT.**      **LIST PRICE**

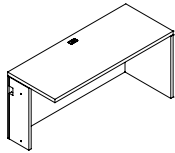

**24" Deep Connectable Table - RIGHT**

LVR9624CG	24 x 96 x 29	150	200	39		<b>\$3702</b>
LVR9024CG	24 x 90 x 29	150	187	36		<b>\$3491</b>
LVR8424CG	24 x 84 x 29	150	174	34		<b>\$3291</b>
LVR7824CG	24 x 78 x 29	150	162	31		<b>\$3080</b>
LVR7224CG	24 x 72 x 29	150	149	29		<b>\$2880</b>
LVR6624CG	24 x 66 x 29	150	141	27		<b>\$2733</b>
LVR6024CG	24 x 60 x 29	150	132	24		<b>\$2583</b>
LVR5424CG	24 x 54 x 29	150	121	22		<b>\$2456</b>
LVR4824CG	24 x 48 x 29	125	115	19		<b>\$2343</b>
LVR4224CG	24 x 42 x 29	150	99	17		<b>\$2041</b>
LVR3624CG	24 x 36 x 29	150	83	15		<b>\$1985</b>
LVR3024CG	24 x 30 x 29	125	77	12		<b>\$1955</b>
LVR2424CG	24 x 24 x 29	125	61	10		<b>\$1708</b>

**Full end panel on right.** Left narrow end panel connects to **24"D** center/left connectable table; **24"D** extended corners, **24"D** 5-sided corners; Grommet in worksurface. Ships assembled in 1 carton.

- To remove cross grain veneer pattern on top, **delete suffix "CG"** from the model number. Available as a special - no upcharge.

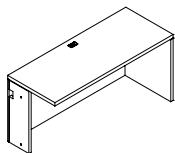

**20" Deep Connectable Table - RIGHT**

LVR9620CG	20 x 96 x 29	150	187	39		<b>\$3010</b>
LVR9020CG	20 x 90 x 29	150	175	36		<b>\$2822</b>
LVR8420CG	20 x 84 x 29	150	163	34		<b>\$2635</b>
LVR7820CG	20 x 78 x 29	150	152	31		<b>\$2447</b>
LVR7220CG	20 x 72 x 29	150	140	29		<b>\$2258</b>
LVR6620CG	20 x 66 x 29	150	133	27		<b>\$2119</b>
LVR6020CG	20 x 60 x 29	150	125	24		<b>\$1985</b>
LVR5420CG	20 x 54 x 29	150	113	22		<b>\$1870</b>
LVR4820CG	20 x 48 x 29	150	110	19		<b>\$1753</b>
LVR4220CG	20 x 42 x 29	150	95	17		<b>\$1484</b>
LVR3620CG	20 x 36 x 29	150	80	15		<b>\$1429</b>
LVR3020CG	20 x 30 x 29	125	75	12		<b>\$1405</b>
LVR2420CG	20 x 24 x 29	125	60	10		<b>\$1176</b>

**Full end panel on right.** Left narrow end panel connects to **20"D** center/left connectable table; **20"D** 5-sided corners; Grommet in worksurface. Ships assembled in 1 carton.

- To remove cross grain veneer pattern on top, **delete suffix "CG"** from the model number. Available as a special - no upcharge.

**Required Specifications**

Veneer Finish  
Edge  
Monopost Finish - D Islands

**Optional Specifications**

Modesty Upgrade  
Modesty Panel  
Monopost (Base) Upgrade - D Islands

## CONNECTABLE TABLES

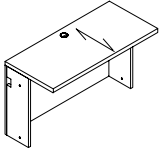

**24" Deep Connectable Table**

MODEL#	DIMENSIONS D x W x H	FREIGHT CLASS	WT/LBS.	CUBIC FT.	LIST PRICE
LV6024CG	24 x 60 x 29	150	132	24	<b>\$2510</b>
LV5424CG	24 x 54 x 29	150	121	22	<b>\$2367</b>
LV4824CG	24 x 48 x 29	125	115	19	<b>\$2223</b>
LV4224CG	24 x 42 x 29	150	99	17	<b>\$1861</b>
LV3624CG	24 x 36 x 29	150	83	15	<b>\$1921</b>
LV3024CG	24 x 30 x 29	125	77	12	<b>\$1760</b>
LV2424CG	24 x 24 x 29	125	61	10	<b>\$1476</b>

**Narrow end panels on left and right** connects to **24"D** connectable table; **24"D** extended corners, **24"D** 5-sided corners; Grommet in worksurface. Ships assembled in 1 carton.

- To remove cross grain veneer pattern on top, **delete suffix "CG"** from the model number. Available as a special - no upcharge.

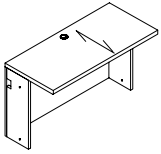

**22" Deep Connectable Table**

LV6020CG	20 x 60 x 29	150	125	24	<b>\$1931</b>
LV5420CG	20 x 54 x 29	150	113	22	<b>\$1816</b>
LV4820CG	20 x 48 x 29	150	110	19	<b>\$1703</b>
LV4220CG	20 x 42 x 29	150	95	17	<b>\$1422</b>
LV3620CG	20 x 36 x 29	150	80	15	<b>\$1378</b>
LV3020CG	20 x 30 x 29	125	75	12	<b>\$1351</b>
LV2420CG	20 x 24 x 29	125	60	10	<b>\$1137</b>

**Narrow end panels on left and right** connects to **22"D** connectable table; **22"D** extended corners, **22"D** 5-sided corners; Grommet in worksurface. Ships assembled in 1 carton.

- To remove cross grain veneer pattern on top, **delete suffix "CG"** from the model number. Available as a special - no upcharge.

## "D" ISLANDS

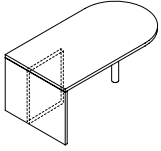

**"D" Island - Full End Panel (T-Base) & Monopost**

MODEL#	DIMENSIONS	FREIGHT CLASS	WT/LBS.	CUBIC FT.	LIST PRICE
LDD8430	30 x 84 x 29	125	343	51	<b>\$5596</b>
LDD7230	30 x 72 x 29	125	264	36	<b>\$4446</b>
LDD6630	30 x 66 x 29	125	245	40	<b>\$4446</b>
LDD6030	30 x 60 x 29	125	225	30	<b>\$4282</b>

Connects to Linking Bridges or Executive Returns. Attaching hardware included. **Not freestanding.** Shipped RTA - ready to assemble.

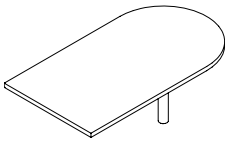

**"D" Island with Monopost**

LRD8430	30 x 84 x 29	125	135	51	<b>\$3994</b>
LRD7230	30 x 72 x 29	125	99	36	<b>\$3180</b>
LRD6630	30 x 66 x 29	125	99	40	<b>\$3180</b>
LRD6030	30 x 60 x 29	125	83	30	<b>\$3057</b>

Attaches to edge of worksurfaces with molding edge. Attaching hardware included. Shipped RTA - ready to assemble.

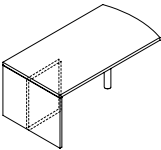

**"D" Island - Full End Panel (T-Base) & Monopost, Bow End**

LDDBE8430	30 x 84 x 29	125	343	51	<b>\$5596</b>
LDDBE7230	30 x 72 x 29	125	264	36	<b>\$4446</b>
LDDBE6630	30 x 66 x 29	125	245	40	<b>\$4446</b>
LDDBE6030	30 x 60 x 29	125	225	30	<b>\$4275</b>

Connects to Linking Bridges or Executive Returns. Attaching hardware included. **Not freestanding.** Shipped RTA - ready to assemble.

### Required Specifications

Veneer Finish  
Edge  
Monopost Finish

### Optional Specifications

Grommet  
Monopost (Base) Upgrade

**"D" ISLANDS**      **MODEL#**      **DIMENSIONS**      **FREIGHT CLASS**      **WT/LBS.**      **CUBIC FT.**      **LIST PRICE**

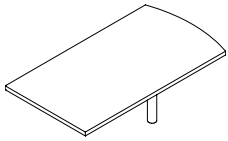

**"D" Island with Monopost, Bow End**

	<b>D x W x H</b>					
LRDBE8430	30 x 84 x 29	125	135	51	<b>\$3994</b>	
LRDBE7230	30 x 72 x 29	125	99	36	<b>\$3180</b>	
LRDBE6630	30 x 66 x 29	125	99	40	<b>\$3180</b>	
LRDBE6030	30 x 60 x 29	125	83	30	<b>\$3057</b>	

Attaches to edge of worksurfaces with molding edge. Attaching hardware included. Shipped RTA - ready to assemble.

**PIANO DESKS**

- Can be ordered as a shell or with pedestals.
- Components include a GM1 grommet in the top center position.
- Hand of Rectangular Desk is determined by location of pedestal from user side.
- Hand of "D" Top is determined by outward orientation of curved end from user projection.
- Hand of "P" Top is determined by outward orientation of conference end from user projection.
- Connectable Tables and Bridges - To remove cross grain veneer pattern on top, delete suffix "CG" from the model number. Available as a special - no upcharge.

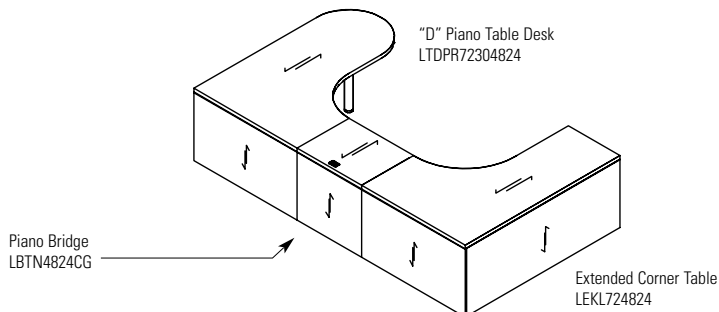
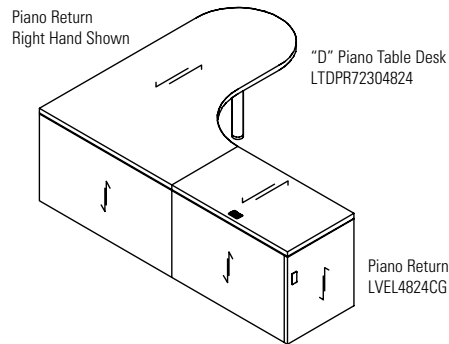
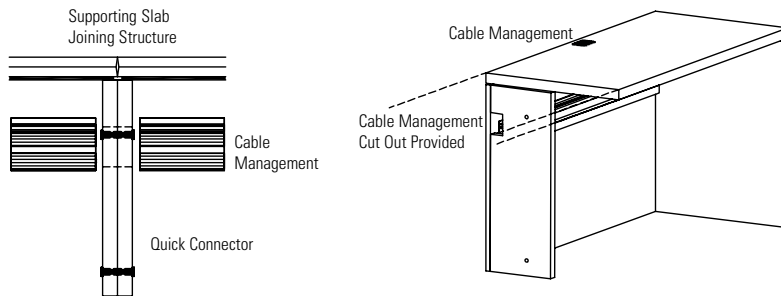

**Required Specifications**

- Veneer Finish
- Edge
- Monopost Finish

**Optional Specifications**

- Grommet
- Monopost (Base) Upgrade

## PIANO DESKS

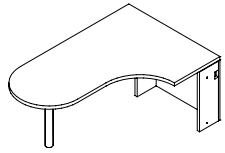

**"D" Island LEFT - Full End Panel & Monopost, Piano Desk**

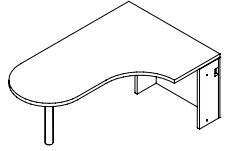

**"D" Island LEFT - Full End Panel & Monopost, Piano Desk**

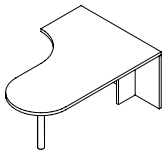

**"D" Island RIGHT - Full End Panel & Monopost, Piano Desk**

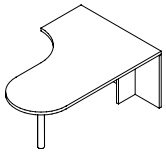

**"D" Island RIGHT - Full End Panel & Monopost, Piano Desk**

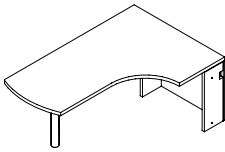

**"D" Island LEFT - Full End Panel & Monopost, Piano Desk - Bow End**

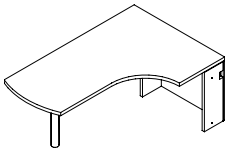

**"D" Island LEFT - Full End Panel & Monopost, Piano Desk - Bow End**

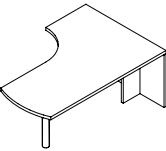

**"D" Island RIGHT - Full End Panel & Monopost, Piano Desk - Bow End**

MODEL#	DIMENSIONS D x W x H	FREIGHT CLASS	WT/LBS.	CUBIC FT.	LIST PRICE
LTDPL84304824	48 x 84 x 29	150	406	68	<b>\$4634</b>
LTDPL72304824	48 x 72 x 29	125	348	58	<b>\$4063</b>

Extended island worksurface on the **left**. Narrow end panel on right connects to **24"D** returns or bridges **for Piano Desks Only** (see page 303). **Not freestanding**. Includes installed horizontal wire management. Shipped RTA (ready to assemble).

LTDPL84304820	48 x 84 x 29	150	406	68	<b>\$4521</b>
LTDPL72304820	48 x 72 x 29	125	348	58	<b>\$3947</b>

Extended island worksurface on the **left**. Narrow end panel on right connects to **20"D** returns or bridges **for Piano Desks Only** (see page 303). **Not freestanding**. Includes installed horizontal wire management. Shipped RTA (ready to assemble).

LTDPR84304824	48 x 84 x 29	150	406	68	<b>\$4634</b>
LTDPR72304824	48 x 72 x 29	125	348	58	<b>\$4063</b>

Extended island worksurface on the **right**. Narrow end panel on left connects to **24"D** returns or bridges **for Piano Desks Only** (see page 303). **Not freestanding**. Includes installed horizontal wire management. Shipped RTA (ready to assemble).

LTDPR84304820	48 x 84 x 29	150	406	68	<b>\$4521</b>
LTDPR72304820	48 x 72 x 29	125	348	58	<b>\$3947</b>

Extended island worksurface on the **right**. Narrow end panel on left connects to **20"D** returns or bridges **for Piano Desks Only** (see page 303). **Not freestanding**. Includes installed horizontal wire management. Shipped RTA (ready to assemble).

LDBEPL84304824	48 x 84 x 29	150	406	68	<b>\$4634</b>
LDBEPL72304824	48 x 72 x 29	125	348	58	<b>\$4063</b>

Extended island worksurface on the **left**. Narrow end panel on right connects to **24"D** returns or bridges **for Piano Desks Only** (see page 303). **Not freestanding**. Includes installed horizontal wire management. Shipped RTA (ready to assemble).

LDBEPL84304820	48 x 84 x 29	150	406	68	<b>\$4521</b>
LDBEPL72304820	48 x 72 x 29	125	348	58	<b>\$3947</b>

Extended island worksurface on the **left**. Narrow end panel on right connects to **20"D** returns or bridges **for Piano Desks Only** (see page 303). **Not freestanding**. Includes installed horizontal wire management. Shipped RTA (ready to assemble).

LDBEPR84304824	48 x 84 x 29	150	406	68	<b>\$4634</b>
LDBEPR72304824	48 x 72 x 29	125	348	58	<b>\$4063</b>

Extended island worksurface on the **right**. Narrow end panel on left connects to **24"D** returns or bridges **for Piano Desks Only** (see page 303). **Not freestanding**. Includes installed horizontal wire management. Shipped RTA (ready to assemble).

### Required Specifications

Veneer Finish  
Edge  
Monopost Finish - Piano Desk

### Optional Specifications

Grommet  
Monopost (Base) Upgrade - Piano Desk

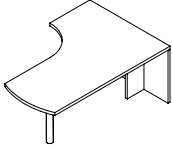
PIANO DESK	MODEL#	DIMENSIONS D x W x H	FREIGHT CLASS	WT/LBS.	CUBIC FT.	LIST PRICE
	LDBEPR84304820	48 x 84 x 29	150	406	68	\$4521
	LDBEPR72304820	48 x 72 x 29	125	348	58	\$3947

**"D" Island RIGHT - Full End Panel & Monopost, Piano Desk - Bow End**

Extended island worksurface on the **right**. Narrow end panel on left connects to **20"D** returns or bridges **for Piano Desks Only** (see page 303). **Not freestanding**. Includes installed horizontal wire management. Shipped RTA (ready to assemble).

CONNECTABLE TABLES - FOR PIANO DESKS	MODEL#	DIMENSIONS	FREIGHT CLASS	WT/LBS.	CUBIC FT.	LIST PRICE
	LVEL8424CG	24 x 84 x 29	150	174	34	\$3405
	LVEL7824CG	24 x 78 x 29	150	162	31	\$3190
	LVEL7224CG	24 x 72 x 29	150	149	29	\$2984
	LVEL6624CG	24 x 66 x 29	150	141	27	\$2822
	LVEL6024CG	24 x 60 x 29	150	132	24	\$2668
	LVEL5424CG	24 x 54 x 29	150	121	22	\$2537
	LVEL4824CG	24 x 48 x 29	125	115	19	\$2418
	LVEL4224CG	24 x 42 x 29	150	99	17	\$2104
	LVEL3624CG	24 x 36 x 29	150	83	15	\$2045

**24" Deep Connectable Table - LEFT For Piano Desk**

**Full end panel on left.** Right narrow end panel connects to **24"D** right connectable table, "D" islands, Boat shaped islands, "P" islands or Delta islands with "T" bases **for Piano Desks Only**. Grommet in worksurface. Ships assembled in 1 carton.

- To remove cross grain veneer pattern on top, **delete suffix "CG"** from the model number. Available as a special - no upcharge.

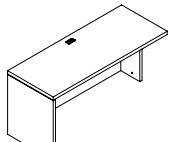
	LVEL8420CG	20 x 84 x 29	150	174	34	\$2635
	LVEL7820CG	20 x 78 x 29	150	162	31	\$2447
	LVEL7220CG	20 x 72 x 29	150	149	29	\$2258
	LVEL6620CG	20 x 66 x 29	150	141	27	\$2119
	LVEL6020CG	20 x 60 x 29	150	132	24	\$1985
	LVEL5420CG	20 x 54 x 29	150	121	22	\$1870
	LVEL4820CG	20 x 48 x 29	125	115	19	\$1753
	LVEL4220CG	20 x 42 x 29	150	99	17	\$1484
	LVEL3620CG	20 x 36 x 29	150	83	15	\$1429

**20" Deep Connectable Table - LEFT For Piano Desk**

**Full end panel on left.** Right narrow end panel connects to **20"D** right connectable table, "D" islands, Boat shaped islands, "P" islands or Delta islands with "T" bases **for Piano Desks Only**. Grommet in worksurface. Ships assembled in 1 carton.

- To remove cross grain veneer pattern on top, **delete suffix "CG"** from the model number. Available as a special - no upcharge.

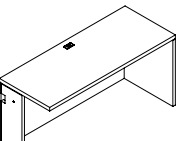
	LVER8424CG	24 x 84 x 29	150	174	34	\$3405
	LVER7824CG	24 x 78 x 29	150	162	31	\$3190
	LVER7224CG	24 x 72 x 29	150	149	29	\$2984
	LVER6624CG	24 x 66 x 29	150	141	27	\$2822
	LVER6024CG	24 x 60 x 29	150	132	24	\$2668
	LVER5424CG	24 x 54 x 29	150	121	22	\$2537
	LVER4824CG	24 x 48 x 29	125	115	19	\$2418
	LVER4224CG	24 x 42 x 29	150	99	17	\$2104
	LVER3624CG	24 x 36 x 29	150	83	15	\$2045

**24" Deep Connectable Table - RIGHT For Piano Desk**

**Full end panel on right.** Left narrow end panel connects to **24"D** left connectable table, "D" islands, Boat shaped islands, "P" islands or Delta islands with "T" bases **for Piano Desks Only**. Grommet in worksurface. Ships assembled in 1 carton.

- To remove cross grain veneer pattern on top, **delete suffix "CG"** from the model number. Available as a special - no upcharge.

**Required Specifications**

Veneer Finish  
Edge  
Monopost Finish - Piano Desk

**Optional Specifications**

Grommet  
Monopost (Base) Upgrade - Piano Desk

## CONNECTABLE TABLES - FOR PIANO DESKS

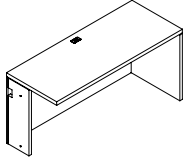

**20" Deep Connectable Table - RIGHT  
For Piano Desk**

MODEL#	DIMENSIONS D x W x H	FREIGHT CLASS	WT/LBS.	CUBIC FT.	LIST PRICE
LVER8420CG	20 x 84 x 29	150	174	34	<b>\$2635</b>
LVER7820CG	20 x 78 x 29	150	162	31	<b>\$2447</b>
LVER7220CG	20 x 72 x 29	150	149	29	<b>\$2258</b>
LVER6620CG	20 x 66 x 29	150	141	27	<b>\$2119</b>
LVER6020CG	20 x 60 x 29	150	132	24	<b>\$1985</b>
LVER5420CG	20 x 54 x 29	150	121	22	<b>\$1870</b>
LVER4820CG	20 x 48 x 29	125	115	19	<b>\$1753</b>
LVER4220CG	20 x 42 x 29	150	99	17	<b>\$1484</b>
LVER3620CG	20 x 36 x 29	150	83	15	<b>\$1429</b>

**Full end panel on right.** Left narrow end panel connects to **20"D** left connectable table, "D" islands, Boat shaped islands, "P" islands or Delta islands with "T" bases **for Piano Desks Only**. Grommet in worksurface. Ships assembled in 1 carton.

- To remove cross grain veneer pattern on top, **delete suffix "CG"** from the model number. Available as a special - no upcharge.

## BRIDGES - FOR PIANO DESKS

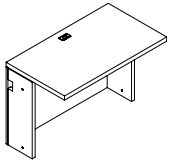

**Flush Bridge**

MODEL#	DIMENSIONS	FREIGHT CLASS	WT/LBS.	CUBIC FT.	LIST PRICE
LBTN4824CG	24 x 48 x 29	125	116	19	<b>\$2139</b>
LBTN4224CG	24 x 42 x 29	125	102	17	<b>\$1861</b>
LBTN3624CG	24 x 36 x 29	150	87	15	<b>\$1805</b>
LBTN3024CG	24 x 30 x 29	125	73	12	<b>\$1772</b>
LBTN2424CG	24 x 24 x 29	150	58	10	<b>\$1562</b>
LBTN1824CG	24 x 18 x 29	150	43	8	<b>\$1280</b>
LBTN1224CG	24 x 12 x 29	150	29	5	<b>\$993</b>

**Full end panel on both sides** connects to **24"D** worksurfaces, "D" islands, Boat shaped islands, "P" islands or Delta islands with "T" bases **for Piano Desks Only**. Grommet in worksurface. Ships assembled in 1 carton.

- To remove cross grain veneer pattern on top, **delete suffix "CG"** from the model number. Available as a special - no upcharge.

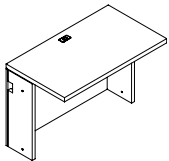

**Flush Bridge**

LBTN4820CG	20 x 48 x 29	125	116	19	<b>\$1703</b>
LBTN4220CG	20 x 42 x 29	125	102	17	<b>\$1422</b>
LBTN3620CG	20 x 36 x 29	150	87	15	<b>\$1378</b>
LBTN3020CG	20 x 30 x 29	125	73	12	<b>\$1351</b>
LBTN2420CG	20 x 24 x 29	150	58	10	<b>\$1137</b>
LBTN1820CG	20 x 18 x 29	150	43	8	<b>\$1081</b>
LBTN1220CG	20 x 12 x 29	150	29	5	<b>\$1006</b>

**Full end panel on both sides** connects to **20"D** worksurfaces, "D" islands, Boat shaped islands, "P" islands or Delta islands with "T" bases **for Piano Desks Only**. Grommet in worksurface. Ships assembled in 1 carton.

- To remove cross grain veneer pattern on top, **delete suffix "CG"** from the model number. Available as a special - no upcharge.

### Required Specifications

Veneer Finish  
Edge  
Metal Finish - Modesty Panel

### Optional Specifications

Grommet

**MODESTY PANEL OPTIONS**      **MODEL#**      **DIMENSIONS**      **FREIGHT CLASS**      **WT/LBS.**      **CUBIC FT.**      **LIST PRICE**

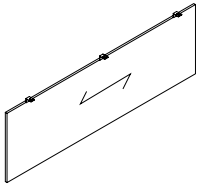

**Veneer Modesty Panel Upgrade\***

CMP72W	0.75 x 67 x 18	--	20	1	<b>\$1728</b>
CMP66W	0.75 x 61 x 18	--	18	1	<b>\$1673</b>
CMP60W	0.75 x 55 x 18	--	16	1	<b>\$1647</b>
CMP54W	0.75 x 49 x 18	--	14	1	<b>\$1619</b>
CMP48W	0.75 x 43 x 18	--	13	1	<b>\$1594</b>

Straight modesty panel. Attaches to underside of worksurface. **Can not be retrofitted in the field *Not sold individually - to be ordered as an upgrade option only.***

- CMP72W - Specify on "P" Top Islands or 96" x 48" Islands for Piano Desks.
- CMP66W - Specify on 84" x 36" "D" Top Islands.
- CMP60W - Specify on 84" x 42" "P" Top Islands or 84" x 48" Islands for Piano Desks.
- CMP54W - Specify on 72" x 30" "D" Top Islands.
- CMP48W - Specify on 66" x 36" , 60" x 30" "D" Top Islands, 72" x 42" "P" Top Islands or 72" x 48" Islands for Piano Desks.

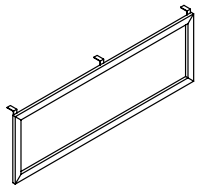

**Glass Modesty Panel Upgrade**

CMP72G	0.75 x 67 x 18	--	20	1	<b>\$2647</b>
CMP66G	0.75 x 61 x 18	--	18	1	<b>\$2504</b>
CMP60G	0.75 x 55 x 18	--	16	1	<b>\$2289</b>
CMP54G	0.75 x 49 x 18	--	14	1	<b>\$2132</b>
CMP48G	0.75 x 43 x 18	--	13	1	<b>\$2036</b>

Straight modesty panel. Translucent, screened glass. Aluminum box frame construction in Tungsten Only. Attaches to underside of worksurface. **Can not be retrofitted in the field. *Not sold individually - to be ordered as an upgrade option only.***

- CMP72G - Specify on "P" Top Islands or 96" x 48" Islands for Piano Desks.
- CMP66G - Specify on 84" x 36" "D" Top Islands.
- CMP60G - Specify on 84" x 42" "P" Top Islands or 84" x 48" Islands for Piano Desks.
- CMP54G - Specify on 72" x 30" "D" Top Islands.
- CMP48G - Specify on 66" x 36" , 60" x 30" "D" Top Islands, 72" x 42" "P" Top Islands or 72" x 48" Islands for Piano Desks.
- Tungsten finish on the aluminum box frame closely resembles the existing Tungsten finish.

**Required Specifications**

Metal finish

# L LUFTON

## SIDE-BY-SIDE COMPONENTS

## MODEL#

## DIMENSIONS

## FREIGHT CLASS

## WT/LBS.

## CUBIC FT.

## LIST PRICE

D x W x H

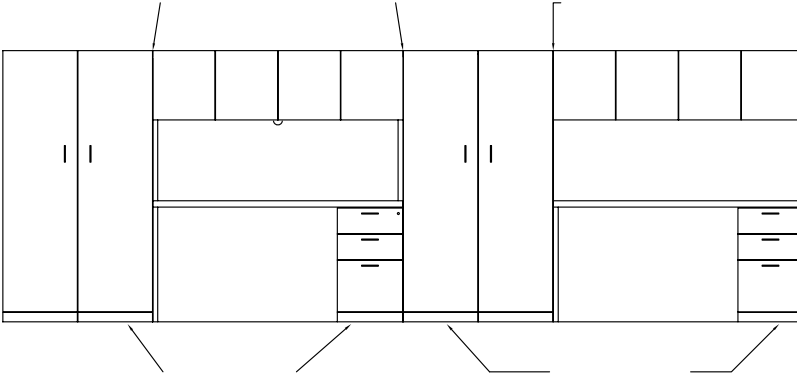

## MODULAR PEDESTALS

- When using Storage Shells, laminate gables will show.
- Credenza shell cannot be completely filled up with storage shells to create a full storage credenza.
- Handle style must be specified.

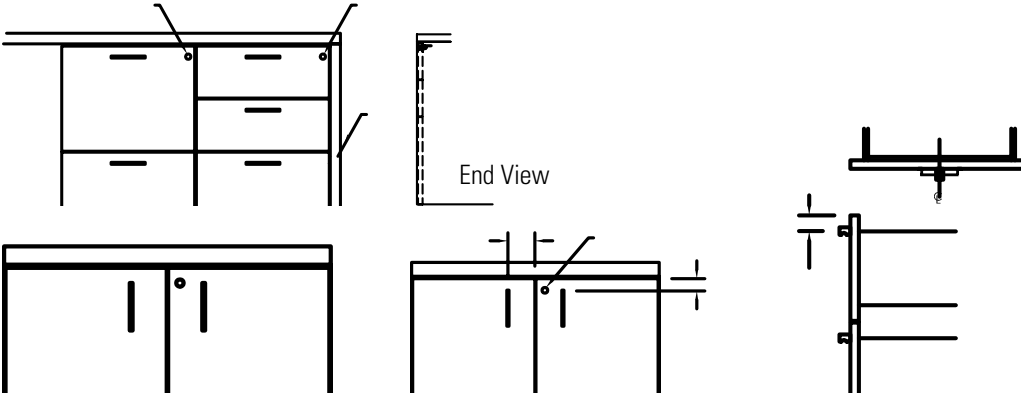

## STORAGE SHELLS

## MODEL#

## DIMENSIONS

## FREIGHT CLASS

## WT/LBS.

## CUBIC FT.

## LIST PRICE

D x W x H

LWG	18 x 35 x 28	92.5	115	11	<b>\$1893</b>
LWM	18 x 30 x 28	92.5	96	9	<b>\$1703</b>
LWG.5	18 x 34 x 28	92.5	115	11	<b>\$1893</b>

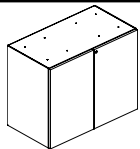

Storage Shell

For use **under a freestanding worksurface (22", 24", 30" or 36"D)**. Top drilled to attach to worksurface. One adjustable shelf. Standard with lock. Ships assembled in 1 carton.

- **Specify LWG and LWM for kneespace applications**
- **Unfinished top and back**

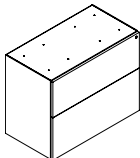

File/File Shell - Lateral

LWF	18 x 35 x 28	92.5	115	11	<b>\$2668</b>
LWN	18 x 30 x 28	92.5	96	9	<b>\$2320</b>
LWF.5	18 x 34 x 28	92.5	115	11	<b>\$2668</b>
LWN.5	18 x 29 x 28	92.5	96	9	<b>\$2320</b>

For use **under a freestanding worksurface (22", 24", 30" or 36"D)**. Top drilled to attach to worksurface. **Two lateral file drawers**. Lock secures all drawers. Side-to-side file bars included. Ships assembled in 1 carton.

- **Specify LWF and LWN for kneespace applications**
- **Unfinished top and back**

### Required Specifications

Veneer Finish  
Edge

**STORAGE MODULES - FREESTANDING**      **MODEL#**      **DIMENSIONS**      **FREIGHT CLASS**      **WT/LBS.**      **CUBIC FT.**      **LIST PRICE**

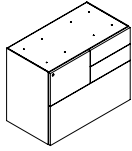

**Mixed Storage Shell - LEFT**

	D x W x H				
LWZL	18 x 35 x 28	92.5	115	11	<b>\$3057</b>
LWZL.5	18 x 34 x 28	92.5	115	11	<b>\$3057</b>

For use **under a freestanding worksurface (22", 24", 30" or 36"D)**. Top drilled to attach to worksurface. One file drawer on **left**, two box drawers on **right** and one lateral file drawer on bottom. File drawer and lateral file drawer lock. One pencil tray. **Not for stacking materials on lateral file drawer bottom.** Ships assembled in 1 carton.

- **Specify LWZL for kneespace applications**
- **Unfinished top and back**

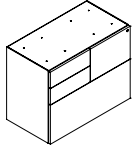

**Mixed Storage Shell - RIGHT**

LWZR	18 x 35 x 28	92.5	115	11	<b>\$3057</b>
LWZR.5	18 x 34 x 28	92.5	115	11	<b>\$3057</b>

For use **under a freestanding worksurface (22", 24", 30" or 36"D)**. Top drilled to attach to worksurface. One file drawer on **right**, two box drawers on **left** and one lateral file drawer on bottom. File drawer and lateral file drawer lock. One pencil tray. **Not for stacking materials on lateral file drawer bottom.** Ships assembled in 1 carton.

- **Specify LWZR for kneespace applications**
- **Unfinished top and back**

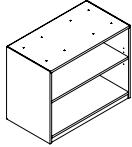

**Open Shelving Shell**

LWOB36	18 x 35 x 28	100	92	11	<b>\$1462</b>
LWOB30	18 x 30 x 28	100	77	9	<b>\$1316</b>

For use **under a freestanding worksurface (22", 24", 30" or 36"D)**. Top drilled to attach to worksurface. One adjustable veneer shelf. Ships assembled in 1 carton.

- **Unfinished top and back**

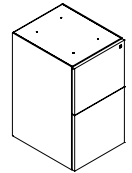

**File/File Shell - Vertical**

<b>LETTER</b>					
LWWE	23 x 16 x 28	92.5	72	6	<b>\$2132</b>
LWE	18 x 16 x 28	92.5	70	5	<b>\$1893</b>
<b>LEGAL</b>					
LWWLE	23 x 19 x 28	92.5	85	7	<b>\$2492</b>
LWLE	18 x 19 x 28	92.5	83	6	<b>\$2207</b>

For use **under a freestanding worksurface (22", 24", 30" or 36"D)**. Top drilled to attach to worksurface. **Two file drawers.** Lock secures all drawers. Ships assembled in 1 carton.

- *For 22" or 24"D worksurface, order **LWE or LWLE**. For 30" or 36"D worksurface, order **LWWE or LWWLE**.*
- **Unfinished top and back**

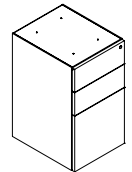

**Box/Box/File Shell**

<b>LETTER</b>					
LWWD	23 x 16 x 28	92.5	72	6	<b>\$2132</b>
LWD	19.1 x 16 x 28	92.5	70	5	<b>\$1893</b>
<b>LEGAL</b>					
LWWLD	23 x 19 x 28	92.5	85	7	<b>\$2492</b>
LWLD	19.1 x 19 x 28	92.5	83	6	<b>\$2207</b>

For use **under a freestanding worksurface (22", 24", 30" or 36"D)**. Top drilled to attach to worksurface. **Two box and one file drawers.** One pencil tray. Lock secures all drawers. Ships assembled in 1 carton.

- *For 22" or 24"D worksurface, order **LWD or LWLD**. For 30" or 36"D worksurface, order **LWWD or LWWLD**.*
- **Unfinished top and back**

**Required Specifications**

Veneer Finish  
Edge

## STORAGE MODULES - FREESTANDING

MODEL# DIMENSIONS FREIGHT CLASS WT/LBS. CUBIC FT. LIST PRICE

D x W x H

LWBM	18 x 16 x 21	85	70	5	<b>\$1578</b>
LWWBM	24 x 16 x 21	85	75	6	<b>\$1851</b>

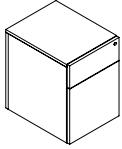

**Box/File Freestanding Mobile Pedestal**

**One box and one file drawer.** One pencil tray. Lock secures all drawers. Finished back. Ships assembled in 1 carton.

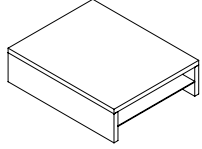

**Spacer**

LSPBOX1620	20 x 16 x 4.8	125	15	2	<b>\$560</b>
------------	---------------	-----	----	---	--------------

For use with 23" high credenzas to support an overlapping return. Includes shelf for paper management. Ships assembled in 1 carton.

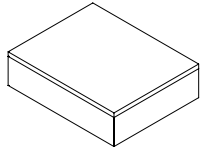

**Spacer, Closed**

LSPBOX1620C	20 x 16 x 4.8	125	15	2	<b>\$618</b>
-------------	---------------	-----	----	---	--------------

For use with 23" high credenzas to support an overlapping return. Ships assembled in 1 carton.

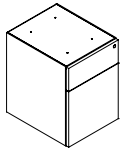

**Box/File Pedestal**

LWB15	19 x 16 x 19.5	70	50	3	<b>\$1351</b>
-------	----------------	----	----	---	---------------

**One box and one file drawer.** One pencil tray. Lock secures all drawers. Finished back. **For use with 23" high credenza shell.** Ships assembled in 1 carton.

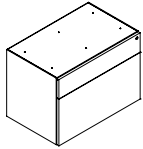

**Box/Lateral File Pedestal**

LWB36	19 x 36 x 19.5	92.5	115	11	<b>\$2456</b>
LWB30	19 x 30 x 19.5	92.5	96	9	<b>\$2149</b>

**One box and one lateral file drawer.** One pencil tray. Lock secures all drawers. Finished back. **For use with 23" high credenza shell.** Ships assembled in 1 carton.

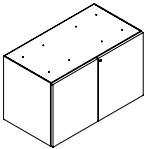

**Storage Cabinet w/Doors**

LWMH19.5	19 x 36 x 29	92.5	130	12	<b>\$1520</b>
LWGH19.5	19 x 30 x 29	92.5	107	10	<b>\$1715</b>

Includes one adjustable shelf. Standard with lock. **For use with 23" high credenza shell.** Ships assembled in 1 carton.

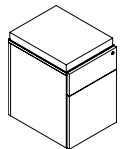

**Box/File Freestanding Pedestal Mobile, with Cushion**

LWBMCU	20 x 16 x 24	85	70	5	<b>GRD 1/GRD 2 \$2373</b>	<b>GRD 3 \$2889</b>	<b>GRD 4 \$2967</b>
LWWBMCU	24 x 16 x 24	85	75	6	<b>\$2709</b>	<b>\$3298</b>	<b>\$3387</b>

**One box and one file drawer.** One pencil tray. Lock secures all drawers. Casters. Ships assembled in 1 carton. Pricing in grade 1 through 4. Pricing beyond grade 4 must be submitted as special.

**Required Specifications**

Veneer Finish  
Edge

**STORAGE MODULES - FREESTANDING**      **MODEL#**      **DIMENSIONS**      **FREIGHT CLASS**      **WT/LBS.**      **CUBIC FT.**      **LIST PRICE**

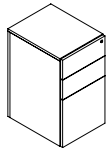

**Box/Box/File Freestanding Pedestal**

	D x W x H				
LWDB	19 x 16 x 28	85	70	5	<b>\$1893</b>
LWWDB	24 x 16 x 28	85	75	6	<b>\$2176</b>

**Two box and one file drawer.** One pencil tray. Lock secures all drawers. Finished back. Ships assembled in 1 carton.

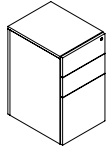

**Box/Box/File Module, Mobile**

LWDM	19 x 16 x 28	85	70	5	<b>\$2036</b>
LWWDM	24 x 16 x 28	85	75	6	<b>\$2337</b>

**Two box and one file drawer.** One pencil tray. Lock secures all drawers. Casters. Ships assembled in 1 carton.

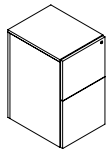

**File/File Module, Mobile**

LWEM	19 x 16 x 28	85	70	5	<b>\$2207</b>
LWWEM	24 x 16 x 28	85	75	6	<b>\$2372</b>

**Two file drawer.** Lock secures all drawers. Casters. Ships assembled in 1 carton. Ships assembled in 1 carton.

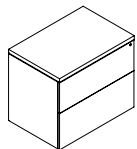

**File/File Module, Lateral**

LF3624	24 x 36 x 29	85	184	15	<b>\$3491</b>
LN3024	24 x 30 x 29	85	153	12	<b>\$3057</b>
LF3620	20 x 36 x 29	85	159	12	<b>\$2621</b>
LN3020	20 x 30 x 29	85	131	10	<b>\$2292</b>

**Two lateral file drawers.** Lock secures all drawers. Ships assembled in 1 carton.

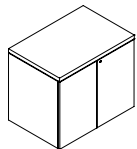

**Storage Cabinet w/Doors**

LBD3624	24 x 36 x 29	92.5	152	15	<b>\$2375</b>
LBD3024	24 x 30 x 29	92.5	127	12	<b>\$2086</b>
LBD3620	20 x 36 x 29	92.5	130	12	<b>\$1875</b>
LBD3020	20 x 30 x 29	92.5	107	10	<b>\$1634</b>

Includes one adjustable shelf. Standard with lock. Ships assembled in 1 carton.

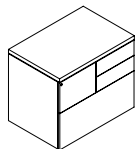

**Mixed Storage Cabinet - LEFT**

LZL3624	24 x 36 x 29	85	184	15	<b>\$3791</b>
LZL3620	20 x 36 x 29	85	170	13	<b>\$2978</b>

One file drawer on the **left**, two box drawers on the **right** and one lateral file drawer on the bottom. File drawer and lateral file drawer lock. One pencil tray. **Not for stacking materials on lateral file drawer bottom.** Ships assembled in 1 carton.

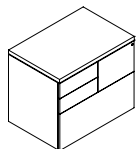

**Mixed Storage Cabinet - RIGHT**

LZR3624	24 x 36 x 29	85	184	15	<b>\$3791</b>
LZR3620	20 x 36 x 29	85	170	13	<b>\$2978</b>

One file drawer on the **right**, two box drawers on the **left** and one lateral file drawer on the bottom. File drawer and lateral file drawer lock. One pencil tray. **Not for stacking materials on lateral file drawer bottom.** Ships assembled in 1 carton.

**Required Specifications**

Veneer Finish  
Edge

## FREESTANDING STORAGE

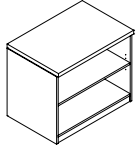

**Open Storage Cabinet**

MODEL#	DIMENSIONS D x W x H	FREIGHT CLASS	WT/LBS.	CUBIC FT.	LIST PRICE
LOB3624	24 x 36 x 29	100	123	15	<b>\$1909</b>
LOB3024	24 x 30 x 29	100	103	12	<b>\$1668</b>
LOB3620	20 x 36 x 29	100	115	13	<b>\$1503</b>
LOB3020	20 x 30 x 29	100	96	11	<b>\$1308</b>

One fixed and **one** adjustable veneer shelf. Shelves are 3/4" thick. Ships assembled in 1 carton.

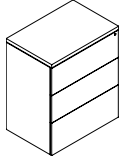

**Three File Module**

LF36243	24 x 36 x 42	92.5	231	21	<b>\$4270</b>
LN30243	24 x 30 x 42	92.5	193	18	<b>\$3733</b>
LF36203	20 x 36 x 42	92.5	212	19	<b>\$3652</b>
LN30203	20 x 30 x 42	92.5	176	16	<b>\$3194</b>

**Three lateral file drawers.** Lock secures all drawers. Ships assembled in 1 carton.

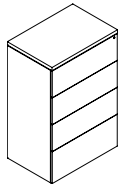

**Four File Module**

LF36244	24 x 36 x 54	92.5	297	27	<b>\$5202</b>
LN30244	24 x 30 x 54	92.5	248	23	<b>\$4549</b>
LF36204	20 x 36 x 54	92.5	270	25	<b>\$4527</b>
LN30204	20 x 30 x 54	92.5	225	21	<b>\$3960</b>

**Four lateral file drawers.** Lock secures all drawers. Ships assembled in 1 carton.

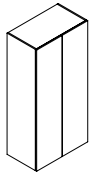

**Storage Cabinet w/Doors\***

L1D24H72	24 x 35 x 72	100	324	36	<b>\$4544</b>
L1D24W30H72	24 x 30 x 72	100	270	30	<b>\$3968</b>
L1D24W24H72	24 x 24 x 72	100	216	24	<b>\$3389</b>
L1H72	20 x 35 x 72	100	269	30	<b>\$3968</b>
L1W30H72	20 x 30 x 72	100	233	25	<b>\$3311</b>
L1W24H72	20 x 24 x 72	100	179	20	<b>\$2645</b>
L1D24	24 x 35 x 65	100	297	33	<b>\$4167</b>
L1D24W30	24 x 30 x 65	100	248	28	<b>\$3647</b>
L1D24W24	24 x 24 x 65	100	198	22	<b>\$3127</b>
L1W35	20 x 35 x 65	100	245	28	<b>\$3640</b>
L1W30	20 x 30 x 65	100	202	23	<b>\$3034</b>
L1W24	20 x 24 x 65	100	163	18	<b>\$2430</b>

Includes four adjustable shelves. Optional lock available. Ships assembled in 1 carton.

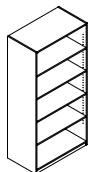

**Open Storage Cabinet**

L7D24H72	24 x 35 x 72	100	306	36	<b>\$3640</b>
L7D24W30H72	24 x 30 x 72	100	255	30	<b>\$3184</b>
L7H72	20 x 35 x 72	100	257	30	<b>\$3180</b>
L7W30H72	20 x 30 x 72	100	223	25	<b>\$2645</b>
L7D24	24 x 35 x 65	100	281	33	<b>\$3339</b>
L7D24W30	24 x 30 x 65	100	234	28	<b>\$2920</b>
L7	20 x 35 x 65	100	234	28	<b>\$2914</b>
L7W30	20 x 30 x 65	100	193	23	<b>\$2430</b>

Includes one fixed and **four** adjustable veneer shelves. Shelves are 3/4" thick. Ships assembled in 1 carton.

### Required Specifications

Veneer finish  
Edge (file modules)

### Optional Specifications

Lock\*

**FREESTANDING STORAGE**      **MODEL#**      **DIMENSIONS**      **FREIGHT CLASS**      **WT/LBS.**      **CUBIC FT.**      **LIST PRICE**

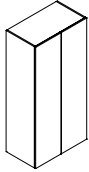

**Wardrobe Cabinet**

D x W x H						
L2D24H72	24 x 35 x 72	100	324	36	<b>\$3873</b>	
L2D24W30H72	24 x 30 x 72	100	270	30	<b>\$3388</b>	
L2D24W24H72	24 x 24 x 72	100	216	24	<b>\$2902</b>	
L2H72	20 x 35 x 72	100	269	30	<b>\$3385</b>	
L2W30H72	20 x 30 x 72	100	233	25	<b>\$2876</b>	
L2W24H72	20 x 24 x 72	100	179	20	<b>\$2296</b>	
L2D24	24 x 35 x 65	100	297	33	<b>\$3550</b>	
L2D24W30	24 x 30 x 65	100	246	28	<b>\$3108</b>	
L2D24W24	24 x 24 x 65	100	198	22	<b>\$2666</b>	
L2	20 x 35 x 65	100	245	28	<b>\$3155</b>	
L2W30	20 x 30 x 65	100	202	23	<b>\$2635</b>	
L2W24	20 x 24 x 65	100	163	18	<b>\$2109</b>	

Includes full length hanging rod and fixed hat shelf. Lock optional. Ships assembled in 1 carton.

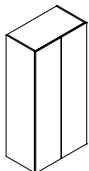

**Wardrobe Cabinet/Shelving Combo**

L25D24H72	24 x 35 x 72	100	324	36	<b>\$5097</b>	
L25D24W30H72	24 x 30 x 72	100	270	30	<b>\$4460</b>	
L25D24W24H72	24 x 24 x 72	100	216	24	<b>\$3930</b>	
L25H72	20 x 35 x 72	100	269	30	<b>\$4446</b>	
L25W30H72	20 x 30 x 72	100	233	25	<b>\$3710</b>	
L25W24H72	20 x 24 x 72	100	179	20	<b>\$2972</b>	
L25D24	24 x 35 x 65	100	297	33	<b>\$4677</b>	
L25D24W30	24 x 30 x 65	100	246	28	<b>\$4086</b>	
L25D24W24	24 x 24 x 65	100	198	22	<b>\$3503</b>	
L25	20 x 35 x 65	100	245	28	<b>\$4075</b>	
L25W30	20 x 30 x 65	100	202	23	<b>\$3401</b>	
L25W24	20 x 24 x 65	100	163	18	<b>\$2726</b>	

Wardrobe compartment on **left** includes hanging rod and fixed hat shelf. Storage compartment on **right** includes three adjustable shelves. Lock optional. Ships assembled in 1 carton.

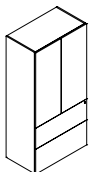

**Two File Module w/Doors**

L13D24H72	24 x 35 x 72	100	324	36	<b>\$5623</b>	
L13D24W30H72	24 x 30 x 72	100	270	30	<b>\$4921</b>	
L13H72	20 x 35 x 72	100	269	30	<b>\$4911</b>	
L13W30H72	20 x 30 x 72	100	233	25	<b>\$4096</b>	
L13D24	24 x 35 x 65	100	297	33	<b>\$5157</b>	
L13D24W30	24 x 30 x 65	100	248	28	<b>\$4508</b>	
L13	20 x 35 x 65	100	245	28	<b>\$4503</b>	
L13W30	20 x 30 x 65	100	202	23	<b>\$3756</b>	

Two lateral file drawers on bottom. Includes **two** adjustable shelves. Lower lock secures two file drawers. Optional lock available for upper storage compartment. **Not for stacking materials on lateral file drawer bottom.** Ships assembled in 1 carton.

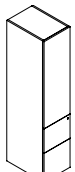

**Two File Module w/Door - LEFT**

L17D24H72L	24 x 16 x 72	125	99	15	<b>\$3870</b>
L17H72L	20 x 16 x 72	125	90	13	<b>\$3291</b>
L17D24L	24 x 16 x 65	125	91	13	<b>\$3588</b>
L17L	20 x 16 x 65	125	83	12	<b>\$3018</b>

Two file drawers on bottom. Includes two adjustable shelves. Lower lock secures two file drawers. Optional lock available for upper storage compartment. Handle is on the **right**, door opens to the **left**. Ships assembled in 1 carton.

**Required Specifications**  
Veneer finish

**Optional Specifications**  
Lock

## FREESTANDING STORAGE

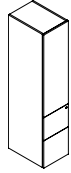

**Two File Module w/Door - RIGHT**

MODEL#	DIMENSIONS D x W x H	FREIGHT CLASS	WT/LBS.	CUBIC FT.	LIST PRICE
L17D24H72R	24 x 16 x 72	125	99	15	<b>\$3870</b>
L17H72R	20 x 16 x 72	125	90	13	<b>\$3291</b>
L17D24R	24 x 16 x 65	125	91	13	<b>\$3588</b>
L17R	20 x 16 x 65	125	83	12	<b>\$3018</b>

Two file drawers on bottom. Includes two adjustable shelves. Optional lock available on upper storage compartment. Lower lock secures two file drawers. Handle is on the **left**, door opens to the **right**. Ships assembled in 1 carton.

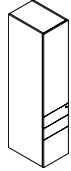

**Box/Box/File Module w/Door - LEFT**

L18D24H72L	24 x 16 x 72	125	99	15	<b>\$3870</b>
L18H72L	20 x 16 x 72	125	90	13	<b>\$3291</b>
L18D24L	24 x 16 x 65	125	91	13	<b>\$3588</b>
L18L	20 x 16 x 65	125	83	12	<b>\$3018</b>

Two box drawers and one file drawer on bottom. Includes two adjustable shelves. Optional lock available on upper storage compartment. Lower lock secures all drawers. Handle is on the **right**, door opens to the **left**. Ships assembled in 1 carton.

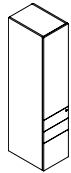

**Box/Box/File Module w/Door - RIGHT**

L18D24H72R	24 x 16 x 72	125	99	15	<b>\$3870</b>
L18H72R	20 x 16 x 72	125	90	13	<b>\$3291</b>
L18D24R	24 x 16 x 65	125	91	13	<b>\$3588</b>
L18R	20 x 16 x 65	125	83	12	<b>\$3018</b>

Two box drawers and one file drawer on bottom. Includes two adjustable shelves. Optional lock available on upper storage compartment. Lower lock secures all drawers. Handle is on the **left**, door opens to the **right**. Ships assembled in 1 carton.

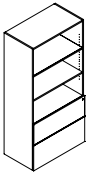

**Two File Module w/Open Shelves**

L12D24H72	24 x 35 x 72	100	324	36	<b>\$4939</b>
L12D24W30H72	24 x 30 x 72	100	270	30	<b>\$4320</b>
L12H72	20 x 35 x 72	100	269	30	<b>\$4311</b>
L12W30H72	20 x 30 x 72	100	233	25	<b>\$3772</b>
L12D24	24 x 35 x 65	100	297	33	<b>\$4527</b>
L12D24W30	24 x 30 x 65	100	248	28	<b>\$3960</b>
L12	20 x 35 x 65	100	245	28	<b>\$3947</b>
L12W30	20 x 30 x 65	100	239	23	<b>\$3298</b>

Three open veneer shelves and two lateral file drawers on bottom. Includes two adjustable shelves. Lock secures all drawers. Front-to-back and side-to-side filing. **Not for stacking materials on lateral file drawer bottom.** Ships assembled in 1 carton.

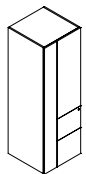

**Personal Tower - LEFT**

L29D24W24H72L	24 x 24 x 72	125	168	24	<b>\$5757</b>
L29W24H72L	20 x 24 x 72	125	140	20	<b>\$4706</b>
L29D24W24L	24 x 24 x 65	125	154	22	<b>\$5167</b>
L29W24L	20 x 24 x 65	125	128	18	<b>\$4263</b>

**Two file** drawers on bottom. Wardrobe compartment on **left** includes hanging rod. Storage compartment on **right** includes one adjustable shelf. Optional lock available on upper storage and wardrobe. Lower lock secures all drawers. Ships assembled in 1 carton.

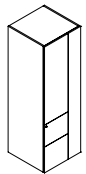

**Personal Tower - RIGHT**

L29D24W24H72R	24 x 24 x 72	125	168	24	<b>\$5757</b>
L29W24H72R	20 x 24 x 72	125	140	20	<b>\$4706</b>
L29D24W24R	24 x 24 x 65	125	154	22	<b>\$5167</b>
L29W24R	20 x 24 x 65	125	128	18	<b>\$4263</b>

**Two file** drawers on bottom. Wardrobe compartment on **right** includes hanging rod. Storage compartment on **left** includes one adjustable shelf. Optional lock available on upper storage and wardrobe. Lower lock secures all drawers. Ships assembled in 1 carton.

**Required Specifications**  
Veneer Finish

**Optional Specifications**  
Lock

**FREESTANDING STORAGE**      **MODEL#**      **DIMENSIONS**      **FREIGHT CLASS**      **WT/LBS.**      **CUBIC FT.**      **LIST PRICE**

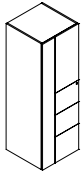

**Personal Tower - LEFT**

D x W x H						
L27D24W24H72L	24 x 24 x 72	125	168	24	<b>\$6349</b>	
L27W24H72L	20 x 24 x 72	125	140	20	<b>\$5551</b>	
L27D24W24L	24 x 24 x 65	125	154	22	<b>\$5825</b>	
L27W24L	20 x 24 x 65	125	128	18	<b>\$5085</b>	

**Three file drawers** on bottom. Wardrobe compartment on **left** includes hanging rod. Storage compartment on **right** includes one adjustable shelf. Optional lock available on upper storage and wardrobe. Lower lock secures all drawers. Ships assembled in 1 carton.

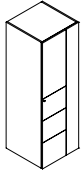

**Personal Tower - RIGHT**

L27D24W24H72R	24 x 24 x 72	125	168	24	<b>\$6349</b>
L27W24H72R	20 x 24 x 72	125	140	20	<b>\$5551</b>
L27D24W24R	24 x 24 x 65	125	154	22	<b>\$5825</b>
L27W24R	20 x 24 x 65	125	128	18	<b>\$5085</b>

**Three file drawers** on bottom. Wardrobe compartment on **right** includes hanging rod. Storage compartment on **left** includes one adjustable shelf. Optional lock available on upper storage and wardrobe. Lower lock secures all drawers. Ships assembled in 1 carton.

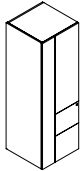

**Personal Tower w/Open Bookcase - LEFT**

L30D24W24H72L	24 x 24 x 72	125	168	24	<b>\$5757</b>
L30W24H72L	20 x 24 x 72	125	140	20	<b>\$4706</b>
L30D24W24L	24 x 24 x 65	125	154	22	<b>\$5167</b>
L30W24L	20 x 24 x 65	125	128	18	<b>\$4263</b>

**Two file drawers** on bottom. Wardrobe compartment on **left** includes hanging rod. Storage compartment on **right** includes one adjustable shelf. Open bookcase on **right** includes two adjustable shelves. Optional lock available on upper storage and wardrobe. Lower lock secures all drawers. Ships assembled in 1 carton.

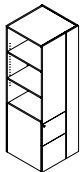

**Personal Tower w/Open Bookcase - RIGHT**

L30D24W24H72R	24 x 24 x 72	125	168	24	<b>\$5757</b>
L30W24H72R	20 x 24 x 72	125	140	20	<b>\$4706</b>
L30D24W24R	24 x 24 x 65	125	154	22	<b>\$5167</b>
L30W24R	20 x 24 x 65	125	128	18	<b>\$4263</b>

**Two file drawers** on bottom. Wardrobe compartment on **right** includes hanging rod. Storage compartment on **left** includes one adjustable shelf. Open bookcase on **left** includes two adjustable shelves. Upper lock secures storage and wardrobe compartments. Lower lock secures all drawers. Ships assembled in 1 carton.

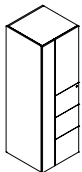

**Personal Tower w/Open Bookcase - LEFT**

L26D24W24H72L	24 x 24 x 72	125	168	24	<b>\$6349</b>
L26W24H72L	20 x 24 x 72	125	140	20	<b>\$6285</b>
L26D24W24L	24 x 24 x 65	125	154	22	<b>\$5825</b>
L26W24L	20 x 24 x 65	125	128	18	<b>\$5807</b>

**Three file drawers** on bottom. Wardrobe compartment on **left** includes hanging rod. Storage compartment on **right** includes one adjustable shelf. Open bookcase on **right** includes one adjustable shelf. Optional lock available on upper storage and wardrobe. Lower lock secures all drawers. Ships assembled in 1 carton.

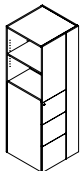

**Personal Tower w/Open Bookcase - RIGHT**

L26D24W24H72R	24 x 24 x 72	125	168	24	<b>\$6349</b>
L26W24H72R	20 x 24 x 72	125	140	20	<b>\$6285</b>
L26D24W24R	24 x 24 x 65	125	154	22	<b>\$5825</b>
L26W24R	20 x 24 x 65	125	128	18	<b>\$5807</b>

**Three file drawers** on bottom. Wardrobe compartment on **right** includes hanging rod. Storage compartment on **left** includes one adjustable shelf. Open bookcase on **left** includes one adjustable shelf. Optional lock available on upper storage and wardrobe. Lower lock secures all drawers. Ships assembled in 1 carton.

**Required Specifications**  
Veneer Finish

**Optional Specifications**  
Lock

## FREESTANDING STORAGE

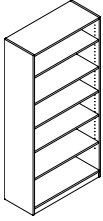

**Bookcase**



**End Shelf - 72" High - Square**

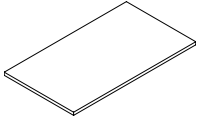

**Shelf for Bookcase**

MODEL#	DIMENSIONS D x W x H	FREIGHT CLASS	WT/LBS.	CUBIC FT.	LIST PRICE
LB73615	15 x 35 x 78	100	228	24	<b>\$2590</b>
LB63615	15 x 35 x 72	100	210	23	<b>\$2389</b>
LB53615	15 x 35 x 65	100	210	23	<b>\$2200</b>
LB73015	15 x 30 x 78	92.5	228	20	<b>\$2265</b>
LB63015	15 x 30 x 72	92.5	210	19	<b>\$2086</b>
LB53015	15 x 30 x 65	92.5	188	17	<b>\$1925</b>

Includes **adjustable** shelves. Shelf is ¾" thick. Ships assembled in 1 carton.

LB7S1515	15 x 15 x 78	100	95	10	<b>\$2041</b>
LB6S1515	15 x 15 x 72	100	83	9	<b>\$1879</b>
LB5S1515	15 x 15 x 65	100	81	9	<b>\$1730</b>
LB4S1515	15 x 15 x 48	100	59	6	<b>\$1429</b>

For use at end of **storage modules, wardrobe cabinets or personal towers**. Includes **adjustable** veneer shelves. Ships assembled in 1 carton.

MAG3624	24 x 35 x 1	92.5	112	10	<b>\$183</b>
MAG3620	20 x 35 x 1	92.5	92	9	<b>\$156</b>
MAG3615	15 x 35 x 1	92.5	81	8	<b>\$131</b>
MAG3024	24 x 30 x 1	92.5	94	9	<b>\$156</b>
MAG3020	20 x 30 x 1	100	76	8	<b>\$124</b>
MAG3015	15 x 30 x 1	100	67	8	<b>\$109</b>

Ships assembled in 1 carton.

### Required Specifications

Veneer finish

FLOATING SHELVES

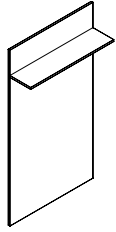

Wall Mounted Panel,  
One Floating Shelf

MODEL#	DIMENSIONS	FREIGHT CLASS	WT/LBS.	CUBIC FT.	LIST PRICE
--------	------------	---------------	---------	-----------	------------

D x W x H

TWF1S2466	11 x 24 x 66	250	42	13	<b>\$1607</b>
TWF1S3066	11 x 30 x 66	250	50	16	<b>\$1874</b>
TWF1S3666	11 x 36 x 66	250	58	19	<b>\$2167</b>
TWF1S4266	11 x 42 x 66	250	66	22	<b>\$2489</b>
TWF1S2472	11 x 24 x 72	250	45	14	<b>\$1710</b>
TWF1S3072	11 x 30 x 72	250	53	17	<b>\$2012</b>
TWF1S3672	11 x 36 x 72	250	62	20	<b>\$2291</b>
TWF1S4272	11 x 42 x 72	250	71	23	<b>\$2624</b>

Standard with pre-mounted "J" bracket for wall mount applications. End cap required at the end of a run of floating shelves. End cap sold separately. Shipped RTA - ready to assemble.

**NOTE:** Care should be taken to mount the units. Units should be mounted to wall studs using correct fasteners. Failure to do so may result in collapse of the unit and subsequent personal injury. **Fastening hardware not included.** Mounting hardware used should be based on wall material. Consult an installation professional for proper wall mounting.

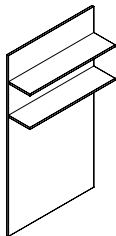

Wall Mounted Panel,  
Two Floating Shelves

TWF2S2466	11 x 24 x 66	250	46	13	<b>\$1645</b>
TWF2S3066	11 x 30 x 66	250	56	16	<b>\$1929</b>
TWF2S3666	11 x 36 x 66	250	65	19	<b>\$2219</b>
TWF2S4266	11 x 42 x 66	250	74	21	<b>\$2566</b>
TWF2S2472	11 x 24 x 72	250	49	14	<b>\$1756</b>
TWF2S3072	11 x 30 x 72	250	59	17	<b>\$2079</b>
TWF2S3672	11 x 36 x 72	250	69	20	<b>\$2343</b>
TWF2S4272	11 x 42 x 72	250	79	23	<b>\$2697</b>

Standard with pre-mounted "J" bracket for wall mount applications. End cap required at the end of a run of floating shelves. End cap sold separately. Shipped RTA - ready to assemble.

**NOTE:** Care should be taken to mount the units. Units should be mounted to wall studs using correct fasteners. Failure to do so may result in collapse of the unit and subsequent personal injury. **Fastening hardware not included.** Mounting hardware used should be based on wall material. Consult an installation professional for proper wall mounting.



End Cap

ENDCAP66	.75 x 66 x 3	60	6	0.04	<b>\$873</b>
ENDCAP72	.75 x 72 x 3	60	8	0.05	<b>\$942</b>

For use with wall mounted panels.

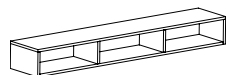

Wall Mounted Open Storage

CBYFO96D12H8	12 x 96 x 8	125	78	10	<b>\$2863</b>
CBYFO64D12H8	12 x 64 x 8	125	50	8	<b>\$1873</b>
CBYFO32D12H8	12 x 32 x 8	100	35	4	<b>\$1697</b>

To be used as a stand alone unit. Ships assembled in 1 carton.

Required Specifications

Veneer finish

## WALLMOUNT STORAGE

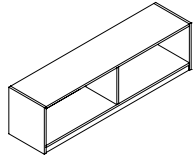

**Open Front Overhead Storage**

MODEL#	DIMENSIONS D x W x H	FREIGHT CLASS	WT/LBS.	CUBIC FT.	LIST PRICE
CSF072	15 x 72 x 17	92.5	100	10	<b>\$1960</b>
CSF066	15 x 66 x 17	100	83	9	<b>\$1799</b>
CSF060	15 x 60 x 17	100	75	8	<b>\$1641</b>
CSF054	15 x 54 x 17	100	68	7	<b>\$1481</b>
CSF048	15 x 48 x 17	100	60	7	<b>\$1316</b>
CSF042	15 x 42 x 17	100	55	6	<b>\$1212</b>
CSF036	15 x 36 x 17	92.5	50	5	<b>\$1194</b>
CSF030	15 x 30 x 17	92.5	45	4	<b>\$1171</b>

Includes pre-mounted "J" brackets for wall mount applications. Ships assembled in 1 carton.

- **NOTE:** Care should be taken to mount the units. Units should be mounted to wall studs using correct fasteners. Failure to do so may result in collapse of the unit and subsequent personal injury. **Mounting hardware not included.** Mounting hardware used should be based on wall material. Consult an installation professional for proper wall mounting.

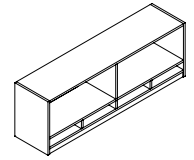

**Open Front Overhead Storage - Pigeon-Hole Storage**

CSFOP72	15 x 72 x 20	92.5	100	12	<b>\$2354</b>
CSFOP66	15 x 66 x 20	100	83	11	<b>\$2162</b>
CSFOP60	15 x 60 x 20	100	75	10	<b>\$1964</b>
CSFOP54	15 x 54 x 20	100	68	9	<b>\$1772</b>
CSFOP48	15 x 48 x 20	100	60	8	<b>\$1569</b>
CSFOP42	15 x 42 x 20	100	55	7	<b>\$1476</b>
CSFOP36	15 x 36 x 20	92.5	50	6	<b>\$1434</b>
CSFOP30	15 x 30 x 20	92.5	45	5	<b>\$1413</b>

Includes pre-mounted "J" brackets for wall mount applications. Horizontal pigeon-hole storage on bottom of overhead. Ships assembled in 1 carton.

- **NOTE:** Care should be taken to mount the units. Units should be mounted to wall studs using correct fasteners. Failure to do so may result in collapse of the unit and subsequent personal injury. **Mounting hardware not included.** Mounting hardware used should be based on wall material. Consult an installation professional for proper wall mounting.

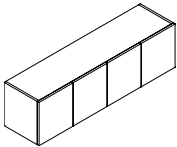

**Closed Front Overhead Storage with Hinge Doors\***

CSF72	15 x 72 x 17	92.5	100	10	<b>\$2418</b>
CSF66	15 x 66 x 17	100	83	9	<b>\$2218</b>
CSF60	15 x 60 x 17	100	75	8	<b>\$2010</b>
CSF54	15 x 54 x 17	100	68	7	<b>\$1812</b>
CSF48	15 x 48 x 17	100	60	7	<b>\$1611</b>
CSF42	15 x 42 x 17	100	55	6	<b>\$1481</b>
CSF36	15 x 36 x 17	92.5	50	5	<b>\$1453</b>
CSF30	15 x 30 x 17	92.5	45	4	<b>\$1429</b>

Includes pre-mounted "J" brackets for wall mount applications. Lock optional. Ships assembled in 1 carton.

- **NOTE:** Care should be taken to mount the units. Units should be mounted to wall studs using correct fasteners. Failure to do so may result in collapse of the unit and subsequent personal injury. **Mounting hardware not included.** Mounting hardware used should be based on wall material. Consult an installation professional for proper wall mounting.

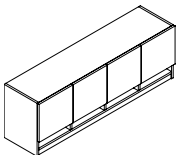

**Closed Front Overhead Storage with Hinge Doors & Pigeon-Hole Storage\***

CSFP72	15 x 72 x 20	92.5	100	12	<b>\$2897</b>
CSFP66	15 x 66 x 20	100	83	11	<b>\$2658</b>
CSFP60	15 x 60 x 20	100	75	10	<b>\$2418</b>
CSFP54	15 x 54 x 20	100	68	9	<b>\$2176</b>
CSFP48	15 x 48 x 20	100	60	8	<b>\$1931</b>
CSFP42	15 x 42 x 20	100	55	7	<b>\$1832</b>
CSFP36	15 x 36 x 20	92.5	50	6	<b>\$1744</b>
CSFP30	15 x 30 x 20	92.5	45	5	<b>\$1715</b>

Includes pre-mounted "J" brackets for wall mount applications. Horizontal pigeon-hole storage on bottom of overhead. Lock optional. Ships assembled in 1 carton.

- **NOTE:** Care should be taken to mount the units. Units should be mounted to wall studs using correct fasteners. Failure to do so may result in collapse of the unit and subsequent personal injury. **Mounting hardware not included.** Mounting hardware used should be based on wall material. Consult an installation professional for proper wall mounting.

**Required Specifications**  
Veneer finish

**Optional Specifications**  
Lock\*

**HUTCHES** **MODEL#** **DIMENSIONS** **FREIGHT CLASS** **WT/LBS.** **CUBIC FT.** **LIST PRICE**

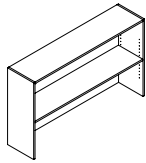

**Open Hutch with Closed Back**

	D x W x H					
L72CL36	14 x 72 x 36	125	155	23		<b>\$2194</b>
L66CL36	14 x 66 x 36	125	140	21		<b>\$2036</b>
L60CL36	14 x 60 x 36	125	130	19		<b>\$1805</b>
L48CL36	14 x 48 x 36	125	110	15		<b>\$1720</b>
L42CL36	14 x 42 x 36	125	95	13		<b>\$1562</b>
L36CL36	14 x 36 x 36	125	80	11		<b>\$1458</b>
L30CL36	14 x 30 x 36	125	67	9		<b>\$1217</b>

One adjustable shelf. Closed back. Ships assembled in 1 carton.  
 • **A Tackboard cannot be used with this hutch.**

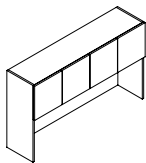

**Closed Hutch w/Veneer Doors 36"H\***

L108SH36	15 x 108 x 36	125	268	34		<b>\$5337</b>
L102SH36	15 x 102 x 36	125	254	32		<b>\$5041</b>
L96SH36	15 x 96 x 36	100	241	30		<b>\$4742</b>
L90SH36	15 x 90 x 36	100	227	28		<b>\$4446</b>
L84SH36	15 x 84 x 36	100	214	26		<b>\$4154</b>
L78SH36	15 x 78 x 36	100	200	24		<b>\$3858</b>
L72SH36	15 x 72 x 36	100	187	23		<b>\$3560</b>
L66SH36	15 x 66 x 36	100	173	21		<b>\$3428</b>
L60SH36	15 x 60 x 36	100	160	19		<b>\$3263</b>
L36SH36	15 x 36 x 36	100	94	11		<b>\$2226</b>
L30SH36	15 x 30 x 36	100	78	9		<b>\$1951</b>

One fixed shelf. Closed back features one grommet. Ships assembled in 1 carton. Lock optional.  
 • Models 108" w have three fixed shelf dividers.  
 • Models 84" w- 102" w have two fixed shelf dividers.  
 • Models 60" w - 78" w have one fixed shelf divider.  
 • Clearance from worksurface to valance is 19.5".

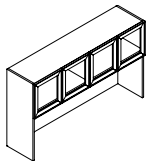

**Closed Hutch w/Glass Doors 36"H**

L108SH36G	15 x 108 x 36	125	268	34		<b>\$7796</b>
L102SH36G	15 x 102 x 36	125	254	32		<b>\$7036</b>
L96SH36G	15 x 96 x 36	100	241	30		<b>\$6709</b>
L90SH36G	15 x 90 x 36	100	227	28		<b>\$6362</b>
L84SH36G	15 x 84 x 36	100	214	26		<b>\$6034</b>
L78SH36G	15 x 78 x 36	100	200	24		<b>\$5709</b>
L72SH36G	15 x 72 x 36	100	187	23		<b>\$4984</b>
L66SH36G	15 x 66 x 36	100	173	21		<b>\$4774</b>
L60SH36G	15 x 60 x 36	100	160	19		<b>\$4553</b>
L36SH36G	15 x 36 x 36	100	94	11		<b>\$2914</b>
L30SH36G	15 x 30 x 36	100	78	9		<b>\$2600</b>

One fixed shelf. Closed back features one grommet. Aluminum frame available in Tungsten finish only. Ships assembled in 1 carton. Translucent, screened glass.  
 • Models 108" w have three fixed shelf dividers.  
 • Models 84" w- 102" w have two fixed shelf dividers.  
 • Models 60" w - 78" w have one fixed shelf divider.  
 • Clearance from worksurface to valance is 19.5".  
 • **Locks are not available on hutches with Glass Doors.**

**Required Specifications**  
 Veneer finish

**Optional Specifications**  
 Lock\*

**HUTCHES**

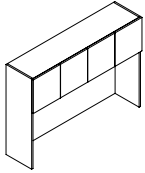

**Closed Hutch w/Veneer Doors 42" H\***

MODEL#	DIMENSIONS D x W x H	FREIGHT CLASS	WT/LBS.	CUBIC FT.	LIST PRICE
L108SH42	15 x 108 x 42	125	307	39	<b>\$6224</b>
L102SH42	15 x 102 x 42	125	290	37	<b>\$5874</b>
L96SH42	15 x 96 x 42	100	273	35	<b>\$5533</b>
L90SH42	15 x 90 x 42	100	256	33	<b>\$5184</b>
L84SH42	15 x 84 x 42	100	239	31	<b>\$4841</b>
L78SH42	15 x 78 x 42	100	222	38	<b>\$4498</b>
L72SH42	15 x 72 x 42	100	205	26	<b>\$4151</b>
L66SH42	15 x 66 x 42	100	188	24	<b>\$4001</b>
L60SH42	15 x 60 x 42	100	171	22	<b>\$3805</b>
L36SH42	15 x 36 x 42	100	102	13	<b>\$2594</b>
L30SH42	15 x 30 x 42	100	85	11	<b>\$2273</b>

One fixed shelf. Closed back features one grommet. Ships assembled in 1 carton. Lock optional.

- Models 108" w have three fixed shelf dividers.
- Models 84" w- 102" w have two fixed shelf dividers.
- Models 60" w - 78" w have one fixed shelf divider.
- *Clearance from worksurface to valance is 19.5".*

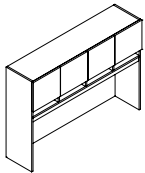

**Closed Hutch w/Veneer Doors Pigeon-Hole Storage, 42" H\***

L108SHP42	15 x 108 x 42	125	307	39	<b>\$7468</b>
L102SHP42	15 x 102 x 42	125	290	37	<b>\$7053</b>
L96SHP42	15 x 96 x 42	100	273	35	<b>\$6637</b>
L90SHP42	15 x 90 x 42	100	256	33	<b>\$6224</b>
L84SHP42	15 x 84 x 42	100	239	31	<b>\$5807</b>
L78SHP42	15 x 78 x 42	100	222	38	<b>\$5394</b>
L72SHP42	15 x 72 x 42	100	205	26	<b>\$4977</b>
L66SHP42	15 x 66 x 42	100	188	24	<b>\$4794</b>
L60SHP42	15 x 60 x 42	100	171	22	<b>\$4567</b>
L36SHP42	15 x 36 x 42	100	102	13	<b>\$3113</b>
L30SHP42	15 x 30 x 42	100	85	11	<b>\$2726</b>

One fixed shelf. Closed back features one grommet. Horizontal pigeon-hole storage top mounted to hutch. Ships assembled in 1 carton. Lock optional.

- Models 120" w- 108" w have three fixed shelf dividers.
- Models 84" w- 102" w have two fixed shelf dividers.
- Models 60" w - 78" w have one fixed shelf divider.
- *Clearance from worksurface to valance is 21.5".*

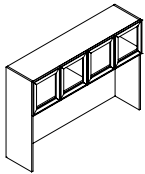

**Closed Hutch w/Glass Doors 42" High**

L108SH42G	15 x 108 x 42	125	307	39	<b>\$8213</b>
L102SH42G	15 x 102 x 42	125	290	37	<b>\$7413</b>
L96SH42G	15 x 96 x 42	100	273	35	<b>\$7057</b>
L90SH42G	15 x 90 x 42	100	256	33	<b>\$6704</b>
L84SH42G	15 x 84 x 42	100	239	31	<b>\$6349</b>
L78SH42G	15 x 78 x 42	100	222	38	<b>\$6001</b>
L72SH42G	15 x 72 x 42	100	205	26	<b>\$5177</b>
L66SH42G	15 x 66 x 42	100	188	24	<b>\$5001</b>
L60SH42G	15 x 60 x 42	100	171	22	<b>\$4819</b>
L36SH42G	15 x 36 x 42	100	102	13	<b>\$3080</b>
L30SH42G	15 x 30 x 42	100	85	11	<b>\$2739</b>

One fixed shelf. Closed back features one grommet. Aluminum frame available in Tungsten finish only. Ships assembled in 1 carton. Translucent, screened glass.

- Models 120" w- 108" w have three fixed shelf dividers.
- Models 84" w- 102" w have two fixed shelf dividers.
- Models 60" w - 78" w have one fixed shelf divider.
- *Clearance from worksurface to valance is 25.5".*
- **Locks are not available on hutches with Glass Doors.**

**Required Specifications**  
Veneer Finish

**Optional Specifications**  
Lock\*

**HUTCHES**      **MODEL#**      **DIMENSIONS**      **FREIGHT CLASS**      **WT/LBS.**      **CUBIC FT.**      **LIST PRICE**

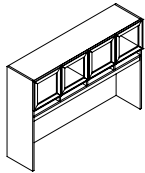

**Closed Hutch w/Glass Doors  
Pigeon-Hole Storage, 42" High**

	<b>D x W x H</b>					
L108SHP42G	15 x 108 x 42	125	307	39	<b>\$9344</b>	
L102SHP42G	15 x 102 x 42	125	290	37	<b>\$8481</b>	
L96SHP42G	15 x 96 x 42	100	273	35	<b>\$8083</b>	
L90SHP42G	15 x 90 x 42	100	256	33	<b>\$8207</b>	
L84SHP42G	15 x 84 x 42	100	239	31	<b>\$7219</b>	
L78SHP42G	15 x 78 x 42	100	222	38	<b>\$6807</b>	
L72SHP42G	15 x 72 x 42	100	205	26	<b>\$5934</b>	
L66SHP42G	15 x 66 x 42	100	188	24	<b>\$5737</b>	
L60SHP42G	15 x 60 x 42	100	171	22	<b>\$5470</b>	
L36SHP42G	15 x 36 x 42	100	102	13	<b>\$3553</b>	
L30SHP42G	15 x 30 x 42	100	85	11	<b>\$3171</b>	

One fixed shelf. Closed back features one grommet. Aluminum frame available in Tungsten finish only. Horizontal pigeon-hole storage top mounted to hutch. Ships assembled in 1 carton. Translucent, screened glass.

- Models 120"w- 108"w have three fixed shelf dividers.
- Models 84"w- 102"w have two fixed shelf dividers.
- Models 60"w - 78"w have one fixed shelf divider.
- *Clearance from worksurface to valance is 21.5".*
- **Locks are not available on hutches with Glass Doors.**

**Required Specifications**  
Veneer Finish

## TACKBOARDS FOR OVERHEAD STORAGE

MODEL# DIMENSIONS FREIGHT CLASS WT/LBS. CUBIC FT. GR. 1-3 GR. 4-5

D x W x H

**TACKBOARD** Notes: Tackboards can be upholstered in all of the following fabrics:

**Grade 1:** Jenny, Quilt, Terrace, Urban, Waterfall

**Grade 2:** Imprint, Lola

**Grade 3:** Anchorage, Merge

LTS108	1 x 108 x 20	92.5	23	2	<b>\$952</b>	<b>\$1193</b>
LTS102	1 x 102 x 20	100	19	2	<b>\$898</b>	<b>\$1125</b>
LTS96	1 x 96 x 20	70	17	1	<b>\$847</b>	<b>\$1063</b>
LTS90	1 x 90 x 20	70	15	1	<b>\$794</b>	<b>\$996</b>
LTS84	1 x 84 x 20	85	14	1	<b>\$744</b>	<b>\$935</b>
LTS78	1 x 78 x 20	85	13	1	<b>\$684</b>	<b>\$859</b>
LTS72	1 x 72 x 20	85	12	1	<b>\$636</b>	<b>\$799</b>
LTS66	1 x 66 x 20	92.5	11	1	<b>\$575</b>	<b>\$722</b>
LTS60	1 x 60 x 20	92.5	10	1	<b>\$532</b>	<b>\$668</b>
LTS36	1 x 36 x 20	125	8	1	<b>\$322</b>	<b>\$408</b>
LTS30	1 x 30 x 20	150	5	1	<b>\$269</b>	<b>\$338</b>

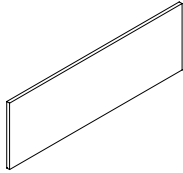

Tackboard for Hutch

For use on **36" H** hutches (**L\_SH36, L\_SH36G**). **Factory installed**, with velcro tape. Please specify hutch to be installed on. See "tackboard notes" exact fabric availability.

- **Not for use on non-Lufton hutches.**

LTS108H26	1 x 108 x 26	70	30	2	<b>\$1234</b>	<b>\$1545</b>
LTS102H26	1 x 102 x 26	85	24	2	<b>\$1167</b>	<b>\$1463</b>
LTS96H26	1 x 96 x 26	92.5	22	2	<b>\$1097</b>	<b>\$1375</b>
LTS90H26	1 x 90 x 26	92.5	20	2	<b>\$1035</b>	<b>\$1296</b>
LTS84H26	1 x 84 x 26	100	18	2	<b>\$960</b>	<b>\$1203</b>
LTS78H26	1 x 78 x 26	100	17	2	<b>\$889</b>	<b>\$1114</b>
LTS72H26	1 x 72 x 26	70	16	1	<b>\$825</b>	<b>\$1035</b>
LTS66H26	1 x 66 x 26	85	14	1	<b>\$753</b>	<b>\$945</b>
LTS60H26	1 x 60 x 26	85	13	1	<b>\$684</b>	<b>\$859</b>
LTS36H26	1 x 36 x 26	100	8	1	<b>\$417</b>	<b>\$526</b>
LTS30H26	1 x 30 x 26	150	5	1	<b>\$349</b>	<b>\$439</b>

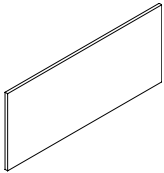

Tackboard for Hutch

For use on **42" H** hutches (**L\_SH42, L\_SH42**). **Factory installed**, with velcro tape. Please specify hutch to be installed on. See "tackboard notes" exact fabric availability.

- **Not for use on non-Lufton hutches.**

LTSP108H23	1 x 108 x 23	70	30	2	<b>\$1067</b>	<b>\$1338</b>
LTSP102H23	1 x 102 x 23	85	24	2	<b>\$1022</b>	<b>\$1280</b>
LTSP96H23	1 x 96 x 23	92.5	20	2	<b>\$956</b>	<b>\$1198</b>
LTSP90H23	1 x 90 x 23	92.5	20	1	<b>\$898</b>	<b>\$1125</b>
LTSP84H23	1 x 84 x 23	70	18	1	<b>\$832</b>	<b>\$1043</b>
LTSP78H23	1 x 78 x 23	70	17	1	<b>\$777</b>	<b>\$974</b>
LTSP72H23	1 x 72 x 23	70	16	1	<b>\$720</b>	<b>\$903</b>
LTSP66H23	1 x 66 x 23	85	14	1	<b>\$655</b>	<b>\$825</b>
LTSP60H23	1 x 60 x 23	85	13	1	<b>\$616</b>	<b>\$757</b>
LTSP36H23	1 x 36 x 23	100	8	1	<b>\$360</b>	<b>\$453</b>
LTSP30H23	1 x 30 x 23	150	5	1	<b>\$304</b>	<b>\$382</b>

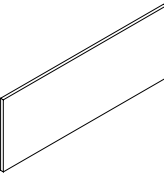

Tackboard for Hutch

For use on **42" H** hutches (**L\_SHP42, L\_SHP42G**) with Pigeon-Hole Storage. **Factory installed**, with velcro tape. Please specify hutch to be installed on. See "tackboard notes" exact fabric availability.

- **Not for use on non-Lufton hutches.**

### Required Specifications

Fabric

**TACKBOARDS FOR OVERHEAD STORAGE**      **MODEL#**      **DIMENSIONS**      **FREIGHT CLASS**      **WT/LBS.**      **CUBIC FT.**      **GR. 1-3**      **GR. 4-5**

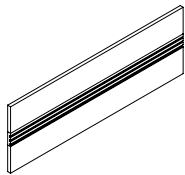

**Tackboard for Hutch - Accessory Rail**

	D x W x H						
LTSAS108	1 x 108 x 20	92.5	23	2		<b>\$1681</b>	<b>\$2106</b>
LTSAS102	1 x 102 x 20	100	19	2		<b>\$1515</b>	<b>\$1896</b>
LTSAS96	1 x 96 x 20	70	15	1		<b>\$1494</b>	<b>\$1872</b>
LTSAS90	1 x 90 x 20	70	15	1		<b>\$1401</b>	<b>\$1756</b>
LTSAS84	1 x 84 x 20	85	14	1		<b>\$1308</b>	<b>\$1640</b>
LTSAS78	1 x 78 x 20	85	13	1		<b>\$1217</b>	<b>\$1525</b>
LTSAS72	1 x 72 x 20	85	12	1		<b>\$1119</b>	<b>\$1402</b>
LTSAS66	1 x 66 x 20	92.5	11	1		<b>\$1029</b>	<b>\$1289</b>
LTSAS60	1 x 60 x 20	92.5	10	1		<b>\$937</b>	<b>\$1174</b>
LTSAS36	1 x 36 x 20	125	6	1		<b>\$560</b>	<b>\$703</b>
LTSAS30	1 x 30 x 20	150	4	1		<b>\$468</b>	<b>\$588</b>

For use on **36" H** hutches (**L\_SH36, L\_SH36G**). **Factory installed**, with velcro tape. Please specify hutch to be installed on. See "tackboard notes" exact fabric availability.

- **Must Specify Black (E) or Tungsten (K) Accessory Rail finish.**
- **Not for use on non-Lufton hutches.**

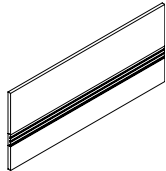

**Tackboard for Hutch - Accessory Rail**

LTSAS108H26	1 x 108 x 26	70	23	2		<b>\$2022</b>	<b>\$2532</b>
LTSAS102H26	1 x 102 x 26	85	19	2		<b>\$1904</b>	<b>\$2383</b>
LTSAS96H26	1 x 96 x 26	92.5	15	1		<b>\$1796</b>	<b>\$2250</b>
LTSAS90H26	1 x 90 x 26	92.5	15	1		<b>\$1687</b>	<b>\$2115</b>
LTSAS84H26	1 x 84 x 26	100	14	1		<b>\$1556</b>	<b>\$1947</b>
LTSAS78H26	1 x 78 x 26	100	13	1		<b>\$1458</b>	<b>\$1825</b>
LTSAS72H26	1 x 72 x 26	70	12	1		<b>\$1324</b>	<b>\$1659</b>
LTSAS66H26	1 x 66 x 26	85	11	1		<b>\$1234</b>	<b>\$1545</b>
LTSAS60H26	1 x 60 x 26	85	10	1		<b>\$1119</b>	<b>\$1402</b>
LTSAS36H26	1 x 36 x 26	100	6	1		<b>\$674</b>	<b>\$846</b>
LTSAS30H26	1 x 30 x 26	150	4	1		<b>\$567</b>	<b>\$712</b>

For use on **42" H** hutches (**L\_SH42, L\_SH42G**). **Factory installed**, with velcro tape. Please specify hutch to be installed on. See "tackboard notes" exact fabric availability.

- **Must Specify Black (E) or Tungsten (K) Accessory Rail finish.**
- **Not for use on non-Lufton hutches.**

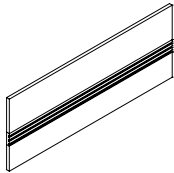

**Tackboard for Hutch - Accessory Rail**

LTSPAS108H23	1 x 108 x 23	92.5	30	2		<b>\$1824</b>	<b>\$2284</b>
LTSPAS102H23	1 x 102 x 23	100	24	2		<b>\$2273</b>	<b>\$2844</b>
LTSPAS96H23	1 x 96 x 23	70	20	2		<b>\$1622</b>	<b>\$2031</b>
LTSPAS90H23	1 x 90 x 23	70	20	2		<b>\$1527</b>	<b>\$1910</b>
LTSPAS84H23	1 x 84 x 23	85	18	2		<b>\$1422</b>	<b>\$1782</b>
LTSPAS78H23	1 x 78 x 23	85	17	2		<b>\$1320</b>	<b>\$1653</b>
LTSPAS72H23	1 x 72 x 23	85	16	1		<b>\$1217</b>	<b>\$1525</b>
LTSPAS66H23	1 x 66 x 23	92.5	14	1		<b>\$1119</b>	<b>\$1402</b>
LTSPAS60H23	1 x 60 x 23	92.5	13	1		<b>\$1018</b>	<b>\$1274</b>
LTSPAS36H23	1 x 36 x 23	125	6	1		<b>\$613</b>	<b>\$769</b>
LTSPAS30H23	1 x 30 x 23	150	4	1		<b>\$514</b>	<b>\$645</b>

For use on **42" H** hutches (**L\_SHP42, L\_SHP42G**) with Pigeon-Hole Storage. **Factory installed**, with velcro tape. Please specify hutch to be installed on. See "tackboard notes" exact fabric availability. List Price shown applies for all fabric grades.

- **Must Specify Black (E) or Tungsten (K) Accessory Rail finish.**
- **Not for use on non-Lufton hutches.**

**Required Specifications**

Fabric

WALLMOUNT TACKBOARDS

MODEL#	DIMENSIONS D x W x H	FREIGHT CLASS	WT/LBS.	CUBIC FT.	GR. 1-3	GR. 4-5
TS108	1 x 106 x 19	70	23	2	\$1460	\$1825
TS102	1 x 100 x 19	85	19	2	\$1383	\$1729
TS96	1 x 94 x 19	70	15	1	\$1293	\$1619
TS90	1 x 88 x 19	70	15	1	\$1216	\$1521
TS84	1 x 82 x 19	70	14	1	\$1139	\$1422
TS78	1 x 76 x 19	70	13	1	\$1055	\$1319
TS72	1 x 70 x 19	70	12	1	\$594	\$744
TS66	1 x 64 x 19	85	11	1	\$546	\$686
TS60	1 x 58 x 19	85	10	1	\$502	\$631
TS36	1 x 34 x 19	100	6	1	\$322	\$408
TS30	1 x 28 x 19	150	4	1	\$268	\$337

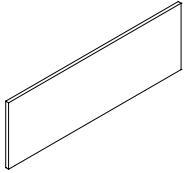

Tackboard - Wallmounted

For use on **16.5"H** overhead storage (CSFO\_, CSF\_, CSFF\_) at a finished height of 66". See "tackboard notes" exact fabric availability. List Price shown applies for all fabric grades.

- **NOTE:** Care should be taken to mount the units. Units should be mounted to wall studs using correct fasteners. Failure to do so may result in collapse of the unit and subsequent personal injury. **Mounting hardware not included.** Mounting hardware used should be based on wall material. Consult an installation professional for proper wall mounting.

TS108H26	1 x 106 x 26	70	30	2	\$1898	\$2374
TS102H26	1 x 100 x 26	85	24	2	\$1788	\$2235
TS96H26	1 x 94 x 26	92.5	20	2	\$1691	\$2116
TS90H26	1 x 88 x 26	92.5	20	2	\$1585	\$1980
TS84H26	1 x 82 x 26	100	18	2	\$1473	\$1842
TS78H26	1 x 76 x 26	100	17	2	\$1370	\$1714
TS72H26	1 x 70 x 26	70	16	1	\$761	\$956
TS66H26	1 x 64 x 26	85	14	1	\$701	\$879
TS60H26	1 x 58 x 26	85	13	1	\$641	\$805
TS36H26	1 x 34 x 26	100	8	1	\$403	\$506
TS30H26	1 x 28 x 26	150	5	1	\$338	\$428

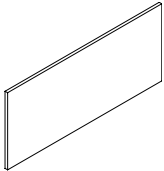

Tackboard - Wallmounted

For use on **16.5"H** overhead storage (CSFO\_, CSF\_) at a finished height of 72". See "tackboard notes" exact fabric availability. List Price shown applies for all fabric grades.

- **NOTE:** Care should be taken to mount the units. Units should be mounted to wall studs using correct fasteners. Failure to do so may result in collapse of the unit and subsequent personal injury. **Mounting hardware not included.** Mounting hardware used should be based on wall material. Consult an installation professional for proper wall mounting.

TSP108H23	1 x 106 x 23	70	30	2	\$1704	\$2045
TSP102H23	1 x 100 x 23	85	24	2	\$1625	\$1951
TSP96H23	1 x 94 x 23	92.5	20	2	\$1467	\$1832
TSP90H23	1 x 88 x 23	92.5	20	1	\$1370	\$1714
TSP84H23	1 x 82 x 23	70	18	1	\$1280	\$1599
TSP78H23	1 x 76 x 23	70	17	1	\$1047	\$1273
TSP72H23	1 x 70 x 23	70	16	1	\$973	\$1222
TSP66H23	1 x 64 x 23	85	14	1	\$884	\$1109
TSP60H23	1 x 58 x 23	85	13	1	\$641	\$805
TSP36H23	1 x 34 x 23	100	8	1	\$488	\$505
TSP30H23	1 x 28 x 23	150	5	1	\$404	\$430

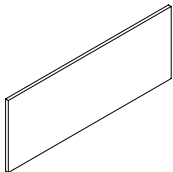

Tackboard - Wallmounted

For use on **19.5"H** overhead storage (CSFOP\_, CSFP\_) with Pigeon-Hole Storage at a finished height of 72". See "tackboard notes" exact fabric availability. List Price shown applies for all fabric grades.

- **NOTE:** Care should be taken to mount the units. Units should be mounted to wall studs using correct fasteners. Failure to do so may result in collapse of the unit and subsequent personal injury. **Mounting hardware not included.** Mounting hardware used should be based on wall material. Consult an installation professional for proper wall mounting.

**Required Specifications**  
Fabric

**WALLMOUNT TACKBOARDS**      **MODEL#**      **DIMENSIONS**      **FREIGHT CLASS**      **WT/LBS.**      **CUBIC FT.**      **GR. 1-3**      **GR. 4-5**

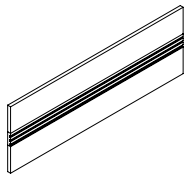

**Tackboard - Accessory Rail, Wallmounted**

	<b>D x W x H</b>						
TSAS108	1 x 106 x 20	92.5	23	2		<b>\$2258</b>	<b>\$2826</b>
TSAS102	1 x 100 x 20	100	19	2		<b>\$2138</b>	<b>\$2668</b>
TSAS96	1 x 94 x 20	70	15	1		<b>\$2003</b>	<b>\$2509</b>
TSAS90	1 x 88 x 20	70	15	1		<b>\$1880</b>	<b>\$2353</b>
TSAS84	1 x 82 x 20	85	14	1		<b>\$1753</b>	<b>\$2194</b>
TSAS78	1 x 76 x 20	85	13	1		<b>\$1633</b>	<b>\$2043</b>
TSAS72	1 x 70 x 20	85	12	1		<b>\$1504</b>	<b>\$1884</b>
TSAS66	1 x 64 x 20	92.5	11	1		<b>\$1383</b>	<b>\$1733</b>
TSAS60	1 x 58 x 20	92.5	10	1		<b>\$1254</b>	<b>\$1569</b>
TSAS36	1 x 34 x 20	125	6	1		<b>\$752</b>	<b>\$938</b>
TSAS30	1 x 28 x 20	150	4	1		<b>\$584</b>	<b>\$732</b>

For use on **16.5"H** overhead storage (**CSFO\_**, **CSF\_**) at a finished height of **66"**. See "tackboard notes" exact fabric availability. List Price shown applies for all fabric grades.

- **Must Specify Black (E) or Tungsten (K) Accessory Rail finish.**
- **NOTE:** Care should be taken to mount the units. Units should be mounted to wall studs using correct fasteners. Failure to do so may result in collapse of the unit and subsequent personal injury. **Mounting hardware not included.** Mounting hardware used should be based on wall material. Consult an installation professional for proper wall mounting.

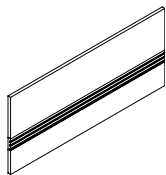

**Tackboard - Accessory Rail, Wallmounted**

TSAS108H26	1 x 106 x 26	70	23	2		<b>\$2715</b>	<b>\$3395</b>
TSAS102H26	1 x 100 x 26	85	19	2		<b>\$2560</b>	<b>\$3201</b>
TSAS96H26	1 x 94 x 26	92.5	15	1		<b>\$2405</b>	<b>\$3010</b>
TSAS90H26	1 x 88 x 26	92.5	15	1		<b>\$2265</b>	<b>\$2833</b>
TSAS78H26	1 x 76 x 26	100	13	1		<b>\$1955</b>	<b>\$2445</b>
TSAS72H26	1 x 70 x 26	70	12	1		<b>\$1779</b>	<b>\$2226</b>
TSAS66H26	1 x 64 x 26	85	11	1		<b>\$1661</b>	<b>\$2072</b>
TSAS60H26	1 x 58 x 26	85	10	1		<b>\$1504</b>	<b>\$1884</b>
TSAS36H26	1 x 34 x 26	100	6	1		<b>\$907</b>	<b>\$1137</b>
TSAS30H26	1 x 28 x 26	150	4	1		<b>\$758</b>	<b>\$950</b>

For use on **16.5"H** overhead storage (**CSFO\_**, **CSF\_**) at a finished height of **72"**. See "tackboard notes" exact fabric availability. List Price shown applies for all fabric grades.

- **Must Specify Black (E) or Tungsten (K) Accessory Rail finish.**
- **NOTE:** Care should be taken to mount the units. Units should be mounted to wall studs using correct fasteners. Failure to do so may result in collapse of the unit and subsequent personal injury. **Mounting hardware not included.** Mounting hardware used should be based on wall material. Consult an installation professional for proper wall mounting.

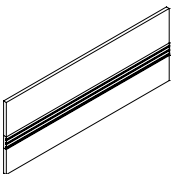

**Tackboard - Accessory Rail, Wallmounted**

TSPAS108H23	1 x 106 x 23	92.5	30	2		<b>\$2447</b>	<b>\$3061</b>
TSPAS102H23	1 x 100 x 23	100	24	2		<b>\$2324</b>	<b>\$2909</b>
TSPAS96H23	1 x 94 x 23	70	20	2		<b>\$2185</b>	<b>\$2734</b>
TSPAS90H23	1 x 88 x 23	70	20	2		<b>\$2042</b>	<b>\$2555</b>
TSPAS84H23	1 x 82 x 23	85	18	2		<b>\$1908</b>	<b>\$2390</b>
TSPAS78H23	1 x 76 x 23	85	17	2		<b>\$1773</b>	<b>\$2217</b>
TSPAS72H23	1 x 70 x 23	85	16	1		<b>\$1640</b>	<b>\$2053</b>
TSPAS66H23	1 x 64 x 23	92.5	14	1		<b>\$1504</b>	<b>\$1884</b>
TSPAS60H23	1 x 58 x 23	92.5	13	1		<b>\$1363</b>	<b>\$1704</b>
TSPAS36H23	1 x 34 x 23	125	8	1		<b>\$682</b>	<b>\$856</b>
TSPAS30H23	1 x 28 x 23	150	5	1		<b>\$665</b>	<b>\$828</b>

For use on **19.5"H** overhead storage (**CSFOP\_**, **CSFP\_**) with Pigeon-Hole Storage at a finished height of **72"**. See "tackboard notes" exact fabric availability. List Price shown applies for all fabric grades.

- **Must Specify Black (E) or Tungsten (K) Accessory Rail finish.**
- **NOTE:** Care should be taken to mount the units. Units should be mounted to wall studs using correct fasteners. Failure to do so may result in collapse of the unit and subsequent personal injury. **Mounting hardware not included.** Mounting hardware used should be based on wall material. Consult an installation professional for proper wall mounting.

**Required Specifications**

Fabric

WALLMOUNT TACKBOARDS

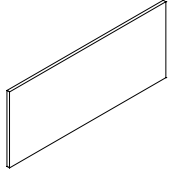

Tackboard - Wallmounted

MODEL#	DIMENSIONS D x W x H	FREIGHT CLASS	WT/LBS.	CUBIC FT.	GR. 1-3	GR. 4-5
TS108H25	1 x 106 x 25	92.5	23	2	\$1608	\$2007
TS102H25	1 x 100 x 25	100	19	2	\$1511	\$1892
TS96H25	1 x 94 x 25	70	17	1	\$1424	\$1777
TS90H25	1 x 88 x 25	70	15	1	\$1335	\$1671
TS84H25	1 x 82 x 25	85	14	1	\$1250	\$1564
TS78H25	1 x 76 x 25	85	13	1	\$1154	\$1444
TS72H25	1 x 70 x 25	85	12	1	\$1067	\$1338
TS66H25	1 x 64 x 25	92.5	11	1	\$980	\$1226
TS60H25	1 x 58 x 25	92.5	10	1	\$893	\$1120

For use on **16.5"H** overhead storage (CSFO\_, CSF\_) mounted above 23"H credenzas for a **finished height of 66"**. See "tackboard notes" exact fabric availability. List Price shown applies for all fabric grades

- **NOTE:** Care should be taken to mount the units. Units should be mounted to wall studs using correct fasteners. Failure to do so may result in collapse of the unit and subsequent personal injury. **Mounting hardware not included.** Mounting hardware used should be based on wall material. Consult an installation professional for proper wall mounting.

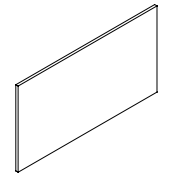

Tackboard - Wallmounted

TS108H32	1 x 106 x 32	70	30	2	\$2057	\$2566
TS102H32	1 x 100 x 32	85	24	2	\$1936	\$2422
TS96H32	1 x 94 x 32	92.5	20	2	\$1827	\$2288
TS90H32	1 x 88 x 32	92.5	20	2	\$1714	\$2145
TS84H32	1 x 82 x 32	100	18	2	\$1592	\$1995
TS78H32	1 x 76 x 32	100	17	2	\$1477	\$1849
TS72H32	1 x 70 x 32	70	16	1	\$1363	\$1704
TS66H32	1 x 64 x 32	85	14	1	\$1254	\$1569
TS60H32	1 x 58 x 32	85	13	1	\$1143	\$1430

For use on **16.5"H** overhead storage (CSFO\_, CSF\_) mounted above 23"H credenzas for a **finished height of 72"**. See "tackboard notes" exact fabric availability. List Price shown applies for all fabric grades

- **NOTE:** Care should be taken to mount the units. Units should be mounted to wall studs using correct fasteners. Failure to do so may result in collapse of the unit and subsequent personal injury. **Mounting hardware not included.** Mounting hardware used should be based on wall material. Consult an installation professional for proper wall mounting.

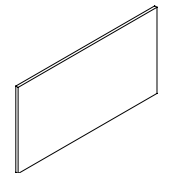

Tackboard - Wallmounted

TSP108H29	1 x 106 x 29	70	30	2	\$1859	\$2326
TSP102H29	1 x 100 x 29	85	24	2	\$1753	\$2194
TSP96H29	1 x 94 x 29	70	20	2	\$1651	\$2068
TSP90H29	1 x 88 x 29	70	20	2	\$1551	\$1940
TSP84H29	1 x 82 x 29	70	18	2	\$1444	\$1807
TSP78H29	1 x 76 x 29	70	17	2	\$1345	\$1676
TSP72H29	1 x 70 x 29	70	16	1	\$1236	\$1547
TSP66H29	1 x 64 x 29	85	14	1	\$1143	\$1430
TSP60H29	1 x 58 x 29	85	13	1	\$1034	\$1294

For use on **16.5"H** overhead storage (CSFO\_, CSF\_) mounted above 23"H credenzas for a **finished height of 72"**. See "tackboard notes" exact fabric availability. List Price shown applies for all fabric grades

- **NOTE:** Care should be taken to mount the units. Units should be mounted to wall studs using correct fasteners. Failure to do so may result in collapse of the unit and subsequent personal injury. **Mounting hardware not included.** Mounting hardware used should be based on wall material. Consult an installation professional for proper wall mounting.

Required Specifications

Fabric

**WALLMOUNT TACKBOARDS**      **MODEL#**      **DIMENSIONS**      **FREIGHT CLASS**      **WT/LBS.**      **CUBIC FT.**      **GR. 1-3**      **GR. 4-5**

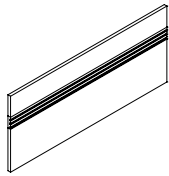

**Tackboard - Accessory Rail, Wallmounted**

	<b>D x W x H</b>						
TSAS108H25	1 x 106 x 25	92.5	23	2		<b>\$2615</b>	<b>\$3270</b>
TSAS102H25	1 x 100 x 25	100	19	2		<b>\$2457</b>	<b>\$3075</b>
TSAS96H25	1 x 94 x 25	70	15	1		<b>\$2310</b>	<b>\$2893</b>
TSAS90H25	1 x 88 x 25	70	15	1		<b>\$2176</b>	<b>\$2724</b>
TSAS78H25	1 x 76 x 25	85	13	1		<b>\$1880</b>	<b>\$2353</b>
TSAS72H25	1 x 70 x 25	85	12	1		<b>\$1707</b>	<b>\$2137</b>
TSAS66H25	1 x 64 x 25	92.5	11	1		<b>\$1598</b>	<b>\$2003</b>
TSAS60H25	1 x 58 x 25	92.5	10	1		<b>\$1452</b>	<b>\$1817</b>

For use on **16.5"H** overhead storage (**CSFO\_**, **CSF\_**) mounted above 23"H credenzas for a **finished height of 66"**. See "tackboard notes" exact fabric availability. List Price shown applies for all fabric grades

- **Must Specify Black (E) or Tungsten (K) Accessory Rail finish.**
- **NOTE:** Care should be taken to mount the units. Units should be mounted to wall studs using correct fasteners. Failure to do so may result in collapse of the unit and subsequent personal injury. **Mounting hardware not included.** Mounting hardware used should be based on wall material. Consult an installation professional for proper wall mounting.

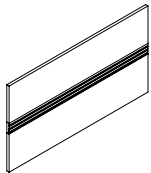

**Tackboard - Accessory Rail, Wallmounted**

TSAS108H32	1 x 106 x 32	70	23	2		<b>\$3341</b>	<b>\$4178</b>
TSAS102H32	1 x 100 x 32	85	19	2		<b>\$3143</b>	<b>\$3930</b>
TSAS96H32	1 x 94 x 32	92.5	15	1		<b>\$2962</b>	<b>\$3707</b>
TSAS90H32	1 x 88 x 32	92.5	15	1		<b>\$2791</b>	<b>\$3485</b>
TSAS78H32	1 x 76 x 32	100	13	1		<b>\$2405</b>	<b>\$3010</b>
TSAS72H32	1 x 70 x 32	70	12	1		<b>\$2185</b>	<b>\$2734</b>
TSAS66H32	1 x 64 x 32	85	11	1		<b>\$2042</b>	<b>\$2555</b>
TSAS60H32	1 x 58 x 32	85	10	1		<b>\$1855</b>	<b>\$2320</b>

For use on **16.5"H** overhead storage (**CSFO\_**, **CSF\_**) mounted above 23"H credenzas for a **finished height of 72"**. See "tackboard notes" exact fabric availability. List Price shown applies for all fabric grades

- **Must Specify Black (E) or Tungsten (K) Accessory Rail finish.**
- **NOTE:** Care should be taken to mount the units. Units should be mounted to wall studs using correct fasteners. Failure to do so may result in collapse of the unit and subsequent personal injury. **Mounting hardware not included.** Mounting hardware used should be based on wall material. Consult an installation professional for proper wall mounting.

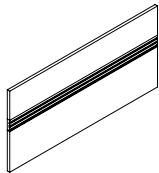

**Tackboard - Accessory Rail, Wallmounted**

TSPAS108H29	1 x 106 x 29	70	30	2		<b>\$3031</b>	<b>\$3791</b>
TSPAS102H29	1 x 100 x 29	85	24	2		<b>\$2849</b>	<b>\$3559</b>
TSPAS96H29	1 x 94 x 29	70	20	2		<b>\$2682</b>	<b>\$3350</b>
TSPAS90H29	1 x 88 x 29	70	20	2		<b>\$2526</b>	<b>\$3161</b>
TSPAS78H29	1 x 76 x 29	70	17	2		<b>\$2185</b>	<b>\$2734</b>
TSPAS72H29	1 x 70 x 29	70	16	1		<b>\$1980</b>	<b>\$2480</b>
TSPAS66H29	1 x 64 x 29	85	14	1		<b>\$1855</b>	<b>\$2320</b>
TSPAS60H29	1 x 58 x 29	85	13	1		<b>\$1678</b>	<b>\$2103</b>

For use on **16.5"H** overhead storage (**CSFO\_**, **CSF\_**) mounted above 23"H credenzas for a **finished height of 72"**. See "tackboard notes" exact fabric availability. List Price shown applies for all fabric grades

- **Must Specify Black (E) or Tungsten (K) Accessory Rail finish.**
- **NOTE:** Care should be taken to mount the units. Units should be mounted to wall studs using correct fasteners. Failure to do so may result in collapse of the unit and subsequent personal injury. **Mounting hardware not included.** Mounting hardware used should be based on wall material. Consult an installation professional for proper wall mounting.

**Required Specifications**

Fabric

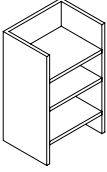
PIGEON-HOLE STORAGE	MODEL#	DIMENSIONS	FREIGHT CLASS	WT/LBS.	CUBIC FT.	LIST PRICE
 <p><b>Vertical Pigeon-Hole Storage*</b></p> <p>Used in conjunction with overhead storage units and hutches that incorporate horizontal pigeon-hole storage. Not freestanding. Shipped RTA (ready to assemble).</p>	<b>D x W x H</b>					
	CPH161226	12 x 16 x 26	125	20	3	<b>\$753</b>
	CPH161223	12 x 16 x 23	125	18	3	<b>\$639</b>
	CPH161219	12 x 16 x 19	125	15	2	<b>\$486</b>
	CPH131226	12 x 13 x 26	100	16	2	<b>\$613</b>
	CPH131223	12 x 13 x 23	125	15	2	<b>\$520</b>
	CPH131219	12 x 13 x 19	125	12	2	<b>\$392</b>

ACCESSORY RAIL/PANEL ORGANIZERS						
<b>Available Finishes:</b>	BLK	Black	SIL	Silver		
	CHR	Charcoal	TPE	Taupe		
	DWT	Designer White	TUN	Tungsten		
	NEV	Nevada				

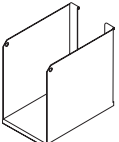
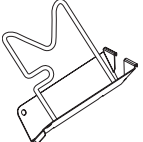
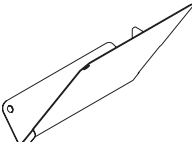
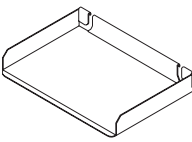
ACCESSORIES	MODEL#	DIMENSIONS	FREIGHT CLASS	WT/LBS.	CUBIC FT.	LIST PRICE
 <p><b>Binder Bin**</b></p> <p>Load bar/accessory rail mounted metal binder bin.</p>	BABB01	10.25 x 4 x 9	100	2	.21	<b>\$75</b>
	 <p><b>Flip Sorter**</b></p> <p>Load bar/accessory rail mounted metal flip sorter. Comes with chrome wire.</p>	BAFS01	9.25 x 2.75 x 9.25	70	.06	.14
 <p><b>Slant Sorter</b></p> <p>Load bar/accessory rail mounted metal slant sorter.</p>		BASS01L	10.25 x 5 x 9.5	70	1	.28
		BASS01R	10.25 x 5 x 9.5	70	1	.28
 <p><b>Letter Tray</b></p> <p>Load bar/accessory rail mounted metal letter tray.</p>	BALTO1	9.25 x 13.5 x 2	70	.50	.15	<b>\$62</b>

**Required Specifications**

- Fabric
- Veneer finish\*
- Metal finish\*\*

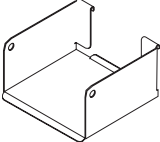
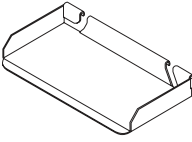
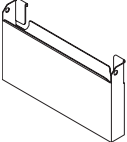
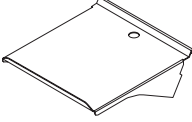
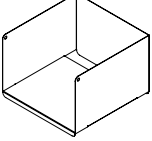
ACCESSORY RAIL/ PANEL ORGANIZERS	MODEL#	DIMENSIONS D x W x H	FREIGHT CLASS	WT/LBS.	CUBIC FT.	LIST PRICE
 <p><b>Media Bin</b></p>	BAMB01	5.25 x 5.75 x 3	70	.08	.05	<b>\$62</b>
Load bar/accessory rail mounted metal media bin.						
 <p><b>Utility Tray</b></p>	BAUT01	3.75 x 5.75 x 3	70	.05	.02	<b>\$41</b>
Load bar/accessory rail mounted metal utility tray.						
 <p><b>Mail Box</b></p>	BAPP01	2.75 x 16 x 9	100	2	.25	<b>\$94</b>
Load bar/accessory rail mounted metal mail box.						
 <p><b>Telephone Holder</b></p>	BATH01	10 x 9 x 2	125	2	.26	<b>\$91</b>
Load bar/accessory rail mounted metal telephone holder.						
 <p><b>Elevated Shelf Binder Bin</b></p>	BRTEBBIN	12 x 12 x 8	100	6	.66	<b>\$193</b>
Load bar/accessory rail mounted elevated shelf binder bin.						

**Required Specifications**  
Metal finish

## RECEPTION DESKS

### MODEL#

### DIMENSIONS

### FREIGHT CLASS

### WT./LBS.

### CUBIC FT.

### LIST PRICE

D x W x H

- To add storage use storage shells. See page 306 .
- Includes GM1 grommet.
- Transaction tops to be specified separately, handed by square edge from user side.
- Decorative Front Panels should be specified separately. Size chosen should be 12" less than desk dimensions. Available in Reverse Diamond, Vertical Rib, Vertical Grain and Horizontal Grain Patterns.

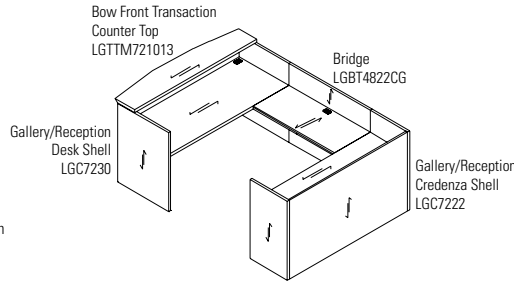
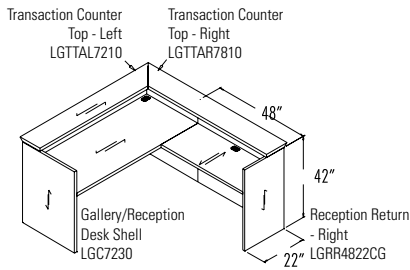

### OPTION DETAILS

Decorative Front Panel (Reverse Diamond Pattern)  
GFDP5430F

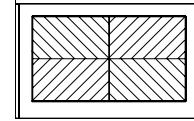

Decorative Front Panel (Vertical Rib Pattern)  
GFDP5430RIB

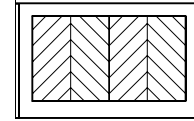

## RECEPTION DESKS

### MODEL#

### DIMENSIONS

### FREIGHT CLASS

### WT./LBS.

### CUBIC FT.

### LIST PRICE

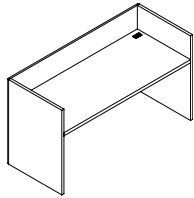

**Gallery/Reception Desk Shell**

LGC10836	36 x 108 x 42	150	533	95	<b>\$7934</b>
LGC10236	36 x 102 x 42	150	503	89	<b>\$7493</b>
LGC9636	36 x 96 x 42	150	473	84	<b>\$7053</b>
LGC9036	36 x 90 x 42	150	444	79	<b>\$6612</b>
LGC8436	36 x 84 x 42	150	414	74	<b>\$6173</b>
LGC7236	36 x 72 x 42	150	355	63	<b>\$5291</b>
LGC7230	30 x 72 x 42	150	315	53	<b>\$5122</b>
LGC6630	30 x 66 x 42	125	295	48	<b>\$4612</b>
LGC6030	30 x 60 x 42	125	275	44	<b>\$4995</b>

No pedestals. Two grommets in worksurface. For use with modular storage components. Ships assembled in 1 carton.

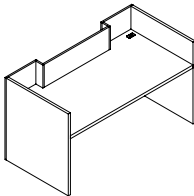

**Gallery/Reception Desk Shell  
Breakfront Style**

LGIC10836	36 x 108 x 42	150	533	95	<b>\$9757</b>
LGIC10236	36 x 102 x 42	150	503	89	<b>\$9205</b>
LGIC9636	36 x 96 x 42	150	473	84	<b>\$8675</b>
LGIC9036	36 x 90 x 42	150	444	79	<b>\$8128</b>
LGIC8436	36 x 84 x 42	150	414	74	<b>\$7595</b>
LGIC7236	36 x 72 x 42	150	355	63	<b>\$6497</b>
LGIC7230	30 x 72 x 42	150	315	53	<b>\$6291</b>
LGIC6630	30 x 66 x 42	125	295	48	<b>\$6132</b>
LGIC6030	30 x 60 x 42	125	275	44	<b>\$5779</b>

No pedestals. Two grommets in worksurface. For use with modular storage components. Ships assembled in 1 carton.

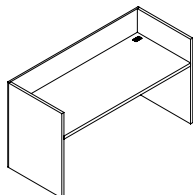

**Gallery/Reception Credenza Shell**

LGC10824	24 x 108 x 42	150	353	63	<b>\$6219</b>
LGC10224	24 x 102 x 42	150	333	60	<b>\$5881</b>
LGC9624	24 x 96 x 42	150	314	56	<b>\$5526</b>
LGC9024	24 x 90 x 42	150	294	53	<b>\$5177</b>
LGC8424	24 x 84 x 42	150	274	49	<b>\$4841</b>
LGC7224	24 x 72 x 42	150	235	42	<b>\$4154</b>
LGC6624	24 x 66 x 42	150	216	39	<b>\$3898</b>
LGC6024	24 x 60 x 42	150	196	35	<b>\$3652</b>

No pedestals. Two grommets in worksurface. For use with modular storage components. Ships assembled in 1 carton.

### Required Specifications

Metal Finish (Accessories)  
Veneer Finish  
Edge

**RECEPTION DESKS**

MODEL#	DIMENSIONS D x W x H	FREIGHT CLASS	WT/LBS.	CUBIC FT.	LIST PRICE
LGBT5624CG	24 x 56 x 42	150	178	32	\$3485
LGBT5424CG	24 x 54 x 42	150	169	29	\$3485
LGBT5024CG	24 x 50 x 42	150	151	27	\$3091
LGBT4824CG	24 x 48 x 42	150	142	26	\$3091
LGBT4424CG	24 x 44 x 42	150	134	23	\$2715
LGBT4224CG	24 x 42 x 42	150	127	22	\$2715
LGBT3824CG	24 x 38 x 42	150	119	20	\$2440
LGBT3624CG	24 x 36 x 42	150	112	19	\$2440

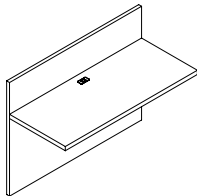

**Bridge**

Attaches between **Gallery Desk and Gallery Credenza Only**. One grommet in center of worksurface. Ships assembled in 1 carton.

- To remove cross-grain veneer pattern on top, **delete "CG"** from model number. Available as a special - no upcharge.

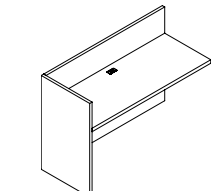

**Reception Return - LEFT**

LGRL7224	24 x 72 x 42	125	273	42	\$5219
LGRL6624	24 x 66 x 42	125	250	39	\$4794
LGRL6024	24 x 60 x 42	125	228	35	\$4363
LGRL5424	24 x 54 x 42	125	205	32	\$3921
LGRL4824	24 x 48 x 42	125	182	28	\$3485
LGRL4224	24 x 42 x 42	125	159	25	\$3053
LGRL3624	24 x 36 x 42	125	137	21	\$2739

No pedestal. One grommet in center of worksurface. For use with modular storage components. Ships assembled in 1 carton.

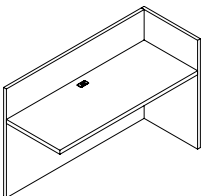

**Reception Return - RIGHT**

LGRR7224	24 x 72 x 42	125	273	42	\$5219
LGRR6624	24 x 66 x 42	125	250	39	\$4794
LGRR6024	24 x 60 x 42	125	228	35	\$4363
LGRR5424	24 x 54 x 42	125	205	32	\$3921
LGRR4824	24 x 48 x 42	125	182	28	\$3485
LGRR4224	24 x 42 x 42	125	159	25	\$3053
LGRR3624	24 x 36 x 42	125	137	21	\$2739

No pedestal. One grommet in center of worksurface. For use with modular storage components. Ships assembled in 1 carton.

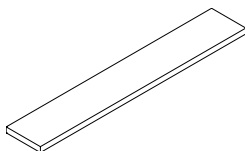

**Transaction Counter Top**

LGTT10810	10 x 108 x 1.50	100	78	8	\$1476
LGTT10210	10 x 102 x 1.50	92.5	72	7	\$1398
LGTT9610	10 x 96 x 1.50	100	66	7	\$1316
LGTT9010	10 x 90 x 1.50	92.5	60	6	\$1234
LGTT8410	10 x 84 x 1.50	100	54	6	\$1154
LGTT7210	10 x 72 x 1.50	100	48	5	\$978
LGTT6610	10 x 66 x 1.50	100	42	5	\$898
LGTT6010	10 x 60 x 1.50	100	36	4	\$816

**Rectangular top** for main reception desk. Counter sits on top of Gallery panels. Does not overhang. **Factory installed - specify Gallery to be used on.** Size must match dimension of desk front or combined desk side and return length. Hardware included.

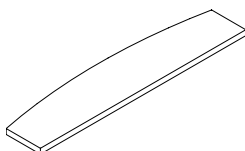

**Bow Front Transaction Counter Top**

LGTTM1081013	10-13 x 108 x 1.50	125	78	10	\$2315
LGTTM1021013	10-13 x 102 x 1.50	100	72	9	\$2190
LGTTM961013	10-13 x 96 x 1.50	125	66	9	\$2058
LGTTM901013	10-13 x 90 x 1.50	125	60	8	\$1925
LGTTM841013	10-13 x 84 x 1.50	125	54	8	\$1799
LGTTM721013	10-13 x 72 x 1.50	125	48	7	\$1547
LGTTM661013	10-13 x 66 x 1.50	125	42	6	\$1416
LGTTM601013	10-13 x 60 x 1.50	125	36	5	\$1284

**Bow top** for main reception desk. Counter sits on top of Gallery panels. Bow front overhangs 3". **Factory installed - specify Gallery to be used on.** Size must match dimension of desk front or combined desk side and return length. Hardware included.

**Required Specifications**  
 Veneer Finish  
 Edge

## TRANSACTION COUNTERS

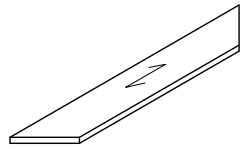

**Trapezoid Transaction Counter Top**

MODEL#	DIMENSIONS D x W x H	FREIGHT CLASS	WT/LBS.	CUBIC FT.	LIST PRICE
LGTTA10810	10 x 108 x 1.50	100	78	8	<b>\$1859</b>
LGTTA10210	10 x 102 x 1.50	92.5	72	7	<b>\$1763</b>
LGTTA9610	10 x 96 x 1.50	100	66	7	<b>\$1672</b>
LGTTA9010	10 x 90 x 1.50	92.5	60	6	<b>\$1581</b>
LGTTA8410	10 x 84 x 1.50	100	54	6	<b>\$1490</b>
LGTTA7210	10 x 72 x 1.50	100	48	5	<b>\$1314</b>
LGTTA6610	10 x 66 x 1.50	100	42	5	<b>\$1218</b>
LGTTA6010	10 x 60 x 1.50	100	36	4	<b>\$1127</b>

**Trapezoid top** for main reception desk. 45° mitered ends on left and right. For use with left and right 45° mitered return transaction counters. Counter sits on top of Gallery panels. Does not overhang. **Factory installed - specify Gallery to be used on.** Size must match dimension of desk front or combined desk side and return length. Hardware included.

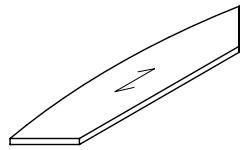

**Bow Front Trapezoid Transaction Counter Top**

LGTTMA1081013	10-13 x 108 x 1.50	125	78	10	<b>\$2551</b>
LGTTMA1021013	10-13 x 102 x 1.50	100	72	9	<b>\$2455</b>
LGTTMA961013	10-13 x 96 x 1.50	125	66	9	<b>\$2364</b>
LGTTMA901013	10-13 x 90 x 1.50	125	60	8	<b>\$2273</b>
LGTTMA841013	10-13 x 84 x 1.50	125	54	8	<b>\$2182</b>
LGTTMA721013	10-13 x 72 x 1.50	125	48	7	<b>\$2000</b>
LGTTMA661013	10-13 x 66 x 1.50	125	42	6	<b>\$1910</b>
LGTTMA601013	10-13 x 60 x 1.50	125	36	5	<b>\$1819</b>

**Trapezoid bow top** for main reception desk. 45° mitered ends on left and right. For use with left and right 45° mitered return transaction counters. Counter sits on top of Gallery panels. Bow front overhangs 3". **Factory installed - specify Gallery to be used on.** Size must match dimension of desk front or combined desk side and return length. Hardware included.

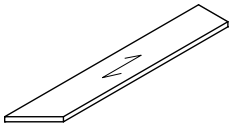

**Transaction Counter Top - RIGHT**

LGTTAR10810	10 x 108 x 1.50	100	78	8	<b>\$1778</b>
LGTTAR10210	10 x 102 x 1.50	92.5	72	7	<b>\$1692</b>
LGTTAR9610	10 x 96 x 1.50	100	66	7	<b>\$1596</b>
LGTTAR9010	10 x 90 x 1.50	92.5	60	6	<b>\$1506</b>
LGTTAR8410	10 x 84 x 1.50	100	54	6	<b>\$1415</b>
LGTTAR7210	10 x 72 x 1.50	100	48	5	<b>\$1233</b>
LGTTAR6610	10 x 66 x 1.50	100	42	5	<b>\$1142</b>
LGTTAR6010	10 x 60 x 1.50	100	36	4	<b>\$1051</b>

**Rectangular top** for main reception desk with 45° mitered end on **right**. For use with rectangular or bow front transaction counters with miters at both ends. **Factory installed - specify Gallery to be used on.** Size must match dimension of desk front or combined desk side and return length. Hardware included.

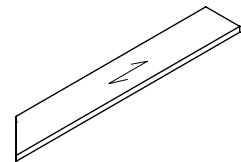

**Transaction Counter Top - LEFT**

LGTTAL10810	10 x 108 x 1.50	100	78	8	<b>\$1778</b>
LGTTAL10210	10 x 102 x 1.50	92.5	72	7	<b>\$1692</b>
LGTTAL9610	10 x 96 x 1.50	100	66	7	<b>\$1596</b>
LGTTAL9010	10 x 90 x 1.50	92.5	60	6	<b>\$1506</b>
LGTTAL8410	10 x 84 x 1.50	100	54	6	<b>\$1415</b>
LGTTAL7210	10 x 72 x 1.50	100	48	5	<b>\$1233</b>
LGTTAL6610	10 x 66 x 1.50	100	42	5	<b>\$1142</b>
LGTTAL6010	10 x 60 x 1.50	100	36	4	<b>\$1051</b>

**Rectangular top** for main reception desk with 45° mitered end on **left**. For use with rectangular or bow front transaction counters with miters at both ends. **Factory installed - specify Gallery to be used on.** Size must match dimension of desk front or combined desk side and return length. Hardware included.

### Required Specifications

Veneer Finish  
Edge

**TRANSACTION COUNTERS**      **MODEL#**      **DIMENSIONS**      **FREIGHT CLASS**      **WT/LBS.**      **CUBIC FT.**      **LIST PRICE**

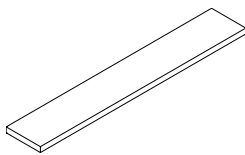

**Transaction Counter Top - Glass**

	<b>D x W x H</b>					
GTT10810G	10 x 108 x 1.50	100	78	8		<b>\$3367</b>
GTT10210G	10 x 102 x 1.50	92.5	72	7		<b>\$3241</b>
GTT9610G	10 x 96 x 1.50	100	66	7		<b>\$3113</b>
GTT9010G	10 x 90 x 1.50	92.5	60	6		<b>\$2988</b>
GTT8410G	10 x 84 x 1.50	100	54	6		<b>\$2864</b>
GTT7210G	10 x 72 x 1.50	100	48	5		<b>\$2679</b>
GTT6610G	10 x 66 x 1.50	100	42	5		<b>\$2554</b>
GTT6010G	10 x 60 x 1.50	100	36	4		<b>\$2430</b>

**Rectangular top** for main reception desk. Counter sits on top of Gallery panels. Does not overhang. **Factory installed - specify Gallery to be used on.** Size must match dimension of desk front or combined desk side and return length. Hardware included. 3/4" clear glass over wood subtop.

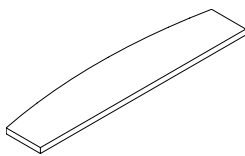

**Bow Front Transaction Counter Top - Glass**

GTTM1081013G	10-13 x 108 x 1.50	125	78	10		<b>\$4154</b>
GTTM1021013G	10-13 x 102 x 1.50	100	72	9		<b>\$4075</b>
GTTM961013G	10-13 x 96 x 1.50	125	66	9		<b>\$4035</b>
GTTM901013G	10-13 x 90 x 1.50	125	60	8		<b>\$3858</b>
GTTM841013G	10-13 x 84 x 1.50	125	54	8		<b>\$3669</b>
GTTM721013G	10-13 x 72 x 1.50	125	48	7		<b>\$3372</b>
GTTM661013G	10-13 x 66 x 1.50	125	42	6		<b>\$3184</b>
GTTM601013G	10-13 x 60 x 1.50	125	36	5		<b>\$3006</b>

**Bow top** for main reception desk. Counter sits on top of Gallery panels. Bow front overhangs 3". **Factory installed - specify Gallery to be used on.** Size must match dimension of desk front or combined desk side and return length. Hardware included. 3/4" clear glass over wood subtop.

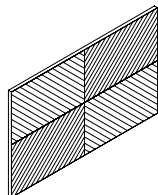

**Decorative Front Panel Reverse Diamond Pattern**

GFDP9630F	1 x 96 x 30	92.5	81	8		<b>\$1904</b>
GFDP9030F	1 x 90 x 30	100	78	8		<b>\$1783</b>
GFDP8430F	1 x 84 x 30	92.5	72	7		<b>\$1663</b>
GFDP7230F	1 x 72 x 30	100	66	7		<b>\$1429</b>
GFDP6030F	1 x 60 x 30	92.5	60	6		<b>\$1194</b>
GFDP5430F	1 x 54 x 30	100	54	6		<b>\$1073</b>
GFDP4830F	1 x 48 x 30	100	48	5		<b>\$956</b>

Raised decorative front panel for a reception desk. Size should be 12" less than desk dimensions. **Factory installed.** Hardware included.

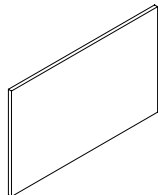

**Decorative Front Panel Vertical Grain Pattern**

GFDP9630V	1 x 96 x 30	92.5	81	8		<b>\$1660</b>
GFDP9030V	1 x 90 x 30	100	78	8		<b>\$1556</b>
GFDP8430V	1 x 84 x 30	92.5	72	7		<b>\$1453</b>
GFDP7230V	1 x 72 x 30	100	66	7		<b>\$1241</b>
GFDP6030V	1 x 60 x 30	92.5	60	6		<b>\$1035</b>
GFDP5430V	1 x 54 x 30	100	54	6		<b>\$937</b>
GFDP4830V	1 x 48 x 30	100	48	5		<b>\$828</b>

Raised decorative front panel for a reception desk. Size should be 12" less than desk dimensions. **Factory installed.** Hardware included.

**Required Specifications**

Veneer Finish\*  
Edge\*

**Optional Specifications**

Grommet\*

## RECEPTION DESKS - CURVED

## MODEL# DIMENSIONS FREIGHT CLASS WT/LBS. CUBIC FT. LIST PRICE

D x W x H

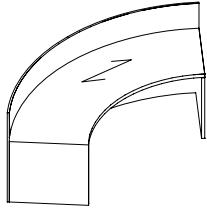

Gallery/Reception Curved Desk Shell\*\*

LGCCUS10630H36	30 x 106 x 36	100	647	72	<b>\$14621</b>
LGCCUS10630H42	30 x 106 x 42	100	592	66	<b>\$16815</b>

No pedestals. For use with modular storage components. Ships assembled in 1 carton.

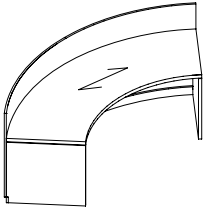

Gallery/Reception Curved Desk Shell\*\*

LGCKCUS10630H36	30 x 106 x 36	100	647	72	<b>\$15350</b>
LGCKCUS10630H42	30 x 106 x 42	100	592	66	<b>\$17655</b>

Includes recessed kick plate. No pedestals. For use with modular storage components. Ships assembled in 1 carton.

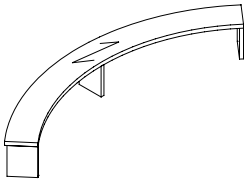

Wood Curved Transaction Counter\*

LGTTMCUS10610	10 x 106 x 1.5	150	84	19	<b>\$6633</b>
---------------	----------------	-----	----	----	---------------

Curved wood transaction top. Ships assembled in 1 carton.

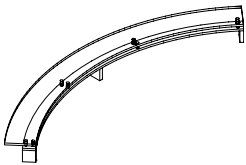

Glass Curved Transaction Counter

GCCCUS10610G	10 x 106 x 0.75	150	84	19	<b>\$12166</b>
--------------	-----------------	-----	----	----	----------------

3/4" clear glass bow front transaction counter over wood subtop. Ships assembled in 1 carton.

**Required Specifications**

Veneer Finish\*

Edge\*

# philadelphia





Philadelphia detailing is traditional with a 1" overhang on all edges. Solid walnut, cherry, maple, oak that bands worksurface perimeter is 1" wide by 1-3/8" thick for an overall thickness of 1-3/8". Philadelphia is a "top over pedestal" detailed series. Philadelphia is standard with a base. Floor storage unit bases (i.e. kick-plates on pedestals, lateral files, bookcases, etc.) are extended out over drawer faces and horizontally grained. Products that are normally positioned against walls, such as credenzas, have a self-edge veneered back edge detail. All primary faces have pin molding decorations.

This elegantly designed traditional furniture series employs state-of-the-art manufacturing to create traditional pieces for executive offices, conference rooms and reception areas. Philadelphia is characterized by solid-wood edge detailing with solid-wood moldings on the cases and brass hardware throughout. The finest clear hardwoods are hand-selected to ensure that the best quality and consistency is achieved. Each piece is protected with a catalyzed conversion varnish to provide one of the most durable finishes in the industry. Philadelphia makes a truly impressive statement for the discerning customer.



**Features and Benefits**

- Philadelphia is a traditional collection characterized by craftsmanship and elegance
- Solid-wood edge detailing with solid-wood moldings on the cases and brass hardware throughout
- Drawers are standard vinyl-wrapped construction with black drawer sides and bottom.
- Pedestals feature antique brass handles, profiled drawer fronts and maple drawer interiors.
- The base is profiled, with pin moldings on desk fronts and sides.
- Bronze glass is standard with clear glass available as an option.
- Modesty panel upgrades are available on select models.

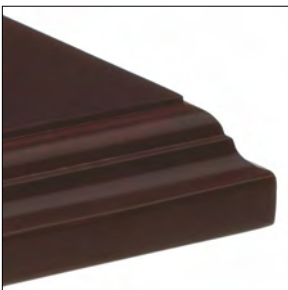

1-3/8" thick solid hardwood edge

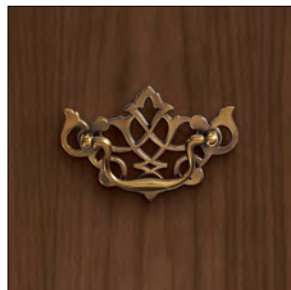

Antique brass pull (PL40)

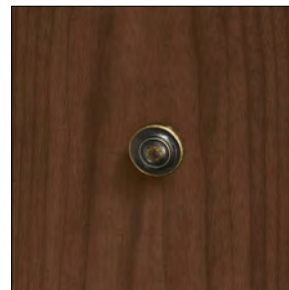

Knob on uppers (DK25)

**GENERAL INFORMATION**

- Philadelphia is comprised of hundreds of models for the traditional executive suite and coordinating meeting areas.
- Solid wood is used on all perimeter worksurface edges, as well as end panel bottoms for mounting leveling glides
- 1" overhang with a traditional detailing is featured on all user and approach sides.
- Brass bulls exclusive to Philadelphia detail the traditional style of the product.
- GM5 grommets are standard on all designated worksurfaces.
- **Level certified**

**CONSTRUCTION**

- Number One select, architectural grade "A" oak, American black walnut, American black cherry or maple. Wood worksurface molded edges are solid oak, walnut, cherry, or maple.
- Traditional detailing with 1" overhang on all edges.
- Solid walnut, cherry, maple, oak that bands worksurface perimeter is 1" wide by 1-3/8" thick for an overall thickness of 1-3/8".

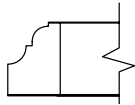

**Edge detail**

- Top over pedestal design
- Products that are normally positioned against walls, such as credenzas, have a self-edge veneered back edge detail. All primary faces have pin molding decorations.

**FINISHES**

- Conversion varnish (similar to catalyzed lacquer, but tougher), 25 degree sheen. Finishes are not buffed or rubbed.
- All Global wood casegood products are veneered and finished on the back sides (360° finishing), except modular under-surface storage - tops and backs are unfinished.
- Touch up kits available, includes a touch up marker and fill crayon. Order **VTUOUCHUPKIT, \$175** list. Specify finish when ordering.
- Global standard finish, on oak and walnut, is open pore and on cherry and maple is semi-closed pore. If a full finish is required for walnut, cherry, anigre and maple tops, Add the suffix "2" to the finish code and Add 5% to the base pricing for each product.

**CUSTOM FINISH IS AVAILABLE.**

**PEDESTALS**

- Full-to-the-floor. Pedestals are fully assembled units that are either installed into desk and credenza shells, or available as modular units. Undersurface storage units include locks.
- Pedestal drawer suspensions are metal ball bearing type. Both box and file drawers are full extension.
- Drawers are standard vinyl-wrapped construction with black drawer sides and bottom.
- The drawer front is an applied element to a four sided drawer. Drawer fronts are veneered on all surfaces except the vertical edges, which are solid oak, walnut, cherry and maple then routed with series detailing. Drawer fronts can be removed or replaced in the field.
- Levelers have 1" range of adjustment.

**LOCKS**

- Locks are standard on all below worksurface level drawer and door storage units, with the exception of pull-out tray units and single lateral file drawer combination tray/slot units.
- Combination storage unit comes with lock for file and lateral file drawer only; box drawers cannot lock.
- Lock color will match the handle option.
- Locks are optional on all above worksurface level closed storage.
- For optional lock, specify **LO. Add \$143** per lock.

**HANDLES**

- All drawer fronts come with traditional antique brass finished handles centered on drawer faces. All cabinet doors come with knobs in the same finish.

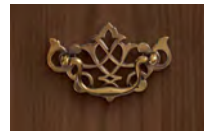

**PL40** Brass Pull, 4.5"

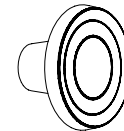

**DK25** Knob on Uppers

**HARDWARE**

- All necessary hardware items for attaching furniture items are included in the shipment. Actual wall attachment fasteners for wall cabinets, tackboards and visual boards are not included due to variation between site conditions.

**LEVELING GLIDES**

- Shipped in a plastic bag attached to the bottom of the item or inside the pedestal. It is important to install leveling glides to ensure the unit is level. Levelers have a 1" range of adjustment.

**HANGING FILE RAILS**

- Pre-installed on file drawer perimeters and accommodate both legal and letter size filing. Legal filing can be achieved either as side-to-side or front-to-back. Letter filing can be achieved as front-to-back filing only.

**FLAT PLATES**

- Flat plates are used to attach bridges and returns to desks and are shipped pre-attached to the bottom of the bridge or return.
  - Mini flat plates for securing bridge back panels to desk or credenza end panels, and quick connectors for securing modular corner units to adjacent pieces, are shipped along with screws in a plastic bag attached to the bottom of the bridge or return.
- CAUTION:** Using screws other than those supplied by Global could result in damage to finished tops.

**WALL-MOUNTED CABINETS, TACKBOARDS AND VISUAL BOARDS**

- Pre-attached with horizontal wall rails to the back of each unit. The wall-side components must be detached from the unit and fastened to the wall accordingly.
- Wall fasteners are not included due to the variable site conditions. Securing the wall rail to a vertical structural member is the required manner of installation. The cabinet or visual board is then lowered on to the wall rail. It is important to level the wall rail before installation.
- Wall cabinets are equipped with levelers at the bottom of the back panels for proper cabinet alignment.
- Units with doors are equipped with adjustable European door hinges to assist in door alignment. It is required to use a #8 wood screw through the back of the cabinet and the wall-mounted rail, to further secure the wall attachment.
- Tackboards have vertical grooves in the back for tasklight wiring.
- Hutches and tackboards are installed with double faced tape applied to the bottom of the end panels. The tape is shipped in a plastic bag found in the hutch. Removal of the hutch requires moderate pressure to be applied on the top of the unit towards the wall for at least a minute for the pressure sensitive tape to release. Additional support may be added by installing flat plates along the outside back of the attached units. *These flat plates are not included in the shipment.*
- Hutch tackboards are factory-installed.
- Tackboards are standard in Grade 3 panel fabrics.

**MODULAR STORAGE UNITS**

- Pre-drilled holes through the unfinished tops for securing to the bottom of worksurfaces
- Screws and lock keys are included in a plastic bag fastened inside the pedestal. Installer should leave a 1/8" reveal between the Modular Storage Unit and the End panel. Disassemble the Modular Unit first before relocating the entire unit to avoid damage or bodily injuries.

**PEDESTAL SPACERS**

- Required if pedestals are placed side by side. A 1" gap is required between the modular pedestals to allow access to vertical fingerpulls. If required, order **SP700**.

**5-SIDED CORNER TABLES**

- Join bridge and credenza run-offs, using the supplied quick connectors.
- Recessed end-panels in these units are pre-drilled to accept quick-connectors for easy alignment
- Accurate leveling is critical for these units to align and connect properly.
- Flat-plates are pre-attached to the worksurface to secure to the desk unit.

## 1. SPECIFY MODEL NUMBER

## 2. SPECIFY FINISH

### WORKSURFACE TOP & DRAWER/DOOR FRONTS, BODY FINISHES (INCLUDING PEDESTALS) - VENEER

Code	Finish	Veneer Type	Cut
AMW	Almond Cherry	Cherry	Flat Sliced
ACW	Amber Cherry	Cherry	Flat Sliced
BTW	Biscotti	White Oak	Rift
CAW	Cocoa Walnut	Walnut	Flat Sliced
CRW	Coral	White Oak	Rift
DCW	Dark Cherry	Cherry	Flat Sliced
DWW	Dark Walnut	Walnut	Flat Sliced
EWV	Espresso Walnut	Walnut	Flat Sliced
EVW	Evening Oak	White Oak	Rift
GRW	Grey on Oak	White Oak	Rift
HAW	Hazelnut	Maple	Flat Sliced
JAW	Java	White Oak	Rift
LTW	Latte Walnut	Walnut	Flat Sliced
MHW	Mahogany on Walnut	Walnut	Flat Sliced
MTW	Milestone	White Oak	Rift
MPW	Natural Maple	Maple	Flat Sliced
NLW	Natural Walnut	Walnut	Flat Sliced
RCW	Red Cherry	Cherry	Flat Sliced
VNW	Vintage Cherry	Cherry	Flat Sliced
ULW	Umber Walnut	Walnut	Flat Sliced
WLW	Walnut	Walnut	Flat Sliced
WCW	Warm Cherry	Cherry	Flat Sliced
WMW	White Maple	Maple	Flat Sliced

### METAL FINISHES:

E	Black
K	Tungsten
DWT	Designer White
P	Brushed Chrome

### GLASS FINISH (for Glass Doors and Modesty Panels)

- Bronze Glass (standard)
- Clear Glass - contact Customer Care

## 3. SPECIFY OPTIONS

### GROMMETS

- Standard grommet on all components is **GM5**. Grommets are included with products where shown in product line drawings.
- Optional grommets may be ordered in standard worksurface locations (left, center or right). Order as **GM5L**, **GM5C** or **GM5R**. **Add \$103**.
- Grommet hole dimensions are 3.5" x 2". Specify **GM5E** for **Black** or **GM5K** for **Tungsten**.

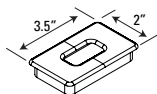

- Components that come standard with grommet may be ordered without a grommet. Order as RSG - **Add \$57**.
- View diagrams on the following pages for additional details.

### GROMMET LOCATIONS

- Grommets and Grommet Locations must be specified.
- Includes standard and optional grommet locations.
- For TEL & TER location please contact Customer Care.

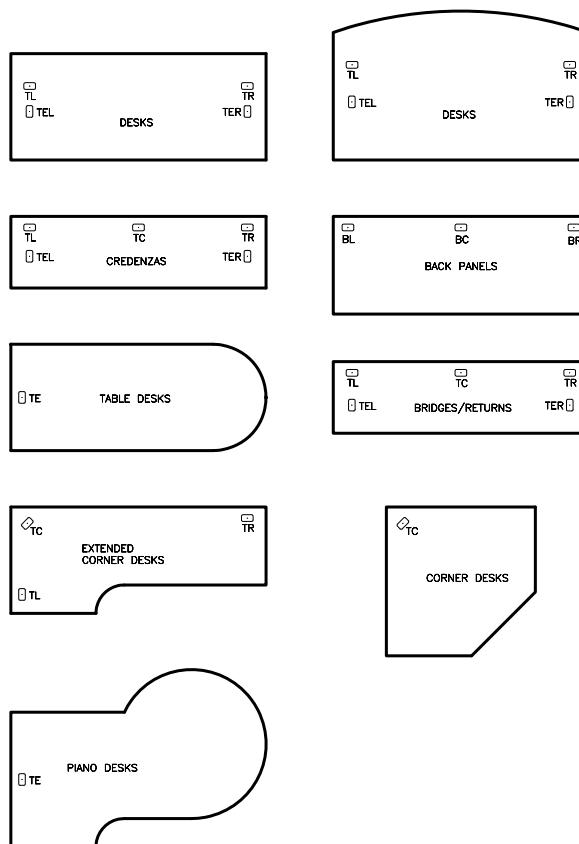

# P PHILADELPHIA - EDGE DETAILS

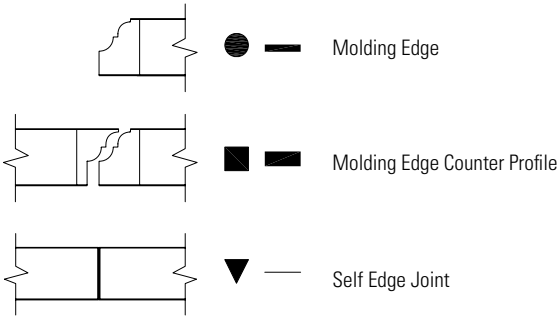

- D** - Desks and Credenzas
- B** - Executive Bridges
- E** - Executive Returns
- C** - Corner Components
- L** - Linking Bridges
- P** - Piano Desks

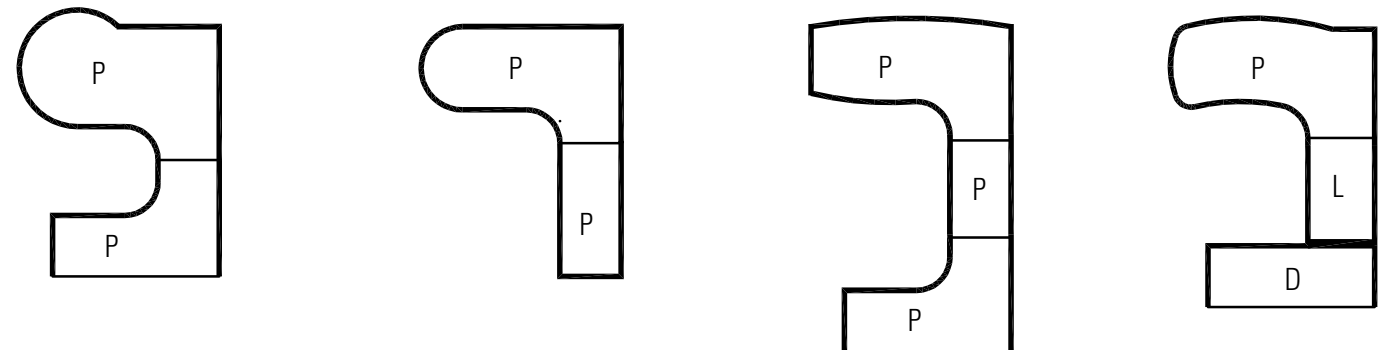
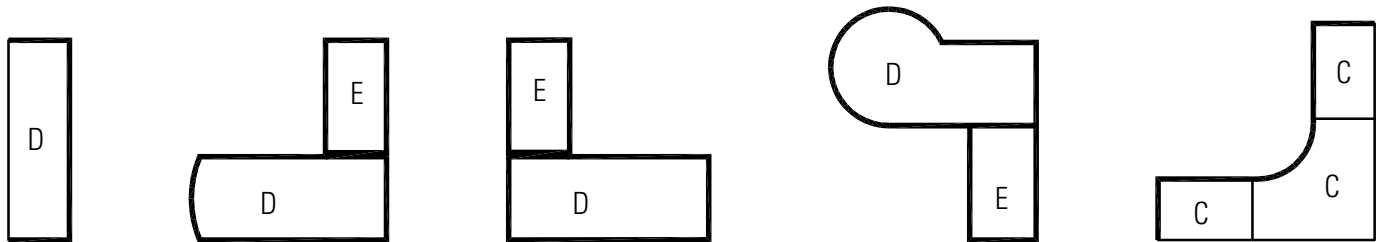
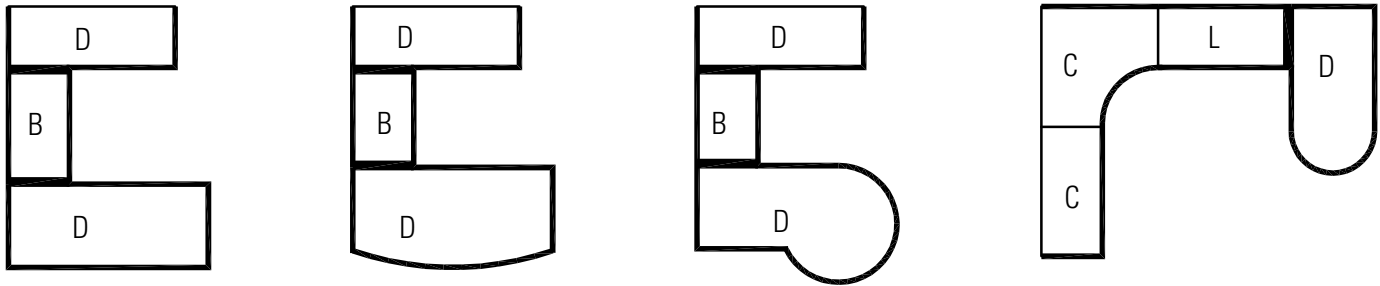
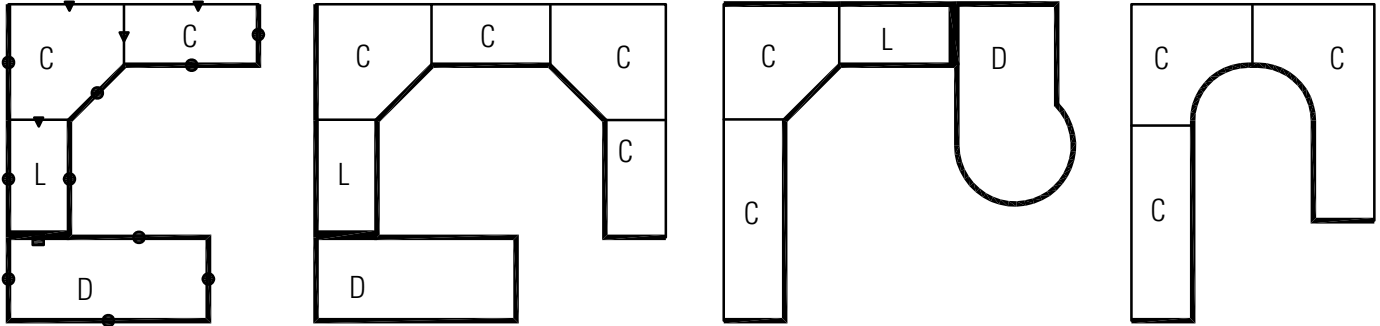

**DESK AND CREDENZA NOTES**

- Can be ordered as a shell or with pedestals
- Hand of Rectangular Desk is determined by location of pedestal from user side
- Hand of "D" Top is determined by outward orientation of curved end from user projection.
- Hand of "P" Top is determined by outward orientation of conference end from user projection.

Isometric View

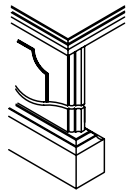

Side View  
1-3/8" Top

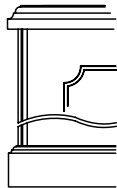

Front View  
1-3/16" Slab

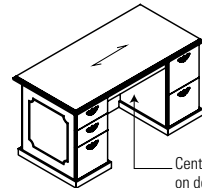
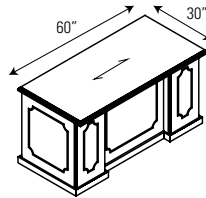
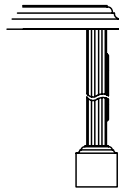

Center drawer standard on double pedestal desk

**MODESTY PANEL CLEARANCE**

PBID7236DE

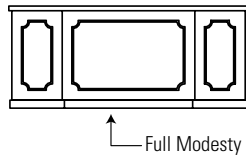

Full Modesty

PBID7236 (7236 indicates top size)

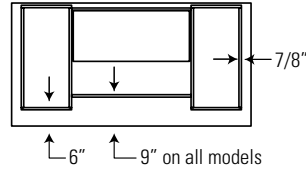

6" 9" on all models

PBISR7230D

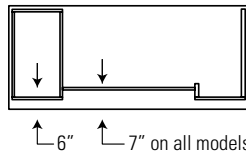

6" 7" on all models

PBDDFL7230 (Left shown)

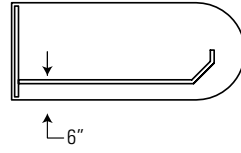

6"

PBTPOL7242 (Left shown)

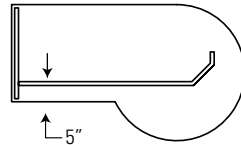

5"

PBC7220

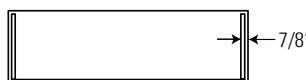

7/8"

## PIANO DESKS AND LINKING RETURNS

- All Desks are shipped assembled.
- Units include standard Grommets shown and installed horizontal wire management
- Unit is handed by Post Leg
- Not for use with regular Corner Units

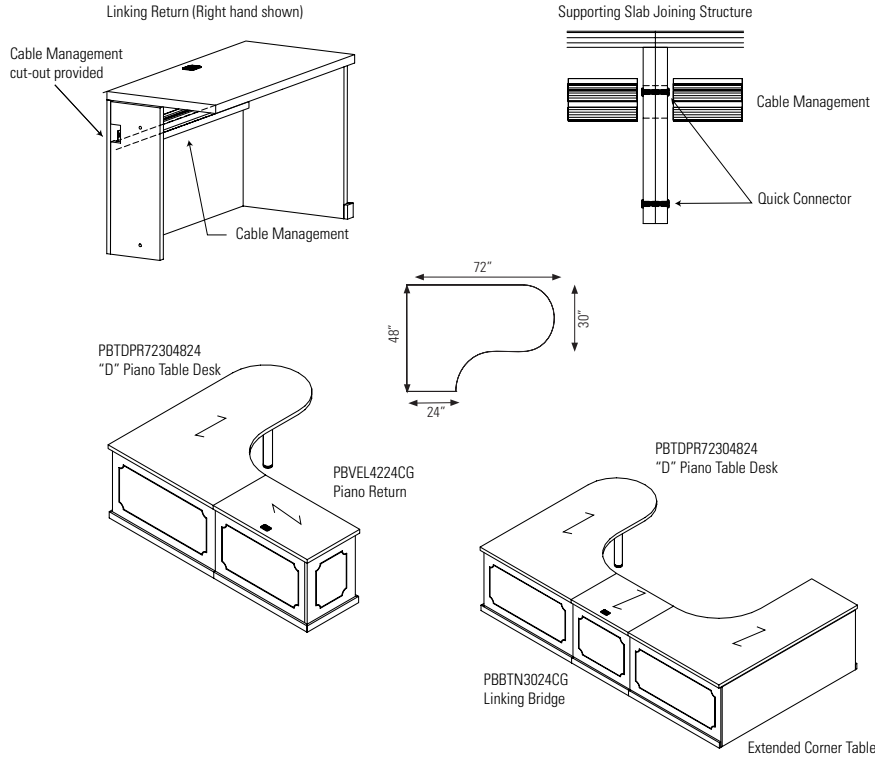

## EXECUTIVE BRIDGES

- Executive Bridge is used to connect a Desk to a Credenza.
- Not to be used with Corner Components or Piano Desks.
- Three Back Panel options
- Back panel flush with end panels of Desk and Credenza
- Includes GM5 Grommet Top Center
- The standard grain direction is cross grain (**CG**). To remove cross grain veneer pattern on top, delete suffix "**CG**" from the model number (no upcharge)

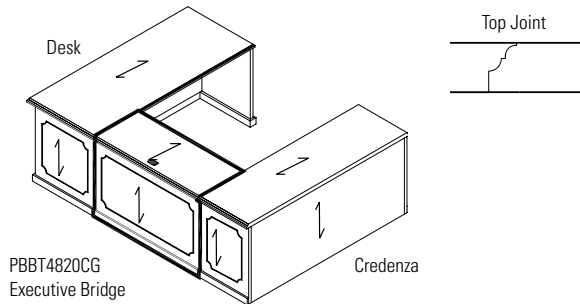

PBBT4820CG  
Dimensions are actual

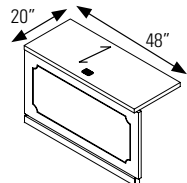

PBBT4820CG  
Full Back Panel

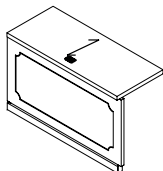

PBBT4820TCG  
Bridge Top only



PBBT4820Q8CG  
8" Back Panel

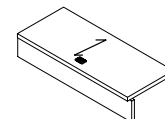

**EXECUTIVE RETURNS**

- Executive Return is used to attach to a Single Pedestal Desk, Single Pedestal Credenza, Desk Shell or Credenza Shell.
- Can be specified as a Shell or with a Pedestal.
- Back Panels are available as either full height or 8" from the underside of the worksurface.
- Hand of Executive Return is determined by location of full end panel from user side.
- Hand of Desk or Credenza is determined by location of pedestal from user side.
- The standard grain direction on return tops is cross grain (**CG**). To remove cross grain veneer pattern on top, delete suffix "**CG**" from the model number (no upcharge)

Executive Return attached to Desk or Credenza

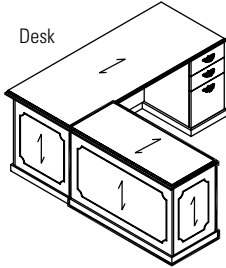

PBRL4822CG  
Executive Return

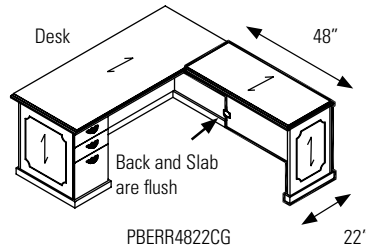

PBERR4822CG  
Executive Return

**CORNER COMPONENTS**

- Corner Table is used to connect to Linking Bridge and Linking Credenza.
- Cable management tray included.
- Back Panels are available as either full height or 8" from the underside of the worksurface.
- Hand of Linking Credenza is determined by location of full end panel from user side.
- Hand of Extended Corner is determined by location of long narrow end from user side
- The standard grain direction is cross grain (**CG**). To remove cross grain veneer pattern on top, delete suffix "**CG**" from the model number (no upcharge)

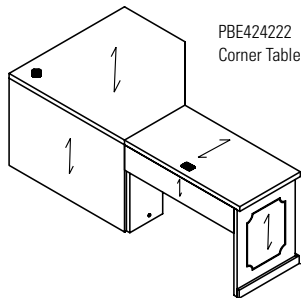

PBE424222  
Corner Table

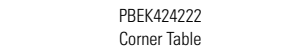

PBEK424222  
Corner Table



PBEK424222  
Corner Table

Supporting Slab Joining Structure

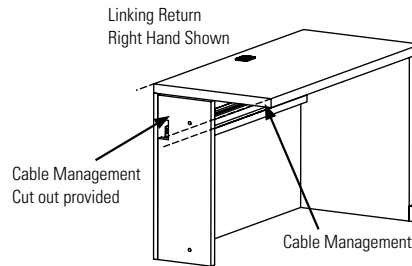
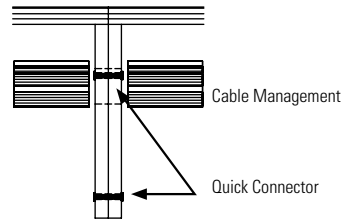

Linking Return  
Right Hand Shown

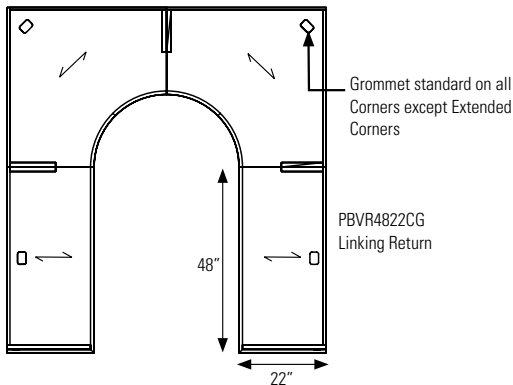

PBVL4822CG  
Linking Return

PBVR4822CG  
Linking Return

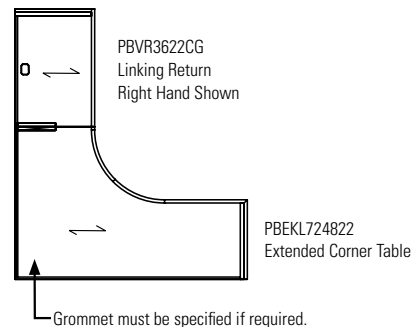

PBVR3622CG  
Linking Return  
Right Hand Shown

PBEKL724822  
Extended Corner Table

## LINKING BRIDGES

- Linking Bridge is used to connect Corner Components to Single Pedestal Desk, Single Pedestal Credenza, Desk Shell or Credenza Shell.
- Back panels are available as either full height or 8" from the underside of the worksurface.
- Includes GM5 Grommet Top Center
- Hand of Linking Bridge is determined by location of half end panel from user side
- The standard grain direction is cross grain (**CG**). To remove cross grain veneer pattern on top, delete suffix "**CG**" from the model number (no upcharge)

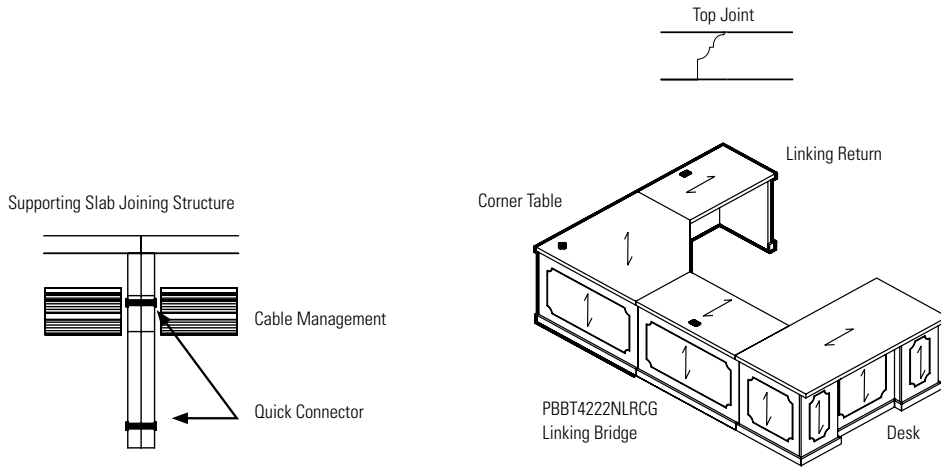

## COPING AND SELF-EDGE OPTIONS

- Coping option provides an undercut on hutches only so that storage cabinets placed next to the hutch fit flush.
  - Specify **COP** for coping on both sides, **COPR** for coping on the right side and **COPL** for coping on the left side. No upcharge.
- Self edge options provide a flush fit when storage units are placed next to one another.
  - Specify **SE** for self-edge on both sides, **SER** for self-edge on the right side and **SEL** for self-edge on the left side. When **SE**, **SER**, **SEL** are specified, the corresponding bottom base molding will also be removed. No upcharge.
  - Coping and self-edge handedness are from the users perspective. See diagram below.

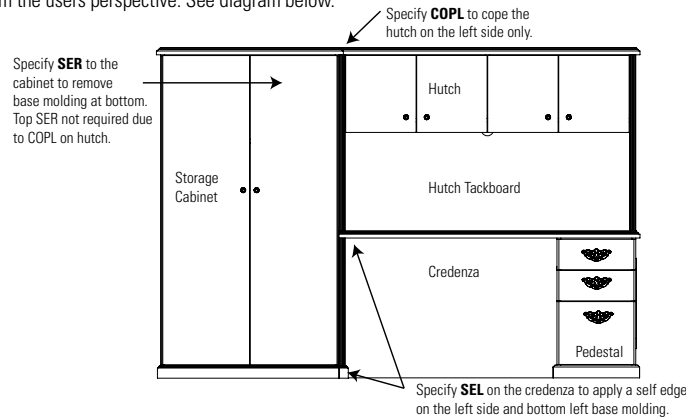

## MODULAR PEDESTALS AND HANDLES

- Modular Pedestal for Philadelphia using "C" components.
- SP700 spacer is required if two Modular Pedestals are placed side by side when there is no handles. Order as special.
- Credenza shell cannot be completely filled up with modular components to create a full storage credenza.

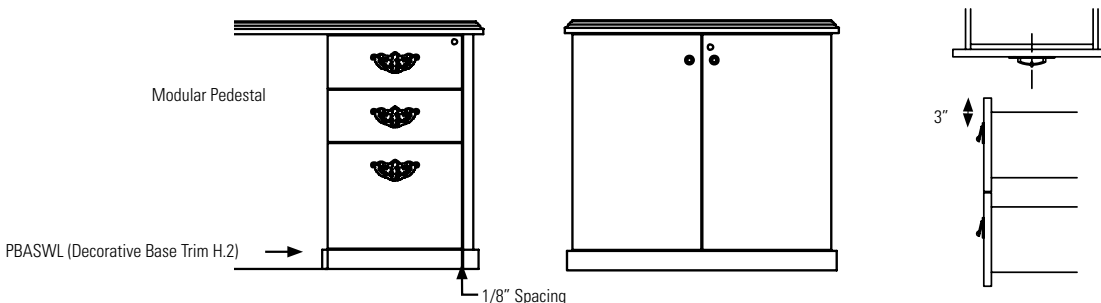

**LOCKING**

- Locks are standard on all below worksurface level drawer and door storage units with the exception of the pull-out tray units and single lateral file drawer combination tray/slot units.
- Locks are optional on all above worksurface level closed storage units.

**Standard Lock Positions**

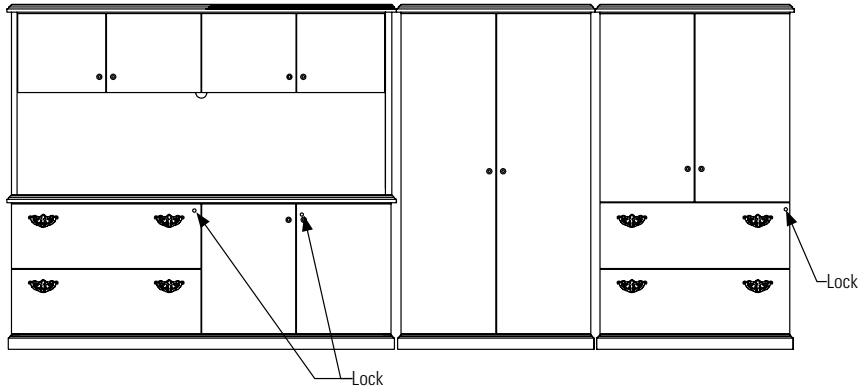

PBCF7222

Full Storage Credenza: Locks are on the front.

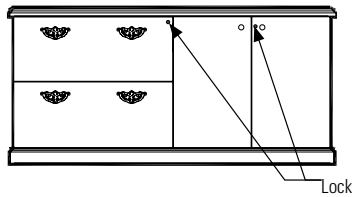

PB7236DE

Double Pedestal Desk/Credenza:

Lock for D and E Pedestals are on the inside Gable.

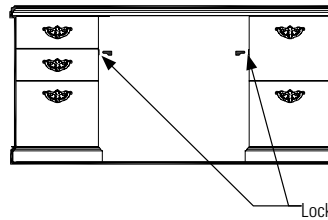

PBZR

Combination Storage Unit:

Lock for File and Lateral File Drawer only,  
Box Drawers do not lock.

Box Drawers  
do not lock

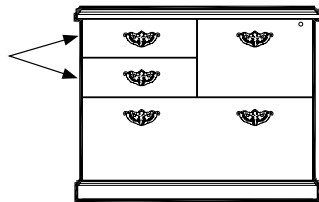

PBWF

Modular Furniture:  
Lock is on the front.

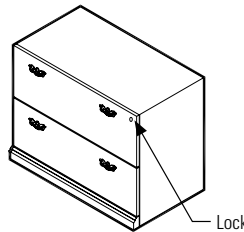

PBWD

Modular Furniture:  
Lock is on the front.

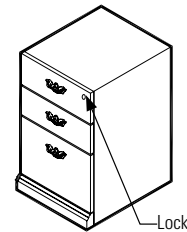

**HUTCH POSITIONING**

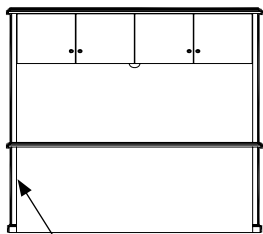

There must be an end panel  
under the hutch

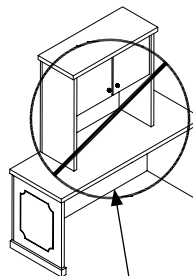
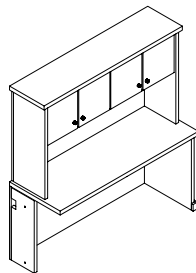

Missing Support  
NOT Recommended

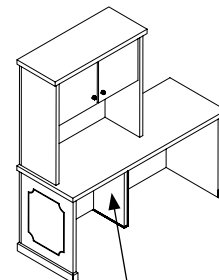

Add optional Support  
SLAB12 (as Special)

## TACKBOARDS

### Tackboards for Storage Huches

PB72SH36

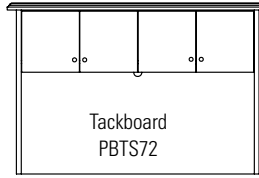

PB72SHP42 and PB722SHP54

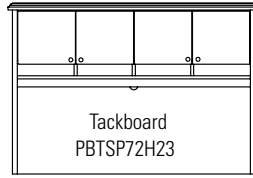

PB72SH42 and PB722SH54

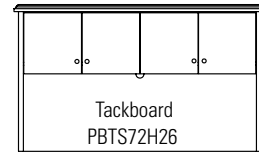

### Tackboards with Accessory Rail

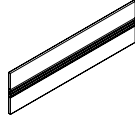

PBTSAS72

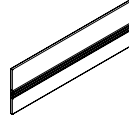

PBTSAS72H23

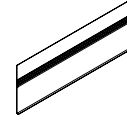

PBTSAS72H26

### Tackboards for Wall Mount Overheads

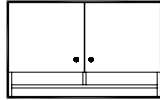

CSF36

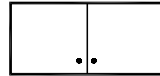

CSFP36

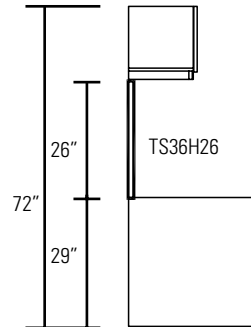
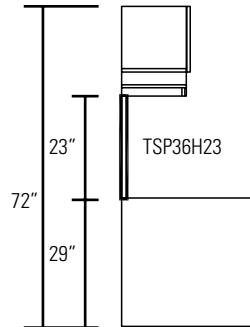
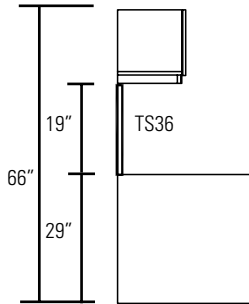

**LIGHTING**

Wall Mount

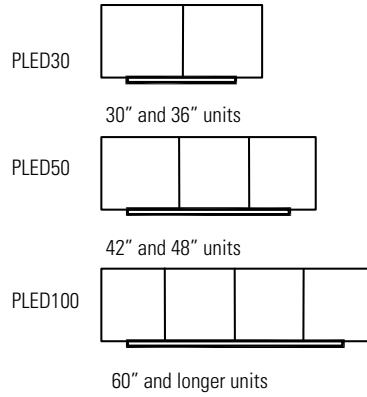

Hutch

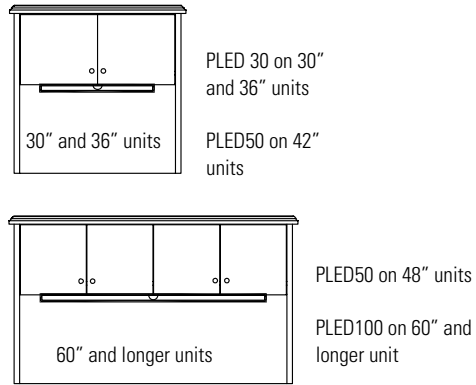

## DESKS - NOTES

**NOTE:** Arrow indicates direction of grain

#### Double Pedestal Desks

- Shipped assembled
- Kneewell locking standard and keyed alike
- Standard with center drawer
- For optional pull-out writing tray, specify **WTD**. Add **\$679**.

#### Single Pedestal Desks

- Shipped assembled
- Kneewell locking standard and keyed alike
- For optional pull-out writing tray, specify **WTS**. Add **\$343**.

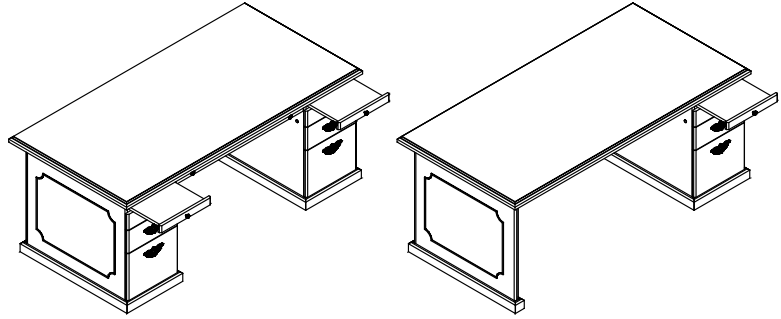

#### D and P shaped desks

- Shipped assembled.

#### D and P shaped connecting desks

- Shipped knocked down.
- The standard grain direction on D and P shaped connecting desks is cross grain (**CG**). To remove cross grain veneer pattern on top, delete suffix "**CG**" from the model number (no upcharge)
- Pedestals are handed:
  - Left pedestals have the handle offset from the center to the right, and the lock is placed on the right end panel
  - Right pedestals have the handle offset from the center to the left, and the lock is placed on the left end panel
- Modesty panels are available in wood or glass
- Grommets are available as an option on Desks and most Credenzas.

**DOUBLE PEDESTAL DESKS**      **MODEL#**      **DIMENSIONS**      **FREIGHT CLASS**      **WT/LBS.**      **CUBIC FT.**      **LIST PRICE**

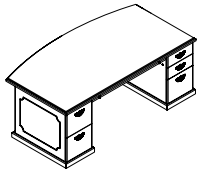

**Double Pedestal Bow Top Desk  
Breakfront Style**

	<b>D x W x H</b>					
PBMID8442ED	42 x 84 x 29	125	443	59		<b>\$13424</b>
PBMID7842ED	42 x 78 x 29	125	412	55		<b>\$12538</b>
PBMID7242ED	42 x 72 x 29	125	380	51		<b>\$11652</b>
PBMID6636ED	36 x 66 x 29	100	340	40		<b>\$11332</b>

Standard with full to floor **file/file** pedestal on **left** and **box/box/file** pedestal on **right**. Pedestals lock.  
Inset Full Height Modesty Panel.

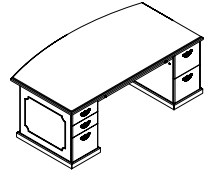

**Double Pedestal Bow Top Desk  
Breakfront Style**

PBMID8442DE	42 x 84 x 29	125	443	59		<b>\$13424</b>
PBMID7842DE	42 x 78 x 29	125	412	55		<b>\$12538</b>
PBMID7242DE	42 x 72 x 29	125	380	51		<b>\$11652</b>
PBMID6636DE	36 x 66 x 29	100	340	40		<b>\$11332</b>

Standard with full to floor **box/box/file** pedestal on **left** and **file/file** pedestal on **right**. Pedestals lock.  
Inset Full Height Modesty Panel.

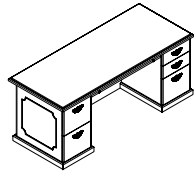

**Double Pedestal Desk  
Breakfront Style**

PBID8442ED	42 x 84 x 29	125	442	59		<b>\$11572</b>
PBID7842ED	42 x 78 x 29	125	421	55		<b>\$10817</b>
PBID7236ED	36 x 72 x 29	100	375	44		<b>\$10066</b>
PBID7230ED	30 x 72 x 29	100	345	36		<b>\$9928</b>
PBID6636ED	36 x 66 x 29	100	360	40		<b>\$9928</b>
PBID6630ED	30 x 66 x 29	92.5	315	30		<b>\$9790</b>
PBID6030ED	30 x 60 x 29	92.5	315	30		<b>\$9511</b>

Standard with full to floor **file/file** pedestal on **left** and **box/box/file** pedestal on **right**. Pedestals lock.  
Inset Full Height Modesty Panel.

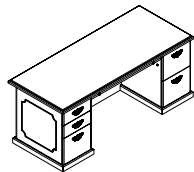

**Double Pedestal Desk  
Breakfront Style**

PBID8442DE	42 x 84 x 29	125	442	59		<b>\$11572</b>
PBID7842DE	42 x 78 x 29	125	421	55		<b>\$10817</b>
PBID7236DE	36 x 72 x 29	100	375	44		<b>\$10066</b>
PBID7230DE	30 x 72 x 29	100	345	36		<b>\$9928</b>
PBID6636DE	36 x 66 x 29	100	360	40		<b>\$9928</b>
PBID6630DE	30 x 66 x 29	92.5	315	30		<b>\$9790</b>
PBID6030DE	30 x 60 x 29	92.5	315	30		<b>\$9511</b>

Standard with full to floor **box/box/file** pedestal on **left** and **file/file** pedestal on **right**. Pedestals lock.  
Inset Full Height Modesty Panel.

**Required Specifications**

Finish

**Optional Specifications**

Grommet  
Modesty panel  
Pull-out writing tray

## SINGLE PEDESTAL DESKS

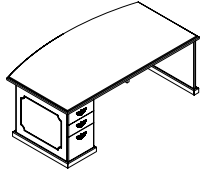

**Single Pedestal Bow Top Desk - Left\***  
*Breakfront Style*

MODEL#	DIMENSIONS D x W x H	FREIGHT CLASS	WT./LBS.	CUBIC FT.	LIST PRICE
PBMISL8442D	42 x 84 x 29	125	452	59	<b>\$9820</b>
PBMISL7842D	42 x 78 x 29	125	337	55	<b>\$9119</b>
PBMISL7242D	42 x 72 x 29	125	322	51	<b>\$8421</b>
PBMISL6636D	36 x 66 x 29	125	290	40	<b>\$8098</b>

Standard with full to floor **box/box/file** pedestal on **left**. Pedestals lock.  
Inset Full Height Modesty Panel.

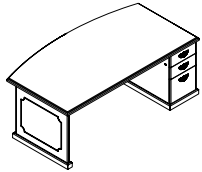

**Single Pedestal Bow Top Desk - Right\***  
*Breakfront Style*

PBMISR8442D	42 x 84 x 29	125	452	59	<b>\$9820</b>
PBMISR7842D	42 x 78 x 29	125	337	55	<b>\$9119</b>
PBMISR7242D	42 x 72 x 29	125	322	51	<b>\$8421</b>
PBMISR6636D	36 x 66 x 29	125	290	40	<b>\$8098</b>

Standard with full to floor **box/box/file** pedestal on **right**. Pedestals lock.  
Inset Full Height Modesty Panel.

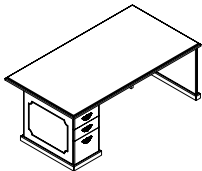

**Single Pedestal Desk - Left\***  
*Breakfront Style*

PBISL8442D	42 x 84 x 29	125	387	59	<b>\$9377</b>
PBISL7842D	42 x 78 x 29	125	366	55	<b>\$8705</b>
PBISL7236D	36 x 72 x 29	125	320	44	<b>\$6889</b>
PBISL7230D	30 x 70 x 29	100	290	36	<b>\$6582</b>
PBISL6636D	36 x 66 x 29	125	305	40	<b>\$6582</b>
PBISL6630D	30 x 66 x 29	100	275	33	<b>\$6282</b>
PBISL6030D	30 x 60 x 29	100	260	30	<b>\$6005</b>

Standard with full to floor **box/box/file** pedestal on **left**. Pedestals lock.  
Inset Full Height Modesty Panel.

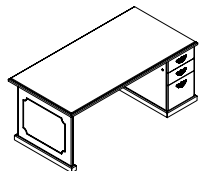

**Single Pedestal Desk - Right\***  
*Breakfront Style*

PBISR8442D	42 x 84 x 29	125	387	59	<b>\$9377</b>
PBISR7842D	42 x 78 x 29	125	366	55	<b>\$8705</b>
PBISR7236D	36 x 72 x 29	125	320	44	<b>\$6889</b>
PBISR7230D	30 x 70 x 29	100	290	36	<b>\$6582</b>
PBISR6636D	36 x 66 x 29	125	305	40	<b>\$6582</b>
PBISR6630D	30 x 66 x 29	100	275	33	<b>\$6282</b>
PBISR6030D	30 x 60 x 29	100	260	30	<b>\$6005</b>

Standard with full to floor **box/box/file** pedestal on **right**. Pedestals lock.  
Inset Full Height Modesty Panel.

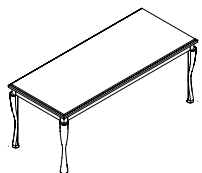

**Table Desk**  
*Queen Anne Style*

PBQATB8442	42 x 84 x 29	150	272	59	<b>\$10902</b>
PBQATB7842	42 x 78 x 29	150	253	55	<b>\$10222</b>
PBQATB7236	36 x 72 x 29	150	205	44	<b>\$8279</b>
PBQATB7230	30 x 70 x 29	150	192	36	<b>\$7458</b>
PBQATB6636	36 x 66 x 29	150	192	40	<b>\$7458</b>
PBQATB6630	30 x 66 x 29	150	188	33	<b>\$6561</b>
PBQATB6030	30 x 60 x 29	150	171	30	<b>\$5852</b>

Inset Full Height Modesty Panel.

### Required Specifications

Finish

### Optional Specifications

Additional grommet  
Modesty panel\*  
Pull-out writing tray\*

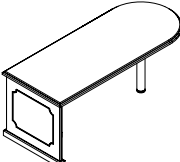
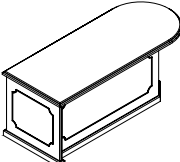
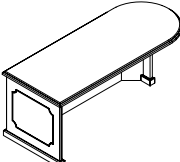
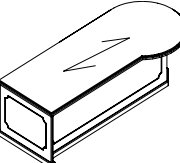
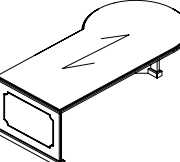
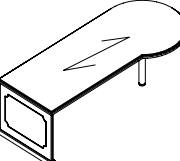
DESKS	MODEL#	DIMENSIONS	FREIGHT CLASS	WT/LBS.	CUBIC FT.	LIST PRICE
 <p><b>"D" Shaped Connecting Table Desk</b></p>	<b>D x W x H</b>					
	PBDD8436	36 x 84 x 29	125	343	51	<b>\$6124</b>
	PBDD7236	36 x 72 x 29	125	294	44	<b>\$5247</b>
	PBDD7230	30 x 72 x 29	125	264	36	<b>\$4876</b>
	PBDD6636	36 x 66 x 29	125	245	40	<b>\$4876</b>
	PBDD6030	30 x 60 x 29	125	225	30	<b>\$4684</b>
Wood column support and full end panel.						
 <p><b>"D" Shaped Table Desk - Left</b></p>	PBDDFL8436	36 x 84 x 29	125	367	51	<b>\$7522</b>
	PBDDFL7236	36 x 72 x 29	125	320	44	<b>\$6449</b>
	PBDDFL7230	30 x 72 x 29	100	290	36	<b>\$6083</b>
	PBDDFL6636	36 x 66 x 29	125	271	40	<b>\$6083</b>
	PBDDFL6030	30 x 60 x 29	100	247	30	<b>\$5887</b>
	With 45° angled modesty and end panel.					
 <p><b>"D" Shaped Table - Right</b></p>	PBDDFR8436	36 x 84 x 29	125	367	51	<b>\$7522</b>
	PBDDFR7236	36 x 72 x 29	125	320	44	<b>\$6449</b>
	PBDDFR7230	30 x 72 x 29	100	290	36	<b>\$6083</b>
	PBDDFR6636	36 x 66 x 29	125	271	40	<b>\$6083</b>
	PBDDFR6030	30 x 60 x 29	100	247	30	<b>\$5887</b>
	With 45° angled modesty and end panel.					
 <p><b>"P" Shaped Connecting Table - Left</b></p>	PBTPOL9642	42 x 96 x 29	150	317	68	<b>\$9021</b>
	PBTPOL8442	42 x 84 x 29	150	277	59	<b>\$7892</b>
	PBTPOL7242	42 x 72 x 29	150	211	51	<b>\$7305</b>
With 45° angled modesty and end panel.						
 <p><b>"P" Shaped Connecting Table - Right</b></p>	PBTPOR9642	42 x 96 x 29	150	317	68	<b>\$9021</b>
	PBTPOR8442	42 x 84 x 29	150	277	59	<b>\$7892</b>
	PBTPOR7242	42 x 72 x 29	150	211	51	<b>\$7305</b>
With 45° angled modesty and end panel.						
 <p><b>"P" Shaped Connecting Table - Left</b></p>	PBTPL9642	42 x 96 x 29	125	440	68	<b>\$7646</b>
	PBTPL8442	42 x 84 x 29	125	385	59	<b>\$6692</b>
	PBTPL7242	42 x 72 x 29	125	319	51	<b>\$6100</b>
Wood column support and full end panel.						

**Required Specifications**  
Finish

**Optional Specifications**  
Additional grommet

**DESKS**

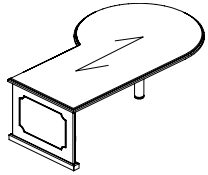

**"P" Shaped Connecting Table - Right**

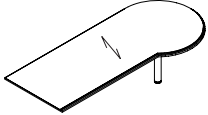

**"P" Shaped Connecting Table - Left**

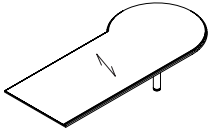

**"P" Shaped Connecting Table - Right**

MODEL#	DIMENSIONS	FREIGHT CLASS	WT./LBS.	CUBIC FT.	LIST PRICE
--------	------------	---------------	----------	-----------	------------

**D x W x H**

PBTPR9642	42 x 96 x 29	125	440	68	<b>\$7646</b>
PBTPR8442	42 x 84 x 29	125	385	59	<b>\$6692</b>
PBTPR7242	42 x 72 x 29	125	319	51	<b>\$6100</b>

Wood column support and full end panel.

PBRPL9642CG	42 x 96 x 29	250	239	68	<b>\$7250</b>
PBRPL8442CG	42 x 84 x 29	250	209	59	<b>\$6346</b>
PBRPL7242CG	42 x 72 x 29	250	143	51	<b>\$5436</b>

Wood column support. No end panel.

PBRPR9642CG	42 x 96 x 29	250	239	68	<b>\$7250</b>
PBRPR8442CG	42 x 84 x 29	250	209	59	<b>\$6346</b>
PBRPR7242CG	42 x 72 x 29	250	143	51	<b>\$5436</b>

Wood column support. No end panel.

**Required Specifications**

Finish

**Optional Specifications**

Additional grommet

**RETURNS - NOTES**

D x W x H

- All returns are shipped assembled
- Kneewell locking standard
- The standard grain direction on returns is cross grain (**CG**). To remove cross grain veneer pattern on top, delete suffix "**CG**" from the model number (no upcharge)
- **NOTE:** Arrow indicates direction of grain

RETURNS	MODEL#	DIMENSIONS	FREIGHT CLASS	WT/LBS.	CUBIC FT.	LIST PRICE
---------	--------	------------	---------------	---------	-----------	------------

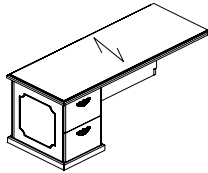

**Executive Return - Left**

PBERL7224ECG	24 x 72 x 29	100	250	29	<b>\$6195</b>
PBERL6624ECG	24 x 66 x 29	100	236	27	<b>\$5969</b>
PBERL6024ECG	24 x 60 x 29	100	227	24	<b>\$5430</b>
PBERL5424ECG	24 x 54 x 29	100	205	22	<b>\$5230</b>
PBERL4824ECG	24 x 48 x 29	100	185	19	<b>\$4648</b>
PBERL4224ECG	24 x 42 x 29	92.5	178	17	<b>\$4473</b>

Standard with full to floor **file/file** pedestal on **left**. Pedestal locks. Full height flush back panel.

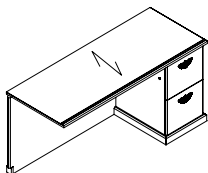

**Executive Return - Right**

PBERR7224ECG	24 x 72 x 29	100	250	29	<b>\$6195</b>
PBERR6624ECG	24 x 66 x 29	100	236	27	<b>\$5969</b>
PBERR6024ECG	24 x 60 x 29	100	227	24	<b>\$5430</b>
PBERR5424ECG	24 x 54 x 29	100	205	22	<b>\$5230</b>
PBERR4824ECG	24 x 48 x 29	100	185	19	<b>\$4648</b>
PBERR4224ECG	24 x 42 x 29	92.5	178	17	<b>\$4473</b>

Standard with full to floor **file/file** pedestal on **right**. Pedestal locks. Full height flush back panel.

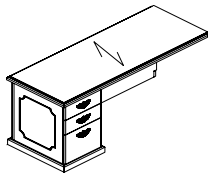

**Executive Return - Left**

PBERL7224DCG	24 x 72 x 29	100	250	29	<b>\$6195</b>
PBERL6624DCG	24 x 66 x 29	100	236	27	<b>\$5969</b>
PBERL6024DCG	24 x 60 x 29	100	227	24	<b>\$5430</b>
PBERL5424DCG	24 x 54 x 29	100	205	22	<b>\$5230</b>
PBERL4824DCG	24 x 48 x 29	100	185	19	<b>\$4648</b>
PBERL4224DCG	24 x 42 x 29	92.5	178	17	<b>\$4473</b>

Standard with full to floor **box/box/file** pedestal on **left**. Pedestal locks. Full height flush back panel.

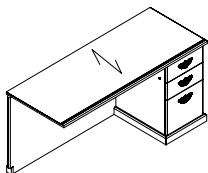

**Executive Return - Right**

PBERR7224DCG	24 x 72 x 29	100	250	29	<b>\$4473</b>
PBERR6624DCG	24 x 66 x 29	100	236	27	<b>\$5969</b>
PBERR6024DCG	24 x 60 x 29	100	227	24	<b>\$5430</b>
PBERR5424DCG	24 x 54 x 29	100	205	22	<b>\$5230</b>
PBERR4824DCG	24 x 48 x 29	100	185	19	<b>\$4648</b>
PBERR4224DCG	24 x 42 x 29	92.5	178	17	<b>\$4473</b>

Standard with full to floor **box/box/file** pedestal on **right**. Pedestal locks. Full height flush back panel.

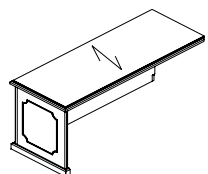

**Executive Return - Left**

PBERL7224CG	24 x 72 x 29	150	135	29	<b>\$3475</b>
PBERL6624CG	24 x 66 x 29	150	127	27	<b>\$3184</b>
PBERL6024CG	24 x 60 x 29	150	120	24	<b>\$2897</b>
PBERL5424CG	24 x 54 x 29	150	112	22	<b>\$2600</b>
PBERL4824CG	24 x 48 x 29	150	105	19	<b>\$2320</b>
PBERL4224CG	24 x 42 x 29	150	97	17	<b>\$2025</b>

Full height flush back panel.

**Required Specifications**  
Finish

**Optional Specifications**  
Grommet

**RETURNS**

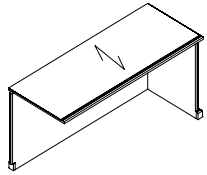

**Executive Return - Right**

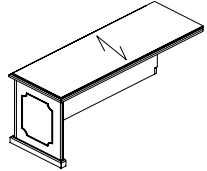

**Executive Return - Left**

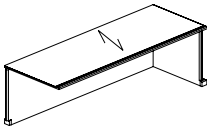

**Executive Return - Right**

**MODEL# DIMENSIONS FREIGHT CLASS WT/LBS. CUBIC FT. LIST PRICE**

**D x W x H**

PBERR7224CG	24 x 72 x 29	150	135	29	<b>\$3475</b>
PBERR6624CG	24 x 66 x 29	150	127	27	<b>\$3184</b>
PBERR6024CG	24 x 60 x 29	150	120	24	<b>\$2897</b>
PBERR5424CG	24 x 54 x 29	150	112	22	<b>\$2600</b>
PBERR4824CG	24 x 48 x 29	150	105	19	<b>\$2320</b>
PBERR4224CG	24 x 42 x 29	150	97	17	<b>\$2025</b>

Full height flush back panel.

PBERL7222CG	22 x 72 x 29	150	130	27	<b>\$3311</b>
PBERL6622CG	22 x 66 x 29	150	122	24	<b>\$3033</b>
PBERL6022CG	22 x 60 x 29	150	115	22	<b>\$2761</b>
PBERL5422CG	22 x 54 x 29	150	105	20	<b>\$2481</b>
PBERL4822CG	22 x 48 x 29	150	100	18	<b>\$2209</b>
PBERL4222CG	22 x 42 x 29	150	90	16	<b>\$1931</b>

Full height flush back panel.

PBERR7222CG	22 x 72 x 29	150	130	27	<b>\$3311</b>
PBERR6622CG	22 x 66 x 29	150	122	24	<b>\$3033</b>
PBERR6022CG	22 x 60 x 29	150	115	22	<b>\$2761</b>
PBERR5422CG	22 x 54 x 29	150	105	20	<b>\$2481</b>
PBERR4822CG	22 x 48 x 29	150	100	18	<b>\$2209</b>
PBERR4222CG	22 x 42 x 29	150	90	16	<b>\$1931</b>

Full height flush back panel.

**Required Specifications**  
Finish

**Optional Specifications**  
Additional grommet

**PIANO DESKS**

D x W x H

- All desks are shipped assembled
- Units include installed horizontal wire management
- Unit is handed by Post Leg
- Not for use with Regular Corner Units
- The standard grain direction on piano desks is cross grain (**CG**). To remove cross grain veneer pattern on top, delete suffix "**CG**" from the model number (no upcharge)
- If grommet color is not specified, Black is standard
- **NOTE:** Arrow indicates direction of grain

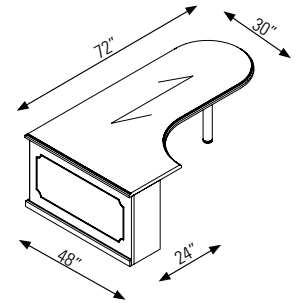

**PIANO DESKS**

**MODEL#      DIMENSIONS      FREIGHT CLASS      WT./LBS.      CUBIC FT.      LIST PRICE**

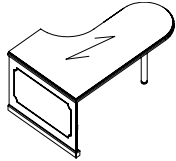

**D-shaped Piano Desk - Left**

PBTDPL96304824	48 x 96 x 29	125	464	77	<b>\$7954</b>
PBTDPL84304824	48 x 84 x 29	150	406	68	<b>\$7074</b>
PBTDPL72304824	48 x 72 x 29	125	348	58	<b>\$6196</b>

Wood column support and full end panel, 30"D worksurface extension and 24" return connection.

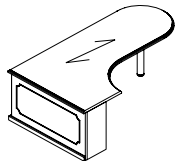

**D-shaped Piano Desk - Right**

PBTDPR96304824	48 x 96 x 29	125	464	77	<b>\$7954</b>
PBTDPR84304824	48 x 84 x 29	150	406	68	<b>\$7074</b>
PBTDPR72304824	48 x 72 x 29	125	348	58	<b>\$6196</b>

Wood column support and full end panel, 30"D worksurface extension and 24" return connection.

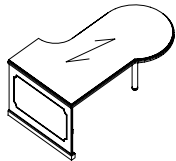

**P-shaped Piano Desk - Left**

PBTPPL96424824	54 x 96 x 29	150	580	97	<b>\$9075</b>
PBTPPL84424824	54 x 84 x 29	150	508	85	<b>\$8114</b>
PBTPPL72424824	54 x 72 x 29	150	435	73	<b>\$7524</b>

Wood column support and full end panel, 42"/30" worksurface and 24" return connection.

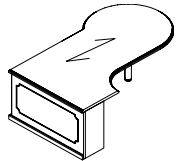

**P-shaped Piano Desk - Right**

PBTPPR96424824	54 x 96 x 29	150	580	97	<b>\$9075</b>
PBTPPR84424824	54 x 84 x 29	150	508	85	<b>\$8114</b>
PBTPPR72424824	54 x 72 x 29	150	435	73	<b>\$7524</b>

Wood column support and full end panel, 42"/30" worksurface and 24" return connection.

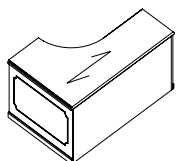

**Extended Corner Table Desk - Left**

PBEKL964824MR	48 x 96 x 29	150	387	77	<b>\$8641</b>
PBEKL904824MR	48 x 90 x 29	150	363	73	<b>\$8159</b>
PBEKL844824MR	48 x 84 x 29	150	338	68	<b>\$8064</b>
PBEKL784824MR	48 x 78 x 29	150	314	63	<b>\$8020</b>
PBEKL724824MR	48 x 72 x 29	150	290	58	<b>\$7623</b>
PBEKL664824MR	48 x 66 x 29	150	266	52	<b>\$7107</b>
PBEKL604824MR	48 x 60 x 29	150	242	48	<b>\$6586</b>

With 24" return connection.

**Required Specifications**

Finish

**Optional Specifications**

Additional grommet

## PIANO DESKS

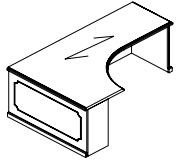

**Extended Corner Table Desk - Right**

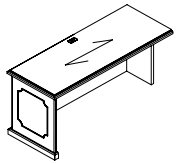

**Linking Return - Left**

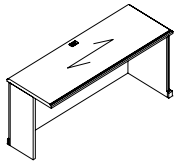

**Linking Return - Right**

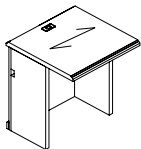

**Bridge**

MODEL#	DIMENSIONS D x W x H	FREIGHT CLASS	WT/LBS.	CUBIC FT.	LIST PRICE
PBEKR489624ML	48 x 96 x 29	150	387	77	<b>\$8641</b>
PBEKR489024ML	48 x 90 x 29	150	363	73	<b>\$8159</b>
PBEKR488424ML	48 x 84 x 29	150	338	68	<b>\$8064</b>
PBEKR487824ML	48 x 78 x 29	150	314	63	<b>\$8020</b>
PBEKR487224ML	48 x 72 x 29	150	290	58	<b>\$7623</b>
PBEKR486624ML	48 x 66 x 29	150	266	52	<b>\$7107</b>
PBEKR486024ML	48 x 60 x 29	150	242	48	<b>\$6586</b>

With 24" return connection.

PBVEL9624CG	24 x 96 x 29	150	200	39	<b>\$5252</b>
PBVEL9024CG	24 x 90 x 29	150	187	36	<b>\$4924</b>
PBVEL8424CG	24 x 84 x 29	150	174	34	<b>\$4596</b>
PBVEL7824CG	24 x 78 x 29	150	162	31	<b>\$4263</b>
PBVEL7224CG	24 x 72 x 29	150	149	29	<b>\$3940</b>
PBVEL6624CG	24 x 66 x 29	150	141	27	<b>\$3698</b>
PBVEL6024CG	24 x 60 x 29	150	132	24	<b>\$3456</b>
PBVEL5424CG	24 x 54 x 29	150	121	22	<b>\$3260</b>
PBVEL4824CG	24 x 48 x 29	125	115	19	<b>\$3066</b>
PBVEL4224CG	24 x 42 x 29	150	99	17	<b>\$2581</b>
PBVEL3624CG	24 x 36 x 29	150	83	15	<b>\$2493</b>
PBVEL3024CG	24 x 30 x 29	125	77	12	<b>\$2477</b>
PBVEL2424CG	24 x 24 x 29	125	61	10	<b>\$2054</b>

Used in conjunction with extended piano corner units or piano shaped desks.

PBVER9624CG	24 x 96 x 29	150	200	39	<b>\$5252</b>
PBVER9024CG	24 x 90 x 29	150	187	36	<b>\$4924</b>
PBVER8424CG	24 x 84 x 29	150	174	34	<b>\$4596</b>
PBVER7824CG	24 x 78 x 29	150	162	31	<b>\$4263</b>
PBVER7224CG	24 x 72 x 29	150	149	29	<b>\$3940</b>
PBVER6624CG	24 x 66 x 29	150	141	27	<b>\$3698</b>
PBVER6024CG	24 x 60 x 29	150	132	24	<b>\$3456</b>
PBVER5424CG	24 x 54 x 29	150	121	22	<b>\$3260</b>
PBVER4824CG	24 x 48 x 29	125	115	19	<b>\$3066</b>
PBVER4224CG	24 x 42 x 29	150	99	17	<b>\$2581</b>
PBVER3624CG	24 x 36 x 29	150	83	15	<b>\$2493</b>
PBVER3024CG	24 x 30 x 29	125	77	12	<b>\$2477</b>
PBVER2424CG	24 x 24 x 29	125	61	10	<b>\$2054</b>

Used in conjunction with extended piano corner units or piano shaped desks.

PBBTN4824CG	24 x 48 x 29	150	110	19	<b>\$2973</b>
PBBTN4224CG	24 x 42 x 29	150	94	17	<b>\$2493</b>
PBBTN3624CG	24 x 36 x 29	150	79	15	<b>\$2400</b>
PBBTN3024CG	24 x 30 x 29	125	72	12	<b>\$2349</b>
PBBTN2424CG	24 x 24 x 29	150	56	10	<b>\$1975</b>
PBBTN1824CG	24 x 18 x 29	150	43	8	<b>\$1482</b>
PBBTN1224CG	24 x 12 x 29	150	29	5	<b>\$988</b>

For extended piano corner units or piano-shaped desks.

### Required Specifications

Finish

### Optional Specifications

Additional grommet

BRIDGES	MODEL#	DIMENSIONS	FREIGHT CLASS	WT/LBS.	CUBIC FT.	LIST PRICE
---------	--------	------------	---------------	---------	-----------	------------

D x W x H

- All bridges are shipped knockdown
- Not for use with Corner Units
- The standard grain direction is cross grain (**CG**). To remove cross grain veneer pattern on top, delete suffix "**CG**" from the model number (no upcharge)
- GM5 TC location is standard. If grommet color is not specified, Black is standard
- **NOTE:** Arrow indicates direction of grain

BRIDGES	MODEL#	DIMENSIONS	FREIGHT CLASS	WT/LBS.	CUBIC FT.	LIST PRICE
---------	--------	------------	---------------	---------	-----------	------------

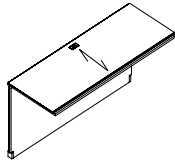

Executive Bridge Top

PBBT6022CG	22 x 60 x 29	92.5	108	10	<b>\$3067</b>
PBBT5422CG	22 x 54 x 29	92.5	99	9	<b>\$2767</b>
PBBT4822CG	22 x 48 x 29	92.5	90	8	<b>\$2457</b>
PBBT4222CG	22 x 42 x 29	92.5	81	7	<b>\$2150</b>
PBBT6020CG	20 x 60 x 29	85	105	8	<b>\$2515</b>
PBBT5420CG	20 x 54 x 29	85	96	8	<b>\$2264</b>
PBBT4820CG	20 x 48 x 29	85	87	7	<b>\$2013</b>
PBBT4220CG	20 x 42 x 29	85	78	6	<b>\$1723</b>

With full back panel.

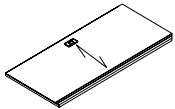

Executive Bridge Top

PBBT5422TCG	22 x 54 x 1.3	125	64	9	<b>\$1661</b>
PBBT4822TCG	22 x 48 x 1.3	125	55	8	<b>\$1473</b>
PBBT4222TCG	22 x 42 x 1.3	125	46	7	<b>\$1293</b>
PBBT5420TCG	20 x 54 x 1.3	125	61	8	<b>\$1356</b>
PBBT4820TCG	20 x 48 x 1.3	125	52	7	<b>\$1211</b>
PBBT4220TCG	20 x 42 x 1.3	125	43	6	<b>\$1038</b>

**Required Specifications**  
Finish

**Optional Specifications**  
Additional grommet

CRENZAS	MODEL#	DIMENSIONS D x W x H	FREIGHT CLASS	WT/LBS.	CUBIC FT.	LIST PRICE
---------	--------	-------------------------	---------------	---------	-----------	------------

- All credenzas are shipped assembled
- All storage cabinets include one adjustable shelf per set of doors
- **F** and **G** depict 36". **M** and **N** depict 30".
- **F** and **N** indicate lateral file drawers. **G** and **M** indicate storage cabinets with doors.
- Credenza shells accept modular storage. Use modular storage for top support allowing no more than 72" unsupported.
- Credenza shells with a width of 96" and more will have a 12" middle support gable.
- For PBCF7220 and PBCF6020, standard face locking for cabinet and lateral file.
- Grommets are available as an option on Desks and most Credenzas.
- **NOTE:** Arrow indicates direction of grain

CRENZAS	MODEL#	DIMENSIONS	FREIGHT CLASS	WT/LBS.	CUBIC FT.	LIST PRICE
---------	--------	------------	---------------	---------	-----------	------------

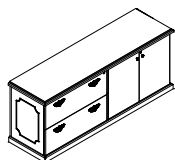

Full Storage Credenza

PBCF7224FG	24 x 72 x 29	92.5	272	24	<b>\$8048</b>
PBC6024NM	24 x 60 x 29	92.5	220	20	<b>\$6704</b>
PBCF7220FG	20 x 72 x 29	92.5	272	24	<b>\$7076</b>
PBCF6020NM	20 x 60 x 29	92.5	220	20	<b>\$5896</b>

Lateral file on **left** and storage cabinet on **right**.

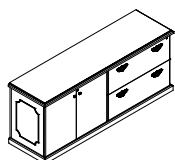

Full Storage Credenza

PBCF7224GF	24 x 72 x 29	92.5	272	24	<b>\$8048</b>
PBC6024MN	24 x 60 x 29	92.5	220	20	<b>\$6704</b>
PBCF7220GF	20 x 72 x 29	92.5	272	24	<b>\$7076</b>
PBCF6020MN	20 x 60 x 29	92.5	220	20	<b>\$5896</b>

Storage cabinet on **left** and lateral file on **right**.

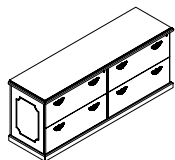

Full Storage Credenza

PBC7224FF	24 x 72 x 29	92.5	287	24	<b>\$9806</b>
PBC6024NN	24 x 60 x 29	92.5	205	20	<b>\$8581</b>
PBC7220FF	20 x 72 x 29	92.5	287	24	<b>\$9053</b>
PBC6020NN	20 x 60 x 29	92.5	205	20	<b>\$7923</b>

Lateral files on **left** and **right**.

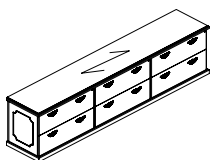

Full Storage Credenza

PBC10824FFF	24 x 108 x 29	92.5	412	36	<b>\$16465</b>
PBC9024NNN	24 x 90 x 29	92.5	337	30	<b>\$13720</b>
PBC10820FFF	20 x 108 x 29	92.5	412	36	<b>\$15200</b>
PBC9020NNN	20 x 90 x 29	92.5	337	30	<b>\$12670</b>

Lateral files on **left, center, and right**.

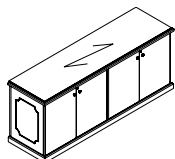

Full Storage Credenza

PBC7224GG	24 x 72 x 29	92.5	253	24	<b>\$7277</b>
PBC6024MM	24 x 60 x 29	92.5	209	20	<b>\$6364</b>
PBC7220GG	20 x 72 x 29	92.5	253	24	<b>\$6719</b>
PBC6020MM	20 x 60 x 29	92.5	209	20	<b>\$5878</b>

Storage cabinets on **left and right**.

**Required Specifications**  
Finish

**Optional Specifications**  
Additional grommet

**CRENZAS MODEL# DIMENSIONS FREIGHT CLASS WT/LBS. CUBIC FT. LIST PRICE**

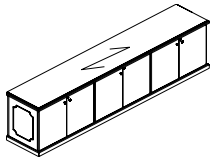

**Full Storage Credenza**

	D x W x H				
PBC10824GGG	24 x 108 x 29	125	278	36	<b>\$13120</b>
PBC9024MMM	24 x 90 x 29	125	228	30	<b>\$10937</b>
PBC10820GGG	20 x 108 x 29	125	278	36	<b>\$12114</b>
PBC9020MMM	20 x 90 x 29	125	228	30	<b>\$10098</b>

Storage cabinets on **left, center,** and **right.**

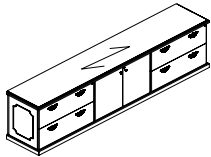

**Full Storage Credenza**

PBC10824FGF	24 x 108 x 29	92.5	479	44	<b>\$17043</b>
PBC9024NNM	24 x 90 x 29	92.5	399	36	<b>\$14198</b>
PBC10820FGF	20 x 108 x 29	92.5	388	36	<b>\$14172</b>
PBC9020NNM	20 x 90 x 29	92.5	321	30	<b>\$11808</b>

Lateral files on **left and right;** storage cabinet in **center.**

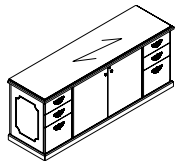

**Full Storage Credenza**

PBC7224DGD	24 x 72 x 29	92.5	319	29	<b>\$10477</b>
PBC6024DGD	24 x 60 x 29	92.5	266	24	<b>\$9603</b>
PBC7220DGD	20 x 72 x 29	85	298	24	<b>\$9129</b>
PBC6020DGD	20 x 60 x 29	85	246	20	<b>\$7988</b>

Box/box/file on **left and right;** storage cabinet in **center.**

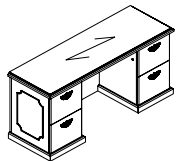

**Double Pedestal Credenza**

PBCK8424EE	24 x 84 x 29	92.5	348	34	<b>\$9953</b>
PBCK7824EE	24 x 78 x 29	92.5	319	31	<b>\$9247</b>
PBCK7224EE	24 x 72 x 29	100	280	29	<b>\$8541</b>
PBCK6624EE	24 x 66 x 29	100	261	27	<b>\$8408</b>
PBCK6024EE	24 x 60 x 29	100	238	24	<b>\$7823</b>

PBCK8420EE	20 x 84 x 29	92.5	307	28	<b>\$8679</b>
PBCK7820EE	20 x 78 x 29	92.5	285	26	<b>\$8058</b>
PBCK7220EE	20 x 72 x 29	92.5	267	24	<b>\$7438</b>
PBCK6620EE	20 x 66 x 29	92.5	244	22	<b>\$6814</b>
PBCK6020EE	20 x 60 x 29	92.5	220	20	<b>\$6200</b>

File/file pedestals on **left and right.** Full height back panel. Kneespace in center.

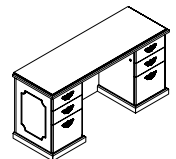

**Double Pedestal Credenza**

PBCK8424DD	24 x 84 x 29	92.5	348	34	<b>\$9953</b>
PBCK7824DD	24 x 78 x 29	92.5	319	31	<b>\$9247</b>
PBCK7224DD	24 x 72 x 29	100	280	29	<b>\$8541</b>
PBCK6624DD	24 x 66 x 29	100	261	27	<b>\$8408</b>
PBCK6024DD	24 x 60 x 29	100	238	24	<b>\$7823</b>

PBCK8420DD	20 x 84 x 29	92.5	307	28	<b>\$8679</b>
PBCK7820DD	20 x 78 x 29	92.5	285	26	<b>\$8058</b>
PBCK7220DD	20 x 72 x 29	92.5	267	24	<b>\$7438</b>
PBCK6620DD	20 x 66 x 29	92.5	244	22	<b>\$6814</b>
PBCK6020DD	20 x 60 x 29	92.5	220	20	<b>\$6200</b>

Box/box/file pedestals on **left and right.** Full height back panel. Kneespace in center.

**Required Specifications**  
Finish

**Optional Specifications**  
Additional grommet

**CREDENZAS**

**MODEL# DIMENSIONS FREIGHT CLASS WT/LBS. CUBIC FT. LIST PRICE**

**D x W x H**

PBCK8424ED	24 x 84 x 29	92.5	348	34	<b>\$9953</b>
PBCK7824ED	24 x 78 x 29	92.5	319	31	<b>\$9247</b>
PBCK7224ED	24 x 72 x 29	100	280	29	<b>\$8541</b>
PBCK6624ED	24 x 66 x 29	100	261	27	<b>\$8408</b>
PBCK6024ED	24 x 60 x 29	100	238	24	<b>\$7823</b>
PBCK8420ED	20 x 84 x 29	92.5	307	28	<b>\$8679</b>
PBCK7820ED	20 x 78 x 29	92.5	285	26	<b>\$8058</b>
PBCK7220ED	20 x 72 x 29	92.5	267	24	<b>\$7438</b>
PBCK6620ED	20 x 66 x 29	92.5	244	22	<b>\$6814</b>
PBCK6020ED	20 x 60 x 29	92.5	220	20	<b>\$6200</b>

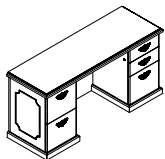

**Double Pedestal Credenza**

File/file pedestal on **left** and box/box/file pedestal on **right**. Full height back panel. Kneespace in center.

PBCK8424DE	24 x 84 x 29	92.5	348	34	<b>\$9953</b>
PBCK7824DE	24 x 78 x 29	92.5	319	31	<b>\$9247</b>
PBCK7224DE	24 x 72 x 29	100	280	29	<b>\$8541</b>
PBCK6624DE	24 x 66 x 29	100	261	27	<b>\$8408</b>
PBCK6024DE	24 x 60 x 29	100	238	24	<b>\$7823</b>
PBCK8420DE	20 x 84 x 29	92.5	307	28	<b>\$8679</b>
PBCK7820DE	20 x 78 x 29	92.5	285	26	<b>\$8058</b>
PBCK7220DE	20 x 72 x 29	92.5	267	24	<b>\$7438</b>
PBCK6620DE	20 x 66 x 29	92.5	244	22	<b>\$6814</b>
PBCK6020DE	20 x 60 x 29	92.5	220	20	<b>\$6200</b>

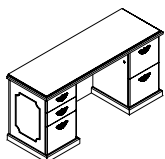

**Double Pedestal Credenza**

Box/box/file pedestal on **left** and file/file pedestal on **right**. Full height back panel. Kneespace in center.

PBCL8424E	24 x 84 x 29	100	315	34	<b>\$7526</b>
PBCL7824E	24 x 78 x 29	100	292	31	<b>\$6991</b>
PBCL7224E	24 x 72 x 29	100	270	29	<b>\$6451</b>
PBCL6624E	24 x 66 x 29	100	247	27	<b>\$6209</b>
PBCL6024E	24 x 60 x 29	100	225	24	<b>\$5646</b>
PBCL8420E	20 x 84 x 29	100	273	28	<b>\$6560</b>
PBCL7820E	20 x 78 x 29	100	252	26	<b>\$6091</b>
PBCL7220E	20 x 72 x 29	100	237	24	<b>\$5624</b>
PBCL6620E	20 x 66 x 29	100	216	22	<b>\$5413</b>
PBCL6020E	20 x 60 x 29	100	195	20	<b>\$4924</b>

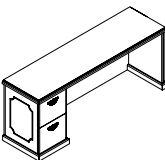

**Single Pedestal Credenza - Left**

File/file pedestal on **left**.

PBCR8424E	24 x 84 x 29	100	315	34	<b>\$7526</b>
PBCR7824E	24 x 78 x 29	100	292	31	<b>\$6991</b>
PBCR7224E	24 x 72 x 29	100	270	29	<b>\$6451</b>
PBCR6624E	24 x 66 x 29	100	247	27	<b>\$6209</b>
PBCR6024E	24 x 60 x 29	100	225	24	<b>\$5646</b>
PBCR8420E	20 x 84 x 29	100	273	28	<b>\$6560</b>
PBCR7820E	20 x 78 x 29	100	252	26	<b>\$6091</b>
PBCR7220E	20 x 72 x 29	100	237	24	<b>\$5624</b>
PBCR6620E	20 x 66 x 29	100	216	22	<b>\$5413</b>
PBCR6020E	20 x 60 x 29	100	195	20	<b>\$4924</b>

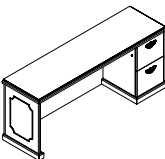

**Single Pedestal Credenza - Right**

File/file pedestal on **right**.

**Required Specifications**  
Finish

**Optional Specifications**  
Additional grommet

CREDENZAS	MODEL#	DIMENSIONS	FREIGHT CLASS	WT/LBS.	CUBIC FT.	LIST PRICE
		<b>D x W x H</b>				
	PBCL8424D	24 x 84 x 29	100	315	34	<b>\$7526</b>
	PBCL7824D	24 x 78 x 29	100	292	31	<b>\$6991</b>
	PBCL7224D	24 x 72 x 29	100	270	29	<b>\$6451</b>
	PBCL6624D	24 x 66 x 29	100	247	27	<b>\$6209</b>
	PBCL6024D	24 x 60 x 29	100	225	24	<b>\$5646</b>
<hr/>						
	PBCL8420D	20 x 84 x 29	100	273	28	<b>\$6560</b>
	PBCL7820D	20 x 78 x 29	100	252	26	<b>\$6091</b>
	PBCL7220D	20 x 72 x 29	100	237	24	<b>\$5624</b>
	PBCL6620D	20 x 66 x 29	100	216	22	<b>\$5413</b>
	PBCL6020D	20 x 60 x 29	100	195	20	<b>\$4924</b>

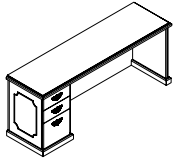

**Single Pedestal Credenza - Left**

Box/box/file pedestal on **left**.

	PBCR8424D	24 x 84 x 29	100	315	34	<b>\$7526</b>
	PBCR7824D	24 x 78 x 29	100	292	31	<b>\$6991</b>
	PBCR7224D	24 x 72 x 29	100	270	29	<b>\$6451</b>
	PBCR6624D	24 x 66 x 29	100	247	27	<b>\$6209</b>
	PBCR6024D	24 x 60 x 29	100	225	24	<b>\$5646</b>
<hr/>						
	PBCR8420D	20 x 84 x 29	100	273	28	<b>\$6560</b>
	PBCR7820D	20 x 78 x 29	100	252	26	<b>\$6091</b>
	PBCR7220D	20 x 72 x 29	100	237	24	<b>\$5624</b>
	PBCR6620D	20 x 66 x 29	100	216	22	<b>\$5413</b>
	PBCR6020D	20 x 60 x 29	100	195	20	<b>\$4924</b>

Box/box/file pedestal on **right**.

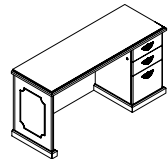

**Single Pedestal Credenza - Right**

	PBCL8424F	24 x 84 x 29	100	305	34	<b>\$8748</b>
	PBCL7824F	24 x 78 x 29	100	285	31	<b>\$8119</b>
	PBCL7224F	24 x 72 x 29	100	261	29	<b>\$7500</b>
	PBCL6624F	24 x 66 x 29	100	239	27	<b>\$7281</b>
	PBCL6024F	24 x 60 x 29	100	218	24	<b>\$6553</b>
<hr/>						
	PBCL8420F	20 x 84 x 29	100	253	28	<b>\$7626</b>
	PBCL7820F	20 x 78 x 29	100	233	26	<b>\$7075</b>
	PBCL7220F	20 x 72 x 29	100	218	24	<b>\$6531</b>
	PBCL6620F	20 x 66 x 29	100	197	22	<b>\$6289</b>
	PBCL6020F	20 x 60 x 29	100	176	20	<b>\$5711</b>

36" lateral file on **left**.

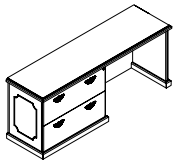

**Single Pedestal Credenza - Left**

	PBCR8424F	24 x 84 x 29	100	305	34	<b>\$8748</b>
	PBCR7824F	24 x 78 x 29	100	285	31	<b>\$8119</b>
	PBCR7224F	24 x 72 x 29	100	261	29	<b>\$7500</b>
	PBCR6624F	24 x 66 x 29	100	239	27	<b>\$7281</b>
	PBCR6024F	24 x 60 x 29	100	218	24	<b>\$6553</b>
<hr/>						
	PBCR8420F	20 x 84 x 29	100	253	28	<b>\$7626</b>
	PBCR7820F	20 x 78 x 29	100	233	26	<b>\$7075</b>
	PBCR7220F	20 x 72 x 29	100	218	24	<b>\$6531</b>
	PBCR6620F	20 x 66 x 29	100	197	22	<b>\$6289</b>
	PBCR6020F	20 x 60 x 29	100	176	20	<b>\$5711</b>

36" lateral file on **right**.

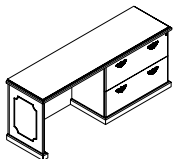

**Single Pedestal Credenza - Right**

**Required Specifications**  
Finish

**Optional Specifications**  
Additional grommet

**CREDENZAS**

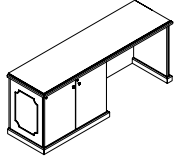

**Single Pedestal Credenza - Left**

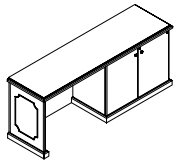

**Single Pedestal Credenza - Right**

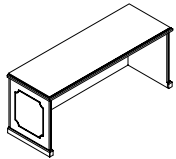

**Credenza Shell**

MODEL#	DIMENSIONS D x W x H	FREIGHT CLASS	WT/LBS.	CUBIC FT.	LIST PRICE
PBCL8424G	24 x 84 x 29	100	338	34	<b>\$7858</b>
PBCL7824G	24 x 78 x 29	92.5	314	31	<b>\$7294</b>
PBCL7224G	24 x 72 x 29	92.5	290	29	<b>\$6754</b>
PBCL6624G	24 x 66 x 29	100	266	27	<b>\$6482</b>
PBCL6024G	24 x 60 x 29	92.5	242	24	<b>\$5893</b>
PBCL8420G	20 x 84 x 29	92.5	290	28	<b>\$6847</b>
PBCL7820G	20 x 78 x 29	92.5	272	26	<b>\$6357</b>
PBCL7220G	20 x 72 x 29	92.5	252	24	<b>\$5870</b>
PBCL6620G	20 x 66 x 29	92.5	230	22	<b>\$5641</b>
PBCL6020G	20 x 60 x 29	92.5	208	20	<b>\$5137</b>

36" storage cabinet on **left**.

PBCR8424G	24 x 84 x 29	100	338	34	<b>\$7858</b>
PBCR7824G	24 x 78 x 29	92.5	314	31	<b>\$7294</b>
PBCR7224G	24 x 72 x 29	92.5	290	29	<b>\$6754</b>
PBCR6624G	24 x 66 x 29	100	266	27	<b>\$6482</b>
PBCR6024G	24 x 60 x 29	92.5	242	24	<b>\$5893</b>
PBCR8420G	20 x 84 x 29	92.5	290	28	<b>\$6847</b>
PBCR7820G	20 x 78 x 29	92.5	272	26	<b>\$6357</b>
PBCR7220G	20 x 72 x 29	92.5	252	24	<b>\$5870</b>
PBCR6620G	20 x 66 x 29	92.5	230	22	<b>\$5641</b>
PBCR6020G	20 x 60 x 29	92.5	208	20	<b>\$5137</b>

36" storage cabinet on **right**.

PBC12024	24 x 120 x 29	100	387	48	<b>\$6704</b>
PBC11424	24 x 114 x 29	125	367	46	<b>\$6372</b>
PBC10824	24 x 108 x 29	125	348	44	<b>\$6036</b>
PBC10224	24 x 102 x 29	100	329	41	<b>\$5694</b>
PBC9624	24 x 96 x 29	125	309	39	<b>\$5363</b>
PBC9024	24 x 90 x 29	100	290	36	<b>\$5025</b>
PBC8424	24 x 84 x 29	125	271	34	<b>\$4694</b>
PBC7824	24 x 78 x 29	100	251	31	<b>\$4355</b>
PBC7224	24 x 72 x 29	100	232	29	<b>\$4024</b>
PBC6624	24 x 66 x 29	125	213	27	<b>\$3881</b>
PBC6024	24 x 60 x 29	100	193	24	<b>\$3522</b>
PBC5424	24 x 54 x 29	125	174	22	<b>\$3332</b>
PBC4824	24 x 48 x 29	100	155	19	<b>\$3150</b>
PBC4224	24 x 42 x 29	125	135	17	<b>\$2669</b>

With full back panel.

**Required Specifications**  
Finish

**Optional Specifications**  
Additional grommet

**CORNERS - NOTES**

**NOTE:** Arrow indicates direction of grain

D x W x H

**Corners**

- All units are shipped assembled
- Unit includes grommets shown and installed horizontal wire management
- Corner units and extended corner units must be used exclusively with linking bridges and linking returns
- **Linking bridges** are handed by recessed end panel
- **Extended corner tables** have no molding on back side. Grommets are not included and must be specified.
- **Linking returns** include grommets shown and installed horizontal wire management. Handed by full end panel.
- **Tables** include grommets shown and installed horizontal wire management.

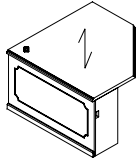
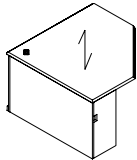
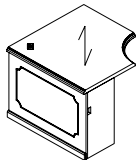
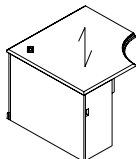
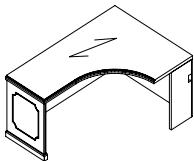
CORNERS AND COMPONENTS	MODEL#	DIMENSIONS	FREIGHT CLASS	WT/LBS.	CUBIC FT.	LIST PRICE
 <p><b>Corner Table - Left</b></p>	PBE484824ML	48 x 48 x 29	150	196	35	<b>\$4685</b>
	PBE424224ML	42 x 42 x 29	150	150	30	<b>\$3604</b>
	PBE363624ML	36 x 36 x 29	150	130	22	<b>\$3426</b>
With 2 recessed end panels.						
 <p><b>Corner Table - Right</b></p>	PBE484824MR	48 x 48 x 29	150	196	35	<b>\$4685</b>
	PBE424224MR	42 x 42 x 29	150	150	30	<b>\$3604</b>
	PBE363624MR	36 x 36 x 29	150	130	22	<b>\$3426</b>
With 2 recessed end panels.						
 <p><b>Corner Table - Left</b></p>	PBEK484824ML	48 x 48 x 29	150	196	39	<b>\$5388</b>
	PBEK424224ML	42 x 42 x 29	150	150	30	<b>\$4147</b>
	PBEK363624ML	36 x 36 x 29	150	130	22	<b>\$3939</b>
With 2 recessed end panels and inner curve.						
 <p><b>Corner Table - Right</b></p>	PBEK484824MR	48 x 48 x 29	150	196	39	<b>\$5388</b>
	PBEK424224MR	42 x 42 x 29	150	150	30	<b>\$4147</b>
	PBEK363624MR	36 x 36 x 29	150	130	22	<b>\$3939</b>
With 2 recessed end panels and inner curve.						
 <p><b>Extended Corner Table - Left</b></p>	PBEKL964824	96 x 48 x 29	150	387	77	<b>\$7855</b>
	PBEKL904824	90 x 48 x 29	150	363	73	<b>\$7416</b>
	PBEKL844824	84 x 48 x 29	150	338	68	<b>\$7326</b>
	PBEKL784824	78 x 48 x 29	150	314	63	<b>\$7289</b>
	PBEKL724824	72 x 48 x 29	150	290	58	<b>\$6927</b>
	PBEKL664824	66 x 48 x 29	150	266	52	<b>\$6455</b>
	PBEKL604824	60 x 48 x 29	150	242	48	<b>\$5991</b>
	With full back panel.					

**Required Specifications**  
Finish

**Optional Specifications**  
Additional grommet

## CORNERS AND COMPONENTS

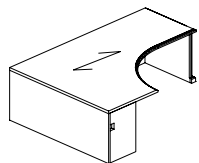

**Extended Corner Table - Right**

MODEL#	DIMENSIONS D x W x H	FREIGHT CLASS	WT/LBS.	CUBIC FT.	LIST PRICE
PBEKR489624	96 x 48 x 29	150	387	77	<b>\$7855</b>
PBEKR489024	90 x 48 x 29	150	363	73	<b>\$7416</b>
PBEKR488424	84 x 48 x 29	150	338	68	<b>\$7326</b>
PBEKR487824	78 x 48 x 29	150	314	63	<b>\$7289</b>
PBEKR487224	72 x 48 x 29	150	290	58	<b>\$6927</b>
PBEKR486624	66 x 48 x 29	150	266	52	<b>\$6455</b>
PBEKR486024	60 x 48 x 29	150	242	48	<b>\$5991</b>

With full back panel.

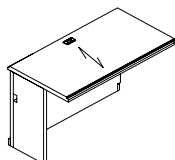

**Linking Bridge - Left**

PBBT6024NLLCG	24 x 60 x 29	125	145	24	<b>\$3052</b>
PBBT5424NLLCG	24 x 54 x 29	150	131	22	<b>\$2745</b>
PBBT4824NLLCG	24 x 48 x 29	125	116	19	<b>\$2440</b>
PBBT4224NLLCG	24 x 42 x 29	125	102	17	<b>\$1977</b>
PBBT3624NLLCG	24 x 36 x 29	150	87	15	<b>\$1796</b>
PBBT3024NLLCG	24 x 30 x 29	125	73	12	<b>\$1755</b>

To join corner worksurface to desk or credenza. Full back panel.

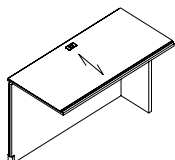

**Linking Bridge - Right**

PBBT6024NLR CG	24 x 60 x 29	125	145	24	<b>\$3052</b>
PBBT5424NLR CG	24 x 54 x 29	150	131	22	<b>\$2745</b>
PBBT4824NLR CG	24 x 48 x 29	125	116	19	<b>\$2440</b>
PBBT4224NLR CG	24 x 42 x 29	125	102	17	<b>\$1977</b>
PBBT3624NLR CG	24 x 36 x 29	150	87	15	<b>\$1796</b>
PBBT3024NLR CG	24 x 30 x 29	125	73	12	<b>\$1755</b>

To join corner worksurface to desk or credenza. Full back panel.

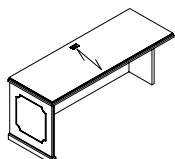

**Linking Return - Left**

PBVL9624CG	24 x 96 x 29	150	200	39	<b>\$5054</b>
PBVL9024CG	24 x 90 x 29	150	187	36	<b>\$4738</b>
PBVL8424CG	24 x 84 x 29	150	174	34	<b>\$4423</b>
PBVL7824CG	24 x 78 x 29	150	162	31	<b>\$4108</b>
PBVL7224CG	24 x 72 x 29	150	149	29	<b>\$3791</b>
PBVL6624CG	24 x 66 x 29	150	141	27	<b>\$3558</b>
PBVL6024CG	24 x 60 x 29	150	132	24	<b>\$3325</b>
PBVL5424CG	24 x 54 x 29	150	121	22	<b>\$3139</b>
PBVL4824CG	24 x 48 x 29	125	115	19	<b>\$2948</b>
PBVL4224CG	24 x 42 x 29	150	99	17	<b>\$2487</b>
PBVL3624CG	24 x 36 x 29	150	83	15	<b>\$2397</b>
PBVL3024CG	24 x 30 x 29	125	77	12	<b>\$2354</b>
PBVL2424CG	24 x 24 x 29	125	61	10	<b>\$1975</b>

To be used with corner unit.

**Required Specifications**  
Finish

**Optional Specifications**  
Additional grommet

**CORNERS AND COMPONENTS**      **MODEL#**      **DIMENSIONS**      **FREIGHT CLASS**      **WT/LBS.**      **CUBIC FT.**      **LIST PRICE**

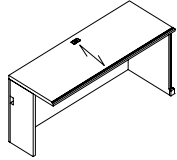

**Linking Return - Right**

	<b>D x W x H</b>					
PBVR9624CG	24 x 96 x 29	150	200	39		<b>\$5054</b>
PBVR9024CG	24 x 90 x 29	150	187	36		<b>\$4738</b>
PBVR8424CG	24 x 84 x 29	150	174	34		<b>\$4423</b>
PBVR7824CG	24 x 78 x 29	150	162	31		<b>\$4108</b>
PBVR7224CG	24 x 72 x 29	150	149	29		<b>\$3791</b>
PBVR6624CG	24 x 66 x 29	150	141	27		<b>\$3558</b>
PBVR6024CG	24 x 60 x 29	150	132	24		<b>\$3325</b>
PBVR5424CG	24 x 54 x 29	150	121	22		<b>\$3139</b>
PBVR4824CG	24 x 48 x 29	125	115	19		<b>\$2948</b>
PBVR4224CG	24 x 42 x 29	150	99	17		<b>\$2487</b>
PBVR3624CG	24 x 36 x 29	150	83	15		<b>\$2397</b>
PBVR3024CG	24 x 30 x 29	125	77	12		<b>\$2354</b>
PBVR2424CG	24 x 24 x 29	125	61	10		<b>\$1975</b>

To be used with corner unit.

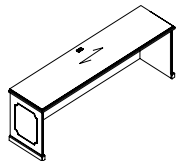

**Freestanding Table**

PBVT9624	24 x 96 x 29	150	213	39		<b>\$5164</b>
PBVT9024	24 x 90 x 29	150	199	36		<b>\$4841</b>
PBVT8424	24 x 84 x 29	150	186	34		<b>\$4519</b>
PBVT7824	24 x 78 x 29	150	173	31		<b>\$4190</b>
PBVT7224	24 x 72 x 29	150	160	29		<b>\$3874</b>
PBVT6624	24 x 66 x 29	150	146	27		<b>\$3641</b>
PBVT6024	24 x 60 x 29	150	133	24		<b>\$3413</b>
PBVT5424	24 x 54 x 29	150	128	22		<b>\$3221</b>
PBVT4824	24 x 48 x 29	125	120	19		<b>\$3033</b>
PBVT4224	24 x 42 x 29	125	104	17		<b>\$2566</b>
PBVT3624	24 x 36 x 29	150	88	15		<b>\$2481</b>
PBVT3024	24 x 30 x 29	125	82	12		<b>\$2433</b>
PBVT2424	24 x 24 x 29	125	65	10		<b>\$2046</b>

Full end panels.



**Corner Filler Top**

PBV1212CT	12 x 12 x 1.3	150	5	1		<b>\$1038</b>
-----------	---------------	-----	---	---	--	---------------

**Required Specifications**  
Finish

**Optional Specifications**  
Additional grommet

## MODULAR STORAGE - NOTES

D x W x H

- All storage components are shipped assembled
- Components 28" high are intended for use with a desk, credenza or return shell
- Backs on 28" high pedestals and cabinets are unfinished. If finished back is required, see page 365.
- If a profiled top is required, please see "Freestanding Storage" section.

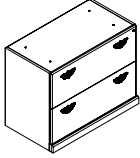
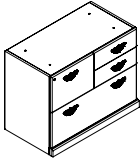
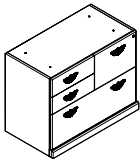
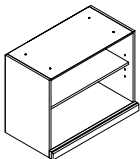
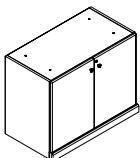
MODULAR STORAGE	MODEL#	DIMENSIONS	FREIGHT CLASS	WT/LBS.	CUBIC FT.	LIST PRICE
 <p><b>Modular Lateral File</b></p>	PBWF	19.1 x 35.1 x 28	92.5	115	11	<b>\$4220</b>
	PBWN	19.1 x 30 x 28	92.5	96	9	<b>\$3694</b>
 <p><b>Modular Combination Storage</b></p>	PBWZL	19.1 x 35.1 x 28	92.5	115	11	<b>\$4148</b>
	With 1 lateral file, 2 box drawers in the top right, and 1 file drawer in the top left.					
 <p><b>Modular Combination Storage</b></p>	PBWZR	19.1 x 35.1 x 28	92.5	115	11	<b>\$4148</b>
	With 1 lateral file, 2 box drawers in the top left, and 1 file drawer in the top right.					
 <p><b>Modular Open Storage</b></p>	PBWOB36	19.1 x 35.1 x 28	100	92	11	<b>\$2083</b>
	PBWOB30	19.1 x 30 x 28	100	77	9	<b>\$1846</b>
 <p><b>Modular Storage Cabinet w/Doors</b></p>	PBWG	19.1 x 35.1 x 28	92.5	115	11	<b>\$2600</b>
	PBWM	19.1 x 30 x 28	92.5	96	9	<b>\$2305</b>
Storage with 1 adjustable shelf.						

### Required Specifications

Finish

**MODULAR STORAGE**      **MODEL#**      **DIMENSIONS**      **FREIGHT CLASS**      **WT./LBS.**      **CUBIC FT.**      **LIST PRICE**

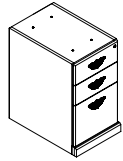

**Box/Box/File Shell - Vertical**

**D x W x H**

Letter width:

PBWWDD	23 x 15.6 x 28	85	72	6	<b>\$3257</b>
PBWD	19 x 15.6 x 28	85	70	5	<b>\$2834</b>

Legal width:

PBWWLD	23 x 18.5 x 28	85	85	7	<b>\$3908</b>
PBWLD	19 x 18.5 x 28	85	83	6	<b>\$3401</b>

For use under a freestanding worksurface (22", 24", 30" or 36"D). Top drilled to attach to worksurface. **Two box and one file drawer.** One pencil tray. Lock secures all drawers.

- For 22" or 24"D worksurface, order or **PBWD or PBWLD**. For 30" or 36"D worksurface, order **PBWWDD or PBWWLD**.
- **Unfinished top and back**

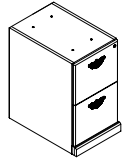

**File/File Shell - Vertical**

Letter width:

PBWWLE	23 x 15.6 x 28	85	72	6	<b>\$3257</b>
PBWE	19 x 15.6 x 28	85	70	5	<b>\$2834</b>

Legal width:

PBWWLE	23 x 18.5 x 28	85	85	7	<b>\$3908</b>
PBWLE	19 x 18.5 x 28	85	83	6	<b>\$3401</b>

For use under a freestanding worksurface (22", 24", 30" or 36"D). Top drilled to attach to worksurface. **Two file drawers.** Lock secures all drawers.

- For 22" or 24"D worksurface, order or **PBWE or PBWLE**. For 30" or 36"D worksurface, order **PBWWLE or PBWWLE**.
- **Unfinished top and back**

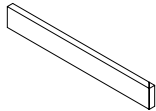

**Decorative Base Trim - Left**

PBAS-WL	1 x 19 x 2.5	70	1	0.01	<b>\$319</b>
PBAS-WWL	1 x 23 x 2.5	70	1	0.01	<b>\$392</b>

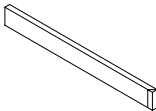

**Decorative Base Trim - Right**

PBAS-WR	1 x 19 x 2.5	70	1	0.01	<b>\$319</b>
PBAS-WWR	1 x 23 x 2.5	70	1	0.01	<b>\$392</b>

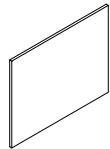

**Finished Back**

PBBA36	0.8 x 35 x 27.5	125	18	3	<b>\$498</b>
PBBA30	0.8 x 30 x 27.5	150	15	3	<b>\$414</b>
PBBA18	0.8 x 18.5 x 27.5	150	10	2	<b>\$241</b>
PBBA15	0.8 x 15.5 x 27.5	150	8	2	<b>\$209</b>

For modular pedestals.

**Required Specifications**

Finish

## HUTCHES & WALL MOUNTED STORAGE NOTES

D x W x H

**NOTE:** Arrow indicates direction of grain

### Hutches

- All hutches are shipped assembled
- Bronze glass door is standard. Clear glass is available, please contact customer care.

### Closed pigeon hole storage hutch

- 42" unit has 21.5" of clearance
- Hutches longer than 102" have 8 doors, hutches between 102" and 84" have 6 doors, and hutches less than 84" have 4 doors.

### Closed storage hutch

- 36" unit has 19.5" of clearance.
- 42" and 54" units have 25.5" of clearance
- Hutches longer than 102" have 8 doors, hutches between 102" and 84" have 6 doors, and hutches less than 84" have 4 doors.

### Tasklight

- For proper size see page 345.

## HUTCHES & WALL MOUNTED STORAGE

### MODEL#

### DIMENSIONS

### FREIGHT CLASS

### WT./LBS.

### CUBIC FT.

### LIST PRICE

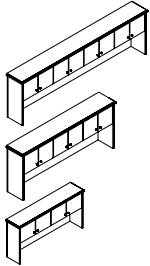

**36" H Storage Hutch w/Wood Doors\***

PB108SH36	15 x 108 x 36	125	268	34	<b>\$8123</b>
PB102SH36	15 x 102 x 36	125	254	32	<b>\$7671</b>
PB96SH36	15 x 96 x 36	100	241	30	<b>\$7216</b>
PB90SH36	15 x 90 x 36	100	227	28	<b>\$6766</b>
PB84SH36	15 x 84 x 36	100	214	26	<b>\$6317</b>
PB78SH36	15 x 78 x 36	100	200	24	<b>\$5869</b>
PB72SH36	15 x 72 x 36	100	187	23	<b>\$5415</b>
PB66SH36	15 x 66 x 36	100	173	21	<b>\$5209</b>
PB60SH36	15 x 60 x 36	100	160	19	<b>\$4967</b>

Hutches longer than 102" have 8 doors, hutches between 102" and 84" have 6 doors, and hutches less than 84" have 4 doors. Locks are optional.

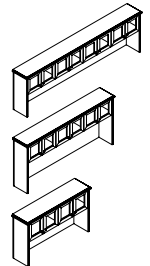

**36" H Storage Hutch w/Glass Doors**

PB108SH36G	15 x 108 x 36	125	268	34	<b>\$11331</b>
PB102SH36G	15 x 102 x 36	125	254	32	<b>\$10222</b>
PB96SH36G	15 x 96 x 36	100	241	30	<b>\$9727</b>
PB90SH36G	15 x 90 x 36	100	227	28	<b>\$9247</b>
PB84SH36G	15 x 84 x 36	100	214	26	<b>\$8756</b>
PB78SH36G	15 x 78 x 36	100	200	24	<b>\$8277</b>
PB72SH36G	15 x 72 x 36	100	187	23	<b>\$7140</b>
PB66SH36G	15 x 66 x 36	100	173	21	<b>\$6881</b>
PB60SH36G	15 x 60 x 36	100	160	19	<b>\$6591</b>

Wood framed glass doors. Hutches longer than 102" have 8 doors, hutches between 102" and 84" have 6 doors, and hutches less than 84" have 4 doors. No lock option available.

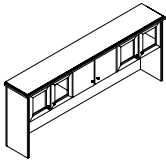

**36" H Storage Hutch w/Doors\***

PB102SH36GDG	15 x 102 x 36	125	254	32	<b>\$9426</b>
PB96SH36GDG	15 x 96 x 36	100	241	30	<b>\$8934</b>
PB90SH36GDG	15 x 90 x 36	100	227	28	<b>\$8452</b>
PB84SH36GDG	15 x 84 x 36	100	214	26	<b>\$7962</b>

Wood doors in the center and wood framed glass doors on left and right. Locks are optional on wood doors.

### Required Specifications

Finish

### Optional Specifications

Additional grommet  
Locks\* (wood doors only)

**HUTCHES & WALL MOUNTED STORAGE**

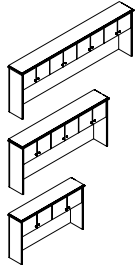

**42" H Storage Hutch w/Wood Doors\***

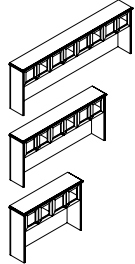

**42" H Storage Hutch w/Glass Doors**

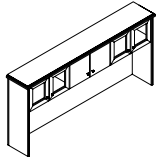

**42" H Storage Hutch w/Doors\***

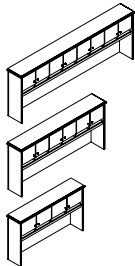

**42" H Storage Hutch w/Wood Doors & Pigeon-Holes\***

MODEL#	DIMENSIONS	FREIGHT CLASS	WT/LBS.	CUBIC FT.	LIST PRICE
D x W x H					
PB108SH42	15 x 108 x 42	125	307	39	<b>\$9470</b>
PB102SH42	15 x 102 x 42	125	290	37	<b>\$8945</b>
PB96SH42	15 x 96 x 42	125	273	35	<b>\$8421</b>
PB90SH42	15 x 90 x 42	125	256	33	<b>\$7892</b>
PB84SH42	15 x 84 x 42	125	239	31	<b>\$7366</b>
PB78SH42	15 x 78 x 42	150	222	38	<b>\$6840</b>
PB72SH42	15 x 72 x 42	125	205	26	<b>\$6317</b>
PB66SH42	15 x 66 x 42	125	188	24	<b>\$6084</b>
PB60SH42	15 x 60 x 42	125	171	22	<b>\$5791</b>

Hutches longer than 102" have 8 doors, hutches between 102" and 84" have 6 doors, and hutches less than 84" have 4 doors. Locks are optional.

PB108SH42G	15 x 108 x 42	125	307	39	<b>\$12613</b>
PB102SH42G	15 x 102 x 42	125	290	37	<b>\$11496</b>
PB96SH42G	15 x 96 x 42	125	273	35	<b>\$10934</b>
PB90SH42G	15 x 90 x 42	125	256	33	<b>\$10367</b>
PB84SH42G	15 x 84 x 42	125	239	31	<b>\$9809</b>
PB78SH42G	15 x 78 x 42	150	222	38	<b>\$9251</b>
PB72SH42G	15 x 72 x 42	125	205	26	<b>\$8040</b>
PB66SH42G	15 x 66 x 42	125	188	24	<b>\$7754</b>
PB60SH42G	15 x 60 x 42	125	171	22	<b>\$7413</b>

Wood framed glass doors. Hutches longer than 102" have 8 doors, hutches between 102" and 84" have 6 doors, and hutches less than 84" have 4 doors. No lock option available.

PB102SH42GDG	15 x 102 x 42	125	290	37	<b>\$10701</b>
PB96SH42GDG	15 x 96 x 42	125	273	35	<b>\$10137</b>
PB90SH42GDG	15 x 90 x 42	125	256	33	<b>\$9575</b>
PB84SH42GDG	15 x 84 x 42	125	239	31	<b>\$9015</b>

Wood doors in the center and wood framed glass doors on left and right. Locks are optional on wood doors.

PB108SHP42	15 x 108 x 42	125	307	39	<b>\$11361</b>
PB102SHP42	15 x 102 x 42	125	290	37	<b>\$10734</b>
PB96SHP42	15 x 96 x 42	125	273	35	<b>\$10104</b>
PB90SHP42	15 x 90 x 42	125	256	33	<b>\$9470</b>
PB84SHP42	15 x 84 x 42	125	239	31	<b>\$8836</b>
PB78SHP42	15 x 78 x 42	150	222	38	<b>\$8210</b>
PB72SHP42	15 x 72 x 42	125	205	26	<b>\$7582</b>
PB66SHP42	15 x 66 x 42	125	241	31	<b>\$6704</b>
PB60SHP42	15 x 60 x 42	125	171	22	<b>\$6947</b>

Hutches longer than 102" have 8 doors, hutches between 102" and 84" have 6 doors, and hutches less than 84" have 4 doors. Locks are optional.

**Required Specifications**  
Finish

**Optional Specifications**  
Additional grommet  
Locks\* (wood doors only)

**HUTCHES & WALL MOUNTED STORAGE**

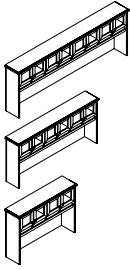

**42" H Storage Hutch w/Glass Doors & Pigeon-Holes**

MODEL#	DIMENSIONS D x W x H	FREIGHT CLASS	WT/LBS.	CUBIC FT.	LIST PRICE
PB108SHP42G	15 x 108 x 42	125	307	39	<b>\$14497</b>
PB102SHP42G	15 x 102 x 42	125	290	37	<b>\$13217</b>
PB96SHP42G	15 x 96 x 42	125	273	35	<b>\$12587</b>
PB90SHP42G	15 x 90 x 42	125	256	33	<b>\$11911</b>
PB84SHP42G	15 x 84 x 42	125		31	
PB78SHP42G	15 x 78 x 42	150	222	38	<b>\$10553</b>
PB72SHP42G	15 x 72 x 42	125	205	26	<b>\$9261</b>
PB66SHP42G	15 x 66 x 42	125	188	24	<b>\$8956</b>
PB60SHP42G	15 x 60 x 42	125	171	22	<b>\$8522</b>

Wood framed glass doors. Hutches longer than 102" have 8 doors, hutches between 102" and 84" have 6 doors, and hutches less than 84" have 4 doors. No lock option available.

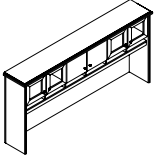

**42" H Storage Hutch w/Doors & Pigeon-Holes**

PB102SHP42GDG	15 x 102 x 42	125	290	37	<b>\$12423</b>
PB96SHP42GDG	15 x 96 x 42	125	273	35	<b>\$11789</b>
PB90SHP42GDG	15 x 90 x 42	125	256	33	<b>\$11117</b>
PB84SHP42GDG	15 x 84 x 42	125	239	31	<b>\$10410</b>

Wood doors in the center and wood framed glass doors on left and right. Locks are optional on wood doors.

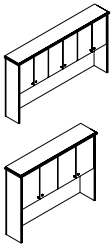

**54" H Storage Hutch w/Wood Doors**

PB962SH54	15 x 96 x 55	125	351	45	<b>\$10819</b>
PB902SH54	15 x 90 x 55	125	329	42	<b>\$10146</b>
PB842SH54	15 x 84 x 55	125	309	39	<b>\$9470</b>
PB782SH54	15 x 78 x 55	125	285	37	<b>\$8794</b>
PB722SH54	15 x 72 x 55	125	263	34	<b>\$8122</b>
PB662SH54	15 x 66 x 55	125	241	31	<b>\$7818</b>
PB602SH54	15 x 60 x 55	125	219	28	<b>\$7440</b>

Hutches between 96" and 84" have 6 doors; hutches less than 84" have 4 doors. One adjustable shelf. Locks are optional.

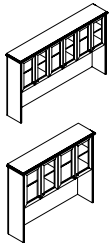

**54" H Storage Hutch w/Glass Doors**

PB962SH54G	15 x 96 x 55	125	351	45	<b>\$13967</b>
PB902SH54G	15 x 90 x 55	125	329	42	<b>\$13019</b>
PB842SH54G	15 x 84 x 55	125	307	39	<b>\$12063</b>
PB782SH54G	15 x 78 x 55	125	285	37	<b>\$11113</b>
PB722SH54G	15 x 72 x 55	125	263	34	<b>\$10165</b>
PB662SH54G	15 x 66 x 55	125	241	31	<b>\$9794</b>
PB602SH54G	15 x 60 x 55	125	219	28	<b>\$9352</b>

Wood framed glass doors. Hutches between 96" and 84" have 6 doors; hutches less than 84" have 4 doors. One adjustable shelf. No lock option available.

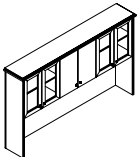

**54" H Storage Hutch w/Doors**

PB962SH54GDG	15 x 96 x 55	125	351	45	<b>\$12974</b>
PB902SH54GDG	15 x 90 x 55	125	329	42	<b>\$12029</b>
PB842SH54GDG	15 x 84 x 55	125	307	39	<b>\$11070</b>

Wood doors in the center and wood framed glass doors on left and right. One adjustable shelf. Locks are optional on wood doors.

**Required Specifications**

Finish

**Optional Specifications**

Locks\* (wood doors only)

**HUTCHES & WALL MOUNTED STORAGE**

**MODEL#      DIMENSIONS      FREIGHT CLASS      WT/LBS.      CUBIC FT.      LIST PRICE**

**D x W x H**

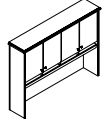
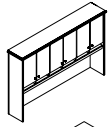

**54" H Storage Hutch w/Wood Doors & Pigeon-Holes**

PB962SHP54	15 x 96 x 55	125	351	45	<b>\$12988</b>
PB902SHP54	15 x 90 x 55	125	329	42	<b>\$12178</b>
PB842SHP54	15 x 84 x 55	125	307	39	<b>\$11361</b>
PB782SHP54	15 x 78 x 55	125	285	37	<b>\$10553</b>
PB722SHP54	15 x 72 x 55	125	263	34	<b>\$9741</b>
PB662SHP54	15 x 66 x 55	125	241	31	<b>\$9379</b>
PB602SHP54	15 x 60 x 55	125	219	28	<b>\$8926</b>

Hutches between 96" and 84" have 6 doors; hutches less than 84" have 4 doors. One adjustable shelf. Locks are optional.

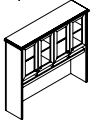
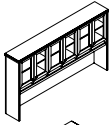

**54" H Storage Hutch w/Glass Doors & Pigeon-Holes**

PB962SHP54	15 x 96 x 55	125	351	45	<b>\$12988</b>
PB902SHP54	15 x 90 x 55	125	329	42	<b>\$12178</b>
PB842SHP54	15 x 84 x 55	125	307	39	<b>\$11361</b>
PB782SHP54	15 x 78 x 55	125	285	37	<b>\$10553</b>
PB722SHP54	15 x 72 x 55	125	263	34	<b>\$9741</b>
PB662SHP54	15 x 66 x 55	125	241	31	<b>\$9379</b>
PB602SHP54	15 x 60 x 55	125	219	28	<b>\$8926</b>

Wood framed glass doors. Hutches between 96" and 84" have 6 doors; hutches less than 84" have 4 doors. One adjustable shelf. No lock option available.

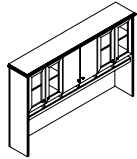

**54" H Storage Hutch w/Doors & Pigeon-Holes**

PB962SHP54GDG	15 x 96 x 55	125	351	45	<b>\$15143</b>
PB902SHP54GDG	15 x 90 x 55	125	329	42	<b>\$14331</b>
PB842SHP54GDG	15 x 84 x 55	125	307	39	<b>\$13159</b>

Wood doors in the center and wood framed glass doors on left and right. One adjustable shelf. Locks are optional on wood doors.

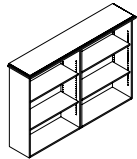

**Open Hutch**

PB720B54	15 x 72 x 55	125	260	35	<b>\$7450</b>
PB360B54	15 x 36.75 x 55	125	130	18	<b>\$3735</b>

Four adjustable shelves.

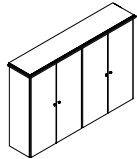

**Hutch w/Wood Doors**

PB72BD54	15 x 72 x 55	100	320	35	<b>\$9594</b>
PB36BD54	15 x 36.75 x 55	100	160	18	<b>\$4806</b>

Four adjustable shelves. Locks are optional.

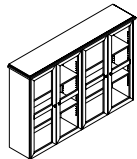

**Hutch w/Glass Doors**

PB72BG54	15 x 72 x 55	100	320	35	<b>\$10877</b>
PB36BG54	15 x 36.75 x 55	100	160	18	<b>\$5442</b>

Wood framed glass doors. Four adjustable shelves. No lock option available.

**Required Specifications**

Finish

**Optional Specifications**

Additional grommet  
Locks\* (wood doors only)

**HUTCHES & WALL MOUNTED STORAGE**

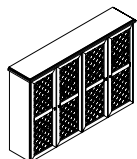

**Hutch w/Wire Mesh Doors**

MODEL#	DIMENSIONS D x W x H	FREIGHT CLASS	WT/LBS.	CUBIC FT.	LIST PRICE
PB72BW54	15 x 72 x 55	100	320	35	<b>\$12164</b>
PB36BW54	15 x 36.75 x 55	100	160	18	<b>\$6241</b>

Antique Brass wire mesh wood framed doors. Four adjustable shelves. No lock option available.

**FREESTANDING STORAGE NOTES**

**NOTE:** Arrow indicates direction of grain

**Pedestals**

- All units are shipped assembled.
- Standard face locking.

**Combination Storage**

- All units are shipped assembled.
- No modifications accepted for this unit.
- Box drawers do not lock.
- Standard face locking.

**Storage Cabinets**

- All units are shipped assembled.
- Units include adjustable shelves.
- Standard face locking.

**TV Cabinets**

- All units are shipped assembled.
- Units include 170° hinges, grommet on fixed shelf and adjustable shelf in lower cabinet.
- Standard face locking for lower cabinet.
- To add lock for upper cabinet, specify "LO".

**FREESTANDING STORAGE**

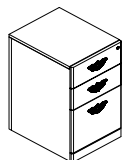

**Freestanding Pedestal**

MODEL#	DIMENSIONS D x W x H	FREIGHT CLASS	WT/LBS.	CUBIC FT.	LIST PRICE
PBWDB	19.8 x 15.5 x 28	85	70	5	<b>\$2877</b>
PBWWDB	23.8 x 15.5 x 28	85	75	6	<b>\$3314</b>

Box/box/file.

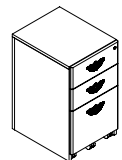

**Freestanding Mobile Pedestal**

PBWDM	19.8 x 15.5 x 28	85	70	5	<b>\$3095</b>
PBWWDM	23.8 x 15.5 x 28	85	75	6	<b>\$3557</b>

Box/box/file.

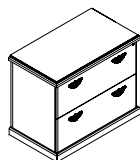

**Lateral File - 2 high**

PBF3624	24 x 36.75 x 29	85	184	15	<b>\$5325</b>
PBF3620	20 x 36.75 x 29	85	159	12	<b>\$4429</b>
PBN3024	24 x 31.63 x 29	85	153	12	<b>\$4660</b>
PBN3020	20 x 31.63 x 29	85	131	10	<b>\$3875</b>

Two lateral file drawers.

**Required Specifications**  
Finish

**Optional Specifications**  
Additional grommet

**FREESTANDING STORAGE**

**MODEL# DIMENSIONS FREIGHT CLASS WT/LBS. CUBIC FT. LIST PRICE**

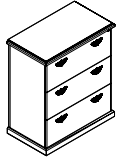

**Lateral File - 3 high**

D x W x H						
PBF36243	24 x 36.75 x 42	92.5	231	21		<b>\$6510</b>
PBF36203	20 x 36.75 x 42	92.5	193	18		<b>\$5557</b>
PBN30243	24 x 31.63 x 42	92.5	193	18		<b>\$5691</b>
PBN30203	20 x 31.63 x 42	92.5	160	15		<b>\$4861</b>

Three lateral file drawers.

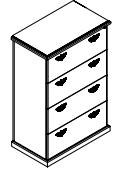

**Lateral File - 4 high**

PBF36244	24 x 36.75 x 54	92.5	297	27		<b>\$7927</b>
PBF36204	20 x 36.75 x 54	92.5	259	23		<b>\$6885</b>
PBN30244	24 x 31.63 x 54	92.5	248	23		<b>\$6932</b>
PBN30204	20 x 31.63 x 54	92.5	214	19		<b>\$6024</b>

Four lateral file drawers.

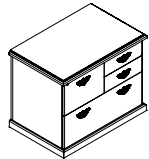

**Combination Storage - Left**

PBZL3624	24 x 36.75 x 29	85	184	15		<b>\$5771</b>
PBZL3620	20 x 36.75 x 29	85	160	12		<b>\$4660</b>

With 1 lateral file, 2 box drawers in the top right, and 1 file drawer in the top left.

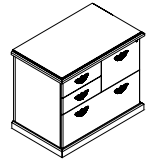

**Combination Storage - Right**

PBZR3624	24 x 36.75 x 29	85	184	15		<b>\$5771</b>
PBZR3620	20 x 36.75 x 29	85	160	12		<b>\$4660</b>

With 1 lateral file, 2 box drawers in the top left, and 1 file drawer in the top right.

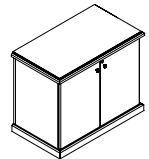

**Storage Cabinet w/Doors**

PBBD3624	24 x 36.75 x 29	92.5	152	15		<b>\$3627</b>
PBBD3620	20 x 36.75 x 29	92.5	129	12		<b>\$3159</b>
PBBD3024	24 x 31.63 x 29	92.5	127	12		<b>\$3175</b>
PBBD3020	20 x 31.63 x 29	92.5	106	10		<b>\$2761</b>

Storage with 1 adjustable shelf.

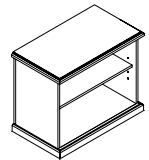

**Open Storage Cabinet**

PBOB3624	24 x 36.75 x 29	100	123	15		<b>\$2910</b>
PBOB3620	20 x 36.75 x 29	100	104	12		<b>\$2535</b>
PBOB3024	24 x 31.63 x 29	100	103	12		<b>\$2541</b>
PBOB3020	20 x 31.63 x 29	100	85	10		<b>\$2210</b>

Storage with 1 adjustable shelf.

**Required Specifications**

Finish

**Optional Specifications**

Additional grommet

**FREESTANDING STORAGE**

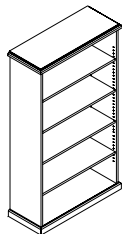

**Open Bookcase**

MODEL#	DIMENSIONS D x W x H	FREIGHT CLASS	WT/LBS.	CUBIC FT.	LIST PRICE
PBB83615	15 x 36.75 x 84	100	246	26	<b>\$4459</b>
PBB73615	15 x 36.75 x 78	100	228	24	<b>\$4140</b>
PBB63615	15 x 36.75 x 72	100	210	23	<b>\$3822</b>
PBB53615	15 x 36.75 x 65	100	188	21	<b>\$3517</b>
PBB43615	15 x 36.75 x 48	100	140	15	<b>\$2897</b>
PBB23615	15 x 36.75 x 29	92.5	90	8	<b>\$2322</b>
PBB83015	15 x 31.63 x 84	92.5	246	22	<b>\$3897</b>
PBB73015	15 x 31.63 x 78	92.5	228	20	<b>\$3619</b>
PBB63015	15 x 31.63 x 72	92.5	210	19	<b>\$3344</b>
PBB53015	15 x 31.63 x 65	92.5	188	17	<b>\$3087</b>
PBB43015	15 x 31.63 x 48	92.5	140	13	<b>\$2535</b>
PBB23015	15 x 31.63 x 29	92.5	90	8	<b>\$2034</b>

84" and 78" high models have 6 adjustable shelves, 72" has 5 adjustable shelves, 65" has 4 adjustable shelves, 48" has 3 adjustable shelves, 29" has 1 adjustable shelves.

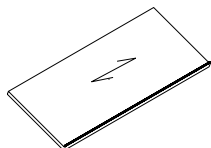

**Additional Shelf**

PBAG3624	24 x 36 x 1	92.5	112	10	<b>\$240</b>
PBAG3622	22 x 36 x 1	92.5	104	10	<b>\$218</b>
PBAG3620	20 x 36 x 1	92.5	92	9	<b>\$196</b>
PBAG3615	15 x 36 x 1	92.5	81	8	<b>\$173</b>
PBAG3024	24 x 30 x 1	92.5	94	9	<b>\$202</b>
PBAG3022	22 x 30 x 1	100	87	9	<b>\$184</b>
PBAG3020	20 x 30 x 1	100	76	8	<b>\$162</b>
PBAG3015	15 x 30 x 1	100	67	8	<b>\$143</b>

**For use with open bookcase.** Can be specified for each shelf in an open bookcase.

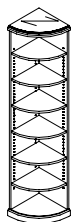

**Quarter Round Open Bookcase**

PB8R1515	15 x 15 x 84	125	142	22	<b>\$3510</b>
PB7R1515	15 x 15 x 78	100	95	10	<b>\$3260</b>
PB6R1515	15 x 15 x 72	100	83	9	<b>\$3009</b>
PB5R1515	15 x 15 x 65	100	81	9	<b>\$2774</b>
PB4R1515	15 x 15 x 48	100	59	6	<b>\$2282</b>
PB2R1515	15 x 15 x 29	100	37	4	<b>\$1831</b>

84" and 78" high models have 6 adjustable shelves, 72" has 5 adjustable shelves, 65" has 4 adjustable shelves, 48" has 3 adjustable shelves, 29" has 1 adjustable shelf.

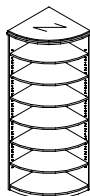

**Quarter Round Open Bookcase**

PBB7R2424H84	24 x 24 x 84	100	234	28	<b>\$6126</b>
PBB7R2424H72	24 x 24 x 72	125	204	28	<b>\$5254</b>
PBB7R2424H65	24 x 24 x 65	100	187	22	<b>\$4819</b>
PBB7R2020H84	20 x 20 x 84	100	163	19	<b>\$5354</b>
PBB7R2020H72	20 x 20 x 72	100	142	17	<b>\$4587</b>
PBB7R2020H65	20 x 20 x 65	100	130	15	<b>\$4302</b>

84" high models have 6 adjustable shelves, 72" has 5 adjustable shelves, and 65" has 4 adjustable shelves

**Required Specifications**

Finish

**FREESTANDING STORAGE**

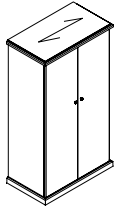

**Storage Cabinet w/Wood Doors**

**MODEL# DIMENSIONS FREIGHT CLASS WT/LBS. CUBIC FT. LIST PRICE**

**D x W x H**

PB1D24W36H84	24 x 36.75 x 84	125	304	42	<b>\$8510</b>
PB1D24W36H72	24 x 36.75 x 72	100	283	33	<b>\$7294</b>
PB1D24W36H65	24 x 36.75 x 65	100	259	30	<b>\$6684</b>
PB1D24W30H84	24 x 30.63 x 84	125	304	42	<b>\$7435</b>
PB1D24W30H72	24 x 30.63 x 72	100	283	33	<b>\$6372</b>
PB1D24W30H65	24 x 30.63 x 65	100	259	30	<b>\$5853</b>
PB1D24W24H84	24 x 24 x 84	92.5	320	28	<b>\$6352</b>
PB1D24W24H72	24 x 24 x 72	92.5	255	24	<b>\$5446</b>
PB1D24W24H65	24 x 24 x 65	125	173	22	<b>\$5019</b>
PB1D20W36H84	20 x 36.75 x 84	100	297	35	<b>\$7435</b>
PB1D20W36H72	20 x 36.75 x 72	100	269	30	<b>\$6372</b>
PB1D20W36H65	20 x 36.75 x 65	100	245	28	<b>\$5842</b>
PB1D20W30H84	20 x 30.63 x 84	100	257	29	<b>\$6195</b>
PB1D20W30H72	20 x 30.63 x 72	100	233	25	<b>\$5312</b>
PB1D20W30H65	20 x 30.63 x 65	100	202	23	<b>\$4869</b>
PB1D20W24H84	20 x 24 x 84	100	198	23	<b>\$4959</b>
PB1D20W24H72	20 x 24 x 72	100	179	20	<b>\$4250</b>
PB1D20W24H65	20 x 24 x 65	100	163	18	<b>\$3889</b>

84" high models have 6 adjustable shelves, 72" has 5 adjustable shelves, 65" has 4 adjustable shelves. For wood framed glass door option, please contact customer care. Lock is optional.

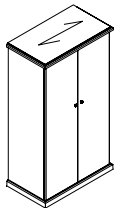

**Wardrobe Cabinet**

PB2D24W36H84	24 x 36.75 x 84	100	356	42	<b>\$7384</b>
PB2D24W36H72	24 x 36.75 x 72	100	324	36	<b>\$6332</b>
PB2D24W36H65	24 x 36.75 x 65	100	297	33	<b>\$5804</b>
PB2D24W30H84	24 x 30.63 x 84	100	296	35	<b>\$6465</b>
PB2D24W30H72	24 x 30.63 x 72	100	270	30	<b>\$5541</b>
PB2D24W30H65	24 x 30.63 x 65	100	248	28	<b>\$5078</b>
PB2D24W24H84	24 x 24 x 84	100	238	28	<b>\$5541</b>
PB2D24W24H72	24 x 24 x 72	100	216	24	<b>\$4749</b>
PB2D24W24H65	24 x 24 x 65	100	198	22	<b>\$4353</b>
PB2D20W36H84	20 x 36.75 x 84	100	297	35	<b>\$6448</b>
PB2D20W36H72	20 x 36.75 x 72	100	269	30	<b>\$5517</b>
PB2D20W36H65	20 x 36.75 x 65	100	245	28	<b>\$5054</b>
PB2D20W30H84	20 x 30.63 x 84	100	257	29	<b>\$5376</b>
PB2D20W30H72	20 x 30.63 x 72	100	233	25	<b>\$4599</b>
PB2D20W30H65	20 x 30.63 x 65	100	202	23	<b>\$4216</b>
PB2D20W24H84	20 x 24 x 84	100	198	23	<b>\$4297</b>
PB2D20W24H72	20 x 24 x 72	100	179	20	<b>\$3675</b>
PB2D20W24H65	20 x 24 x 65	100	163	18	<b>\$3372</b>

Doors, coat rack and hat shelf. 84" high models have 6 adjustable shelves, 72" has 5 adjustable shelves, 65" has 4 adjustable shelves. For wood framed glass door option, please contact customer care. Lock is optional.

**Required Specifications**

Finish

**Optional Specifications**

Lock

## FREESTANDING STORAGE

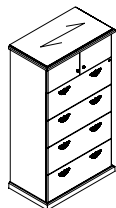

**Storage Cupboard\***

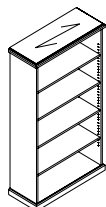

**Open Bookcase**

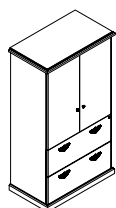

**Storage Cabinet w/Doors\***

MODEL#	DIMENSIONS D x W x H	FREIGHT CLASS	WT/LBS.	CUBIC FT.	LIST PRICE
PB6D24W36H84	24 x 36.75 x 84	92.5	449	42	<b>\$12441</b>
PB6D24W36H72	24 x 36.75 x 72	92.5	414	36	<b>\$10666</b>
PB6D24W36H65	24 x 36.75 x 65	92.5	380	33	<b>\$9778</b>
PB6D24W30H84	24 x 30.63 x 84	92.5	375	35	<b>\$10891</b>
PB6D24W30H72	24 x 30.63 x 72	92.5	345	30	<b>\$9336</b>
PB6D24W30H65	24 x 30.63 x 65	92.5	316	28	<b>\$8557</b>
PB6D20W36H84	20 x 36.75 x 84	92.5	382	35	<b>\$10863</b>
PB6D20W36H72	20 x 36.75 x 72	92.5	351	30	<b>\$9294</b>
PB6D20W36H65	20 x 36.75 x 65	92.5	321	28	<b>\$8515</b>
PB6D20W30H84	20 x 30.63 x 84	92.5	347	29	<b>\$9053</b>
PB6D20W30H72	20 x 30.63 x 72	85	306	25	<b>\$7747</b>
PB6D20W30H65	20 x 30.63 x 65	92.5	265	23	<b>\$7102</b>

Above lateral file cabinet with 4 drawers. 84" high model has 1 adjustable shelf. For wood framed glass door option, please contact customer care. Optional lock available for upper storage.

PB7D24W36H84	24 x 36.75 x 84	125	331	43	<b>\$6812</b>
PB7D24W36H72	24 x 36.75 x 72	100	306	36	<b>\$5842</b>
PB7D24W36H65	24 x 36.75 x 65	100	281	33	<b>\$5354</b>
PB7D24W30H84	24 x 30.63 x 84	125	280	36	<b>\$5961</b>
PB7D24W30H72	24 x 30.63 x 72	100	255	30	<b>\$5097</b>
PB7D24W30H65	24 x 30.63 x 65	100	234	28	<b>\$4677</b>
PB7D20W36H84	20 x 36.75 x 84	100	282	35	<b>\$5947</b>
PB7D20W36H72	20 x 36.75 x 72	100	257	30	<b>\$5097</b>
PB7D20W36H65	20 x 36.75 x 65	100	234	28	<b>\$4677</b>
PB7D20W30H84	20 x 30.63 x 84	100	248	29	<b>\$4954</b>
PB7D20W30H72	20 x 30.63 x 72	100	223	25	<b>\$4248</b>
PB7D20W30H65	20 x 30.63 x 65	100	193	23	<b>\$3892</b>

84" high models have 6 adjustable shelves, 72" has 5 adjustable shelves, and 65" has 4 adjustable shelves.

PB13D24W36H84	24 x 36.75 x 84	100	407	42	<b>\$10532</b>
PB13D24W36H72	24 x 36.75 x 72	92.5	387	36	<b>\$9029</b>
PB13D24W36H65	24 x 36.75 x 65	92.5	347	33	<b>\$8278</b>
PB13D24W30H84	24 x 30.63 x 84	92.5	350	35	<b>\$9217</b>
PB13D24W30H72	24 x 30.63 x 72	92.5	315	30	<b>\$7900</b>
PB13D24W30H65	24 x 30.63 x 65	92.5	289	28	<b>\$7240</b>
PB13D20W36H84	20 x 36.75 x 84	92.5	365	35	<b>\$9194</b>
PB13D20W36H72	20 x 36.75 x 72	92.5	327	30	<b>\$7866</b>
PB13D20W36H65	20 x 36.75 x 65	92.5	299	28	<b>\$7211</b>
PB13D20W30H84	20 x 30.63 x 84	92.5	305	29	<b>\$7665</b>
PB13D20W30H72	20 x 30.63 x 72	92.5	285	25	<b>\$6558</b>
PB13D20W30H65	20 x 30.63 x 65	92.5	247	23	<b>\$6008</b>

Above two lateral file drawers. 84" high models have 3 adjustable shelves, 72" has 2 adjustable shelves, and 65" has 1 adjustable shelf. For wood framed glass door option, please contact customer care. Optional lock available for upper storage.

### Required Specifications

Finish

### Optional Specifications

Additional grommet

Lock\*

**FREESTANDING STORAGE**

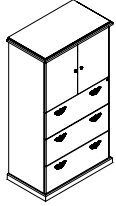

**Storage Cabinet w/Doors**

**MODEL# DIMENSIONS FREIGHT CLASS WT/LBS. CUBIC FT. LIST PRICE**

**D x W x H**

PB14D24W36H84	24 x 36.75 x 84	100	390	42	<b>\$11324</b>
PB14D24W36H72	24 x 36.75 x 72	92.5	360	36	<b>\$9707</b>
PB14D24W36H65	24 x 36.75 x 65	92.5	330	33	<b>\$8896</b>
PB14D24W30H84	24 x 30.63 x 84	100	325	35	<b>\$9910</b>
PB14D24W30H72	24 x 30.63 x 72	92.5	300	30	<b>\$8382</b>
PB14D24W30H65	24 x 30.63 x 65	100	275	28	<b>\$7787</b>

PB14D20W36H84	20 x 36.75 x 84	100	330	35	<b>\$9885</b>
PB14D20W36H72	20 x 36.75 x 72	92.5	305	30	<b>\$8457</b>
PB14D20W36H65	20 x 36.75 x 65	100	278	28	<b>\$7754</b>
PB14D20W30H84	20 x 30.63 x 84	92.5	298	29	<b>\$8238</b>
PB14D20W30H72	20 x 30.63 x 72	92.5	265	25	<b>\$7047</b>
PB14D20W30H65	20 x 30.63 x 65	100	229	23	<b>\$6462</b>

Above three lateral file drawers. 84" high models have 2 adjustable shelves, 72" and 65" have 1 adjustable shelf. For wood framed glass door option, please contact customer care. Optional lock available for upper storage.

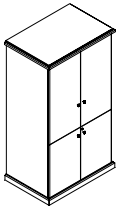

**Closed Storage Cabinet**

PB23D24W36H84	24 x 36.75 x 84	100	390	42	<b>\$9089</b>
PB23D24W36H72	24 x 36.75 x 72	92.5	360	36	<b>\$7790</b>
PB23D24W36H65	24 x 36.75 x 65	92.5	330	33	<b>\$7140</b>
PB23D24W30H84	24 x 30.63 x 84	100	325	35	<b>\$7550</b>
PB23D24W30H72	24 x 30.63 x 72	92.5	300	30	<b>\$6475</b>
PB23D24W30H65	24 x 30.63 x 65	100	275	28	<b>\$5950</b>

PB23D20W36H84	20 x 36.75 x 84	100	330	35	<b>\$7934</b>
PB23D20W36H72	20 x 36.75 x 72	92.5	305	30	<b>\$6791</b>
PB23D20W36H65	20 x 36.75 x 65	100	278	28	<b>\$6220</b>
PB23D20W30H84	20 x 30.63 x 84	92.5	298	29	<b>\$6611</b>
PB23D20W30H72	20 x 30.63 x 72	92.5	265	25	<b>\$5655</b>
PB23D20W30H65	20 x 30.63 x 65	100	229	23	<b>\$5186</b>

With upper and lower split doors. 1 fixed shelf and 2 adjustable shelves. For wood framed glass door option, please contact customer care. Optional lock available for upper storage.

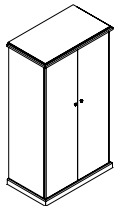

**Cabinet w/Doors and Storage**

PB25D24W36H84	24 x 36.75 x 84	100	390	42	<b>\$9548</b>
PB25D24W36H72	24 x 36.75 x 72	92.5	360	36	<b>\$8182</b>
PB25D24W36H65	24 x 36.75 x 65	92.5	330	33	<b>\$7500</b>
PB25D24W30H84	24 x 30.63 x 84	100	325	35	<b>\$8352</b>
PB25D24W30H72	24 x 30.63 x 72	92.5	300	30	<b>\$7156</b>
PB25D24W30H65	24 x 30.63 x 65	100	275	28	<b>\$6565</b>
PB25D24W24H84	24 x 24 x 84	100	260	28	<b>\$7150</b>
PB25D24W24H72	24 x 24 x 72	92.5	240	24	<b>\$6126</b>
PB25D24W24H65	24 x 24 x 65	92.5	220	22	<b>\$5624</b>

PB25D20W36H84	20 x 36.75 x 84	100	330	35	<b>\$8330</b>
PB25D20W36H72	20 x 36.75 x 72	92.5	305	30	<b>\$7127</b>
PB25D20W36H65	20 x 36.75 x 65	100	278	28	<b>\$6528</b>
PB25D20W30H84	20 x 30.63 x 84	92.5	300	29	<b>\$6944</b>
PB25D20W30H72	20 x 30.63 x 72	92.5	265	25	<b>\$5938</b>
PB25D20W30H65	20 x 30.63 x 65	100	229	23	<b>\$5444</b>
PB25D20W24H84	20 x 24 x 84	92.5	235	23	<b>\$5559</b>
PB25D20W24H72	20 x 24 x 72	92.5	203	20	<b>\$4757</b>
PB25D20W24H65	20 x 24 x 65	92.5	185	18	<b>\$4362</b>

Wardrobe with coat rack and hat shelf on left. Storage with adjustable shelves on right. 84" high models have 5 adjustable shelves, 72" and 65" have 4 adjustable shelves. For wood framed glass door option, please contact customer care. Lock is optional.

**Required Specifications**

Finish

**Optional Specifications**

Additional grommet  
Lock

## RECEPTION DESKS

### MODEL#

### DIMENSIONS

### FREIGHT CLASS

### WT./LBS.

### CUBIC FT.

### LIST PRICE

D x W x H

- To add storage use modular components. See page 364.
- Includes GM5 grommet.
- Transaction tops to be specified separately, handed by square edge from user side.

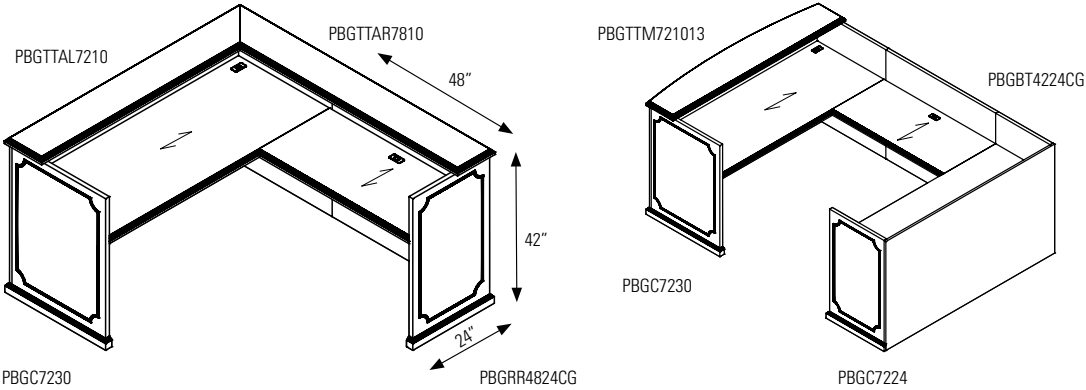

## RECEPTION DESKS

### MODEL#

### DIMENSIONS

### FREIGHT CLASS

### WT./LBS.

### CUBIC FT.

### LIST PRICE

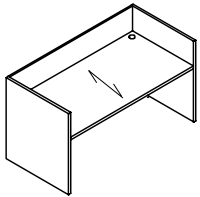

**Gallery/Reception Desk Shell\***

PBGC12036	36 x 120 x 42	150	592	105	<b>\$13070</b>
PBGC10836	36 x 108 x 42	150	533	95	<b>\$11762</b>
PBGC10236	36 x 102 x 42	150	503	89	<b>\$11110</b>
PBGC9636	36 x 96 x 42	150	473	84	<b>\$10453</b>
PBGC9036	36 x 90 x 42	150	444	79	<b>\$9804</b>
PBGC8436	36 x 84 x 42	150	414	74	<b>\$9146</b>
PBGC7236	36 x 72 x 42	150	355	63	<b>\$7847</b>
PBGC7230	30 x 72 x 42	150	315	53	<b>\$7588</b>
PBGC6630	30 x 66 x 42	125	295	48	<b>\$7399</b>
PBGC6030	30 x 60 x 42	125	275	44	<b>\$6978</b>

No pedestals. Two grommets in worksurface. For use with modular storage components. Pin molding included.

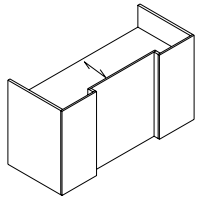

**Gallery/Reception Desk Shell  
Breakfront Style**

PBGIC12036	36 x 120 x 42	150	592	105	<b>\$14375</b>
PBGIC10836	36 x 108 x 42	150	533	95	<b>\$12935</b>
PBGIC10236	36 x 102 x 42	150	503	89	<b>\$12219</b>
PBGIC9636	36 x 96 x 42	150	473	84	<b>\$11498</b>
PBGIC9036	36 x 90 x 42	150	444	79	<b>\$10785</b>
PBGIC8436	36 x 84 x 42	150	414	74	<b>\$10060</b>
PBGIC7236	36 x 72 x 42	150	355	63	<b>\$8626</b>
PBGIC7230	30 x 72 x 42	150	315	53	<b>\$8348</b>
PBGIC6630	30 x 66 x 42	125	295	48	<b>\$8138</b>
PBGIC6030	30 x 60 x 42	125	275	44	<b>\$7676</b>

No pedestals. Two grommets in worksurface. For use with modular storage components. Pin molding included.

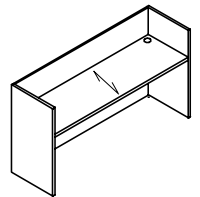

**Gallery/Reception Credenza Shell\***

PBGC12024	24 x 120 x 42	150	392	70	<b>\$10253</b>
PBGC10824	24 x 108 x 42	150	353	63	<b>\$9217</b>
PBGC10224	24 x 102 x 42	150	333	60	<b>\$8709</b>
PBGC9624	24 x 96 x 42	150	314	56	<b>\$8194</b>
PBGC9024	24 x 90 x 42	150	294	53	<b>\$7682</b>
PBGC8424	24 x 84 x 42	150	274	49	<b>\$7173</b>
PBGC7224	24 x 72 x 42	150	235	42	<b>\$6150</b>
PBGC6624	24 x 66 x 42	150	216	39	<b>\$5778</b>
PBGC6024	24 x 60 x 42	150	196	35	<b>\$5414</b>

**No pedestals.** Two grommets in worksurface. For use with modular storage components. Pin molding included.

### Required Specifications

Finish

### Optional Specifications

Additional grommet

RECEPTION DESKS

MODEL# DIMENSIONS FREIGHT CLASS WT/LBS. CUBIC FT. LIST PRICE

D x W x H

PBGBT5624CG	24 x 56 x 42	150	178	32	\$5520
PBGBT5424CG	24 x 54 x 42	150	169	29	\$5520
PBGBT5024CG	24 x 50 x 42	150	151	27	\$4906
PBGBT4824CG	24 x 48 x 42	150	142	26	\$4906
PBGBT4424CG	24 x 44 x 42	150	134	23	\$4291
PBGBT4224CG	24 x 42 x 42	150	127	22	\$4291
PBGBT3824CG	24 x 38 x 42	150	119	20	\$3865
PBGBT3624CG	24 x 36 x 42	150	112	19	\$3865

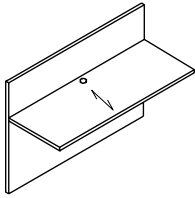

Bridge

Attaches between **Gallery Desk and Gallery Credenza Only**. One grommet in center of worksurface. Shipped RTA (ready to assemble). Pin molding included.

- To remove cross-grain veneer pattern on top, **delete "CG"** from model number. Available as a special - no upcharge.

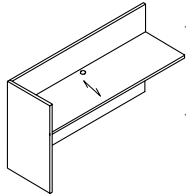

Reception Return - LEFT

PBGRL7224CG	24 x 72 x 42	125	273	42	\$7739
PBGRL6624CG	24 x 66 x 42	125	250	39	\$7098
PBGRL6024CG	24 x 60 x 42	125	228	35	\$6454
PBGRL5424CG	24 x 54 x 42	125	205	32	\$5813
PBGRL4824CG	24 x 48 x 42	125	182	28	\$5159
PBGRL4224CG	24 x 42 x 42	125	159	25	\$4519
PBGRL3624CG	24 x 36 x 42	125	137	21	\$4066

**No pedestal.** One grommet in center of worksurface. For use with modular storage components. Pin molding included.

- To remove cross-grain veneer pattern on top, **delete "CG"** from model number. Available as a special - no upcharge.

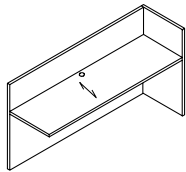

Reception Return - RIGHT

PBGRR7224CG	24 x 72 x 42	125	273	42	\$7739
PBGRR6624CG	24 x 66 x 42	125	250	39	\$7098
PBGRR6024CG	24 x 60 x 42	125	228	35	\$6454
PBGRR5424CG	24 x 54 x 42	125	205	32	\$5813
PBGRR4824CG	24 x 48 x 42	125	182	28	\$5159
PBGRR4224CG	24 x 42 x 42	125	159	25	\$4519
PBGRR3624CG	24 x 36 x 42	125	137	21	\$4066

**No pedestal.** One grommet in center of worksurface. For use with modular storage components. Pin molding included.

- To remove cross-grain veneer pattern on top, **delete "CG"** from model number. Available as a special - no upcharge.

Required Specifications

Finish

Optional Specifications

Additional grommet

## TRANSACTION COUNTERS

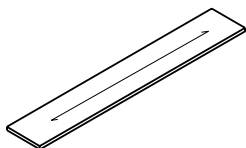

**Transaction Counter Top**

MODEL#	DIMENSIONS	FREIGHT CLASS	WT/LBS.	CUBIC FT.	LIST PRICE
	<b>D x W x H</b>				
PBGTT12010	10 x 120 x 1.50	92.5	84	8	<b>\$2189</b>
PBGTT10810	10 x 108 x 1.50	100	78	8	<b>\$1973</b>
PBGTT10210	10 x 102 x 1.50	92.5	72	7	<b>\$1865</b>
PBGTT9610	10 x 96 x 1.50	100	66	7	<b>\$1756</b>
PBGTT9010	10 x 90 x 1.50	92.5	60	6	<b>\$1644</b>
PBGTT8410	10 x 84 x 1.50	100	54	6	<b>\$1530</b>
PBGTT7210	10 x 72 x 1.50	100	48	5	<b>\$1313</b>
PBGTT6610	10 x 66 x 1.50	100	42	5	<b>\$1204</b>
PBGTT6010	10 x 60 x 1.50	100	36	4	<b>\$1097</b>

**Rectangular top** for main reception desk. Counter sits on top of Gallery panels. Does not overhang. **Factory installed - specify Gallery to be used on.** Size must match dimension of desk front or combined desk side and return length. Hardware included.

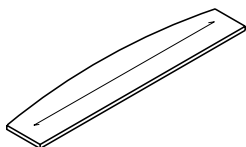

**Bow Front Transaction Counter Top**

PBGTTM1081013	10-13 x 108 x 1.50	125	78	10	<b>\$2948</b>
PBGTTM1021013	10-13 x 102 x 1.50	100	72	9	<b>\$2840</b>
PBGTTM961013	10-13 x 96 x 1.50	125	66	9	<b>\$2733</b>
PBGTTM901013	10-13 x 90 x 1.50	125	60	8	<b>\$2621</b>
PBGTTM841013	10-13 x 84 x 1.50	125	54	8	<b>\$2505</b>
PBGTTM721013	10-13 x 72 x 1.50	125	48	7	<b>\$2290</b>
PBGTTM661013	10-13 x 66 x 1.50	125	42	6	<b>\$2182</b>
PBGTTM601013	10-13 x 60 x 1.50	125	36	5	<b>\$2073</b>

**Bow top** for main reception desk. Counter sits on top of Gallery panels. Bow front overhangs 3". **Factory installed - specify Gallery to be used on.** Size must match dimension of desk front or combined desk side and return length. Hardware included.

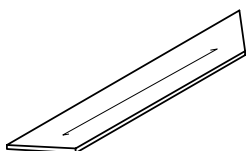

**Trapezoid Transaction Counter Top**

PBGTTA10810	10 x 108 x 1.50	100	78	8	<b>\$2237</b>
PBGTTA10210	10 x 102 x 1.50	92.5	72	7	<b>\$2126</b>
PBGTTA9610	10 x 96 x 1.50	100	66	7	<b>\$2017</b>
PBGTTA9010	10 x 90 x 1.50	92.5	60	6	<b>\$1908</b>
PBGTTA8410	10 x 84 x 1.50	100	54	6	<b>\$1796</b>
PBGTTA7210	10 x 72 x 1.50	100	48	5	<b>\$1578</b>
PBGTTA6610	10 x 66 x 1.50	100	42	5	<b>\$1469</b>
PBGTTA6010	10 x 60 x 1.50	100	36	4	<b>\$1361</b>

**Trapezoid top** for main reception desk. 45° mitered ends on left and right. For use with left and right 45° mitered return transaction counters. Counter sits on top of Gallery panels. Does not overhang. **Factory installed - specify Gallery to be used on.** Width must match dimension of desk front. Hardware included.

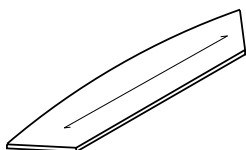

**Bow Front Trapezoid Transaction Counter Top**

PBGTTMA1081013	10-13 x 108 x 1.50	125	78	10	<b>\$3072</b>
PBGTTMA1021013	10-13 x 102 x 1.50	100	72	9	<b>\$2960</b>
PBGTTMA961013	10-13 x 96 x 1.50	125	66	9	<b>\$2854</b>
PBGTTMA901013	10-13 x 90 x 1.50	125	60	8	<b>\$2741</b>
PBGTTMA841013	10-13 x 84 x 1.50	125	54	8	<b>\$2631</b>
PBGTTMA721013	10-13 x 72 x 1.50	125	48	7	<b>\$2413</b>
PBGTTMA661013	10-13 x 66 x 1.50	125	42	6	<b>\$2299</b>
PBGTTMA601013	10-13 x 60 x 1.50	125	36	5	<b>\$2193</b>

**Trapezoid bow top** for main reception desk. 45° mitered ends on left and right. For use with left and right 45° mitered return transaction counters. Counter sits on top of Gallery panels. Bow front overhangs 3". **Factory installed - specify Gallery to be used on.** Width must match dimension of desk front. Hardware included.

**Required Specifications**  
Finish

**Optional Specifications**  
Additional grommet

**TRANSACTION COUNTERS**      **MODEL#**      **DIMENSIONS**      **FREIGHT CLASS**      **WT/LBS.**      **CUBIC FT.**      **LIST PRICE**

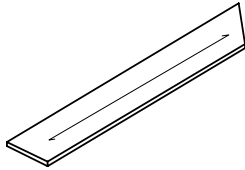

**Transaction Counter Top - LEFT**

	<b>D x W x H</b>					
PBGTTAL12010	10 x 120 x 1.50	92.5	84	8		<b>\$2363</b>
PBGTTAL11410	10 x 114 x 1.50	92.5	81	8		<b>\$2247</b>
PBGTTAL10810	10 x 108 x 1.50	100	78	8		<b>\$2142</b>
PBGTTAL10210	10 x 102 x 1.50	92.5	72	7		<b>\$2036</b>
PBGTTAL9610	10 x 96 x 1.50	100	66	7		<b>\$1926</b>
PBGTTAL9010	10 x 90 x 1.50	92.5	60	6		<b>\$1817</b>
PBGTTAL8410	10 x 84 x 1.50	100	54	6		<b>\$1704</b>
PBGTTAL7210	10 x 72 x 1.50	100	48	5		<b>\$1487</b>
PBGTTAL6610	10 x 66 x 1.50	100	42	5		<b>\$1374</b>
PBGTTAL6010	10 x 60 x 1.50	100	36	4		<b>\$1269</b>
PBGTTAL3610	10 x 36 x 1.50	100	24	3		<b>\$762</b>
PBGTTAL3010	10 x 30 x 1.50	92.5	20	2		<b>\$633</b>
PBGTTAL2410	10 x 24 x 1.50	100	16	2		<b>\$510</b>

**Rectangular top** for main reception desk with 45° mitered end on **left**. For use with rectangular or bow front transaction counters with miters at both ends. Width must match dimension of Gallery Desk end and Return width. Counter sits on top of Gallery panels. Does not overhang. **Factory installed - specify Gallery to be used on.** Hardware included.

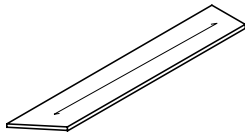

**Transaction Counter Top - RIGHT**

PBGTTAR12010	10 x 120 x 1.50	92.5	84	8		<b>\$2363</b>
PBGTTAR11410	10 x 114 x 1.50	92.5	81	8		<b>\$2247</b>
PBGTTAR10810	10 x 108 x 1.50	100	78	8		<b>\$2142</b>
PBGTTAR10210	10 x 102 x 1.50	92.5	72	7		<b>\$2036</b>
PBGTTAR9610	10 x 96 x 1.50	100	66	7		<b>\$1926</b>
PBGTTAR9010	10 x 90 x 1.50	92.5	60	6		<b>\$1817</b>
PBGTTAR8410	10 x 84 x 1.50	100	54	6		<b>\$1704</b>
PBGTTAR7210	10 x 72 x 1.50	100	48	5		<b>\$1487</b>
PBGTTAR6610	10 x 66 x 1.50	100	42	5		<b>\$1374</b>
PBGTTAR6010	10 x 60 x 1.50	100	36	4		<b>\$1269</b>
PBGTTAR3610	10 x 36 x 1.50	100	24	3		<b>\$762</b>
PBGTTAR3010	10 x 30 x 1.50	92.5	20	2		<b>\$633</b>
PBGTTAR2410	10 x 24 x 1.50	100	16	2		<b>\$510</b>

**Rectangular top** for main reception desk with 45° mitered end on **right**. For use with rectangular or bow front transaction counters with miters at both ends. Width must match dimension of Gallery Desk end and Return width. Counter sits on top of Gallery panels. Does not overhang. **Factory installed - specify Gallery to be used on.** Hardware included.

**Required Specifications**  
Finish

**Optional Specifications**  
Additional grommet

## TACKBOARDS FOR HUTCHES & ACCESSORIES

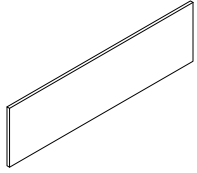

**Tackboard for 36"H\*  
Non-Pigeon Hole Hutches**

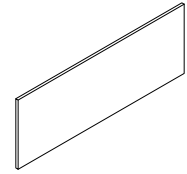

**Tackboard for 42"H & 54"H\*  
Pigeon Hole Hutches**

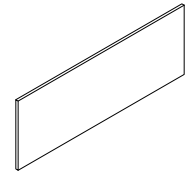

**Tackboard for 42"H & 54"H\*  
Non-Pigeon Hole Hutches**

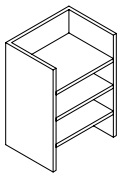

**Paper Organizer, Letter & Legal Format**

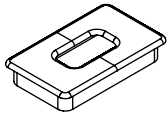

**Grommet**

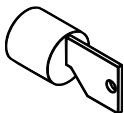

**Lock Assembly**

MODEL#	DIMENSIONS D x W x H	FREIGHT CLASS	WT/LBS.	CUBIC FT.	LIST PRICE
PBTS108	1 x 104.5 x 20	92.5	23	2	<b>\$1313</b>
PBTS102	1 x 98.5 x 20	100	19	2	<b>\$1242</b>
PBTS96	1 x 92.5 x 20	70	17	1	<b>\$1169</b>
PBTS90	1 x 86.5 x 20	70	15	1	<b>\$1097</b>
PBTS84	1 x 80.5 x 20	85	14	1	<b>\$1030</b>
PBTS78	1 x 74.5 x 20	85	13	1	<b>\$953</b>
PBTS72	1 x 68.5 x 20	85	12	1	<b>\$879</b>
PBTS66	1 x 62.5 x 20	92.5	11	1	<b>\$802</b>
PBTS60	1 x 56.5 x 20	92.5	10	1	<b>\$733</b>

Factory installed hutch tackboard.

PBTSP108H23	1 x 104.5 x 23	70	30	2	<b>\$1485</b>
PBTSP102H23	1 x 98.5 x 23	85	24	2	<b>\$1415</b>
PBTSP96H23	1 x 92.5 x 23	92.5	22	2	<b>\$1321</b>
PBTSP90H23	1 x 86.5 x 23	70	20	1	<b>\$1238</b>
PBTSP84H23	1 x 80.5 x 23	70	18	1	<b>\$1156</b>
PBTSP78H23	1 x 74.5 x 23	70	17	1	<b>\$1074</b>
PBTSP72H23	1 x 68.5 x 23	70	16	1	<b>\$998</b>
PBTSP66H23	1 x 62.5 x 23	85	14	1	<b>\$908</b>
PBTSP60H23	1 x 56.5 x 23	85	13	1	<b>\$830</b>

Factory installed hutch tackboard.

PBTS108H26	1 x 104.5 x 26	70	30	2	<b>\$1716</b>
PBTS102H26	1 x 98.5 x 26	85	24	2	<b>\$1617</b>
PBTS102H26	1 x 92.5 x 26	85	24	2	<b>\$1617</b>
PBTS90H26	1 x 86.5 x 26	92.5	20	2	<b>\$1432</b>
PBTS84H26	1 x 80.5 x 26	100	18	2	<b>\$1236</b>
PBTS78H26	1 x 74.5 x 26	100	17	2	<b>\$1046</b>
PBTS72H26	1 x 68.5 x 26	70	16	1	<b>\$953</b>
PBTS66H26	1 x 62.5 x 26	85	14	1	<b>\$855</b>
PBTS60H26	1 x 56.5 x 26	85	13	1	<b>\$662</b>

Factory installed hutch tackboard.

PBCPH161226	12 x 16 x 27	125	20	3	<b>\$1045</b>
PBCPH161223	12 x 16 x 23	125	18	3	<b>\$1422</b>
PBCPH161219	12 x 16 x 20	125	15	2	<b>\$674</b>
PBCPH131226	12 x 13 x 27	100	16	2	<b>\$847</b>
PBCPH131223	12 x 13 x 23	125	15	2	<b>\$719</b>
PBCPH131219	12 x 13 x 20	125	12	2	<b>\$546</b>

GM5C	2 x 3.5 x --	70	--	--	<b>\$114</b>
------	--------------	----	----	----	--------------

Rectangular grommet in metal, tungsten finish.

LO/C	--	70	--	--	<b>\$113</b>
------	----	----	----	----	--------------

Tungsten.

### Required Specifications

Fabric\*

# boardroom tables



# T BOARDROOM TABLES - NOTES

## Boardroom Tops - all series

- Tops 120" and under ship in one piece
- Tops over 120" ship in two pieces
- Veneer wood grain will run with the **length** of the table and align at the seam

## HOW TO SPECIFY

### 1. SPECIFY MODEL NUMBER

### 2. SPECIFY FINISH

#### TOP FINISH - WOOD VENEER

Code	Finish	Veneer Type	Cut
AMW	Almond Cherry	Cherry	Flat Sliced
ACW	Amber Cherry	Cherry	Flat Sliced
BTW	Biscotti	White Oak	Rift
CAW	Cocoa Walnut	Walnut	Flat Sliced
CRW	Coral	White Oak	Rift
DCW	Dark Cherry	Cherry	Flat Sliced
DWW	Dark Walnut	Walnut	Flat Sliced
EWV	Espresso Walnut	Walnut	Flat Sliced
EVW	Evening Oak	White Oak	Rift
GRW	Grey on Oak	White Oak	Rift
HAW	Hazelnut	Maple	Flat Sliced
JAW	Java	White Oak	Rift
LTW	Latte Walnut	Walnut	Flat Sliced
MHW	Mahogany on Walnut	Walnut	Flat Sliced
MTW	Milestone	White Oak	Rift
MPW	Natural Maple	Maple	Flat Sliced
NLW	Natural Walnut	Walnut	Flat Sliced
RCW	Red Cherry	Cherry	Flat Sliced
VNW	Vintage Cherry	Cherry	Flat Sliced
ULW	Umber Walnut	Walnut	Flat Sliced
WLW	Walnut	Walnut	Flat Sliced
WCW	Warm Cherry	Cherry	Flat Sliced
WMW	White Maple	Maple	Flat Sliced

#### BASE FINISH (refer to specific model for availability):

K	Black
E	Tungsten

## 3. SPECIFY OPTIONS

### GROMMETS: DUFFERIN conference table tops

- Optional grommets may be ordered in standard table top locations (left, center or right). Order as **GM1TL, GM1TC or GM1TR. Add \$103.**
- Grommet hole dimensions are 2.75" in diameter. Specify **GM1** for **Black** or **GM1K** for **Tungsten.**

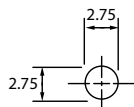

#### Standard Grommet Locations, Dufferin:

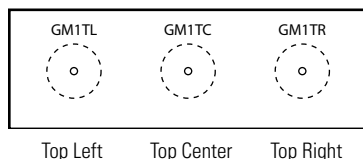

### GROMMETS: KINGSTON + PHILADELPHIA conference table tops

- Optional grommets may be ordered in standard table top locations (left, center or right). Order as **GM5TL, GM5TC or GM5TR. Add \$103.**
- Grommet hole dimensions are 3.5" x 2".
- To order a grommet cover only, specify **GM5E** for Black or **GM5K** for Tungsten. Add **\$61.**

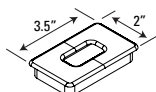

#### Standard Grommet Locations, Kingston and Philadelphia:

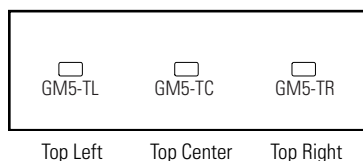

Order as **GM5L, GM5C or GM5R. Add \$103.**

- Grommet hole dimensions are 3.5" x 2". Specify **GM5E** for **Black** or **GM5K** for **Tungsten.**

### GROMMETS: LUFTON conference table tops

- Optional grommets may be ordered in standard table top locations (left, center or right). Order as **G5PTL, G5PTC or G5PTR. Add \$103.**
- Grommet hole dimensions are 3.5" x 2". To order a grommet cover only, specify **G5PEC** for Black or **G5PKC** for Tungsten. Add **\$61.**

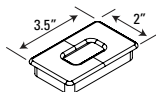

#### Standard Grommet Locations, Lufton:

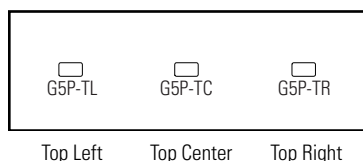

### POWER/DATA ACCESSORIES: ALL SERIES

- Match power block desired with cut-out code and location from grid below.
- Please specify location in top as left, center or right (**TL/x, TC/x, or TR/x**) as per line drawing below. Location must be specified on product to be placed on at the time of the order. Please note orientation of power/data accessories on Boardroom Table tops is as shown in drawings below. **Add \$320** for each cut-out.
- When an **"M"** cut-out is ordered, certain bases will be notched to allow clearance for the Oasis Mini.

#### PRODUCT CODE DIAGRAM

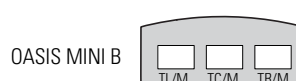
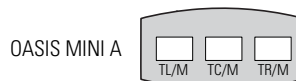
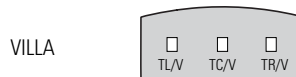

#### PRODUCT CODE DIAGRAM

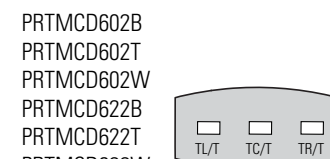
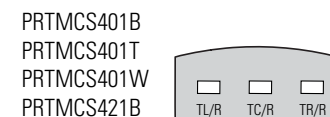

#### Custom Cut-out

- Optional custom sized cut-out available in standard locations - **CCUTL** (left), **CCUTC** (center) and **CCUTR** (right) for all boardroom table tops. Submit appropriate form (beginning on page 432) with order. **Add \$320** for each cut-out.

# T BOARDROOM TABLES

## BOARDROOM TABLE TOP AND BASE GUIDE

**Pedestal Base**   **Drum Base**   **Cross Base**   **Post Leg w/Plate and Trumpet Base**   **Tubular & Flat Bar 4-Prong Base**   **Post Legs (Wood)**   **Post Legs (Metal)**

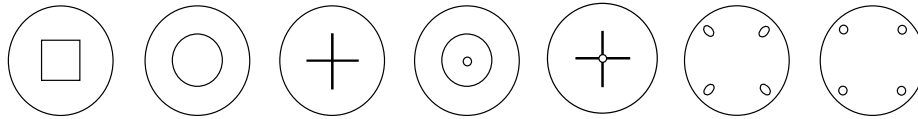

Requires 1 of the following: Pedestal, Drum, Cross, Post Leg w/Plate, Tubular and Flat Bar 4-Prong base, Trumpet Column Base

Requires 4 of the following: Wood Post Legs or Metal Post Legs.

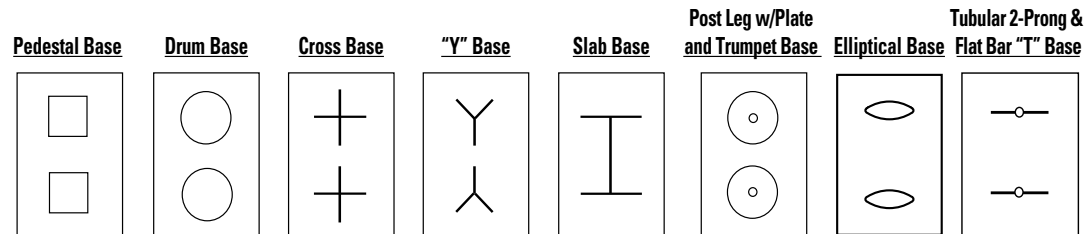

**3-Prong Tubular or**

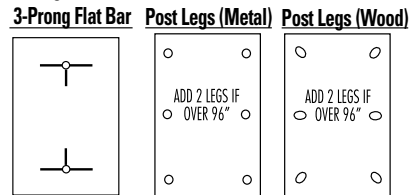
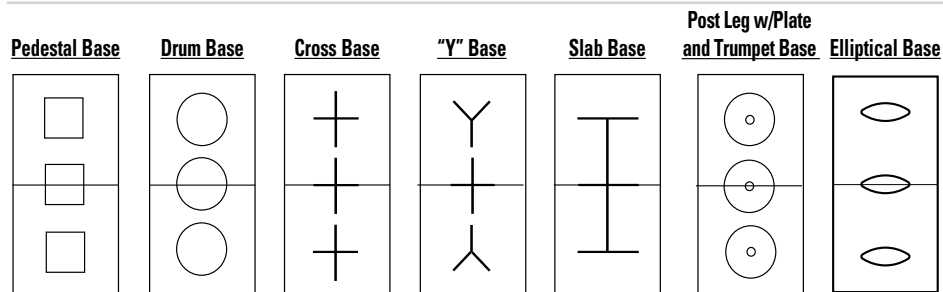

Table Tops up to 120" are in one section and require (2) bases.

Tubular, 2-Prong Base - Table Tops up to 84" require (2) bases.

Tubular and Flat Bar "T" Base - Table Tops up to 120" require (2) bases.

Post Legs - Table Tops up to 96" are in one section and require (4) legs. Tops 108" to 168" require (6) legs.



**3-Prong Tubular or**

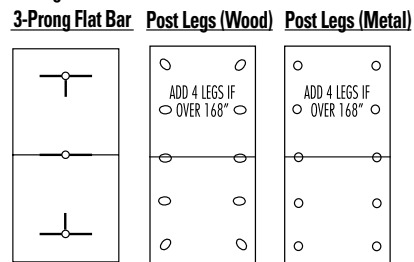

Table Tops 144" and over are in two sections and require (3) bases.

"Y" Base - Require (2) "Y" bases and (1) Cross base in the center.

Slab Base - Require (3) Slab bases.

Tubular and Flat Bar 3-Prong Base - Require (2) 3-Prong bases and (1) 2-Prong base in the center.

Post Legs - Table Tops 180" to 240" require (10) legs.

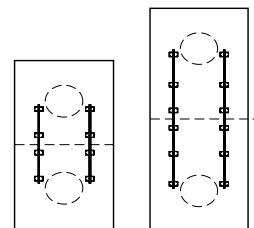

If design considerations or dimension requirements dictate an unsupported table joint, use metal table support rail.

*Top section must not exceed 72" to use metal supports.*

**BOARDROOM TABLES - TOPS WITH DUFFERIN EDGE**    **MODEL#**    **DIMENSIONS**    **FREIGHT CLASS**    **WT./LBS.**    **CUBIC FT.**    **LIST PRICE**

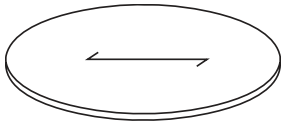

**Round Top**

	<b>D x W x H</b>					
RO60D	60 x 60 x 1.37	85	150	11		<b>\$3134</b>
RO48D	48 x 48 x 1.37	85	96	7		<b>\$2506</b>
RO42D	42 x 42 x 1.37	85	74	6		<b>\$2267</b>
RO36D	36 x 36 x 1.37	85	54	4		<b>\$1925</b>
RO30D	30 x 30 x 1.37	85	38	3		<b>\$1348</b>

For use with Drum Base, Pedestal Base, Cross Base, Wood Post Legs, Metal Post Legs, 4 Prong Base, Post leg w/Flat Plate, Flat Square Column Base, Trumpet Column base, Flat Bar "X" Base", Square Panel Base.

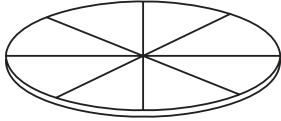

**Round Top - Sunburst Veneer Pattern**

RO60SD	60 x 60 x 1.37	85	150	11		<b>\$3393</b>
RO48SD	48 x 48 x 1.37	85	96	7		<b>\$2870</b>
RO42SD	42 x 42 x 1.37	85	74	6		<b>\$2454</b>
RO36SD	36 x 36 x 1.37	85	54	4		<b>\$2112</b>
RO30SD	30 x 30 x 1.37	85	38	3		<b>\$1755</b>

For use with Drum Base, Pedestal Base, "X" Shape Slab Base, Wood Post Legs, Metal Post Legs, 4 Prong Base, Post leg w/Flat Plate, Flat Square Column Base, Trumpet Column base, Flat Bar "X" Base", Square Panel Base.

RE24054D	54 x 240 x 1.37	85	540	39		<b>\$10034</b>
RE21654D	54 x 216 x 1.37	85	486	35		<b>\$9031</b>
RE19254D	54 x 192 x 1.37	85	432	31		<b>\$7751</b>
RE5454D	54 x 54 x 1.37	85	121	9		<b>\$2206</b>
RE16848D	48 x 168 x 1.37	85	336	25		<b>\$5770</b>
RE14448D	48 x 144 x 1.37	85	288	21		<b>\$4347</b>
RE12048D	48 x 120 x 1.37	85	240	18		<b>\$3871</b>
RE9648D	48 x 96 x 1.37	85	192	14		<b>\$2856</b>
RE4848D	48 x 48 x 1.37	85	96	7		<b>\$1569</b>
RE8442D	42 x 84 x 1.37	85	147	11		<b>\$2632</b>
RE7242D	42 x 72 x 1.37	85	126	9		<b>\$2250</b>
RE4242D	42 x 42 x 1.37	85	74	5		<b>\$1468</b>
RE8436D	36 x 84 x 1.37	85	126	9		<b>\$2511</b>
RE7236D	36 x 72 x 1.37	85	108	8		<b>\$2153</b>
RE6636D	36 x 66 x 1.37	85	99	7		<b>\$1650</b>
RE3636D	36 x 36 x 1.37	85	54	4		<b>\$901</b>
RE8430D	30 x 84 x 1.37	85	105	8		<b>\$2095</b>
RE7230D	30 x 72 x 1.37	85	90	7		<b>\$1797</b>
RE6630D	30 x 66 x 1.37	85	83	6		<b>\$1650</b>
RE6030D	30 x 60 x 1.37	85	75	6		<b>\$1499</b>
RE5430D	30 x 54 x 1.37	85	68	5		<b>\$1353</b>
RE3030D	30 x 30 x 1.37	85	38	3		<b>\$756</b>
RE8424D	24 x 84 x 1.37	85	84	6		<b>\$1828</b>
RE7224D	24 x 72 x 1.37	85	72	5		<b>\$1567</b>
RE6624D	24 x 66 x 1.37	85	66	5		<b>\$1440</b>
RE6024D	24 x 60 x 1.37	70	60	4		<b>\$1308</b>
RE5424D	24 x 54 x 1.37	85	55	4		<b>\$1176</b>
RE4824D	24 x 48 x 1.37	70	48	3		<b>\$1134</b>
RE2424D	24 x 24 x 1.37	125	21	3		<b>\$521</b>
RE8422D	22 x 84 x 1.37	85	77	6		<b>\$1678</b>
RE7222D	22 x 72 x 1.37	85	66	5		<b>\$1440</b>
RE6622D	22 x 66 x 1.37	85	61	5		<b>\$1318</b>
RE6022D	22 x 60 x 1.37	85	55	4		<b>\$1200</b>
RE5422D	22 x 54 x 1.37	85	50	4		<b>\$1085</b>
RE4822D	22 x 48 x 1.37	85	44	3		<b>\$1039</b>
RE2222D	22 x 22 x 1.37	92.5	20	2		<b>\$479</b>

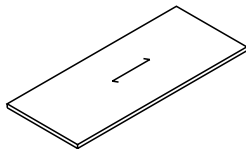

**Rectangular Top**

Grain runs the **length** of the worksurface. Tops 120" and under are shipped in one piece and require 2 bases. Tops 144" and over are shipped in two pieces and require 3 bases.

**Required Specifications**

Veneer Finish

**Optional Specifications**

Boardroom Table Base  
Grommet (not available on Round Tops)  
Custom cut-out

# T BOARDROOM TABLES - DUFFERIN

## BOARDROOM TABLES - TOPS

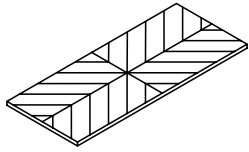

**Rectangular Top -  
Reverse Diamond Pattern**

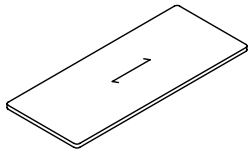

**Rectangular Top Radius Corners**

MODEL#	DIMENSIONS D x W x H	FREIGHT CLASS	WT/LBS.	CUBIC FT.	LIST PRICE
RE24054FD	54 x 240 x 1.37	85	540	39	<b>\$11499</b>
RE21654FD	54 x 216 x 1.37	85	486	35	<b>\$10397</b>
RE19254FD	54 x 192 x 1.37	85	432	31	<b>\$8986</b>
RE5454FD	54 x 54 x 1.37	85	119	9	<b>\$2517</b>
RE16848FD	48 x 168 x 1.37	85	336	25	<b>\$6809</b>
RE14448FD	48 x 144 x 1.37	85	288	21	<b>\$5246</b>
RE12048FD	48 x 120 x 1.37	85	240	18	<b>\$4566</b>
RE9648FD	48 x 96 x 1.37	85	192	14	<b>\$3452</b>
RE4848FD	48 x 48 x 1.37	85	98	7	<b>\$1842</b>
RE8442FD	42 x 84 x 1.37	85	147	11	<b>\$3159</b>
RE7242FD	42 x 72 x 1.37	85	126	9	<b>\$2745</b>
RE4242FD	42 x 42 x 1.37	85	74	5	<b>\$1730</b>
RE8436FD	36 x 84 x 1.37	85	126	9	<b>\$2955</b>
RE7236FD	36 x 72 x 1.37	85	108	8	<b>\$2539</b>
RE6636FD	36 x 66 x 1.37	85	99	7	<b>\$1936</b>
RE3636FD	36 x 36 x 1.37	85	54	4	<b>\$1236</b>
RE8430FD	30 x 84 x 1.37	85	105	8	<b>\$2459</b>
RE7230FD	30 x 72 x 1.37	85	90	7	<b>\$2198</b>
RE6630FD	30 x 66 x 1.37	85	83	6	<b>\$2117</b>
RE6030FD	30 x 60 x 1.37	85	75	6	<b>\$1936</b>
RE5430FD	30 x 54 x 1.37	85	68	5	<b>\$1585</b>
RE3030FD	30 x 30 x 1.37	85	38	3	<b>\$879</b>

Tops 120" and under are shipped in one piece and require 2 bases. Tops 144" and over are shipped in two pieces and require 3 bases.

RRE24054D	54 x 240 x 1.37	85	540	39	<b>\$12233</b>
RRE21654D	54 x 216 x 1.37	85	486	35	<b>\$11076</b>
RRE19254D	54 x 192 x 1.37	85	432	31	<b>\$9607</b>
RRE5454D	54 x 54 x 1.37	85	119	9	<b>\$2679</b>
RRE16848D	48 x 168 x 1.37	85	336	25	<b>\$7330</b>
RRE14448D	48 x 144 x 1.37	85	288	21	<b>\$5692</b>
RRE12048D	48 x 120 x 1.37	85	240	18	<b>\$4913</b>
RRE9648D	48 x 96 x 1.37	85	192	14	<b>\$3748</b>
RRE4848D	48 x 48 x 1.37	85	98	7	<b>\$1972</b>
RRE8442D	42 x 84 x 1.37	85	147	11	<b>\$3426</b>
RRE7242D	42 x 72 x 1.37	85	126	9	<b>\$2988</b>
RRE4242D	42 x 42 x 1.37	85	74	5	<b>\$1855</b>
RRE8436D	36 x 84 x 1.37	85	126	9	<b>\$3182</b>
RRE7236D	36 x 72 x 1.37	85	108	8	<b>\$2729</b>
RRE6636D	36 x 66 x 1.37	85	99	7	<b>\$2082</b>
RRE3636D	36 x 36 x 1.37	85	54	4	<b>\$1143</b>
RRE8430D	30 x 84 x 1.37	85	105	8	<b>\$2647</b>
RRE7230D	30 x 72 x 1.37	85	90	7	<b>\$2269</b>
RRE6630D	30 x 66 x 1.37	85	83	6	<b>\$2082</b>
RRE6030D	30 x 60 x 1.37	85	75	6	<b>\$1898</b>
RRE5430D	30 x 54 x 1.37	85	68	5	<b>\$1702</b>
RRE3030D	30 x 30 x 1.37	85	38	3	<b>\$953</b>

Grain runs the **length** of the worksurface. Tops 120" and under are shipped in one piece and require 2 bases. Tops 144" and over are shipped in two pieces and require 3 bases.

**Required Specifications**  
Veneer Finish

**Optional Specifications**  
Boardroom Table Base  
Grommet  
Custom cut-out

## BOARDROOM TABLES - TOPS

**MODEL#      DIMENSIONS      FREIGHT CLASS      WT/LBS.      CUBIC FT.      LIST PRICE**

**D x W x H**

REBE24054D	54 x 240 x 1.37	85	540	39	<b>\$11352</b>
REBE21654D	54 x 216 x 1.37	85	486	35	<b>\$10313</b>
REBE19254D	54 x 192 x 1.37	85	432	31	<b>\$9001</b>
REBE16848D	48 x 168 x 1.37	85	336	25	<b>\$6909</b>
REBE14448D	48 x 144 x 1.37	85	288	21	<b>\$5469</b>
REBE12048D	48 x 120 x 1.37	85	240	18	<b>\$4645</b>
REBE9648D	48 x 96 x 1.37	85	192	14	<b>\$3604</b>
REBE8442D	42 x 84 x 1.37	85	147	11	<b>\$3285</b>
REBE7242D	42 x 72 x 1.37	85	126	9	<b>\$2891</b>
REBE8436D	36 x 84 x 1.37	85	126	9	<b>\$2891</b>
REBE7236D	36 x 72 x 1.37	85	108	8	<b>\$2474</b>
REBE6636D	36 x 66 x 1.37	85	99	7	<b>\$1893</b>
REBE8430D	30 x 84 x 1.37	85	105	8	<b>\$2408</b>
REBE7230D	30 x 72 x 1.37	85	90	7	<b>\$2067</b>
REBE6630D	30 x 66 x 1.37	85	83	6	<b>\$1893</b>
REBE6030D	30 x 60 x 1.37	85	75	6	<b>\$1716</b>
REBE5430D	30 x 54 x 1.37	85	68	5	<b>\$1550</b>

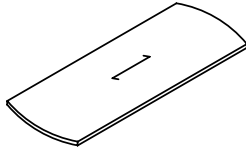

**Rectangular Top - Bow Ends**

Grain runs the **length** of the worksurface. Tops 120" and under are shipped in one piece and require 2 bases. Tops 144" and over are shipped in two pieces and require 3 bases.

RA24054D	54 x 240 x 1.37	85	540	39	<b>\$13822</b>
RA21654D	54 x 216 x 1.37	85	486	35	<b>\$11676</b>
RA19254D	54 x 192 x 1.37	85	432	31	<b>\$11043</b>
RA16848D	48 x 168 x 1.37	85	336	25	<b>\$8268</b>
RA14448D	48 x 144 x 1.37	85	288	21	<b>\$6496</b>
RA12048D	48 x 120 x 1.37	85	240	18	<b>\$5763</b>
RA9648D	48 x 96 x 1.37	85	192	14	<b>\$4577</b>
RA8442D	42 x 84 x 1.37	85	147	11	<b>\$4145</b>
RA7242D	42 x 72 x 1.37	85	126	9	<b>\$3640</b>
RA8436D	36 x 84 x 1.37	85	126	9	<b>\$3763</b>
RA7236D	36 x 72 x 1.37	85	108	8	<b>\$3224</b>
RA6636D	36 x 66 x 1.37	85	99	7	<b>\$2466</b>
RA8430D	30 x 84 x 1.37	85	105	8	<b>\$3137</b>
RA7230D	30 x 72 x 1.37	85	90	7	<b>\$2693</b>
RA6630D	30 x 66 x 1.37	85	83	6	<b>\$2466</b>
RA6030D	30 x 60 x 1.37	85	75	6	<b>\$2242</b>
RA5430D	30 x 54 x 1.37	85	68	5	<b>\$2022</b>
RA8422D	22 x 84 x 1.37	85	77	6	<b>\$2511</b>
RA7222D	22 x 72 x 1.37	85	66	5	<b>\$2153</b>
RA6622D	22 x 66 x 1.37	85	61	5	<b>\$1972</b>
RA6022D	22 x 60 x 1.37	85	55	4	<b>\$1797</b>
RA5422D	22 x 54 x 1.37	85	50	4	<b>\$1615</b>
RA4822D	22 x 48 x 1.37	85	44	3	<b>\$1558</b>

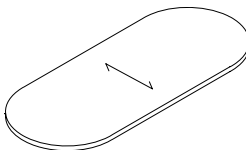

**Racetrack Top - Cross Grain**

Grain runs the **depth** of the worksurface. Tops 120" and under are shipped in one piece and require 2 bases. Tops 144" and over are shipped in two pieces and require 3 bases.

**Required Specifications**

Veneer Finish

**Optional Specifications**

Boardroom Table Base  
Grommet  
Custom cut-out

# T BOARDROOM TABLES - DUFFERIN

## BOARDROOM TABLES - TOPS

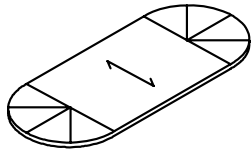

**Racetrack Top Cross Grain Center,  
Sunburst Veneer Pattern on Left & Right**

MODEL#	DIMENSIONS D x W x H	FREIGHT CLASS	WT/LBS.	CUBIC FT.	LIST PRICE
RA24054SD	54 x 240 x 1.37	85	540	39	<b>\$14893</b>
RA21654SD	54 x 216 x 1.37	85	486	35	<b>\$12729</b>
RA19254SD	54 x 192 x 1.37	85	432	31	<b>\$12089</b>
RA16848SD	48 x 168 x 1.37	85	336	25	<b>\$9285</b>
RA14448SD	48 x 144 x 1.37	85	288	21	<b>\$7493</b>
RA12048SD	48 x 120 x 1.37	85	240	18	<b>\$6444</b>
RA9648SD	48 x 96 x 1.37	85	192	14	<b>\$5252</b>
RA8442SD	42 x 84 x 1.37	85	147	11	<b>\$4675</b>
RA7242SD	42 x 72 x 1.37	85	126	9	<b>\$4222</b>
RA8436SD	36 x 84 x 1.37	85	126	9	<b>\$4222</b>
RA7236SD	36 x 72 x 1.37	85	108	8	<b>\$3617</b>
RA6636SD	36 x 66 x 1.37	85	99	7	<b>\$2765</b>
RA8430SD	30 x 84 x 1.37	85	105	8	<b>\$3515</b>
RA7230SD	30 x 72 x 1.37	85	90	7	<b>\$3020</b>
RA6630SD	30 x 66 x 1.37	85	83	6	<b>\$2765</b>
RA6030SD	30 x 60 x 1.37	85	75	6	<b>\$2517</b>
RA5430SD	30 x 54 x 1.37	85	68	5	<b>\$2265</b>
RA8422SD	22 x 84 x 1.37	85	77	6	<b>\$2818</b>
RA7222SD	22 x 72 x 1.37	85	66	5	<b>\$2416</b>
RA6622SD	22 x 66 x 1.37	85	61	5	<b>\$2220</b>
RA6022SD	22 x 60 x 1.37	85	55	4	<b>\$2014</b>
RA5422SD	22 x 54 x 1.37	85	50	4	<b>\$1812</b>
RA4822SD	22 x 48 x 1.37	85	44	3	<b>\$1746</b>

Grain runs the **depth** of the worksurface. Tops 120" and under are shipped in one piece and require 2 bases. Tops 144" and over are shipped in two pieces and require 3 bases.

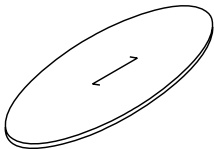

**Oval Top**

OV24054D	54 x 240 x 1.37	85	540	39	<b>\$17278</b>
OV21654D	54 x 216 x 1.37	85	486	35	<b>\$14594</b>
OV19254D	54 x 192 x 1.37	85	432	31	<b>\$13803</b>
OV16848D	48 x 168 x 1.37	85	336	25	<b>\$10331</b>
OV14448D	48 x 144 x 1.37	85	288	21	<b>\$8121</b>
OV12048D	48 x 120 x 1.37	85	240	18	<b>\$7203</b>
OV9648D	48 x 96 x 1.37	85	192	14	<b>\$5720</b>
OV8442D	42 x 84 x 1.37	85	147	11	<b>\$5182</b>
OV7242D	42 x 72 x 1.37	85	126	9	<b>\$4548</b>
OV8436D	36 x 84 x 1.37	85	126	9	<b>\$4548</b>
OV7236D	36 x 72 x 1.37	85	108	8	<b>\$3899</b>
OV6636D	36 x 66 x 1.37	85	99	7	<b>\$2979</b>
OV8430D	30 x 84 x 1.37	85	105	8	<b>\$3924</b>
OV7230D	30 x 72 x 1.37	85	90	7	<b>\$3365</b>
OV6630D	30 x 66 x 1.37	85	83	6	<b>\$3087</b>
OV6030D	30 x 60 x 1.37	85	75	6	<b>\$2800</b>
OV5430D	30 x 54 x 1.37	85	68	5	<b>\$2525</b>
OV8422D	22 x 84 x 1.37	85	77	6	<b>\$3137</b>
OV7222D	22 x 72 x 1.37	85	66	5	<b>\$2693</b>
OV6622D	22 x 66 x 1.37	85	61	5	<b>\$2466</b>
OV6022D	22 x 60 x 1.37	85	55	4	<b>\$2242</b>
OV5422D	22 x 54 x 1.37	85	50	4	<b>\$2022</b>
OV4822D	22 x 48 x 1.37	85	44	3	<b>\$1943</b>

Grain runs the **length** of the worksurface. Tops 120" and under are shipped in one piece and require 2 bases. Tops 144" and over are shipped in two pieces and require 3 bases.

### Required Specifications

Veneer Finish

### Optional Specifications

Boardroom Table Base  
Grommet  
Custom cut-out

## BOARDROOM TABLES - TOPS

MODEL#	DIMENSIONS	FREIGHT CLASS	WT/LBS.	CUBIC FT.	LIST PRICE
--------	------------	---------------	---------	-----------	------------

**D x W x H**

B024054D	54 x 240 x 1.37	85	540	39	<b>\$11246</b>
B021654D	54 x 216 x 1.37	85	486	35	<b>\$10108</b>
B019254D	54 x 192 x 1.37	85	432	31	<b>\$8967</b>
B016848D	48 x 168 x 1.37	85	336	25	<b>\$7145</b>
B014448D	48 x 144 x 1.37	85	288	21	<b>\$5782</b>
B012048D	48 x 120 x 1.37	85	240	18	<b>\$4842</b>
B09648D	48 x 96 x 1.37	85	192	14	<b>\$3930</b>
B08442D	42 x 84 x 1.37	85	147	11	<b>\$3627</b>
B07242D	42 x 72 x 1.37	85	126	9	<b>\$3194</b>

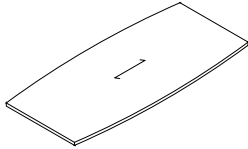

**Boat Shape Top**

Grain runs the **length** of the worksurface. Tops 120" and under are shipped in one piece and require 2 bases. Tops 144" and over are shipped in two pieces and require 3 bases.

BOBE24054D	54 x 240 x 1.37	85	540	39	<b>\$12927</b>
BOBE21654D	54 x 216 x 1.37	85	486	35	<b>\$11624</b>
BOBE19254D	54 x 192 x 1.37	85	432	31	<b>\$10313</b>
BOBE5454D	54 x 54 x 1.37	85	121	9	<b>\$2904</b>
BOBE16848D	48 x 168 x 1.37	85	336	25	<b>\$8215</b>
BOBE14448D	48 x 144 x 1.37	85	288	21	<b>\$6642</b>
BOBE12048D	48 x 120 x 1.37	85	240	18	<b>\$5572</b>
BOBE9648D	48 x 96 x 1.37	85	192	14	<b>\$4521</b>
BOBE4848D	48 x 48 x 1.37	85	96	7	<b>\$2453</b>
BOBE8442D	42 x 84 x 1.37	85	147	11	<b>\$4173</b>
BOBE7242D	42 x 72 x 1.37	85	126	9	<b>\$3678</b>
BOBE4242D	42 x 42 x 1.37	85	74	5	<b>\$2140</b>

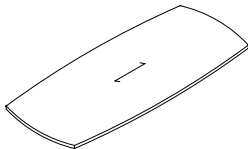

**Boat Shape Top - Bow Ends**

Grain runs the **length** of the worksurface. Tops 120" and under are shipped in one piece and require 2 bases. Tops 144" and over are shipped in two pieces and require 3 bases.

WE2405442D	54 - 42 x 240 x 1.37	85	540	39	<b>\$9875</b>
WE2165442D	54 - 42 x 216 x 1.37	85	486	35	<b>\$8967</b>
WE1925442D	54 - 42 x 192 x 1.37	85	432	31	<b>\$7829</b>
WE1684836D	48 - 36 x 168 x 1.37	85	336	25	<b>\$6007</b>
WE1444836D	48 - 36 x 144 x 1.37	85	288	21	<b>\$4755</b>
WE1204836D	48 - 36 x 120 x 1.37	85	240	18	<b>\$4040</b>
WE964836D	48 - 36 x 96 x 1.37	85	192	14	<b>\$3133</b>
WE844230D	42 - 30 x 84 x 1.37	85	147	11	<b>\$2853</b>
WE724230D	42 - 30 x 72 x 1.37	85	126	9	<b>\$2511</b>
WE843624D	36 - 24 x 84 x 1.37	85	126	9	<b>\$2511</b>
WE723624D	36 - 24 x 72 x 1.37	85	108	8	<b>\$2153</b>
WE663624D	36 - 24 x 66 x 1.37	85	99	7	<b>\$1650</b>

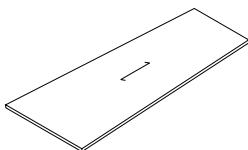

**Wedge Shape Top**

Grain runs the **length** of the worksurface. Tops 120" and under are shipped in one piece and require 2 bases. Tops 144" and over are shipped in two pieces and require 3 bases.

WEBE2405442D	54 - 42 x 240 x 1.37	85	540	39	<b>\$11352</b>
WEBE2165442D	54 - 42 x 216 x 1.37	85	486	35	<b>\$10313</b>
WEBE1925442D	54 - 42 x 192 x 1.37	85	432	31	<b>\$9001</b>
WEBE1684836D	48 - 36 x 168 x 1.37	85	336	25	<b>\$6909</b>
WEBE1444836D	48 - 36 x 144 x 1.37	85	288	21	<b>\$5469</b>
WEBE1204836D	48 - 36 x 120 x 1.37	85	240	18	<b>\$4645</b>
WEBE964836D	48 - 36 x 96 x 1.37	85	192	14	<b>\$3604</b>
WEBE844230D	42 - 30 x 84 x 1.37	85	147	11	<b>\$3285</b>
WEBE724230D	42 - 30 x 72 x 1.37	85	126	9	<b>\$2891</b>
WEBE843624D	36 - 24 x 84 x 1.37	85	126	9	<b>\$2891</b>
WEBE723624D	36 - 24 x 72 x 1.37	85	108	8	<b>\$2474</b>
WEBE663624D	36 - 24 x 66 x 1.37	85	99	7	<b>\$1893</b>

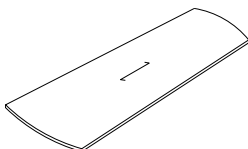

**Wedge Shape Top - Bow Ends**

Grain runs the **length** of the worksurface. Tops 120" and under are shipped in one piece and require 2 bases. Tops 144" and over are shipped in two pieces and require 3 bases.

**Required Specifications**

Veneer Finish

**Optional Specifications**

Boardroom Table Base  
Grommet  
Custom cut-out

# T BOARDROOM TABLES - LUFTON

## BOARDROOM TABLES - TOPS WITH LUFTON EDGE

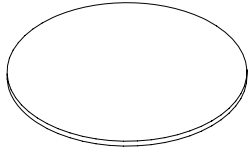

**Round Top**

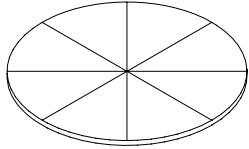

**Round Top - Sunburst Veneer Pattern**

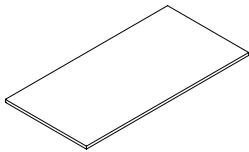

**Rectangular Top**

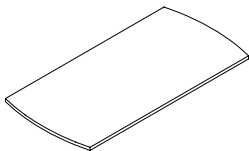

**Rectangular Top - Bow Ends**

MODEL#	DIMENSIONS D x W x H	FREIGHT CLASS	WT./LBS.	CUBIC FT.	LIST PRICE
RO60L	60 x 60 x 1.37	85	150	11	<b>\$3057</b>
RO48L	48 x 48 x 1.37	85	96	7	<b>\$2440</b>
RO42L	42 x 42 x 1.37	85	74	6	<b>\$2200</b>
RO36L	36 x 36 x 1.37	85	54	4	<b>\$1960</b>
RO30L	30 x 30 x 1.37	85	38	3	<b>\$1308</b>

For use with Drum Base, Pedestal Base, Cross Base, Wood Post Legs, Metal Post Legs, 4 Prong Base, Post leg w/Flat Plate, Flat Square Column Base, Trumpet Column base, Flat Bar "X" Base", Square Panel Base.

RO60SL	60 x 60 x 1.37	85	150	11	<b>\$3354</b>
RO48SL	48 x 48 x 1.37	85	96	7	<b>\$2760</b>
RO42SL	42 x 42 x 1.37	85	74	6	<b>\$2389</b>
RO36SL	36 x 36 x 1.37	85	54	4	<b>\$2153</b>
RO30SL	30 x 30 x 1.37	85	38	3	<b>\$1904</b>

For use with Drum Base, Pedestal Base, Cross Base, Wood Post Legs, Metal Post Legs, 4 Prong Base, Post leg w/Flat Plate, Flat Square Column Base, Trumpet Column base, Flat Bar "X" Base", Square Panel Base.

RE24054L	54 x 240 x 1.37	85	540	39	<b>\$9517</b>
RE21654L	54 x 216 x 1.37	85	486	35	<b>\$8638</b>
RE19254L	54 x 192 x 1.37	85	432	31	<b>\$7540</b>
RE16848L	48 x 168 x 1.37	85	336	25	<b>\$5783</b>
RE14448L	48 x 144 x 1.37	85	288	21	<b>\$4578</b>
RE12048L	48 x 120 x 1.37	300	240	18	<b>\$3892</b>
RE9648L	48 x 96 x 1.37	85	192	14	<b>\$3018</b>
RE8442L	42 x 84 x 1.37	85	147	11	<b>\$2749</b>
RE7242L	42 x 72 x 1.37	85	126	9	<b>\$2418</b>
RE8436L	36 x 84 x 1.37	85	126	9	<b>\$2418</b>
RE7236L	36 x 72 x 1.37	85	108	8	<b>\$2074</b>
RE6636L	36 x 66 x 1.37	92.5	99	7	<b>\$1589</b>
RE8430L	30 x 84 x 1.37	85	105	8	<b>\$2018</b>
RE7230L	30 x 72 x 1.37	85	90	7	<b>\$1730</b>
RE6630L	30 x 66 x 1.37	85	83	6	<b>\$1589</b>
RE6030L	30 x 60 x 1.37	85	75	6	<b>\$1446</b>
RE5430L	30 x 54 x 1.37	85	68	5	<b>\$1298</b>
RE4830L	30 x 48 x 1.37	85	44	3	<b>\$1270</b>

Grain runs the **length** of the worksurface. Tops 120" and under are shipped in one piece and require 2 bases. Tops 144" and over are shipped in two pieces and require 3 bases.

REBE24054L	54 x 240 x 1.37	85	540	39	<b>\$10939</b>
REBE21654L	54 x 216 x 1.37	85	486	35	<b>\$9927</b>
REBE19254L	54 x 192 x 1.37	85	432	31	<b>\$8670</b>
REBE16848L	48 x 168 x 1.37	85	336	25	<b>\$6652</b>
REBE14448L	48 x 144 x 1.37	85	288	21	<b>\$5265</b>
REBE12048L	48 x 120 x 1.37	300	240	18	<b>\$4475</b>
REBE9648L	48 x 96 x 1.37	85	192	14	<b>\$3470</b>
REBE8442L	42 x 84 x 1.37	85	147	11	<b>\$3160</b>
REBE7242L	42 x 72 x 1.37	85	126	9	<b>\$2783</b>
REBE8436L	36 x 84 x 1.37	85	126	9	<b>\$2783</b>
REBE7236L	36 x 72 x 1.37	85	108	8	<b>\$2384</b>

Grain runs the **length** of the worksurface. Tops 120" and under are shipped in one piece and require 2 bases. Tops 144" and over are shipped in two pieces and require 3 bases.

### Required Specifications

Veneer Finish

### Optional Specifications

Boardroom Table Base  
Grommet  
Custom cut-out

**BOARDROOM TABLES - TOPS W/LUFTON EDGE**    **MODEL#**    **DIMENSIONS**    **FREIGHT CLASS**    **WT/LBS.**    **CUBIC FT.**    **LIST PRICE**

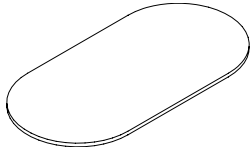

**Racetrack Top - Cross Grain**

	<b>D x W x H</b>					
RA24054L	54 x 240 x 1.37	85	540	39		<b>\$12803</b>
RA21654L	54 x 216 x 1.37	85	486	35		<b>\$10939</b>
RA19254L	54 x 192 x 1.37	85	432	31		<b>\$10390</b>
RA16848L	48 x 168 x 1.37	85	336	25		<b>\$7978</b>
RA14448L	48 x 144 x 1.37	85	288	21		<b>\$6442</b>
RA12048L	48 x 120 x 1.37	300	240	18		<b>\$5538</b>
RA9648L	48 x 96 x 1.37	85	192	14		<b>\$4508</b>
RA8442L	42 x 84 x 1.37	85	147	11		<b>\$4063</b>
RA7242L	42 x 72 x 1.37	85	126	9		<b>\$3630</b>
RA8436L	36 x 84 x 1.37	85	126	9		<b>\$3630</b>
RA7236L	36 x 72 x 1.37	85	108	8		<b>\$3109</b>
RA6636L	36 x 66 x 1.37	92.5	99	7		<b>\$2375</b>

Grain runs the **depth** of the worksurface. Tops 120" and under are shipped in one piece and require 2 bases. Tops 144" and over are shipped in two pieces and require 3 bases.

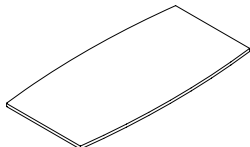

**Boat Shape Top**

B024054L	54 x 240 x 1.37	85	540	39		<b>\$10823</b>
B021654L	54 x 216 x 1.37	85	486	35		<b>\$9732</b>
B019254L	54 x 192 x 1.37	85	432	31		<b>\$8638</b>
B016848L	48 x 168 x 1.37	85	336	25		<b>\$6883</b>
B014448L	48 x 144 x 1.37	85	288	21		<b>\$5560</b>
B012048L	48 x 120 x 1.37	85	240	18		<b>\$4663</b>
B09648L	48 x 96 x 1.37	85	192	14		<b>\$3791</b>
B08442L	42 x 84 x 1.37	85	147	11		<b>\$3491</b>
B07242L	42 x 72 x 1.37	85	126	9		<b>\$3080</b>

Grain runs the **length** of the worksurface. Tops 120" and under are shipped in one piece and require 2 bases. Tops 144" and over are shipped in two pieces and require 3 bases.

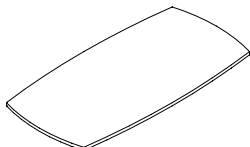

**Boat Shape Top - Bow Ends**

BOBE24054L	54 x 240 x 1.37	85	540	39		<b>\$12452</b>
BOBE21654L	54 x 216 x 1.37	85	486	35		<b>\$11196</b>
BOBE19254L	54 x 192 x 1.37	85	432	31		<b>\$9927</b>
BOBE5454L	54 x 54 x 1.37	85	121	9		<b>\$2795</b>
BOBE16848L	48 x 168 x 1.37	85	336	25		<b>\$7910</b>
BOBE14448L	48 x 144 x 1.37	85	288	21		<b>\$6402</b>
BOBE12048L	48 x 120 x 1.37	85	240	18		<b>\$5363</b>
BOBE9648L	48 x 96 x 1.37	85	192	14		<b>\$3291</b>
BOBE4848L	48 x 48 x 1.37	85	96	7		<b>\$2367</b>
BOBE8442L	42 x 84 x 1.37	85	147	11		<b>\$3662</b>
BOBE7242L	42 x 72 x 1.37	85	126	9		<b>\$3536</b>
BOBE4242L	42 x 42 x 1.37	85	74	5		<b>\$2068</b>

Grain runs the **length** of the worksurface. Tops 120" and under are shipped in one piece and require 2 bases. Tops 144" and over are shipped in two pieces and require 3 bases.

**Required Specifications**

Veneer Finish

**Optional Specifications**

Boardroom Table Base  
Grommet  
Custom cut-out

# T BOARDROOM TABLES - LUFTON

## BOARDROOM TABLES - TOPS W/LUFTON EDGE

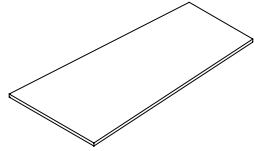

**Wedge Shape Top**

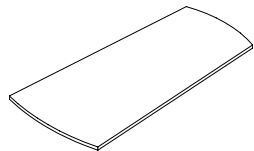

**Wedge Shape Top - Bow Ends**

MODEL#	DIMENSIONS D x W x H	FREIGHT CLASS	WT/LBS.	CUBIC FT.	LIST PRICE
WE2405442L	54 - 42 x 240 x 1.37	85	540	39	<b>\$9517</b>
WE2165442L	54 - 42 x 216 x 1.37	85	486	35	<b>\$8638</b>
WE1925442L	54 - 42 x 192 x 1.37	85	432	31	<b>\$7540</b>
WE1684836L	48 - 36 x 168 x 1.37	85	336	25	<b>\$5783</b>
WE1444836L	48 - 36 x 144 x 1.37	85	288	21	<b>\$4578</b>
WE1204836L	48 - 36 x 120 x 1.37	85	240	18	<b>\$3892</b>
WE964836L	48 - 36 x 96 x 1.37	85	192	14	<b>\$3772</b>
WE844230L	42 - 30 x 84 x 1.37	85	147	11	<b>\$2749</b>
WE724230L	42 - 30 x 72 x 1.37	85	126	9	<b>\$2418</b>

Grain runs the **length** of the worksurface. Tops 120" and under are shipped in one piece and require 2 bases. Tops 144" and over are shipped in two pieces and require 3 bases.

WEBE2405442L	54 - 42 x 240 x 1.37	85	540	39	<b>\$10939</b>
WEBE2165442L	54 - 42 x 216 x 1.37	85	486	35	<b>\$9927</b>
WEBE1925442L	54 - 42 x 192 x 1.37	85	432	31	<b>\$8670</b>
WEBE1684836L	48 - 36 x 168 x 1.37	85	336	25	<b>\$6652</b>
WEBE1444836L	48 - 36 x 144 x 1.37	85	288	21	<b>\$5265</b>
WEBE1204836L	48 - 36 x 120 x 1.37	85	240	18	<b>\$4475</b>
WEBE964836L	48 - 36 x 96 x 1.37	85	192	14	<b>\$3470</b>
WEBE844230L	42 - 30 x 84 x 1.37	85	147	11	<b>\$3160</b>
WEBE724230L	42 - 30 x 72 x 1.37	85	126	9	<b>\$2783</b>

Grain runs the **length** of the worksurface. Tops 120" and under are shipped in one piece and require 2 bases. Tops 144" and over are shipped in two pieces and require 3 bases.

### Required Specifications

Veneer Finish

### Optional Specifications

Boardroom Table Base

Grommet

Custom cut-out

**BOARDROOM TABLES - TOPS W/PHILADELPHIA EDGE MODEL# DIMENSIONS FREIGHT CLASS WT/LBS. CUBIC FT. LIST PRICE**

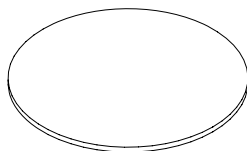

**Round Top**

	D x W x H					
RO60PB	60 x 60 x 1.5	85	150	11		<b>\$5281</b>
RO48PB	48 x 48 x 1.5	85	96	7		<b>\$4225</b>
RO42PB	42 x 42 x 1.5	85	74	6		<b>\$3795</b>
RO36PB	36 x 36 x 1.5	85	54	4		<b>\$3384</b>
RO30PB	30 x 30 x 1.5	85	38	3		<b>\$2822</b>

For use with Drum Base, Pedestal Base, Cross Base, Wood Post Legs, Metal Post Legs, 4 Prong Base, Post leg w/Flat Plate, Flat Square Column Base, Trumpet Column base, Flat Bar "X" Base", Square Panel Base.

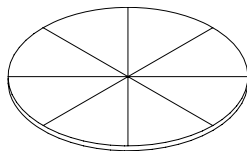

**Round Top - Sunburst Veneer Pattern**

RO60SPB	60 x 60 x 1.5	85	150	11		<b>\$5806</b>
RO48SPB	48 x 48 x 1.5	85	96	7		<b>\$4771</b>
RO42SPB	42 x 42 x 1.5	85	74	6		<b>\$4127</b>
RO36SPB	36 x 36 x 1.5	85	54	4		<b>\$3713</b>
RO30SPB	30 x 30 x 1.5	85	38	3		<b>\$3291</b>

For use with Drum Base, Pedestal Base, Cross Base, Wood Post Legs, Metal Post Legs, 4 Prong Base, Post leg w/Flat Plate, Flat Square Column Base, Trumpet Column base, Flat Bar "X" Base", Square Panel Base.

RE24054PB	54 x 240 x 1.5	85	540	39		<b>\$16455</b>
RE21654PB	54 x 216 x 1.5	85	486	35		<b>\$14938</b>
RE19254PB	54 x 192 x 1.5	85	432	31		<b>\$13039</b>
RE5454PB	54 x 54 x 1.5	85	121	9		<b>\$3667</b>
RE16848PB	48 x 168 x 1.5	85	336	25		<b>\$10004</b>
RE14448PB	48 x 144 x 1.5	85	288	21		<b>\$7919</b>
RE12048PB	48 x 120 x 1.5	85	240	18		<b>\$6730</b>
RE9648PB	48 x 96 x 1.5	85	192	14		<b>\$5218</b>
RE4848PB	48 x 48 x 1.5	85	96	7		<b>\$2607</b>
RE8442PB	42 x 84 x 1.5	85	147	11		<b>\$4751</b>
RE7242PB	42 x 72 x 1.5	85	126	9		<b>\$4181</b>
RE4242PB	42 x 42 x 1.5	85	74	5		<b>\$2443</b>
RE8436PB	36 x 84 x 1.5	85	126	9		<b>\$4251</b>
RE7236PB	36 x 72 x 1.5	85	108	8		<b>\$3590</b>
RE6636PB	36 x 66 x 1.5	85	99	7		<b>\$2741</b>
RE3636PB	36 x 36 x 1.5	85	54	4		<b>\$1494</b>
RE8430PB	30 x 84 x 1.5	85	105	8		<b>\$3486</b>
RE7230PB	30 x 72 x 1.5	85	90	7		<b>\$2993</b>
RE6630PB	30 x 66 x 1.5	85	83	6		<b>\$2741</b>
RE6030PB	30 x 60 x 1.5	85	75	6		<b>\$2487</b>
RE5430PB	30 x 54 x 1.5	85	68	5		<b>\$2248</b>
RE3030PB	30 x 30 x 1.5	85	38	3		<b>\$1247</b>
RE8424PB	24 x 84 x 1.5	85	84	6		<b>\$3042</b>
RE7224PB	24 x 72 x 1.5	85	72	5		<b>\$2603</b>
RE6624PB	24 x 66 x 1.5	85	66	5		<b>\$2388</b>
RE6024PB	24 x 60 x 1.5	70	60	4		<b>\$2171</b>
RE5424PB	24 x 54 x 1.5	85	55	4		<b>\$1957</b>
RE4824PB	24 x 48 x 1.5	70	48	3		<b>\$1879</b>
RE2424PB	24 x 24 x 1.5	125	21	3		<b>\$867</b>
RE8422PB	22 x 84 x 1.5	85	77	6		<b>\$2793</b>
RE7222PB	22 x 72 x 1.5	85	66	5		<b>\$2388</b>
RE6622PB	22 x 66 x 1.5	85	61	5		<b>\$2192</b>
RE6022PB	22 x 60 x 1.5	85	55	4		<b>\$1995</b>
RE5422PB	22 x 54 x 1.5	85	50	4		<b>\$1790</b>
RE4822PB	22 x 48 x 1.5	85	44	3		<b>\$1726</b>
RE2222PB	22 x 22 x 1.5	92.5	20	2		<b>\$793</b>

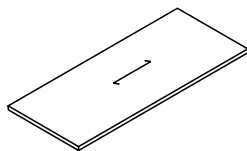

**Rectangular Top**

Grain runs the **length** of the worksurface. Tops 120" and under are shipped in one piece and require 2 bases. Tops 144" and over are shipped in two pieces and require 3 bases.

**Required Specifications**

Veneer Finish

**Optional Specifications**

Boardroom Table Base  
Grommet  
Custom cut-out

# T BOARDROOM TABLES - PHILADELPHIA

## BOARDROOM TABLES - TOPS W/PHILADELPHIA EDGE

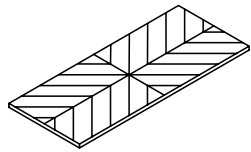

**Rectangular Top -  
Reverse Diamond Pattern**

MODEL#	DIMENSIONS D x W x H	FREIGHT CLASS	WT./LBS.	CUBIC FT.	LIST PRICE
RE24054FPB	54 x 240 x 1.5	85	540	39	<b>\$18652</b>
RE21654FPB	54 x 216 x 1.5	85	486	35	<b>\$16988</b>
RE19254FPB	54 x 192 x 1.5	85	432	31	<b>\$14895</b>
RE5454FPB	54 x 54 x 1.5	85	121	9	<b>\$4191</b>
RE16848FPB	48 x 168 x 1.5	85	336	25	<b>\$11563</b>
RE14448FPB	48 x 144 x 1.5	85	288	21	<b>\$9266</b>
RE12048FPB	48 x 120 x 1.5	85	240	18	<b>\$7774</b>
RE9648FPB	48 x 96 x 1.5	85	192	14	<b>\$6111</b>
RE4848FPB	48 x 48 x 1.5	85	96	7	<b>\$3054</b>
RE8442FPB	42 x 84 x 1.5	85	147	11	<b>\$4046</b>
RE7242FPB	42 x 72 x 1.5	85	126	9	<b>\$4921</b>
RE4242FPB	42 x 42 x 1.5	85	74	5	<b>\$2876</b>
RE8436FPB	36 x 84 x 1.5	85	126	9	<b>\$4921</b>
RE7236FPB	36 x 72 x 1.5	85	108	8	<b>\$4220</b>
RE6636FPB	36 x 66 x 1.5	85	99	7	<b>\$3225</b>
RE3636FPB	36 x 36 x 1.5	85	54	4	<b>\$2060</b>
RE8430FPB	30 x 84 x 1.5	85	105	8	<b>\$4098</b>
RE7230FPB	30 x 72 x 1.5	85	90	7	<b>\$3655</b>
RE6630FPB	30 x 66 x 1.5	85	83	6	<b>\$3518</b>
RE6030FPB	30 x 60 x 1.5	85	75	6	<b>\$3225</b>
RE5430FPB	30 x 54 x 1.5	85	68	5	<b>\$2639</b>
RE3030FPB	30 x 30 x 1.5	85	38	3	<b>\$1464</b>

Tops 120" and under are shipped in one piece and require 2 bases. Tops 144" and over are shipped in two pieces and require 3 bases.

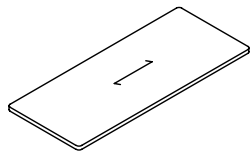

**Rectangular Top - Radius Corners**

RRE24054PB	54 x 240 x 1.5	85	540	39	<b>\$19759</b>
RRE21654PB	54 x 216 x 1.5	85	486	35	<b>\$18012</b>
RRE19254PB	54 x 192 x 1.5	85	432	31	<b>\$15832</b>
RRE5454PB	54 x 54 x 1.5	85	121	9	<b>\$4458</b>
RRE16848PB	48 x 168 x 1.5	85	336	25	<b>\$12341</b>
RRE14448PB	48 x 144 x 1.5	85	288	21	<b>\$9939</b>
RRE12048PB	48 x 120 x 1.5	85	240	18	<b>\$8301</b>
RRE9648PB	48 x 96 x 1.5	85	192	14	<b>\$6557</b>
RRE4848PB	48 x 48 x 1.5	85	96	7	<b>\$3276</b>
RRE8442PB	42 x 84 x 1.5	85	147	11	<b>\$5945</b>
RRE7242PB	42 x 72 x 1.5	85	126	9	<b>\$5295</b>
RRE4242PB	42 x 42 x 1.5	85	74	5	<b>\$3091</b>
RRE8436PB	36 x 84 x 1.5	85	126	9	<b>\$5295</b>
RRE7236PB	36 x 72 x 1.5	85	108	8	<b>\$4535</b>
RRE6636PB	36 x 66 x 1.5	85	99	7	<b>\$3466</b>
RRE3636PB	36 x 36 x 1.5	85	54	4	<b>\$1893</b>
RRE8430PB	30 x 84 x 1.5	85	105	8	<b>\$4414</b>
RRE7230PB	30 x 72 x 1.5	85	90	7	<b>\$3780</b>
RRE6630PB	30 x 66 x 1.5	85	83	6	<b>\$3466</b>
RRE6030PB	30 x 60 x 1.5	85	75	6	<b>\$3149</b>
RRE5430PB	30 x 54 x 1.5	85	68	5	<b>\$2840</b>
RRE3030PB	30 x 30 x 1.5	85	38	3	<b>\$1580</b>

Grain runs the **length** of the worksurface. Tops 120" and under are shipped in one piece and require 2 bases. Tops 144" and over are shipped in two pieces and require 3 bases.

**Required Specifications**  
Veneer Finish

**Optional Specifications**  
Boardroom Table Base  
Grommet  
Custom cut-out

**BOARDROOM TABLES - TOPS W/PHILADELPHIA EDGE    MODEL#    DIMENSIONS    FREIGHT CLASS    WT/LBS.    CUBIC FT.    LIST PRICE**

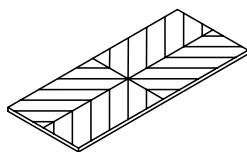

**Rectangular Top - Radius Corners  
Reverse Diamond Pattern**

	D x W x H					
RRE24054FPB	54 x 240 x 1.5	85	540	39	\$22287	
RRE21654FPB	54 x 216 x 1.5	85	486	35	\$20366	
RRE19254FPB	54 x 192 x 1.5	85	432	31	\$17964	
RRE5454FPB	54 x 54 x 1.5	85	121	9	\$5055	
RRE16848FPB	48 x 168 x 1.5	85	336	25	\$14130	
RRE14448FPB	48 x 144 x 1.5	85	288	21	\$11484	
RRE12048FPB	48 x 120 x 1.5	85	240	18	\$9499	
RRE9648FPB	48 x 96 x 1.5	85	192	14	\$7572	
RRE4848FPB	48 x 48 x 1.5	85	96	7	\$3792	
RRE8442FPB	42 x 84 x 1.5	85	147	11	\$6864	
RRE7242FPB	42 x 72 x 1.5	85	126	9	\$6141	
RRE4242FPB	42 x 42 x 1.5	85	74	5	\$3582	
RRE8436FPB	36 x 84 x 1.5	85	126	9	\$6141	
RRE7236FPB	36 x 72 x 1.5	85	108	8	\$5269	
RRE6636FPB	36 x 66 x 1.5	85	99	7	\$4025	
RRE3636FPB	36 x 36 x 1.5	85	54	4	\$2200	
RRE8430FPB	30 x 84 x 1.5	85	105	8	\$5117	
RRE7230FPB	30 x 72 x 1.5	85	90	7	\$4389	
RRE6630FPB	30 x 66 x 1.5	85	83	6	\$4025	
RRE6030FPB	30 x 60 x 1.5	85	75	6	\$3655	
RRE5430FPB	30 x 54 x 1.5	85	68	5	\$3293	
RRE3030FPB	30 x 30 x 1.5	85	38	3	\$1832	

Tops 120" and under are shipped in one piece and require 2 bases. Tops 144" and over are shipped in two pieces and require 3 bases.

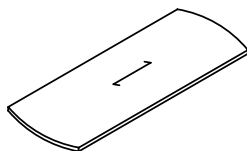

**Rectangular Top - Bow Ends**

REBE24054PB	54 x 240 x 1.5	85	540	39	\$18921	
REBE21654PB	54 x 216 x 1.5	85	486	35	\$17182	
REBE19254PB	54 x 192 x 1.5	85	432	31	\$14999	
REBE16848PB	48 x 168 x 1.5	85	336	25	\$11505	
REBE14448PB	48 x 144 x 1.5	85	288	21	\$9109	
REBE12048PB	48 x 120 x 1.5	85	240	18	\$7742	
REBE9648PB	48 x 96 x 1.5	85	192	14	\$5999	
REBE8442PB	42 x 84 x 1.5	85	147	11	\$5464	
REBE7242PB	42 x 72 x 1.5	85	126	9	\$4808	
REBE8436PB	36 x 84 x 1.5	85	126	9	\$4810	
REBE7236PB	36 x 72 x 1.5	85	108	8	\$4126	
REBE6636PB	36 x 66 x 1.5	85	99	7	\$3148	
REBE8430PB	30 x 84 x 1.5	85	105	8	\$4011	
REBE7230PB	30 x 72 x 1.5	85	90	7	\$3440	
REBE6630PB	30 x 66 x 1.5	85	83	6	\$3148	
REBE6030PB	30 x 60 x 1.5	85	75	6	\$2861	
REBE5430PB	30 x 54 x 1.5	85	68	5	\$2581	

Grain runs the **length** of the worksurface. Tops 120" and under are shipped in one piece and require 2 bases. Tops 144" and over are shipped in two pieces and require 3 bases.

**Required Specifications**

Veneer Finish

**Optional Specifications**

Boardroom Table Base  
Grommet  
Custom cut-out

# T BOARDROOM TABLES - PHILADELPHIA

## BOARDROOM TABLES - TOPS W/PHILADELPHIA EDGE MODEL# DIMENSIONS FREIGHT CLASS WT/LBS. CUBIC FT. LIST PRICE

D x W x H

RA24054PB	54 x 240 x 1.5	85	540	39	<b>\$22147</b>
RA21654PB	54 x 216 x 1.5	85	486	35	<b>\$18921</b>
RA19254PB	54 x 192 x 1.5	85	432	31	<b>\$17976</b>
RA16848PB	48 x 168 x 1.5	85	336	25	<b>\$13800</b>
RA14448PB	48 x 144 x 1.5	85	288	21	<b>\$11145</b>
RA12048PB	48 x 120 x 1.5	85	240	18	<b>\$9579</b>
RA9648PB	48 x 96 x 1.5	85	192	14	<b>\$7798</b>
RA8442PB	42 x 84 x 1.5	85	147	11	<b>\$7025</b>
RA7242PB	42 x 72 x 1.5	85	126	9	<b>\$6269</b>
RA8436PB	36 x 84 x 1.5	85	126	9	<b>\$6269</b>
RA7236PB	36 x 72 x 1.5	85	108	8	<b>\$5370</b>
RA6636PB	36 x 66 x 1.5	85	99	7	<b>\$4104</b>
RA8430PB	30 x 84 x 1.5	85	105	8	<b>\$5224</b>
RA7230PB	30 x 72 x 1.5	85	90	7	<b>\$4479</b>
RA6630PB	30 x 66 x 1.5	85	83	6	<b>\$4104</b>
RA6030PB	30 x 60 x 1.5	85	75	6	<b>\$3731</b>
RA5430PB	30 x 54 x 1.5	85	68	5	<b>\$3363</b>
RA8422PB	22 x 84 x 1.5	85	77	6	<b>\$4181</b>
RA7222PB	22 x 72 x 1.5	85	66	5	<b>\$3590</b>
RA6622PB	22 x 66 x 1.5	85	61	5	<b>\$3287</b>
RA6022PB	22 x 60 x 1.5	85	55	4	<b>\$2988</b>
RA5422PB	22 x 54 x 1.5	85	50	4	<b>\$2694</b>
RA4822PB	22 x 48 x 1.5	85	44	3	<b>\$2592</b>

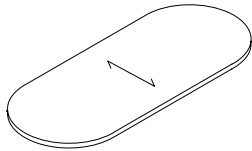

**Racetrack Top - Cross Grain**

Grain runs the **depth** of the worksurface. Tops 120" and under are shipped in one piece and require 2 bases. Tops 144" and over are shipped in two pieces and require 3 bases.

RA24054SPB	54 x 240 x 1.5	85	540	39	<b>\$24819</b>
RA21654SPB	54 x 216 x 1.5	85	486	35	<b>\$21207</b>
RA19254SPB	54 x 192 x 1.5	85	432	31	<b>\$20143</b>
RA16848SPB	48 x 168 x 1.5	85	336	25	<b>\$15463</b>
RA14448SPB	48 x 144 x 1.5	85	288	21	<b>\$12487</b>
RA12048SPB	48 x 120 x 1.5	85	240	18	<b>\$10736</b>
RA9648SPB	48 x 96 x 1.5	85	192	14	<b>\$8737</b>
RA8442SPB	42 x 84 x 1.5	85	147	11	<b>\$7789</b>
RA7242SPB	42 x 72 x 1.5	85	126	9	<b>\$7025</b>
RA8436SPB	36 x 84 x 1.5	85	126	9	<b>\$7025</b>
RA7236SPB	36 x 72 x 1.5	85	108	8	<b>\$6026</b>
RA6636SPB	36 x 66 x 1.5	85	99	7	<b>\$4602</b>
RA8430SPB	30 x 84 x 1.5	85	105	8	<b>\$5852</b>
RA7230SPB	30 x 72 x 1.5	85	90	7	<b>\$5021</b>
RA6630SPB	30 x 66 x 1.5	85	83	6	<b>\$4852</b>
RA6030SPB	30 x 60 x 1.5	85	75	6	<b>\$4188</b>
RA5430SPB	30 x 54 x 1.5	85	68	5	<b>\$3767</b>
RA8422SPB	22 x 84 x 1.5	85	77	5	<b>\$4684</b>
RA7222SPB	22 x 72 x 1.5	85	66	5	<b>\$4017</b>
RA6622SPB	22 x 66 x 1.5	85	61	5	<b>\$3684</b>
RA6022SPB	22 x 60 x 1.5	85	55	4	<b>\$3349</b>
RA5422SPB	22 x 54 x 1.5	85	50	4	<b>\$3014</b>
RA4822SPB	22 x 48 x 1.5	85	44	3	<b>\$2902</b>

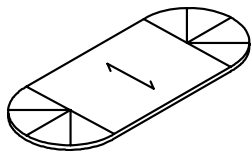

**Racetrack Top Cross Grain Center, Sunburst Veneer Pattern on Left & Right**

Grain runs the **depth** of the worksurface. Tops 120" and under are shipped in one piece and require 2 bases. Tops 144" and over are shipped in two pieces and require 3 bases.

### Required Specifications

Veneer Finish

### Optional Specifications

Boardroom Table Base

Grommet

Custom cut-out

**BOARDROOM TABLES - TOPS W/PHILADELPHIA EDGE    MODEL#    DIMENSIONS    FREIGHT CLASS    WT/LBS.    CUBIC FT.    LIST PRICE**

**D x W x H**

OV24054PB	54 x 240 x 1.5	85	540	39	\$27685
OV21654PB	54 x 216 x 1.5	85	486	35	\$23658
OV19254PB	54 x 192 x 1.5	85	432	31	\$22463
OV16848PB	48 x 168 x 1.5	85	336	25	\$17252
OV14448PB	48 x 144 x 1.5	85	288	21	\$13928
OV12048PB	48 x 120 x 1.5	85	240	18	\$11782
OV9648PB	48 x 96 x 1.5	85	192	14	\$9748
OV8442PB	42 x 84 x 1.5	85	147	11	\$8785
OV7242PB	42 x 72 x 1.5	85	126	9	\$7840
OV8436PB	36 x 84 x 1.5	85	126	9	\$7840
OV7236PB	36 x 72 x 1.5	85	108	8	\$6716
OV6636PB	36 x 66 x 1.5	85	99	7	\$5137
OV8430PB	30 x 84 x 1.5	85	105	8	\$6530
OV7230PB	30 x 72 x 1.5	85	90	7	\$5599
OV6630PB	30 x 66 x 1.5	85	83	6	\$5137
OV6030PB	30 x 60 x 1.5	85	75	6	\$4667
OV5430PB	30 x 54 x 1.5	85	68	5	\$4204
OV8422PB	22 x 84 x 1.5	85	77	6	\$5224
OV7222PB	22 x 72 x 1.5	85	66	5	\$4479
OV6622PB	22 x 66 x 1.5	85	61	5	\$4104
OV6022PB	22 x 60 x 1.5	85	55	4	\$3731
OV5422PB	22 x 54 x 1.5	85	50	4	\$3363
OV4822PB	22 x 48 x 1.5	85	44	3	\$3236

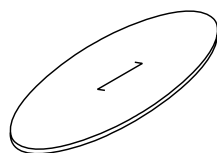

**Oval Top**

Grain runs the **length** of the worksurface. Tops 120" and under are shipped in one piece and require 2 bases. Tops 144" and over are shipped in two pieces and require 3 bases.

B024054PB	54 x 240 x 1.5	85	540	39	\$18732
B021654PB	54 x 216 x 1.5	85	486	35	\$16837
B019254PB	54 x 192 x 1.5	85	432	31	\$14938
B016848PB	48 x 168 x 1.5	85	336	25	\$11899
B014448PB	48 x 144 x 1.5	85	288	21	\$9629
B012048PB	48 x 120 x 1.5	85	240	18	\$8063
B09648PB	48 x 96 x 1.5	85	192	14	\$6549
B08442PB	42 x 84 x 1.5	85	147	11	\$6042
B07242PB	42 x 72 x 1.5	85	126	9	\$5317

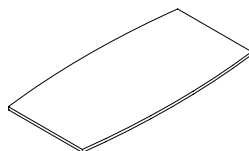

**Boat Shape Top**

Grain runs the **length** of the worksurface. Tops 120" and under are shipped in one piece and require 2 bases. Tops 144" and over are shipped in two pieces and require 3 bases.

BOBE24054PB	54 x 240 x 1.5	85	540	39	\$21539
BOBE21654PB	54 x 216 x 1.5	85	486	35	\$19363
BOBE19254PB	54 x 192 x 1.5	85	432	31	\$17182
BOBE5454PB	54 x 54 x 1.5	85	121	9	\$4832
BOBE16848PB	48 x 168 x 1.5	85	336	25	\$13687
BOBE14448PB	48 x 144 x 1.5	85	288	21	\$11070
BOBE12048PB	48 x 120 x 1.5	85	240	18	\$9272
BOBE9648PB	48 x 96 x 1.5	85	96	7	\$7531
BOBE4848PB	48 x 48 x 1.5	85	96	7	\$4076
BOBE8442PB	42 x 84 x 1.5	85	147	11	\$6737
BOBE7242PB	42 x 72 x 1.5	85	126	9	\$6116
BOBE4242PB	42 x 42 x 1.5	85	74	5	\$3569

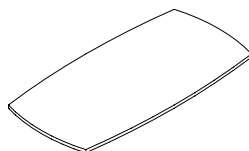

**Boat Shape Top - Bow Ends**

Grain runs the **length** of the worksurface. Tops 120" and under are shipped in one piece and require 2 bases. Tops 144" and over are shipped in two pieces and require 3 bases.

**Required Specifications**

Veneer Finish

**Optional Specifications**

Boardroom Table Base  
Grommet  
Custom cut-out

# T BOARDROOM TABLES - PHILADELPHIA

## BOARDROOM TABLES - TOPS W/PHILADELPHIA EDGE

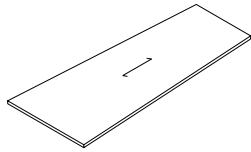

**Wedge Shape Top**

MODEL#	DIMENSIONS D x W x H	FREIGHT CLASS	WT/LBS.	CUBIC FT.	LIST PRICE
WE2405442PB	54 - 42 x 240 x 1.5	85	540	39	<b>\$16455</b>
WE2165442PB	54 - 42 x 216 x 1.5	85	486	35	<b>\$14938</b>
WE1925442PB	54 - 42 x 192 x 1.5	85	432	31	<b>\$13039</b>
WE1684836PB	48 - 36 x 168 x 1.5	85	336	25	<b>\$10004</b>
WE1444836PB	48 - 36 x 144 x 1.5	85	288	21	<b>\$7919</b>
WE1204836PB	48 - 36 x 120 x 1.5	85	240	18	<b>\$6730</b>
WE964836PB	48 - 36 x 96 x 1.5	85	192	14	<b>\$5870</b>
WE844230PB	42 - 30 x 84 x 1.5	85	147	11	<b>\$4751</b>
WE724230PB	42 - 30 x 72 x 1.5	85	126	9	<b>\$4181</b>
WE843624PB	36 - 24 x 84 x 1.5	85	126	9	<b>\$4181</b>
WE723624PB	36 - 24 x 72 x 1.5	85	108	8	<b>\$3590</b>
WE663624PB	36 - 24 x 66 x 1.5	85	99	7	<b>\$2741</b>

Grain runs the **length** of the worksurface. Tops 120" and under are shipped in one piece and require 2 bases. Tops 144" and over are shipped in two pieces and require 3 bases.

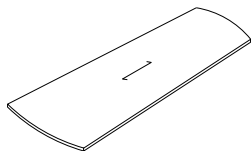

**Wedge Shape Top - Bow Ends**

WEBE2405442PB	54 - 42 x 240 x 1.5	85	540	39	<b>\$18921</b>
WEBE2165442PB	54 - 42 x 216 x 1.5	85	486	35	<b>\$17182</b>
WEBE1925442PB	54 - 42 x 192 x 1.5	85	432	31	<b>\$14997</b>
WEBE1684836PB	48 - 36 x 168 x 1.5	85	336	25	<b>\$11505</b>
WEBE1444836PB	48 - 36 x 144 x 1.5	85	288	21	<b>\$9109</b>
WEBE1204836PB	48 - 36 x 120 x 1.5	85	240	18	<b>\$7742</b>
WEBE964836PB	48 - 36 x 96 x 1.5	85	192	14	<b>\$6000</b>
WEBE844230PB	42 - 30 x 84 x 1.5	85	147	11	<b>\$5464</b>
WEBE724230PB	42 - 30 x 72 x 1.5	85	126	9	<b>\$4808</b>
WEBE843624PB	36 - 24 x 84 x 1.5	85	126	9	<b>\$4808</b>
WEBE723624PB	36 - 24 x 72 x 1.5	85	108	8	<b>\$4126</b>
WEBE663624PB	36 - 24 x 66 x 1.5	85	99	7	<b>\$3148</b>

Grain runs the **length** of the worksurface. Tops 120" and under are shipped in one piece and require 2 bases. Tops 144" and over are shipped in two pieces and require 3 bases.

### Required Specifications

Veneer Finish

### Optional Specifications

Boardroom Table Base  
Grommet  
Custom cut-out

## BOARDROOM TABLES - TOPS W/KINGSTON EDGE

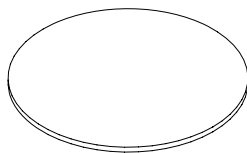

**Round Top**

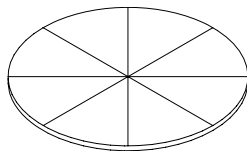

**Round Top - Sunburst Veneer Pattern**

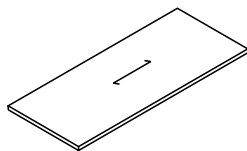

**Rectangular Top**

MODEL#	DIMENSIONS	FREIGHT CLASS	WT/LBS.	CUBIC FT.	LIST PRICE
	<b>D x W x H</b>				
RO60K	60 x 60 x 1.5	85	150	11	<b>\$5809</b>
RO48K	48 x 48 x 1.5	85	96	7	<b>\$4648</b>
RO42K	42 x 42 x 1.5	85	74	6	<b>\$4174</b>
RO36K	36 x 36 x 1.5	85	54	4	<b>\$3722</b>
RO30K	30 x 30 x 1.5	85	38	3	<b>\$3104</b>

For use with Drum Base, Pedestal Base, Cross Base, Wood Post Legs, Metal Post Legs, 4 Prong Base, Post leg w/Flat Plate, Flat Square Column Base, Trumpet Column base, Flat Bar "X" Base", Square Panel Base.

RO60SK	60 x 60 x 1.5	85	150	11	<b>\$6386</b>
RO48SK	48 x 48 x 1.5	85	96	7	<b>\$5248</b>
RO42SK	42 x 42 x 1.5	85	74	6	<b>\$4541</b>
RO36SK	36 x 36 x 1.5	85	54	4	<b>\$4085</b>
RO30SK	30 x 30 x 1.5	85	38	3	<b>\$3620</b>

For use with Drum Base, Pedestal Base, Cross Base, Wood Post Legs, Metal Post Legs, 4 Prong Base, Post leg w/Flat Plate, Flat Square Column Base, Trumpet Column base, Flat Bar "X" Base", Square Panel Base.

RE24054K	54 x 240 x 1.5	85	540	39	<b>\$18100</b>
RE21654K	54 x 216 x 1.5	85	486	35	<b>\$16431</b>
RE19254K	54 x 192 x 1.5	85	432	31	<b>\$14343</b>
RE5454K	54 x 54 x 1.5	85	121	9	<b>\$4034</b>
RE16848K	48 x 168 x 1.5	85	336	25	<b>\$11004</b>
RE14448K	48 x 144 x 1.5	85	288	21	<b>\$8710</b>
RE12048K	48 x 120 x 1.5	85	240	18	<b>\$7403</b>
RE9648K	48 x 96 x 1.5	85	192	14	<b>\$5740</b>
RE4848K	48 x 48 x 1.5	85	96	7	<b>\$2867</b>
RE8442K	42 x 84 x 1.5	85	147	11	<b>\$5226</b>
RE7242K	42 x 72 x 1.5	85	126	9	<b>\$4598</b>
RE4242K	42 x 42 x 1.5	85	74	5	<b>\$2686</b>
RE8436K	36 x 84 x 1.5	85	126	9	<b>\$4676</b>
RE7236K	36 x 72 x 1.5	85	108	8	<b>\$3948</b>
RE6636K	36 x 66 x 1.5	85	99	7	<b>\$3014</b>
RE3636K	36 x 36 x 1.5	85	54	4	<b>\$1643</b>
RE8430K	30 x 84 x 1.5	85	105	8	<b>\$3834</b>
RE7230K	30 x 72 x 1.5	85	90	7	<b>\$3292</b>
RE6630K	30 x 66 x 1.5	85	83	6	<b>\$3014</b>
RE6030K	30 x 60 x 1.5	85	75	6	<b>\$2736</b>
RE5430K	30 x 54 x 1.5	85	68	5	<b>\$2472</b>
RE3030K	30 x 30 x 1.5	85	38	3	<b>\$1371</b>
RE8424K	24 x 84 x 1.5	85	84	6	<b>\$3346</b>
RE7224K	24 x 72 x 1.5	85	72	5	<b>\$2863</b>
RE6624K	24 x 66 x 1.5	85	66	5	<b>\$2627</b>
RE6024K	24 x 60 x 1.5	70	60	4	<b>\$2388</b>
RE5424K	24 x 54 x 1.5	85	55	4	<b>\$2153</b>
RE4824K	24 x 48 x 1.5	70	48	3	<b>\$2067</b>
RE2424K	24 x 24 x 1.5	125	21	3	<b>\$954</b>
RE8422K	22 x 84 x 1.5	85	77	6	<b>\$3072</b>
RE7222K	22 x 72 x 1.5	85	66	5	<b>\$2627</b>
RE6622K	22 x 66 x 1.5	85	61	5	<b>\$2412</b>
RE6022K	22 x 60 x 1.5	85	55	4	<b>\$2194</b>
RE5422K	22 x 54 x 1.5	85	50	4	<b>\$1969</b>
RE4822K	22 x 48 x 1.5	85	44	3	<b>\$1898</b>
RE2222K	22 x 22 x 1.5	92.5	20	2	<b>\$873</b>

Grain runs the **length** of the worksurface. Tops 120" and under are shipped in one piece and require 2 bases. Tops 144" and over are shipped in two pieces and require 3 bases.

### Required Specifications

Veneer Finish

### Optional Specifications

Boardroom Table Base  
Grommet  
Custom cut-out

# T BOARDROOM TABLES - KINGSTON

## BOARDROOM TABLES - TOPS W/KINGSTON EDGE

MODEL# DIMENSIONS FREIGHT CLASS WT/LBS. CUBIC FT. LIST PRICE

D x W x H

RE24054FK	54 x 240 x 1.5	85	540	39	<b>\$20517</b>
RE21654FK	54 x 216 x 1.5	85	486	35	<b>\$18687</b>
RE19254FK	54 x 192 x 1.5	85	432	31	<b>\$16383</b>
RE5454FK	54 x 54 x 1.5	85	121	9	<b>\$4610</b>
RE16848FK	48 x 168 x 1.5	85	336	25	<b>\$12719</b>
RE14448FK	48 x 144 x 1.5	85	288	21	<b>\$10193</b>
RE12048FK	48 x 120 x 1.5	85	240	18	<b>\$8551</b>
RE9648FK	48 x 96 x 1.5	85	192	14	<b>\$6722</b>
RE4848FK	48 x 48 x 1.5	85	96	7	<b>\$3360</b>
RE8442FK	42 x 84 x 1.5	85	147	11	<b>\$4451</b>
RE7242FK	42 x 72 x 1.5	85	126	9	<b>\$5413</b>
RE4242FK	42 x 42 x 1.5	85	74	5	<b>\$3164</b>
RE8436FK	36 x 84 x 1.5	85	126	9	<b>\$5413</b>
RE7236FK	36 x 72 x 1.5	85	108	8	<b>\$4642</b>
RE6636FK	36 x 66 x 1.5	85	99	7	<b>\$3548</b>
RE3636FK	36 x 36 x 1.5	85	54	4	<b>\$2266</b>
RE8430FK	30 x 84 x 1.5	85	105	8	<b>\$4508</b>
RE7230FK	30 x 72 x 1.5	85	90	7	<b>\$4020</b>
RE6630FK	30 x 66 x 1.5	85	83	6	<b>\$3870</b>
RE6030FK	30 x 60 x 1.5	85	75	6	<b>\$3548</b>
RE5430FK	30 x 54 x 1.5	85	68	5	<b>\$2902</b>
RE3030FK	30 x 30 x 1.5	85	38	3	<b>\$1610</b>

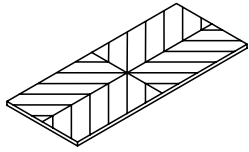

**Rectangular Top -  
Reverse Diamond Pattern**

Tops 120" and under are shipped in one piece and require 2 bases. Tops 144" and over are shipped in two pieces and require 3 bases.

RRE24054K	54 x 240 x 1.5	85	540	39	<b>\$21735</b>
RRE21654K	54 x 216 x 1.5	85	486	35	<b>\$19813</b>
RRE19254K	54 x 192 x 1.5	85	432	31	<b>\$17414</b>
RRE5454K	54 x 54 x 1.5	85	121	9	<b>\$4903</b>
RRE16848K	48 x 168 x 1.5	85	336	25	<b>\$13574</b>
RRE14448K	48 x 144 x 1.5	85	288	21	<b>\$10934</b>
RRE12048K	48 x 120 x 1.5	85	240	18	<b>\$9131</b>
RRE9648K	48 x 96 x 1.5	85	192	14	<b>\$7213</b>
RRE4848K	48 x 48 x 1.5	85	96	7	<b>\$3604</b>
RRE8442K	42 x 84 x 1.5	85	147	11	<b>\$6540</b>
RRE7242K	42 x 72 x 1.5	85	126	9	<b>\$5824</b>
RRE4242K	42 x 42 x 1.5	85	74	5	<b>\$3400</b>
RRE8436K	36 x 84 x 1.5	85	126	9	<b>\$5824</b>
RRE7236K	36 x 72 x 1.5	85	108	8	<b>\$4989</b>
RRE6636K	36 x 66 x 1.5	85	99	7	<b>\$3813</b>
RRE3636K	36 x 36 x 1.5	85	54	4	<b>\$2082</b>
RRE8430K	30 x 84 x 1.5	85	105	8	<b>\$4855</b>
RRE7230K	30 x 72 x 1.5	85	90	7	<b>\$4157</b>
RRE6630K	30 x 66 x 1.5	85	83	6	<b>\$3813</b>
RRE6030K	30 x 60 x 1.5	85	75	6	<b>\$3464</b>
RRE5430K	30 x 54 x 1.5	85	68	5	<b>\$3124</b>
RRE3030K	30 x 30 x 1.5	85	38	3	<b>\$1738</b>

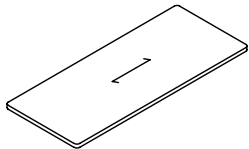

**Rectangular Top - Radius Corners**

Grain runs the **length** of the worksurface. Tops 120" and under are shipped in one piece and require 2 bases. Tops 144" and over are shipped in two pieces and require 3 bases.

### Required Specifications

Veneer Finish

### Optional Specifications

Boardroom Table Base

Grommet

Custom cut-out

**BOARDROOM TABLES - TOPS W/KINGSTON EDGE**    **MODEL#**    **DIMENSIONS**    **FREIGHT CLASS**    **WT/LBS.**    **CUBIC FT.**    **LIST PRICE**

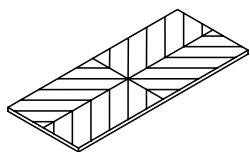

**Rectangular Top - Radius Corners**  
**Reverse Diamond Pattern**

	<b>D x W x H</b>					
RRE24054FK	54 x 240 x 1.5	85	540	39		<b>\$24515</b>
RRE21654FK	54 x 216 x 1.5	85	486	35		<b>\$22403</b>
RRE19254FK	54 x 192 x 1.5	85	432	31		<b>\$19761</b>
RRE5454FK	54 x 54 x 1.5	85	121	9		<b>\$5561</b>
RRE16848FK	48 x 168 x 1.5	85	336	25		<b>\$15542</b>
RRE14448FK	48 x 144 x 1.5	85	288	21		<b>\$12634</b>
RRE12048FK	48 x 120 x 1.5	85	240	18		<b>\$10449</b>
RRE9648FK	48 x 96 x 1.5	85	192	14		<b>\$8329</b>
RRE4848FK	48 x 48 x 1.5	85	96	7		<b>\$4171</b>
RRE8442FK	42 x 84 x 1.5	85	147	11		<b>\$7550</b>
RRE7242FK	42 x 72 x 1.5	85	126	9		<b>\$6755</b>
RRE4242FK	42 x 42 x 1.5	85	74	5		<b>\$3941</b>
RRE8436FK	36 x 84 x 1.5	85	126	9		<b>\$6755</b>
RRE7236FK	36 x 72 x 1.5	85	108	8		<b>\$5796</b>
RRE6636FK	36 x 66 x 1.5	85	99	7		<b>\$4428</b>
RRE3636FK	36 x 36 x 1.5	85	54	4		<b>\$2420</b>
RRE8430FK	30 x 84 x 1.5	85	105	8		<b>\$5629</b>
RRE7230FK	30 x 72 x 1.5	85	90	7		<b>\$4828</b>
RRE6630FK	30 x 66 x 1.5	85	83	6		<b>\$4428</b>
RRE6030FK	30 x 60 x 1.5	85	75	6		<b>\$4020</b>
RRE5430FK	30 x 54 x 1.5	85	68	5		<b>\$3623</b>
RRE3030FK	30 x 30 x 1.5	85	38	3		<b>\$2015</b>

Tops 120" and under are shipped in one piece and require 2 bases. Tops 144" and over are shipped in two pieces and require 3 bases.

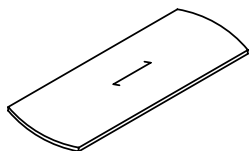

**Rectangular Top - Bow Ends**

REBE24054K	54 x 240 x 1.5	85	540	39		<b>\$20814</b>
REBE21654K	54 x 216 x 1.5	85	486	35		<b>\$18900</b>
REBE19254K	54 x 192 x 1.5	85	432	31		<b>\$16498</b>
REBE16848K	48 x 168 x 1.5	85	336	25		<b>\$12655</b>
REBE14448K	48 x 144 x 1.5	85	288	21		<b>\$10020</b>
REBE12048K	48 x 120 x 1.5	85	240	18		<b>\$8516</b>
REBE9648K	48 x 96 x 1.5	85	192	14		<b>\$6598</b>
REBE8442K	42 x 84 x 1.5	85	147	11		<b>\$6009</b>
REBE7242K	42 x 72 x 1.5	85	126	9		<b>\$5289</b>
REBE8436K	36 x 84 x 1.5	85	126	9		<b>\$5290</b>
REBE7236K	36 x 72 x 1.5	85	108	8		<b>\$4538</b>
REBE6636K	36 x 66 x 1.5	85	99	7		<b>\$3462</b>
REBE8430K	30 x 84 x 1.5	85	105	8		<b>\$4413</b>
REBE7230K	30 x 72 x 1.5	85	90	7		<b>\$3784</b>
REBE6630K	30 x 66 x 1.5	85	83	6		<b>\$3462</b>
REBE6030K	30 x 60 x 1.5	85	75	6		<b>\$3147</b>
REBE5430K	30 x 54 x 1.5	85	68	5		<b>\$2839</b>

Grain runs the **length** of the worksurface. Tops 120" and under are shipped in one piece and require 2 bases. Tops 144" and over are shipped in two pieces and require 3 bases.

**Required Specifications**  
Veneer Finish

**Optional Specifications**  
Boardroom Table Base  
Grommet  
Custom cut-out

# T BOARDROOM TABLES - KINGSTON

## BOARDROOM TABLES - TOPS W/KINGSTON EDGE

MODEL# DIMENSIONS FREIGHT CLASS WT/LBS. CUBIC FT. LIST PRICE

D x W x H

RA24054K	54 x 240 x 1.5	85	540	39	<b>\$24362</b>
RA21654K	54 x 216 x 1.5	85	486	35	<b>\$20814</b>
RA19254K	54 x 192 x 1.5	85	432	31	<b>\$19773</b>
RA16848K	48 x 168 x 1.5	85	336	25	<b>\$15179</b>
RA14448K	48 x 144 x 1.5	85	288	21	<b>\$12259</b>
RA12048K	48 x 120 x 1.5	85	240	18	<b>\$10538</b>
RA9648K	48 x 96 x 1.5	85	192	14	<b>\$8578</b>
RA8442K	42 x 84 x 1.5	85	147	11	<b>\$7728</b>
RA7242K	42 x 72 x 1.5	85	126	9	<b>\$6896</b>
RA8436K	36 x 84 x 1.5	85	126	9	<b>\$6896</b>
RA7236K	36 x 72 x 1.5	85	108	8	<b>\$5907</b>
RA6636K	36 x 66 x 1.5	85	99	7	<b>\$4514</b>
RA8430K	30 x 84 x 1.5	85	105	8	<b>\$5746</b>
RA7230K	30 x 72 x 1.5	85	90	7	<b>\$4926</b>
RA6630K	30 x 66 x 1.5	85	83	6	<b>\$4514</b>
RA6030K	30 x 60 x 1.5	85	75	6	<b>\$4105</b>
RA5430K	30 x 54 x 1.5	85	68	5	<b>\$3698</b>
RA8422K	22 x 84 x 1.5	85	77	6	<b>\$4598</b>
RA7222K	22 x 72 x 1.5	85	61	5	<b>\$3948</b>
RA6622K	22 x 66 x 1.5	85	61	5	<b>\$3616</b>
RA6022K	22 x 60 x 1.5	85	55	4	<b>\$3286</b>
RA5422K	22 x 54 x 1.5	85	50	4	<b>\$2963</b>
RA4822K	22 x 48 x 1.5	85	44	3	<b>\$2850</b>

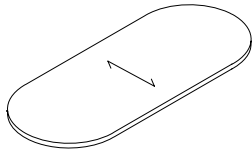

**Racetrack Top - Cross Grain**

Grain runs the **depth** of the worksurface. Tops 120" and under are shipped in one piece and require 2 bases. Tops 144" and over are shipped in two pieces and require 3 bases.

RA24054SK	54 x 240 x 1.5	85	540	39	<b>\$27301</b>
RA21654SK	54 x 216 x 1.5	85	486	35	<b>\$23327</b>
RA19254SK	54 x 192 x 1.5	85	432	31	<b>\$22157</b>
RA16848SK	48 x 168 x 1.5	85	336	25	<b>\$17010</b>
RA14448SK	48 x 144 x 1.5	85	288	21	<b>\$13735</b>
RA12048SK	48 x 120 x 1.5	85	240	18	<b>\$11809</b>
RA9648SK	48 x 96 x 1.5	85	192	14	<b>\$9610</b>
RA8442SK	42 x 84 x 1.5	85	147	11	<b>\$8567</b>
RA7242SK	42 x 72 x 1.5	85	126	9	<b>\$7728</b>
RA8436SK	36 x 84 x 1.5	85	126	9	<b>\$7728</b>
RA7236SK	36 x 72 x 1.5	85	108	8	<b>\$6629</b>
RA6636SK	36 x 66 x 1.5	85	99	7	<b>\$5062</b>
RA8430SK	30 x 84 x 1.5	85	105	8	<b>\$6437</b>
RA7230SK	30 x 72 x 1.5	85	90	7	<b>\$5523</b>
RA6630SK	30 x 66 x 1.5	85	83	6	<b>\$5337</b>
RA6030SK	30 x 60 x 1.5	85	75	6	<b>\$4607</b>
RA5430SK	30 x 54 x 1.5	85	68	5	<b>\$4144</b>
RA8422SK	22 x 84 x 1.5	85	77	6	<b>\$5153</b>
RA7222SK	22 x 72 x 1.5	85	66	5	<b>\$4418</b>
RA6622SK	22 x 66 x 1.5	85	61	5	<b>\$4053</b>
RA6022SK	22 x 60 x 1.5	85	55	4	<b>\$3683</b>
RA5422SK	22 x 54 x 1.5	85	50	4	<b>\$3316</b>
RA4822SK	22 x 48 x 1.5	85	44	3	<b>\$3191</b>

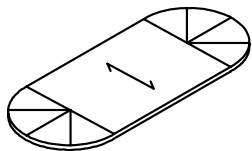

**Racetrack Top Cross Grain Center, Sunburst Veneer Pattern on Left & Right**

Grain runs the **depth** of the worksurface. Tops 120" and under are shipped in one piece and require 2 bases. Tops 144" and over are shipped in two pieces and require 3 bases.

### Required Specifications

Veneer Finish

### Optional Specifications

Boardroom Table Base

Grommet

Custom cut-out

## BOARDROOM TABLES - TOPS W/KINGSTON EDGE

MODEL# DIMENSIONS FREIGHT CLASS WT/LBS. CUBIC FT. LIST PRICE

**D x W x H**

OV24054K	54 x 240 x 1.5	85	540	39	<b>\$30454</b>
OV21654K	54 x 216 x 1.5	85	486	35	<b>\$26024</b>
OV19254K	54 x 192 x 1.5	85	432	31	<b>\$24711</b>
OV16848K	48 x 168 x 1.5	85	336	25	<b>\$18978</b>
OV14448K	48 x 144 x 1.5	85	288	21	<b>\$15321</b>
OV12048K	48 x 120 x 1.5	85	240	18	<b>\$12959</b>
OV9648K	48 x 96 x 1.5	85	192	14	<b>\$10723</b>
OV8442K	42 x 84 x 1.5	85	147	11	<b>\$9662</b>
OV7242K	42 x 72 x 1.5	85	126	9	<b>\$8624</b>
OV8436K	36 x 84 x 1.5	85	126	9	<b>\$8624</b>
OV7236K	36 x 72 x 1.5	85	108	8	<b>\$7388</b>
OV6636K	36 x 66 x 1.5	85	99	7	<b>\$5650</b>
OV8430K	30 x 84 x 1.5	85	105	8	<b>\$7183</b>
OV7230K	30 x 72 x 1.5	85	90	7	<b>\$6158</b>
OV6630K	30 x 66 x 1.5	85	83	6	<b>\$5650</b>
OV6030K	30 x 60 x 1.5	85	75	6	<b>\$5134</b>
OV5430K	30 x 54 x 1.5	85	68	5	<b>\$4625</b>
OV8422K	22 x 84 x 1.5	85	77	6	<b>\$5746</b>
OV7222K	22 x 72 x 1.5	85	66	5	<b>\$4926</b>
OV6622K	22 x 66 x 1.5	85	61	5	<b>\$4514</b>
OV6022K	22 x 60 x 1.5	85	55	4	<b>\$4105</b>
OV5422K	22 x 54 x 1.5	85	50	4	<b>\$3698</b>
OV4822K	22 x 48 x 1.5	85	44	3	<b>\$3560</b>

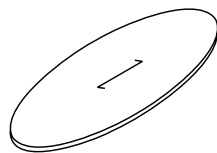

**Oval Top**

Grain runs the **length** of the worksurface. Tops 120" and under are shipped in one piece and require 2 bases. Tops 144" and over are shipped in two pieces and require 3 bases.

B024054K	54 x 240 x 1.5	85	540	39	<b>\$20605</b>
B021654K	54 x 216 x 1.5	85	486	35	<b>\$18521</b>
B019254K	54 x 192 x 1.5	85	432	31	<b>\$16431</b>
B016848K	48 x 168 x 1.5	85	336	25	<b>\$13088</b>
B014448K	48 x 144 x 1.5	85	288	21	<b>\$10592</b>
B012048K	48 x 120 x 1.5	85	240	18	<b>\$8869</b>
B09648K	48 x 96 x 1.5	85	192	14	<b>\$7204</b>
B08442K	42 x 84 x 1.5	85	147	11	<b>\$6646</b>
B07242K	42 x 72 x 1.5	85	126	9	<b>\$5849</b>

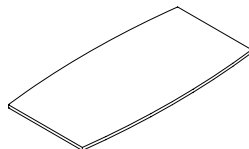

**Boat Shape Top**

Grain runs the **length** of the worksurface. Tops 120" and under are shipped in one piece and require 2 bases. Tops 144" and over are shipped in two pieces and require 3 bases.

BOBE24054K	54 x 240 x 1.5	85	540	39	<b>\$23692</b>
BOBE21654K	54 x 216 x 1.5	85	486	35	<b>\$21299</b>
BOBE19254K	54 x 192 x 1.5	85	432	31	<b>\$18900</b>
BOBE5454K	54 x 54 x 1.5	85	121	9	<b>\$5316</b>
BOBE16848K	48 x 168 x 1.5	85	336	25	<b>\$15055</b>
BOBE14448K	48 x 144 x 1.5	85	288	21	<b>\$12178</b>
BOBE12048K	48 x 120 x 1.5	85	240	18	<b>\$10199</b>
BOBE9648K	48 x 96 x 1.5	85	192	14	<b>\$8284</b>
BOBE4848K	48 x 48 x 1.5	85	96	7	<b>\$4484</b>
BOBE8442K	42 x 84 x 1.5	85	147	11	<b>\$7410</b>
BOBE7242K	42 x 72 x 1.5	85	126	9	<b>\$6727</b>
BOBE4242K	42 x 42 x 1.5	85	74	5	<b>\$3926</b>

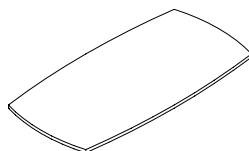

**Boat Shape Top - Bow Ends**

Grain runs the **length** of the worksurface. Tops 120" and under are shipped in one piece and require 2 bases. Tops 144" and over are shipped in two pieces and require 3 bases.

**Required Specifications**

Veneer Finish

**Optional Specifications**

Boardroom Table Base  
Grommet  
Custom cut-out

# T BOARDROOM TABLES - KINGSTON

## BOARDROOM TABLES - TOPS W/KINGSTON EDGE

MODEL# DIMENSIONS FREIGHT CLASS WT/LBS. CUBIC FT. LIST PRICE

D x W x H

WE2405442K	54 - 42 x 240 x 1.5	85	540	39	<b>\$18100</b>
WE2165442K	54 - 42 x 216 x 1.5	85	486	35	<b>\$16431</b>
WE1925442K	54 - 42 x 192 x 1.5	85	432	31	<b>\$14343</b>
WE1684836K	48 - 36 x 168 x 1.5	85	336	25	<b>\$11004</b>
WE1444836K	48 - 36 x 144 x 1.5	85	288	21	<b>\$8710</b>
WE1204836K	48 - 36 x 120 x 1.5	85	240	18	<b>\$7403</b>
WE964836K	48 - 36 x 96 x 1.5	85	192	14	<b>\$6457</b>
WE844230K	42 - 30 x 84 x 1.5	85	147	11	<b>\$5226</b>
WE724230K	42 - 30 x 72 x 1.5	85	126	9	<b>\$4598</b>
WE843624K	36 - 24 x 84 x 1.5	85	126	9	<b>\$4598</b>
WE723624K	36 - 24 x 72 x 1.5	85	108	8	<b>\$3948</b>
WE663624K	36 - 24 x 66 x 1.5	85	99	7	<b>\$3014</b>

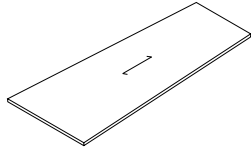

**Wedge Shape Top**

Grain runs the **length** of the worksurface. Tops 120" and under are shipped in one piece and require 2 bases. Tops 144" and over are shipped in two pieces and require 3 bases.

WEBE2405442K	54 - 42 x 240 x 1.5	85	540	39	<b>\$20814</b>
WEBE2165442K	54 - 42 x 216 x 1.5	85	486	35	<b>\$18900</b>
WEBE1925442K	54 - 42 x 192 x 1.5	85	432	31	<b>\$16496</b>
WEBE1684836K	48 - 36 x 168 x 1.5	85	336	25	<b>\$12655</b>
WEBE1444836K	48 - 36 x 144 x 1.5	85	288	21	<b>\$10020</b>
WEBE1204836K	48 - 36 x 120 x 1.5	85	240	18	<b>\$8516</b>
WEBE964836K	48 - 36 x 96 x 1.5	85	192	14	<b>\$6599</b>
WEBE844230K	42 - 30 x 84 x 1.5	85	147	11	<b>\$6009</b>
WEBE724230K	42 - 30 x 72 x 1.5	85	126	9	<b>\$5289</b>
WEBE843624K	36 - 24 x 84 x 1.5	85	126	9	<b>\$5289</b>
WEBE723624K	36 - 24 x 72 x 1.5	85	108	8	<b>\$4538</b>
WEBE663624K	36 - 24 x 66 x 1.5	85	99	7	<b>\$3462</b>

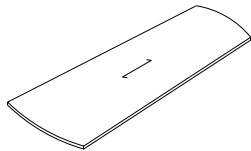

**Wedge Shape Top - Bow Ends**

Grain runs the **length** of the worksurface. Tops 120" and under are shipped in one piece and require 2 bases. Tops 144" and over are shipped in two pieces and require 3 bases.

### Required Specifications

Veneer Finish

### Optional Specifications

Boardroom Table Base

Grommet

Custom cut-out

## BOARDROOM TABLE BASES - ALL SERIES

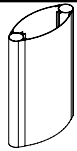

**Elliptical Base\***

MODEL#	DIMENSIONS	FREIGHT CLASS	WT/LBS.	CUBIC FT.	LIST PRICE
<b>D x W x H</b>					
TE42	8 x 42 x 28	100	70	8	<b>\$1965</b>
TE36	7 x 36 x 28	92.5	60	6	<b>\$1965</b>
TE30	6 x 30 x 28	85	50	4	<b>\$1904</b>
TE24	6 x 24 x 28	70	40	2	<b>\$1827</b>

**Not to be used with round table tops.** For tops up to 120", two Elliptical Bases must be ordered. For tops 144" and more, three Elliptical Bases must be ordered.

• **Plastic end gables are available in a Tungsten (K) or Black (E) finish. Please specify.**

- For 30" and 36" deep tops, order a 24" base (**TE24**).
- For 42" and 48" deep tops, order a 30" base (**TE30**).
- For 54" and 60" deep tops, order a 36" base (**TE36**) or 42" base (**TE42**).

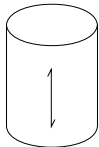

**Drum Base - Veneer**

TD30	30 x 30 x 28	125	93	15	<b>\$3207</b>
TD22	22 x 22 x 28	100	70	8	<b>\$1545</b>
TD18	18 x 18 x 28	85	62	5	<b>\$1346</b>

For tops up to 120", two Drum Bases must be ordered. For tops 144" and more, three Drum Bases must be ordered. Sand bag included to provide adequate stability.

- For 30", 36" and 42" deep tops, order a 18" base (**TD18**).
- For 48" and 54" deep tops, order a 22" base (**TD22**).
- For 60" deep tops, order a 30" base (**TD30**).

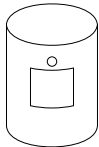

**Drum Base with Power Access Door - Veneer**

TD30J	30 x 30 x 28	125	93	15	<b>\$4009</b>
TD22J	22 x 22 x 28	100	70	8	<b>\$2350</b>
TD18J	18 x 18 x 28	85	62	5	<b>\$2149</b>

Access door and top and bottom cut-out to accommodate power/data grommet. For tops up to 120", two Drum Bases must be ordered. For tops 144" and more, three Drum Bases must be ordered. Sand bag included to provide adequate stability.

- Power access door is 12" x 12"
- For 30", 36" and 42" deep tops, order a 18" base (**TD18J**).
- For 48" and 54" deep tops, order a 22" base (**TD22J**).
- For 60" deep tops, order a 30" base (**TD30J**).

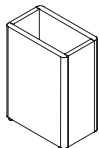

**Rectangular Wood Pedestal Base**

TP2412	12 x 24 x 28	85	86	7	<b>\$1845</b>
TP2012	12 x 20 x 28	70	71	4	<b>\$1756</b>
TP1612	12 x 16 x 28	70	58	3	<b>\$1678</b>

For tops up to 120", two Pedestal Bases must be ordered. For tops 144" and more, three Pedestal Bases must be ordered.

- For 30", 36" and 42" deep tops, order a 16" base (**TP1612**).
- For 48" and 54" deep tops, order a 20" base (**TP2012**).
- For 60" deep tops, order a 24" base (**TP2412**).

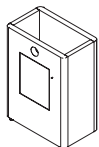

**Rectangular Wood Pedestal Base w/Power Access Door**

TP2412J	12 x 24 x 28	85	86	7	<b>\$2423</b>
TP2012J	12 x 20 x 28	70	71	4	<b>\$2362</b>
TP1612J	12 x 16 x 28	70	58	3	<b>\$2289</b>

Access door and top and bottom cut-out to accommodate power/data grommet. For tops up to 120", two Pedestal Bases must be ordered. For tops 144" and more, three Pedestal Bases must be ordered.

- Power access door is 12" x 12"
- For 30", 36" and 42" deep tops, order a 16" base (**TP1612J**).
- For 48" and 54" deep tops, order a 20" base (**TP2012J**).
- For 60" deep tops, order a 24" base (**TP2412J**).

### Required Specifications

Veneer finish  
Plastic finish\*

# T BOARDROOM TABLES

## BOARDROOM TABLE BASES - ALL SERIES

MODEL# DIMENSIONS FREIGHT CLASS WT/LBS. CUBIC FT. LIST PRICE ALL VENEER

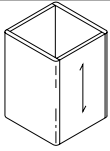

**Pedestal Base**

	D x W x H					
TP24	24 x 24 x 28	92.5	106	10		<b>\$1678</b>
TP20	20 x 20 x 28	85	89	7		<b>\$1612</b>
TP16	16 x 16 x 28	70	71	4		<b>\$1545</b>

For tops up to 120", two pedestal bases must be ordered. For tops 144" and more, three pedestal bases must be ordered.

- For 30", 36" and 42" deep tops, order a 16" base (**TP16**).
- For 48" and 54" deep tops, order a 20" base (**TP20**).
- For 60" deep tops, order a 24" base (**TP24**).

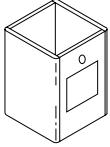

**Pedestal Base with Power Access Door**

TP24J	24 x 24 x 28	92.5	106	10		<b>\$2483</b>
TP20J	20 x 20 x 28	85	89	7		<b>\$2416</b>
TP16J	16 x 16 x 28	70	71	4		<b>\$2350</b>

Access door and top and bottom cut-out to accommodate power/data grommet. For tops up to 120", two pedestal bases must be ordered. For tops 144" and more, three pedestal bases must be ordered.

- Power access door is 12" x 12"
- For 30", 36" and 42" deep tops, order a 16" base (**TP16J**).
- For 48" and 54" deep tops, order a 20" base (**TP20J**).
- For 60" deep tops, order a 24" base (**TP24J**).

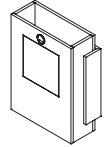

**Lam. Pedestal Base w/Power Access Door + Decorative Outside Panel**

TPML24J	10 x 24 x 28	92.5	53	5		<b>\$2800</b>
TPML20J	10 x 20 x 28	85	43	3		<b>\$2512</b>
TPML18J	10 x 18 x 28	70	36	2		<b>\$2228</b>

Access door and top and bottom cut-out to accommodate power/data grommet. For tops up to 120", two pedestal bases must be ordered. For tops 144" and more, three pedestal bases must be ordered.

- Power access door is 12" x 12"
- For 30", 36" and 42" deep tops, order a 18" base (**TPML18J**).
- For 48" and 54" deep tops, order a 20" base (**TPML20J**).
- For 60" deep tops, order a 24" base (**TPML24J**).

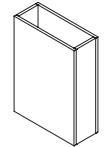

**Laminate Rectangular Center Base**

TPMLC24	10 x 24 x 28	92.5	53	5		<b>\$1617</b>
TPMLC20	10 x 20 x 28	85	43	3		<b>\$1528</b>
TPMLC18	10 x 18 x 28	70	36	2		<b>\$1445</b>

For tops up to 120", two pedestal bases must be ordered. For tops 144" and more, three pedestal bases must be ordered.

- Power access door is 12" x 12"
- For 30", 36" and 42" deep tops, order a 18" base (**TPMLC18**).
- For 48" and 54" deep tops, order a 20" base (**TPMLC20**).
- For 60" deep tops, order a 24" base (**TPMLC24**).

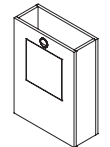

**Laminate Rectangular Center Base w/Power Access Door**

TPMLC24J	10 x 24 x 28	92.5	53	5		<b>\$2073</b>
TPMLC20J	10 x 20 x 28	85	43	3		<b>\$1984</b>
TPMLC18J	10 x 18 x 28	70	36	2		<b>\$1906</b>

Access door and top and bottom cut-out to accommodate power/data grommet. For tops up to 120", two pedestal bases must be ordered. For tops 144" and more, three pedestal bases must be ordered.

- Power access door is 12" x 12"
- For 30", 36" and 42" deep tops, order a 18" base (**TPMLC18J**).
- For 48" and 54" deep tops, order a 20" base (**TPMLC20J**).
- For 60" deep tops, order a 24" base (**TPMLC24J**).

### Required Specifications

Veneer finish  
Laminate finish\*

## BOARDROOM TABLE BASES - ALL SERIES

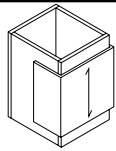

**Pedestal Base - Veneer  
Decorative Outside Panel\***

MODEL#	DIMENSIONS D x W x H	FREIGHT CLASS	WT./LBS.	CUBIC FT.	LIST PRICE	
TPM24	24 x 24 x 28	92.5	106	10	<b>\$2599</b>	<b>\$3116</b>
TPM20	20 x 20 x 28	85	86	7	<b>\$2490</b>	<b>\$2987</b>
TPM16	16 x 16 x 28	70	71	4	<b>\$2392</b>	<b>\$2869</b>

For tops up to 120", two pedestal bases must be ordered. For tops 144" and more, three pedestal bases must be ordered.

- For 30", 36" and 42" deep tops, order a 16" base (**TPM16**).
- For 48" and 54" deep tops, order a 20" base (**TPM20**).
- For 60" deep tops, order a 24" base (**TPM24**).

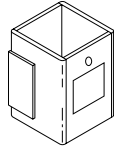

**Pedestal Base with Power Access Door  
Veneer Decorative Outside Panel\***

TPM24J	24 x 24 x 28	92.5	106	10	<b>\$3020</b>	<b>\$3627</b>
TPM20J	20 x 20 x 28	85	86	7	<b>\$2910</b>	<b>\$3495</b>
TPM16J	16 x 16 x 28	70	71	4	<b>\$2932</b>	<b>\$3521</b>

Access door and top and bottom cut-out to accommodate power/data grommet. For tops up to 120", two pedestal bases must be ordered. For tops 144" and more, three pedestal bases must be ordered.

- Power access door is 12" x 12"
- For 30", 36" and 42" deep tops, order a 16" base (**TPM16J**).
- For 48" and 54" deep tops, order a 20" base (**TPM20J**).
- For 60" deep tops, order a 24" base (**TPM24J**).

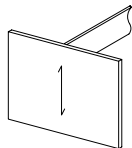

**Slab Base**

TH42	3 x 42 x 28	60	148	2	<b>\$2353</b>
TH36	3 x 36 x 28	60	127	2	<b>\$2123</b>
TH30	3 x 30 x 28	60	106	2	<b>\$1545</b>
TH22	3 x 22 x 28	60	89	2	<b>\$1338</b>

Not to be used with round table tops. For tops up to 120", two slab bases must be ordered. For tops 144" and more, three slab bases must be ordered.

- For 30" and 36" deep tops, order a 22" base (**TH22**).
- For 42" and 48" deep tops, order a 30" base (**TH30**).
- For 54" deep tops, order a 36" base (**TH36**).
- For 60" deep tops, order a 42" base (**TH42**).

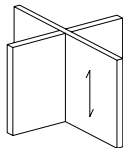

**Cross Base**

TX42	3 x 42 x 28	100	180	20	<b>\$2269</b>
TX36	3 x 36 x 28	100	155	17	<b>\$2123</b>
TX30	3 x 30 x 28	100	133	15	<b>\$1545</b>
TX22	3 x 22 x 28	100	97	11	<b>\$1338</b>

For tops up to 120", two cross bases must be ordered. For tops 144" and more, three cross bases must be ordered.

- For 30" and 36" deep tops, order a 22" base (**TX22**).
- For 42" and 48" deep tops, order a 30" base (**TX30**).
- For 54" deep tops, order a 36" base (**TX36**).
- For 60" deep tops, order a 42" base (**TX42**).

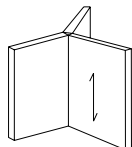

**"Y" Base**

TW42	4 x 42 x 28	125	140	20	<b>\$1965</b>
TW36	4 x 36 x 28	125	120	17	<b>\$1731</b>
TW30	4 x 30 x 28	125	100	15	<b>\$1422</b>
TW22	4 x 22 x 28	125	73	11	<b>\$1331</b>

**Not to be used with round table tops.** For tops up to 120", two "Y" bases must be ordered. For tops 144" and more, two "Y" bases and one cross base must be ordered.

- For 30" and 36" deep tops, order a 22" base (**TW22**).
- For 42" and 48" deep tops, order a 30" base (**TW30**).
- For 54" deep tops, order a 36" base (**TW36**).
- For 60" deep tops, order a 42" base (**TW42**).

### Required Specifications

Veneer Finish (Veneer Post Legs)  
Metal Finish (Metal Legs)

# T BOARDROOM TABLES

## BOARDROOM TABLE BASES - ALL SERIES

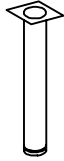

**Post Leg Veneer**

MODEL#	DIMENSIONS D x W x H	FREIGHT CLASS	WT/LBS.	CUBIC FT.	LIST PRICE
SN06	6 dia x 28	250	10	3	<b>\$1617</b>
SN04	4 dia x 28	125	7	1	<b>\$1245</b>
SN03	3 dia x 28	150	5	1	<b>\$785</b>

Available in 3", 4" and 6" diameters. Round tops and tops up to 96" require four legs. Tops 108" to 168" require six legs; tops 180" to 240" require ten legs.

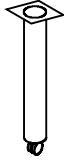

**Post Leg Veneer w/Caster**

SN06M	6 dia x 28	100	10	3	<b>\$1708</b>
SN04M	4 dia x 28	125	7	1	<b>\$1335</b>
SN03M	3 dia x 28	150	5	1	<b>\$878</b>

Available in 3", 4" and 6" diameters. Caster included. Round tops and tops up to 96" require four legs. Tops 108" to 168" require six legs; tops 180" to 240" require ten legs.

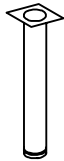

**Post Leg Metal**

SM06	6 dia x 28	100	10	3	<b>\$1105</b>
SM04	4 dia x 28	125	7	1	<b>\$610</b>
SM03	3 dia x 28	150	5	1	<b>\$434</b>

Available in 3", 4" and 6" diameters. Round tops and tops up to 96" require four legs. Tops 108" to 168" require six legs; tops 180" to 240" require ten legs.

• **Must Specify Black (E) or Tungsten (K) finish**

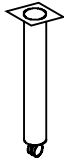

**Post Leg Metal w/Casters**

SM06M	6 dia x 28	100	10	3	<b>\$1199</b>
SM04M	4 dia x 28	125	7	1	<b>\$702</b>
SM03M	3 dia x 28	150	5	1	<b>\$528</b>

Available in 3", 4" and 6" diameters. Caster included. Round tops and tops up to 96" require four legs. Tops 108" to 168" require six legs; tops 180" to 240" require ten legs.

• **Must Specify Black (E) or Tungsten (K) finish**

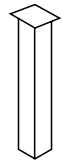

**Post Leg Metal, Square**

SMS4	4 x 4 x 28	125	7	1	<b>\$479</b>
------	------------	-----	---	---	--------------

Available in 4". Round tops and tops up to 96" require four legs. Tops 108" to 168" require six legs; tops 180" to 240" require ten legs.

• **Must Specify Black (E) or Tungsten (K) finish**

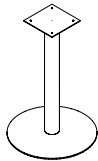

**Post Leg w/Flat Plate**

F6P36	36 x 36 x 28	150	100	22	<b>\$3794</b>
F4P30	30 x 30 x 28	150	80	15	<b>\$2310</b>
F4P24	24 x 24 x 28	125	60	10	<b>\$1846</b>
F3P18	18 x 18 x 28	100	45	5	<b>\$1638</b>

Round tops require a single base. For tops up to 120", two bases must be ordered. For tops 144" or more, three bases must be ordered.

• **Must Specify Black (E) or Tungsten (K) finish**

- For 30" deep tops, order a 18" base (**F3P18**).
- For 36" deep tops, order a 24" base (**F4P24**).
- For 42" and 48" deep tops, order a 30" base (**F4P30**).
- For 54" deep tops, order a 36" base (**F6P36**).

### Required Specifications

Veneer Finish  
\* Laminate Finish

## BOARDROOM TABLE BASES - ALL SERIES

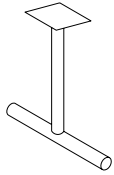

**Tubular 2-Prong Base**

MODEL#	DIMENSIONS D x W x H	FREIGHT CLASS	WT/LBS.	CUBIC FT.	LIST PRICE
TTM36	36 x 36 x 28	100	28	22	<b>\$913</b>
TTM26	26 x 26 x 28	85	24	11	<b>\$876</b>

**Not to be used with round table tops.** Two square edged prongs. For tops up to 84", two Tubular 2-Prong Bases must be ordered. Used as a 3rd base to provide center support in conjunction with two 3-Prong bases on tops 144" or more.

- **Must Specify Black (E) or Tungsten (K) finish**
- For 30", 36" and 42" deep tops, order a 26" base (**TTM26**).
- For 48", 54" and 60" deep tops, order a 36" base (**TTM36**).

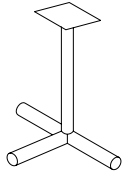

**Tubular 3-Prong Base**

TTE36	36 x 36 x 28	250	36	22	<b>\$973</b>
TTE26	26 x 26 x 28	85	32	11	<b>\$866</b>

**Not to be used with round table tops.** Three square edged prongs. For tops up to 120", two Tubular 3-Prong Bases must be ordered. For tops 144" and more, two Tubular 3-Prong Bases and one Tubular 2-Prong Base for the center must be ordered.

- **Must Specify Black (E) or Tungsten (K) finish**
- For 30", 36" and 42" deep tops, order a 26" base (**TTE26**).
- For 48", 54" and 60" deep tops, order a 36" base (**TTE36**).

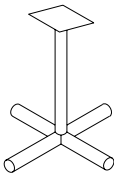

**Tubular 4-Prong Base**

TT36	36 x 36 x 28	300	40	22	<b>\$1458</b>
TT26	26 x 26 x 28	250	36	11	<b>\$1005</b>

Four square edged prongs. For tops up to 120", two Tubular 4-Prong Bases must be ordered. For tops 144" and more, three Tubular 4-Prong Bases must be ordered.

- **Must Specify Black (E) or Tungsten (K) finish**
  - For 30", 36" and 42" deep tops, order a 26" base (**TT26**).
  - For 48" and 54" deep tops, order a 36" base (**TT36**)\*
- \* Maximum diameter for Round Tops is 54".

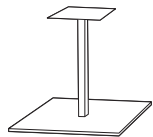

**Flat Square Column Base**

TTSQ23BH	23 x 23 x 41	150	75	14	<b>\$3635</b>
TTSQ18BH	18 x 18 x 41	125	65	10	<b>\$3367</b>
TTSQ30	30 x 30 x 28	150	80	14	<b>\$3771</b>
TTSQ23	23 x 23 x 28	150	55	12	<b>\$3098</b>
TTSQ18	18 x 18 x 28	150	45	8	<b>\$2828</b>

Round tops require a single base. For tops up to 120", two bases must be ordered. For tops 144" or more, three bases must be ordered.

- **Must Specify Black (E) or Tungsten (K) finish**
- For 30" deep tops, order a 18" base (**TTSQ18** or **TTSQ18BH**).
- For 36" deep tops, order a 24" base (**TTSQ23** or **TTSQ23BH**).
- For 42" and 48" deep tops, order a 30" base (**TTSQ30**).
  - Max diameter for round tops at standard height is 48".
  - Max diameter for round tops at bar height is 36".

### Required Specifications

Veneer Finish (Veneer Post Legs)  
Metal Finish (Metal Legs)

# T BOARDROOM TABLES

## BOARDROOM TABLE BASES

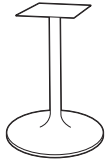

**Trumpet Column Base**

MODEL#	DIMENSIONS D x W x H	FREIGHT CLASS	WT/LBS.	CUBIC FT.	LIST PRICE
TRUM24BH	24 x 24 x 41	300	26	14	<b>\$1753</b>
TRUM18BH	18 x 18 x 41	300	24	16	<b>\$1619</b>
TRUM30	30 x 30 x 28	300	18	14	<b>\$1687</b>
TRUM24	24 x 24 x 28	300	16	12	<b>\$1216</b>
TRUM18	18 x 18 x 28	300	14	8	<b>\$1081</b>

Round tops require a single base. For tops up to 120", two bases must be ordered. For tops 144" or more, three bases must be ordered.

- **Must Specify Black (E) or Tungsten (K) finish**
- For 30" deep tops, order a 18" base (**TRUM18** or **TRUM18BH**).
- For 36" deep tops, order a 24" base (**TRUM24** or **TRUM24BH**).
- For 42" and 48" deep tops, order a 30" base (**TRUM30**).
  - Max diameter for round tops at standard height is 48".
  - Max diameter for round tops at bar height is 36".

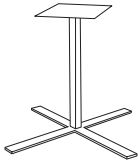

**Flat Bar "X" Column Base**

TTFLT36	36 x 36 x 28	300	18	14	<b>\$3367</b>
TTFLT30	30 x 30 x 28	300	16	12	<b>\$3234</b>
TTFLT22	22 x 22 x 28	300	15	10	<b>\$2976</b>

Round tops require a single base. For tops up to 120", two bases must be ordered. For tops 144" or more, three bases must be ordered.

- **Must Specify Black (E) or Tungsten (K) finish**
- For 30" and 36" deep tops, order a 22" base (**TTFLT22**)
- For 42" and 48" deep tops, order a 30" base (**TTFLT30**).
- For 54" deep tops, order a 36" base (**TTFLT36**).

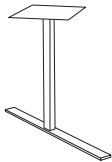

**Flat Bar "T" Column Base**

TTFLT36	36 x 36 x 28	150	14	3	<b>\$2828</b>
TTFLT24	24 x 24 x 28	150	10	2.50	<b>\$2560</b>

**Not to be used with round table tops.** For tops up to 84", two bases must be ordered. To be used as a 3rd base for center support in conjunction with two 3-prong bases on tops 144" or more.

- **Must Specify Black (E) or Tungsten (K) finish**
- For 30", 36" and 42" deep tops, order a 24" base (**TTFLT24**).
- For 48" and 54" deep tops, order a 36" base (**TTFLT36**).
- TTFLTxx bases are to be used as a middle base in combination with two TTFL3P bases



**Flat Bar 3 Prong Column Base**

TTFL3P36	36 x 36 x 28	400	16	22	<b>\$3234</b>
TTFL3P24	24 x 24 x 28	400	12	14	<b>\$2962</b>

**Not to be used with round table tops.** For tops up to 120", two bases must be ordered. For tops 144" or more, two 3-prong bases and one "T" column base must be ordered.

- **Must Specify Black (E) or Tungsten (K) finish**
- For 30", 36" and 42" deep tops, order a 24" base (**TTFL3P24**).
- For 48" and 54" deep tops, order a 36" base (**TTFL3P36**).
- When a third base is required, a TTFLTxx base may be used as the center base

### Required Specifications

Finish

**BOARDROOM TABLE BASES**

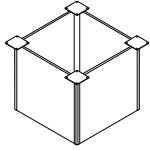

**Square Panel Base - Anodized Aluminum Radius Corner Detail**

MODEL#	DIMENSIONS	FREIGHT CLASS	WT/LBS.	CUBIC FT.	LIST PRICE
<b>D x W x H</b>					
TELRS24J	24 x 24 x 28	100	75	8	<b>\$2721</b>
TELRS20J	20 x 20 x 28	92.5	70	6	<b>\$2347</b>
TELRS16J	16 x 16 x 28	70	65	4	<b>\$2129</b>
TELRS24	24 x 24 x 28	100	75	8	<b>\$2385</b>
TELRS20	20 x 20 x 28	92.5	70	6	<b>\$2008</b>
TELRS16	16 x 16 x 28	70	65	4	<b>\$1795</b>

Round tops require a single base. For tops up to 120" two Square Panel bases must be ordered. For tops 144" or more, three bases must be ordered.

- **Model #'s with a "J" denote a power access door on one panel.**
- For 30", 36" and 42" deep tops, order a 16" base (**TELRS16** or **TELRS16J**).
- For 48" and 54" deep tops, order a 20" base (**TELRS20** or **TELRS20J**).
- For 60" deep tops, order a 24" base (**TELRS24** or **TELRS24J**).

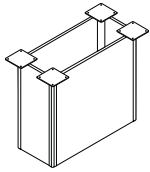

**Rectangular Panel Base - Anodized Aluminum Radius Corner Detail**

TELRR24J	12 x 24 x 28	100	65	8	<b>\$2587</b>
TELRR20J	12 x 20 x 28	92.5	60	6	<b>\$2210</b>
TELRR16J	12 x 16 x 28	85	50	4	<b>\$1995</b>
TELRR24	12 x 24 x 28	100	65	8	<b>\$2250</b>
TELRR20	12 x 20 x 28	92.5	60	6	<b>\$1875</b>
TELRR16	12 x 16 x 28	85	50	4	<b>\$1661</b>

**Not to be used with round table tops.** For tops up to 96" two Rectangular Panel bases must be ordered. To be used as a 3rd base for center support in conjunction with two Square Panel bases on tops 144" or more.

- **Model #'s with a "J" denote a power access door on one panel.**
- For 30", 36" and 42" deep tops, order a 16" base (**TELRR16** or **TELRR16J**).
- For 48" and 54" deep tops, order a 20" base (**TELRR20** or **TELRR20J**).
- For 60" deep tops, order a 24" base (**TELRR24** or **TELRR24J**).

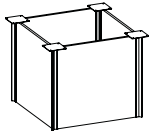

**Square Panel Base - Anodized Aluminum Rectangular Corner Detail**

TELBS24J	24 x 24 x 28	100	65	8	<b>\$2721</b>
TELBS20J	20 x 20 x 28	92.5	60	6	<b>\$2347</b>
TELBS16J	16 x 16 x 28	85	50	4	<b>\$2129</b>
TELBS24	24 x 24 x 28	100	65	8	<b>\$2385</b>
TELBS20	20 x 20 x 28	92.5	60	6	<b>\$2008</b>
TELBS16	16 x 16 x 28	85	50	4	<b>\$1795</b>

Round tops require a single base. For tops up to 120" two Square Panel bases must be ordered. For tops 144" or more, three bases must be ordered.

- **Model #'s with a "J" denote a power access door on one panel.**
- For 30", 36" and 42" deep tops, order a 16" base (**TELBS16** or **TELBS16J**).
- For 48" and 54" deep tops, order a 20" base (**TELBS20** or **TELBS20J**).
- For 60" deep tops, order a 24" base (**TELBS24** or **TELBS24J**).

**Required Specifications**

Finish

# T BOARDROOM TABLES

## BOARDROOM TABLE BASES

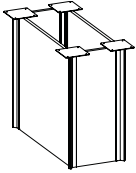

**Rectangular Panel Base - Anodized Aluminum Rectangular Corner Detail**

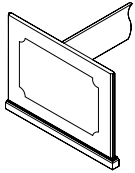

**Philadelphia Wood Slab Base and Stretcher**

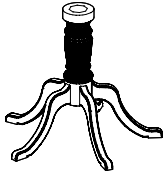

**Wood Queen Anne Base**

MODEL#	DIMENSIONS D x W x H	FREIGHT CLASS	WT/LBS.	CUBIC FT.	LIST PRICE
TELBR24J	12 x 24 x 28	100	65	8	<b>\$2587</b>
TELBR20J	12 x 20 x 28	92.5	60	6	<b>\$2210</b>
TELBR16J	12 x 16 x 28	85	50	4	<b>\$1995</b>
TELBR24	12 x 24 x 28	100	65	8	<b>\$2250</b>
TELBR20	12 x 20 x 28	92.5	60	6	<b>\$1875</b>
TELBR16	12 x 16 x 28	85	50	4	<b>\$1661</b>

**Not to be used with round table tops.** For tops up to 96" two Rectangular Panel bases must be ordered. To be used as a 3rd base for center support in conjunction with two Square Panel bases on tops 144" or more.

- **Model #'s with a "J" denote a power access door on one panel.**
- For 30", 36" and 42" deep tops, order a 16" base (**TELBR16** or **TELBR16J**).
- For 48" and 54" deep tops, order a 20" base (**TELBR20** or **TELBR20J**).
- For 60" deep tops, order a 24" base (**TELBR24** or **TELBR24J**).

PTH42PB	1 x 42 x 28	60	148	2	<b>\$3706</b>
PTH36PB	1 x 36 x 28	60	127	2	<b>\$3348</b>
PTH30PB	1 x 30 x 28	60	106	2	<b>\$2439</b>
PTH22PB	1 x 22 x 28	60	89	1	<b>\$2111</b>

- For 54" and 60" deep tops, order PTH36PB
- For 42" and 48" deep tops, order PTH30PB
- For 30" and 36" deep tops, order PTH22PB

PTQA30	30 x 30 x 28	150	73	15	<b>\$3790</b>
--------	--------------	-----	----	----	---------------

For use with 36", 42" and 48" deep tops.

### Required Specifications

Finish

## BOARDROOM - ACCESSORIES

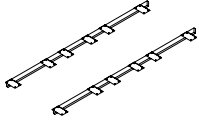

**Metal Support Rails**

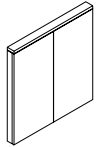

**Visual Board**

MODEL#	DIMENSIONS	FREIGHT CLASS	WT/LBS.	CUBIC FT.	LIST PRICE
	<b>D x W x H</b>				
TSUP102	1 x 102 x 2	70	0.10	0.10	<b>\$1239</b>
TSUP96	1 x 96 x 2	70	0.10	0.10	<b>\$1162</b>
TSUP90	1 x 90 x 2	70	0.10	0.10	<b>\$1075</b>
TSUP84	1 x 84 x 2	70	0.10	0.10	<b>\$993</b>
TSUP78	1 x 78 x 2	70	0.10	0.10	<b>\$910</b>
TSUP72	1 x 72 x 2	70	0.10	0.10	<b>\$828</b>
TSUP66	1 x 66 x 2	70	0.10	0.10	<b>\$748</b>
TSUP60	1 x 60 x 2	70	0.10	0.10	<b>\$667</b>
TSUP54	1 x 54 x 2	70	0.10	0.10	<b>\$613</b>

To be used when design considerations or dimension requirements dictate an unsupported table joint. Top section **MUST NOT** exceed 72" to use metal supports. **Sold in sets of two**

- Available in Black only.

VB4848E	5 x 48 x 48	70	115	7	<b>\$4541</b>
---------	-------------	----	-----	---	---------------

Includes porcelain on steel magnetic board and two side opening straight edge doors containing tackable fabric panels and 50-sheet paper writing pad that can be used on either door. Magnetic board can be used for projection. Set of 6 dry erase markers and eraser included. Interior fabric panels available in Anchorage. Specify color:

AN40 Birch	AN41 Green Apple	AN42 Lapis	AN43 Straw	AN44 Wolf
AN45 Goose	AN46 Angora	AN47 Cumin	AN48 Asteroid	AN49 Geranium
AN50 Thistle	AN51 Graphite	AN52 Slate	AN53 Quarry Blue	AN54 Onyx
AN55 Pumpkin	AN56 Red Delicious	AN57 Sunshine	AN59 Waterfall	AN61 Vanilla
AN62 Cobalt	AN64 Cloud			

- **NOTE:** Care should be taken to mount the units. Units should be mounted to wall studs using correct fasteners. Failure to do so may result in collapse of the unit and subsequent personal injury. **Mounting hardware not included.** Mounting hardware used should be based on wall material. Consult an installation professional for proper wall mounting.

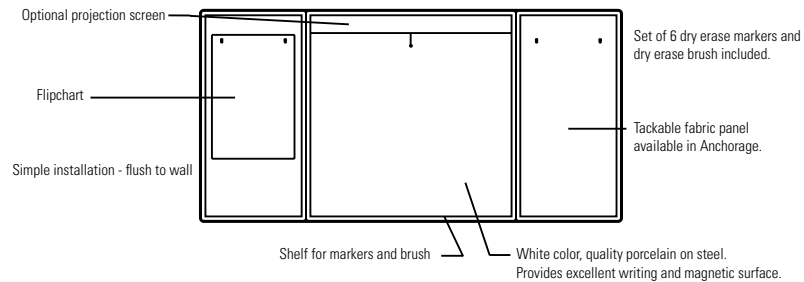

### Required Specifications

Finish  
Fabric

# T BOARDROOM TABLES

## BOARDROOM - ACCESSORIES

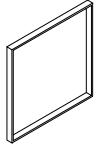

Visual Board, No Doors

MODEL#	DIMENSIONS D x W x H	FREIGHT CLASS	WT/LBS.	CUBIC FT.	LIST PRICE	
VB48480	5 x 48 x 48	70	115	7	<b>\$3051</b>	

Includes porcelain on steel magnetic board. Magnetic board can be used for projection. Set of 6 dry erase markers and eraser included.

• **NOTE:** Care should be taken to mount the units. Units should be mounted to wall studs using correct fasteners. Failure to do so may result in collapse of the unit and subsequent personal injury. **Mounting hardware not included.** Mounting hardware used should be based on wall material. Consult an installation professional for proper wall mounting.

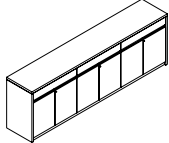

Credenza Buffet - Dufferin

DCB9022H36	22 x 90 x 36	92.5	440	44	<b>\$9735</b>	<b>\$11680</b>
DCB9020H36	20 x 90 x 36	92.5	400	40	<b>\$8850</b>	<b>\$10621</b>
DCB7222H36	22 x 72 x 36	92.5	330	33	<b>\$6610</b>	<b>\$7932</b>
DCB7220H36	20 x 72 x 36	92.5	300	30	<b>\$5889</b>	<b>\$7069</b>
DCB6022H36	22 x 60 x 36	100	275	28	<b>\$5669</b>	<b>\$6804</b>
DCB6020H36	20 x 60 x 36	92.5	250	25	<b>\$5153</b>	<b>\$6182</b>

90" w units have (3) two door storage cabinets with top drawer side-by-side. 72" w & 60" w units have (2) two door storage cabinets with top drawer side-by-side. Locking doors. Self-closing hinged doors cover one adjustable shelf.

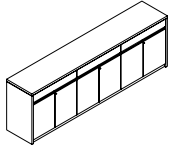

Credenza Buffet - Lufton

LCB9022H36	22 x 90 x 36	92.5	440	44	<b>\$10567</b>	
LCB9020H36	20 x 90 x 36	92.5	400	40	<b>\$9615</b>	
LCB7222H36	22 x 72 x 36	92.5	330	33	<b>\$7180</b>	
LCB7220H36	20 x 72 x 36	92.5	300	30	<b>\$6390</b>	
LCB6022H36	22 x 60 x 36	100	275	28	<b>\$6165</b>	
LCB6020H36	20 x 60 x 36	92.5	250	25	<b>\$5602</b>	

90" w units have (3) two door storage cabinets with top drawer side-by-side. 72" w & 60" w units have (2) two door storage cabinets with top drawer side-by-side. Locking doors. Self-closing hinged doors cover one adjustable shelf.

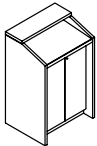

Lectern - Dufferin

DLEC3624	24 x 36 x 48	92.5	240	24	<b>\$4611</b>	<b>\$5533</b>
DLEC3024	24 x 30 x 48	92.5	200	20	<b>\$3845</b>	<b>\$4613</b>
DLEC2424	24 x 24 x 48	92.5	160	16	<b>\$3075</b>	<b>\$3689</b>

Features angled stand. Storage compartment with one adjustable and one fixed shelf. Locks optional.

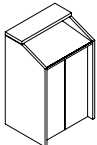

Lectern - Lufton

LEC3624L	24 x 36 x 48	92.5	240	24	<b>\$5230</b>	
LEC3024L	24 x 30 x 48	92.5	200	20	<b>\$4363</b>	
LEC2424L	24 x 24 x 48	92.5	160	16	<b>\$3476</b>	

Features angled stand. Storage compartment with one adjustable and one fixed shelf. Locks optional.

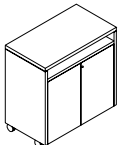



Utility Table - Dufferin

DTV3620M	20 x 36 x 34	85	121	10	<b>\$2791</b>	<b>\$3346</b>
----------	--------------	----	-----	----	---------------	---------------

Open shelf and storage compartment with one adjustable shelf. Locking doors. Casters.

### Required Specifications

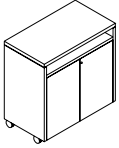
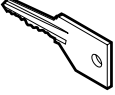
Finish

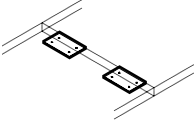
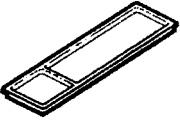
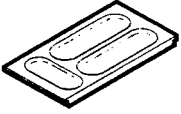
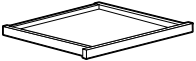
ACCESSORIES	MODEL#	DIMENSIONS	FREIGHT CLASS	WT/LBS.	CUBIC FT.	LIST PRICE
 <b>Utility Table - Lufton</b>	LTV3620M	D x W x H 20 x 36 x 34	85	121	10	<b>\$3023</b>
	Open shelf and storage compartment with one adjustable shelf. Locking doors. Casters.					
 <b>Extra Key</b>	LOCK	--	70	--	--	<b>\$46</b>
	Specify key #. Key range 400 - 500.					
 <b>Grommet Cover, Round</b>	GM1	2 dia x --	70	--	--	<b>\$70</b>
	GM1K	2 dia x --	70	--	--	<b>\$70</b>
	2.75" diameter. <ul style="list-style-type: none"> <li>• <b>Specify GM1 for Black or GM1K for Tungsten.</b></li> </ul>					
 <b>Mending Plates</b>	MP53	3 x 5 x 0.50	300	3	2	<b>\$65</b>
	Sold in sets of 2. <ul style="list-style-type: none"> <li>• <b>Available in Black Only.</b></li> </ul>					
 <b>Pencil Tray - Black Plastic</b>	PT	3 x 12.50 x 1	250	2	1	<b>\$23</b>
	Provides space for writing instruments and small items at the workspace. <ul style="list-style-type: none"> <li>• <b>Available in Black Only.</b></li> </ul>					
 <b>Pencil Tray - Veneer</b>	OPT	6 x 12.50 x 2	150	4	1	<b>\$183</b>
	Provides space for writing instruments and small items at the workspace. Solid oak finish.					
 <b>Center Drawer - Veneer</b>	CD	21 x 23 x 2	100	8	1	<b>\$744</b>
	Veneer drawer front is attached to a 4-sided frame. Must specify wood finish for drawer front.					

**Required Specifications**

Finish

# T BOARDROOM TABLES

## KEYBOARD DRAWERS

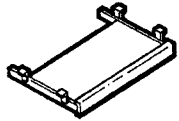

**Keyboard Drawer**

MODEL#	DIMENSIONS D x W x H	FREIGHT CLASS	WT/LBS.	CUBIC FT.	LIST PRICE
KD30	10 x 30 x 1	70	16	1	<b>\$999</b>
KD22	10 x 22 x 1	85	12	1	<b>\$893</b>
KD10	10 x 10 x 1	125	6	1	<b>\$452</b>

Pull-out veneer keyboard shelf. Clearance is 2 1/4". Must specify wood finish for drawer front.

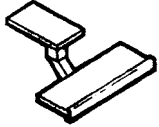

**Articulating Keyboard Drawer**

AKD30	10 x 30 x 1	65	24	1	<b>\$1380</b>
AKD22	10 x 22 x 1	70	18	1	<b>\$1277</b>

Adjustable pull-out keyboard shelf with articulating arm. Adjusts from flush with the worksurface to 5" below worksurface. Swivels 360° full arm rotation, angles -10° to +15°. Must specify wood finish for keyboard deck.

## WIRE MANAGEMENT



**Wire Management Cover**

MODEL#	DIMENSIONS	FREIGHT CLASS	WT/LBS.	CUBIC FT.	LIST PRICE
WH24	1 x 1 x 24	70	1	1	<b>\$79</b>

To conceal wires and cords. Plastic.

- **Available in Black Plastic Only.**

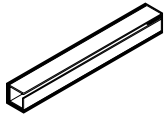

**Wire Management Track - Single**





C2M72	2 x 72 x 2	70	0.10	0.10	<b>\$89</b>
C2M60	2 x 60 x 2	70	0.10	0.10	<b>\$74</b>
C2M48	2 x 48 x 2	70	0.10	0.10	<b>\$61</b>
C2M36	2 x 36 x 2	70	0.10	0.10	<b>\$45</b>
C2M24	2 x 24 x 2	70	0.10	0.10	<b>\$34</b>
C2M12	2 x 12 x 2	70	0.10	0.10	<b>\$19</b>

To conceal and organize wires and cords. Attaches to Modesty Panel with double sided tape. Plastic.

- **Available in Black Plastic Only.**

### Required Specifications

Finish

POWER / DATA	MODEL#	DIMENSIONS	FREIGHT CLASS	WT/LBS.	CUBIC FT.	LIST PRICE
 <p><b>Single Sided Recessed Power Block</b></p>	<b>D x W x H</b>					
	PRTMCS401B	4.22 x 10.78 x 4.86	100	4.3	0.51	<b>\$486</b>
	PRTMCS401T	4.22 x 10.78 x 4.86	100	4.3	0.51	<b>\$486</b>
	PRTMCS401W	4.22 x 10.78 x 4.86	100	4.3	0.51	<b>\$486</b>
<p>Single-sided recessed power block with <b>one regular duplex and one telecom knockout on top; one power duplex on bottom</b>. 10' power cord with straight plug. Specify telecom options separately, see page 418. Available in Black (<b>B</b>), Tungsten (<b>T</b>) or Designer White (<b>W</b>) as indicated by the last letter of model number. Duplexes always Grey. Corresponding cut-out options are <b>R1, R2</b> or <b>R3</b>. Units are not approved for daisy chaining. UL listed: UL 1363.</p>						
 <p><b>Single Sided Recessed Power Block - USB-A + USB-C</b></p>	<b>D x W x H</b>					
	PRTMCS421B	4.22 x 10.78 x 4.86	100	4.3	0.51	<b>\$638</b>
	PRTMCS421T	4.22 x 10.78 x 4.86	100	4.3	0.51	<b>\$638</b>
	PRTMCS421W	4.22 x 10.78 x 4.86	100	4.3	0.51	<b>\$638</b>
<p>Single-sided recessed power block with <b>one power/USB-A/USB-C duplex and one telecom knockout on top; one power duplex on bottom</b>. USB-A port charges max 2.4 amps at 5V and USB-C port charges max 3 amps at 5V. 10' power cord with straight plug. Specify telecom options separately, see page 418. Available in Black (<b>B</b>), Tungsten (<b>T</b>) or Designer White (<b>W</b>) as indicated by the last letter of model number. Duplexes always Grey (duplex with USB ports is glossy finish). Corresponding cut-out options are <b>R1, R2</b> or <b>R3</b>. Units are not approved for daisy chaining. UL listed: UL 1363.</p>						
 <p><b>Double Sided Recessed Power Block</b></p>	<b>D x W x H</b>					
	PRTMCD602B	6.22 x 10.78 x 4.86	92.5	5.9	0.51	<b>\$555</b>
	PRTMCD602T	6.22 x 10.78 x 4.86	92.5	5.9	0.51	<b>\$555</b>
	PRTMCD602W	6.22 x 10.78 x 4.86	92.5	5.9	0.51	<b>\$555</b>
<p>Double-sided recessed power block with <b>two regular power duplexes and two telecom knockouts on top; one power duplex on bottom</b>. 10' power cord with straight plug. Specify telecom options separately, see page 418. Available in Black (<b>B</b>), Tungsten (<b>T</b>) or Designer White (<b>W</b>) as indicated by last letter of model number. Duplexes always Grey. Corresponding cut-out options are <b>T1, T2</b> or <b>T3</b>. Units are not approved for daisy chaining. UL listed: UL 1363.</p>						
 <p><b>Double Sided Recessed Power Block - USB-A + USB-C</b></p>	<b>D x W x H</b>					
	PRTMCD622B	6.22 x 10.78 x 4.86	92.5	6.1	0.51	<b>\$699</b>
	PRTMCD622T	6.22 x 10.78 x 4.86	92.5	6.1	0.51	<b>\$699</b>
	PRTMCD622W	6.22 x 10.78 x 4.86	92.5	6.1	0.51	<b>\$699</b>
<p>Double-sided recessed power block with <b>one regular power duplex, one power/USB-A/USB-C duplex and two telecom knockouts on top; one power duplex on bottom</b>. USB-A port charges max 2.4 amps at 5V and USB-C port charges max 3 amps at 5V. 10' power cord with straight plug. Specify telecom options separately, see page 418. Available in Black (<b>B</b>), Tungsten (<b>T</b>) or Designer White (<b>W</b>) as indicated by last letter of model number. Duplexes always Grey (duplex with USB ports is glossy finish). Corresponding cut-out options are <b>T1, T2</b> or <b>T3</b>. Units are not approved for daisy chaining. UL listed: UL 1363.</p>						
 <p><b>Double Sided Recessed Power Block - USB-A + USB-C</b></p>	<b>D x W x H</b>					
	PRTMCD642B	6.22 x 10.78 x 4.86	85	6.3	0.51	<b>\$842</b>
	PRTMCD642T	6.22 x 10.78 x 4.86	85	6.3	0.51	<b>\$842</b>
	PRTMCD642W	6.22 x 10.78 x 4.86	85	6.3	0.51	<b>\$842</b>
<p>Double-sided recessed power block with <b>two power/USB-A/USB-C duplexes and two telecom knockouts on top; one power duplex on bottom</b>. USB-A port charges max 2.4 amps at 5V and USB-C port charges max 3 amps at 5V. 10' power cord with straight plug. Specify telecom options separately, see page 418. Available in Black (<b>B</b>), Tungsten (<b>T</b>) or Designer White (<b>W</b>) as indicated by last letter of model number. Duplexes always Grey (duplex with USB ports is glossy finish). Corresponding cut-out options are <b>T1, T2</b> or <b>T3</b>. Units are not approved for daisy chaining. UL listed: UL 1363.</p>						

**Required Specifications**  
Finish

# T BOARDROOM TABLES

## TELECOM PLATES

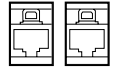

**Telecom Plate - 2 x 6**

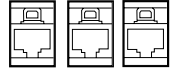

**Telecom Plate - 3 x 6**

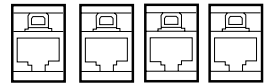

**Telecom Plate - 4 x 6**



**Telecom Plate - 3TSV**

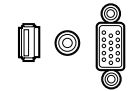

**Telecom Plate - 3SVH**

MODEL#	DIMENSIONS	FREIGHT CLASS	WT/LBS.	CUBIC FT.	LIST PRICE
--------	------------	---------------	---------	-----------	------------

D x W x H

PTELO1	- x - x -	70	0.01	0.05	<b>\$175</b>
--------	-----------	----	------	------	--------------

Includes 2 x RJ45 cat 6 data. Black telecom plate. To be hardwired by data contractor.

PTELO2	- x - x -	70	0.01	0.05	<b>\$237</b>
--------	-----------	----	------	------	--------------

Includes 2 x RJ45 cat 6 data and 1 RJ11 cat phone. Black telecom plate. To be hardwired by data contractor.

PTELO3	- x - x -	70	0.01	0.05	<b>\$363</b>
--------	-----------	----	------	------	--------------

Includes 4 x RJ45 cat 6 data. Black telecom plate. To be hardwired by data contractor.

PTELO4	- x - x -	70	0.01	0.05	<b>\$309</b>
--------	-----------	----	------	------	--------------



Includes 1 x RJ45 cat 6 data, mini stereo and 15 pin HD VGA. Black telecom plate. To be hardwired by data contractor.

PTELO5	- x - x -	70	0.01	0.05	<b>\$428</b>
--------	-----------	----	------	------	--------------

Includes mini stereo, 15 pin HD VGA and HDMI. Black telecom plate.

**Required Specifications**

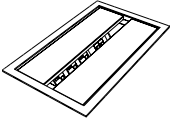
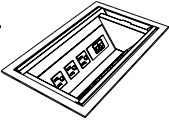
Finish

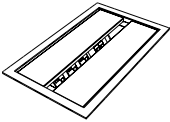
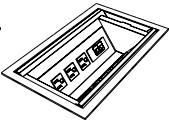
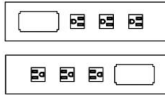
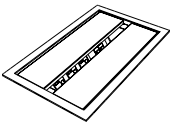
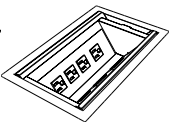
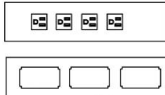
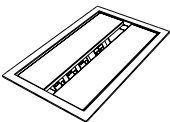
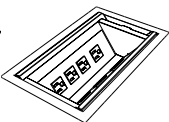
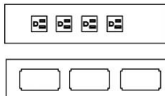
VILLA I SERIES CORDED UNITS	MODEL#	DIMENSIONS	FREIGHT CLASS	WT/LBS.	CUBIC FT.	LIST PRICE
 	OAM-A-PC-__	D x W x H 15 x 9 x 5.25	92.5	16	1.53	<b>\$1945</b>
	 <p>Mini Oasis A unit. 15" Trough with six power receptacles, two telecom plate cut-outs (<b>telecom plates sold separate</b>, see page page 424) and two 108" 3-prong plugs. <b>M1, M2 or M3 cut-out(s) must be specified on conference table</b> (see product notes section for more details and cut-out upcharge). UL Listed.</p> <ul style="list-style-type: none"> <li>• <b>Cannot be daisy-chained.</b></li> <li>• Replace _ with <b>B</b> for <b>Black</b></li> <li>• Replace _ with <b>S</b> for <b>Silver Pearl</b></li> </ul>					
 	OAM-A-PC-4-1-__	15 x 9 x 5.25	92.5	16	1.53	<b>\$2227</b>
	 <p><b>For hardwire and daisy chain applications.</b> Mini Oasis A unit. 15" Trough with six power receptacles, two telecom plate cut-outs (<b>telecom plates sold separate</b>, see page page 424). <b>Power infeed sold separate</b> (see page page 425). <b>M1, M2 or M3 cut-out(s) must be specified on conference table</b> (see product notes section for more details and cut-out upcharge). For multiple circuit configurations, please contact customer service. <i>Please see our <b>Daisy-Chain guide</b> on page page 422 for appropriate cable lengths and important notes.</i> UL Listed.</p> <ul style="list-style-type: none"> <li>• Replace _ with <b>B</b> for <b>Black</b></li> <li>• Replace _ with <b>S</b> for <b>Silver Pearl</b></li> </ul>					
 	OAM-B-PC-__	15 x 9 x 5.25	92.5	16	1.53	<b>\$1945</b>
	 <p>Mini Oasis B unit. 15" Trough with four power receptacles, three telecom plate cut-outs (<b>telecom plates sold separate</b>, see page page 424) and one 108" 3-prong plug. <b>M1, M2 or M3 cut-out(s) must be specified on conference table</b> (see product notes section for more details and cut-out upcharge). UL Listed.</p> <ul style="list-style-type: none"> <li>• <b>Cannot be daisy-chained.</b></li> <li>• Replace _ with <b>B</b> for <b>Black</b></li> <li>• Replace _ with <b>S</b> for <b>Silver Pearl</b></li> </ul>					
 	OAM-B-PC-4-1-__	15 x 9 x 5.25	92.5	16	1.53	<b>\$2227</b>
	 <p><b>For hardwire and daisy chain applications.</b> Mini Oasis B unit. 15" Trough with four power receptacles, three telecom plate cut-outs (<b>telecom plates sold separate</b>, see page page 424). <b>Power infeed sold separate</b> (see page page 425). <b>M1, M2 or M3 cut-out(s) must be specified on conference table</b> (see product notes section for more details and cut-out upcharge). For multiple circuit configurations, please contact customer service. <i>Please see our <b>Daisy-Chain guide</b> on page page 422 for appropriate cable lengths and important notes.</i> UL Listed.</p> <ul style="list-style-type: none"> <li>• Replace _ with <b>B</b> for <b>Black</b></li> <li>• Replace _ with <b>S</b> for <b>Silver Pearl</b></li> </ul>					

**Required Specifications**

- Finish
- Power infeed
- Cut-out location

# T BOARDROOM TABLES

## OASIS MINI

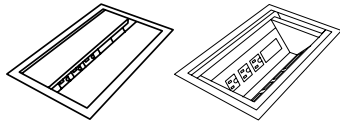

**Oasis Mini USB, Corded**

MODEL#	DIMENSIONS D x W x H	FREIGHT CLASS	WT/LBS.	CUBIC FT.	LIST PRICE
OAM-U-PC-__	15 x 9 x 5.25	92.5	16	1.53	<b>\$2177</b>

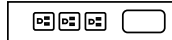
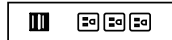

Mini Oasis USB unit. 15" trough with six power receptacles, two 2.1 AMP USB charging ports and one telecom plate cut-out (**telecom plates sold separate**, see page page 424) and two 108" 3-prong plugs. **M1, M2 or M3 cut-out(s) must be specified on conference table** (see product notes section for more details and cut-out upcharge). UL Listed.

- **Cannot be daisy-chained.**
- Replace \_ with **B** for **Black**
- Replace \_ with **S** for **Silver Pearl**

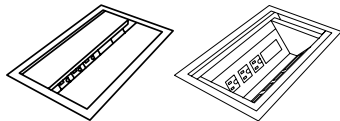

**Oasis Mini USB, DaisyLink Version**

OAM-U-PC-4-1-__	15 x 9 x 5.25	92.5	16	1.53	<b>\$2457</b>
-----------------	---------------	------	----	------	---------------

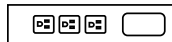
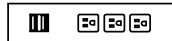

**For hardwire and daisy chain applications.** Mini Oasis USB unit. 15" trough with six power receptacles, two 2.1 AMP USB charging ports and one telecom plate cut-out (**telecom plates sold separate**, see page page 424). **Power infeed sold separate** (see page page 425). **M1, M2 or M3 cut-out(s) must be specified on conference table** (see product notes section for more details and cut-out upcharge). For multiple circuit configurations, please contact customer service. *Please see our **Daisy-Chain guide** on page page 422 for appropriate cable lengths and important notes.* UL Listed.

- Replace \_ with **B** for **Black**
- Replace \_ with **S** for **Silver Pearl**

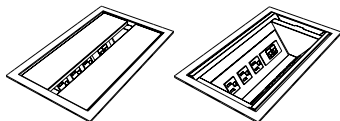

**Oasis Mini, Chicago Code**

GL-OAMPD_P72HW	15 x 9 x 5.25	92.5	16	1.53	<b>\$2652</b>
----------------	---------------	------	----	------	---------------

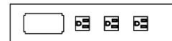

Mini Oasis for Chicago code includes electrical trough with (2) separate hardwire inserts. Each insert includes (3) simplex outlets and (1) telecom plate cut-out (**telecom plates sold separate**, see page page 424). **M1, M2 or M3 cut-out(s) must be specified on conference table** (see product notes section for more details and cut-out upcharge). Each component is UL listed.

- **Cannot be daisy-chained.**
- Replace \_ with **B** for **Black**
- Replace \_ with **S** for **Silver Pearl**

### Required Specifications

Finish  
Power infeed  
Cut-out location

OASIS MINI CUT OUT POSITIONS

D x W x H

**OASIS MINI A & B CABLE LENGTHS NEEDED FOR DAISY-CHAINING**

Model #	Oasis Mini A & Oasis Mini B	Oasis Mini A & Oasis Mini B	Oasis Mini A	Oasis Mini A	Oasis Mini B	Oasis Mini B
<b>Cut-out Positions</b>	TL/M & TR/M	TL/M & TR/M	TL/M, TC/M & TR/M	TL/M, TC/M & TR/M	TL/M, TC/M & TR/M	TL/M, TC/M & TR/M
<b>Infeed Position</b>	Left or Right	Center	Left or Right	Center	Left or Right	Center
<b>Reference</b>	Drawing 1A/1B	Drawing 2A/2B	Drawing 3	Drawing 4	Drawing 5	Drawing 6
<b>8' Dufferin &amp; Lufton Tables</b>	(1) 42FF-55 SPECIFY INFEED	(1) 42FF-29 (1) 42FM-29 (1) DAISY-T SPECIFY INFEED	N/A	N/A	N/A	N/A
<b>10' Dufferin &amp; Lufton Tables</b>	(1) 42FF-79 SPECIFY INFEED	(1) 42FF-41 (1) 42FM-41 (1) DAISY-T SPECIFY INFEED	(3) 42FF-37 SPECIFY INFEED	(3) 42FF-37 SPECIFY INFEED	(2) 42FF-37 SPECIFY INFEED	(2) 42FF-37 (1) 42FM-12 (1) DAISY-T SPECIFY INFEED
<b>12' Dufferin &amp; Lufton Tables</b>	(1) 42FF-103 SPECIFY INFEED	(1) 42FF-55 (1) 42FM-55 (1) DAISY-T SPECIFY INFEED	(3) 42FF-52 SPECIFY INFEED	(3) 42FF-52 SPECIFY INFEED	(2) 42FF-52 SPECIFY INFEED	(2) 42FF-52 (1) 42FM-12 (1) DAISY-T SPECIFY INFEED
<b>14' Dufferin &amp; Lufton Tables</b>	(1) 42FF-64 (1) 42FM-64 SPECIFY INFEED	1) 42FF-67 (1) 42FM-67 (1) DAISY-T SPECIFY INFEED	(3) 42FF-61 SPECIFY INFEED	(3) 42FF-61 SPECIFY INFEED	(2) 42FF-61 SPECIFY INFEED	(2) 42FF-61 (1) 42FM-12 (1) DAISY-T SPECIFY INFEED
<b>16' Dufferin &amp; Lufton Tables</b>	(1) 42FF-79 (1) 42FM-79 SPECIFY INFEED	1) 42FF-82 (1) 42FM-82 (1) DAISY-T SPECIFY INFEED	(3) 42FF-76 SPECIFY INFEED	(3) 42FF-76 SPECIFY INFEED	(2) 42FF-76 SPECIFY INFEED	(2) 42FF-76 (1) 42FM-12 (1) DAISY-T SPECIFY INFEED
<b>18' Dufferin &amp; Lufton Tables</b>	(1) 42FF-88 (1) 42FM-88 SPECIFY INFEED	1) 42FF-91 (1) 42FM-91 (1) DAISY-T SPECIFY INFEED	(3) 42FF-85 SPECIFY INFEED	(3) 42FF-85 SPECIFY INFEED	(2) 42FF-85 SPECIFY INFEED	(2) 42FF-85 (1) 42FM-12 (1) DAISY-T SPECIFY INFEED
<b>20' Dufferin &amp; Lufton Tables</b>	(1) 42FF-100 (1) 42FM-100 SPECIFY INFEED	1) 42FF-103 (1) 42FM-103 (1) DAISY-T SPECIFY INFEED	(3) 42FF-100 SPECIFY INFEED	(3) 42FF-100 SPECIFY INFEED	(2) 42FF-100 SPECIFY INFEED	(2) 42FF-100 (1) 42FM-12 (1) DAISY-T SPECIFY INFEED

**Interconnecting Cables - Common Cable Lengths (in inches)**

**Female/Female**

42FF-21 .....	\$116	42FF-94 .....	\$212	42FM-91 .....	\$215
42FF-29 .....	\$127	42FF-100 .....	\$219	42FM-94 .....	\$217
42FF-32 .....	\$129	42FF-103 .....	\$222	42FM-103 .....	\$231
42FF-37 .....	\$137	42FF-106 .....	\$225	42FM-106 .....	\$233
42FF-41 .....	\$142	42FF-112 .....	\$234	42FM-115 .....	\$245
42FF-46 .....	\$149	42FF-115 .....	\$240	42FM-118 .....	\$251
42FF-52 .....	\$157	42FF-118 .....	\$243		
42FF-55 .....	\$161				
42FF-58 .....	\$165	<b>Female/Male</b>			
42FF-61 .....	\$168	42FM-12 .....	\$111		
42FF-64 .....	\$172	42FM-21 .....	\$123		
42FF-67 .....	\$176	42FM-32 .....	\$137		
42FF-70 .....	\$179	42FM-46 .....	\$156		
42FF-76 .....	\$188	42FM-55 .....	\$167		
42FF-79 .....	\$192	42FM-58 .....	\$170		
42FF-82 .....	\$196	42FM-67 .....	\$182		
42FF-85 .....	\$200	42FM-70 .....	\$187		
42FF-88 .....	\$204	42FM-79 .....	\$199		
42FF-91 .....	\$208	42FM-82 .....	\$203		

# T BOARDROOM TABLES

## OASIS MINI NOTES

D x W x H

### DRAWING 1A - MINI OASIS A

Female/ Female Interconnecting Cable Included with Oasis A Unit

Female/ Female Interconnecting Cable Included with Oasis A Unit

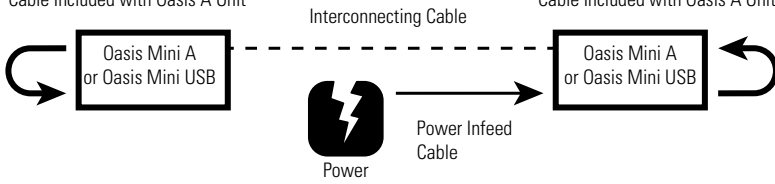

### DRAWING 1B - MINI OASIS B

Interconnecting Cable

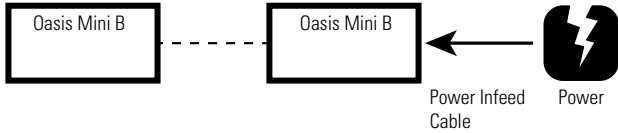

### DRAWING 2A - MINI OASIS A

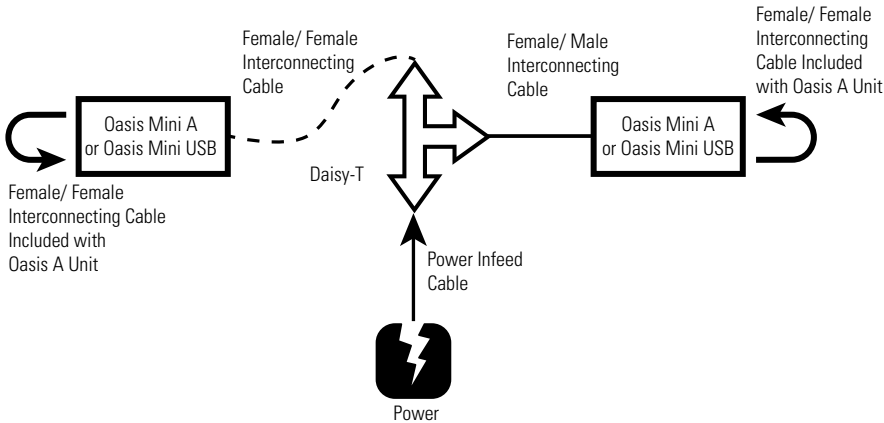

### DRAWING 2B - MINI OASIS B

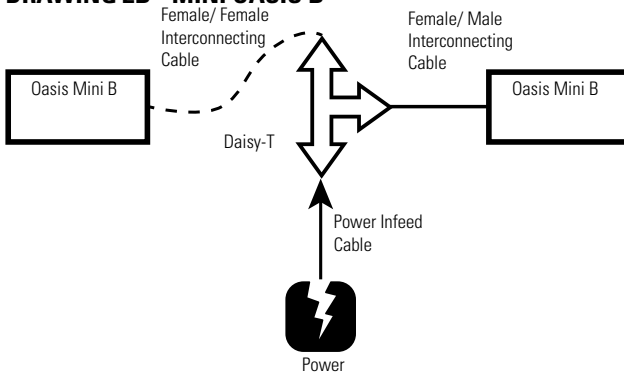

### DRAWING 3 - MINI OASIS A

Female/ Female Interconnecting Cable Included with Oasis A Unit

Female/ Female Interconnecting Cable

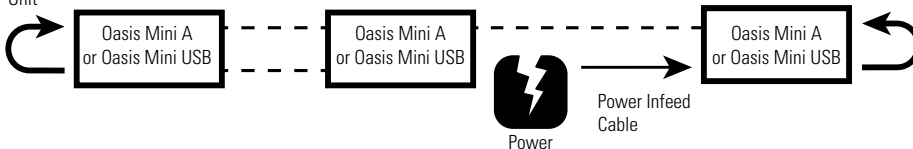

**OASIS MINI NOTES**

D x W x H

**DRAWING 4 - MINI OASIS A**

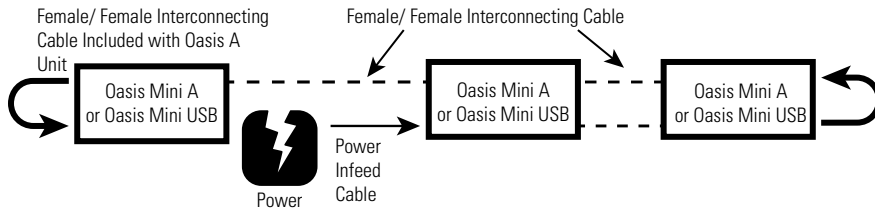

**DRAWING 5 - MINI OASIS B**

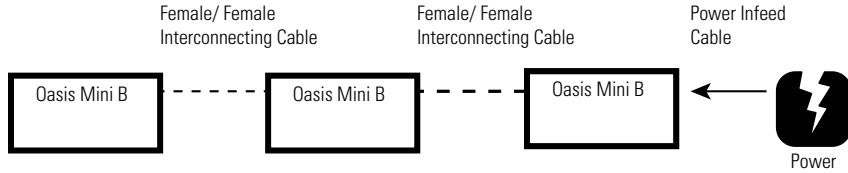

**DRAWING 6 - MINI OASIS B**

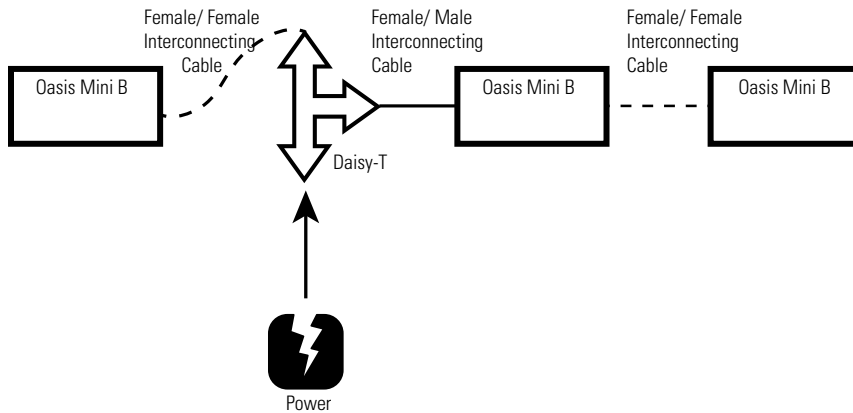







# T BOARDROOM TABLES

## TOP TELECOM PLATES

TOP TELECOM PLATE	MODEL	CONFIGURATION	D x W x H	LIST PRICE
	A-__-A-B	Telecom plate with RJ11 Cat 3 Phone and RJ45 Cat 6 Data		\$116
	A-__-B-B	(2) RJ45 Cat 6 Connectors		\$151
	A-__-B-B-B	(3) RJ45 Cat 6 Connectors		\$220
	A-__-B-B-B-B	(4) RJ45 Cat 6 Connectors		\$292
	A-__-B-C51-L	RJ45 Cat 6 Data, Mini-Stereo Inline and 15 pin HD VGA Female/Female with 72" patch cord attached.		\$260
	A-__-B-B-C51	(2) RJ45 Cat 6 Data and (1) 15 pin HD VGA Female/Female with 72" patch cord attached.		\$271
	A-__-A-B-102	RJ11 Cat 3 phone, RJ45 Cat 6 Data and USB with 72" patch cord attached.		\$260
	A-__-B	RJ45 Cat 6 Data		\$81
	A-__-C51-L	Mini Stereo Inline and 15 pin HD VGA Female/Female with 72" patch cord attached.		\$204
	A-__-CRDMINDER	Cordminder Plate - 2 5/8" holes and 1 7/8" holes		\$46
	A-__-C45-C51-L	HDMI Female/Female with 36" patch cord attached. Mini Stereo Inline and 15 Pin HD VGA Female/Female with 72" patch cord attached.		\$355

### Required Specifications

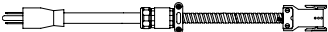
Finish  
Power infeed  
Cut-out location

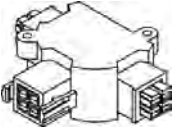
TOP TELECOM PLATES		MODEL#	DIMENSIONS	FREIGHT CLASS	WT./LBS.	CUBIC FT.	LIST PRICE
TOP TELECOM PLATE	MODEL	CONFIGURATION	D x W x H				LIST PRICE
	A-__-C45	HDMI Female/Female with 36" patch cord attached.					<b>\$175</b>
	A-__-A-B-B	(1) RJ11 Cat 3 Phone and (2) RJ45 Cat 6 data.					<b>\$190</b>
	A-__	Blank telecom plate					<b>\$29</b>
	A-__-102	USB with 72" patch cord attached.					<b>\$81</b>
	A-__-C51	15 pin HD VGA Female/Female with 72" patch cord attached.					<b>\$131</b>
		<ul style="list-style-type: none"> <li>• Replace __ with <b>BL</b> for <b>Black</b></li> <li>• Replace __ with <b>GR</b> for <b>Grey</b></li> </ul>					
		42AP1-72	--	--	--	--	<b>\$261</b>
<b>Plug and Play Infeed</b>		Single Circuit 20 AMP Power Infeed with 72" 3-prong plug. Provides single power entry from floor or wall mounted standard power supply. Connects to Oasis Mini or Villa units that require a separate infeed. UL Listed.					
		42SB2-108	--	--	--	--	<b>\$217</b>
		42SB2-72	--	--	--	--	<b>\$169</b>
		42SB2-36	--	--	--	--	<b>\$123</b>
<b>Multi-Circuit Hardwire Power Infeed</b>		Multi-Circuit Hardwire Infeed (up to 20 AMPS per circuit), two circuits. Provides single power entry from floor or wall located building power supply. Connects to Oasis Mini or Villa units that require a power infeed. <b>TO BE HARDWIRED BY A LICENSED ELECTRICIAN.</b> UL Listed.					
		DAISY-T	--	70	1	1	<b>\$200</b>
<b>3 Way Power Splitter</b>		Daisy-T power manager includes two male and one female connection. For use in splitting a power source two ways.					

**Required Specifications**

Veneer Finish  
Laminate Finish  
Handle Style

**Optional Specifications**

Grommet

# T BOARDROOM TABLES

POWER INFEEDES

MODEL#

DIMENSIONS

FREIGHT CLASS

WT/LBS.

CUBIC FT.

LIST PRICE

D x W x H

**Required Specifications**

Veneer Finish  
Laminate Finish  
Handle Style

**Optional Specifications**

Grommet

# textiles and finishes

## Care and Cleaning

### Textiles

**Fabrics:** To extend the life of your seating upholstered in fabric, regularly dust the chair to prevent airborne particles from penetrating the fabric surface.

For light soiling, use a damp cloth and blot the spot with very slight pressure, taking care never to soak the fabric. Dry with a clean cloth by blotting - never rub fabric. More intense stains can be treated the same way, but with a mild detergent. Always test fabric first in an unseen area before using any cleaning method.

**Leather:** For regular cleaning, simply use a soft damp cloth, taking care not to soak the leather. For more thorough treatment, soak a soft cloth in mild soap solution and wipe surface in a light circular motion. Repeat with clean water. Allow to dry and polish with a soft dry cloth. Do not use detergents, aerosol sprays or other polishes.

### Hard Surfaces

**Wood Veneer Finishes:** Waxing or polishing catalyzed finishes is not recommended because this will give a greasy, cloudy or uneven appearance to the product and could void your warranty. Global's conversion varnish is best cleaned by wiping the surface with a damp cloth, followed by a soft dry cloth in the direction of the grain. If the surfaces are heavily soiled, a gentle product like "Windex" can be used, following the same instructions as above.

**Laminate, painted & plated metal finishes, and solid surfaces:** Wipe the surface with a clean soft damp cloth; if needed, a mild soap solution can be used. To prevent streaks, dry the surface with a clean dry cloth moving in a circular motion.

- 
- **Water-Based Cleaner:** Spot clean, using the foam only from a water-based cleaning agent, such as a mild detergent or non-solvent upholstery shampoo product. Apply foam with a soft brush in a circular motion. Vacuum when dry. Pretest small area before proceeding.
  - **Solvent Cleaner:** Spot clean, using a mild water-free solvent or dry cleaning product. Clean only in a well-ventilated room and avoid any product containing carbon tetrachloride or other toxic materials. Pretest a small area before proceeding.
  - **Water/Solvent Cleaner:** Spot clean with a mild solvent, an upholstery shampoo, or the foam from a mild detergent. When using a solvent or dry cleaning product, follow instructions carefully and clean only in a well-ventilated room. Avoid any product that contains carbon tetrachloride or other toxic materials. With either method, pretest a small area before proceeding.
  - **Vacuum Only:** Clean this fabric only by vacuuming or light brushing to prevent accumulation of dust and grime. Water-based foam cleaning agents of any kind may cause excessive shrinking, staining, or distortion of the surface pile and therefore, should not be used.
  - **Crypton Cleaning:** Generally stains are removed with plain water and powdered enzyme detergent. Upholstery foam shampoo, water-based cleaning products and germicidal detergents can be used. Be sure to remove all residue from cleaning products with clean water. Do not use solvent-based cleaners or dry cleaning products.
  - These recommendations and codes were developed by fabric specialists. However, because of the various ways fabric can be stained or damaged, there is no guarantee that the results will be completely successful. Use suggested methods on your own responsibility. To help prevent overall soil, frequent vacuuming or light brushing to remove dust and grime is recommended. Use professional furniture cleaning service when overall soiled condition has been reached.

## Textile Price Grades - Global Textiles

Grade 1	Carrera, Dobby, Fusion, Illusion, Jenny, Quilt, Terrace, Trak, Urban, Waterfall, Wavelength
Grade 2	Allante FRee, Elevate, Etch, GC Linen, Imprint, Luxhide, Release
Grade 3	Non standard GLOBAL textiles
Grade 4	Non standard GLOBAL textiles
Grade 5	Non standard GLOBAL textiles
Grade 6	Novaro Genuine Leather, non standard GLOBAL textiles
Grade 7	Non standard GLOBAL textiles
Grade 8	Non standard GLOBAL textiles
Grade 9	Non standard GLOBAL textiles
Grade 11	Non standard GLOBAL textiles
Grade 10	Non standard GLOBAL textiles
Grade 12	Non standard GLOBAL textiles

Please refer to individual seating series for availability of a particular textile.

The charts above do not include Textiles offered by Alliance Partners: Arc-Com Fabrics, Architex, CF Stinson, Designtex, Knoll Textiles, Green Hides, LDI Interiors, Luum Textiles, Maharam, Mayer Fabrics, Momentum, and Ultrafabrics.

## Blend Seating Textiles

The grid below outlines the grade structure for using multiple textiles on select seating series. Blended textiles occur when one textile is chosen for one part of the chair and a different textile is selected for another part of the chair, resulting in a revised blended grade. For opportunities regarding more than two different textiles, please contact Global CustomerCare for approval process and grading.

		FIRST TEXTILE SELECTED																	
		1	2	3	4	5	6	7	8	9	10	11	12	13	14	15	16	17	18
SECOND TEXTILE SELECTED	1	1																	
	2	2	2																
	3	3	3	3															
	4	3	4	4	4														
	5	4	4	5	5	5													
	6	5	5	5	6	6	6												
	7	5	6	6	6	7	7	7											
	8	6	6	7	7	7	8	8	8										
	9	7	7	7	8	8	8	9	9	9									
	10	8	8	8	8	9	9	9	10	10	10								
	11	9	9	9	9	9	10	10	10	11	11	11							
	12	10	10	10	10	10	10	11	11	11	12	12	12						
	13	11	11	11	11	11	11	12	12	12	12	13	13	13					
	14	11	12	12	12	12	12	12	13	13	13	13	14	14	14				
	15	12	12	13	13	13	13	13	13	14	14	14	14	15	15	15			
	16	13	13	13	14	14	14	14	14	14	15	15	15	15	16	16	16		
	17	14	14	14	14	15	15	15	15	15	15	16	16	16	16	17	17	17	
	18	15	15	15	15	15	16	16	16	16	16	16	17	17	17	17	18	18	18

**TEXTILE AND COLOR LISTINGS**

**Grade 1**

**Carrera** 100% Polyester

CE84 Zest	CE85 Savannah	CE86 Slate	CE87 Rainforest	CE88 Aspen	CE89 Dune	CE90 Flannel
CE91 Azure	CE92 Chili	CE93 Jute	CE95 Ink	CE96 Sangria	CE97 Java	CE98 Charcoal

**Dobby** 96% Recycled Polyester / 4% Virgin Polyester

DB30 Snowcap	DB31 Bonsai	DB32 Cloud	DB33 Sand	DB34 Pewter	DB35 Santa Fe	DB36 Corfu
DB37 Medium Taupe	DB38 Charcoal	DB39 Berry	DB40 Royal	DB41 Titanium	DB42 Black	

**Fusion** 90% Virgin Polyester / 10% Post-Consumer Recycled Polyester

FU71 Tangerine	FU72 Fresh	FU73 Moss	FU74 Tomato	FU75 Aqua	FU76 Sandstone	FU77 Granite
FU78 Poppy	FU79 Cadet	FU80 Oasis	FU81 Graphite	FU82 Viola	FU83 Cobalt	FU84 Flax
FU85 Carbon						

**Illusion** 100% Virgin Polyester

II01 Cappuccino	II02 Paprika	II03 Tropic	II04 Wicker	II05 Hemp	II06 Cayenne	II07 Maui
II08 Dusk	II09 Smoke	II10 Currant	II11 Fiji	II12 Ozone	II13 Ebony	

**Jenny** 100% Polyester

JN01 Midnite	JN02 Ebony	JN03 Slate	JN07 Vermilion	JN08 Admiral	JN11 Charcoal	JN25 Silver Lining
JN26 Oatmeal	JN27 Sunflower	JN28 Cascade	JN29 Harvest	JN30 Melon	JN31 Berry	JN32 Green Grass
JN33 Roast						

**Quilt** 100% Polyester

QL10 Black	QL11 Charcoal Grey	QL14 Navy	QL16 Wine	QL19 Silver	QL20 Feather	QL21 Dune
QL22 Meadow	QL23 Cadet	QL24 Geranium	QL25 Daisy	QL26 Quest	QL27 Punch	QL28 Tangerine
QL29 Cocoa						

**Terrace** 70% Virgin Polyester / 30% Post-Consumer Recycled Polyester

TC61 Tigerlily	TC62 Shadow	TC63 Cobble	TC64 Cherry Blossom	TC65 Bluebell	TC66 Apple	TC67 Haze
TC68 Cerise	TC69 Twilight	TC70 Wintergreen	TC71 Ironwork	TC72 Pine Cone	TC73 Flirt	TC74 Echo
TC75 Glacier						

**Trak** 100% Recycled Polyester

TK40 Taupe	TK41 Mustard	TK42 Latte	TK43 Cement	TK44 Silver	TK45 Copper	TK46 Teal
TK47 Apple	TK48 Steel	TK49 Merlot	TK50 Midnight Sky	TK51 Mocha	TK52 Carbon	

**Urban** 62% Recycled Polyester / 32% Polyester

UR10 Red Rose	UR11 Ocean Blue	UR12 Blue Bayou	UR13 Green Grass	UR14 Sandcastle	UR15 Beach Day	UR16 Boardwalk
UR17 Earth	UR18 Brown Ridge	UR19 White Sand	UR20 Granite Rock	UR21 Gravel Road	UR22 Black Coal	

**Waterfall** 60% Virgin Polyester / 40% Post-Consumer Recycled Polyester

WA40 Trance	WA41 Tryst	WA42 Splash	WA43 Victoria	WA44 Imagine	WA45 Sky	WA46 Rainforest
WA47 Rumble	WA48 Prism	WA49 Tranquility	WA50 Grand	WA51 Rushing	WA52 Magestic	WA53 Pacific
WA54 Dance						

**Wavelength** 100% Virgin Polyester

WV01 Lime	WV02 Mint	WV03 Stone	WV04 Flame	WV05 Mykonos	WV06 Savannah	WV07 Mesa
WV08 Plasma	WV09 Cancun	WV10 Quartz	WV11 Moonrock	WV12 Rubine	WV13 Corfu	WV14 Bluejay
WV14 Panther						

**Grade 2**

**Elevate** 80% Post-Consumer Recycled Polyester / 20% Rayon

EL51 Halo	EL52 Dove	EL53 Safari	EL54 Sunglow	EL55 Margarita	EL56 Fiji	EL57 Mist
EL58 Blaze	EL59 Wasabi	EL60 Mystic	EL61 Mica	EL62 Cherry	EL63 Scuba	EL64 Lapis
EL65 Onyx						

**Etch** 80% Post-Consumer Recycled Polyester / 20% Rayon

ET81 Drift	ET82 Citron	ET83 Calypso	ET84 Mandarin	ET85 Crisp	ET86 Iris	ET87 Nickel
ET88 Paprika	ET89 Nutmeg	ET90 Marine	ET91 Magnet	ET92 Infrared	ET93 Espresso	ET94 Indigo
ET95 Anthracite						

**Imprint** 100% Post-Consumer Polyester

IM70 Almond	IM71 Cork	IM72 Sand	IM73 Currie	IM74 Candy Apple	IM75 Ocean	IM76 Navy
IM77 Green Tea	IM78 Celery	IM79 Oregon	IM80 Walnut	IM81 Paprika	IM82 Graphite	IM83 Slate
IM84 Licorice						

# T TEXTILES + FINISHES

**Grade 2 (Vinyl)** For availability of chair series in Vinyl, please contact a Global Sales Representative.

**Allante Free** 100% Vinyl Face / 100% Polyester Backing

A01F Illusion	A02F Bright White	A03F White Crush	A04F Ivory	A05F Ice	A06F Bleached Sand	A07F Taupe Fawn
A08F Warm Smoke	A09F Autumn Rain	A10F Cookie	A11F Sierra Brick	A12F Gibraltar	A13F Chateau Grey	A14F Garden Green
A15F Oasis Green	A16F Ink Black	A17F Purple Impulse	A18F Italian Rose	A19F Mountain Sky	A20F Old Navy	A21F Galaxy
A22F Red Truffle	A23F Chocolate Sundae	A24F Province Blue	A25F Eclipse			

**GC Linen** 100% Vinyl Face

LE50 Potters Clay	LE51 Pearl	LE52 Tan	LE53 Storm	LE54 Butter	LE55 Haystack	LE56 Ganache
LE57 Sunset	LE58 Burnt Orange	LE59 Cayenne	LE60 Navy	LE61 Bamboo	LE62 Gray	LE63 Charcoal
LE64 Moss						

**Luxhide** 100% Vinyl Face / Bonded Leather Backing

BL20 Black	BL22 Parchment	BL23 Saddle	BL24 Dark Brown	BL26 Burgundy	BL27 Charcoal	BL28 White
BL34 Light Grey						

**Release** 100% Vinyl Face

RL11 White	RL12 Chalk	RL13 Stone	RL14 Taupe	RL15 Orange	RL16 Country	RL17 Tuscan
RL18 Cottage	RL19 Yellow	RL21 Red Barn	RL22 Brave Red	RL23 Gypsy Red	RL24 Cajun	RL25 Vineyard
RL26 Olive	RL27 Bonsai	RL28 Summer's Dream	RL29 Calico	RL31 Green	RL32 Blue	RL33 Black
RL34 Cool Grey	RL35 Thunder Grey	RL36 Navy	RL37 Dark Chocolate	RL38 Espresso		

**Grade 6**

**Novaro Genuine Leather** 100% Leather

N050 Ash	N051 Asphalt	N052 Bison	N053 Blueberry	N054 Cloud	N055 Clove	N056 Cordovan
N057 Doe	N058 Linen	N059 Marina	N060 Phantom	N061 Pigeon	N062 Scarlet	N063 Turtle
N064 Wheat						

**PANEL/TACKBOARD FABRICS**

**GRADE 2**

**Lola** 100% Polyester.

LL11 Medium Taupe	LL12 Caramel Cream	LL14 Blue Mist	LL35 Spray	LL36 Granite	LL37 Cinder	LL38 Sandstone
-------------------	--------------------	----------------	------------	--------------	-------------	----------------

**GRADE 3**

**Anchorage** 65% Pre-consumer Polyester / 35% Post-consumer Polyester

AN40 Birch	AN41 Green Apple	AN42 Lapis	AN43 Straw	AN44 Wolf	AN45 Goose	AN46 Angora
AN47 Cumin	AN48 Asteroid	AN49 Geranium	AN50 Thistle	AN51 Graphite	AN52 Slate	AN53 Quarry Blue
AN54 Onyx	AN55 Pumpkin	AN56 Red Delicious	AN57 Sunshine	AN59 Waterfall	AN61 Vanilla	AN62 Cobalt
AN64 Cloud						

**Merge** 100% Polyester / 75% Post-consumer Recycled Polyester

MG20 Fawn	MG21 Marshmallow	MG22 Driftwood	MG23 Dove	MG24 Graphite	MG25 Slate	MG26 Eucalyptus
MG27 Fire Engine	MG28 Mediterranean	MG29 Midnight				

**FINISHES**

**Seating Finishes - Metal & Polymer:** *Please consult each Seating Series for finish availability.*

Black (BK)	Charcoal Grey (CHR)	Chrome (CHM)	Fog (FG)	Polished Aluminum (ALU)	Tungsten (TUN)
------------	---------------------	--------------	----------	-------------------------	----------------

**Seating Finishes - Plastic** (Duet, Popcorn, Sonic and Stream)

Buzz Blue (BZB)	Cactus (CCT)	Carrot (CRO)	Cloud (IVC)	Dijon (DJN)	Eggplant (EGP)	Fog (FOG)
Frost (FRO)	Ink (INK)	Latte (LAB)	Night (BLK)	Sand (SND)	Scarlet (SAR)	Shadow (SHW)

**Seating Finishes - Wood** Seating finishes will not necessarily match Casegoods finishes. This is due to the fact that Seating and Casegoods finishes use different wood species and are manufactured at multiple locations.

Absolute (AAM)	Black (BKM)	Cherry (ACM)	Espresso Cafe (ECM)	English Oak (EOM)	Fruitwood (TFM)	Gray (HGM)
Honey (AHM)	Mahogany (TMM)	Maple (AVM)	Medium Walnut (MWM)	Natural Walnut (NLW)	Night (ASM)	Noce Biondo (NBM)
Noce Grigio (NGM)	Noce Leggero (NEM)	Noce Medio (NMM)	Shaker Cherry (SKM)	Walnut (TWM)	WC Cream (WTM)	White (WHM)
Winter Cherry (WCM)						

**Desks, Workstations, Tables and Accessories - Laminate**

Absolute Acajou (ACJ)	Asian Night (ASN)	Avant Cherry (AWC)	Avant Honey (AWH)	Black (BLK)	Blizzard (BZD)	Brushed Cobalt (BRC)
Clear Maple (CMB)	Custom Grey (CGY)	Dark Espresso (DES)	Designer White (DWT)	Fashionista (FAS)	First Class (FCL)	Noce Biondo (NBL)
Noce Grigio (NGL)	Noce Leggero (NEL)	Noce Medio (NML)	Quartered Mahogany (QTM)	Sheer Beauty (SBY)	Stonedust (SDT)	Storm Grey (SOG)
Walnut Heights (WHE)	White Chocolate (WHC)	Winter Cherry (WCR)				

**Desks, Workstations, Tables and Accessories - Wood Veneer**

Almond Cherry (AMW)	Amber Cherry (ACW)	Biscotti (BTW)	Cocoa Walnut (CAW)	Coral (CRW)	Dark Cherry (DCW)	Dark Walnut (DWW)
Espresso Walnut (EWW)	Evening Oak (EVW)	Grey on Oak (GRW)	Hazelnut (HAW)	Java (JAW)	Latte Walnut (LTW)	Mahogany on Walnut (MHW)
Milestone (MTW)	Natural Maple (MPW)	Natural Walnut (NLW)	Red Cherry (RCW)	Umber Walnut (ULW)	Vintage Cherry (VNW)	Walnut (WLW)
Warm Cherry (WCW)	White Maple (WMM)					

**Metal Leg Finishes** *(check series for applicable finishes)*

Antique Copper (ACO)	Black (TBL)	Brushed Chrome (BCH)	Buzz Blue (TBZ)	Cactus (TCC)	Carrot (TCR)	Cloud (TIV)
Chrome (CHM)	Designer White (TDW)	Dijon (TDJ)	Eggplant (TEG)	Fog (TFO)	Frost (TFR)	Ink (TIN)
Kalua (TKA)	Latte (TLA)	Mocha (TMO)	Nevada (TNE)	Sand (TSN)	Satin Brass (SBR)	Scarlet (TSR)
Shadow (TSH)	Toast (TOA)	Tungsten (TTU)				

**Metal File + Storage Finishes**

Business Grey (BGR)	Black Coffee Textured (BKC)	Black (BLK)	Bone (BNE)	Blizzard Textured (BZD)	Charcoal (CHR)
Claret (CLT)	Dark Chocolate Textured (DCH)	Desert Putty (DPT)	Designer White (DWT)	Fog (FOG)	Grey (GRY)
Light Grey (LGR)	Ice (ICE)	Ivory (IVR)	Mocha Textured (MCH)	Metro (MET)	Moss (MOS)
Nevada (NEV)	Navy (NVY)	Oyster (OYS)	Stonedust Textured (SDT)	Storm Grey (SGR)	Silver (SIL)
Sky (SKY)	Stone (STN)	Taupe (TPE)	Tahiti Sand (TSA)	Tungsten (TUN)*	Willow (WIL)

\* 10% upcharge applies

# THIS FORM IS TO BE USED FOR NON-STANDARD CUT-OUT SIZES

Dufferin and Lufton tables up to 120" (Corby up to 84").

Model # \_\_\_\_\_ (please use one page for each model #)

Please check all that apply. Note: Base positions will vary based on style chosen. Outer cut-outs are approximately 18"-20" in from each end.

## CUT-OUT POSITION(S)

- Position 1 - near left base - use option code **CCUTL**
- Position 2 - center of table - use option code **CCUTC**
- Position 3 - near right base - use option code **CCUTR**
- Custom position(s) - indicate on diagram below w/dimensions to **center point** of cut-outs - use option code **CCUS**

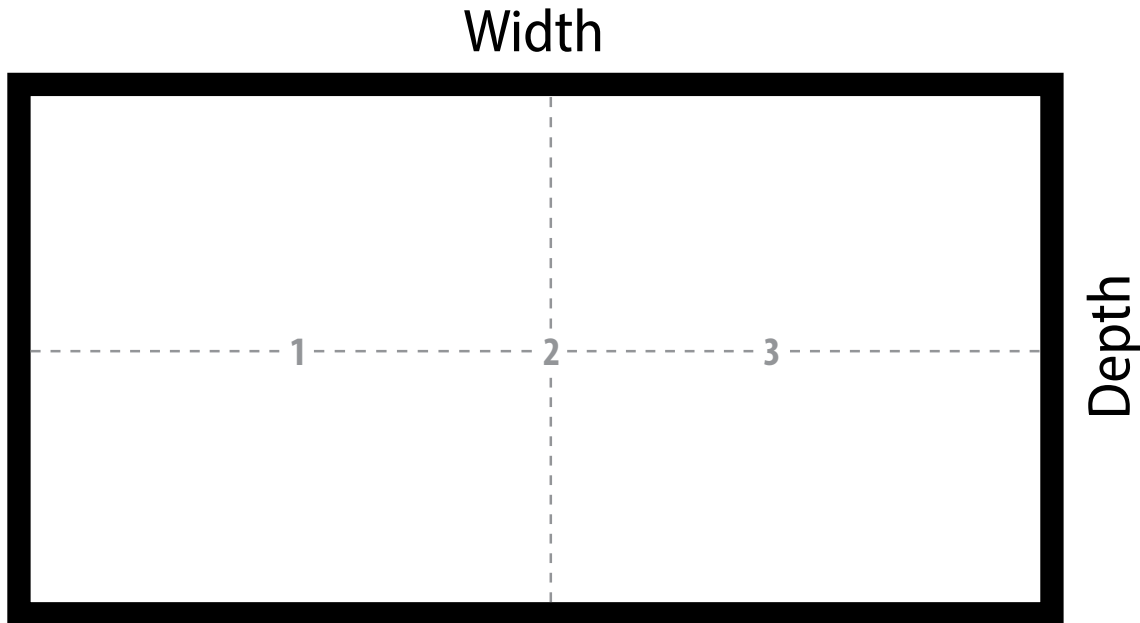

## CUT-OUT CRITERIA

All cut-outs require a minimum 8mm radius at each corner.

Cut-outs **must be centered** on the depth of each table due to wire management runners below the worksurface.

### Indicate cut-out size:

\_\_\_\_\_ " X dimension of cut-out runs the width of the table.

\_\_\_\_\_ " Y dimension of cut-out runs the depth of the table.

Y dimension not to exceed 14"

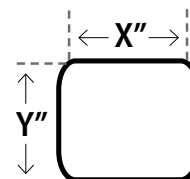

Dealer PO# \_\_\_\_\_

Internal use only

Global order# \_\_\_\_\_

Global trailer/load #: L \_\_\_\_\_ ID #: \_\_\_\_\_

# THIS FORM IS TO BE USED FOR NON-STANDARD CUT-OUT SIZES

Dufferin and Lufton tables 144" - 240".

Model # \_\_\_\_\_ (please use one page for each model #)

Please check all that apply. Note: Base positions will vary based on style chosen. Outer cutouts are approximately 18"-20" in from each end

## CUT-OUT POSITION(S)

- Position 1 - near left base - use option code **CCUTL**
- Position 2 - center of table - use option code **CCUTC**
- Position 3 - near right base - use option code **CCUTR**
- Custom position(s) - indicate on diagram below w/dimensions to **center point** of cut-outs - use option code **CCUS**

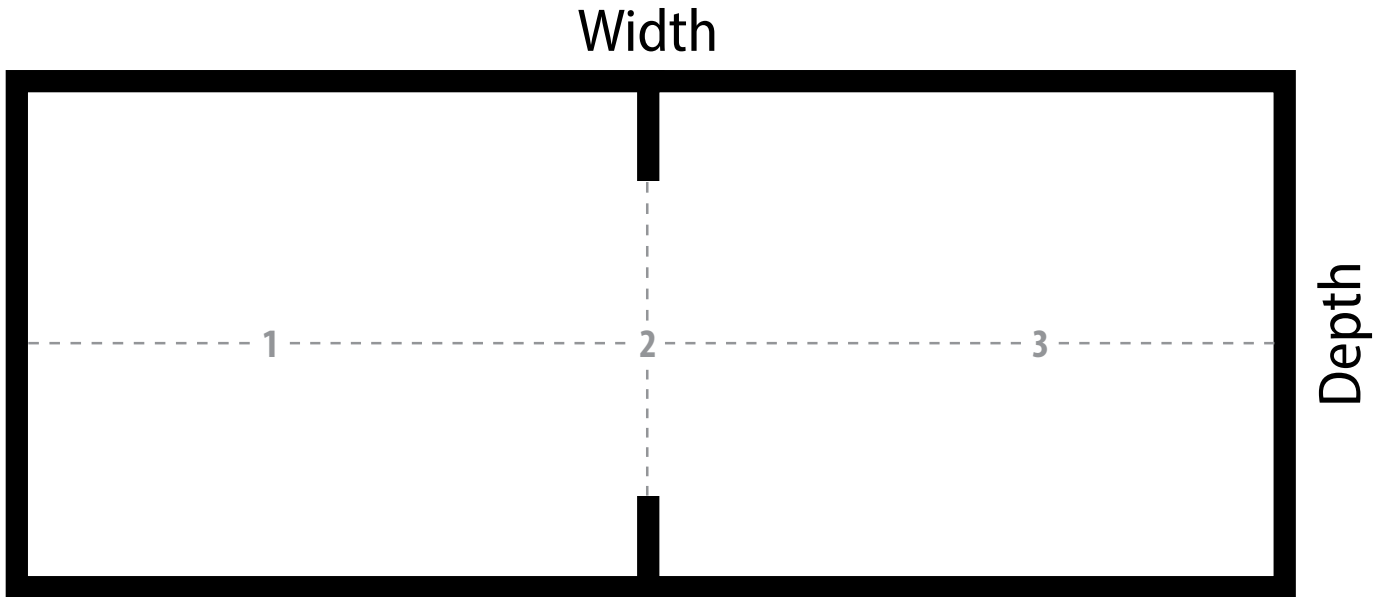

## CUT-OUT CRITERIA

All cut-outs require a minimum 8mm radius at each corner.

Cut-outs **must be centered** on the depth of each table due to wire management runners below the worksurface.

### Indicate cut-out size:

\_\_\_\_\_ " X dimension of cut-out runs the width of the table.

\_\_\_\_\_ " Y dimension of cut-out runs the depth of the table.

Y dimension not to exceed 14"

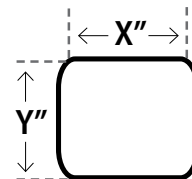

Dealer PO# \_\_\_\_\_

Internal use only

Global order# \_\_\_\_\_

Global trailer/load #: L \_\_\_\_\_ ID #: \_\_\_\_\_

# CUSTOM COLOR APPROVAL FORM - GLOBAL WOOD VENEER DESKS AND TABLES

## Corby, Dufferin, Kadin and Lufton series only

Dealer will be billed a matching fee of \$375 upon receipt of the match sample.  
All standard and special products with a custom stain receive a 15% upcharge.  
Please complete the form below and mail it, along with TWO samples (no smaller than 3" x 3") to:

Global Furniture Group  
ATTN: Casegoods - Custom Stain Match  
17 West Stow Road, PO Box 562  
Marlton, NJ 08053

### CONTACT INFORMATION

Date:	Project Name:		
A+D/Dealer/Company Name:	Contact Name:		
Billing Address:	Phone:		
City:	State:	Zip:	E-mail:

### CUSTOM STAIN INFORMATION

Manufacturer's Name:
Color Name:
Color Code:
Comments / Sample to be matched on (species):

**PLEASE FILL OUT THE SECTION BELOW ONCE SAMPLE HAS BEEN RECEIVED AND APPROVED. SUBMIT THIS PAPERWORK WITH THE ORDER.**

APPROVED:	YES	NO	DATE:
SIGNATURE			
PRINT NAME			
PO #			

### INTERNAL USE ONLY

Sample Received on:	VMID:
Special Finish Upcharge:	Color #:
Wood Species:	

## CARE AND MAINTENANCE GUIDE

**Wood Casegoods Care:** Global furniture is constructed to strict specifications to ensure years of satisfied use. As with all wood products, certain care requirements and periodic maintenance are necessary in order to maintain the original new appearance and function.

**Finishes:** Global veneers and solid woods are carefully selected for color, tone and grain. Since the distinctive characteristics and nature of wood cause variations, exact matches are not always possible. Wood veneer, being a natural material, will have shade differences between veneer leaves. This will be more apparent between flitches. Fading on wood veneers can be caused by exposure to UV rays / sunlight.

**Finish Protection:** All clear wood finishes are susceptible to scratches from rough and abrasive objects, such as staples, paper clips, ceramic coffee mugs, flower pots, picture frames, etc. Computer equipment with rubber feet can also cause discoloration and softening of the finish due to petroleum distillates in the rubber.

The most practical protection is the use of desk pads, paper management bins and coasters. Common sense, caution with rough items, and adding pressure sensitive felt to the feet or bottoms of any potentially destructive item will help to ensure a mar free surface.

**Finish Care:** Wax or polish should never be used on the finish; they will give a greasy, cloudy or uneven appearance to the product. Global's conversion varnish finish is best cleaned by wiping the surfaces with a damp cloth, followed by a soft dry cloth in the direction of the grain. If the surfaces are very dirty, use of a glass cleaning type of product is recommended. Touch-up of wood furniture should only be attempted by a qualified refinisher/touch-up technician. Contact your furniture dealer if this need should arise.

---

## GENERAL INSTALLATION AND HARDWARE

**Leveling wood office furniture properly is the most important procedure to ensure proper functioning and alignment of drawers, locks and doors.**

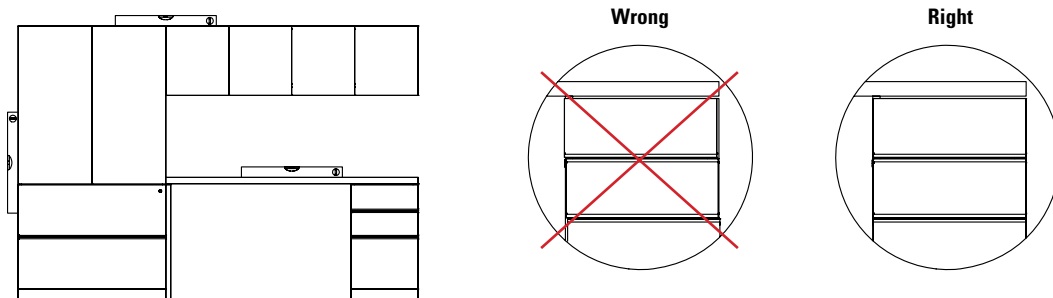

Hutch and wall cabinet doors may require field adjustment from time to time, due to shifting weight load factors inside the cabinet.

Modular furniture items, such as Desk Shells and Modular Pedestals **must be disassembled** prior to moving or relocating to avoid damage to the furniture.

Drawer suspensions are lubricated prior to shipment. Periodic lubrication may be applied to the ball bearing housing with a high quality lubricant found in most hardware stores.

**Hanging file rails:** Pre-installed on file drawer perimeters and accommodates both letter (front to back) and legal (side to side) size filing.

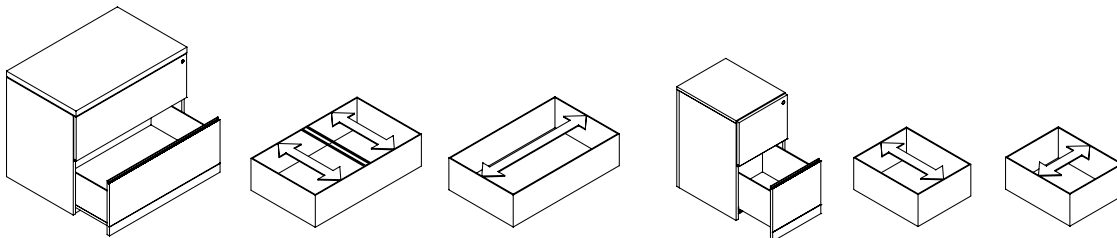

**ATTENTION: Always load the bottom drawer of Lateral Files and Freestanding Pedestals first!**

This illustrated price list has been designed to facilitate fast reference and easy use. Products are categorized into "seating", "desks", "files", "panels", or "tables", and are listed numerically within their categories. The line drawings match actual photographs (where possible) to aid in instant recognition of the total range within a series.

Sales of Global Furniture Group ("Global") products are made only on Global's standard Terms and Conditions of sale which are contained in this price book. These standard terms and conditions may be modified or supplemented only by a separately written document signed by Global's authorized personnel at its head office in Marlton, NJ. Any term or condition contained in any purchase order or other form used by dealer/purchaser to order goods (including standard, printed language) which is different from, in addition to, or in any way inconsistent with Global's standard terms and conditions shall be of no force or effect whatsoever.

All illustrations, specifications and prices in this list price book are based on the latest product information available at time of publication. Global reserves the right to make changes at any time and without prior notice to prices, colors, materials, specifications and models offered.

### Description

Each product shown or described in this price list is standard Global product. Available options are noted at the beginning of each series. Available options may require additional delivery time and cost, and may affect the warranty given. Sizes and weights shown are approximate and are subject to slight changes from time to time.

### Prices and Payment

The prices shown in this book, as well as those quoted by Global, are in United States dollars for orders shipped to destinations in the U.S. and Mexico.

If shipping date requested is more than 90 days from date of order, Global shall reserve right to use published list prices effective at the time of shipment.

Orders are invoiced at the time of shipment. Terms of payment are net 30 days from date of invoice unless otherwise stated.

If dealer/purchaser's most recent annual net volume is less than \$5,000.00, payment must be made in advance.

Any products sold by Global shall remain the personal property of Global until fully paid.

Prices are suggested list prices only and are subject to change without notice. Global will, however, attempt to keep dealer/purchasers up-to-date on all developments including price changes.

### Taxes

All prices shown in this book are exclusive of sales, use, excise and other applicable taxes and are the dealer/purchaser's responsibility as per the invoice issued by Global. If dealer/purchaser claims an exemption from such taxes, it shall be the dealer/purchaser's responsibility to furnish Global with an appropriate exemption certificate at time of order.

### Ordering Information

To avoid errors and/or duplication, Global requires that all orders be submitted in writing. All orders submitted to Global in writing and will be acknowledged on Global's acknowledgment forms governing the transaction. The details appearing on this acknowledgment will describe the items to be shipped and the approximate shipping date. It is the dealer/purchaser's responsibility to determine that the information

in the acknowledgment is correct. In the event of an error, the dealer/purchaser must notify Global immediately by telephone followed by written confirmation. Shipping dates are assigned to orders based on the item having the longest manufacturing lead time (unless instructed to partial ship).

When ordering, please provide the following information:

- 1) Account number (if possible)
- 2) P.O. number
- 3) "Bill to" and "ship to" name and address
- 4) Complete model number
- 5) Description
- 6) Options:
  - a. Upholstery fabric type and color (specify by name and number)
  - b. Color of paint finish, laminate or wood (if applicable)
  - c. Trim options (frame)
  - d. Arms
  - e. Base, Casters
  - f. Mechanism
  - g. Accessories

Dealer/purchaser is responsible for providing correct information when placing an order. Orders with incorrect information (finish, etc.) will be scheduled for manufacturing upon receipt of complete information.

All phone orders must be confirmed in writing by the customer within 7 days.

To prevent a delay in processing orders, please specify delivery routing.

### Changes and Cancellations

After the date of Global's acknowledgment of a dealer/purchaser's order, the order may not be changed or canceled by dealer/purchaser without the written consent of Global. Special order items, C.O.M. and fabric-covered items already in production are not subject to change or cancellation under any circumstances. Textile-covered items are considered to be in production once the textile is scheduled for cutting. Other standard items already in production are subject to a minimum 35% cancellation charge.

### Errors and Omissions

All quotations, acknowledgements and invoices are subject to corrections for any errors and omissions.

### FINISHES

#### Wood Finishes

For custom stain requests, submit a special request for quotation. Non-standard wood finish orders will incur a one time charge of \$250 net to dealer per matching custom wood stain. This one time fee will be valid for 5 years from the time of matching. After 5 years, a new \$250 net to dealer charge will apply. All custom wood stain products will receive a 10% list per unit upcharge, included on the special quote. Requests with unit quantities of 30 or more, may be considered for reduced or eliminated upcharge. At time of order, a 3" x 3" color sample is required to be submitted with order. Extended order lead time is required for custom matching and approval process.

### File Finishes

All non-standard file finishes must be approved by Global prior to acceptance of order and may be subject to an upcharge.

Laminate Tops - pricing for all non-standard finishes and sizes must be provided by Global Customer Service and may be subject to an upcharge.

### Desk Finishes

Because the distinctive characteristics and the nature of wood products cause variations, exact matches are not always possible.

Global has launched a finishes program between marketing companies within the Global Group to match products as best as possible when same finishes are specified.

### Customers Own Material (COM)

Use of COM must be approved by Global prior to acceptance of order. Please refer to the back of the Seating List Price Book and fill out the Authorization Request Form. Photocopy and use this form as often as necessary. The customer must provide a 12" x 12" fabric sample and advise how the fabric is to be applied. **Textile yardage requirement will be advised by the factory, and additional yardage may be required if pattern requires matching.** Yardage shown in the List Price Book does not allow for pattern repeat/matching. Send to the address provided on shipping document upon approval from Global. If C.O.M. is difficult to apply or if product shall be modified, extra charges shall be made. Global reserves the right to cancel an order at any time if C.O.M. is inadequate for any reason. Customer's Own Material must be shipped freight and duties paid to our factory. Such shipment must be fully identified with purchaser's order number, RGA # provided by Global, and the item for which material is intended. Performance of C.O.M. when applied to product is the sole responsibility of the purchaser. Global's standard product warranty shall not apply to C.O.M. Use of C.O.M. will not reduce the published list price.

### Textile Grading

All products are priced according to their standard textile grade. Lower grade textiles are available (unless otherwise specified) at same price as standard textile grade.

The listing of prices for each model indicates the prices for higher upholstery grades. Prices are based on yardage in imperial measurements.

### TEXTILE PRICE GRADES - GLOBAL TEXTILES

#### Grade Upholstery (Seating Fabrics)

1	Carrera, Dobby, Fusion, Illusion, Jenny, LuxPlus, Quilt, Terrace, Trak, Urban, Waterfall, Wavelength
2	Allante FRee, Elevate, Etch, GC Linen, Imprint, Release
6	Novaro Genuine Leather

#### Grade Upholstery (Panel Fabrics)

2	Lola
3	Anchorage, Merge

The charts above do not include textiles offered by Alliance Partners: Arc-Com Fabrics, CF Stinson, Designtex, Knoll Textiles, Green Hides, LDI Interiors, Luum Textiles, Maharam, Mayer Fabrics, Momentum, and Ultrafabrics.

## Upholstery Coverings

Slight variations in color may occur between dye lots. Although Global attempts to minimize these variances, they do occur and must be accepted as normal and will not be considered defects.

## Yardage

Required yardage (ydg) is based on unmatched materials with widths of 54" for seating, 63" for panels. Yardage calculations are based on imperial measurements.

## Arms

A wide selection of arms are available for some series. See Arm Charts in the Seating price list for details.

## Delays

Global's order acknowledgement will state a shipping date which is Global's best estimate at the time the order is acknowledged. However, Global shall not incur any obligation or liability to Purchaser for failure to ship by specified date unless Global has agreed to an unequivocal shipping date in a separately signed written document executed by its authorized personnel at its head office. In addition, Global shall not be liable for any loss or damage resulting from any delay or failure in shipment or other failure to perform all or any part of the agreement between the parties with respect to the goods shown on the face of the order acknowledgement where such delay, failure, loss or damage is the proximate result of any act of any governmental authority or political subdivision thereof, revolution, riot, civil disorder or disturbance, delay or default in transportation, strike disputes among or between labor unions or other labor disputes, delay or inability in obtaining materials and facilities, fire, flood, act of God or any cause not within the reasonable control of the company, whether of the class of causes enumerated or otherwise.

## F.O.B.

F.O.B. point is Global's Factory, Downsview, Ontario, Canada, or any Global Regional Distribution Center.

## FedEx and UPS Shipments

Seating products marked with a FedEx or UPS symbol are packaged for shipment via FedEx or UPS.

## Handling

Non-UPS/FedEx orders under \$10,000 list incur \$100 net handling fee. Small packages (FedEx, UPS) incur \$25 net handling fee per carton (up to four cartons).

## Special Delivery Requirements

Global's delivered pricing provides for dock delivery during normal business hours (considered to be 8 am to 4 pm Monday through Friday) to customer/end user only. Additional delivery requirements such as inside delivery, lift gate, limited access sites, installations and weekend deliveries will incur an additional expense and will be the responsibility of the dealer.

## Service

Service requests are normally the responsibility of Global's authorized dealers. Where this cannot be accomplished on a local level, service problems should be referred to Global's Customer Service Department in the nearest distribution center.

## Returns

No returns of goods will be accepted without written consent and shipping instruction of Global. A minimum re-stocking charge of 35% is made on all authorized returns for credit or refund, provided goods are received by Global in the condition in which they left the factory. This may increase depending on the type of product. Global's Return Goods Authorization (R.G.A.) numbers must appear prominently on all authorized

returns. Global will not be responsible for freight costs. No credit will be given if goods cannot be reused as new. Special order items, non-stock items and C.O.M. products are in no event subject to return. All returns must be approved and authorized in writing by Global Customer Service. Global reserves the right to refuse delivery of any unauthorized returns.

## Claims

All goods are sold FOB plant or Global Distribution Center. Global is not responsible for damage which occurs in transit (or in storage). The carrier signs for all goods received in apparently good order. It is the dealer/purchaser's responsibility to examine goods upon receipt and to file any claims with the carrier for losses or damage to the product occurring during transit, including concealed damage.

Any claims made against Global for apparent defects, errors or shortages must be made by the dealer/purchaser, in writing, within 15 working days after any delivery. Failure by the dealer/purchaser to make any claim against Global within 15 days shall constitute acceptance of the goods and a waiver of any apparent defects, errors or shortages.

## Suspension

In the event that the dealer/purchaser defaults in the payment of any sum due to Global, or in the event the dealer/purchaser's financial condition becomes unsatisfactory to Global, Global shall have the right to defer or discontinue shipment of any goods until such time as the default is cured or the dealer/purchaser provides assurance of payment to Global.

## Copyright

All catalogs, photographs, drawings, price lists and other printed material are protected by copyright. All rights reserved.

## Trademarks

All trademarks are owned by Global Furniture Group other than OBUSFORME™ which is owned by OBUSFORME LTD. and are used under license. OBUSFORME® and the distinctive backrest design are registered trademarks of OBUSFORME LTD.

## Designs and Patents

Many of the products produced by Global are protected by design registrations, design patents and/or patents. Design and specifications are subject to change, discontinuance or additions without notice.

For a full listing of issued trademarks, please visit [globalfurnituregroup.com](http://globalfurnituregroup.com).

## Cubic Measure

The stated volume is an approximate cubic foot measure to calculate freight costs. The figure shown is the total shipping volume of a unit (e.g. if a part is sent in 2 cartons the volume indicated reflects both cartons together) and is subject to change without notice. It is most economical to purchase the specified number per carton.

## Combined Shipments

Global will make every effort to combine shipments and orders on written request. However, Global cannot be held responsible where such request is not complied with.

## Offer of Sale

Possession of this price list or any other literature shall not imply the company's willingness to sell to the holder and shall not be construed as a direct offer of sale.

If a conflict arises between: (i) prices found in software support packages furnished to the customer by Global or by any other source on behalf of Global; and (ii) Global's current pricing found on Global's website, then the most current shall prevail.

## Disclaimer

All dimensions are in inches. Prices shown are current manufacturer's suggested list prices at the time of printing. Updated pricing is available on Global's website. All applicable taxes are extra. Descriptions, specifications and prices are subject to change without notice. Errors and omissions are subject to correction.

## Testing Qualifications

Many Global products pass or exceed the most stringent industry testing standards.

## Flammability

The foam used in Global chairs meets the requirements of California TB117:2013. In addition to the foam, upholstery materials must also meet the California TB117 smolder resistant requirements. Please contact Customer Care to determine if a selected textile meets the California TB117 requirement.

## This list price book is effective as of July 14, 2025.

For periodic updates, please check the PDF at [globalfurnituregroup.com](http://globalfurnituregroup.com). Select Resources then Price Lists. From here you will have the option to select either the Seating, Desking + Tables or Metal Filing + Storage price list books. Global warrants that all commercial products are free from defects in material and workmanship, for the life of the product, to the original Purchaser.

# LIMITED LIFETIME WARRANTY

---

Global will repair or replace, at Global's option, as the sole remedy for any defect covered by the warranty. The warranty applies to products manufactured after March 22, 2016.

Global makes no warranty that any of its products are suitable for any particular purpose and makes no other warranties, express or implied, other than those set out here. As codes and standards vary from one jurisdiction to another, references to compliance are solely for convenience and without any representation as to accuracy or suitability. Users must verify the suitability of such information or product for their specific application. In no event shall Global be liable in either tort or contract for any loss or direct, special, incidental, consequential, or exemplary damages. The warranty applies to single shift, standard commercial usage, defined as a standard eight (8) hour day, forty (40) hour week for users weighing up to 300 pounds.

## General Commercial Seating

Global's warranty for general commercial seating covers all chair components including pneumatic cylinders, bases, casters, glides, frames, arms, plastic seats, backs and other structural components.

Exceptions to the warranty for general commercial seating are as follows:

- Foam, textiles (as sampled on Global branded and textile program cards), mesh material and electrical devices, are warranted for five (5) Years. Novaro Leather is warranted for one (1) year.
- Control mechanisms are warranted for twelve (12) Years
- Heavy duty seating and Indoor/Outdoor Furniture are not defined as General commercial seating (see below for warranty exceptions)

## Heavy Duty Seating

Global offers products designed for multiple shift applications (24 hours a day / 7 days a week) and larger individuals weighing up to 400, 500 and/or 600 pounds (depending on series and/or model). Global warrants these products for twelve (12) years to the original purchaser. All components (including control mechanisms, pneumatic cylinders, bases, casters, glides, frames, arms, plastic seats/backs, etc.) are covered for 24/7 applications under the warranty. The exceptions are foam, upholstery and textiles, which are covered for five (5) years. Fabric or upholstery material on these products must exceed 100,000 double rubs for the textile portion of the warranty to apply. Heavy Duty product series that apply under this warranty can be found in the Heavy Duty section of this list price book.

## Outdoor Furniture

Global offers products designed for use indoors or outdoors. Global warrants these products for three (3) years to the original purchaser. This warranty applies to single shift (eight (8) hour day, forty (40) hour week) for users weighing up to 275 pounds, unless noted otherwise. Outdoor furniture must be stored indoors during inclement or extreme weather such as extreme cold, extreme heat, or excessive wind.

Exceptions to the warranty for indoor/outdoor furniture is as follows:

- Only Global branded textiles and Alliance Partner carded textile program materials expressly identified for outdoor application are covered for three (3) years when used outdoors.

## Global's Warranty does not apply (for any product category) to the following:

- Products not purchased directly from authorized Global resellers
- Nominal or normal amount of wear and tear that can occur over time
- Failures which result from negligence, abuse, accident or misuse
- Failure to apply, install or maintain products according to Global's written instructions and warnings
- Modifications, attachments or repair methods not approved by Global
- Damage caused by a carrier in transit, or delivery/installation contractors
- The matching of colors, grains or textures (wood, leather, etc.) of natural materials
- Products exposed to extreme hot or cold temperatures or excessively dry or humid environments
- Colorfastness or the matching of color of textiles, dye lots of textile can vary
- Damage by markings or staining; damage by sharp objects or imprinting from instruments
- Damage to textiles or laminate and wood surfaces/edges from exposure to sunlight (including UV rays)
- Products used for rental purposes
- Purchased parts are warranted for one (1) year
- Failure to follow specific cleaning and disinfecting instructions posted on [globalfurnituregroup.com](http://globalfurnituregroup.com)

## Seating Warranty Summary

Seating Type	Components Warranty For Original Purchaser	Use Time For Warranty Coverage	Exceptions
General Commercial Seating	Lifetime	8 Hours/5 Days Per Week	Foam/Upholstery/Textiles/Mesh/Electrical Devices - 5 Years Control Mechanisms - 12 Years
Heavy Duty Seating	12 Years	24 Hours/7 Days Per Week	Foam/Upholstery/Textiles - 5 Years
Indoor/Outdoor Furniture	3 Years	8 Hours/5 Days Per Week	Outdoor Use Textiles – 3 Years

---

## Textiles

Global warrants Global branded textiles and Alliance Partner carded textile programs inclusive of fabrics, vinyls and leather products for five (5) years, with the exception of Novaro Leather, which has a one (1) year warranty. Global does not warrant COM (Customer Own Materials) or graded-in materials (non-carded) and purchased by Global for a customer. For graded-in or COM products, please contact the textile supplier for performance information and warranty details. Please refer to our website at [globalfurnituregroup.com](http://globalfurnituregroup.com) for detailed information on cleaning and disinfecting procedures. Improper usage of disinfecting/cleaning products may void the warranty.

Global textiles and finishes are updated periodically to meet the demand and trends of the market. As a result, some textiles and finishes may be discontinued by Global or the manufacturer. In the event that a textile or finish is discontinued, Global will make every reasonable effort to provide an alternative product(s) of comparable function.

---

# LIMITED LIFETIME WARRANTY

Global warrants that all commercial products are free from defects in material and workmanship, for the life of the product, to the original Purchaser.

Global will repair or replace, at Global's option, as the sole remedy for any defect covered by the warranty. The warranty applies to products manufactured after March 22, 2016.

Global makes no warranty that any of its products are suitable for any particular purpose and makes no other warranties, express or implied, other than those set out here. As codes and standards vary from one jurisdiction to another, references to compliance are solely for convenience and without any representation as to accuracy or suitability. Users must verify the suitability of such information or product for their specific application. In no event shall Global be liable in either tort or contract for any loss or direct, special, incidental, consequential, or exemplary damages.

## Files, Desks, Modular Furniture, Tables, Panels & Accessories

Global warrants all components of metal storage and filing, laminate and wood veneer desks, laminate and wood veneer tables, metal leg components and panels for the lifetime of the product to the original purchaser.

The warranty applies to single shift, standard commercial usage, defined as a standard eight (8) hour day, forty (40) hour week. Load restrictions apply, refer to individual product descriptions.

Exceptions to the warranty for files/desks/tables and panels are as follows:

- Electrical devices, panel and tackboard textiles, adjustable keyboard mechanisms, non-electrical table mechanisms, monitor arms, lecterns, coat trees and task lights - five (5) years
- Writeable surfaces and whiteboards - three (3) years
- Laminate folding tables - one (1) year
- Motorized electrical components - two (2) years
- Keyless lock options - two (2) years

## Files, Desks, Modular Furniture, Tables, Panels & Accessories Warranty Summary

Product Type	Components Warranty For Original Purchaser	Exceptions
<b>Metal storage and filing</b>	lifetime	keyless lock options - 2 years
<b>Laminate/wood veneer desks and modular furniture</b>	lifetime	tackboard textiles, electrical devices, task lights - 5 years
<b>Boardroom, conference, training and general tables</b>	lifetime	electrical devices - 5 years moving parts - 5 years
<b>Electric height adjustable bases</b>	7 years	battery pack - 1 year
<b>Non-electric height adjustable bases</b>	5 years	
<b>Productivity Solutions and Accessories</b> (adjustable keyboard mechanisms, monitor arms, coat trees, writeable surfaces/whiteboards)	5 years	writeable surfaces/whiteboards - 3 years
<b>Overbed tables</b>	2 years	
<b>Panels</b>	lifetime	panel and tackboard textiles, electrical devices, task lights - 5 years

## Global's Warranty does not apply (for any product category) to the following:

- Nominal or normal amount of wear and tear that can occur over time
- Failures which result from negligence, abuse, accident or misuse
- Failure to apply, install or maintain products according to Global's written instructions and warnings
- Modifications, attachments or repair methods not approved by Global
- Damage caused by a carrier in transit, or delivery/installation contractors
- The matching of colors, grains or textures (wood, leather, etc.) of natural materials
- Products exposed to extreme hot or cold temperatures or excessively dry or humid environments
- Colorfastness or the matching of color of textiles, dye lots of textile can vary
- Damage by markings or staining; damage by sharp objects or imprinting from instruments
- Damage to textiles or laminate and wood surfaces/edges from exposure to sunlight (including UV rays)
- Products used for rental purposes
- Purchased parts are warranted for one (1) year
- Failure to follow specific cleaning and disinfecting instructions posted on [globalfurnituregroup.com](http://globalfurnituregroup.com)

Global's warranty does not cover the costs of transportation or labor. Repair or replacement will be at Global's option.

Global's warranty applies to products sold within the United States of America, Mexico, the Commonwealth of Puerto Rico and Canada.

## Textiles and Finishes

Global textiles and finishes are updated periodically to meet the demand and trends of the market. As a result, some textiles and finishes may be discontinued by Global or the manufacturer. In the event that a textile or finish is discontinued, Global will make every reasonable effort to provide an alternative product(s) of comparable function.

## Global US Headquarters

17 West Stow Road, P.O. Box 562  
Marlton, New Jersey U.S.A. 08053  
T (856) 596-3390  
T (800) 220-1900

---

## Showrooms

### Atlanta

10 10th Street  
Suite 150  
Atlanta, GA 30309  
T (404) 879-0998

### New York City

386 Park Avenue South  
7th floor  
New York, NY 10016  
T (212) 545-9900

### Boston

One Harbor Street  
Suite 104  
Boston, MA 02210  
T (617) 406-5435

### Philadelphia

1735 Market Street  
38th Floor  
Philadelphia PA, 19103  
T (215) 861-0963

### Chicago

1045 W Fulton Street  
Chicago, IL 60607  
T (312) 755-0843

### New Jersey (Southern)

119 West Greentree Road  
Marlton, NJ 08053  
T (856) 596-3390

### Irvine

18400 Von Karman Ave.  
Suite 100  
Irvine, CA 92618

### Phoenix

4675 E Cotton Center Blvd.  
Suite 165  
Phoenix, AZ 85040  
T (602) 426-0666  
T (602) 426-0777

### Miami

112 NE 41st Street  
6th floor  
Miami, FL 33137

### Washington, DC

1130 Connecticut Ave.  
10th Floor, Suite 1000  
Washington, DC 20036  
T (202) 659-0230  
T (202) 659-0236

## Distribution Centers

### Atlanta Area

6715 Maple Ave.  
Suite 100  
Buford, GA 30518  
T (678) 602-4130

### Denver Area

19080 E. 38th Ave.  
Unit # 30  
Aurora, CO 80011  
T (303) 340-1617

### Los Angeles Area

3629 Workman Mill Road  
Whittier, CA 90601  
T (562) 484-9686

### Baltimore Area

Troy Hill  
Corporate Center  
7030 Troy Hill Drive  
Elkridge, MD 21075  
T (410) 379-8021

### Ft. Lauderdale Area

560 Sawgrass  
Corporate Pkwy  
Sunrise, FL 33325  
T (954) 846-8888

### Philadelphia Area

181 Walter A Gaines Way  
Suite 200  
Lawnside, NJ 08045  
T (856) 596-3390

### Chicago Area

27W501 North Ave.  
Suite 300  
West Chicago, IL 60185  
T (630) 681-2818

### Houston Area

7865 Northcourt Road  
Suite 200  
Houston, TX 77040  
T (713) 695-5777

### Seattle Area

Oakesdale Commerce Ctr.  
820 Southwest 34th St.  
Building W7, Suite A  
Renton, WA 98057  
T (425) 291-9282

### Cincinnati Area

8712 LeSaint Drive  
Fairfield, OH 45014  
T (513) 777-0009

### Kansas City Area

11617 West 81st Street  
Lenexa, KS 66214  
T (913) 310-9963

### Tampa Area

10351 Windhorst Road  
Tampa, FL 33619  
T (813) 621-6272

### Dallas Area

2025 West Beltline Road  
#100  
Carrollton, TX 75006  
T (972) 236-1366

