

# T BOARDROOM TABLES - NOTES

## Boardroom Tops - all series

- Tops 120" and under ship in one piece
- Tops over 120" ship in two pieces
- Veneer wood grain will run with the **length** of the table and align at the seam

## HOW TO SPECIFY

### 1. SPECIFY MODEL NUMBER

### 2. SPECIFY FINISH

#### TOP FINISH - WOOD VENEER

Code	Finish	Veneer Type	Cut
AMW	Almond Cherry	Cherry	Flat Sliced
ACW	Amber Cherry	Cherry	Flat Sliced
BTW	Biscotti	White Oak	Rift
CAW	Cocoa Walnut	Walnut	Flat Sliced
CRW	Coral	White Oak	Rift
DCW	Dark Cherry	Cherry	Flat Sliced
DWW	Dark Walnut	Walnut	Flat Sliced
EWV	Espresso Walnut	Walnut	Flat Sliced
EVW	Evening Oak	White Oak	Rift
GRW	Grey on Oak	White Oak	Rift
HAW	Hazelnut	Maple	Flat Sliced
JAW	Java	White Oak	Rift
LTW	Latte Walnut	Walnut	Flat Sliced
MHW	Mahogany on Walnut	Walnut	Flat Sliced
MTW	Milestone	White Oak	Rift
MPW	Natural Maple	Maple	Flat Sliced
NLW	Natural Walnut	Walnut	Flat Sliced
RCW	Red Cherry	Cherry	Flat Sliced
VNW	Vintage Cherry	Cherry	Flat Sliced
ULW	Umber Walnut	Walnut	Flat Sliced
WLW	Walnut	Walnut	Flat Sliced
WCW	Warm Cherry	Cherry	Flat Sliced
WMW	White Maple	Maple	Flat Sliced

#### BASE FINISH (refer to specific model for availability):

K	Black
E	Tungsten

## 3. SPECIFY OPTIONS

### GROMMETS: DUFFERIN conference table tops

- Optional grommets may be ordered in standard table top locations (left, center or right). Order as **GM1TL, GM1TC or GM1TR. Add \$103.**
- Grommet hole dimensions are 2.75" in diameter. Specify **GM1** for **Black** or **GM1K** for **Tungsten.**

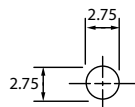

#### Standard Grommet Locations, Dufferin:

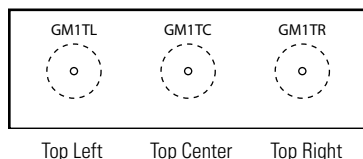

### GROMMETS: KINGSTON + PHILADELPHIA conference table tops

- Optional grommets may be ordered in standard table top locations (left, center or right). Order as **GM5TL, GM5TC or GM5TR. Add \$103.**
- Grommet hole dimensions are 3.5" x 2".
- To order a grommet cover only, specify **GM5E** for Black or **GM5K** for Tungsten. Add **\$61.**

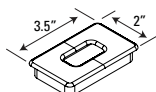

#### Standard Grommet Locations, Kingston and Philadelphia:

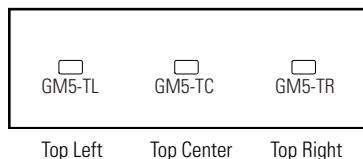

Order as **GM5L, GM5C or GM5R. Add \$103.**

- Grommet hole dimensions are 3.5" x 2". Specify **GM5E** for **Black** or **GM5K** for **Tungsten.**

### GROMMETS: LUFTON conference table tops

- Optional grommets may be ordered in standard table top locations (left, center or right). Order as **G5PTL, G5PTC or G5PTR. Add \$103.**
- Grommet hole dimensions are 3.5" x 2". To order a grommet cover only, specify **G5PEC** for Black or **G5PKC** for Tungsten. Add **\$61.**

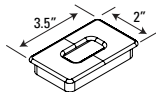

#### Standard Grommet Locations, Lufton:

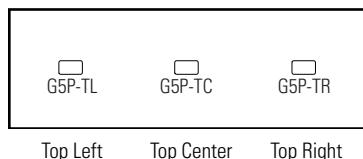

### POWER/DATA ACCESSORIES: ALL SERIES

- Match power block desired with cut-out code and location from grid below.
- Please specify location in top as left, center or right (**TL/x, TC/x, or TR/x**) as per line drawing below. Location must be specified on product to be placed on at the time of the order. Please note orientation of power/data accessories on Boardroom Table tops is as shown in drawings below. **Add \$320** for each cut-out.
- When an **"M"** cut-out is ordered, certain bases will be notched to allow clearance for the Oasis Mini.

#### PRODUCT CODE DIAGRAM

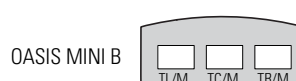
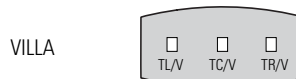
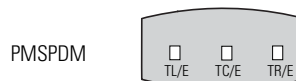

#### PRODUCT CODE DIAGRAM

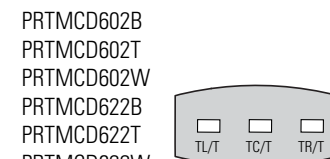
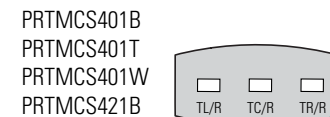

#### Custom Cut-out

- Optional custom sized cut-out available in standard locations - **CCUTL** (left), **CCUTC** (center) and **CCUTR** (right) for all boardroom table tops. Submit appropriate form (beginning on page 432) with order. **Add \$320** for each cut-out.

# T BOARDROOM TABLES

## BOARDROOM TABLE TOP AND BASE GUIDE

**Pedestal Base**   **Drum Base**   **Cross Base**   **Post Leg w/Plate and Trumpet Base**   **Tubular & Flat Bar 4-Prong Base**   **Post Legs (Wood)**   **Post Legs (Metal)**

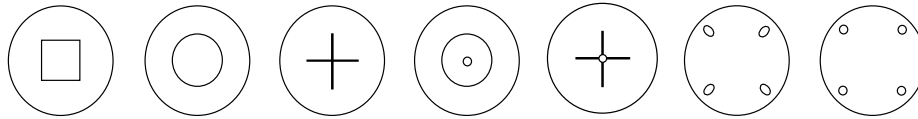

Requires 1 of the following: Pedestal, Drum, Cross, Post Leg w/Plate, Tubular and Flat Bar 4-Prong base, Trumpet Column Base

Requires 4 of the following: Wood Post Legs or Metal Post Legs.

**Pedestal Base**   **Drum Base**   **Cross Base**   **"Y" Base**   **Slab Base**   **Post Leg w/Plate and Trumpet Base**   **Elliptical Base**   **Tubular 2-Prong & Flat Bar "T" Base**

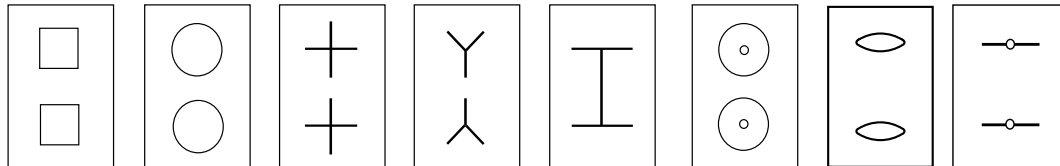

**3-Prong Tubular or**

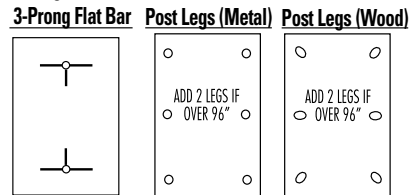

Table Tops up to 120" are in one section and require (2) bases.

Tubular, 2-Prong Base - Table Tops up to 84" require (2) bases.

Tubular and Flat Bar "T" Base - Table Tops up to 120" require (2) bases.

Post Legs - Table Tops up to 96" are in one section and require (4) legs. Tops 108" to 168" require (6) legs.

**Pedestal Base**   **Drum Base**   **Cross Base**   **"Y" Base**   **Slab Base**   **Post Leg w/Plate and Trumpet Base**   **Elliptical Base**

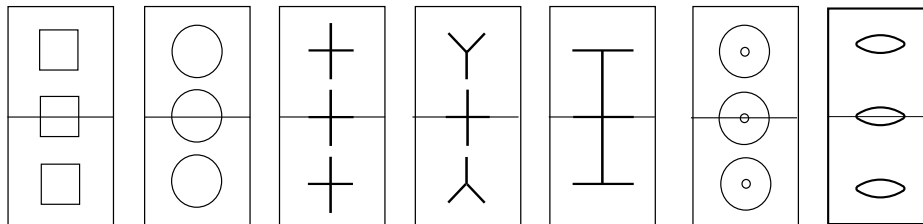

**3-Prong Tubular or**

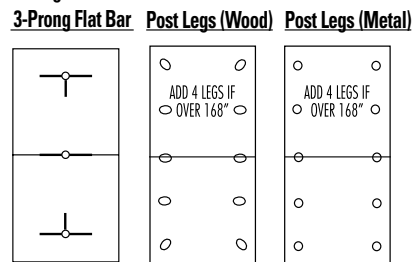

Table Tops 144" and over are in two sections and require (3) bases.

"Y" Base - Require (2) "Y" bases and (1) Cross base in the center.

Slab Base - Require (3) Slab bases.

Tubular and Flat Bar 3-Prong Base - Require (2) 3-Prong bases and (1) 2-Prong base in the center.

Post Legs - Table Tops 180" to 240" require (10) legs.

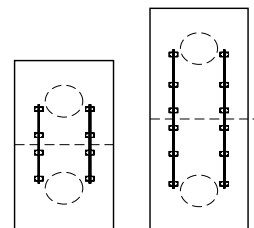

If design considerations or dimension requirements dictate an unsupported table joint, use metal table support rail.

*Top section must not exceed 72" to use metal supports.*

**BOARDROOM TABLES - TOPS WITH DUFFERIN EDGE**    **MODEL#**    **DIMENSIONS**    **FREIGHT CLASS**    **WT./LBS.**    **CUBIC FT.**    **LIST PRICE**

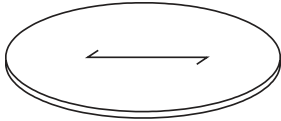

**Round Top**

	<b>D x W x H</b>					
RO60D	60 x 60 x 1.37	85	150	11		<b>\$3134</b>
RO48D	48 x 48 x 1.37	85	96	7		<b>\$2506</b>
RO42D	42 x 42 x 1.37	85	74	6		<b>\$2267</b>
RO36D	36 x 36 x 1.37	85	54	4		<b>\$1925</b>
RO30D	30 x 30 x 1.37	85	38	3		<b>\$1348</b>

For use with Drum Base, Pedestal Base, Cross Base, Wood Post Legs, Metal Post Legs, 4 Prong Base, Post leg w/Flat Plate, Flat Square Column Base, Trumpet Column base, Flat Bar "X" Base", Square Panel Base.

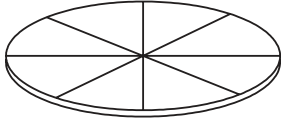

**Round Top - Sunburst Veneer Pattern**

RO60SD	60 x 60 x 1.37	85	150	11		<b>\$3393</b>
RO48SD	48 x 48 x 1.37	85	96	7		<b>\$2870</b>
RO42SD	42 x 42 x 1.37	85	74	6		<b>\$2454</b>
RO36SD	36 x 36 x 1.37	85	54	4		<b>\$2112</b>
RO30SD	30 x 30 x 1.37	85	38	3		<b>\$1755</b>

For use with Drum Base, Pedestal Base, "X" Shape Slab Base, Wood Post Legs, Metal Post Legs, 4 Prong Base, Post leg w/Flat Plate, Flat Square Column Base, Trumpet Column base, Flat Bar "X" Base", Square Panel Base.

RE24054D	54 x 240 x 1.37	85	540	39		<b>\$10034</b>
RE21654D	54 x 216 x 1.37	85	486	35		<b>\$9031</b>
RE19254D	54 x 192 x 1.37	85	432	31		<b>\$7751</b>
RE5454D	54 x 54 x 1.37	85	121	9		<b>\$2206</b>
RE16848D	48 x 168 x 1.37	85	336	25		<b>\$5770</b>
RE14448D	48 x 144 x 1.37	85	288	21		<b>\$4347</b>
RE12048D	48 x 120 x 1.37	85	240	18		<b>\$3871</b>
RE9648D	48 x 96 x 1.37	85	192	14		<b>\$2856</b>
RE4848D	48 x 48 x 1.37	85	96	7		<b>\$1569</b>
RE8442D	42 x 84 x 1.37	85	147	11		<b>\$2632</b>
RE7242D	42 x 72 x 1.37	85	126	9		<b>\$2250</b>
RE4242D	42 x 42 x 1.37	85	74	5		<b>\$1468</b>
RE8436D	36 x 84 x 1.37	85	126	9		<b>\$2511</b>
RE7236D	36 x 72 x 1.37	85	108	8		<b>\$2153</b>
RE6636D	36 x 66 x 1.37	85	99	7		<b>\$1650</b>
RE3636D	36 x 36 x 1.37	85	54	4		<b>\$901</b>
RE8430D	30 x 84 x 1.37	85	105	8		<b>\$2095</b>
RE7230D	30 x 72 x 1.37	85	90	7		<b>\$1797</b>
RE6630D	30 x 66 x 1.37	85	83	6		<b>\$1650</b>
RE6030D	30 x 60 x 1.37	85	75	6		<b>\$1499</b>
RE5430D	30 x 54 x 1.37	85	68	5		<b>\$1353</b>
RE3030D	30 x 30 x 1.37	85	38	3		<b>\$756</b>
RE8424D	24 x 84 x 1.37	85	84	6		<b>\$1828</b>
RE7224D	24 x 72 x 1.37	85	72	5		<b>\$1567</b>
RE6624D	24 x 66 x 1.37	85	66	5		<b>\$1440</b>
RE6024D	24 x 60 x 1.37	70	60	4		<b>\$1308</b>
RE5424D	24 x 54 x 1.37	85	55	4		<b>\$1176</b>
RE4824D	24 x 48 x 1.37	70	48	3		<b>\$1134</b>
RE2424D	24 x 24 x 1.37	125	21	3		<b>\$521</b>
RE8422D	22 x 84 x 1.37	85	77	6		<b>\$1678</b>
RE7222D	22 x 72 x 1.37	85	66	5		<b>\$1440</b>
RE6622D	22 x 66 x 1.37	85	61	5		<b>\$1318</b>
RE6022D	22 x 60 x 1.37	85	55	4		<b>\$1200</b>
RE5422D	22 x 54 x 1.37	85	50	4		<b>\$1085</b>
RE4822D	22 x 48 x 1.37	85	44	3		<b>\$1039</b>
RE2222D	22 x 22 x 1.37	92.5	20	2		<b>\$479</b>

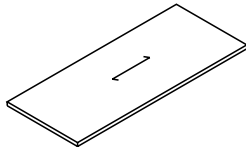

**Rectangular Top**

Grain runs the **length** of the worksurface. Tops 120" and under are shipped in one piece and require 2 bases. Tops 144" and over are shipped in two pieces and require 3 bases.

**Required Specifications**

Veneer Finish

**Optional Specifications**

Boardroom Table Base  
Grommet (not available on Round Tops)  
Custom cut-out

# T BOARDROOM TABLES - DUFFERIN

## BOARDROOM TABLES - TOPS

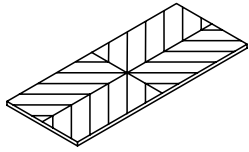

**Rectangular Top -  
Reverse Diamond Pattern**

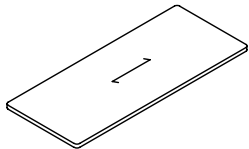

**Rectangular Top Radius Corners**

MODEL#	DIMENSIONS D x W x H	FREIGHT CLASS	WT/LBS.	CUBIC FT.	LIST PRICE
RE24054FD	54 x 240 x 1.37	85	540	39	<b>\$11499</b>
RE21654FD	54 x 216 x 1.37	85	486	35	<b>\$10397</b>
RE19254FD	54 x 192 x 1.37	85	432	31	<b>\$8986</b>
RE5454FD	54 x 54 x 1.37	85	119	9	<b>\$2517</b>
RE16848FD	48 x 168 x 1.37	85	336	25	<b>\$6809</b>
RE14448FD	48 x 144 x 1.37	85	288	21	<b>\$5246</b>
RE12048FD	48 x 120 x 1.37	85	240	18	<b>\$4566</b>
RE9648FD	48 x 96 x 1.37	85	192	14	<b>\$3452</b>
RE4848FD	48 x 48 x 1.37	85	98	7	<b>\$1842</b>
RE8442FD	42 x 84 x 1.37	85	147	11	<b>\$3159</b>
RE7242FD	42 x 72 x 1.37	85	126	9	<b>\$2745</b>
RE4242FD	42 x 42 x 1.37	85	74	5	<b>\$1730</b>
RE8436FD	36 x 84 x 1.37	85	126	9	<b>\$2955</b>
RE7236FD	36 x 72 x 1.37	85	108	8	<b>\$2539</b>
RE6636FD	36 x 66 x 1.37	85	99	7	<b>\$1936</b>
RE3636FD	36 x 36 x 1.37	85	54	4	<b>\$1236</b>
RE8430FD	30 x 84 x 1.37	85	105	8	<b>\$2459</b>
RE7230FD	30 x 72 x 1.37	85	90	7	<b>\$2198</b>
RE6630FD	30 x 66 x 1.37	85	83	6	<b>\$2117</b>
RE6030FD	30 x 60 x 1.37	85	75	6	<b>\$1936</b>
RE5430FD	30 x 54 x 1.37	85	68	5	<b>\$1585</b>
RE3030FD	30 x 30 x 1.37	85	38	3	<b>\$879</b>

Tops 120" and under are shipped in one piece and require 2 bases. Tops 144" and over are shipped in two pieces and require 3 bases.

RRE24054D	54 x 240 x 1.37	85	540	39	<b>\$12233</b>
RRE21654D	54 x 216 x 1.37	85	486	35	<b>\$11076</b>
RRE19254D	54 x 192 x 1.37	85	432	31	<b>\$9607</b>
RRE5454D	54 x 54 x 1.37	85	119	9	<b>\$2679</b>
RRE16848D	48 x 168 x 1.37	85	336	25	<b>\$7330</b>
RRE14448D	48 x 144 x 1.37	85	288	21	<b>\$5692</b>
RRE12048D	48 x 120 x 1.37	85	240	18	<b>\$4913</b>
RRE9648D	48 x 96 x 1.37	85	192	14	<b>\$3748</b>
RRE4848D	48 x 48 x 1.37	85	98	7	<b>\$1972</b>
RRE8442D	42 x 84 x 1.37	85	147	11	<b>\$3426</b>
RRE7242D	42 x 72 x 1.37	85	126	9	<b>\$2988</b>
RRE4242D	42 x 42 x 1.37	85	74	5	<b>\$1855</b>
RRE8436D	36 x 84 x 1.37	85	126	9	<b>\$3182</b>
RRE7236D	36 x 72 x 1.37	85	108	8	<b>\$2729</b>
RRE6636D	36 x 66 x 1.37	85	99	7	<b>\$2082</b>
RRE3636D	36 x 36 x 1.37	85	54	4	<b>\$1143</b>
RRE8430D	30 x 84 x 1.37	85	105	8	<b>\$2647</b>
RRE7230D	30 x 72 x 1.37	85	90	7	<b>\$2269</b>
RRE6630D	30 x 66 x 1.37	85	83	6	<b>\$2082</b>
RRE6030D	30 x 60 x 1.37	85	75	6	<b>\$1898</b>
RRE5430D	30 x 54 x 1.37	85	68	5	<b>\$1702</b>
RRE3030D	30 x 30 x 1.37	85	38	3	<b>\$953</b>

Grain runs the **length** of the worksurface. Tops 120" and under are shipped in one piece and require 2 bases. Tops 144" and over are shipped in two pieces and require 3 bases.

### Required Specifications

Veneer Finish

### Optional Specifications

Boardroom Table Base  
Grommet  
Custom cut-out

## BOARDROOM TABLES - TOPS

**MODEL#      DIMENSIONS      FREIGHT CLASS      WT/LBS.      CUBIC FT.      LIST PRICE**

**D x W x H**

REBE24054D	54 x 240 x 1.37	85	540	39	<b>\$11352</b>
REBE21654D	54 x 216 x 1.37	85	486	35	<b>\$10313</b>
REBE19254D	54 x 192 x 1.37	85	432	31	<b>\$9001</b>
REBE16848D	48 x 168 x 1.37	85	336	25	<b>\$6909</b>
REBE14448D	48 x 144 x 1.37	85	288	21	<b>\$5469</b>
REBE12048D	48 x 120 x 1.37	85	240	18	<b>\$4645</b>
REBE9648D	48 x 96 x 1.37	85	192	14	<b>\$3604</b>
REBE8442D	42 x 84 x 1.37	85	147	11	<b>\$3285</b>
REBE7242D	42 x 72 x 1.37	85	126	9	<b>\$2891</b>
REBE8436D	36 x 84 x 1.37	85	126	9	<b>\$2891</b>
REBE7236D	36 x 72 x 1.37	85	108	8	<b>\$2474</b>
REBE6636D	36 x 66 x 1.37	85	99	7	<b>\$1893</b>
REBE8430D	30 x 84 x 1.37	85	105	8	<b>\$2408</b>
REBE7230D	30 x 72 x 1.37	85	90	7	<b>\$2067</b>
REBE6630D	30 x 66 x 1.37	85	83	6	<b>\$1893</b>
REBE6030D	30 x 60 x 1.37	85	75	6	<b>\$1716</b>
REBE5430D	30 x 54 x 1.37	85	68	5	<b>\$1550</b>

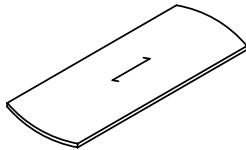

**Rectangular Top - Bow Ends**

Grain runs the **length** of the worksurface. Tops 120" and under are shipped in one piece and require 2 bases. Tops 144" and over are shipped in two pieces and require 3 bases.

RA24054D	54 x 240 x 1.37	85	540	39	<b>\$13822</b>
RA21654D	54 x 216 x 1.37	85	486	35	<b>\$11676</b>
RA19254D	54 x 192 x 1.37	85	432	31	<b>\$11043</b>
RA16848D	48 x 168 x 1.37	85	336	25	<b>\$8268</b>
RA14448D	48 x 144 x 1.37	85	288	21	<b>\$6496</b>
RA12048D	48 x 120 x 1.37	85	240	18	<b>\$5763</b>
RA9648D	48 x 96 x 1.37	85	192	14	<b>\$4577</b>
RA8442D	42 x 84 x 1.37	85	147	11	<b>\$4145</b>
RA7242D	42 x 72 x 1.37	85	126	9	<b>\$3640</b>
RA8436D	36 x 84 x 1.37	85	126	9	<b>\$3763</b>
RA7236D	36 x 72 x 1.37	85	108	8	<b>\$3224</b>
RA6636D	36 x 66 x 1.37	85	99	7	<b>\$2466</b>
RA8430D	30 x 84 x 1.37	85	105	8	<b>\$3137</b>
RA7230D	30 x 72 x 1.37	85	90	7	<b>\$2693</b>
RA6630D	30 x 66 x 1.37	85	83	6	<b>\$2466</b>
RA6030D	30 x 60 x 1.37	85	75	6	<b>\$2242</b>
RA5430D	30 x 54 x 1.37	85	68	5	<b>\$2022</b>
RA8422D	22 x 84 x 1.37	85	77	6	<b>\$2511</b>
RA7222D	22 x 72 x 1.37	85	66	5	<b>\$2153</b>
RA6622D	22 x 66 x 1.37	85	61	5	<b>\$1972</b>
RA6022D	22 x 60 x 1.37	85	55	4	<b>\$1797</b>
RA5422D	22 x 54 x 1.37	85	50	4	<b>\$1615</b>
RA4822D	22 x 48 x 1.37	85	44	3	<b>\$1558</b>

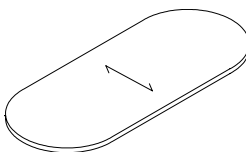

**Racetrack Top - Cross Grain**

Grain runs the **depth** of the worksurface. Tops 120" and under are shipped in one piece and require 2 bases. Tops 144" and over are shipped in two pieces and require 3 bases.

**Required Specifications**

Veneer Finish

**Optional Specifications**

Boardroom Table Base  
Grommet  
Custom cut-out

# T BOARDROOM TABLES - DUFFERIN

## BOARDROOM TABLES - TOPS

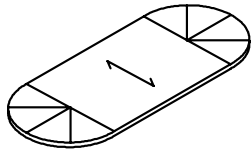

**Racetrack Top Cross Grain Center,  
Sunburst Veneer Pattern on Left & Right**

MODEL#	DIMENSIONS D x W x H	FREIGHT CLASS	WT/LBS.	CUBIC FT.	LIST PRICE
RA24054SD	54 x 240 x 1.37	85	540	39	<b>\$14893</b>
RA21654SD	54 x 216 x 1.37	85	486	35	<b>\$12729</b>
RA19254SD	54 x 192 x 1.37	85	432	31	<b>\$12089</b>
RA16848SD	48 x 168 x 1.37	85	336	25	<b>\$9285</b>
RA14448SD	48 x 144 x 1.37	85	288	21	<b>\$7493</b>
RA12048SD	48 x 120 x 1.37	85	240	18	<b>\$6444</b>
RA9648SD	48 x 96 x 1.37	85	192	14	<b>\$5252</b>
RA8442SD	42 x 84 x 1.37	85	147	11	<b>\$4675</b>
RA7242SD	42 x 72 x 1.37	85	126	9	<b>\$4222</b>
RA8436SD	36 x 84 x 1.37	85	126	9	<b>\$4222</b>
RA7236SD	36 x 72 x 1.37	85	108	8	<b>\$3617</b>
RA6636SD	36 x 66 x 1.37	85	99	7	<b>\$2765</b>
RA8430SD	30 x 84 x 1.37	85	105	8	<b>\$3515</b>
RA7230SD	30 x 72 x 1.37	85	90	7	<b>\$3020</b>
RA6630SD	30 x 66 x 1.37	85	83	6	<b>\$2765</b>
RA6030SD	30 x 60 x 1.37	85	75	6	<b>\$2517</b>
RA5430SD	30 x 54 x 1.37	85	68	5	<b>\$2265</b>
RA8422SD	22 x 84 x 1.37	85	77	6	<b>\$2818</b>
RA7222SD	22 x 72 x 1.37	85	66	5	<b>\$2416</b>
RA6622SD	22 x 66 x 1.37	85	61	5	<b>\$2220</b>
RA6022SD	22 x 60 x 1.37	85	55	4	<b>\$2014</b>
RA5422SD	22 x 54 x 1.37	85	50	4	<b>\$1812</b>
RA4822SD	22 x 48 x 1.37	85	44	3	<b>\$1746</b>

Grain runs the **depth** of the worksurface. Tops 120" and under are shipped in one piece and require 2 bases. Tops 144" and over are shipped in two pieces and require 3 bases.

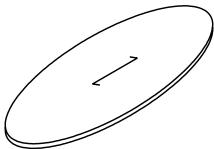

**Oval Top**

OV24054D	54 x 240 x 1.37	85	540	39	<b>\$17278</b>
OV21654D	54 x 216 x 1.37	85	486	35	<b>\$14594</b>
OV19254D	54 x 192 x 1.37	85	432	31	<b>\$13803</b>
OV16848D	48 x 168 x 1.37	85	336	25	<b>\$10331</b>
OV14448D	48 x 144 x 1.37	85	288	21	<b>\$8121</b>
OV12048D	48 x 120 x 1.37	85	240	18	<b>\$7203</b>
OV9648D	48 x 96 x 1.37	85	192	14	<b>\$5720</b>
OV8442D	42 x 84 x 1.37	85	147	11	<b>\$5182</b>
OV7242D	42 x 72 x 1.37	85	126	9	<b>\$4548</b>
OV8436D	36 x 84 x 1.37	85	126	9	<b>\$4548</b>
OV7236D	36 x 72 x 1.37	85	108	8	<b>\$3899</b>
OV6636D	36 x 66 x 1.37	85	99	7	<b>\$2979</b>
OV8430D	30 x 84 x 1.37	85	105	8	<b>\$3924</b>
OV7230D	30 x 72 x 1.37	85	90	7	<b>\$3365</b>
OV6630D	30 x 66 x 1.37	85	83	6	<b>\$3087</b>
OV6030D	30 x 60 x 1.37	85	75	6	<b>\$2800</b>
OV5430D	30 x 54 x 1.37	85	68	5	<b>\$2525</b>
OV8422D	22 x 84 x 1.37	85	77	6	<b>\$3137</b>
OV7222D	22 x 72 x 1.37	85	66	5	<b>\$2693</b>
OV6622D	22 x 66 x 1.37	85	61	5	<b>\$2466</b>
OV6022D	22 x 60 x 1.37	85	55	4	<b>\$2242</b>
OV5422D	22 x 54 x 1.37	85	50	4	<b>\$2022</b>
OV4822D	22 x 48 x 1.37	85	44	3	<b>\$1943</b>

Grain runs the **length** of the worksurface. Tops 120" and under are shipped in one piece and require 2 bases. Tops 144" and over are shipped in two pieces and require 3 bases.

### Required Specifications

Veneer Finish

### Optional Specifications

Boardroom Table Base  
Grommet  
Custom cut-out

## BOARDROOM TABLES - TOPS

MODEL#	DIMENSIONS	FREIGHT CLASS	WT/LBS.	CUBIC FT.	LIST PRICE
--------	------------	---------------	---------	-----------	------------

**D x W x H**

B024054D	54 x 240 x 1.37	85	540	39	<b>\$11246</b>
B021654D	54 x 216 x 1.37	85	486	35	<b>\$10108</b>
B019254D	54 x 192 x 1.37	85	432	31	<b>\$8967</b>
B016848D	48 x 168 x 1.37	85	336	25	<b>\$7145</b>
B014448D	48 x 144 x 1.37	85	288	21	<b>\$5782</b>
B012048D	48 x 120 x 1.37	85	240	18	<b>\$4842</b>
B09648D	48 x 96 x 1.37	85	192	14	<b>\$3930</b>
B08442D	42 x 84 x 1.37	85	147	11	<b>\$3627</b>
B07242D	42 x 72 x 1.37	85	126	9	<b>\$3194</b>

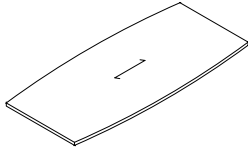

**Boat Shape Top**

Grain runs the **length** of the worksurface. Tops 120" and under are shipped in one piece and require 2 bases. Tops 144" and over are shipped in two pieces and require 3 bases.

BOBE24054D	54 x 240 x 1.37	85	540	39	<b>\$12927</b>
BOBE21654D	54 x 216 x 1.37	85	486	35	<b>\$11624</b>
BOBE19254D	54 x 192 x 1.37	85	432	31	<b>\$10313</b>
BOBE5454D	54 x 54 x 1.37	85	121	9	<b>\$2904</b>
BOBE16848D	48 x 168 x 1.37	85	336	25	<b>\$8215</b>
BOBE14448D	48 x 144 x 1.37	85	288	21	<b>\$6642</b>
BOBE12048D	48 x 120 x 1.37	85	240	18	<b>\$5572</b>
BOBE9648D	48 x 96 x 1.37	85	192	14	<b>\$4521</b>
BOBE4848D	48 x 48 x 1.37	85	96	7	<b>\$2453</b>
BOBE8442D	42 x 84 x 1.37	85	147	11	<b>\$4173</b>
BOBE7242D	42 x 72 x 1.37	85	126	9	<b>\$3678</b>
BOBE4242D	42 x 42 x 1.37	85	74	5	<b>\$2140</b>

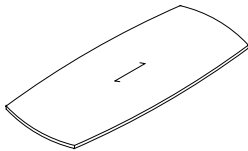

**Boat Shape Top - Bow Ends**

Grain runs the **length** of the worksurface. Tops 120" and under are shipped in one piece and require 2 bases. Tops 144" and over are shipped in two pieces and require 3 bases.

WE2405442D	54 - 42 x 240 x 1.37	85	540	39	<b>\$9875</b>
WE2165442D	54 - 42 x 216 x 1.37	85	486	35	<b>\$8967</b>
WE1925442D	54 - 42 x 192 x 1.37	85	432	31	<b>\$7829</b>
WE1684836D	48 - 36 x 168 x 1.37	85	336	25	<b>\$6007</b>
WE1444836D	48 - 36 x 144 x 1.37	85	288	21	<b>\$4755</b>
WE1204836D	48 - 36 x 120 x 1.37	85	240	18	<b>\$4040</b>
WE964836D	48 - 36 x 96 x 1.37	85	192	14	<b>\$3133</b>
WE844230D	42 - 30 x 84 x 1.37	85	147	11	<b>\$2853</b>
WE724230D	42 - 30 x 72 x 1.37	85	126	9	<b>\$2511</b>
WE843624D	36 - 24 x 84 x 1.37	85	126	9	<b>\$2511</b>
WE723624D	36 - 24 x 72 x 1.37	85	108	8	<b>\$2153</b>
WE663624D	36 - 24 x 66 x 1.37	85	99	7	<b>\$1650</b>

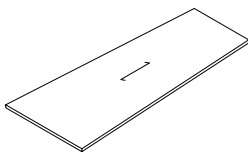

**Wedge Shape Top**

Grain runs the **length** of the worksurface. Tops 120" and under are shipped in one piece and require 2 bases. Tops 144" and over are shipped in two pieces and require 3 bases.

WEBE2405442D	54 - 42 x 240 x 1.37	85	540	39	<b>\$11352</b>
WEBE2165442D	54 - 42 x 216 x 1.37	85	486	35	<b>\$10313</b>
WEBE1925442D	54 - 42 x 192 x 1.37	85	432	31	<b>\$9001</b>
WEBE1684836D	48 - 36 x 168 x 1.37	85	336	25	<b>\$6909</b>
WEBE1444836D	48 - 36 x 144 x 1.37	85	288	21	<b>\$5469</b>
WEBE1204836D	48 - 36 x 120 x 1.37	85	240	18	<b>\$4645</b>
WEBE964836D	48 - 36 x 96 x 1.37	85	192	14	<b>\$3604</b>
WEBE844230D	42 - 30 x 84 x 1.37	85	147	11	<b>\$3285</b>
WEBE724230D	42 - 30 x 72 x 1.37	85	126	9	<b>\$2891</b>
WEBE843624D	36 - 24 x 84 x 1.37	85	126	9	<b>\$2891</b>
WEBE723624D	36 - 24 x 72 x 1.37	85	108	8	<b>\$2474</b>
WEBE663624D	36 - 24 x 66 x 1.37	85	99	7	<b>\$1893</b>

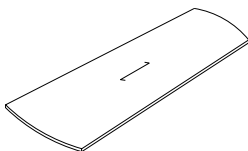

**Wedge Shape Top - Bow Ends**

Grain runs the **length** of the worksurface. Tops 120" and under are shipped in one piece and require 2 bases. Tops 144" and over are shipped in two pieces and require 3 bases.

**Required Specifications**

Veneer Finish

**Optional Specifications**

Boardroom Table Base  
Grommet  
Custom cut-out

# T BOARDROOM TABLES - LUFTON

## BOARDROOM TABLES - TOPS WITH LUFTON EDGE

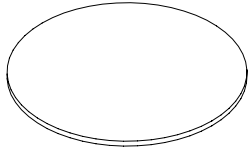

**Round Top**

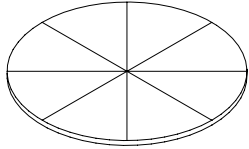

**Round Top - Sunburst Veneer Pattern**

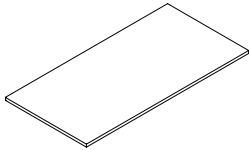

**Rectangular Top**

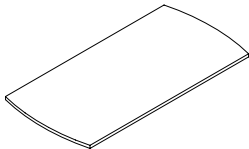

**Rectangular Top - Bow Ends**

MODEL#	DIMENSIONS D x W x H	FREIGHT CLASS	WT./LBS.	CUBIC FT.	LIST PRICE
RO60L	60 x 60 x 1.37	85	150	11	<b>\$3057</b>
RO48L	48 x 48 x 1.37	85	96	7	<b>\$2440</b>
RO42L	42 x 42 x 1.37	85	74	6	<b>\$2200</b>
RO36L	36 x 36 x 1.37	85	54	4	<b>\$1960</b>
RO30L	30 x 30 x 1.37	85	38	3	<b>\$1308</b>

For use with Drum Base, Pedestal Base, Cross Base, Wood Post Legs, Metal Post Legs, 4 Prong Base, Post leg w/Flat Plate, Flat Square Column Base, Trumpet Column base, Flat Bar "X" Base", Square Panel Base.

RO60SL	60 x 60 x 1.37	85	150	11	<b>\$3354</b>
RO48SL	48 x 48 x 1.37	85	96	7	<b>\$2760</b>
RO42SL	42 x 42 x 1.37	85	74	6	<b>\$2389</b>
RO36SL	36 x 36 x 1.37	85	54	4	<b>\$2153</b>
RO30SL	30 x 30 x 1.37	85	38	3	<b>\$1904</b>

For use with Drum Base, Pedestal Base, Cross Base, Wood Post Legs, Metal Post Legs, 4 Prong Base, Post leg w/Flat Plate, Flat Square Column Base, Trumpet Column base, Flat Bar "X" Base", Square Panel Base.

RE24054L	54 x 240 x 1.37	85	540	39	<b>\$9517</b>
RE21654L	54 x 216 x 1.37	85	486	35	<b>\$8638</b>
RE19254L	54 x 192 x 1.37	85	432	31	<b>\$7540</b>
RE16848L	48 x 168 x 1.37	85	336	25	<b>\$5783</b>
RE14448L	48 x 144 x 1.37	85	288	21	<b>\$4578</b>
RE12048L	48 x 120 x 1.37	300	240	18	<b>\$3892</b>
RE9648L	48 x 96 x 1.37	85	192	14	<b>\$3018</b>
RE8442L	42 x 84 x 1.37	85	147	11	<b>\$2749</b>
RE7242L	42 x 72 x 1.37	85	126	9	<b>\$2418</b>
RE8436L	36 x 84 x 1.37	85	126	9	<b>\$2418</b>
RE7236L	36 x 72 x 1.37	85	108	8	<b>\$2074</b>
RE6636L	36 x 66 x 1.37	92.5	99	7	<b>\$1589</b>
RE8430L	30 x 84 x 1.37	85	105	8	<b>\$2018</b>
RE7230L	30 x 72 x 1.37	85	90	7	<b>\$1730</b>
RE6630L	30 x 66 x 1.37	85	83	6	<b>\$1589</b>
RE6030L	30 x 60 x 1.37	85	75	6	<b>\$1446</b>
RE5430L	30 x 54 x 1.37	85	68	5	<b>\$1298</b>
RE4830L	30 x 48 x 1.37	85	44	3	<b>\$1270</b>

Grain runs the **length** of the worksurface. Tops 120" and under are shipped in one piece and require 2 bases. Tops 144" and over are shipped in two pieces and require 3 bases.

REBE24054L	54 x 240 x 1.37	85	540	39	<b>\$10939</b>
REBE21654L	54 x 216 x 1.37	85	486	35	<b>\$9927</b>
REBE19254L	54 x 192 x 1.37	85	432	31	<b>\$8670</b>
REBE16848L	48 x 168 x 1.37	85	336	25	<b>\$6652</b>
REBE14448L	48 x 144 x 1.37	85	288	21	<b>\$5265</b>
REBE12048L	48 x 120 x 1.37	300	240	18	<b>\$4475</b>
REBE9648L	48 x 96 x 1.37	85	192	14	<b>\$3470</b>
REBE8442L	42 x 84 x 1.37	85	147	11	<b>\$3160</b>
REBE7242L	42 x 72 x 1.37	85	126	9	<b>\$2783</b>
REBE8436L	36 x 84 x 1.37	85	126	9	<b>\$2783</b>
REBE7236L	36 x 72 x 1.37	85	108	8	<b>\$2384</b>

Grain runs the **length** of the worksurface. Tops 120" and under are shipped in one piece and require 2 bases. Tops 144" and over are shipped in two pieces and require 3 bases.

### Required Specifications

Veneer Finish

### Optional Specifications

Boardroom Table Base  
Grommet  
Custom cut-out

**BOARDROOM TABLES - TOPS W/LUFTON EDGE**

MODEL#	DIMENSIONS	FREIGHT CLASS	WT/LBS.	CUBIC FT.	LIST PRICE
--------	------------	---------------	---------	-----------	------------

**D x W x H**

RA24054L	54 x 240 x 1.37	85	540	39	<b>\$12803</b>
RA21654L	54 x 216 x 1.37	85	486	35	<b>\$10939</b>
RA19254L	54 x 192 x 1.37	85	432	31	<b>\$10390</b>
RA16848L	48 x 168 x 1.37	85	336	25	<b>\$7978</b>
RA14448L	48 x 144 x 1.37	85	288	21	<b>\$6442</b>
RA12048L	48 x 120 x 1.37	300	240	18	<b>\$5538</b>
RA9648L	48 x 96 x 1.37	85	192	14	<b>\$4508</b>
RA8442L	42 x 84 x 1.37	85	147	11	<b>\$4063</b>
RA7242L	42 x 72 x 1.37	85	126	9	<b>\$3630</b>
RA8436L	36 x 84 x 1.37	85	126	9	<b>\$3630</b>
RA7236L	36 x 72 x 1.37	85	108	8	<b>\$3109</b>
RA6636L	36 x 66 x 1.37	92.5	99	7	<b>\$2375</b>

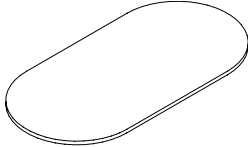

**Racetrack Top - Cross Grain**

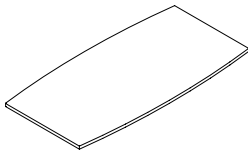
Grain runs the **depth** of the worksurface. Tops 120" and under are shipped in one piece and require 2 bases. Tops 144" and over are shipped in two pieces and require 3 bases.

**Boat Shape Top**

B024054L	54 x 240 x 1.37	85	540	39	<b>\$10823</b>
B021654L	54 x 216 x 1.37	85	486	35	<b>\$9732</b>
B019254L	54 x 192 x 1.37	85	432	31	<b>\$8638</b>
B016848L	48 x 168 x 1.37	85	336	25	<b>\$6883</b>
B014448L	48 x 144 x 1.37	85	288	21	<b>\$5560</b>
B012048L	48 x 120 x 1.37	85	240	18	<b>\$4663</b>
B09648L	48 x 96 x 1.37	85	192	14	<b>\$3791</b>
B08442L	42 x 84 x 1.37	85	147	11	<b>\$3491</b>
B07242L	42 x 72 x 1.37	85	126	9	<b>\$3080</b>

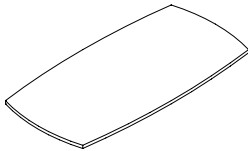
Grain runs the **length** of the worksurface. Tops 120" and under are shipped in one piece and require 2 bases. Tops 144" and over are shipped in two pieces and require 3 bases.

**Boat Shape Top - Bow Ends**

BOBE24054L	54 x 240 x 1.37	85	540	39	<b>\$12452</b>
BOBE21654L	54 x 216 x 1.37	85	486	35	<b>\$11196</b>
BOBE19254L	54 x 192 x 1.37	85	432	31	<b>\$9927</b>
BOBE5454L	54 x 54 x 1.37	85	121	9	<b>\$2795</b>
BOBE16848L	48 x 168 x 1.37	85	336	25	<b>\$7910</b>
BOBE14448L	48 x 144 x 1.37	85	288	21	<b>\$6402</b>
BOBE12048L	48 x 120 x 1.37	85	240	18	<b>\$5363</b>
BOBE9648L	48 x 96 x 1.37	85	192	14	<b>\$3291</b>
BOBE4848L	48 x 48 x 1.37	85	96	7	<b>\$2367</b>
BOBE8442L	42 x 84 x 1.37	85	147	11	<b>\$3662</b>
BOBE7242L	42 x 72 x 1.37	85	126	9	<b>\$3536</b>
BOBE4242L	42 x 42 x 1.37	85	74	5	<b>\$2068</b>

Grain runs the **length** of the worksurface. Tops 120" and under are shipped in one piece and require 2 bases. Tops 144" and over are shipped in two pieces and require 3 bases.

**Required Specifications**

Veneer Finish

**Optional Specifications**

 Boardroom Table Base  
 Grommet  
 Custom cut-out

# T BOARDROOM TABLES - LUFTON

## BOARDROOM TABLES - TOPS W/LUFTON EDGE

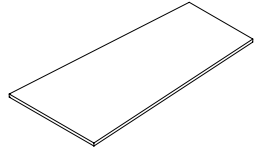

**Wedge Shape Top**

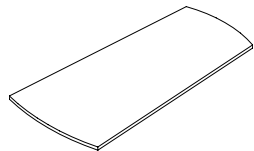

**Wedge Shape Top - Bow Ends**

MODEL#	DIMENSIONS D x W x H	FREIGHT CLASS	WT/LBS.	CUBIC FT.	LIST PRICE
WE2405442L	54 - 42 x 240 x 1.37	85	540	39	<b>\$9517</b>
WE2165442L	54 - 42 x 216 x 1.37	85	486	35	<b>\$8638</b>
WE1925442L	54 - 42 x 192 x 1.37	85	432	31	<b>\$7540</b>
WE1684836L	48 - 36 x 168 x 1.37	85	336	25	<b>\$5783</b>
WE1444836L	48 - 36 x 144 x 1.37	85	288	21	<b>\$4578</b>
WE1204836L	48 - 36 x 120 x 1.37	85	240	18	<b>\$3892</b>
WE964836L	48 - 36 x 96 x 1.37	85	192	14	<b>\$3772</b>
WE844230L	42 - 30 x 84 x 1.37	85	147	11	<b>\$2749</b>
WE724230L	42 - 30 x 72 x 1.37	85	126	9	<b>\$2418</b>

Grain runs the **length** of the worksurface. Tops 120" and under are shipped in one piece and require 2 bases. Tops 144" and over are shipped in two pieces and require 3 bases.

WEBE2405442L	54 - 42 x 240 x 1.37	85	540	39	<b>\$10939</b>
WEBE2165442L	54 - 42 x 216 x 1.37	85	486	35	<b>\$9927</b>
WEBE1925442L	54 - 42 x 192 x 1.37	85	432	31	<b>\$8670</b>
WEBE1684836L	48 - 36 x 168 x 1.37	85	336	25	<b>\$6652</b>
WEBE1444836L	48 - 36 x 144 x 1.37	85	288	21	<b>\$5265</b>
WEBE1204836L	48 - 36 x 120 x 1.37	85	240	18	<b>\$4475</b>
WEBE964836L	48 - 36 x 96 x 1.37	85	192	14	<b>\$3470</b>
WEBE844230L	42 - 30 x 84 x 1.37	85	147	11	<b>\$3160</b>
WEBE724230L	42 - 30 x 72 x 1.37	85	126	9	<b>\$2783</b>

Grain runs the **length** of the worksurface. Tops 120" and under are shipped in one piece and require 2 bases. Tops 144" and over are shipped in two pieces and require 3 bases.

### Required Specifications

Veneer Finish

### Optional Specifications

Boardroom Table Base  
Grommet  
Custom cut-out

**BOARDROOM TABLES - TOPS W/PHILADELPHIA EDGE MODEL# DIMENSIONS FREIGHT CLASS WT/LBS. CUBIC FT. LIST PRICE**

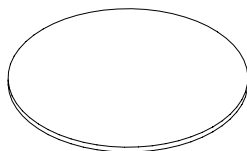

**Round Top**

	D x W x H					
RO60PB	60 x 60 x 1.5	85	150	11		<b>\$5281</b>
RO48PB	48 x 48 x 1.5	85	96	7		<b>\$4225</b>
RO42PB	42 x 42 x 1.5	85	74	6		<b>\$3795</b>
RO36PB	36 x 36 x 1.5	85	54	4		<b>\$3384</b>
RO30PB	30 x 30 x 1.5	85	38	3		<b>\$2822</b>

For use with Drum Base, Pedestal Base, Cross Base, Wood Post Legs, Metal Post Legs, 4 Prong Base, Post leg w/Flat Plate, Flat Square Column Base, Trumpet Column base, Flat Bar "X" Base", Square Panel Base.

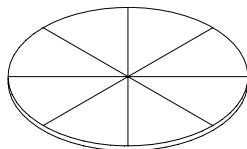

**Round Top - Sunburst Veneer Pattern**

RO60SPB	60 x 60 x 1.5	85	150	11		<b>\$5806</b>
RO48SPB	48 x 48 x 1.5	85	96	7		<b>\$4771</b>
RO42SPB	42 x 42 x 1.5	85	74	6		<b>\$4127</b>
RO36SPB	36 x 36 x 1.5	85	54	4		<b>\$3713</b>
RO30SPB	30 x 30 x 1.5	85	38	3		<b>\$3291</b>

For use with Drum Base, Pedestal Base, Cross Base, Wood Post Legs, Metal Post Legs, 4 Prong Base, Post leg w/Flat Plate, Flat Square Column Base, Trumpet Column base, Flat Bar "X" Base", Square Panel Base.

RE24054PB	54 x 240 x 1.5	85	540	39		<b>\$16455</b>
RE21654PB	54 x 216 x 1.5	85	486	35		<b>\$14938</b>
RE19254PB	54 x 192 x 1.5	85	432	31		<b>\$13039</b>
RE5454PB	54 x 54 x 1.5	85	121	9		<b>\$3667</b>
RE16848PB	48 x 168 x 1.5	85	336	25		<b>\$10004</b>
RE14448PB	48 x 144 x 1.5	85	288	21		<b>\$7919</b>
RE12048PB	48 x 120 x 1.5	85	240	18		<b>\$6730</b>
RE9648PB	48 x 96 x 1.5	85	192	14		<b>\$5218</b>
RE4848PB	48 x 48 x 1.5	85	96	7		<b>\$2607</b>
RE8442PB	42 x 84 x 1.5	85	147	11		<b>\$4751</b>
RE7242PB	42 x 72 x 1.5	85	126	9		<b>\$4181</b>
RE4242PB	42 x 42 x 1.5	85	74	5		<b>\$2443</b>
RE8436PB	36 x 84 x 1.5	85	126	9		<b>\$4251</b>
RE7236PB	36 x 72 x 1.5	85	108	8		<b>\$3590</b>
RE6636PB	36 x 66 x 1.5	85	99	7		<b>\$2741</b>
RE3636PB	36 x 36 x 1.5	85	54	4		<b>\$1494</b>
RE8430PB	30 x 84 x 1.5	85	105	8		<b>\$3486</b>
RE7230PB	30 x 72 x 1.5	85	90	7		<b>\$2993</b>
RE6630PB	30 x 66 x 1.5	85	83	6		<b>\$2741</b>
RE6030PB	30 x 60 x 1.5	85	75	6		<b>\$2487</b>
RE5430PB	30 x 54 x 1.5	85	68	5		<b>\$2248</b>
RE3030PB	30 x 30 x 1.5	85	38	3		<b>\$1247</b>
RE8424PB	24 x 84 x 1.5	85	84	6		<b>\$3042</b>
RE7224PB	24 x 72 x 1.5	85	72	5		<b>\$2603</b>
RE6624PB	24 x 66 x 1.5	85	66	5		<b>\$2388</b>
RE6024PB	24 x 60 x 1.5	70	60	4		<b>\$2171</b>
RE5424PB	24 x 54 x 1.5	85	55	4		<b>\$1957</b>
RE4824PB	24 x 48 x 1.5	70	48	3		<b>\$1879</b>
RE2424PB	24 x 24 x 1.5	125	21	3		<b>\$867</b>
RE8422PB	22 x 84 x 1.5	85	77	6		<b>\$2793</b>
RE7222PB	22 x 72 x 1.5	85	66	5		<b>\$2388</b>
RE6622PB	22 x 66 x 1.5	85	61	5		<b>\$2192</b>
RE6022PB	22 x 60 x 1.5	85	55	4		<b>\$1995</b>
RE5422PB	22 x 54 x 1.5	85	50	4		<b>\$1790</b>
RE4822PB	22 x 48 x 1.5	85	44	3		<b>\$1726</b>
RE2222PB	22 x 22 x 1.5	92.5	20	2		<b>\$793</b>

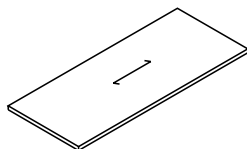

**Rectangular Top**

Grain runs the **length** of the worksurface. Tops 120" and under are shipped in one piece and require 2 bases. Tops 144" and over are shipped in two pieces and require 3 bases.

**Required Specifications**

Veneer Finish

**Optional Specifications**

Boardroom Table Base  
Grommet  
Custom cut-out

# T BOARDROOM TABLES - PHILADELPHIA

## BOARDROOM TABLES - TOPS W/PHILADELPHIA EDGE MODEL# DIMENSIONS FREIGHT CLASS WT/LBS. CUBIC FT. LIST PRICE

### D x W x H

RE24054FPB	54 x 240 x 1.5	85	540	39	<b>\$18652</b>
RE21654FPB	54 x 216 x 1.5	85	486	35	<b>\$16988</b>
RE19254FPB	54 x 192 x 1.5	85	432	31	<b>\$14895</b>
RE5454FPB	54 x 54 x 1.5	85	121	9	<b>\$4191</b>
RE16848FPB	48 x 168 x 1.5	85	336	25	<b>\$11563</b>
RE14448FPB	48 x 144 x 1.5	85	288	21	<b>\$9266</b>
RE12048FPB	48 x 120 x 1.5	85	240	18	<b>\$7774</b>
RE9648FPB	48 x 96 x 1.5	85	192	14	<b>\$6111</b>
RE4848FPB	48 x 48 x 1.5	85	96	7	<b>\$3054</b>
RE8442FPB	42 x 84 x 1.5	85	147	11	<b>\$4046</b>
RE7242FPB	42 x 72 x 1.5	85	126	9	<b>\$4921</b>
RE4242FPB	42 x 42 x 1.5	85	74	5	<b>\$2876</b>
RE8436FPB	36 x 84 x 1.5	85	126	9	<b>\$4921</b>
RE7236FPB	36 x 72 x 1.5	85	108	8	<b>\$4220</b>
RE6636FPB	36 x 66 x 1.5	85	99	7	<b>\$3225</b>
RE3636FPB	36 x 36 x 1.5	85	54	4	<b>\$2060</b>
RE8430FPB	30 x 84 x 1.5	85	105	8	<b>\$4098</b>
RE7230FPB	30 x 72 x 1.5	85	90	7	<b>\$3655</b>
RE6630FPB	30 x 66 x 1.5	85	83	6	<b>\$3518</b>
RE6030FPB	30 x 60 x 1.5	85	75	6	<b>\$3225</b>
RE5430FPB	30 x 54 x 1.5	85	68	5	<b>\$2639</b>
RE3030FPB	30 x 30 x 1.5	85	38	3	<b>\$1464</b>

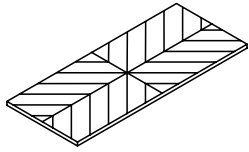

**Rectangular Top -  
Reverse Diamond Pattern**

Tops 120" and under are shipped in one piece and require 2 bases. Tops 144" and over are shipped in two pieces and require 3 bases.

RRE24054PB	54 x 240 x 1.5	85	540	39	<b>\$19759</b>
RRE21654PB	54 x 216 x 1.5	85	486	35	<b>\$18012</b>
RRE19254PB	54 x 192 x 1.5	85	432	31	<b>\$15832</b>
RRE5454PB	54 x 54 x 1.5	85	121	9	<b>\$4458</b>
RRE16848PB	48 x 168 x 1.5	85	336	25	<b>\$12341</b>
RRE14448PB	48 x 144 x 1.5	85	288	21	<b>\$9939</b>
RRE12048PB	48 x 120 x 1.5	85	240	18	<b>\$8301</b>
RRE9648PB	48 x 96 x 1.5	85	192	14	<b>\$6557</b>
RRE4848PB	48 x 48 x 1.5	85	96	7	<b>\$3276</b>
RRE8442PB	42 x 84 x 1.5	85	147	11	<b>\$5945</b>
RRE7242PB	42 x 72 x 1.5	85	126	9	<b>\$5295</b>
RRE4242PB	42 x 42 x 1.5	85	74	5	<b>\$3091</b>
RRE8436PB	36 x 84 x 1.5	85	126	9	<b>\$5295</b>
RRE7236PB	36 x 72 x 1.5	85	108	8	<b>\$4535</b>
RRE6636PB	36 x 66 x 1.5	85	99	7	<b>\$3466</b>
RRE3636PB	36 x 36 x 1.5	85	54	4	<b>\$1893</b>
RRE8430PB	30 x 84 x 1.5	85	105	8	<b>\$4414</b>
RRE7230PB	30 x 72 x 1.5	85	90	7	<b>\$3780</b>
RRE6630PB	30 x 66 x 1.5	85	83	6	<b>\$3466</b>
RRE6030PB	30 x 60 x 1.5	85	75	6	<b>\$3149</b>
RRE5430PB	30 x 54 x 1.5	85	68	5	<b>\$2840</b>
RRE3030PB	30 x 30 x 1.5	85	38	3	<b>\$1580</b>

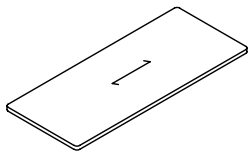

**Rectangular Top - Radius Corners**

Grain runs the **length** of the worksurface. Tops 120" and under are shipped in one piece and require 2 bases. Tops 144" and over are shipped in two pieces and require 3 bases.

### Required Specifications

Veneer Finish

### Optional Specifications

Boardroom Table Base

Grommet

Custom cut-out

**BOARDROOM TABLES - TOPS W/PHILADELPHIA EDGE    MODEL#    DIMENSIONS    FREIGHT CLASS    WT/LBS.    CUBIC FT.    LIST PRICE**

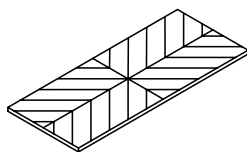

**Rectangular Top - Radius Corners  
Reverse Diamond Pattern**

	D x W x H					
RRE24054FPB	54 x 240 x 1.5	85	540	39	\$22287	
RRE21654FPB	54 x 216 x 1.5	85	486	35	\$20366	
RRE19254FPB	54 x 192 x 1.5	85	432	31	\$17964	
RRE5454FPB	54 x 54 x 1.5	85	121	9	\$5055	
RRE16848FPB	48 x 168 x 1.5	85	336	25	\$14130	
RRE14448FPB	48 x 144 x 1.5	85	288	21	\$11484	
RRE12048FPB	48 x 120 x 1.5	85	240	18	\$9499	
RRE9648FPB	48 x 96 x 1.5	85	192	14	\$7572	
RRE4848FPB	48 x 48 x 1.5	85	96	7	\$3792	
RRE8442FPB	42 x 84 x 1.5	85	147	11	\$6864	
RRE7242FPB	42 x 72 x 1.5	85	126	9	\$6141	
RRE4242FPB	42 x 42 x 1.5	85	74	5	\$3582	
RRE8436FPB	36 x 84 x 1.5	85	126	9	\$6141	
RRE7236FPB	36 x 72 x 1.5	85	108	8	\$5269	
RRE6636FPB	36 x 66 x 1.5	85	99	7	\$4025	
RRE3636FPB	36 x 36 x 1.5	85	54	4	\$2200	
RRE8430FPB	30 x 84 x 1.5	85	105	8	\$5117	
RRE7230FPB	30 x 72 x 1.5	85	90	7	\$4389	
RRE6630FPB	30 x 66 x 1.5	85	83	6	\$4025	
RRE6030FPB	30 x 60 x 1.5	85	75	6	\$3655	
RRE5430FPB	30 x 54 x 1.5	85	68	5	\$3293	
RRE3030FPB	30 x 30 x 1.5	85	38	3	\$1832	

Tops 120" and under are shipped in one piece and require 2 bases. Tops 144" and over are shipped in two pieces and require 3 bases.

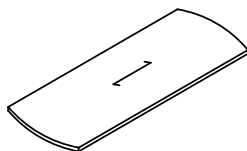

**Rectangular Top - Bow Ends**

REBE24054PB	54 x 240 x 1.5	85	540	39	\$18921	
REBE21654PB	54 x 216 x 1.5	85	486	35	\$17182	
REBE19254PB	54 x 192 x 1.5	85	432	31	\$14999	
REBE16848PB	48 x 168 x 1.5	85	336	25	\$11505	
REBE14448PB	48 x 144 x 1.5	85	288	21	\$9109	
REBE12048PB	48 x 120 x 1.5	85	240	18	\$7742	
REBE9648PB	48 x 96 x 1.5	85	192	14	\$5999	
REBE8442PB	42 x 84 x 1.5	85	147	11	\$5464	
REBE7242PB	42 x 72 x 1.5	85	126	9	\$4808	
REBE8436PB	36 x 84 x 1.5	85	126	9	\$4810	
REBE7236PB	36 x 72 x 1.5	85	108	8	\$4126	
REBE6636PB	36 x 66 x 1.5	85	99	7	\$3148	
REBE8430PB	30 x 84 x 1.5	85	105	8	\$4011	
REBE7230PB	30 x 72 x 1.5	85	90	7	\$3440	
REBE6630PB	30 x 66 x 1.5	85	83	6	\$3148	
REBE6030PB	30 x 60 x 1.5	85	75	6	\$2861	
REBE5430PB	30 x 54 x 1.5	85	68	5	\$2581	

Grain runs the **length** of the worksurface. Tops 120" and under are shipped in one piece and require 2 bases. Tops 144" and over are shipped in two pieces and require 3 bases.

**Required Specifications**  
Veneer Finish

**Optional Specifications**  
Boardroom Table Base  
Grommet  
Custom cut-out

# T BOARDROOM TABLES - PHILADELPHIA

## BOARDROOM TABLES - TOPS W/PHILADELPHIA EDGE

MODEL#	DIMENSIONS D x W x H	FREIGHT CLASS	WT/LBS.	CUBIC FT.	LIST PRICE
RA24054PB	54 x 240 x 1.5	85	540	39	\$22147
RA21654PB	54 x 216 x 1.5	85	486	35	\$18921
RA19254PB	54 x 192 x 1.5	85	432	31	\$17976
RA16848PB	48 x 168 x 1.5	85	336	25	\$13800
RA14448PB	48 x 144 x 1.5	85	288	21	\$11145
RA12048PB	48 x 120 x 1.5	85	240	18	\$9579
RA9648PB	48 x 96 x 1.5	85	192	14	\$7798
RA8442PB	42 x 84 x 1.5	85	147	11	\$7025
RA7242PB	42 x 72 x 1.5	85	126	9	\$6269
RA8436PB	36 x 84 x 1.5	85	126	9	\$6269
RA7236PB	36 x 72 x 1.5	85	108	8	\$5370
RA6636PB	36 x 66 x 1.5	85	99	7	\$4104
RA8430PB	30 x 84 x 1.5	85	105	8	\$5224
RA7230PB	30 x 72 x 1.5	85	90	7	\$4479
RA6630PB	30 x 66 x 1.5	85	83	6	\$4104
RA6030PB	30 x 60 x 1.5	85	75	6	\$3731
RA5430PB	30 x 54 x 1.5	85	68	5	\$3363
RA8422PB	22 x 84 x 1.5	85	77	6	\$4181
RA7222PB	22 x 72 x 1.5	85	66	5	\$3590
RA6622PB	22 x 66 x 1.5	85	61	5	\$3287
RA6022PB	22 x 60 x 1.5	85	55	4	\$2988
RA5422PB	22 x 54 x 1.5	85	50	4	\$2694
RA4822PB	22 x 48 x 1.5	85	44	3	\$2592

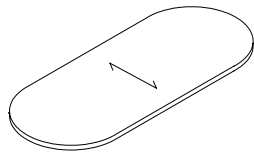

**Racetrack Top - Cross Grain**

Grain runs the **depth** of the worksurface. Tops 120" and under are shipped in one piece and require 2 bases. Tops 144" and over are shipped in two pieces and require 3 bases.

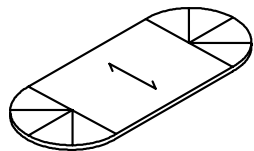

**Racetrack Top Cross Grain Center, Sunburst Veneer Pattern on Left & Right**

RA24054SPB	54 x 240 x 1.5	85	540	39	\$24819
RA21654SPB	54 x 216 x 1.5	85	486	35	\$21207
RA19254SPB	54 x 192 x 1.5	85	432	31	\$20143
RA16848SPB	48 x 168 x 1.5	85	336	25	\$15463
RA14448SPB	48 x 144 x 1.5	85	288	21	\$12487
RA12048SPB	48 x 120 x 1.5	85	240	18	\$10736
RA9648SPB	48 x 96 x 1.5	85	192	14	\$8737
RA8442SPB	42 x 84 x 1.5	85	147	11	\$7789
RA7242SPB	42 x 72 x 1.5	85	126	9	\$7025
RA8436SPB	36 x 84 x 1.5	85	126	9	\$7025
RA7236SPB	36 x 72 x 1.5	85	108	8	\$6026
RA6636SPB	36 x 66 x 1.5	85	99	7	\$4602
RA8430SPB	30 x 84 x 1.5	85	105	8	\$5852
RA7230SPB	30 x 72 x 1.5	85	90	7	\$5021
RA6630SPB	30 x 66 x 1.5	85	83	6	\$4852
RA6030SPB	30 x 60 x 1.5	85	75	6	\$4188
RA5430SPB	30 x 54 x 1.5	85	68	5	\$3767
RA8422SPB	22 x 84 x 1.5	85	77	5	\$4684
RA7222SPB	22 x 72 x 1.5	85	66	5	\$4017
RA6622SPB	22 x 66 x 1.5	85	61	5	\$3684
RA6022SPB	22 x 60 x 1.5	85	55	4	\$3349
RA5422SPB	22 x 54 x 1.5	85	50	4	\$3014
RA4822SPB	22 x 48 x 1.5	85	44	3	\$2902

Grain runs the **depth** of the worksurface. Tops 120" and under are shipped in one piece and require 2 bases. Tops 144" and over are shipped in two pieces and require 3 bases.

### Required Specifications

Veneer Finish

### Optional Specifications

Boardroom Table Base  
Grommet  
Custom cut-out

**BOARDROOM TABLES - TOPS W/PHILADELPHIA EDGE    MODEL#    DIMENSIONS    FREIGHT CLASS    WT/LBS.    CUBIC FT.    LIST PRICE**

**D x W x H**

OV24054PB	54 x 240 x 1.5	85	540	39	<b>\$27685</b>
OV21654PB	54 x 216 x 1.5	85	486	35	<b>\$23658</b>
OV19254PB	54 x 192 x 1.5	85	432	31	<b>\$22463</b>
OV16848PB	48 x 168 x 1.5	85	336	25	<b>\$17252</b>
OV14448PB	48 x 144 x 1.5	85	288	21	<b>\$13928</b>
OV12048PB	48 x 120 x 1.5	85	240	18	<b>\$11782</b>
OV9648PB	48 x 96 x 1.5	85	192	14	<b>\$9748</b>
OV8442PB	42 x 84 x 1.5	85	147	11	<b>\$8785</b>
OV7242PB	42 x 72 x 1.5	85	126	9	<b>\$7840</b>
OV8436PB	36 x 84 x 1.5	85	126	9	<b>\$7840</b>
OV7236PB	36 x 72 x 1.5	85	108	8	<b>\$6716</b>
OV6636PB	36 x 66 x 1.5	85	99	7	<b>\$5137</b>
OV8430PB	30 x 84 x 1.5	85	105	8	<b>\$6530</b>
OV7230PB	30 x 72 x 1.5	85	90	7	<b>\$5599</b>
OV6630PB	30 x 66 x 1.5	85	83	6	<b>\$5137</b>
OV6030PB	30 x 60 x 1.5	85	75	6	<b>\$4667</b>
OV5430PB	30 x 54 x 1.5	85	68	5	<b>\$4204</b>
OV8422PB	22 x 84 x 1.5	85	77	6	<b>\$5224</b>
OV7222PB	22 x 72 x 1.5	85	66	5	<b>\$4479</b>
OV6622PB	22 x 66 x 1.5	85	61	5	<b>\$4104</b>
OV6022PB	22 x 60 x 1.5	85	55	4	<b>\$3731</b>
OV5422PB	22 x 54 x 1.5	85	50	4	<b>\$3363</b>
OV4822PB	22 x 48 x 1.5	85	44	3	<b>\$3236</b>

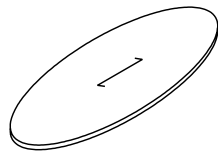

**Oval Top**

Grain runs the **length** of the worksurface. Tops 120" and under are shipped in one piece and require 2 bases. Tops 144" and over are shipped in two pieces and require 3 bases.

B024054PB	54 x 240 x 1.5	85	540	39	<b>\$18732</b>
B021654PB	54 x 216 x 1.5	85	486	35	<b>\$16837</b>
B019254PB	54 x 192 x 1.5	85	432	31	<b>\$14938</b>
B016848PB	48 x 168 x 1.5	85	336	25	<b>\$11899</b>
B014448PB	48 x 144 x 1.5	85	288	21	<b>\$9629</b>
B012048PB	48 x 120 x 1.5	85	240	18	<b>\$8063</b>
B09648PB	48 x 96 x 1.5	85	192	14	<b>\$6549</b>
B08442PB	42 x 84 x 1.5	85	147	11	<b>\$6042</b>
B07242PB	42 x 72 x 1.5	85	126	9	<b>\$5317</b>

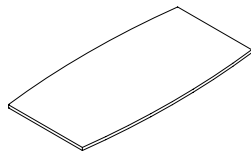

**Boat Shape Top**

Grain runs the **length** of the worksurface. Tops 120" and under are shipped in one piece and require 2 bases. Tops 144" and over are shipped in two pieces and require 3 bases.

BOBE24054PB	54 x 240 x 1.5	85	540	39	<b>\$21539</b>
BOBE21654PB	54 x 216 x 1.5	85	486	35	<b>\$19363</b>
BOBE19254PB	54 x 192 x 1.5	85	432	31	<b>\$17182</b>
BOBE5454PB	54 x 54 x 1.5	85	121	9	<b>\$4832</b>
BOBE16848PB	48 x 168 x 1.5	85	336	25	<b>\$13687</b>
BOBE14448PB	48 x 144 x 1.5	85	288	21	<b>\$11070</b>
BOBE12048PB	48 x 120 x 1.5	85	240	18	<b>\$9272</b>
BOBE9648PB	48 x 96 x 1.5	85	96	7	<b>\$7531</b>
BOBE4848PB	48 x 48 x 1.5	85	96	7	<b>\$4076</b>
BOBE8442PB	42 x 84 x 1.5	85	147	11	<b>\$6737</b>
BOBE7242PB	42 x 72 x 1.5	85	126	9	<b>\$6116</b>
BOBE4242PB	42 x 42 x 1.5	85	74	5	<b>\$3569</b>

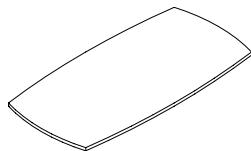

**Boat Shape Top - Bow Ends**

Grain runs the **length** of the worksurface. Tops 120" and under are shipped in one piece and require 2 bases. Tops 144" and over are shipped in two pieces and require 3 bases.

**Required Specifications**

Veneer Finish

**Optional Specifications**

Boardroom Table Base  
Grommet  
Custom cut-out

# T BOARDROOM TABLES - PHILADELPHIA

## BOARDROOM TABLES - TOPS W/PHILADELPHIA EDGE

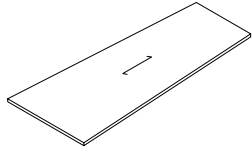

**Wedge Shape Top**

MODEL#	DIMENSIONS D x W x H	FREIGHT CLASS	WT/LBS.	CUBIC FT.	LIST PRICE
WE2405442PB	54 - 42 x 240 x 1.5	85	540	39	<b>\$16455</b>
WE2165442PB	54 - 42 x 216 x 1.5	85	486	35	<b>\$14938</b>
WE1925442PB	54 - 42 x 192 x 1.5	85	432	31	<b>\$13039</b>
WE1684836PB	48 - 36 x 168 x 1.5	85	336	25	<b>\$10004</b>
WE1444836PB	48 - 36 x 144 x 1.5	85	288	21	<b>\$7919</b>
WE1204836PB	48 - 36 x 120 x 1.5	85	240	18	<b>\$6730</b>
WE964836PB	48 - 36 x 96 x 1.5	85	192	14	<b>\$5870</b>
WE844230PB	42 - 30 x 84 x 1.5	85	147	11	<b>\$4751</b>
WE724230PB	42 - 30 x 72 x 1.5	85	126	9	<b>\$4181</b>
WE843624PB	36 - 24 x 84 x 1.5	85	126	9	<b>\$4181</b>
WE723624PB	36 - 24 x 72 x 1.5	85	108	8	<b>\$3590</b>
WE663624PB	36 - 24 x 66 x 1.5	85	99	7	<b>\$2741</b>

Grain runs the **length** of the worksurface. Tops 120" and under are shipped in one piece and require 2 bases. Tops 144" and over are shipped in two pieces and require 3 bases.

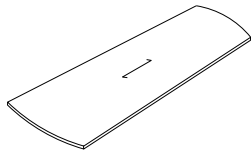

**Wedge Shape Top - Bow Ends**

WEBE2405442PB	54 - 42 x 240 x 1.5	85	540	39	<b>\$18921</b>
WEBE2165442PB	54 - 42 x 216 x 1.5	85	486	35	<b>\$17182</b>
WEBE1925442PB	54 - 42 x 192 x 1.5	85	432	31	<b>\$14997</b>
WEBE1684836PB	48 - 36 x 168 x 1.5	85	336	25	<b>\$11505</b>
WEBE1444836PB	48 - 36 x 144 x 1.5	85	288	21	<b>\$9109</b>
WEBE1204836PB	48 - 36 x 120 x 1.5	85	240	18	<b>\$7742</b>
WEBE964836PB	48 - 36 x 96 x 1.5	85	192	14	<b>\$6000</b>
WEBE844230PB	42 - 30 x 84 x 1.5	85	147	11	<b>\$5464</b>
WEBE724230PB	42 - 30 x 72 x 1.5	85	126	9	<b>\$4808</b>
WEBE843624PB	36 - 24 x 84 x 1.5	85	126	9	<b>\$4808</b>
WEBE723624PB	36 - 24 x 72 x 1.5	85	108	8	<b>\$4126</b>
WEBE663624PB	36 - 24 x 66 x 1.5	85	99	7	<b>\$3148</b>

Grain runs the **length** of the worksurface. Tops 120" and under are shipped in one piece and require 2 bases. Tops 144" and over are shipped in two pieces and require 3 bases.

### Required Specifications

Veneer Finish

### Optional Specifications

Boardroom Table Base

Grommet

Custom cut-out

## BOARDROOM TABLES - TOPS W/KINGSTON EDGE

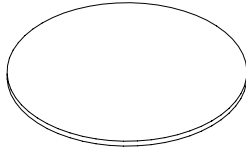

**Round Top**

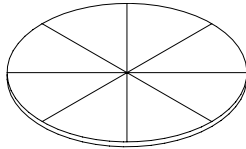

**Round Top - Sunburst Veneer Pattern**

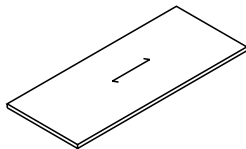

**Rectangular Top**

MODEL#	DIMENSIONS	FREIGHT CLASS	WT/LBS.	CUBIC FT.	LIST PRICE
<b>D x W x H</b>					
RO60K	60 x 60 x 1.5	85	150	11	<b>\$5809</b>
RO48K	48 x 48 x 1.5	85	96	7	<b>\$4648</b>
RO42K	42 x 42 x 1.5	85	74	6	<b>\$4174</b>
RO36K	36 x 36 x 1.5	85	54	4	<b>\$3722</b>
RO30K	30 x 30 x 1.5	85	38	3	<b>\$3104</b>

For use with Drum Base, Pedestal Base, Cross Base, Wood Post Legs, Metal Post Legs, 4 Prong Base, Post leg w/Flat Plate, Flat Square Column Base, Trumpet Column base, Flat Bar "X" Base", Square Panel Base.

RO60SK	60 x 60 x 1.5	85	150	11	<b>\$6386</b>
RO48SK	48 x 48 x 1.5	85	96	7	<b>\$5248</b>
RO42SK	42 x 42 x 1.5	85	74	6	<b>\$4541</b>
RO36SK	36 x 36 x 1.5	85	54	4	<b>\$4085</b>
RO30SK	30 x 30 x 1.5	85	38	3	<b>\$3620</b>

For use with Drum Base, Pedestal Base, Cross Base, Wood Post Legs, Metal Post Legs, 4 Prong Base, Post leg w/Flat Plate, Flat Square Column Base, Trumpet Column base, Flat Bar "X" Base", Square Panel Base.

RE24054K	54 x 240 x 1.5	85	540	39	<b>\$18100</b>
RE21654K	54 x 216 x 1.5	85	486	35	<b>\$16431</b>
RE19254K	54 x 192 x 1.5	85	432	31	<b>\$14343</b>
RE5454K	54 x 54 x 1.5	85	121	9	<b>\$4034</b>
RE16848K	48 x 168 x 1.5	85	336	25	<b>\$11004</b>
RE14448K	48 x 144 x 1.5	85	288	21	<b>\$8710</b>
RE12048K	48 x 120 x 1.5	85	240	18	<b>\$7403</b>
RE9648K	48 x 96 x 1.5	85	192	14	<b>\$5740</b>
RE4848K	48 x 48 x 1.5	85	96	7	<b>\$2867</b>
RE8442K	42 x 84 x 1.5	85	147	11	<b>\$5226</b>
RE7242K	42 x 72 x 1.5	85	126	9	<b>\$4598</b>
RE4242K	42 x 42 x 1.5	85	74	5	<b>\$2686</b>
RE8436K	36 x 84 x 1.5	85	126	9	<b>\$4676</b>
RE7236K	36 x 72 x 1.5	85	108	8	<b>\$3948</b>
RE6636K	36 x 66 x 1.5	85	99	7	<b>\$3014</b>
RE3636K	36 x 36 x 1.5	85	54	4	<b>\$1643</b>
RE8430K	30 x 84 x 1.5	85	105	8	<b>\$3834</b>
RE7230K	30 x 72 x 1.5	85	90	7	<b>\$3292</b>
RE6630K	30 x 66 x 1.5	85	83	6	<b>\$3014</b>
RE6030K	30 x 60 x 1.5	85	75	6	<b>\$2736</b>
RE5430K	30 x 54 x 1.5	85	68	5	<b>\$2472</b>
RE3030K	30 x 30 x 1.5	85	38	3	<b>\$1371</b>
RE8424K	24 x 84 x 1.5	85	84	6	<b>\$3346</b>
RE7224K	24 x 72 x 1.5	85	72	5	<b>\$2863</b>
RE6624K	24 x 66 x 1.5	85	66	5	<b>\$2627</b>
RE6024K	24 x 60 x 1.5	70	60	4	<b>\$2388</b>
RE5424K	24 x 54 x 1.5	85	55	4	<b>\$2153</b>
RE4824K	24 x 48 x 1.5	70	48	3	<b>\$2067</b>
RE2424K	24 x 24 x 1.5	125	21	3	<b>\$954</b>
RE8422K	22 x 84 x 1.5	85	77	6	<b>\$3072</b>
RE7222K	22 x 72 x 1.5	85	66	5	<b>\$2627</b>
RE6622K	22 x 66 x 1.5	85	61	5	<b>\$2412</b>
RE6022K	22 x 60 x 1.5	85	55	4	<b>\$2194</b>
RE5422K	22 x 54 x 1.5	85	50	4	<b>\$1969</b>
RE4822K	22 x 48 x 1.5	85	44	3	<b>\$1898</b>
RE2222K	22 x 22 x 1.5	92.5	20	2	<b>\$873</b>

Grain runs the **length** of the worksurface. Tops 120" and under are shipped in one piece and require 2 bases. Tops 144" and over are shipped in two pieces and require 3 bases.

### Required Specifications

Veneer Finish

### Optional Specifications

Boardroom Table Base  
Grommet  
Custom cut-out

# T BOARDROOM TABLES - KINGSTON

## BOARDROOM TABLES - TOPS W/KINGSTON EDGE

MODEL# DIMENSIONS FREIGHT CLASS WT/LBS. CUBIC FT. LIST PRICE

D x W x H

RE24054FK	54 x 240 x 1.5	85	540	39	<b>\$20517</b>
RE21654FK	54 x 216 x 1.5	85	486	35	<b>\$18687</b>
RE19254FK	54 x 192 x 1.5	85	432	31	<b>\$16383</b>
RE5454FK	54 x 54 x 1.5	85	121	9	<b>\$4610</b>
RE16848FK	48 x 168 x 1.5	85	336	25	<b>\$12719</b>
RE14448FK	48 x 144 x 1.5	85	288	21	<b>\$10193</b>
RE12048FK	48 x 120 x 1.5	85	240	18	<b>\$8551</b>
RE9648FK	48 x 96 x 1.5	85	192	14	<b>\$6722</b>
RE4848FK	48 x 48 x 1.5	85	96	7	<b>\$3360</b>
RE8442FK	42 x 84 x 1.5	85	147	11	<b>\$4451</b>
RE7242FK	42 x 72 x 1.5	85	126	9	<b>\$5413</b>
RE4242FK	42 x 42 x 1.5	85	74	5	<b>\$3164</b>
RE8436FK	36 x 84 x 1.5	85	126	9	<b>\$5413</b>
RE7236FK	36 x 72 x 1.5	85	108	8	<b>\$4642</b>
RE6636FK	36 x 66 x 1.5	85	99	7	<b>\$3548</b>
RE3636FK	36 x 36 x 1.5	85	54	4	<b>\$2266</b>
RE8430FK	30 x 84 x 1.5	85	105	8	<b>\$4508</b>
RE7230FK	30 x 72 x 1.5	85	90	7	<b>\$4020</b>
RE6630FK	30 x 66 x 1.5	85	83	6	<b>\$3870</b>
RE6030FK	30 x 60 x 1.5	85	75	6	<b>\$3548</b>
RE5430FK	30 x 54 x 1.5	85	68	5	<b>\$2902</b>
RE3030FK	30 x 30 x 1.5	85	38	3	<b>\$1610</b>

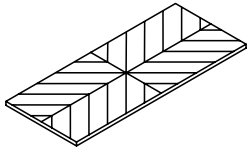

**Rectangular Top -  
Reverse Diamond Pattern**

Tops 120" and under are shipped in one piece and require 2 bases. Tops 144" and over are shipped in two pieces and require 3 bases.

RRE24054K	54 x 240 x 1.5	85	540	39	<b>\$21735</b>
RRE21654K	54 x 216 x 1.5	85	486	35	<b>\$19813</b>
RRE19254K	54 x 192 x 1.5	85	432	31	<b>\$17414</b>
RRE5454K	54 x 54 x 1.5	85	121	9	<b>\$4903</b>
RRE16848K	48 x 168 x 1.5	85	336	25	<b>\$13574</b>
RRE14448K	48 x 144 x 1.5	85	288	21	<b>\$10934</b>
RRE12048K	48 x 120 x 1.5	85	240	18	<b>\$9131</b>
RRE9648K	48 x 96 x 1.5	85	192	14	<b>\$7213</b>
RRE4848K	48 x 48 x 1.5	85	96	7	<b>\$3604</b>
RRE8442K	42 x 84 x 1.5	85	147	11	<b>\$6540</b>
RRE7242K	42 x 72 x 1.5	85	126	9	<b>\$5824</b>
RRE4242K	42 x 42 x 1.5	85	74	5	<b>\$3400</b>
RRE8436K	36 x 84 x 1.5	85	126	9	<b>\$5824</b>
RRE7236K	36 x 72 x 1.5	85	108	8	<b>\$4989</b>
RRE6636K	36 x 66 x 1.5	85	99	7	<b>\$3813</b>
RRE3636K	36 x 36 x 1.5	85	54	4	<b>\$2082</b>
RRE8430K	30 x 84 x 1.5	85	105	8	<b>\$4855</b>
RRE7230K	30 x 72 x 1.5	85	90	7	<b>\$4157</b>
RRE6630K	30 x 66 x 1.5	85	83	6	<b>\$3813</b>
RRE6030K	30 x 60 x 1.5	85	75	6	<b>\$3464</b>
RRE5430K	30 x 54 x 1.5	85	68	5	<b>\$3124</b>
RRE3030K	30 x 30 x 1.5	85	38	3	<b>\$1738</b>

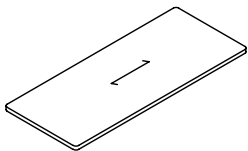

**Rectangular Top - Radius Corners**

Grain runs the **length** of the worksurface. Tops 120" and under are shipped in one piece and require 2 bases. Tops 144" and over are shipped in two pieces and require 3 bases.

### Required Specifications

Veneer Finish

### Optional Specifications

Boardroom Table Base

Grommet

Custom cut-out

**BOARDROOM TABLES - TOPS W/KINGSTON EDGE**    **MODEL#**    **DIMENSIONS**    **FREIGHT CLASS**    **WT/LBS.**    **CUBIC FT.**    **LIST PRICE**

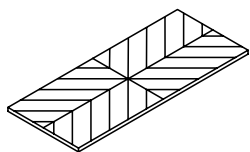

**Rectangular Top - Radius Corners**  
**Reverse Diamond Pattern**

	<b>D x W x H</b>					
RRE24054FK	54 x 240 x 1.5	85	540	39		<b>\$24515</b>
RRE21654FK	54 x 216 x 1.5	85	486	35		<b>\$22403</b>
RRE19254FK	54 x 192 x 1.5	85	432	31		<b>\$19761</b>
RRE5454FK	54 x 54 x 1.5	85	121	9		<b>\$5561</b>
RRE16848FK	48 x 168 x 1.5	85	336	25		<b>\$15542</b>
RRE14448FK	48 x 144 x 1.5	85	288	21		<b>\$12634</b>
RRE12048FK	48 x 120 x 1.5	85	240	18		<b>\$10449</b>
RRE9648FK	48 x 96 x 1.5	85	192	14		<b>\$8329</b>
RRE4848FK	48 x 48 x 1.5	85	96	7		<b>\$4171</b>
RRE8442FK	42 x 84 x 1.5	85	147	11		<b>\$7550</b>
RRE7242FK	42 x 72 x 1.5	85	126	9		<b>\$6755</b>
RRE4242FK	42 x 42 x 1.5	85	74	5		<b>\$3941</b>
RRE8436FK	36 x 84 x 1.5	85	126	9		<b>\$6755</b>
RRE7236FK	36 x 72 x 1.5	85	108	8		<b>\$5796</b>
RRE6636FK	36 x 66 x 1.5	85	99	7		<b>\$4428</b>
RRE3636FK	36 x 36 x 1.5	85	54	4		<b>\$2420</b>
RRE8430FK	30 x 84 x 1.5	85	105	8		<b>\$5629</b>
RRE7230FK	30 x 72 x 1.5	85	90	7		<b>\$4828</b>
RRE6630FK	30 x 66 x 1.5	85	83	6		<b>\$4428</b>
RRE6030FK	30 x 60 x 1.5	85	75	6		<b>\$4020</b>
RRE5430FK	30 x 54 x 1.5	85	68	5		<b>\$3623</b>
RRE3030FK	30 x 30 x 1.5	85	38	3		<b>\$2015</b>

Tops 120" and under are shipped in one piece and require 2 bases. Tops 144" and over are shipped in two pieces and require 3 bases.

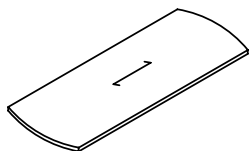

**Rectangular Top - Bow Ends**

REBE24054K	54 x 240 x 1.5	85	540	39		<b>\$20814</b>
REBE21654K	54 x 216 x 1.5	85	486	35		<b>\$18900</b>
REBE19254K	54 x 192 x 1.5	85	432	31		<b>\$16498</b>
REBE16848K	48 x 168 x 1.5	85	336	25		<b>\$12655</b>
REBE14448K	48 x 144 x 1.5	85	288	21		<b>\$10020</b>
REBE12048K	48 x 120 x 1.5	85	240	18		<b>\$8516</b>
REBE9648K	48 x 96 x 1.5	85	192	14		<b>\$6598</b>
REBE8442K	42 x 84 x 1.5	85	147	11		<b>\$6009</b>
REBE7242K	42 x 72 x 1.5	85	126	9		<b>\$5289</b>
REBE8436K	36 x 84 x 1.5	85	126	9		<b>\$5290</b>
REBE7236K	36 x 72 x 1.5	85	108	8		<b>\$4538</b>
REBE6636K	36 x 66 x 1.5	85	99	7		<b>\$3462</b>
REBE8430K	30 x 84 x 1.5	85	105	8		<b>\$4413</b>
REBE7230K	30 x 72 x 1.5	85	90	7		<b>\$3784</b>
REBE6630K	30 x 66 x 1.5	85	83	6		<b>\$3462</b>
REBE6030K	30 x 60 x 1.5	85	75	6		<b>\$3147</b>
REBE5430K	30 x 54 x 1.5	85	68	5		<b>\$2839</b>

Grain runs the **length** of the worksurface. Tops 120" and under are shipped in one piece and require 2 bases. Tops 144" and over are shipped in two pieces and require 3 bases.

**Required Specifications**

Veneer Finish

**Optional Specifications**

- Boardroom Table Base
- Grommet
- Custom cut-out

# T BOARDROOM TABLES - KINGSTON

## BOARDROOM TABLES - TOPS W/KINGSTON EDGE

MODEL# DIMENSIONS FREIGHT CLASS WT/LBS. CUBIC FT. LIST PRICE

D x W x H

RA24054K	54 x 240 x 1.5	85	540	39	<b>\$24362</b>
RA21654K	54 x 216 x 1.5	85	486	35	<b>\$20814</b>
RA19254K	54 x 192 x 1.5	85	432	31	<b>\$19773</b>
RA16848K	48 x 168 x 1.5	85	336	25	<b>\$15179</b>
RA14448K	48 x 144 x 1.5	85	288	21	<b>\$12259</b>
RA12048K	48 x 120 x 1.5	85	240	18	<b>\$10538</b>
RA9648K	48 x 96 x 1.5	85	192	14	<b>\$8578</b>
RA8442K	42 x 84 x 1.5	85	147	11	<b>\$7728</b>
RA7242K	42 x 72 x 1.5	85	126	9	<b>\$6896</b>
RA8436K	36 x 84 x 1.5	85	126	9	<b>\$6896</b>
RA7236K	36 x 72 x 1.5	85	108	8	<b>\$5907</b>
RA6636K	36 x 66 x 1.5	85	99	7	<b>\$4514</b>
RA8430K	30 x 84 x 1.5	85	105	8	<b>\$5746</b>
RA7230K	30 x 72 x 1.5	85	90	7	<b>\$4926</b>
RA6630K	30 x 66 x 1.5	85	83	6	<b>\$4514</b>
RA6030K	30 x 60 x 1.5	85	75	6	<b>\$4105</b>
RA5430K	30 x 54 x 1.5	85	68	5	<b>\$3698</b>
RA8422K	22 x 84 x 1.5	85	77	6	<b>\$4598</b>
RA7222K	22 x 72 x 1.5	85	61	5	<b>\$3948</b>
RA6622K	22 x 66 x 1.5	85	61	5	<b>\$3616</b>
RA6022K	22 x 60 x 1.5	85	55	4	<b>\$3286</b>
RA5422K	22 x 54 x 1.5	85	50	4	<b>\$2963</b>
RA4822K	22 x 48 x 1.5	85	44	3	<b>\$2850</b>

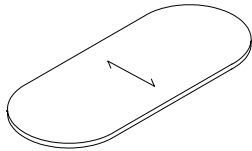

**Racetrack Top - Cross Grain**

Grain runs the **depth** of the worksurface. Tops 120" and under are shipped in one piece and require 2 bases. Tops 144" and over are shipped in two pieces and require 3 bases.

RA24054SK	54 x 240 x 1.5	85	540	39	<b>\$27301</b>
RA21654SK	54 x 216 x 1.5	85	486	35	<b>\$23327</b>
RA19254SK	54 x 192 x 1.5	85	432	31	<b>\$22157</b>
RA16848SK	48 x 168 x 1.5	85	336	25	<b>\$17010</b>
RA14448SK	48 x 144 x 1.5	85	288	21	<b>\$13735</b>
RA12048SK	48 x 120 x 1.5	85	240	18	<b>\$11809</b>
RA9648SK	48 x 96 x 1.5	85	192	14	<b>\$9610</b>
RA8442SK	42 x 84 x 1.5	85	147	11	<b>\$8567</b>
RA7242SK	42 x 72 x 1.5	85	126	9	<b>\$7728</b>
RA8436SK	36 x 84 x 1.5	85	126	9	<b>\$7728</b>
RA7236SK	36 x 72 x 1.5	85	108	8	<b>\$6629</b>
RA6636SK	36 x 66 x 1.5	85	99	7	<b>\$5062</b>
RA8430SK	30 x 84 x 1.5	85	105	8	<b>\$6437</b>
RA7230SK	30 x 72 x 1.5	85	90	7	<b>\$5523</b>
RA6630SK	30 x 66 x 1.5	85	83	6	<b>\$5337</b>
RA6030SK	30 x 60 x 1.5	85	75	6	<b>\$4607</b>
RA5430SK	30 x 54 x 1.5	85	68	5	<b>\$4144</b>
RA8422SK	22 x 84 x 1.5	85	77	6	<b>\$5153</b>
RA7222SK	22 x 72 x 1.5	85	66	5	<b>\$4418</b>
RA6622SK	22 x 66 x 1.5	85	61	5	<b>\$4053</b>
RA6022SK	22 x 60 x 1.5	85	55	4	<b>\$3683</b>
RA5422SK	22 x 54 x 1.5	85	50	4	<b>\$3316</b>
RA4822SK	22 x 48 x 1.5	85	44	3	<b>\$3191</b>

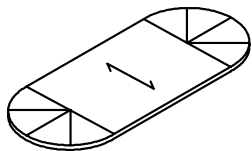

**Racetrack Top Cross Grain Center, Sunburst Veneer Pattern on Left & Right**

Grain runs the **depth** of the worksurface. Tops 120" and under are shipped in one piece and require 2 bases. Tops 144" and over are shipped in two pieces and require 3 bases.

### Required Specifications

Veneer Finish

### Optional Specifications

Boardroom Table Base  
Grommet  
Custom cut-out

BOARDROOM TABLES - TOPS W/KINGSTON EDGE

MODEL# DIMENSIONS FREIGHT CLASS WT/LBS. CUBIC FT. LIST PRICE

D x W x H

OV24054K	54 x 240 x 1.5	85	540	39	<b>\$30454</b>
OV21654K	54 x 216 x 1.5	85	486	35	<b>\$26024</b>
OV19254K	54 x 192 x 1.5	85	432	31	<b>\$24711</b>
OV16848K	48 x 168 x 1.5	85	336	25	<b>\$18978</b>
OV14448K	48 x 144 x 1.5	85	288	21	<b>\$15321</b>
OV12048K	48 x 120 x 1.5	85	240	18	<b>\$12959</b>
OV9648K	48 x 96 x 1.5	85	192	14	<b>\$10723</b>
OV8442K	42 x 84 x 1.5	85	147	11	<b>\$9662</b>
OV7242K	42 x 72 x 1.5	85	126	9	<b>\$8624</b>
OV8436K	36 x 84 x 1.5	85	126	9	<b>\$8624</b>
OV7236K	36 x 72 x 1.5	85	108	8	<b>\$7388</b>
OV6636K	36 x 66 x 1.5	85	99	7	<b>\$5650</b>
OV8430K	30 x 84 x 1.5	85	105	8	<b>\$7183</b>
OV7230K	30 x 72 x 1.5	85	90	7	<b>\$6158</b>
OV6630K	30 x 66 x 1.5	85	83	6	<b>\$5650</b>
OV6030K	30 x 60 x 1.5	85	75	6	<b>\$5134</b>
OV5430K	30 x 54 x 1.5	85	68	5	<b>\$4625</b>
OV8422K	22 x 84 x 1.5	85	77	6	<b>\$5746</b>
OV7222K	22 x 72 x 1.5	85	66	5	<b>\$4926</b>
OV6622K	22 x 66 x 1.5	85	61	5	<b>\$4514</b>
OV6022K	22 x 60 x 1.5	85	55	4	<b>\$4105</b>
OV5422K	22 x 54 x 1.5	85	50	4	<b>\$3698</b>
OV4822K	22 x 48 x 1.5	85	44	3	<b>\$3560</b>

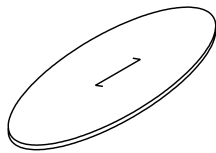

Oval Top

Grain runs the **length** of the worksurface. Tops 120" and under are shipped in one piece and require 2 bases. Tops 144" and over are shipped in two pieces and require 3 bases.

B024054K	54 x 240 x 1.5	85	540	39	<b>\$20605</b>
B021654K	54 x 216 x 1.5	85	486	35	<b>\$18521</b>
B019254K	54 x 192 x 1.5	85	432	31	<b>\$16431</b>
B016848K	48 x 168 x 1.5	85	336	25	<b>\$13088</b>
B014448K	48 x 144 x 1.5	85	288	21	<b>\$10592</b>
B012048K	48 x 120 x 1.5	85	240	18	<b>\$8869</b>
B09648K	48 x 96 x 1.5	85	192	14	<b>\$7204</b>
B08442K	42 x 84 x 1.5	85	147	11	<b>\$6646</b>
B07242K	42 x 72 x 1.5	85	126	9	<b>\$5849</b>

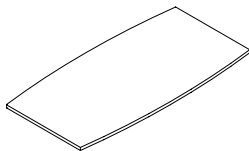

Boat Shape Top

Grain runs the **length** of the worksurface. Tops 120" and under are shipped in one piece and require 2 bases. Tops 144" and over are shipped in two pieces and require 3 bases.

BOBE24054K	54 x 240 x 1.5	85	540	39	<b>\$23692</b>
BOBE21654K	54 x 216 x 1.5	85	486	35	<b>\$21299</b>
BOBE19254K	54 x 192 x 1.5	85	432	31	<b>\$18900</b>
BOBE5454K	54 x 54 x 1.5	85	121	9	<b>\$5316</b>
BOBE16848K	48 x 168 x 1.5	85	336	25	<b>\$15055</b>
BOBE14448K	48 x 144 x 1.5	85	288	21	<b>\$12178</b>
BOBE12048K	48 x 120 x 1.5	85	240	18	<b>\$10199</b>
BOBE9648K	48 x 96 x 1.5	85	192	14	<b>\$8284</b>
BOBE4848K	48 x 48 x 1.5	85	96	7	<b>\$4484</b>
BOBE8442K	42 x 84 x 1.5	85	147	11	<b>\$7410</b>
BOBE7242K	42 x 72 x 1.5	85	126	9	<b>\$6727</b>
BOBE4242K	42 x 42 x 1.5	85	74	5	<b>\$3926</b>

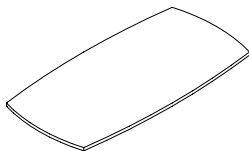

Boat Shape Top - Bow Ends

Grain runs the **length** of the worksurface. Tops 120" and under are shipped in one piece and require 2 bases. Tops 144" and over are shipped in two pieces and require 3 bases.

**Required Specifications**

Veneer Finish

**Optional Specifications**

Boardroom Table Base  
Grommet  
Custom cut-out

# T BOARDROOM TABLES - KINGSTON

## BOARDROOM TABLES - TOPS W/KINGSTON EDGE

MODEL# DIMENSIONS FREIGHT CLASS WT/LBS. CUBIC FT. LIST PRICE

D x W x H

WE2405442K	54 - 42 x 240 x 1.5	85	540	39	<b>\$18100</b>
WE2165442K	54 - 42 x 216 x 1.5	85	486	35	<b>\$16431</b>
WE1925442K	54 - 42 x 192 x 1.5	85	432	31	<b>\$14343</b>
WE1684836K	48 - 36 x 168 x 1.5	85	336	25	<b>\$11004</b>
WE1444836K	48 - 36 x 144 x 1.5	85	288	21	<b>\$8710</b>
WE1204836K	48 - 36 x 120 x 1.5	85	240	18	<b>\$7403</b>
WE964836K	48 - 36 x 96 x 1.5	85	192	14	<b>\$6457</b>
WE844230K	42 - 30 x 84 x 1.5	85	147	11	<b>\$5226</b>
WE724230K	42 - 30 x 72 x 1.5	85	126	9	<b>\$4598</b>
WE843624K	36 - 24 x 84 x 1.5	85	126	9	<b>\$4598</b>
WE723624K	36 - 24 x 72 x 1.5	85	108	8	<b>\$3948</b>
WE663624K	36 - 24 x 66 x 1.5	85	99	7	<b>\$3014</b>

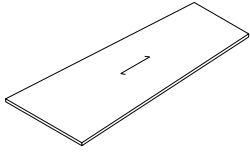

**Wedge Shape Top**

Grain runs the **length** of the worksurface. Tops 120" and under are shipped in one piece and require 2 bases. Tops 144" and over are shipped in two pieces and require 3 bases.

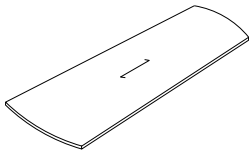

**Wedge Shape Top - Bow Ends**

WEBE2405442K	54 - 42 x 240 x 1.5	85	540	39	<b>\$20814</b>
WEBE2165442K	54 - 42 x 216 x 1.5	85	486	35	<b>\$18900</b>
WEBE1925442K	54 - 42 x 192 x 1.5	85	432	31	<b>\$16496</b>
WEBE1684836K	48 - 36 x 168 x 1.5	85	336	25	<b>\$12655</b>
WEBE1444836K	48 - 36 x 144 x 1.5	85	288	21	<b>\$10020</b>
WEBE1204836K	48 - 36 x 120 x 1.5	85	240	18	<b>\$8516</b>
WEBE964836K	48 - 36 x 96 x 1.5	85	192	14	<b>\$6599</b>
WEBE844230K	42 - 30 x 84 x 1.5	85	147	11	<b>\$6009</b>
WEBE724230K	42 - 30 x 72 x 1.5	85	126	9	<b>\$5289</b>
WEBE843624K	36 - 24 x 84 x 1.5	85	126	9	<b>\$5289</b>
WEBE723624K	36 - 24 x 72 x 1.5	85	108	8	<b>\$4538</b>
WEBE663624K	36 - 24 x 66 x 1.5	85	99	7	<b>\$3462</b>

Grain runs the **length** of the worksurface. Tops 120" and under are shipped in one piece and require 2 bases. Tops 144" and over are shipped in two pieces and require 3 bases.

### Required Specifications

Veneer Finish

### Optional Specifications

Boardroom Table Base

Grommet

Custom cut-out

## BOARDROOM TABLE BASES - ALL SERIES

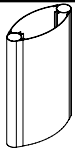

**Elliptical Base\***

MODEL#	DIMENSIONS	FREIGHT CLASS	WT/LBS.	CUBIC FT.	LIST PRICE
<b>D x W x H</b>					
TE42	8 x 42 x 28	100	70	8	<b>\$1965</b>
TE36	7 x 36 x 28	92.5	60	6	<b>\$1965</b>
TE30	6 x 30 x 28	85	50	4	<b>\$1904</b>
TE24	6 x 24 x 28	70	40	2	<b>\$1827</b>

**Not to be used with round table tops.** For tops up to 120", two Elliptical Bases must be ordered. For tops 144" and more, three Elliptical Bases must be ordered.

• **Plastic end gables are available in a Tungsten (K) or Black (E) finish. Please specify.**

- For 30" and 36" deep tops, order a 24" base (**TE24**).
- For 42" and 48" deep tops, order a 30" base (**TE30**).
- For 54" and 60" deep tops, order a 36" base (**TE36**) or 42" base (**TE42**).

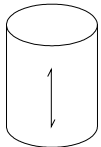

**Drum Base - Veneer**

TD30	30 x 30 x 28	125	93	15	<b>\$3207</b>
TD22	22 x 22 x 28	100	70	8	<b>\$1545</b>
TD18	18 x 18 x 28	85	62	5	<b>\$1346</b>

For tops up to 120", two Drum Bases must be ordered. For tops 144" and more, three Drum Bases must be ordered. Sand bag included to provide adequate stability.

- For 30", 36" and 42" deep tops, order a 18" base (**TD18**).
- For 48" and 54" deep tops, order a 22" base (**TD22**).
- For 60" deep tops, order a 30" base (**TD30**).

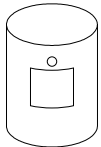

**Drum Base with Power Access Door - Veneer**

TD30J	30 x 30 x 28	125	93	15	<b>\$4009</b>
TD22J	22 x 22 x 28	100	70	8	<b>\$2350</b>
TD18J	18 x 18 x 28	85	62	5	<b>\$2149</b>

Access door and top and bottom cut-out to accommodate power/data grommet. For tops up to 120", two Drum Bases must be ordered. For tops 144" and more, three Drum Bases must be ordered. Sand bag included to provide adequate stability.

- Power access door is 12" x 12"
- For 30", 36" and 42" deep tops, order a 18" base (**TD18J**).
- For 48" and 54" deep tops, order a 22" base (**TD22J**).
- For 60" deep tops, order a 30" base (**TD30J**).

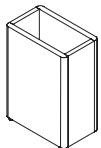

**Rectangular Wood Pedestal Base**

TP2412	12 x 24 x 28	85	86	7	<b>\$1845</b>
TP2012	12 x 20 x 28	70	71	4	<b>\$1756</b>
TP1612	12 x 16 x 28	70	58	3	<b>\$1678</b>

For tops up to 120", two Pedestal Bases must be ordered. For tops 144" and more, three Pedestal Bases must be ordered.

- For 30", 36" and 42" deep tops, order a 16" base (**TP1612**).
- For 48" and 54" deep tops, order a 20" base (**TP2012**).
- For 60" deep tops, order a 24" base (**TP2412**).

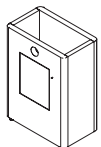

**Rectangular Wood Pedestal Base w/Power Access Door**

TP2412J	12 x 24 x 28	85	86	7	<b>\$2423</b>
TP2012J	12 x 20 x 28	70	71	4	<b>\$2362</b>
TP1612J	12 x 16 x 28	70	58	3	<b>\$2289</b>

Access door and top and bottom cut-out to accommodate power/data grommet. For tops up to 120", two Pedestal Bases must be ordered. For tops 144" and more, three Pedestal Bases must be ordered.

- Power access door is 12" x 12"
- For 30", 36" and 42" deep tops, order a 16" base (**TP1612J**).
- For 48" and 54" deep tops, order a 20" base (**TP2012J**).
- For 60" deep tops, order a 24" base (**TP2412J**).

### Required Specifications

Veneer finish  
Plastic finish\*

# T BOARDROOM TABLES

## BOARDROOM TABLE BASES - ALL SERIES

MODEL# DIMENSIONS FREIGHT CLASS WT/LBS. CUBIC FT. LIST PRICE ALL VENEER

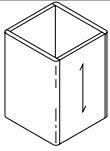

**Pedestal Base**

	D x W x H					
TP24	24 x 24 x 28	92.5	106	10		<b>\$1678</b>
TP20	20 x 20 x 28	85	89	7		<b>\$1612</b>
TP16	16 x 16 x 28	70	71	4		<b>\$1545</b>

For tops up to 120", two pedestal bases must be ordered. For tops 144" and more, three pedestal bases must be ordered.

- For 30", 36" and 42" deep tops, order a 16" base (**TP16**).
- For 48" and 54" deep tops, order a 20" base (**TP20**).
- For 60" deep tops, order a 24" base (**TP24**).

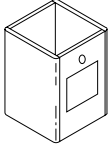

**Pedestal Base with Power Access Door**

TP24J	24 x 24 x 28	92.5	106	10		<b>\$2483</b>
TP20J	20 x 20 x 28	85	89	7		<b>\$2416</b>
TP16J	16 x 16 x 28	70	71	4		<b>\$2350</b>

Access door and top and bottom cut-out to accommodate power/data grommet. For tops up to 120", two pedestal bases must be ordered. For tops 144" and more, three pedestal bases must be ordered.

- Power access door is 12" x 12"
- For 30", 36" and 42" deep tops, order a 16" base (**TP16J**).
- For 48" and 54" deep tops, order a 20" base (**TP20J**).
- For 60" deep tops, order a 24" base (**TP24J**).

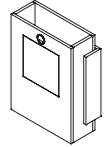

**Lam. Pedestal Base w/Power Access Door + Decorative Outside Panel**

TPML24J	10 x 24 x 28	92.5	53	5		<b>\$2800</b>
TPML20J	10 x 20 x 28	85	43	3		<b>\$2512</b>
TPML18J	10 x 18 x 28	70	36	2		<b>\$2228</b>

Access door and top and bottom cut-out to accommodate power/data grommet. For tops up to 120", two pedestal bases must be ordered. For tops 144" and more, three pedestal bases must be ordered.

- Power access door is 12" x 12"
- For 30", 36" and 42" deep tops, order a 18" base (**TPML18J**).
- For 48" and 54" deep tops, order a 20" base (**TPML20J**).
- For 60" deep tops, order a 24" base (**TPML24J**).

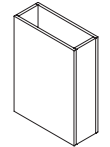

**Laminate Rectangular Center Base**

TPMLC24	10 x 24 x 28	92.5	53	5		<b>\$1617</b>
TPMLC20	10 x 20 x 28	85	43	3		<b>\$1528</b>
TPMLC18	10 x 18 x 28	70	36	2		<b>\$1445</b>

For tops up to 120", two pedestal bases must be ordered. For tops 144" and more, three pedestal bases must be ordered.

- Power access door is 12" x 12"
- For 30", 36" and 42" deep tops, order a 18" base (**TPMLC18**).
- For 48" and 54" deep tops, order a 20" base (**TPMLC20**).
- For 60" deep tops, order a 24" base (**TPMLC24**).

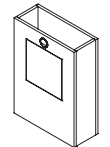

**Laminate Rectangular Center Base w/Power Access Door**

TPMLC24J	10 x 24 x 28	92.5	53	5		<b>\$2073</b>
TPMLC20J	10 x 20 x 28	85	43	3		<b>\$1984</b>
TPMLC18J	10 x 18 x 28	70	36	2		<b>\$1906</b>

Access door and top and bottom cut-out to accommodate power/data grommet. For tops up to 120", two pedestal bases must be ordered. For tops 144" and more, three pedestal bases must be ordered.

- Power access door is 12" x 12"
- For 30", 36" and 42" deep tops, order a 18" base (**TPMLC18J**).
- For 48" and 54" deep tops, order a 20" base (**TPMLC20J**).
- For 60" deep tops, order a 24" base (**TPMLC24J**).

### Required Specifications

Veneer finish  
Laminate finish\*

## BOARDROOM TABLE BASES - ALL SERIES

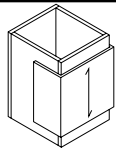

**Pedestal Base - Veneer  
Decorative Outside Panel\***

MODEL#	DIMENSIONS D x W x H	FREIGHT CLASS	WT/LBS.	CUBIC FT.	LIST PRICE	
TPM24	24 x 24 x 28	92.5	106	10	<b>\$2599</b>	<b>\$3116</b>
TPM20	20 x 20 x 28	85	86	7	<b>\$2490</b>	<b>\$2987</b>
TPM16	16 x 16 x 28	70	71	4	<b>\$2392</b>	<b>\$2869</b>

For tops up to 120", two pedestal bases must be ordered. For tops 144" and more, three pedestal bases must be ordered.

- For 30", 36" and 42" deep tops, order a 16" base (**TPM16**).
- For 48" and 54" deep tops, order a 20" base (**TPM20**).
- For 60" deep tops, order a 24" base (**TPM24**).

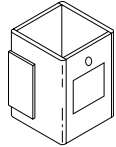

**Pedestal Base with Power Access Door  
Veneer Decorative Outside Panel\***

TPM24J	24 x 24 x 28	92.5	106	10	<b>\$3020</b>	<b>\$3627</b>
TPM20J	20 x 20 x 28	85	86	7	<b>\$2910</b>	<b>\$3495</b>
TPM16J	16 x 16 x 28	70	71	4	<b>\$2932</b>	<b>\$3521</b>

Access door and top and bottom cut-out to accommodate power/data grommet. For tops up to 120", two pedestal bases must be ordered. For tops 144" and more, three pedestal bases must be ordered.

- Power access door is 12" x 12"
- For 30", 36" and 42" deep tops, order a 16" base (**TPM16J**).
- For 48" and 54" deep tops, order a 20" base (**TPM20J**).
- For 60" deep tops, order a 24" base (**TPM24J**).

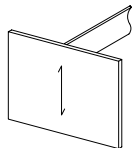

**Slab Base**

TH42	3 x 42 x 28	60	148	2	<b>\$2353</b>
TH36	3 x 36 x 28	60	127	2	<b>\$2123</b>
TH30	3 x 30 x 28	60	106	2	<b>\$1545</b>
TH22	3 x 22 x 28	60	89	2	<b>\$1338</b>

Not to be used with round table tops. For tops up to 120", two slab bases must be ordered. For tops 144" and more, three slab bases must be ordered.

- For 30" and 36" deep tops, order a 22" base (**TH22**).
- For 42" and 48" deep tops, order a 30" base (**TH30**).
- For 54" deep tops, order a 36" base (**TH36**).
- For 60" deep tops, order a 42" base (**TH42**).

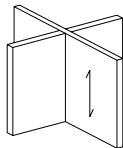

**Cross Base**

TX42	3 x 42 x 28	100	180	20	<b>\$2269</b>
TX36	3 x 36 x 28	100	155	17	<b>\$2123</b>
TX30	3 x 30 x 28	100	133	15	<b>\$1545</b>
TX22	3 x 22 x 28	100	97	11	<b>\$1338</b>

For tops up to 120", two cross bases must be ordered. For tops 144" and more, three cross bases must be ordered.

- For 30" and 36" deep tops, order a 22" base (**TX22**).
- For 42" and 48" deep tops, order a 30" base (**TX30**).
- For 54" deep tops, order a 36" base (**TX36**).
- For 60" deep tops, order a 42" base (**TX42**).

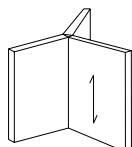

**"Y" Base**

TW42	4 x 42 x 28	125	140	20	<b>\$1965</b>
TW36	4 x 36 x 28	125	120	17	<b>\$1731</b>
TW30	4 x 30 x 28	125	100	15	<b>\$1422</b>
TW22	4 x 22 x 28	125	73	11	<b>\$1331</b>

**Not to be used with round table tops.** For tops up to 120", two "Y" bases must be ordered. For tops 144" and more, two "Y" bases and one cross base must be ordered.

- For 30" and 36" deep tops, order a 22" base (**TW22**).
- For 42" and 48" deep tops, order a 30" base (**TW30**).
- For 54" deep tops, order a 36" base (**TW36**).
- For 60" deep tops, order a 42" base (**TW42**).

### Required Specifications

Veneer Finish (Veneer Post Legs)  
Metal Finish (Metal Legs)

# T BOARDROOM TABLES

## BOARDROOM TABLE BASES - ALL SERIES

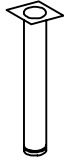

**Post Leg Veneer**

MODEL#	DIMENSIONS D x W x H	FREIGHT CLASS	WT/LBS.	CUBIC FT.	LIST PRICE
SN06	6 dia x 28	250	10	3	<b>\$1617</b>
SN04	4 dia x 28	125	7	1	<b>\$1245</b>
SN03	3 dia x 28	150	5	1	<b>\$785</b>

Available in 3", 4" and 6" diameters. Round tops and tops up to 96" require four legs. Tops 108" to 168" require six legs; tops 180" to 240" require ten legs.

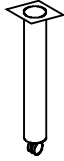

**Post Leg Veneer w/Caster**

SN06M	6 dia x 28	100	10	3	<b>\$1708</b>
SN04M	4 dia x 28	125	7	1	<b>\$1335</b>
SN03M	3 dia x 28	150	5	1	<b>\$878</b>

Available in 3", 4" and 6" diameters. Caster included. Round tops and tops up to 96" require four legs. Tops 108" to 168" require six legs; tops 180" to 240" require ten legs.

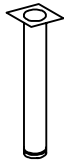

**Post Leg Metal**

SM06	6 dia x 28	100	10	3	<b>\$1105</b>
SM04	4 dia x 28	125	7	1	<b>\$610</b>
SM03	3 dia x 28	150	5	1	<b>\$434</b>

Available in 3", 4" and 6" diameters. Round tops and tops up to 96" require four legs. Tops 108" to 168" require six legs; tops 180" to 240" require ten legs.

• **Must Specify Black (E) or Tungsten (K) finish**

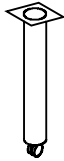

**Post Leg Metal w/Casters**

SM06M	6 dia x 28	100	10	3	<b>\$1199</b>
SM04M	4 dia x 28	125	7	1	<b>\$702</b>
SM03M	3 dia x 28	150	5	1	<b>\$528</b>

Available in 3", 4" and 6" diameters. Caster included. Round tops and tops up to 96" require four legs. Tops 108" to 168" require six legs; tops 180" to 240" require ten legs.

• **Must Specify Black (E) or Tungsten (K) finish**

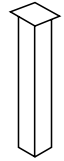

**Post Leg Metal, Square**

SMS4	4 x 4 x 28	125	7	1	<b>\$479</b>
------	------------	-----	---	---	--------------

Available in 4". Round tops and tops up to 96" require four legs. Tops 108" to 168" require six legs; tops 180" to 240" require ten legs.

• **Must Specify Black (E) or Tungsten (K) finish**

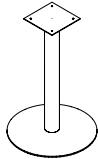

**Post Leg w/Flat Plate**

F6P36	36 x 36 x 28	150	100	22	<b>\$3794</b>
F4P30	30 x 30 x 28	150	80	15	<b>\$2310</b>
F4P24	24 x 24 x 28	125	60	10	<b>\$1846</b>
F3P18	18 x 18 x 28	100	45	5	<b>\$1638</b>

Round tops require a single base. For tops up to 120", two bases must be ordered. For tops 144" or more, three bases must be ordered.

• **Must Specify Black (E) or Tungsten (K) finish**

- For 30" deep tops, order a 18" base (**F3P18**).
- For 36" deep tops, order a 24" base (**F4P24**).
- For 42" and 48" deep tops, order a 30" base (**F4P30**).
- For 54" deep tops, order a 36" base (**F6P36**).

### Required Specifications

Veneer Finish  
\* Laminate Finish

## BOARDROOM TABLE BASES - ALL SERIES

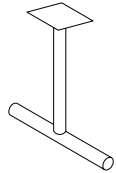

**Tubular 2-Prong Base**

MODEL#	DIMENSIONS D x W x H	FREIGHT CLASS	WT/LBS.	CUBIC FT.	LIST PRICE
TTM36	36 x 36 x 28	100	28	22	<b>\$913</b>
TTM26	26 x 26 x 28	85	24	11	<b>\$876</b>

**Not to be used with round table tops.** Two square edged prongs. For tops up to 84", two Tubular 2-Prong Bases must be ordered. Used as a 3rd base to provide center support in conjunction with two 3-Prong bases on tops 144" or more.

- **Must Specify Black (E) or Tungsten (K) finish**
- For 30", 36" and 42" deep tops, order a 26" base (**TTM26**).
- For 48", 54" and 60" deep tops, order a 36" base (**TTM36**).

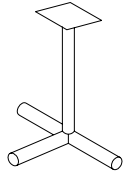

**Tubular 3-Prong Base**

TTE36	36 x 36 x 28	250	36	22	<b>\$973</b>
TTE26	26 x 26 x 28	85	32	11	<b>\$866</b>

**Not to be used with round table tops.** Three square edged prongs. For tops up to 120", two Tubular 3-Prong Bases must be ordered. For tops 144" and more, two Tubular 3-Prong Bases and one Tubular 2-Prong Base for the center must be ordered.

- **Must Specify Black (E) or Tungsten (K) finish**
- For 30", 36" and 42" deep tops, order a 26" base (**TTE26**).
- For 48", 54" and 60" deep tops, order a 36" base (**TTE36**).

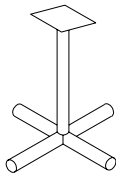

**Tubular 4-Prong Base**

TT36	36 x 36 x 28	300	40	22	<b>\$1458</b>
TT26	26 x 26 x 28	250	36	11	<b>\$1005</b>

Four square edged prongs. For tops up to 120", two Tubular 4-Prong Bases must be ordered. For tops 144" and more, three Tubular 4-Prong Bases must be ordered.

- **Must Specify Black (E) or Tungsten (K) finish**
  - For 30", 36" and 42" deep tops, order a 26" base (**TT26**).
  - For 48" and 54" deep tops, order a 36" base (**TT36**)\*
- \* Maximum diameter for Round Tops is 54".

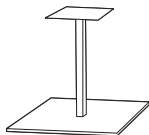

**Flat Square Column Base**

TTSQ23BH	23 x 23 x 41	150	75	14	<b>\$3635</b>
TTSQ18BH	18 x 18 x 41	125	65	10	<b>\$3367</b>
TTSQ30	30 x 30 x 28	150	80	14	<b>\$3771</b>
TTSQ23	23 x 23 x 28	150	55	12	<b>\$3098</b>
TTSQ18	18 x 18 x 28	150	45	8	<b>\$2828</b>

Round tops require a single base. For tops up to 120", two bases must be ordered. For tops 144" or more, three bases must be ordered.

- **Must Specify Black (E) or Tungsten (K) finish**
- For 30" deep tops, order a 18" base (**TTSQ18** or **TTSQ18BH**).
- For 36" deep tops, order a 24" base (**TTSQ23** or **TTSQ23BH**).
- For 42" and 48" deep tops, order a 30" base (**TTSQ30**).
  - Max diameter for round tops at standard height is 48".
  - Max diameter for round tops at bar height is 36".

### Required Specifications

Veneer Finish (Veneer Post Legs)  
Metal Finish (Metal Legs)

# T BOARDROOM TABLES

## BOARDROOM TABLE BASES

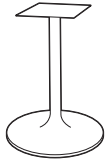

**Trumpet Column Base**

MODEL#	DIMENSIONS D x W x H	FREIGHT CLASS	WT/LBS.	CUBIC FT.	LIST PRICE
TRUM24BH	24 x 24 x 41	300	26	14	<b>\$1753</b>
TRUM18BH	18 x 18 x 41	300	24	16	<b>\$1619</b>
TRUM30	30 x 30 x 28	300	18	14	<b>\$1687</b>
TRUM24	24 x 24 x 28	300	16	12	<b>\$1216</b>
TRUM18	18 x 18 x 28	300	14	8	<b>\$1081</b>

Round tops require a single base. For tops up to 120", two bases must be ordered. For tops 144" or more, three bases must be ordered.

- **Must Specify Black (E) or Tungsten (K) finish**
- For 30" deep tops, order a 18" base (**TRUM18** or **TRUM18BH**).
- For 36" deep tops, order a 24" base (**TRUM24** or **TRUM24BH**).
- For 42" and 48" deep tops, order a 30" base (**TRUM30**).
  - Max diameter for round tops at standard height is 48".
  - Max diameter for round tops at bar height is 36".

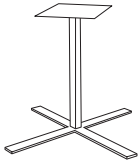

**Flat Bar "X" Column Base**

TTFLT36	36 x 36 x 28	300	18	14	<b>\$3367</b>
TTFLT30	30 x 30 x 28	300	16	12	<b>\$3234</b>
TTFLT22	22 x 22 x 28	300	15	10	<b>\$2976</b>

Round tops require a single base. For tops up to 120", two bases must be ordered. For tops 144" or more, three bases must be ordered.

- **Must Specify Black (E) or Tungsten (K) finish**
- For 30" and 36" deep tops, order a 22" base (**TTFLT22**).
- For 42" and 48" deep tops, order a 30" base (**TTFLT30**).
- For 54" deep tops, order a 36" base (**TTFLT36**).

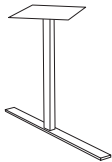

**Flat Bar "T" Column Base**

TTFLT36	36 x 36 x 28	150	14	3	<b>\$2828</b>
TTFLT24	24 x 24 x 28	150	10	2.50	<b>\$2560</b>

**Not to be used with round table tops.** For tops up to 84", two bases must be ordered. To be used as a 3rd base for center support in conjunction with two 3-prong bases on tops 144" or more.

- **Must Specify Black (E) or Tungsten (K) finish**
- For 30", 36" and 42" deep tops, order a 24" base (**TTFLT24**).
- For 48" and 54" deep tops, order a 36" base (**TTFLT36**).
- TTFLTxx bases are to be used as a middle base in combination with two TTFL3P bases



**Flat Bar 3 Prong Column Base**

TTFL3P36	36 x 36 x 28	400	16	22	<b>\$3234</b>
TTFL3P24	24 x 24 x 28	400	12	14	<b>\$2962</b>

**Not to be used with round table tops.** For tops up to 120", two bases must be ordered. For tops 144" or more, two 3-prong bases and one "T" column base must be ordered.

- **Must Specify Black (E) or Tungsten (K) finish**
- For 30", 36" and 42" deep tops, order a 24" base (**TTFL3P24**).
- For 48" and 54" deep tops, order a 36" base (**TTFL3P36**).
- When a third base is required, a TTFLTxx base may be used as the center base

### Required Specifications

Finish

## BOARDROOM TABLE BASES

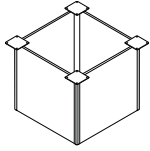

**Square Panel Base - Anodized Aluminum Radius Corner Detail**

MODEL#	DIMENSIONS	FREIGHT CLASS	WT/LBS.	CUBIC FT.	LIST PRICE
--------	------------	---------------	---------	-----------	------------

**D x W x H**

TELRS24J	24 x 24 x 28	100	75	8	<b>\$2721</b>
TELRS20J	20 x 20 x 28	92.5	70	6	<b>\$2347</b>
TELRS16J	16 x 16 x 28	70	65	4	<b>\$2129</b>
TELRS24	24 x 24 x 28	100	75	8	<b>\$2385</b>
TELRS20	20 x 20 x 28	92.5	70	6	<b>\$2008</b>
TELRS16	16 x 16 x 28	70	65	4	<b>\$1795</b>

Round tops require a single base. For tops up to 120" two Square Panel bases must be ordered. For tops 144" or more, three bases must be ordered.

- **Model #'s with a "J" denote a power access door on one panel.**
- For 30", 36" and 42" deep tops, order a 16" base (**TELRS16** or **TELRS16J**).
- For 48" and 54" deep tops, order a 20" base (**TELRS20** or **TELRS20J**).
- For 60" deep tops, order a 24" base (**TELRS24** or **TELRS24J**).

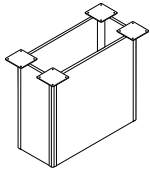

**Rectangular Panel Base - Anodized Aluminum Radius Corner Detail**

TELRR24J	12 x 24 x 28	100	65	8	<b>\$2587</b>
TELRR20J	12 x 20 x 28	92.5	60	6	<b>\$2210</b>
TELRR16J	12 x 16 x 28	85	50	4	<b>\$1995</b>
TELRR24	12 x 24 x 28	100	65	8	<b>\$2250</b>
TELRR20	12 x 20 x 28	92.5	60	6	<b>\$1875</b>
TELRR16	12 x 16 x 28	85	50	4	<b>\$1661</b>

**Not to be used with round table tops.** For tops up to 96" two Rectangular Panel bases must be ordered. To be used as a 3rd base for center support in conjunction with two Square Panel bases on tops 144" or more.

- **Model #'s with a "J" denote a power access door on one panel.**
- For 30", 36" and 42" deep tops, order a 16" base (**TELRR16** or **TELRR16J**).
- For 48" and 54" deep tops, order a 20" base (**TELRR20** or **TELRR20J**).
- For 60" deep tops, order a 24" base (**TELRR24** or **TELRR24J**).

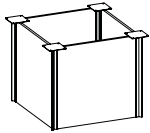

**Square Panel Base - Anodized Aluminum Rectangular Corner Detail**

TELBS24J	24 x 24 x 28	100	65	8	<b>\$2721</b>
TELBS20J	20 x 20 x 28	92.5	60	6	<b>\$2347</b>
TELBS16J	16 x 16 x 28	85	50	4	<b>\$2129</b>
TELBS24	24 x 24 x 28	100	65	8	<b>\$2385</b>
TELBS20	20 x 20 x 28	92.5	60	6	<b>\$2008</b>
TELBS16	16 x 16 x 28	85	50	4	<b>\$1795</b>

Round tops require a single base. For tops up to 120" two Square Panel bases must be ordered. For tops 144" or more, three bases must be ordered.

- **Model #'s with a "J" denote a power access door on one panel.**
- For 30", 36" and 42" deep tops, order a 16" base (**TELBS16** or **TELBS16J**).
- For 48" and 54" deep tops, order a 20" base (**TELBS20** or **TELBS20J**).
- For 60" deep tops, order a 24" base (**TELBS24** or **TELBS24J**).

**Required Specifications**

Finish

# T BOARDROOM TABLES

## BOARDROOM TABLE BASES

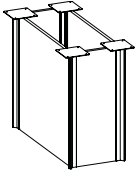

**Rectangular Panel Base - Anodized Aluminum Rectangular Corner Detail**

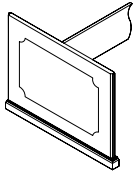

**Philadelphia Wood Slab Base and Stretcher**

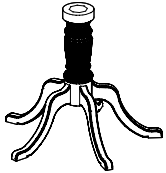

**Wood Queen Anne Base**

MODEL#	DIMENSIONS D x W x H	FREIGHT CLASS	WT/LBS.	CUBIC FT.	LIST PRICE
TELBR24J	12 x 24 x 28	100	65	8	<b>\$2587</b>
TELBR20J	12 x 20 x 28	92.5	60	6	<b>\$2210</b>
TELBR16J	12 x 16 x 28	85	50	4	<b>\$1995</b>
TELBR24	12 x 24 x 28	100	65	8	<b>\$2250</b>
TELBR20	12 x 20 x 28	92.5	60	6	<b>\$1875</b>
TELBR16	12 x 16 x 28	85	50	4	<b>\$1661</b>

**Not to be used with round table tops.** For tops up to 96" two Rectangular Panel bases must be ordered. To be used as a 3rd base for center support in conjunction with two Square Panel bases on tops 144" or more.

- **Model #'s with a "J" denote a power access door on one panel.**
- For 30", 36" and 42" deep tops, order a 16" base (**TELBR16** or **TELBR16J**).
- For 48" and 54" deep tops, order a 20" base (**TELBR20** or **TELBR20J**).
- For 60" deep tops, order a 24" base (**TELBR24** or **TELBR24J**).

PTH42PB	1 x 42 x 28	60	148	2	<b>\$3706</b>
PTH36PB	1 x 36 x 28	60	127	2	<b>\$3348</b>
PTH30PB	1 x 30 x 28	60	106	2	<b>\$2439</b>
PTH22PB	1 x 22 x 28	60	89	1	<b>\$2111</b>

- For 54" and 60" deep tops, order PTH36PB
- For 42" and 48" deep tops, order PTH30PB
- For 30" and 36" deep tops, order PTH22PB

PTQA30	30 x 30 x 28	150	73	15	<b>\$3790</b>
--------	--------------	-----	----	----	---------------

For use with 36", 42" and 48" deep tops.

### Required Specifications

Finish

## BOARDROOM - ACCESSORIES

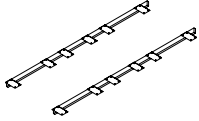

**Metal Support Rails**

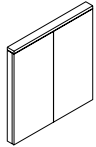

**Visual Board**

MODEL#	DIMENSIONS	FREIGHT CLASS	WT/LBS.	CUBIC FT.	LIST PRICE
	<b>D x W x H</b>				
TSUP102	1 x 102 x 2	70	0.10	0.10	<b>\$1239</b>
TSUP96	1 x 96 x 2	70	0.10	0.10	<b>\$1162</b>
TSUP90	1 x 90 x 2	70	0.10	0.10	<b>\$1075</b>
TSUP84	1 x 84 x 2	70	0.10	0.10	<b>\$993</b>
TSUP78	1 x 78 x 2	70	0.10	0.10	<b>\$910</b>
TSUP72	1 x 72 x 2	70	0.10	0.10	<b>\$828</b>
TSUP66	1 x 66 x 2	70	0.10	0.10	<b>\$748</b>
TSUP60	1 x 60 x 2	70	0.10	0.10	<b>\$667</b>
TSUP54	1 x 54 x 2	70	0.10	0.10	<b>\$613</b>

To be used when design considerations or dimension requirements dictate an unsupported table joint. Top section **MUST NOT** exceed 72" to use metal supports. **Sold in sets of two**

- Available in Black only.

VB4848E	5 x 48 x 48	70	115	7	<b>\$4541</b>
---------	-------------	----	-----	---	---------------

Includes porcelain on steel magnetic board and two side opening straight edge doors containing tackable fabric panels and 50-sheet paper writing pad that can be used on either door. Magnetic board can be used for projection. Set of 6 dry erase markers and eraser included. Interior fabric panels available in Anchorage. Specify color:

AN40 Birch	AN41 Green Apple	AN42 Lapis	AN43 Straw	AN44 Wolf
AN45 Goose	AN46 Angora	AN47 Cumin	AN48 Asteroid	AN49 Geranium
AN50 Thistle	AN51 Graphite	AN52 Slate	AN53 Quarry Blue	AN54 Onyx
AN55 Pumpkin	AN56 Red Delicious	AN57 Sunshine	AN59 Waterfall	AN61 Vanilla
AN62 Cobalt	AN64 Cloud			

- **NOTE:** Care should be taken to mount the units. Units should be mounted to wall studs using correct fasteners. Failure to do so may result in collapse of the unit and subsequent personal injury. **Mounting hardware not included.** Mounting hardware used should be based on wall material. Consult an installation professional for proper wall mounting.

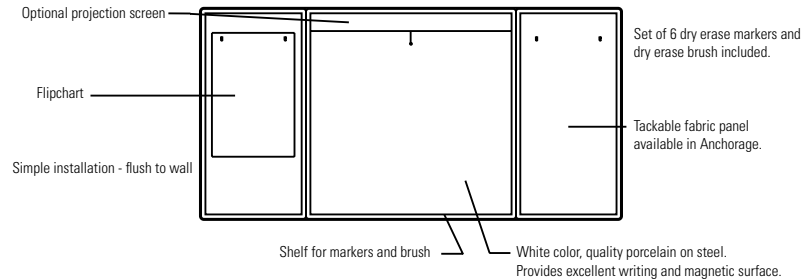

### Required Specifications

Finish  
Fabric

# T BOARDROOM TABLES

## BOARDROOM - ACCESSORIES

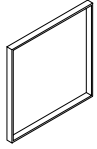

Visual Board, No Doors

MODEL#	DIMENSIONS D x W x H	FREIGHT CLASS	WT/LBS.	CUBIC FT.	LIST PRICE	
VB48480	5 x 48 x 48	70	115	7	<b>\$3051</b>	

Includes porcelain on steel magnetic board. Magnetic board can be used for projection. Set of 6 dry erase markers and eraser included.

• **NOTE:** Care should be taken to mount the units. Units should be mounted to wall studs using correct fasteners. Failure to do so may result in collapse of the unit and subsequent personal injury. **Mounting hardware not included.** Mounting hardware used should be based on wall material. Consult an installation professional for proper wall mounting.

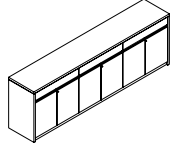

Credenza Buffet - Dufferin

DCB9022H36	22 x 90 x 36	92.5	440	44	<b>\$9735</b>	<b>\$11680</b>
DCB9020H36	20 x 90 x 36	92.5	400	40	<b>\$8850</b>	<b>\$10621</b>
DCB7222H36	22 x 72 x 36	92.5	330	33	<b>\$6610</b>	<b>\$7932</b>
DCB7220H36	20 x 72 x 36	92.5	300	30	<b>\$5889</b>	<b>\$7069</b>
DCB6022H36	22 x 60 x 36	100	275	28	<b>\$5669</b>	<b>\$6804</b>
DCB6020H36	20 x 60 x 36	92.5	250	25	<b>\$5153</b>	<b>\$6182</b>

90" w units have (3) two door storage cabinets with top drawer side-by-side. 72" w & 60" w units have (2) two door storage cabinets with top drawer side-by-side. Locking doors. Self-closing hinged doors cover one adjustable shelf.

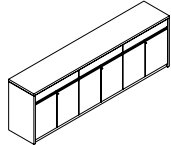

Credenza Buffet - Lufton

LCB9022H36	22 x 90 x 36	92.5	440	44	<b>\$10567</b>	
LCB9020H36	20 x 90 x 36	92.5	400	40	<b>\$9615</b>	
LCB7222H36	22 x 72 x 36	92.5	330	33	<b>\$7180</b>	
LCB7220H36	20 x 72 x 36	92.5	300	30	<b>\$6390</b>	
LCB6022H36	22 x 60 x 36	100	275	28	<b>\$6165</b>	
LCB6020H36	20 x 60 x 36	92.5	250	25	<b>\$5602</b>	

90" w units have (3) two door storage cabinets with top drawer side-by-side. 72" w & 60" w units have (2) two door storage cabinets with top drawer side-by-side. Locking doors. Self-closing hinged doors cover one adjustable shelf.

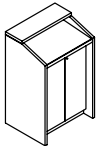

Lectern - Dufferin

DLEC3624	24 x 36 x 48	92.5	240	24	<b>\$4611</b>	<b>\$5533</b>
DLEC3024	24 x 30 x 48	92.5	200	20	<b>\$3845</b>	<b>\$4613</b>
DLEC2424	24 x 24 x 48	92.5	160	16	<b>\$3075</b>	<b>\$3689</b>

Features angled stand. Storage compartment with one adjustable and one fixed shelf. Locks optional.

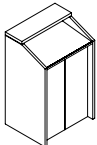

Lectern - Lufton

LEC3624L	24 x 36 x 48	92.5	240	24	<b>\$5230</b>	
LEC3024L	24 x 30 x 48	92.5	200	20	<b>\$4363</b>	
LEC2424L	24 x 24 x 48	92.5	160	16	<b>\$3476</b>	

Features angled stand. Storage compartment with one adjustable and one fixed shelf. Locks optional.

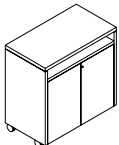





Utility Table - Dufferin

DTV3620M	20 x 36 x 34	85	121	10	<b>\$2791</b>	<b>\$3346</b>
----------	--------------	----	-----	----	---------------	---------------

Open shelf and storage compartment with one adjustable shelf. Locking doors. Casters.

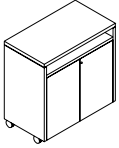
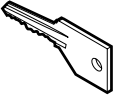
### Required Specifications

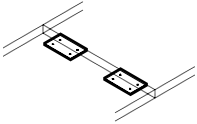
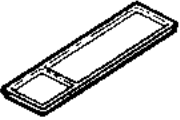
Finish

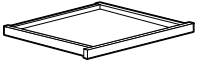
ACCESSORIES	MODEL#	DIMENSIONS	FREIGHT CLASS	WT/LBS.	CUBIC FT.	LIST PRICE
 <b>Utility Table - Lufton</b>	LTV3620M	D x W x H 20 x 36 x 34	85	121	10	<b>\$3023</b>
	Open shelf and storage compartment with one adjustable shelf. Locking doors. Casters.					
 <b>Extra Key</b>	LOCK	--	70	--	--	<b>\$46</b>
	Specify key #. Key range 400 - 500.					
 <b>Grommet Cover, Round</b>	GM1	2 dia x --	70	--	--	<b>\$70</b>
	GM1K	2 dia x --	70	--	--	<b>\$70</b>
	2.75" diameter. <ul style="list-style-type: none"> <li>• <b>Specify GM1 for Black or GM1K for Tungsten.</b></li> </ul>					
 <b>Mending Plates</b>	MP53	3 x 5 x 0.50	300	3	2	<b>\$65</b>
	Sold in sets of 2. <ul style="list-style-type: none"> <li>• <b>Available in Black Only.</b></li> </ul>					
 <b>Pencil Tray - Black Plastic</b>	PT	3 x 12.50 x 1	250	2	1	<b>\$23</b>
	Provides space for writing instruments and small items at the workspace. <ul style="list-style-type: none"> <li>• <b>Available in Black Only.</b></li> </ul>					
 <b>Pencil Tray - Veneer</b>	OPT	6 x 12.50 x 2	150	4	1	<b>\$183</b>
	Provides space for writing instruments and small items at the workspace. Solid oak finish.					
 <b>Center Drawer - Veneer</b>	CD	21 x 23 x 2	100	8	1	<b>\$744</b>
	Veneer drawer front is attached to a 4-sided frame. Must specify wood finish for drawer front.					

**Required Specifications**

Finish

# T BOARDROOM TABLES

## KEYBOARD DRAWERS

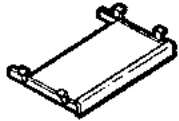

**Keyboard Drawer**

MODEL#	DIMENSIONS D x W x H	FREIGHT CLASS	WT/LBS.	CUBIC FT.	LIST PRICE
KD30	10 x 30 x 1	70	16	1	<b>\$999</b>
KD22	10 x 22 x 1	85	12	1	<b>\$893</b>
KD10	10 x 10 x 1	125	6	1	<b>\$452</b>

Pull-out veneer keyboard shelf. Clearance is 2 1/4". Must specify wood finish for drawer front.

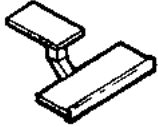

**Articulating Keyboard Drawer**

AKD30	10 x 30 x 1	65	24	1	<b>\$1380</b>
AKD22	10 x 22 x 1	70	18	1	<b>\$1277</b>

Adjustable pull-out keyboard shelf with articulating arm. Adjusts from flush with the worksurface to 5" below worksurface. Swivels 360° full arm rotation, angles -10° to +15°. Must specify wood finish for keyboard deck.

## WIRE MANAGEMENT



**Wire Management Cover**

MODEL#	DIMENSIONS	FREIGHT CLASS	WT/LBS.	CUBIC FT.	LIST PRICE
WH24	1 x 1 x 24	70	1	1	<b>\$79</b>

To conceal wires and cords. Plastic.

- **Available in Black Plastic Only.**



**Wire Management Track - Single**





C2M72	2 x 72 x 2	70	0.10	0.10	<b>\$89</b>
C2M60	2 x 60 x 2	70	0.10	0.10	<b>\$74</b>
C2M48	2 x 48 x 2	70	0.10	0.10	<b>\$61</b>
C2M36	2 x 36 x 2	70	0.10	0.10	<b>\$45</b>
C2M24	2 x 24 x 2	70	0.10	0.10	<b>\$34</b>
C2M12	2 x 12 x 2	70	0.10	0.10	<b>\$19</b>

To conceal and organize wires and cords. Attaches to Modesty Panel with double sided tape. Plastic.

- **Available in Black Plastic Only.**

### Required Specifications

Finish

POWER / DATA	MODEL#	DIMENSIONS	FREIGHT CLASS	WT/LBS.	CUBIC FT.	LIST PRICE
 <p><b>Single Sided Recessed Power Block</b></p>	<b>D x W x H</b>					
	PRTMCS401B	4.22 x 10.78 x 4.86	100	4.3	0.51	<b>\$486</b>
	PRTMCS401T	4.22 x 10.78 x 4.86	100	4.3	0.51	<b>\$486</b>
	PRTMCS401W	4.22 x 10.78 x 4.86	100	4.3	0.51	<b>\$486</b>
<p>Single-sided recessed power block with <b>one regular duplex and one telecom knockout on top; one power duplex on bottom</b>. 10' power cord with straight plug. Specify telecom options separately, see page 418. Available in Black (<b>B</b>), Tungsten (<b>T</b>) or Designer White (<b>W</b>) as indicated by the last letter of model number. Duplexes always Grey. Corresponding cut-out options are <b>R1, R2</b> or <b>R3</b>. Units are not approved for daisy chaining. UL listed: UL 1363.</p>						
 <p><b>Single Sided Recessed Power Block - USB-A + USB-C</b></p>	<b>D x W x H</b>					
	PRTMCS421B	4.22 x 10.78 x 4.86	100	4.3	0.51	<b>\$638</b>
	PRTMCS421T	4.22 x 10.78 x 4.86	100	4.3	0.51	<b>\$638</b>
	PRTMCS421W	4.22 x 10.78 x 4.86	100	4.3	0.51	<b>\$638</b>
<p>Single-sided recessed power block with <b>one power/USB-A/USB-C duplex and one telecom knockout on top; one power duplex on bottom</b>. USB-A port charges max 2.4 amps at 5V and USB-C port charges max 3 amps at 5V. 10' power cord with straight plug. Specify telecom options separately, see page 418. Available in Black (<b>B</b>), Tungsten (<b>T</b>) or Designer White (<b>W</b>) as indicated by the last letter of model number. Duplexes always Grey (duplex with USB ports is glossy finish). Corresponding cut-out options are <b>R1, R2</b> or <b>R3</b>. Units are not approved for daisy chaining. UL listed: UL 1363.</p>						
 <p><b>Double Sided Recessed Power Block</b></p>	<b>D x W x H</b>					
	PRTMCD602B	6.22 x 10.78 x 4.86	92.5	5.9	0.51	<b>\$555</b>
	PRTMCD602T	6.22 x 10.78 x 4.86	92.5	5.9	0.51	<b>\$555</b>
	PRTMCD602W	6.22 x 10.78 x 4.86	92.5	5.9	0.51	<b>\$555</b>
<p>Double-sided recessed power block with <b>two regular power duplexes and two telecom knockouts on top; one power duplex on bottom</b>. 10' power cord with straight plug. Specify telecom options separately, see page 418. Available in Black (<b>B</b>), Tungsten (<b>T</b>) or Designer White (<b>W</b>) as indicated by last letter of model number. Duplexes always Grey. Corresponding cut-out options are <b>T1, T2</b> or <b>T3</b>. Units are not approved for daisy chaining. UL listed: UL 1363.</p>						
 <p><b>Double Sided Recessed Power Block - USB-A + USB-C</b></p>	<b>D x W x H</b>					
	PRTMCD622B	6.22 x 10.78 x 4.86	92.5	6.1	0.51	<b>\$699</b>
	PRTMCD622T	6.22 x 10.78 x 4.86	92.5	6.1	0.51	<b>\$699</b>
	PRTMCD622W	6.22 x 10.78 x 4.86	92.5	6.1	0.51	<b>\$699</b>
<p>Double-sided recessed power block with <b>one regular power duplex, one power/USB-A/USB-C duplex and two telecom knockouts on top; one power duplex on bottom</b>. USB-A port charges max 2.4 amps at 5V and USB-C port charges max 3 amps at 5V. 10' power cord with straight plug. Specify telecom options separately, see page 418. Available in Black (<b>B</b>), Tungsten (<b>T</b>) or Designer White (<b>W</b>) as indicated by last letter of model number. Duplexes always Grey (duplex with USB ports is glossy finish). Corresponding cut-out options are <b>T1, T2</b> or <b>T3</b>. Units are not approved for daisy chaining. UL listed: UL 1363.</p>						
 <p><b>Double Sided Recessed Power Block - USB-A + USB-C</b></p>	<b>D x W x H</b>					
	PRTMCD642B	6.22 x 10.78 x 4.86	85	6.3	0.51	<b>\$842</b>
	PRTMCD642T	6.22 x 10.78 x 4.86	85	6.3	0.51	<b>\$842</b>
	PRTMCD642W	6.22 x 10.78 x 4.86	85	6.3	0.51	<b>\$842</b>
<p>Double-sided recessed power block with <b>two power/USB-A/USB-C duplexes and two telecom knockouts on top; one power duplex on bottom</b>. USB-A port charges max 2.4 amps at 5V and USB-C port charges max 3 amps at 5V. 10' power cord with straight plug. Specify telecom options separately, see page 418. Available in Black (<b>B</b>), Tungsten (<b>T</b>) or Designer White (<b>W</b>) as indicated by last letter of model number. Duplexes always Grey (duplex with USB ports is glossy finish). Corresponding cut-out options are <b>T1, T2</b> or <b>T3</b>. Units are not approved for daisy chaining. UL listed: UL 1363.</p>						

**Required Specifications**

Finish

# T BOARDROOM TABLES

## TELECOM PLATES

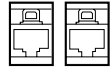

**Telecom Plate - 2 x 6**

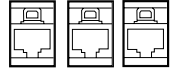

**Telecom Plate - 3 x 6**

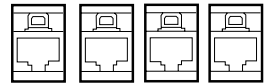

**Telecom Plate - 4 x 6**



**Telecom Plate - 3TSV**

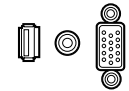

**Telecom Plate - 3SVH**

MODEL#	DIMENSIONS	FREIGHT CLASS	WT/LBS.	CUBIC FT.	LIST PRICE
--------	------------	---------------	---------	-----------	------------

D x W x H

PTELO1	- x - x -	70	0.01	0.05	<b>\$175</b>
--------	-----------	----	------	------	--------------

Includes 2 x RJ45 cat 6 data. Black telecom plate. To be hardwired by data contractor.

PTELO2	- x - x -	70	0.01	0.05	<b>\$237</b>
--------	-----------	----	------	------	--------------

Includes 2 x RJ45 cat 6 data and 1 RJ11 cat phone. Black telecom plate. To be hardwired by data contractor.

PTELO3	- x - x -	70	0.01	0.05	<b>\$363</b>
--------	-----------	----	------	------	--------------

Includes 4 x RJ45 cat 6 data. Black telecom plate. To be hardwired by data contractor.

PTELO4	- x - x -	70	0.01	0.05	<b>\$309</b>
--------	-----------	----	------	------	--------------

Includes 1 x RJ45 cat 6 data, mini stereo and 15 pin HD VGA. Black telecom plate. To be hardwired by data contractor.

PTELO5	- x - x -	70	0.01	0.05	<b>\$428</b>
--------	-----------	----	------	------	--------------

Includes mini stereo, 15 pin HD VGA and HDMI. Black telecom plate.

**Required Specifications**

Finish

## OASIS CORDED UNITS

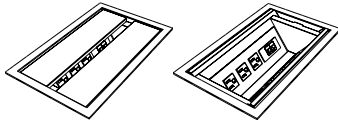

**Oasis Mini A, Corded**

MODEL#	DIMENSIONS	FREIGHT CLASS	WT/LBS.	CUBIC FT.	LIST PRICE
OAM-A-PC- <u>  </u>	15 x 9 x 5.25	92.5	16	1.53	<b>\$1945</b>

D x W x H

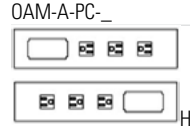

Mini Oasis A unit. 15" Trough with six power receptacles, two telecom plate cut-outs (**telecom plates sold separate**, see page 424) and two 108" 3-prong plugs. **M1, M2 or M3 cut-out(s) must be specified on conference table** (see product notes section for more details and cut-out upcharge). Cut-out dimensions: 14.12" x 8.25". UL Listed: UL 962A.

- **Cannot be daisy-chained.**
- Replace    with **B** for **Black** or **S** for **Silver Pearl**

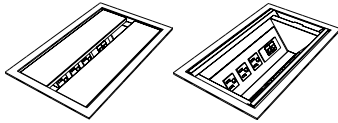

**Oasis Mini A, DaisyLink Version**

OAM-A-PC-4-1- <u>  </u>	15 x 9 x 5.25	92.5	16	1.53	<b>\$2227</b>
-------------------------	---------------	------	----	------	---------------



**For hardwire and daisy chain applications.** Mini Oasis A unit. 15" Trough with six power receptacles, two telecom plate cut-outs (**telecom plates sold separate**, see page 424). **Power infeed sold separate** (see page 426). **M1, M2 or M3 cut-out(s) must be specified on conference table** (see product notes section for more details and cut-out upcharge). For multiple circuit configurations, please contact customer service. *Please see our **Daisy-Chain guide** on page page 422 for appropriate cable lengths and important notes.* UL Listed: UL 183.

- Replace    with **B** for **Black** or **S** for **Silver Pearl**

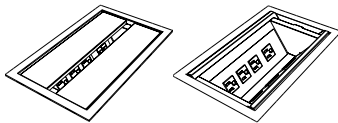

**Oasis Mini B, Corded**

OAM-B-PC- <u>  </u>	15 x 9 x 5.25	92.5	16	1.53	<b>\$1945</b>
---------------------	---------------	------	----	------	---------------



Mini Oasis B unit. 15" Trough with four power receptacles, three telecom plate cut-outs (**telecom plates sold separate**, see page 424) and one 108" 3-prong plug. **M1, M2 or M3 cut-out(s) must be specified on conference table** (see product notes section for more details and cut-out upcharge). UL Listed: UL 962A.

- **Cannot be daisy-chained.**
- Replace    with **B** for **Black** or **S** for **Silver Pearl**

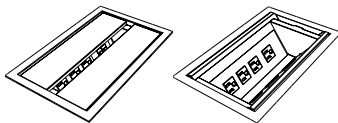

**Oasis Mini B, DaisyLink Version**

OAM-B-PC-4-1- <u>  </u>	15 x 9 x 5.25	92.5	16	1.53	<b>\$2227</b>
-------------------------	---------------	------	----	------	---------------



**For hardwire and daisy chain applications.** Mini Oasis B unit. 15" Trough with four power receptacles, three telecom plate cut-outs (**telecom plates sold separate**, see page 424). **Power infeed sold separate** (see page 426). **M1, M2 or M3 cut-out(s) must be specified on conference table** (see product notes section for more details and cut-out upcharge). For multiple circuit configurations, please contact customer service. *Please see our **Daisy-Chain guide** on page page 422 for appropriate cable lengths and important notes.* UL Listed: UL 183.

- Replace    with **B** for **Black**
- Replace    with **S** for **Silver Pearl**

### Required Specifications

Finish  
Power infeed  
Cut-out location

# T BOARDROOM TABLES

## OASIS MINI

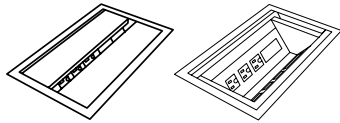

**Oasis Mini USB A+C, Corded**

MODEL#	DIMENSIONS D x W x H	FREIGHT CLASS	WT/LBS.	CUBIC FT.	LIST PRICE
305300.03_09	15 x 9 x 5.25	92.5	16	1.53	<b>\$2177</b>

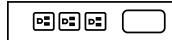
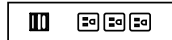

Mini Oasis USB unit. 15" trough with six power receptacles, (1) 2.4A Reversible USB-A Charging Port & (1) 60-Watt USB-C Power Delivery Port with GaN Technology and one telecom plate cut-out (**telecom plates sold separate**, see page 424) and two 108" 3-prong plugs. **M1, M2 or M3 cut-out(s) must be specified on conference table** (see product notes section for more details and cut-out upcharge). UL Listed: UL 962A.

- **Cannot be daisy-chained.**
- Replace \_ with **04** for **Black** or **27** for **Silver Pearl**

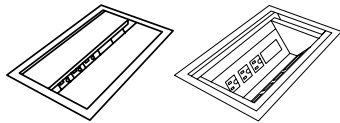

**Oasis Mini USB A+C, DaisyLink Version**

306023.03_C1	15 x 9 x 5.25	92.5	16	1.53	<b>\$2457</b>
--------------	---------------	------	----	------	---------------

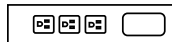
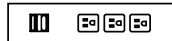

**For hardwire and daisy chain applications.** Mini Oasis USB unit. 15" trough with six power receptacles, one 2.4A reversible USB-A charging port & one 60-Watt USB-C Power Delivery Port with GaN Technology, and one telecom plate cut-out (**telecom plates sold separate**, see page 424). **Power infeed sold separate** (see page 426). **M1, M2 or M3 cut-out(s) must be specified on conference table** (see product notes section for more details and cut-out upcharge). For multiple circuit configurations, please contact customer service. *Please see our **Daisy-Chain guide** on page 422 for appropriate cable lengths and important notes.* UL Listed: UL 183.

- Replace \_ with **04** for **Black** or **27** for **Silver Pearl**

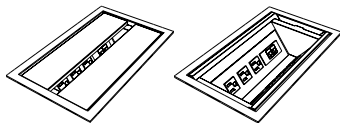

**Oasis Mini, Chicago Code**

GL-OAMPD_P72HW	15 x 9 x 5.25	92.5	16	1.53	<b>\$2652</b>
----------------	---------------	------	----	------	---------------

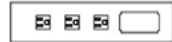

Mini Oasis for Chicago code includes electrical trough with (2) separate hardwire inserts. Each insert includes (3) simplex outlets and (1) telecom plate cut-out (**telecom plates sold separate**, see page 424). **M1, M2 or M3 cut-out(s) must be specified on conference table** (see product notes section for more details and cut-out upcharge). Each component is UL Listed: UL 962A.

- **Cannot be daisy-chained.**
- Replace \_ with **B** for **Black**
- Replace \_ with **S** for **Silver Pearl**

### Required Specifications

Finish  
Power infeed  
Cut-out location

OASIS MINI CUT OUT POSITIONS

D x W x H

**OASIS MINI A & B CABLE LENGTHS NEEDED FOR DAISY-CHAINING**

Model #	Oasis Mini A & Oasis Mini B	Oasis Mini A & Oasis Mini B	Oasis Mini A	Oasis Mini A	Oasis Mini B	Oasis Mini B
<b>Cut-out Positions</b>	TL/M & TR/M	TL/M & TR/M	TL/M, TC/M & TR/M	TL/M, TC/M & TR/M	TL/M, TC/M & TR/M	TL/M, TC/M & TR/M
<b>Infeed Position</b>	Left or Right	Center	Left or Right	Center	Left or Right	Center
<b>Reference</b>	Drawing 1A/1B	Drawing 2A/2B	Drawing 3	Drawing 4	Drawing 5	Drawing 6
<b>8' Dufferin &amp; Lufton Tables</b>	(1) 42FF-55 SPECIFY INFEED	(1) 42FF-29 (1) 42FM-29 (1) DAISY-T SPECIFY INFEED	N/A	N/A	N/A	N/A
<b>10' Dufferin &amp; Lufton Tables</b>	(1) 42FF-79 SPECIFY INFEED	(1) 42FF-41 (1) 42FM-41 (1) DAISY-T SPECIFY INFEED	(3) 42FF-37 SPECIFY INFEED	(3) 42FF-37 SPECIFY INFEED	(2) 42FF-37 SPECIFY INFEED	(2) 42FF-37 (1) 42FM-12 (1) DAISY-T SPECIFY INFEED
<b>12' Dufferin &amp; Lufton Tables</b>	(1) 42FF-103 SPECIFY INFEED	(1) 42FF-55 (1) 42FM-55 (1) DAISY-T SPECIFY INFEED	(3) 42FF-52 SPECIFY INFEED	(3) 42FF-52 SPECIFY INFEED	(2) 42FF-52 SPECIFY INFEED	(2) 42FF-52 (1) 42FM-12 (1) DAISY-T SPECIFY INFEED
<b>14' Dufferin &amp; Lufton Tables</b>	(1) 42FF-64 (1) 42FM-64 SPECIFY INFEED	1) 42FF-67 (1) 42FM-67 (1) DAISY-T SPECIFY INFEED	(3) 42FF-61 SPECIFY INFEED	(3) 42FF-61 SPECIFY INFEED	(2) 42FF-61 SPECIFY INFEED	(2) 42FF-61 (1) 42FM-12 (1) DAISY-T SPECIFY INFEED
<b>16' Dufferin &amp; Lufton Tables</b>	(1) 42FF-79 (1) 42FM-79 SPECIFY INFEED	1) 42FF-82 (1) 42FM-82 (1) DAISY-T SPECIFY INFEED	(3) 42FF-76 SPECIFY INFEED	(3) 42FF-76 SPECIFY INFEED	(2) 42FF-76 SPECIFY INFEED	(2) 42FF-76 (1) 42FM-12 (1) DAISY-T SPECIFY INFEED
<b>18' Dufferin &amp; Lufton Tables</b>	(1) 42FF-88 (1) 42FM-88 SPECIFY INFEED	1) 42FF-91 (1) 42FM-91 (1) DAISY-T SPECIFY INFEED	(3) 42FF-85 SPECIFY INFEED	(3) 42FF-85 SPECIFY INFEED	(2) 42FF-85 SPECIFY INFEED	(2) 42FF-85 (1) 42FM-12 (1) DAISY-T SPECIFY INFEED
<b>20' Dufferin &amp; Lufton Tables</b>	(1) 42FF-100 (1) 42FM-100 SPECIFY INFEED	1) 42FF-103 (1) 42FM-103 (1) DAISY-T SPECIFY INFEED	(3) 42FF-100 SPECIFY INFEED	(3) 42FF-100 SPECIFY INFEED	(2) 42FF-100 SPECIFY INFEED	(2) 42FF-100 (1) 42FM-12 (1) DAISY-T SPECIFY INFEED

**Interconnecting Cables - Common Cable Lengths (in inches)**

**Female/Female**

42FF-21 .....	\$116	42FF-94 .....	\$212	42FM-91 .....	\$215
42FF-29 .....	\$127	42FF-100 .....	\$219	42FM-94 .....	\$217
42FF-32 .....	\$129	42FF-103 .....	\$222	42FM-103 .....	\$231
42FF-37 .....	\$137	42FF-106 .....	\$225	42FM-106 .....	\$233
42FF-41 .....	\$142	42FF-112 .....	\$234	42FM-115 .....	\$245
42FF-46 .....	\$149	42FF-115 .....	\$240	42FM-118 .....	\$251
42FF-52 .....	\$157	42FF-118 .....	\$243		
42FF-55 .....	\$161				
42FF-58 .....	\$165	<b>Female/Male</b>			
42FF-61 .....	\$168	42FM-12 .....	\$111		
42FF-64 .....	\$172	42FM-21 .....	\$123		
42FF-67 .....	\$176	42FM-32 .....	\$137		
42FF-70 .....	\$179	42FM-46 .....	\$156		
42FF-76 .....	\$188	42FM-55 .....	\$167		
42FF-79 .....	\$192	42FM-58 .....	\$170		
42FF-82 .....	\$196	42FM-67 .....	\$182		
42FF-85 .....	\$200	42FM-70 .....	\$187		
42FF-88 .....	\$204	42FM-79 .....	\$199		
42FF-91 .....	\$208	42FM-82 .....	\$203		

# T BOARDROOM TABLES

## OASIS MINI NOTES

D x W x H

### DRAWING 1A - MINI OASIS A

Female/ Female Interconnecting Cable Included with Oasis A Unit

Female/ Female Interconnecting Cable Included with Oasis A Unit

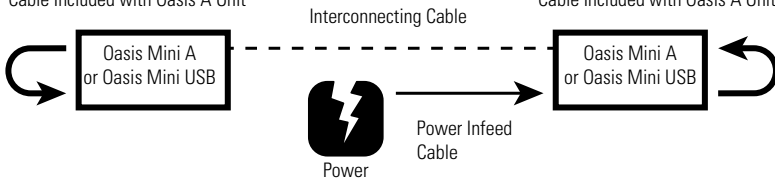

### DRAWING 1B - MINI OASIS B

Interconnecting Cable

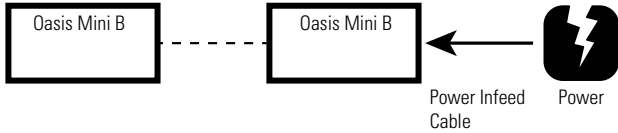

### DRAWING 2A - MINI OASIS A

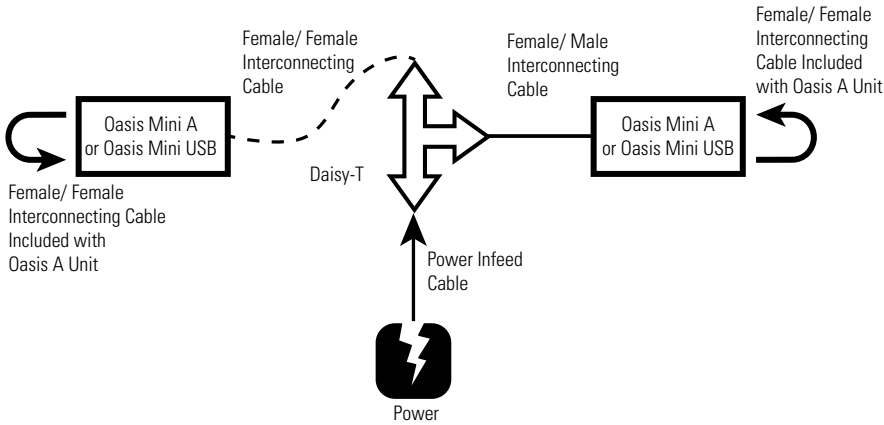

### DRAWING 2B - MINI OASIS B

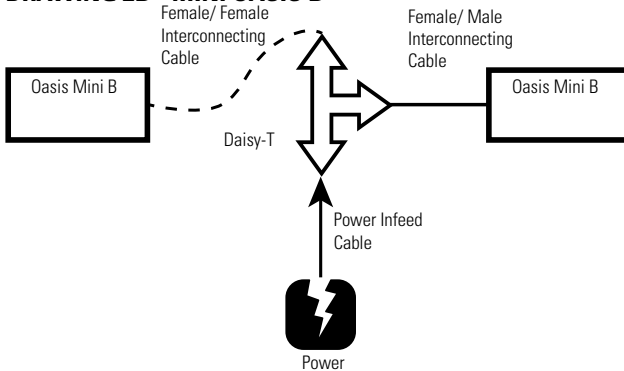

### DRAWING 3 - MINI OASIS A

Female/ Female Interconnecting Cable Included with Oasis A Unit

Female/ Female Interconnecting Cable

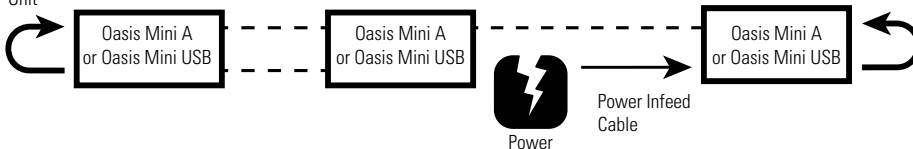

**OASIS MINI NOTES**

D x W x H

**DRAWING 4 - MINI OASIS A**

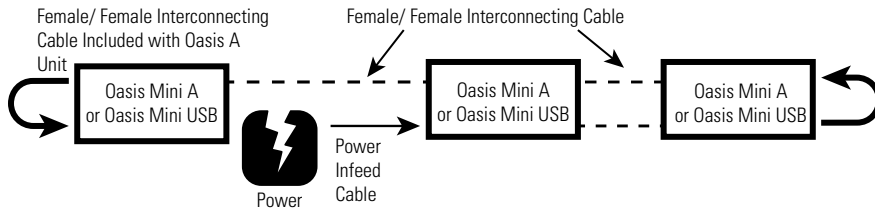

**DRAWING 5 - MINI OASIS B**

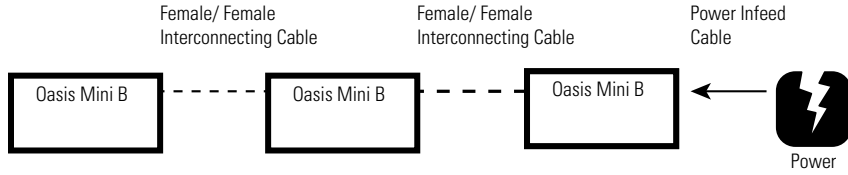



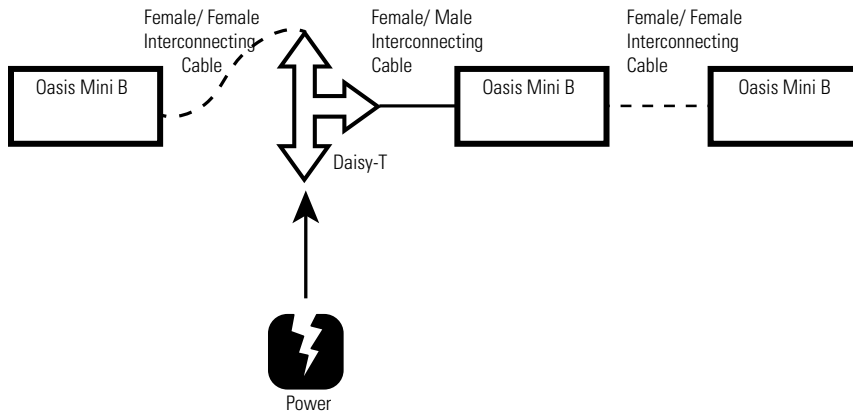





**DRAWING 6 - MINI OASIS B**

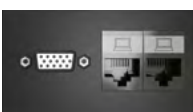





# T BOARDROOM TABLES

## TOP TELECOM PLATES

TOP TELECOM PLATE	MODEL	CONFIGURATION	D x W x H	LIST PRICE
	A-__-A-B	Telecom plate with RJ11 Cat 3 Phone and RJ45 Cat 6 Data		\$116
	A-__-B-B	(2) RJ45 Cat 6 Connectors		\$151
	A-__-B-B-B	(3) RJ45 Cat 6 Connectors		\$220
	A-__-B-B-B-B	(4) RJ45 Cat 6 Connectors		\$292
	A-__-B-C51-L	RJ45 Cat 6 Data, Mini-Stereo Inline and 15 pin HD VGA Female/Female with 72" patch cord attached.		\$260
	A-__-B-B-C51	(2) RJ45 Cat 6 Data and (1) 15 pin HD VGA Female/Female with 72" patch cord attached.		\$271
	A-__-A-B-102	RJ11 Cat 3 phone, RJ45 Cat 6 Data and USB with 72" patch cord attached.		\$260
	A-__-B	RJ45 Cat 6 Data		\$81
	A-__-C51-L	Mini Stereo Inline and 15 pin HD VGA Female/Female with 72" patch cord attached.		\$204
	A-__-CRDMINDER	Cordminder Plate - 2 5/8" holes and 1 7/8" holes		\$46
	A-__-C45-C51-L	HDMI Female/Female with 36" patch cord attached. Mini Stereo Inline and 15 Pin HD VGA Female/Female with 72" patch cord attached.		\$355

### Required Specifications

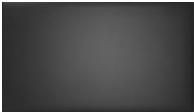
Finish  
Power infeed  
Cut-out location

TOP TELECOM PLATES		MODEL#	DIMENSIONS D x W x H	FREIGHT CLASS	WT/LBS.	CUBIC FT.	LIST PRICE
TOP TELECOM PLATE	MODEL	CONFIGURATION					LIST PRICE
	A-__-C45	HDMI Female/Female with 36" patch cord attached.					<b>\$175</b>
	A-__-A-B-B	(1) RJ11 Cat 3 Phone and (2) RJ45 Cat 6 data.					<b>\$190</b>
	A-__	Blank telecom plate					<b>\$29</b>
	A-__-102	USB with 72" patch cord attached.					<b>\$81</b>
	A-__-C51	15 pin HD VGA Female/Female with 72" patch cord attached.					<b>\$131</b>
<ul style="list-style-type: none"> <li>• Replace _ with <b>BL</b> for <b>Black</b></li> <li>• Replace _ with <b>GR</b> for <b>Grey</b></li> </ul>							

**Required Specifications**

Veneer Finish  
Laminate Finish  
Handle Style

**Optional Specifications**

Grommet

# T BOARDROOM TABLES

## POWER INFEEDS

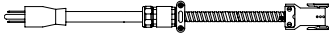

### Plug and Play Infeed

MODEL#	DIMENSIONS	FREIGHT CLASS	WT/LBS.	CUBIC FT.	LIST PRICE
	<b>D x W x H</b>				
42AP1-72	--	--	--	--	<b>\$261</b>

Single Circuit 20 AMP Power Infeed with 72" 3-prong plug. Provides single power entry from floor or wall mounted standard power supply. Connects to Oasis Mini or Villa units that require a separate infeed. UL Listed.

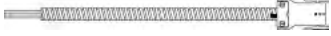

### Multi-Circuit Hardwire Power Infeed

42SB2-108	--	--	--	--	<b>\$217</b>
42SB2-72	--	--	--	--	<b>\$169</b>
42SB2-36	--	--	--	--	<b>\$123</b>

Multi-Circuit Hardwire Infeed (up to 20 AMPS per circuit), two circuits. Provides single power entry from floor or wall located building power supply. Connects to Oasis Mini or Villa units that require a power infeed. **TO BE HARDWIRED BY A LICENSED ELECTRICIAN.** UL Listed.

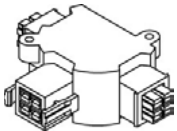

### 3 Way Power Splitter

DAISY-T	--	70	1	1	<b>\$200</b>
---------	----	----	---	---	--------------

Daisy-T power manager includes two male and one female connection. For use in splitting a power source two ways.

#### Required Specifications

Veneer Finish  
Laminate Finish  
Handle Style

#### Optional Specifications

Grommet