

T BOARDROOM TABLES - NOTES

1. SPECIFY MODEL NUMBER

2. SPECIFY FINISH

TOP FINISH - WOOD VENEER

Code	Finish	Veneer Type	Cut
AMW	Almond Cherry	Cherry	Flat Sliced
ACW	Amber Cherry	Cherry	Flat Sliced
BTW	Biscotti	White Oak	Rift
CAW	Cocoa Walnut	Walnut	Flat Sliced
CRW	Coral	White Oak	Rift
DCW	Dark Cherry	Cherry	Flat Sliced
DWW	Dark Walnut	Walnut	Flat Sliced
EWV	Espresso Walnut	Walnut	Flat Sliced
EVW	Evening Oak	White Oak	Rift
GRW	Grey on Oak	White Oak	Rift
HAW	Hazelnut	Maple	Flat Sliced
JAW	Java	White Oak	Rift
LTW	Latte Walnut	Walnut	Flat Sliced
MHW	Mahogany on Walnut	Walnut	Flat Sliced
MTW	Milestone	White Oak	Rift
MPW	Natural Maple	Maple	Flat Sliced
NLW	Natural Walnut	Walnut	Flat Sliced
RCW	Red Cherry	Cherry	Flat Sliced
VNW	Vintage Cherry	Cherry	Flat Sliced
ULW	Umber Walnut	Walnut	Flat Sliced
WLW	Walnut	Walnut	Flat Sliced
WCW	Warm Cherry	Cherry	Flat Sliced
WMW	White Maple	Maple	Flat Sliced

BASE FINISH (refer to specific model for availability):

K	Black
E	Tungsten

3. SPECIFY OPTIONS

Boardroom Tops

- Tops 120" and under ship in one piece
- Tops over 120" ship in two pieces
- Veneer wood grain will run with the **length** of the table and align at the seam

Grommets

- Optional grommets may be ordered in standard table top locations (left, center or right). Order as **GM1TL, GM1TC or GM1TR. Add \$96.**
- Grommet hole dimensions are 2 3/4" in diameter. Specify **GM1** for **Black** or **GM1K** for **Tungsten. Standard Grommet Locations:**

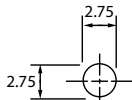

Grommet Locations - Boardroom Tables

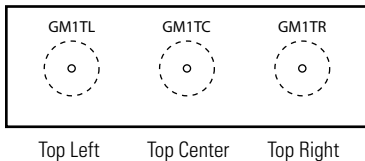

Power/Data Accessories

- Match power block desired with cut-out code and location from grid below.
- Please specify location in top as left, center or right (**TL/x, TC/x, or TR/x**) as per line drawing below. Location must be specified on product to be placed on at the time of the order. Please note orientation of power/data accessories on Boardroom Table tops as is shown in drawings below. **Add \$300** for each cut-out.
- When an "M" cut-out is ordered, certain bases will be notched to allow clearance for the Oasis Mini.

PRODUCT CODE DIAGRAM

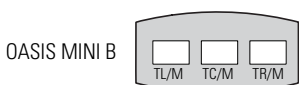
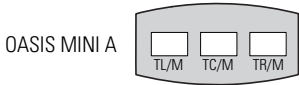
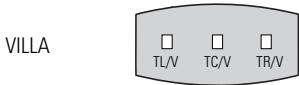
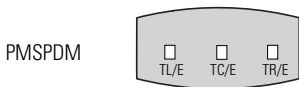

PRODUCT CODE DIAGRAM

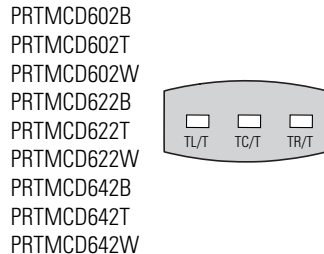
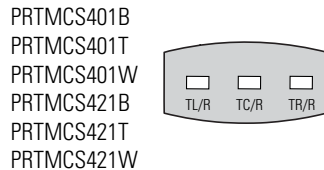

Custom Cut-out

- Optional custom sized cut-out available in standard locations - **CCUTL** (left), **CCUTC** (center) and **CCUTR** (right) for all boardroom table tops. Submit appropriate form (beginning on page 402) with order. **Add \$300** for each cut-out.

T BOARDROOM TABLES

BOARDROOM TABLE TOP AND BASE GUIDE

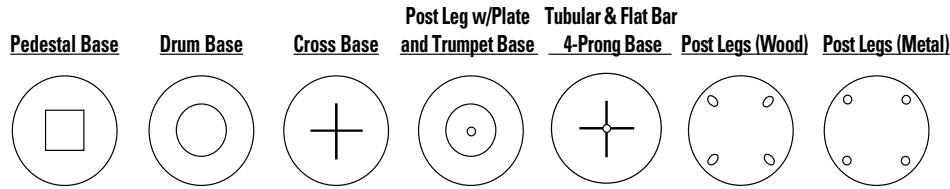

Requires 1 of the following: Pedestal, Drum, Cross, Post Leg w/Plate, Tubular and Flat Bar 4-Prong base, Trumpet Column Base

Requires 4 of the following: Wood Post Legs or Metal Post Legs.

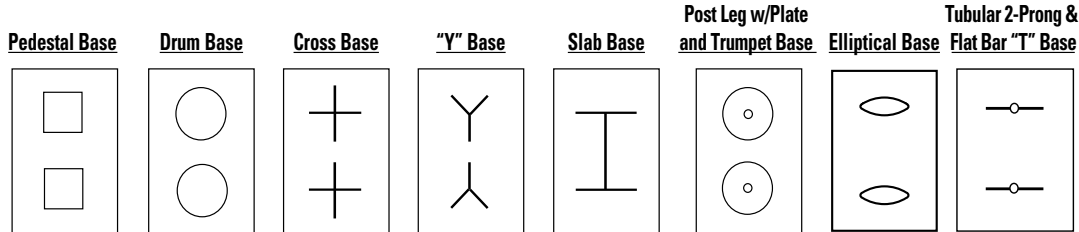

3-Prong Tubular or

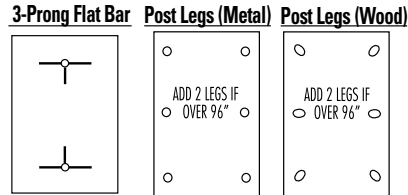
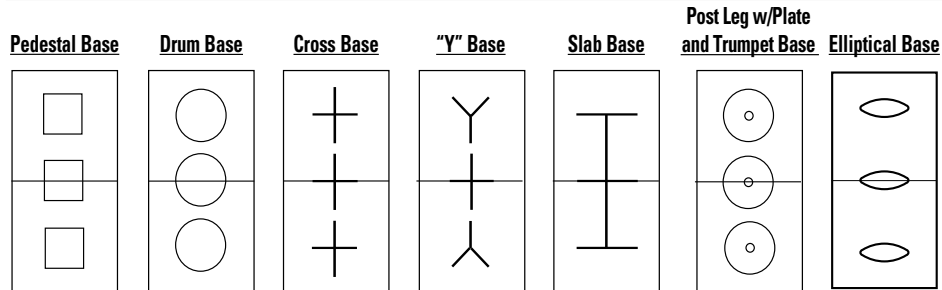

Table Tops up to 120" are in one section and require (2) bases.

Tubular, 2-Prong Base - Table Tops up to 84" require (2) bases.

Tubular and Flat Bar "T" Base - Table Tops up to 120" require (2) bases.

Post Legs - Table Tops up to 96" are in one section and require (4) legs. Tops 108" to 168" require (6) legs.



3-Prong Tubular or

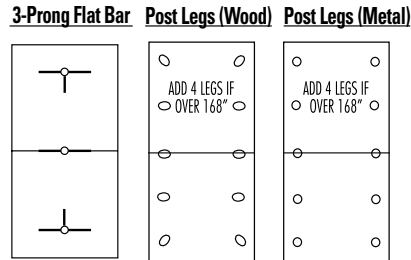

Table Tops 144" and over are in two sections and require (3) bases.

"Y" Base - Require (2) "Y" bases and (1) Cross base in the center.

Slab Base - Require (3) Slab bases.

Tubular and Flat Bar 3-Prong Base - Require (2) 3-Prong bases and (1) 2-Prong base in the center.

Post Legs - Table Tops 180" to 240" require (10) legs.

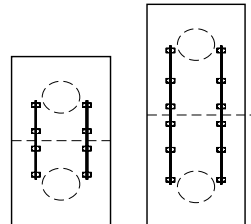

If design considerations or dimension requirements dictate an unsupported table joint, use metal table support rail.

Top section must not exceed 72" to use metal supports.

BOARDROOM TABLES - TOPS WITH DUFFERIN EDGE **MODEL#** **DIMENSIONS** **FREIGHT CLASS** **WT./LBS.** **CUBIC FT.** **LIST PRICE**

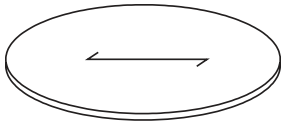

Round Top

	D x W x H					
RO60D	60 x 60 x 1.37	85	150	11		\$2942
RO48D	48 x 48 x 1.37	85	96	7		\$2353
RO42D	42 x 42 x 1.37	85	74	6		\$2128
RO36D	36 x 36 x 1.37	85	54	4		\$1807
RO30D	30 x 30 x 1.37	85	38	3		\$1265

For use with Drum Base, Pedestal Base, Cross Base, Wood Post Legs, Metal Post Legs, 4 Prong Base, Post leg w/Flat Plate, Flat Square Column Base, Trumpet Column base, Flat Bar "X" Base", Square Panel Base.

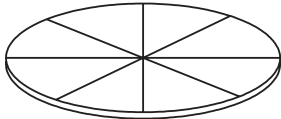

Round Top - Sunburst Veneer Pattern

RO60SD	60 x 60 x 1.37	85	150	11		\$3185
RO48SD	48 x 48 x 1.37	85	96	7		\$2694
RO42SD	42 x 42 x 1.37	85	74	6		\$2304
RO36SD	36 x 36 x 1.37	85	54	4		\$1983
RO30SD	30 x 30 x 1.37	85	38	3		\$1647

For use with Drum Base, Pedestal Base, "X" Shape Slab Base, Wood Post Legs, Metal Post Legs, 4 Prong Base, Post leg w/Flat Plate, Flat Square Column Base, Trumpet Column base, Flat Bar "X" Base", Square Panel Base.

RE24054D	54 x 240 x 1.37	85	540	39		\$9421
RE21654D	54 x 216 x 1.37	85	486	35		\$8479
RE19254D	54 x 192 x 1.37	85	432	31		\$7277
RE5454D	54 x 54 x 1.37	85	121	9		\$2071
RE16848D	48 x 168 x 1.37	85	336	25		\$5417
RE14448D	48 x 144 x 1.37	85	288	21		\$4081
RE12048D	48 x 120 x 1.37	85	240	18		\$3634
RE9648D	48 x 96 x 1.37	85	192	14		\$2681
RE4848D	48 x 48 x 1.37	85	96	7		\$1473
RE8442D	42 x 84 x 1.37	85	147	11		\$2471
RE7242D	42 x 72 x 1.37	85	126	9		\$2112
RE4242D	42 x 42 x 1.37	85	74	5		\$1378
RE8436D	36 x 84 x 1.37	85	126	9		\$2357
RE7236D	36 x 72 x 1.37	85	108	8		\$2021
RE6636D	36 x 66 x 1.37	85	99	7		\$1549
RE3636D	36 x 36 x 1.37	85	54	4		\$846
RE8430D	30 x 84 x 1.37	85	105	8		\$1967
RE7230D	30 x 72 x 1.37	85	90	7		\$1687
RE6630D	30 x 66 x 1.37	85	83	6		\$1549
RE6030D	30 x 60 x 1.37	85	75	6		\$1407
RE5430D	30 x 54 x 1.37	85	68	5		\$1270
RE3030D	30 x 30 x 1.37	85	38	3		\$709
RE8424D	24 x 84 x 1.37	85	84	6		\$1716
RE7224D	24 x 72 x 1.37	85	72	5		\$1471
RE6624D	24 x 66 x 1.37	85	66	5		\$1352
RE6024D	24 x 60 x 1.37	70	60	4		\$1228
RE5424D	24 x 54 x 1.37	85	55	4		\$1104
RE4824D	24 x 48 x 1.37	70	48	3		\$1064
RE2424D	24 x 24 x 1.37	125	21	3		\$489
RE8422D	22 x 84 x 1.37	85	77	6		\$1575
RE7222D	22 x 72 x 1.37	85	66	5		\$1352
RE6622D	22 x 66 x 1.37	85	61	5		\$1237
RE6022D	22 x 60 x 1.37	85	55	4		\$1126
RE5422D	22 x 54 x 1.37	85	50	4		\$1018
RE4822D	22 x 48 x 1.37	85	44	3		\$975
RE2222D	22 x 22 x 1.37	92.5	20	2		\$449

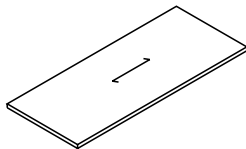

Rectangular Top

Grain runs the **length** of the worksurface. Tops 120" and under are shipped in one piece and require 2 bases. Tops 144" and over are shipped in two pieces and require 3 bases.

Required Specifications

Veneer Finish

Optional Specifications

Boardroom Table Base
Grommet (not available on Round Tops)
Custom cut-out

T BOARDROOM TABLES - DUFFERIN

BOARDROOM TABLES - TOPS

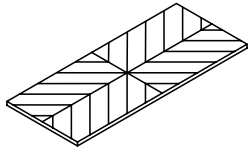

**Rectangular Top -
Reverse Diamond Pattern**

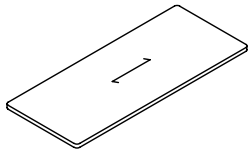

Rectangular Top Radius Corners

MODEL#	DIMENSIONS D x W x H	FREIGHT CLASS	WT./LBS.	CUBIC FT.	LIST PRICE
RE24054FD	54 x 240 x 1.37	85	540	39	\$10797
RE21654FD	54 x 216 x 1.37	85	486	35	\$9762
RE19254FD	54 x 192 x 1.37	85	432	31	\$8437
RE5454FD	54 x 54 x 1.37	85	119	9	\$2363
RE16848FD	48 x 168 x 1.37	85	336	25	\$6393
RE14448FD	48 x 144 x 1.37	85	288	21	\$4925
RE12048FD	48 x 120 x 1.37	85	240	18	\$4287
RE9648FD	48 x 96 x 1.37	85	192	14	\$3241
RE4848FD	48 x 48 x 1.37	85	98	7	\$1729
RE8442FD	42 x 84 x 1.37	85	147	11	\$2966
RE7242FD	42 x 72 x 1.37	85	126	9	\$2577
RE4242FD	42 x 42 x 1.37	85	74	5	\$1624
RE8436FD	36 x 84 x 1.37	85	126	9	\$2774
RE7236FD	36 x 72 x 1.37	85	108	8	\$2384
RE6636FD	36 x 66 x 1.37	85	99	7	\$1817
RE3636FD	36 x 36 x 1.37	85	54	4	\$1160
RE8430FD	30 x 84 x 1.37	85	105	8	\$2308
RE7230FD	30 x 72 x 1.37	85	90	7	\$2063
RE6630FD	30 x 66 x 1.37	85	83	6	\$1987
RE6030FD	30 x 60 x 1.37	85	75	6	\$1817
RE5430FD	30 x 54 x 1.37	85	68	5	\$1488
RE3030FD	30 x 30 x 1.37	85	38	3	\$825

Tops 120" and under are shipped in one piece and require 2 bases. Tops 144" and over are shipped in two pieces and require 3 bases.

RRE24054D	54 x 240 x 1.37	85	540	39	\$11486
RRE21654D	54 x 216 x 1.37	85	486	35	\$10400
RRE19254D	54 x 192 x 1.37	85	432	31	\$9020
RRE5454D	54 x 54 x 1.37	85	119	9	\$2515
RRE16848D	48 x 168 x 1.37	85	336	25	\$6882
RRE14448D	48 x 144 x 1.37	85	288	21	\$5344
RRE12048D	48 x 120 x 1.37	85	240	18	\$4613
RRE9648D	48 x 96 x 1.37	85	192	14	\$3519
RRE4848D	48 x 48 x 1.37	85	98	7	\$1851
RRE8442D	42 x 84 x 1.37	85	147	11	\$3216
RRE7242D	42 x 72 x 1.37	85	126	9	\$2805
RRE4242D	42 x 42 x 1.37	85	74	5	\$1741
RRE8436D	36 x 84 x 1.37	85	126	9	\$2987
RRE7236D	36 x 72 x 1.37	85	108	8	\$2562
RRE6636D	36 x 66 x 1.37	85	99	7	\$1954
RRE3636D	36 x 36 x 1.37	85	54	4	\$1073
RRE8430D	30 x 84 x 1.37	85	105	8	\$2485
RRE7230D	30 x 72 x 1.37	85	90	7	\$2130
RRE6630D	30 x 66 x 1.37	85	83	6	\$1954
RRE6030D	30 x 60 x 1.37	85	75	6	\$1782
RRE5430D	30 x 54 x 1.37	85	68	5	\$1598
RRE3030D	30 x 30 x 1.37	85	38	3	\$894

Grain runs the **length** of the worksurface. Tops 120" and under are shipped in one piece and require 2 bases. Tops 144" and over are shipped in two pieces and require 3 bases.

Required Specifications
Veneer Finish

Optional Specifications
Boardroom Table Base
Grommet
Custom cut-out

BOARDROOM TABLES - TOPS

MODEL#	DIMENSIONS	FREIGHT CLASS	WT/LBS.	CUBIC FT.	LIST PRICE
--------	------------	---------------	---------	-----------	------------

D x W x H

REBE24054D	54 x 240 x 1.37	85	540	39	\$10659
REBE21654D	54 x 216 x 1.37	85	486	35	\$9683
REBE19254D	54 x 192 x 1.37	85	432	31	\$8451
REBE16848D	48 x 168 x 1.37	85	336	25	\$6487
REBE14448D	48 x 144 x 1.37	85	288	21	\$5135
REBE12048D	48 x 120 x 1.37	85	240	18	\$4361
REBE9648D	48 x 96 x 1.37	85	192	14	\$3384
REBE8442D	42 x 84 x 1.37	85	147	11	\$3084
REBE7242D	42 x 72 x 1.37	85	126	9	\$2714
REBE8436D	36 x 84 x 1.37	85	126	9	\$2714
REBE7236D	36 x 72 x 1.37	85	108	8	\$2323
REBE6636D	36 x 66 x 1.37	85	99	7	\$1777
REBE8430D	30 x 84 x 1.37	85	105	8	\$2261
REBE7230D	30 x 72 x 1.37	85	90	7	\$1940
REBE6630D	30 x 66 x 1.37	85	83	6	\$1777
REBE6030D	30 x 60 x 1.37	85	75	6	\$1611
REBE5430D	30 x 54 x 1.37	85	68	5	\$1455

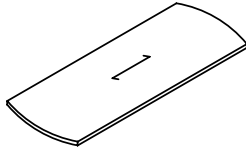
Rectangular Top - Bow Ends

Grain runs the **length** of the worksurface. Tops 120" and under are shipped in one piece and require 2 bases. Tops 144" and over are shipped in two pieces and require 3 bases.

RA24054D	54 x 240 x 1.37	85	540	39	\$12978
RA21654D	54 x 216 x 1.37	85	486	35	\$10963
RA19254D	54 x 192 x 1.37	85	432	31	\$10369
RA16848D	48 x 168 x 1.37	85	336	25	\$7763
RA14448D	48 x 144 x 1.37	85	288	21	\$6099
RA12048D	48 x 120 x 1.37	85	240	18	\$5411
RA9648D	48 x 96 x 1.37	85	192	14	\$4297
RA8442D	42 x 84 x 1.37	85	147	11	\$3892
RA7242D	42 x 72 x 1.37	85	126	9	\$3417
RA8436D	36 x 84 x 1.37	85	126	9	\$3533
RA7236D	36 x 72 x 1.37	85	108	8	\$3027
RA6636D	36 x 66 x 1.37	85	99	7	\$2315
RA8430D	30 x 84 x 1.37	85	105	8	\$2945
RA7230D	30 x 72 x 1.37	85	90	7	\$2528
RA6630D	30 x 66 x 1.37	85	83	6	\$2315
RA6030D	30 x 60 x 1.37	85	75	6	\$2105
RA5430D	30 x 54 x 1.37	85	68	5	\$1898
RA8422D	22 x 84 x 1.37	85	77	6	\$2357
RA7222D	22 x 72 x 1.37	85	66	5	\$2021
RA6622D	22 x 66 x 1.37	85	61	5	\$1851
RA6022D	22 x 60 x 1.37	85	55	4	\$1687
RA5422D	22 x 54 x 1.37	85	50	4	\$1516
RA4822D	22 x 48 x 1.37	85	44	3	\$1462

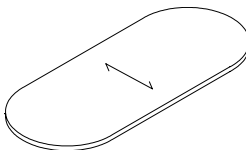
Racetrack Top - Cross Grain

Grain runs the **depth** of the worksurface. Tops 120" and under are shipped in one piece and require 2 bases. Tops 144" and over are shipped in two pieces and require 3 bases.

Required Specifications

Veneer Finish

Optional Specifications

 Boardroom Table Base
 Grommet
 Custom cut-out

T BOARDROOM TABLES - DUFFERIN

BOARDROOM TABLES - TOPS

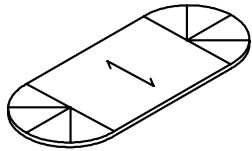

**Racetrack Top Cross Grain Center,
Sunburst Veneer Pattern on Left & Right**

MODEL#	DIMENSIONS D x W x H	FREIGHT CLASS	WT/LBS.	CUBIC FT.	LIST PRICE
RA24054SD	54 x 240 x 1.37	85	540	39	\$13984
RA21654SD	54 x 216 x 1.37	85	486	35	\$11952
RA19254SD	54 x 192 x 1.37	85	432	31	\$11351
RA16848SD	48 x 168 x 1.37	85	336	25	\$8718
RA14448SD	48 x 144 x 1.37	85	288	21	\$7035
RA12048SD	48 x 120 x 1.37	85	240	18	\$6050
RA9648SD	48 x 96 x 1.37	85	192	14	\$4931
RA8442SD	42 x 84 x 1.37	85	147	11	\$4389
RA7242SD	42 x 72 x 1.37	85	126	9	\$3964
RA8436SD	36 x 84 x 1.37	85	126	9	\$3964
RA7236SD	36 x 72 x 1.37	85	108	8	\$3396
RA6636SD	36 x 66 x 1.37	85	99	7	\$2596
RA8430SD	30 x 84 x 1.37	85	105	8	\$3300
RA7230SD	30 x 72 x 1.37	85	90	7	\$2835
RA6630SD	30 x 66 x 1.37	85	83	6	\$2596
RA6030SD	30 x 60 x 1.37	85	75	6	\$2363
RA5430SD	30 x 54 x 1.37	85	68	5	\$2126
RA8422SD	22 x 84 x 1.37	85	77	6	\$2646
RA7222SD	22 x 72 x 1.37	85	66	5	\$2268
RA6622SD	22 x 66 x 1.37	85	61	5	\$2084
RA6022SD	22 x 60 x 1.37	85	55	4	\$1891
RA5422SD	22 x 54 x 1.37	85	50	4	\$1701
RA4822SD	22 x 48 x 1.37	85	44	3	\$1639

Grain runs the **depth** of the worksurface. Tops 120" and under are shipped in one piece and require 2 bases. Tops 144" and over are shipped in two pieces and require 3 bases.

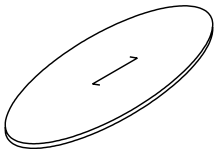

Oval Top

OV24054D	54 x 240 x 1.37	85	540	39	\$16223
OV21654D	54 x 216 x 1.37	85	486	35	\$13703
OV19254D	54 x 192 x 1.37	85	432	31	\$12960
OV16848D	48 x 168 x 1.37	85	336	25	\$9700
OV14448D	48 x 144 x 1.37	85	288	21	\$7625
OV12048D	48 x 120 x 1.37	85	240	18	\$6763
OV9648D	48 x 96 x 1.37	85	192	14	\$5370
OV8442D	42 x 84 x 1.37	85	147	11	\$4865
OV7242D	42 x 72 x 1.37	85	126	9	\$4270
OV8436D	36 x 84 x 1.37	85	126	9	\$4270
OV7236D	36 x 72 x 1.37	85	108	8	\$3661
OV6636D	36 x 66 x 1.37	85	99	7	\$2797
OV8430D	30 x 84 x 1.37	85	105	8	\$3684
OV7230D	30 x 72 x 1.37	85	90	7	\$3159
OV6630D	30 x 66 x 1.37	85	83	6	\$2898
OV6030D	30 x 60 x 1.37	85	75	6	\$2629
OV5430D	30 x 54 x 1.37	85	68	5	\$2370
OV8422D	22 x 84 x 1.37	85	77	6	\$2945
OV7222D	22 x 72 x 1.37	85	66	5	\$2528
OV6622D	22 x 66 x 1.37	85	61	5	\$2315
OV6022D	22 x 60 x 1.37	85	55	4	\$2105
OV5422D	22 x 54 x 1.37	85	50	4	\$1898
OV4822D	22 x 48 x 1.37	85	44	3	\$1824

Grain runs the **length** of the worksurface. Tops 120" and under are shipped in one piece and require 2 bases. Tops 144" and over are shipped in two pieces and require 3 bases.

Required Specifications

Veneer Finish

Optional Specifications

Boardroom Table Base

Grommet

Custom cut-out

BOARDROOM TABLES - TOPS

MODEL#	DIMENSIONS	FREIGHT CLASS	WT/LBS.	CUBIC FT.	LIST PRICE
--------	------------	---------------	---------	-----------	------------

D x W x H

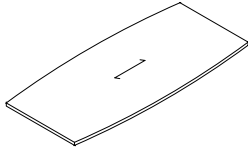

Boat Shape Top

B024054D	54 x 240 x 1.37	85	540	39	\$10559
B021654D	54 x 216 x 1.37	85	486	35	\$9491
B019254D	54 x 192 x 1.37	85	432	31	\$8419
B016848D	48 x 168 x 1.37	85	336	25	\$6708
B014448D	48 x 144 x 1.37	85	288	21	\$5429
B012048D	48 x 120 x 1.37	85	240	18	\$4546
B09648D	48 x 96 x 1.37	85	192	14	\$3690
B08442D	42 x 84 x 1.37	85	147	11	\$3405
B07242D	42 x 72 x 1.37	85	126	9	\$2999

Grain runs the **length** of the worksurface. Tops 120" and under are shipped in one piece and require 2 bases. Tops 144" and over are shipped in two pieces and require 3 bases.

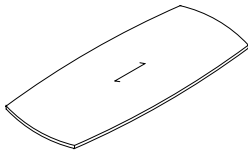

Boat Shape Top - Bow Ends

BOBE24054D	54 x 240 x 1.37	85	540	39	\$12138
BOBE21654D	54 x 216 x 1.37	85	486	35	\$10914
BOBE19254D	54 x 192 x 1.37	85	432	31	\$9683
BOBE5454D	54 x 54 x 1.37	85	121	9	\$2726
BOBE16848D	48 x 168 x 1.37	85	336	25	\$7713
BOBE14448D	48 x 144 x 1.37	85	288	21	\$6236
BOBE12048D	48 x 120 x 1.37	85	240	18	\$5231
BOBE9648D	48 x 96 x 1.37	85	192	14	\$4245
BOBE4848D	48 x 48 x 1.37	85	96	7	\$2303
BOBE8442D	42 x 84 x 1.37	85	147	11	\$3918
BOBE7242D	42 x 72 x 1.37	85	126	9	\$3453
BOBE4242D	42 x 42 x 1.37	85	74	5	\$2009

Grain runs the **length** of the worksurface. Tops 120" and under are shipped in one piece and require 2 bases. Tops 144" and over are shipped in two pieces and require 3 bases.

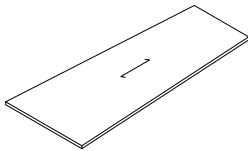

Wedge Shape Top

WE2405442D	54 - 42 x 240 x 1.37	85	540	39	\$9272
WE2165442D	54 - 42 x 216 x 1.37	85	486	35	\$8419
WE1925442D	54 - 42 x 192 x 1.37	85	432	31	\$7351
WE1684836D	48 - 36 x 168 x 1.37	85	336	25	\$5640
WE1444836D	48 - 36 x 144 x 1.37	85	288	21	\$4464
WE1204836D	48 - 36 x 120 x 1.37	85	240	18	\$3793
WE964836D	48 - 36 x 96 x 1.37	85	192	14	\$2941
WE844230D	42 - 30 x 84 x 1.37	85	147	11	\$2678
WE724230D	42 - 30 x 72 x 1.37	85	126	9	\$2357
WE843624D	36 - 24 x 84 x 1.37	85	126	9	\$2357
WE723624D	36 - 24 x 72 x 1.37	85	108	8	\$2021
WE663624D	36 - 24 x 66 x 1.37	85	99	7	\$1549

Grain runs the **length** of the worksurface. Tops 120" and under are shipped in one piece and require 2 bases. Tops 144" and over are shipped in two pieces and require 3 bases.

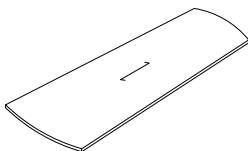

Wedge Shape Top - Bow Ends

WEBE2405442D	54 - 42 x 240 x 1.37	85	540	39	\$10659
WEBE2165442D	54 - 42 x 216 x 1.37	85	486	35	\$9683
WEBE1925442D	54 - 42 x 192 x 1.37	85	432	31	\$8451
WEBE1684836D	48 - 36 x 168 x 1.37	85	336	25	\$6487
WEBE1444836D	48 - 36 x 144 x 1.37	85	288	21	\$5135
WEBE1204836D	48 - 36 x 120 x 1.37	85	240	18	\$4361
WEBE964836D	48 - 36 x 96 x 1.37	85	192	14	\$3384
WEBE844230D	42 - 30 x 84 x 1.37	85	147	11	\$3084
WEBE724230D	42 - 30 x 72 x 1.37	85	126	9	\$2714
WEBE843624D	36 - 24 x 84 x 1.37	85	126	9	\$2714
WEBE723624D	36 - 24 x 72 x 1.37	85	108	8	\$2323
WEBE663624D	36 - 24 x 66 x 1.37	85	99	7	\$1777

Grain runs the **length** of the worksurface. Tops 120" and under are shipped in one piece and require 2 bases. Tops 144" and over are shipped in two pieces and require 3 bases.

Required Specifications

Veneer Finish

Optional Specifications

Boardroom Table Base
Grommet
Custom cut-out

T BOARDROOM TABLES - LUFTON

BOARDROOM TABLES - TOPS WITH LUFTON EDGE

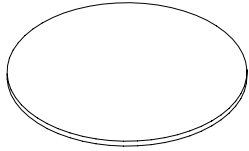

Round Top

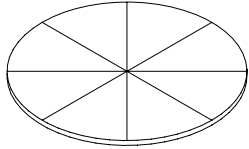

Round Top - Sunburst Veneer Pattern

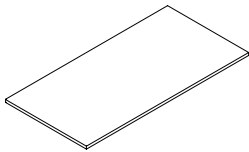

Rectangular Top

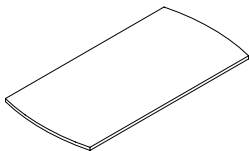

Rectangular Top - Bow Ends

MODEL#	DIMENSIONS D x W x H	FREIGHT CLASS	WT./LBS.	CUBIC FT.	LIST PRICE
RO60L	60 x 60 x 1.37	85	150	11	\$2870
RO48L	48 x 48 x 1.37	85	96	7	\$2291
RO42L	42 x 42 x 1.37	85	74	6	\$2065
RO36L	36 x 36 x 1.37	85	54	4	\$1840
RO30L	30 x 30 x 1.37	85	38	3	\$1228

For use with Drum Base, Pedestal Base, Cross Base, Wood Post Legs, Metal Post Legs, 4 Prong Base, Post leg w/Flat Plate, Flat Square Column Base, Trumpet Column base, Flat Bar "X" Base", Square Panel Base.

RO60SL	60 x 60 x 1.37	85	150	11	\$3149
RO48SL	48 x 48 x 1.37	85	96	7	\$2591
RO42SL	42 x 42 x 1.37	85	74	6	\$2243
RO36SL	36 x 36 x 1.37	85	54	4	\$2021
RO30SL	30 x 30 x 1.37	85	38	3	\$1787

For use with Drum Base, Pedestal Base, Cross Base, Wood Post Legs, Metal Post Legs, 4 Prong Base, Post leg w/Flat Plate, Flat Square Column Base, Trumpet Column base, Flat Bar "X" Base", Square Panel Base.

RE24054L	54 x 240 x 1.37	85	540	39	\$8936
RE21654L	54 x 216 x 1.37	85	486	35	\$8110
RE19254L	54 x 192 x 1.37	85	432	31	\$7079
RE16848L	48 x 168 x 1.37	85	336	25	\$5430
RE14448L	48 x 144 x 1.37	85	288	21	\$4298
RE12048L	48 x 120 x 1.37	300	240	18	\$3654
RE9648L	48 x 96 x 1.37	85	192	14	\$2833
RE8442L	42 x 84 x 1.37	85	147	11	\$2581
RE7242L	42 x 72 x 1.37	85	126	9	\$2270
RE8436L	36 x 84 x 1.37	85	126	9	\$2270
RE7236L	36 x 72 x 1.37	85	108	8	\$1947
RE6636L	36 x 66 x 1.37	92.5	99	7	\$1492
RE8430L	30 x 84 x 1.37	85	105	8	\$1894
RE7230L	30 x 72 x 1.37	85	90	7	\$1624
RE6630L	30 x 66 x 1.37	85	83	6	\$1492
RE6030L	30 x 60 x 1.37	85	75	6	\$1357
RE5430L	30 x 54 x 1.37	85	68	5	\$1218
RE4830L	30 x 48 x 1.37	85	44	3	\$1192

Grain runs the **length** of the worksurface. Tops 120" and under are shipped in one piece and require 2 bases. Tops 144" and over are shipped in two pieces and require 3 bases.

REBE24054L	54 x 240 x 1.37	85	540	39	\$10271
REBE21654L	54 x 216 x 1.37	85	486	35	\$9321
REBE19254L	54 x 192 x 1.37	85	432	31	\$8140
REBE16848L	48 x 168 x 1.37	85	336	25	\$6246
REBE14448L	48 x 144 x 1.37	85	288	21	\$4943
REBE12048L	48 x 120 x 1.37	300	240	18	\$4201
REBE9648L	48 x 96 x 1.37	85	192	14	\$3258
REBE8442L	42 x 84 x 1.37	85	147	11	\$2967
REBE7242L	42 x 72 x 1.37	85	126	9	\$2613
REBE8436L	36 x 84 x 1.37	85	126	9	\$2613
REBE7236L	36 x 72 x 1.37	85	108	8	\$2238

Grain runs the **length** of the worksurface. Tops 120" and under are shipped in one piece and require 2 bases. Tops 144" and over are shipped in two pieces and require 3 bases.

Required Specifications

Veneer Finish

Optional Specifications

Boardroom Table Base
Grommet
Custom cut-out

BOARDROOM TABLES - TOPS W/LUFTON EDGE

MODEL# DIMENSIONS FREIGHT CLASS WT/LBS. CUBIC FT. LIST PRICE

D x W x H

RA24054L	54 x 240 x 1.37	85	540	39	\$12021
RA21654L	54 x 216 x 1.37	85	486	35	\$10271
RA19254L	54 x 192 x 1.37	85	432	31	\$9755
RA16848L	48 x 168 x 1.37	85	336	25	\$7491
RA14448L	48 x 144 x 1.37	85	288	21	\$6048
RA12048L	48 x 120 x 1.37	300	240	18	\$5200
RA9648L	48 x 96 x 1.37	85	192	14	\$4232
RA8442L	42 x 84 x 1.37	85	147	11	\$3815
RA7242L	42 x 72 x 1.37	85	126	9	\$3408
RA8436L	36 x 84 x 1.37	85	126	9	\$3408
RA7236L	36 x 72 x 1.37	85	108	8	\$2919
RA6636L	36 x 66 x 1.37	92.5	99	7	\$2230

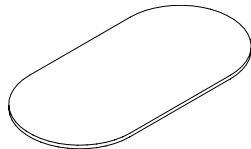

Racetrack Top - Cross Grain

Grain runs the **depth** of the worksurface. Tops 120" and under are shipped in one piece and require 2 bases. Tops 144" and over are shipped in two pieces and require 3 bases.

B024054L	54 x 240 x 1.37	85	540	39	\$10162
B021654L	54 x 216 x 1.37	85	486	35	\$9138
B019254L	54 x 192 x 1.37	85	432	31	\$8110
B016848L	48 x 168 x 1.37	85	336	25	\$6462
B014448L	48 x 144 x 1.37	85	288	21	\$5220
B012048L	48 x 120 x 1.37	85	240	18	\$4378
B09648L	48 x 96 x 1.37	85	192	14	\$3559
B08442L	42 x 84 x 1.37	85	147	11	\$3277
B07242L	42 x 72 x 1.37	85	126	9	\$2892

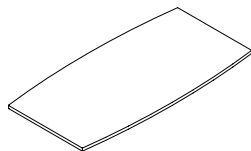

Boat Shape Top

Grain runs the **length** of the worksurface. Tops 120" and under are shipped in one piece and require 2 bases. Tops 144" and over are shipped in two pieces and require 3 bases.

BOBE24054L	54 x 240 x 1.37	85	540	39	\$11692
BOBE21654L	54 x 216 x 1.37	85	486	35	\$10512
BOBE19254L	54 x 192 x 1.37	85	432	31	\$9321
BOBE5454L	54 x 54 x 1.37	85	121	9	\$2624
BOBE16848L	48 x 168 x 1.37	85	336	25	\$7427
BOBE14448L	48 x 144 x 1.37	85	288	21	\$6011
BOBE12048L	48 x 120 x 1.37	85	240	18	\$5035
BOBE9648L	48 x 96 x 1.37	85	192	14	\$3090
BOBE4848L	48 x 48 x 1.37	85	96	7	\$2222
BOBE8442L	42 x 84 x 1.37	85	147	11	\$3438
BOBE7242L	42 x 72 x 1.37	85	126	9	\$3320
BOBE4242L	42 x 42 x 1.37	85	74	5	\$1941

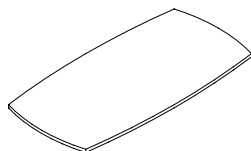

Boat Shape Top - Bow Ends

Grain runs the **length** of the worksurface. Tops 120" and under are shipped in one piece and require 2 bases. Tops 144" and over are shipped in two pieces and require 3 bases.

Required Specifications

Veneer Finish

Optional Specifications

Boardroom Table Base
Grommet
Custom cut-out

T BOARDROOM TABLES - LUFTON

BOARDROOM TABLES - TOPS W/LUFTON EDGE

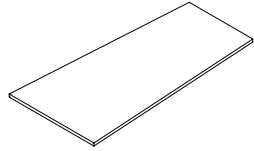

Wedge Shape Top

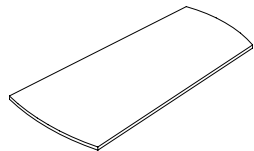

Wedge Shape Top - Bow Ends

MODEL#	DIMENSIONS	FREIGHT CLASS	WT/LBS.	CUBIC FT.	LIST PRICE
D x W x H					
WE2405442L	54 - 42 x 240 x 1.37	85	540	39	\$8936
WE2165442L	54 - 42 x 216 x 1.37	85	486	35	\$8110
WE1925442L	54 - 42 x 192 x 1.37	85	432	31	\$7079
WE1684836L	48 - 36 x 168 x 1.37	85	336	25	\$5430
WE1444836L	48 - 36 x 144 x 1.37	85	288	21	\$4298
WE1204836L	48 - 36 x 120 x 1.37	85	240	18	\$3654
WE964836L	48 - 36 x 96 x 1.37	85	192	14	\$3541
WE844230L	42 - 30 x 84 x 1.37	85	147	11	\$2581
WE724230L	42 - 30 x 72 x 1.37	85	126	9	\$2270

Grain runs the **length** of the worksurface. Tops 120" and under are shipped in one piece and require 2 bases. Tops 144" and over are shipped in two pieces and require 3 bases.

WEBE2405442L	54 - 42 x 240 x 1.37	85	540	39	\$10271
WEBE2165442L	54 - 42 x 216 x 1.37	85	486	35	\$9321
WEBE1925442L	54 - 42 x 192 x 1.37	85	432	31	\$8140
WEBE1684836L	48 - 36 x 168 x 1.37	85	336	25	\$6246
WEBE1444836L	48 - 36 x 144 x 1.37	85	288	21	\$4943
WEBE1204836L	48 - 36 x 120 x 1.37	85	240	18	\$4201
WEBE964836L	48 - 36 x 96 x 1.37	85	192	14	\$3258
WEBE844230L	42 - 30 x 84 x 1.37	85	147	11	\$2967
WEBE724230L	42 - 30 x 72 x 1.37	85	126	9	\$2613

Grain runs the **length** of the worksurface. Tops 120" and under are shipped in one piece and require 2 bases. Tops 144" and over are shipped in two pieces and require 3 bases.

Required Specifications

Veneer Finish

Optional Specifications

Boardroom Table Base
Grommet
Custom cut-out

BOARDROOM TABLES - TOPS W/PHILADELPHIA EDGE **MODEL#** **DIMENSIONS** **FREIGHT CLASS** **WT./LBS.** **CUBIC FT.** **LIST PRICE**

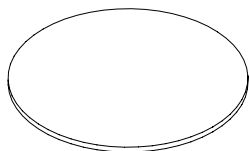

Round Top

	D x W x H					
RO60PB	60 x 60 x 1.5	85	150	11		\$4958
RO48PB	48 x 48 x 1.5	85	96	7		\$3967
RO42PB	42 x 42 x 1.5	85	74	6		\$3563
RO36PB	36 x 36 x 1.5	85	54	4		\$3177
RO30PB	30 x 30 x 1.5	85	38	3		\$2649

For use with Drum Base, Pedestal Base, Cross Base, Wood Post Legs, Metal Post Legs, 4 Prong Base, Post leg w/Flat Plate, Flat Square Column Base, Trumpet Column base, Flat Bar "X" Base", Square Panel Base.

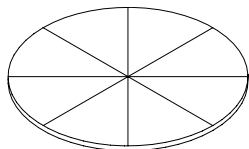

Round Top - Sunburst Veneer Pattern

RO60SPB	60 x 60 x 1.5	85	150	11		\$5451
RO48SPB	48 x 48 x 1.5	85	96	7		\$4479
RO42SPB	42 x 42 x 1.5	85	74	6		\$3875
RO36SPB	36 x 36 x 1.5	85	54	4		\$3486
RO30SPB	30 x 30 x 1.5	85	38	3		\$3090

For use with Drum Base, Pedestal Base, Cross Base, Wood Post Legs, Metal Post Legs, 4 Prong Base, Post leg w/Flat Plate, Flat Square Column Base, Trumpet Column base, Flat Bar "X" Base", Square Panel Base.

RE24054PB	54 x 240 x 1.5	85	540	39		\$15450
RE21654PB	54 x 216 x 1.5	85	486	35		\$14026
RE19254PB	54 x 192 x 1.5	85	432	31		\$12243
RE5454PB	54 x 54 x 1.5	85	121	9		\$3443
RE16848PB	48 x 168 x 1.5	85	336	25		\$9393
RE14448PB	48 x 144 x 1.5	85	288	21		\$7435
RE12048PB	48 x 120 x 1.5	85	240	18		\$6319
RE9648PB	48 x 96 x 1.5	85	192	14		\$4899
RE4848PB	48 x 48 x 1.5	85	96	7		\$2447
RE8442PB	42 x 84 x 1.5	85	147	11		\$4461
RE7242PB	42 x 72 x 1.5	85	126	9		\$3925
RE4242PB	42 x 42 x 1.5	85	74	5		\$2293
RE8436PB	36 x 84 x 1.5	85	126	9		\$3991
RE7236PB	36 x 72 x 1.5	85	108	8		\$3370
RE6636PB	36 x 66 x 1.5	85	99	7		\$2573
RE3636PB	36 x 36 x 1.5	85	54	4		\$1402
RE8430PB	30 x 84 x 1.5	85	105	8		\$3273
RE7230PB	30 x 72 x 1.5	85	90	7		\$2810
RE6630PB	30 x 66 x 1.5	85	83	6		\$2573
RE6030PB	30 x 60 x 1.5	85	75	6		\$2335
RE5430PB	30 x 54 x 1.5	85	68	5		\$2110
RE3030PB	30 x 30 x 1.5	85	38	3		\$1170
RE8424PB	24 x 84 x 1.5	85	84	6		\$2856
RE7224PB	24 x 72 x 1.5	85	72	5		\$2444
RE6624PB	24 x 66 x 1.5	85	66	5		\$2242
RE6024PB	24 x 60 x 1.5	70	60	4		\$2038
RE5424PB	24 x 54 x 1.5	85	55	4		\$1837
RE4824PB	24 x 48 x 1.5	70	48	3		\$1764
RE2424PB	24 x 24 x 1.5	125	21	3		\$814
RE8422PB	22 x 84 x 1.5	85	77	6		\$2622
RE7222PB	22 x 72 x 1.5	85	66	5		\$2242
RE6622PB	22 x 66 x 1.5	85	61	5		\$2058
RE6022PB	22 x 60 x 1.5	85	55	4		\$1873
RE5422PB	22 x 54 x 1.5	85	50	4		\$1680
RE4822PB	22 x 48 x 1.5	85	44	3		\$1620
RE2222PB	22 x 22 x 1.5	92.5	20	2		\$744

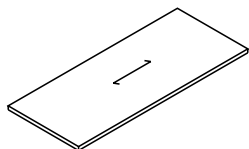

Rectangular Top

Grain runs the **length** of the worksurface. Tops 120" and under are shipped in one piece and require 2 bases. Tops 144" and over are shipped in two pieces and require 3 bases.

Required Specifications

Veneer Finish

Optional Specifications

Boardroom Table Base
Grommet
Custom cut-out

T BOARDROOM TABLES - PHILADELPHIA

BOARDROOM TABLES - TOPS W/PHILADELPHIA EDGE

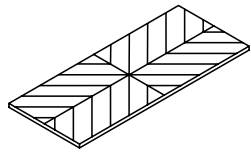

**Rectangular Top -
Reverse Diamond Pattern**

MODEL#	DIMENSIONS D x W x H	FREIGHT CLASS	WT./LBS.	CUBIC FT.	LIST PRICE
RE24054FPB	54 x 240 x 1.5	85	540	39	\$17513
RE21654FPB	54 x 216 x 1.5	85	486	35	\$15951
RE19254FPB	54 x 192 x 1.5	85	432	31	\$13985
RE5454FPB	54 x 54 x 1.5	85	121	9	\$3935
RE16848FPB	48 x 168 x 1.5	85	336	25	\$10857
RE14448FPB	48 x 144 x 1.5	85	288	21	\$8700
RE12048FPB	48 x 120 x 1.5	85	240	18	\$7299
RE9648FPB	48 x 96 x 1.5	85	192	14	\$5738
RE4848FPB	48 x 48 x 1.5	85	96	7	\$2867
RE8442FPB	42 x 84 x 1.5	85	147	11	\$3799
RE7242FPB	42 x 72 x 1.5	85	126	9	\$4620
RE4242FPB	42 x 42 x 1.5	85	74	5	\$2700
RE8436FPB	36 x 84 x 1.5	85	126	9	\$4620
RE7236FPB	36 x 72 x 1.5	85	108	8	\$3962
RE6636FPB	36 x 66 x 1.5	85	99	7	\$3028
RE3636FPB	36 x 36 x 1.5	85	54	4	\$1934
RE8430FPB	30 x 84 x 1.5	85	105	8	\$3847
RE7230FPB	30 x 72 x 1.5	85	90	7	\$3431
RE6630FPB	30 x 66 x 1.5	85	83	6	\$3303
RE6030FPB	30 x 60 x 1.5	85	75	6	\$3028
RE5430FPB	30 x 54 x 1.5	85	68	5	\$2477
RE3030FPB	30 x 30 x 1.5	85	38	3	\$1374

Tops 120" and under are shipped in one piece and require 2 bases. Tops 144" and over are shipped in two pieces and require 3 bases.

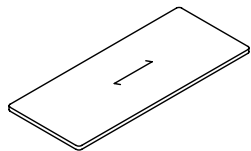

Rectangular Top - Radius Corners

RRE24054PB	54 x 240 x 1.5	85	540	39	\$18553
RRE21654PB	54 x 216 x 1.5	85	486	35	\$16912
RRE19254PB	54 x 192 x 1.5	85	432	31	\$14865
RRE5454PB	54 x 54 x 1.5	85	121	9	\$4185
RRE16848PB	48 x 168 x 1.5	85	336	25	\$11587
RRE14448PB	48 x 144 x 1.5	85	288	21	\$9332
RRE12048PB	48 x 120 x 1.5	85	240	18	\$7794
RRE9648PB	48 x 96 x 1.5	85	192	14	\$6156
RRE4848PB	48 x 48 x 1.5	85	96	7	\$3076
RRE8442PB	42 x 84 x 1.5	85	147	11	\$5582
RRE7242PB	42 x 72 x 1.5	85	126	9	\$4971
RRE4242PB	42 x 42 x 1.5	85	74	5	\$2902
RRE8436PB	36 x 84 x 1.5	85	126	9	\$4971
RRE7236PB	36 x 72 x 1.5	85	108	8	\$4258
RRE6636PB	36 x 66 x 1.5	85	99	7	\$3254
RRE3636PB	36 x 36 x 1.5	85	54	4	\$1777
RRE8430PB	30 x 84 x 1.5	85	105	8	\$4144
RRE7230PB	30 x 72 x 1.5	85	90	7	\$3549
RRE6630PB	30 x 66 x 1.5	85	83	6	\$3254
RRE6030PB	30 x 60 x 1.5	85	75	6	\$2956
RRE5430PB	30 x 54 x 1.5	85	68	5	\$2666
RRE3030PB	30 x 30 x 1.5	85	38	3	\$1483

Grain runs the **length** of the worksurface. Tops 120" and under are shipped in one piece and require 2 bases. Tops 144" and over are shipped in two pieces and require 3 bases.

Required Specifications
Veneer Finish

Optional Specifications
Boardroom Table Base
Grommet
Custom cut-out

BOARDROOM TABLES - TOPS W/PHILADELPHIA EDGE MODEL# DIMENSIONS FREIGHT CLASS WT/LBS. CUBIC FT. LIST PRICE

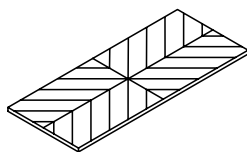

**Rectangular Top - Radius Corners
Reverse Diamond Pattern**

	D x W x H					
RRE24054FPB	54 x 240 x 1.5	85	540	39	\$20926	
RRE21654FPB	54 x 216 x 1.5	85	486	35	\$19123	
RRE19254FPB	54 x 192 x 1.5	85	432	31	\$16867	
RRE5454FPB	54 x 54 x 1.5	85	121	9	\$4746	
RRE16848FPB	48 x 168 x 1.5	85	336	25	\$13267	
RRE14448FPB	48 x 144 x 1.5	85	288	21	\$10783	
RRE12048FPB	48 x 120 x 1.5	85	240	18	\$8919	
RRE9648FPB	48 x 96 x 1.5	85	192	14	\$7109	
RRE4848FPB	48 x 48 x 1.5	85	96	7	\$3560	
RRE8442FPB	42 x 84 x 1.5	85	147	11	\$6445	
RRE7242FPB	42 x 72 x 1.5	85	126	9	\$5766	
RRE4242FPB	42 x 42 x 1.5	85	74	5	\$3363	
RRE8436FPB	36 x 84 x 1.5	85	126	9	\$5766	
RRE7236FPB	36 x 72 x 1.5	85	108	8	\$4947	
RRE6636FPB	36 x 66 x 1.5	85	99	7	\$3779	
RRE3636FPB	36 x 36 x 1.5	85	54	4	\$2065	
RRE8430FPB	30 x 84 x 1.5	85	105	8	\$4804	
RRE7230FPB	30 x 72 x 1.5	85	90	7	\$4121	
RRE6630FPB	30 x 66 x 1.5	85	83	6	\$3779	
RRE6030FPB	30 x 60 x 1.5	85	75	6	\$3431	
RRE5430FPB	30 x 54 x 1.5	85	68	5	\$3092	
RRE3030FPB	30 x 30 x 1.5	85	38	3	\$1720	

Tops 120" and under are shipped in one piece and require 2 bases. Tops 144" and over are shipped in two pieces and require 3 bases.

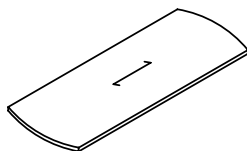

Rectangular Top - Bow Ends

REBE24054PB	54 x 240 x 1.5	85	540	39	\$17766	
REBE21654PB	54 x 216 x 1.5	85	486	35	\$16133	
REBE19254PB	54 x 192 x 1.5	85	432	31	\$14083	
REBE16848PB	48 x 168 x 1.5	85	336	25	\$10802	
REBE14448PB	48 x 144 x 1.5	85	288	21	\$8553	
REBE12048PB	48 x 120 x 1.5	85	240	18	\$7269	
REBE9648PB	48 x 96 x 1.5	85	192	14	\$5632	
REBE8442PB	42 x 84 x 1.5	85	147	11	\$5130	
REBE7242PB	42 x 72 x 1.5	85	126	9	\$4514	
REBE8436PB	36 x 84 x 1.5	85	126	9	\$4516	
REBE7236PB	36 x 72 x 1.5	85	108	8	\$3874	
REBE6636PB	36 x 66 x 1.5	85	99	7	\$2955	
REBE8430PB	30 x 84 x 1.5	85	105	8	\$3766	
REBE7230PB	30 x 72 x 1.5	85	90	7	\$3230	
REBE6630PB	30 x 66 x 1.5	85	83	6	\$2955	
REBE6030PB	30 x 60 x 1.5	85	75	6	\$2686	
REBE5430PB	30 x 54 x 1.5	85	68	5	\$2423	

Grain runs the **length** of the worksurface. Tops 120" and under are shipped in one piece and require 2 bases. Tops 144" and over are shipped in two pieces and require 3 bases.

Required Specifications
Veneer Finish

Optional Specifications
Boardroom Table Base
Grommet
Custom cut-out

T BOARDROOM TABLES - PHILADELPHIA

BOARDROOM TABLES - TOPS W/PHILADELPHIA EDGE MODEL# DIMENSIONS FREIGHT CLASS WT/LBS. CUBIC FT. LIST PRICE

D x W x H

RA24054PB	54 x 240 x 1.5	85	540	39	\$20795
RA21654PB	54 x 216 x 1.5	85	486	35	\$17766
RA19254PB	54 x 192 x 1.5	85	432	31	\$16878
RA16848PB	48 x 168 x 1.5	85	336	25	\$12957
RA14448PB	48 x 144 x 1.5	85	288	21	\$10464
RA12048PB	48 x 120 x 1.5	85	240	18	\$8994
RA9648PB	48 x 96 x 1.5	85	192	14	\$7322
RA8442PB	42 x 84 x 1.5	85	147	11	\$6596
RA7242PB	42 x 72 x 1.5	85	126	9	\$5886
RA8436PB	36 x 84 x 1.5	85	126	9	\$5886
RA7236PB	36 x 72 x 1.5	85	108	8	\$5042
RA6636PB	36 x 66 x 1.5	85	99	7	\$3853
RA8430PB	30 x 84 x 1.5	85	105	8	\$4905
RA7230PB	30 x 72 x 1.5	85	90	7	\$4205
RA6630PB	30 x 66 x 1.5	85	83	6	\$3853
RA6030PB	30 x 60 x 1.5	85	75	6	\$3503
RA5430PB	30 x 54 x 1.5	85	68	5	\$3157
RA8422PB	22 x 84 x 1.5	85	77	6	\$3925
RA7222PB	22 x 72 x 1.5	85	66	5	\$3370
RA6622PB	22 x 66 x 1.5	85	61	5	\$3086
RA6022PB	22 x 60 x 1.5	85	55	4	\$2805
RA5422PB	22 x 54 x 1.5	85	50	4	\$2529
RA4822PB	22 x 48 x 1.5	85	44	3	\$2433

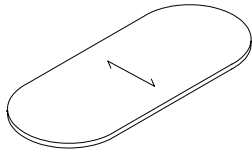

Racetrack Top - Cross Grain

Grain runs the **depth** of the worksurface. Tops 120" and under are shipped in one piece and require 2 bases. Tops 144" and over are shipped in two pieces and require 3 bases.

RA24054SPB	54 x 240 x 1.5	85	540	39	\$23304
RA21654SPB	54 x 216 x 1.5	85	486	35	\$19912
RA19254SPB	54 x 192 x 1.5	85	432	31	\$18913
RA16848SPB	48 x 168 x 1.5	85	336	25	\$14519
RA14448SPB	48 x 144 x 1.5	85	288	21	\$11724
RA12048SPB	48 x 120 x 1.5	85	240	18	\$10080
RA9648SPB	48 x 96 x 1.5	85	192	14	\$8203
RA8442SPB	42 x 84 x 1.5	85	147	11	\$7313
RA7242SPB	42 x 72 x 1.5	85	126	9	\$6596
RA8436SPB	36 x 84 x 1.5	85	126	9	\$6596
RA7236SPB	36 x 72 x 1.5	85	108	8	\$5658
RA6636SPB	36 x 66 x 1.5	85	99	7	\$4321
RA8430SPB	30 x 84 x 1.5	85	105	8	\$5494
RA7230SPB	30 x 72 x 1.5	85	90	7	\$4714
RA6630SPB	30 x 66 x 1.5	85	83	6	\$4555
RA6030SPB	30 x 60 x 1.5	85	75	6	\$3932
RA5430SPB	30 x 54 x 1.5	85	68	5	\$3537
RA8422SPB	22 x 84 x 1.5	85	77	5	\$4398
RA7222SPB	22 x 72 x 1.5	85	66	5	\$3771
RA6622SPB	22 x 66 x 1.5	85	61	5	\$3459
RA6022SPB	22 x 60 x 1.5	85	55	4	\$3144
RA5422SPB	22 x 54 x 1.5	85	50	4	\$2830
RA4822SPB	22 x 48 x 1.5	85	44	3	\$2724

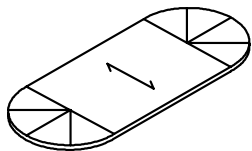

Racetrack Top Cross Grain Center, Sunburst Veneer Pattern on Left & Right

Grain runs the **depth** of the worksurface. Tops 120" and under are shipped in one piece and require 2 bases. Tops 144" and over are shipped in two pieces and require 3 bases.

Required Specifications

Veneer Finish

Optional Specifications

Boardroom Table Base

Grommet

Custom cut-out

BOARDROOM TABLES - TOPS W/PHILADELPHIA EDGE MODEL# DIMENSIONS FREIGHT CLASS WT/LBS. CUBIC FT. LIST PRICE

D x W x H

OV24054PB	54 x 240 x 1.5	85	540	39	\$25995
OV21654PB	54 x 216 x 1.5	85	486	35	\$22214
OV19254PB	54 x 192 x 1.5	85	432	31	\$21092
OV16848PB	48 x 168 x 1.5	85	336	25	\$16199
OV14448PB	48 x 144 x 1.5	85	288	21	\$13077
OV12048PB	48 x 120 x 1.5	85	240	18	\$11062
OV9648PB	48 x 96 x 1.5	85	192	14	\$9153
OV8442PB	42 x 84 x 1.5	85	147	11	\$8248
OV7242PB	42 x 72 x 1.5	85	126	9	\$7361
OV8436PB	36 x 84 x 1.5	85	126	9	\$7361
OV7236PB	36 x 72 x 1.5	85	108	8	\$6306
OV6636PB	36 x 66 x 1.5	85	99	7	\$4823
OV8430PB	30 x 84 x 1.5	85	105	8	\$6131
OV7230PB	30 x 72 x 1.5	85	90	7	\$5257
OV6630PB	30 x 66 x 1.5	85	83	6	\$4823
OV6030PB	30 x 60 x 1.5	85	75	6	\$4382
OV5430PB	30 x 54 x 1.5	85	68	5	\$3947
OV8422PB	22 x 84 x 1.5	85	77	6	\$4905
OV7222PB	22 x 72 x 1.5	85	66	5	\$4205
OV6622PB	22 x 66 x 1.5	85	61	5	\$3853
OV6022PB	22 x 60 x 1.5	85	55	4	\$3503
OV5422PB	22 x 54 x 1.5	85	50	4	\$3157
OV4822PB	22 x 48 x 1.5	85	44	3	\$3038

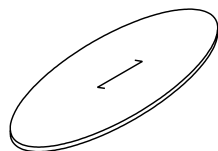

Oval Top

Grain runs the **length** of the worksurface. Tops 120" and under are shipped in one piece and require 2 bases. Tops 144" and over are shipped in two pieces and require 3 bases.

B024054PB	54 x 240 x 1.5	85	540	39	\$17588
B021654PB	54 x 216 x 1.5	85	486	35	\$15809
B019254PB	54 x 192 x 1.5	85	432	31	\$14026
B016848PB	48 x 168 x 1.5	85	336	25	\$11172
B014448PB	48 x 144 x 1.5	85	288	21	\$9041
B012048PB	48 x 120 x 1.5	85	240	18	\$7570
B09648PB	48 x 96 x 1.5	85	192	14	\$6149
B08442PB	42 x 84 x 1.5	85	147	11	\$5673
B07242PB	42 x 72 x 1.5	85	126	9	\$4992

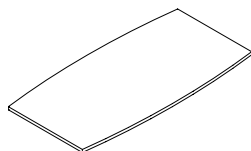

Boat Shape Top

Grain runs the **length** of the worksurface. Tops 120" and under are shipped in one piece and require 2 bases. Tops 144" and over are shipped in two pieces and require 3 bases.

BOBE24054PB	54 x 240 x 1.5	85	540	39	\$20224
BOBE21654PB	54 x 216 x 1.5	85	486	35	\$18181
BOBE19254PB	54 x 192 x 1.5	85	432	31	\$16133
BOBE5454PB	54 x 54 x 1.5	85	121	9	\$4537
BOBE16848PB	48 x 168 x 1.5	85	336	25	\$12851
BOBE14448PB	48 x 144 x 1.5	85	288	21	\$10394
BOBE12048PB	48 x 120 x 1.5	85	240	18	\$8706
BOBE9648PB	48 x 96 x 1.5	85	96	7	\$7071
BOBE4848PB	48 x 48 x 1.5	85	96	7	\$3827
BOBE8442PB	42 x 84 x 1.5	85	147	11	\$6325
BOBE7242PB	42 x 72 x 1.5	85	126	9	\$5742
BOBE4242PB	42 x 42 x 1.5	85	74	5	\$3351

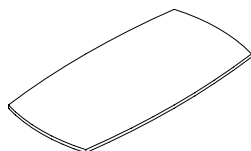

Boat Shape Top - Bow Ends

Grain runs the **length** of the worksurface. Tops 120" and under are shipped in one piece and require 2 bases. Tops 144" and over are shipped in two pieces and require 3 bases.

Required Specifications

Veneer Finish

Optional Specifications

Boardroom Table Base
Grommet
Custom cut-out

T BOARDROOM TABLES - PHILADELPHIA

BOARDROOM TABLES - TOPS W/PHILADELPHIA EDGE

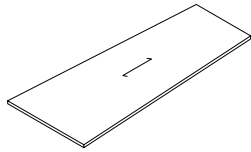

Wedge Shape Top

MODEL#	DIMENSIONS D x W x H	FREIGHT CLASS	WT/LBS.	CUBIC FT.	LIST PRICE
WE2405442PB	54 - 42 x 240 x 1.5	85	540	39	\$15450
WE2165442PB	54 - 42 x 216 x 1.5	85	486	35	\$14026
WE1925442PB	54 - 42 x 192 x 1.5	85	432	31	\$12243
WE1684836PB	48 - 36 x 168 x 1.5	85	336	25	\$9393
WE1444836PB	48 - 36 x 144 x 1.5	85	288	21	\$7435
WE1204836PB	48 - 36 x 120 x 1.5	85	240	18	\$6319
WE964836PB	48 - 36 x 96 x 1.5	85	192	14	\$5511
WE844230PB	42 - 30 x 84 x 1.5	85	147	11	\$4461
WE724230PB	42 - 30 x 72 x 1.5	85	126	9	\$3925
WE843624PB	36 - 24 x 84 x 1.5	85	126	9	\$3925
WE723624PB	36 - 24 x 72 x 1.5	85	108	8	\$3370
WE663624PB	36 - 24 x 66 x 1.5	85	99	7	\$2573

Grain runs the **length** of the worksurface. Tops 120" and under are shipped in one piece and require 2 bases. Tops 144" and over are shipped in two pieces and require 3 bases.

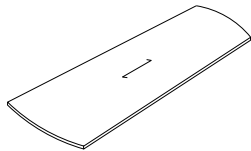

Wedge Shape Top - Bow Ends

WEBE2405442PB	54 - 42 x 240 x 1.5	85	540	39	\$17766
WEBE2165442PB	54 - 42 x 216 x 1.5	85	486	35	\$16133
WEBE1925442PB	54 - 42 x 192 x 1.5	85	432	31	\$14081
WEBE1684836PB	48 - 36 x 168 x 1.5	85	336	25	\$10802
WEBE1444836PB	48 - 36 x 144 x 1.5	85	288	21	\$8553
WEBE1204836PB	48 - 36 x 120 x 1.5	85	240	18	\$7269
WEBE964836PB	48 - 36 x 96 x 1.5	85	192	14	\$5633
WEBE844230PB	42 - 30 x 84 x 1.5	85	147	11	\$5130
WEBE724230PB	42 - 30 x 72 x 1.5	85	126	9	\$4514
WEBE843624PB	36 - 24 x 84 x 1.5	85	126	9	\$4514
WEBE723624PB	36 - 24 x 72 x 1.5	85	108	8	\$3874
WEBE663624PB	36 - 24 x 66 x 1.5	85	99	7	\$2955

Grain runs the **length** of the worksurface. Tops 120" and under are shipped in one piece and require 2 bases. Tops 144" and over are shipped in two pieces and require 3 bases.

Required Specifications

Veneer Finish

Optional Specifications

Boardroom Table Base
Grommet
Custom cut-out

BOARDROOM TABLE BASES - ALL SERIES

MODEL# DIMENSIONS FREIGHT CLASS WT/LBS. CUBIC FT. LIST PRICE

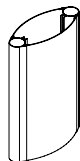

Elliptical Base

	D x W x H				
TE42	8 x 42 x 28	100	70	8	\$1845
TE36	7 x 36 x 28	92.5	60	6	\$1845
TE36	7 x 36 x 28	92.5	60	6	\$1845
TE30	6 x 30 x 28	85	50	4	\$1787
TE24	6 x 24 x 28	70	40	2	\$1715

Not to be used with round table tops. For tops up to 120", two Elliptical Bases must be ordered. For tops 144" and more, three Elliptical Bases must be ordered.

• **Plastic End Gables are available in a Tungsten (K) or Black (E) finish. Please Specify.**

- For 30" and 36" deep tops, order a 24" base (**TE24**).
- For 42" and 48" deep tops, order a 30" base (**TE30**).
- For 54" and 60" deep tops, order a 36" base (**TE36**) or 42" base (**TE42**).

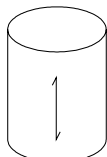

Drum Base - Veneer

TD30	30 x 30 x 28	125	93	15	\$3011
TD22	22 x 22 x 28	100	70	8	\$1450
TD18	18 x 18 x 28	85	62	5	\$1263

For tops up to 120", two Drum Bases must be ordered. For tops 144" and more, three Drum Bases must be ordered. Sand bag included to provide adequate stability.

- For 30", 36" and 42" deep tops, order a 18" base (**TD18**).
- For 48" and 54" deep tops, order a 22" base (**TD22**).
- For 60" deep tops, order a 30" base (**TD30**).

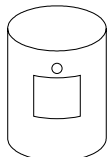

Drum Base with Power Access Door - Veneer

TD30J	30 x 30 x 28	125	93	15	\$3764
TD22J	22 x 22 x 28	100	70	8	\$2206
TD18J	18 x 18 x 28	85	62	5	\$2017

Access door and top and bottom cut-out to accommodate power/data grommet. For tops up to 120", two Drum Bases must be ordered. For tops 144" and more, three Drum Bases must be ordered. Sand bag included to provide adequate stability.

- Power access door is 12" x 12"
- For 30", 36" and 42" deep tops, order a 18" base (**TD18J**).
- For 48" and 54" deep tops, order a 22" base (**TD22J**).
- For 60" deep tops, order a 30" base (**TD30J**).

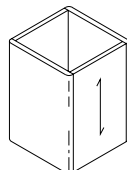

Pedestal Base

TP24	24 x 24 x 28	92.5	106	10	\$1575
TP20	20 x 20 x 28	85	89	7	\$1513
TP16	16 x 16 x 28	70	71	4	\$1450

For tops up to 120", two Pedestal Bases must be ordered. For tops 144" and more, three Pedestal Bases must be ordered.

- For 30", 36" and 42" deep tops, order a 16" base (**TP16**).
- For 48" and 54" deep tops, order a 20" base (**TP20**).
- For 60" deep tops, order a 24" base (**TP24**).

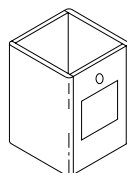

Pedestal Base with Power Access Door

TP24J	24 x 24 x 28	92.5	106	10	\$2331
TP20J	20 x 20 x 28	85	89	7	\$2268
TP16J	16 x 16 x 28	70	71	4	\$2206

Access door and top and bottom cut-out to accommodate power/data grommet. For tops up to 120", two Pedestal Bases must be ordered. For tops 144" and more, three Pedestal Bases must be ordered.

- Power access door is 12" x 12"
- For 30", 36" and 42" deep tops, order a 16" base (**TP16J**).
- For 48" and 54" deep tops, order a 20" base (**TP20J**).
- For 60" deep tops, order a 24" base (**TP24J**).

Required Specifications

Veneer Finish

T BOARDROOM TABLES

BOARDROOM TABLE BASES - ALL SERIES

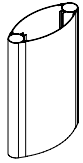

Elliptical Base

MODEL#	DIMENSIONS D x W x H	FREIGHT CLASS	WT/LBS.	CUBIC FT.	LIST PRICE	ALL VENEER
TE42	8 x 42 x 28	100	70	8	\$1845	
TE36	7 x 36 x 28	92.5	60	6	\$1845	
TE36	7 x 36 x 28	92.5	60	6	\$1845	
TE30	6 x 30 x 28	85	50	4	\$1787	
TE24	6 x 24 x 28	70	40	2	\$1715	

Not to be used with round table tops. For tops up to 120", two Elliptical Bases must be ordered. For tops 144" and more, three Elliptical Bases must be ordered.

• **Plastic End Gables are available in a Tungsten (K) or Black (E) finish. Please Specify.**

- For 30" and 36" deep tops, order a 24" base (**TE24**).
- For 42" and 48" deep tops, order a 30" base (**TE30**).
- For 54" and 60" deep tops, order a 36" base (**TE36**) or 42" base (**TE42**).

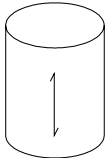

Drum Base - Veneer

TD30	30 x 30 x 28	125	93	15	\$3011	
TD22	22 x 22 x 28	100	70	8	\$1450	
TD18	18 x 18 x 28	85	62	5	\$1263	

For tops up to 120", two Drum Bases must be ordered. For tops 144" and more, three Drum Bases must be ordered. Sand bag included to provide adequate stability.

- For 30", 36" and 42" deep tops, order a 18" base (**TD18**).
- For 48" and 54" deep tops, order a 22" base (**TD22**).
- For 60" deep tops, order a 30" base (**TD30**).

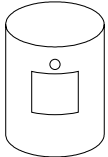

Drum Base with Power Access Door - Veneer

TD30J	30 x 30 x 28	125	93	15	\$3764	
TD22J	22 x 22 x 28	100	70	8	\$2206	
TD18J	18 x 18 x 28	85	62	5	\$2017	

Access door and top and bottom cut-out to accommodate power/data grommet. For tops up to 120", two Drum Bases must be ordered. For tops 144" and more, three Drum Bases must be ordered. Sand bag included to provide adequate stability.

- Power access door is 12" x 12"
- For 30", 36" and 42" deep tops, order a 18" base (**TD18J**).
- For 48" and 54" deep tops, order a 22" base (**TD22J**).
- For 60" deep tops, order a 30" base (**TD30J**).

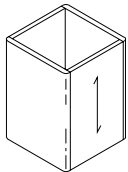

Pedestal Base

TP24	24 x 24 x 28	92.5	106	10	\$1575	
TP20	20 x 20 x 28	85	89	7	\$1513	
TP16	16 x 16 x 28	70	71	4	\$1450	

For tops up to 120", two Pedestal Bases must be ordered. For tops 144" and more, three Pedestal Bases must be ordered.

- For 30", 36" and 42" deep tops, order a 16" base (**TP16**).
- For 48" and 54" deep tops, order a 20" base (**TP20**).
- For 60" deep tops, order a 24" base (**TP24**).

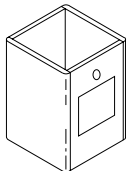

Pedestal Base with Power Access Door

TP24J	24 x 24 x 28	92.5	106	10	\$2331	
TP20J	20 x 20 x 28	85	89	7	\$2268	
TP16J	16 x 16 x 28	70	71	4	\$2206	

Access door and top and bottom cut-out to accommodate power/data grommet. For tops up to 120", two Pedestal Bases must be ordered. For tops 144" and more, three Pedestal Bases must be ordered.

- Power access door is 12" x 12"
- For 30", 36" and 42" deep tops, order a 16" base (**TP16J**).
- For 48" and 54" deep tops, order a 20" base (**TP20J**).
- For 60" deep tops, order a 24" base (**TP24J**).

Required Specifications

Veneer Finish

* Laminate Finish

BOARDROOM TABLE BASES - ALL SERIES

MODEL# DIMENSIONS FREIGHT CLASS WT/LBS. CUBIC FT. LIST PRICE

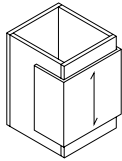

**Pedestal Base - Veneer
Decorative Outside Panel***

	D x W x H					
TPM24	24 x 24 x 28	92.5	106	10	\$2440	\$2925
TPM20	20 x 20 x 28	85	86	7	\$2338	\$2804
TPM16	16 x 16 x 28	70	71	4	\$2246	\$2693

For tops up to 120", two Pedestal Bases must be ordered. For tops 144" and more, three Pedestal Bases must be ordered.

- For 30", 36" and 42" deep tops, order a 16" base (**TPM16**).
- For 48" and 54" deep tops, order a 20" base (**TPM20**).
- For 60" deep tops, order a 24" base (**TPM24**).

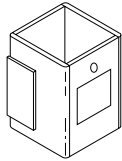

**Pedestal Base with Power Access Door
Veneer Decorative Outside Panel***

TPM24J	24 x 24 x 28	92.5	106	10	\$2835	\$3405
TPM20J	20 x 20 x 28	85	86	7	\$2732	\$3281
TPM16J	16 x 16 x 28	70	71	4	\$2753	\$3306

Access door and top and bottom cut-out to accommodate power/data grommet. For tops up to 120", two Pedestal Bases must be ordered. For tops 144" and more, three Pedestal Bases must be ordered.

- Power access door is 12" x 12"
- For 30", 36" and 42" deep tops, order a 16" base (**TPM16J**).
- For 48" and 54" deep tops, order a 20" base (**TPM20J**).
- For 60" deep tops, order a 24" base (**TPM24J**).

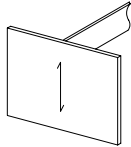

Slab Base

TH42	3 x 42 x 28	60	148	2	\$2209	
TH36	3 x 36 x 28	60	127	2	\$1993	
TH30	3 x 30 x 28	60	106	2	\$1450	
TH22	3 x 22 x 28	60	89	2	\$1256	

Not to be used with round table tops. For tops up to 120", two Slab Bases must be ordered. For tops 144" and more, three Slab Bases must be ordered.

- For 30" and 36" deep tops, order a 22" base (**TH22**).
- For 42" and 48" deep tops, order a 30" base (**TH30**).
- For 54" deep tops, order a 36" base (**TH36**).
- For 60" deep tops, order a 42" base (**TH42**).

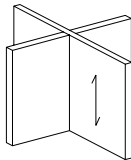

Cross Base

TX42	3 x 42 x 28	100	180	20	\$2130	
TX36	3 x 36 x 28	100	155	17	\$1993	
TX30	3 x 30 x 28	100	133	15	\$1450	
TX22	3 x 22 x 28	100	97	11	\$1256	

For tops up to 120", two Cross Bases must be ordered. For tops 144" and more, three Cross Bases must be ordered.

- For 30" and 36" deep tops, order a 22" base (**TX22**).
- For 42" and 48" deep tops, order a 30" base (**TX30**).
- For 54" deep tops, order a 36" base (**TX36**).
- For 60" deep tops, order a 42" base (**TX42**).

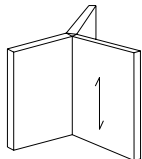

"Y" Base

TW42	4 x 42 x 28	125	140	20	\$1845	
TW36	4 x 36 x 28	125	120	17	\$1625	
TW30	4 x 30 x 28	125	100	15	\$1335	
TW22	4 x 22 x 28	125	73	11	\$1249	

Not to be used with round table tops. For tops up to 120", two "Y" Bases must be ordered. For tops 144" and more, two "Y" Bases and one Cross Base must be ordered.

- For 30" and 36" deep tops, order a 22" base (**TW22**).
- For 42" and 48" deep tops, order a 30" base (**TW30**).
- For 54" deep tops, order a 36" base (**TW36**).
- For 60" deep tops, order a 42" base (**TW42**).

Required Specifications

Veneer Finish (Veneer Post Legs)
Metal Finish (Metal Legs)

T BOARDROOM TABLES

BOARDROOM TABLE BASES - ALL SERIES

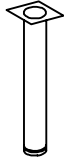

Post Leg Veneer

MODEL#	DIMENSIONS D x W x H	FREIGHT CLASS	WT/LBS.	CUBIC FT.	LIST PRICE
SN06	6 dia x 28	250	10	3	\$1518
SN04	4 dia x 28	125	7	1	\$1169
SN03	3 dia x 28	150	5	1	\$737

Available in 3", 4" and 6" diameters. Round tops and tops up to 96" require four legs. Tops 108" to 168" require six legs; tops 180" to 240" require ten legs.

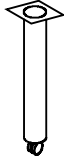

Post Leg Veneer w/Caster

SN06M	6 dia x 28	100	10	3	\$1603
SN04M	4 dia x 28	125	7	1	\$1253
SN03M	3 dia x 28	150	5	1	\$824

Available in 3", 4" and 6" diameters. Caster included. Round tops and tops up to 96" require four legs. Tops 108" to 168" require six legs; tops 180" to 240" require ten legs.

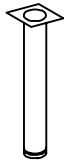

Post Leg Metal

SM06	6 dia x 28	100	10	3	\$1037
SM04	4 dia x 28	125	7	1	\$572
SM03	3 dia x 28	150	5	1	\$407

Available in 3", 4" and 6" diameters. Round tops and tops up to 96" require four legs. Tops 108" to 168" require six legs; tops 180" to 240" require ten legs.

• **Must Specify Black (E) or Tungsten (K) finish**

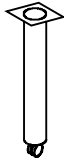

Post Leg Metal w/Casters

SM06M	6 dia x 28	100	10	3	\$1125
SM04M	4 dia x 28	125	7	1	\$659
SM03M	3 dia x 28	150	5	1	\$495

Available in 3", 4" and 6" diameters. Caster included. Round tops and tops up to 96" require four legs. Tops 108" to 168" require six legs; tops 180" to 240" require ten legs.

• **Must Specify Black (E) or Tungsten (K) finish**

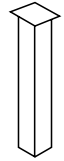

Post Leg Metal, Square

SMS4	4 x 4 x 28	125	7	1	\$449
------	------------	-----	---	---	--------------

Available in 4". Round tops and tops up to 96" require four legs. Tops 108" to 168" require six legs; tops 180" to 240" require ten legs.

• **Must Specify Black (E) or Tungsten (K) finish**

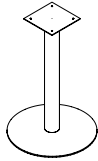

Post Leg w/Flat Plate

F6P36	36 x 36 x 28	150	100	22	\$3562
F4P30	30 x 30 x 28	150	80	15	\$2169
F4P24	24 x 24 x 28	125	60	10	\$1733
F3P18	18 x 18 x 28	100	45	5	\$1538

Round tops require a single base. For tops up to 120", two bases must be ordered. For tops 144" or more, three bases must be ordered.

• **Must Specify Black (E) or Tungsten (K) finish**

- For 30" deep tops, order a 18" base (**F3P18**).
- For 36" deep tops, order a 24" base (**F4P24**).
- For 42" and 48" deep tops, order a 30" base (**F4P30**).
- For 54" deep tops, order a 36" base (**F6P36**).

Required Specifications

Metal Finish (Metal Legs)

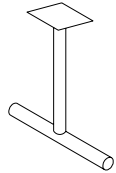
BOARDROOM TABLE BASES - ALL SERIES

Tubular 2-Prong Base

MODEL#	DIMENSIONS D x W x H	FREIGHT CLASS	WT/LBS.	CUBIC FT.	LIST PRICE
TTM36	36 x 36 x 28	100	28	22	\$857
TTM26	26 x 26 x 28	85	24	11	\$822

Not to be used with round table tops. Two square edged prongs. For tops up to 84", two Tubular 2-Prong Bases must be ordered. Used as a 3rd base to provide center support in conjunction with two 3-Prong bases on tops 144" or more.

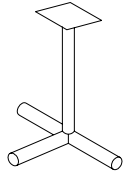
- **Must Specify Black (E) or Tungsten (K) finish**
- For 30", 36" and 42" deep tops, order a 26" base (**TTM26**).
- For 48", 54" and 60" deep tops, order a 36" base (**TTM36**).

Tubular 3-Prong Base

TTE36	36 x 36 x 28	250	36	22	\$913
TTE26	26 x 26 x 28	85	32	11	\$813

Not to be used with round table tops. Three square edged prongs. For tops up to 120", two Tubular 3-Prong Bases must be ordered. For tops 144" and more, two Tubular 3-Prong Bases and one Tubular 2-Prong Base for the center must be ordered.

- **Must Specify Black (E) or Tungsten (K) finish**
- For 30", 36" and 42" deep tops, order a 26" base (**TTE26**).
- For 48", 54" and 60" deep tops, order a 36" base (**TTE36**).

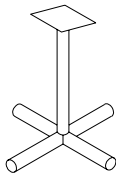
Tubular 4-Prong Base

TT36	36 x 36 x 28	300	40	22	\$1369
TT26	26 x 26 x 28	250	36	11	\$943

Four square edged prongs. For tops up to 120", two Tubular 4-Prong Bases must be ordered. For tops 144" and more, three Tubular 4-Prong Bases must be ordered.

- **Must Specify Black (E) or Tungsten (K) finish**
 - For 30", 36" and 42" deep tops, order a 26" base (**TT26**).
 - For 48" and 54" deep tops, order a 36" base (**TT36**)*
- * Maximum diameter for Round Tops is 54".

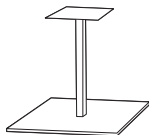
Flat Square Column Base

TTSQ23BH	23 x 23 x 41	150	75	14	\$3413
TTSQ18BH	18 x 18 x 41	125	65	10	\$3161
TTSQ30	30 x 30 x 28	150	80	14	\$3540
TTSQ23	23 x 23 x 28	150	55	12	\$2908
TTSQ18	18 x 18 x 28	150	45	8	\$2655

Round tops require a single base. For tops up to 120", two bases must be ordered. For tops 144" or more, three bases must be ordered.

- **Must Specify Black (E) or Tungsten (K) finish**
- For 30" deep tops, order a 18" base (**TTSQ18** or **TTSQ18BH**).
- For 36" deep tops, order a 24" base (**TTSQ23** or **TTSQ23BH**).
- For 42" and 48" deep tops, order a 30" base (**TTSQ30**).
 - Max diameter for round tops at standard height is 48".
 - Max diameter for round tops at bar height is 36".

Required Specifications

Metal Finish

T BOARDROOM TABLES

BOARDROOM TABLE BASES

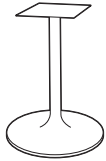

Trumpet Column Base

MODEL#	DIMENSIONS D x W x H	FREIGHT CLASS	WT/LBS.	CUBIC FT.	LIST PRICE
TRUM24BH	24 x 24 x 41	300	26	14	\$1646
TRUM18BH	18 x 18 x 41	300	24	16	\$1520
TRUM30	30 x 30 x 28	300	18	14	\$1584
TRUM24	24 x 24 x 28	300	16	12	\$1141
TRUM18	18 x 18 x 28	300	14	8	\$1015

Round tops require a single base. For tops up to 120", two bases must be ordered. For tops 144" or more, three bases must be ordered.

- **Must Specify Black (E) or Tungsten (K) finish**
- For 30" deep tops, order a 18" base (**TRUM18** or **TRUM18BH**).
- For 36" deep tops, order a 24" base (**TRUM24** or **TRUM24BH**).
- For 42" and 48" deep tops, order a 30" base (**TRUM30**).
 - Max diameter for round tops at standard height is 48".
 - Max diameter for round tops at bar height is 36".

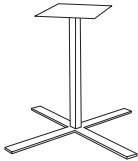

Flat Bar "X" Column Base

TTFLT36	36 x 36 x 28	300	18	14	\$3161
TTFLT30	30 x 30 x 28	300	16	12	\$3036
TTFLT22	22 x 22 x 28	300	15	10	\$2794

Round tops require a single base. For tops up to 120", two bases must be ordered. For tops 144" or more, three bases must be ordered.

- **Must Specify Black (E) or Tungsten (K) finish**
- For 30" and 36" deep tops, order a 22" base (**TTFLT22**).
- For 42" and 48" deep tops, order a 30" base (**TTFLT30**).
- For 54" deep tops, order a 36" base (**TTFLT36**).

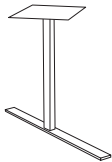

Flat Bar "T" Column Base

TTFLT36	36 x 36 x 28	150	14	3	\$2655
TTFLT24	24 x 24 x 28	150	10	2.50	\$2403

Not to be used with round table tops. For tops up to 84", two bases must be ordered. To be used as a 3rd base for center support in conjunction with two 3-prong bases on tops 144" or more.

- **Must Specify Black (E) or Tungsten (K) finish**
- For 30", 36" and 42" deep tops, order a 24" base (**TTFLT24**).
- For 48" and 54" deep tops, order a 36" base (**TTFLT36**).
- TTFLTxx bases are to be used as a middle base in combination with two TTFL3P bases



Flat Bar 3 Prong Column Base

TTFL3P36	36 x 36 x 28	400	16	22	\$3036
TTFL3P24	24 x 24 x 28	400	12	14	\$2781

Not to be used with round table tops. For tops up to 120", two bases must be ordered. For tops 144" or more, two 3-prong bases and one "T" column base must be ordered.

- **Must Specify Black (E) or Tungsten (K) finish**
- For 30", 36" and 42" deep tops, order a 24" base (**TTFL3P24**).
- For 48" and 54" deep tops, order a 36" base (**TTFL3P36**).
- When a third base is required, a TTFLTxx base may be used as the center base

Required Specifications

Finish

BOARDROOM TABLE BASES

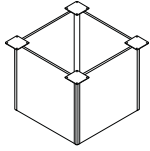

Square Panel Base - Anodized Aluminum Radius Corner Detail

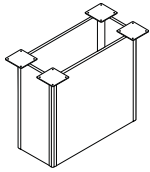

Rectangular Panel Base - Anodized Aluminum Radius Corner Detail

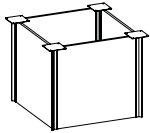

Square Panel Base - Anodized Aluminum Rectangular Corner Detail

MODEL#	DIMENSIONS	FREIGHT CLASS	WT/LBS.	CUBIC FT.	LIST PRICE
D x W x H					
TELS24J	24 x 24 x 28	100	75	8	\$2554
TELS20J	20 x 20 x 28	92.5	70	6	\$2203
TELS16J	16 x 16 x 28	70	65	4	\$1999
TELS24	24 x 24 x 28	100	75	8	\$2239
TELS20	20 x 20 x 28	92.5	70	6	\$1885
TELS16	16 x 16 x 28	70	65	4	\$1685

Round tops require a single base. For tops up to 120" two Square Panel bases must be ordered. For tops 144" or more, three bases must be ordered.

- **Model #'s with a "J" denote a power access door on one panel.**
- For 30", 36" and 42" deep tops, order a 16" base (**TELS16** or **TELS16J**).
- For 48" and 54" deep tops, order a 20" base (**TELS20** or **TELS20J**).
- For 60" deep tops, order a 24" base (**TELS24** or **TELS24J**).

TELR24J	12 x 24 x 28	100	65	8	\$2429
TELR20J	12 x 20 x 28	92.5	60	6	\$2075
TELR16J	12 x 16 x 28	85	50	4	\$1873
TELR24	12 x 24 x 28	100	65	8	\$2112
TELR20	12 x 20 x 28	92.5	60	6	\$1760
TELR16	12 x 16 x 28	85	50	4	\$1559

Not to be used with round table tops. For tops up to 96" two Rectangular Panel bases must be ordered. To be used as a 3rd base for center support in conjunction with two Square Panel bases on tops 144" or more.

- **Model #'s with a "J" denote a power access door on one panel.**
- For 30", 36" and 42" deep tops, order a 16" base (**TELR16** or **TELR16J**).
- For 48" and 54" deep tops, order a 20" base (**TELR20** or **TELR20J**).
- For 60" deep tops, order a 24" base (**TELR24** or **TELR24J**).

TELS24J	24 x 24 x 28	100	65	8	\$2554
TELS20J	20 x 20 x 28	92.5	60	6	\$2203
TELS16J	16 x 16 x 28	85	50	4	\$1999
TELS24	24 x 24 x 28	100	65	8	\$2239
TELS20	20 x 20 x 28	92.5	60	6	\$1885
TELS16	16 x 16 x 28	85	50	4	\$1685

Round tops require a single base. For tops up to 120" two Square Panel bases must be ordered. For tops 144" or more, three bases must be ordered.

- **Model #'s with a "J" denote a power access door on one panel.**
- For 30", 36" and 42" deep tops, order a 16" base (**TELS16** or **TELS16J**).
- For 48" and 54" deep tops, order a 20" base (**TELS20** or **TELS20J**).
- For 60" deep tops, order a 24" base (**TELS24** or **TELS24J**).

Required Specifications

Finish

T BOARDROOM TABLES

BOARDROOM TABLE BASES

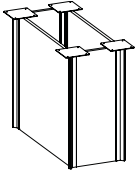

Rectangular Panel Base - Anodized Aluminum Rectangular Corner Detail

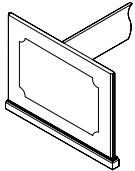

Philadelphia Wood Slab Base and Stretcher

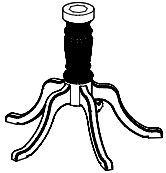

Wood Queen Anne Base

MODEL#	DIMENSIONS D x W x H	FREIGHT CLASS	WT./LBS.	CUBIC FT.	LIST PRICE
TELBR24J	12 x 24 x 28	100	65	8	\$2429
TELBR20J	12 x 20 x 28	92.5	60	6	\$2075
TELBR16J	12 x 16 x 28	85	50	4	\$1873
TELBR24	12 x 24 x 28	100	65	8	\$2112
TELBR20	12 x 20 x 28	92.5	60	6	\$1760
TELBR16	12 x 16 x 28	85	50	4	\$1559

Not to be used with round table tops. For tops up to 96" two Rectangular Panel bases must be ordered. To be used as a 3rd base for center support in conjunction with two Square Panel bases on tops 144" or more.

- **Model #'s with a "J" denote a power access door on one panel.**
- For 30", 36" and 42" deep tops, order a 16" base (**TELBR16** or **TELBR16J**).
- For 48" and 54" deep tops, order a 20" base (**TELBR20** or **TELBR20J**).
- For 60" deep tops, order a 24" base (**TELBR24** or **TELBR24J**).

PTH42PB	1 x 42 x 28	60	148	2	\$3479
PTH36PB	1 x 36 x 28	60	127	2	\$3143
PTH30PB	1 x 30 x 28	60	106	2	\$2290
PTH22PB	1 x 22 x 28	60	89	1	\$1982

Need description

- For 54" and 60" deep tops, order PTH36PB
- For 42" and 48" deep tops, order PTH30PB
- For 30" and 36" deep tops, order PTH22PB

PTQA30	30 x 30 x 28	150	73	15	\$3558
--------	--------------	-----	----	----	---------------

For use with 36", 42" and 48" deep tops.

Required Specifications

Finish

BOARDROOM - ACCESSORIES

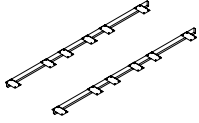

Metal Support Rails

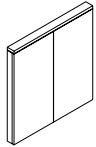

Visual Board

MODEL#	DIMENSIONS	FREIGHT CLASS	WT/LBS.	CUBIC FT.	LIST PRICE
	D x W x H				
TSUP102	1 x 102 x 2	70	0.10	0.10	\$1163
TSUP96	1 x 96 x 2	70	0.10	0.10	\$1091
TSUP90	1 x 90 x 2	70	0.10	0.10	\$1009
TSUP84	1 x 84 x 2	70	0.10	0.10	\$932
TSUP78	1 x 78 x 2	70	0.10	0.10	\$854
TSUP72	1 x 72 x 2	70	0.10	0.10	\$777
TSUP66	1 x 66 x 2	70	0.10	0.10	\$702
TSUP60	1 x 60 x 2	70	0.10	0.10	\$626
TSUP54	1 x 54 x 2	70	0.10	0.10	\$575

To be used when design considerations or dimension requirements dictate an unsupported table joint. Top section MUST NOT exceed 72" to use metal supports. **Sold in sets of two**

- Available in Black only.

VB4848E	5 x 48 x 48	70	115	7	\$4263
---------	-------------	----	-----	---	---------------

Includes porcelain on steel magnetic board and two side opening straight edge doors containing tackable fabric panels and 50-sheet paper writing pad that can be used on either door. Magnetic board can be used for projection. Set of 6 dry erase markers and eraser included. Interior fabric panels available in Anchorage. Specify color:

AN40 Birch	AN41 Green Apple	AN42 Lapis	AN43 Straw	AN44 Wolf
AN45 Goose	AN46 Angora	AN47 Cumin	AN48 Asteroid	AN49 Geranium
AN50 Thistle	AN51 Graphite	AN52 Slate	AN53 Quarry Blue	AN54 Onyx
AN55 Pumpkin	AN56 Red Delicious	AN57 Sunshine	AN59 Waterfall	AN61 Vanilla
AN62 Cobalt	AN64 Cloud			

- **NOTE:** Care should be taken to mount the units. Units should be mounted to wall studs using correct fasteners. Failure to do so may result in collapse of the unit and subsequent personal injury. **Mounting hardware not included.** Mounting hardware used should be based on wall material. Consult an installation professional for proper wall mounting.

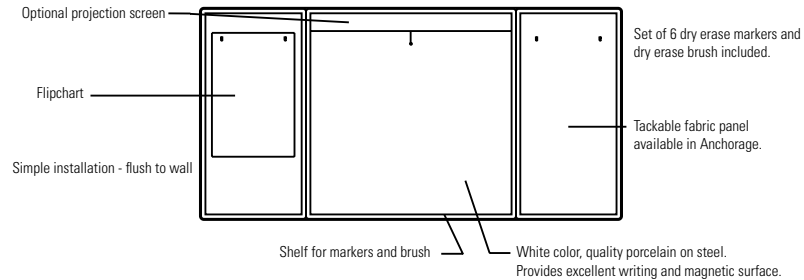

Required Specifications

Finish
Fabric

T BOARDROOM TABLES

BOARDROOM - ACCESSORIES

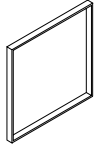

Visual Board, No Doors

MODEL#	DIMENSIONS D x W x H	FREIGHT CLASS	WT/LBS.	CUBIC FT.	LIST PRICE	ALL VENEER
VB48480	5 x 48 x 48	70	115	7	\$2864	

Includes porcelain on steel magnetic board. Magnetic board can be used for projection. Set of 6 dry erase markers and eraser included.

• **NOTE:** Care should be taken to mount the units. Units should be mounted to wall studs using correct fasteners. Failure to do so may result in collapse of the unit and subsequent personal injury. **Mounting hardware not included.** Mounting hardware used should be based on wall material. Consult an installation professional for proper wall mounting.

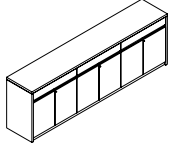

Credenza Buffet - Dufferin

DCB9022H36	22 x 90 x 36	92.5	440	44	\$9140	\$10967
DCB9020H36	20 x 90 x 36	92.5	400	40	\$8309	\$9972
DCB7222H36	22 x 72 x 36	92.5	330	33	\$6206	\$7447
DCB7220H36	20 x 72 x 36	92.5	300	30	\$5529	\$6637
DCB6022H36	22 x 60 x 36	100	275	28	\$5323	\$6388
DCB6020H36	20 x 60 x 36	92.5	250	25	\$4838	\$5804

90" w units have (3) two door storage cabinets with top drawer side-by-side. 72" w & 60" w units have (2) two door storage cabinets with top drawer side-by-side. Locking doors. Self-closing hinged doors cover one adjustable shelf.

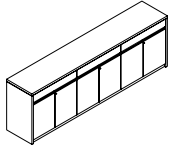

Credenza Buffet - Lufton

LCB9022H36	22 x 90 x 36	92.5	440	44	\$9922	
LCB9020H36	20 x 90 x 36	92.5	400	40	\$9028	
LCB7222H36	22 x 72 x 36	92.5	330	33	\$6741	
LCB7220H36	20 x 72 x 36	92.5	300	30	\$6000	
LCB6022H36	22 x 60 x 36	100	275	28	\$5788	
LCB6020H36	20 x 60 x 36	92.5	250	25	\$5260	

90" w units have (3) two door storage cabinets with top drawer side-by-side. 72" w & 60" w units have (2) two door storage cabinets with top drawer side-by-side. Locking doors. Self-closing hinged doors cover one adjustable shelf.

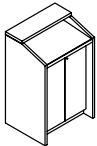

Lectern - Dufferin

DLEC3624	24 x 36 x 48	92.5	240	24	\$4329	\$5195
DLEC3024	24 x 30 x 48	92.5	200	20	\$3610	\$4331
DLEC2424	24 x 24 x 48	92.5	160	16	\$2887	\$3463

Features angled stand. Storage compartment with one adjustable and one fixed shelf. Locks optional.

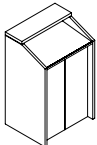

Lectern - Lufton

LEC3624L	24 x 36 x 48	92.5	240	24	\$4910	
LEC3024L	24 x 30 x 48	92.5	200	20	\$4096	
LEC2424L	24 x 24 x 48	92.5	160	16	\$3263	

Features angled stand. Storage compartment with one adjustable and one fixed shelf. Locks optional.

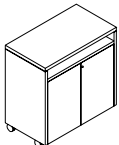



Utility Table - Dufferin

DTV3620M	20 x 36 x 34	85	121	10	\$2620	\$3141
----------	--------------	----	-----	----	--------	--------

Open shelf and storage compartment with one adjustable shelf. Locking doors. Casters.

Required Specifications

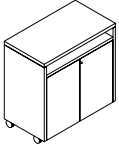
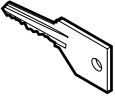
Finish

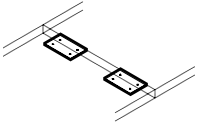
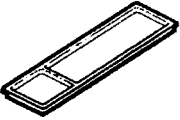
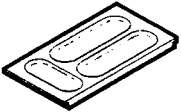
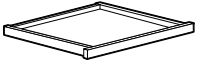
ACCESSORIES	MODEL#	DIMENSIONS	FREIGHT CLASS	WT/LBS.	CUBIC FT.	LIST PRICE
 Utility Table - Lufton	LTV3620M	D x W x H 20 x 36 x 34	85	121	10	\$2838
	Open shelf and storage compartment with one adjustable shelf. Locking doors. Casters.					
 Extra Key	LOCK	--	70	--	--	\$43
	Specify key #. Key range 400 - 500.					
 Grommet Cover, Round	GM1	2 dia x --	70	--	--	\$65
	GM1K	2 dia x --	70	--	--	\$65
	2.75" diameter. <ul style="list-style-type: none"> • Specify GM1 for Black or GM1K for Tungsten. 					
 Mending Plates	MP53	3 x 5 x 0.50	300	3	2	\$61
	Sold in sets of 2. <ul style="list-style-type: none"> • Available in Black Only. 					
 Pencil Tray - Black Plastic	PT	3 x 12.50 x 1	250	2	1	\$21
	Provides space for writing instruments and small items at the workspace. <ul style="list-style-type: none"> • Available in Black Only. 					
 Pencil Tray - Veneer	OPT	6 x 12.50 x 2	150	4	1	\$171
	Provides space for writing instruments and small items at the workspace. Solid oak finish.					
 Center Drawer - Veneer	CD	21 x 23 x 2	100	8	1	\$698
	Veneer drawer front is attached to a 4-sided frame. Must specify wood finish for drawer front.					

Required Specifications

Finish

T BOARDROOM TABLES

KEYBOARD DRAWERS

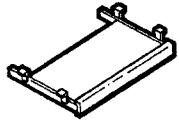

Keyboard Drawer

MODEL#	DIMENSIONS D x W x H	FREIGHT CLASS	WT/LBS.	CUBIC FT.	LIST PRICE
KD30	10 x 30 x 1	70	16	1	\$938
KD22	10 x 22 x 1	85	12	1	\$838
KD10	10 x 10 x 1	125	6	1	\$424

Pull-out veneer keyboard shelf. Clearance is 2 1/4". Must specify wood finish for drawer front.

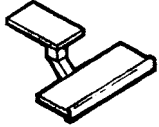

Articulating Keyboard Drawer

AKD30	10 x 30 x 1	65	24	1	\$1295
AKD22	10 x 22 x 1	70	18	1	\$1199

Adjustable pull-out keyboard shelf with articulating arm. Adjusts from flush with the worksurface to 5" below worksurface. Swivels 360° full arm rotation, angles -10° to +15°. Must specify wood finish for keyboard deck.

WIRE MANAGEMENT



Wire Management Cover

MODEL#	DIMENSIONS	FREIGHT CLASS	WT/LBS.	CUBIC FT.	LIST PRICE
WH24	1 x 1 x 24	70	1	1	\$74

To conceal wires and cords. Plastic.

- **Available in Black Plastic Only.**

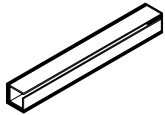

Wire Management Track - Single





C2M72	2 x 72 x 2	70	0.10	0.10	\$83
C2M60	2 x 60 x 2	70	0.10	0.10	\$69
C2M48	2 x 48 x 2	70	0.10	0.10	\$57
C2M36	2 x 36 x 2	70	0.10	0.10	\$42
C2M24	2 x 24 x 2	70	0.10	0.10	\$31
C2M12	2 x 12 x 2	70	0.10	0.10	\$17

To conceal and organize wires and cords. Attaches to Modesty Panel with double sided tape. Plastic.

- **Available in Black Plastic Only.**

Required Specifications

Finish

POWER / DATA	MODEL#	DIMENSIONS	FREIGHT CLASS	WT/LBS.	CUBIC FT.	LIST PRICE
 <p>Single Sided Recessed Power Block</p>	D x W x H					
	PRTMCS401B	4.22 x 10.78 x 4.86	100	4.3	0.51	\$456
	PRTMCS401T	4.22 x 10.78 x 4.86	100	4.3	0.51	\$456
	PRTMCS401W	4.22 x 10.78 x 4.86	100	4.3	0.51	\$456
<p>Single-sided recessed power block with one regular duplex and one telecom knockout on top; one power duplex on bottom. 10' power cord with straight plug. Specify telecom options separately, see page 404. Available in Black (B), Tungsten (T) or Designer White (W) as indicated by the last letter of model number. Duplexes always Grey. Corresponding cut-out options are R1, R2 or R3. Units are not approved for daisy chaining. UL listed: UL 1363.</p>						
 <p>Single Sided Recessed Power Block - USB-A + USB-C</p>	D x W x H					
	PRTMCS421B	4.22 x 10.78 x 4.86	100	4.3	0.51	\$599
	PRTMCS421T	4.22 x 10.78 x 4.86	100	4.3	0.51	\$599
	PRTMCS421W	4.22 x 10.78 x 4.86	100	4.3	0.51	\$599
<p>Single-sided recessed power block with one power/USB-A/USB-C duplex and one telecom knockout on top; one power duplex on bottom. USB-A port charges max 2.4 amps at 5V and USB-C port charges max 3 amps at 5V. 10' power cord with straight plug. Specify telecom options separately, see page 404. Available in Black (B), Tungsten (T) or Designer White (W) as indicated by the last letter of model number. Duplexes always Grey (duplex with USB ports is glossy finish). Corresponding cut-out options are R1, R2 or R3. Units are not approved for daisy chaining. UL listed: UL 1363.</p>						
 <p>Double Sided Recessed Power Block</p>	D x W x H					
	PRTMCD602B	6.22 x 10.78 x 4.86	92.5	5.9	0.51	\$521
	PRTMCD602T	6.22 x 10.78 x 4.86	92.5	5.9	0.51	\$521
	PRTMCD602W	6.22 x 10.78 x 4.86	92.5	5.9	0.51	\$521
<p>Double-sided recessed power block with two regular power duplexes and two telecom knockouts on top; one power duplex on bottom. 10' power cord with straight plug. Specify telecom options separately, see page 404. Available in Black (B), Tungsten (T) or Designer White (W) as indicated by last letter of model number. Duplexes always Grey. Corresponding cut-out options are T1, T2 or T3. Units are not approved for daisy chaining. UL listed: UL 1363.</p>						
 <p>Double Sided Recessed Power Block - USB-A + USB-C</p>	D x W x H					
	PRTMCD622B	6.22 x 10.78 x 4.86	92.5	6.1	0.51	\$656
	PRTMCD622T	6.22 x 10.78 x 4.86	92.5	6.1	0.51	\$656
	PRTMCD622W	6.22 x 10.78 x 4.86	92.5	6.1	0.51	\$656
<p>Double-sided recessed power block with one regular power duplex, one power/USB-A/USB-C duplex and two telecom knockouts on top; one power duplex on bottom. USB-A port charges max 2.4 amps at 5V and USB-C port charges max 3 amps at 5V. 10' power cord with straight plug. Specify telecom options separately, see page 404. Available in Black (B), Tungsten (T) or Designer White (W) as indicated by last letter of model number. Duplexes always Grey (duplex with USB ports is glossy finish). Corresponding cut-out options are T1, T2 or T3. Units are not approved for daisy chaining. UL listed: UL 1363.</p>						
 <p>Double Sided Recessed Power Block - USB-A + USB-C</p>	D x W x H					
	PRTMCD642B	6.22 x 10.78 x 4.86	85	6.3	0.51	\$790
	PRTMCD642T	6.22 x 10.78 x 4.86	85	6.3	0.51	\$790
	PRTMCD642W	6.22 x 10.78 x 4.86	85	6.3	0.51	\$790
<p>Double-sided recessed power block with two power/USB-A/USB-C duplexes and two telecom knockouts on top; one power duplex on bottom. USB-A port charges max 2.4 amps at 5V and USB-C port charges max 3 amps at 5V. 10' power cord with straight plug. Specify telecom options separately, see page 404. Available in Black (B), Tungsten (T) or Designer White (W) as indicated by last letter of model number. Duplexes always Grey (duplex with USB ports is glossy finish). Corresponding cut-out options are T1, T2 or T3. Units are not approved for daisy chaining. UL listed: UL 1363.</p>						

Required Specifications
Finish

T BOARDROOM TABLES

TELECOM PLATES

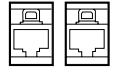

Telecom Plate - 2 x 6

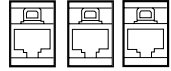

Telecom Plate - 3 x 6

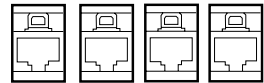

Telecom Plate - 4 x 6



Telecom Plate - 3TSV

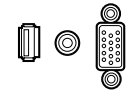

Telecom Plate - 3SVH

MODEL#	DIMENSIONS	FREIGHT CLASS	WT/LBS.	CUBIC FT.	LIST PRICE
--------	------------	---------------	---------	-----------	------------

D x W x H

PTEL01	- x - x -	70	0.01	0.05	\$164
--------	-----------	----	------	------	--------------

Includes 2 x RJ45 cat 6 data. Black telecom plate. To be hardwired by data contractor.

PTEL02	- x - x -	70	0.01	0.05	\$222
--------	-----------	----	------	------	--------------

Includes 2 x RJ45 cat 6 data and 1 RJ11 cat phone. Black telecom plate. To be hardwired by data contractor.

PTEL03	- x - x -	70	0.01	0.05	\$340
--------	-----------	----	------	------	--------------

Includes 4 x RJ45 cat 6 data. Black telecom plate. To be hardwired by data contractor.

PTEL04	- x - x -	70	0.01	0.05	\$290
--------	-----------	----	------	------	--------------

Includes 1 x RJ45 cat 6 data, mini stereo and 15 pin HD VGA. Black telecom plate. To be hardwired by data contractor.

PTEL05	- x - x -	70	0.01	0.05	\$401
--------	-----------	----	------	------	--------------

Includes mini stereo, 15 pin HD VGA and HDMI. Black telecom plate.

Required Specifications

Finish

VILLA I SERIES CORDED UNITS

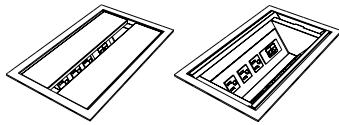

Oasis Mini A, Corded

MODEL#	DIMENSIONS	FREIGHT CLASS	WT/LBS.	CUBIC FT.	LIST PRICE
OAM-A-PC- <u> </u>	15 x 9 x 5.25	92.5	16	1.53	\$1826

D x W x H

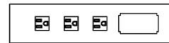
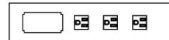

Mini Oasis A unit. 15" Trough with six power receptacles, two telecom plate cut-outs (**telecom plates sold separate**, see page page 410) and two 108" 3-prong plugs. **M1, M2 or M3 cut-out(s) must be specified on conference table** (see product notes section for more details and cut-out upcharge). UL Listed.

- **Cannot be daisy-chained.**
- Replace with **B** for **Black**
- Replace with **S** for **Silver Pearl**

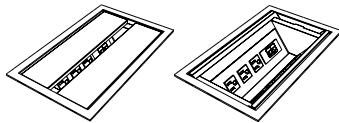

Oasis Mini A, DaisyLink Version

OAM-A-PC-4-1- <u> </u>	15 x 9 x 5.25	92.5	16	1.53	\$2091
-------------------------	---------------	------	----	------	---------------

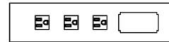
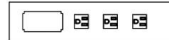

For hardwire and daisy chain applications. Mini Oasis A unit. 15" Trough with six power receptacles, two telecom plate cut-outs (**telecom plates sold separate**, see page page 410). **Power infeed sold separate** (see page page 412). **M1, M2 or M3 cut-out(s) must be specified on conference table** (see product notes section for more details and cut-out upcharge). For multiple circuit configurations, please contact customer service. *Please see our **Daisy-Chain guide** on page page 408 for appropriate cable lengths and important notes.* UL Listed.

- Replace with **B** for **Black**
- Replace with **S** for **Silver Pearl**

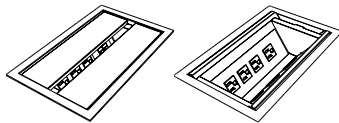

Oasis Mini B, Corded

OAM-B-PC- <u> </u>	15 x 9 x 5.25	92.5	16	1.53	\$1826
---------------------	---------------	------	----	------	---------------

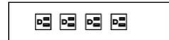

Mini Oasis B unit. 15" Trough with four power receptacles, three telecom plate cut-outs (**telecom plates sold separate**, see page page 410) and one 108" 3-prong plug. **M1, M2 or M3 cut-out(s) must be specified on conference table** (see product notes section for more details and cut-out upcharge). UL Listed.

- **Cannot be daisy-chained.**
- Replace with **B** for **Black**
- Replace with **S** for **Silver Pearl**

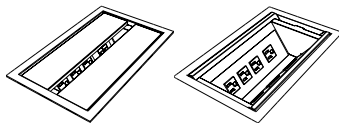

Oasis Mini B, DaisyLink Version

OAM-B-PC-4-1- <u> </u>	15 x 9 x 5.25	92.5	16	1.53	\$2091
-------------------------	---------------	------	----	------	---------------

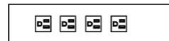

For hardwire and daisy chain applications. Mini Oasis B unit. 15" Trough with four power receptacles, three telecom plate cut-outs (**telecom plates sold separate**, see page page 410). **Power infeed sold separate** (see page page 412). **M1, M2 or M3 cut-out(s) must be specified on conference table** (see product notes section for more details and cut-out upcharge). For multiple circuit configurations, please contact customer service. *Please see our **Daisy-Chain guide** on page page 408 for appropriate cable lengths and important notes.* UL Listed.

- Replace with **B** for **Black**
- Replace with **S** for **Silver Pearl**

Required Specifications

Finish
Power infeed
Cut-out location

T BOARDROOM TABLES

OASIS MINI	MODEL#	DIMENSIONS	FREIGHT CLASS	WT/LBS.	CUBIC FT.	LIST PRICE
------------	--------	------------	---------------	---------	-----------	------------

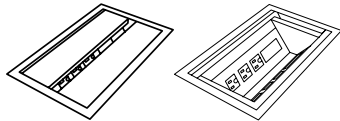

Oasis Mini USB, Corded

	D x W x H					
OAM-U-PC-__	15 x 9 x 5.25	92.5	16	1.53		\$2044

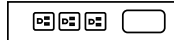
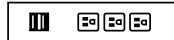

Mini Oasis USB unit. 15" trough with six power receptacles, two 2.1 AMP USB charging ports and one telecom plate cut-out (**telecom plates sold separate**, see page page 410) and two 108" 3-prong plugs. **M1, M2 or M3 cut-out(s) must be specified on conference table** (see product notes section for more details and cut-out upcharge). UL Listed.

- **Cannot be daisy-chained.**
- Replace _ with **B** for **Black**
- Replace _ with **S** for **Silver Pearl**

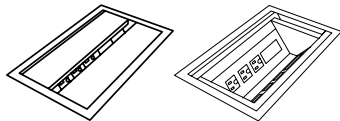

Oasis Mini USB, DaisyLink Version

OAM-U-PC-4-1-__	15 x 9 x 5.25	92.5	16	1.53		\$2307
-----------------	---------------	------	----	------	--	---------------

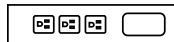
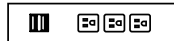

For hardwire and daisy chain applications. Mini Oasis USB unit. 15" trough with six power receptacles, two 2.1 AMP USB charging ports and one telecom plate cut-out (**telecom plates sold separate**, see page page 410). **Power infeed sold separate** (see page page 412). **M1, M2 or M3 cut-out(s) must be specified on conference table** (see product notes section for more details and cut-out upcharge). For multiple circuit configurations, please contact customer service. *Please see our **Daisy-Chain guide** on page page 408 for appropriate cable lengths and important notes.* UL Listed.

- Replace _ with **B** for **Black**
- Replace _ with **S** for **Silver Pearl**

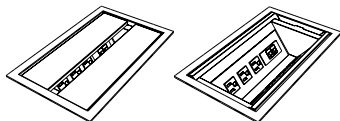

Oasis Mini, Chicago Code

GL-OAMPD_P72HW	15 x 9 x 5.25	92.5	16	1.53		\$2490
----------------	---------------	------	----	------	--	---------------

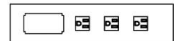

Mini Oasis for Chicago code includes electrical trough with (2) separate hardwire inserts. Each insert includes (3) simplex outlets and (1) telecom plate cut-out (**telecom plates sold separate**, see page page 410). **M1, M2 or M3 cut-out(s) must be specified on conference table** (see product notes section for more details and cut-out upcharge). Each component is UL listed.

- **Cannot be daisy-chained.**
- Replace _ with **B** for **Black**
- Replace _ with **S** for **Silver Pearl**

Required Specifications

- Finish
- Power infeed
- Cut-out location

OASIS MINI CUT OUT POSITIONS

D x W x H

OASIS MINI A & B CABLE LENGTHS NEEDED FOR DAISY-CHAINING

Model #	Oasis Mini A & Oasis Mini B	Oasis Mini A & Oasis Mini B	Oasis Mini A	Oasis Mini A	Oasis Mini B	Oasis Mini B
Cut-out Positions	TL/M & TR/M	TL/M & TR/M	TL/M, TC/M & TR/M	TL/M, TC/M & TR/M	TL/M, TC/M & TR/M	TL/M, TC/M & TR/M
Infeed Position	Left or Right	Center	Left or Right	Center	Left or Right	Center
Reference	Drawing 1A/1B	Drawing 2A/2B	Drawing 3	Drawing 4	Drawing 5	Drawing 6
8' Dufferin & Lufton Tables	(1) 42FF-55 SPECIFY INFEED	(1) 42FF-29 (1) 42FM-29 (1) DAISY-T SPECIFY INFEED	N/A	N/A	N/A	N/A
10' Dufferin & Lufton Tables	(1) 42FF-79 SPECIFY INFEED	(1) 42FF-41 (1) 42FM-41 (1) DAISY-T SPECIFY INFEED	(3) 42FF-37 SPECIFY INFEED	(3) 42FF-37 SPECIFY INFEED	(2) 42FF-37 SPECIFY INFEED	(2) 42FF-37 (1) 42FM-12 (1) DAISY-T SPECIFY INFEED
12' Dufferin & Lufton Tables	(1) 42FF-103 SPECIFY INFEED	(1) 42FF-55 (1) 42FM-55 (1) DAISY-T SPECIFY INFEED	(3) 42FF-52 SPECIFY INFEED	(3) 42FF-52 SPECIFY INFEED	(2) 42FF-52 SPECIFY INFEED	(2) 42FF-52 (1) 42FM-12 (1) DAISY-T SPECIFY INFEED
14' Dufferin & Lufton Tables	(1) 42FF-64 (1) 42FM-64 SPECIFY INFEED	1) 42FF-67 (1) 42FM-67 (1) DAISY-T SPECIFY INFEED	(3) 42FF-61 SPECIFY INFEED	(3) 42FF-61 SPECIFY INFEED	(2) 42FF-61 SPECIFY INFEED	(2) 42FF-61 (1) 42FM-12 (1) DAISY-T SPECIFY INFEED
16' Dufferin & Lufton Tables	(1) 42FF-79 (1) 42FM-79 SPECIFY INFEED	1) 42FF-82 (1) 42FM-82 (1) DAISY-T SPECIFY INFEED	(3) 42FF-76 SPECIFY INFEED	(3) 42FF-76 SPECIFY INFEED	(2) 42FF-76 SPECIFY INFEED	(2) 42FF-76 (1) 42FM-12 (1) DAISY-T SPECIFY INFEED
18' Dufferin & Lufton Tables	(1) 42FF-88 (1) 42FM-88 SPECIFY INFEED	1) 42FF-91 (1) 42FM-91 (1) DAISY-T SPECIFY INFEED	(3) 42FF-85 SPECIFY INFEED	(3) 42FF-85 SPECIFY INFEED	(2) 42FF-85 SPECIFY INFEED	(2) 42FF-85 (1) 42FM-12 (1) DAISY-T SPECIFY INFEED
20' Dufferin & Lufton Tables	(1) 42FF-100 (1) 42FM-100 SPECIFY INFEED	1) 42FF-103 (1) 42FM-103 (1) DAISY-T SPECIFY INFEED	(3) 42FF-100 SPECIFY INFEED	(3) 42FF-100 SPECIFY INFEED	(2) 42FF-100 SPECIFY INFEED	(2) 42FF-100 (1) 42FM-12 (1) DAISY-T SPECIFY INFEED

Interconnecting Cables - Common Cable Lengths (in inches)

Female/Female

42FF-21	\$108	42FF-94	\$199	42FM-91	\$201
42FF-29	\$119	42FF-100	\$205	42FM-94	\$203
42FF-32	\$121	42FF-103	\$208	42FM-103	\$216
42FF-37	\$128	42FF-106	\$211	42FM-106	\$218
42FF-41	\$133	42FF-112	\$219	42FM-115	\$230
42FF-46	\$139	42FF-115	\$225	42FM-118	\$235
42FF-52	\$147	42FF-118	\$228		
42FF-55	\$151				
42FF-58	\$154	Female/Male			
42FF-61	\$157	42FM-12	\$104		
42FF-64	\$161	42FM-21	\$115		
42FF-67	\$165	42FM-32	\$128		
42FF-70	\$168	42FM-46	\$146		
42FF-76	\$176	42FM-55	\$156		
42FF-79	\$180	42FM-58	\$159		
42FF-82	\$184	42FM-67	\$170		
42FF-85	\$187	42FM-70	\$175		
42FF-88	\$191	42FM-79	\$186		
42FF-91	\$195	42FM-82	\$190		

T BOARDROOM TABLES

OASIS MINI NOTES

D x W x H

DRAWING 1A - MINI OASIS A

Female/ Female Interconnecting Cable Included with Oasis A Unit

Female/ Female Interconnecting Cable Included with Oasis A Unit

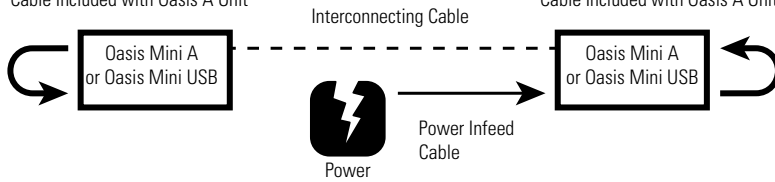

DRAWING 1B - MINI OASIS B

Interconnecting Cable

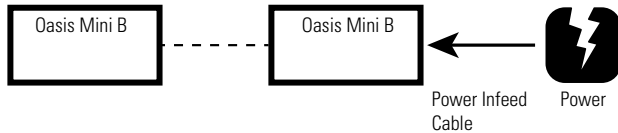

DRAWING 2A - MINI OASIS A

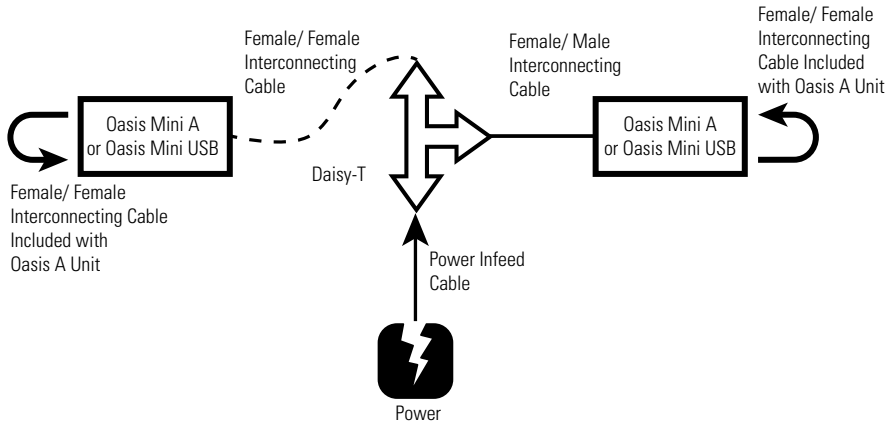

DRAWING 2B - MINI OASIS B

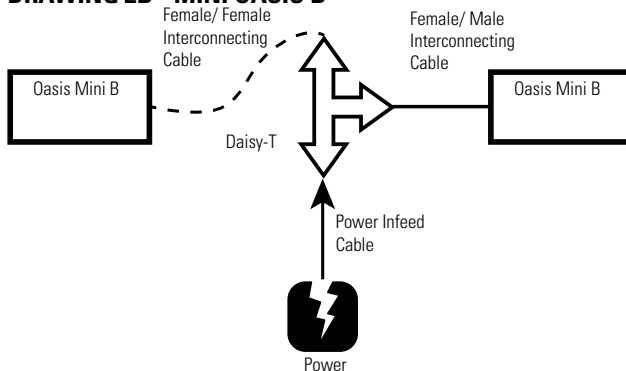

DRAWING 3 - MINI OASIS A

Female/ Female Interconnecting Cable Included with Oasis A Unit

Female/ Female Interconnecting Cable

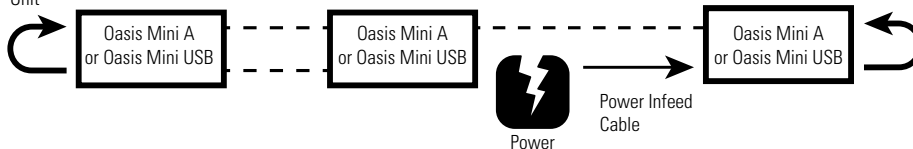

OASIS MINI NOTES

D x W x H

DRAWING 4 - MINI OASIS A

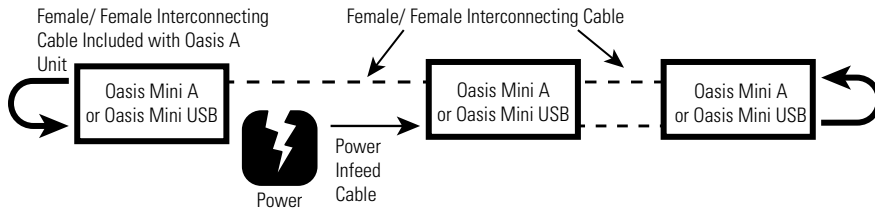

DRAWING 5 - MINI OASIS B

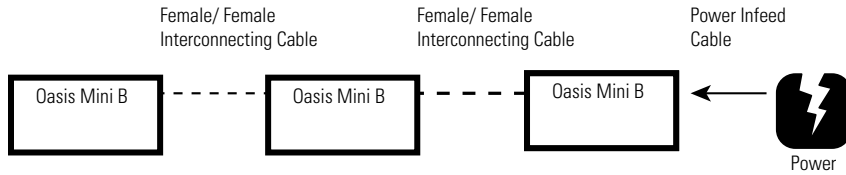



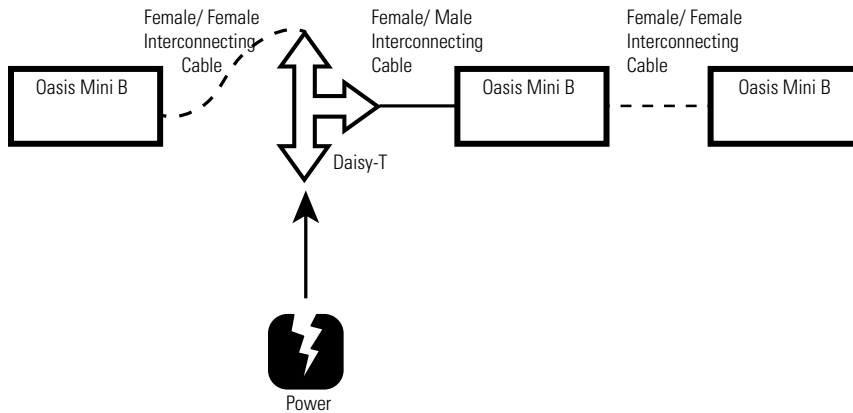







DRAWING 6 - MINI OASIS B

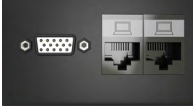





T BOARDROOM TABLES

TOP TELECOM PLATES

TOP TELECOM PLATE	MODEL	CONFIGURATION	D x W x H	LIST PRICE
	A-__-A-B	Telecom plate with RJ11 Cat 3 Phone and RJ45 Cat 6 Data		\$108
	A-__-B-B	(2) RJ45 Cat 6 Connectors		\$141
	A-__-B-B-B	(3) RJ45 Cat 6 Connectors		\$206
	A-__-B-B-B-B	(4) RJ45 Cat 6 Connectors		\$274
	A-__-B-C51-L	RJ45 Cat 6 Data, Mini-Stereo Inline and 15 pin HD VGA Female/Female with 72" patch cord attached.		\$244
	A-__-B-B-C51	(2) RJ45 Cat 6 Data and (1) 15 pin HD VGA Female/Female with 72" patch cord attached.		\$254
	A-__-A-B-102	RJ11 Cat 3 phone, RJ45 Cat 6 Data and USB with 72" patch cord attached.		\$244
	A-__-B	RJ45 Cat 6 Data		\$76
	A-__-C51-L	Mini Stereo Inline and 15 pin HD VGA Female/Female with 72" patch cord attached.		\$191
	A-__-CRDMINDER	Cordminder Plate - 2 5/8" holes and 1 7/8" holes		\$43
	A-__-C45-C51-L	HDMI Female/Female with 36" patch cord attached. Mini Stereo Inline and 15 Pin HD VGA Female/Female with 72" patch cord attached.		\$333

Required Specifications

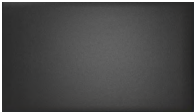
Finish
Power infeed
Cut-out location

TOP TELECOM PLATES		MODEL#	DIMENSIONS	FREIGHT CLASS	WT/LBS.	CUBIC FT.	LIST PRICE
TOP TELECOM PLATE	MODEL	CONFIGURATION					LIST PRICE
	A-__-C45	HDMI Female/Female with 36" patch cord attached.					\$164
	A-__-A-B-B	(1) RJ11 Cat 3 Phone and (2) RJ45 Cat 6 data.					\$178
	A-__	Blank telecom plate					\$10
	A-__-102	USB with 72" patch cord attached.					\$76
	A-__-C51	15 pin HD VGA Female/Female with 72" patch cord attached.					\$123

- Replace _ with **BL** for **Black**
- Replace _ with **GR** for **Grey**



Required Specifications

Veneer Finish
Laminate Finish
Handle Style

Optional Specifications

Grommet

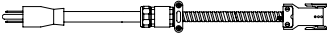
T BOARDROOM TABLES

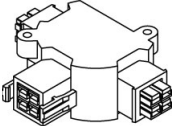
POWER INFEEDS	MODEL#	DIMENSIONS D x W x H	FREIGHT CLASS	WT/LBS.	CUBIC FT.	LIST PRICE
 <p>Plug and Play Infeed</p> <p>Single Circuit 20 AMP Power Infeed with 72" 3-prong plug. Provides single power entry from floor or wall mounted standard power supply. Connects to Oasis Mini or Villa units that require a separate infeed. UL Listed.</p>	42AP1-72	--	--	--	--	\$245
	<hr/>					
 <p>Multi-Circuit Hardwire Power Infeed</p> <p>Multi-Circuit Hardwire Infeed (up to 20 AMPS per circuit), two circuits. Provides single power entry from floor or wall located building power supply. Connects to Oasis Mini or Villa units that require a power infeed. TO BE HARDWIRED BY A LICENSED ELECTRICIAN. UL Listed.</p>	42SB2-108	--	--	--	--	\$203
	42SB2-72	--	--	--	--	\$158
	42SB2-36	--	--	--	--	\$115
	<hr/>					
 <p>3 Way Power Splitter</p> <p>Daisy-T power manager includes two male and one female connection. For use in splitting a power source two ways.</p>	DAISY-T	--	70	1	1	\$187
	<hr/>					

Required Specifications

Veneer Finish
Laminate Finish
Handle Style

Optional Specifications

Grommet

textiles and finishes

Care and Cleaning

Textiles

Fabrics: To extend the life of your seating upholstered in fabric, regularly dust the chair to prevent airborne particles from penetrating the fabric surface.

For light soiling, use a damp cloth and blot the spot with very slight pressure, taking care never to soak the fabric. Dry with a clean cloth by blotting - never rub fabric. More intense stains can be treated the same way, but with a mild detergent. Always test fabric first in an unseen area before using any cleaning method.

Leather: For regular cleaning, simply use a soft damp cloth, taking care not to soak the leather. For more thorough treatment, soak a soft cloth in mild soap solution and wipe surface in a light circular motion. Repeat with clean water. Allow to dry and polish with a soft dry cloth. Do not use detergents, aerosol sprays or other polishes.

Hard Surfaces

Wood Veneer Finishes: Waxing or polishing catalyzed finishes is not recommended because this will give a greasy, cloudy or uneven appearance to the product and could void your warranty. Global's conversion varnish is best cleaned by wiping the surface with a damp cloth, followed by a soft dry cloth in the direction of the grain. If the surfaces are heavily soiled, a gentle product like "Windex" can be used, following the same instructions as above.

Laminate, painted & plated metal finishes, and solid surfaces: Wipe the surface with a clean soft damp cloth; if needed, a mild soap solution can be used. To prevent streaks, dry the surface with a clean dry cloth moving in a circular motion.

-
- **Water-Based Cleaner:** Spot clean, using the foam only from a water-based cleaning agent, such as a mild detergent or non-solvent upholstery shampoo product. Apply foam with a soft brush in a circular motion. Vacuum when dry. Pretest small area before proceeding.
 - **Solvent Cleaner:** Spot clean, using a mild water-free solvent or dry cleaning product. Clean only in a well-ventilated room and avoid any product containing carbon tetrachloride or other toxic materials. Pretest a small area before proceeding.
 - **Water/Solvent Cleaner:** Spot clean with a mild solvent, an upholstery shampoo, or the foam from a mild detergent. When using a solvent or dry cleaning product, follow instructions carefully and clean only in a well-ventilated room. Avoid any product that contains carbon tetrachloride or other toxic materials. With either method, pretest a small area before proceeding.
 - **Vacuum Only:** Clean this fabric only by vacuuming or light brushing to prevent accumulation of dust and grime. Water-based foam cleaning agents of any kind may cause excessive shrinking, staining, or distortion of the surface pile and therefore, should not be used.
 - **Crypton Cleaning:** Generally stains are removed with plain water and powdered enzyme detergent. Upholstery foam shampoo, water-based cleaning products and germicidal detergents can be used. Be sure to remove all residue from cleaning products with clean water. Do not use solvent-based cleaners or dry cleaning products.
 - These recommendations and codes were developed by fabric specialists. However, because of the various ways fabric can be stained or damaged, there is no guarantee that the results will be completely successful. Use suggested methods on your own responsibility. To help prevent overall soil, frequent vacuuming or light brushing to remove dust and grime is recommended. Use professional furniture cleaning service when overall soiled condition has been reached.