

# T BOARDROOM TABLES - NOTES

## 1. SPECIFY MODEL NUMBER

## 2. SPECIFY FINISH

### TOP FINISH - WOOD VENEER

Code	Finish	Veneer Type	Cut
AMW	Almond Cherry	Cherry	Flat Sliced
CAW	Cocoa Walnut	Walnut	Flat Sliced
CRW	Coral	White Oak	Rift
DCW	Dark Cherry	Cherry	Flat Sliced
EWV	Espresso Walnut	Walnut	Flat Sliced
EVW	Evening Oak	White Oak	Rift
GRW	Grey on Oak	White Oak	Rift
HAW	Hazelnut	Maple	Flat Sliced
SMW	Honey Maple	Maple	Flat Sliced
JAW	Java	White Oak	Rift
LTW	Latte Walnut	Walnut	Flat Sliced
MTW	Milestone	White Oak	Rift
MCW	Mocha	White Oak	Rift
MPW	Natural Maple	Maple	Flat Sliced
RCW	Red Cherry	Cherry	Flat Sliced
VNW	Vintage Cherry	Cherry	Flat Sliced
WLW	Walnut	Walnut	Flat Sliced
WCW	Warm Cherry	Cherry	Flat Sliced
WMW	White Maple	Maple	Flat Sliced

### BASE FINISH (refer to specific model for availability):

K	Black
E	Tungsten

**3. SPECIFY OPTIONS**

**Boardroom Tops**

- Tops 120" and under ship in one piece
- Tops over 120" ship in two pieces
- Veneer wood grain will run with the **length** of the table and align at the seam

**Grommets**

- Optional grommets may be ordered in standard table top locations (left, center or right). Order as **GM1TL, GM1TC or GM1TR**. Add \$96.
- Grommet hole dimensions are 2 3/4" in diameter. Specify **GM1** for **Black** or **GM1K** for **Tungsten**. **Standard Grommet Locations:**

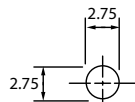

**Grommet Locations - Boardroom Tables**

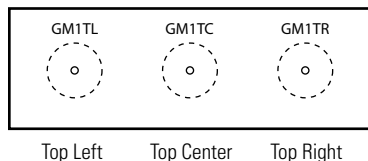

**Power/Data Accessories**

- Power/data accessories may be factory installed on Boardroom Table tops.
- Please specify location in top as left, center or right (**TL/x, TC/x, or TR/x**) as per line drawing below. Location must be specified on product to be placed on at the time of the order. Please note orientation of power/data accessories on Boardroom Table tops is as shown in drawings below. Add \$300 for each cut-out.
- When an "M" cut-out is ordered, certain bases will be notched to allow clearance for the Oasis Mini.

**PRODUCT CODE DIAGRAM**

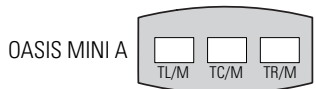
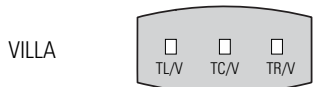
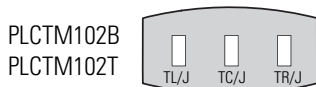
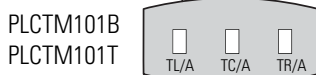
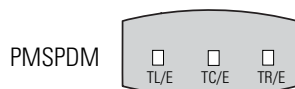

**PRODUCT CODE DIAGRAM**

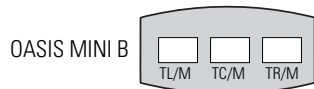
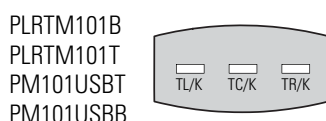
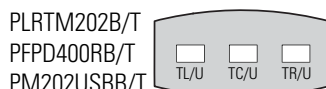

**Custom Cut-out**

- Optional custom sized cut-out available in standard locations - **CCUTL** (left), **CCUTC** (center) and **CCUTR** (right) for all boardroom table tops. Submit appropriate form (beginning on page 402) with order. Add \$300 for each cut-out.

# T BOARDROOM TABLES

## BOARDROOM TABLE TOP AND BASE GUIDE

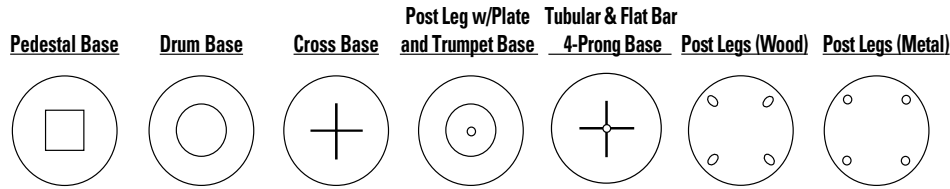

Requires 1 of the following: Pedestal, Drum, Cross, Post Leg w/Plate, Tubular and Flat Bar 4-Prong base, Trumpet Column Base

Requires 4 of the following: Wood Post Legs or Metal Post Legs.

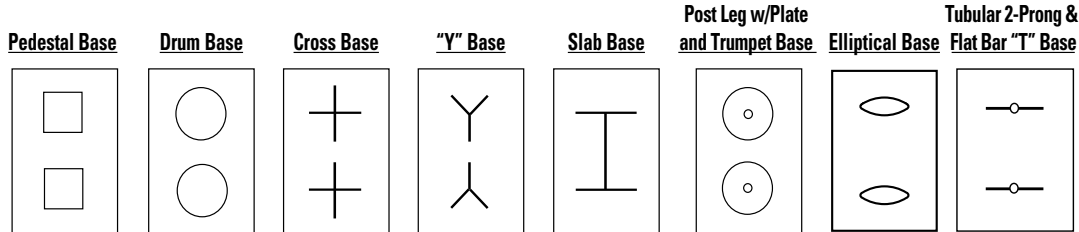

**3-Prong Tubular or**

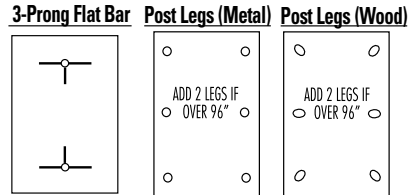
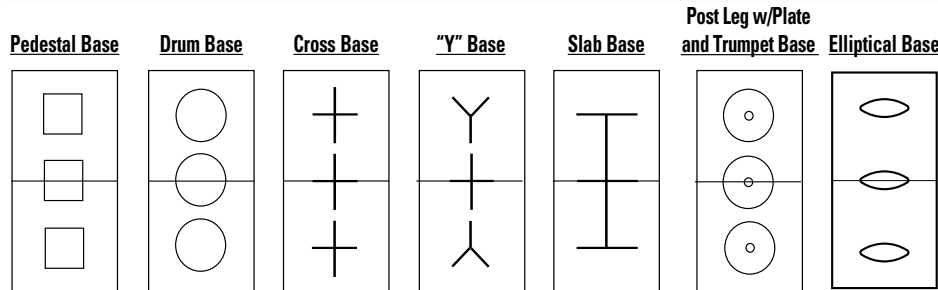

Table Tops up to 120" are in one section and require (2) bases.

Tubular, 2-Prong Base - Table Tops up to 84" require (2) bases.

Tubular and Flat Bar "T" Base - Table Tops up to 120" require (2) bases.

Post Legs - Table Tops up to 96" are in one section and require (4) legs. Tops 108" to 168" require (6) legs.



**3-Prong Tubular or**

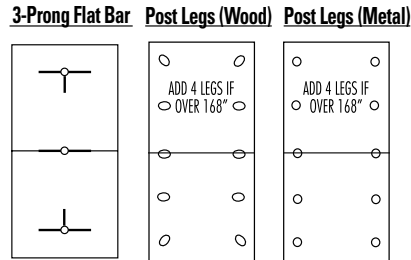

Table Tops 144" and over are in two sections and require (3) bases.

"Y" Base - Require (2) "Y" bases and (1) Cross base in the center.

Slab Base - Require (3) Slab bases.

Tubular and Flat Bar 3-Prong Base - Require (2) 3-Prong bases and (1) 2-Prong base in the center.

Post Legs - Table Tops 180" to 240" require (10) legs.

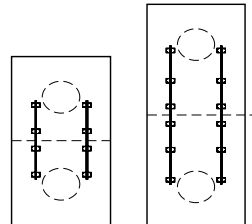

If design considerations or dimension requirements dictate an unsupported table joint, use metal table support rail.

*Top section must not exceed 72" to use metal supports.*

## BOARDROOM TABLES - TOPS WITH DUFFERIN EDGE

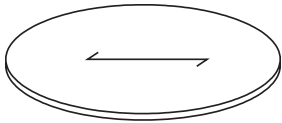

**Round Top**

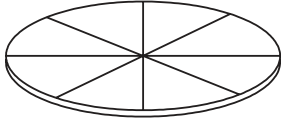

**Round Top - Sunburst Veneer Pattern**

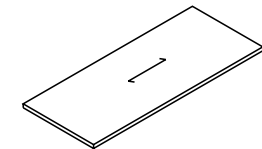

**Rectangular Top**

MODEL#	DIMENSIONS D x W x H	FREIGHT CLASS	WT./LBS.	CUBIC FT.	LIST PRICE
RO60D	60 x 60 x 1.37	85	150	11	<b>\$2942</b>
RO48D	48 x 48 x 1.37	85	96	7	<b>\$2353</b>
RO42D	42 x 42 x 1.37	85	74	6	<b>\$2128</b>
RO36D	36 x 36 x 1.37	85	54	4	<b>\$1807</b>
RO30D	30 x 30 x 1.37	85	38	3	<b>\$1265</b>

For use with Drum Base, Pedestal Base, Cross Base, Wood Post Legs, Metal Post Legs, 4 Prong Base, Post leg w/Flat Plate, Flat Square Column Base, Trumpet Column base, Flat Bar "X" Base", Square Panel Base.

RO60SD	60 x 60 x 1.37	85	150	11	<b>\$3185</b>
RO48SD	48 x 48 x 1.37	85	96	7	<b>\$2694</b>
RO42SD	42 x 42 x 1.37	85	74	6	<b>\$2304</b>
RO36SD	36 x 36 x 1.37	85	54	4	<b>\$1983</b>
RO30SD	30 x 30 x 1.37	85	38	3	<b>\$1647</b>

For use with Drum Base, Pedestal Base, "X" Shape Slab Base, Wood Post Legs, Metal Post Legs, 4 Prong Base, Post leg w/Flat Plate, Flat Square Column Base, Trumpet Column base, Flat Bar "X" Base", Square Panel Base.

RE24054D	54 x 240 x 1.37	85	540	39	<b>\$9421</b>
RE21654D	54 x 216 x 1.37	85	486	35	<b>\$8479</b>
RE19254D	54 x 192 x 1.37	85	432	31	<b>\$7277</b>
RE5454D	54 x 54 x 1.37	85	121	9	<b>\$2071</b>
RE16848D	48 x 168 x 1.37	85	336	25	<b>\$5417</b>
RE14448D	48 x 144 x 1.37	85	288	21	<b>\$4081</b>
RE12048D	48 x 120 x 1.37	85	240	18	<b>\$3634</b>
RE9648D	48 x 96 x 1.37	85	192	14	<b>\$2681</b>
RE4848D	48 x 48 x 1.37	85	96	7	<b>\$1473</b>
RE8442D	42 x 84 x 1.37	85	147	11	<b>\$2471</b>
RE7242D	42 x 72 x 1.37	85	126	9	<b>\$2112</b>
RE4242D	42 x 42 x 1.37	85	74	5	<b>\$1378</b>
RE8436D	36 x 84 x 1.37	85	126	9	<b>\$2357</b>
RE7236D	36 x 72 x 1.37	85	108	8	<b>\$2021</b>
RE6636D	36 x 66 x 1.37	85	99	7	<b>\$1549</b>
RE3636D	36 x 36 x 1.37	85	54	4	<b>\$846</b>
RE8430D	30 x 84 x 1.37	85	105	8	<b>\$1967</b>
RE7230D	30 x 72 x 1.37	85	90	7	<b>\$1687</b>
RE6630D	30 x 66 x 1.37	85	83	6	<b>\$1549</b>
RE6030D	30 x 60 x 1.37	85	75	6	<b>\$1407</b>
RE5430D	30 x 54 x 1.37	85	68	5	<b>\$1270</b>
RE3030D	30 x 30 x 1.37	85	38	3	<b>\$709</b>
RE8424D	24 x 84 x 1.37	85	84	6	<b>\$1716</b>
RE7224D	24 x 72 x 1.37	85	72	5	<b>\$1471</b>
RE6624D	24 x 66 x 1.37	85	66	5	<b>\$1352</b>
RE6024D	24 x 60 x 1.37	70	60	4	<b>\$1228</b>
RE5424D	24 x 54 x 1.37	85	55	4	<b>\$1104</b>
RE4824D	24 x 48 x 1.37	70	48	3	<b>\$1064</b>
RE2424D	24 x 24 x 1.37	125	21	3	<b>\$489</b>
RE8422D	22 x 84 x 1.37	85	77	6	<b>\$1575</b>
RE7222D	22 x 72 x 1.37	85	66	5	<b>\$1352</b>
RE6622D	22 x 66 x 1.37	85	61	5	<b>\$1237</b>
RE6022D	22 x 60 x 1.37	85	55	4	<b>\$1126</b>
RE5422D	22 x 54 x 1.37	85	50	4	<b>\$1018</b>
RE4822D	22 x 48 x 1.37	85	44	3	<b>\$975</b>
RE2222D	22 x 22 x 1.37	92.5	20	2	<b>\$449</b>

Grain runs the **length** of the worksurface. Tops 120" and under are shipped in one piece and require 2 bases. Tops 144" and over are shipped in two pieces and require 3 bases.

### Required Specifications

Veneer Finish

### Optional Specifications

Boardroom Table Base  
Grommet (not available on Round Tops)  
Custom cut-out

# T BOARDROOM TABLES - DUFFERIN

## BOARDROOM TABLES - TOPS

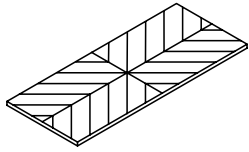

**Rectangular Top -  
Reverse Diamond Pattern**

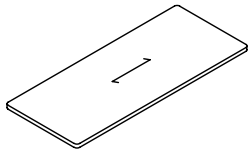

**Rectangular Top Radius Corners**

MODEL#	DIMENSIONS D x W x H	FREIGHT CLASS	WT./LBS.	CUBIC FT.	LIST PRICE
RE24054FD	54 x 240 x 1.37	85	540	39	<b>\$10797</b>
RE21654FD	54 x 216 x 1.37	85	486	35	<b>\$9762</b>
RE19254FD	54 x 192 x 1.37	85	432	31	<b>\$8437</b>
RE5454FD	54 x 54 x 1.37	85	119	9	<b>\$2363</b>
RE16848FD	48 x 168 x 1.37	85	336	25	<b>\$6393</b>
RE14448FD	48 x 144 x 1.37	85	288	21	<b>\$4925</b>
RE12048FD	48 x 120 x 1.37	85	240	18	<b>\$4287</b>
RE9648FD	48 x 96 x 1.37	85	192	14	<b>\$3241</b>
RE4848FD	48 x 48 x 1.37	85	98	7	<b>\$1729</b>
RE8442FD	42 x 84 x 1.37	85	147	11	<b>\$2966</b>
RE7242FD	42 x 72 x 1.37	85	126	9	<b>\$2577</b>
RE4242FD	42 x 42 x 1.37	85	74	5	<b>\$1624</b>
RE8436FD	36 x 84 x 1.37	85	126	9	<b>\$2774</b>
RE7236FD	36 x 72 x 1.37	85	108	8	<b>\$2384</b>
RE6636FD	36 x 66 x 1.37	85	99	7	<b>\$1817</b>
RE3636FD	36 x 36 x 1.37	85	54	4	<b>\$1160</b>
RE8430FD	30 x 84 x 1.37	85	105	8	<b>\$2308</b>
RE7230FD	30 x 72 x 1.37	85	90	7	<b>\$2063</b>
RE6630FD	30 x 66 x 1.37	85	83	6	<b>\$1987</b>
RE6030FD	30 x 60 x 1.37	85	75	6	<b>\$1817</b>
RE5430FD	30 x 54 x 1.37	85	68	5	<b>\$1488</b>
RE3030FD	30 x 30 x 1.37	85	38	3	<b>\$825</b>

Tops 120" and under are shipped in one piece and require 2 bases. Tops 144" and over are shipped in two pieces and require 3 bases.

RRE24054D	54 x 240 x 1.37	85	540	39	<b>\$11486</b>
RRE21654D	54 x 216 x 1.37	85	486	35	<b>\$10400</b>
RRE19254D	54 x 192 x 1.37	85	432	31	<b>\$9020</b>
RRE5454D	54 x 54 x 1.37	85	119	9	<b>\$2515</b>
RRE16848D	48 x 168 x 1.37	85	336	25	<b>\$6882</b>
RRE14448D	48 x 144 x 1.37	85	288	21	<b>\$5344</b>
RRE12048D	48 x 120 x 1.37	85	240	18	<b>\$4613</b>
RRE9648D	48 x 96 x 1.37	85	192	14	<b>\$3519</b>
RRE4848D	48 x 48 x 1.37	85	98	7	<b>\$1851</b>
RRE8442D	42 x 84 x 1.37	85	147	11	<b>\$3216</b>
RRE7242D	42 x 72 x 1.37	85	126	9	<b>\$2805</b>
RRE4242D	42 x 42 x 1.37	85	74	5	<b>\$1741</b>
RRE8436D	36 x 84 x 1.37	85	126	9	<b>\$2987</b>
RRE7236D	36 x 72 x 1.37	85	108	8	<b>\$2562</b>
RRE6636D	36 x 66 x 1.37	85	99	7	<b>\$1954</b>
RRE3636D	36 x 36 x 1.37	85	54	4	<b>\$1073</b>
RRE8430D	30 x 84 x 1.37	85	105	8	<b>\$2485</b>
RRE7230D	30 x 72 x 1.37	85	90	7	<b>\$2130</b>
RRE6630D	30 x 66 x 1.37	85	83	6	<b>\$1954</b>
RRE6030D	30 x 60 x 1.37	85	75	6	<b>\$1782</b>
RRE5430D	30 x 54 x 1.37	85	68	5	<b>\$1598</b>
RRE3030D	30 x 30 x 1.37	85	38	3	<b>\$894</b>

Grain runs the **length** of the worksurface. Tops 120" and under are shipped in one piece and require 2 bases. Tops 144" and over are shipped in two pieces and require 3 bases.

**Required Specifications**  
Veneer Finish

**Optional Specifications**  
Boardroom Table Base  
Grommet  
Custom cut-out

## BOARDROOM TABLES - TOPS

MODEL#      DIMENSIONS      FREIGHT CLASS      WT/LBS.      CUBIC FT.      LIST PRICE

**D x W x H**

REBE24054D	54 x 240 x 1.37	85	540	39	<b>\$10659</b>
REBE21654D	54 x 216 x 1.37	85	486	35	<b>\$9683</b>
REBE19254D	54 x 192 x 1.37	85	432	31	<b>\$8451</b>
REBE16848D	48 x 168 x 1.37	85	336	25	<b>\$6487</b>
REBE14448D	48 x 144 x 1.37	85	288	21	<b>\$5135</b>
REBE12048D	48 x 120 x 1.37	85	240	18	<b>\$4361</b>
REBE9648D	48 x 96 x 1.37	85	192	14	<b>\$3384</b>
REBE8442D	42 x 84 x 1.37	85	147	11	<b>\$3084</b>
REBE7242D	42 x 72 x 1.37	85	126	9	<b>\$2714</b>
REBE8436D	36 x 84 x 1.37	85	126	9	<b>\$2714</b>
REBE7236D	36 x 72 x 1.37	85	108	8	<b>\$2323</b>
REBE6636D	36 x 66 x 1.37	85	99	7	<b>\$1777</b>
REBE8430D	30 x 84 x 1.37	85	105	8	<b>\$2261</b>
REBE7230D	30 x 72 x 1.37	85	90	7	<b>\$1940</b>
REBE6630D	30 x 66 x 1.37	85	83	6	<b>\$1777</b>
REBE6030D	30 x 60 x 1.37	85	75	6	<b>\$1611</b>
REBE5430D	30 x 54 x 1.37	85	68	5	<b>\$1455</b>

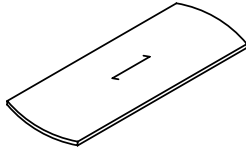

**Rectangular Top - Bow Ends**

Grain runs the **length** of the worksurface. Tops 120" and under are shipped in one piece and require 2 bases. Tops 144" and over are shipped in two pieces and require 3 bases.

RA24054D	54 x 240 x 1.37	85	540	39	<b>\$12978</b>
RA21654D	54 x 216 x 1.37	85	486	35	<b>\$10963</b>
RA19254D	54 x 192 x 1.37	85	432	31	<b>\$10369</b>
RA16848D	48 x 168 x 1.37	85	336	25	<b>\$7763</b>
RA14448D	48 x 144 x 1.37	85	288	21	<b>\$6099</b>
RA12048D	48 x 120 x 1.37	85	240	18	<b>\$5411</b>
RA9648D	48 x 96 x 1.37	85	192	14	<b>\$4297</b>
RA8442D	42 x 84 x 1.37	85	147	11	<b>\$3892</b>
RA7242D	42 x 72 x 1.37	85	126	9	<b>\$3417</b>
RA8436D	36 x 84 x 1.37	85	126	9	<b>\$3533</b>
RA7236D	36 x 72 x 1.37	85	108	8	<b>\$3027</b>
RA6636D	36 x 66 x 1.37	85	99	7	<b>\$2315</b>
RA8430D	30 x 84 x 1.37	85	105	8	<b>\$2945</b>
RA7230D	30 x 72 x 1.37	85	90	7	<b>\$2528</b>
RA6630D	30 x 66 x 1.37	85	83	6	<b>\$2315</b>
RA6030D	30 x 60 x 1.37	85	75	6	<b>\$2105</b>
RA5430D	30 x 54 x 1.37	85	68	5	<b>\$1898</b>
RA8422D	22 x 84 x 1.37	85	77	6	<b>\$2357</b>
RA7222D	22 x 72 x 1.37	85	66	5	<b>\$2021</b>
RA6622D	22 x 66 x 1.37	85	61	5	<b>\$1851</b>
RA6022D	22 x 60 x 1.37	85	55	4	<b>\$1687</b>
RA5422D	22 x 54 x 1.37	85	50	4	<b>\$1516</b>
RA4822D	22 x 48 x 1.37	85	44	3	<b>\$1462</b>

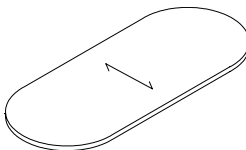

**Racetrack Top - Cross Grain**

Grain runs the **depth** of the worksurface. Tops 120" and under are shipped in one piece and require 2 bases. Tops 144" and over are shipped in two pieces and require 3 bases.

**Required Specifications**

Veneer Finish

**Optional Specifications**

Boardroom Table Base  
Grommet  
Custom cut-out

# T BOARDROOM TABLES - DUFFERIN

## BOARDROOM TABLES - TOPS

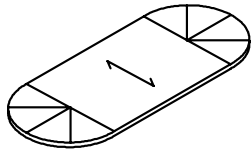

**Racetrack Top Cross Grain Center,  
Sunburst Veneer Pattern on Left & Right**

MODEL#	DIMENSIONS D x W x H	FREIGHT CLASS	WT/LBS.	CUBIC FT.	LIST PRICE
RA24054SD	54 x 240 x 1.37	85	540	39	<b>\$13984</b>
RA21654SD	54 x 216 x 1.37	85	486	35	<b>\$11952</b>
RA19254SD	54 x 192 x 1.37	85	432	31	<b>\$11351</b>
RA16848SD	48 x 168 x 1.37	85	336	25	<b>\$8718</b>
RA14448SD	48 x 144 x 1.37	85	288	21	<b>\$7035</b>
RA12048SD	48 x 120 x 1.37	85	240	18	<b>\$6050</b>
RA9648SD	48 x 96 x 1.37	85	192	14	<b>\$4931</b>
RA8442SD	42 x 84 x 1.37	85	147	11	<b>\$4389</b>
RA7242SD	42 x 72 x 1.37	85	126	9	<b>\$3964</b>
RA8436SD	36 x 84 x 1.37	85	126	9	<b>\$3964</b>
RA7236SD	36 x 72 x 1.37	85	108	8	<b>\$3396</b>
RA6636SD	36 x 66 x 1.37	85	99	7	<b>\$2596</b>
RA8430SD	30 x 84 x 1.37	85	105	8	<b>\$3300</b>
RA7230SD	30 x 72 x 1.37	85	90	7	<b>\$2835</b>
RA6630SD	30 x 66 x 1.37	85	83	6	<b>\$2596</b>
RA6030SD	30 x 60 x 1.37	85	75	6	<b>\$2363</b>
RA5430SD	30 x 54 x 1.37	85	68	5	<b>\$2126</b>
RA8422SD	22 x 84 x 1.37	85	77	6	<b>\$2646</b>
RA7222SD	22 x 72 x 1.37	85	66	5	<b>\$2268</b>
RA6622SD	22 x 66 x 1.37	85	61	5	<b>\$2084</b>
RA6022SD	22 x 60 x 1.37	85	55	4	<b>\$1891</b>
RA5422SD	22 x 54 x 1.37	85	50	4	<b>\$1701</b>
RA4822SD	22 x 48 x 1.37	85	44	3	<b>\$1639</b>

Grain runs the **depth** of the worksurface. Tops 120" and under are shipped in one piece and require 2 bases. Tops 144" and over are shipped in two pieces and require 3 bases.

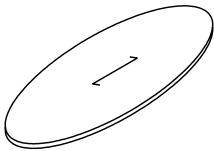

**Oval Top**

OV24054D	54 x 240 x 1.37	85	540	39	<b>\$16223</b>
OV21654D	54 x 216 x 1.37	85	486	35	<b>\$13703</b>
OV19254D	54 x 192 x 1.37	85	432	31	<b>\$12960</b>
OV16848D	48 x 168 x 1.37	85	336	25	<b>\$9700</b>
OV14448D	48 x 144 x 1.37	85	288	21	<b>\$7625</b>
OV12048D	48 x 120 x 1.37	85	240	18	<b>\$6763</b>
OV9648D	48 x 96 x 1.37	85	192	14	<b>\$5370</b>
OV8442D	42 x 84 x 1.37	85	147	11	<b>\$4865</b>
OV7242D	42 x 72 x 1.37	85	126	9	<b>\$4270</b>
OV8436D	36 x 84 x 1.37	85	126	9	<b>\$4270</b>
OV7236D	36 x 72 x 1.37	85	108	8	<b>\$3661</b>
OV6636D	36 x 66 x 1.37	85	99	7	<b>\$2797</b>
OV8430D	30 x 84 x 1.37	85	105	8	<b>\$3684</b>
OV7230D	30 x 72 x 1.37	85	90	7	<b>\$3159</b>
OV6630D	30 x 66 x 1.37	85	83	6	<b>\$2898</b>
OV6030D	30 x 60 x 1.37	85	75	6	<b>\$2629</b>
OV5430D	30 x 54 x 1.37	85	68	5	<b>\$2370</b>
OV8422D	22 x 84 x 1.37	85	77	6	<b>\$2945</b>
OV7222D	22 x 72 x 1.37	85	66	5	<b>\$2528</b>
OV6622D	22 x 66 x 1.37	85	61	5	<b>\$2315</b>
OV6022D	22 x 60 x 1.37	85	55	4	<b>\$2105</b>
OV5422D	22 x 54 x 1.37	85	50	4	<b>\$1898</b>
OV4822D	22 x 48 x 1.37	85	44	3	<b>\$1824</b>

Grain runs the **length** of the worksurface. Tops 120" and under are shipped in one piece and require 2 bases. Tops 144" and over are shipped in two pieces and require 3 bases.

**Required Specifications**  
Veneer Finish

**Optional Specifications**  
Boardroom Table Base  
Grommet  
Custom cut-out

## BOARDROOM TABLES - TOPS

MODEL#	DIMENSIONS	FREIGHT CLASS	WT/LBS.	CUBIC FT.	LIST PRICE
--------	------------	---------------	---------	-----------	------------

**D x W x H**

BO24054D	54 x 240 x 1.37	85	540	39	<b>\$10559</b>
BO21654D	54 x 216 x 1.37	85	486	35	<b>\$9491</b>
BO19254D	54 x 192 x 1.37	85	432	31	<b>\$8419</b>
BO16848D	48 x 168 x 1.37	85	336	25	<b>\$6708</b>
BO14448D	48 x 144 x 1.37	85	288	21	<b>\$5429</b>
BO12048D	48 x 120 x 1.37	85	240	18	<b>\$4546</b>
BO9648D	48 x 96 x 1.37	85	192	14	<b>\$3690</b>
BO8442D	42 x 84 x 1.37	85	147	11	<b>\$3405</b>
BO7242D	42 x 72 x 1.37	85	126	9	<b>\$2999</b>

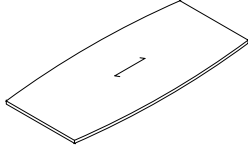

**Boat Shape Top**

Grain runs the **length** of the worksurface. Tops 120" and under are shipped in one piece and require 2 bases. Tops 144" and over are shipped in two pieces and require 3 bases.

BOBE24054D	54 x 240 x 1.37	85	540	39	<b>\$12138</b>
BOBE21654D	54 x 216 x 1.37	85	486	35	<b>\$10914</b>
BOBE19254D	54 x 192 x 1.37	85	432	31	<b>\$9683</b>
BOBE5454D	54 x 54 x 1.37	85	121	9	<b>\$2726</b>
BOBE16848D	48 x 168 x 1.37	85	336	25	<b>\$7713</b>
BOBE14448D	48 x 144 x 1.37	85	288	21	<b>\$6236</b>
BOBE12048D	48 x 120 x 1.37	85	240	18	<b>\$5231</b>
BOBE9648D	48 x 96 x 1.37	85	192	14	<b>\$4245</b>
BOBE4848D	48 x 48 x 1.37	85	96	7	<b>\$2303</b>
BOBE8442D	42 x 84 x 1.37	85	147	11	<b>\$3918</b>
BOBE7242D	42 x 72 x 1.37	85	126	9	<b>\$3453</b>
BOBE4242D	42 x 42 x 1.37	85	74	5	<b>\$2009</b>

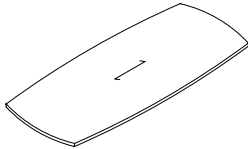

**Boat Shape Top - Bow Ends**

Grain runs the **length** of the worksurface. Tops 120" and under are shipped in one piece and require 2 bases. Tops 144" and over are shipped in two pieces and require 3 bases.

WE2405442D	54 - 42 x 240 x 1.37	85	540	39	<b>\$9272</b>
WE2165442D	54 - 42 x 216 x 1.37	85	486	35	<b>\$8419</b>
WE1925442D	54 - 42 x 192 x 1.37	85	432	31	<b>\$7351</b>
WE1684836D	48 - 36 x 168 x 1.37	85	336	25	<b>\$5640</b>
WE1444836D	48 - 36 x 144 x 1.37	85	288	21	<b>\$4464</b>
WE1204836D	48 - 36 x 120 x 1.37	85	240	18	<b>\$3793</b>
WE964836D	48 - 36 x 96 x 1.37	85	192	14	<b>\$2941</b>
WE844230D	42 - 30 x 84 x 1.37	85	147	11	<b>\$2678</b>
WE724230D	42 - 30 x 72 x 1.37	85	126	9	<b>\$2357</b>
WE843624D	36 - 24 x 84 x 1.37	85	126	9	<b>\$2357</b>
WE723624D	36 - 24 x 72 x 1.37	85	108	8	<b>\$2021</b>
WE663624D	36 - 24 x 66 x 1.37	85	99	7	<b>\$1549</b>

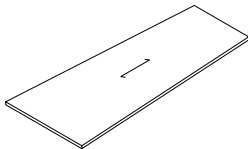

**Wedge Shape Top**

Grain runs the **length** of the worksurface. Tops 120" and under are shipped in one piece and require 2 bases. Tops 144" and over are shipped in two pieces and require 3 bases.

WEBE2405442D	54 - 42 x 240 x 1.37	85	540	39	<b>\$10659</b>
WEBE2165442D	54 - 42 x 216 x 1.37	85	486	35	<b>\$9683</b>
WEBE1925442D	54 - 42 x 192 x 1.37	85	432	31	<b>\$8451</b>
WEBE1684836D	48 - 36 x 168 x 1.37	85	336	25	<b>\$6487</b>
WEBE1444836D	48 - 36 x 144 x 1.37	85	288	21	<b>\$5135</b>
WEBE1204836D	48 - 36 x 120 x 1.37	85	240	18	<b>\$4361</b>
WEBE964836D	48 - 36 x 96 x 1.37	85	192	14	<b>\$3384</b>
WEBE844230D	42 - 30 x 84 x 1.37	85	147	11	<b>\$3084</b>
WEBE724230D	42 - 30 x 72 x 1.37	85	126	9	<b>\$2714</b>
WEBE843624D	36 - 24 x 84 x 1.37	85	126	9	<b>\$2714</b>
WEBE723624D	36 - 24 x 72 x 1.37	85	108	8	<b>\$2323</b>
WEBE663624D	36 - 24 x 66 x 1.37	85	99	7	<b>\$1777</b>

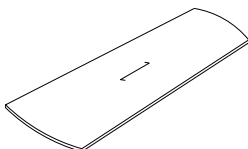

**Wedge Shape Top - Bow Ends**

Grain runs the **length** of the worksurface. Tops 120" and under are shipped in one piece and require 2 bases. Tops 144" and over are shipped in two pieces and require 3 bases.

**Required Specifications**

Veneer Finish

**Optional Specifications**

Boardroom Table Base  
Grommet  
Custom cut-out



# T BOARDROOM TABLES - LUFTON

## BOARDROOM TABLES - TOPS WITH LUFTON EDGE

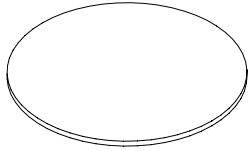

**Round Top**

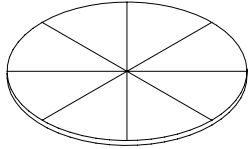

**Round Top - Sunburst Veneer Pattern**

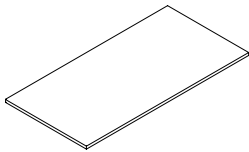

**Rectangular Top**

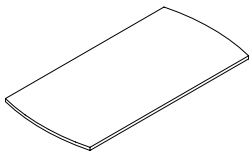

**Rectangular Top - Bow Ends**

MODEL#	DIMENSIONS D x W x H	FREIGHT CLASS	WT./LBS.	CUBIC FT.	LIST PRICE
RO60L	60 x 60 x 1.37	85	150	11	<b>\$2870</b>
RO48L	48 x 48 x 1.37	85	96	7	<b>\$2291</b>
RO42L	42 x 42 x 1.37	85	74	6	<b>\$2065</b>
RO36L	36 x 36 x 1.37	85	54	4	<b>\$1840</b>
RO30L	30 x 30 x 1.37	85	38	3	<b>\$1228</b>

For use with Drum Base, Pedestal Base, Cross Base, Wood Post Legs, Metal Post Legs, 4 Prong Base, Post leg w/Flat Plate, Flat Square Column Base, Trumpet Column base, Flat Bar "X" Base", Square Panel Base.

RO60SL	60 x 60 x 1.37	85	150	11	<b>\$3149</b>
RO48SL	48 x 48 x 1.37	85	96	7	<b>\$2591</b>
RO42SL	42 x 42 x 1.37	85	74	6	<b>\$2243</b>
RO36SL	36 x 36 x 1.37	85	54	4	<b>\$2021</b>
RO30SL	30 x 30 x 1.37	85	38	3	<b>\$1787</b>

For use with Drum Base, Pedestal Base, Cross Base, Wood Post Legs, Metal Post Legs, 4 Prong Base, Post leg w/Flat Plate, Flat Square Column Base, Trumpet Column base, Flat Bar "X" Base", Square Panel Base.

RE24054L	54 x 240 x 1.37	85	540	39	<b>\$8936</b>
RE21654L	54 x 216 x 1.37	85	486	35	<b>\$8110</b>
RE19254L	54 x 192 x 1.37	85	432	31	<b>\$7079</b>
RE16848L	48 x 168 x 1.37	85	336	25	<b>\$5430</b>
RE14448L	48 x 144 x 1.37	85	288	21	<b>\$4298</b>
RE12048L	48 x 120 x 1.37	300	240	18	<b>\$3654</b>
RE9648L	48 x 96 x 1.37	85	192	14	<b>\$2833</b>
RE8442L	42 x 84 x 1.37	85	147	11	<b>\$2581</b>
RE7242L	42 x 72 x 1.37	85	126	9	<b>\$2270</b>
RE8436L	36 x 84 x 1.37	85	126	9	<b>\$2270</b>
RE7236L	36 x 72 x 1.37	85	108	8	<b>\$1947</b>
RE6636L	36 x 66 x 1.37	92.5	99	7	<b>\$1492</b>
RE8430L	30 x 84 x 1.37	85	105	8	<b>\$1894</b>
RE7230L	30 x 72 x 1.37	85	90	7	<b>\$1624</b>
RE6630L	30 x 66 x 1.37	85	83	6	<b>\$1492</b>
RE6030L	30 x 60 x 1.37	85	75	6	<b>\$1357</b>
RE5430L	30 x 54 x 1.37	85	68	5	<b>\$1218</b>
RE4830L	30 x 48 x 1.37	85	44	3	<b>\$1192</b>

Grain runs the **length** of the worksurface. Tops 120" and under are shipped in one piece and require 2 bases. Tops 144" and over are shipped in two pieces and require 3 bases.

REBE24054L	54 x 240 x 1.37	85	540	39	<b>\$10271</b>
REBE21654L	54 x 216 x 1.37	85	486	35	<b>\$9321</b>
REBE19254L	54 x 192 x 1.37	85	432	31	<b>\$8140</b>
REBE16848L	48 x 168 x 1.37	85	336	25	<b>\$6246</b>
REBE14448L	48 x 144 x 1.37	85	288	21	<b>\$4943</b>
REBE12048L	48 x 120 x 1.37	300	240	18	<b>\$4201</b>
REBE9648L	48 x 96 x 1.37	85	192	14	<b>\$3258</b>
REBE8442L	42 x 84 x 1.37	85	147	11	<b>\$2967</b>
REBE7242L	42 x 72 x 1.37	85	126	9	<b>\$2613</b>
REBE8436L	36 x 84 x 1.37	85	126	9	<b>\$2613</b>
REBE7236L	36 x 72 x 1.37	85	108	8	<b>\$2238</b>

Grain runs the **length** of the worksurface. Tops 120" and under are shipped in one piece and require 2 bases. Tops 144" and over are shipped in two pieces and require 3 bases.

### Required Specifications

Veneer Finish

### Optional Specifications

Boardroom Table Base  
Grommet  
Custom cut-out

## BOARDROOM TABLES - TOPS

**MODEL#      DIMENSIONS      FREIGHT CLASS      WT/LBS.      CUBIC FT.      LIST PRICE**

**D x W x H**

RA24054L	54 x 240 x 1.37	85	540	39	<b>\$12021</b>
RA21654L	54 x 216 x 1.37	85	486	35	<b>\$10271</b>
RA19254L	54 x 192 x 1.37	85	432	31	<b>\$9755</b>
RA16848L	48 x 168 x 1.37	85	336	25	<b>\$7491</b>
RA14448L	48 x 144 x 1.37	85	288	21	<b>\$6048</b>
RA12048L	48 x 120 x 1.37	300	240	18	<b>\$5200</b>
RA9648L	48 x 96 x 1.37	85	192	14	<b>\$4232</b>
RA8442L	42 x 84 x 1.37	85	147	11	<b>\$3815</b>
RA7242L	42 x 72 x 1.37	85	126	9	<b>\$3408</b>
RA8436L	36 x 84 x 1.37	85	126	9	<b>\$3408</b>
RA7236L	36 x 72 x 1.37	85	108	8	<b>\$2919</b>
RA6636L	36 x 66 x 1.37	92.5	99	7	<b>\$2230</b>

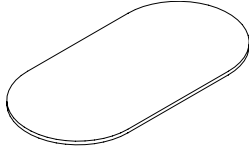

**Racetrack Top - Cross Grain**

Grain runs the **depth** of the worksurface. Tops 120" and under are shipped in one piece and require 2 bases. Tops 144" and over are shipped in two pieces and require 3 bases.

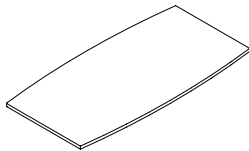

**Boat Shape Top**

B024054L	54 x 240 x 1.37	85	540	39	<b>\$10162</b>
B021654L	54 x 216 x 1.37	85	486	35	<b>\$9138</b>
B019254L	54 x 192 x 1.37	85	432	31	<b>\$8110</b>
B016848L	48 x 168 x 1.37	85	336	25	<b>\$6462</b>
B014448L	48 x 144 x 1.37	85	288	21	<b>\$5220</b>
B012048L	48 x 120 x 1.37	85	240	18	<b>\$4378</b>
B09648L	48 x 96 x 1.37	85	192	14	<b>\$3559</b>
B08442L	42 x 84 x 1.37	85	147	11	<b>\$3277</b>
B07242L	42 x 72 x 1.37	85	126	9	<b>\$2892</b>

Grain runs the **length** of the worksurface. Tops 120" and under are shipped in one piece and require 2 bases. Tops 144" and over are shipped in two pieces and require 3 bases.

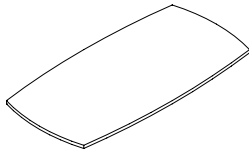

**Boat Shape Top - Bow Ends**

BOBE24054L	54 x 240 x 1.37	85	540	39	<b>\$11692</b>
BOBE21654L	54 x 216 x 1.37	85	486	35	<b>\$10512</b>
BOBE19254L	54 x 192 x 1.37	85	432	31	<b>\$9321</b>
BOBE5454L	54 x 54 x 1.37	85	121	9	<b>\$2624</b>
BOBE16848L	48 x 168 x 1.37	85	336	25	<b>\$7427</b>
BOBE14448L	48 x 144 x 1.37	85	288	21	<b>\$6011</b>
BOBE12048L	48 x 120 x 1.37	85	240	18	<b>\$5035</b>
BOBE9648L	48 x 96 x 1.37	85	192	14	<b>\$3090</b>
BOBE4848L	48 x 48 x 1.37	85	96	7	<b>\$2222</b>
BOBE8442L	42 x 84 x 1.37	85	147	11	<b>\$3438</b>
BOBE7242L	42 x 72 x 1.37	85	126	9	<b>\$3320</b>
BOBE4242L	42 x 42 x 1.37	85	74	5	<b>\$1941</b>

Grain runs the **length** of the worksurface. Tops 120" and under are shipped in one piece and require 2 bases. Tops 144" and over are shipped in two pieces and require 3 bases.

**Required Specifications**

Veneer Finish

**Optional Specifications**

Boardroom Table Base  
Grommet  
Custom cut-out

# T BOARDROOM TABLES - LUFTON

## BOARDROOM TABLES - TOPS

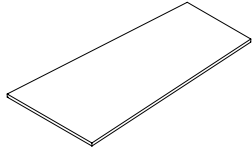

**Wedge Shape Top**

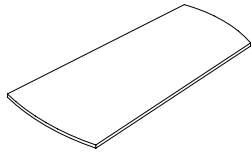

**Wedge Shape Top - Bow Ends**

MODEL#	DIMENSIONS D x W x H	FREIGHT CLASS	WT/LBS.	CUBIC FT.	LIST PRICE
WE2405442L	54 - 42 x 240 x 1.37	85	540	39	<b>\$8936</b>
WE2165442L	54 - 42 x 216 x 1.37	85	486	35	<b>\$8110</b>
WE1925442L	54 - 42 x 192 x 1.37	85	432	31	<b>\$7079</b>
WE1684836L	48 - 36 x 168 x 1.37	85	336	25	<b>\$5430</b>
WE1444836L	48 - 36 x 144 x 1.37	85	288	21	<b>\$4298</b>
WE1204836L	48 - 36 x 120 x 1.37	85	240	18	<b>\$3654</b>
WE964836L	48 - 36 x 96 x 1.37	85	192	14	<b>\$3541</b>
WE844230L	42 - 30 x 84 x 1.37	85	147	11	<b>\$2581</b>
WE724230L	42 - 30 x 72 x 1.37	85	126	9	<b>\$2270</b>

Grain runs the **length** of the worksurface. Tops 120" and under are shipped in one piece and require 2 bases. Tops 144" and over are shipped in two pieces and require 3 bases.

WEBE2405442L	54 - 42 x 240 x 1.37	85	540	39	<b>\$10271</b>
WEBE2165442L	54 - 42 x 216 x 1.37	85	486	35	<b>\$9321</b>
WEBE1925442L	54 - 42 x 192 x 1.37	85	432	31	<b>\$8140</b>
WEBE1684836L	48 - 36 x 168 x 1.37	85	336	25	<b>\$6246</b>
WEBE1444836L	48 - 36 x 144 x 1.37	85	288	21	<b>\$4943</b>
WEBE1204836L	48 - 36 x 120 x 1.37	85	240	18	<b>\$4201</b>
WEBE964836L	48 - 36 x 96 x 1.37	85	192	14	<b>\$3258</b>
WEBE844230L	42 - 30 x 84 x 1.37	85	147	11	<b>\$2967</b>
WEBE724230L	42 - 30 x 72 x 1.37	85	126	9	<b>\$2613</b>

Grain runs the **length** of the worksurface. Tops 120" and under are shipped in one piece and require 2 bases. Tops 144" and over are shipped in two pieces and require 3 bases.

### Required Specifications

Veneer Finish

### Optional Specifications

Boardroom Table Base

Grommet

Custom cut-out

## BOARDROOM TABLE BASES - ALL SERIES

MODEL#	DIMENSIONS	FREIGHT CLASS	WT/LBS.	CUBIC FT.	LIST PRICE
--------	------------	---------------	---------	-----------	------------

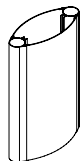

**Elliptical Base**

	D x W x H				
TE42	8 x 42 x 28	100	70	8	<b>\$1845</b>
TE36	7 x 36 x 28	92.5	60	6	<b>\$1845</b>
TE36	7 x 36 x 28	92.5	60	6	<b>\$1845</b>
TE30	6 x 30 x 28	85	50	4	<b>\$1787</b>
TE24	6 x 24 x 28	70	40	2	<b>\$1715</b>

**Not to be used with round table tops.** For tops up to 120", two Elliptical Bases must be ordered. For tops 144" and more, three Elliptical Bases must be ordered.

• **Plastic End Gables are available in a Tungsten (K) or Black (E) finish. Please Specify.**

- For 30" and 36" deep tops, order a 24" base (**TE24**).
- For 42" and 48" deep tops, order a 30" base (**TE30**).
- For 54" and 60" deep tops, order a 36" base (**TE36**) or 42" base (**TE42**).

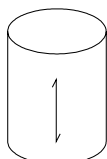

**Drum Base - Veneer**

TD30	30 x 30 x 28	125	93	15	<b>\$3011</b>
TD22	22 x 22 x 28	100	70	8	<b>\$1450</b>
TD18	18 x 18 x 28	85	62	5	<b>\$1263</b>

For tops up to 120", two Drum Bases must be ordered. For tops 144" and more, three Drum Bases must be ordered. Sand bag included to provide adequate stability.

- For 30", 36" and 42" deep tops, order a 18" base (**TD18**).
- For 48" and 54" deep tops, order a 22" base (**TD22**).
- For 60" deep tops, order a 30" base (**TD30**).

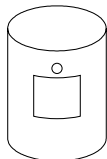

**Drum Base with Power Access Door - Veneer**

TD30J	30 x 30 x 28	125	93	15	<b>\$3764</b>
TD22J	22 x 22 x 28	100	70	8	<b>\$2206</b>
TD18J	18 x 18 x 28	85	62	5	<b>\$2017</b>

Access door and top and bottom cut-out to accommodate power/data grommet. For tops up to 120", two Drum Bases must be ordered. For tops 144" and more, three Drum Bases must be ordered. Sand bag included to provide adequate stability.

- Power access door is 12" x 12"
- For 30", 36" and 42" deep tops, order a 18" base (**TD18J**).
- For 48" and 54" deep tops, order a 22" base (**TD22J**).
- For 60" deep tops, order a 30" base (**TD30J**).

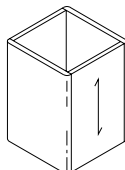

**Pedestal Base**

TP24	24 x 24 x 28	92.5	106	10	<b>\$1575</b>
TP20	20 x 20 x 28	85	89	7	<b>\$1513</b>
TP16	16 x 16 x 28	70	71	4	<b>\$1450</b>

For tops up to 120", two Pedestal Bases must be ordered. For tops 144" and more, three Pedestal Bases must be ordered.

- For 30", 36" and 42" deep tops, order a 16" base (**TP16**).
- For 48" and 54" deep tops, order a 20" base (**TP20**).
- For 60" deep tops, order a 24" base (**TP24**).

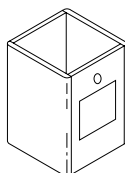

**Pedestal Base with Power Access Door**

TP24J	24 x 24 x 28	92.5	106	10	<b>\$2331</b>
TP20J	20 x 20 x 28	85	89	7	<b>\$2268</b>
TP16J	16 x 16 x 28	70	71	4	<b>\$2206</b>

Access door and top and bottom cut-out to accommodate power/data grommet. For tops up to 120", two Pedestal Bases must be ordered. For tops 144" and more, three Pedestal Bases must be ordered.

- Power access door is 12" x 12"
- For 30", 36" and 42" deep tops, order a 16" base (**TP16J**).
- For 48" and 54" deep tops, order a 20" base (**TP20J**).
- For 60" deep tops, order a 24" base (**TP24J**).

### Required Specifications

Veneer Finish

# T BOARDROOM TABLES

## BOARDROOM TABLE BASES - ALL SERIES

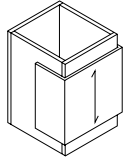

**Pedestal Base - Veneer  
Decorative Outside Panel\***

MODEL#	DIMENSIONS D x W x H	FREIGHT CLASS	WT./LBS.	CUBIC FT.	LIST PRICE	ALL VENEER
TPM24	24 x 24 x 28	92.5	106	10	<b>\$2440</b>	<b>\$2925</b>
TPM20	20 x 20 x 28	85	86	7	<b>\$2338</b>	<b>\$2804</b>
TPM16	16 x 16 x 28	70	71	4	<b>\$2246</b>	<b>\$2693</b>

For tops up to 120", two Pedestal Bases must be ordered. For tops 144" and more, three Pedestal Bases must be ordered.

- For 30", 36" and 42" deep tops, order a 16" base (**TPM16**).
- For 48" and 54" deep tops, order a 20" base (**TPM20**).
- For 60" deep tops, order a 24" base (**TPM24**).

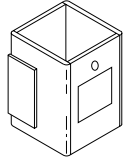

**Pedestal Base with Power Access Door  
Veneer Decorative Outside Panel\***

TPM24J	24 x 24 x 28	92.5	106	10	<b>\$2835</b>	<b>\$3405</b>
TPM20J	20 x 20 x 28	85	86	7	<b>\$2732</b>	<b>\$3281</b>
TPM16J	16 x 16 x 28	70	71	4	<b>\$2753</b>	<b>\$3306</b>

Access door and top and bottom cut-out to accommodate power/data grommet. For tops up to 120", two Pedestal Bases must be ordered. For tops 144" and more, three Pedestal Bases must be ordered.

- Power access door is 12" x 12"
- For 30", 36" and 42" deep tops, order a 16" base (**TPM16J**).
- For 48" and 54" deep tops, order a 20" base (**TPM20J**).
- For 60" deep tops, order a 24" base (**TPM24J**).

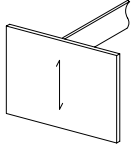

**Slab Base**

TH42	3 x 42 x 28	60	148	2	<b>\$2209</b>
TH36	3 x 36 x 28	60	127	2	<b>\$1993</b>
TH30	3 x 30 x 28	60	106	2	<b>\$1450</b>
TH22	3 x 22 x 28	60	89	2	<b>\$1256</b>

Not to be used with round table tops. For tops up to 120", two Slab Bases must be ordered. For tops 144" and more, three Slab Bases must be ordered.

- For 30" and 36" deep tops, order a 22" base (**TH22**).
- For 42" and 48" deep tops, order a 30" base (**TH30**).
- For 54" deep tops, order a 36" base (**TH36**).
- For 60" deep tops, order a 42" base (**TH42**).

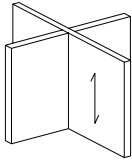

**Cross Base**

TX42	3 x 42 x 28	100	180	20	<b>\$2130</b>
TX36	3 x 36 x 28	100	155	17	<b>\$1993</b>
TX30	3 x 30 x 28	100	133	15	<b>\$1450</b>
TX22	3 x 22 x 28	100	97	11	<b>\$1256</b>

For tops up to 120", two Cross Bases must be ordered. For tops 144" and more, three Cross Bases must be ordered.

- For 30" and 36" deep tops, order a 22" base (**TX22**).
- For 42" and 48" deep tops, order a 30" base (**TX30**).
- For 54" deep tops, order a 36" base (**TX36**).
- For 60" deep tops, order a 42" base (**TX42**).

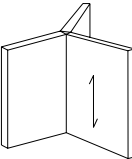

**"Y" Base**

TW42	4 x 42 x 28	125	140	20	<b>\$1845</b>
TW36	4 x 36 x 28	125	120	17	<b>\$1625</b>
TW30	4 x 30 x 28	125	100	15	<b>\$1335</b>
TW22	4 x 22 x 28	125	73	11	<b>\$1249</b>

**Not to be used with round table tops.** For tops up to 120", two "Y" Bases must be ordered. For tops 144" and more, two "Y" Bases and one Cross Base must be ordered.

- For 30" and 36" deep tops, order a 22" base (**TW22**).
- For 42" and 48" deep tops, order a 30" base (**TW30**).
- For 54" deep tops, order a 36" base (**TW36**).
- For 60" deep tops, order a 42" base (**TW42**).

### Required Specifications

Veneer Finish

\* Laminate Finish

## BOARDROOM TABLE BASES - ALL SERIES

MODEL#      DIMENSIONS      FREIGHT CLASS      WT/LBS.      CUBIC FT.      LIST PRICE

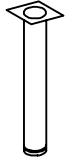

**Post Leg Veneer**

	D x W x H				
SN06	6 dia x 28	250	10	3	<b>\$1518</b>
SN04	4 dia x 28	125	7	1	<b>\$1169</b>
SN03	3 dia x 28	150	5	1	<b>\$737</b>

Available in 3", 4" and 6" diameters. Round tops and tops up to 96" require four legs. Tops 108" to 168" require six legs; tops 180" to 240" require ten legs.

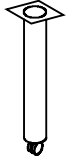

**Post Leg Veneer w/Caster**

SN06M	6 dia x 28	100	10	3	<b>\$1603</b>
SN04M	4 dia x 28	125	7	1	<b>\$1253</b>
SN03M	3 dia x 28	150	5	1	<b>\$824</b>

Available in 3", 4" and 6" diameters. Caster included. Round tops and tops up to 96" require four legs. Tops 108" to 168" require six legs; tops 180" to 240" require ten legs.

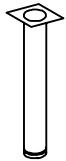

**Post Leg Metal**

SM06	6 dia x 28	100	10	3	<b>\$1037</b>
SM04	4 dia x 28	125	7	1	<b>\$572</b>
SM03	3 dia x 28	150	5	1	<b>\$407</b>

Available in 3", 4" and 6" diameters. Round tops and tops up to 96" require four legs. Tops 108" to 168" require six legs; tops 180" to 240" require ten legs.

• **Must Specify Black (E) or Tungsten (K) finish**

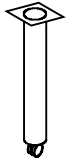

**Post Leg Metal w/Casters**

SM06M	6 dia x 28	100	10	3	<b>\$1125</b>
SM04M	4 dia x 28	125	7	1	<b>\$659</b>
SM03M	3 dia x 28	150	5	1	<b>\$495</b>

Available in 3", 4" and 6" diameters. Caster included. Round tops and tops up to 96" require four legs. Tops 108" to 168" require six legs; tops 180" to 240" require ten legs.

• **Must Specify Black (E) or Tungsten (K) finish**

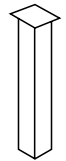

**Post Leg Metal, Square**

SMS4	4 x 4 x 28	125	7	1	<b>\$449</b>
------	------------	-----	---	---	--------------

Available in 4". Round tops and tops up to 96" require four legs. Tops 108" to 168" require six legs; tops 180" to 240" require ten legs.

• **Must Specify Black (E) or Tungsten (K) finish**

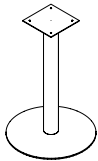

**Post Leg w/Flat Plate**

F6P36	36 x 36 x 28	150	100	22	<b>\$3562</b>
F4P30	30 x 30 x 28	150	80	15	<b>\$2169</b>
F4P24	24 x 24 x 28	125	60	10	<b>\$1733</b>
F3P18	18 x 18 x 28	100	45	5	<b>\$1538</b>

Round tops require a single base. For tops up to 120", two bases must be ordered. For tops 144" or more, three bases must be ordered.

• **Must Specify Black (E) or Tungsten (K) finish**

- For 30" deep tops, order a 18" base (**F3P18**).
- For 36" deep tops, order a 24" base (**F4P24**).
- For 42" and 48" deep tops, order a 30" base (**F4P30**).
- For 54" deep tops, order a 36" base (**F6P36**).

**Required Specifications**

Veneer Finish (Veneer Post Legs)  
Metal Finish (Metal Legs)

# T BOARDROOM TABLES

## BOARDROOM TABLE BASES - ALL SERIES

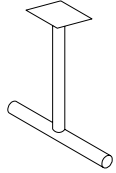

**Tubular 2-Prong Base**

MODEL#	DIMENSIONS D x W x H	FREIGHT CLASS	WT/LBS.	CUBIC FT.	LIST PRICE
TTM36	36 x 36 x 28	100	28	22	<b>\$857</b>
TTM26	26 x 26 x 28	85	24	11	<b>\$822</b>

**Not to be used with round table tops.** Two square edged prongs. For tops up to 84", two Tubular 2-Prong Bases must be ordered. Used as a 3rd base to provide center support in conjunction with two 3-Prong bases on tops 144" or more.

- **Must Specify Black (E) or Tungsten (K) finish**
- For 30", 36" and 42" deep tops, order a 26" base (**TTM26**).
- For 48", 54" and 60" deep tops, order a 36" base (**TTM36**).

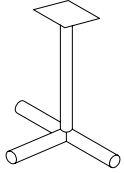

**Tubular 3-Prong Base**

TTE36	36 x 36 x 28	250	36	22	<b>\$913</b>
TTE26	26 x 26 x 28	85	32	11	<b>\$813</b>

**Not to be used with round table tops.** Three square edged prongs. For tops up to 120", two Tubular 3-Prong Bases must be ordered. For tops 144" and more, two Tubular 3-Prong Bases and one Tubular 2-Prong Base for the center must be ordered.

- **Must Specify Black (E) or Tungsten (K) finish**
- For 30", 36" and 42" deep tops, order a 26" base (**TTE26**).
- For 48", 54" and 60" deep tops, order a 36" base (**TTE36**).

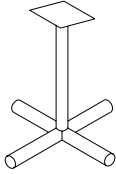

**Tubular 4-Prong Base**

TT36	36 x 36 x 28	300	40	22	<b>\$1369</b>
TT26	26 x 26 x 28	250	36	11	<b>\$943</b>

Four square edged prongs. For tops up to 120", two Tubular 4-Prong Bases must be ordered. For tops 144" and more, three Tubular 4-Prong Bases must be ordered.

- **Must Specify Black (E) or Tungsten (K) finish**
  - For 30", 36" and 42" deep tops, order a 26" base (**TT26**).
  - For 48" and 54" deep tops, order a 36" base (**TT36**)\*
- \* Maximum diameter for Round Tops is 54".

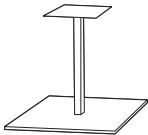

**Flat Square Column Base**

TTSQ23BH	23 x 23 x 41	150	75	14	<b>\$3413</b>
TTSQ18BH	18 x 18 x 41	125	65	10	<b>\$3161</b>
TTSQ30	30 x 30 x 28	150	80	14	<b>\$3540</b>
TTSQ23	23 x 23 x 28	150	55	12	<b>\$2908</b>
TTSQ18	18 x 18 x 28	150	45	8	<b>\$2655</b>

Round tops require a single base. For tops up to 120", two bases must be ordered. For tops 144" or more, three bases must be ordered.

- **Must Specify Black (E) or Tungsten (K) finish**
- For 30" deep tops, order a 18" base (**TTSQ18** or **TTSQ18BH**).
- For 36" deep tops, order a 24" base (**TTSQ23** or **TTSQ23BH**).
- For 42" and 48" deep tops, order a 30" base (**TTSQ30**).
  - Max diameter for round tops at standard height is 48".
  - Max diameter for round tops at bar height is 36".

**Required Specifications**  
Metal Finish (Metal Legs)

## BOARDROOM TABLE BASES - ALL SERIES

MODEL#	DIMENSIONS	FREIGHT CLASS	WT/LBS.	CUBIC FT.	LIST PRICE
--------	------------	---------------	---------	-----------	------------

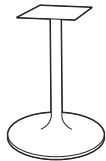

**Trumpet Column Base**

	D x W x H				
TRUM24BH	24 x 24 x 41	300	26	14	<b>\$1646</b>
TRUM18BH	18 x 18 x 41	300	24	16	<b>\$1520</b>
TRUM30	30 x 30 x 28	300	18	14	<b>\$1584</b>
TRUM24	24 x 24 x 28	300	16	12	<b>\$1141</b>
TRUM18	18 x 18 x 28	300	14	8	<b>\$1015</b>

Round tops require a single base. For tops up to 120", two bases must be ordered. For tops 144" or more, three bases must be ordered.

- **Must Specify Black (E) or Tungsten (K) finish**
- For 30" deep tops, order a 18" base (**TRUM18** or **TRUM18BH**).
- For 36" deep tops, order a 24" base (**TRUM24** or **TRUM24BH**).
- For 42" and 48" deep tops, order a 30" base (**TRUM30**).
  - Max diameter for round tops at standard height is 48".
  - Max diameter for round tops at bar height is 36".



**Flat Bar "X" Column Base**

TTFLT36	36 x 36 x 28	300	18	14	<b>\$3161</b>
TTFLT30	30 x 30 x 28	300	16	12	<b>\$3036</b>
TTFLT22	22 x 22 x 28	300	15	10	<b>\$2794</b>

Round tops require a single base. For tops up to 120", two bases must be ordered. For tops 144" or more, three bases must be ordered.

- **Must Specify Black (E) or Tungsten (K) finish**
- For 30" and 36" deep tops, order a 22" base (**TTFLT22**).
- For 42" and 48" deep tops, order a 30" base (**TTFLT30**).
- For 54" deep tops, order a 36" base (**TTFLT36**).

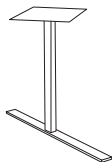

**Flat Bar "T" Column Base**

TTFLT36	36 x 36 x 28	150	14	3	<b>\$2655</b>
TTFLT24	24 x 24 x 28	150	10	2.50	<b>\$2403</b>

**Not to be used with round table tops.** For tops up to 84", two bases must be ordered. To be used as a 3rd base for center support in conjunction with two 3-prong bases on tops 144" or more.

- **Must Specify Black (E) or Tungsten (K) finish**
- For 30", 36" and 42" deep tops, order a 24" base (**TTFLT24**).
- For 48" and 54" deep tops, order a 36" base (**TTFLT36**).
- TTFLTxx bases are to be used as a middle base in combination with two TTFL3P bases



**Flat Bar 3 Prong Column Base**

TTFL3P36	36 x 36 x 28	400	16	22	<b>\$3036</b>
TTFL3P24	24 x 24 x 28	400	12	14	<b>\$2781</b>

**Not to be used with round table tops.** For tops up to 120", two bases must be ordered. For tops 144" or more, two 3-prong bases and one "T" column base must be ordered.

- **Must Specify Black (E) or Tungsten (K) finish**
- For 30", 36" and 42" deep tops, order a 24" base (**TTFL3P24**).
- For 48" and 54" deep tops, order a 36" base (**TTFL3P36**).
- When a third base is required, a TTFLTxx base may be used as the center base

### Required Specifications

Metal Finish



# T BOARDROOM TABLES

## BOARDROOM TABLE BASES

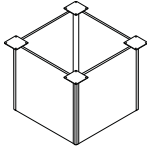

**Square Panel Base - Anodized Aluminum Radius Corner Detail**

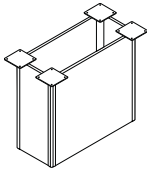

**Rectangular Panel Base - Anodized Aluminum Radius Corner Detail**

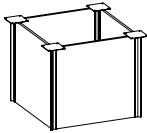

**Square Panel Base - Anodized Aluminum Radius Corner Detail**

MODEL#	DIMENSIONS D x W x H	FREIGHT CLASS	WT/LBS.	CUBIC FT.	LIST PRICE
TELRS24J	24 x 24 x 28	100	75	8	<b>\$2554</b>
TELRS20J	20 x 20 x 28	92.5	70	6	<b>\$2203</b>
TELRS16J	16 x 16 x 28	70	65	4	<b>\$1999</b>
TELRS24	24 x 24 x 28	100	75	8	<b>\$2239</b>
TELRS20	20 x 20 x 28	92.5	70	6	<b>\$1885</b>
TELRS16	16 x 16 x 28	70	65	4	<b>\$1685</b>

Round tops require a single base. For tops up to 120" two Square Panel bases must be ordered. For tops 144" or more, three bases must be ordered.

- **Model #'s with a "J" denote a power access door on one panel.**
- For 30", 36" and 42" deep tops, order a 16" base (**TELRS16** or **TELRS16J**).
- For 48" and 54" deep tops, order a 20" base (**TELRS20** or **TELRS20J**).
- For 60" deep tops, order a 24" base (**TELRS24** or **TELRS24J**).

TELRR24J	12 x 24 x 28	100	65	8	<b>\$2429</b>
TELRR20J	12 x 20 x 28	92.5	60	6	<b>\$2075</b>
TELRR16J	12 x 16 x 28	85	50	4	<b>\$1873</b>
TELRR24	12 x 24 x 28	100	65	8	<b>\$2112</b>
TELRR20	12 x 20 x 28	92.5	60	6	<b>\$1760</b>
TELRR16	12 x 16 x 28	85	50	4	<b>\$1559</b>

**Not to be used with round table tops.** For tops up to 96" two Rectangular Panel bases must be ordered. To be used as a 3rd base for center support in conjunction with two Square Panel bases on tops 144" or more.

- **Model #'s with a "J" denote a power access door on one panel.**
- For 30", 36" and 42" deep tops, order a 16" base (**TELRR16** or **TELRR16J**).
- For 48" and 54" deep tops, order a 20" base (**TELRR20** or **TELRR20J**).
- For 60" deep tops, order a 24" base (**TELRR24** or **TELRR24J**).

TELBS24J	24 x 24 x 28	100	65	8	<b>\$2554</b>
TELBS20J	20 x 20 x 28	92.5	60	6	<b>\$2203</b>
TELBS16J	16 x 16 x 28	85	50	4	<b>\$1999</b>
TELBS24	24 x 24 x 28	100	65	8	<b>\$2239</b>
TELBS20	20 x 20 x 28	92.5	60	6	<b>\$1885</b>
TELBS16	16 x 16 x 28	85	50	4	<b>\$1685</b>

Round tops require a single base. For tops up to 120" two Square Panel bases must be ordered. For tops 144" or more, three bases must be ordered.

- **Model #'s with a "J" denote a power access door on one panel.**
- For 30", 36" and 42" deep tops, order a 16" base (**TELBS16** or **TELBS16J**).
- For 48" and 54" deep tops, order a 20" base (**TELBS20** or **TELBS20J**).
- For 60" deep tops, order a 24" base (**TELBS24** or **TELBS24J**).

### Required Specifications

Finish

## BOARDROOM TABLE BASES

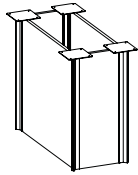

**Rectangular Panel Base - Anodized Aluminum Rectangular Corner Detail**

MODEL#	DIMENSIONS	FREIGHT CLASS	WT/LBS.	CUBIC FT.	LIST PRICE
<b>D x W x H</b>					
TELBR24J	12 x 24 x 28	100	65	8	<b>\$2429</b>
TELBR20J	12 x 20 x 28	92.5	60	6	<b>\$2075</b>
TELBR16J	12 x 16 x 28	85	50	4	<b>\$1873</b>
TELBR24	12 x 24 x 28	100	65	8	<b>\$2112</b>
TELBR20	12 x 20 x 28	92.5	60	6	<b>\$1760</b>
TELBR16	12 x 16 x 28	85	50	4	<b>\$1559</b>

**Not to be used with round table tops.** For tops up to 96" two Rectangular Panel bases must be ordered. To be used as a 3rd base for center support in conjunction with two Square Panel bases on tops 144" or more.

- **Model #'s with a "J" denote a power access door on one panel.**
- For 30", 36" and 42" deep tops, order a 16" base (**TELBR16** or **TELBR16J**).
- For 48" and 54" deep tops, order a 20" base (**TELBR20** or **TELBR20J**).
- For 60" deep tops, order a 24" base (**TELBR24** or **TELBR24J**).

## BOARDROOM - ACCESSORIES

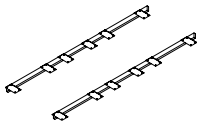

**Metal Support Rails**

MODEL#	DIMENSIONS	FREIGHT CLASS	WT/LBS.	CUBIC FT.	LIST PRICE
TSUP102	1 x 102 x 2	70	0.10	0.10	<b>\$1163</b>
TSUP96	1 x 96 x 2	70	0.10	0.10	<b>\$1091</b>
TSUP90	1 x 90 x 2	70	0.10	0.10	<b>\$1009</b>
TSUP84	1 x 84 x 2	70	0.10	0.10	<b>\$932</b>
TSUP78	1 x 78 x 2	70	0.10	0.10	<b>\$854</b>
TSUP72	1 x 72 x 2	70	0.10	0.10	<b>\$777</b>
TSUP66	1 x 66 x 2	70	0.10	0.10	<b>\$702</b>
TSUP60	1 x 60 x 2	70	0.10	0.10	<b>\$626</b>
TSUP54	1 x 54 x 2	70	0.10	0.10	<b>\$575</b>

To be used when design considerations or dimension requirements dictate an unsupported table joint. Top section **MUST NOT** exceed 72" to use metal supports. **Sold in sets of two**

- **Available in Black only.**

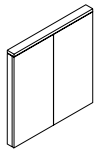

**Visual Board**

VB4848E	5 x 48 x 48	70	115	7	<b>\$4263</b>
---------	-------------	----	-----	---	---------------

Includes porcelain on steel magnetic board and two side opening straight edge doors containing tackable fabric panels and 50-sheet paper writing pad that can be used on either door. Magnetic board can be used for projection. Set of 6 dry erase markers and eraser included. Interior fabric panels available in Anchorage. Specify color:

AN40 Birch	AN41 Green Apple	AN42 Lapis	AN43 Straw	AN44 Wolf
AN45 Goose	AN46 Angora	AN47 Cumin	AN48 Asteroid	AN49 Geranium
AN50 Thistle	AN51 Graphite	AN52 Slate	AN53 Quarry Blue	AN54 Onyx
AN55 Pumpkin	AN56 Red Delicious	AN57 Sunshine	AN59 Waterfall	AN61 Vanilla
AN62 Cobalt	AN64 Cloud			

- **NOTE:** Care should be taken to mount the units. Units should be mounted to wall studs using correct fasteners. Failure to do so may result in collapse of the unit and subsequent personal injury. **Mounting hardware not included.** Mounting hardware used should be based on wall material. Consult an installation professional for proper wall mounting.

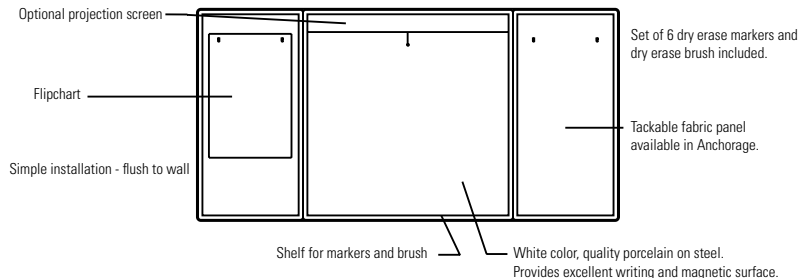

### Required Specifications

Finish  
Fabric

# T BOARDROOM TABLES

## BOARDROOM - ACCESSORIES

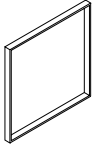

Visual Board, No Doors

MODEL#	DIMENSIONS D x W x H	FREIGHT CLASS	WT/LBS.	CUBIC FT.	LIST PRICE	ALL VENEER
VB48480	5 x 48 x 48	70	115	7	<b>\$2864</b>	

Includes porcelain on steel magnetic board. Magnetic board can be used for projection. Set of 6 dry erase markers and eraser included.

• **NOTE:** Care should be taken to mount the units. Units should be mounted to wall studs using correct fasteners. Failure to do so may result in collapse of the unit and subsequent personal injury. **Mounting hardware not included.** Mounting hardware used should be based on wall material. Consult an installation professional for proper wall mounting.

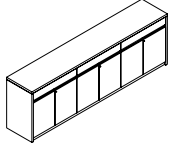

Credenza Buffet - Dufferin

DCB9022H36	22 x 90 x 36	92.5	440	44	<b>\$9140</b>	<b>\$10967</b>
DCB9020H36	20 x 90 x 36	92.5	400	40	<b>\$8309</b>	<b>\$9972</b>
DCB7222H36	22 x 72 x 36	92.5	330	33	<b>\$6206</b>	<b>\$7447</b>
DCB7220H36	20 x 72 x 36	92.5	300	30	<b>\$5529</b>	<b>\$6637</b>
DCB6022H36	22 x 60 x 36	100	275	28	<b>\$5323</b>	<b>\$6388</b>
DCB6020H36	20 x 60 x 36	92.5	250	25	<b>\$4838</b>	<b>\$5804</b>

90" w units have (3) two door storage cabinets with top drawer side-by-side. 72" w & 60" w units have (2) two door storage cabinets with top drawer side-by-side. Locking doors. Self-closing hinged doors cover one adjustable shelf.

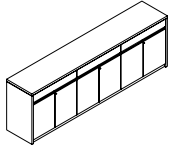

Credenza Buffet - Lufton

LCB9022H36	22 x 90 x 36	92.5	440	44	<b>\$9922</b>	
LCB9020H36	20 x 90 x 36	92.5	400	40	<b>\$9028</b>	
LCB7222H36	22 x 72 x 36	92.5	330	33	<b>\$6741</b>	
LCB7220H36	20 x 72 x 36	92.5	300	30	<b>\$6000</b>	
LCB6022H36	22 x 60 x 36	100	275	28	<b>\$5788</b>	
LCB6020H36	20 x 60 x 36	92.5	250	25	<b>\$5260</b>	

90" w units have (3) two door storage cabinets with top drawer side-by-side. 72" w & 60" w units have (2) two door storage cabinets with top drawer side-by-side. Locking doors. Self-closing hinged doors cover one adjustable shelf.

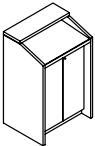

Lectern - Dufferin

DLEC3624	24 x 36 x 48	92.5	240	24	<b>\$4329</b>	<b>\$5195</b>
DLEC3024	24 x 30 x 48	92.5	200	20	<b>\$3610</b>	<b>\$4331</b>
DLEC2424	24 x 24 x 48	92.5	160	16	<b>\$2887</b>	<b>\$3463</b>

Features angled stand. Storage compartment with one adjustable and one fixed shelf. Locking doors.

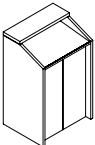

Lectern - Lufton

LEC3624L	24 x 36 x 48	92.5	240	24	<b>\$4910</b>	
LEC3024L	24 x 30 x 48	92.5	200	20	<b>\$4096</b>	
LEC2424L	24 x 24 x 48	92.5	160	16	<b>\$3263</b>	

Features angled stand. Storage compartment with one adjustable and one fixed shelf. Locking doors.

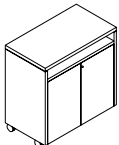

Utility Table - Dufferin

DTV3620M	20 x 36 x 34	85	121	10	<b>\$2620</b>	<b>\$3141</b>
----------	--------------	----	-----	----	---------------	---------------

Open shelf and storage compartment with one adjustable shelf. Locking doors. Casters.

### Required Specifications

Finish

## ACCESSORIES

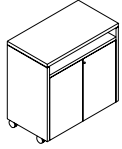

**Utility Table - Lufton**

MODEL#	DIMENSIONS	FREIGHT CLASS	WT/LBS.	CUBIC FT.	LIST PRICE
LTV3620M	D x W x H 20 x 36 x 34	85	121	10	<b>\$2838</b>

Open shelf and storage compartment with one adjustable shelf. Locking doors. Casters.

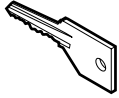

**Extra Key**

LOCK	--	70	--	--	<b>\$43</b>
------	----	----	----	----	-------------

Specify key #. Key range 400 - 500.



**Grommet Cover, Round**

GM1	2 dia x --	70	--	--	<b>\$65</b>
GM1K	2 dia x --	70	--	--	<b>\$65</b>

2.75" diameter.

• **Specify GM1 for Black or GM1K for Tungsten.**

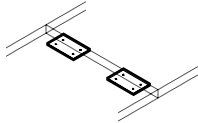

**Mending Plates**

MP53	3 x 5 x 0.50	300	3	2	<b>\$61</b>
------	--------------	-----	---	---	-------------

Sold in sets of 2.

• **Available in Black Only.**

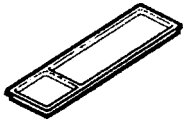

**Pencil Tray - Black Plastic**

PT	3 x 12.50 x 1	250	2	1	<b>\$21</b>
----	---------------	-----	---	---	-------------

Provides space for writing instruments and small items at the workspace.

• **Available in Black Only.**

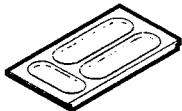

**Pencil Tray - Veneer**

OPT	6 x 12.50 x 2	150	4	1	<b>\$171</b>
-----	---------------	-----	---	---	--------------

Provides space for writing instruments and small items at the workspace. Solid oak finish.

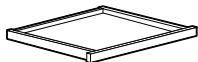

**Center Drawer - Veneer**

CD	21 x 23 x 2	100	8	1	<b>\$698</b>
----	-------------	-----	---	---	--------------

Veneer drawer front is attached to a 4-sided frame. Must specify wood finish for drawer front.

### Required Specifications

Finish

# T BOARDROOM TABLES

## KEYBOARD DRAWERS

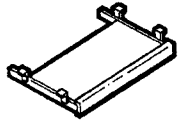

**Keyboard Drawer**

MODEL#	DIMENSIONS D x W x H	FREIGHT CLASS	WT/LBS.	CUBIC FT.	LIST PRICE
KD30	10 x 30 x 1	70	16	1	<b>\$938</b>
KD22	10 x 22 x 1	85	12	1	<b>\$838</b>
KD10	10 x 10 x 1	125	6	1	<b>\$424</b>

Pull-out veneer keyboard shelf. Clearance is 2 ¼". Must specify wood finish for drawer front.

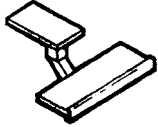

**Articulating Keyboard Drawer**

AKD30	10 x 30 x 1	65	24	1	<b>\$1295</b>
AKD22	10 x 22 x 1	70	18	1	<b>\$1199</b>

Adjustable pull-out keyboard shelf with articulating arm. Adjusts from flush with the worksurface to 5" below worksurface. Swivels 360° full arm rotation, angles -10° to +15°. Must specify wood finish for keyboard deck.

## WIRE MANAGEMENT



**Wire Management Cover**

MODEL#	DIMENSIONS	FREIGHT CLASS	WT/LBS.	CUBIC FT.	LIST PRICE
WH24	1 x 1 x 24	70	1	1	<b>\$74</b>

To conceal wires and cords. Plastic.

- **Available in Black Plastic Only.**



**Wire Management Track - Single**





C2M72	2 x 72 x 2	70	0.10	0.10	<b>\$83</b>
C2M60	2 x 60 x 2	70	0.10	0.10	<b>\$69</b>
C2M48	2 x 48 x 2	70	0.10	0.10	<b>\$57</b>
C2M36	2 x 36 x 2	70	0.10	0.10	<b>\$42</b>
C2M24	2 x 24 x 2	70	0.10	0.10	<b>\$31</b>
C2M12	2 x 12 x 2	70	0.10	0.10	<b>\$17</b>

To conceal and organize wires and cords. Attaches to Modesty Panel with double sided tape. Plastic.

- **Available in Black Plastic Only.**

### Required Specifications

Finish

POWER / DATA	MODEL#	DIMENSIONS	FREIGHT CLASS	WT/LBS.	CUBIC FT.	LIST PRICE
 <p><b>Single Sided Recessed Power Block</b></p>	<b>D x W x H</b>					
	PRTMCS401B	4.22 x 10.78 x 4.86	100	4.3	0.51	<b>\$456</b>
	PRTMCS401T	4.22 x 10.78 x 4.86	100	4.3	0.51	<b>\$456</b>
	PRTMCS401W	4.22 x 10.78 x 4.86	100	4.3	0.51	<b>\$456</b>
<p>Single-sided recessed power block with <b>one regular duplex and one telecom knockout on top; one power duplex on bottom</b>. 10' power cord with straight plug. Specify telecom options separately, see page 390. Available in Black (<b>B</b>), Tungsten (<b>T</b>) or Designer White (<b>W</b>) as indicated by the last letter of model number. Duplexes always Grey. Corresponding cut-out options are <b>R1, R2</b> or <b>R3</b>. Units are not approved for daisy chaining. UL listed: UL 1363.</p>						
 <p><b>Single Sided Recessed Power Block - USB-A + USB-C</b></p>	<b>D x W x H</b>					
	PRTMCS421B	4.22 x 10.78 x 4.86	100	4.3	0.51	<b>\$599</b>
	PRTMCS421T	4.22 x 10.78 x 4.86	100	4.3	0.51	<b>\$599</b>
	PRTMCS421W	4.22 x 10.78 x 4.86	100	4.3	0.51	<b>\$599</b>
<p>Single-sided recessed power block with <b>one power/USB-A/USB-C duplex and one telecom knockout on top; one power duplex on bottom</b>. USB-A port charges max 2.4 amps at 5V and USB-C port charges max 3 amps at 5V. 10' power cord with straight plug. Specify telecom options separately, see page 390. Available in Black (<b>B</b>), Tungsten (<b>T</b>) or Designer White (<b>W</b>) as indicated by the last letter of model number. Duplexes always Grey (duplex with USB ports is glossy finish). Corresponding cut-out options are <b>R1, R2</b> or <b>R3</b>. Units are not approved for daisy chaining. UL listed: UL 1363.</p>						
 <p><b>Double Sided Recessed Power Block</b></p>	<b>D x W x H</b>					
	PRTMCD602B	6.22 x 10.78 x 4.86	92.5	5.9	0.51	<b>\$521</b>
	PRTMCD602T	6.22 x 10.78 x 4.86	92.5	5.9	0.51	<b>\$521</b>
	PRTMCD602W	6.22 x 10.78 x 4.86	92.5	5.9	0.51	<b>\$521</b>
<p>Double-sided recessed power block with <b>two regular power duplexes and two telecom knockouts on top; one power duplex on bottom</b>. 10' power cord with straight plug. Specify telecom options separately, see page 390. Available in Black (<b>B</b>), Tungsten (<b>T</b>) or Designer White (<b>W</b>) as indicated by last letter of model number. Duplexes always Grey. Corresponding cut-out options are <b>T1, T2</b> or <b>T3</b>. Units are not approved for daisy chaining. UL listed: UL 1363.</p>						
 <p><b>Double Sided Recessed Power Block - USB-A + USB-C</b></p>	<b>D x W x H</b>					
	PRTMCD622B	6.22 x 10.78 x 4.86	92.5	6.1	0.51	<b>\$656</b>
	PRTMCD622T	6.22 x 10.78 x 4.86	92.5	6.1	0.51	<b>\$656</b>
	PRTMCD622W	6.22 x 10.78 x 4.86	92.5	6.1	0.51	<b>\$656</b>
<p>Double-sided recessed power block with <b>one regular power duplex, one power/USB-A/USB-C duplex and two telecom knockouts on top; one power duplex on bottom</b>. USB-A port charges max 2.4 amps at 5V and USB-C port charges max 3 amps at 5V. 10' power cord with straight plug. Specify telecom options separately, see page 390. Available in Black (<b>B</b>), Tungsten (<b>T</b>) or Designer White (<b>W</b>) as indicated by last letter of model number. Duplexes always Grey (duplex with USB ports is glossy finish). Corresponding cut-out options are <b>T1, T2</b> or <b>T3</b>. Units are not approved for daisy chaining. UL listed: UL 1363.</p>						
 <p><b>Double Sided Recessed Power Block - USB-A + USB-C</b></p>	<b>D x W x H</b>					
	PRTMCD642B	6.22 x 10.78 x 4.86	85	6.3	0.51	<b>\$790</b>
	PRTMCD642T	6.22 x 10.78 x 4.86	85	6.3	0.51	<b>\$790</b>
	PRTMCD642W	6.22 x 10.78 x 4.86	85	6.3	0.51	<b>\$790</b>
<p>Double-sided recessed power block with <b>two power/USB-A/USB-C duplexes and two telecom knockouts on top; one power duplex on bottom</b>. USB-A port charges max 2.4 amps at 5V and USB-C port charges max 3 amps at 5V. 10' power cord with straight plug. Specify telecom options separately, see page 390. Available in Black (<b>B</b>), Tungsten (<b>T</b>) or Designer White (<b>W</b>) as indicated by last letter of model number. Duplexes always Grey (duplex with USB ports is glossy finish). Corresponding cut-out options are <b>T1, T2</b> or <b>T3</b>. Units are not approved for daisy chaining. UL listed: UL 1363.</p>						

**Required Specifications**  
Finish

# T BOARDROOM TABLES

## TELECOM PLATES

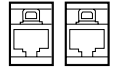

**Telecom Plate - 2 x 6**

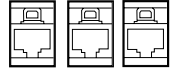

**Telecom Plate - 3 x 6**

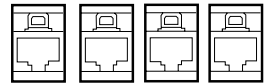

**Telecom Plate - 4 x 6**



**Telecom Plate - 3TSV**

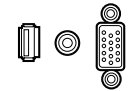

**Telecom Plate - 3SVH**

MODEL#	DIMENSIONS	FREIGHT CLASS	WT/LBS.	CUBIC FT.	LIST PRICE
--------	------------	---------------	---------	-----------	------------

D x W x H

PTELO1	- x - x -	70	0.01	0.05	<b>\$164</b>
--------	-----------	----	------	------	--------------

Includes 2 x RJ45 cat 6 data. Black telecom plate. To be hardwired by data contractor.

PTELO2	- x - x -	70	0.01	0.05	<b>\$222</b>
--------	-----------	----	------	------	--------------

Includes 2 x RJ45 cat 6 data and 1 RJ11 cat phone. Black telecom plate. To be hardwired by data contractor.

PTELO3	- x - x -	70	0.01	0.05	<b>\$340</b>
--------	-----------	----	------	------	--------------

Includes 4 x RJ45 cat 6 data. Black telecom plate. To be hardwired by data contractor.

PTELO4	- x - x -	70	0.01	0.05	<b>\$290</b>
--------	-----------	----	------	------	--------------

Includes 1 x RJ45 cat 6 data, mini stereo and 15 pin HD VGA. Black telecom plate. To be hardwired by data contractor.

PTELO5	- x - x -	70	0.01	0.05	<b>\$401</b>
--------	-----------	----	------	------	--------------

Includes mini stereo, 15 pin HD VGA and HDMI. Black telecom plate.

**Required Specifications**

Finish

## VILLA I SERIES CORDED UNITS

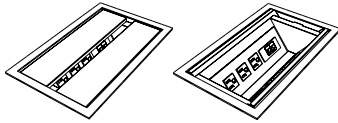

**Oasis Mini A, Corded**

MODEL#	DIMENSIONS	FREIGHT CLASS	WT/LBS.	CUBIC FT.	LIST PRICE
--------	------------	---------------	---------	-----------	------------

D x W x H

OAM-A-PC-__	15 x 9 x 5.25	92.5	16	1.53	\$1826
-------------	---------------	------	----	------	--------



Mini Oasis A unit. 15" Trough with six power receptacles, two telecom plate cut-outs (**telecom plates sold separate**, see page page 396) and two 108" 3-prong plugs. **M1, M2 or M3 cut-out(s) must be specified on conference table** (see product notes section for more details and cut-out upcharge). UL Listed.

- **Cannot be daisy-chained.**
- Replace \_ with **B** for **Black**
- Replace \_ with **S** for **Silver Pearl**

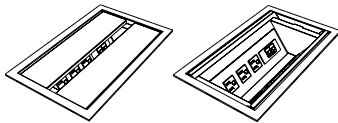

**Oasis Mini A, DaisyLink Version**

OAM-A-PC-4-1-__	15 x 9 x 5.25	92.5	16	1.53	\$2091
-----------------	---------------	------	----	------	--------

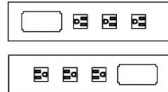

**For hardwire and daisy chain applications.** Mini Oasis A unit. 15" Trough with six power receptacles, two telecom plate cut-outs (**telecom plates sold separate**, see page page 396). **Power infeed sold separate** (see page page 398). **M1, M2 or M3 cut-out(s) must be specified on conference table** (see product notes section for more details and cut-out upcharge). For multiple circuit configurations, please contact customer service. *Please see our **Daisy-Chain guide** on page page 394 for appropriate cable lengths and important notes.* UL Listed.

- Replace \_ with **B** for **Black**
- Replace \_ with **S** for **Silver Pearl**

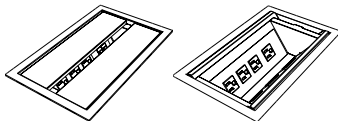

**Oasis Mini B, Corded**

OAM-B-PC-__	15 x 9 x 5.25	92.5	16	1.53	\$1826
-------------	---------------	------	----	------	--------

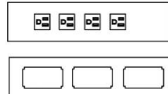

Mini Oasis B unit. 15" Trough with four power receptacles, three telecom plate cut-outs (**telecom plates sold separate**, see page page 396) and one 108" 3-prong plug. **M1, M2 or M3 cut-out(s) must be specified on conference table** (see product notes section for more details and cut-out upcharge). UL Listed.

- **Cannot be daisy-chained.**
- Replace \_ with **B** for **Black**
- Replace \_ with **S** for **Silver Pearl**

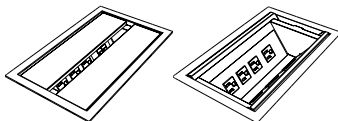

**Oasis Mini B, DaisyLink Version**

OAM-B-PC-4-1-__	15 x 9 x 5.25	92.5	16	1.53	\$2091
-----------------	---------------	------	----	------	--------

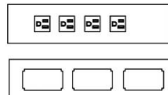

**For hardwire and daisy chain applications.** Mini Oasis B unit. 15" Trough with four power receptacles, three telecom plate cut-outs (**telecom plates sold separate**, see page page 396). **Power infeed sold separate** (see page page 398). **M1, M2 or M3 cut-out(s) must be specified on conference table** (see product notes section for more details and cut-out upcharge). For multiple circuit configurations, please contact customer service. *Please see our **Daisy-Chain guide** on page page 394 for appropriate cable lengths and important notes.* UL Listed.

- Replace \_ with **B** for **Black**
- Replace \_ with **S** for **Silver Pearl**

### Required Specifications

Finish  
Power infeed  
Cut-out location



# T BOARDROOM TABLES

## OASIS MINI

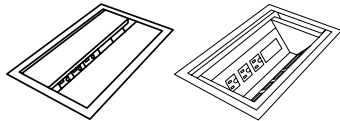

**Oasis Mini USB, Corded**

MODEL#	DIMENSIONS D x W x H	FREIGHT CLASS	WT/LBS.	CUBIC FT.	LIST PRICE
OAM-U-PC-__	15 x 9 x 5.25	92.5	16	1.53	<b>\$2044</b>

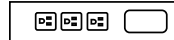
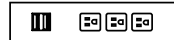

Mini Oasis USB unit. 15" trough with six power receptacles, two 2.1 AMP USB charging ports and one telecom plate cut-out (**telecom plates sold separate**, see page page 396) and two 108" 3-prong plugs. **M1, M2 or M3 cut-out(s) must be specified on conference table** (see product notes section for more details and cut-out upcharge). UL Listed.

- **Cannot be daisy-chained.**
- Replace \_ with **B** for **Black**
- Replace \_ with **S** for **Silver Pearl**

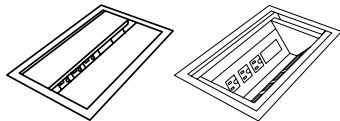

**Oasis Mini USB, DaisyLink Version**

OAM-U-PC-4-1-__	15 x 9 x 5.25	92.5	16	1.53	<b>\$2307</b>
-----------------	---------------	------	----	------	---------------

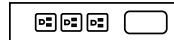
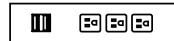

**For hardwire and daisy chain applications.** Mini Oasis USB unit. 15" trough with six power receptacles, two 2.1 AMP USB charging ports and one telecom plate cut-out (**telecom plates sold separate**, see page page 396). **Power infeed sold separate** (see page page 398). **M1, M2 or M3 cut-out(s) must be specified on conference table** (see product notes section for more details and cut-out upcharge). For multiple circuit configurations, please contact customer service. *Please see our **Daisy-Chain guide** on page page 394 for appropriate cable lengths and important notes.* UL Listed.

- Replace \_ with **B** for **Black**
- Replace \_ with **S** for **Silver Pearl**

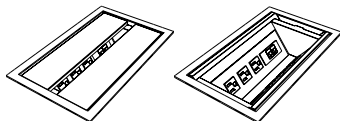

**Oasis Mini, Chicago Code**

GL-OAMPD_P72HW	15 x 9 x 5.25	92.5	16	1.53	<b>\$2490</b>
----------------	---------------	------	----	------	---------------

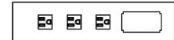
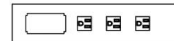

Mini Oasis for Chicago code includes electrical trough with (2) separate hardwire inserts. Each insert includes (3) simplex outlets and (1) telecom plate cut-out (**telecom plates sold separate**, see page page 396). **M1, M2 or M3 cut-out(s) must be specified on conference table** (see product notes section for more details and cut-out upcharge). Each component is UL listed.

- **Cannot be daisy-chained.**
- Replace \_ with **B** for **Black**
- Replace \_ with **S** for **Silver Pearl**

### Required Specifications

Finish  
Power infeed  
Cut-out location

OASIS MINI CUT OUT POSITIONS

D x W x H

**OASIS MINI A & B CABLE LENGTHS NEEDED FOR DAISY-CHAINING**

Model #	Oasis Mini A & Oasis Mini B	Oasis Mini A & Oasis Mini B	Oasis Mini A	Oasis Mini A	Oasis Mini B	Oasis Mini B
<b>Cut-out Positions</b>	TL/M & TR/M	TL/M & TR/M	TL/M, TC/M & TR/M	TL/M, TC/M & TR/M	TL/M, TC/M & TR/M	TL/M, TC/M & TR/M
<b>Infeed Position</b>	Left or Right	Center	Left or Right	Center	Left or Right	Center
<b>Reference</b>	Drawing 1A/1B	Drawing 2A/2B	Drawing 3	Drawing 4	Drawing 5	Drawing 6
<b>8' Dufferin &amp; Lufton Tables</b>	(1) 42FF-55 SPECIFY INFEED	(1) 42FF-29 (1) 42FM-29 (1) DAISY-T SPECIFY INFEED	N/A	N/A	N/A	N/A
<b>10' Dufferin &amp; Lufton Tables</b>	(1) 42FF-79 SPECIFY INFEED	(1) 42FF-41 (1) 42FM-41 (1) DAISY-T SPECIFY INFEED	(3) 42FF-37 SPECIFY INFEED	(3) 42FF-37 SPECIFY INFEED	(2) 42FF-37 SPECIFY INFEED	(2) 42FF-37 (1) 42FM-12 (1) DAISY-T SPECIFY INFEED
<b>12' Dufferin &amp; Lufton Tables</b>	(1) 42FF-103 SPECIFY INFEED	(1) 42FF-55 (1) 42FM-55 (1) DAISY-T SPECIFY INFEED	(3) 42FF-52 SPECIFY INFEED	(3) 42FF-52 SPECIFY INFEED	(2) 42FF-52 SPECIFY INFEED	(2) 42FF-52 (1) 42FM-12 (1) DAISY-T SPECIFY INFEED
<b>14' Dufferin &amp; Lufton Tables</b>	(1) 42FF-64 (1) 42FM-64 SPECIFY INFEED	1) 42FF-67 (1) 42FM-67 (1) DAISY-T SPECIFY INFEED	(3) 42FF-61 SPECIFY INFEED	(3) 42FF-61 SPECIFY INFEED	(2) 42FF-61 SPECIFY INFEED	(2) 42FF-61 (1) 42FM-12 (1) DAISY-T SPECIFY INFEED
<b>16' Dufferin &amp; Lufton Tables</b>	(1) 42FF-79 (1) 42FM-79 SPECIFY INFEED	1) 42FF-82 (1) 42FM-82 (1) DAISY-T SPECIFY INFEED	(3) 42FF-76 SPECIFY INFEED	(3) 42FF-76 SPECIFY INFEED	(2) 42FF-76 SPECIFY INFEED	(2) 42FF-76 (1) 42FM-12 (1) DAISY-T SPECIFY INFEED
<b>18' Dufferin &amp; Lufton Tables</b>	(1) 42FF-88 (1) 42FM-88 SPECIFY INFEED	1) 42FF-91 (1) 42FM-91 (1) DAISY-T SPECIFY INFEED	(3) 42FF-85 SPECIFY INFEED	(3) 42FF-85 SPECIFY INFEED	(2) 42FF-85 SPECIFY INFEED	(2) 42FF-85 (1) 42FM-12 (1) DAISY-T SPECIFY INFEED
<b>20' Dufferin &amp; Lufton Tables</b>	(1) 42FF-100 (1) 42FM-100 SPECIFY INFEED	1) 42FF-103 (1) 42FM-103 (1) DAISY-T SPECIFY INFEED	(3) 42FF-100 SPECIFY INFEED	(3) 42FF-100 SPECIFY INFEED	(2) 42FF-100 SPECIFY INFEED	(2) 42FF-100 (1) 42FM-12 (1) DAISY-T SPECIFY INFEED

**Interconnecting Cables - Common Cable Lengths (in inches)**

**Female/Female**

42FF-21 .....	\$108	42FF-94 .....	\$199	42FM-91 .....	\$201
42FF-29 .....	\$119	42FF-100 .....	\$205	42FM-94 .....	\$203
42FF-32 .....	\$121	42FF-103 .....	\$208	42FM-103 .....	\$216
42FF-37 .....	\$128	42FF-106 .....	\$211	42FM-106 .....	\$218
42FF-41 .....	\$133	42FF-112 .....	\$219	42FM-115 .....	\$230
42FF-46 .....	\$139	42FF-115 .....	\$225	42FM-118 .....	\$235
42FF-52 .....	\$147	42FF-118 .....	\$228		
42FF-55 .....	\$151				
42FF-58 .....	\$154	<b>Female/Male</b>			
42FF-61 .....	\$157	42FM-12 .....	\$104		
42FF-64 .....	\$161	42FM-21 .....	\$115		
42FF-67 .....	\$165	42FM-32 .....	\$128		
42FF-70 .....	\$168	42FM-46 .....	\$146		
42FF-76 .....	\$176	42FM-55 .....	\$156		
42FF-79 .....	\$180	42FM-58 .....	\$159		
42FF-82 .....	\$184	42FM-67 .....	\$170		
42FF-85 .....	\$187	42FM-70 .....	\$175		
42FF-88 .....	\$191	42FM-79 .....	\$186		
42FF-91 .....	\$195	42FM-82 .....	\$190		

# T BOARDROOM TABLES

## OASIS MINI NOTES

D x W x H

### DRAWING 1A - MINI OASIS A

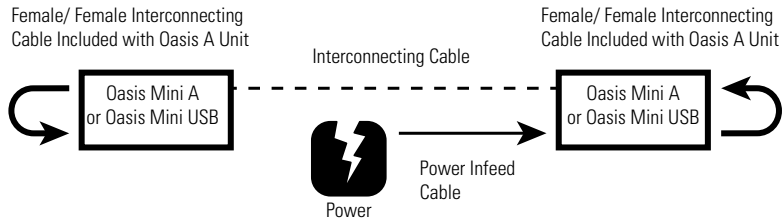

### DRAWING 1B - MINI OASIS B

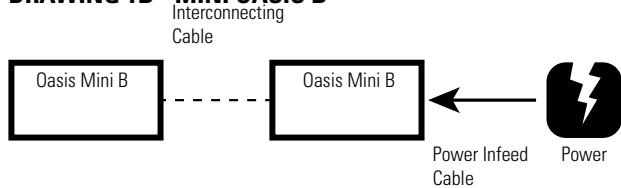

### DRAWING 2A - MINI OASIS A

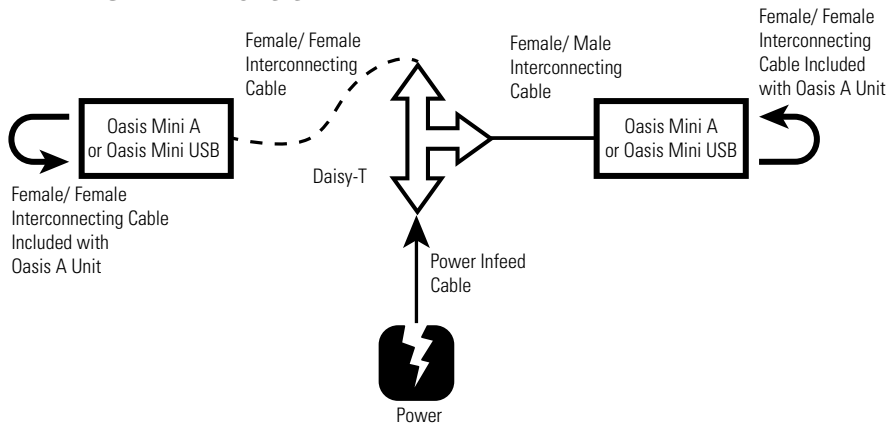

### DRAWING 2B - MINI OASIS B

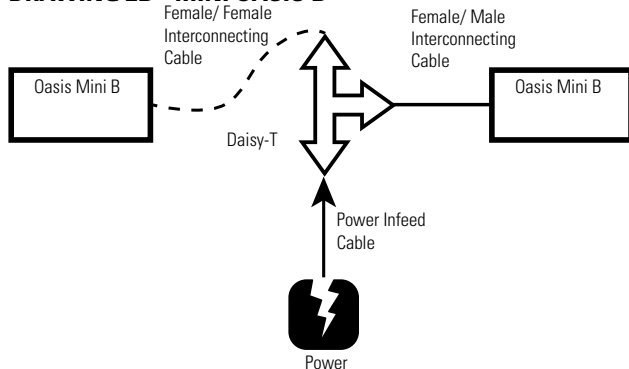

### DRAWING 3 - MINI OASIS A

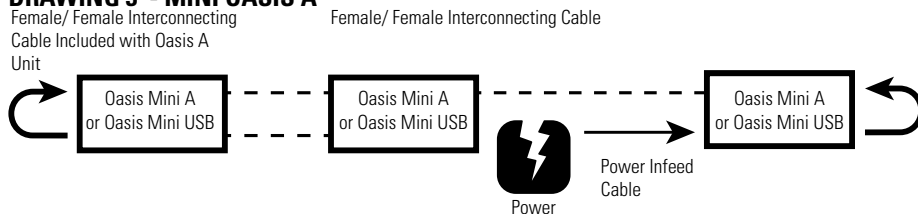

OASIS MINI NOTES

D x W x H

**DRAWING 4 - MINI OASIS A**

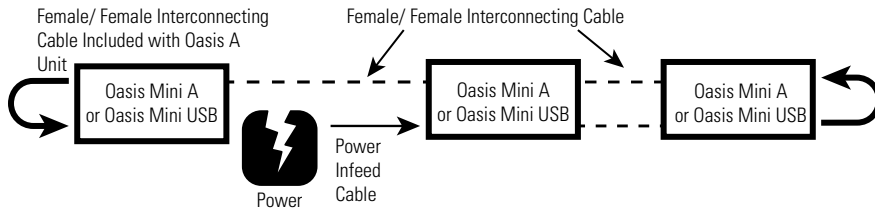

**DRAWING 5 - MINI OASIS B**

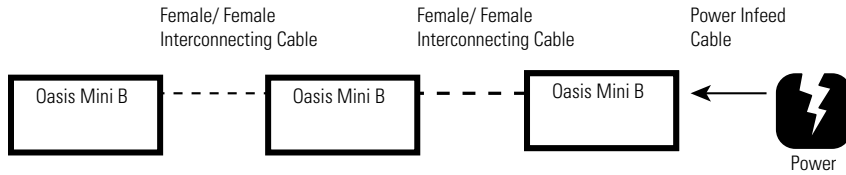



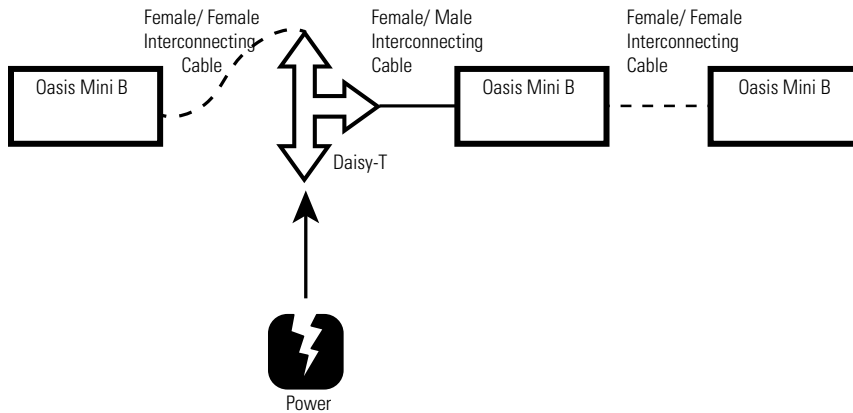



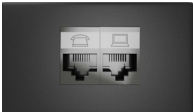
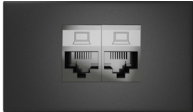
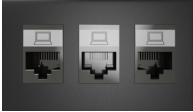
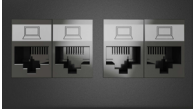

**DRAWING 6 - MINI OASIS B**

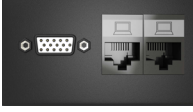

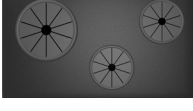

# T BOARDROOM TABLES

## TOP TELECOM PLATES

TOP TELECOM PLATE	MODEL	CONFIGURATION	D x W x H	LIST PRICE
	A-__-A-B	Telecom plate with RJ11 Cat 3 Phone and RJ45 Cat 6 Data		\$108
	A-__-B-B	(2) RJ45 Cat 6 Connectors		\$141
	A-__-B-B-B	(3) RJ45 Cat 6 Connectors		\$206
	A-__-B-B-B-B	(4) RJ45 Cat 6 Connectors		\$274
	A-__-B-C51-L	RJ45 Cat 6 Data, Mini-Stereo Inline and 15 pin HD VGA Female/Female with 72" patch cord attached.		\$244
	A-__-B-B-C51	(2) RJ45 Cat 6 Data and (1) 15 pin HD VGA Female/Female with 72" patch cord attached.		\$254
	A-__-A-B-102	RJ11 Cat 3 phone, RJ45 Cat 6 Data and USB with 72" patch cord attached.		\$244
	A-__-B	RJ45 Cat 6 Data		\$76
	A-__-C51-L	Mini Stereo Inline and 15 pin HD VGA Female/Female with 72" patch cord attached.		\$191
	A-__-CRDMINDER	Cordminder Plate - 2 5/8" holes and 1 7/8" holes		\$43
	A-__-C45-C51-L	HDMI Female/Female with 36" patch cord attached. Mini Stereo Inline and 15 Pin HD VGA Female/Female with 72" patch cord attached.		\$333

### Required Specifications

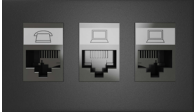
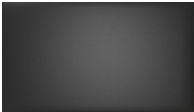
Finish  
Power infeed  
Cut-out location

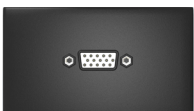
TOP TELECOM PLATES		MODEL#	DIMENSIONS D x W x H	FREIGHT CLASS	WT/LBS.	CUBIC FT.	LIST PRICE
TOP TELECOM PLATE	MODEL	CONFIGURATION					LIST PRICE
	A-__-C45	HDMI Female/Female with 36" patch cord attached.					\$164
	A-__-A-B-B	(1) RJ11 Cat 3 Phone and (2) RJ45 Cat 6 data.					\$178
	A-__	Blank telecom plate					\$10
	A-__-102	USB with 72" patch cord attached.					\$76
	A-__-C51	15 pin HD VGA Female/Female with 72" patch cord attached.					\$123

- Replace \_ with **BL** for **Black**
- Replace \_ with **GR** for **Grey**

**Required Specifications**

Veneer Finish  
Laminate Finish  
Handle Style

**Optional Specifications**

Grommet

# T BOARDROOM TABLES

## POWER INFEEDS

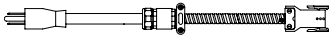

### Plug and Play Infeed

MODEL#	DIMENSIONS	FREIGHT CLASS	WT/LBS.	CUBIC FT.	LIST PRICE
	<b>D x W x H</b>				
42AP1-72	--	--	--	--	<b>\$245</b>

Single Circuit 20 AMP Power Infeed with 72" 3-prong plug. Provides single power entry from floor or wall mounted standard power supply. Connects to Oasis Mini or Villa units that require a separate infeed. UL Listed.



### Multi-Circuit Hardwire Power Infeed

42SB2-108	--	--	--	--	<b>\$203</b>
42SB2-72	--	--	--	--	<b>\$158</b>
42SB2-36	--	--	--	--	<b>\$115</b>

Multi-Circuit Hardwire Infeed (up to 20 AMPS per circuit), two circuits. Provides single power entry from floor or wall located building power supply. Connects to Oasis Mini or Villa units that require a power infeed. **TO BE HARDWIRED BY A LICENSED ELECTRICIAN.** UL Listed.

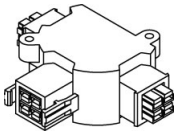

### 3 Way Power Splitter

DAISY-T	--	70	1	1	<b>\$187</b>
---------	----	----	---	---	--------------

Daisy-T power manager includes two male and one female connection. For use in splitting a power source two ways.

#### Required Specifications

Veneer Finish  
Laminate Finish  
Handle Style

#### Optional Specifications

Grommet