



Philadelphia detailing is traditional with a 1" overhang on all edges. Solid walnut, cherry, maple, oak that bands worksurface perimeter is 1" wide by 1-3/8" thick for an overall thickness of 1-3/8". Philadelphia is a "top over pedestal" detailed series. Philadelphia is standard with a base. Floor storage unit bases (i.e. kick-plates on pedestals, lateral files, bookcases, etc.) are extended out over drawer faces and horizontally grained. Products that are normally positioned against walls, such as credenzas, have a self-edge veneered back edge detail. All primary faces have pin molding decorations.

This elegantly designed traditional furniture series employs state-of-the-art manufacturing to create traditional pieces for executive offices, conference rooms and reception areas. Philadelphia is characterized by solid-wood edge detailing with solid-wood moldings on the cases and brass hardware throughout. The finest clear hardwoods are hand-selected to ensure that the best quality and consistency is achieved. Each piece is protected with a catalyzed conversion varnish to provide one of the most durable finishes in the industry. Philadelphia makes a truly impressive statement for the discerning customer.



Features and Benefits

- Philadelphia is a traditional collection characterized by craftsmanship and elegance
- Solid-wood edge detailing with solid-wood moldings on the cases and brass hardware throughout
- Drawers are standard vinyl-wrapped construction with black drawer sides and bottom.
- Pedestals feature antique brass handles, profiled drawer fronts and maple drawer interiors.
- The base is profiled, with pin moldings on desk fronts and sides.
- Bronze glass is standard with clear glass available as an option.
- Modesty panel upgrades are available on select models.

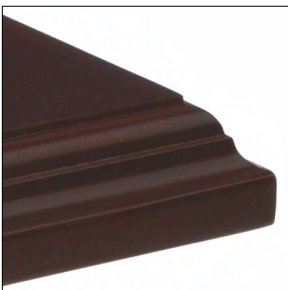

1-3/8" thick solid hardwood edge

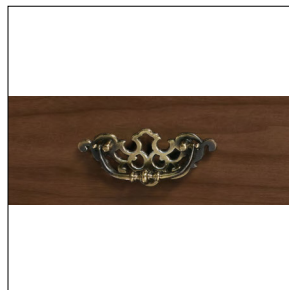

Antique brass pull

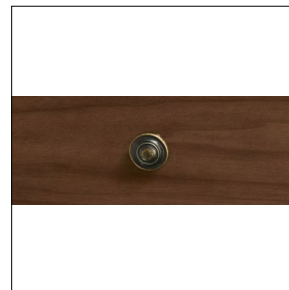

Knob

GENERAL INFORMATION

- Philadelphia is comprised of hundreds of models for the traditional executive suite and coordinating meeting areas.
- Solid wood is used on all perimeter worksurface edges, as well as end panel bottoms for mounting leveling glides
- 1" overhang with a traditional detailing is featured on all user and approach sides.
- Brass bulls exclusive to Philadelphia detail the traditional style of the product.
- GM5 grommets are standard on all designated worksurfaces.
- **Level certified**

CONSTRUCTION

- Number One select, architectural grade "A" oak, American black walnut, American black cherry or maple. Wood worksurface molded edges are solid oak, walnut, cherry, or maple.
- Traditional detailing with 1" overhang on all edges.
- Solid walnut, cherry, maple, oak that bands worksurface perimeter is 1" wide by 1-3/8" thick for an overall thickness of 1-3/8".

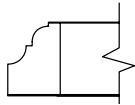

Edge detail

- Top over pedestal design
- Products that are normally positioned against walls, such as credenzas, have a self-edge veneered back edge detail. All primary faces have pin molding decorations.

FINISHES

- Conversion varnish (similar to catalyzed lacquer, but tougher), 25 degree sheen. Finishes are not buffed or rubbed.
- All Global wood casegood products are veneered and finished on the back sides (360° finishing), except modular under-surface storage - tops and backs are unfinished.
- Touch up kits available, includes a touch up marker and fill crayon. Order **VTOUCHUPKIT, \$164** list. Specify finish when ordering.
- Global standard finish, on oak and walnut, is open pore and on cherry and maple is semi-closed pore. If a full finish is required for walnut, cherry, anigre and maple tops, Add the suffix "2" to the finish code and Add 5% to the base pricing for each product.

CUSTOM FINISH IS AVAILABLE.

PEDESTALS

- Full-to-the-floor. Pedestals are fully assembled units that are either installed into desk and credenza shells, or available as modular units. Undersurface storage units include locks.
- Pedestal drawer suspensions are metal ball bearing type. Both box and file drawers are full extension.
- Drawers are standard vinyl-wrapped construction with black drawer sides and bottom.
- The drawer front is an applied element to a four sided drawer. Drawer fronts are veneered on all surfaces except the vertical edges, which are solid oak, walnut, cherry and maple then routed with series detailing. Drawer fronts can be removed or replaced in the field.
- Levelers have 1" range of adjustment.

LOCKS

- Locks are standard on all below worksurface level drawer and door storage units, with the exception of pull-out tray units and single lateral file drawer combination tray/slot units.
- Combination storage unit comes with lock for file and lateral file drawer only; box drawers cannot lock.
- Lock color will match the handle option.
- Locks are optional on all above worksurface level closed storage

HANDLES

- All drawer fronts come with traditional antique brass finished handles centered on drawer faces. All cabinet doors come with knobs in the same finish.

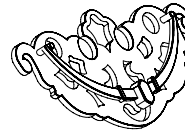

PL40 Brass Pull, 4.5"

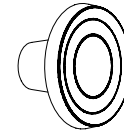

DK25 Knob on Uppers

HARDWARE

- All necessary hardware items for attaching furniture items are included in the shipment. Actual wall attachment fasteners for wall cabinets, tackboards and visual boards are not included due to variation between site conditions.

LEVELING GLIDES

- Shipped in a plastic bag attached to the bottom of the item or inside the pedestal. It is important to install leveling glides to ensure the unit is level. Levelers have a 1" range of adjustment.

HANGING FILE RAILS

- Pre-installed on file drawer perimeters and accommodate both legal and letter size filing. Legal filing can be achieved either as side-to-side or front-to-back. Letter filing can be achieved as front-to-back filing only.

FLAT PLATES

- Flat plates are used to attach bridges and returns to desks and are shipped pre-attached to the bottom of the bridge or return.
 - Mini flat plates for securing bridge back panels to desk or credenza end panels, and quick connectors for securing modular corner units to adjacent pieces, are shipped along with screws in a plastic bag attached to the bottom of the bridge or return.
- CAUTION:** Using screws other than those supplied by Global could result in damage to finished tops.

WALL-MOUNTED CABINETS, TACKBOARDS AND VISUAL BOARDS

- Pre-attached with horizontal wall rails to the back of each unit. The wall-side components must be detached from the unit and fastened to the wall accordingly.
- Wall fasteners are not included due to the variable site conditions. Securing the wall rail to a vertical structural member is the required manner of installation. The cabinet or visual board is then lowered on to the wall rail. It is important to level the wall rail before installation.
- Wall cabinets are equipped with levelers at the bottom of the back panels for proper cabinet alignment.
- Units with doors are equipped with adjustable European door hinges to assist in door alignment. It is required to use a #8 wood screw through the back of the cabinet and the wall-mounted rail, to further secure the wall attachment.
- Tackboards have vertical grooves in the back for tasklight wiring.
- Hutches and tackboards are installed with double faced tape applied to the bottom of the end panels. The tape is shipped in a plastic bag found in the hutch. Removal of the hutch requires moderate pressure to be applied on the top of the unit towards the wall for at least a minute for the pressure sensitive tape to release. Additional support may be added by installing flat plates along the outside back of the attached units. *These flat plates are not included in the shipment.*
- Hutch tackboards are factory-installed.
- Tackboards are standard in Grade 3 panel fabrics.

MODULAR STORAGE UNITS

- Pre-drilled holes through the unfinished tops for securing to the bottom of worksurfaces
- Screws and lock keys are included in a plastic bag fastened inside the pedestal. Installer should leave a 1/8" reveal between the Modular Storage Unit and the End panel. Disassemble the Modular Unit first before relocating the entire unit to avoid damage or bodily injuries.

PEDESTAL SPACERS

- Required if pedestals are placed side by side. A 1" gap is required between the modular pedestals to allow access to vertical fingerpulls. If required, order **SP700**.

5-SIDED CORNER TABLES

- Join bridge and credenza run-offs, using the supplied quick connectors.
- Recessed end-panels in these units are pre-drilled to accept quick-connectors for easy alignment
- Accurate leveling is critical for these units to align and connect properly.
- Flat-plates are pre-attached to the worksurface to secure to the desk unit.

1. SPECIFY MODEL NUMBER

2. SPECIFY FINISH

WORKSURFACE TOP & DRAWER/DOOR FRONTS, BODY FINISHES (INCLUDING PEDESTALS) - VENEER

Code	Finish	Veneer Type	Cut
AMW	Almond Cherry	Cherry	Flat Sliced
ACW	Amber Cherry	Cherry	Flat Sliced
BTW	Biscotti	White Oak	Rift
CAW	Cocoa Walnut	Walnut	Flat Sliced
CRW	Coral	White Oak	Rift
DCW	Dark Cherry	Cherry	Flat Sliced
DWW	Dark Walnut	Walnut	Flat Sliced
EWV	Espresso Walnut	Walnut	Flat Sliced
EVW	Evening Oak	White Oak	Rift
GRW	Grey on Oak	White Oak	Rift
HAW	Hazelnut	Maple	Flat Sliced
JAW	Java	White Oak	Rift
LTW	Latte Walnut	Walnut	Flat Sliced
MHW	Mahogany on Walnut	Walnut	Flat Sliced
MTW	Milestone	White Oak	Rift
MPW	Natural Maple	Maple	Flat Sliced
NLW	Natural Walnut	Walnut	Flat Sliced
RCW	Red Cherry	Cherry	Flat Sliced
VNW	Vintage Cherry	Cherry	Flat Sliced
ULW	Umber Walnut	Walnut	Flat Sliced
WLW	Walnut	Walnut	Flat Sliced
WCW	Warm Cherry	Cherry	Flat Sliced
WMW	White Maple	Maple	Flat Sliced

METAL FINISHES:

E	Black
K	Tungsten
DWT	Designer White
P	Brushed Chrome

GLASS FINISH (for Glass Doors and Modesty Panels)

- Bronze Glass (standard)
- Clear Glass - contact Customer Care

3. SPECIFY OPTIONS

GROMMETS

- Standard grommet on all components is **GM5**. Grommets are included with products where shown in product line drawings.
- Optional grommets may be ordered in standard worksurface locations (left, center or right). Order as **GM5L**, **GM5C** or **GM5R**. **Add \$96**.
- Grommet hole dimensions are 3.5" x 2". Specify **GM5E** for **Black** or **GM5K** for **Tungsten**.
- Color of grommet will be automatically coordinated with handle color where applicable

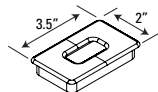

- Components that come standard with grommet may be ordered without a grommet. Order as RSG - **Add \$53**.
- View diagrams on the following pages for additional details.

GROMMET LOCATIONS

- Grommets and Grommet Locations must be specified.
- Includes standard and optional grommet locations.
- For TEL & TER location please contact Customer Care.

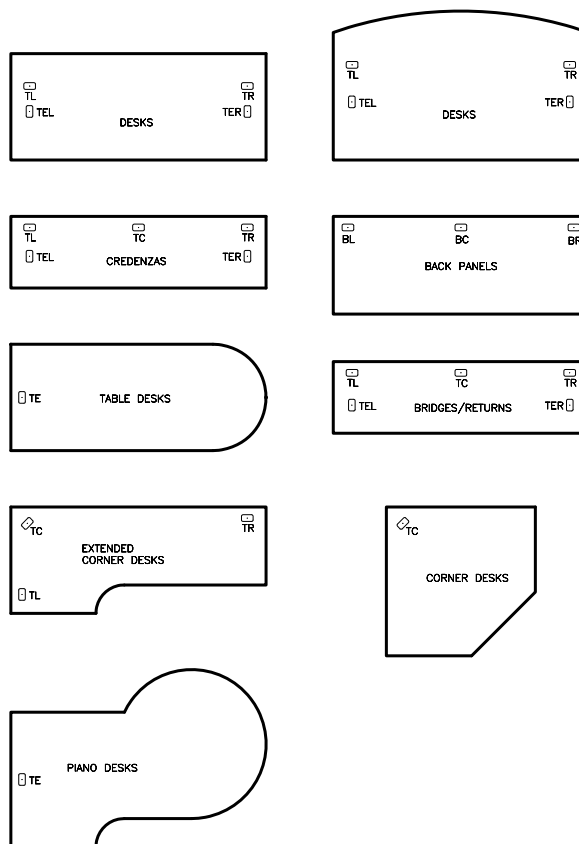

P PHILADELPHIA - EDGE DETAILS

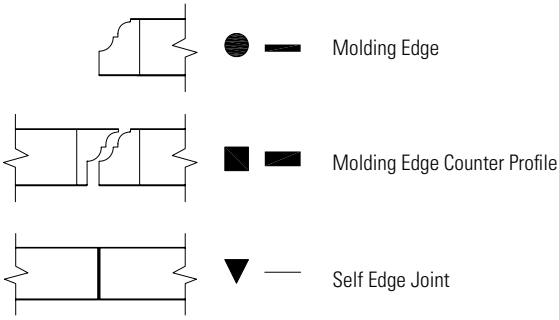

- D** - Desks and Credenzas
- B** - Executive Bridges
- E** - Executive Returns
- C** - Corner Components
- L** - Linking Bridges
- P** - Piano Desks

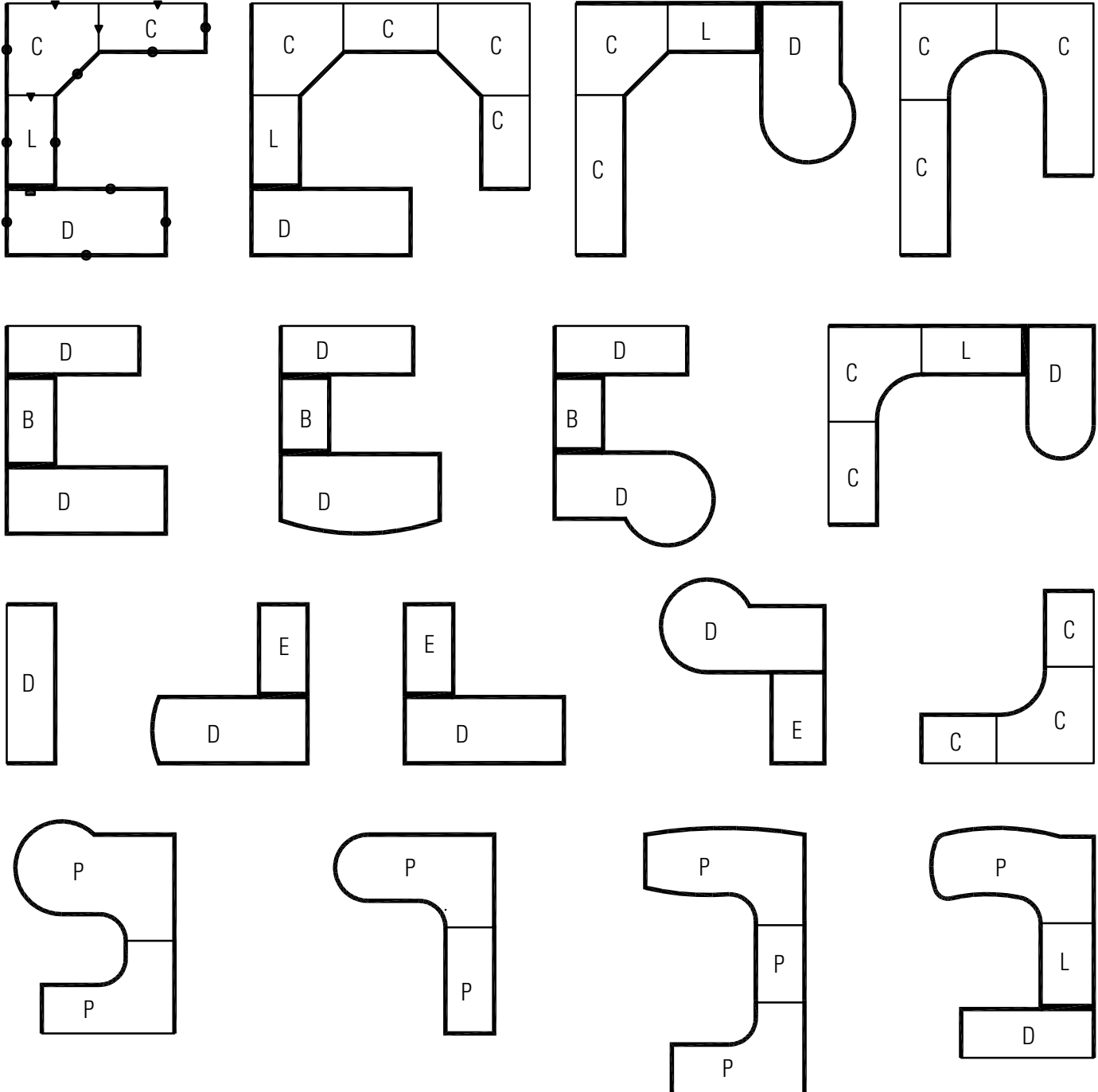

DESK AND CREDENZA NOTES

- Can be ordered as a shell or with pedestals
- Hand of Rectangular Desk is determined by location of pedestal from user side
- Hand of "D" Top is determined by outward orientation of curved end from user projection.
- Hand of "P" Top is determined by outward orientation of conference end from user projection.

Isometric View

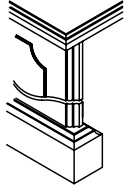

Side View
1-3/8" Top

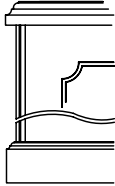

Front View
1-3/16" Slab

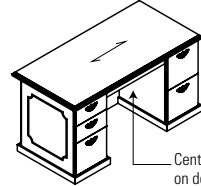
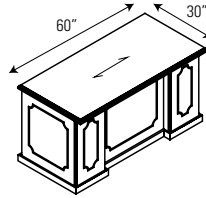
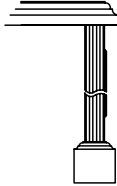

Center drawer standard on double pedestal desk

MODESTY PANEL CLEARANCE

PBID7236DE

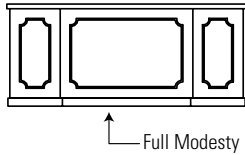

Full Modesty

PBID7236 (7236 indicates top size)

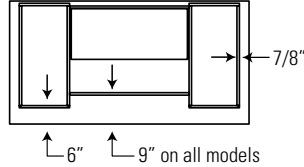

6" 9" on all models

PBISR7230D

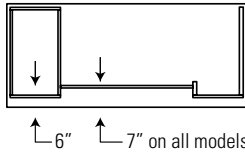

6" 7" on all models

PBDDFL7230 (Left shown)

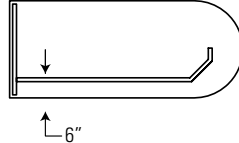

6"

PBTPOL7242 (Left shown)

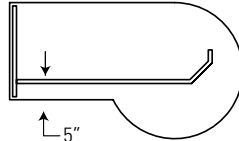

5"

PBC7220

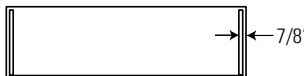

7/8"

P PHILADELPHIA - NOTES

PIANO DESKS AND LINKING RETURNS

- All Desks are shipped assembled.
- Units include standard Grommets shown and installed horizontal wire management
- Unit is handed by Post Leg • Not for use with regular Corner Units

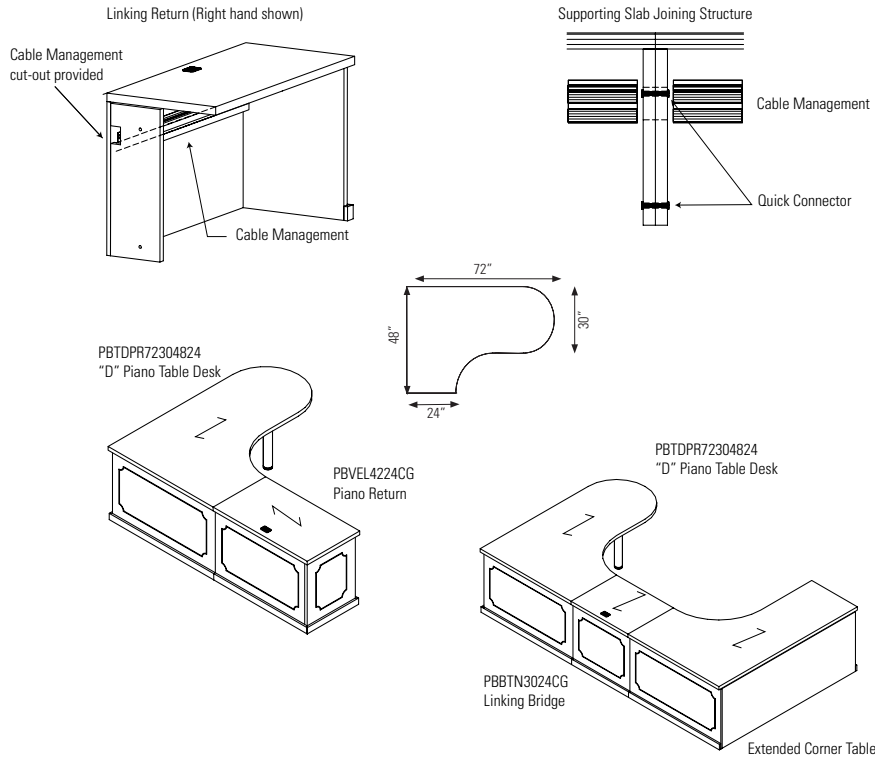

EXECUTIVE BRIDGES

- Executive Bridge is used to connect a Desk to a Credenza.
- Not to be used with Corner Components or Piano Desks.
- Three Back Panel options
- Back panel flush with end panels of Desk and Credenza
- Includes GM5 Grommet Top Center
- The standard grain direction is cross grain (**CG**). To remove cross grain veneer pattern on top, delete suffix "**CG**" from the model number (no upcharge)

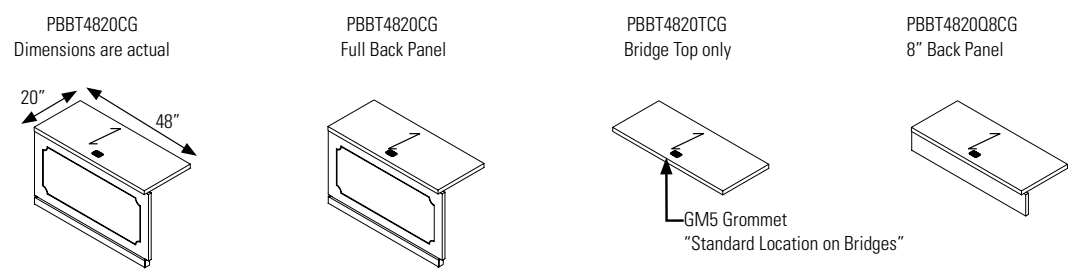
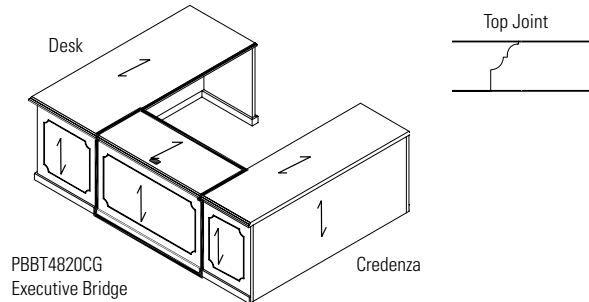

EXECUTIVE RETURNS

- Executive Return is used to attach to a Single Pedestal Desk, Single Pedestal Credenza, Desk Shell or Credenza Shell.
- Can be specified as a Shell or with a Pedestal.
- Back Panels are available as either full height or 8" from the underside of the worksurface.
- Hand of Executive Return is determined by location of full end panel from user side.
- Hand of Desk or Credenza is determined by location of pedestal from user side.
- The standard grain direction on return tops is cross grain (**CG**). To remove cross grain veneer pattern on top, delete suffix "**CG**" from the model number (no upcharge)

Executive Return attached to Desk or Credenza

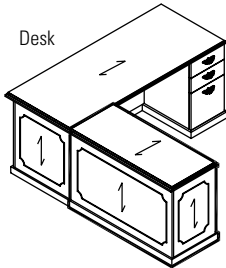

PBRL4822CG
Executive Return

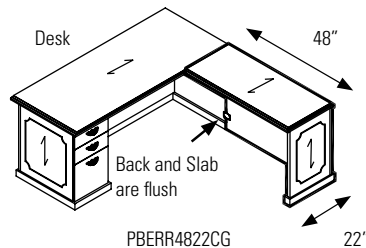

PBERR4822CG
Executive Return

CORNER COMPONENTS

- Corner Table is used to connect to Linking Bridge and Linking Credenza.
- Cable management tray included.
- Back Panels are available as either full height or 8" from the underside of the worksurface.
- Hand of Linking Credenza is determined by location of full end panel from user side.
- Hand of Extended Corner is determined by location of long narrow end from user side
- The standard grain direction is cross grain (**CG**). To remove cross grain veneer pattern on top, delete suffix "**CG**" from the model number (no upcharge)

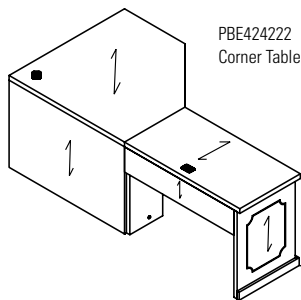

PBE424222
Corner Table

PBEK424222
Corner Table

PBEK424222
Corner Table

Supporting Slab Joining Structure

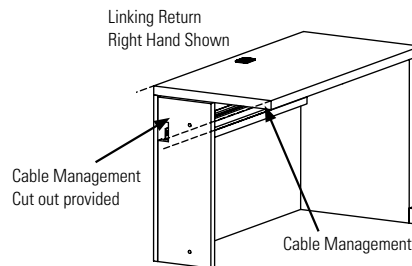
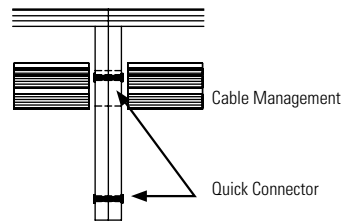

Linking Return
Right Hand Shown

Cable Management
Cut out provided

Cable Management

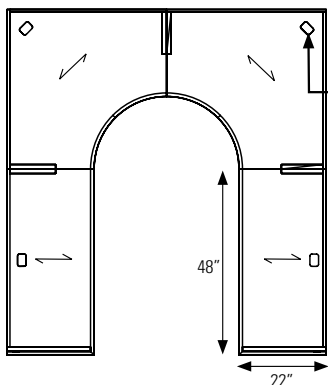

PBVL4822CG
Linking Return

Grommet standard on all
Corners except Extended
Corners

PBVR4822CG
Linking Return

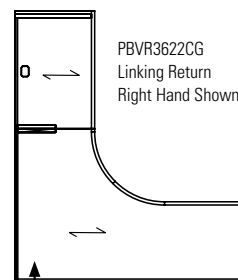

PBVR3622CG
Linking Return
Right Hand Shown

PBEKL724822
Extended Corner Table

Grommet must be specified if required.

LINKING BRIDGES

- Linking Bridge is used to connect Corner Components to Single Pedestal Desk, Single Pedestal Credenza, Desk Shell or Credenza Shell.
- Back panels are available as either full height or 8" from the underside of the worksurface.
- Includes GM5 Grommet Top Center
- Hand of Linking Bridge is determined by location of half end panel from user side
- The standard grain direction is cross grain (**CG**). To remove cross grain veneer pattern on top, delete suffix "**CG**" from the model number (no upcharge)

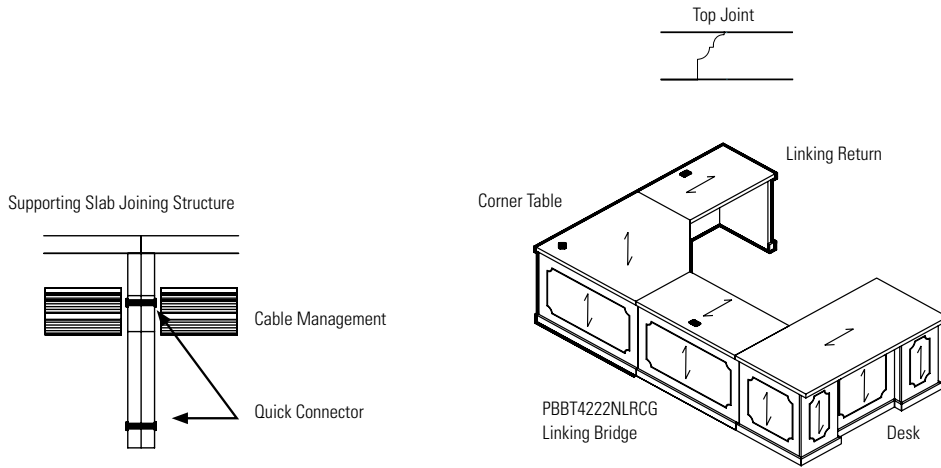

COPING AND SELF-EDGE OPTIONS

- Coping option provides an undercut on hutches only so that storage cabinets placed next to the hutch fit flush.
 - Specify **COP** for coping on both sides, **COPR** for coping on the right side and **COPL** for coping on the left side. No upcharge.
- Self edge options provide a flush fit when storage units are placed next to one another.
 - Specify **SE** for self-edge on both sides, **SER** for self-edge on the right side and **SEL** for self-edge on the left side. When **SE**, **SER**, **SEL** are specified, the corresponding bottom base molding will also be removed. No upcharge.
 - Coping and self-edge handedness are from the users perspective. See diagram below.

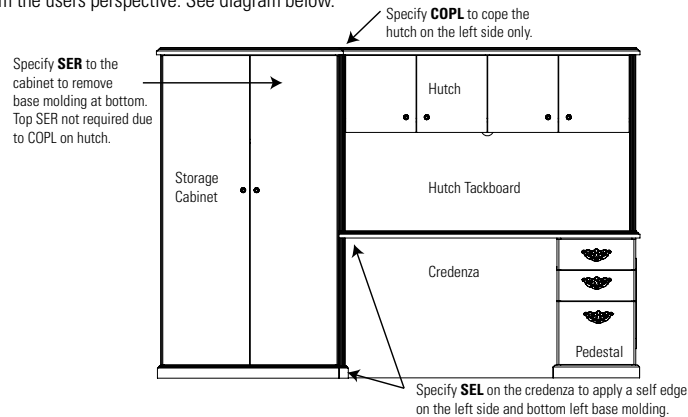

MODULAR PEDESTALS AND HANDLES

- Modular Pedestal for Philadelphia using "C" components.
- SP700 spacer is required if two Modular Pedestals are placed side by side when there is no handles. Order as special.
- Credenza shell cannot be completely filled up with modular components to create a full storage credenza.

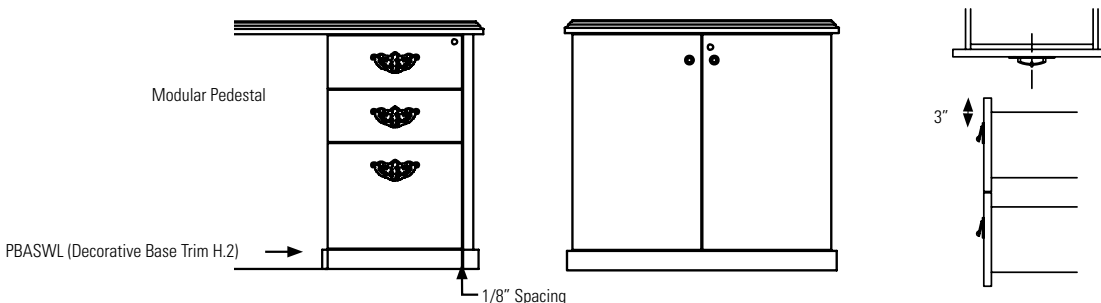

LOCKING

- Locks are standard on all below worksurface level drawer and door storage units with the exception of the pull-out tray units and single lateral file drawer combination tray/slot units.
- Locks are optional on all above worksurface level closed storage units.

Standard Lock Positions

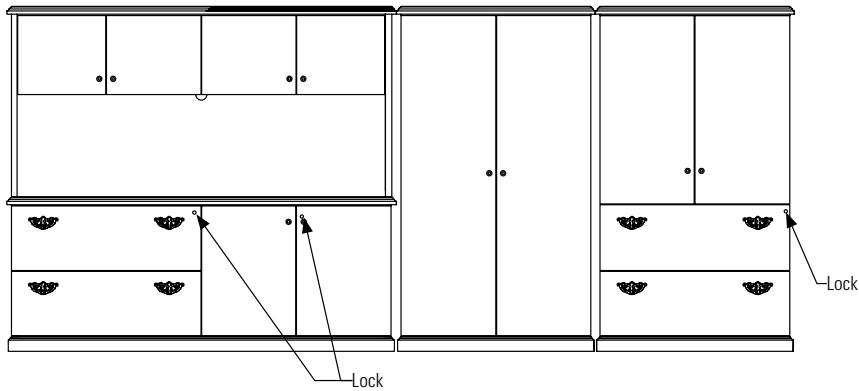

PBCF7222

Full Storage Credenza: Locks are on the front.

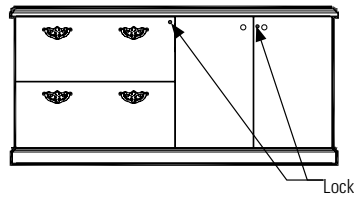

PB7236DE

Double Pedestal Desk/Credenza:

Lock for D and E Pedestals are on the inside Gable.

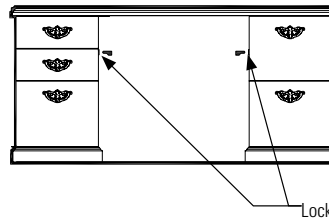

PBZR

Combination Storage Unit:

Lock for File and Lateral File Drawer only,
Box Drawers do not lock.

Box Drawers
do not lock

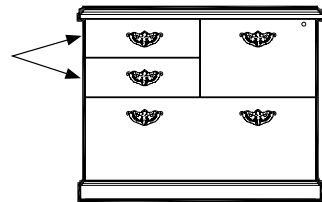

PBWF

Modular Furniture:
Lock is on the front.

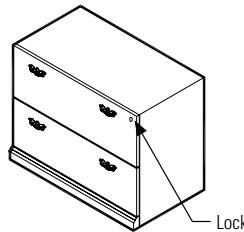

PBWD

Modular Furniture:
Lock is on the front.

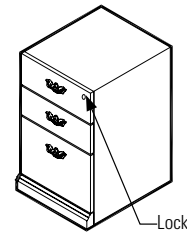

HUTCH POSITIONING

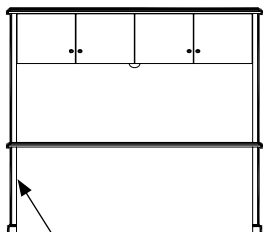

There must be an end panel
under the hutch

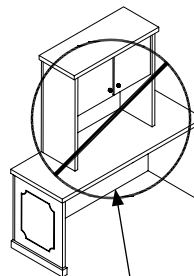
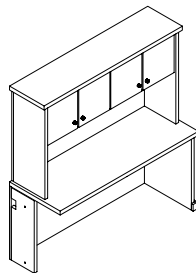

Missing Support
NOT Recommended

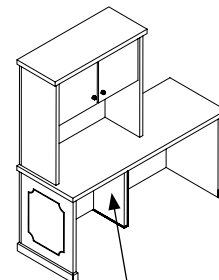

Add optional Support
SLAB12 (as Special)

TACKBOARDS

Tackboards for Storage Huches

PB72SH36

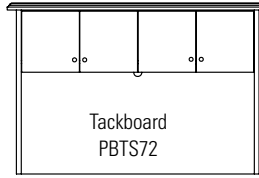

PB72SHP42 and PB722SHP54

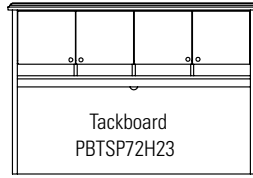

PB72SH42 and PB722SH54

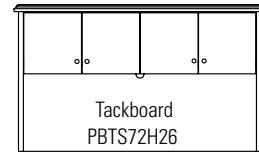

Tackboards with Accessory Rail

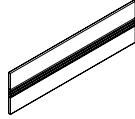

PBTSAS72

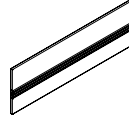

PBTSAS72H23

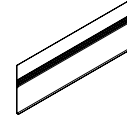

PBTSAS72H26

Tackboards for Wall Mount Overheads

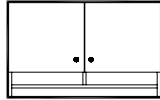

CSF36

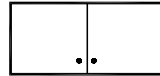

CSFP36

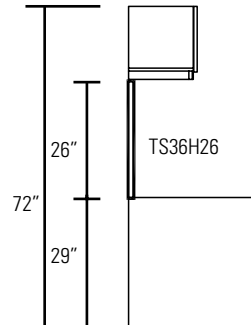
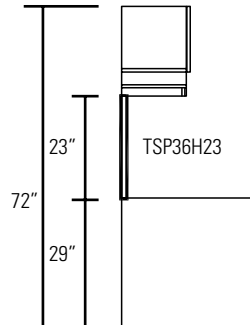
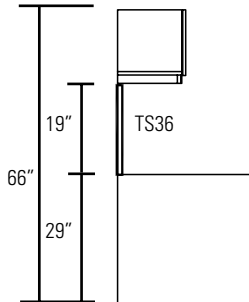

LIGHTING

Wall Mount

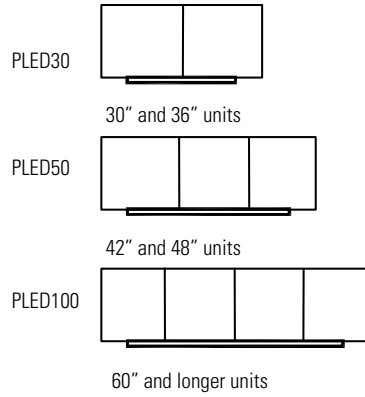

Hutch

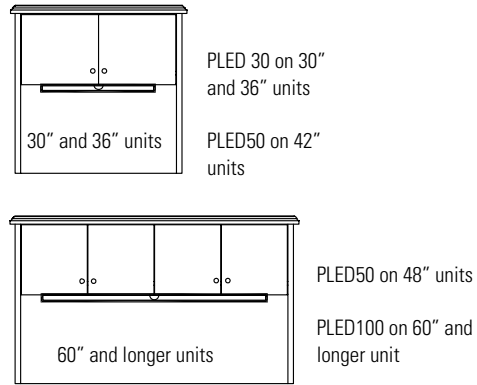

DESKS - NOTES

NOTE: Arrow indicates direction of grain

Double Pedestal Desks

- Shipped assembled
- Kneewell locking standard and keyed alike
- Standard with center drawer
- For optional pull-out writing tray, specify **WTD**. Add **\$679**.

Single Pedestal Desks

- Shipped assembled
- Kneewell locking standard and keyed alike
- For optional pull-out writing tray, specify **WTS**. Add **\$343**.

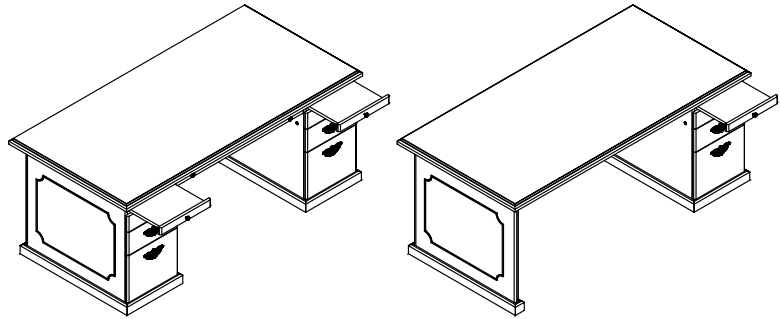

D and P shaped desks

- Shipped assembled.

D and P shaped connecting desks

- Shipped knocked down.
- The standard grain direction on D and P shaped connecting desks is cross grain (**CG**). To remove cross grain veneer pattern on top, delete suffix "**CG**" from the model number (no upcharge)
- Pedestals are handed:
 - Left pedestals have the handle offset from the center to the right, and the lock is placed on the right end panel
 - Right pedestals have the handle offset from the center to the left, and the lock is placed on the left end panel
- Modesty panels are available in wood or glass
- Grommets are available as an option on Desks and most Credenzas.

DOUBLE PEDESTAL DESKS

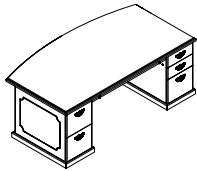

**Double Pedestal Bow Top Desk
Breakfront Style**

MODEL# DIMENSIONS FREIGHT CLASS WT/LBS. CUBIC FT. LIST PRICE

D x W x H

PBMID8442ED	42 x 84 x 29	125	443	59	\$12604
PBMID7842ED	42 x 78 x 29	125	412	55	\$11772
PBMID7242ED	42 x 72 x 29	125	380	51	\$10940
PBMID6636ED	36 x 66 x 29	100	340	40	\$10640

Standard with full to floor **file/file** pedestal on **left** and **box/box/file** pedestal on **right**. Pedestals lock.
Inset Full Height Modesty Panel.

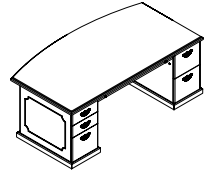

**Double Pedestal Bow Top Desk
Breakfront Style**

PBMID8442DE	42 x 84 x 29	125	443	59	\$12604
PBMID7842DE	42 x 78 x 29	125	412	55	\$11772
PBMID7242DE	42 x 72 x 29	125	380	51	\$10940
PBMID6636DE	36 x 66 x 29	100	340	40	\$10640

Standard with full to floor **box/box/file** pedestal on **left** and **file/file** pedestal on **right**. Pedestals lock.
Inset Full Height Modesty Panel.

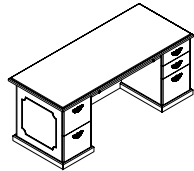

**Double Pedestal Desk
Breakfront Style**

PBID8442ED	42 x 84 x 29	125	442	59	\$10865
PBID7842ED	42 x 78 x 29	125	421	55	\$10156
PBID7236ED	36 x 72 x 29	100	375	44	\$9451
PBID7230ED	30 x 72 x 29	100	345	36	\$9322
PBID6636ED	36 x 66 x 29	100	360	40	\$9322
PBID6630ED	30 x 66 x 29	92.5	315	30	\$9192
PBID6030ED	30 x 60 x 29	92.5	315	30	\$8930

Standard with full to floor **file/file** pedestal on **left** and **box/box/file** pedestal on **right**. Pedestals lock.
Inset Full Height Modesty Panel.

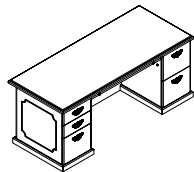

**Double Pedestal Desk
Breakfront Style**

PBID8442DE	42 x 84 x 29	125	442	59	\$10865
PBID7842DE	42 x 78 x 29	125	421	55	\$10156
PBID7236DE	36 x 72 x 29	100	375	44	\$9451
PBID7230DE	30 x 72 x 29	100	345	36	\$9322
PBID6636DE	36 x 66 x 29	100	360	40	\$9322
PBID6630DE	30 x 66 x 29	92.5	315	30	\$9192
PBID6030DE	30 x 60 x 29	92.5	315	30	\$8930

Standard with full to floor **box/box/file** pedestal on **left** and **file/file** pedestal on **right**. Pedestals lock.
Inset Full Height Modesty Panel.

Required Specifications

Finish

Optional Specifications

Grommet
Modesty panel
Pull-out writing tray

SINGLE PEDESTAL DESKS

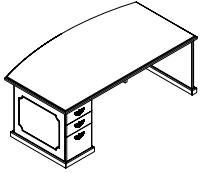

Single Pedestal Bow Top Desk - Left*
Breakfront Style

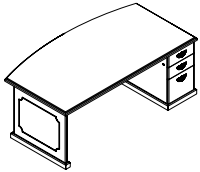

Single Pedestal Bow Top Desk - Right*
Breakfront Style

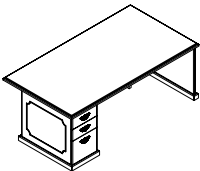

Single Pedestal Desk - Left*
Breakfront Style

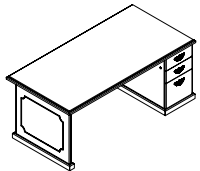

Single Pedestal Desk - Right*
Breakfront Style

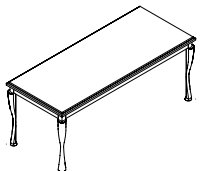

Table Desk
Queen Anne Style

MODEL#	DIMENSIONS D x W x H	FREIGHT CLASS	WT./LBS.	CUBIC FT.	LIST PRICE
PBMISL8442D	42 x 84 x 29	125	452	59	\$9220
PBMISL7842D	42 x 78 x 29	125	337	55	\$8562
PBMISL7242D	42 x 72 x 29	125	322	51	\$7907
PBMISL6636D	36 x 66 x 29	125	290	40	\$7603

Standard with full to floor **box/box/file** pedestal on **left**. Pedestals lock.
Inset Full Height Modesty Panel.

PBMISR8442D	42 x 84 x 29	125	452	59	\$9220
PBMISR7842D	42 x 78 x 29	125	337	55	\$8562
PBMISR7242D	42 x 72 x 29	125	322	51	\$7907
PBMISR6636D	36 x 66 x 29	125	290	40	\$7603

Standard with full to floor **box/box/file** pedestal on **right**. Pedestals lock.
Inset Full Height Modesty Panel.

PBISL8442D	42 x 84 x 29	125	387	59	\$8804
PBISL7842D	42 x 78 x 29	125	366	55	\$8173
PBISL7236D	36 x 72 x 29	125	320	44	\$6468
PBISL7230D	30 x 70 x 29	100	290	36	\$6180
PBISL6636D	36 x 66 x 29	125	305	40	\$6180
PBISL6630D	30 x 66 x 29	100	275	33	\$5898
PBISL6030D	30 x 60 x 29	100	260	30	\$5638

Standard with full to floor **box/box/file** pedestal on **left**. Pedestals lock.
Inset Full Height Modesty Panel.

PBISR8442D	42 x 84 x 29	125	387	59	\$8804
PBISR7842D	42 x 78 x 29	125	366	55	\$8173
PBISR7236D	36 x 72 x 29	125	320	44	\$6468
PBISR7230D	30 x 70 x 29	100	290	36	\$6180
PBISR6636D	36 x 66 x 29	125	305	40	\$6180
PBISR6630D	30 x 66 x 29	100	275	33	\$5898
PBISR6030D	30 x 60 x 29	100	260	30	\$5638

Standard with full to floor **box/box/file** pedestal on **right**. Pedestals lock.
Inset Full Height Modesty Panel.

PBQATB8442	42 x 84 x 29	150	272	59	\$10236
PBQATB7842	42 x 78 x 29	150	253	55	\$9598
PBQATB7236	36 x 72 x 29	150	205	44	\$7773
PBQATB7230	30 x 70 x 29	150	192	36	\$7002
PBQATB6636	36 x 66 x 29	150	192	40	\$7002
PBQATB6630	30 x 66 x 29	150	188	33	\$6160
PBQATB6030	30 x 60 x 29	150	171	30	\$5494

Inset Full Height Modesty Panel.

Required Specifications

Finish

Optional Specifications

Additional grommet
Modesty panel*
Pull-out writing tray*

DESKS

MODEL# DIMENSIONS FREIGHT CLASS WT/LBS. CUBIC FT. LIST PRICE

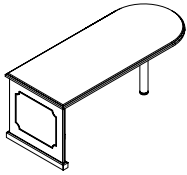

"D" Shaped Connecting Table Desk

D x W x H						
PBDD8436	36 x 84 x 29	125	343	51		\$5750
PBDD7236	36 x 72 x 29	125	294	44		\$4926
PBDD7230	30 x 72 x 29	125	264	36		\$4578
PBDD6636	36 x 66 x 29	125	245	40		\$4578
PBDD6030	30 x 60 x 29	125	225	30		\$4398

Wood column support and full end panel.

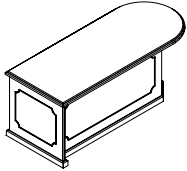

"D" Shaped Table Desk - Left

PBDDFL8436	36 x 84 x 29	125	367	51		\$7062
PBDDFL7236	36 x 72 x 29	125	320	44		\$6055
PBDDFL7230	30 x 72 x 29	100	290	36		\$5711
PBDDFL6636	36 x 66 x 29	125	271	40		\$5711
PBDDFL6030	30 x 60 x 29	100	247	30		\$5527

With 45° angled modesty and end panel.

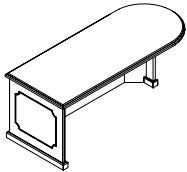

"D" Shaped Table - Right

PBDDFR8436	36 x 84 x 29	125	367	51		\$7062
PBDDFR7236	36 x 72 x 29	125	320	44		\$6055
PBDDFR7230	30 x 72 x 29	100	290	36		\$5711
PBDDFR6636	36 x 66 x 29	125	271	40		\$5711
PBDDFR6030	30 x 60 x 29	100	247	30		\$5527

With 45° angled modesty and end panel.

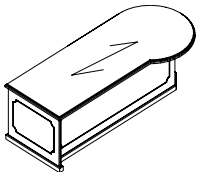

"P" Shaped Connecting Table - Left

PBTPOL9642	42 x 96 x 29	150	317	68		\$8470
PBTPOL8442	42 x 84 x 29	150	277	59		\$7410
PBTPOL7242	42 x 72 x 29	150	211	51		\$6859

With 45° angled modesty and end panel.

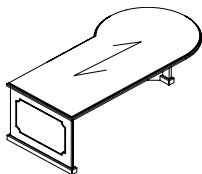

"P" Shaped Connecting Table - Right

PBTPOR9642	42 x 96 x 29	150	317	68		\$8470
PBTPOR8442	42 x 84 x 29	150	277	59		\$7410
PBTPOR7242	42 x 72 x 29	150	211	51		\$6859

With 45° angled modesty and end panel.

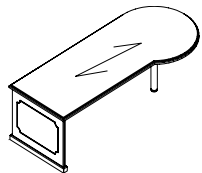

"P" Shaped Connecting Table - Left

PBTPL9642	42 x 96 x 29	125	440	68		\$7179
PBTPL8442	42 x 84 x 29	125	385	59		\$6283
PBTPL7242	42 x 72 x 29	125	319	51		\$5727

Wood column support and full end panel.

Required Specifications

Finish

Optional Specifications

Additional grommet

DESKS

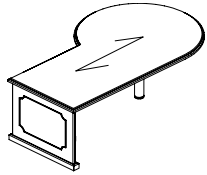

"P" Shaped Connecting Table - Right

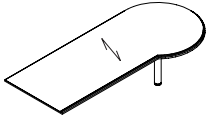

"P" Shaped Connecting Table - Left

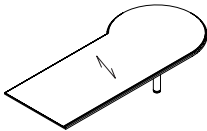

"P" Shaped Connecting Table - Right

MODEL#	DIMENSIONS D x W x H	FREIGHT CLASS	WT./LBS.	CUBIC FT.	LIST PRICE
PBTPR9642	42 x 96 x 29	125	440	68	\$7179
PBTPR8442	42 x 84 x 29	125	385	59	\$6283
PBTPR7242	42 x 72 x 29	125	319	51	\$5727

Wood column support and full end panel.

PBRPL9642CG	42 x 96 x 29	250	239	68	\$6807
PBRPL8442CG	42 x 84 x 29	250	209	59	\$5958
PBRPL7242CG	42 x 72 x 29	250	143	51	\$5104

Wood column support. No end panel.

PBRPR9642CG	42 x 96 x 29	250	239	68	\$6807
PBRPR8442CG	42 x 84 x 29	250	209	59	\$5958
PBRPR7242CG	42 x 72 x 29	250	143	51	\$5104

Wood column support. No end panel.

Required Specifications
Finish

Optional Specifications
Additional grommet

RETURNS - NOTES

D x W x H

- All returns are shipped assembled
- Kneewell locking standard
- The standard grain direction on returns is cross grain (**CG**). To remove cross grain veneer pattern on top, delete suffix "**CG**" from the model number (no upcharge)
- **NOTE:** Arrow indicates direction of grain

RETURNS MODEL# DIMENSIONS FREIGHT CLASS WT/LBS. CUBIC FT. LIST PRICE

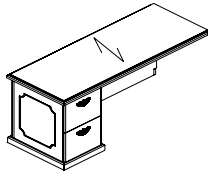

Executive Return - Left

PBERL7224ECG	24 x 72 x 29	100	250	29	\$5816
PBERL6624ECG	24 x 66 x 29	100	236	27	\$5604
PBERL6024ECG	24 x 60 x 29	100	227	24	\$5098
PBERL5424ECG	24 x 54 x 29	100	205	22	\$4910
PBERL4824ECG	24 x 48 x 29	100	185	19	\$4364
PBERL4224ECG	24 x 42 x 29	92.5	178	17	\$4200

Standard with full to floor **file/file** pedestal on **left**. Pedestal locks. Full height flush back panel.

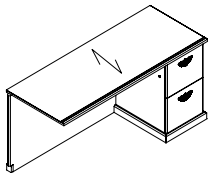

Executive Return - Right

PBERR7224ECG	24 x 72 x 29	100	250	29	\$5816
PBERR6624ECG	24 x 66 x 29	100	236	27	\$5604
PBERR6024ECG	24 x 60 x 29	100	227	24	\$5098
PBERR5424ECG	24 x 54 x 29	100	205	22	\$4910
PBERR4824ECG	24 x 48 x 29	100	185	19	\$4364
PBERR4224ECG	24 x 42 x 29	92.5	178	17	\$4200

Standard with full to floor **file/file** pedestal on **right**. Pedestal locks. Full height flush back panel.

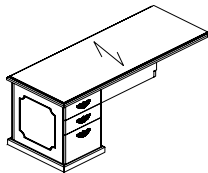

Executive Return - Left

PBERL7224DCG	24 x 72 x 29	100	250	29	\$5816
PBERL6624DCG	24 x 66 x 29	100	236	27	\$5604
PBERL6024DCG	24 x 60 x 29	100	227	24	\$5098
PBERL5424DCG	24 x 54 x 29	100	205	22	\$4910
PBERL4824DCG	24 x 48 x 29	100	185	19	\$4364
PBERL4224DCG	24 x 42 x 29	92.5	178	17	\$4200

Standard with full to floor **box/box/file** pedestal on **left**. Pedestal locks. Full height flush back panel.

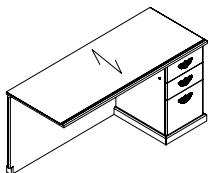

Executive Return - Right

PBERR7224DCG	24 x 72 x 29	100	250	29	\$4200
PBERR6624DCG	24 x 66 x 29	100	236	27	\$5604
PBERR6024DCG	24 x 60 x 29	100	227	24	\$5098
PBERR5424DCG	24 x 54 x 29	100	205	22	\$4910
PBERR4824DCG	24 x 48 x 29	100	185	19	\$4364
PBERR4224DCG	24 x 42 x 29	92.5	178	17	\$4200

Standard with full to floor **box/box/file** pedestal on **right**. Pedestal locks. Full height flush back panel.

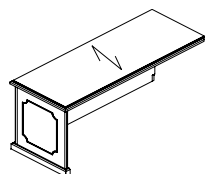

Executive Return - Left

PBERL7224CG	24 x 72 x 29	150	135	29	\$3262
PBERL6624CG	24 x 66 x 29	150	127	27	\$2989
PBERL6024CG	24 x 60 x 29	150	120	24	\$2720
PBERL5424CG	24 x 54 x 29	150	112	22	\$2441
PBERL4824CG	24 x 48 x 29	150	105	19	\$2178
PBERL4224CG	24 x 42 x 29	150	97	17	\$1901

Full height flush back panel.

Required Specifications
Finish

Optional Specifications
Grommet

RETURNS

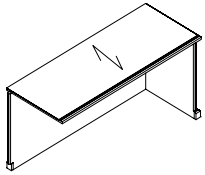

Executive Return - Right

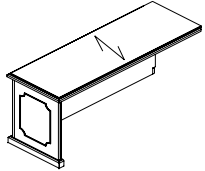

Executive Return - Left

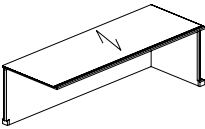

Executive Return - Right

MODEL# DIMENSIONS FREIGHT CLASS WT/LBS. CUBIC FT. LIST PRICE

D x W x H

PBERR7224CG	24 x 72 x 29	150	135	29	\$3262
PBERR6624CG	24 x 66 x 29	150	127	27	\$2989
PBERR6024CG	24 x 60 x 29	150	120	24	\$2720
PBERR5424CG	24 x 54 x 29	150	112	22	\$2441
PBERR4824CG	24 x 48 x 29	150	105	19	\$2178
PBERR4224CG	24 x 42 x 29	150	97	17	\$1901

Full height flush back panel.

PBERL7222CG	22 x 72 x 29	150	130	27	\$3108
PBERL6622CG	22 x 66 x 29	150	122	24	\$2847
PBERL6022CG	22 x 60 x 29	150	115	22	\$2592
PBERL5422CG	22 x 54 x 29	150	105	20	\$2329
PBERL4822CG	22 x 48 x 29	150	100	18	\$2074
PBERL4222CG	22 x 42 x 29	150	90	16	\$1813

Full height flush back panel.

PBERR7222CG	22 x 72 x 29	150	130	27	\$3108
PBERR6622CG	22 x 66 x 29	150	122	24	\$2847
PBERR6022CG	22 x 60 x 29	150	115	22	\$2592
PBERR5422CG	22 x 54 x 29	150	105	20	\$2329
PBERR4822CG	22 x 48 x 29	150	100	18	\$2074
PBERR4222CG	22 x 42 x 29	150	90	16	\$1813

Full height flush back panel.

Required Specifications
Finish

Optional Specifications
Additional grommet

PIANO DESKS

D x W x H

- All desks are shipped assembled
- Units include installed horizontal wire management
- Unit is handed by Post Leg
- Not for use with Regular Corner Units
- The standard grain direction on piano desks is cross grain (**CG**). To remove cross grain veneer pattern on top, delete suffix "**CG**" from the model number (no upcharge)
- If grommet color is not specified, Black is standard
- **NOTE:** Arrow indicates direction of grain

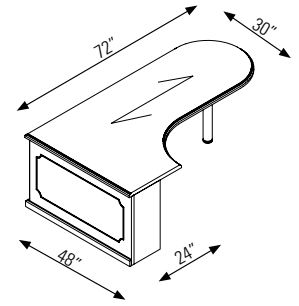

PIANO DESKS **MODEL#** **DIMENSIONS** **FREIGHT CLASS** **WT./LBS.** **CUBIC FT.** **LIST PRICE**

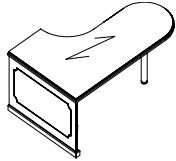

D-shaped Piano Desk - Left

PBTDPL96304824	48 x 96 x 29	125	464	77	\$7468
PBTDPL84304824	48 x 84 x 29	150	406	68	\$6642
PBTDPL72304824	48 x 72 x 29	125	348	58	\$5817

Wood column support and full end panel, 30"D worksurface extension and 24" return connection.

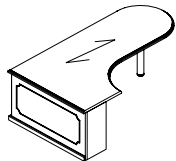

D-shaped Piano Desk - Right

PBTDPR96304824	48 x 96 x 29	125	464	77	\$7468
PBTDPR84304824	48 x 84 x 29	150	406	68	\$6642
PBTDPR72304824	48 x 72 x 29	125	348	58	\$5817

Wood column support and full end panel, 30"D worksurface extension and 24" return connection.

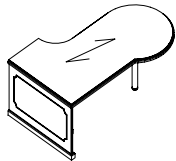

P-shaped Piano Desk - Left

PBTPPL96424824	54 x 96 x 29	150	580	97	\$8521
PBTPPL84424824	54 x 84 x 29	150	508	85	\$7618
PBTPPL72424824	54 x 72 x 29	150	435	73	\$7064

Wood column support and full end panel, 42"/30" worksurface and 24" return connection.

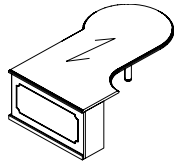

P-shaped Piano Desk - Right

PBTPPR96424824	54 x 96 x 29	150	580	97	\$8521
PBTPPR84424824	54 x 84 x 29	150	508	85	\$7618
PBTPPR72424824	54 x 72 x 29	150	435	73	\$7064

Wood column support and full end panel, 42"/30" worksurface and 24" return connection.

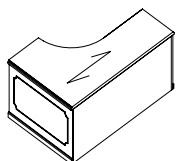

Extended Corner Table Desk - Left

PBEKL964824MR	48 x 96 x 29	150	387	77	\$8113
PBEKL904824MR	48 x 90 x 29	150	363	73	\$7661
PBEKL844824MR	48 x 84 x 29	150	338	68	\$7571
PBEKL784824MR	48 x 78 x 29	150	314	63	\$7530
PBEKL724824MR	48 x 72 x 29	150	290	58	\$7157
PBEKL664824MR	48 x 66 x 29	150	266	52	\$6673
PBEKL604824MR	48 x 60 x 29	150	242	48	\$6184

With 24" return connection.

Required Specifications
Finish

Optional Specifications
Additional grommet

PIANO DESKS

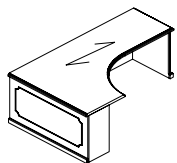

Extended Corner Table Desk - Right

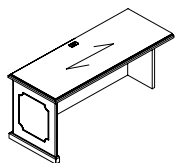

Linking Return - Left

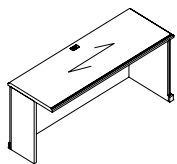

Linking Return - Right

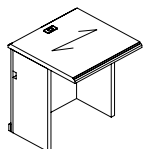

Bridge

MODEL#	DIMENSIONS	FREIGHT CLASS	WT./LBS.	CUBIC FT.	LIST PRICE
--------	------------	---------------	----------	-----------	------------

D x W x H

PBEKR489624ML	48 x 96 x 29	150	387	77	\$8113
PBEKR489024ML	48 x 90 x 29	150	363	73	\$7661
PBEKR488424ML	48 x 84 x 29	150	338	68	\$7571
PBEKR487824ML	48 x 78 x 29	150	314	63	\$7530
PBEKR487224ML	48 x 72 x 29	150	290	58	\$7157
PBEKR486624ML	48 x 66 x 29	150	266	52	\$6673
PBEKR486024ML	48 x 60 x 29	150	242	48	\$6184

With 24" return connection.

PBVEL9624CG	24 x 96 x 29	150	200	39	\$4931
PBVEL9024CG	24 x 90 x 29	150	187	36	\$4623
PBVEL8424CG	24 x 84 x 29	150	174	34	\$4315
PBVEL7824CG	24 x 78 x 29	150	162	31	\$4002
PBVEL7224CG	24 x 72 x 29	150	149	29	\$3699
PBVEL6624CG	24 x 66 x 29	150	141	27	\$3472
PBVEL6024CG	24 x 60 x 29	150	132	24	\$3245
PBVEL5424CG	24 x 54 x 29	150	121	22	\$3061
PBVEL4824CG	24 x 48 x 29	125	115	19	\$2878
PBVEL4224CG	24 x 42 x 29	150	99	17	\$2423
PBVEL3624CG	24 x 36 x 29	150	83	15	\$2340
PBVEL3024CG	24 x 30 x 29	125	77	12	\$2325
PBVEL2424CG	24 x 24 x 29	125	61	10	\$1928

Used in conjunction with extended piano corner units or piano shaped desks.

PBVER9624CG	24 x 96 x 29	150	200	39	\$4931
PBVER9024CG	24 x 90 x 29	150	187	36	\$4623
PBVER8424CG	24 x 84 x 29	150	174	34	\$4315
PBVER7824CG	24 x 78 x 29	150	162	31	\$4002
PBVER7224CG	24 x 72 x 29	150	149	29	\$3699
PBVER6624CG	24 x 66 x 29	150	141	27	\$3472
PBVER6024CG	24 x 60 x 29	150	132	24	\$3245
PBVER5424CG	24 x 54 x 29	150	121	22	\$3061
PBVER4824CG	24 x 48 x 29	125	115	19	\$2878
PBVER4224CG	24 x 42 x 29	150	99	17	\$2423
PBVER3624CG	24 x 36 x 29	150	83	15	\$2340
PBVER3024CG	24 x 30 x 29	125	77	12	\$2325
PBVER2424CG	24 x 24 x 29	125	61	10	\$1928

Used in conjunction with extended piano corner units or piano shaped desks.

PBBTN4824CG	24 x 48 x 29	150	110	19	\$2791
PBBTN4224CG	24 x 42 x 29	150	94	17	\$2340
PBBTN3624CG	24 x 36 x 29	150	79	15	\$2253
PBBTN3024CG	24 x 30 x 29	125	72	12	\$2205
PBBTN2424CG	24 x 24 x 29	150	56	10	\$1854
PBBTN1824CG	24 x 18 x 29	150	43	8	\$1391
PBBTN1224CG	24 x 12 x 29	150	29	5	\$927

For extended piano corner units or piano-shaped desks.

Required Specifications

Finish

Optional Specifications

Additional grommet

BRIDGES

MODEL#

DIMENSIONS

FREIGHT CLASS

WT/LBS.

CUBIC FT.

LIST PRICE

D x W x H

- All bridges are shipped knockdown
- Not for use with Corner Units
- The standard grain direction is cross grain (**CG**). To remove cross grain veneer pattern on top, delete suffix "**CG**" from the model number (no upcharge)
- GM5 TC location is standard. If grommet color is not specified, Black is standard
- **NOTE:** Arrow indicates direction of grain

BRIDGES

MODEL#

DIMENSIONS

FREIGHT CLASS

WT/LBS.

CUBIC FT.

LIST PRICE

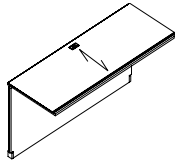

Executive Bridge Top

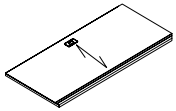

Executive Bridge Top

PBBT6022CG	22 x 60 x 29	92.5	108	10	\$2879
PBBT5422CG	22 x 54 x 29	92.5	99	9	\$2598
PBBT4822CG	22 x 48 x 29	92.5	90	8	\$2307
PBBT4222CG	22 x 42 x 29	92.5	81	7	\$2018
PBBT6020CG	20 x 60 x 29	85	105	8	\$2361
PBBT5420CG	20 x 54 x 29	85	96	8	\$2125
PBBT4820CG	20 x 48 x 29	85	87	7	\$1890
PBBT4220CG	20 x 42 x 29	85	78	6	\$1617

With full back panel.

PBBT5422TCG	22 x 54 x 1.3	125	64	9	\$1559
PBBT4822TCG	22 x 48 x 1.3	125	55	8	\$1383
PBBT4222TCG	22 x 42 x 1.3	125	46	7	\$1214
PBBT5420TCG	20 x 54 x 1.3	125	61	8	\$1273
PBBT4820TCG	20 x 48 x 1.3	125	52	7	\$1137
PBBT4220TCG	20 x 42 x 1.3	125	43	6	\$974

Required Specifications

Finish

Optional Specifications

Additional grommet

CRENZAS	MODEL#	DIMENSIONS D x W x H	FREIGHT CLASS	WT./LBS.	CUBIC FT.	LIST PRICE
---------	--------	-------------------------	---------------	----------	-----------	------------

- All credenzas are shipped assembled
- All storage cabinets include one adjustable shelf per set of doors
- **F** and **G** depict 36". **M** and **N** depict 30".
- **F** and **N** indicate lateral file drawers. **G** and **M** indicate storage cabinets with doors.
- Credenza shells accept modular storage. Use modular storage for top support allowing no more than 72" unsupported.
- Credenza shells with a width of 96" and more will have a 12" middle support gable.
- For PBCF7220 and PBCF6020, standard face locking for cabinet and lateral file.
- Grommets are available as an option on Desks and most Credenzas.
- **NOTE:** Arrow indicates direction of grain

CRENZAS	MODEL#	DIMENSIONS	FREIGHT CLASS	WT./LBS.	CUBIC FT.	LIST PRICE
---------	--------	------------	---------------	----------	-----------	------------

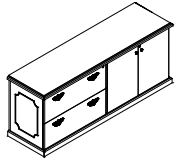

Full Storage Credenza

PBCF7220FG	20 x 72 x 29	92.5	272	24	\$6644
PBCF6020NM	20 x 60 x 29	92.5	220	20	\$5536

Lateral file on **left** and storage cabinet on **right**.

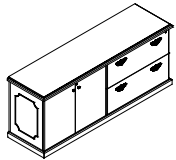

Full Storage Credenza

PBCF7220GF	20 x 72 x 29	92.5	272	24	\$6644
PBCF6020MN	20 x 60 x 29	92.5	220	20	\$5536

Storage cabinet on **left** and lateral file on **right**.

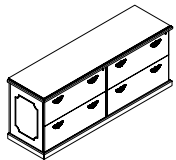

Full Storage Credenza

PBC7220FF	20 x 72 x 29	92.5	287	24	\$8500
PBC6020NN	20 x 60 x 29	92.5	205	20	\$7439

Lateral files on **left** and **right**.

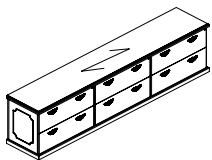

Full Storage Credenza

PBC10820FFF	20 x 108 x 29	92.5	412	36	\$14272
PBC9020NNN	20 x 90 x 29	92.5	337	30	\$11896

Lateral files on **left, center, and right**.

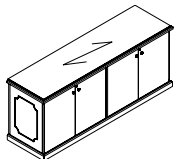

Full Storage Credenza

PBC7220GG	20 x 72 x 29	92.5	253	24	\$6308
PBC6020MM	20 x 60 x 29	92.5	209	20	\$5519

Storage cabinets on **left and right**.

Required Specifications
Finish

Optional Specifications
Additional grommet

CRENZAS

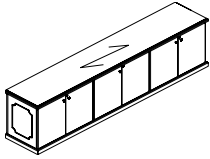

Full Storage Credenza

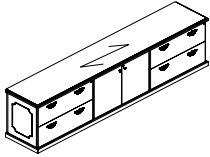

Full Storage Credenza

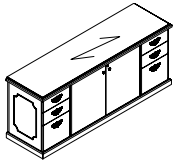

Full Storage Credenza

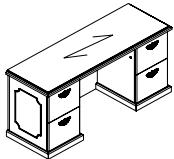

Double Pedestal Credenza

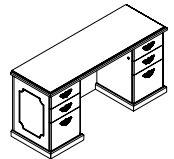

Double Pedestal Credenza

MODEL# DIMENSIONS FREIGHT CLASS WT/LBS. CUBIC FT. LIST PRICE

D x W x H

PBC10820GGG	20 x 108 x 29	125	278	36	\$11374
PBC9020MMM	20 x 90 x 29	125	228	30	\$9481

Storage cabinets on **left, center,** and **right.**

PBC10824FGF	24 x 108 x 29	92.5	479	44	\$16002
PBC9024NNM	24 x 90 x 29	92.5	399	36	\$13331
PBC10820FGF	20 x 108 x 29	92.5	388	36	\$13307
PBC9020NNM	20 x 90 x 29	92.5	321	30	\$11087

Lateral files on **left** and **right**; storage cabinet in **center.**

PBC7224DGD	24 x 72 x 29	92.5	319	29	\$9837
PBC6024DGD	24 x 60 x 29	92.5	266	24	\$9016
PBC7220DGD	20 x 72 x 29	85	298	24	\$8571
PBC6020DGD	20 x 60 x 29	85	246	20	\$7500

Box/box/file on **left** and **right**; storage cabinet in **center.**

PBCK8424EE	24 x 84 x 29	92.5	348	34	\$9345
PBCK7824EE	24 x 78 x 29	92.5	319	31	\$8682
PBCK7224EE	24 x 72 x 29	100	280	29	\$8019
PBCK6624EE	24 x 66 x 29	100	261	27	\$7894
PBCK6024EE	24 x 60 x 29	100	238	24	\$7345

PBCK8420EE	20 x 84 x 29	92.5	307	28	\$8149
PBCK7820EE	20 x 78 x 29	92.5	285	26	\$7566
PBCK7220EE	20 x 72 x 29	92.5	267	24	\$6984
PBCK6620EE	20 x 66 x 29	92.5	244	22	\$6398
PBCK6020EE	20 x 60 x 29	92.5	220	20	\$5821

File/file pedestals on **left** and **right**. Full height back panel. Kneespace in center.

PBCK8424DD	24 x 84 x 29	92.5	348	34	\$9345
PBCK7824DD	24 x 78 x 29	92.5	319	31	\$8682
PBCK7224DD	24 x 72 x 29	100	280	29	\$8019
PBCK6624DD	24 x 66 x 29	100	261	27	\$7894
PBCK6024DD	24 x 60 x 29	100	238	24	\$7345

PBCK8420DD	20 x 84 x 29	92.5	307	28	\$8149
PBCK7820DD	20 x 78 x 29	92.5	285	26	\$7566
PBCK7220DD	20 x 72 x 29	92.5	267	24	\$6984
PBCK6620DD	20 x 66 x 29	92.5	244	22	\$6398
PBCK6020DD	20 x 60 x 29	92.5	220	20	\$5821

Box/box/file pedestals on **left** and **right**. Full height back panel. Kneespace in center.

Required Specifications

Finish

Optional Specifications

Additional grommet

CREDENZAS

MODEL# DIMENSIONS FREIGHT CLASS WT/LBS. CUBIC FT. LIST PRICE

D x W x H

PBCK8424ED	24 x 84 x 29	92.5	348	34	\$9345
PBCK7824ED	24 x 78 x 29	92.5	319	31	\$8682
PBCK7224ED	24 x 72 x 29	100	280	29	\$8019
PBCK6624ED	24 x 66 x 29	100	261	27	\$7894
PBCK6024ED	24 x 60 x 29	100	238	24	\$7345
PBCK8420ED	20 x 84 x 29	92.5	307	28	\$8149
PBCK7820ED	20 x 78 x 29	92.5	285	26	\$7566
PBCK7220ED	20 x 72 x 29	92.5	267	24	\$6984
PBCK6620ED	20 x 66 x 29	92.5	244	22	\$6398
PBCK6020ED	20 x 60 x 29	92.5	220	20	\$5821

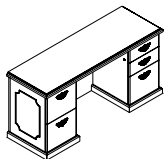

Double Pedestal Credenza

File/file pedestal on **left** and box/box/file pedestal on **right**. Full height back panel. Kneespace in center.

PBCK8424DE	24 x 84 x 29	92.5	348	34	\$9345
PBCK7824DE	24 x 78 x 29	92.5	319	31	\$8682
PBCK7224DE	24 x 72 x 29	100	280	29	\$8019
PBCK6624DE	24 x 66 x 29	100	261	27	\$7894
PBCK6024DE	24 x 60 x 29	100	238	24	\$7345
PBCK8420DE	20 x 84 x 29	92.5	307	28	\$8149
PBCK7820DE	20 x 78 x 29	92.5	285	26	\$7566
PBCK7220DE	20 x 72 x 29	92.5	267	24	\$6984
PBCK6620DE	20 x 66 x 29	92.5	244	22	\$6398
PBCK6020DE	20 x 60 x 29	92.5	220	20	\$5821

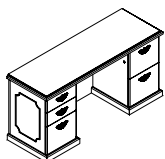

Double Pedestal Credenza

Box/box/file pedestal on **left** and file/file pedestal on **right**. Full height back panel. Kneespace in center.

PBCL8424E	24 x 84 x 29	100	315	34	\$7066
PBCL7824E	24 x 78 x 29	100	292	31	\$6564
PBCL7224E	24 x 72 x 29	100	270	29	\$6057
PBCL6624E	24 x 66 x 29	100	247	27	\$5830
PBCL6024E	24 x 60 x 29	100	225	24	\$5301
PBCL8420E	20 x 84 x 29	100	273	28	\$6159
PBCL7820E	20 x 78 x 29	100	252	26	\$5719
PBCL7220E	20 x 72 x 29	100	237	24	\$5280
PBCL6620E	20 x 66 x 29	100	216	22	\$5082
PBCL6020E	20 x 60 x 29	100	195	20	\$4623

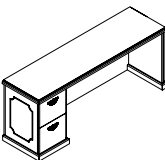

Single Pedestal Credenza - Left

File/file pedestal on **left**.

PBCR8424E	24 x 84 x 29	100	315	34	\$7066
PBCR7824E	24 x 78 x 29	100	292	31	\$6564
PBCR7224E	24 x 72 x 29	100	270	29	\$6057
PBCR6624E	24 x 66 x 29	100	247	27	\$5830
PBCR6024E	24 x 60 x 29	100	225	24	\$5301
PBCR8420E	20 x 84 x 29	100	273	28	\$6159
PBCR7820E	20 x 78 x 29	100	252	26	\$5719
PBCR7220E	20 x 72 x 29	100	237	24	\$5280
PBCR6620E	20 x 66 x 29	100	216	22	\$5082
PBCR6020E	20 x 60 x 29	100	195	20	\$4623

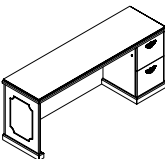

Single Pedestal Credenza - Right

File/file pedestal on **right**.

Required Specifications
Finish

Optional Specifications
Additional grommet

CREDENZAS **MODEL#** **DIMENSIONS** **FREIGHT CLASS** **WT/LBS.** **CUBIC FT.** **LIST PRICE**

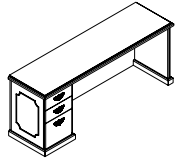

Single Pedestal Credenza - Left

	D x W x H					
PBCL8424D	24 x 84 x 29	100	315	34	\$7066	
PBCL7824D	24 x 78 x 29	100	292	31	\$6564	
PBCL7224D	24 x 72 x 29	100	270	29	\$6057	
PBCL6624D	24 x 66 x 29	100	247	27	\$5830	
PBCL6024D	24 x 60 x 29	100	225	24	\$5301	
PBCL8420D	20 x 84 x 29	100	273	28	\$6159	
PBCL7820D	20 x 78 x 29	100	252	26	\$5719	
PBCL7220D	20 x 72 x 29	100	237	24	\$5280	
PBCL6620D	20 x 66 x 29	100	216	22	\$5082	
PBCL6020D	20 x 60 x 29	100	195	20	\$4623	

Box/box/file pedestal on **left**.

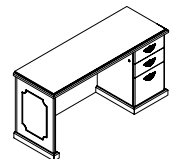

Single Pedestal Credenza - Right

PBCR8424D	24 x 84 x 29	100	315	34	\$7066	
PBCR7824D	24 x 78 x 29	100	292	31	\$6564	
PBCR7224D	24 x 72 x 29	100	270	29	\$6057	
PBCR6624D	24 x 66 x 29	100	247	27	\$5830	
PBCR6024D	24 x 60 x 29	100	225	24	\$5301	
PBCR8420D	20 x 84 x 29	100	273	28	\$6159	
PBCR7820D	20 x 78 x 29	100	252	26	\$5719	
PBCR7220D	20 x 72 x 29	100	237	24	\$5280	
PBCR6620D	20 x 66 x 29	100	216	22	\$5082	
PBCR6020D	20 x 60 x 29	100	195	20	\$4623	

Box/box/file pedestal on **right**.

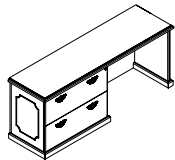

Single Pedestal Credenza - Left

PBCL8424F	24 x 84 x 29	100	305	34	\$8214	
PBCL7824F	24 x 78 x 29	100	285	31	\$7623	
PBCL7224F	24 x 72 x 29	100	261	29	\$7042	
PBCL6624F	24 x 66 x 29	100	239	27	\$6836	
PBCL6024F	24 x 60 x 29	100	218	24	\$6153	
PBCL8420F	20 x 84 x 29	100	253	28	\$7160	
PBCL7820F	20 x 78 x 29	100	233	26	\$6643	
PBCL7220F	20 x 72 x 29	100	218	24	\$6132	
PBCL6620F	20 x 66 x 29	100	197	22	\$5905	
PBCL6020F	20 x 60 x 29	100	176	20	\$5362	

36" lateral file on **left**.

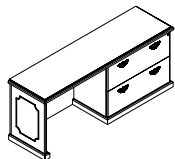

Single Pedestal Credenza - Right

PBCR8424F	24 x 84 x 29	100	305	34	\$8214	
PBCR7824F	24 x 78 x 29	100	285	31	\$7623	
PBCR7224F	24 x 72 x 29	100	261	29	\$7042	
PBCR6624F	24 x 66 x 29	100	239	27	\$6836	
PBCR6024F	24 x 60 x 29	100	218	24	\$6153	
PBCR8420F	20 x 84 x 29	100	253	28	\$7160	
PBCR7820F	20 x 78 x 29	100	233	26	\$6643	
PBCR7220F	20 x 72 x 29	100	218	24	\$6132	
PBCR6620F	20 x 66 x 29	100	197	22	\$5905	
PBCR6020F	20 x 60 x 29	100	176	20	\$5362	

36" lateral file on **right**.

Required Specifications
Finish

Optional Specifications
Additional grommet

CREDENZAS

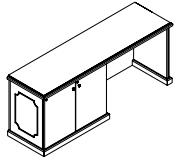

Single Pedestal Credenza - Left

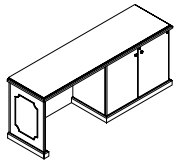

Single Pedestal Credenza - Right

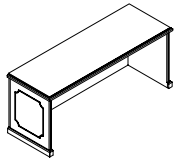

Credenza Shell

MODEL#	DIMENSIONS D x W x H	FREIGHT CLASS	WT/LBS.	CUBIC FT.	LIST PRICE
PBCL8424G	24 x 84 x 29	100	338	34	\$7378
PBCL7824G	24 x 78 x 29	92.5	314	31	\$6848
PBCL7224G	24 x 72 x 29	92.5	290	29	\$6341
PBCL6624G	24 x 66 x 29	100	266	27	\$6086
PBCL6024G	24 x 60 x 29	92.5	242	24	\$5533
PBCL8420G	20 x 84 x 29	92.5	290	28	\$6429
PBCL7820G	20 x 78 x 29	92.5	272	26	\$5969
PBCL7220G	20 x 72 x 29	92.5	252	24	\$5511
PBCL6620G	20 x 66 x 29	92.5	230	22	\$5296
PBCL6020G	20 x 60 x 29	92.5	208	20	\$4823

36" storage cabinet on **left**.

PBCR8424G	24 x 84 x 29	100	338	34	\$7378
PBCR7824G	24 x 78 x 29	92.5	314	31	\$6848
PBCR7224G	24 x 72 x 29	92.5	290	29	\$6341
PBCR6624G	24 x 66 x 29	100	266	27	\$6086
PBCR6024G	24 x 60 x 29	92.5	242	24	\$5533
PBCR8420G	20 x 84 x 29	92.5	290	28	\$6429
PBCR7820G	20 x 78 x 29	92.5	272	26	\$5969
PBCR7220G	20 x 72 x 29	92.5	252	24	\$5511
PBCR6620G	20 x 66 x 29	92.5	230	22	\$5296
PBCR6020G	20 x 60 x 29	92.5	208	20	\$4823

36" storage cabinet on **right**.

PBC12024	24 x 120 x 29	100	387	48	\$6294
PBC11424	24 x 114 x 29	125	367	46	\$5983
PBC10824	24 x 108 x 29	125	348	44	\$5667
PBC10224	24 x 102 x 29	100	329	41	\$5346
PBC9624	24 x 96 x 29	125	309	39	\$5035
PBC9024	24 x 90 x 29	100	290	36	\$4718
PBC8424	24 x 84 x 29	125	271	34	\$4407
PBC7824	24 x 78 x 29	100	251	31	\$4089
PBC7224	24 x 72 x 29	100	232	29	\$3778
PBC6624	24 x 66 x 29	125	213	27	\$3644
PBC6024	24 x 60 x 29	100	193	24	\$3307
PBC5424	24 x 54 x 29	125	174	22	\$3128
PBC4824	24 x 48 x 29	100	155	19	\$2957
PBC4224	24 x 42 x 29	125	135	17	\$2506

With full back panel.

Required Specifications
Finish

Optional Specifications
Additional grommet

CORNERS - NOTES

NOTE: Arrow indicates direction of grain

D x W x H

Corners

- All units are shipped assembled
- Unit includes grommets shown and installed horizontal wire management
- Corner units and extended corner units must be used exclusively with linking bridges and linking returns
- **Linking bridges** are handed by recessed end panel
- **Extended corner tables** have no molding on back side. Grommets are not included and must be specified.
- **Linking returns** include grommets shown and installed horizontal wire management. Handed by full end panel.
- **Tables** include grommets shown and installed horizontal wire management.

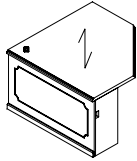
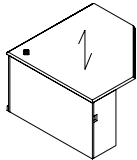
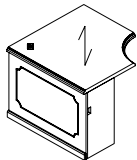
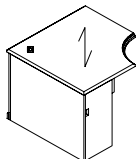
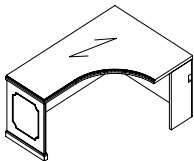
CORNERS AND COMPONENTS	MODEL#	DIMENSIONS	FREIGHT CLASS	WT/LBS.	CUBIC FT.	LIST PRICE
 <p>Corner Table - Left</p>	PBE484824ML	48 x 48 x 29	150	196	35	\$4399
	PBE424224ML	42 x 42 x 29	150	150	30	\$3384
	PBE363624ML	36 x 36 x 29	150	130	22	\$3216
With 2 recessed end panels.						
 <p>Corner Table - Right</p>	PBE484824MR	48 x 48 x 29	150	196	35	\$4399
	PBE424224MR	42 x 42 x 29	150	150	30	\$3384
	PBE363624MR	36 x 36 x 29	150	130	22	\$3216
With 2 recessed end panels.						
 <p>Corner Table - Left</p>	PBEK484824ML	48 x 48 x 29	150	196	39	\$5059
	PBEK424224ML	42 x 42 x 29	150	150	30	\$3893
	PBEK363624ML	36 x 36 x 29	150	130	22	\$3698
With 2 recessed end panels and inner curve.						
 <p>Corner Table - Right</p>	PBEK484824MR	48 x 48 x 29	150	196	39	\$5059
	PBEK424224MR	42 x 42 x 29	150	150	30	\$3893
	PBEK363624MR	36 x 36 x 29	150	130	22	\$3698
With 2 recessed end panels and inner curve.						
 <p>Extended Corner Table - Left</p>	PBEKL964824	96 x 48 x 29	150	387	77	\$7375
	PBEKL904824	90 x 48 x 29	150	363	73	\$6963
	PBEKL844824	84 x 48 x 29	150	338	68	\$6878
	PBEKL784824	78 x 48 x 29	150	314	63	\$6844
	PBEKL724824	72 x 48 x 29	150	290	58	\$6504
	PBEKL664824	66 x 48 x 29	150	266	52	\$6061
	PBEKL604824	60 x 48 x 29	150	242	48	\$5625
	With full back panel.					

Required Specifications
Finish

Optional Specifications
Additional grommet

CORNERS AND COMPONENTS

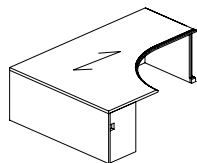

Extended Corner Table - Right

MODEL#	DIMENSIONS D x W x H	FREIGHT CLASS	WT/LBS.	CUBIC FT.	LIST PRICE
PBEKR489624	96 x 48 x 29	150	387	77	\$7375
PBEKR489024	90 x 48 x 29	150	363	73	\$6963
PBEKR488424	84 x 48 x 29	150	338	68	\$6878
PBEKR487824	78 x 48 x 29	150	314	63	\$6844
PBEKR487224	72 x 48 x 29	150	290	58	\$6504
PBEKR486624	66 x 48 x 29	150	266	52	\$6061
PBEKR486024	60 x 48 x 29	150	242	48	\$5625

With full back panel.

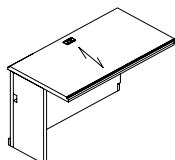

Linking Bridge - Left

PBBT6024NLLCG	24 x 60 x 29	125	145	24	\$2865
PBBT5424NLLCG	24 x 54 x 29	150	131	22	\$2577
PBBT4824NLLCG	24 x 48 x 29	125	116	19	\$2291
PBBT4224NLLCG	24 x 42 x 29	125	102	17	\$1856
PBBT3624NLLCG	24 x 36 x 29	150	87	15	\$1686
PBBT3024NLLCG	24 x 30 x 29	125	73	12	\$1647

To join corner worksurface to desk or credenza. Full back panel.

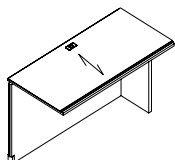

Linking Bridge - Right

PBBT6024NLR CG	24 x 60 x 29	125	145	24	\$2865
PBBT5424NLR CG	24 x 54 x 29	150	131	22	\$2577
PBBT4824NLR CG	24 x 48 x 29	125	116	19	\$2291
PBBT4224NLR CG	24 x 42 x 29	125	102	17	\$1856
PBBT3624NLR CG	24 x 36 x 29	150	87	15	\$1686
PBBT3024NLR CG	24 x 30 x 29	125	73	12	\$1647

To join corner worksurface to desk or credenza. Full back panel.

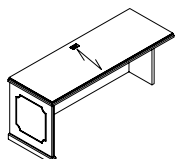

Linking Return - Left

PBVL9624CG	24 x 96 x 29	150	200	39	\$4745
PBVL9024CG	24 x 90 x 29	150	187	36	\$4448
PBVL8424CG	24 x 84 x 29	150	174	34	\$4153
PBVL7824CG	24 x 78 x 29	150	162	31	\$3857
PBVL7224CG	24 x 72 x 29	150	149	29	\$3559
PBVL6624CG	24 x 66 x 29	150	141	27	\$3340
PBVL6024CG	24 x 60 x 29	150	132	24	\$3122
PBVL5424CG	24 x 54 x 29	150	121	22	\$2947
PBVL4824CG	24 x 48 x 29	125	115	19	\$2768
PBVL4224CG	24 x 42 x 29	150	99	17	\$2335
PBVL3624CG	24 x 36 x 29	150	83	15	\$2250
PBVL3024CG	24 x 30 x 29	125	77	12	\$2210
PBVL2424CG	24 x 24 x 29	125	61	10	\$1854

To be used with corner unit.

Required Specifications
Finish

Optional Specifications
Additional grommet

CORNERS AND COMPONENTS

MODEL# DIMENSIONS FREIGHT CLASS WT/LBS. CUBIC FT. LIST PRICE

D x W x H

PBVR9624CG	24 x 96 x 29	150	200	39	\$4745
PBVR9024CG	24 x 90 x 29	150	187	36	\$4448
PBVR8424CG	24 x 84 x 29	150	174	34	\$4153
PBVR7824CG	24 x 78 x 29	150	162	31	\$3857
PBVR7224CG	24 x 72 x 29	150	149	29	\$3559
PBVR6624CG	24 x 66 x 29	150	141	27	\$3340
PBVR6024CG	24 x 60 x 29	150	132	24	\$3122
PBVR5424CG	24 x 54 x 29	150	121	22	\$2947
PBVR4824CG	24 x 48 x 29	125	115	19	\$2768
PBVR4224CG	24 x 42 x 29	150	99	17	\$2335
PBVR3624CG	24 x 36 x 29	150	83	15	\$2250
PBVR3024CG	24 x 30 x 29	125	77	12	\$2210
PBVR2424CG	24 x 24 x 29	125	61	10	\$1854

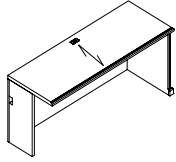

Linking Return - Right

To be used with corner unit.

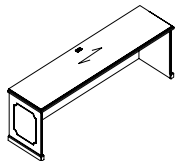

Freestanding Table

PBVT9624	24 x 96 x 29	150	213	39	\$4848
PBVT9024	24 x 90 x 29	150	199	36	\$4545
PBVT8424	24 x 84 x 29	150	186	34	\$4243
PBVT7824	24 x 78 x 29	150	173	31	\$3934
PBVT7224	24 x 72 x 29	150	160	29	\$3637
PBVT6624	24 x 66 x 29	150	146	27	\$3418
PBVT6024	24 x 60 x 29	150	133	24	\$3204
PBVT5424	24 x 54 x 29	150	128	22	\$3024
PBVT4824	24 x 48 x 29	125	120	19	\$2847
PBVT4224	24 x 42 x 29	125	104	17	\$2409
PBVT3624	24 x 36 x 29	150	88	15	\$2329
PBVT3024	24 x 30 x 29	125	82	12	\$2284
PBVT2424	24 x 24 x 29	125	65	10	\$1921

Full end panels.

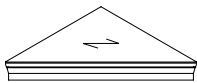

Corner Filler Top

PBV1212CT	12 x 12 x 1.3	150	5	1	\$974
-----------	---------------	-----	---	---	--------------

Required Specifications
Finish

Optional Specifications
Additional grommet

MODULAR STORAGE - NOTES

D x W x H

- All storage components are shipped assembled
- Components 28" high are intended for use with a desk, credenza or return shell
- Backs on 28" high pedestals and cabinets are unfinished. If finished back is required, see page 355.
- If a profiled top is required, please see "Freestanding Storage" section.

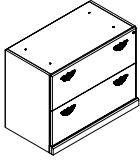
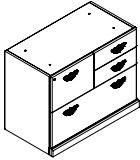
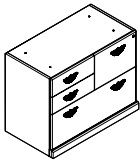
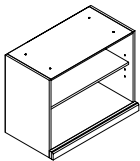
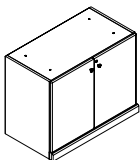
MODULAR STORAGE	MODEL#	DIMENSIONS	FREIGHT CLASS	WT/LBS.	CUBIC FT.	LIST PRICE
 <p>Modular Lateral File</p>	PBWF	19.1 x 35.1 x 28	92.5	115	11	\$3962
	PBWN	19.1 x 30 x 28	92.5	96	9	\$3468
 <p>Modular Combination Storage</p>	PBWZL	19.1 x 35.1 x 28	92.5	115	11	\$3894
	With 1 lateral file, 2 box drawers in the top right, and 1 file drawer in the top left.					
 <p>Modular Combination Storage</p>	PBWZR	19.1 x 35.1 x 28	92.5	115	11	\$3894
	With 1 lateral file, 2 box drawers in the top left, and 1 file drawer in the top right.					
 <p>Modular Open Storage</p>	PBWOB36	19.1 x 35.1 x 28	100	92	11	\$1955
	PBWOB30	19.1 x 30 x 28	100	77	9	\$1733
 <p>Modular Storage Cabinet w/Doors</p>	PBWG	19.1 x 35.1 x 28	92.5	115	11	\$2441
	PBWM	19.1 x 30 x 28	92.5	96	9	\$2164
Storage with 1 adjustable shelf.						

Required Specifications

Finish

MODULAR STORAGE **MODEL#** **DIMENSIONS** **FREIGHT CLASS** **WT./LBS.** **CUBIC FT.** **LIST PRICE**

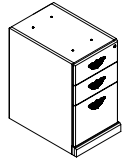

Modular Pedestal

D x W x H

Letter width:

PBWWD	23 x 15.6 x 28	85	72	6	\$3058
PBWD	19 x 15.6 x 28	85	70	5	\$2661

Legal width:

PBWWLD	23 x 18.5 x 28	85	85	7	\$3669
PBWLD	19 x 18.5 x 28	85	83	6	\$3193

Box/box/file pedestal.

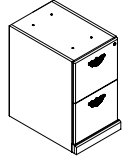

Modular Pedestal

Letter width:

PBWWLE	23 x 15.6 x 28	85	72	6	\$3058
PBWE	19 x 15.6 x 28	85	70	5	\$2661

Legal width:

PBWWLE	23 x 18.5 x 28	85	85	7	\$3669
PBWLE	19 x 18.5 x 28	85	83	6	\$3193

File/file pedestal.

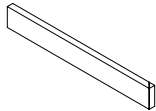

Decorative Base Trim - Left

PBAS-WL	1 x 19 x 2.5	70	1	0.01	\$299
PBAS-WWL	1 x 23 x 2.5	70	1	0.01	\$368

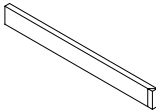

Decorative Base Trim - Right

PBAS-WR	1 x 19 x 2.5	70	1	0.01	\$299
PBAS-WWR	1 x 23 x 2.5	70	1	0.01	\$368

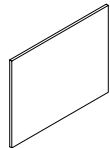

Finished Back

PBBA36	0.8 x 35 x 27.5	125	18	3	\$467
PBBA30	0.8 x 30 x 27.5	150	15	3	\$388
PBBA18	0.8 x 18.5 x 27.5	150	10	2	\$226
PBBA15	0.8 x 15.5 x 27.5	150	8	2	\$196

For modular pedestals.

Required Specifications

Finish

HUTCHES & WALL MOUNTED STORAGE NOTES

D x W x H

NOTE: Arrow indicates direction of grain

Hutches

- All hutches are shipped assembled
- Bronze glass door is standard. Clear glass is available, please contact customer care.

Closed pigeon hole storage hutch

- 42" unit has 21.5" of clearance
- Hutches longer than 102" have 8 doors, hutches between 102" and 84" have 6 doors, and hutches less than 84" have 4 doors.

Closed storage hutch

- 36" unit has 19.5" of clearance.
- 42" and 54" units have 25.5" of clearance
- Hutches longer than 102" have 8 doors, hutches between 102" and 84" have 6 doors, and hutches less than 84" have 4 doors.

Tasklight

- For proper size see page 335.

HUTCHES & WALL MOUNTED STORAGE	MODEL#	DIMENSIONS	FREIGHT CLASS	WT./LBS.	CUBIC FT.	LIST PRICE
--------------------------------	--------	------------	---------------	----------	-----------	------------

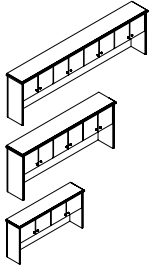

36" H Storage Hutch w/Wood Doors

PB108SH36	15 x 108 x 36	125	268	34	\$7627
PB102SH36	15 x 102 x 36	125	254	32	\$7202
PB96SH36	15 x 96 x 36	100	241	30	\$6775
PB90SH36	15 x 90 x 36	100	227	28	\$6353
PB84SH36	15 x 84 x 36	100	214	26	\$5931
PB78SH36	15 x 78 x 36	100	200	24	\$5510
PB72SH36	15 x 72 x 36	100	187	23	\$5084
PB66SH36	15 x 66 x 36	100	173	21	\$4891
PB60SH36	15 x 60 x 36	100	160	19	\$4663

Hutches longer than 102" have 8 doors, hutches between 102" and 84" have 6 doors, and hutches less than 84" have 4 doors.

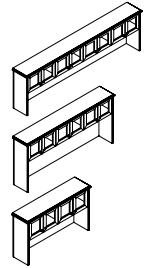

36" H Storage Hutch w/Glass Doors

PB108SH36G	15 x 108 x 36	125	268	34	\$10639
PB102SH36G	15 x 102 x 36	125	254	32	\$9598
PB96SH36G	15 x 96 x 36	100	241	30	\$9133
PB90SH36G	15 x 90 x 36	100	227	28	\$8682
PB84SH36G	15 x 84 x 36	100	214	26	\$8221
PB78SH36G	15 x 78 x 36	100	200	24	\$7771
PB72SH36G	15 x 72 x 36	100	187	23	\$6704
PB66SH36G	15 x 66 x 36	100	173	21	\$6461
PB60SH36G	15 x 60 x 36	100	160	19	\$6188

Wood framed glass doors. Hutches longer than 102" have 8 doors, hutches between 102" and 84" have 6 doors, and hutches less than 84" have 4 doors.

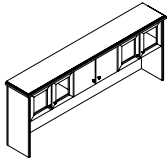

36" H Storage Hutch w/Doors

PB102SH36GDG	15 x 102 x 36	125	254	32	\$8850
PB96SH36GDG	15 x 96 x 36	100	241	30	\$8388
PB90SH36GDG	15 x 90 x 36	100	227	28	\$7936
PB84SH36GDG	15 x 84 x 36	100	214	26	\$7476

Wood doors in the center and wood framed glass doors on left and right.

Required Specifications

Finish

Optional Specifications

Additional grommet

HUTCHES & WALL MOUNTED STORAGE

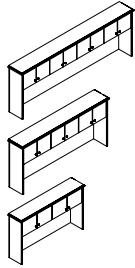

42" H Storage Hutch w/Wood Doors

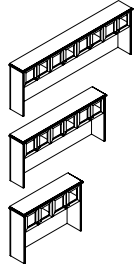

42" H Storage Hutch w/Glass Doors

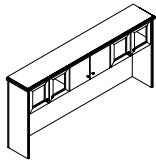

42" H Storage Hutch w/Doors

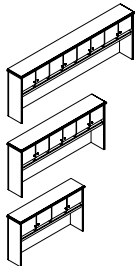

42" H Storage Hutch w/Wood Doors & Pigeon-Holes

MODEL#	DIMENSIONS	FREIGHT CLASS	WT/LBS.	CUBIC FT.	LIST PRICE
--------	------------	---------------	---------	-----------	------------

	D x W x H				
PB108SH42	15 x 108 x 42	125	307	39	\$8892
PB102SH42	15 x 102 x 42	125	290	37	\$8399
PB96SH42	15 x 96 x 42	125	273	35	\$7907
PB90SH42	15 x 90 x 42	125	256	33	\$7410
PB84SH42	15 x 84 x 42	125	239	31	\$6916
PB78SH42	15 x 78 x 42	150	222	38	\$6422
PB72SH42	15 x 72 x 42	125	205	26	\$5931
PB66SH42	15 x 66 x 42	125	188	24	\$5712
PB60SH42	15 x 60 x 42	125	171	22	\$5437

Hutches longer than 102" have 8 doors, hutches between 102" and 84" have 6 doors, and hutches less than 84" have 4 doors.

PB108SH42G	15 x 108 x 42	125	307	39	\$11843
PB102SH42G	15 x 102 x 42	125	290	37	\$10794
PB96SH42G	15 x 96 x 42	125	273	35	\$10266
PB90SH42G	15 x 90 x 42	125	256	33	\$9734
PB84SH42G	15 x 84 x 42	125	239	31	\$9210
PB78SH42G	15 x 78 x 42	150	222	38	\$8686
PB72SH42G	15 x 72 x 42	125	205	26	\$7549
PB66SH42G	15 x 66 x 42	125	188	24	\$7280
PB60SH42G	15 x 60 x 42	125	171	22	\$6960

Wood framed glass doors. Hutches longer than 102" have 8 doors, hutches between 102" and 84" have 6 doors, and hutches less than 84" have 4 doors.

PB102SH42GDG	15 x 102 x 42	125	290	37	\$10047
PB96SH42GDG	15 x 96 x 42	125	273	35	\$9518
PB90SH42GDG	15 x 90 x 42	125	256	33	\$8990
PB84SH42GDG	15 x 84 x 42	125	239	31	\$8464

Wood doors in the center and wood framed glass doors on left and right.

PB108SHP42	15 x 108 x 42	125	307	39	\$10667
PB102SHP42	15 x 102 x 42	125	290	37	\$10078
PB96SHP42	15 x 96 x 42	125	273	35	\$9487
PB90SHP42	15 x 90 x 42	125	256	33	\$8892
PB84SHP42	15 x 84 x 42	125	239	31	\$8296
PB78SHP42	15 x 78 x 42	150	222	38	\$7708
PB72SHP42	15 x 72 x 42	125	205	26	\$7119
PB66SHP42	15 x 66 x 42	125	241	31	\$7340
PB60SHP42	15 x 60 x 42	125	171	22	\$6523

Hutches longer than 102" have 8 doors, hutches between 102" and 84" have 6 doors, and hutches less than 84" have 4 doors.

Required Specifications
Finish

Optional Specifications
Additional grommet

HUTCHES & WALL MOUNTED STORAGE

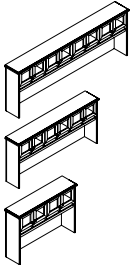

42" H Storage Hutch w/Glass Doors & Pigeon-Holes

MODEL#	DIMENSIONS D x W x H	FREIGHT CLASS	WT/LBS.	CUBIC FT.	LIST PRICE
PB108SHP42G	15 x 108 x 42	125	307	39	\$13612
PB102SHP42G	15 x 102 x 42	125	290	37	\$12410
PB96SHP42G	15 x 96 x 42	125	273	35	\$11818
PB90SHP42G	15 x 90 x 42	125	256	33	\$11184
PB84SHP42G	15 x 84 x 42	125		31	
PB78SHP42G	15 x 78 x 42	150	222	38	\$9908
PB72SHP42G	15 x 72 x 42	125	205	26	\$8695
PB66SHP42G	15 x 66 x 42	125	188	24	\$8409
PB60SHP42G	15 x 60 x 42	125	171	22	\$8001

Wood framed glass doors. Hutches longer than 102" have 8 doors, hutches between 102" and 84" have 6 doors, and hutches less than 84" have 4 doors.

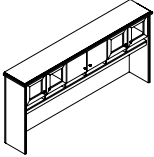

42" H Storage Hutch w/Doors & Pigeon-Holes

PB102SHP42GDG	15 x 102 x 42	125	290	37	\$11664
PB96SHP42GDG	15 x 96 x 42	125	273	35	\$11069
PB90SHP42GDG	15 x 90 x 42	125	256	33	\$10438
PB84SHP42GDG	15 x 84 x 42	125	239	31	\$9774

Wood doors in the center and wood framed glass doors on left and right.

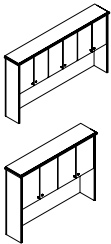

54" H Storage Hutch w/Wood Doors

PB962SH54	15 x 96 x 55	125	351	45	\$10158
PB902SH54	15 x 90 x 55	125	329	42	\$9526
PB842SH54	15 x 84 x 55	125	309	39	\$8892
PB782SH54	15 x 78 x 55	125	285	37	\$8257
PB722SH54	15 x 72 x 55	125	263	34	\$7626
PB662SH54	15 x 66 x 55	125	241	31	\$7340
PB602SH54	15 x 60 x 55	125	219	28	\$6985

Hutches between 96" and 84" have 6 doors; hutches less than 84" have 4 doors. One adjustable shelf.

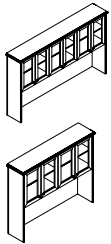

54" H Storage Hutch w/Glass Doors

PB962SH54G	15 x 96 x 55	125	351	45	\$13114
PB902SH54G	15 x 90 x 55	125	329	42	\$12224
PB842SH54G	15 x 84 x 55	125	307	39	\$11326
PB782SH54G	15 x 78 x 55	125	285	37	\$10434
PB722SH54G	15 x 72 x 55	125	263	34	\$9544
PB662SH54G	15 x 66 x 55	125	241	31	\$9196
PB602SH54G	15 x 60 x 55	125	219	28	\$8781

Wood framed glass doors. Hutches between 96" and 84" have 6 doors; hutches less than 84" have 4 doors. One adjustable shelf.

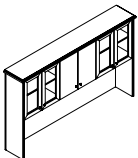

54" H Storage Hutch w/Doors

PB962SH54GDG	15 x 96 x 55	125	351	45	\$12182
PB902SH54GDG	15 x 90 x 55	125	329	42	\$11294
PB842SH54GDG	15 x 84 x 55	125	307	39	\$10394

Wood doors in the center and wood framed glass doors on left and right. One adjustable shelf.

Required Specifications

Finish

HUTCHES & WALL MOUNTED STORAGE

MODEL# DIMENSIONS FREIGHT CLASS WT/LBS. CUBIC FT. LIST PRICE

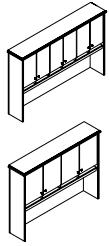

54" H Storage Hutch w/Wood Doors & Pigeon-Holes

	D x W x H					
PB962SHP54	15 x 96 x 55	125	351	45	\$12195	
PB902SHP54	15 x 90 x 55	125	329	42	\$11434	
PB842SHP54	15 x 84 x 55	125	307	39	\$10667	
PB782SHP54	15 x 78 x 55	125	285	37	\$9908	
PB722SHP54	15 x 72 x 55	125	263	34	\$9146	
PB662SHP54	15 x 66 x 55	125	241	31	\$8806	
PB602SHP54	15 x 60 x 55	125	219	28	\$8381	

Hutches between 96" and 84" have 6 doors; hutches less than 84" have 4 doors. One adjustable shelf.

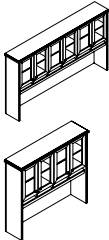

54" H Storage Hutch w/Glass Doors & Pigeon-Holes

PB962SHP54	15 x 96 x 55	125	351	45	\$12195	
PB902SHP54	15 x 90 x 55	125	329	42	\$11434	
PB842SHP54	15 x 84 x 55	125	307	39	\$10667	
PB782SHP54	15 x 78 x 55	125	285	37	\$9908	
PB722SHP54	15 x 72 x 55	125	263	34	\$9146	
PB662SHP54	15 x 66 x 55	125	241	31	\$8806	
PB602SHP54	15 x 60 x 55	125	219	28	\$8381	

Wood framed glass doors. Hutches between 96" and 84" have 6 doors; hutches less than 84" have 4 doors. One adjustable shelf.

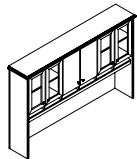

54" H Storage Hutch w/Doors & Pigeon-Holes

PB962SHP54GDG	15 x 96 x 55	125	351	45	\$14218	
PB902SHP54GDG	15 x 90 x 55	125	329	42	\$13456	
PB842SHP54GDG	15 x 84 x 55	125	307	39	\$12355	

Wood doors in the center and wood framed glass doors on left and right. One adjustable shelf.

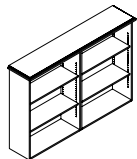

Open Hutch

PB720B54	15 x 72 x 55	125	260	35	\$6995	
PB360B54	15 x 36.75 x 55	125	130	18	\$3507	

Four adjustable shelves.

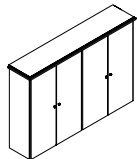

Hutch w/Wood Doors

PB72BD54	15 x 72 x 55	100	320	35	\$9008	
PB36BD54	15 x 36.75 x 55	100	160	18	\$4512	

Four adjustable shelves.

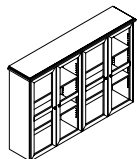

Hutch w/Glass Doors

PB72BG54	15 x 72 x 55	100	320	35	\$10213	
PB36BG54	15 x 36.75 x 55	100	160	18	\$5109	

Wood framed glass doors. Four adjustable shelves.

Required Specifications
Finish

Optional Specifications
Additional grommet

HUTCHES & WALL MOUNTED STORAGE

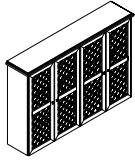

Hutch w/Wire Mesh Doors

MODEL#	DIMENSIONS D x W x H	FREIGHT CLASS	WT/LBS.	CUBIC FT.	LIST PRICE
PB72BW54	15 x 72 x 55	100	320	35	\$11421
PB36BW54	15 x 36.75 x 55	100	160	18	\$5860

Antique Brass wire mesh wood framed doors. Four adjustable shelves.

FREESTANDING STORAGE NOTES

NOTE: Arrow indicates direction of grain

Pedestals

- All units are shipped assembled.
- Standard face locking.

Combination Storage

- All units are shipped assembled.
- No modifications accepted for this unit.
- Box drawers do not lock.
- Standard face locking.

Storage Cabinets

- All units are shipped assembled.
- Units include adjustable shelves.
- Standard face locking.

TV Cabinets

- All units are shipped assembled.
- Units include 170° hinges, grommet on fixed shelf and adjustable shelf in lower cabinet.
- Standard face locking for lower cabinet.
- To add lock for upper cabinet, specify "LO".

FREESTANDING STORAGE

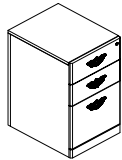

Freestanding Pedestal

MODEL#	DIMENSIONS D x W x H	FREIGHT CLASS	WT/LBS.	CUBIC FT.	LIST PRICE
PBWDB	19.8 x 15.5 x 28	85	70	5	\$2701
PBWWDB	23.8 x 15.5 x 28	85	75	6	\$3111

Box/box/file.

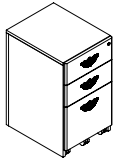

Freestanding Mobile Pedestal

PBWDM	19.8 x 15.5 x 28	85	70	5	\$2906
PBWWDM	23.8 x 15.5 x 28	85	75	6	\$3339

Box/box/file.

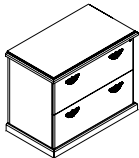

Lateral File - 2 high

PBF3624	24 x 36.75 x 29	85	184	15	\$5000
PBF3620	20 x 36.75 x 29	85	159	12	\$4158
PBN3024	24 x 31.63 x 29	85	153	12	\$4375
PBN3020	20 x 31.63 x 29	85	131	10	\$3638

Two lateral file drawers.

Required Specifications
Finish

Optional Specifications
Additional grommet

FREESTANDING STORAGE

MODEL# DIMENSIONS FREIGHT CLASS WT/LBS. CUBIC FT. LIST PRICE

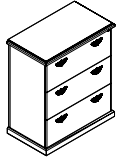

Lateral File - 3 high

D x W x H					
PBF36243	24 x 36.75 x 42	92.5	231	21	\$6112
PBF36203	20 x 36.75 x 42	92.5	193	18	\$5217
PBN30243	24 x 31.63 x 42	92.5	193	18	\$5343
PBN30203	20 x 31.63 x 42	92.5	160	15	\$4564

Three lateral file drawers.

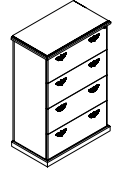

Lateral File - 4 high

PBF36244	24 x 36.75 x 54	92.5	297	27	\$7443
PBF36204	20 x 36.75 x 54	92.5	259	23	\$6466
PBN30244	24 x 31.63 x 54	92.5	248	23	\$6508
PBN30204	20 x 31.63 x 54	92.5	214	19	\$5656

Four lateral file drawers.

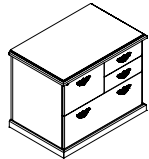

Combination Storage - Left

PBZL3624	24 x 36.75 x 29	85	184	15	\$5418
PBZL3620	20 x 36.75 x 29	85	160	12	\$4375

With 1 lateral file, 2 box drawers in the top right, and 1 file drawer in the top left.

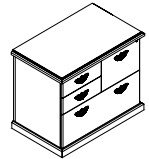

Combination Storage - Right

PBZR3624	24 x 36.75 x 29	85	184	15	\$5418
PBZR3620	20 x 36.75 x 29	85	160	12	\$4375

With 1 lateral file, 2 box drawers in the top left, and 1 file drawer in the top right.

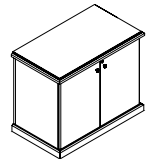

Storage Cabinet w/Doors

PBBD3624	24 x 36.75 x 29	92.5	152	15	\$3405
PBBD3620	20 x 36.75 x 29	92.5	129	12	\$2966
PBBD3024	24 x 31.63 x 29	92.5	127	12	\$2981
PBBD3020	20 x 31.63 x 29	92.5	106	10	\$2592

Storage with 1 adjustable shelf.

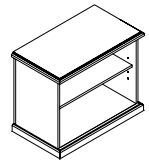

Open Storage Cabinet

PBOB3624	24 x 36.75 x 29	100	123	15	\$2732
PBOB3620	20 x 36.75 x 29	100	104	12	\$2380
PBOB3024	24 x 31.63 x 29	100	103	12	\$2385
PBOB3020	20 x 31.63 x 29	100	85	10	\$2075

Storage with 1 adjustable shelf.

Required Specifications

Finish

Optional Specifications

Additional grommet

FREESTANDING STORAGE

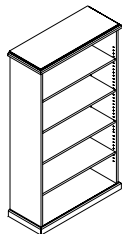

Open Bookcase

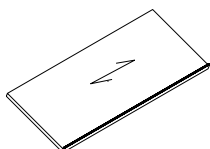

Additional Shelf

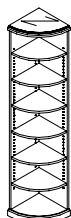

Quarter Round Open Bookcase

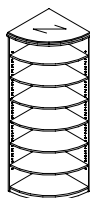

Quarter Round Open Bookcase

MODEL# DIMENSIONS FREIGHT CLASS WT/LBS. CUBIC FT. LIST PRICE

D x W x H

PBB83615	15 x 36.75 x 84	100	246	26	\$4186
PBB73615	15 x 36.75 x 78	100	228	24	\$3887
PBB63615	15 x 36.75 x 72	100	210	23	\$3588
PBB53615	15 x 36.75 x 65	100	188	21	\$3302
PBB43615	15 x 36.75 x 48	100	140	15	\$2720
PBB23615	15 x 36.75 x 29	92.5	90	8	\$2180
PBB23015	15 x 31.63 x 29	92.5	90	8	\$1909
PBB83615	15 x 31.63 x 84	100	246	26	\$4186
PBB73615	15 x 31.63 x 78	100	228	24	\$3887
PBB63615	15 x 31.63 x 72	100	210	23	\$3588
PBB53615	15 x 31.63 x 65	100	188	21	\$3302
PBB43615	15 x 31.63 x 48	100	140	15	\$2720

84" and 78" high models have 6 adjustable shelves, 72" has 5 adjustable shelves, 65" has 4 adjustable shelves, 48" has 3 adjustable shelves, 29" has 1 adjustable shelves.

PBAG3624	24 x 36 x 1	92.5	112	10	\$225
PBAG3622	22 x 36 x 1	92.5	104	10	\$204
PBAG3620	20 x 36 x 1	92.5	92	9	\$184
PBAG3615	15 x 36 x 1	92.5	81	8	\$162
PBAG3024	24 x 30 x 1	92.5	94	9	\$189
PBAG3022	22 x 30 x 1	100	87	9	\$172
PBAG3020	20 x 30 x 1	100	76	8	\$152
PBAG3015	15 x 30 x 1	100	67	8	\$134

For use with open bookcase. Can be specified for each shelf in an open bookcase.

PB8R1515	15 x 15 x 84	125	142	22	\$3295
PB7R1515	15 x 15 x 78	100	95	10	\$3061
PB6R1515	15 x 15 x 72	100	83	9	\$2825
PB5R1515	15 x 15 x 65	100	81	9	\$2604
PB4R1515	15 x 15 x 48	100	59	6	\$2142
PB2R1515	15 x 15 x 29	100	37	4	\$1719

84" and 78" high models have 6 adjustable shelves, 72" has 5 adjustable shelves, 65" has 4 adjustable shelves, 48" has 3 adjustable shelves, 29" has 1 adjustable shelf.

PBB7R2424H84	24 x 24 x 84	100	234	28	\$5752
PBB7R2424H72	24 x 24 x 72	125	204	28	\$4933
PBB7R2424H65	24 x 24 x 65	100	187	22	\$4524
PBB7R2020H84	20 x 20 x 84	100	163	19	\$5027
PBB7R2020H72	20 x 20 x 72	100	142	17	\$4307
PBB7R2020H65	20 x 20 x 65	100	130	15	\$4039

84" high models have 6 adjustable shelves, 72" has 5 adjustable shelves, and 65" has 4 adjustable shelves

Required Specifications

Finish

FREESTANDING STORAGE

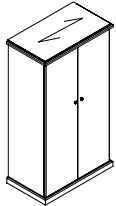

Storage Cabinet w/Wood Doors

MODEL# DIMENSIONS FREIGHT CLASS WT/LBS. CUBIC FT. LIST PRICE

D x W x H

PB1D24W36H84	24 x 36.75 x 84	125	304	42	\$7990
PB1D24W36H72	24 x 36.75 x 72	100	283	33	\$6848
PB1D24W36H65	24 x 36.75 x 65	100	259	30	\$6276
PB1D24W30H84	24 x 30.63 x 84	125	304	42	\$6981
PB1D24W30H72	24 x 30.63 x 72	100	283	33	\$5983
PB1D24W30H65	24 x 30.63 x 65	100	259	30	\$5495
PB1D24W24H84	24 x 24 x 84	92.5	320	28	\$5964
PB1D24W24H72	24 x 24 x 72	92.5	255	24	\$5113
PB1D24W24H65	24 x 24 x 65	125	173	22	\$4712

PB1D20W36H84	20 x 36.75 x 84	100	297	35	\$6981
PB1D20W36H72	20 x 36.75 x 72	100	269	30	\$5983
PB1D20W36H65	20 x 36.75 x 65	100	245	28	\$5485
PB1D20W30H84	20 x 30.63 x 84	100	257	29	\$5816
PB1D20W30H72	20 x 30.63 x 72	100	233	25	\$4987
PB1D20W30H65	20 x 30.63 x 65	100	202	23	\$4571
PB1D20W24H84	20 x 24 x 84	100	198	23	\$4656
PB1D20W24H72	20 x 24 x 72	100	179	20	\$3990
PB1D20W24H65	20 x 24 x 65	100	163	18	\$3651

84" high models have 6 adjustable shelves, 72" has 5 adjustable shelves, 65" has 4 adjustable shelves. For wood framed glass door option, please contact customer care.

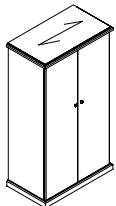

Wardrobe Cabinet

PB2D24W36H84	24 x 36.75 x 84	100	356	42	\$6933
PB2D24W36H72	24 x 36.75 x 72	100	324	36	\$5945
PB2D24W36H65	24 x 36.75 x 65	100	297	33	\$5449
PB2D24W30H84	24 x 30.63 x 84	100	296	35	\$6070
PB2D24W30H72	24 x 30.63 x 72	100	270	30	\$5202
PB2D24W30H65	24 x 30.63 x 65	100	248	28	\$4768
PB2D24W24H84	24 x 24 x 84	100	238	28	\$5202
PB2D24W24H72	24 x 24 x 72	100	216	24	\$4459
PB2D24W24H65	24 x 24 x 65	100	198	22	\$4087

PB2D20W36H84	20 x 36.75 x 84	100	297	35	\$6054
PB2D20W36H72	20 x 36.75 x 72	100	269	30	\$5180
PB2D20W36H65	20 x 36.75 x 65	100	245	28	\$4745
PB2D20W30H84	20 x 30.63 x 84	100	257	29	\$5047
PB2D20W30H72	20 x 30.63 x 72	100	233	25	\$4318
PB2D20W30H65	20 x 30.63 x 65	100	202	23	\$3958
PB2D20W24H84	20 x 24 x 84	100	198	23	\$4034
PB2D20W24H72	20 x 24 x 72	100	179	20	\$3450
PB2D20W24H65	20 x 24 x 65	100	163	18	\$3166

Doors, coat rack and hat shelf. 84" high models have 6 adjustable shelves, 72" has 5 adjustable shelves, 65" has 4 adjustable shelves. For wood framed glass door option, please contact customer care.

Required Specifications

Finish

FREESTANDING STORAGE

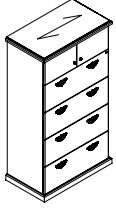

Storage Cupboard

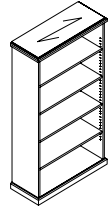

Open Bookcase

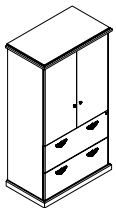

Storage Cabinet w/Doors

MODEL#	DIMENSIONS D x W x H	FREIGHT CLASS	WT/LBS.	CUBIC FT.	LIST PRICE
PB6D24W36H84	24 x 36.75 x 84	92.5	449	42	\$11681
PB6D24W36H72	24 x 36.75 x 72	92.5	414	36	\$10015
PB6D24W36H65	24 x 36.75 x 65	92.5	380	33	\$9181
PB6D24W30H84	24 x 30.63 x 84	92.5	375	35	\$10226
PB6D24W30H72	24 x 30.63 x 72	92.5	345	30	\$8766
PB6D24W30H65	24 x 30.63 x 65	92.5	316	28	\$8034
PB6D20W36H84	20 x 36.75 x 84	92.5	382	35	\$10200
PB6D20W36H72	20 x 36.75 x 72	92.5	351	30	\$8726
PB6D20W36H65	20 x 36.75 x 65	92.5	321	28	\$7995
PB6D20W30H84	20 x 30.63 x 84	92.5	347	29	\$8500
PB6D20W30H72	20 x 30.63 x 72	85	306	25	\$7274
PB6D20W30H65	20 x 30.63 x 65	92.5	265	23	\$6668

Above lateral file cabinet with 4 drawers. 84" high model has 1 adjustable shelf. For wood framed glass door option, please contact customer care.

PB7D24W36H84	24 x 36.75 x 84	125	331	43	\$6396
PB7D24W36H72	24 x 36.75 x 72	100	306	36	\$5485
PB7D24W36H65	24 x 36.75 x 65	100	281	33	\$5027
PB7D24W30H84	24 x 30.63 x 84	125	280	36	\$5597
PB7D24W30H72	24 x 30.63 x 72	100	255	30	\$4785
PB7D24W30H65	24 x 30.63 x 65	100	234	28	\$4391
PB7D20W36H84	20 x 36.75 x 84	100	282	35	\$5584
PB7D20W36H72	20 x 36.75 x 72	100	257	30	\$4785
PB7D20W36H65	20 x 36.75 x 65	100	234	28	\$4391
PB7D20W30H84	20 x 30.63 x 84	100	248	29	\$4651
PB7D20W30H72	20 x 30.63 x 72	100	223	25	\$3988
PB7D20W30H65	20 x 30.63 x 65	100	193	23	\$3654

84" high models have 6 adjustable shelves, 72" has 5 adjustable shelves, and 65" has 4 adjustable shelves.

PB13D24W36H84	24 x 36.75 x 84	100	407	42	\$9889
PB13D24W36H72	24 x 36.75 x 72	92.5	387	36	\$8477
PB13D24W36H65	24 x 36.75 x 65	92.5	347	33	\$7772
PB13D24W30H84	24 x 30.63 x 84	92.5	350	35	\$8654
PB13D24W30H72	24 x 30.63 x 72	92.5	315	30	\$7417
PB13D24W30H65	24 x 30.63 x 65	92.5	289	28	\$6798
PB13D20W36H84	20 x 36.75 x 84	92.5	365	35	\$8632
PB13D20W36H72	20 x 36.75 x 72	92.5	327	30	\$7385
PB13D20W36H65	20 x 36.75 x 65	92.5	299	28	\$6770
PB13D20W30H84	20 x 30.63 x 84	92.5	305	29	\$7197
PB13D20W30H72	20 x 30.63 x 72	92.5	285	25	\$6157
PB13D20W30H65	20 x 30.63 x 65	92.5	247	23	\$5641

Above two lateral file drawers. 84" high models have 3 adjustable shelves, 72" has 2 adjustable shelves, and 65" has 1 adjustable shelf. For wood framed glass door option, please contact customer care.

Required Specifications

Finish

Optional Specifications

Additional grommet

FREESTANDING STORAGE

MODEL# DIMENSIONS FREIGHT CLASS WT/LBS. CUBIC FT. LIST PRICE

D x W x H

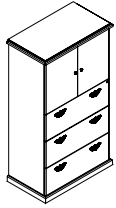

Storage Cabinet w/Doors

PB14D24W36H84	24 x 36.75 x 84	100	390	42	\$10632
PB14D24W36H72	24 x 36.75 x 72	92.5	360	36	\$9114
PB14D24W36H65	24 x 36.75 x 65	92.5	330	33	\$8353
PB14D24W30H84	24 x 30.63 x 84	100	325	35	\$9305
PB14D24W30H72	24 x 30.63 x 72	92.5	300	30	\$7870
PB14D24W30H65	24 x 30.63 x 65	100	275	28	\$7311

PB14D20W36H84	20 x 36.75 x 84	100	330	35	\$9281
PB14D20W36H72	20 x 36.75 x 72	92.5	305	30	\$7940
PB14D20W36H65	20 x 36.75 x 65	100	278	28	\$7280
PB14D20W30H84	20 x 30.63 x 84	92.5	298	29	\$7735
PB14D20W30H72	20 x 30.63 x 72	92.5	265	25	\$6616
PB14D20W30H65	20 x 30.63 x 65	100	229	23	\$6067

Above three lateral file drawers. 84" high models have 2 adjustable shelves, 72" and 65" have 1 adjustable shelf. For wood framed glass door option, please contact customer care.

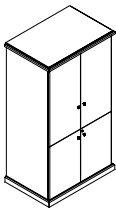

Closed Storage Cabinet

PB23D24W36H84	24 x 36.75 x 84	100	390	42	\$8534
PB23D24W36H72	24 x 36.75 x 72	92.5	360	36	\$7314
PB23D24W36H65	24 x 36.75 x 65	92.5	330	33	\$6704
PB23D24W30H84	24 x 30.63 x 84	100	325	35	\$7089
PB23D24W30H72	24 x 30.63 x 72	92.5	300	30	\$6079
PB23D24W30H65	24 x 30.63 x 65	100	275	28	\$5586

PB23D20W36H84	20 x 36.75 x 84	100	330	35	\$7449
PB23D20W36H72	20 x 36.75 x 72	92.5	305	30	\$6376
PB23D20W36H65	20 x 36.75 x 65	100	278	28	\$5840
PB23D20W30H84	20 x 30.63 x 84	92.5	298	29	\$6207
PB23D20W30H72	20 x 30.63 x 72	92.5	265	25	\$5309
PB23D20W30H65	20 x 30.63 x 65	100	229	23	\$4869

With upper and lower split doors. 1 fixed shelf and 2 adjustable shelves. For wood framed glass door option, please contact customer care.

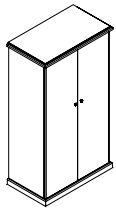

Cabinet w/Doors and Storage

PB25D24W36H84	24 x 36.75 x 84	100	390	42	\$8965
PB25D24W36H72	24 x 36.75 x 72	92.5	360	36	\$7682
PB25D24W36H65	24 x 36.75 x 65	92.5	330	33	\$7042
PB25D24W30H84	24 x 30.63 x 84	100	325	35	\$7842
PB25D24W30H72	24 x 30.63 x 72	92.5	300	30	\$6719
PB25D24W30H65	24 x 30.63 x 65	100	275	28	\$6164
PB25D24W24H84	24 x 24 x 84	100	260	28	\$6713
PB25D24W24H72	24 x 24 x 72	92.5	240	24	\$5752
PB25D24W24H65	24 x 24 x 65	92.5	220	22	\$5280

PB25D20W36H84	20 x 36.75 x 84	100	330	35	\$7821
PB25D20W36H72	20 x 36.75 x 72	92.5	305	30	\$6692
PB25D20W36H65	20 x 36.75 x 65	100	278	28	\$6129
PB25D20W30H84	20 x 30.63 x 84	92.5	300	29	\$6520
PB25D20W30H72	20 x 30.63 x 72	92.5	265	25	\$5575
PB25D20W30H65	20 x 30.63 x 65	100	229	23	\$5111
PB25D20W24H84	20 x 24 x 84	92.5	235	23	\$5219
PB25D20W24H72	20 x 24 x 72	92.5	203	20	\$4466
PB25D20W24H65	20 x 24 x 65	92.5	185	18	\$4095

Wardrobe with coat rack and hat shelf on left. Storage with adjustable shelves on right. 84" high models have 5 adjustable shelves, 72" and 65" have 4 adjustable shelves. For wood framed glass door option, please contact customer care.

Required Specifications

Finish

Optional Specifications

Additional grommet

RECEPTION DESKS

MODEL#

DIMENSIONS

FREIGHT CLASS

WT./LBS.

CUBIC FT.

LIST PRICE

D x W x H

- To add storage use modular components. See page 354.
- Includes GM1 grommet.
- Transaction tops to be specified separately, handed by square edge from user side.

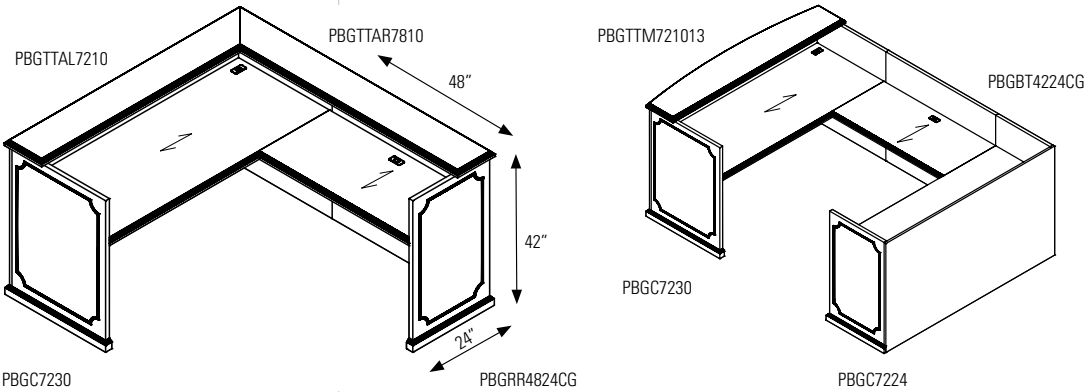

RECEPTION DESKS

MODEL#

DIMENSIONS

FREIGHT CLASS

WT./LBS.

CUBIC FT.

LIST PRICE

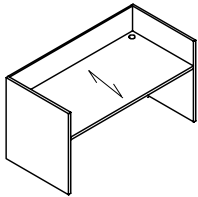

Gallery/Reception Desk Shell*

PBGC12036	36 x 120 x 42	150	592	105	\$12272
PBGC10836	36 x 108 x 42	150	533	95	\$11044
PBGC10236	36 x 102 x 42	150	503	89	\$10431
PBGC9636	36 x 96 x 42	150	473	84	\$9815
PBGC9036	36 x 90 x 42	150	444	79	\$9205
PBGC8436	36 x 84 x 42	150	414	74	\$8587
PBGC7236	36 x 72 x 42	150	355	63	\$7368
PBGC7230	30 x 72 x 42	150	315	53	\$7124
PBGC6630	30 x 66 x 42	125	295	48	\$6947
PBGC6030	30 x 60 x 42	125	275	44	\$6552

No pedestals. Two grommets in worksurface. For use with modular storage components. Pin molding included.

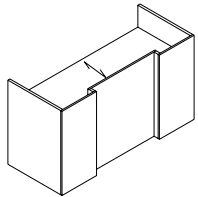

**Gallery/Reception Desk Shell
Breakfront Style**

PBGIC12036	36 x 120 x 42	150	592	105	\$13497
PBGIC10836	36 x 108 x 42	150	533	95	\$12145
PBGIC10236	36 x 102 x 42	150	503	89	\$11473
PBGIC9636	36 x 96 x 42	150	473	84	\$10796
PBGIC9036	36 x 90 x 42	150	444	79	\$10126
PBGIC8436	36 x 84 x 42	150	414	74	\$9446
PBGIC7236	36 x 72 x 42	150	355	63	\$8099
PBGIC7230	30 x 72 x 42	150	315	53	\$7838
PBGIC6630	30 x 66 x 42	125	295	48	\$7641
PBGIC6030	30 x 60 x 42	125	275	44	\$7207

No pedestals. Two grommets in worksurface. For use with modular storage components. Pin molding included.

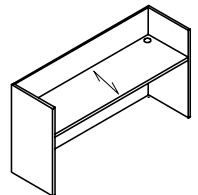

Gallery/Reception Credenza Shell*

PBGC12024	24 x 120 x 42	150	392	70	\$9627
PBGC10824	24 x 108 x 42	150	353	63	\$8654
PBGC10224	24 x 102 x 42	150	333	60	\$8177
PBGC9624	24 x 96 x 42	150	314	56	\$7693
PBGC9024	24 x 90 x 42	150	294	53	\$7213
PBGC8424	24 x 84 x 42	150	274	49	\$6735
PBGC7224	24 x 72 x 42	150	235	42	\$5774
PBGC6624	24 x 66 x 42	150	216	39	\$5425
PBGC6024	24 x 60 x 42	150	196	35	\$5083

No pedestals. Two grommets in worksurface. For use with modular storage components. Pin molding included.

Required Specifications

Finish

Optional Specifications

Additional grommet

RECEPTION DESKS

MODEL# DIMENSIONS FREIGHT CLASS WT/LBS. CUBIC FT. LIST PRICE

D x W x H

PBGBT5624CG	24 x 56 x 42	150	178	32	\$5183
PBGBT5424CG	24 x 54 x 42	150	169	29	\$5183
PBGBT5024CG	24 x 50 x 42	150	151	27	\$4606
PBGBT4824CG	24 x 48 x 42	150	142	26	\$4606
PBGBT4424CG	24 x 44 x 42	150	134	23	\$4029
PBGBT4224CG	24 x 42 x 42	150	127	22	\$4029
PBGBT3824CG	24 x 38 x 42	150	119	20	\$3629
PBGBT3624CG	24 x 36 x 42	150	112	19	\$3629

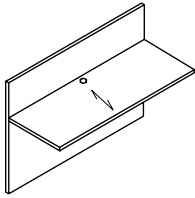

Bridge

Attaches between **Gallery Desk and Gallery Credenza Only**. One grommet in center of worksurface. Shipped RTA (ready to assemble). Pin molding included.

- To remove cross-grain veneer pattern on top, **delete "CG"** from model number. Available as a special - no upcharge.

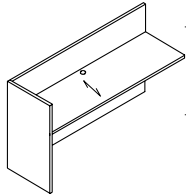

Reception Return - LEFT

PBGRL7224CG	24 x 72 x 42	125	273	42	\$7266
PBGRL6624CG	24 x 66 x 42	125	250	39	\$6664
PBGRL6024CG	24 x 60 x 42	125	228	35	\$6060
PBGRL5424CG	24 x 54 x 42	125	205	32	\$5458
PBGRL4824CG	24 x 48 x 42	125	182	28	\$4844
PBGRL4224CG	24 x 42 x 42	125	159	25	\$4243
PBGRL3624CG	24 x 36 x 42	125	137	21	\$3817

No pedestal. One grommet in center of worksurface. For use with modular storage components. Pin molding included.

- To remove cross-grain veneer pattern on top, **delete "CG"** from model number. Available as a special - no upcharge.

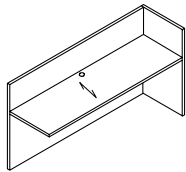

Reception Return - RIGHT

PBGRR7224CG	24 x 72 x 42	125	273	42	\$7266
PBGRR6624CG	24 x 66 x 42	125	250	39	\$6664
PBGRR6024CG	24 x 60 x 42	125	228	35	\$6060
PBGRR5424CG	24 x 54 x 42	125	205	32	\$5458
PBGRR4824CG	24 x 48 x 42	125	182	28	\$4844
PBGRR4224CG	24 x 42 x 42	125	159	25	\$4243
PBGRR3624CG	24 x 36 x 42	125	137	21	\$3817

No pedestal. One grommet in center of worksurface. For use with modular storage components. Pin molding included.

- To remove cross-grain veneer pattern on top, **delete "CG"** from model number. Available as a special - no upcharge.

Required Specifications

Finish

Optional Specifications

Additional grommet

TRANSACTION COUNTERS

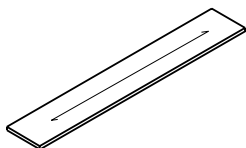

Transaction Counter Top

MODEL#	DIMENSIONS D x W x H	FREIGHT CLASS	WT./LBS.	CUBIC FT.	LIST PRICE
PBGTT12010	10 x 120 x 1.50	92.5	84	8	\$2055
PBGTT10810	10 x 108 x 1.50	100	78	8	\$1852
PBGTT10210	10 x 102 x 1.50	92.5	72	7	\$1751
PBGTT9610	10 x 96 x 1.50	100	66	7	\$1648
PBGTT9010	10 x 90 x 1.50	92.5	60	6	\$1543
PBGTT8410	10 x 84 x 1.50	100	54	6	\$1436
PBGTT7210	10 x 72 x 1.50	100	48	5	\$1232
PBGTT6610	10 x 66 x 1.50	100	42	5	\$1130
PBGTT6010	10 x 60 x 1.50	100	36	4	\$1030

Rectangular top for main reception desk. Counter sits on top of Gallery panels. Does not overhang. **Factory installed - specify Gallery to be used on.** Size must match dimension of desk front or combined desk side and return length. Hardware included.

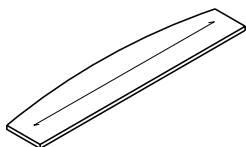

Bow Front Transaction Counter Top

PBGTTM1081013	10-13 x 108 x 1.50	125	78	10	\$2768
PBGTTM1021013	10-13 x 102 x 1.50	100	72	9	\$2666
PBGTTM961013	10-13 x 96 x 1.50	125	66	9	\$2566
PBGTTM901013	10-13 x 90 x 1.50	125	60	8	\$2461
PBGTTM841013	10-13 x 84 x 1.50	125	54	8	\$2352
PBGTTM721013	10-13 x 72 x 1.50	125	48	7	\$2150
PBGTTM661013	10-13 x 66 x 1.50	125	42	6	\$2048
PBGTTM601013	10-13 x 60 x 1.50	125	36	5	\$1946

Bow top for main reception desk. Counter sits on top of Gallery panels. Bow front overhangs 3". **Factory installed - specify Gallery to be used on.** Size must match dimension of desk front or combined desk side and return length. Hardware included.

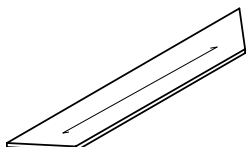

Trapezoid Transaction Counter Top

PBGTTA10810	10 x 108 x 1.50	100	78	8	\$2100
PBGTTA10210	10 x 102 x 1.50	92.5	72	7	\$1996
PBGTTA9610	10 x 96 x 1.50	100	66	7	\$1893
PBGTTA9010	10 x 90 x 1.50	92.5	60	6	\$1791
PBGTTA8410	10 x 84 x 1.50	100	54	6	\$1686
PBGTTA7210	10 x 72 x 1.50	100	48	5	\$1481
PBGTTA6610	10 x 66 x 1.50	100	42	5	\$1379
PBGTTA6010	10 x 60 x 1.50	100	36	4	\$1277

Trapezoid top for main reception desk. 45° mitered ends on left and right. For use with left and right 45° mitered return transaction counters. Counter sits on top of Gallery panels. Does not overhang. **Factory installed - specify Gallery to be used on.** Width must match dimension of desk front. Hardware included.

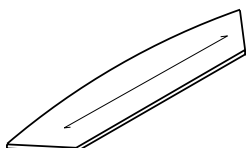

Bow Front Trapezoid Transaction Counter Top

PBGTTMA1081013	10-13 x 108 x 1.50	125	78	10	\$2884
PBGTTMA1021013	10-13 x 102 x 1.50	100	72	9	\$2779
PBGTTMA961013	10-13 x 96 x 1.50	125	66	9	\$2679
PBGTTMA901013	10-13 x 90 x 1.50	125	60	8	\$2573
PBGTTMA841013	10-13 x 84 x 1.50	125	54	8	\$2470
PBGTTMA721013	10-13 x 72 x 1.50	125	48	7	\$2265
PBGTTMA661013	10-13 x 66 x 1.50	125	42	6	\$2158
PBGTTMA601013	10-13 x 60 x 1.50	125	36	5	\$2059

Trapezoid bow top for main reception desk. 45° mitered ends on left and right. For use with left and right 45° mitered return transaction counters. Counter sits on top of Gallery panels. Bow front overhangs 3". **Factory installed - specify Gallery to be used on.** Width must match dimension of desk front. Hardware included.

Required Specifications
Finish

Optional Specifications
Additional grommet

TRANSACTION COUNTERS	MODEL#	DIMENSIONS	FREIGHT CLASS	WT/LBS.	CUBIC FT.	LIST PRICE
		D x W x H				
	PBGTTAL12010	10 x 120 x 1.50	92.5	84	8	\$2218
	PBGTTAL11410	10 x 114 x 1.50	92.5	81	8	\$2109
	PBGTTAL10810	10 x 108 x 1.50	100	78	8	\$2011
	PBGTTAL10210	10 x 102 x 1.50	92.5	72	7	\$1911
	PBGTTAL9610	10 x 96 x 1.50	100	66	7	\$1808
	PBGTTAL9010	10 x 90 x 1.50	92.5	60	6	\$1706
	PBGTTAL8410	10 x 84 x 1.50	100	54	6	\$1600
	PBGTTAL7210	10 x 72 x 1.50	100	48	5	\$1396
	PBGTTAL6610	10 x 66 x 1.50	100	42	5	\$1290
	PBGTTAL6010	10 x 60 x 1.50	100	36	4	\$1191
	PBGTTAL3610	10 x 36 x 1.50	100	24	3	\$715
	PBGTTAL3010	10 x 30 x 1.50	92.5	20	2	\$594
	PBGTTAL2410	10 x 24 x 1.50	100	16	2	\$478

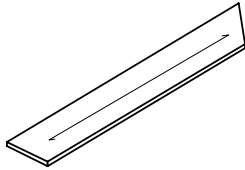

Transaction Counter Top - LEFT

Rectangular top for main reception desk with 45° mitered end on **left**. For use with rectangular or bow front transaction counters with miters at both ends. Width must match dimension of Gallery Desk end and Return width. Counter sits on top of Gallery panels. Does not overhang. **Factory installed - specify Gallery to be used on.** Hardware included.

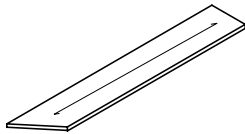

Transaction Counter Top - RIGHT

PBGTTAR12010	10 x 120 x 1.50	92.5	84	8	\$2218
PBGTTAR11410	10 x 114 x 1.50	92.5	81	8	\$2109
PBGTTAR10810	10 x 108 x 1.50	100	78	8	\$2011
PBGTTAR10210	10 x 102 x 1.50	92.5	72	7	\$1911
PBGTTAR9610	10 x 96 x 1.50	100	66	7	\$1808
PBGTTAR9010	10 x 90 x 1.50	92.5	60	6	\$1706
PBGTTAR8410	10 x 84 x 1.50	100	54	6	\$1600
PBGTTAR7210	10 x 72 x 1.50	100	48	5	\$1396
PBGTTAR6610	10 x 66 x 1.50	100	42	5	\$1290
PBGTTAR6010	10 x 60 x 1.50	100	36	4	\$1191
PBGTTAR3610	10 x 36 x 1.50	100	24	3	\$715
PBGTTAR3010	10 x 30 x 1.50	92.5	20	2	\$594
PBGTTAR2410	10 x 24 x 1.50	100	16	2	\$478

Rectangular top for main reception desk with 45° mitered end on **right**. For use with rectangular or bow front transaction counters with miters at both ends. Width must match dimension of Gallery Desk end and Return width. Counter sits on top of Gallery panels. Does not overhang. **Factory installed - specify Gallery to be used on.** Hardware included.

Required Specifications
Finish

Optional Specifications
Additional grommet

TACKBOARDS FOR HUTCHES & ACCESSORIES

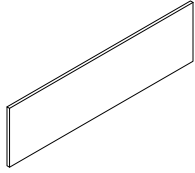

**Tackboard for 36"H*
Non-Pigeon Hole Hutches**

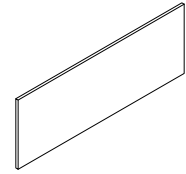

**Tackboard for 42"H & 54"H*
Pigeon Hole Hutches**

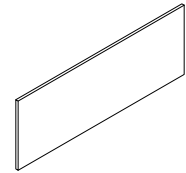

**Tackboard for 42"H & 54"H*
Non-Pigeon Hole Hutches**

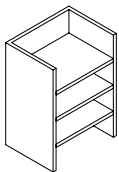

Paper Organizer, Letter & Legal Format

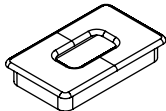

Grommet

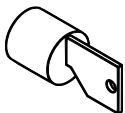

Lock Assembly

MODEL#	DIMENSIONS D x W x H	FREIGHT CLASS	WT/LBS.	CUBIC FT.	LIST PRICE
PBTS108	1 x 104.5 x 20	92.5	23	2	\$1232
PBTS102	1 x 98.5 x 20	100	19	2	\$1166
PBTS96	1 x 92.5 x 20	70	17	1	\$1097
PBTS90	1 x 86.5 x 20	70	15	1	\$1030
PBTS84	1 x 80.5 x 20	85	14	1	\$967
PBTS78	1 x 74.5 x 20	85	13	1	\$894
PBTS72	1 x 68.5 x 20	85	12	1	\$825
PBTS66	1 x 62.5 x 20	92.5	11	1	\$753
PBTS60	1 x 56.5 x 20	92.5	10	1	\$688

Factory installed hutch tackboard.

PBTSP108H23	1 x 104.5 x 23	70	30	2	\$1394
PBTSP102H23	1 x 98.5 x 23	85	24	2	\$1328
PBTSP96H23	1 x 92.5 x 23	92.5	22	2	\$1240
PBTSP90H23	1 x 86.5 x 23	70	20	1	\$1162
PBTSP84H23	1 x 80.5 x 23	70	18	1	\$1085
PBTSP78H23	1 x 74.5 x 23	70	17	1	\$1008
PBTSP72H23	1 x 68.5 x 23	70	16	1	\$937
PBTSP66H23	1 x 62.5 x 23	85	14	1	\$852
PBTSP60H23	1 x 56.5 x 23	85	13	1	\$779

Factory installed hutch tackboard.

PBTS108H26	1 x 104.5 x 26	70	30	2	\$1611
PBTS102H26	1 x 98.5 x 26	85	24	2	\$1518
PBTS102H26	1 x 92.5 x 26	85	24	2	\$1518
PBTS90H26	1 x 86.5 x 26	92.5	20	2	\$1344
PBTS84H26	1 x 80.5 x 26	100	18	2	\$1160
PBTS78H26	1 x 74.5 x 26	100	17	2	\$982
PBTS72H26	1 x 68.5 x 26	70	16	1	\$894
PBTS66H26	1 x 62.5 x 26	85	14	1	\$802
PBTS60H26	1 x 56.5 x 26	85	13	1	\$621

Factory installed hutch tackboard.

PBCPH161226	12 x 16 x 27	125	20	3	\$981
PBCPH161223	12 x 16 x 23	125	18	3	\$1335
PBCPH161219	12 x 16 x 20	125	15	2	\$632
PBCPH131226	12 x 13 x 27	100	16	2	\$795
PBCPH131223	12 x 13 x 23	125	15	2	\$675
PBCPH131219	12 x 13 x 20	125	12	2	\$512

GM5C	2 x 3.5 x --	70	--	--	\$107
------	--------------	----	----	----	--------------

Rectangular grommet in metal, tungsten finish.

LO/C	--	70	--	--	\$106
------	----	----	----	----	--------------

Tungsten.

Required Specifications

Fabric*

boardroom tables

