



Philadelphia detailing is traditional with a 1" overhang on all edges. Solid walnut, cherry, maple, oak that bands worksurface perimeter is 1" wide by 1-3/8" thick for an overall thickness of 1-3/8". Philadelphia is a "top over pedestal" detailed series. Philadelphia is standard with a base. Floor storage unit bases (i.e. kick-plates on pedestals, lateral files, bookcases, etc.) are extended out over drawer faces and horizontally grained. Products that are normally positioned against walls, such as credenzas, have a self-edge veneered back edge detail. All primary faces have pin molding decorations.

This elegantly designed traditional furniture series employs state-of-the-art manufacturing to create traditional pieces for executive offices, conference rooms and reception areas. Philadelphia is characterized by solid-wood edge detailing with solid-wood moldings on the cases and brass hardware throughout. The finest clear hardwoods are hand-selected to ensure that the best quality and consistency is achieved. Each piece is protected with a catalyzed conversion varnish to provide one of the most durable finishes in the industry. Philadelphia makes a truly impressive statement for the discerning customer.



**Features and Benefits**

- Philadelphia is a traditional collection characterized by craftsmanship and elegance
- Solid-wood edge detailing with solid-wood moldings on the cases and brass hardware throughout
- Drawers are standard vinyl-wrapped construction with black drawer sides and bottom.
- Pedestals feature antique brass handles, profiled drawer fronts and maple drawer interiors.
- The base is profiled, with pin moldings on desk fronts and sides.
- Bronze glass is standard with clear glass available as an option.
- Modesty panel upgrades are available on select models.

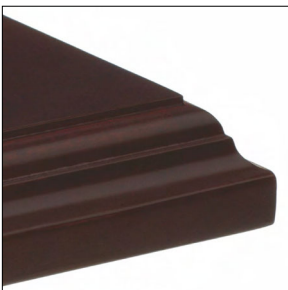

1-3/8" thick solid hardwood edge

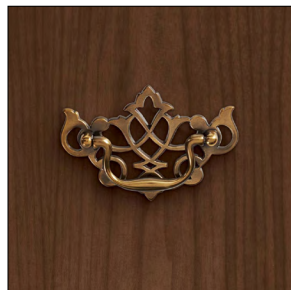

Antique brass pull (PL40)

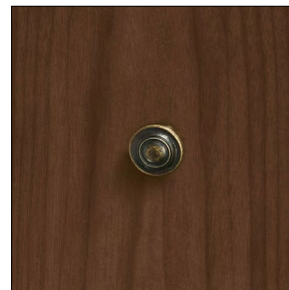

Knob on uppers (DK25)

**GENERAL INFORMATION**

- Philadelphia is comprised of hundreds of models for the traditional executive suite and coordinating meeting areas.
- Solid wood is used on all perimeter worksurface edges, as well as end panel bottoms for mounting leveling glides
- 1" overhang with a traditional detailing is featured on all user and approach sides.
- Brass bulls exclusive to Philadelphia detail the traditional style of the product.
- GM5 grommets are standard on all designated worksurfaces.
- **Level certified**

**CONSTRUCTION**

- Number One select, architectural grade "A" oak, American black walnut, American black cherry or maple. Wood worksurface molded edges are solid oak, walnut, cherry, or maple.
- Traditional detailing with 1" overhang on all edges.
- Solid walnut, cherry, maple, oak that bands worksurface perimeter is 1" wide by 1-3/8" thick for an overall thickness of 1-3/8".

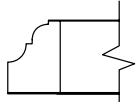
**Edge detail**

- Top over pedestal design
- Products that are normally positioned against walls, such as credenzas, have a self-edge veneered back edge detail. All primary faces have pin molding decorations.

**FINISHES**

- Conversion varnish (similar to catalyzed lacquer, but tougher), 25 degree sheen. Finishes are not buffed or rubbed.
- All Global wood casegood products are veneered and finished on the back sides (360° finishing), except modular under-surface storage - tops and backs are unfinished.
- Touch up kits available, includes a touch up marker and fill crayon. Order **VTUOUCHUPKIT, \$164** list. Specify finish when ordering.
- Global standard finish, on oak and walnut, is open pore and on cherry and maple is semi-closed pore. If a full finish is required for walnut, cherry, anigre and maple tops, Add the suffix "2" to the finish code and Add 5% to the base pricing for each product.

**CUSTOM FINISH IS AVAILABLE.****PEDESTALS**

- Full-to-the-floor. Pedestals are fully assembled units that are either installed into desk and credenza shells, or available as modular units. Undersurface storage units include locks.
- Pedestal drawer suspensions are metal ball bearing type. Both box and file drawers are full extension.
- Drawers are standard vinyl-wrapped construction with black drawer sides and bottom.
- The drawer front is an applied element to a four sided drawer. Drawer fronts are veneered on all surfaces except the vertical edges, which are solid oak, walnut, cherry and maple then routed with series detailing. Drawer fronts can be removed or replaced in the field.
- Levelers have 1" range of adjustment.

**LOCKS**

- Locks are standard on all below worksurface level drawer and door storage units, with the exception of pull-out tray units and single lateral file drawer combination tray/slot units.
- Combination storage unit comes with lock for file and lateral file drawer only; box drawers cannot lock.
- Lock color will match the handle option.
- Locks are optional on all above worksurface level closed storage.
- For optional lock, specify **LO**. Add **\$134** per lock.

**HANDLES**

- All drawer fronts come with traditional antique brass finished handles centered on drawer faces. All cabinet doors come with knobs in the same finish.

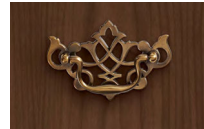
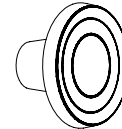
**PL40** Brass Pull, 4.5"**DK25** Knob on Uppers**HARDWARE**

- All necessary hardware items for attaching furniture items are included in the shipment. Actual wall attachment fasteners for wall cabinets, tackboards and visual boards are not included due to variation between site conditions.

**LEVELING GLIDES**

- Shipped in a plastic bag attached to the bottom of the item or inside the pedestal. It is important to install leveling glides to ensure the unit is level. Levelers have a 1" range of adjustment.

**HANGING FILE RAILS**

- Pre-installed on file drawer perimeters and accommodate both legal and letter size filing. Legal filing can be achieved either as side-to-side or front-to-back. Letter filing can be achieved as front-to-back filing only.

**FLAT PLATES**

- Flat plates are used to attach bridges and returns to desks and are shipped pre-attached to the bottom of the bridge or return.
  - Mini flat plates for securing bridge back panels to desk or credenza end panels, and quick connectors for securing modular corner units to adjacent pieces, are shipped along with screws in a plastic bag attached to the bottom of the bridge or return.
- CAUTION:** Using screws other than those supplied by Global could result in damage to finished tops.

**WALL-MOUNTED CABINETS, TACKBOARDS AND VISUAL BOARDS**

- Pre-attached with horizontal wall rails to the back of each unit. The wall-side components must be detached from the unit and fastened to the wall accordingly.
- Wall fasteners are not included due to the variable site conditions. Securing the wall rail to a vertical structural member is the required manner of installation. The cabinet or visual board is then lowered on to the wall rail. It is important to level the wall rail before installation.
- Wall cabinets are equipped with levelers at the bottom of the back panels for proper cabinet alignment.
- Units with doors are equipped with adjustable European door hinges to assist in door alignment. It is required to use a #8 wood screw through the back of the cabinet and the wall-mounted rail, to further secure the wall attachment.
- Tackboards have vertical grooves in the back for tasklight wiring.
- Hutches and tackboards are installed with double faced tape applied to the bottom of the end panels. The tape is shipped in a plastic bag found in the hutch. Removal of the hutch requires moderate pressure to be applied on the top of the unit towards the wall for at least a minute for the pressure sensitive tape to release. Additional support may be added by installing flat plates along the outside back of the attached units. *These flat plates are not included in the shipment.*
- Hutch tackboards are factory-installed.
- Tackboards are standard in Grade 3 panel fabrics.

**MODULAR STORAGE UNITS**

- Pre-drilled holes through the unfinished tops for securing to the bottom of worksurfaces
- Screws and lock keys are included in a plastic bag fastened inside the pedestal. Installer should leave a 1/8" reveal between the Modular Storage Unit and the End panel. Disassemble the Modular Unit first before relocating the entire unit to avoid damage or bodily injuries.

**PEDESTAL SPACERS**

- Required if pedestals are placed side by side. A 1" gap is required between the modular pedestals to allow access to vertical fingerpulls. If required, order **SP700**.

**5-SIDED CORNER TABLES**

- Join bridge and credenza run-offs, using the supplied quick connectors.
- Recessed end-panels in these units are pre-drilled to accept quick-connectors for easy alignment
- Accurate leveling is critical for these units to align and connect properly.
- Flat-plates are pre-attached to the worksurface to secure to the desk unit.

## 1. SPECIFY MODEL NUMBER

## 2. SPECIFY FINISH

### WORKSURFACE TOP & DRAWER/DOOR FRONTS, BODY FINISHES (INCLUDING PEDESTALS) - VENEER

Code	Finish	Veneer Type	Cut
AMW	Almond Cherry	Cherry	Flat Sliced
ACW	Amber Cherry	Cherry	Flat Sliced
BTW	Biscotti	White Oak	Rift
CAW	Cocoa Walnut	Walnut	Flat Sliced
CRW	Coral	White Oak	Rift
DCW	Dark Cherry	Cherry	Flat Sliced
DWW	Dark Walnut	Walnut	Flat Sliced
EWV	Espresso Walnut	Walnut	Flat Sliced
EVW	Evening Oak	White Oak	Rift
GRW	Grey on Oak	White Oak	Rift
HAW	Hazelnut	Maple	Flat Sliced
JAW	Java	White Oak	Rift
LTW	Latte Walnut	Walnut	Flat Sliced
MHW	Mahogany on Walnut	Walnut	Flat Sliced
MTW	Milestone	White Oak	Rift
MPW	Natural Maple	Maple	Flat Sliced
NLW	Natural Walnut	Walnut	Flat Sliced
RCW	Red Cherry	Cherry	Flat Sliced
VNW	Vintage Cherry	Cherry	Flat Sliced
ULW	Umber Walnut	Walnut	Flat Sliced
WLW	Walnut	Walnut	Flat Sliced
WCW	Warm Cherry	Cherry	Flat Sliced
WMW	White Maple	Maple	Flat Sliced

### METAL FINISHES:

E	Black
K	Tungsten
DWT	Designer White
P	Brushed Chrome

### GLASS FINISH (for Glass Doors and Modesty Panels)

- Bronze Glass (standard)
- Clear Glass - contact Customer Care

## 3. SPECIFY OPTIONS

### GROMMETS

- Standard grommet on all components is **GM5**. Grommets are included with products where shown in product line drawings.
- Optional grommets may be ordered in standard worksurface locations (left, center or right). Order as **GM5L**, **GM5C** or **GM5R**. **Add \$96**.
- Grommet hole dimensions are 3.5" x 2". Specify **GM5E** for **Black** or **GM5K** for **Tungsten**.
- Color of grommet will be automatically coordinated with handle color where applicable

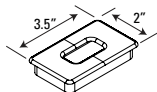

- Components that come standard with grommet may be ordered without a grommet. Order as RSG - **Add \$53**.
- View diagrams on the following pages for additional details.

### GROMMET LOCATIONS

- Grommets and Grommet Locations must be specified.
- Includes standard and optional grommet locations.
- For TEL & TER location please contact Customer Care.

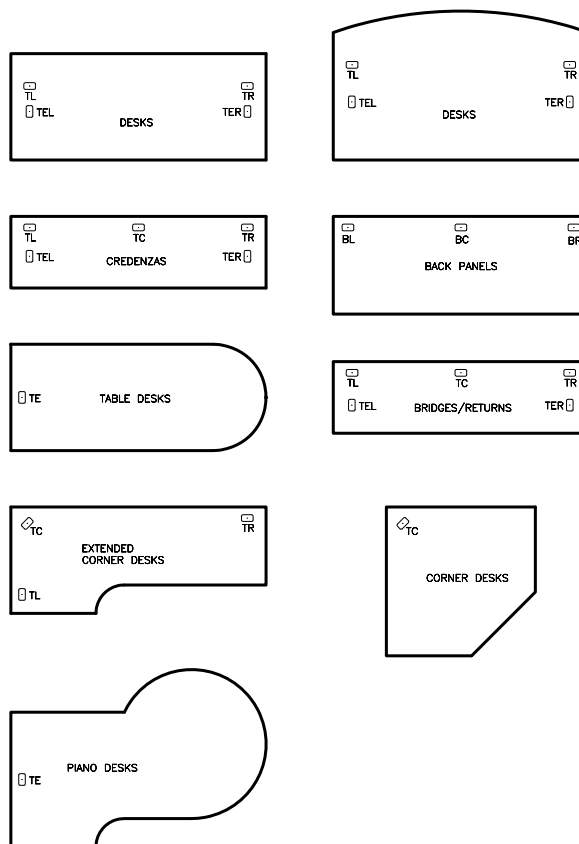

# P PHILADELPHIA - EDGE DETAILS

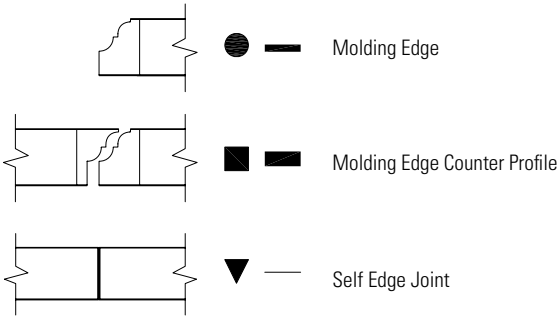

- D** - Desks and Credenzas
- B** - Executive Bridges
- E** - Executive Returns
- C** - Corner Components
- L** - Linking Bridges
- P** - Piano Desks

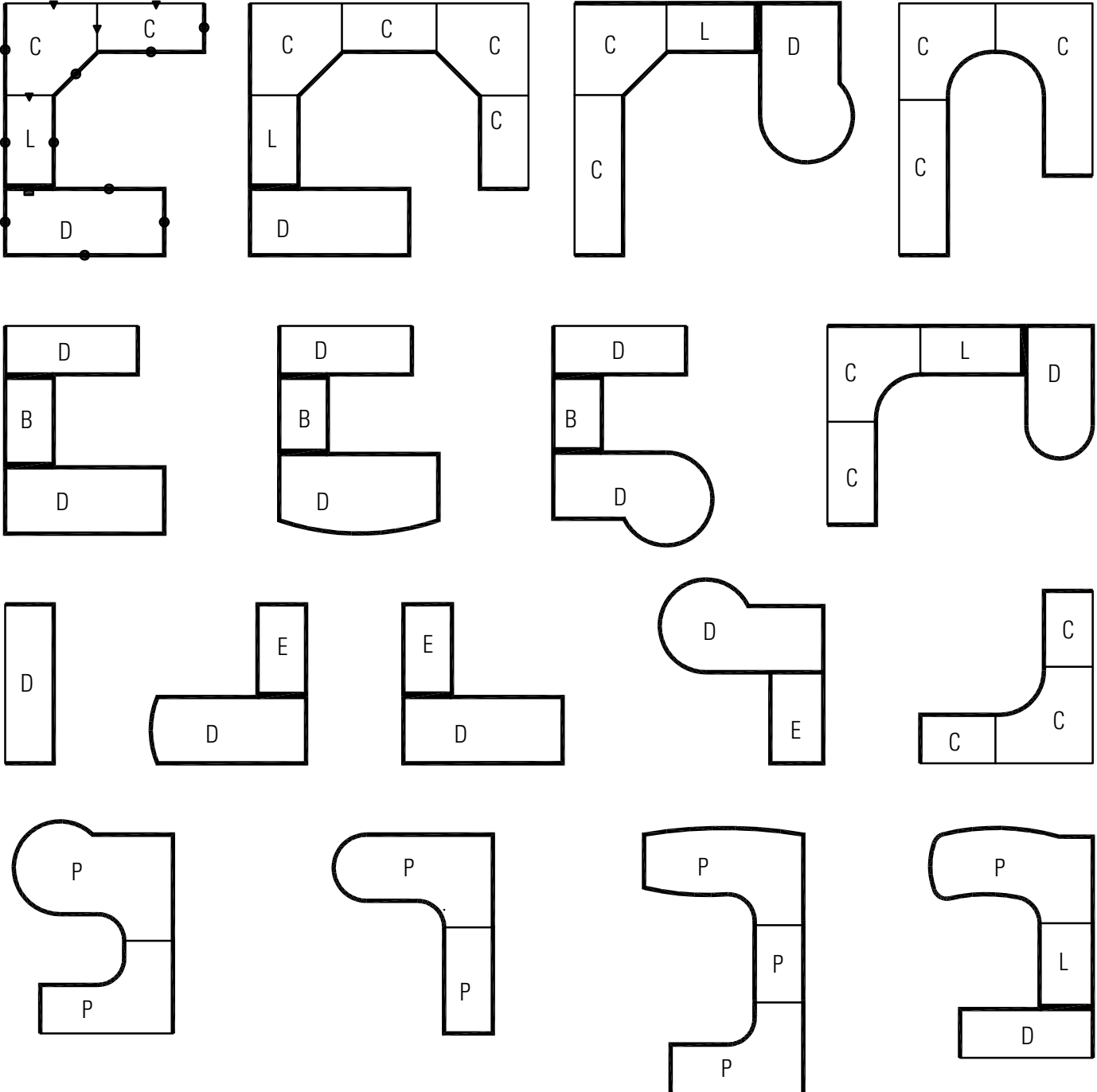

**DESK AND CREDENZA NOTES**

- Can be ordered as a shell or with pedestals
- Hand of Rectangular Desk is determined by location of pedestal from user side
- Hand of "D" Top is determined by outward orientation of curved end from user projection.
- Hand of "P" Top is determined by outward orientation of conference end from user projection.

Isometric View

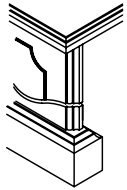

Side View  
1-3/8" Top

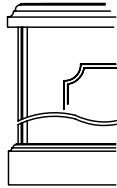

Front View  
1-3/16" Slab

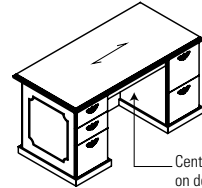
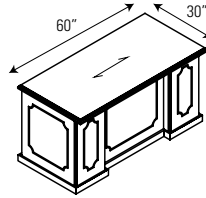
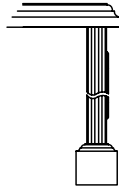

Center drawer standard on double pedestal desk

**MODESTY PANEL CLEARANCE**

PBID7236DE

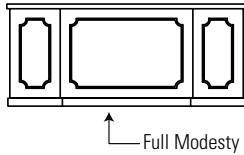

PBID7236 (7236 indicates top size)

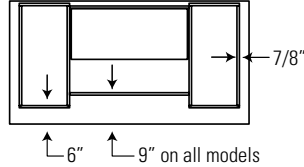

PBISR7230D

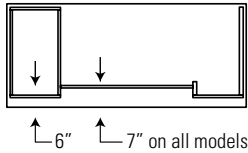

PBDDFL7230 (Left shown)

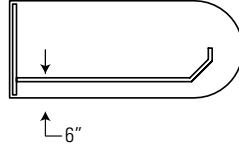

PBTPOL7242 (Left shown)

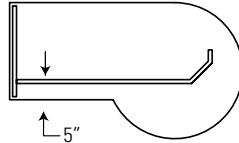

PBC7220

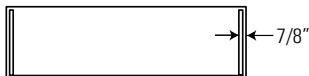

# P PHILADELPHIA - NOTES

## PIANO DESKS AND LINKING RETURNS

- All Desks are shipped assembled.
- Units include standard Grommets shown and installed horizontal wire management
- Unit is handed by Post Leg • Not for use with regular Corner Units

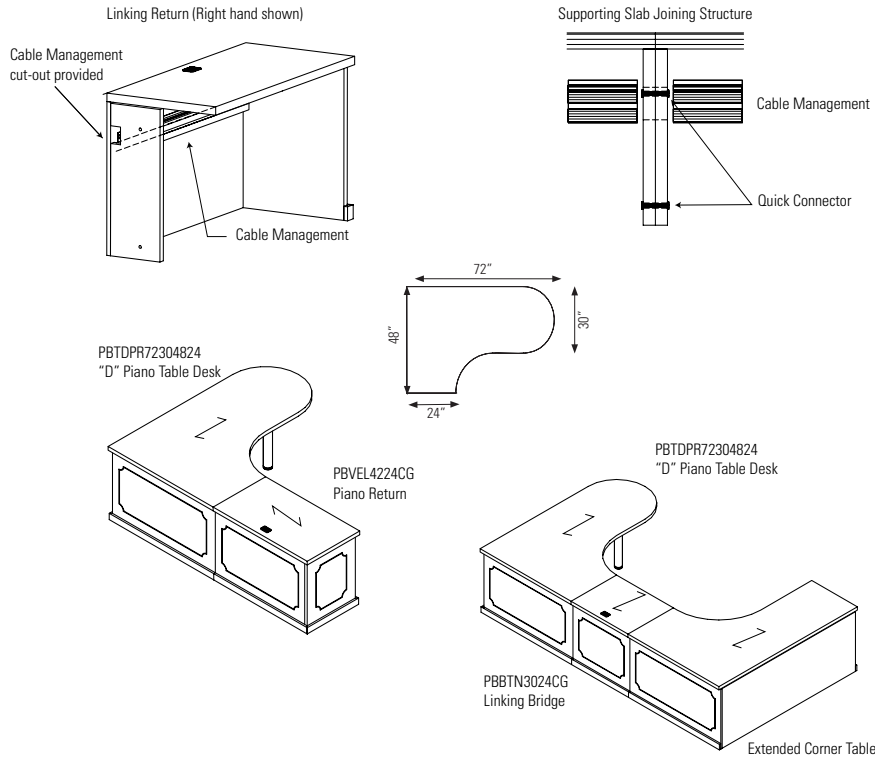

## EXECUTIVE BRIDGES

- Executive Bridge is used to connect a Desk to a Credenza.
- Not to be used with Corner Components or Piano Desks.
- Three Back Panel options
- Back panel flush with end panels of Desk and Credenza
- Includes GM5 Grommet Top Center
- The standard grain direction is cross grain (**CG**). To remove cross grain veneer pattern on top, delete suffix "**CG**" from the model number (no upcharge)

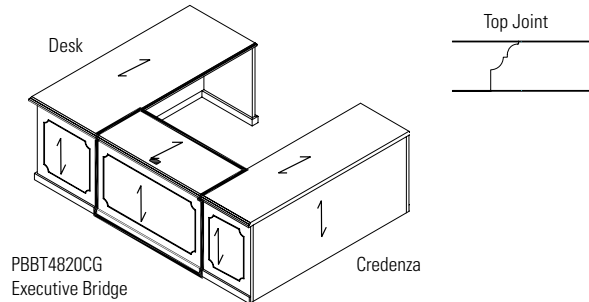

PBBT4820CG  
Dimensions are actual

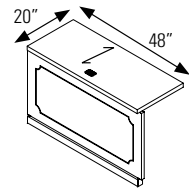

PBBT4820CG  
Full Back Panel

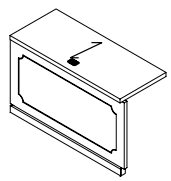

PBBT4820TCG  
Bridge Top only

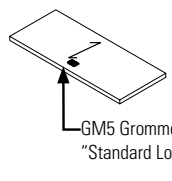

GM5 Grommet  
"Standard Location on Bridges"

PBBT4820Q8CG  
8" Back Panel

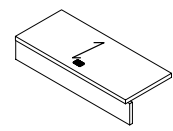

**EXECUTIVE RETURNS**

- Executive Return is used to attach to a Single Pedestal Desk, Single Pedestal Credenza, Desk Shell or Credenza Shell.
- Can be specified as a Shell or with a Pedestal.
- Back Panels are available as either full height or 8" from the underside of the worksurface.
- Hand of Executive Return is determined by location of full end panel from user side.
- Hand of Desk or Credenza is determined by location of pedestal from user side.
- The standard grain direction on return tops is cross grain (**CG**). To remove cross grain veneer pattern on top, delete suffix "**CG**" from the model number (no upcharge)

Executive Return attached to Desk or Credenza

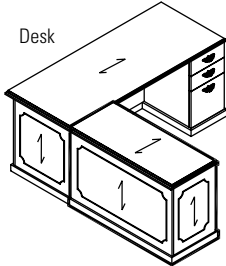

PBERL4822CG  
Executive Return

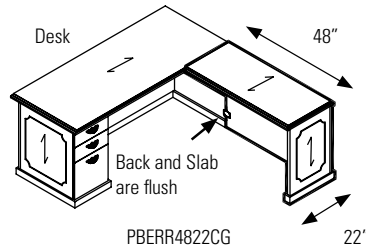

PBERR4822CG  
Executive Return

**CORNER COMPONENTS**

- Corner Table is used to connect to Linking Bridge and Linking Credenza.
- Cable management tray included.
- Back Panels are available as either full height or 8" from the underside of the worksurface.
- Hand of Linking Credenza is determined by location of full end panel from user side.
- Hand of Extended Corner is determined by location of long narrow end from user side
- The standard grain direction is cross grain (**CG**). To remove cross grain veneer pattern on top, delete suffix "**CG**" from the model number (no upcharge)

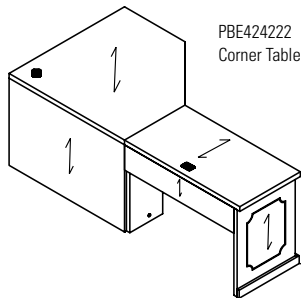

PBE424222  
Corner Table

PBEK424222  
Corner Table

PBEK424222  
Corner Table

Supporting Slab Joining Structure

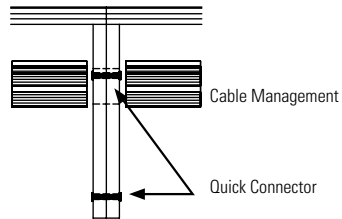

Cable Management

Quick Connector

Linking Return  
Right Hand Shown

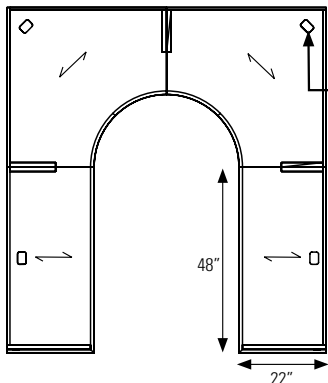
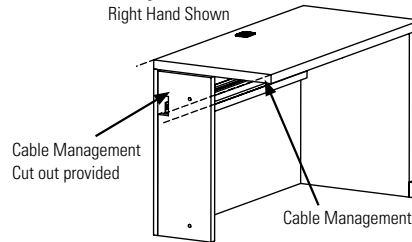

PBVL4822CG  
Linking Return

PBVR4822CG  
Linking Return

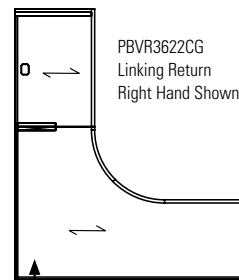

PBVR3622CG  
Linking Return  
Right Hand Shown

PBEKL724822  
Extended Corner Table

Grommet must be specified if required.



## LINKING BRIDGES

- Linking Bridge is used to connect Corner Components to Single Pedestal Desk, Single Pedestal Credenza, Desk Shell or Credenza Shell.
- Back panels are available as either full height or 8" from the underside of the worksurface.
- Includes GM5 Grommet Top Center
- Hand of Linking Bridge is determined by location of half end panel from user side
- The standard grain direction is cross grain (**CG**). To remove cross grain veneer pattern on top, delete suffix "**CG**" from the model number (no upcharge)

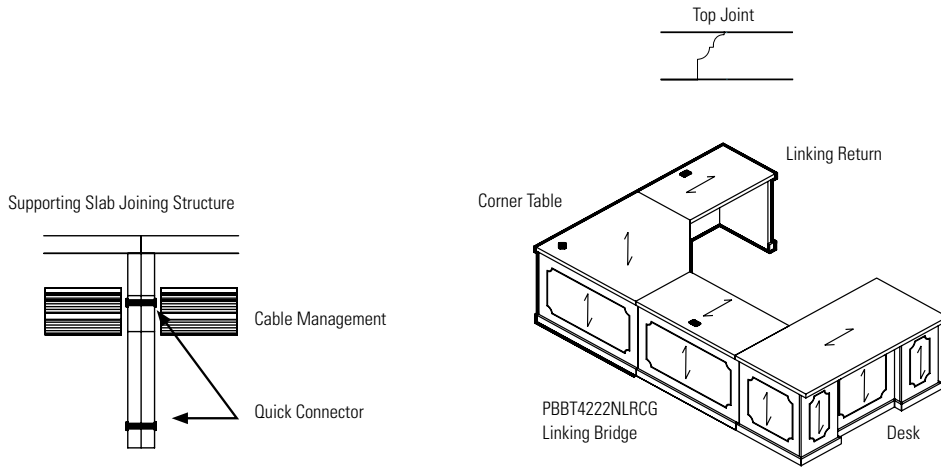

## COPING AND SELF-EDGE OPTIONS

- Coping option provides an undercut on hutches only so that storage cabinets placed next to the hutch fit flush.
  - Specify **COP** for coping on both sides, **COPR** for coping on the right side and **COPL** for coping on the left side. No upcharge.
- Self edge options provide a flush fit when storage units are placed next to one another.
  - Specify **SE** for self-edge on both sides, **SER** for self-edge on the right side and **SEL** for self-edge on the left side. When **SE**, **SER**, **SEL** are specified, the corresponding bottom base molding will also be removed. No upcharge.
  - Coping and self-edge handedness are from the users perspective. See diagram below.

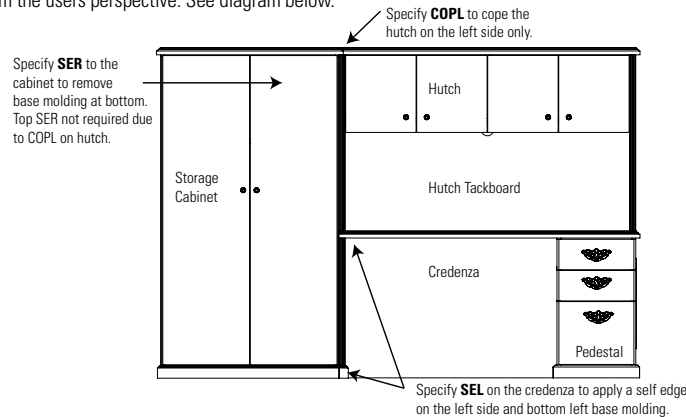

## MODULAR PEDESTALS AND HANDLES

- Modular Pedestal for Philadelphia using "C" components.
- SP700 spacer is required if two Modular Pedestals are placed side by side when there is no handles. Order as special.
- Credenza shell cannot be completely filled up with modular components to create a full storage credenza.

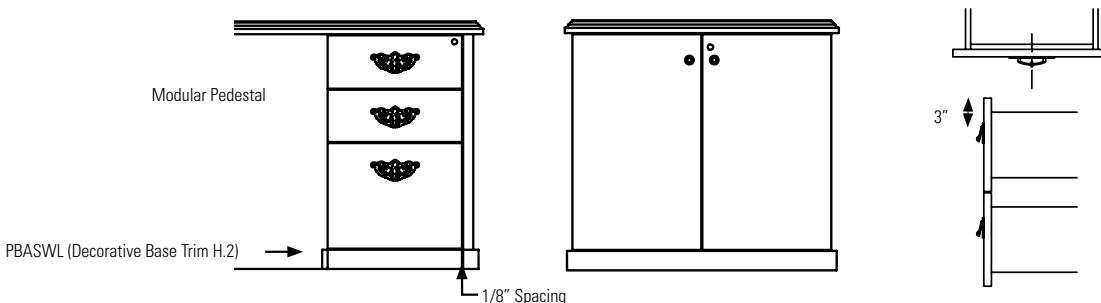

**LOCKING**

- Locks are standard on all below worksurface level drawer and door storage units with the exception of the pull-out tray units and single lateral file drawer combination tray/slot units.
- Locks are optional on all above worksurface level closed storage units.

**Standard Lock Positions**

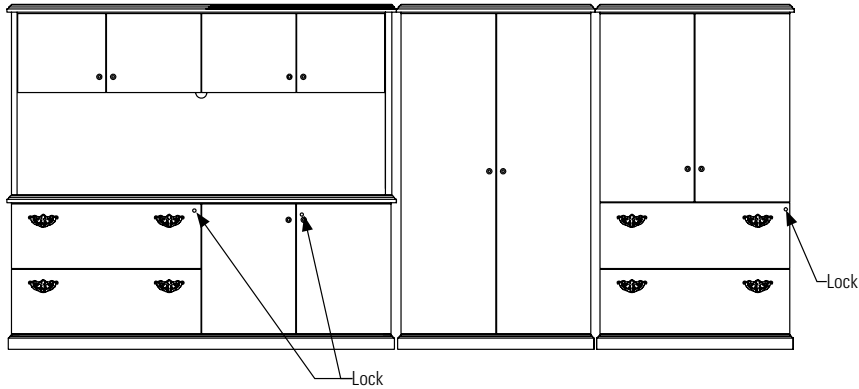

PBCF7222

Full Storage Credenza: Locks are on the front.

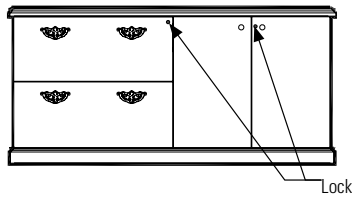

PB7236DE

Double Pedestal Desk/Credenza:

Lock for D and E Pedestals are on the inside Gable.

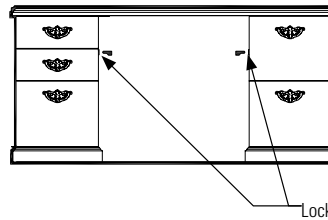

PBZR

Combination Storage Unit:

Lock for File and Lateral File Drawer only,  
Box Drawers do not lock.

Box Drawers  
do not lock

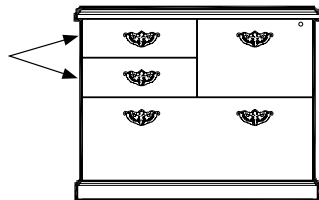

PBWF

Modular Furniture:  
Lock is on the front.

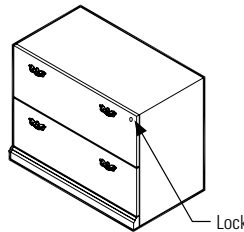

PBWD

Modular Furniture:  
Lock is on the front.

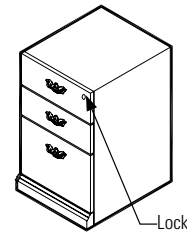

**HUTCH POSITIONING**

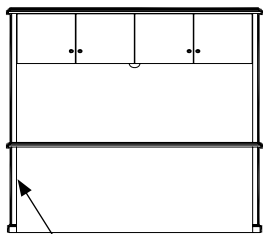

There must be an end panel  
under the hutch

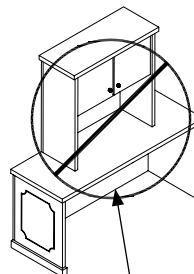
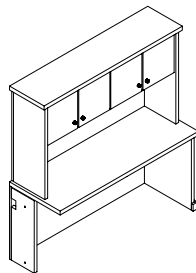

Missing Support  
NOT Recommended

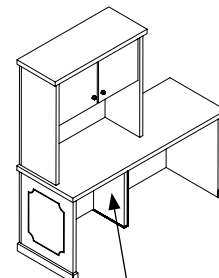

Add optional Support  
SLAB12 (as Special)

## TACKBOARDS

### Tackboards for Storage Huches

PB72SH36

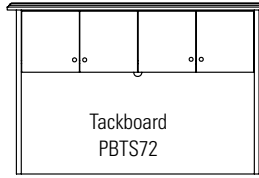

PB72SHP42 and PB722SHP54

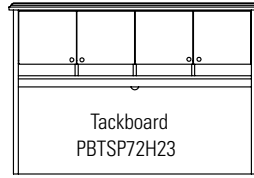

PB72SH42 and PB722SH54

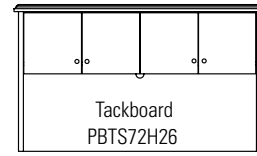

### Tackboards with Accessory Rail

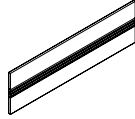

PBTAS72

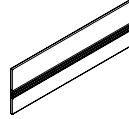

PBTSPAS72H23

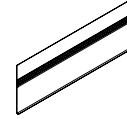

PBTAS72H26

### Tackboards for Wall Mount Overheads

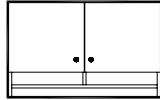

CSF36

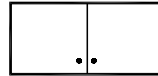

CSFP36

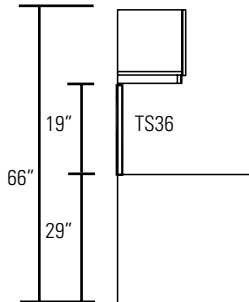

TS36

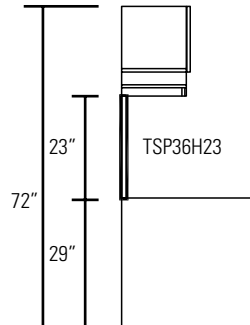

TSP36H23

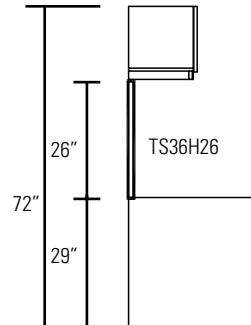

TS36H26

**LIGHTING**

Wall Mount

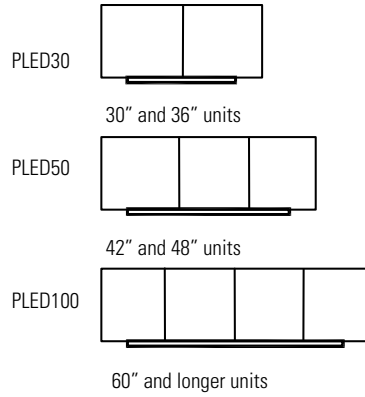

Hutch

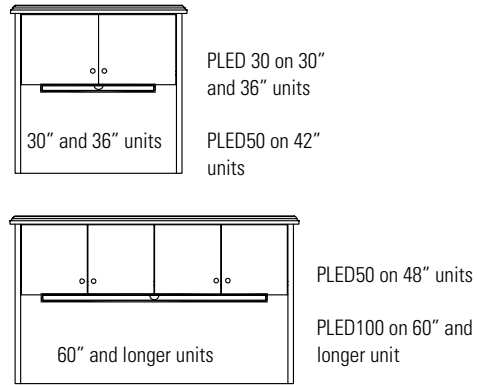

## DESKS - NOTES

**NOTE:** Arrow indicates direction of grain

#### Double Pedestal Desks

- Shipped assembled
- Kneewell locking standard and keyed alike
- Standard with center drawer
- For optional pull-out writing tray, specify **WTD**. Add **\$679**.

#### Single Pedestal Desks

- Shipped assembled
- Kneewell locking standard and keyed alike
- For optional pull-out writing tray, specify **WTS**. Add **\$343**.

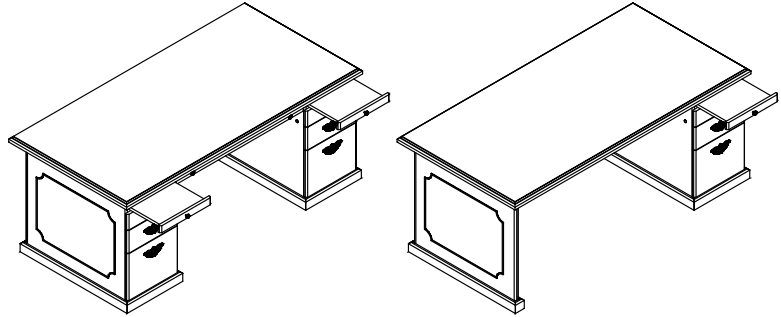

#### D and P shaped desks

- Shipped assembled.

#### D and P shaped connecting desks

- Shipped knocked down.
- The standard grain direction on D and P shaped connecting desks is cross grain (**CG**). To remove cross grain veneer pattern on top, delete suffix "**CG**" from the model number (no upcharge)
- Pedestals are handed:
  - Left pedestals have the handle offset from the center to the right, and the lock is placed on the right end panel
  - Right pedestals have the handle offset from the center to the left, and the lock is placed on the left end panel
- Modesty panels are available in wood or glass
- Grommets are available as an option on Desks and most Credenzas.

**DOUBLE PEDESTAL DESKS**      **MODEL#**      **DIMENSIONS**      **FREIGHT CLASS**      **WT/LBS.**      **CUBIC FT.**      **LIST PRICE**

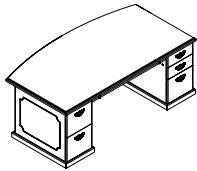

**Double Pedestal Bow Top Desk  
Breakfront Style**

	<b>D x W x H</b>					
PBMID8442ED	42 x 84 x 29	125	443	59		<b>\$12604</b>
PBMID7842ED	42 x 78 x 29	125	412	55		<b>\$11772</b>
PBMID7242ED	42 x 72 x 29	125	380	51		<b>\$10940</b>
PBMID6636ED	36 x 66 x 29	100	340	40		<b>\$10640</b>

Standard with full to floor **file/file** pedestal on **left** and **box/box/file** pedestal on **right**. Pedestals lock.  
Inset Full Height Modesty Panel.

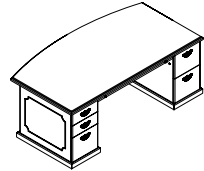

**Double Pedestal Bow Top Desk  
Breakfront Style**

PBMID8442DE	42 x 84 x 29	125	443	59		<b>\$12604</b>
PBMID7842DE	42 x 78 x 29	125	412	55		<b>\$11772</b>
PBMID7242DE	42 x 72 x 29	125	380	51		<b>\$10940</b>
PBMID6636DE	36 x 66 x 29	100	340	40		<b>\$10640</b>

Standard with full to floor **box/box/file** pedestal on **left** and **file/file** pedestal on **right**. Pedestals lock.  
Inset Full Height Modesty Panel.

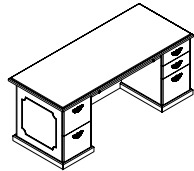

**Double Pedestal Desk  
Breakfront Style**

PBID8442ED	42 x 84 x 29	125	442	59		<b>\$10865</b>
PBID7842ED	42 x 78 x 29	125	421	55		<b>\$10156</b>
PBID7236ED	36 x 72 x 29	100	375	44		<b>\$9451</b>
PBID7230ED	30 x 72 x 29	100	345	36		<b>\$9322</b>
PBID6636ED	36 x 66 x 29	100	360	40		<b>\$9322</b>
PBID6630ED	30 x 66 x 29	92.5	315	30		<b>\$9192</b>
PBID6030ED	30 x 60 x 29	92.5	315	30		<b>\$8930</b>

Standard with full to floor **file/file** pedestal on **left** and **box/box/file** pedestal on **right**. Pedestals lock.  
Inset Full Height Modesty Panel.

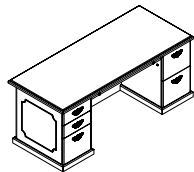

**Double Pedestal Desk  
Breakfront Style**

PBID8442DE	42 x 84 x 29	125	442	59		<b>\$10865</b>
PBID7842DE	42 x 78 x 29	125	421	55		<b>\$10156</b>
PBID7236DE	36 x 72 x 29	100	375	44		<b>\$9451</b>
PBID7230DE	30 x 72 x 29	100	345	36		<b>\$9322</b>
PBID6636DE	36 x 66 x 29	100	360	40		<b>\$9322</b>
PBID6630DE	30 x 66 x 29	92.5	315	30		<b>\$9192</b>
PBID6030DE	30 x 60 x 29	92.5	315	30		<b>\$8930</b>

Standard with full to floor **box/box/file** pedestal on **left** and **file/file** pedestal on **right**. Pedestals lock.  
Inset Full Height Modesty Panel.

**Required Specifications**

Finish

**Optional Specifications**

Grommet  
Modesty panel  
Pull-out writing tray

## SINGLE PEDESTAL DESKS

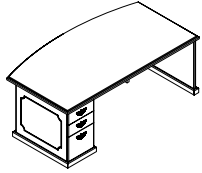

**Single Pedestal Bow Top Desk - Left\***  
*Breakfront Style*

MODEL#	DIMENSIONS D x W x H	FREIGHT CLASS	WT./LBS.	CUBIC FT.	LIST PRICE
PBMISL8442D	42 x 84 x 29	125	452	59	<b>\$9220</b>
PBMISL7842D	42 x 78 x 29	125	337	55	<b>\$8562</b>
PBMISL7242D	42 x 72 x 29	125	322	51	<b>\$7907</b>
PBMISL6636D	36 x 66 x 29	125	290	40	<b>\$7603</b>

Standard with full to floor **box/box/file** pedestal on **left**. Pedestals lock.  
Inset Full Height Modesty Panel.

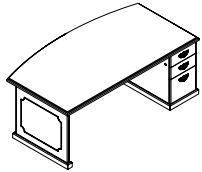

**Single Pedestal Bow Top Desk - Right\***  
*Breakfront Style*

PBMISR8442D	42 x 84 x 29	125	452	59	<b>\$9220</b>
PBMISR7842D	42 x 78 x 29	125	337	55	<b>\$8562</b>
PBMISR7242D	42 x 72 x 29	125	322	51	<b>\$7907</b>
PBMISR6636D	36 x 66 x 29	125	290	40	<b>\$7603</b>

Standard with full to floor **box/box/file** pedestal on **right**. Pedestals lock.  
Inset Full Height Modesty Panel.

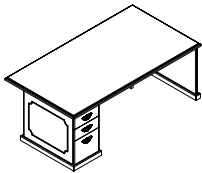

**Single Pedestal Desk - Left\***  
*Breakfront Style*

PBISL8442D	42 x 84 x 29	125	387	59	<b>\$8804</b>
PBISL7842D	42 x 78 x 29	125	366	55	<b>\$8173</b>
PBISL7236D	36 x 72 x 29	125	320	44	<b>\$6468</b>
PBISL7230D	30 x 70 x 29	100	290	36	<b>\$6180</b>
PBISL6636D	36 x 66 x 29	125	305	40	<b>\$6180</b>
PBISL6630D	30 x 66 x 29	100	275	33	<b>\$5898</b>
PBISL6030D	30 x 60 x 29	100	260	30	<b>\$5638</b>

Standard with full to floor **box/box/file** pedestal on **left**. Pedestals lock.  
Inset Full Height Modesty Panel.

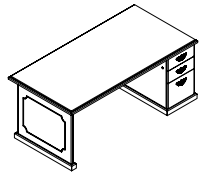

**Single Pedestal Desk - Right\***  
*Breakfront Style*

PBISR8442D	42 x 84 x 29	125	387	59	<b>\$8804</b>
PBISR7842D	42 x 78 x 29	125	366	55	<b>\$8173</b>
PBISR7236D	36 x 72 x 29	125	320	44	<b>\$6468</b>
PBISR7230D	30 x 70 x 29	100	290	36	<b>\$6180</b>
PBISR6636D	36 x 66 x 29	125	305	40	<b>\$6180</b>
PBISR6630D	30 x 66 x 29	100	275	33	<b>\$5898</b>
PBISR6030D	30 x 60 x 29	100	260	30	<b>\$5638</b>

Standard with full to floor **box/box/file** pedestal on **right**. Pedestals lock.  
Inset Full Height Modesty Panel.

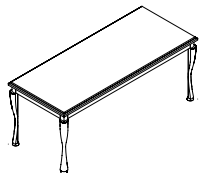

**Table Desk**  
*Queen Anne Style*

PBQATB8442	42 x 84 x 29	150	272	59	<b>\$10236</b>
PBQATB7842	42 x 78 x 29	150	253	55	<b>\$9598</b>
PBQATB7236	36 x 72 x 29	150	205	44	<b>\$7773</b>
PBQATB7230	30 x 70 x 29	150	192	36	<b>\$7002</b>
PBQATB6636	36 x 66 x 29	150	192	40	<b>\$7002</b>
PBQATB6630	30 x 66 x 29	150	188	33	<b>\$6160</b>
PBQATB6030	30 x 60 x 29	150	171	30	<b>\$5494</b>

Inset Full Height Modesty Panel.

### Required Specifications

Finish

### Optional Specifications

Additional grommet  
Modesty panel\*  
Pull-out writing tray\*

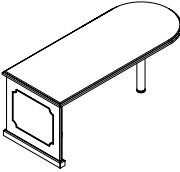
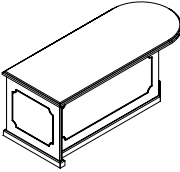
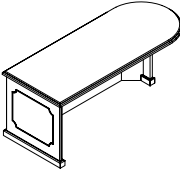
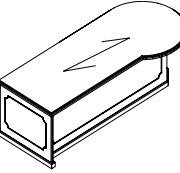
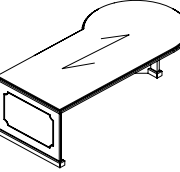
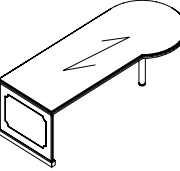
DESKS	MODEL#	DIMENSIONS	FREIGHT CLASS	WT/LBS.	CUBIC FT.	LIST PRICE
 <p><b>"D" Shaped Connecting Table Desk</b></p>	<b>D x W x H</b>					
	PBDD8436	36 x 84 x 29	125	343	51	<b>\$5750</b>
	PBDD7236	36 x 72 x 29	125	294	44	<b>\$4926</b>
	PBDD7230	30 x 72 x 29	125	264	36	<b>\$4578</b>
	PBDD6636	36 x 66 x 29	125	245	40	<b>\$4578</b>
	PBDD6030	30 x 60 x 29	125	225	30	<b>\$4398</b>
Wood column support and full end panel.						
 <p><b>"D" Shaped Table Desk - Left</b></p>	PBDDFL8436	36 x 84 x 29	125	367	51	<b>\$7062</b>
	PBDDFL7236	36 x 72 x 29	125	320	44	<b>\$6055</b>
	PBDDFL7230	30 x 72 x 29	100	290	36	<b>\$5711</b>
	PBDDFL6636	36 x 66 x 29	125	271	40	<b>\$5711</b>
	PBDDFL6030	30 x 60 x 29	100	247	30	<b>\$5527</b>
	With 45° angled modesty and end panel.					
 <p><b>"D" Shaped Table - Right</b></p>	PBDDFR8436	36 x 84 x 29	125	367	51	<b>\$7062</b>
	PBDDFR7236	36 x 72 x 29	125	320	44	<b>\$6055</b>
	PBDDFR7230	30 x 72 x 29	100	290	36	<b>\$5711</b>
	PBDDFR6636	36 x 66 x 29	125	271	40	<b>\$5711</b>
	PBDDFR6030	30 x 60 x 29	100	247	30	<b>\$5527</b>
	With 45° angled modesty and end panel.					
 <p><b>"P" Shaped Connecting Table - Left</b></p>	PBTPOL9642	42 x 96 x 29	150	317	68	<b>\$8470</b>
	PBTPOL8442	42 x 84 x 29	150	277	59	<b>\$7410</b>
	PBTPOL7242	42 x 72 x 29	150	211	51	<b>\$6859</b>
	With 45° angled modesty and end panel.					
 <p><b>"P" Shaped Connecting Table - Right</b></p>	PBTPOR9642	42 x 96 x 29	150	317	68	<b>\$8470</b>
	PBTPOR8442	42 x 84 x 29	150	277	59	<b>\$7410</b>
	PBTPOR7242	42 x 72 x 29	150	211	51	<b>\$6859</b>
	With 45° angled modesty and end panel.					
 <p><b>"P" Shaped Connecting Table - Left</b></p>	PBTPL9642	42 x 96 x 29	125	440	68	<b>\$7179</b>
	PBTPL8442	42 x 84 x 29	125	385	59	<b>\$6283</b>
	PBTPL7242	42 x 72 x 29	125	319	51	<b>\$5727</b>
	Wood column support and full end panel.					

**Required Specifications**  
Finish

**Optional Specifications**  
Additional grommet



**DESKS**

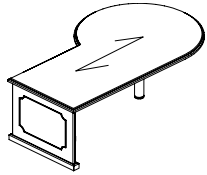

**"P" Shaped Connecting Table - Right**

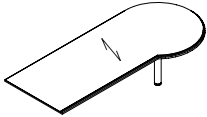

**"P" Shaped Connecting Table - Left**

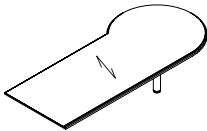

**"P" Shaped Connecting Table - Right**

MODEL#	DIMENSIONS D x W x H	FREIGHT CLASS	WT./LBS.	CUBIC FT.	LIST PRICE
PBTPR9642	42 x 96 x 29	125	440	68	<b>\$7179</b>
PBTPR8442	42 x 84 x 29	125	385	59	<b>\$6283</b>
PBTPR7242	42 x 72 x 29	125	319	51	<b>\$5727</b>

Wood column support and full end panel.

PBRPL9642CG	42 x 96 x 29	250	239	68	<b>\$6807</b>
PBRPL8442CG	42 x 84 x 29	250	209	59	<b>\$5958</b>
PBRPL7242CG	42 x 72 x 29	250	143	51	<b>\$5104</b>

Wood column support. No end panel.

PBRPR9642CG	42 x 96 x 29	250	239	68	<b>\$6807</b>
PBRPR8442CG	42 x 84 x 29	250	209	59	<b>\$5958</b>
PBRPR7242CG	42 x 72 x 29	250	143	51	<b>\$5104</b>

Wood column support. No end panel.

**Required Specifications**  
Finish

**Optional Specifications**  
Additional grommet

**RETURNS - NOTES**

D x W x H

- All returns are shipped assembled
- Kneewell locking standard
- The standard grain direction on returns is cross grain (**CG**). To remove cross grain veneer pattern on top, delete suffix "**CG**" from the model number (no upcharge)
- **NOTE:** Arrow indicates direction of grain

RETURNS	MODEL#	DIMENSIONS	FREIGHT CLASS	WT/LBS.	CUBIC FT.	LIST PRICE
---------	--------	------------	---------------	---------	-----------	------------

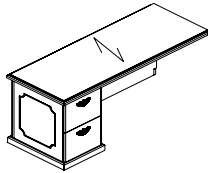

**Executive Return - Left**

PBERL7224ECG	24 x 72 x 29	100	250	29	<b>\$5816</b>
PBERL6624ECG	24 x 66 x 29	100	236	27	<b>\$5604</b>
PBERL6024ECG	24 x 60 x 29	100	227	24	<b>\$5098</b>
PBERL5424ECG	24 x 54 x 29	100	205	22	<b>\$4910</b>
PBERL4824ECG	24 x 48 x 29	100	185	19	<b>\$4364</b>
PBERL4224ECG	24 x 42 x 29	92.5	178	17	<b>\$4200</b>

Standard with full to floor **file/file** pedestal on **left**. Pedestal locks. Full height flush back panel.

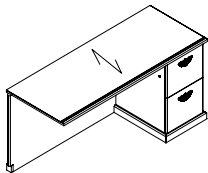

**Executive Return - Right**

PBERR7224ECG	24 x 72 x 29	100	250	29	<b>\$5816</b>
PBERR6624ECG	24 x 66 x 29	100	236	27	<b>\$5604</b>
PBERR6024ECG	24 x 60 x 29	100	227	24	<b>\$5098</b>
PBERR5424ECG	24 x 54 x 29	100	205	22	<b>\$4910</b>
PBERR4824ECG	24 x 48 x 29	100	185	19	<b>\$4364</b>
PBERR4224ECG	24 x 42 x 29	92.5	178	17	<b>\$4200</b>

Standard with full to floor **file/file** pedestal on **right**. Pedestal locks. Full height flush back panel.

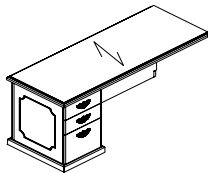

**Executive Return - Left**

PBERL7224DCG	24 x 72 x 29	100	250	29	<b>\$5816</b>
PBERL6624DCG	24 x 66 x 29	100	236	27	<b>\$5604</b>
PBERL6024DCG	24 x 60 x 29	100	227	24	<b>\$5098</b>
PBERL5424DCG	24 x 54 x 29	100	205	22	<b>\$4910</b>
PBERL4824DCG	24 x 48 x 29	100	185	19	<b>\$4364</b>
PBERL4224DCG	24 x 42 x 29	92.5	178	17	<b>\$4200</b>

Standard with full to floor **box/box/file** pedestal on **left**. Pedestal locks. Full height flush back panel.

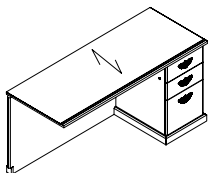

**Executive Return - Right**

PBERR7224DCG	24 x 72 x 29	100	250	29	<b>\$4200</b>
PBERR6624DCG	24 x 66 x 29	100	236	27	<b>\$5604</b>
PBERR6024DCG	24 x 60 x 29	100	227	24	<b>\$5098</b>
PBERR5424DCG	24 x 54 x 29	100	205	22	<b>\$4910</b>
PBERR4824DCG	24 x 48 x 29	100	185	19	<b>\$4364</b>
PBERR4224DCG	24 x 42 x 29	92.5	178	17	<b>\$4200</b>

Standard with full to floor **box/box/file** pedestal on **right**. Pedestal locks. Full height flush back panel.

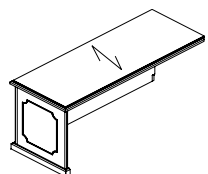

**Executive Return - Left**

PBERL7224CG	24 x 72 x 29	150	135	29	<b>\$3262</b>
PBERL6624CG	24 x 66 x 29	150	127	27	<b>\$2989</b>
PBERL6024CG	24 x 60 x 29	150	120	24	<b>\$2720</b>
PBERL5424CG	24 x 54 x 29	150	112	22	<b>\$2441</b>
PBERL4824CG	24 x 48 x 29	150	105	19	<b>\$2178</b>
PBERL4224CG	24 x 42 x 29	150	97	17	<b>\$1901</b>

Full height flush back panel.

**Required Specifications**  
Finish

**Optional Specifications**  
Grommet

**RETURNS**

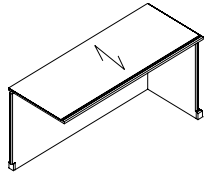

**Executive Return - Right**

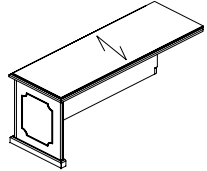

**Executive Return - Left**

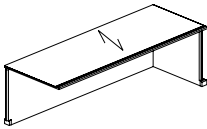

**Executive Return - Right**

**MODEL# DIMENSIONS FREIGHT CLASS WT/LBS. CUBIC FT. LIST PRICE**

**D x W x H**

PBERR7224CG	24 x 72 x 29	150	135	29	<b>\$3262</b>
PBERR6624CG	24 x 66 x 29	150	127	27	<b>\$2989</b>
PBERR6024CG	24 x 60 x 29	150	120	24	<b>\$2720</b>
PBERR5424CG	24 x 54 x 29	150	112	22	<b>\$2441</b>
PBERR4824CG	24 x 48 x 29	150	105	19	<b>\$2178</b>
PBERR4224CG	24 x 42 x 29	150	97	17	<b>\$1901</b>

Full height flush back panel.

PBERL7222CG	22 x 72 x 29	150	130	27	<b>\$3108</b>
PBERL6622CG	22 x 66 x 29	150	122	24	<b>\$2847</b>
PBERL6022CG	22 x 60 x 29	150	115	22	<b>\$2592</b>
PBERL5422CG	22 x 54 x 29	150	105	20	<b>\$2329</b>
PBERL4822CG	22 x 48 x 29	150	100	18	<b>\$2074</b>
PBERL4222CG	22 x 42 x 29	150	90	16	<b>\$1813</b>

Full height flush back panel.

PBERR7222CG	22 x 72 x 29	150	130	27	<b>\$3108</b>
PBERR6622CG	22 x 66 x 29	150	122	24	<b>\$2847</b>
PBERR6022CG	22 x 60 x 29	150	115	22	<b>\$2592</b>
PBERR5422CG	22 x 54 x 29	150	105	20	<b>\$2329</b>
PBERR4822CG	22 x 48 x 29	150	100	18	<b>\$2074</b>
PBERR4222CG	22 x 42 x 29	150	90	16	<b>\$1813</b>

Full height flush back panel.

**Required Specifications**  
Finish

**Optional Specifications**  
Additional grommet

**PIANO DESKS**

D x W x H

- All desks are shipped assembled
- Units include installed horizontal wire management
- Unit is handed by Post Leg
- Not for use with Regular Corner Units
- The standard grain direction on piano desks is cross grain (**CG**). To remove cross grain veneer pattern on top, delete suffix "**CG**" from the model number (no upcharge)
- If grommet color is not specified, Black is standard
- **NOTE:** Arrow indicates direction of grain

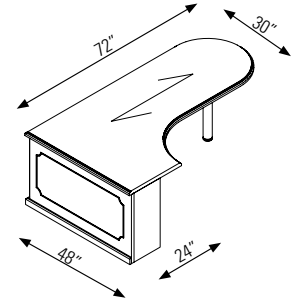

**PIANO DESKS**

**MODEL#      DIMENSIONS      FREIGHT CLASS      WT./LBS.      CUBIC FT.      LIST PRICE**

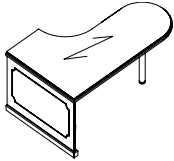

**D-shaped Piano Desk - Left**

PBTDPL96304824	48 x 96 x 29	125	464	77	<b>\$7468</b>
PBTDPL84304824	48 x 84 x 29	150	406	68	<b>\$6642</b>
PBTDPL72304824	48 x 72 x 29	125	348	58	<b>\$5817</b>

Wood column support and full end panel, 30"D worksurface extension and 24" return connection.

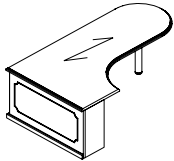

**D-shaped Piano Desk - Right**

PBTDPR96304824	48 x 96 x 29	125	464	77	<b>\$7468</b>
PBTDPR84304824	48 x 84 x 29	150	406	68	<b>\$6642</b>
PBTDPR72304824	48 x 72 x 29	125	348	58	<b>\$5817</b>

Wood column support and full end panel, 30"D worksurface extension and 24" return connection.

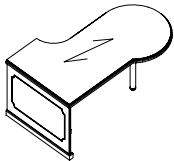

**P-shaped Piano Desk - Left**

PBTPPL96424824	54 x 96 x 29	150	580	97	<b>\$8521</b>
PBTPPL84424824	54 x 84 x 29	150	508	85	<b>\$7618</b>
PBTPPL72424824	54 x 72 x 29	150	435	73	<b>\$7064</b>

Wood column support and full end panel, 42"/30" worksurface and 24" return connection.

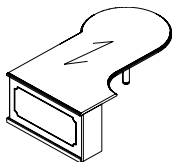

**P-shaped Piano Desk - Right**

PBTPPR96424824	54 x 96 x 29	150	580	97	<b>\$8521</b>
PBTPPR84424824	54 x 84 x 29	150	508	85	<b>\$7618</b>
PBTPPR72424824	54 x 72 x 29	150	435	73	<b>\$7064</b>

Wood column support and full end panel, 42"/30" worksurface and 24" return connection.

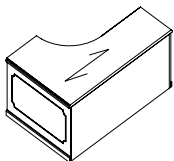

**Extended Corner Table Desk - Left**

PBEKL964824MR	48 x 96 x 29	150	387	77	<b>\$8113</b>
PBEKL904824MR	48 x 90 x 29	150	363	73	<b>\$7661</b>
PBEKL844824MR	48 x 84 x 29	150	338	68	<b>\$7571</b>
PBEKL784824MR	48 x 78 x 29	150	314	63	<b>\$7530</b>
PBEKL724824MR	48 x 72 x 29	150	290	58	<b>\$7157</b>
PBEKL664824MR	48 x 66 x 29	150	266	52	<b>\$6673</b>
PBEKL604824MR	48 x 60 x 29	150	242	48	<b>\$6184</b>

With 24" return connection.

**Required Specifications**

Finish

**Optional Specifications**

Additional grommet

## PIANO DESKS

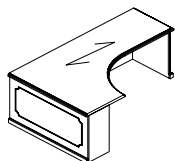

**Extended Corner Table Desk - Right**

MODEL#	DIMENSIONS D x W x H	FREIGHT CLASS	WT./LBS.	CUBIC FT.	LIST PRICE
PBEKR489624ML	48 x 96 x 29	150	387	77	<b>\$8113</b>
PBEKR489024ML	48 x 90 x 29	150	363	73	<b>\$7661</b>
PBEKR488424ML	48 x 84 x 29	150	338	68	<b>\$7571</b>
PBEKR487824ML	48 x 78 x 29	150	314	63	<b>\$7530</b>
PBEKR487224ML	48 x 72 x 29	150	290	58	<b>\$7157</b>
PBEKR486624ML	48 x 66 x 29	150	266	52	<b>\$6673</b>
PBEKR486024ML	48 x 60 x 29	150	242	48	<b>\$6184</b>

With 24" return connection.

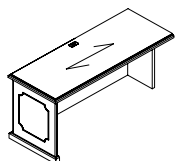

**Linking Return - Left**

PBVEL9624CG	24 x 96 x 29	150	200	39	<b>\$4931</b>
PBVEL9024CG	24 x 90 x 29	150	187	36	<b>\$4623</b>
PBVEL8424CG	24 x 84 x 29	150	174	34	<b>\$4315</b>
PBVEL7824CG	24 x 78 x 29	150	162	31	<b>\$4002</b>
PBVEL7224CG	24 x 72 x 29	150	149	29	<b>\$3699</b>
PBVEL6624CG	24 x 66 x 29	150	141	27	<b>\$3472</b>
PBVEL6024CG	24 x 60 x 29	150	132	24	<b>\$3245</b>
PBVEL5424CG	24 x 54 x 29	150	121	22	<b>\$3061</b>
PBVEL4824CG	24 x 48 x 29	125	115	19	<b>\$2878</b>
PBVEL4224CG	24 x 42 x 29	150	99	17	<b>\$2423</b>
PBVEL3624CG	24 x 36 x 29	150	83	15	<b>\$2340</b>
PBVEL3024CG	24 x 30 x 29	125	77	12	<b>\$2325</b>
PBVEL2424CG	24 x 24 x 29	125	61	10	<b>\$1928</b>

Used in conjunction with extended piano corner units or piano shaped desks.

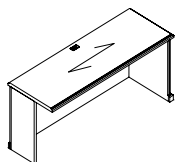

**Linking Return - Right**

PBVER9624CG	24 x 96 x 29	150	200	39	<b>\$4931</b>
PBVER9024CG	24 x 90 x 29	150	187	36	<b>\$4623</b>
PBVER8424CG	24 x 84 x 29	150	174	34	<b>\$4315</b>
PBVER7824CG	24 x 78 x 29	150	162	31	<b>\$4002</b>
PBVER7224CG	24 x 72 x 29	150	149	29	<b>\$3699</b>
PBVER6624CG	24 x 66 x 29	150	141	27	<b>\$3472</b>
PBVER6024CG	24 x 60 x 29	150	132	24	<b>\$3245</b>
PBVER5424CG	24 x 54 x 29	150	121	22	<b>\$3061</b>
PBVER4824CG	24 x 48 x 29	125	115	19	<b>\$2878</b>
PBVER4224CG	24 x 42 x 29	150	99	17	<b>\$2423</b>
PBVER3624CG	24 x 36 x 29	150	83	15	<b>\$2340</b>
PBVER3024CG	24 x 30 x 29	125	77	12	<b>\$2325</b>
PBVER2424CG	24 x 24 x 29	125	61	10	<b>\$1928</b>

Used in conjunction with extended piano corner units or piano shaped desks.

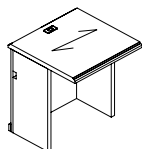

**Bridge**

PBBTN4824CG	24 x 48 x 29	150	110	19	<b>\$2791</b>
PBBTN4224CG	24 x 42 x 29	150	94	17	<b>\$2340</b>
PBBTN3624CG	24 x 36 x 29	150	79	15	<b>\$2253</b>
PBBTN3024CG	24 x 30 x 29	125	72	12	<b>\$2205</b>
PBBTN2424CG	24 x 24 x 29	150	56	10	<b>\$1854</b>
PBBTN1824CG	24 x 18 x 29	150	43	8	<b>\$1391</b>
PBBTN1224CG	24 x 12 x 29	150	29	5	<b>\$927</b>

For extended piano corner units or piano-shaped desks.

### Required Specifications

Finish

### Optional Specifications

Additional grommet

BRIDGES	MODEL#	DIMENSIONS	FREIGHT CLASS	WT/LBS.	CUBIC FT.	LIST PRICE
---------	--------	------------	---------------	---------	-----------	------------

D x W x H

- All bridges are shipped knockdown
- Not for use with Corner Units
- The standard grain direction is cross grain (**CG**). To remove cross grain veneer pattern on top, delete suffix "**CG**" from the model number (no upcharge)
- GM5 TC location is standard. If grommet color is not specified, Black is standard
- **NOTE:** Arrow indicates direction of grain

BRIDGES	MODEL#	DIMENSIONS	FREIGHT CLASS	WT/LBS.	CUBIC FT.	LIST PRICE
---------	--------	------------	---------------	---------	-----------	------------

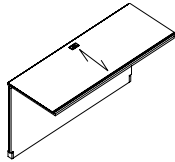

Executive Bridge Top

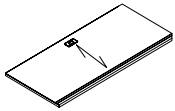

Executive Bridge Top

PBBT6022CG	22 x 60 x 29	92.5	108	10	<b>\$2879</b>
PBBT5422CG	22 x 54 x 29	92.5	99	9	<b>\$2598</b>
PBBT4822CG	22 x 48 x 29	92.5	90	8	<b>\$2307</b>
PBBT4222CG	22 x 42 x 29	92.5	81	7	<b>\$2018</b>
PBBT6020CG	20 x 60 x 29	85	105	8	<b>\$2361</b>
PBBT5420CG	20 x 54 x 29	85	96	8	<b>\$2125</b>
PBBT4820CG	20 x 48 x 29	85	87	7	<b>\$1890</b>
PBBT4220CG	20 x 42 x 29	85	78	6	<b>\$1617</b>

With full back panel.

PBBT5422TCG	22 x 54 x 1.3	125	64	9	<b>\$1559</b>
PBBT4822TCG	22 x 48 x 1.3	125	55	8	<b>\$1383</b>
PBBT4222TCG	22 x 42 x 1.3	125	46	7	<b>\$1214</b>
PBBT5420TCG	20 x 54 x 1.3	125	61	8	<b>\$1273</b>
PBBT4820TCG	20 x 48 x 1.3	125	52	7	<b>\$1137</b>
PBBT4220TCG	20 x 42 x 1.3	125	43	6	<b>\$974</b>

**Required Specifications**  
Finish

**Optional Specifications**  
Additional grommet

# P PHILADELPHIA

CRENZAS	MODEL#	DIMENSIONS	FREIGHT CLASS	WT/LBS.	CUBIC FT.	LIST PRICE
---------	--------	------------	---------------	---------	-----------	------------

D x W x H

- All credenzas are shipped assembled
- All storage cabinets include one adjustable shelf per set of doors
- **F** and **G** depict 36". **M** and **N** depict 30".
- **F** and **N** indicate lateral file drawers. **G** and **M** indicate storage cabinets with doors.
- Credenza shells accept modular storage. Use modular storage for top support allowing no more than 72" unsupported.
- Credenza shells with a width of 96" and more will have a 12" middle support gable.
- For PBCF7220 and PBCF6020, standard face locking for cabinet and lateral file.
- Grommets are available as an option on Desks and most Credenzas.
- **NOTE:** Arrow indicates direction of grain

CRENZAS	MODEL#	DIMENSIONS	FREIGHT CLASS	WT/LBS.	CUBIC FT.	LIST PRICE
---------	--------	------------	---------------	---------	-----------	------------

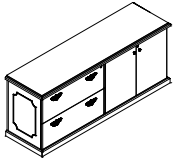

Full Storage Credenza

PBCF7220FG	20 x 72 x 29	92.5	272	24	<b>\$6644</b>
PBCF6020NM	20 x 60 x 29	92.5	220	20	<b>\$5536</b>

Lateral file on **left** and storage cabinet on **right**.

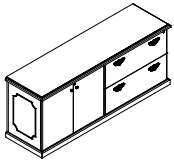

Full Storage Credenza

PBCF7220GF	20 x 72 x 29	92.5	272	24	<b>\$6644</b>
PBCF6020MN	20 x 60 x 29	92.5	220	20	<b>\$5536</b>

Storage cabinet on **left** and lateral file on **right**.

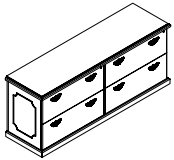

Full Storage Credenza

PBC7220FF	20 x 72 x 29	92.5	287	24	<b>\$8500</b>
PBC6020NN	20 x 60 x 29	92.5	205	20	<b>\$7439</b>

Lateral files on **left** and **right**.

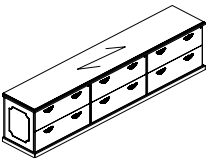

Full Storage Credenza

PBC10820FFF	20 x 108 x 29	92.5	412	36	<b>\$14272</b>
PBC9020NNN	20 x 90 x 29	92.5	337	30	<b>\$11896</b>

Lateral files on **left**, **center**, and **right**.

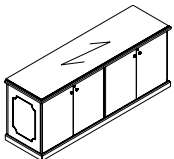

Full Storage Credenza

PBC7220GG	20 x 72 x 29	92.5	253	24	<b>\$6308</b>
PBC6020MM	20 x 60 x 29	92.5	209	20	<b>\$5519</b>

Storage cabinets on **left** and **right**.

**Required Specifications**  
Finish

**Optional Specifications**  
Additional grommet

CRENZAS

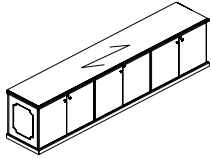

Full Storage Credenza

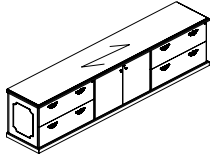

Full Storage Credenza

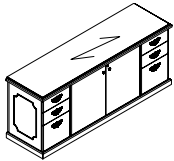

Full Storage Credenza

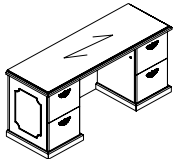

Double Pedestal Credenza

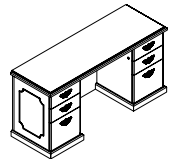

Double Pedestal Credenza

MODEL# DIMENSIONS FREIGHT CLASS WT/LBS. CUBIC FT. LIST PRICE

D x W x H

PBC10820GGG	20 x 108 x 29	125	278	36	\$11374
PBC9020MMM	20 x 90 x 29	125	228	30	\$9481

Storage cabinets on **left, center,** and **right.**

PBC10824FGF	24 x 108 x 29	92.5	479	44	\$16002
PBC9024NNM	24 x 90 x 29	92.5	399	36	\$13331
PBC10820FGF	20 x 108 x 29	92.5	388	36	\$13307
PBC9020NNM	20 x 90 x 29	92.5	321	30	\$11087

Lateral files on **left** and **right**; storage cabinet in **center.**

PBC7224DGD	24 x 72 x 29	92.5	319	29	\$9837
PBC6024DGD	24 x 60 x 29	92.5	266	24	\$9016
PBC7220DGD	20 x 72 x 29	85	298	24	\$8571
PBC6020DGD	20 x 60 x 29	85	246	20	\$7500

Box/box/file on **left** and **right**; storage cabinet in **center.**

PBCK8424EE	24 x 84 x 29	92.5	348	34	\$9345
PBCK7824EE	24 x 78 x 29	92.5	319	31	\$8682
PBCK7224EE	24 x 72 x 29	100	280	29	\$8019
PBCK6624EE	24 x 66 x 29	100	261	27	\$7894
PBCK6024EE	24 x 60 x 29	100	238	24	\$7345

PBCK8420EE	20 x 84 x 29	92.5	307	28	\$8149
PBCK7820EE	20 x 78 x 29	92.5	285	26	\$7566
PBCK7220EE	20 x 72 x 29	92.5	267	24	\$6984
PBCK6620EE	20 x 66 x 29	92.5	244	22	\$6398
PBCK6020EE	20 x 60 x 29	92.5	220	20	\$5821

File/file pedestals on **left** and **right**. Full height back panel. Kneespace in center.

PBCK8424DD	24 x 84 x 29	92.5	348	34	\$9345
PBCK7824DD	24 x 78 x 29	92.5	319	31	\$8682
PBCK7224DD	24 x 72 x 29	100	280	29	\$8019
PBCK6624DD	24 x 66 x 29	100	261	27	\$7894
PBCK6024DD	24 x 60 x 29	100	238	24	\$7345

PBCK8420DD	20 x 84 x 29	92.5	307	28	\$8149
PBCK7820DD	20 x 78 x 29	92.5	285	26	\$7566
PBCK7220DD	20 x 72 x 29	92.5	267	24	\$6984
PBCK6620DD	20 x 66 x 29	92.5	244	22	\$6398
PBCK6020DD	20 x 60 x 29	92.5	220	20	\$5821

Box/box/file pedestals on **left** and **right**. Full height back panel. Kneespace in center.

Required Specifications

Finish

Optional Specifications

Additional grommet



**CREDENZAS**

**MODEL# DIMENSIONS FREIGHT CLASS WT/LBS. CUBIC FT. LIST PRICE**

**D x W x H**

PBCK8424ED	24 x 84 x 29	92.5	348	34	<b>\$9345</b>
PBCK7824ED	24 x 78 x 29	92.5	319	31	<b>\$8682</b>
PBCK7224ED	24 x 72 x 29	100	280	29	<b>\$8019</b>
PBCK6624ED	24 x 66 x 29	100	261	27	<b>\$7894</b>
PBCK6024ED	24 x 60 x 29	100	238	24	<b>\$7345</b>
PBCK8420ED	20 x 84 x 29	92.5	307	28	<b>\$8149</b>
PBCK7820ED	20 x 78 x 29	92.5	285	26	<b>\$7566</b>
PBCK7220ED	20 x 72 x 29	92.5	267	24	<b>\$6984</b>
PBCK6620ED	20 x 66 x 29	92.5	244	22	<b>\$6398</b>
PBCK6020ED	20 x 60 x 29	92.5	220	20	<b>\$5821</b>

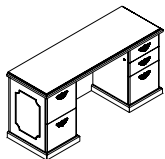

**Double Pedestal Credenza**

File/file pedestal on **left** and box/box/file pedestal on **right**. Full height back panel. Kneespace in center.

PBCK8424DE	24 x 84 x 29	92.5	348	34	<b>\$9345</b>
PBCK7824DE	24 x 78 x 29	92.5	319	31	<b>\$8682</b>
PBCK7224DE	24 x 72 x 29	100	280	29	<b>\$8019</b>
PBCK6624DE	24 x 66 x 29	100	261	27	<b>\$7894</b>
PBCK6024DE	24 x 60 x 29	100	238	24	<b>\$7345</b>
PBCK8420DE	20 x 84 x 29	92.5	307	28	<b>\$8149</b>
PBCK7820DE	20 x 78 x 29	92.5	285	26	<b>\$7566</b>
PBCK7220DE	20 x 72 x 29	92.5	267	24	<b>\$6984</b>
PBCK6620DE	20 x 66 x 29	92.5	244	22	<b>\$6398</b>
PBCK6020DE	20 x 60 x 29	92.5	220	20	<b>\$5821</b>

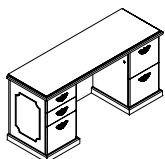

**Double Pedestal Credenza**

Box/box/file pedestal on **left** and file/file pedestal on **right**. Full height back panel. Kneespace in center.

PBCL8424E	24 x 84 x 29	100	315	34	<b>\$7066</b>
PBCL7824E	24 x 78 x 29	100	292	31	<b>\$6564</b>
PBCL7224E	24 x 72 x 29	100	270	29	<b>\$6057</b>
PBCL6624E	24 x 66 x 29	100	247	27	<b>\$5830</b>
PBCL6024E	24 x 60 x 29	100	225	24	<b>\$5301</b>
PBCL8420E	20 x 84 x 29	100	273	28	<b>\$6159</b>
PBCL7820E	20 x 78 x 29	100	252	26	<b>\$5719</b>
PBCL7220E	20 x 72 x 29	100	237	24	<b>\$5280</b>
PBCL6620E	20 x 66 x 29	100	216	22	<b>\$5082</b>
PBCL6020E	20 x 60 x 29	100	195	20	<b>\$4623</b>

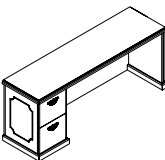

**Single Pedestal Credenza - Left**

File/file pedestal on **left**.

PBCR8424E	24 x 84 x 29	100	315	34	<b>\$7066</b>
PBCR7824E	24 x 78 x 29	100	292	31	<b>\$6564</b>
PBCR7224E	24 x 72 x 29	100	270	29	<b>\$6057</b>
PBCR6624E	24 x 66 x 29	100	247	27	<b>\$5830</b>
PBCR6024E	24 x 60 x 29	100	225	24	<b>\$5301</b>
PBCR8420E	20 x 84 x 29	100	273	28	<b>\$6159</b>
PBCR7820E	20 x 78 x 29	100	252	26	<b>\$5719</b>
PBCR7220E	20 x 72 x 29	100	237	24	<b>\$5280</b>
PBCR6620E	20 x 66 x 29	100	216	22	<b>\$5082</b>
PBCR6020E	20 x 60 x 29	100	195	20	<b>\$4623</b>

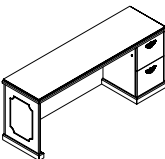

**Single Pedestal Credenza - Right**

File/file pedestal on **right**.

**Required Specifications**  
Finish

**Optional Specifications**  
Additional grommet

**CREDENZAS** **MODEL#** **DIMENSIONS** **FREIGHT CLASS** **WT/LBS.** **CUBIC FT.** **LIST PRICE**

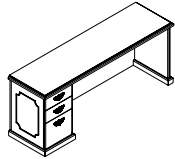

**Single Pedestal Credenza - Left**

	<b>D x W x H</b>					
PBCL8424D	24 x 84 x 29	100	315	34	<b>\$7066</b>	
PBCL7824D	24 x 78 x 29	100	292	31	<b>\$6564</b>	
PBCL7224D	24 x 72 x 29	100	270	29	<b>\$6057</b>	
PBCL6624D	24 x 66 x 29	100	247	27	<b>\$5830</b>	
PBCL6024D	24 x 60 x 29	100	225	24	<b>\$5301</b>	
PBCL8420D	20 x 84 x 29	100	273	28	<b>\$6159</b>	
PBCL7820D	20 x 78 x 29	100	252	26	<b>\$5719</b>	
PBCL7220D	20 x 72 x 29	100	237	24	<b>\$5280</b>	
PBCL6620D	20 x 66 x 29	100	216	22	<b>\$5082</b>	
PBCL6020D	20 x 60 x 29	100	195	20	<b>\$4623</b>	

Box/box/file pedestal on **left**.

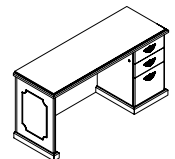

**Single Pedestal Credenza - Right**

PBCR8424D	24 x 84 x 29	100	315	34	<b>\$7066</b>	
PBCR7824D	24 x 78 x 29	100	292	31	<b>\$6564</b>	
PBCR7224D	24 x 72 x 29	100	270	29	<b>\$6057</b>	
PBCR6624D	24 x 66 x 29	100	247	27	<b>\$5830</b>	
PBCR6024D	24 x 60 x 29	100	225	24	<b>\$5301</b>	
PBCR8420D	20 x 84 x 29	100	273	28	<b>\$6159</b>	
PBCR7820D	20 x 78 x 29	100	252	26	<b>\$5719</b>	
PBCR7220D	20 x 72 x 29	100	237	24	<b>\$5280</b>	
PBCR6620D	20 x 66 x 29	100	216	22	<b>\$5082</b>	
PBCR6020D	20 x 60 x 29	100	195	20	<b>\$4623</b>	

Box/box/file pedestal on **right**.

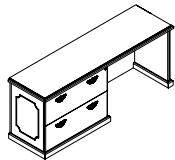

**Single Pedestal Credenza - Left**

PBCL8424F	24 x 84 x 29	100	305	34	<b>\$8214</b>	
PBCL7824F	24 x 78 x 29	100	285	31	<b>\$7623</b>	
PBCL7224F	24 x 72 x 29	100	261	29	<b>\$7042</b>	
PBCL6624F	24 x 66 x 29	100	239	27	<b>\$6836</b>	
PBCL6024F	24 x 60 x 29	100	218	24	<b>\$6153</b>	
PBCL8420F	20 x 84 x 29	100	253	28	<b>\$7160</b>	
PBCL7820F	20 x 78 x 29	100	233	26	<b>\$6643</b>	
PBCL7220F	20 x 72 x 29	100	218	24	<b>\$6132</b>	
PBCL6620F	20 x 66 x 29	100	197	22	<b>\$5905</b>	
PBCL6020F	20 x 60 x 29	100	176	20	<b>\$5362</b>	

36" lateral file on **left**.

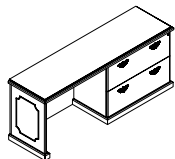

**Single Pedestal Credenza - Right**

PBCR8424F	24 x 84 x 29	100	305	34	<b>\$8214</b>	
PBCR7824F	24 x 78 x 29	100	285	31	<b>\$7623</b>	
PBCR7224F	24 x 72 x 29	100	261	29	<b>\$7042</b>	
PBCR6624F	24 x 66 x 29	100	239	27	<b>\$6836</b>	
PBCR6024F	24 x 60 x 29	100	218	24	<b>\$6153</b>	
PBCR8420F	20 x 84 x 29	100	253	28	<b>\$7160</b>	
PBCR7820F	20 x 78 x 29	100	233	26	<b>\$6643</b>	
PBCR7220F	20 x 72 x 29	100	218	24	<b>\$6132</b>	
PBCR6620F	20 x 66 x 29	100	197	22	<b>\$5905</b>	
PBCR6020F	20 x 60 x 29	100	176	20	<b>\$5362</b>	

36" lateral file on **right**.

**Required Specifications**  
Finish

**Optional Specifications**  
Additional grommet

**CREDENZAS**

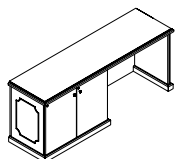

**Single Pedestal Credenza - Left**

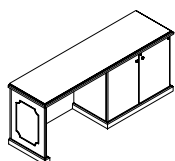

**Single Pedestal Credenza - Right**

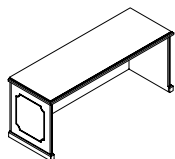

**Credenza Shell**

MODEL#	DIMENSIONS D x W x H	FREIGHT CLASS	WT/LBS.	CUBIC FT.	LIST PRICE
PBCL8424G	24 x 84 x 29	100	338	34	<b>\$7378</b>
PBCL7824G	24 x 78 x 29	92.5	314	31	<b>\$6848</b>
PBCL7224G	24 x 72 x 29	92.5	290	29	<b>\$6341</b>
PBCL6624G	24 x 66 x 29	100	266	27	<b>\$6086</b>
PBCL6024G	24 x 60 x 29	92.5	242	24	<b>\$5533</b>
PBCL8420G	20 x 84 x 29	92.5	290	28	<b>\$6429</b>
PBCL7820G	20 x 78 x 29	92.5	272	26	<b>\$5969</b>
PBCL7220G	20 x 72 x 29	92.5	252	24	<b>\$5511</b>
PBCL6620G	20 x 66 x 29	92.5	230	22	<b>\$5296</b>
PBCL6020G	20 x 60 x 29	92.5	208	20	<b>\$4823</b>

36" storage cabinet on **left**.

PBCR8424G	24 x 84 x 29	100	338	34	<b>\$7378</b>
PBCR7824G	24 x 78 x 29	92.5	314	31	<b>\$6848</b>
PBCR7224G	24 x 72 x 29	92.5	290	29	<b>\$6341</b>
PBCR6624G	24 x 66 x 29	100	266	27	<b>\$6086</b>
PBCR6024G	24 x 60 x 29	92.5	242	24	<b>\$5533</b>
PBCR8420G	20 x 84 x 29	92.5	290	28	<b>\$6429</b>
PBCR7820G	20 x 78 x 29	92.5	272	26	<b>\$5969</b>
PBCR7220G	20 x 72 x 29	92.5	252	24	<b>\$5511</b>
PBCR6620G	20 x 66 x 29	92.5	230	22	<b>\$5296</b>
PBCR6020G	20 x 60 x 29	92.5	208	20	<b>\$4823</b>

36" storage cabinet on **right**.

PBC12024	24 x 120 x 29	100	387	48	<b>\$6294</b>
PBC11424	24 x 114 x 29	125	367	46	<b>\$5983</b>
PBC10824	24 x 108 x 29	125	348	44	<b>\$5667</b>
PBC10224	24 x 102 x 29	100	329	41	<b>\$5346</b>
PBC9624	24 x 96 x 29	125	309	39	<b>\$5035</b>
PBC9024	24 x 90 x 29	100	290	36	<b>\$4718</b>
PBC8424	24 x 84 x 29	125	271	34	<b>\$4407</b>
PBC7824	24 x 78 x 29	100	251	31	<b>\$4089</b>
PBC7224	24 x 72 x 29	100	232	29	<b>\$3778</b>
PBC6624	24 x 66 x 29	125	213	27	<b>\$3644</b>
PBC6024	24 x 60 x 29	100	193	24	<b>\$3307</b>
PBC5424	24 x 54 x 29	125	174	22	<b>\$3128</b>
PBC4824	24 x 48 x 29	100	155	19	<b>\$2957</b>
PBC4224	24 x 42 x 29	125	135	17	<b>\$2506</b>

With full back panel.

**Required Specifications**  
Finish

**Optional Specifications**  
Additional grommet

**CORNERS - NOTES**

**NOTE:** Arrow indicates direction of grain

D x W x H

**Corners**

- All units are shipped assembled
- Unit includes grommets shown and installed horizontal wire management
- Corner units and extended corner units must be used exclusively with linking bridges and linking returns
- **Linking bridges** are handed by recessed end panel
- **Extended corner tables** have no molding on back side. Grommets are not included and must be specified.
- **Linking returns** include grommets shown and installed horizontal wire management. Handed by full end panel.
- **Tables** include grommets shown and installed horizontal wire management.

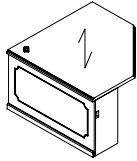
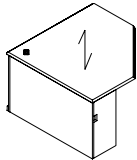
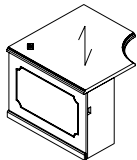
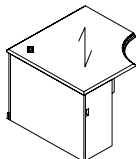
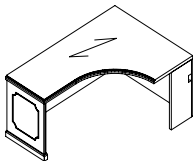
CORNERS AND COMPONENTS	MODEL#	DIMENSIONS	FREIGHT CLASS	WT/LBS.	CUBIC FT.	LIST PRICE
 <p><b>Corner Table - Left</b></p>	PBE484824ML	48 x 48 x 29	150	196	35	<b>\$4399</b>
	PBE424224ML	42 x 42 x 29	150	150	30	<b>\$3384</b>
	PBE363624ML	36 x 36 x 29	150	130	22	<b>\$3216</b>
With 2 recessed end panels.						
 <p><b>Corner Table - Right</b></p>	PBE484824MR	48 x 48 x 29	150	196	35	<b>\$4399</b>
	PBE424224MR	42 x 42 x 29	150	150	30	<b>\$3384</b>
	PBE363624MR	36 x 36 x 29	150	130	22	<b>\$3216</b>
With 2 recessed end panels.						
 <p><b>Corner Table - Left</b></p>	PBEK484824ML	48 x 48 x 29	150	196	39	<b>\$5059</b>
	PBEK424224ML	42 x 42 x 29	150	150	30	<b>\$3893</b>
	PBEK363624ML	36 x 36 x 29	150	130	22	<b>\$3698</b>
With 2 recessed end panels and inner curve.						
 <p><b>Corner Table - Right</b></p>	PBEK484824MR	48 x 48 x 29	150	196	39	<b>\$5059</b>
	PBEK424224MR	42 x 42 x 29	150	150	30	<b>\$3893</b>
	PBEK363624MR	36 x 36 x 29	150	130	22	<b>\$3698</b>
With 2 recessed end panels and inner curve.						
 <p><b>Extended Corner Table - Left</b></p>	PBEKL964824	96 x 48 x 29	150	387	77	<b>\$7375</b>
	PBEKL904824	90 x 48 x 29	150	363	73	<b>\$6963</b>
	PBEKL844824	84 x 48 x 29	150	338	68	<b>\$6878</b>
	PBEKL784824	78 x 48 x 29	150	314	63	<b>\$6844</b>
	PBEKL724824	72 x 48 x 29	150	290	58	<b>\$6504</b>
	PBEKL664824	66 x 48 x 29	150	266	52	<b>\$6061</b>
	PBEKL604824	60 x 48 x 29	150	242	48	<b>\$5625</b>
With full back panel.						

**Required Specifications**  
Finish

**Optional Specifications**  
Additional grommet

## CORNERS AND COMPONENTS

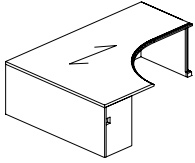

**Extended Corner Table - Right**

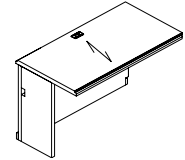

**Linking Bridge - Left**

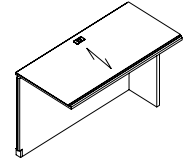

**Linking Bridge - Right**

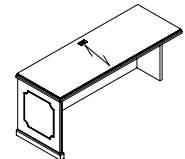

**Linking Return - Left**

MODEL#	DIMENSIONS	FREIGHT CLASS	WT/LBS.	CUBIC FT.	LIST PRICE
--------	------------	---------------	---------	-----------	------------

**D x W x H**

PBEKR489624	96 x 48 x 29	150	387	77	<b>\$7375</b>
PBEKR489024	90 x 48 x 29	150	363	73	<b>\$6963</b>
PBEKR488424	84 x 48 x 29	150	338	68	<b>\$6878</b>
PBEKR487824	78 x 48 x 29	150	314	63	<b>\$6844</b>
PBEKR487224	72 x 48 x 29	150	290	58	<b>\$6504</b>
PBEKR486624	66 x 48 x 29	150	266	52	<b>\$6061</b>
PBEKR486024	60 x 48 x 29	150	242	48	<b>\$5625</b>

With full back panel.

PBBT6024NLLCG	24 x 60 x 29	125	145	24	<b>\$2865</b>
PBBT5424NLLCG	24 x 54 x 29	150	131	22	<b>\$2577</b>
PBBT4824NLLCG	24 x 48 x 29	125	116	19	<b>\$2291</b>
PBBT4224NLLCG	24 x 42 x 29	125	102	17	<b>\$1856</b>
PBBT3624NLLCG	24 x 36 x 29	150	87	15	<b>\$1686</b>
PBBT3024NLLCG	24 x 30 x 29	125	73	12	<b>\$1647</b>

To join corner worksurface to desk or credenza. Full back panel.

PBBT6024NLR CG	24 x 60 x 29	125	145	24	<b>\$2865</b>
PBBT5424NLR CG	24 x 54 x 29	150	131	22	<b>\$2577</b>
PBBT4824NLR CG	24 x 48 x 29	125	116	19	<b>\$2291</b>
PBBT4224NLR CG	24 x 42 x 29	125	102	17	<b>\$1856</b>
PBBT3624NLR CG	24 x 36 x 29	150	87	15	<b>\$1686</b>
PBBT3024NLR CG	24 x 30 x 29	125	73	12	<b>\$1647</b>

To join corner worksurface to desk or credenza. Full back panel.

PBVL9624CG	24 x 96 x 29	150	200	39	<b>\$4745</b>
PBVL9024CG	24 x 90 x 29	150	187	36	<b>\$4448</b>
PBVL8424CG	24 x 84 x 29	150	174	34	<b>\$4153</b>
PBVL7824CG	24 x 78 x 29	150	162	31	<b>\$3857</b>
PBVL7224CG	24 x 72 x 29	150	149	29	<b>\$3559</b>
PBVL6624CG	24 x 66 x 29	150	141	27	<b>\$3340</b>
PBVL6024CG	24 x 60 x 29	150	132	24	<b>\$3122</b>
PBVL5424CG	24 x 54 x 29	150	121	22	<b>\$2947</b>
PBVL4824CG	24 x 48 x 29	125	115	19	<b>\$2768</b>
PBVL4224CG	24 x 42 x 29	150	99	17	<b>\$2335</b>
PBVL3624CG	24 x 36 x 29	150	83	15	<b>\$2250</b>
PBVL3024CG	24 x 30 x 29	125	77	12	<b>\$2210</b>
PBVL2424CG	24 x 24 x 29	125	61	10	<b>\$1854</b>

To be used with corner unit.

**Required Specifications**

Finish

**Optional Specifications**

Additional grommet

**CORNERS AND COMPONENTS**

**MODEL# DIMENSIONS FREIGHT CLASS WT/LBS. CUBIC FT. LIST PRICE**

**D x W x H**

PBVR9624CG	24 x 96 x 29	150	200	39	<b>\$4745</b>
PBVR9024CG	24 x 90 x 29	150	187	36	<b>\$4448</b>
PBVR8424CG	24 x 84 x 29	150	174	34	<b>\$4153</b>
PBVR7824CG	24 x 78 x 29	150	162	31	<b>\$3857</b>
PBVR7224CG	24 x 72 x 29	150	149	29	<b>\$3559</b>
PBVR6624CG	24 x 66 x 29	150	141	27	<b>\$3340</b>
PBVR6024CG	24 x 60 x 29	150	132	24	<b>\$3122</b>
PBVR5424CG	24 x 54 x 29	150	121	22	<b>\$2947</b>
PBVR4824CG	24 x 48 x 29	125	115	19	<b>\$2768</b>
PBVR4224CG	24 x 42 x 29	150	99	17	<b>\$2335</b>
PBVR3624CG	24 x 36 x 29	150	83	15	<b>\$2250</b>
PBVR3024CG	24 x 30 x 29	125	77	12	<b>\$2210</b>
PBVR2424CG	24 x 24 x 29	125	61	10	<b>\$1854</b>

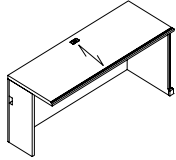

**Linking Return - Right**

To be used with corner unit.

PBVT9624	24 x 96 x 29	150	213	39	<b>\$4848</b>
PBVT9024	24 x 90 x 29	150	199	36	<b>\$4545</b>
PBVT8424	24 x 84 x 29	150	186	34	<b>\$4243</b>
PBVT7824	24 x 78 x 29	150	173	31	<b>\$3934</b>
PBVT7224	24 x 72 x 29	150	160	29	<b>\$3637</b>
PBVT6624	24 x 66 x 29	150	146	27	<b>\$3418</b>
PBVT6024	24 x 60 x 29	150	133	24	<b>\$3204</b>
PBVT5424	24 x 54 x 29	150	128	22	<b>\$3024</b>
PBVT4824	24 x 48 x 29	125	120	19	<b>\$2847</b>
PBVT4224	24 x 42 x 29	125	104	17	<b>\$2409</b>
PBVT3624	24 x 36 x 29	150	88	15	<b>\$2329</b>
PBVT3024	24 x 30 x 29	125	82	12	<b>\$2284</b>
PBVT2424	24 x 24 x 29	125	65	10	<b>\$1921</b>

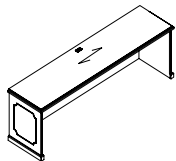

**Freestanding Table**

Full end panels.

PBV1212CT	12 x 12 x 1.3	150	5	1	<b>\$974</b>
-----------	---------------	-----	---	---	--------------



**Corner Filler Top**

**Required Specifications**  
Finish

**Optional Specifications**  
Additional grommet

MODULAR STORAGE - NOTES

D x W x H

- All storage components are shipped assembled
- Components 28" high are intended for use with a desk, credenza or return shell
- Backs on 28" high pedestals and cabinets are unfinished. If finished back is required, see page 357.
- If a profiled top is required, please see "Freestanding Storage" section.

MODULAR STORAGE	MODEL#	DIMENSIONS	FREIGHT CLASS	WT/LBS.	CUBIC FT.	LIST PRICE
-----------------	--------	------------	---------------	---------	-----------	------------

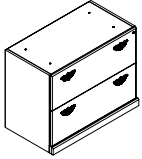

Modular Lateral File

PBWF	19.1 x 35.1 x 28	92.5	115	11	<b>\$3962</b>
PBWN	19.1 x 30 x 28	92.5	96	9	<b>\$3468</b>

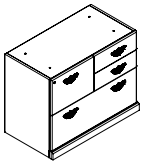

Modular Combination Storage

PBWZL	19.1 x 35.1 x 28	92.5	115	11	<b>\$3894</b>
-------	------------------	------	-----	----	---------------

With 1 lateral file, 2 box drawers in the top right, and 1 file drawer in the top left.

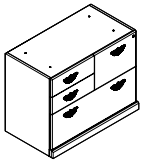

Modular Combination Storage

PBWZR	19.1 x 35.1 x 28	92.5	115	11	<b>\$3894</b>
-------	------------------	------	-----	----	---------------

With 1 lateral file, 2 box drawers in the top left, and 1 file drawer in the top right.

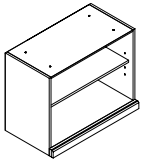

Modular Open Storage

PBWOB36	19.1 x 35.1 x 28	100	92	11	<b>\$1955</b>
PBWOB30	19.1 x 30 x 28	100	77	9	<b>\$1733</b>

Storage with 1 adjustable shelf.

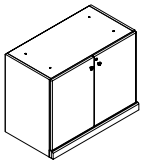

Modular Storage Cabinet w/Doors

PBWG	19.1 x 35.1 x 28	92.5	115	11	<b>\$2441</b>
PBWM	19.1 x 30 x 28	92.5	96	9	<b>\$2164</b>

Storage with 1 adjustable shelf.

Required Specifications

Finish

**MODULAR STORAGE**      **MODEL#**      **DIMENSIONS**      **FREIGHT CLASS**      **WT./LBS.**      **CUBIC FT.**      **LIST PRICE**

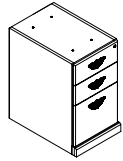

**Modular Pedestal**

**D x W x H**

Letter width:

PBWWDD	23 x 15.6 x 28	85	72	6	<b>\$3058</b>
PBWD	19 x 15.6 x 28	85	70	5	<b>\$2661</b>

Legal width:

PBWWLD	23 x 18.5 x 28	85	85	7	<b>\$3669</b>
PBWLD	19 x 18.5 x 28	85	83	6	<b>\$3193</b>

Box/box/file pedestal.

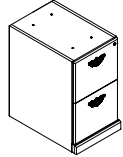

**Modular Pedestal**

Letter width:

PBWWWE	23 x 15.6 x 28	85	72	6	<b>\$3058</b>
PBWE	19 x 15.6 x 28	85	70	5	<b>\$2661</b>

Legal width:

PBWWLE	23 x 18.5 x 28	85	85	7	<b>\$3669</b>
PBWLE	19 x 18.5 x 28	85	83	6	<b>\$3193</b>

File/file pedestal.

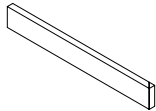

**Decorative Base Trim - Left**

PBAS-WL	1 x 19 x 2.5	70	1	0.01	<b>\$299</b>
PBAS-WWL	1 x 23 x 2.5	70	1	0.01	<b>\$368</b>

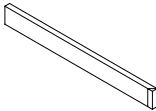

**Decorative Base Trim - Right**

PBAS-WR	1 x 19 x 2.5	70	1	0.01	<b>\$299</b>
PBAS-WWR	1 x 23 x 2.5	70	1	0.01	<b>\$368</b>

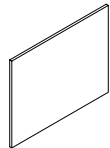

**Finished Back**

PBBA36	0.8 x 35 x 27.5	125	18	3	<b>\$467</b>
PBBA30	0.8 x 30 x 27.5	150	15	3	<b>\$388</b>
PBBA18	0.8 x 18.5 x 27.5	150	10	2	<b>\$226</b>
PBBA15	0.8 x 15.5 x 27.5	150	8	2	<b>\$196</b>

For modular pedestals.

**Required Specifications**

Finish



## HUTCHES & WALL MOUNTED STORAGE NOTES

D x W x H

**NOTE:** Arrow indicates direction of grain

### Hutches

- All hutches are shipped assembled
- Bronze glass door is standard. Clear glass is available, please contact customer care.

### Closed pigeon hole storage hutch

- 42" unit has 21.5" of clearance
- Hutches longer than 102" have 8 doors, hutches between 102" and 84" have 6 doors, and hutches less than 84" have 4 doors.

### Closed storage hutch

- 36" unit has 19.5" of clearance.
- 42" and 54" units have 25.5" of clearance
- Hutches longer than 102" have 8 doors, hutches between 102" and 84" have 6 doors, and hutches less than 84" have 4 doors.

### Tasklight

- For proper size see page 337.

## HUTCHES & WALL MOUNTED STORAGE

### MODEL#

### DIMENSIONS

### FREIGHT CLASS

### WT./LBS.

### CUBIC FT.

### LIST PRICE

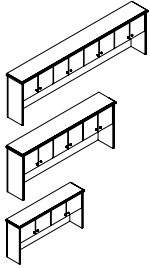

**36" H Storage Hutch w/Wood Doors\***

PB108SH36	15 x 108 x 36	125	268	34	<b>\$7627</b>
PB102SH36	15 x 102 x 36	125	254	32	<b>\$7202</b>
PB96SH36	15 x 96 x 36	100	241	30	<b>\$6775</b>
PB90SH36	15 x 90 x 36	100	227	28	<b>\$6353</b>
PB84SH36	15 x 84 x 36	100	214	26	<b>\$5931</b>
PB78SH36	15 x 78 x 36	100	200	24	<b>\$5510</b>
PB72SH36	15 x 72 x 36	100	187	23	<b>\$5084</b>
PB66SH36	15 x 66 x 36	100	173	21	<b>\$4891</b>
PB60SH36	15 x 60 x 36	100	160	19	<b>\$4663</b>

Hutches longer than 102" have 8 doors, hutches between 102" and 84" have 6 doors, and hutches less than 84" have 4 doors. Locks are optional.

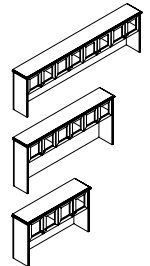

**36" H Storage Hutch w/Glass Doors**

PB108SH36G	15 x 108 x 36	125	268	34	<b>\$10639</b>
PB102SH36G	15 x 102 x 36	125	254	32	<b>\$9598</b>
PB96SH36G	15 x 96 x 36	100	241	30	<b>\$9133</b>
PB90SH36G	15 x 90 x 36	100	227	28	<b>\$8682</b>
PB84SH36G	15 x 84 x 36	100	214	26	<b>\$8221</b>
PB78SH36G	15 x 78 x 36	100	200	24	<b>\$7771</b>
PB72SH36G	15 x 72 x 36	100	187	23	<b>\$6704</b>
PB66SH36G	15 x 66 x 36	100	173	21	<b>\$6461</b>
PB60SH36G	15 x 60 x 36	100	160	19	<b>\$6188</b>

Wood framed glass doors. Hutches longer than 102" have 8 doors, hutches between 102" and 84" have 6 doors, and hutches less than 84" have 4 doors. No lock option available.

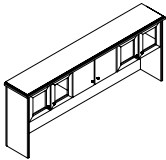

**36" H Storage Hutch w/Doors\***

PB102SH36GDG	15 x 102 x 36	125	254	32	<b>\$8850</b>
PB96SH36GDG	15 x 96 x 36	100	241	30	<b>\$8388</b>
PB90SH36GDG	15 x 90 x 36	100	227	28	<b>\$7936</b>
PB84SH36GDG	15 x 84 x 36	100	214	26	<b>\$7476</b>

Wood doors in the center and wood framed glass doors on left and right. Locks are optional on wood doors.

### Required Specifications

Finish

### Optional Specifications

Additional grommet  
Locks\* (wood doors only)

**HUTCHES & WALL MOUNTED STORAGE**

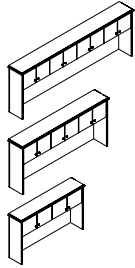

**42" H Storage Hutch w/Wood Doors\***

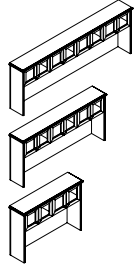

**42" H Storage Hutch w/Glass Doors**

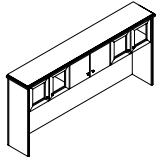

**42" H Storage Hutch w/Doors\***

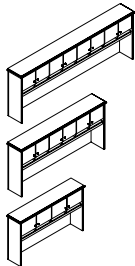

**42" H Storage Hutch w/Wood Doors & Pigeon-Holes\***

MODEL#	DIMENSIONS D x W x H	FREIGHT CLASS	WT/LBS.	CUBIC FT.	LIST PRICE
PB108SH42	15 x 108 x 42	125	307	39	<b>\$8892</b>
PB102SH42	15 x 102 x 42	125	290	37	<b>\$8399</b>
PB96SH42	15 x 96 x 42	125	273	35	<b>\$7907</b>
PB90SH42	15 x 90 x 42	125	256	33	<b>\$7410</b>
PB84SH42	15 x 84 x 42	125	239	31	<b>\$6916</b>
PB78SH42	15 x 78 x 42	150	222	38	<b>\$6422</b>
PB72SH42	15 x 72 x 42	125	205	26	<b>\$5931</b>
PB66SH42	15 x 66 x 42	125	188	24	<b>\$5712</b>
PB60SH42	15 x 60 x 42	125	171	22	<b>\$5437</b>

Hutches longer than 102" have 8 doors, hutches between 102" and 84" have 6 doors, and hutches less than 84" have 4 doors. Locks are optional.

PB108SH42G	15 x 108 x 42	125	307	39	<b>\$11843</b>
PB102SH42G	15 x 102 x 42	125	290	37	<b>\$10794</b>
PB96SH42G	15 x 96 x 42	125	273	35	<b>\$10266</b>
PB90SH42G	15 x 90 x 42	125	256	33	<b>\$9734</b>
PB84SH42G	15 x 84 x 42	125	239	31	<b>\$9210</b>
PB78SH42G	15 x 78 x 42	150	222	38	<b>\$8686</b>
PB72SH42G	15 x 72 x 42	125	205	26	<b>\$7549</b>
PB66SH42G	15 x 66 x 42	125	188	24	<b>\$7280</b>
PB60SH42G	15 x 60 x 42	125	171	22	<b>\$6960</b>

Wood framed glass doors. Hutches longer than 102" have 8 doors, hutches between 102" and 84" have 6 doors, and hutches less than 84" have 4 doors. No lock option available.

PB102SH42GDG	15 x 102 x 42	125	290	37	<b>\$10047</b>
PB96SH42GDG	15 x 96 x 42	125	273	35	<b>\$9518</b>
PB90SH42GDG	15 x 90 x 42	125	256	33	<b>\$8990</b>
PB84SH42GDG	15 x 84 x 42	125	239	31	<b>\$8464</b>

Wood doors in the center and wood framed glass doors on left and right. Locks are optional on wood doors.

PB108SHP42	15 x 108 x 42	125	307	39	<b>\$10667</b>
PB102SHP42	15 x 102 x 42	125	290	37	<b>\$10078</b>
PB96SHP42	15 x 96 x 42	125	273	35	<b>\$9487</b>
PB90SHP42	15 x 90 x 42	125	256	33	<b>\$8892</b>
PB84SHP42	15 x 84 x 42	125	239	31	<b>\$8296</b>
PB78SHP42	15 x 78 x 42	150	222	38	<b>\$7708</b>
PB72SHP42	15 x 72 x 42	125	205	26	<b>\$7119</b>
PB66SHP42	15 x 66 x 42	125	241	31	<b>\$7340</b>
PB60SHP42	15 x 60 x 42	125	171	22	<b>\$6523</b>

Hutches longer than 102" have 8 doors, hutches between 102" and 84" have 6 doors, and hutches less than 84" have 4 doors. Locks are optional.

**Required Specifications**  
Finish

**Optional Specifications**  
Additional grommet  
Locks\* (wood doors only)

## HUTCHES & WALL MOUNTED STORAGE

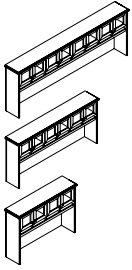

**42" H Storage Hutch w/Glass Doors & Pigeon-Holes**

MODEL#	DIMENSIONS D x W x H	FREIGHT CLASS	WT/LBS.	CUBIC FT.	LIST PRICE
PB108SHP42G	15 x 108 x 42	125	307	39	<b>\$13612</b>
PB102SHP42G	15 x 102 x 42	125	290	37	<b>\$12410</b>
PB96SHP42G	15 x 96 x 42	125	273	35	<b>\$11818</b>
PB90SHP42G	15 x 90 x 42	125	256	33	<b>\$11184</b>
PB84SHP42G	15 x 84 x 42	125		31	
PB78SHP42G	15 x 78 x 42	150	222	38	<b>\$9908</b>
PB72SHP42G	15 x 72 x 42	125	205	26	<b>\$8695</b>
PB66SHP42G	15 x 66 x 42	125	188	24	<b>\$8409</b>
PB60SHP42G	15 x 60 x 42	125	171	22	<b>\$8001</b>

Wood framed glass doors. Hutches longer than 102" have 8 doors, hutches between 102" and 84" have 6 doors, and hutches less than 84" have 4 doors. No lock option available.

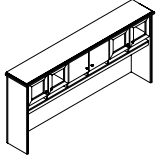

**42" H Storage Hutch w/Doors & Pigeon-Holes**

PB102SHP42GDG	15 x 102 x 42	125	290	37	<b>\$11664</b>
PB96SHP42GDG	15 x 96 x 42	125	273	35	<b>\$11069</b>
PB90SHP42GDG	15 x 90 x 42	125	256	33	<b>\$10438</b>
PB84SHP42GDG	15 x 84 x 42	125	239	31	<b>\$9774</b>

Wood doors in the center and wood framed glass doors on left and right. Locks are optional on wood doors.

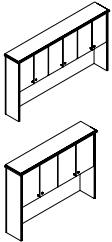

**54" H Storage Hutch w/Wood Doors**

PB962SH54	15 x 96 x 55	125	351	45	<b>\$10158</b>
PB902SH54	15 x 90 x 55	125	329	42	<b>\$9526</b>
PB842SH54	15 x 84 x 55	125	309	39	<b>\$8892</b>
PB782SH54	15 x 78 x 55	125	285	37	<b>\$8257</b>
PB722SH54	15 x 72 x 55	125	263	34	<b>\$7626</b>
PB662SH54	15 x 66 x 55	125	241	31	<b>\$7340</b>
PB602SH54	15 x 60 x 55	125	219	28	<b>\$6985</b>

Hutches between 96" and 84" have 6 doors; hutches less than 84" have 4 doors. One adjustable shelf. Locks are optional.

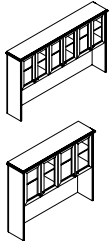

**54" H Storage Hutch w/Glass Doors**

PB962SH54G	15 x 96 x 55	125	351	45	<b>\$13114</b>
PB902SH54G	15 x 90 x 55	125	329	42	<b>\$12224</b>
PB842SH54G	15 x 84 x 55	125	307	39	<b>\$11326</b>
PB782SH54G	15 x 78 x 55	125	285	37	<b>\$10434</b>
PB722SH54G	15 x 72 x 55	125	263	34	<b>\$9544</b>
PB662SH54G	15 x 66 x 55	125	241	31	<b>\$9196</b>
PB602SH54G	15 x 60 x 55	125	219	28	<b>\$8781</b>

Wood framed glass doors. Hutches between 96" and 84" have 6 doors; hutches less than 84" have 4 doors. One adjustable shelf. No lock option available.

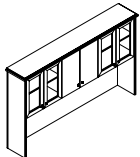

**54" H Storage Hutch w/Doors**

PB962SH54GDG	15 x 96 x 55	125	351	45	<b>\$12182</b>
PB902SH54GDG	15 x 90 x 55	125	329	42	<b>\$11294</b>
PB842SH54GDG	15 x 84 x 55	125	307	39	<b>\$10394</b>

Wood doors in the center and wood framed glass doors on left and right. One adjustable shelf. Locks are optional on wood doors.

### Required Specifications

Finish

### Optional Specifications

Locks\* (wood doors only)

**HUTCHES & WALL MOUNTED STORAGE**

**MODEL# DIMENSIONS FREIGHT CLASS WT/LBS. CUBIC FT. LIST PRICE**

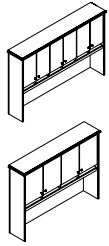

**54" H Storage Hutch w/Wood Doors & Pigeon-Holes**

	<b>D x W x H</b>					
PB962SHP54	15 x 96 x 55	125	351	45	<b>\$12195</b>	
PB902SHP54	15 x 90 x 55	125	329	42	<b>\$11434</b>	
PB842SHP54	15 x 84 x 55	125	307	39	<b>\$10667</b>	
PB782SHP54	15 x 78 x 55	125	285	37	<b>\$9908</b>	
PB722SHP54	15 x 72 x 55	125	263	34	<b>\$9146</b>	
PB662SHP54	15 x 66 x 55	125	241	31	<b>\$8806</b>	
PB602SHP54	15 x 60 x 55	125	219	28	<b>\$8381</b>	

Hutches between 96" and 84" have 6 doors; hutches less than 84" have 4 doors. One adjustable shelf. Locks are optional.

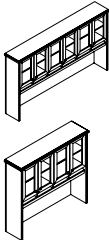

**54" H Storage Hutch w/Glass Doors & Pigeon-Holes**

PB962SHP54	15 x 96 x 55	125	351	45	<b>\$12195</b>	
PB902SHP54	15 x 90 x 55	125	329	42	<b>\$11434</b>	
PB842SHP54	15 x 84 x 55	125	307	39	<b>\$10667</b>	
PB782SHP54	15 x 78 x 55	125	285	37	<b>\$9908</b>	
PB722SHP54	15 x 72 x 55	125	263	34	<b>\$9146</b>	
PB662SHP54	15 x 66 x 55	125	241	31	<b>\$8806</b>	
PB602SHP54	15 x 60 x 55	125	219	28	<b>\$8381</b>	

Wood framed glass doors. Hutches between 96" and 84" have 6 doors; hutches less than 84" have 4 doors. One adjustable shelf. No lock option available.

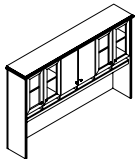

**54" H Storage Hutch w/Doors & Pigeon-Holes**

PB962SHP54GDG	15 x 96 x 55	125	351	45	<b>\$14218</b>	
PB902SHP54GDG	15 x 90 x 55	125	329	42	<b>\$13456</b>	
PB842SHP54GDG	15 x 84 x 55	125	307	39	<b>\$12355</b>	

Wood doors in the center and wood framed glass doors on left and right. One adjustable shelf. Locks are optional on wood doors.

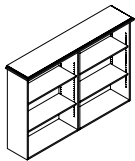

**Open Hutch**

PB720B54	15 x 72 x 55	125	260	35	<b>\$6995</b>	
PB360B54	15 x 36.75 x 55	125	130	18	<b>\$3507</b>	

Four adjustable shelves.

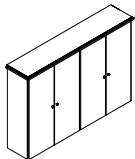

**Hutch w/Wood Doors**

PB72BD54	15 x 72 x 55	100	320	35	<b>\$9008</b>	
PB36BD54	15 x 36.75 x 55	100	160	18	<b>\$4512</b>	

Four adjustable shelves. Locks are optional.

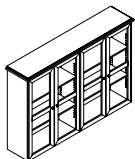

**Hutch w/Glass Doors**

PB72BG54	15 x 72 x 55	100	320	35	<b>\$10213</b>	
PB36BG54	15 x 36.75 x 55	100	160	18	<b>\$5109</b>	

Wood framed glass doors. Four adjustable shelves. No lock option available.

**Required Specifications**

Finish

**Optional Specifications**

Additional grommet  
Locks\* (wood doors only)

## HUTCHES & WALL MOUNTED STORAGE

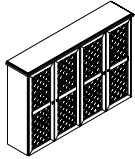

**Hutch w/Wire Mesh Doors**

MODEL#	DIMENSIONS D x W x H	FREIGHT CLASS	WT/LBS.	CUBIC FT.	LIST PRICE
PB72BW54	15 x 72 x 55	100	320	35	<b>\$11421</b>
PB36BW54	15 x 36.75 x 55	100	160	18	<b>\$5860</b>

Antique Brass wire mesh wood framed doors. Four adjustable shelves. No lock option available.

## FREESTANDING STORAGE NOTES

**NOTE:** Arrow indicates direction of grain

### Pedestals

- All units are shipped assembled.
- Standard face locking.

### Combination Storage

- All units are shipped assembled.
- No modifications accepted for this unit.
- Box drawers do not lock.
- Standard face locking.

### Storage Cabinets

- All units are shipped assembled.
- Units include adjustable shelves.
- Standard face locking.

### TV Cabinets

- All units are shipped assembled.
- Units include 170° hinges, grommet on fixed shelf and adjustable shelf in lower cabinet.
- Standard face locking for lower cabinet.
- To add lock for upper cabinet, specify "LO".

## FREESTANDING STORAGE

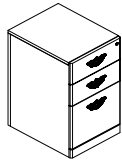

**Freestanding Pedestal**

MODEL#	DIMENSIONS D x W x H	FREIGHT CLASS	WT/LBS.	CUBIC FT.	LIST PRICE
PBWDB	19.8 x 15.5 x 28	85	70	5	<b>\$2701</b>
PBWWDB	23.8 x 15.5 x 28	85	75	6	<b>\$3111</b>

Box/box/file.

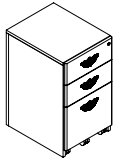

**Freestanding Mobile Pedestal**

PBWDM	19.8 x 15.5 x 28	85	70	5	<b>\$2906</b>
PBWWDM	23.8 x 15.5 x 28	85	75	6	<b>\$3339</b>

Box/box/file.

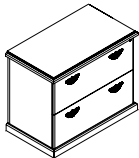

**Lateral File - 2 high**

PBF3624	24 x 36.75 x 29	85	184	15	<b>\$5000</b>
PBF3620	20 x 36.75 x 29	85	159	12	<b>\$4158</b>
PBN3024	24 x 31.63 x 29	85	153	12	<b>\$4375</b>
PBN3020	20 x 31.63 x 29	85	131	10	<b>\$3638</b>

Two lateral file drawers.

**Required Specifications**  
Finish

**Optional Specifications**  
Additional grommet

**FREESTANDING STORAGE**

**MODEL# DIMENSIONS FREIGHT CLASS WT/LBS. CUBIC FT. LIST PRICE**

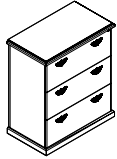

**Lateral File - 3 high**

D x W x H						
PBF36243	24 x 36.75 x 42	92.5	231	21		<b>\$6112</b>
PBF36203	20 x 36.75 x 42	92.5	193	18		<b>\$5217</b>
PBN30243	24 x 31.63 x 42	92.5	193	18		<b>\$5343</b>
PBN30203	20 x 31.63 x 42	92.5	160	15		<b>\$4564</b>

Three lateral file drawers.

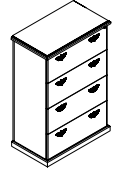

**Lateral File - 4 high**

PBF36244	24 x 36.75 x 54	92.5	297	27		<b>\$7443</b>
PBF36204	20 x 36.75 x 54	92.5	259	23		<b>\$6466</b>
PBN30244	24 x 31.63 x 54	92.5	248	23		<b>\$6508</b>
PBN30204	20 x 31.63 x 54	92.5	214	19		<b>\$5656</b>

Four lateral file drawers.

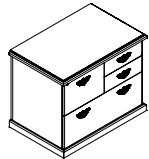

**Combination Storage - Left**

PBZL3624	24 x 36.75 x 29	85	184	15		<b>\$5418</b>
PBZL3620	20 x 36.75 x 29	85	160	12		<b>\$4375</b>

With 1 lateral file, 2 box drawers in the top right, and 1 file drawer in the top left.

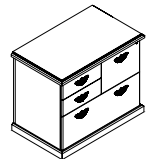

**Combination Storage - Right**

PBZR3624	24 x 36.75 x 29	85	184	15		<b>\$5418</b>
PBZR3620	20 x 36.75 x 29	85	160	12		<b>\$4375</b>

With 1 lateral file, 2 box drawers in the top left, and 1 file drawer in the top right.

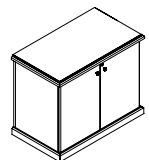

**Storage Cabinet w/Doors**

PBBD3624	24 x 36.75 x 29	92.5	152	15		<b>\$3405</b>
PBBD3620	20 x 36.75 x 29	92.5	129	12		<b>\$2966</b>
PBBD3024	24 x 31.63 x 29	92.5	127	12		<b>\$2981</b>
PBBD3020	20 x 31.63 x 29	92.5	106	10		<b>\$2592</b>

Storage with 1 adjustable shelf.

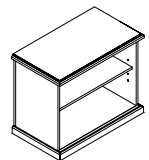

**Open Storage Cabinet**

PBOB3624	24 x 36.75 x 29	100	123	15		<b>\$2732</b>
PBOB3620	20 x 36.75 x 29	100	104	12		<b>\$2380</b>
PBOB3024	24 x 31.63 x 29	100	103	12		<b>\$2385</b>
PBOB3020	20 x 31.63 x 29	100	85	10		<b>\$2075</b>

Storage with 1 adjustable shelf.

**Required Specifications**

Finish

**Optional Specifications**

Additional grommet

## FREESTANDING STORAGE

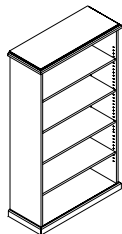

**Open Bookcase**

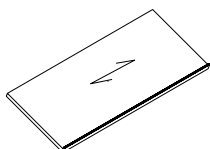

**Additional Shelf**

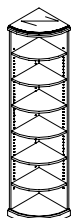

**Quarter Round Open Bookcase**

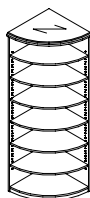

**Quarter Round Open Bookcase**

MODEL#	DIMENSIONS D x W x H	FREIGHT CLASS	WT/LBS.	CUBIC FT.	LIST PRICE
PBB83615	15 x 36.75 x 84	100	246	26	<b>\$4186</b>
PBB73615	15 x 36.75 x 78	100	228	24	<b>\$3887</b>
PBB63615	15 x 36.75 x 72	100	210	23	<b>\$3588</b>
PBB53615	15 x 36.75 x 65	100	188	21	<b>\$3302</b>
PBB43615	15 x 36.75 x 48	100	140	15	<b>\$2720</b>
PBB23615	15 x 36.75 x 29	92.5	90	8	<b>\$2180</b>
PBB23015	15 x 31.63 x 29	92.5	90	8	<b>\$1909</b>
PBB83615	15 x 31.63 x 84	100	246	26	<b>\$4186</b>
PBB73615	15 x 31.63 x 78	100	228	24	<b>\$3887</b>
PBB63615	15 x 31.63 x 72	100	210	23	<b>\$3588</b>
PBB53615	15 x 31.63 x 65	100	188	21	<b>\$3302</b>
PBB43615	15 x 31.63 x 48	100	140	15	<b>\$2720</b>

84" and 78" high models have 6 adjustable shelves, 72" has 5 adjustable shelves, 65" has 4 adjustable shelves, 48" has 3 adjustable shelves, 29" has 1 adjustable shelves.

PBAG3624	24 x 36 x 1	92.5	112	10	<b>\$225</b>
PBAG3622	22 x 36 x 1	92.5	104	10	<b>\$204</b>
PBAG3620	20 x 36 x 1	92.5	92	9	<b>\$184</b>
PBAG3615	15 x 36 x 1	92.5	81	8	<b>\$162</b>
PBAG3024	24 x 30 x 1	92.5	94	9	<b>\$189</b>
PBAG3022	22 x 30 x 1	100	87	9	<b>\$172</b>
PBAG3020	20 x 30 x 1	100	76	8	<b>\$152</b>
PBAG3015	15 x 30 x 1	100	67	8	<b>\$134</b>

**For use with open bookcase.** Can be specified for each shelf in an open bookcase.

PB8R1515	15 x 15 x 84	125	142	22	<b>\$3295</b>
PB7R1515	15 x 15 x 78	100	95	10	<b>\$3061</b>
PB6R1515	15 x 15 x 72	100	83	9	<b>\$2825</b>
PB5R1515	15 x 15 x 65	100	81	9	<b>\$2604</b>
PB4R1515	15 x 15 x 48	100	59	6	<b>\$2142</b>
PB2R1515	15 x 15 x 29	100	37	4	<b>\$1719</b>

84" and 78" high models have 6 adjustable shelves, 72" has 5 adjustable shelves, 65" has 4 adjustable shelves, 48" has 3 adjustable shelves, 29" has 1 adjustable shelf.

PBB7R2424H84	24 x 24 x 84	100	234	28	<b>\$5752</b>
PBB7R2424H72	24 x 24 x 72	125	204	28	<b>\$4933</b>
PBB7R2424H65	24 x 24 x 65	100	187	22	<b>\$4524</b>
PBB7R2020H84	20 x 20 x 84	100	163	19	<b>\$5027</b>
PBB7R2020H72	20 x 20 x 72	100	142	17	<b>\$4307</b>
PBB7R2020H65	20 x 20 x 65	100	130	15	<b>\$4039</b>

84" high models have 6 adjustable shelves, 72" has 5 adjustable shelves, and 65" has 4 adjustable shelves

### Required Specifications

Finish

**FREESTANDING STORAGE**

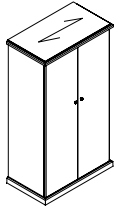

**Storage Cabinet w/Wood Doors**

**MODEL# DIMENSIONS FREIGHT CLASS WT/LBS. CUBIC FT. LIST PRICE**

**D x W x H**

PB1D24W36H84	24 x 36.75 x 84	125	304	42	<b>\$7990</b>
PB1D24W36H72	24 x 36.75 x 72	100	283	33	<b>\$6848</b>
PB1D24W36H65	24 x 36.75 x 65	100	259	30	<b>\$6276</b>
PB1D24W30H84	24 x 30.63 x 84	125	304	42	<b>\$6981</b>
PB1D24W30H72	24 x 30.63 x 72	100	283	33	<b>\$5983</b>
PB1D24W30H65	24 x 30.63 x 65	100	259	30	<b>\$5495</b>
PB1D24W24H84	24 x 24 x 84	92.5	320	28	<b>\$5964</b>
PB1D24W24H72	24 x 24 x 72	92.5	255	24	<b>\$5113</b>
PB1D24W24H65	24 x 24 x 65	125	173	22	<b>\$4712</b>
PB1D20W36H84	20 x 36.75 x 84	100	297	35	<b>\$6981</b>
PB1D20W36H72	20 x 36.75 x 72	100	269	30	<b>\$5983</b>
PB1D20W36H65	20 x 36.75 x 65	100	245	28	<b>\$5485</b>
PB1D20W30H84	20 x 30.63 x 84	100	257	29	<b>\$5816</b>
PB1D20W30H72	20 x 30.63 x 72	100	233	25	<b>\$4987</b>
PB1D20W30H65	20 x 30.63 x 65	100	202	23	<b>\$4571</b>
PB1D20W24H84	20 x 24 x 84	100	198	23	<b>\$4656</b>
PB1D20W24H72	20 x 24 x 72	100	179	20	<b>\$3990</b>
PB1D20W24H65	20 x 24 x 65	100	163	18	<b>\$3651</b>

84" high models have 6 adjustable shelves, 72" has 5 adjustable shelves, 65" has 4 adjustable shelves. For wood framed glass door option, please contact customer care. Lock is optional.

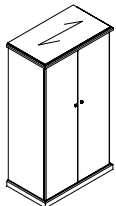

**Wardrobe Cabinet**

PB2D24W36H84	24 x 36.75 x 84	100	356	42	<b>\$6933</b>
PB2D24W36H72	24 x 36.75 x 72	100	324	36	<b>\$5945</b>
PB2D24W36H65	24 x 36.75 x 65	100	297	33	<b>\$5449</b>
PB2D24W30H84	24 x 30.63 x 84	100	296	35	<b>\$6070</b>
PB2D24W30H72	24 x 30.63 x 72	100	270	30	<b>\$5202</b>
PB2D24W30H65	24 x 30.63 x 65	100	248	28	<b>\$4768</b>
PB2D24W24H84	24 x 24 x 84	100	238	28	<b>\$5202</b>
PB2D24W24H72	24 x 24 x 72	100	216	24	<b>\$4459</b>
PB2D24W24H65	24 x 24 x 65	100	198	22	<b>\$4087</b>
PB2D20W36H84	20 x 36.75 x 84	100	297	35	<b>\$6054</b>
PB2D20W36H72	20 x 36.75 x 72	100	269	30	<b>\$5180</b>
PB2D20W36H65	20 x 36.75 x 65	100	245	28	<b>\$4745</b>
PB2D20W30H84	20 x 30.63 x 84	100	257	29	<b>\$5047</b>
PB2D20W30H72	20 x 30.63 x 72	100	233	25	<b>\$4318</b>
PB2D20W30H65	20 x 30.63 x 65	100	202	23	<b>\$3958</b>
PB2D20W24H84	20 x 24 x 84	100	198	23	<b>\$4034</b>
PB2D20W24H72	20 x 24 x 72	100	179	20	<b>\$3450</b>
PB2D20W24H65	20 x 24 x 65	100	163	18	<b>\$3166</b>

Doors, coat rack and hat shelf. 84" high models have 6 adjustable shelves, 72" has 5 adjustable shelves, 65" has 4 adjustable shelves. For wood framed glass door option, please contact customer care. Lock is optional.

**Required Specifications**

Finish

**Optional Specifications**

Lock



## FREESTANDING STORAGE

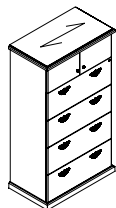

**Storage Cupboard\***

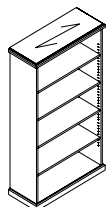

**Open Bookcase**

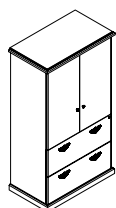

**Storage Cabinet w/Doors\***

MODEL#	DIMENSIONS D x W x H	FREIGHT CLASS	WT/LBS.	CUBIC FT.	LIST PRICE
PB6D24W36H84	24 x 36.75 x 84	92.5	449	42	<b>\$11681</b>
PB6D24W36H72	24 x 36.75 x 72	92.5	414	36	<b>\$10015</b>
PB6D24W36H65	24 x 36.75 x 65	92.5	380	33	<b>\$9181</b>
PB6D24W30H84	24 x 30.63 x 84	92.5	375	35	<b>\$10226</b>
PB6D24W30H72	24 x 30.63 x 72	92.5	345	30	<b>\$8766</b>
PB6D24W30H65	24 x 30.63 x 65	92.5	316	28	<b>\$8034</b>
PB6D20W36H84	20 x 36.75 x 84	92.5	382	35	<b>\$10200</b>
PB6D20W36H72	20 x 36.75 x 72	92.5	351	30	<b>\$8726</b>
PB6D20W36H65	20 x 36.75 x 65	92.5	321	28	<b>\$7995</b>
PB6D20W30H84	20 x 30.63 x 84	92.5	347	29	<b>\$8500</b>
PB6D20W30H72	20 x 30.63 x 72	85	306	25	<b>\$7274</b>
PB6D20W30H65	20 x 30.63 x 65	92.5	265	23	<b>\$6668</b>

Above lateral file cabinet with 4 drawers. 84" high model has 1 adjustable shelf. For wood framed glass door option, please contact customer care. Optional lock available for upper storage.

PB7D24W36H84	24 x 36.75 x 84	125	331	43	<b>\$6396</b>
PB7D24W36H72	24 x 36.75 x 72	100	306	36	<b>\$5485</b>
PB7D24W36H65	24 x 36.75 x 65	100	281	33	<b>\$5027</b>
PB7D24W30H84	24 x 30.63 x 84	125	280	36	<b>\$5597</b>
PB7D24W30H72	24 x 30.63 x 72	100	255	30	<b>\$4785</b>
PB7D24W30H65	24 x 30.63 x 65	100	234	28	<b>\$4391</b>
PB7D20W36H84	20 x 36.75 x 84	100	282	35	<b>\$5584</b>
PB7D20W36H72	20 x 36.75 x 72	100	257	30	<b>\$4785</b>
PB7D20W36H65	20 x 36.75 x 65	100	234	28	<b>\$4391</b>
PB7D20W30H84	20 x 30.63 x 84	100	248	29	<b>\$4651</b>
PB7D20W30H72	20 x 30.63 x 72	100	223	25	<b>\$3988</b>
PB7D20W30H65	20 x 30.63 x 65	100	193	23	<b>\$3654</b>

84" high models have 6 adjustable shelves, 72" has 5 adjustable shelves, and 65" has 4 adjustable shelves.

PB13D24W36H84	24 x 36.75 x 84	100	407	42	<b>\$9889</b>
PB13D24W36H72	24 x 36.75 x 72	92.5	387	36	<b>\$8477</b>
PB13D24W36H65	24 x 36.75 x 65	92.5	347	33	<b>\$7772</b>
PB13D24W30H84	24 x 30.63 x 84	92.5	350	35	<b>\$8654</b>
PB13D24W30H72	24 x 30.63 x 72	92.5	315	30	<b>\$7417</b>
PB13D24W30H65	24 x 30.63 x 65	92.5	289	28	<b>\$6798</b>
PB13D20W36H84	20 x 36.75 x 84	92.5	365	35	<b>\$8632</b>
PB13D20W36H72	20 x 36.75 x 72	92.5	327	30	<b>\$7385</b>
PB13D20W36H65	20 x 36.75 x 65	92.5	299	28	<b>\$6770</b>
PB13D20W30H84	20 x 30.63 x 84	92.5	305	29	<b>\$7197</b>
PB13D20W30H72	20 x 30.63 x 72	92.5	285	25	<b>\$6157</b>
PB13D20W30H65	20 x 30.63 x 65	92.5	247	23	<b>\$5641</b>

Above two lateral file drawers. 84" high models have 3 adjustable shelves, 72" has 2 adjustable shelves, and 65" has 1 adjustable shelf. For wood framed glass door option, please contact customer care. Optional lock available for upper storage.

### Required Specifications

Finish

### Optional Specifications

Additional grommet

Lock\*

**FREESTANDING STORAGE**

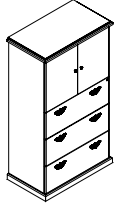

**Storage Cabinet w/Doors**

**MODEL# DIMENSIONS FREIGHT CLASS WT/LBS. CUBIC FT. LIST PRICE**

**D x W x H**

PB14D24W36H84	24 x 36.75 x 84	100	390	42	<b>\$10632</b>
PB14D24W36H72	24 x 36.75 x 72	92.5	360	36	<b>\$9114</b>
PB14D24W36H65	24 x 36.75 x 65	92.5	330	33	<b>\$8353</b>
PB14D24W30H84	24 x 30.63 x 84	100	325	35	<b>\$9305</b>
PB14D24W30H72	24 x 30.63 x 72	92.5	300	30	<b>\$7870</b>
PB14D24W30H65	24 x 30.63 x 65	100	275	28	<b>\$7311</b>

PB14D20W36H84	20 x 36.75 x 84	100	330	35	<b>\$9281</b>
PB14D20W36H72	20 x 36.75 x 72	92.5	305	30	<b>\$7940</b>
PB14D20W36H65	20 x 36.75 x 65	100	278	28	<b>\$7280</b>
PB14D20W30H84	20 x 30.63 x 84	92.5	298	29	<b>\$7735</b>
PB14D20W30H72	20 x 30.63 x 72	92.5	265	25	<b>\$6616</b>
PB14D20W30H65	20 x 30.63 x 65	100	229	23	<b>\$6067</b>

Above three lateral file drawers. 84" high models have 2 adjustable shelves, 72" and 65" have 1 adjustable shelf. For wood framed glass door option, please contact customer care. Optional lock available for upper storage.

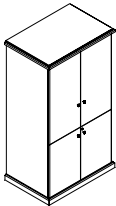

**Closed Storage Cabinet**

PB23D24W36H84	24 x 36.75 x 84	100	390	42	<b>\$8534</b>
PB23D24W36H72	24 x 36.75 x 72	92.5	360	36	<b>\$7314</b>
PB23D24W36H65	24 x 36.75 x 65	92.5	330	33	<b>\$6704</b>
PB23D24W30H84	24 x 30.63 x 84	100	325	35	<b>\$7089</b>
PB23D24W30H72	24 x 30.63 x 72	92.5	300	30	<b>\$6079</b>
PB23D24W30H65	24 x 30.63 x 65	100	275	28	<b>\$5586</b>

PB23D20W36H84	20 x 36.75 x 84	100	330	35	<b>\$7449</b>
PB23D20W36H72	20 x 36.75 x 72	92.5	305	30	<b>\$6376</b>
PB23D20W36H65	20 x 36.75 x 65	100	278	28	<b>\$5840</b>
PB23D20W30H84	20 x 30.63 x 84	92.5	298	29	<b>\$6207</b>
PB23D20W30H72	20 x 30.63 x 72	92.5	265	25	<b>\$5309</b>
PB23D20W30H65	20 x 30.63 x 65	100	229	23	<b>\$4869</b>

With upper and lower split doors. 1 fixed shelf and 2 adjustable shelves. For wood framed glass door option, please contact customer care. Optional lock available for upper storage.

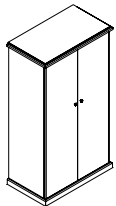

**Cabinet w/Doors and Storage**

PB25D24W36H84	24 x 36.75 x 84	100	390	42	<b>\$8965</b>
PB25D24W36H72	24 x 36.75 x 72	92.5	360	36	<b>\$7682</b>
PB25D24W36H65	24 x 36.75 x 65	92.5	330	33	<b>\$7042</b>
PB25D24W30H84	24 x 30.63 x 84	100	325	35	<b>\$7842</b>
PB25D24W30H72	24 x 30.63 x 72	92.5	300	30	<b>\$6719</b>
PB25D24W30H65	24 x 30.63 x 65	100	275	28	<b>\$6164</b>
PB25D24W24H84	24 x 24 x 84	100	260	28	<b>\$6713</b>
PB25D24W24H72	24 x 24 x 72	92.5	240	24	<b>\$5752</b>
PB25D24W24H65	24 x 24 x 65	92.5	220	22	<b>\$5280</b>

PB25D20W36H84	20 x 36.75 x 84	100	330	35	<b>\$7821</b>
PB25D20W36H72	20 x 36.75 x 72	92.5	305	30	<b>\$6692</b>
PB25D20W36H65	20 x 36.75 x 65	100	278	28	<b>\$6129</b>
PB25D20W30H84	20 x 30.63 x 84	92.5	300	29	<b>\$6520</b>
PB25D20W30H72	20 x 30.63 x 72	92.5	265	25	<b>\$5575</b>
PB25D20W30H65	20 x 30.63 x 65	100	229	23	<b>\$5111</b>
PB25D20W24H84	20 x 24 x 84	92.5	235	23	<b>\$5219</b>
PB25D20W24H72	20 x 24 x 72	92.5	203	20	<b>\$4466</b>
PB25D20W24H65	20 x 24 x 65	92.5	185	18	<b>\$4095</b>

Wardrobe with coat rack and hat shelf on left. Storage with adjustable shelves on right. 84" high models have 5 adjustable shelves, 72" and 65" have 4 adjustable shelves. For wood framed glass door option, please contact customer care. Lock is optional.

**Required Specifications**

Finish

**Optional Specifications**

Additional grommet  
Lock

## RECEPTION DESKS

### MODEL#

### DIMENSIONS

### FREIGHT CLASS

### WT./LBS.

### CUBIC FT.

### LIST PRICE

D x W x H

- To add storage use modular components. See page 356.
- Includes GM5 grommet.
- Transaction tops to be specified separately, handed by square edge from user side.

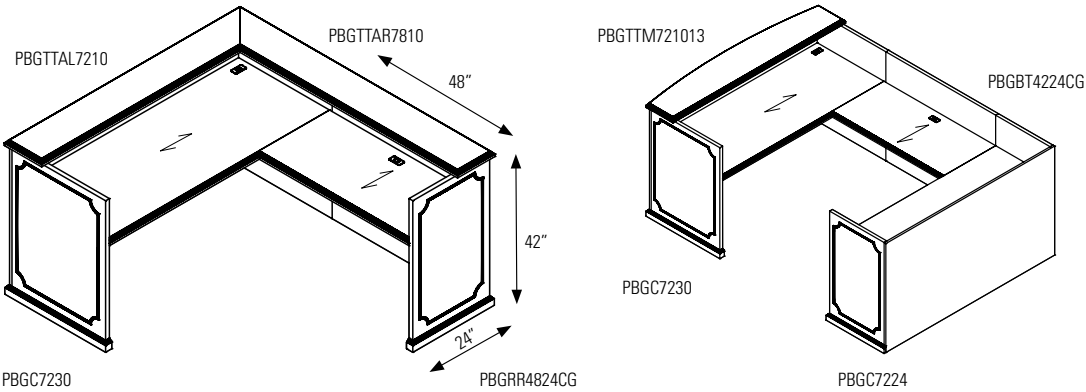

## RECEPTION DESKS

### MODEL#

### DIMENSIONS

### FREIGHT CLASS

### WT./LBS.

### CUBIC FT.

### LIST PRICE

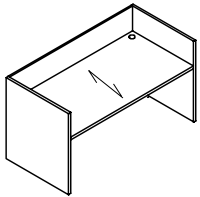

**Gallery/Reception Desk Shell\***

PBGC12036	36 x 120 x 42	150	592	105	<b>\$12272</b>
PBGC10836	36 x 108 x 42	150	533	95	<b>\$11044</b>
PBGC10236	36 x 102 x 42	150	503	89	<b>\$10431</b>
PBGC9636	36 x 96 x 42	150	473	84	<b>\$9815</b>
PBGC9036	36 x 90 x 42	150	444	79	<b>\$9205</b>
PBGC8436	36 x 84 x 42	150	414	74	<b>\$8587</b>
PBGC7236	36 x 72 x 42	150	355	63	<b>\$7368</b>
PBGC7230	30 x 72 x 42	150	315	53	<b>\$7124</b>
PBGC6630	30 x 66 x 42	125	295	48	<b>\$6947</b>
PBGC6030	30 x 60 x 42	125	275	44	<b>\$6552</b>

No pedestals. Two grommets in worksurface. For use with modular storage components. Pin molding included.

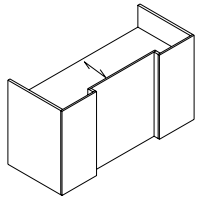

**Gallery/Reception Desk Shell  
Breakfront Style**

PBGIC12036	36 x 120 x 42	150	592	105	<b>\$13497</b>
PBGIC10836	36 x 108 x 42	150	533	95	<b>\$12145</b>
PBGIC10236	36 x 102 x 42	150	503	89	<b>\$11473</b>
PBGIC9636	36 x 96 x 42	150	473	84	<b>\$10796</b>
PBGIC9036	36 x 90 x 42	150	444	79	<b>\$10126</b>
PBGIC8436	36 x 84 x 42	150	414	74	<b>\$9446</b>
PBGIC7236	36 x 72 x 42	150	355	63	<b>\$8099</b>
PBGIC7230	30 x 72 x 42	150	315	53	<b>\$7838</b>
PBGIC6630	30 x 66 x 42	125	295	48	<b>\$7641</b>
PBGIC6030	30 x 60 x 42	125	275	44	<b>\$7207</b>

No pedestals. Two grommets in worksurface. For use with modular storage components. Pin molding included.

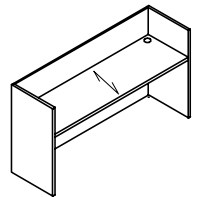

**Gallery/Reception Credenza Shell\***

PBGC12024	24 x 120 x 42	150	392	70	<b>\$9627</b>
PBGC10824	24 x 108 x 42	150	353	63	<b>\$8654</b>
PBGC10224	24 x 102 x 42	150	333	60	<b>\$8177</b>
PBGC9624	24 x 96 x 42	150	314	56	<b>\$7693</b>
PBGC9024	24 x 90 x 42	150	294	53	<b>\$7213</b>
PBGC8424	24 x 84 x 42	150	274	49	<b>\$6735</b>
PBGC7224	24 x 72 x 42	150	235	42	<b>\$5774</b>
PBGC6624	24 x 66 x 42	150	216	39	<b>\$5425</b>
PBGC6024	24 x 60 x 42	150	196	35	<b>\$5083</b>

**No pedestals.** Two grommets in worksurface. For use with modular storage components. Pin molding included.

### Required Specifications

Finish

### Optional Specifications

Additional grommet

RECEPTION DESKS

MODEL# DIMENSIONS FREIGHT CLASS WT/LBS. CUBIC FT. LIST PRICE

D x W x H

PBGBT5624CG	24 x 56 x 42	150	178	32	\$5183
PBGBT5424CG	24 x 54 x 42	150	169	29	\$5183
PBGBT5024CG	24 x 50 x 42	150	151	27	\$4606
PBGBT4824CG	24 x 48 x 42	150	142	26	\$4606
PBGBT4424CG	24 x 44 x 42	150	134	23	\$4029
PBGBT4224CG	24 x 42 x 42	150	127	22	\$4029
PBGBT3824CG	24 x 38 x 42	150	119	20	\$3629
PBGBT3624CG	24 x 36 x 42	150	112	19	\$3629

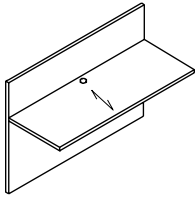

Bridge

Attaches between **Gallery Desk and Gallery Credenza Only**. One grommet in center of worksurface. Shipped RTA (ready to assemble). Pin molding included.

- To remove cross-grain veneer pattern on top, **delete "CG"** from model number. Available as a special - no upcharge.

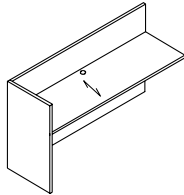

Reception Return - LEFT

PBGRL7224CG	24 x 72 x 42	125	273	42	\$7266
PBGRL6624CG	24 x 66 x 42	125	250	39	\$6664
PBGRL6024CG	24 x 60 x 42	125	228	35	\$6060
PBGRL5424CG	24 x 54 x 42	125	205	32	\$5458
PBGRL4824CG	24 x 48 x 42	125	182	28	\$4844
PBGRL4224CG	24 x 42 x 42	125	159	25	\$4243
PBGRL3624CG	24 x 36 x 42	125	137	21	\$3817

**No pedestal.** One grommet in center of worksurface. For use with modular storage components. Pin molding included.

- To remove cross-grain veneer pattern on top, **delete "CG"** from model number. Available as a special - no upcharge.

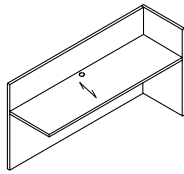

Reception Return - RIGHT

PBGRR7224CG	24 x 72 x 42	125	273	42	\$7266
PBGRR6624CG	24 x 66 x 42	125	250	39	\$6664
PBGRR6024CG	24 x 60 x 42	125	228	35	\$6060
PBGRR5424CG	24 x 54 x 42	125	205	32	\$5458
PBGRR4824CG	24 x 48 x 42	125	182	28	\$4844
PBGRR4224CG	24 x 42 x 42	125	159	25	\$4243
PBGRR3624CG	24 x 36 x 42	125	137	21	\$3817

**No pedestal.** One grommet in center of worksurface. For use with modular storage components. Pin molding included.

- To remove cross-grain veneer pattern on top, **delete "CG"** from model number. Available as a special - no upcharge.

Required Specifications

Finish

Optional Specifications

Additional grommet

## TRANSACTION COUNTERS

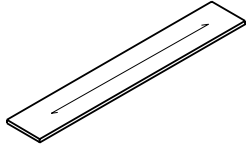

**Transaction Counter Top**

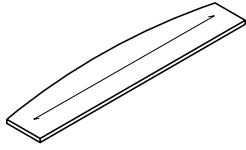

**Bow Front Transaction Counter Top**

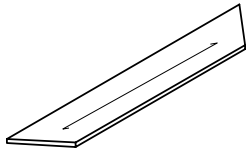

**Trapezoid Transaction Counter Top**

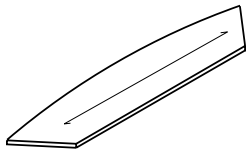

**Bow Front Trapezoid Transaction Counter Top**

MODEL#	DIMENSIONS	FREIGHT CLASS	WT/LBS.	CUBIC FT.	LIST PRICE
--------	------------	---------------	---------	-----------	------------

**D x W x H**

PBGTT12010	10 x 120 x 1.50	92.5	84	8	<b>\$2055</b>
PBGTT10810	10 x 108 x 1.50	100	78	8	<b>\$1852</b>
PBGTT10210	10 x 102 x 1.50	92.5	72	7	<b>\$1751</b>
PBGTT9610	10 x 96 x 1.50	100	66	7	<b>\$1648</b>
PBGTT9010	10 x 90 x 1.50	92.5	60	6	<b>\$1543</b>
PBGTT8410	10 x 84 x 1.50	100	54	6	<b>\$1436</b>
PBGTT7210	10 x 72 x 1.50	100	48	5	<b>\$1232</b>
PBGTT6610	10 x 66 x 1.50	100	42	5	<b>\$1130</b>
PBGTT6010	10 x 60 x 1.50	100	36	4	<b>\$1030</b>

**Rectangular top** for main reception desk. Counter sits on top of Gallery panels. Does not overhang. **Factory installed - specify Gallery to be used on.** Size must match dimension of desk front or combined desk side and return length. Hardware included.

PBGTTM1081013	10-13 x 108 x 1.50	125	78	10	<b>\$2768</b>
PBGTTM1021013	10-13 x 102 x 1.50	100	72	9	<b>\$2666</b>
PBGTTM961013	10-13 x 96 x 1.50	125	66	9	<b>\$2566</b>
PBGTTM901013	10-13 x 90 x 1.50	125	60	8	<b>\$2461</b>
PBGTTM841013	10-13 x 84 x 1.50	125	54	8	<b>\$2352</b>
PBGTTM721013	10-13 x 72 x 1.50	125	48	7	<b>\$2150</b>
PBGTTM661013	10-13 x 66 x 1.50	125	42	6	<b>\$2048</b>
PBGTTM601013	10-13 x 60 x 1.50	125	36	5	<b>\$1946</b>

**Bow top** for main reception desk. Counter sits on top of Gallery panels. Bow front overhangs 3". **Factory installed - specify Gallery to be used on.** Size must match dimension of desk front or combined desk side and return length. Hardware included.

PBGTTA10810	10 x 108 x 1.50	100	78	8	<b>\$2100</b>
PBGTTA10210	10 x 102 x 1.50	92.5	72	7	<b>\$1996</b>
PBGTTA9610	10 x 96 x 1.50	100	66	7	<b>\$1893</b>
PBGTTA9010	10 x 90 x 1.50	92.5	60	6	<b>\$1791</b>
PBGTTA8410	10 x 84 x 1.50	100	54	6	<b>\$1686</b>
PBGTTA7210	10 x 72 x 1.50	100	48	5	<b>\$1481</b>
PBGTTA6610	10 x 66 x 1.50	100	42	5	<b>\$1379</b>
PBGTTA6010	10 x 60 x 1.50	100	36	4	<b>\$1277</b>

**Trapezoid top** for main reception desk. 45° mitered ends on left and right. For use with left and right 45° mitered return transaction counters. Counter sits on top of Gallery panels. Does not overhang. **Factory installed - specify Gallery to be used on.** Width must match dimension of desk front. Hardware included.

PBGTTMA1081013	10-13 x 108 x 1.50	125	78	10	<b>\$2884</b>
PBGTTMA1021013	10-13 x 102 x 1.50	100	72	9	<b>\$2779</b>
PBGTTMA961013	10-13 x 96 x 1.50	125	66	9	<b>\$2679</b>
PBGTTMA901013	10-13 x 90 x 1.50	125	60	8	<b>\$2573</b>
PBGTTMA841013	10-13 x 84 x 1.50	125	54	8	<b>\$2470</b>
PBGTTMA721013	10-13 x 72 x 1.50	125	48	7	<b>\$2265</b>
PBGTTMA661013	10-13 x 66 x 1.50	125	42	6	<b>\$2158</b>
PBGTTMA601013	10-13 x 60 x 1.50	125	36	5	<b>\$2059</b>

**Trapezoid bow top** for main reception desk. 45° mitered ends on left and right. For use with left and right 45° mitered return transaction counters. Counter sits on top of Gallery panels. Bow front overhangs 3". **Factory installed - specify Gallery to be used on.** Width must match dimension of desk front. Hardware included.

**Required Specifications**

Finish

**Optional Specifications**

Additional grommet

**TRANSACTION COUNTERS**      **MODEL#**      **DIMENSIONS**      **FREIGHT CLASS**      **WT/LBS.**      **CUBIC FT.**      **LIST PRICE**

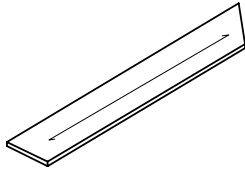

**Transaction Counter Top - LEFT**

	<b>D x W x H</b>					
PBGTTAL12010	10 x 120 x 1.50	92.5	84	8		<b>\$2218</b>
PBGTTAL11410	10 x 114 x 1.50	92.5	81	8		<b>\$2109</b>
PBGTTAL10810	10 x 108 x 1.50	100	78	8		<b>\$2011</b>
PBGTTAL10210	10 x 102 x 1.50	92.5	72	7		<b>\$1911</b>
PBGTTAL9610	10 x 96 x 1.50	100	66	7		<b>\$1808</b>
PBGTTAL9010	10 x 90 x 1.50	92.5	60	6		<b>\$1706</b>
PBGTTAL8410	10 x 84 x 1.50	100	54	6		<b>\$1600</b>
PBGTTAL7210	10 x 72 x 1.50	100	48	5		<b>\$1396</b>
PBGTTAL6610	10 x 66 x 1.50	100	42	5		<b>\$1290</b>
PBGTTAL6010	10 x 60 x 1.50	100	36	4		<b>\$1191</b>
PBGTTAL3610	10 x 36 x 1.50	100	24	3		<b>\$715</b>
PBGTTAL3010	10 x 30 x 1.50	92.5	20	2		<b>\$594</b>
PBGTTAL2410	10 x 24 x 1.50	100	16	2		<b>\$478</b>

**Rectangular top** for main reception desk with 45° mitered end on **left**. For use with rectangular or bow front transaction counters with miters at both ends. Width must match dimension of Gallery Desk end and Return width. Counter sits on top of Gallery panels. Does not overhang. **Factory installed - specify Gallery to be used on.** Hardware included.

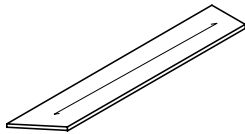

**Transaction Counter Top - RIGHT**

PBGTTAR12010	10 x 120 x 1.50	92.5	84	8		<b>\$2218</b>
PBGTTAR11410	10 x 114 x 1.50	92.5	81	8		<b>\$2109</b>
PBGTTAR10810	10 x 108 x 1.50	100	78	8		<b>\$2011</b>
PBGTTAR10210	10 x 102 x 1.50	92.5	72	7		<b>\$1911</b>
PBGTTAR9610	10 x 96 x 1.50	100	66	7		<b>\$1808</b>
PBGTTAR9010	10 x 90 x 1.50	92.5	60	6		<b>\$1706</b>
PBGTTAR8410	10 x 84 x 1.50	100	54	6		<b>\$1600</b>
PBGTTAR7210	10 x 72 x 1.50	100	48	5		<b>\$1396</b>
PBGTTAR6610	10 x 66 x 1.50	100	42	5		<b>\$1290</b>
PBGTTAR6010	10 x 60 x 1.50	100	36	4		<b>\$1191</b>
PBGTTAR3610	10 x 36 x 1.50	100	24	3		<b>\$715</b>
PBGTTAR3010	10 x 30 x 1.50	92.5	20	2		<b>\$594</b>
PBGTTAR2410	10 x 24 x 1.50	100	16	2		<b>\$478</b>

**Rectangular top** for main reception desk with 45° mitered end on **right**. For use with rectangular or bow front transaction counters with miters at both ends. Width must match dimension of Gallery Desk end and Return width. Counter sits on top of Gallery panels. Does not overhang. **Factory installed - specify Gallery to be used on.** Hardware included.

**Required Specifications**  
Finish

**Optional Specifications**  
Additional grommet

## TACKBOARDS FOR HUTCHES & ACCESSORIES

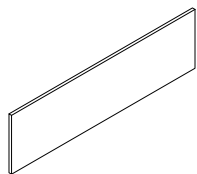

**Tackboard for 36"H\*  
Non-Pigeon Hole Hutches**

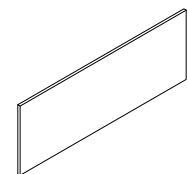

**Tackboard for 42"H & 54"H\*  
Pigeon Hole Hutches**

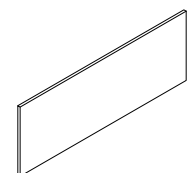

**Tackboard for 42"H & 54"H\*  
Non-Pigeon Hole Hutches**

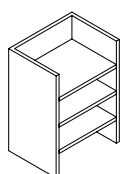

**Paper Organizer, Letter & Legal Format**

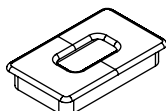

**Grommet**

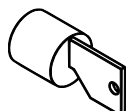

**Lock Assembly**

MODEL#	DIMENSIONS D x W x H	FREIGHT CLASS	WT/LBS.	CUBIC FT.	LIST PRICE
PBTS108	1 x 104.5 x 20	92.5	23	2	<b>\$1232</b>
PBTS102	1 x 98.5 x 20	100	19	2	<b>\$1166</b>
PBTS96	1 x 92.5 x 20	70	17	1	<b>\$1097</b>
PBTS90	1 x 86.5 x 20	70	15	1	<b>\$1030</b>
PBTS84	1 x 80.5 x 20	85	14	1	<b>\$967</b>
PBTS78	1 x 74.5 x 20	85	13	1	<b>\$894</b>
PBTS72	1 x 68.5 x 20	85	12	1	<b>\$825</b>
PBTS66	1 x 62.5 x 20	92.5	11	1	<b>\$753</b>
PBTS60	1 x 56.5 x 20	92.5	10	1	<b>\$688</b>

Factory installed hutch tackboard.

PBTSP108H23	1 x 104.5 x 23	70	30	2	<b>\$1394</b>
PBTSP102H23	1 x 98.5 x 23	85	24	2	<b>\$1328</b>
PBTSP96H23	1 x 92.5 x 23	92.5	22	2	<b>\$1240</b>
PBTSP90H23	1 x 86.5 x 23	70	20	1	<b>\$1162</b>
PBTSP84H23	1 x 80.5 x 23	70	18	1	<b>\$1085</b>
PBTSP78H23	1 x 74.5 x 23	70	17	1	<b>\$1008</b>
PBTSP72H23	1 x 68.5 x 23	70	16	1	<b>\$937</b>
PBTSP66H23	1 x 62.5 x 23	85	14	1	<b>\$852</b>
PBTSP60H23	1 x 56.5 x 23	85	13	1	<b>\$779</b>

Factory installed hutch tackboard.

PBTS108H26	1 x 104.5 x 26	70	30	2	<b>\$1611</b>
PBTS102H26	1 x 98.5 x 26	85	24	2	<b>\$1518</b>
PBTS102H26	1 x 92.5 x 26	85	24	2	<b>\$1518</b>
PBTS90H26	1 x 86.5 x 26	92.5	20	2	<b>\$1344</b>
PBTS84H26	1 x 80.5 x 26	100	18	2	<b>\$1160</b>
PBTS78H26	1 x 74.5 x 26	100	17	2	<b>\$982</b>
PBTS72H26	1 x 68.5 x 26	70	16	1	<b>\$894</b>
PBTS66H26	1 x 62.5 x 26	85	14	1	<b>\$802</b>
PBTS60H26	1 x 56.5 x 26	85	13	1	<b>\$621</b>

Factory installed hutch tackboard.

PBCPH161226	12 x 16 x 27	125	20	3	<b>\$981</b>
PBCPH161223	12 x 16 x 23	125	18	3	<b>\$1335</b>
PBCPH161219	12 x 16 x 20	125	15	2	<b>\$632</b>
PBCPH131226	12 x 13 x 27	100	16	2	<b>\$795</b>
PBCPH131223	12 x 13 x 23	125	15	2	<b>\$675</b>
PBCPH131219	12 x 13 x 20	125	12	2	<b>\$512</b>

GM5C	2 x 3.5 x --	70	--	--	<b>\$107</b>
------	--------------	----	----	----	--------------

Rectangular grommet in metal, tungsten finish.

LO/C	--	70	--	--	<b>\$106</b>
------	----	----	----	----	--------------

Tungsten.

### Required Specifications

Fabric\*