



Philadelphia detailing is traditional with a 1" overhang on all edges. Solid walnut, cherry, maple, oak that bands worksurface perimeter is 1" wide by 1-3/8" thick for an overall thickness of 1-3/8". Philadelphia is a "top over pedestal" detailed series. Philadelphia is standard with a base. Floor storage unit bases (i.e. kick-plates on pedestals, lateral files, bookcases, etc.) are extended out over drawer faces and horizontally grained. Products that are normally positioned against walls, such as credenzas, have a self-edge veneered back edge detail. All primary faces have pin molding decorations.

This elegantly designed traditional furniture series employs state-of-the-art manufacturing to create traditional pieces for executive offices, conference rooms and reception areas. Philadelphia is characterized by solid-wood edge detailing with solid-wood moldings on the cases and brass hardware throughout. The finest clear hardwoods are hand-selected to ensure that the best quality and consistency is achieved. Each piece is protected with a catalyzed conversion varnish to provide one of the most durable finishes in the industry. Philadelphia makes a truly impressive statement for the discerning customer.



Features and Benefits

- Philadelphia is a traditional collection characterized by craftsmanship and elegance
- Solid-wood edge detailing with solid-wood moldings on the cases and brass hardware throughout
- Drawers are standard vinyl-wrapped construction with black drawer sides and bottom.
- Pedestals feature antique brass handles, profiled drawer fronts and maple drawer interiors.
- The base is profiled, with pin moldings on desk fronts and sides.
- Bronze glass is standard with clear glass available as an option.
- Modesty panel upgrades are available on select models.

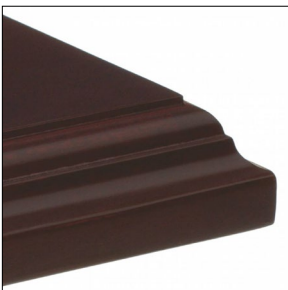

1-3/8" thick solid hardwood edge

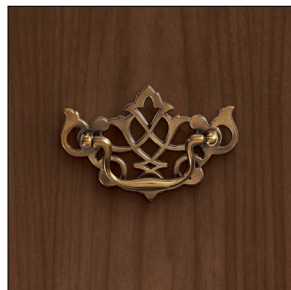

Antique brass pull (PL40)



Knob on uppers (DK25)

GENERAL INFORMATION

- Philadelphia is comprised of hundreds of models for the traditional executive suite and coordinating meeting areas.
- Solid wood is used on all perimeter worksurface edges, as well as end panel bottoms for mounting leveling glides
- 1" overhang with a traditional detailing is featured on all user and approach sides.
- Brass bulls exclusive to Philadelphia detail the traditional style of the product.
- GM5 grommets are standard on all designated worksurfaces.
- **Level certified**

CONSTRUCTION

- Number One select, architectural grade "A" oak, American black walnut, American black cherry or maple. Wood worksurface molded edges are solid oak, walnut, cherry, or maple.
- Traditional detailing with 1" overhang on all edges.
- Solid walnut, cherry, maple, oak that bands worksurface perimeter is 1" wide by 1-3/8" thick for an overall thickness of 1-3/8".

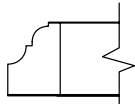
**Edge detail**

- Top over pedestal design
- Products that are normally positioned against walls, such as credenzas, have a self-edge veneered back edge detail. All primary faces have pin molding decorations.

FINISHES

- Conversion varnish (similar to catalyzed lacquer, but tougher), 25 degree sheen. Finishes are not buffed or rubbed.
- All Global wood casegood products are veneered and finished on the back sides (360° finishing), except modular under-surface storage - tops and backs are unfinished.
- Touch up kits available, includes a touch up marker and fill crayon. Order **VTOUCHUPKIT, \$175** list. Specify finish when ordering.
- Global standard finish, on oak and walnut, is open pore and on cherry and maple is semi-closed pore. If a full finish is required for walnut, cherry, anigre and maple tops, Add the suffix "2" to the finish code and Add 5% to the base pricing for each product.

CUSTOM FINISH IS AVAILABLE.**PEDESTALS**

- Full-to-the-floor. Pedestals are fully assembled units that are either installed into desk and credenza shells, or available as modular units. Undersurface storage units include locks.
- Pedestal drawer suspensions are metal ball bearing type. Both box and file drawers are full extension.
- Drawers are standard vinyl-wrapped construction with black drawer sides and bottom.
- The drawer front is an applied element to a four sided drawer. Drawer fronts are veneered on all surfaces except the vertical edges, which are solid oak, walnut, cherry and maple then routed with series detailing. Drawer fronts can be removed or replaced in the field.
- Levelers have 1" range of adjustment.

LOCKS

- Locks are standard on all below worksurface level drawer and door storage units, with the exception of pull-out tray units and single lateral file drawer combination tray/slot units.
- Combination storage unit comes with lock for file and lateral file drawer only; box drawers cannot lock.
- Lock color will match the handle option.
- Locks are optional on all above worksurface level closed storage.
- For optional lock, specify **LO. Add \$143** per lock.

HANDLES

- All drawer fronts come with traditional antique brass finished handles centered on drawer faces. All cabinet doors come with knobs in the same finish.

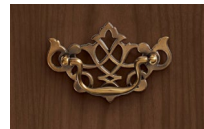
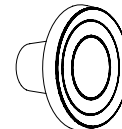
**PL40** Brass Pull, 4.5"**DK25** Knob on Uppers**HARDWARE**

- All necessary hardware items for attaching furniture items are included in the shipment. Actual wall attachment fasteners for wall cabinets, tackboards and visual boards are not included due to variation between site conditions.

LEVELING GLIDES

- Shipped in a plastic bag attached to the bottom of the item or inside the pedestal. It is important to install leveling glides to ensure the unit is level. Levelers have a 1" range of adjustment.

HANGING FILE RAILS

- Pre-installed on file drawer perimeters and accommodate both legal and letter size filing. Legal filing can be achieved either as side-to-side or front-to-back. Letter filing can be achieved as front-to-back filing only.

FLAT PLATES

- Flat plates are used to attach bridges and returns to desks and are shipped pre-attached to the bottom of the bridge or return.
 - Mini flat plates for securing bridge back panels to desk or credenza end panels, and quick connectors for securing modular corner units to adjacent pieces, are shipped along with screws in a plastic bag attached to the bottom of the bridge or return.
- CAUTION:** Using screws other than those supplied by Global could result in damage to finished tops.

WALL-MOUNTED CABINETS, TACKBOARDS AND VISUAL BOARDS

- Pre-attached with horizontal wall rails to the back of each unit. The wall-side components must be detached from the unit and fastened to the wall accordingly.
- Wall fasteners are not included due to the variable site conditions. Securing the wall rail to a vertical structural member is the required manner of installation. The cabinet or visual board is then lowered on to the wall rail. It is important to level the wall rail before installation.
- Wall cabinets are equipped with levelers at the bottom of the back panels for proper cabinet alignment.
- Units with doors are equipped with adjustable European door hinges to assist in door alignment. It is required to use a #8 wood screw through the back of the cabinet and the wall-mounted rail, to further secure the wall attachment.
- Tackboards have vertical grooves in the back for tasklight wiring.
- Hutches and tackboards are installed with double faced tape applied to the bottom of the end panels. The tape is shipped in a plastic bag found in the hutch. Removal of the hutch requires moderate pressure to be applied on the top of the unit towards the wall for at least a minute for the pressure sensitive tape to release. Additional support may be added by installing flat plates along the outside back of the attached units. *These flat plates are not included in the shipment.*
- Hutch tackboards are factory-installed.
- Tackboards are standard in Grade 3 panel fabrics.

MODULAR STORAGE UNITS

- Pre-drilled holes through the unfinished tops for securing to the bottom of worksurfaces
- Screws and lock keys are included in a plastic bag fastened inside the pedestal. Installer should leave a 1/8" reveal between the Modular Storage Unit and the End panel. Disassemble the Modular Unit first before relocating the entire unit to avoid damage or bodily injuries.

PEDESTAL SPACERS

- Required if pedestals are placed side by side. A 1" gap is required between the modular pedestals to allow access to vertical fingerpulls. If required, order **SP700**.

5-SIDED CORNER TABLES

- Join bridge and credenza run-offs, using the supplied quick connectors.
- Recessed end-panels in these units are pre-drilled to accept quick-connectors for easy alignment
- Accurate leveling is critical for these units to align and connect properly.
- Flat-plates are pre-attached to the worksurface to secure to the desk unit.

1. SPECIFY MODEL NUMBER

2. SPECIFY FINISH

WORKSURFACE TOP & DRAWER/DOOR FRONTS, BODY FINISHES (INCLUDING PEDESTALS) - VENEER

Code	Finish	Veneer Type	Cut
AMW	Almond Cherry	Cherry	Flat Sliced
ACW	Amber Cherry	Cherry	Flat Sliced
BTW	Biscotti	White Oak	Rift
CAW	Cocoa Walnut	Walnut	Flat Sliced
CRW	Coral	White Oak	Rift
DCW	Dark Cherry	Cherry	Flat Sliced
DWW	Dark Walnut	Walnut	Flat Sliced
EWV	Espresso Walnut	Walnut	Flat Sliced
EVW	Evening Oak	White Oak	Rift
GRW	Grey on Oak	White Oak	Rift
HAW	Hazelnut	Maple	Flat Sliced
JAW	Java	White Oak	Rift
LTW	Latte Walnut	Walnut	Flat Sliced
MHW	Mahogany on Walnut	Walnut	Flat Sliced
MTW	Milestone	White Oak	Rift
MPW	Natural Maple	Maple	Flat Sliced
NLW	Natural Walnut	Walnut	Flat Sliced
RCW	Red Cherry	Cherry	Flat Sliced
VNW	Vintage Cherry	Cherry	Flat Sliced
ULW	Umber Walnut	Walnut	Flat Sliced
WLW	Walnut	Walnut	Flat Sliced
WCW	Warm Cherry	Cherry	Flat Sliced
WMW	White Maple	Maple	Flat Sliced

METAL FINISHES:

E	Black
K	Tungsten
DWT	Designer White
P	Brushed Chrome

GLASS FINISH (for Glass Doors and Modesty Panels)

- Bronze Glass (standard)
- Clear Glass - contact Customer Care

3. SPECIFY OPTIONS

GROMMETS

- Standard grommet on all components is **GM5**. Grommets are included with products where shown in product line drawings.
- Optional grommets may be ordered in standard worksurface locations (left, center or right). Order as **GM5L**, **GM5C** or **GM5R**. **Add \$103**.
- Grommet hole dimensions are 3.5" x 2". Specify **GM5E** for **Black** or **GM5K** for **Tungsten**.

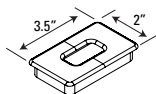

- Components that come standard with grommet may be ordered without a grommet. Order as RSG - **Add \$57**.
- View diagrams on the following pages for additional details.

GROMMET LOCATIONS

- Grommets and Grommet Locations must be specified.
- Includes standard and optional grommet locations.
- For TEL & TER location please contact Customer Care.

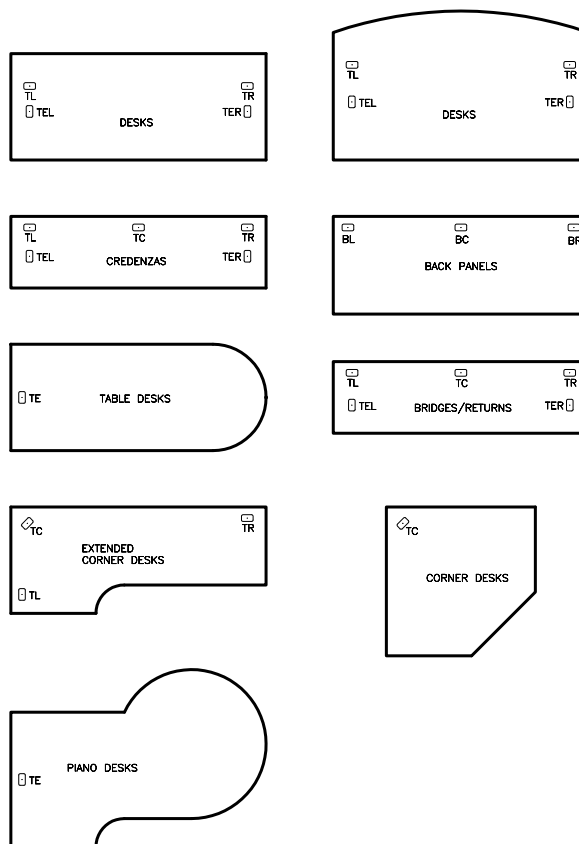

P PHILADELPHIA - EDGE DETAILS

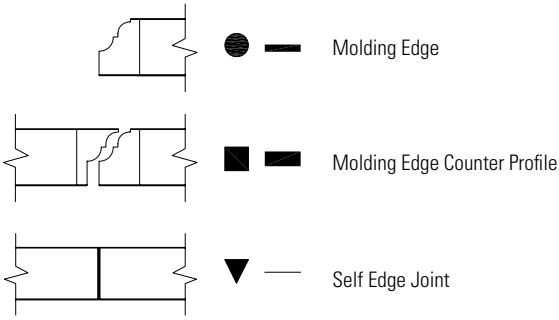

- D** - Desks and Credenzas
- B** - Executive Bridges
- E** - Executive Returns
- C** - Corner Components
- L** - Linking Bridges
- P** - Piano Desks

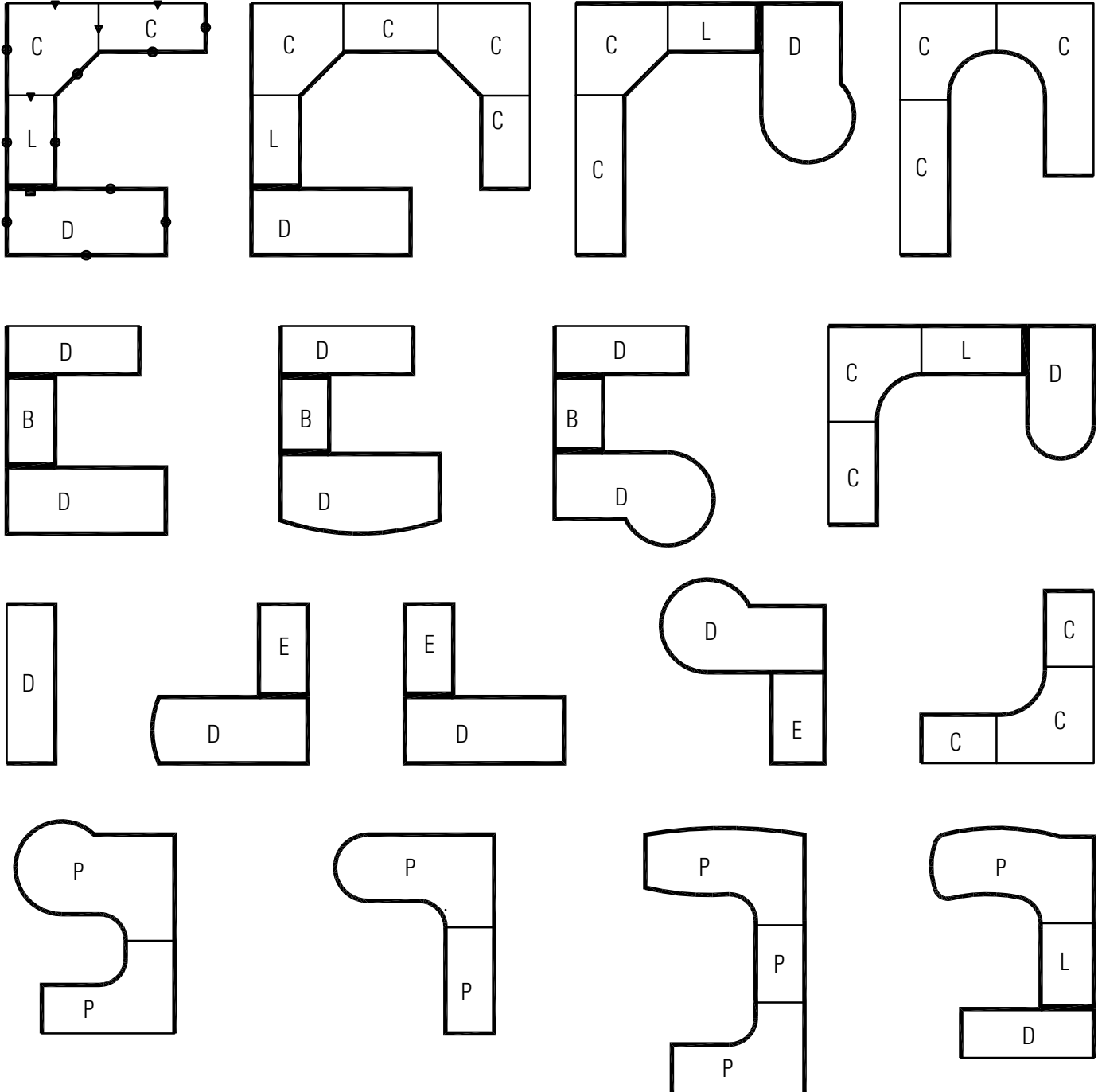

DESK AND CREDENZA NOTES

- Can be ordered as a shell or with pedestals
- Hand of Rectangular Desk is determined by location of pedestal from user side
- Hand of "D" Top is determined by outward orientation of curved end from user projection.
- Hand of "P" Top is determined by outward orientation of conference end from user projection.

Isometric View

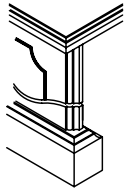

Side View
1-3/8" Top

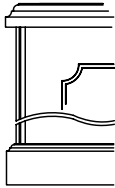

Front View
1-3/16" Slab

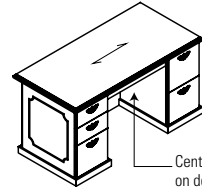
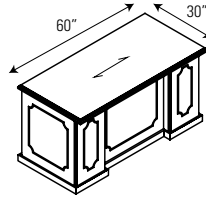
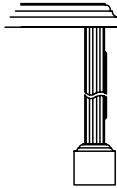

Center drawer standard on double pedestal desk

MODESTY PANEL CLEARANCE

PBID7236DE

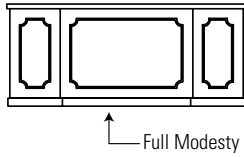

PBID7236 (7236 indicates top size)

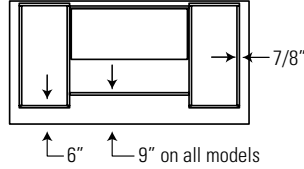

PBISR7230D

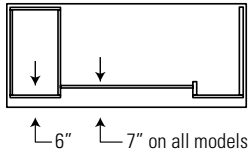

PBDDFL7230 (Left shown)

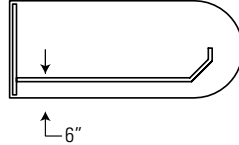

PBTPOL7242 (Left shown)

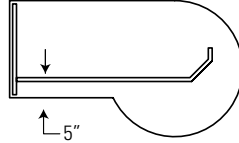

PBC7220

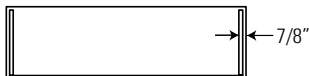

PIANO DESKS AND LINKING RETURNS

- All Desks are shipped assembled.
- Units include standard Grommets shown and installed horizontal wire management
- Unit is handed by Post Leg
- Not for use with regular Corner Units

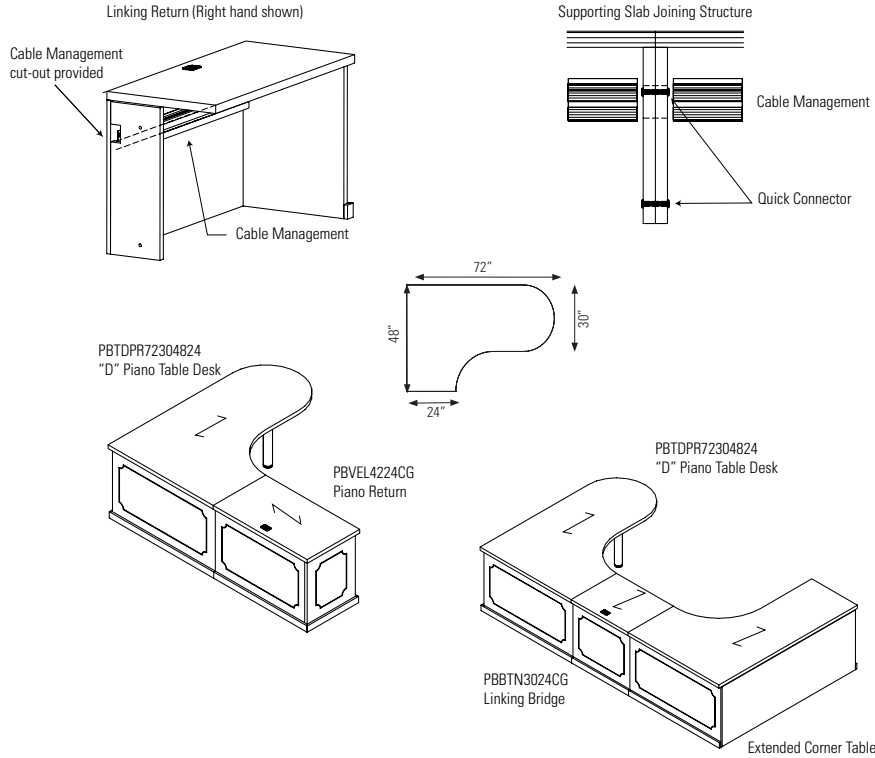

EXECUTIVE BRIDGES

- Executive Bridge is used to connect a Desk to a Credenza.
- Not to be used with Corner Components or Piano Desks.
- Three Back Panel options
- Back panel flush with end panels of Desk and Credenza
- Includes GM5 Grommet Top Center
- The standard grain direction is cross grain (**CG**). To remove cross grain veneer pattern on top, delete suffix "**CG**" from the model number (no upcharge)

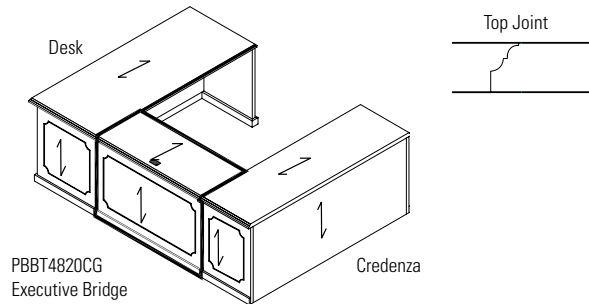

PBBT4820CG
Dimensions are actual

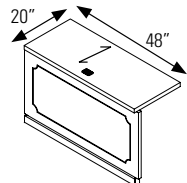

PBBT4820CG
Full Back Panel

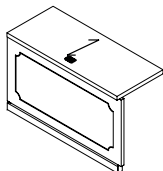

PBBT4820TCG
Bridge Top only



PBBT4820Q8CG
8" Back Panel

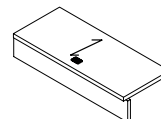

EXECUTIVE RETURNS

- Executive Return is used to attach to a Single Pedestal Desk, Single Pedestal Credenza, Desk Shell or Credenza Shell.
- Can be specified as a Shell or with a Pedestal.
- Back Panels are available as either full height or 8" from the underside of the worksurface.
- Hand of Executive Return is determined by location of full end panel from user side.
- Hand of Desk or Credenza is determined by location of pedestal from user side.
- The standard grain direction on return tops is cross grain (**CG**). To remove cross grain veneer pattern on top, delete suffix "**CG**" from the model number (no upcharge)

Executive Return attached to Desk or Credenza

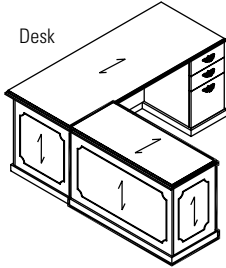

PBERL4822CG
Executive Return

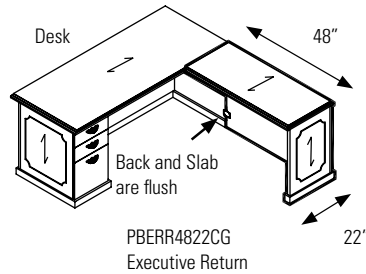

PBERR4822CG
Executive Return

CORNER COMPONENTS

- Corner Table is used to connect to Linking Bridge and Linking Credenza.
- Cable management tray included.
- Back Panels are available as either full height or 8" from the underside of the worksurface.
- Hand of Linking Credenza is determined by location of full end panel from user side.
- Hand of Extended Corner is determined by location of long narrow end from user side
- The standard grain direction is cross grain (**CG**). To remove cross grain veneer pattern on top, delete suffix "**CG**" from the model number (no upcharge)

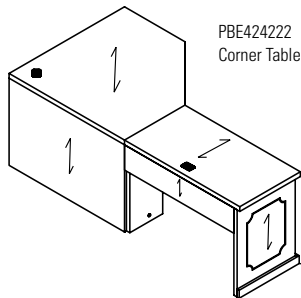

PBE424222
Corner Table

PBEK424222
Corner Table

PBEK424222
Corner Table

Supporting Slab Joining Structure

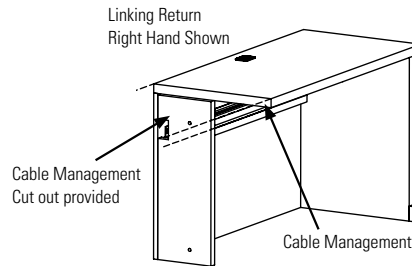
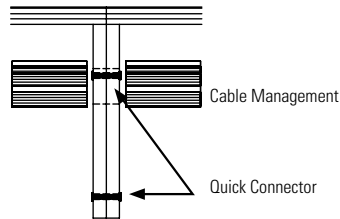

Linking Return
Right Hand Shown

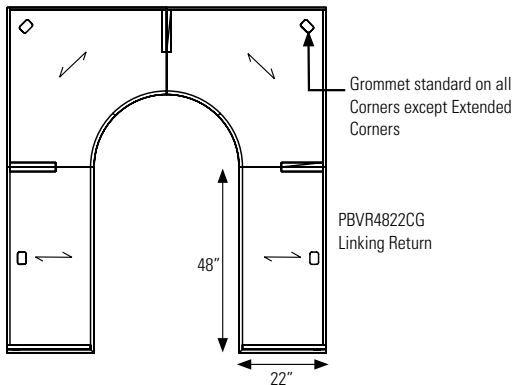

PBVL4822CG
Linking Return

PBVR4822CG
Linking Return

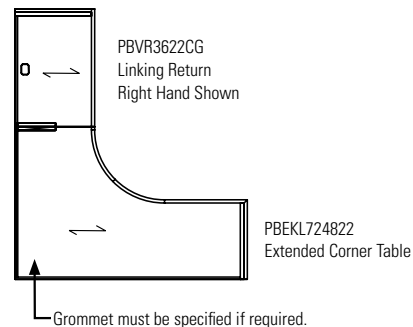

PBVR3622CG
Linking Return
Right Hand Shown

PBEKL724822
Extended Corner Table

LINKING BRIDGES

- Linking Bridge is used to connect Corner Components to Single Pedestal Desk, Single Pedestal Credenza, Desk Shell or Credenza Shell.
- Back panels are available as either full height or 8" from the underside of the worksurface.
- Includes GM5 Grommet Top Center
- Hand of Linking Bridge is determined by location of half end panel from user side
- The standard grain direction is cross grain (**CG**). To remove cross grain veneer pattern on top, delete suffix "**CG**" from the model number (no upcharge)

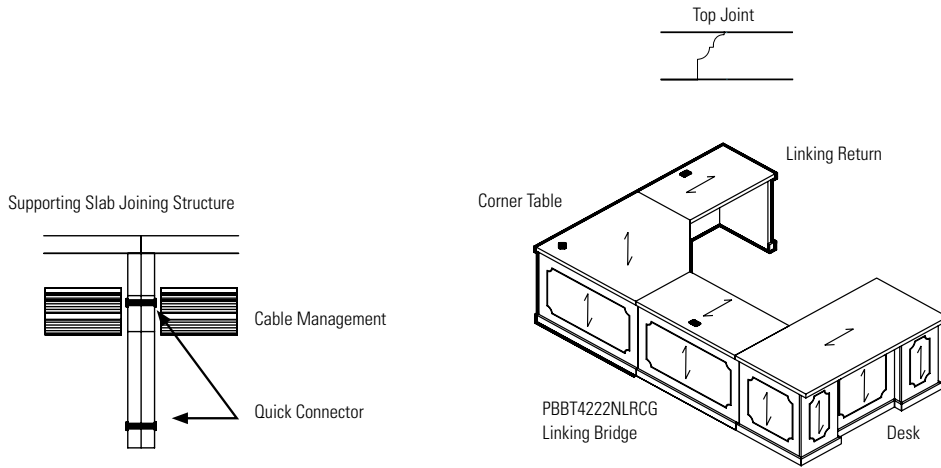

COPING AND SELF-EDGE OPTIONS

- Coping option provides an undercut on hutches only so that storage cabinets placed next to the hutch fit flush.
 - Specify **COP** for coping on both sides, **COPR** for coping on the right side and **COPL** for coping on the left side. No upcharge.
- Self edge options provide a flush fit when storage units are placed next to one another.
 - Specify **SE** for self-edge on both sides, **SER** for self-edge on the right side and **SEL** for self-edge on the left side. When **SE**, **SER**, **SEL** are specified, the corresponding bottom base molding will also be removed. No upcharge.
 - Coping and self-edge handedness are from the users perspective. See diagram below.

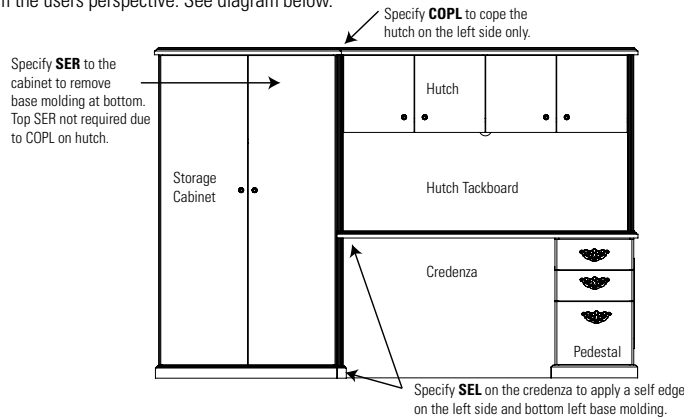

MODULAR PEDESTALS AND HANDLES

- Modular Pedestal for Philadelphia using "C" components.
- SP700 spacer is required if two Modular Pedestals are placed side by side when there is no handles. Order as special.
- Credenza shell cannot be completely filled up with modular components to create a full storage credenza.

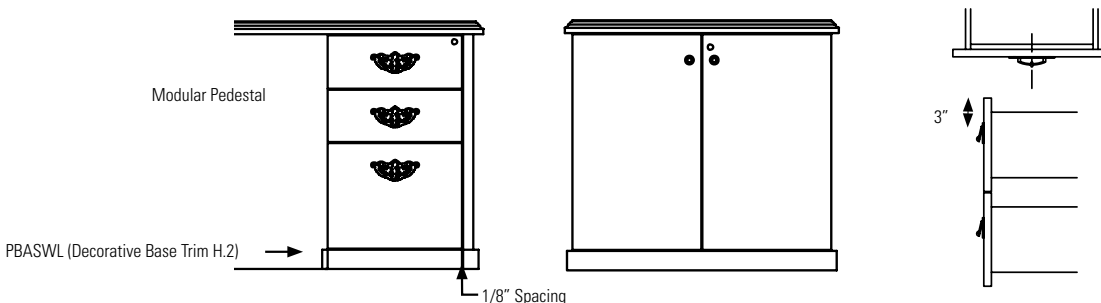

LOCKING

- Locks are standard on all below worksurface level drawer and door storage units with the exception of the pull-out tray units and single lateral file drawer combination tray/slot units.
- Locks are optional on all above worksurface level closed storage units.

Standard Lock Positions

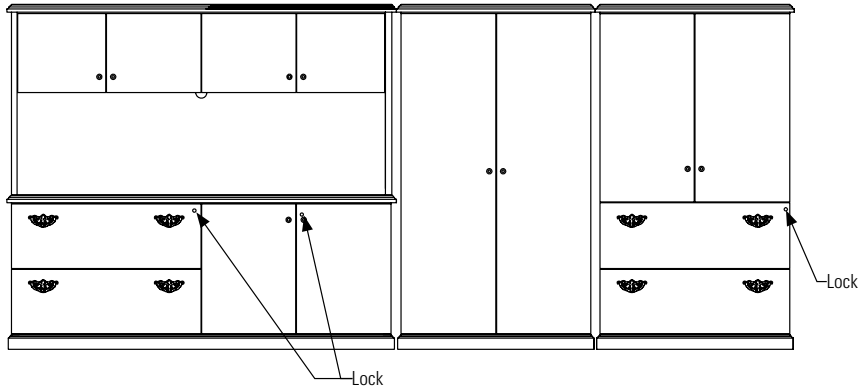

PBCF7222

Full Storage Credenza: Locks are on the front.

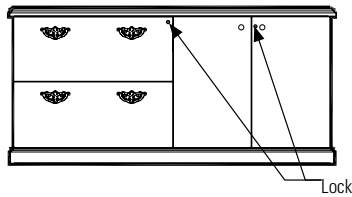

PB7236DE

Double Pedestal Desk/Credenza:

Lock for D and E Pedestals are on the inside Gable.

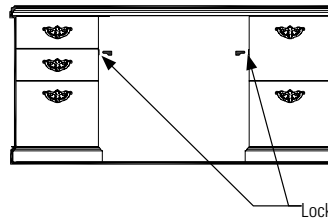

PBZR

Combination Storage Unit:

Lock for File and Lateral File Drawer only,
Box Drawers do not lock.

Box Drawers
do not lock

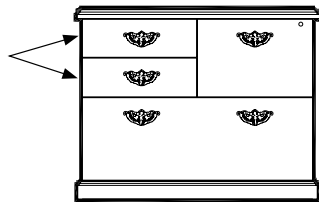

PBWF

Modular Furniture:
Lock is on the front.

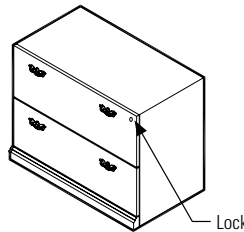

PBWD

Modular Furniture:
Lock is on the front.

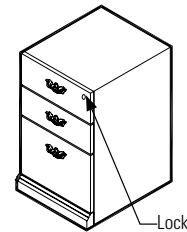

HUTCH POSITIONING

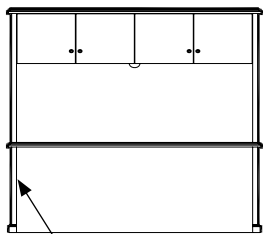

There must be an end panel
under the hutch

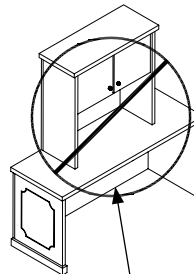
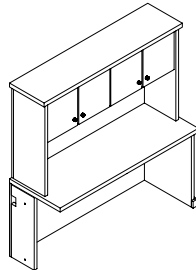

Missing Support
NOT Recommended

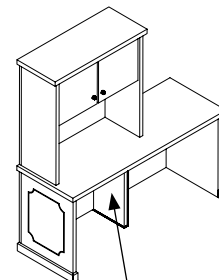

Add optional Support
SLAB12 (as Special)

TACKBOARDS

Tackboards for Storage Huches

PB72SH36

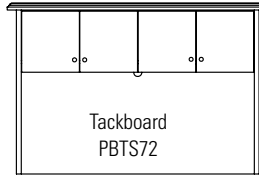

Tackboard
PBTS72

PB72SHP42 and PB722SHP54

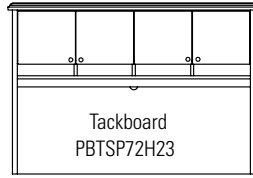

Tackboard
PBTS72H23

PB72SH42 and PB722SH54

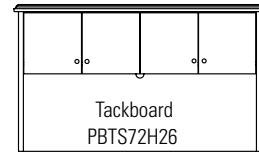

Tackboard
PBTS72H26

Tackboards with Accessory Rail

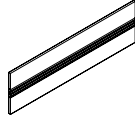

PBTSAS72

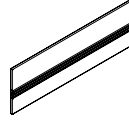

PBTSAS72H23

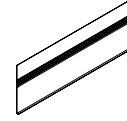

PBTSAS72H26

Tackboards for Wall Mount Overheads

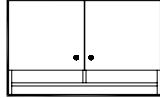

CSF36

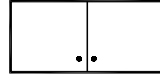

CSFP36

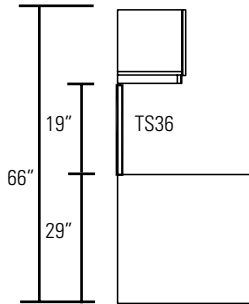

TS36

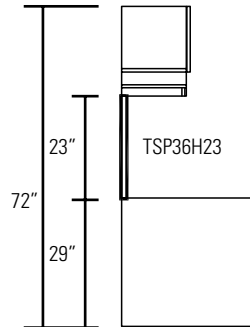

TSP36H23

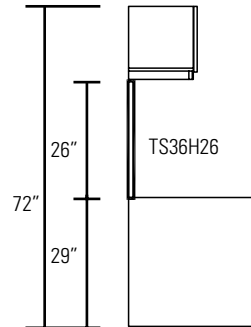

TS36H26

LIGHTING

Wall Mount

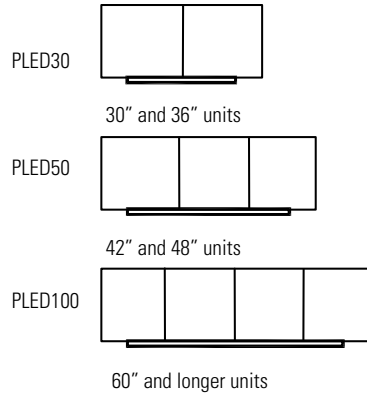

Hutch

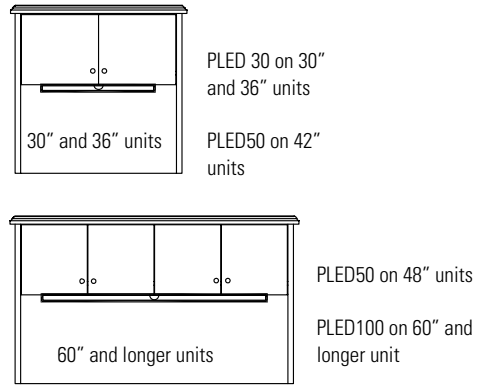

DESKS - NOTES

NOTE: Arrow indicates direction of grain

Double Pedestal Desks

- Shipped assembled
- Kneewell locking standard and keyed alike
- Standard with center drawer
- For optional pull-out writing tray, specify **WTD**. Add **\$679**.

Single Pedestal Desks

- Shipped assembled
- Kneewell locking standard and keyed alike
- For optional pull-out writing tray, specify **WTS**. Add **\$343**.

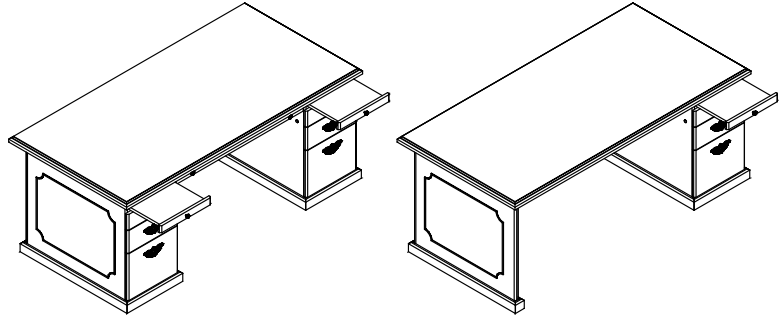

D and P shaped desks

- Shipped assembled.

D and P shaped connecting desks

- Shipped knocked down.
- The standard grain direction on D and P shaped connecting desks is cross grain (**CG**). To remove cross grain veneer pattern on top, delete suffix "**CG**" from the model number (no upcharge)
- Pedestals are handed:
 - Left pedestals have the handle offset from the center to the right, and the lock is placed on the right end panel
 - Right pedestals have the handle offset from the center to the left, and the lock is placed on the left end panel
- Modesty panels are available in wood or glass
- Grommets are available as an option on Desks and most Credenzas.

DOUBLE PEDESTAL DESKS **MODEL#** **DIMENSIONS** **FREIGHT CLASS** **WT/LBS.** **CUBIC FT.** **LIST PRICE**

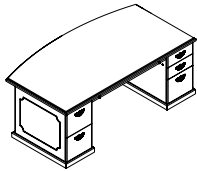

**Double Pedestal Bow Top Desk
Breakfront Style**

	D x W x H					
PBMID8442ED	42 x 84 x 29	125	443	59		\$13424
PBMID7842ED	42 x 78 x 29	125	412	55		\$12538
PBMID7242ED	42 x 72 x 29	125	380	51		\$11652
PBMID6636ED	36 x 66 x 29	100	340	40		\$11332

Standard with full to floor **file/file** pedestal on **left** and **box/box/file** pedestal on **right**. Pedestals lock.
Inset Full Height Modesty Panel.

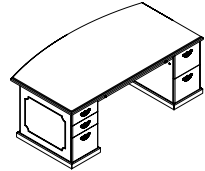

**Double Pedestal Bow Top Desk
Breakfront Style**

PBMID8442DE	42 x 84 x 29	125	443	59		\$13424
PBMID7842DE	42 x 78 x 29	125	412	55		\$12538
PBMID7242DE	42 x 72 x 29	125	380	51		\$11652
PBMID6636DE	36 x 66 x 29	100	340	40		\$11332

Standard with full to floor **box/box/file** pedestal on **left** and **file/file** pedestal on **right**. Pedestals lock.
Inset Full Height Modesty Panel.

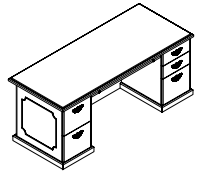

**Double Pedestal Desk
Breakfront Style**

PBID8442ED	42 x 84 x 29	125	442	59		\$11572
PBID7842ED	42 x 78 x 29	125	421	55		\$10817
PBID7236ED	36 x 72 x 29	100	375	44		\$10066
PBID7230ED	30 x 72 x 29	100	345	36		\$9928
PBID6636ED	36 x 66 x 29	100	360	40		\$9928
PBID6630ED	30 x 66 x 29	92.5	315	30		\$9790
PBID6030ED	30 x 60 x 29	92.5	315	30		\$9511

Standard with full to floor **file/file** pedestal on **left** and **box/box/file** pedestal on **right**. Pedestals lock.
Inset Full Height Modesty Panel.

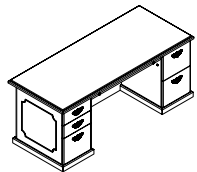

**Double Pedestal Desk
Breakfront Style**

PBID8442DE	42 x 84 x 29	125	442	59		\$11572
PBID7842DE	42 x 78 x 29	125	421	55		\$10817
PBID7236DE	36 x 72 x 29	100	375	44		\$10066
PBID7230DE	30 x 72 x 29	100	345	36		\$9928
PBID6636DE	36 x 66 x 29	100	360	40		\$9928
PBID6630DE	30 x 66 x 29	92.5	315	30		\$9790
PBID6030DE	30 x 60 x 29	92.5	315	30		\$9511

Standard with full to floor **box/box/file** pedestal on **left** and **file/file** pedestal on **right**. Pedestals lock.
Inset Full Height Modesty Panel.

Required Specifications

Finish

Optional Specifications

Grommet
Modesty panel
Pull-out writing tray

SINGLE PEDESTAL DESKS

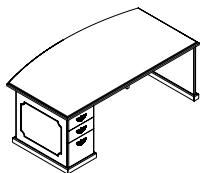

Single Pedestal Bow Top Desk - Left*
Breakfront Style

MODEL#	DIMENSIONS D x W x H	FREIGHT CLASS	WT./LBS.	CUBIC FT.	LIST PRICE
PBMISL8442D	42 x 84 x 29	125	452	59	\$9820
PBMISL7842D	42 x 78 x 29	125	337	55	\$9119
PBMISL7242D	42 x 72 x 29	125	322	51	\$8421
PBMISL6636D	36 x 66 x 29	125	290	40	\$8098

Standard with full to floor **box/box/file** pedestal on **left**. Pedestals lock.
Inset Full Height Modesty Panel.

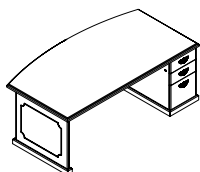

Single Pedestal Bow Top Desk - Right*
Breakfront Style

PBMISR8442D	42 x 84 x 29	125	452	59	\$9820
PBMISR7842D	42 x 78 x 29	125	337	55	\$9119
PBMISR7242D	42 x 72 x 29	125	322	51	\$8421
PBMISR6636D	36 x 66 x 29	125	290	40	\$8098

Standard with full to floor **box/box/file** pedestal on **right**. Pedestals lock.
Inset Full Height Modesty Panel.

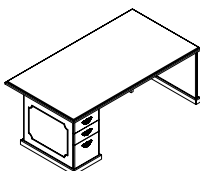

Single Pedestal Desk - Left*
Breakfront Style

PBISL8442D	42 x 84 x 29	125	387	59	\$9377
PBISL7842D	42 x 78 x 29	125	366	55	\$8705
PBISL7236D	36 x 72 x 29	125	320	44	\$6889
PBISL7230D	30 x 70 x 29	100	290	36	\$6582
PBISL6636D	36 x 66 x 29	125	305	40	\$6582
PBISL6630D	30 x 66 x 29	100	275	33	\$6282
PBISL6030D	30 x 60 x 29	100	260	30	\$6005

Standard with full to floor **box/box/file** pedestal on **left**. Pedestals lock.
Inset Full Height Modesty Panel.

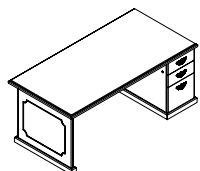

Single Pedestal Desk - Right*
Breakfront Style

PBISR8442D	42 x 84 x 29	125	387	59	\$9377
PBISR7842D	42 x 78 x 29	125	366	55	\$8705
PBISR7236D	36 x 72 x 29	125	320	44	\$6889
PBISR7230D	30 x 70 x 29	100	290	36	\$6582
PBISR6636D	36 x 66 x 29	125	305	40	\$6582
PBISR6630D	30 x 66 x 29	100	275	33	\$6282
PBISR6030D	30 x 60 x 29	100	260	30	\$6005

Standard with full to floor **box/box/file** pedestal on **right**. Pedestals lock.
Inset Full Height Modesty Panel.

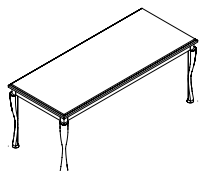

Table Desk
Queen Anne Style

PBQATB8442	42 x 84 x 29	150	272	59	\$10902
PBQATB7842	42 x 78 x 29	150	253	55	\$10222
PBQATB7236	36 x 72 x 29	150	205	44	\$8279
PBQATB7230	30 x 70 x 29	150	192	36	\$7458
PBQATB6636	36 x 66 x 29	150	192	40	\$7458
PBQATB6630	30 x 66 x 29	150	188	33	\$6561
PBQATB6030	30 x 60 x 29	150	171	30	\$5852

Inset Full Height Modesty Panel.

Required Specifications

Finish

Optional Specifications

Additional grommet
Modesty panel*
Pull-out writing tray*

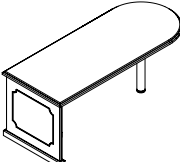
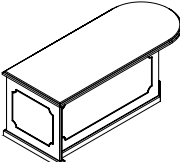
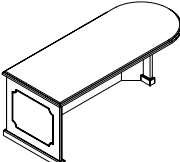
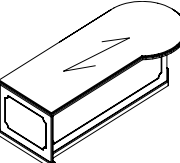
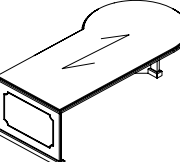
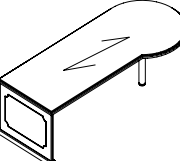
DESKS	MODEL#	DIMENSIONS	FREIGHT CLASS	WT/LBS.	CUBIC FT.	LIST PRICE
 <p>"D" Shaped Connecting Table Desk</p>	D x W x H					
	PBDD8436	36 x 84 x 29	125	343	51	\$6124
	PBDD7236	36 x 72 x 29	125	294	44	\$5247
	PBDD7230	30 x 72 x 29	125	264	36	\$4876
	PBDD6636	36 x 66 x 29	125	245	40	\$4876
	PBDD6030	30 x 60 x 29	125	225	30	\$4684
Wood column support and full end panel.						
 <p>"D" Shaped Table Desk - Left</p>	PBDDFL8436	36 x 84 x 29	125	367	51	\$7522
	PBDDFL7236	36 x 72 x 29	125	320	44	\$6449
	PBDDFL7230	30 x 72 x 29	100	290	36	\$6083
	PBDDFL6636	36 x 66 x 29	125	271	40	\$6083
	PBDDFL6030	30 x 60 x 29	100	247	30	\$5887
	With 45° angled modesty and end panel.					
 <p>"D" Shaped Table - Right</p>	PBDDFR8436	36 x 84 x 29	125	367	51	\$7522
	PBDDFR7236	36 x 72 x 29	125	320	44	\$6449
	PBDDFR7230	30 x 72 x 29	100	290	36	\$6083
	PBDDFR6636	36 x 66 x 29	125	271	40	\$6083
	PBDDFR6030	30 x 60 x 29	100	247	30	\$5887
	With 45° angled modesty and end panel.					
 <p>"P" Shaped Connecting Table - Left</p>	PBTPOL9642	42 x 96 x 29	150	317	68	\$9021
	PBTPOL8442	42 x 84 x 29	150	277	59	\$7892
	PBTPOL7242	42 x 72 x 29	150	211	51	\$7305
With 45° angled modesty and end panel.						
 <p>"P" Shaped Connecting Table - Right</p>	PBTPOR9642	42 x 96 x 29	150	317	68	\$9021
	PBTPOR8442	42 x 84 x 29	150	277	59	\$7892
	PBTPOR7242	42 x 72 x 29	150	211	51	\$7305
With 45° angled modesty and end panel.						
 <p>"P" Shaped Connecting Table - Left</p>	PBTPL9642	42 x 96 x 29	125	440	68	\$7646
	PBTPL8442	42 x 84 x 29	125	385	59	\$6692
	PBTPL7242	42 x 72 x 29	125	319	51	\$6100
Wood column support and full end panel.						

Required Specifications
Finish

Optional Specifications
Additional grommet

DESKS

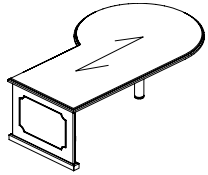

"P" Shaped Connecting Table - Right

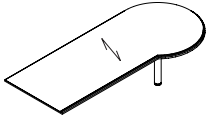

"P" Shaped Connecting Table - Left

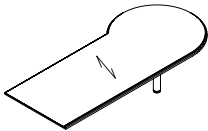

"P" Shaped Connecting Table - Right

MODEL#	DIMENSIONS D x W x H	FREIGHT CLASS	WT./LBS.	CUBIC FT.	LIST PRICE
PBTPR9642	42 x 96 x 29	125	440	68	\$7646
PBTPR8442	42 x 84 x 29	125	385	59	\$6692
PBTPR7242	42 x 72 x 29	125	319	51	\$6100

Wood column support and full end panel.

PBRPL9642CG	42 x 96 x 29	250	239	68	\$7250
PBRPL8442CG	42 x 84 x 29	250	209	59	\$6346
PBRPL7242CG	42 x 72 x 29	250	143	51	\$5436

Wood column support. No end panel.

PBRPR9642CG	42 x 96 x 29	250	239	68	\$7250
PBRPR8442CG	42 x 84 x 29	250	209	59	\$6346
PBRPR7242CG	42 x 72 x 29	250	143	51	\$5436

Wood column support. No end panel.

Required Specifications
Finish

Optional Specifications
Additional grommet

RETURNS - NOTES

D x W x H

- All returns are shipped assembled
- Kneewell locking standard
- The standard grain direction on returns is cross grain (**CG**). To remove cross grain veneer pattern on top, delete suffix "**CG**" from the model number (no upcharge)
- **NOTE:** Arrow indicates direction of grain

RETURNS	MODEL#	DIMENSIONS	FREIGHT CLASS	WT/LBS.	CUBIC FT.	LIST PRICE
---------	--------	------------	---------------	---------	-----------	------------

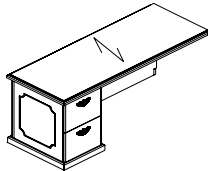

Executive Return - Left

PBERL7224ECG	24 x 72 x 29	100	250	29	\$6195
PBERL6624ECG	24 x 66 x 29	100	236	27	\$5969
PBERL6024ECG	24 x 60 x 29	100	227	24	\$5430
PBERL5424ECG	24 x 54 x 29	100	205	22	\$5230
PBERL4824ECG	24 x 48 x 29	100	185	19	\$4648
PBERL4224ECG	24 x 42 x 29	92.5	178	17	\$4473

Standard with full to floor **file/file** pedestal on **left**. Pedestal locks. Full height flush back panel.

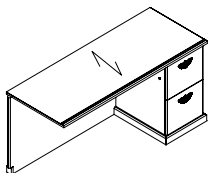

Executive Return - Right

PBERR7224ECG	24 x 72 x 29	100	250	29	\$6195
PBERR6624ECG	24 x 66 x 29	100	236	27	\$5969
PBERR6024ECG	24 x 60 x 29	100	227	24	\$5430
PBERR5424ECG	24 x 54 x 29	100	205	22	\$5230
PBERR4824ECG	24 x 48 x 29	100	185	19	\$4648
PBERR4224ECG	24 x 42 x 29	92.5	178	17	\$4473

Standard with full to floor **file/file** pedestal on **right**. Pedestal locks. Full height flush back panel.

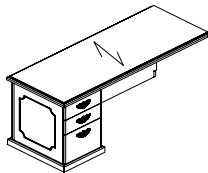

Executive Return - Left

PBERL7224DCG	24 x 72 x 29	100	250	29	\$6195
PBERL6624DCG	24 x 66 x 29	100	236	27	\$5969
PBERL6024DCG	24 x 60 x 29	100	227	24	\$5430
PBERL5424DCG	24 x 54 x 29	100	205	22	\$5230
PBERL4824DCG	24 x 48 x 29	100	185	19	\$4648
PBERL4224DCG	24 x 42 x 29	92.5	178	17	\$4473

Standard with full to floor **box/box/file** pedestal on **left**. Pedestal locks. Full height flush back panel.

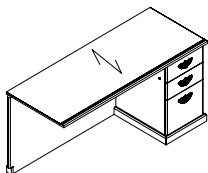

Executive Return - Right

PBERR7224DCG	24 x 72 x 29	100	250	29	\$4473
PBERR6624DCG	24 x 66 x 29	100	236	27	\$5969
PBERR6024DCG	24 x 60 x 29	100	227	24	\$5430
PBERR5424DCG	24 x 54 x 29	100	205	22	\$5230
PBERR4824DCG	24 x 48 x 29	100	185	19	\$4648
PBERR4224DCG	24 x 42 x 29	92.5	178	17	\$4473

Standard with full to floor **box/box/file** pedestal on **right**. Pedestal locks. Full height flush back panel.

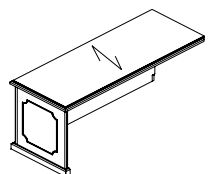

Executive Return - Left

PBERL7224CG	24 x 72 x 29	150	135	29	\$3475
PBERL6624CG	24 x 66 x 29	150	127	27	\$3184
PBERL6024CG	24 x 60 x 29	150	120	24	\$2897
PBERL5424CG	24 x 54 x 29	150	112	22	\$2600
PBERL4824CG	24 x 48 x 29	150	105	19	\$2320
PBERL4224CG	24 x 42 x 29	150	97	17	\$2025

Full height flush back panel.

Required Specifications
Finish

Optional Specifications
Grommet

RETURNS

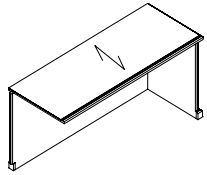

Executive Return - Right

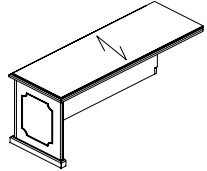

Executive Return - Left

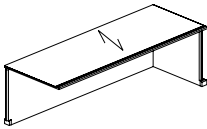

Executive Return - Right

MODEL# DIMENSIONS FREIGHT CLASS WT/LBS. CUBIC FT. LIST PRICE

D x W x H

PBERR7224CG	24 x 72 x 29	150	135	29	\$3475
PBERR6624CG	24 x 66 x 29	150	127	27	\$3184
PBERR6024CG	24 x 60 x 29	150	120	24	\$2897
PBERR5424CG	24 x 54 x 29	150	112	22	\$2600
PBERR4824CG	24 x 48 x 29	150	105	19	\$2320
PBERR4224CG	24 x 42 x 29	150	97	17	\$2025

Full height flush back panel.

PBERL7222CG	22 x 72 x 29	150	130	27	\$3311
PBERL6622CG	22 x 66 x 29	150	122	24	\$3033
PBERL6022CG	22 x 60 x 29	150	115	22	\$2761
PBERL5422CG	22 x 54 x 29	150	105	20	\$2481
PBERL4822CG	22 x 48 x 29	150	100	18	\$2209
PBERL4222CG	22 x 42 x 29	150	90	16	\$1931

Full height flush back panel.

PBERR7222CG	22 x 72 x 29	150	130	27	\$3311
PBERR6622CG	22 x 66 x 29	150	122	24	\$3033
PBERR6022CG	22 x 60 x 29	150	115	22	\$2761
PBERR5422CG	22 x 54 x 29	150	105	20	\$2481
PBERR4822CG	22 x 48 x 29	150	100	18	\$2209
PBERR4222CG	22 x 42 x 29	150	90	16	\$1931

Full height flush back panel.

Required Specifications
Finish

Optional Specifications
Additional grommet

PIANO DESKS

D x W x H

- All desks are shipped assembled
- Units include installed horizontal wire management
- Unit is handed by Post Leg
- Not for use with Regular Corner Units
- The standard grain direction on piano desks is cross grain (**CG**). To remove cross grain veneer pattern on top, delete suffix "**CG**" from the model number (no upcharge)
- If grommet color is not specified, Black is standard
- **NOTE:** Arrow indicates direction of grain

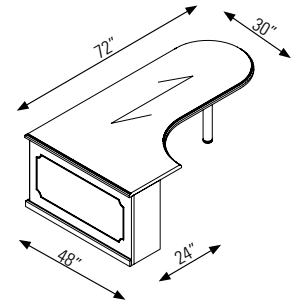

PIANO DESKS

MODEL# DIMENSIONS FREIGHT CLASS WT./LBS. CUBIC FT. LIST PRICE

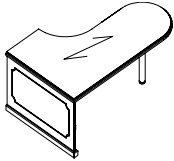

D-shaped Piano Desk - Left

PBTDPL96304824	48 x 96 x 29	125	464	77	\$7954
PBTDPL84304824	48 x 84 x 29	150	406	68	\$7074
PBTDPL72304824	48 x 72 x 29	125	348	58	\$6196

Wood column support and full end panel, 30"D worksurface extension and 24" return connection.

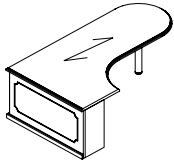

D-shaped Piano Desk - Right

PBTDPR96304824	48 x 96 x 29	125	464	77	\$7954
PBTDPR84304824	48 x 84 x 29	150	406	68	\$7074
PBTDPR72304824	48 x 72 x 29	125	348	58	\$6196

Wood column support and full end panel, 30"D worksurface extension and 24" return connection.

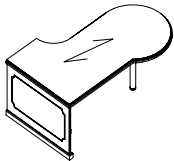

P-shaped Piano Desk - Left

PBTPPL96424824	54 x 96 x 29	150	580	97	\$9075
PBTPPL84424824	54 x 84 x 29	150	508	85	\$8114
PBTPPL72424824	54 x 72 x 29	150	435	73	\$7524

Wood column support and full end panel, 42"/30" worksurface and 24" return connection.

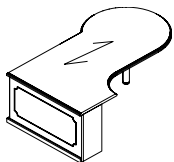

P-shaped Piano Desk - Right

PBTPPR96424824	54 x 96 x 29	150	580	97	\$9075
PBTPPR84424824	54 x 84 x 29	150	508	85	\$8114
PBTPPR72424824	54 x 72 x 29	150	435	73	\$7524

Wood column support and full end panel, 42"/30" worksurface and 24" return connection.

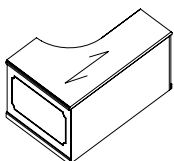

Extended Corner Table Desk - Left

PBEKL964824MR	48 x 96 x 29	150	387	77	\$8641
PBEKL904824MR	48 x 90 x 29	150	363	73	\$8159
PBEKL844824MR	48 x 84 x 29	150	338	68	\$8064
PBEKL784824MR	48 x 78 x 29	150	314	63	\$8020
PBEKL724824MR	48 x 72 x 29	150	290	58	\$7623
PBEKL664824MR	48 x 66 x 29	150	266	52	\$7107
PBEKL604824MR	48 x 60 x 29	150	242	48	\$6586

With 24" return connection.

Required Specifications

Finish

Optional Specifications

Additional grommet

PIANO DESKS

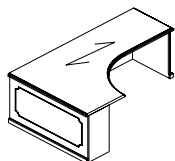

Extended Corner Table Desk - Right

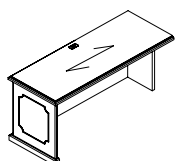

Linking Return - Left

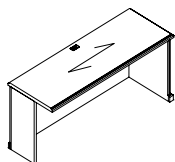

Linking Return - Right

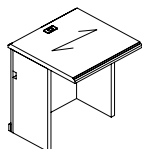

Bridge

MODEL#	DIMENSIONS	FREIGHT CLASS	WT/LBS.	CUBIC FT.	LIST PRICE
--------	------------	---------------	---------	-----------	------------

D x W x H

PBEKR489624ML	48 x 96 x 29	150	387	77	\$8641
PBEKR489024ML	48 x 90 x 29	150	363	73	\$8159
PBEKR488424ML	48 x 84 x 29	150	338	68	\$8064
PBEKR487824ML	48 x 78 x 29	150	314	63	\$8020
PBEKR487224ML	48 x 72 x 29	150	290	58	\$7623
PBEKR486624ML	48 x 66 x 29	150	266	52	\$7107
PBEKR486024ML	48 x 60 x 29	150	242	48	\$6586

With 24" return connection.

PBVEL9624CG	24 x 96 x 29	150	200	39	\$5252
PBVEL9024CG	24 x 90 x 29	150	187	36	\$4924
PBVEL8424CG	24 x 84 x 29	150	174	34	\$4596
PBVEL7824CG	24 x 78 x 29	150	162	31	\$4263
PBVEL7224CG	24 x 72 x 29	150	149	29	\$3940
PBVEL6624CG	24 x 66 x 29	150	141	27	\$3698
PBVEL6024CG	24 x 60 x 29	150	132	24	\$3456
PBVEL5424CG	24 x 54 x 29	150	121	22	\$3260
PBVEL4824CG	24 x 48 x 29	125	115	19	\$3066
PBVEL4224CG	24 x 42 x 29	150	99	17	\$2581
PBVEL3624CG	24 x 36 x 29	150	83	15	\$2493
PBVEL3024CG	24 x 30 x 29	125	77	12	\$2477
PBVEL2424CG	24 x 24 x 29	125	61	10	\$2054

Used in conjunction with extended piano corner units or piano shaped desks.

PBVER9624CG	24 x 96 x 29	150	200	39	\$5252
PBVER9024CG	24 x 90 x 29	150	187	36	\$4924
PBVER8424CG	24 x 84 x 29	150	174	34	\$4596
PBVER7824CG	24 x 78 x 29	150	162	31	\$4263
PBVER7224CG	24 x 72 x 29	150	149	29	\$3940
PBVER6624CG	24 x 66 x 29	150	141	27	\$3698
PBVER6024CG	24 x 60 x 29	150	132	24	\$3456
PBVER5424CG	24 x 54 x 29	150	121	22	\$3260
PBVER4824CG	24 x 48 x 29	125	115	19	\$3066
PBVER4224CG	24 x 42 x 29	150	99	17	\$2581
PBVER3624CG	24 x 36 x 29	150	83	15	\$2493
PBVER3024CG	24 x 30 x 29	125	77	12	\$2477
PBVER2424CG	24 x 24 x 29	125	61	10	\$2054

Used in conjunction with extended piano corner units or piano shaped desks.

PBBTN4824CG	24 x 48 x 29	150	110	19	\$2973
PBBTN4224CG	24 x 42 x 29	150	94	17	\$2493
PBBTN3624CG	24 x 36 x 29	150	79	15	\$2400
PBBTN3024CG	24 x 30 x 29	125	72	12	\$2349
PBBTN2424CG	24 x 24 x 29	150	56	10	\$1975
PBBTN1824CG	24 x 18 x 29	150	43	8	\$1482
PBBTN1224CG	24 x 12 x 29	150	29	5	\$988

For extended piano corner units or piano-shaped desks.

Required Specifications

Finish

Optional Specifications

Additional grommet

BRIDGES	MODEL#	DIMENSIONS	FREIGHT CLASS	WT/LBS.	CUBIC FT.	LIST PRICE
---------	--------	------------	---------------	---------	-----------	------------

D x W x H

- All bridges are shipped knockdown
- Not for use with Corner Units
- The standard grain direction is cross grain (**CG**). To remove cross grain veneer pattern on top, delete suffix "**CG**" from the model number (no upcharge)
- GM5 TC location is standard. If grommet color is not specified, Black is standard
- **NOTE:** Arrow indicates direction of grain

BRIDGES	MODEL#	DIMENSIONS	FREIGHT CLASS	WT/LBS.	CUBIC FT.	LIST PRICE
---------	--------	------------	---------------	---------	-----------	------------

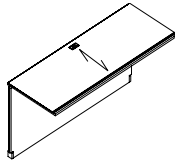

Executive Bridge Top

PBBT6022CG	22 x 60 x 29	92.5	108	10	\$3067
PBBT5422CG	22 x 54 x 29	92.5	99	9	\$2767
PBBT4822CG	22 x 48 x 29	92.5	90	8	\$2457
PBBT4222CG	22 x 42 x 29	92.5	81	7	\$2150
PBBT6020CG	20 x 60 x 29	85	105	8	\$2515
PBBT5420CG	20 x 54 x 29	85	96	8	\$2264
PBBT4820CG	20 x 48 x 29	85	87	7	\$2013
PBBT4220CG	20 x 42 x 29	85	78	6	\$1723

With full back panel.

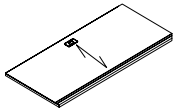

Executive Bridge Top

PBBT5422TCG	22 x 54 x 1.3	125	64	9	\$1661
PBBT4822TCG	22 x 48 x 1.3	125	55	8	\$1473
PBBT4222TCG	22 x 42 x 1.3	125	46	7	\$1293
PBBT5420TCG	20 x 54 x 1.3	125	61	8	\$1356
PBBT4820TCG	20 x 48 x 1.3	125	52	7	\$1211
PBBT4220TCG	20 x 42 x 1.3	125	43	6	\$1038

Required Specifications
Finish

Optional Specifications
Additional grommet

CRENZAS	MODEL#	DIMENSIONS	FREIGHT CLASS	WT/LBS.	CUBIC FT.	LIST PRICE
---------	--------	------------	---------------	---------	-----------	------------

D x W x H

- All credenzas are shipped assembled
- All storage cabinets include one adjustable shelf per set of doors
- **F** and **G** depict 36". **M** and **N** depict 30".
- **F** and **N** indicate lateral file drawers. **G** and **M** indicate storage cabinets with doors.
- Credenza shells accept modular storage. Use modular storage for top support allowing no more than 72" unsupported.
- Credenza shells with a width of 96" and more will have a 12" middle support gable.
- For PBCF7220 and PBCF6020, standard face locking for cabinet and lateral file.
- Grommets are available as an option on Desks and most Credenzas.
- **NOTE:** Arrow indicates direction of grain

CRENZAS	MODEL#	DIMENSIONS	FREIGHT CLASS	WT/LBS.	CUBIC FT.	LIST PRICE
---------	--------	------------	---------------	---------	-----------	------------

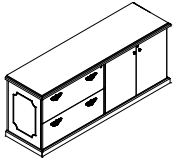

Full Storage Credenza

PBCF7224FG	24 x 72 x 29	92.5	272	24	\$8048
PBC6024NM	24 x 60 x 29	92.5	220	20	\$6704
PBCF7220FG	20 x 72 x 29	92.5	272	24	\$7076
PBCF6020NM	20 x 60 x 29	92.5	220	20	\$5896

Lateral file on **left** and storage cabinet on **right**.

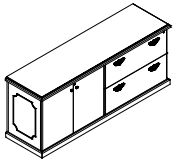

Full Storage Credenza

PBCF7224GF	24 x 72 x 29	92.5	272	24	\$8048
PBC6024MN	24 x 60 x 29	92.5	220	20	\$6704
PBCF7220GF	20 x 72 x 29	92.5	272	24	\$7076
PBCF6020MN	20 x 60 x 29	92.5	220	20	\$5896

Storage cabinet on **left** and lateral file on **right**.

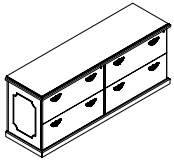

Full Storage Credenza

PBC7224FF	24 x 72 x 29	92.5	287	24	\$9806
PBC6024NN	24 x 60 x 29	92.5	205	20	\$8581
PBC7220FF	20 x 72 x 29	92.5	287	24	\$9053
PBC6020NN	20 x 60 x 29	92.5	205	20	\$7923

Lateral files on **left** and **right**.

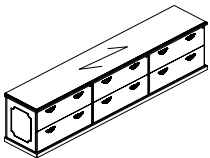

Full Storage Credenza

PBC10824FFF	24 x 108 x 29	92.5	412	36	\$16465
PBC9024NNN	24 x 90 x 29	92.5	337	30	\$13720
PBC10820FFF	20 x 108 x 29	92.5	412	36	\$15200
PBC9020NNN	20 x 90 x 29	92.5	337	30	\$12670

Lateral files on **left, center,** and **right**.

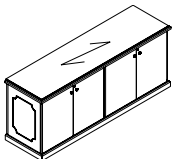

Full Storage Credenza

PBC7224GG	24 x 72 x 29	92.5	253	24	\$7277
PBC6024MM	24 x 60 x 29	92.5	209	20	\$6364
PBC7220GG	20 x 72 x 29	92.5	253	24	\$6719
PBC6020MM	20 x 60 x 29	92.5	209	20	\$5878

Storage cabinets on **left** and **right**.

Required Specifications
Finish

Optional Specifications
Additional grommet

CRENZAS

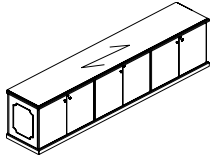

Full Storage Credenza

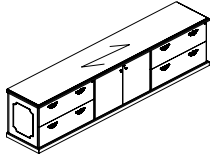

Full Storage Credenza

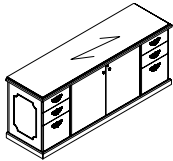

Full Storage Credenza

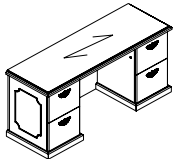

Double Pedestal Credenza

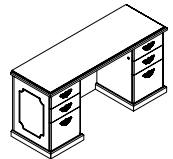

Double Pedestal Credenza

MODEL# DIMENSIONS FREIGHT CLASS WT./LBS. CUBIC FT. LIST PRICE

D x W x H

PBC10824GGG	24 x 108 x 29	125	278	36	\$13120
PBC9024MMM	24 x 90 x 29	125	228	30	\$10937
PBC10820GGG	20 x 108 x 29	125	278	36	\$12114
PBC9020MMM	20 x 90 x 29	125	228	30	\$10098

Storage cabinets on **left, center,** and **right.**

PBC10824FGF	24 x 108 x 29	92.5	479	44	\$17043
PBC9024NNM	24 x 90 x 29	92.5	399	36	\$14198
PBC10820FGF	20 x 108 x 29	92.5	388	36	\$14172
PBC9020NNM	20 x 90 x 29	92.5	321	30	\$11808

Lateral files on **left and right;** storage cabinet in **center.**

PBC7224DGD	24 x 72 x 29	92.5	319	29	\$10477
PBC6024DGD	24 x 60 x 29	92.5	266	24	\$9603
PBC7220DGD	20 x 72 x 29	85	298	24	\$9129
PBC6020DGD	20 x 60 x 29	85	246	20	\$7988

Box/box/file on **left and right;** storage cabinet in **center.**

PBCK8424EE	24 x 84 x 29	92.5	348	34	\$9953
PBCK7824EE	24 x 78 x 29	92.5	319	31	\$9247
PBCK7224EE	24 x 72 x 29	100	280	29	\$8541
PBCK6624EE	24 x 66 x 29	100	261	27	\$8408
PBCK6024EE	24 x 60 x 29	100	238	24	\$7823

PBCK8420EE	20 x 84 x 29	92.5	307	28	\$8679
PBCK7820EE	20 x 78 x 29	92.5	285	26	\$8058
PBCK7220EE	20 x 72 x 29	92.5	267	24	\$7438
PBCK6620EE	20 x 66 x 29	92.5	244	22	\$6814
PBCK6020EE	20 x 60 x 29	92.5	220	20	\$6200

File/file pedestals on **left and right.** Full height back panel. Kneespace in center.

PBCK8424DD	24 x 84 x 29	92.5	348	34	\$9953
PBCK7824DD	24 x 78 x 29	92.5	319	31	\$9247
PBCK7224DD	24 x 72 x 29	100	280	29	\$8541
PBCK6624DD	24 x 66 x 29	100	261	27	\$8408
PBCK6024DD	24 x 60 x 29	100	238	24	\$7823

PBCK8420DD	20 x 84 x 29	92.5	307	28	\$8679
PBCK7820DD	20 x 78 x 29	92.5	285	26	\$8058
PBCK7220DD	20 x 72 x 29	92.5	267	24	\$7438
PBCK6620DD	20 x 66 x 29	92.5	244	22	\$6814
PBCK6020DD	20 x 60 x 29	92.5	220	20	\$6200

Box/box/file pedestals on **left and right.** Full height back panel. Kneespace in center.

Required Specifications

Finish

Optional Specifications

Additional grommet

CREDENZAS

MODEL# DIMENSIONS FREIGHT CLASS WT/LBS. CUBIC FT. LIST PRICE

D x W x H

PBCK8424ED	24 x 84 x 29	92.5	348	34	\$9953
PBCK7824ED	24 x 78 x 29	92.5	319	31	\$9247
PBCK7224ED	24 x 72 x 29	100	280	29	\$8541
PBCK6624ED	24 x 66 x 29	100	261	27	\$8408
PBCK6024ED	24 x 60 x 29	100	238	24	\$7823
PBCK8420ED	20 x 84 x 29	92.5	307	28	\$8679
PBCK7820ED	20 x 78 x 29	92.5	285	26	\$8058
PBCK7220ED	20 x 72 x 29	92.5	267	24	\$7438
PBCK6620ED	20 x 66 x 29	92.5	244	22	\$6814
PBCK6020ED	20 x 60 x 29	92.5	220	20	\$6200

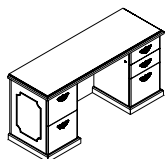

Double Pedestal Credenza

File/file pedestal on **left** and box/box/file pedestal on **right**. Full height back panel. Kneespace in center.

PBCK8424DE	24 x 84 x 29	92.5	348	34	\$9953
PBCK7824DE	24 x 78 x 29	92.5	319	31	\$9247
PBCK7224DE	24 x 72 x 29	100	280	29	\$8541
PBCK6624DE	24 x 66 x 29	100	261	27	\$8408
PBCK6024DE	24 x 60 x 29	100	238	24	\$7823
PBCK8420DE	20 x 84 x 29	92.5	307	28	\$8679
PBCK7820DE	20 x 78 x 29	92.5	285	26	\$8058
PBCK7220DE	20 x 72 x 29	92.5	267	24	\$7438
PBCK6620DE	20 x 66 x 29	92.5	244	22	\$6814
PBCK6020DE	20 x 60 x 29	92.5	220	20	\$6200

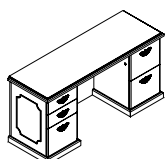

Double Pedestal Credenza

Box/box/file pedestal on **left** and file/file pedestal on **right**. Full height back panel. Kneespace in center.

PBCL8424E	24 x 84 x 29	100	315	34	\$7526
PBCL7824E	24 x 78 x 29	100	292	31	\$6991
PBCL7224E	24 x 72 x 29	100	270	29	\$6451
PBCL6624E	24 x 66 x 29	100	247	27	\$6209
PBCL6024E	24 x 60 x 29	100	225	24	\$5646
PBCL8420E	20 x 84 x 29	100	273	28	\$6560
PBCL7820E	20 x 78 x 29	100	252	26	\$6091
PBCL7220E	20 x 72 x 29	100	237	24	\$5624
PBCL6620E	20 x 66 x 29	100	216	22	\$5413
PBCL6020E	20 x 60 x 29	100	195	20	\$4924

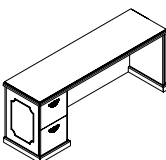

Single Pedestal Credenza - Left

File/file pedestal on **left**.

PBCR8424E	24 x 84 x 29	100	315	34	\$7526
PBCR7824E	24 x 78 x 29	100	292	31	\$6991
PBCR7224E	24 x 72 x 29	100	270	29	\$6451
PBCR6624E	24 x 66 x 29	100	247	27	\$6209
PBCR6024E	24 x 60 x 29	100	225	24	\$5646
PBCR8420E	20 x 84 x 29	100	273	28	\$6560
PBCR7820E	20 x 78 x 29	100	252	26	\$6091
PBCR7220E	20 x 72 x 29	100	237	24	\$5624
PBCR6620E	20 x 66 x 29	100	216	22	\$5413
PBCR6020E	20 x 60 x 29	100	195	20	\$4924

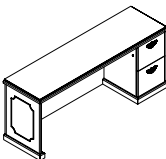

Single Pedestal Credenza - Right

File/file pedestal on **right**.

Required Specifications
Finish

Optional Specifications
Additional grommet

CREDENZAS	MODEL#	DIMENSIONS	FREIGHT CLASS	WT/LBS.	CUBIC FT.	LIST PRICE
		D x W x H				
	PBCL8424D	24 x 84 x 29	100	315	34	\$7526
	PBCL7824D	24 x 78 x 29	100	292	31	\$6991
	PBCL7224D	24 x 72 x 29	100	270	29	\$6451
	PBCL6624D	24 x 66 x 29	100	247	27	\$6209
	PBCL6024D	24 x 60 x 29	100	225	24	\$5646
	PBCL8420D	20 x 84 x 29	100	273	28	\$6560
	PBCL7820D	20 x 78 x 29	100	252	26	\$6091
	PBCL7220D	20 x 72 x 29	100	237	24	\$5624
	PBCL6620D	20 x 66 x 29	100	216	22	\$5413
	PBCL6020D	20 x 60 x 29	100	195	20	\$4924

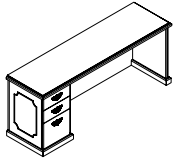

Single Pedestal Credenza - Left

Box/box/file pedestal on **left**.

PBCR8424D	24 x 84 x 29	100	315	34	\$7526
PBCR7824D	24 x 78 x 29	100	292	31	\$6991
PBCR7224D	24 x 72 x 29	100	270	29	\$6451
PBCR6624D	24 x 66 x 29	100	247	27	\$6209
PBCR6024D	24 x 60 x 29	100	225	24	\$5646
PBCR8420D	20 x 84 x 29	100	273	28	\$6560
PBCR7820D	20 x 78 x 29	100	252	26	\$6091
PBCR7220D	20 x 72 x 29	100	237	24	\$5624
PBCR6620D	20 x 66 x 29	100	216	22	\$5413
PBCR6020D	20 x 60 x 29	100	195	20	\$4924

Box/box/file pedestal on **right**.

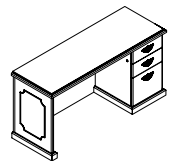

Single Pedestal Credenza - Right

PBCL8424F	24 x 84 x 29	100	305	34	\$8748
PBCL7824F	24 x 78 x 29	100	285	31	\$8119
PBCL7224F	24 x 72 x 29	100	261	29	\$7500
PBCL6624F	24 x 66 x 29	100	239	27	\$7281
PBCL6024F	24 x 60 x 29	100	218	24	\$6553
PBCL8420F	20 x 84 x 29	100	253	28	\$7626
PBCL7820F	20 x 78 x 29	100	233	26	\$7075
PBCL7220F	20 x 72 x 29	100	218	24	\$6531
PBCL6620F	20 x 66 x 29	100	197	22	\$6289
PBCL6020F	20 x 60 x 29	100	176	20	\$5711

36" lateral file on **left**.

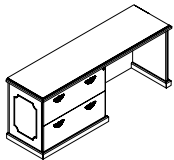

Single Pedestal Credenza - Left

PBCR8424F	24 x 84 x 29	100	305	34	\$8748
PBCR7824F	24 x 78 x 29	100	285	31	\$8119
PBCR7224F	24 x 72 x 29	100	261	29	\$7500
PBCR6624F	24 x 66 x 29	100	239	27	\$7281
PBCR6024F	24 x 60 x 29	100	218	24	\$6553
PBCR8420F	20 x 84 x 29	100	253	28	\$7626
PBCR7820F	20 x 78 x 29	100	233	26	\$7075
PBCR7220F	20 x 72 x 29	100	218	24	\$6531
PBCR6620F	20 x 66 x 29	100	197	22	\$6289
PBCR6020F	20 x 60 x 29	100	176	20	\$5711

36" lateral file on **right**.

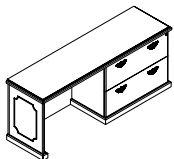

Single Pedestal Credenza - Right

Required Specifications
Finish

Optional Specifications
Additional grommet

CREDENZAS

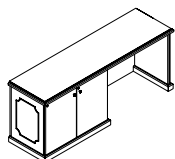

Single Pedestal Credenza - Left

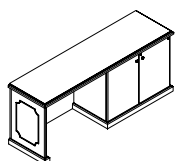

Single Pedestal Credenza - Right

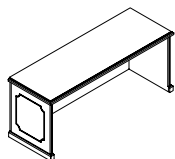

Credenza Shell

MODEL#	DIMENSIONS D x W x H	FREIGHT CLASS	WT/LBS.	CUBIC FT.	LIST PRICE
PBCL8424G	24 x 84 x 29	100	338	34	\$7858
PBCL7824G	24 x 78 x 29	92.5	314	31	\$7294
PBCL7224G	24 x 72 x 29	92.5	290	29	\$6754
PBCL6624G	24 x 66 x 29	100	266	27	\$6482
PBCL6024G	24 x 60 x 29	92.5	242	24	\$5893
PBCL8420G	20 x 84 x 29	92.5	290	28	\$6847
PBCL7820G	20 x 78 x 29	92.5	272	26	\$6357
PBCL7220G	20 x 72 x 29	92.5	252	24	\$5870
PBCL6620G	20 x 66 x 29	92.5	230	22	\$5641
PBCL6020G	20 x 60 x 29	92.5	208	20	\$5137

36" storage cabinet on **left**.

PBCR8424G	24 x 84 x 29	100	338	34	\$7858
PBCR7824G	24 x 78 x 29	92.5	314	31	\$7294
PBCR7224G	24 x 72 x 29	92.5	290	29	\$6754
PBCR6624G	24 x 66 x 29	100	266	27	\$6482
PBCR6024G	24 x 60 x 29	92.5	242	24	\$5893
PBCR8420G	20 x 84 x 29	92.5	290	28	\$6847
PBCR7820G	20 x 78 x 29	92.5	272	26	\$6357
PBCR7220G	20 x 72 x 29	92.5	252	24	\$5870
PBCR6620G	20 x 66 x 29	92.5	230	22	\$5641
PBCR6020G	20 x 60 x 29	92.5	208	20	\$5137

36" storage cabinet on **right**.

PBC12024	24 x 120 x 29	100	387	48	\$6704
PBC11424	24 x 114 x 29	125	367	46	\$6372
PBC10824	24 x 108 x 29	125	348	44	\$6036
PBC10224	24 x 102 x 29	100	329	41	\$5694
PBC9624	24 x 96 x 29	125	309	39	\$5363
PBC9024	24 x 90 x 29	100	290	36	\$5025
PBC8424	24 x 84 x 29	125	271	34	\$4694
PBC7824	24 x 78 x 29	100	251	31	\$4355
PBC7224	24 x 72 x 29	100	232	29	\$4024
PBC6624	24 x 66 x 29	125	213	27	\$3881
PBC6024	24 x 60 x 29	100	193	24	\$3522
PBC5424	24 x 54 x 29	125	174	22	\$3332
PBC4824	24 x 48 x 29	100	155	19	\$3150
PBC4224	24 x 42 x 29	125	135	17	\$2669

With full back panel.

Required Specifications

Finish

Optional Specifications

Additional grommet

CORNERS - NOTES

NOTE: Arrow indicates direction of grain

D x W x H

Corners

- All units are shipped assembled
- Unit includes grommets shown and installed horizontal wire management
- Corner units and extended corner units must be used exclusively with linking bridges and linking returns
- **Linking bridges** are handed by recessed end panel
- **Extended corner tables** have no molding on back side. Grommets are not included and must be specified.
- **Linking returns** include grommets shown and installed horizontal wire management. Handed by full end panel.
- **Tables** include grommets shown and installed horizontal wire management.

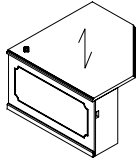
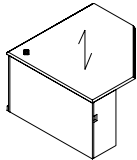
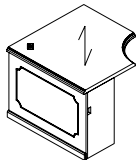
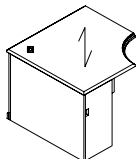
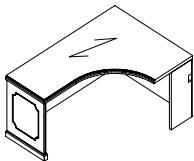
CORNERS AND COMPONENTS	MODEL#	DIMENSIONS	FREIGHT CLASS	WT/LBS.	CUBIC FT.	LIST PRICE
 <p>Corner Table - Left</p>	PBE484824ML	48 x 48 x 29	150	196	35	\$4685
	PBE424224ML	42 x 42 x 29	150	150	30	\$3604
	PBE363624ML	36 x 36 x 29	150	130	22	\$3426
With 2 recessed end panels.						
 <p>Corner Table - Right</p>	PBE484824MR	48 x 48 x 29	150	196	35	\$4685
	PBE424224MR	42 x 42 x 29	150	150	30	\$3604
	PBE363624MR	36 x 36 x 29	150	130	22	\$3426
With 2 recessed end panels.						
 <p>Corner Table - Left</p>	PBEK484824ML	48 x 48 x 29	150	196	39	\$5388
	PBEK424224ML	42 x 42 x 29	150	150	30	\$4147
	PBEK363624ML	36 x 36 x 29	150	130	22	\$3939
With 2 recessed end panels and inner curve.						
 <p>Corner Table - Right</p>	PBEK484824MR	48 x 48 x 29	150	196	39	\$5388
	PBEK424224MR	42 x 42 x 29	150	150	30	\$4147
	PBEK363624MR	36 x 36 x 29	150	130	22	\$3939
With 2 recessed end panels and inner curve.						
 <p>Extended Corner Table - Left</p>	PBEKL964824	96 x 48 x 29	150	387	77	\$7855
	PBEKL904824	90 x 48 x 29	150	363	73	\$7416
	PBEKL844824	84 x 48 x 29	150	338	68	\$7326
	PBEKL784824	78 x 48 x 29	150	314	63	\$7289
	PBEKL724824	72 x 48 x 29	150	290	58	\$6927
	PBEKL664824	66 x 48 x 29	150	266	52	\$6455
	PBEKL604824	60 x 48 x 29	150	242	48	\$5991
With full back panel.						

Required Specifications
Finish

Optional Specifications
Additional grommet

CORNERS AND COMPONENTS

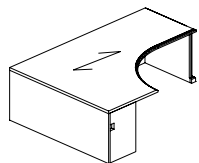

Extended Corner Table - Right

MODEL#	DIMENSIONS D x W x H	FREIGHT CLASS	WT/LBS.	CUBIC FT.	LIST PRICE
PBEKR489624	96 x 48 x 29	150	387	77	\$7855
PBEKR489024	90 x 48 x 29	150	363	73	\$7416
PBEKR488424	84 x 48 x 29	150	338	68	\$7326
PBEKR487824	78 x 48 x 29	150	314	63	\$7289
PBEKR487224	72 x 48 x 29	150	290	58	\$6927
PBEKR486624	66 x 48 x 29	150	266	52	\$6455
PBEKR486024	60 x 48 x 29	150	242	48	\$5991

With full back panel.

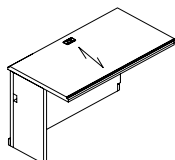

Linking Bridge - Left

PBBT6024NLLCG	24 x 60 x 29	125	145	24	\$3052
PBBT5424NLLCG	24 x 54 x 29	150	131	22	\$2745
PBBT4824NLLCG	24 x 48 x 29	125	116	19	\$2440
PBBT4224NLLCG	24 x 42 x 29	125	102	17	\$1977
PBBT3624NLLCG	24 x 36 x 29	150	87	15	\$1796
PBBT3024NLLCG	24 x 30 x 29	125	73	12	\$1755

To join corner worksurface to desk or credenza. Full back panel.

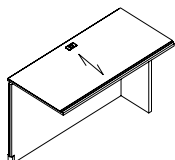

Linking Bridge - Right

PBBT6024NLR CG	24 x 60 x 29	125	145	24	\$3052
PBBT5424NLR CG	24 x 54 x 29	150	131	22	\$2745
PBBT4824NLR CG	24 x 48 x 29	125	116	19	\$2440
PBBT4224NLR CG	24 x 42 x 29	125	102	17	\$1977
PBBT3624NLR CG	24 x 36 x 29	150	87	15	\$1796
PBBT3024NLR CG	24 x 30 x 29	125	73	12	\$1755

To join corner worksurface to desk or credenza. Full back panel.

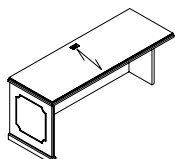

Linking Return - Left

PBVL9624CG	24 x 96 x 29	150	200	39	\$5054
PBVL9024CG	24 x 90 x 29	150	187	36	\$4738
PBVL8424CG	24 x 84 x 29	150	174	34	\$4423
PBVL7824CG	24 x 78 x 29	150	162	31	\$4108
PBVL7224CG	24 x 72 x 29	150	149	29	\$3791
PBVL6624CG	24 x 66 x 29	150	141	27	\$3558
PBVL6024CG	24 x 60 x 29	150	132	24	\$3325
PBVL5424CG	24 x 54 x 29	150	121	22	\$3139
PBVL4824CG	24 x 48 x 29	125	115	19	\$2948
PBVL4224CG	24 x 42 x 29	150	99	17	\$2487
PBVL3624CG	24 x 36 x 29	150	83	15	\$2397
PBVL3024CG	24 x 30 x 29	125	77	12	\$2354
PBVL2424CG	24 x 24 x 29	125	61	10	\$1975

To be used with corner unit.

Required Specifications
Finish

Optional Specifications
Additional grommet

CORNERS AND COMPONENTS **MODEL#** **DIMENSIONS** **FREIGHT CLASS** **WT/LBS.** **CUBIC FT.** **LIST PRICE**

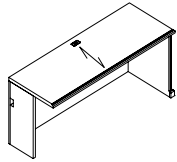

Linking Return - Right

	D x W x H					
PBVR9624CG	24 x 96 x 29	150	200	39		\$5054
PBVR9024CG	24 x 90 x 29	150	187	36		\$4738
PBVR8424CG	24 x 84 x 29	150	174	34		\$4423
PBVR7824CG	24 x 78 x 29	150	162	31		\$4108
PBVR7224CG	24 x 72 x 29	150	149	29		\$3791
PBVR6624CG	24 x 66 x 29	150	141	27		\$3558
PBVR6024CG	24 x 60 x 29	150	132	24		\$3325
PBVR5424CG	24 x 54 x 29	150	121	22		\$3139
PBVR4824CG	24 x 48 x 29	125	115	19		\$2948
PBVR4224CG	24 x 42 x 29	150	99	17		\$2487
PBVR3624CG	24 x 36 x 29	150	83	15		\$2397
PBVR3024CG	24 x 30 x 29	125	77	12		\$2354
PBVR2424CG	24 x 24 x 29	125	61	10		\$1975

To be used with corner unit.

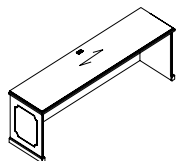

Freestanding Table

PBVT9624	24 x 96 x 29	150	213	39		\$5164
PBVT9024	24 x 90 x 29	150	199	36		\$4841
PBVT8424	24 x 84 x 29	150	186	34		\$4519
PBVT7824	24 x 78 x 29	150	173	31		\$4190
PBVT7224	24 x 72 x 29	150	160	29		\$3874
PBVT6624	24 x 66 x 29	150	146	27		\$3641
PBVT6024	24 x 60 x 29	150	133	24		\$3413
PBVT5424	24 x 54 x 29	150	128	22		\$3221
PBVT4824	24 x 48 x 29	125	120	19		\$3033
PBVT4224	24 x 42 x 29	125	104	17		\$2566
PBVT3624	24 x 36 x 29	150	88	15		\$2481
PBVT3024	24 x 30 x 29	125	82	12		\$2433
PBVT2424	24 x 24 x 29	125	65	10		\$2046

Full end panels.

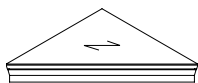

Corner Filler Top

PBV1212CT	12 x 12 x 1.3	150	5	1		\$1038
-----------	---------------	-----	---	---	--	---------------

Required Specifications
Finish

Optional Specifications
Additional grommet

MODULAR STORAGE - NOTES

D x W x H

- All storage components are shipped assembled
- Components 28" high are intended for use with a desk, credenza or return shell
- Backs on 28" high pedestals and cabinets are unfinished. If finished back is required, see page 365.
- If a profiled top is required, please see "Freestanding Storage" section.

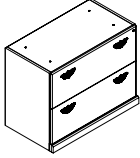
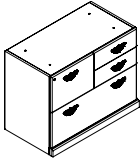
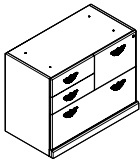
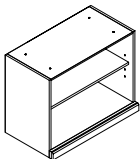
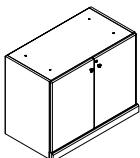
MODULAR STORAGE	MODEL#	DIMENSIONS	FREIGHT CLASS	WT/LBS.	CUBIC FT.	LIST PRICE
 <p>Modular Lateral File</p>	PBWF	19.1 x 35.1 x 28	92.5	115	11	\$4220
	PBWN	19.1 x 30 x 28	92.5	96	9	\$3694
 <p>Modular Combination Storage</p>	PBWZL	19.1 x 35.1 x 28	92.5	115	11	\$4148
	With 1 lateral file, 2 box drawers in the top right, and 1 file drawer in the top left.					
 <p>Modular Combination Storage</p>	PBWZR	19.1 x 35.1 x 28	92.5	115	11	\$4148
	With 1 lateral file, 2 box drawers in the top left, and 1 file drawer in the top right.					
 <p>Modular Open Storage</p>	PBWOB36	19.1 x 35.1 x 28	100	92	11	\$2083
	PBWOB30	19.1 x 30 x 28	100	77	9	\$1846
 <p>Modular Storage Cabinet w/Doors</p>	PBWG	19.1 x 35.1 x 28	92.5	115	11	\$2600
	PBWM	19.1 x 30 x 28	92.5	96	9	\$2305
Storage with 1 adjustable shelf.						

Required Specifications

Finish

MODULAR STORAGE

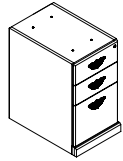

Box/Box/File Shell - Vertical

MODEL#	DIMENSIONS	FREIGHT CLASS	WT./LBS.	CUBIC FT.	LIST PRICE
D x W x H					
Letter width:					
PBWWDD	23 x 15.6 x 28	85	72	6	\$3257
PBWD	19 x 15.6 x 28	85	70	5	\$2834
Legal width:					
PBWWLD	23 x 18.5 x 28	85	85	7	\$3908
PBWLD	19 x 18.5 x 28	85	83	6	\$3401

For use under a freestanding worksurface (22", 24", 30" or 36"D). Top drilled to attach to worksurface. **Two box and one file drawer.** One pencil tray. Lock secures all drawers.

- For 22" or 24"D worksurface, order or **PBWD or PBWLD**. For 30" or 36"D worksurface, order **PBWWDD or PBWWLD**.
- **Unfinished top and back**

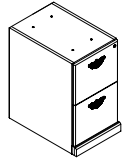

File/File Shell - Vertical

Letter width:					
PBWWLE	23 x 15.6 x 28	85	72	6	\$3257
PBWE	19 x 15.6 x 28	85	70	5	\$2834
Legal width:					
PBWWLE	23 x 18.5 x 28	85	85	7	\$3908
PBWLE	19 x 18.5 x 28	85	83	6	\$3401

For use under a freestanding worksurface (22", 24", 30" or 36"D). Top drilled to attach to worksurface. **Two file drawers.** Lock secures all drawers.

- For 22" or 24"D worksurface, order or **PBWE or PBWLE**. For 30" or 36"D worksurface, order **PBWWLE or PBWWLE**.
- **Unfinished top and back**

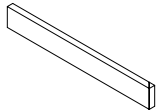

Decorative Base Trim - Left

PBAS-WL	1 x 19 x 2.5	70	1	0.01	\$319
PBAS-WWL	1 x 23 x 2.5	70	1	0.01	\$392

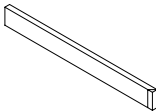

Decorative Base Trim - Right

PBAS-WR	1 x 19 x 2.5	70	1	0.01	\$319
PBAS-WWR	1 x 23 x 2.5	70	1	0.01	\$392

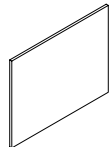

Finished Back

PBBA36	0.8 x 35 x 27.5	125	18	3	\$498
PBBA30	0.8 x 30 x 27.5	150	15	3	\$414
PBBA18	0.8 x 18.5 x 27.5	150	10	2	\$241
PBBA15	0.8 x 15.5 x 27.5	150	8	2	\$209

For modular pedestals.

Required Specifications

Finish

HUTCHES & WALL MOUNTED STORAGE NOTES

D x W x H

NOTE: Arrow indicates direction of grain

Hutches

- All hutches are shipped assembled
- Bronze glass door is standard. Clear glass is available, please contact customer care.

Closed pigeon hole storage hutch

- 42" unit has 21.5" of clearance
- Hutches longer than 102" have 8 doors, hutches between 102" and 84" have 6 doors, and hutches less than 84" have 4 doors.

Closed storage hutch

- 36" unit has 19.5" of clearance.
- 42" and 54" units have 25.5" of clearance
- Hutches longer than 102" have 8 doors, hutches between 102" and 84" have 6 doors, and hutches less than 84" have 4 doors.

Tasklight

- For proper size see page 345.

HUTCHES & WALL MOUNTED STORAGE

MODEL#

DIMENSIONS

FREIGHT CLASS

WT./LBS.

CUBIC FT.

LIST PRICE

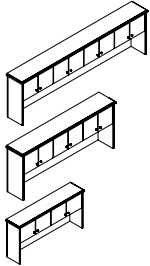

36" H Storage Hutch w/Wood Doors*

PB108SH36	15 x 108 x 36	125	268	34	\$8123
PB102SH36	15 x 102 x 36	125	254	32	\$7671
PB96SH36	15 x 96 x 36	100	241	30	\$7216
PB90SH36	15 x 90 x 36	100	227	28	\$6766
PB84SH36	15 x 84 x 36	100	214	26	\$6317
PB78SH36	15 x 78 x 36	100	200	24	\$5869
PB72SH36	15 x 72 x 36	100	187	23	\$5415
PB66SH36	15 x 66 x 36	100	173	21	\$5209
PB60SH36	15 x 60 x 36	100	160	19	\$4967

Hutches longer than 102" have 8 doors, hutches between 102" and 84" have 6 doors, and hutches less than 84" have 4 doors. Locks are optional.

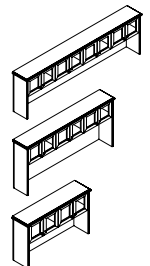

36" H Storage Hutch w/Glass Doors

PB108SH36G	15 x 108 x 36	125	268	34	\$11331
PB102SH36G	15 x 102 x 36	125	254	32	\$10222
PB96SH36G	15 x 96 x 36	100	241	30	\$9727
PB90SH36G	15 x 90 x 36	100	227	28	\$9247
PB84SH36G	15 x 84 x 36	100	214	26	\$8756
PB78SH36G	15 x 78 x 36	100	200	24	\$8277
PB72SH36G	15 x 72 x 36	100	187	23	\$7140
PB66SH36G	15 x 66 x 36	100	173	21	\$6881
PB60SH36G	15 x 60 x 36	100	160	19	\$6591

Wood framed glass doors. Hutches longer than 102" have 8 doors, hutches between 102" and 84" have 6 doors, and hutches less than 84" have 4 doors. No lock option available.

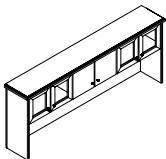

36" H Storage Hutch w/Doors*

PB102SH36GDG	15 x 102 x 36	125	254	32	\$9426
PB96SH36GDG	15 x 96 x 36	100	241	30	\$8934
PB90SH36GDG	15 x 90 x 36	100	227	28	\$8452
PB84SH36GDG	15 x 84 x 36	100	214	26	\$7962

Wood doors in the center and wood framed glass doors on left and right. Locks are optional on wood doors.

Required Specifications

Finish

Optional Specifications

Additional grommet
Locks* (wood doors only)

HUTCHES & WALL MOUNTED STORAGE

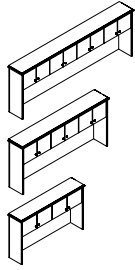

42" H Storage Hutch w/Wood Doors*

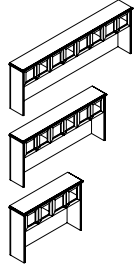

42" H Storage Hutch w/Glass Doors

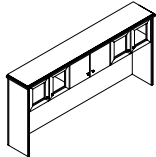

42" H Storage Hutch w/Doors*

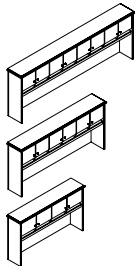

42" H Storage Hutch w/Wood Doors & Pigeon-Holes*

MODEL#	DIMENSIONS D x W x H	FREIGHT CLASS	WT/LBS.	CUBIC FT.	LIST PRICE
PB108SH42	15 x 108 x 42	125	307	39	\$9470
PB102SH42	15 x 102 x 42	125	290	37	\$8945
PB96SH42	15 x 96 x 42	125	273	35	\$8421
PB90SH42	15 x 90 x 42	125	256	33	\$7892
PB84SH42	15 x 84 x 42	125	239	31	\$7366
PB78SH42	15 x 78 x 42	150	222	38	\$6840
PB72SH42	15 x 72 x 42	125	205	26	\$6317
PB66SH42	15 x 66 x 42	125	188	24	\$6084
PB60SH42	15 x 60 x 42	125	171	22	\$5791

Hutches longer than 102" have 8 doors, hutches between 102" and 84" have 6 doors, and hutches less than 84" have 4 doors. Locks are optional.

PB108SH42G	15 x 108 x 42	125	307	39	\$12613
PB102SH42G	15 x 102 x 42	125	290	37	\$11496
PB96SH42G	15 x 96 x 42	125	273	35	\$10934
PB90SH42G	15 x 90 x 42	125	256	33	\$10367
PB84SH42G	15 x 84 x 42	125	239	31	\$9809
PB78SH42G	15 x 78 x 42	150	222	38	\$9251
PB72SH42G	15 x 72 x 42	125	205	26	\$8040
PB66SH42G	15 x 66 x 42	125	188	24	\$7754
PB60SH42G	15 x 60 x 42	125	171	22	\$7413

Wood framed glass doors. Hutches longer than 102" have 8 doors, hutches between 102" and 84" have 6 doors, and hutches less than 84" have 4 doors. No lock option available.

PB102SH42GDG	15 x 102 x 42	125	290	37	\$10701
PB96SH42GDG	15 x 96 x 42	125	273	35	\$10137
PB90SH42GDG	15 x 90 x 42	125	256	33	\$9575
PB84SH42GDG	15 x 84 x 42	125	239	31	\$9015

Wood doors in the center and wood framed glass doors on left and right. Locks are optional on wood doors.

PB108SHP42	15 x 108 x 42	125	307	39	\$11361
PB102SHP42	15 x 102 x 42	125	290	37	\$10734
PB96SHP42	15 x 96 x 42	125	273	35	\$10104
PB90SHP42	15 x 90 x 42	125	256	33	\$9470
PB84SHP42	15 x 84 x 42	125	239	31	\$8836
PB78SHP42	15 x 78 x 42	150	222	38	\$8210
PB72SHP42	15 x 72 x 42	125	205	26	\$7582
PB66SHP42	15 x 66 x 42	125	241	31	\$6704
PB60SHP42	15 x 60 x 42	125	171	22	\$6947

Hutches longer than 102" have 8 doors, hutches between 102" and 84" have 6 doors, and hutches less than 84" have 4 doors. Locks are optional.

Required Specifications
Finish

Optional Specifications
Additional grommet
Locks* (wood doors only)

HUTCHES & WALL MOUNTED STORAGE

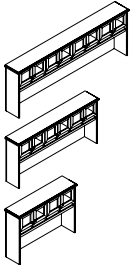

42" H Storage Hutch w/Glass Doors & Pigeon-Holes

MODEL#	DIMENSIONS D x W x H	FREIGHT CLASS	WT/LBS.	CUBIC FT.	LIST PRICE
PB108SHP42G	15 x 108 x 42	125	307	39	\$14497
PB102SHP42G	15 x 102 x 42	125	290	37	\$13217
PB96SHP42G	15 x 96 x 42	125	273	35	\$12587
PB90SHP42G	15 x 90 x 42	125	256	33	\$11911
PB84SHP42G	15 x 84 x 42	125		31	
PB78SHP42G	15 x 78 x 42	150	222	38	\$10553
PB72SHP42G	15 x 72 x 42	125	205	26	\$9261
PB66SHP42G	15 x 66 x 42	125	188	24	\$8956
PB60SHP42G	15 x 60 x 42	125	171	22	\$8522

Wood framed glass doors. Hutches longer than 102" have 8 doors, hutches between 102" and 84" have 6 doors, and hutches less than 84" have 4 doors. No lock option available.

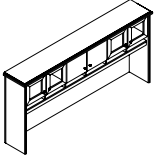

42" H Storage Hutch w/Doors & Pigeon-Holes

PB102SHP42GDG	15 x 102 x 42	125	290	37	\$12423
PB96SHP42GDG	15 x 96 x 42	125	273	35	\$11789
PB90SHP42GDG	15 x 90 x 42	125	256	33	\$11117
PB84SHP42GDG	15 x 84 x 42	125	239	31	\$10410

Wood doors in the center and wood framed glass doors on left and right. Locks are optional on wood doors.

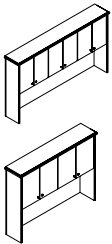

54" H Storage Hutch w/Wood Doors

PB962SH54	15 x 96 x 55	125	351	45	\$10819
PB902SH54	15 x 90 x 55	125	329	42	\$10146
PB842SH54	15 x 84 x 55	125	309	39	\$9470
PB782SH54	15 x 78 x 55	125	285	37	\$8794
PB722SH54	15 x 72 x 55	125	263	34	\$8122
PB662SH54	15 x 66 x 55	125	241	31	\$7818
PB602SH54	15 x 60 x 55	125	219	28	\$7440

Hutches between 96" and 84" have 6 doors; hutches less than 84" have 4 doors. One adjustable shelf. Locks are optional.

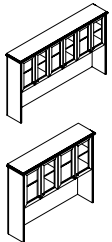

54" H Storage Hutch w/Glass Doors

PB962SH54G	15 x 96 x 55	125	351	45	\$13967
PB902SH54G	15 x 90 x 55	125	329	42	\$13019
PB842SH54G	15 x 84 x 55	125	307	39	\$12063
PB782SH54G	15 x 78 x 55	125	285	37	\$11113
PB722SH54G	15 x 72 x 55	125	263	34	\$10165
PB662SH54G	15 x 66 x 55	125	241	31	\$9794
PB602SH54G	15 x 60 x 55	125	219	28	\$9352

Wood framed glass doors. Hutches between 96" and 84" have 6 doors; hutches less than 84" have 4 doors. One adjustable shelf. No lock option available.

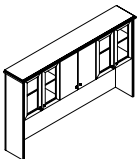

54" H Storage Hutch w/Doors

PB962SH54GDG	15 x 96 x 55	125	351	45	\$12974
PB902SH54GDG	15 x 90 x 55	125	329	42	\$12029
PB842SH54GDG	15 x 84 x 55	125	307	39	\$11070

Wood doors in the center and wood framed glass doors on left and right. One adjustable shelf. Locks are optional on wood doors.

Required Specifications

Finish

Optional Specifications

Locks* (wood doors only)

HUTCHES & WALL MOUNTED STORAGE

MODEL# DIMENSIONS FREIGHT CLASS WT/LBS. CUBIC FT. LIST PRICE

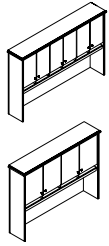

54" H Storage Hutch w/Wood Doors & Pigeon-Holes

	D x W x H					
PB962SHP54	15 x 96 x 55	125	351	45	\$12988	
PB902SHP54	15 x 90 x 55	125	329	42	\$12178	
PB842SHP54	15 x 84 x 55	125	307	39	\$11361	
PB782SHP54	15 x 78 x 55	125	285	37	\$10553	
PB722SHP54	15 x 72 x 55	125	263	34	\$9741	
PB662SHP54	15 x 66 x 55	125	241	31	\$9379	
PB602SHP54	15 x 60 x 55	125	219	28	\$8926	

Hutches between 96" and 84" have 6 doors; hutches less than 84" have 4 doors. One adjustable shelf. Locks are optional.

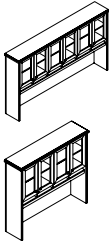

54" H Storage Hutch w/Glass Doors & Pigeon-Holes

PB962SHP54	15 x 96 x 55	125	351	45	\$12988	
PB902SHP54	15 x 90 x 55	125	329	42	\$12178	
PB842SHP54	15 x 84 x 55	125	307	39	\$11361	
PB782SHP54	15 x 78 x 55	125	285	37	\$10553	
PB722SHP54	15 x 72 x 55	125	263	34	\$9741	
PB662SHP54	15 x 66 x 55	125	241	31	\$9379	
PB602SHP54	15 x 60 x 55	125	219	28	\$8926	

Wood framed glass doors. Hutches between 96" and 84" have 6 doors; hutches less than 84" have 4 doors. One adjustable shelf. No lock option available.

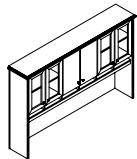

54" H Storage Hutch w/Doors & Pigeon-Holes

PB962SHP54GDG	15 x 96 x 55	125	351	45	\$15143	
PB902SHP54GDG	15 x 90 x 55	125	329	42	\$14331	
PB842SHP54GDG	15 x 84 x 55	125	307	39	\$13159	

Wood doors in the center and wood framed glass doors on left and right. One adjustable shelf. Locks are optional on wood doors.

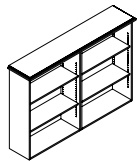

Open Hutch

PB720B54	15 x 72 x 55	125	260	35	\$7450	
PB360B54	15 x 36.75 x 55	125	130	18	\$3735	

Four adjustable shelves.

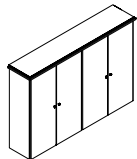

Hutch w/Wood Doors

PB72BD54	15 x 72 x 55	100	320	35	\$9594	
PB36BD54	15 x 36.75 x 55	100	160	18	\$4806	

Four adjustable shelves. Locks are optional.

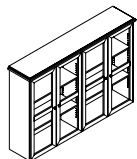

Hutch w/Glass Doors

PB72BG54	15 x 72 x 55	100	320	35	\$10877	
PB36BG54	15 x 36.75 x 55	100	160	18	\$5442	

Wood framed glass doors. Four adjustable shelves. No lock option available.

Required Specifications

Finish

Optional Specifications

Additional grommet
Locks* (wood doors only)

HUTCHES & WALL MOUNTED STORAGE

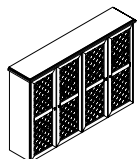

Hutch w/Wire Mesh Doors

MODEL#	DIMENSIONS D x W x H	FREIGHT CLASS	WT/LBS.	CUBIC FT.	LIST PRICE
PB72BW54	15 x 72 x 55	100	320	35	\$12164
PB36BW54	15 x 36.75 x 55	100	160	18	\$6241

Antique Brass wire mesh wood framed doors. Four adjustable shelves. No lock option available.

FREESTANDING STORAGE NOTES

NOTE: Arrow indicates direction of grain

Pedestals

- All units are shipped assembled.
- Standard face locking.

Combination Storage

- All units are shipped assembled.
- No modifications accepted for this unit.
- Box drawers do not lock.
- Standard face locking.

Storage Cabinets

- All units are shipped assembled.
- Units include adjustable shelves.
- Standard face locking.

TV Cabinets

- All units are shipped assembled.
- Units include 170° hinges, grommet on fixed shelf and adjustable shelf in lower cabinet.
- Standard face locking for lower cabinet.
- To add lock for upper cabinet, specify "LO".

FREESTANDING STORAGE

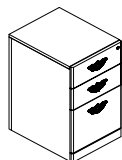

Freestanding Pedestal

MODEL#	DIMENSIONS D x W x H	FREIGHT CLASS	WT/LBS.	CUBIC FT.	LIST PRICE
PBWDB	19.8 x 15.5 x 28	85	70	5	\$2877
PBWWDB	23.8 x 15.5 x 28	85	75	6	\$3314

Box/box/file.

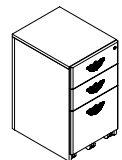

Freestanding Mobile Pedestal

PBWDM	19.8 x 15.5 x 28	85	70	5	\$3095
PBWWDM	23.8 x 15.5 x 28	85	75	6	\$3557

Box/box/file.

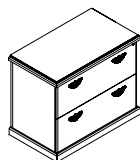

Lateral File - 2 high

PBF3624	24 x 36.75 x 29	85	184	15	\$5325
PBF3620	20 x 36.75 x 29	85	159	12	\$4429
PBN3024	24 x 31.63 x 29	85	153	12	\$4660
PBN3020	20 x 31.63 x 29	85	131	10	\$3875

Two lateral file drawers.

Required Specifications
Finish

Optional Specifications
Additional grommet

FREESTANDING STORAGE

MODEL# DIMENSIONS FREIGHT CLASS WT/LBS. CUBIC FT. LIST PRICE

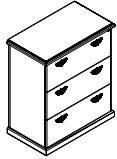

Lateral File - 3 high

D x W x H						
PBF36243	24 x 36.75 x 42	92.5	231	21		\$6510
PBF36203	20 x 36.75 x 42	92.5	193	18		\$5557
PBN30243	24 x 31.63 x 42	92.5	193	18		\$5691
PBN30203	20 x 31.63 x 42	92.5	160	15		\$4861

Three lateral file drawers.

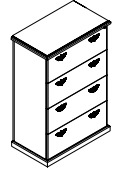

Lateral File - 4 high

PBF36244	24 x 36.75 x 54	92.5	297	27		\$7927
PBF36204	20 x 36.75 x 54	92.5	259	23		\$6885
PBN30244	24 x 31.63 x 54	92.5	248	23		\$6932
PBN30204	20 x 31.63 x 54	92.5	214	19		\$6024

Four lateral file drawers.

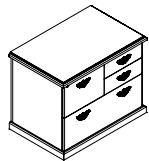

Combination Storage - Left

PBZL3624	24 x 36.75 x 29	85	184	15		\$5771
PBZL3620	20 x 36.75 x 29	85	160	12		\$4660

With 1 lateral file, 2 box drawers in the top right, and 1 file drawer in the top left.

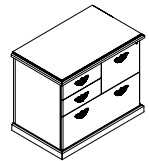

Combination Storage - Right

PBZR3624	24 x 36.75 x 29	85	184	15		\$5771
PBZR3620	20 x 36.75 x 29	85	160	12		\$4660

With 1 lateral file, 2 box drawers in the top left, and 1 file drawer in the top right.

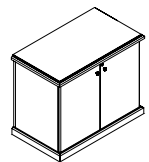

Storage Cabinet w/Doors

PBBD3624	24 x 36.75 x 29	92.5	152	15		\$3627
PBBD3620	20 x 36.75 x 29	92.5	129	12		\$3159
PBBD3024	24 x 31.63 x 29	92.5	127	12		\$3175
PBBD3020	20 x 31.63 x 29	92.5	106	10		\$2761

Storage with 1 adjustable shelf.

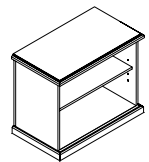

Open Storage Cabinet

PBOB3624	24 x 36.75 x 29	100	123	15		\$2910
PBOB3620	20 x 36.75 x 29	100	104	12		\$2535
PBOB3024	24 x 31.63 x 29	100	103	12		\$2541
PBOB3020	20 x 31.63 x 29	100	85	10		\$2210

Storage with 1 adjustable shelf.

Required Specifications

Finish

Optional Specifications

Additional grommet

FREESTANDING STORAGE

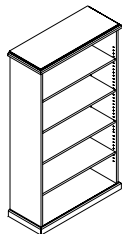

Open Bookcase

MODEL#	DIMENSIONS D x W x H	FREIGHT CLASS	WT/LBS.	CUBIC FT.	LIST PRICE
PBB83615	15 x 36.75 x 84	100	246	26	\$4459
PBB73615	15 x 36.75 x 78	100	228	24	\$4140
PBB63615	15 x 36.75 x 72	100	210	23	\$3822
PBB53615	15 x 36.75 x 65	100	188	21	\$3517
PBB43615	15 x 36.75 x 48	100	140	15	\$2897
PBB23615	15 x 36.75 x 29	92.5	90	8	\$2322
PBB83015	15 x 31.63 x 84	92.5	246	22	\$3897
PBB73015	15 x 31.63 x 78	92.5	228	20	\$3619
PBB63015	15 x 31.63 x 72	92.5	210	19	\$3344
PBB53015	15 x 31.63 x 65	92.5	188	17	\$3087
PBB43015	15 x 31.63 x 48	92.5	140	13	\$2535
PBB23015	15 x 31.63 x 29	92.5	90	8	\$2034

84" and 78" high models have 6 adjustable shelves, 72" has 5 adjustable shelves, 65" has 4 adjustable shelves, 48" has 3 adjustable shelves, 29" has 1 adjustable shelves.

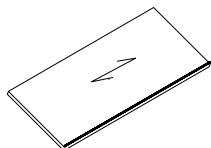

Additional Shelf

PBAG3624	24 x 36 x 1	92.5	112	10	\$240
PBAG3622	22 x 36 x 1	92.5	104	10	\$218
PBAG3620	20 x 36 x 1	92.5	92	9	\$196
PBAG3615	15 x 36 x 1	92.5	81	8	\$173
PBAG3024	24 x 30 x 1	92.5	94	9	\$202
PBAG3022	22 x 30 x 1	100	87	9	\$184
PBAG3020	20 x 30 x 1	100	76	8	\$162
PBAG3015	15 x 30 x 1	100	67	8	\$143

For use with open bookcase. Can be specified for each shelf in an open bookcase.

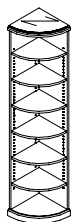

Quarter Round Open Bookcase

PB8R1515	15 x 15 x 84	125	142	22	\$3510
PB7R1515	15 x 15 x 78	100	95	10	\$3260
PB6R1515	15 x 15 x 72	100	83	9	\$3009
PB5R1515	15 x 15 x 65	100	81	9	\$2774
PB4R1515	15 x 15 x 48	100	59	6	\$2282
PB2R1515	15 x 15 x 29	100	37	4	\$1831

84" and 78" high models have 6 adjustable shelves, 72" has 5 adjustable shelves, 65" has 4 adjustable shelves, 48" has 3 adjustable shelves, 29" has 1 adjustable shelf.

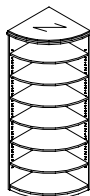

Quarter Round Open Bookcase

PBB7R2424H84	24 x 24 x 84	100	234	28	\$6126
PBB7R2424H72	24 x 24 x 72	125	204	28	\$5254
PBB7R2424H65	24 x 24 x 65	100	187	22	\$4819
PBB7R2020H84	20 x 20 x 84	100	163	19	\$5354
PBB7R2020H72	20 x 20 x 72	100	142	17	\$4587
PBB7R2020H65	20 x 20 x 65	100	130	15	\$4302

84" high models have 6 adjustable shelves, 72" has 5 adjustable shelves, and 65" has 4 adjustable shelves

Required Specifications

Finish

FREESTANDING STORAGE

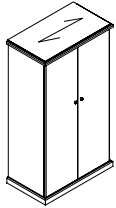

Storage Cabinet w/Wood Doors

MODEL# DIMENSIONS FREIGHT CLASS WT/LBS. CUBIC FT. LIST PRICE

D x W x H

PB1D24W36H84	24 x 36.75 x 84	125	304	42	\$8510
PB1D24W36H72	24 x 36.75 x 72	100	283	33	\$7294
PB1D24W36H65	24 x 36.75 x 65	100	259	30	\$6684
PB1D24W30H84	24 x 30.63 x 84	125	304	42	\$7435
PB1D24W30H72	24 x 30.63 x 72	100	283	33	\$6372
PB1D24W30H65	24 x 30.63 x 65	100	259	30	\$5853
PB1D24W24H84	24 x 24 x 84	92.5	320	28	\$6352
PB1D24W24H72	24 x 24 x 72	92.5	255	24	\$5446
PB1D24W24H65	24 x 24 x 65	125	173	22	\$5019
PB1D20W36H84	20 x 36.75 x 84	100	297	35	\$7435
PB1D20W36H72	20 x 36.75 x 72	100	269	30	\$6372
PB1D20W36H65	20 x 36.75 x 65	100	245	28	\$5842
PB1D20W30H84	20 x 30.63 x 84	100	257	29	\$6195
PB1D20W30H72	20 x 30.63 x 72	100	233	25	\$5312
PB1D20W30H65	20 x 30.63 x 65	100	202	23	\$4869
PB1D20W24H84	20 x 24 x 84	100	198	23	\$4959
PB1D20W24H72	20 x 24 x 72	100	179	20	\$4250
PB1D20W24H65	20 x 24 x 65	100	163	18	\$3889

84" high models have 6 adjustable shelves, 72" has 5 adjustable shelves, 65" has 4 adjustable shelves. For wood framed glass door option, please contact customer care. Lock is optional.

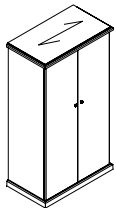

Wardrobe Cabinet

PB2D24W36H84	24 x 36.75 x 84	100	356	42	\$7384
PB2D24W36H72	24 x 36.75 x 72	100	324	36	\$6332
PB2D24W36H65	24 x 36.75 x 65	100	297	33	\$5804
PB2D24W30H84	24 x 30.63 x 84	100	296	35	\$6465
PB2D24W30H72	24 x 30.63 x 72	100	270	30	\$5541
PB2D24W30H65	24 x 30.63 x 65	100	248	28	\$5078
PB2D24W24H84	24 x 24 x 84	100	238	28	\$5541
PB2D24W24H72	24 x 24 x 72	100	216	24	\$4749
PB2D24W24H65	24 x 24 x 65	100	198	22	\$4353
PB2D20W36H84	20 x 36.75 x 84	100	297	35	\$6448
PB2D20W36H72	20 x 36.75 x 72	100	269	30	\$5517
PB2D20W36H65	20 x 36.75 x 65	100	245	28	\$5054
PB2D20W30H84	20 x 30.63 x 84	100	257	29	\$5376
PB2D20W30H72	20 x 30.63 x 72	100	233	25	\$4599
PB2D20W30H65	20 x 30.63 x 65	100	202	23	\$4216
PB2D20W24H84	20 x 24 x 84	100	198	23	\$4297
PB2D20W24H72	20 x 24 x 72	100	179	20	\$3675
PB2D20W24H65	20 x 24 x 65	100	163	18	\$3372

Doors, coat rack and hat shelf. 84" high models have 6 adjustable shelves, 72" has 5 adjustable shelves, 65" has 4 adjustable shelves. For wood framed glass door option, please contact customer care. Lock is optional.

Required Specifications

Finish

Optional Specifications

Lock

FREESTANDING STORAGE

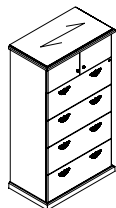

Storage Cupboard*

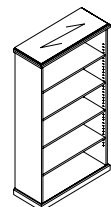

Open Bookcase

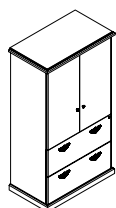

Storage Cabinet w/Doors*

MODEL#	DIMENSIONS D x W x H	FREIGHT CLASS	WT/LBS.	CUBIC FT.	LIST PRICE
PB6D24W36H84	24 x 36.75 x 84	92.5	449	42	\$12441
PB6D24W36H72	24 x 36.75 x 72	92.5	414	36	\$10666
PB6D24W36H65	24 x 36.75 x 65	92.5	380	33	\$9778
PB6D24W30H84	24 x 30.63 x 84	92.5	375	35	\$10891
PB6D24W30H72	24 x 30.63 x 72	92.5	345	30	\$9336
PB6D24W30H65	24 x 30.63 x 65	92.5	316	28	\$8557
PB6D20W36H84	20 x 36.75 x 84	92.5	382	35	\$10863
PB6D20W36H72	20 x 36.75 x 72	92.5	351	30	\$9294
PB6D20W36H65	20 x 36.75 x 65	92.5	321	28	\$8515
PB6D20W30H84	20 x 30.63 x 84	92.5	347	29	\$9053
PB6D20W30H72	20 x 30.63 x 72	85	306	25	\$7747
PB6D20W30H65	20 x 30.63 x 65	92.5	265	23	\$7102

Above lateral file cabinet with 4 drawers. 84" high model has 1 adjustable shelf. For wood framed glass door option, please contact customer care. Optional lock available for upper storage.

PB7D24W36H84	24 x 36.75 x 84	125	331	43	\$6812
PB7D24W36H72	24 x 36.75 x 72	100	306	36	\$5842
PB7D24W36H65	24 x 36.75 x 65	100	281	33	\$5354
PB7D24W30H84	24 x 30.63 x 84	125	280	36	\$5961
PB7D24W30H72	24 x 30.63 x 72	100	255	30	\$5097
PB7D24W30H65	24 x 30.63 x 65	100	234	28	\$4677
PB7D20W36H84	20 x 36.75 x 84	100	282	35	\$5947
PB7D20W36H72	20 x 36.75 x 72	100	257	30	\$5097
PB7D20W36H65	20 x 36.75 x 65	100	234	28	\$4677
PB7D20W30H84	20 x 30.63 x 84	100	248	29	\$4954
PB7D20W30H72	20 x 30.63 x 72	100	223	25	\$4248
PB7D20W30H65	20 x 30.63 x 65	100	193	23	\$3892

84" high models have 6 adjustable shelves, 72" has 5 adjustable shelves, and 65" has 4 adjustable shelves.

PB13D24W36H84	24 x 36.75 x 84	100	407	42	\$10532
PB13D24W36H72	24 x 36.75 x 72	92.5	387	36	\$9029
PB13D24W36H65	24 x 36.75 x 65	92.5	347	33	\$8278
PB13D24W30H84	24 x 30.63 x 84	92.5	350	35	\$9217
PB13D24W30H72	24 x 30.63 x 72	92.5	315	30	\$7900
PB13D24W30H65	24 x 30.63 x 65	92.5	289	28	\$7240
PB13D20W36H84	20 x 36.75 x 84	92.5	365	35	\$9194
PB13D20W36H72	20 x 36.75 x 72	92.5	327	30	\$7866
PB13D20W36H65	20 x 36.75 x 65	92.5	299	28	\$7211
PB13D20W30H84	20 x 30.63 x 84	92.5	305	29	\$7665
PB13D20W30H72	20 x 30.63 x 72	92.5	285	25	\$6558
PB13D20W30H65	20 x 30.63 x 65	92.5	247	23	\$6008

Above two lateral file drawers. 84" high models have 3 adjustable shelves, 72" has 2 adjustable shelves, and 65" has 1 adjustable shelf. For wood framed glass door option, please contact customer care. Optional lock available for upper storage.

Required Specifications

Finish

Optional Specifications

Additional grommet

Lock*

FREESTANDING STORAGE

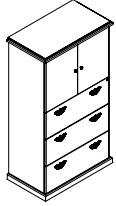

Storage Cabinet w/Doors

MODEL# DIMENSIONS FREIGHT CLASS WT/LBS. CUBIC FT. LIST PRICE

D x W x H

PB14D24W36H84	24 x 36.75 x 84	100	390	42	\$11324
PB14D24W36H72	24 x 36.75 x 72	92.5	360	36	\$9707
PB14D24W36H65	24 x 36.75 x 65	92.5	330	33	\$8896
PB14D24W30H84	24 x 30.63 x 84	100	325	35	\$9910
PB14D24W30H72	24 x 30.63 x 72	92.5	300	30	\$8382
PB14D24W30H65	24 x 30.63 x 65	100	275	28	\$7787

PB14D20W36H84	20 x 36.75 x 84	100	330	35	\$9885
PB14D20W36H72	20 x 36.75 x 72	92.5	305	30	\$8457
PB14D20W36H65	20 x 36.75 x 65	100	278	28	\$7754
PB14D20W30H84	20 x 30.63 x 84	92.5	298	29	\$8238
PB14D20W30H72	20 x 30.63 x 72	92.5	265	25	\$7047
PB14D20W30H65	20 x 30.63 x 65	100	229	23	\$6462

Above three lateral file drawers. 84" high models have 2 adjustable shelves, 72" and 65" have 1 adjustable shelf. For wood framed glass door option, please contact customer care. Optional lock available for upper storage.

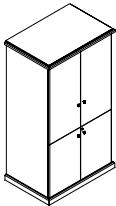

Closed Storage Cabinet

PB23D24W36H84	24 x 36.75 x 84	100	390	42	\$9089
PB23D24W36H72	24 x 36.75 x 72	92.5	360	36	\$7790
PB23D24W36H65	24 x 36.75 x 65	92.5	330	33	\$7140
PB23D24W30H84	24 x 30.63 x 84	100	325	35	\$7550
PB23D24W30H72	24 x 30.63 x 72	92.5	300	30	\$6475
PB23D24W30H65	24 x 30.63 x 65	100	275	28	\$5950

PB23D20W36H84	20 x 36.75 x 84	100	330	35	\$7934
PB23D20W36H72	20 x 36.75 x 72	92.5	305	30	\$6791
PB23D20W36H65	20 x 36.75 x 65	100	278	28	\$6220
PB23D20W30H84	20 x 30.63 x 84	92.5	298	29	\$6611
PB23D20W30H72	20 x 30.63 x 72	92.5	265	25	\$5655
PB23D20W30H65	20 x 30.63 x 65	100	229	23	\$5186

With upper and lower split doors. 1 fixed shelf and 2 adjustable shelves. For wood framed glass door option, please contact customer care. Optional lock available for upper storage.

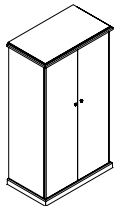

Cabinet w/Doors and Storage

PB25D24W36H84	24 x 36.75 x 84	100	390	42	\$9548
PB25D24W36H72	24 x 36.75 x 72	92.5	360	36	\$8182
PB25D24W36H65	24 x 36.75 x 65	92.5	330	33	\$7500
PB25D24W30H84	24 x 30.63 x 84	100	325	35	\$8352
PB25D24W30H72	24 x 30.63 x 72	92.5	300	30	\$7156
PB25D24W30H65	24 x 30.63 x 65	100	275	28	\$6565
PB25D24W24H84	24 x 24 x 84	100	260	28	\$7150
PB25D24W24H72	24 x 24 x 72	92.5	240	24	\$6126
PB25D24W24H65	24 x 24 x 65	92.5	220	22	\$5624

PB25D20W36H84	20 x 36.75 x 84	100	330	35	\$8330
PB25D20W36H72	20 x 36.75 x 72	92.5	305	30	\$7127
PB25D20W36H65	20 x 36.75 x 65	100	278	28	\$6528
PB25D20W30H84	20 x 30.63 x 84	92.5	300	29	\$6944
PB25D20W30H72	20 x 30.63 x 72	92.5	265	25	\$5938
PB25D20W30H65	20 x 30.63 x 65	100	229	23	\$5444
PB25D20W24H84	20 x 24 x 84	92.5	235	23	\$5559
PB25D20W24H72	20 x 24 x 72	92.5	203	20	\$4757
PB25D20W24H65	20 x 24 x 65	92.5	185	18	\$4362

Wardrobe with coat rack and hat shelf on left. Storage with adjustable shelves on right. 84" high models have 5 adjustable shelves, 72" and 65" have 4 adjustable shelves. For wood framed glass door option, please contact customer care. Lock is optional.

Required Specifications

Finish

Optional Specifications

Additional grommet
Lock

RECEPTION DESKS

MODEL#

DIMENSIONS

FREIGHT CLASS

WT./LBS.

CUBIC FT.

LIST PRICE

D x W x H

- To add storage use modular components. See page 364.
- Includes GM5 grommet.
- Transaction tops to be specified separately, handed by square edge from user side.

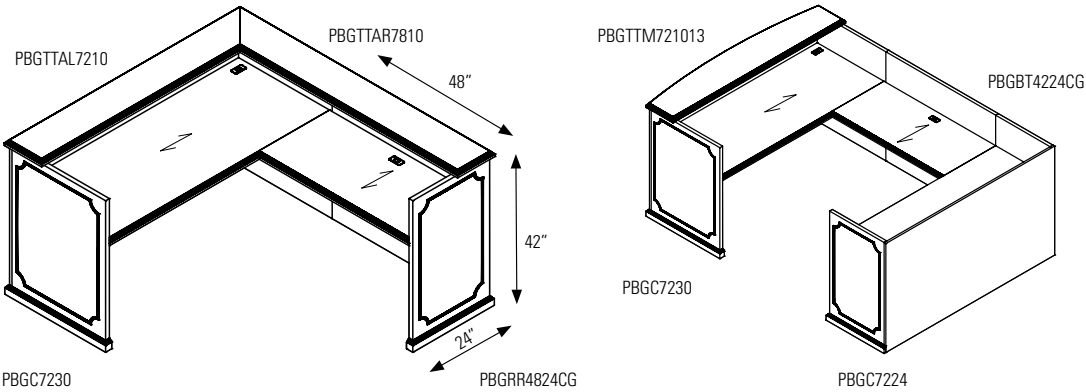

RECEPTION DESKS

MODEL#

DIMENSIONS

FREIGHT CLASS

WT./LBS.

CUBIC FT.

LIST PRICE

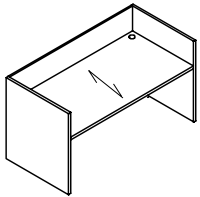

Gallery/Reception Desk Shell*

PBGC12036	36 x 120 x 42	150	592	105	\$13070
PBGC10836	36 x 108 x 42	150	533	95	\$11762
PBGC10236	36 x 102 x 42	150	503	89	\$11110
PBGC9636	36 x 96 x 42	150	473	84	\$10453
PBGC9036	36 x 90 x 42	150	444	79	\$9804
PBGC8436	36 x 84 x 42	150	414	74	\$9146
PBGC7236	36 x 72 x 42	150	355	63	\$7847
PBGC7230	30 x 72 x 42	150	315	53	\$7588
PBGC6630	30 x 66 x 42	125	295	48	\$7399
PBGC6030	30 x 60 x 42	125	275	44	\$6978

No pedestals. Two grommets in worksurface. For use with modular storage components. Pin molding included.

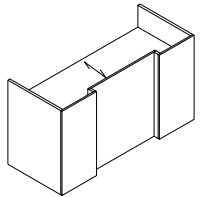

**Gallery/Reception Desk Shell
Breakfront Style**

PBGIC12036	36 x 120 x 42	150	592	105	\$14375
PBGIC10836	36 x 108 x 42	150	533	95	\$12935
PBGIC10236	36 x 102 x 42	150	503	89	\$12219
PBGIC9636	36 x 96 x 42	150	473	84	\$11498
PBGIC9036	36 x 90 x 42	150	444	79	\$10785
PBGIC8436	36 x 84 x 42	150	414	74	\$10060
PBGIC7236	36 x 72 x 42	150	355	63	\$8626
PBGIC7230	30 x 72 x 42	150	315	53	\$8348
PBGIC6630	30 x 66 x 42	125	295	48	\$8138
PBGIC6030	30 x 60 x 42	125	275	44	\$7676

No pedestals. Two grommets in worksurface. For use with modular storage components. Pin molding included.

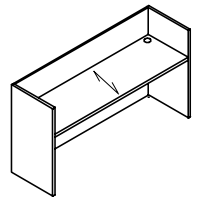

Gallery/Reception Credenza Shell*

PBGC12024	24 x 120 x 42	150	392	70	\$10253
PBGC10824	24 x 108 x 42	150	353	63	\$9217
PBGC10224	24 x 102 x 42	150	333	60	\$8709
PBGC9624	24 x 96 x 42	150	314	56	\$8194
PBGC9024	24 x 90 x 42	150	294	53	\$7682
PBGC8424	24 x 84 x 42	150	274	49	\$7173
PBGC7224	24 x 72 x 42	150	235	42	\$6150
PBGC6624	24 x 66 x 42	150	216	39	\$5778
PBGC6024	24 x 60 x 42	150	196	35	\$5414

No pedestals. Two grommets in worksurface. For use with modular storage components. Pin molding included.

Required Specifications

Finish

Optional Specifications

Additional grommet

RECEPTION DESKS

MODEL# DIMENSIONS FREIGHT CLASS WT/LBS. CUBIC FT. LIST PRICE

D x W x H

PBGBT5624CG	24 x 56 x 42	150	178	32	\$5520
PBGBT5424CG	24 x 54 x 42	150	169	29	\$5520
PBGBT5024CG	24 x 50 x 42	150	151	27	\$4906
PBGBT4824CG	24 x 48 x 42	150	142	26	\$4906
PBGBT4424CG	24 x 44 x 42	150	134	23	\$4291
PBGBT4224CG	24 x 42 x 42	150	127	22	\$4291
PBGBT3824CG	24 x 38 x 42	150	119	20	\$3865
PBGBT3624CG	24 x 36 x 42	150	112	19	\$3865

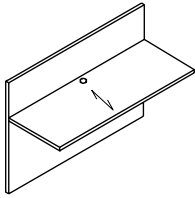

Bridge

Attaches between **Gallery Desk and Gallery Credenza Only**. One grommet in center of worksurface. Shipped RTA (ready to assemble). Pin molding included.

- To remove cross-grain veneer pattern on top, **delete "CG"** from model number. Available as a special - no upcharge.

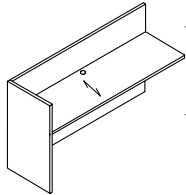

Reception Return - LEFT

PBGRL7224CG	24 x 72 x 42	125	273	42	\$7739
PBGRL6624CG	24 x 66 x 42	125	250	39	\$7098
PBGRL6024CG	24 x 60 x 42	125	228	35	\$6454
PBGRL5424CG	24 x 54 x 42	125	205	32	\$5813
PBGRL4824CG	24 x 48 x 42	125	182	28	\$5159
PBGRL4224CG	24 x 42 x 42	125	159	25	\$4519
PBGRL3624CG	24 x 36 x 42	125	137	21	\$4066

No pedestal. One grommet in center of worksurface. For use with modular storage components. Pin molding included.

- To remove cross-grain veneer pattern on top, **delete "CG"** from model number. Available as a special - no upcharge.

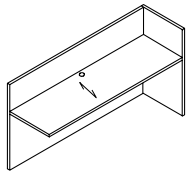

Reception Return - RIGHT

PBGRR7224CG	24 x 72 x 42	125	273	42	\$7739
PBGRR6624CG	24 x 66 x 42	125	250	39	\$7098
PBGRR6024CG	24 x 60 x 42	125	228	35	\$6454
PBGRR5424CG	24 x 54 x 42	125	205	32	\$5813
PBGRR4824CG	24 x 48 x 42	125	182	28	\$5159
PBGRR4224CG	24 x 42 x 42	125	159	25	\$4519
PBGRR3624CG	24 x 36 x 42	125	137	21	\$4066

No pedestal. One grommet in center of worksurface. For use with modular storage components. Pin molding included.

- To remove cross-grain veneer pattern on top, **delete "CG"** from model number. Available as a special - no upcharge.

Required Specifications

Finish

Optional Specifications

Additional grommet

TRANSACTION COUNTERS

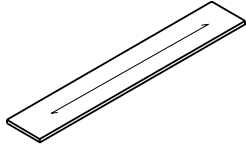

Transaction Counter Top

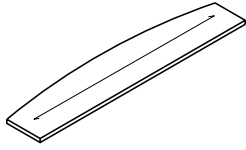

Bow Front Transaction Counter Top

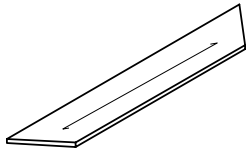

Trapezoid Transaction Counter Top

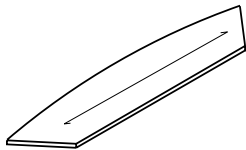

Bow Front Trapezoid Transaction Counter Top

MODEL#	DIMENSIONS	FREIGHT CLASS	WT/LBS.	CUBIC FT.	LIST PRICE
--------	------------	---------------	---------	-----------	------------

D x W x H

PBGTT12010	10 x 120 x 1.50	92.5	84	8	\$2189
PBGTT10810	10 x 108 x 1.50	100	78	8	\$1973
PBGTT10210	10 x 102 x 1.50	92.5	72	7	\$1865
PBGTT9610	10 x 96 x 1.50	100	66	7	\$1756
PBGTT9010	10 x 90 x 1.50	92.5	60	6	\$1644
PBGTT8410	10 x 84 x 1.50	100	54	6	\$1530
PBGTT7210	10 x 72 x 1.50	100	48	5	\$1313
PBGTT6610	10 x 66 x 1.50	100	42	5	\$1204
PBGTT6010	10 x 60 x 1.50	100	36	4	\$1097

Rectangular top for main reception desk. Counter sits on top of Gallery panels. Does not overhang. **Factory installed - specify Gallery to be used on.** Size must match dimension of desk front or combined desk side and return length. Hardware included.

PBGTTM1081013	10-13 x 108 x 1.50	125	78	10	\$2948
PBGTTM1021013	10-13 x 102 x 1.50	100	72	9	\$2840
PBGTTM961013	10-13 x 96 x 1.50	125	66	9	\$2733
PBGTTM901013	10-13 x 90 x 1.50	125	60	8	\$2621
PBGTTM841013	10-13 x 84 x 1.50	125	54	8	\$2505
PBGTTM721013	10-13 x 72 x 1.50	125	48	7	\$2290
PBGTTM661013	10-13 x 66 x 1.50	125	42	6	\$2182
PBGTTM601013	10-13 x 60 x 1.50	125	36	5	\$2073

Bow top for main reception desk. Counter sits on top of Gallery panels. Bow front overhangs 3". **Factory installed - specify Gallery to be used on.** Size must match dimension of desk front or combined desk side and return length. Hardware included.

PBGTTA10810	10 x 108 x 1.50	100	78	8	\$2237
PBGTTA10210	10 x 102 x 1.50	92.5	72	7	\$2126
PBGTTA9610	10 x 96 x 1.50	100	66	7	\$2017
PBGTTA9010	10 x 90 x 1.50	92.5	60	6	\$1908
PBGTTA8410	10 x 84 x 1.50	100	54	6	\$1796
PBGTTA7210	10 x 72 x 1.50	100	48	5	\$1578
PBGTTA6610	10 x 66 x 1.50	100	42	5	\$1469
PBGTTA6010	10 x 60 x 1.50	100	36	4	\$1361

Trapezoid top for main reception desk. 45° mitered ends on left and right. For use with left and right 45° mitered return transaction counters. Counter sits on top of Gallery panels. Does not overhang. **Factory installed - specify Gallery to be used on.** Width must match dimension of desk front. Hardware included.

PBGTTMA1081013	10-13 x 108 x 1.50	125	78	10	\$3072
PBGTTMA1021013	10-13 x 102 x 1.50	100	72	9	\$2960
PBGTTMA961013	10-13 x 96 x 1.50	125	66	9	\$2854
PBGTTMA901013	10-13 x 90 x 1.50	125	60	8	\$2741
PBGTTMA841013	10-13 x 84 x 1.50	125	54	8	\$2631
PBGTTMA721013	10-13 x 72 x 1.50	125	48	7	\$2413
PBGTTMA661013	10-13 x 66 x 1.50	125	42	6	\$2299
PBGTTMA601013	10-13 x 60 x 1.50	125	36	5	\$2193

Trapezoid bow top for main reception desk. 45° mitered ends on left and right. For use with left and right 45° mitered return transaction counters. Counter sits on top of Gallery panels. Bow front overhangs 3". **Factory installed - specify Gallery to be used on.** Width must match dimension of desk front. Hardware included.

Required Specifications

Finish

Optional Specifications

Additional grommet

TRANSACTION COUNTERS **MODEL#** **DIMENSIONS** **FREIGHT CLASS** **WT/LBS.** **CUBIC FT.** **LIST PRICE**

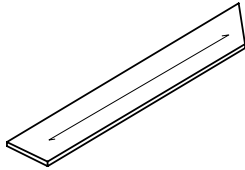

Transaction Counter Top - LEFT

	D x W x H					
PBGTTAL12010	10 x 120 x 1.50	92.5	84	8		\$2363
PBGTTAL11410	10 x 114 x 1.50	92.5	81	8		\$2247
PBGTTAL10810	10 x 108 x 1.50	100	78	8		\$2142
PBGTTAL10210	10 x 102 x 1.50	92.5	72	7		\$2036
PBGTTAL9610	10 x 96 x 1.50	100	66	7		\$1926
PBGTTAL9010	10 x 90 x 1.50	92.5	60	6		\$1817
PBGTTAL8410	10 x 84 x 1.50	100	54	6		\$1704
PBGTTAL7210	10 x 72 x 1.50	100	48	5		\$1487
PBGTTAL6610	10 x 66 x 1.50	100	42	5		\$1374
PBGTTAL6010	10 x 60 x 1.50	100	36	4		\$1269
PBGTTAL3610	10 x 36 x 1.50	100	24	3		\$762
PBGTTAL3010	10 x 30 x 1.50	92.5	20	2		\$633
PBGTTAL2410	10 x 24 x 1.50	100	16	2		\$510

Rectangular top for main reception desk with 45° mitered end on **left**. For use with rectangular or bow front transaction counters with miters at both ends. Width must match dimension of Gallery Desk end and Return width. Counter sits on top of Gallery panels. Does not overhang. **Factory installed - specify Gallery to be used on.** Hardware included.

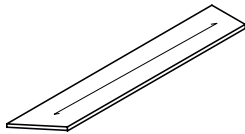

Transaction Counter Top - RIGHT

PBGTTAR12010	10 x 120 x 1.50	92.5	84	8		\$2363
PBGTTAR11410	10 x 114 x 1.50	92.5	81	8		\$2247
PBGTTAR10810	10 x 108 x 1.50	100	78	8		\$2142
PBGTTAR10210	10 x 102 x 1.50	92.5	72	7		\$2036
PBGTTAR9610	10 x 96 x 1.50	100	66	7		\$1926
PBGTTAR9010	10 x 90 x 1.50	92.5	60	6		\$1817
PBGTTAR8410	10 x 84 x 1.50	100	54	6		\$1704
PBGTTAR7210	10 x 72 x 1.50	100	48	5		\$1487
PBGTTAR6610	10 x 66 x 1.50	100	42	5		\$1374
PBGTTAR6010	10 x 60 x 1.50	100	36	4		\$1269
PBGTTAR3610	10 x 36 x 1.50	100	24	3		\$762
PBGTTAR3010	10 x 30 x 1.50	92.5	20	2		\$633
PBGTTAR2410	10 x 24 x 1.50	100	16	2		\$510

Rectangular top for main reception desk with 45° mitered end on **right**. For use with rectangular or bow front transaction counters with miters at both ends. Width must match dimension of Gallery Desk end and Return width. Counter sits on top of Gallery panels. Does not overhang. **Factory installed - specify Gallery to be used on.** Hardware included.

Required Specifications
Finish

Optional Specifications
Additional grommet

TACKBOARDS FOR HUTCHES & ACCESSORIES

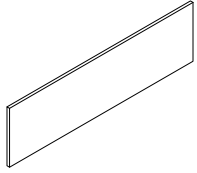

**Tackboard for 36"H*
Non-Pigeon Hole Hutches**

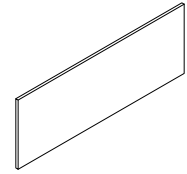

**Tackboard for 42"H & 54"H*
Pigeon Hole Hutches**

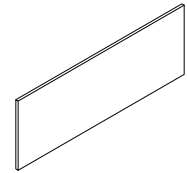

**Tackboard for 42"H & 54"H*
Non-Pigeon Hole Hutches**

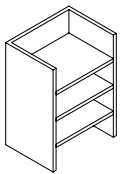

Paper Organizer, Letter & Legal Format

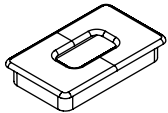

Grommet

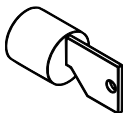

Lock Assembly

MODEL#	DIMENSIONS D x W x H	FREIGHT CLASS	WT/LBS.	CUBIC FT.	LIST PRICE
PBTS108	1 x 104.5 x 20	92.5	23	2	\$1313
PBTS102	1 x 98.5 x 20	100	19	2	\$1242
PBTS96	1 x 92.5 x 20	70	17	1	\$1169
PBTS90	1 x 86.5 x 20	70	15	1	\$1097
PBTS84	1 x 80.5 x 20	85	14	1	\$1030
PBTS78	1 x 74.5 x 20	85	13	1	\$953
PBTS72	1 x 68.5 x 20	85	12	1	\$879
PBTS66	1 x 62.5 x 20	92.5	11	1	\$802
PBTS60	1 x 56.5 x 20	92.5	10	1	\$733

Factory installed hutch tackboard.

PBTSP108H23	1 x 104.5 x 23	70	30	2	\$1485
PBTSP102H23	1 x 98.5 x 23	85	24	2	\$1415
PBTSP96H23	1 x 92.5 x 23	92.5	22	2	\$1321
PBTSP90H23	1 x 86.5 x 23	70	20	1	\$1238
PBTSP84H23	1 x 80.5 x 23	70	18	1	\$1156
PBTSP78H23	1 x 74.5 x 23	70	17	1	\$1074
PBTSP72H23	1 x 68.5 x 23	70	16	1	\$998
PBTSP66H23	1 x 62.5 x 23	85	14	1	\$908
PBTSP60H23	1 x 56.5 x 23	85	13	1	\$830

Factory installed hutch tackboard.

PBTS108H26	1 x 104.5 x 26	70	30	2	\$1716
PBTS102H26	1 x 98.5 x 26	85	24	2	\$1617
PBTS102H26	1 x 92.5 x 26	85	24	2	\$1617
PBTS90H26	1 x 86.5 x 26	92.5	20	2	\$1432
PBTS84H26	1 x 80.5 x 26	100	18	2	\$1236
PBTS78H26	1 x 74.5 x 26	100	17	2	\$1046
PBTS72H26	1 x 68.5 x 26	70	16	1	\$953
PBTS66H26	1 x 62.5 x 26	85	14	1	\$855
PBTS60H26	1 x 56.5 x 26	85	13	1	\$662

Factory installed hutch tackboard.

PBCPH161226	12 x 16 x 27	125	20	3	\$1045
PBCPH161223	12 x 16 x 23	125	18	3	\$1422
PBCPH161219	12 x 16 x 20	125	15	2	\$674
PBCPH131226	12 x 13 x 27	100	16	2	\$847
PBCPH131223	12 x 13 x 23	125	15	2	\$719
PBCPH131219	12 x 13 x 20	125	12	2	\$546

GM5C	2 x 3.5 x --	70	--	--	\$114
------	--------------	----	----	----	--------------

Rectangular grommet in metal, tungsten finish.

LO/C	--	70	--	--	\$113
------	----	----	----	----	--------------

Tungsten.

Required Specifications

Fabric*

boardroom tables

