



GLOBAL is pleased to introduce the **LUFTON** wood veneer series. This contemporary collection features an all wood veneer construction with a variety of features that emphasize a modern approach to the private office.

1-3/16" worksurfaces include a choice of four 1/4" hardwood edges to choose from – Flat (L10), Radius (L20), Fluted (L30) and Soft Tail (L40). A black 5mm PVC inlay between the worksurface and gable provides a striking visual detail.

Drawers and storage items feature eight handle options to choose from (where applicable) – storage options are available in 29", 66" and 72" heights. Various models include different types of storage configurations.

New 23" height credenzas allow for different visual planes – combined with a spacer unit, worksurfaces can be supported over this credenza.

Above worksurface storage selections include overhead storage and hutches with or without pigeon-hole storage. Hutch doors are available in a choice of veneer or glass with an aluminum frame. Tackboards are offered in all fabric or with a built-in accessory rail for organizing folders, binders, CDs and more!



Features and Benefits

- Choice of eight handle options for every door/drawer that features handles.
- Modesty panel options include metal (in Black or Tungsten), veneer, and glass.
- Base upgrades to replace standard monopost on islands are available in four styles.
- Drawers are standard vinyl wrapped construction with black drawer slides and bottom.
- 75 lb. box – 150 lb. file drawer weight capacity with full height sides – pencil tray included in box drawer.
- Lateral file drawers can accommodate legal or letter documents.
- Box drawers mounted on 3/4 extension premium ball bearing slides.
- Power/Data accessories are available to be factory installed on any LUFTON unit, including Boardroom Tables to meet all today's technological requirements.
- A full array of complementary Boardroom and Reception area furnishings are available to coordinate the entire office.

GENERAL INFORMATION

- Lufton is a veneer desking system composed of hundreds of models, capable of furnishing executive suites, boardrooms and reception areas.
- 1-3/16" worksurfaces with 1/4" solid Wood Edge all around.
- 5MM Black PVC inlay between top and gables
- **Level 3 Certified**

FINISHES

- Conversion varnish (similar to catalyzed lacquer, but tougher), 35 to 40 degree sheen. Finishes are not buffed or rubbed.
- All Global wood casegood products are veneered and finished on the back sides (3600 finishing), except modular under-surface storage - tops and backs are unfinished.
- Touch up kits available, includes a touch up marker and fill crayon. Order **VTOUCHUPKIT**, **\$175** list. Specify finish when ordering.
- Global standard finish, on oak and walnut, is open pore and on cherry and maple is semi-closed pore. If a full finish is required for walnut, cherry, anigre and maple tops, add the suffix **"2"** to the finish code and add 5% to the base pricing for each product. Custom finish on standard veneer is available. Add 15% to the base pricing for each product.
- High Pressure laminate inlays are available at no upcharge. Contact Customer Care for specification information.
- Hanging file rails are pre-installed on file drawer perimeters and accommodate both legal and letter size filing. Legal filing can be achieved either as side-to-side or front-to-back. Letter filing can be achieved as front-to-back filing only.

WORKSURFACE TOP & DRAWER/DOOR FRONTS, BODY FINISHES

(INCLUDING PEDESTALS) - VENEER

Code	Finish	Veneer Type	Cut
AMW	Almond Cherry	Cherry	Flat Sliced
ACW	Amber Cherry	Cherry	Flat Sliced
BTW	Biscotti	White Oak	Rift
CAW	Cocoa Walnut	Walnut	Flat Sliced
CRW	Coral	White Oak	Rift
DCW	Dark Cherry	Cherry	Flat Sliced
DWW	Dark Walnut	Walnut	Flat Sliced
EWW	Espresso Walnut	Walnut	Flat Sliced
EVW	Evening Oak	White Oak	Rift
GRW	Grey on Oak	White Oak	Rift
HAW	Hazelnut	Maple	Flat Sliced
JAW	Java	White Oak	Rift
LTW	Latte Walnut	Walnut	Flat Sliced
MHW	Mahogany on Walnut	Walnut	Flat Sliced
MTW	Milestone	White Oak	Rift
MPW	Natural Maple	Maple	Flat Sliced
NLW	Natural Walnut	Walnut	Flat Sliced
RCW	Red Cherry	Cherry	Flat Sliced
VNW	Vintage Cherry	Cherry	Flat Sliced
ULW	Umber Walnut	Walnut	Flat Sliced
WLW	Walnut	Walnut	Flat Sliced
WCW	Warm Cherry	Cherry	Flat Sliced
WMW	White Maple	Maple	Flat Sliced

EDGES

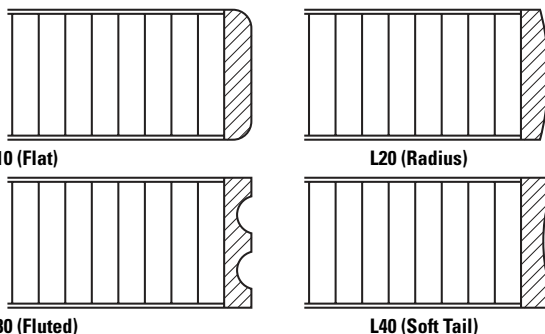

LOCKS

- Locks come standard on all storage beneath worksurface height. Above worksurface height locks are optional.
- For optional lock, specify **L0**. Add **\$143** per lock.

HANDLES

- Handles are standard on most drawers/storage modules. Each handle is identified by letters: **PL33, PL34, PL64, PL66, PL92, PL93, PL94, PL95, PL96, PL97, PL98, PL99, PLS7, and PLS8**. To specify a handle, specify the code after the model number and finish selections.



GROMMETS

- Standard grommet on all components is **GM5P**. Grommet is included with products where shown in line drawings in price book.
- Optional grommets may be ordered in standard worksurface locations (left, center or right). Order as **GM5PTL, GM5PTC or GM5PTR**. Add **\$103**.
- Grommet hole dimensions are 3.5" x 2".
- To order a grommet cover only, specify **GM5EP** for Black or **GM5KP** for Tungsten. Add **\$61**.
- Components that come standard with grommet may be ordered without a grommet. Order as **RSG** - Add **\$57**.

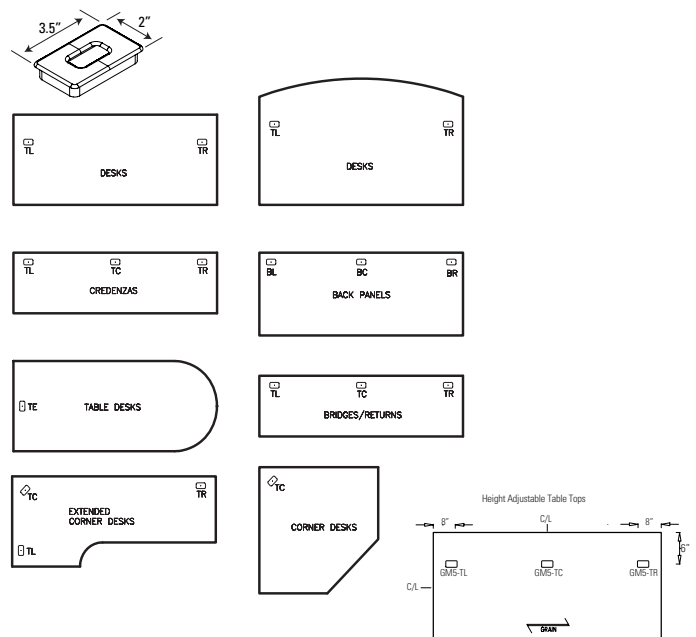

DOUBLE PEDESTAL DESK NOTES

- Can be ordered as a shell or with pedestals.
- Grommets are available as an option on Desks and most Credenzas.
- Hand of Rectangular Desk is determined by location of pedestal from user side.
- Hand of "D" Island is determined by outward orientation of conference end from user projection.

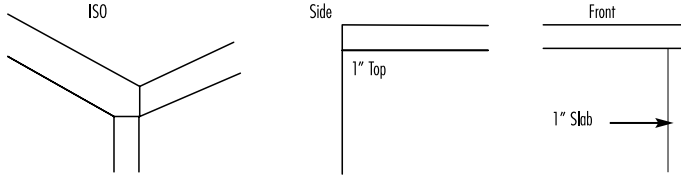

MODESTY PANEL CLEARANCE:

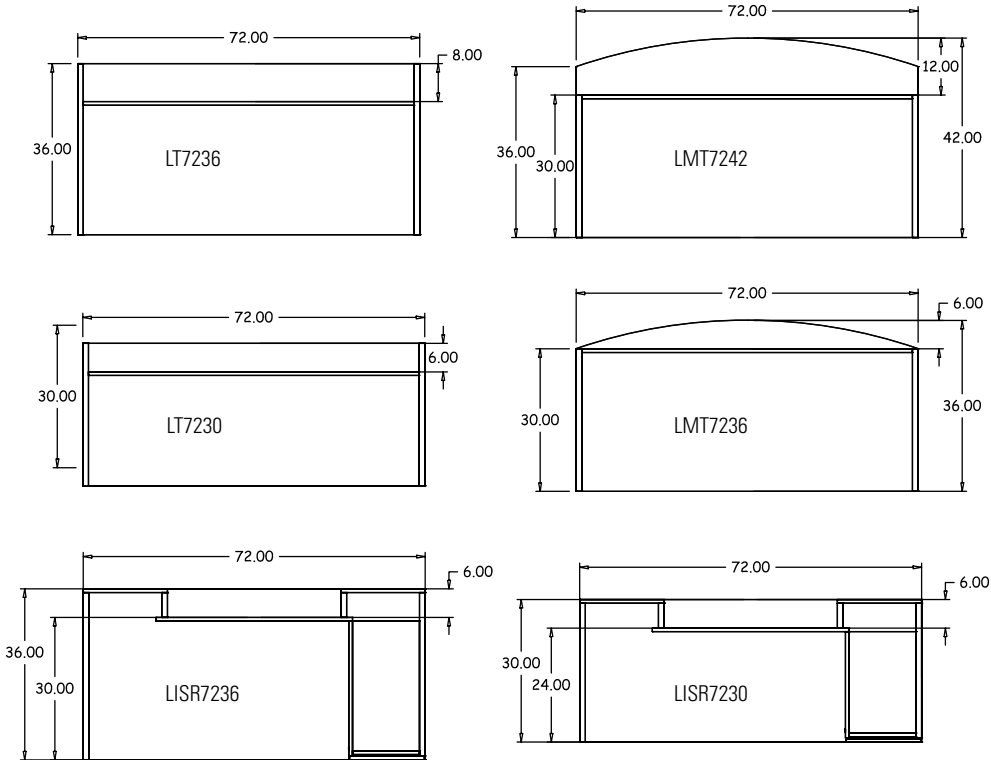

NOTE: Arrow indicates direction of grain.

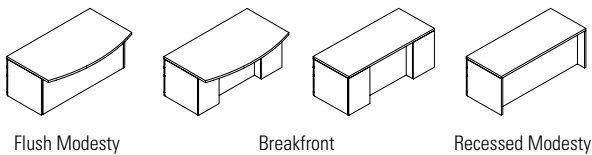
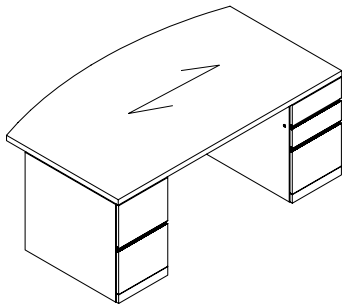

DESK MODESTY OPTIONS:

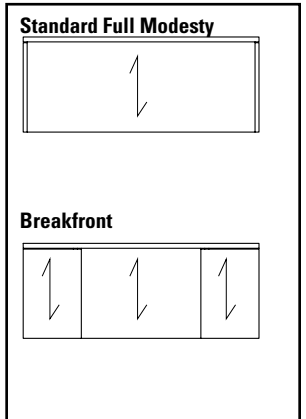

DOUBLE PEDESTAL DESKS - RECESSED FRONT MODESTY MODEL# **DIMENSIONS** **FREIGHT CLASS** **WT/LBS.** **CUBIC FT.** **LIST PRICE**

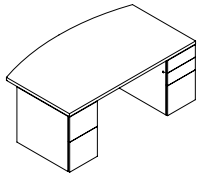

Double Pedestal Bow Top Desk

	D x W x H				
LMD8442ED	42 x 84 x 29	125	443	59	\$7401
LMD7842ED	42 x 78 x 29	125	412	55	\$6876
LMD7242ED	42 x 72 x 29	125	380	51	\$6344
LMD6636ED	36 x 66 x 29	125	240	40	\$6156

Standard with full to floor **file/file** pedestal on **left** and **box/box/file** pedestal on **right**. Bow top. Pedestals lock. One pencil tray. Refer to the Desks and Credenzas Notes Section above for overhang dimensions. Ships assembled in one carton.

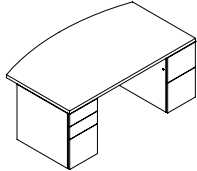

Double Pedestal Bow Top Desk

LMD8442DE	42 x 84 x 29	125	443	59	\$7401
LMD7842DE	42 x 78 x 29	125	412	55	\$6876
LMD7242DE	42 x 72 x 29	125	380	51	\$6344
LMD6636DE	36 x 66 x 29	125	240	40	\$6156

Standard with full to floor **box/box/file** pedestal on **left** and **file/file** pedestal on **right**. Bow top. Pedestals lock. One pencil tray. Refer to the Desks and Credenzas Notes Section on previous page for overhang dimensions. Ships assembled in one carton.

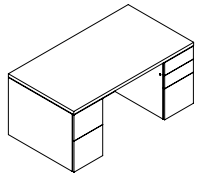

Double Pedestal Desk

LD8436ED	36 x 84 x 29	125	432	59	\$6291
LD7236ED	36 x 72 x 29	100	370	44	\$5394
LD7230ED	30 x 72 x 29	100	349	36	\$5315
LD6636ED	36 x 66 x 29	100	339	40	\$5315
LD6630ED	30 x 66 x 29	100	320	33	\$5230

Standard with full to floor **file/file** pedestal on **left** and **box/box/file** pedestal on **right**. Pedestals lock. Refer to the Desks and Credenzas Notes Section on previous page for overhang dimensions. Ships assembled in one carton.

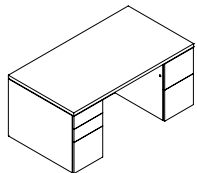

Double Pedestal Desk

LD8436DE	36 x 84 x 29	125	432	59	\$6291
LD7236DE	36 x 72 x 29	100	370	44	\$5394
LD7230DE	30 x 72 x 29	100	349	36	\$5315
LD6636DE	36 x 66 x 29	100	339	40	\$5315
LD6630DE	30 x 66 x 29	100	320	33	\$5230

Standard with full to floor **box/box/file** pedestal on **left** and **file/file** pedestal on **right**. Pedestals lock. Refer to the Desks and Credenzas Notes Section on previous page for overhang dimensions.

DOUBLE PEDESTAL DESKS - BREAKFRONT STYLE **MODEL#** **DIMENSIONS** **FREIGHT CLASS** **WT/LBS.** **CUBIC FT.** **LIST PRICE**

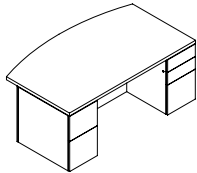

Double Pedestal Bow Top Desk Breakfront Style

LMID8442ED	42 x 84 x 29	125	443	59	\$8278
LMID7842ED	42 x 78 x 29	125	412	55	\$7703
LMID7242ED	42 x 72 x 29	125	380	51	\$7122
LMID6636ED	36 x 66 x 29	125	240	40	\$6856

Standard with full to floor **file/file** pedestal on **left** and **box/box/file** pedestal on **right**. Bow top. Pedestals lock. One pencil tray. Refer to the Desks and Credenzas Notes Section on previous page for overhang dimensions. Ships assembled in one carton.

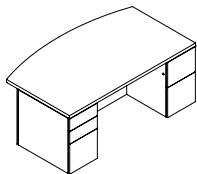

Double Pedestal Bow Top Desk Breakfront Style

LMID8442DE	42 x 84 x 29	125	443	59	\$8278
LMID7842DE	42 x 78 x 29	125	412	55	\$7703
LMID7242DE	42 x 72 x 29	125	380	51	\$7122
LMID6636DE	36 x 66 x 29	125	240	40	\$6856

Standard with full to floor **box/box/file** pedestal on **left** and **file/file** pedestal on **right**. Bow top. Pedestals lock. One pencil tray. Refer to the Desks and Credenzas Notes Section on previous page for overhang dimensions. Ships assembled in one carton.

Required Specifications

Veneer Finish
Edge

Optional Specifications

Grommet

DOUBLE PEDESTAL DESKS - BREAKFRONT STYLE

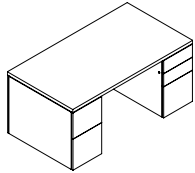

Double Pedestal Desk, Breakfront Style

MODEL#	DIMENSIONS D x W x H	FREIGHT CLASS	WT/LBS.	CUBIC FT.	LIST PRICE
LID8436ED	36 x 84 x 29	125	432	59	\$6496
LID7236ED	36 x 72 x 29	100	370	44	\$6031
LID7230ED	30 x 72 x 29	100	349	36	\$5937
LID6636ED	36 x 66 x 29	100	339	40	\$5937
LID6630ED	30 x 66 x 29	100	320	33	\$5846

Standard with full to floor **file/file** pedestal on **left** and **box/box/file** pedestal on **right**. Pedestals lock. Refer to the Desks and Credenzas Notes Section on previous page for overhang dimensions. Ships assembled in one carton.

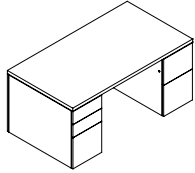

Double Pedestal Desk, Breakfront Style

LID8436DE	36 x 84 x 29	125	432	59	\$6496
LID7236DE	36 x 72 x 29	100	370	44	\$6031
LID7230DE	30 x 72 x 29	100	349	36	\$5937
LID6636DE	36 x 66 x 29	100	339	40	\$5937
LID6630DE	30 x 66 x 29	100	320	33	\$5846

Standard with full to floor **box/box/file** pedestal on **left** and **file/file** pedestal on **right**. Pedestals lock. Refer to the Desks and Credenzas Notes Section on page 274 for overhang dimensions. Ships assembled in one carton.

SINGLE PEDESTAL DESKS

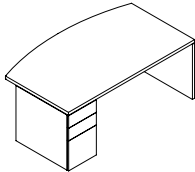

Single Pedestal Bow Top Desk - LEFT

MODEL#	DIMENSIONS	FREIGHT CLASS	WT/LBS.	CUBIC FT.	LIST PRICE
LMSL8442D	42 x 84 x 29	125	432	59	\$7087
LMSL7842D	42 x 78 x 29	125	401	55	\$6577
LMSL7242D	42 x 72 x 29	125	370	51	\$6078
LMSL6636D	36 x 66 x 29	150	230	40	\$5846

Standard with full to floor **box/box/file** pedestal on **left**. Bow top. Pedestal locks. Refer to the Desks and Credenzas Notes Section on page 274 for overhang dimensions. Ships assembled in one carton.

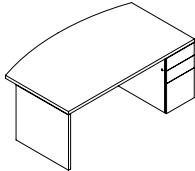

Single Pedestal Bow Top Desk - RIGHT

LMSR8442D	42 x 84 x 29	125	432	59	\$7087
LMSR7842D	42 x 78 x 29	125	401	55	\$6577
LMSR7242D	42 x 72 x 29	125	370	51	\$6078
LMSR6636D	36 x 66 x 29	150	230	40	\$5846

Standard with full to floor **box/box/file** pedestal on **right**. Bow top. Pedestal locks. Refer to the Desks and Credenzas Notes Section on page 274 for overhang dimensions. Ships assembled in one carton.

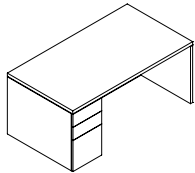

Single Pedestal Desk - LEFT

LSL8436D	42 x 84 x 29	125	463	59	\$4800
LSL7236D	36 x 72 x 29	125	340	44	\$4116
LSL7230D	30 x 72 x 29	125	283	36	\$3930
LSL6636D	36 x 66 x 29	125	312	40	\$3930
LSL6630D	30 x 66 x 29	100	295	33	\$3756

Standard with full to floor **box/box/file** pedestal on **left**. Pedestal locks. Refer to the Desks and Credenzas Notes Section on page 274 for overhang dimensions. Ships assembled in one carton.

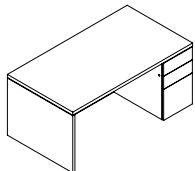

Single Pedestal Desk - RIGHT

LSR8436D	36 x 84 x 29	125	463	59	\$4800
LSR7236D	36 x 72 x 29	125	340	44	\$4116
LSR7230D	30 x 72 x 29	125	283	36	\$3930
LSR6636D	36 x 66 x 29	125	312	40	\$3930
LSR6630D	30 x 66 x 29	100	295	33	\$3756

Standard with full to floor **box/box/file** pedestal on **right**. Pedestal locks. Refer to the Desks and Credenzas Notes Section on page 274 for overhang dimensions. Ships assembled in one carton.

Required Specifications

Veneer Finish
Edge

Optional Specifications

Grommet

ELECTRIC HEIGHT ADJUSTABLE UNITS	MODEL#	DIMENSIONS	FREIGHT CLASS	WT./LBS.	CUBIC FT.	LIST PRICE
		D x W x H				

- All Height Adjustable (HA) units are shipped fully assembled.
- Simple Up / Down function enables the height adjustment of the worksurface.
- The height adjustment range for desks is 29" to 45", for table and bridge top 26" to 43" (including worksurface).
- Single stage HA mechanism with an electric motor in each column is used.
- The height adjustable mechanism operates at 1.5" per second.
- Max. weight / lift is 265 lbs.
- All columns are integrated into fully functional pedestals, or pedestal bases with the exception of the HA table and the HA bridge top.
- Height adjustable bases are available in three colors: **Black (BLK)**, **Tungsten (TUN)**, and **Designer White (DWT)**
- All desks include two (2) PVC wire management channels (L & R side) allowing for cabling through the pedestals.
- Hanging wood modesty panel on desk is standard.
- To avoid risk of pinching:
 - 4.9" / 124mm gap is kept between the pedestal and the lowest point of the worksurface.
 - Wood spacer HASP must be used to attach height adjustable unit in the "U" or "L" configuration. See assembly instructions.
 - 2" gap is required between the worksurfaces when using the HA Table or the HA Bridge Top.
 - Includes collision detector
- Optional grommet locations: **TL** - Top Left or **TR** - Top Right

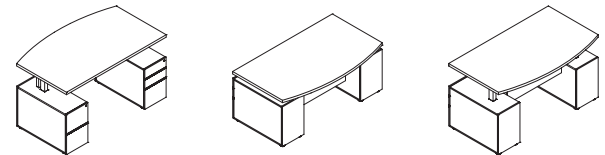
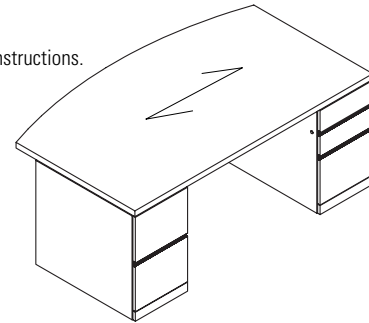

Note: Arrow indicates direction of grain.

HEIGHT ADJUSTABLE DOUBLE PEDESTAL DESKS	MODEL#	DIMENSIONS	FREIGHT CLASS	WT./LBS.	CUBIC FT.	LIST PRICE
		D x W x H				

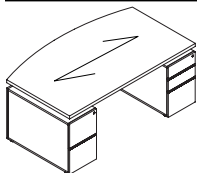

Height Adj. Double Ped. Bow Top Desk Breakfront Style

LHAMID8442ED	42 x 84 x 29	150	450	78	\$14581
LHAMID7842ED	42 x 78 x 29	150	430	72	\$13965
LHAMID7242ED	42 x 72 x 29	150	410	69	\$13349
LHAMID6636ED	36 x 66 x 29	125	390	54	\$12662

Built-in electric height adjustable double pedestal, standard with full to floor **box/box/file** pedestal on **right** and **file/file** pedestal on **left**. Bow top. Pedestals lock. One pencil tray. Refer to the Desks and Credenzas Notes Section on page 274 for overhang dimensions. Shipped RTA - ready to assemble.

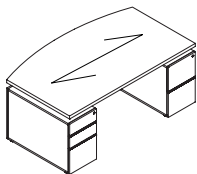

Height Adj. Double Ped. Bow Top Desk Breakfront Style

LHAMID8442DE	42 x 84 x 29	150	450	78	\$14581
LHAMID7842DE	42 x 78 x 29	150	430	72	\$13965
LHAMID7242DE	42 x 72 x 29	150	410	69	\$13349
LHAMID6636DE	36 x 66 x 29	125	390	54	\$12662

Built-in electric height adjustable double pedestal, standard with full to floor **box/box/file** pedestal on **left** and **file/file** pedestal on **right**. Bow top. Pedestals lock. One pencil tray. Refer to the Desks and Credenzas Notes Section on page 274 for overhang dimensions. Shipped RTA - ready to assemble.

Required Specifications

- Top finish
- Edge
- Base finish
- Handle style

Optional Specifications

- Grommet
- Glass modesty

HEIGHT ADJUSTABLE DOUBLE PEDESTAL DESKS

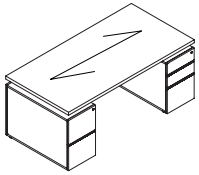

**Height Adj. Double Ped. Desk
Breakfront Style**

MODEL#	DIMENSIONS D x W x H	FREIGHT CLASS	WT/LBS.	CUBIC FT.	LIST PRICE
LHAID8436ED	36 x 84 x 29	125	440	68	\$12415
LHAID7836ED	36 x 78 x 29	125	420	63	\$12332
LHAID7236ED	36 x 72 x 29	125	400	58	\$12243
LHAID7230ED	30 x 72 x 29	125	390	49	\$12152
LHAID6630ED	30 x 66 x 29	100	380	46	\$11983

Built-in electric height adjustable double pedestal, standard with full to floor **box/box/file** pedestal on **right** and **file/file** pedestal on **left**. Pedestals lock. One pencil tray. Refer to the Desks and Credenzas Notes Section on page 274 for overhang dimensions. Shipped RTA - ready to assemble.

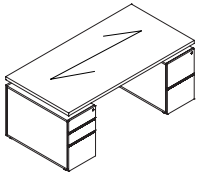

**Height Adj. Double Ped. Desk
Breakfront Style**

LHAID8436DE	36 x 84 x 29	125	440	68	\$12415
LHAID7836DE	36 x 78 x 29	125	420	63	\$12332
LHAID7236DE	36 x 72 x 29	125	400	58	\$12243
LHAID7230DE	30 x 72 x 29	125	390	49	\$12152
LHAID6630DE	30 x 66 x 29	100	380	46	\$11983

Built-in electric height adjustable double pedestal, standard with full to floor **box/box/file** pedestal on **left** and **file/file** pedestal on **right**. Pedestals lock. One pencil tray. Refer to the Desks and Credenzas Notes Section on page 274 for overhang dimensions. Shipped RTA - ready to assemble.

HEIGHT ADJUSTABLE SINGLE PEDESTAL DESKS

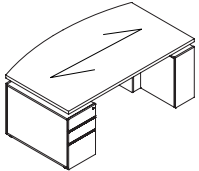

**Height Adj. Single Ped. Bow Top Desk
Breakfront Style - LEFT**

MODEL#	DIMENSIONS	FREIGHT CLASS	WT/LBS.	CUBIC FT.	LIST PRICE
LHAMISL8442D	42 x 84 x 29	150	440	81	\$12787
LHAMISL7842D	42 x 78 x 29	150	420	72	\$12306
LHAMISL7242D	42 x 72 x 29	150	400	67	\$11823
LHAMISL6636D	36 x 66 x 29	125	390	54	\$11220

Built-in electric height adjustable single pedestal bow top desk. Standard with full to floor locking **box/box/file** pedestal on **left** and support pedestal on **right**. Refer to the Desks and Credenzas Notes Section on page 274 for overhang dimensions. Shipped RTA - ready to assemble.

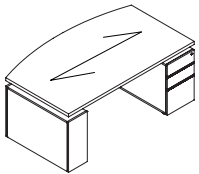

**Height Adj. Single Ped. Bow Top Desk
Breakfront Style - RIGHT**

LHAMISR8442D	42 x 84 x 29	150	440	81	\$12787
LHAMISR7842D	42 x 78 x 29	150	420	72	\$12306
LHAMISR7242D	42 x 72 x 29	150	400	67	\$11823
LHAMISR6636D	36 x 66 x 29	125	390	54	\$11220

Built-in electric height adjustable single pedestal bow top desk. Standard with full to floor locking **box/box/file** pedestal on **right** and support pedestal on **left**. Refer to the Desks and Credenzas Notes Section on page 274 for overhang dimensions. Shipped RTA - ready to assemble.

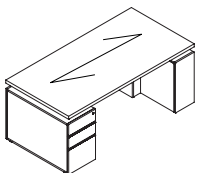

**Height Adjustable Single Ped. Desk
Breakfront Style - LEFT**

LHAISL8436D	36 x 84 x 29	125	430	68	\$10924
LHAISL7836D	36 x 78 x 29	125	410	63	\$10883
LHAISL7236D	36 x 72 x 29	125	390	58	\$10750
LHAISL7230D	30 x 72 x 29	125	380	49	\$10541
LHAISL6630D	30 x 66 x 29	125	360	46	\$10266
LHAISL6030D	30 x 60 x 29	100	340	42	\$10071

Built-in electric height adjustable single pedestal desk. Standard with full to floor locking **box/box/file** pedestal on **left** and support pedestal on **right**. Refer to the Desks and Credenzas Notes Section on page 274 for overhang dimensions. Shipped RTA - ready to assemble.

Required Specifications

Top finish
Edge
Base finish
Handle style

Optional Specifications

Grommet
Glass modesty

HEIGHT ADJUSTABLE SINGLE PEDESTAL DESKS **MODEL#** **DIMENSIONS** **FREIGHT CLASS** **WT./LBS.** **CUBIC FT.** **LIST PRICE**

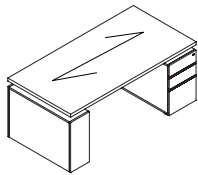

Height Adjustable Single Ped. Desk*
Breakfront Style - RIGHT

	D x W x H					
LHAISR8436D	36 x 84 x 29	125	430	68		\$10924
LHAISR7836D	36 x 78 x 29	125	410	63		\$10883
LHAISR7236D	36 x 72 x 29	125	390	58		\$10750
LHAISR7230D	30 x 72 x 29	125	380	49		\$10541
LHAISR6630D	30 x 66 x 29	125	360	46		\$10266
LHAISR6030D	30 x 60 x 29	100	340	42		\$10071

Built-in electric height adjustable single pedestal desk. Standard with full to floor locking **box/box/file** pedestal on **right** and support pedestal on **left**. Refer to the Desks and Credenzas Notes Section on page 274 for overhang dimensions. Shipped RTA - ready to assemble.

HEIGHT ADJUSTABLE DESK SHELLS **MODEL#** **DIMENSIONS** **FREIGHT CLASS** **WT./LBS.** **CUBIC FT.** **LIST PRICE**

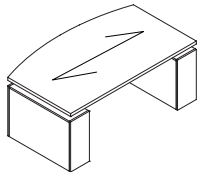

Height Adjustable Bow Top Desk Shell
Breakfront Style

LHAMIT8442	42 x 84 x 29	150	350	81		\$12389
LHAMIT7842	42 x 78 x 29	150	330	72		\$12122
LHAMIT7242	42 x 72 x 29	150	310	67		\$11851
LHAMIT6636	36 x 66 x 29	150	280	54		\$10694

Built-in electric height adjustable bow top desk shell. Refer to the Desks and Credenzas Notes Section on page 274 for overhang dimensions. Shipped RTA - ready to assemble.

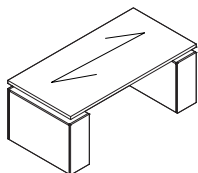

Height Adjustable Desk Shell
Breakfront Style

LHAIT8436	36 x 84 x 29	150	330	68		\$11022
LHAIT7836	36 x 78 x 29	150	310	63		\$10819
LHAIT7236	36 x 72 x 29	150	290	58		\$10602
LHAIT7230	30 x 72 x 29	150	280	49		\$9939
LHAIT6636	36 x 66 x 29	150	260	54		\$10183
LHAIT6630	30 x 66 x 29	150	250	46		\$9939
LHAIT6030	30 x 60 x 29	150	240	42		\$9762

Built-in electric height adjustable desk shell. Refer to the Desks and Credenzas Notes Section on page 274 for overhang dimensions. Shipped RTA - ready to assemble.

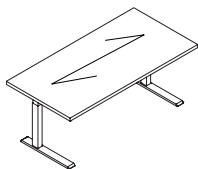

Height Adjustable Table

LHA8436	36 x 84 x 29	250	160	68		\$8921
LHA7836	36 x 78 x 29	250	150	63		\$8720
LHA7236	36 x 72 x 29	250	140	58		\$8501
LHA7230	30 x 72 x 29	250	130	49		\$7835
LHA6636	36 x 66 x 29	250	140	54		\$8081
LHA6630	30 x 66 x 29	250	120	46		\$7835
LHA6030	30 x 60 x 29	250	115	42		\$7661

Electric height adjustable table. Shipped RTA - ready to assemble.

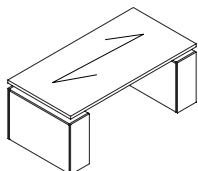

Height Adjustable Desk

LHA8436TP	36 x 84 x 29	150	320	68		\$10673
LHA7836TP	36 x 78 x 29	150	300	63		\$10469
LHA7236TP	36 x 72 x 29	150	280	58		\$10253
LHA7230TP	30 x 72 x 29	150	270	49		\$9587
LHA6636TP	36 x 66 x 29	150	250	54		\$9834
LHA6630TP	30 x 66 x 29	150	240	46		\$9587
LHA6030TP	30 x 60 x 29	150	230	42		\$9412

Built-in electric height adjustable desk on TP bases. Shipped RTA - ready to assemble.

Required Specifications

Top finish
Edge
Base finish
Handle style*

Optional Specifications

Grommet
Glass modesty

HEIGHT ADJUSTABLE UNITS

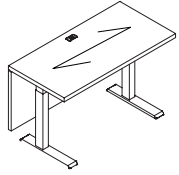

Height Adjustable Bridge Top

MODEL#	DIMENSIONS D x W x H	FREIGHT CLASS	WT/LBS.	CUBIC FT.	LIST PRICE
LHABT6024	24 x 60 x 29	150	150	35	\$8313
LHABT5424	24 x 54 x 29	150	140	31	\$8067
LHABT4824	24 x 48 x 29	150	130	28	\$7821
LHABT4224	24 x 42 x 29	150	120	26	\$7567

Electric height adjustable executive bridge top. Grommet in worksurface. Shipped RTA - ready to assemble.

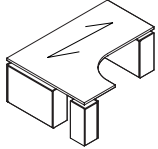

Height Adj. Right Extended Corner Desk*

LHAEKR60842436	24-36 x 60-84 x 29	150	450	108	\$16528
LHAEKR60782436	24-36 x 60-78 x 29	150	430	100	\$16488
LHAEKR60722436	24-36 x 60-72 x 29	150	410	93	\$16124
LHAEKR60662436	24-36 x 60-66 x 29	150	390	86	\$15654
LHAEKR60602436	24-36 x 60-60 x 29	150	370	79	\$15185

Built-in electric height adjustable right extended corner table desk with a 24" return connection. Extended worksurface on **right. Full end panel on right, narrow end panel on left.** Connects to Linking Bridges, Extended Corners and Connectable Tables. Shipped RTA - ready to assemble.

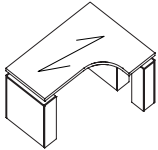

Height Adj. Left Extended Corner Desk*

LHAEKL84603624	24-36 x 60-84 x 29	150	450	108	\$16528
LHAEKL78603624	24-36 x 60-78 x 29	150	430	100	\$16488
LHAEKL72603624	24-36 x 60-72 x 29	150	410	93	\$16124
LHAEKL66603624	24-36 x 60-66 x 29	150	390	86	\$15654
LHAEKL60603624	24-36 x 60-60 x 29	150	370	79	\$15185

Built-in electric height adjustable right extended corner table desk with a 24" return connection. Extended worksurface on **left. Full end panel on left, narrow end panel on right.** Connects to Linking Bridges, Extended Corners and Connectable Tables. Shipped RTA - ready to assemble.



Spacer

LHASP	2 x 8 x 23	70	15	.75	\$598
-------	------------	----	----	-----	--------------

Connects height adjustable desks with linking bridges and returns.

Required Specifications

Top finish
Edge
Base finish

Optional Specifications

Grommet*
Glass modesty

HEIGHT ADJUSTABLE TOPS

MODEL# DIMENSIONS FREIGHT CLASS WT/LBS. CUBIC FT. LIST PRICE

D x W x H

LRE8223T	23 x 82 x 1.18	92.5	82	7	\$1760
LRE7623T	23 x 76 x 1.18	92.5	77	6.5	\$1631
LRE7023T	23 x 70 x 1.18	85	72	6	\$1507
LRE6423T	23 x 64 x 1.18	85	66	5.5	\$1372
LRE5223T	23 x 52 x 1.18	85	56	4.5	\$1114
LRE4623T	23 x 46 x 1.18	85	50	4	\$991
LRE4023T	23 x 40 x 1.18	85	45	3.5	\$862
LRE8229T	29 x 82 x 1.18	85	101	8	\$2222
LRE7629T	29 x 76 x 1.18	85	94	7.5	\$2061
LRE7029T	29 x 70 x 1.18	85	88	7	\$1894
LRE6429T	29 x 64 x 1.18	85	81	6.5	\$1733
LRE5229T	29 x 52 x 1.18	85	68	5.5	\$1411
LRE4629T	29 x 46 x 1.18	85	61	5	\$1249
LRE4029T	29 x 40 x 1.18	85	55	4.5	\$1083
LRE8235T	35 x 82 x 1.18	85	120	10	\$2680
LRE7635T	35 x 76 x 1.18	85	112	9	\$2486
LRE7235T	35 x 72 x 1.18	85	104	8.5	\$2357
LRE6435T	35 x 64 x 1.18	85	96	8	\$2093
LRE5235T	35 x 52 x 1.18	85	80	6.5	\$1700
LRE4635T	35 x 46 x 1.18	85	72	6	\$1507
LRE4035T	35 x 40 x 1.18	85	64	5	\$1308

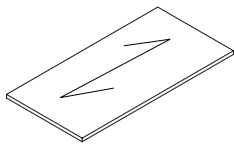

Height Adjustable Top

Lufton tops with Lufton edge on three sides, for use with FreeFit height adjustable table mechanisms, sold separately (FTxxxxx, see page 713 of the Desking price list for information).

- 23" deep tops accommodate FTxxxx24 mechanisms. Depth is exact to accommodate the Lufton edge + the Freefit mechanism. *Cannot be made smaller.*
- 29" and 35" deep tops accommodate FTxxxx30 mechanisms.

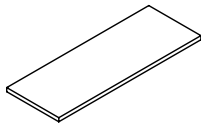

HA Return Top

LRE6024CGT	24 x 60 x 1.18	300	10	5.5	\$1346
LRE5424CGT	24 x 54 x 1.18	250	10	5	\$1211
LRE4824CGT	24 x 48 x 1.18	250	10	4.5	\$1077
LRE4224CGT	24 x 42 x 1.18	250	10	4	\$942

Lufton return tops with Lufton edge on three sides, for use with FreeFit height adjustable table mechanisms, sold separately (FTxxxxx, see page 713 of the Desking price list for information).

Required Specifications

Veneer finish
Edge

Optional Specifications

Grommet

MODESTY PANEL OPTIONS

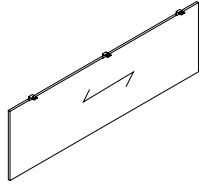

Veneer Modesty Panel Upgrade*

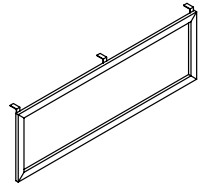

Glass Modesty Panel Upgrade

MODEL#	DIMENSIONS D x W x H	FREIGHT CLASS	WT/LBS.	CUBIC FT.	LIST PRICE
CMP72W	0.75 x 67 x 18	--	20	1	\$1728
CMP66W	0.75 x 61 x 18	--	18	1	\$1673
CMP60W	0.75 x 55 x 18	--	16	1	\$1647
CMP54W	0.75 x 49 x 18	--	14	1	\$1619
CMP48W	0.75 x 43 x 18	--	13	1	\$1594

Straight modesty panel. Attaches to underside of worksurface. **Can not be retrofitted in the field *Not sold individually - to be ordered as an upgrade option only.***

- CMP72W - Specify on "P" Top Islands or 96" x 48" Islands for Piano Desks.
- CMP66W - Specify on 84" x 36" "D" Top Islands.
- CMP60W - Specify on 84" x 42" "P" Top Islands or 84" x 48" Islands for Piano Desks.
- CMP54W - Specify on 72" x 30" "D" Top Islands.
- CMP48W - Specify on 66" x 36" , 60" x 30" "D" Top Islands, 72" x 42" "P" Top Islands or 72" x 48" Islands for Piano Desks.

CMP72G	0.75 x 67 x 18	--	20	1	\$2647
CMP66G	0.75 x 61 x 18	--	18	1	\$2504
CMP60G	0.75 x 55 x 18	--	16	1	\$2289
CMP54G	0.75 x 49 x 18	--	14	1	\$2132
CMP48G	0.75 x 43 x 18	--	13	1	\$2036

Straight modesty panel. Translucent, screened glass. Aluminum box frame construction in Tungsten Only. Attaches to underside of worksurface. **Can not be retrofitted in the field. *Not sold individually - to be ordered as an upgrade option only.***

- CMP72G - Specify on "P" Top Islands or 96" x 48" Islands for Piano Desks.
- CMP66G - Specify on 84" x 36" "D" Top Islands.
- CMP60G - Specify on 84" x 42" "P" Top Islands or 84" x 48" Islands for Piano Desks.
- CMP54G - Specify on 72" x 30" "D" Top Islands.
- CMP48G - Specify on 66" x 36" , 60" x 30" "D" Top Islands, 72" x 42" "P" Top Islands or 72" x 48" Islands for Piano Desks.
- Tungsten finish on the aluminum box frame closely resembles the existing Tungsten finish.

Required Specifications

Veneer finish
Edge
Handle style

Optional Specifications

Grommet

SINGLE PEDESTAL DESKS - BREAKFRONT STYLE **MODEL#** **DIMENSIONS** **FREIGHT CLASS** **WT/LBS.** **CUBIC FT.** **LIST PRICE**

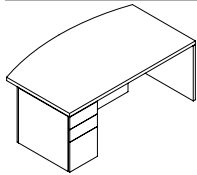

Single Pedestal Bow Top Desk - LEFT Breakfront Style*

	D x W x H					
LMISL8442D	42 x 84 x 29	125	432	59		\$7232
LMISL7842D	42 x 78 x 29	125	401	55		\$6724
LMISL7242D	42 x 72 x 29	125	370	51		\$6228
LMISL6636D	36 x 66 x 29	150	230	40		\$5937

Standard with full to floor **box/box/file** pedestal on **left**. Bow top. Pedestal locks. Refer to the Desks and Credenzas Notes Section on page 274 for overhang dimensions. Ships assembled in 1 carton.

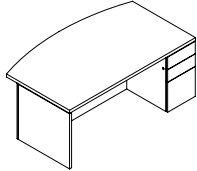

Single Pedestal Bow Top Desk - RIGHT Breakfront Style*

LMISR8442D	42 x 84 x 29	125	432	59		\$7232
LMISR7842D	42 x 78 x 29	125	401	55		\$6724
LMISR7242D	42 x 72 x 29	125	370	51		\$6228
LMISR6636D	36 x 66 x 29	150	230	40		\$5937

Standard with full to floor **box/box/file** pedestal on **right**. Bow top. Pedestal locks. Refer to the Desks and Credenzas Notes Section on page 274 for overhang dimensions. Ships assembled in 1 carton.

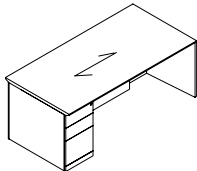

Single Pedestal Desk - LEFT Breakfront Style

LISL8436D	36 x 84 x 29	125	463	59		\$6308
LISL7236D	36 x 72 x 29	125	340	44		\$5373
LISL7230D	30 x 72 x 29	125	283	36		\$4423
LISL6636D	36 x 66 x 29	125	312	40		\$4423
LISL6630D	30 x 66 x 29	100	295	33		\$4225

Standard with full to floor **box/box/file** pedestal on **left**. Pedestal locks. Refer to the Desks and Credenzas Notes Section on page 274 for overhang dimensions. Ships assembled in 1 carton.

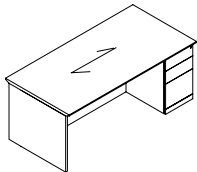

Single Pedestal Desk - RIGHT Breakfront Style

LISR8436D	42 x 84 x 29	125	463	59		\$6308
LISR7236D	36 x 72 x 29	125	340	44		\$5373
LISR7230D	30 x 72 x 29	125	283	36		\$4423
LISR6636D	36 x 66 x 29	125	312	40		\$4423
LISR6630D	30 x 66 x 29	100	295	33		\$4225

Standard with full to floor **box/box/file** pedestal on **right**. Pedestal locks. Refer to the Desks and Credenzas Notes Section on page 274 for overhang dimensions. Ships assembled in 1 carton.

Required Specifications

Veneer Finish
Laminate Finish
Handle Style

Optional Specifications

Grommet

DESK SHELLS

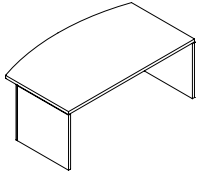

Bow Top Desk Shell

MODEL#	DIMENSIONS	FREIGHT CLASS	WT/LBS.	CUBIC FT.	LIST PRICE
LMT8442	42 x 84 x 29	125	380	59	\$5447
LMT7842	42 x 78 x 29	125	353	55	\$5053
LMT7242	42 x 72 x 29	125	331	51	\$4677
LMT6636	36 x 66 x 29	125	287	40	\$4450

Bow top and recessed modesty panel. Refer to the Desks and Credenzas Notes Section on page 274 for overhang dimensions. Ships assembled in 1 carton.

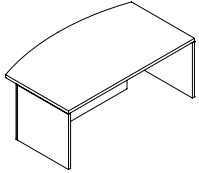

Bow Top Desk Shell, Breakfront Style

LMIT8442	42 x 84 x 29	125	380	59	\$5596
LMIT7842	42 x 78 x 29	125	353	55	\$5274
LMIT7242	42 x 72 x 29	125	331	51	\$4954
LMIT6636	36 x 66 x 29	125	287	40	\$4774

Bow top and recessed modesty panel. Refer to the Desks and Credenzas Notes Section on page 274 for overhang dimensions. Ships assembled in 1 carton.

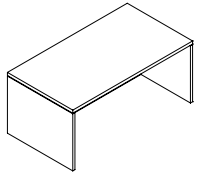

Desk Shell

LT8436	36 x 84 x 29	150	362	51	\$3918
LT7236	36 x 72 x 29	125	315	44	\$3726
LT7230	30 x 72 x 29	125	271	36	\$3512
LT6636	36 x 66 x 29	100	271	40	\$3512
LT6630	30 x 66 x 29	100	265	33	\$3291

Recessed modesty panel. Refer to the Desks and Credenzas Notes Section on page 274 for overhang dimensions. Ships assembled in 1 carton.

Required Specifications

Veneer Finish
Edge

Optional Specifications

Grommet

RETURNS	MODEL#	DIMENSIONS	FREIGHT CLASS	WT/LBS.	CUBIC FT.	LIST PRICE
---------	--------	------------	---------------	---------	-----------	------------

D x W x H

- An Executive Return is used to attach to a Single Pedestal Desk, Single Pedestal Credenza, Desk Shell or Credenza Shell.
- Grommets are available as an option.
- Hand of Executive Return is determined by location of full end panel from user side.
- Hand of Desk or Credenza is determined by location of pedestal from user side.
- To remove cross grain veneer pattern on top, delete suffix "CG" from the model number. Available as a special - no upcharge.

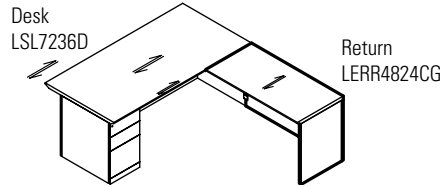
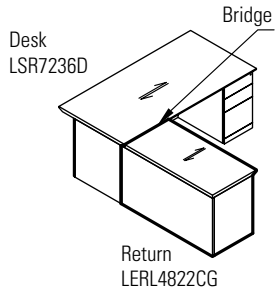

RETURNS	MODEL#	DIMENSIONS	FREIGHT CLASS	WT/LBS.	CUBIC FT.	LIST PRICE
---------	--------	------------	---------------	---------	-----------	------------

D x W x H

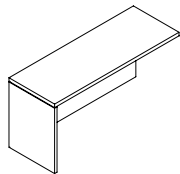

Flush Return - LEFT 24" Deep

LERL7224CG	24 x 72 x 29	150	135	29	\$2856
LERL6624CG	24 x 66 x 29	150	127	27	\$2668
LERL6024CG	24 x 60 x 29	150	120	24	\$2474
LERL5424CG	24 x 54 x 29	150	112	22	\$2289
LERL4824CG	24 x 48 x 29	150	105	19	\$2097
LERL4224CG	24 x 42 x 29	150	97	17	\$1904

Return has **no pedestal**. For use with right handed single pedestal desks, credenzas, desk shells, credenza shells, "D" islands or "P" islands.

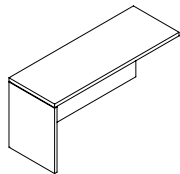

Flush Return - LEFT 20" Deep

LERL7220CG	20 x 72 x 29	150	130	27	\$2074
LERL6620CG	20 x 66 x 29	150	122	24	\$1904
LERL6020CG	20 x 60 x 29	150	115	22	\$1730
LERL5420CG	20 x 54 x 29	150	105	20	\$1562
LERL4820CG	20 x 48 x 29	150	100	18	\$1387
LERL4220CG	20 x 42 x 29	150	90	16	\$1217

Return has **no pedestal**. For use with right handed single pedestal desks, credenzas, desk shells, credenza shells, "D" islands or "P" islands.

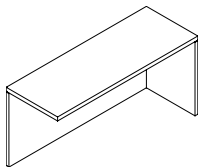

Flush Return - RIGHT 24" Deep

LERR7224CG	24 x 72 x 29	150	135	29	\$2856
LERR6624CG	24 x 66 x 29	150	127	27	\$2668
LERR6024CG	24 x 60 x 29	150	120	24	\$2474
LERR5424CG	24 x 54 x 29	150	112	22	\$2289
LERR4824CG	24 x 48 x 29	150	105	19	\$2097
LERR4224CG	24 x 42 x 29	150	97	17	\$1904

Return has **no pedestal**. For use with left handed single pedestal desks, credenzas, desk shells, credenza shells, "D" islands or "P" islands.

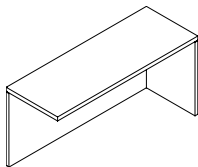

Flush Return - RIGHT 20" Deep

LERR7220CG	20 x 72 x 29	150	130	27	\$2074
LERR6620CG	20 x 66 x 29	150	122	24	\$1904
LERR6020CG	20 x 60 x 29	150	115	22	\$1730
LERR5420CG	20 x 54 x 29	150	105	20	\$1562
LERR4820CG	20 x 48 x 29	150	100	18	\$1387
LERR4220CG	20 x 42 x 29	150	90	16	\$1217

Return has **no pedestal**. For use with left handed single pedestal desks, credenzas, desk shells, credenza shells, "D" islands or "P" islands.

Required Specifications

Veneer Finish
Edge

Optional Specifications

Grommet

RETURNS

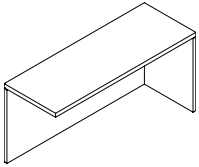

Non-Handed Return

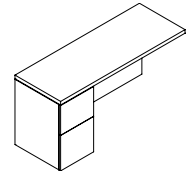

Flush Return - LEFT 24" Deep

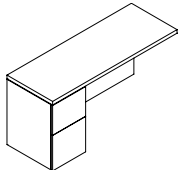

Flush Return - LEFT 20" Deep

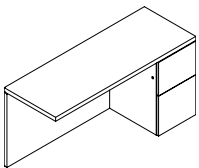

Flush Return - RIGHT 24" Deep

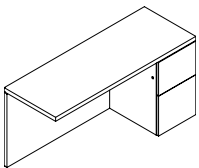

Flush Return - RIGHT 20" Deep

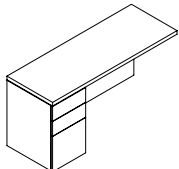

Flush Return - LEFT 24" Deep

MODEL#	DIMENSIONS D x W x H	FREIGHT CLASS	WT/LBS.	CUBIC FT.	LIST PRICE
LERR-L4824CG	24 x 48 x 29	150	105	19	\$2723
LERR-L4224CG	24 x 42 x 29	150	97	17	\$2464
LERR-L4820CG	20 x 48 x 29	150	100	19	\$1804
LERR-L4220CG	20 x 42 x 29	150	90	17	\$1580

Return has **no pedestal**. For use with left or right handed single pedestal desks, credenzas, desk shells, credenza shells, "D" islands or "P" islands. Ships assembled in 1 carton.

LERL7224ECG	24 x 72 x 29	100	250	29	\$4765
LERL6624ECG	24 x 66 x 29	100	236	27	\$4608
LERL6024ECG	24 x 60 x 29	100	227	24	\$4232
LERL5424ECG	24 x 54 x 29	100	205	22	\$4092
LERL4824ECG	24 x 48 x 29	100	185	19	\$3688
LERL4224ECG	24 x 42 x 29	92.5	178	17	\$3565

Return has **file/file** pedestal on the **left**. Pedestal locks. For use with right handed single pedestal desks, credenzas, desk shells, credenza shells, "D" islands or "P" islands. Ships assembled in 1 carton.

LERL7220ECG	20 x 72 x 29	100	240	29	\$3696
LERL6620ECG	20 x 66 x 29	100	231	27	\$3560
LERL6020ECG	20 x 60 x 29	100	222	24	\$3236
LERL5420ECG	20 x 54 x 29	100	200	22	\$3120
LERL4820ECG	20 x 48 x 29	100	180	18	\$2779
LERL4220ECG	20 x 42 x 29	92.5	173	16	\$2668

Return has **file/file** pedestal on the **left**. Pedestal locks. For use with right handed single pedestal desks, credenzas, desk shells, credenza shells, "D" islands or "P" islands. Ships assembled in 1 carton.

LERR7224ECG	24 x 72 x 29	100	250	29	\$4765
LERR6624ECG	24 x 66 x 29	100	236	27	\$4608
LERR6024ECG	24 x 60 x 29	100	227	24	\$4232
LERR5424ECG	24 x 54 x 29	100	205	22	\$4092
LERR4824ECG	24 x 48 x 29	100	185	19	\$3688
LERR4224ECG	24 x 42 x 29	92.5	178	17	\$3565

Return has **file/file** pedestal on the **right**. Pedestal locks. For use with left handed single pedestal desks, credenzas, desk shells, credenza shells, "D" islands or "P" islands. Ships assembled in 1 carton.

LERR7220ECG	20 x 72 x 29	100	240	29	\$3696
LERR6620ECG	20 x 66 x 29	100	231	27	\$3560
LERR6020ECG	20 x 60 x 29	100	222	24	\$3236
LERR5420ECG	20 x 54 x 29	100	200	22	\$3120
LERR4820ECG	20 x 48 x 29	100	180	18	\$2779
LERR4220ECG	20 x 42 x 29	92.5	173	16	\$2668

Return has **file/file** pedestal on the **right**. Pedestal locks. For use with left handed single pedestal desks, credenzas, desk shells, credenza shells, "D" islands or "P" islands. Ships assembled in 1 carton.

LERL7224DCG	24 x 72 x 29	100	250	29	\$4765
LERL6624DCG	24 x 66 x 29	100	236	27	\$4608
LERL6024DCG	24 x 60 x 29	100	227	24	\$4232
LERL5424DCG	24 x 54 x 29	100	205	22	\$4092
LERL4824DCG	24 x 48 x 29	100	185	19	\$3688
LERL4224DCG	24 x 42 x 29	92.5	178	17	\$3565

Return has **box/box/file** pedestal on the **left**. Pedestal locks. For use with right handed single pedestal desks, credenzas, desk shells, credenza shells, "D" islands or "P" islands. Ships assembled in 1 carton.

Required Specifications

Veneer Finish
Edge

Optional Specifications

Grommet

RETURNS

MODEL#	DIMENSIONS D x W x H	FREIGHT CLASS	WT./LBS.	CUBIC FT.	LIST PRICE
LERL7220DCG	20 x 72 x 29	100	240	27	\$3696
LERL6620DCG	20 x 66 x 29	100	231	24	\$3560
LERL6020DCG	20 x 60 x 29	100	222	22	\$3236
LERL5420DCG	20 x 54 x 29	100	200	20	\$3120
LERL4820DCG	20 x 48 x 29	100	180	18	\$2779
LERL4220DCG	20 x 42 x 29	92.5	173	16	\$2668

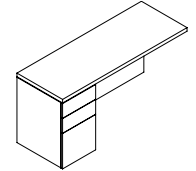

Flush Return - LEFT 20" Deep

Return has **box/box/file** pedestal on the **left**. Pedestal locks. For use with right handed single pedestal desks, credenzas, desk shells, credenza shells, "D" islands or "P" islands. Ships assembled in 1 carton.

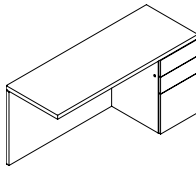

Flush Return - RIGHT 24" Deep

LERR7224DCG	24 x 72 x 29	100	250	29	\$4765
LERR6624DCG	24 x 66 x 29	100	236	27	\$4608
LERR6024DCG	24 x 60 x 29	100	227	24	\$4232
LERR5424DCG	24 x 54 x 29	100	205	22	\$4092
LERR4824DCG	24 x 48 x 29	100	185	19	\$3688
LERR4224DCG	24 x 42 x 29	92.5	178	17	\$3565

Return has **box/box/file** pedestal on the **right**. Pedestal locks. For use with left handed single pedestal desks, credenzas, desk shells, credenza shells, "D" islands or "P" islands. Ships assembled in 1 carton.

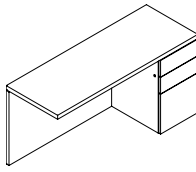

Flush Return - RIGHT 20" Deep

LERR7220DCG	20 x 72 x 29	100	240	27	\$3696
LERR6620DCG	20 x 66 x 29	100	231	24	\$3560
LERR6020DCG	20 x 60 x 29	100	222	22	\$3236
LERR5420DCG	20 x 54 x 29	100	200	20	\$3120
LERR4820DCG	20 x 48 x 29	100	180	18	\$2779
LERR4220DCG	20 x 42 x 29	92.5	173	16	\$2668

Return has **box/box/file** pedestal on the **right**. Pedestal locks. For use with left handed single pedestal desks, credenzas, desk shells, credenza shells, "D" islands or "P" islands. Ships assembled in 1 carton.

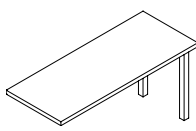

Return

LR8430CG	30 x 84 x 29	150	130	29	\$2074
LR7230CG	30 x 72 x 29	150	122	27	\$1832
LR6630CG	30 x 66 x 29	150	115	24	\$1726
LR6030CG	30 x 60 x 29	150	105	22	\$1608

Return has **no pedestal**. For use with single pedestal desks, credenzas, desk shells, credenza shells, "D" islands or "P" islands. Shipped RTA - ready to assemble.

BRIDGES - EXECUTIVE

- An Executive Bridge is used to connect a Desk to a Credenza.
- Not to be used with Corner Components or Piano Desks,
- Three Modesty Panel options - Full Modesty, 8" Modesty and No Modesty (Flush Bridge Top).
- Modesty panel flush with end panels of Desk and Credenza.
- Includes GM1 grommet in the top center position.
- Both connecting sides of executive bridges feature a reverse profile edge

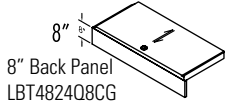
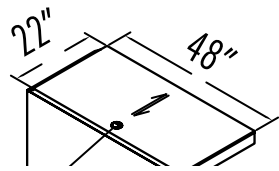
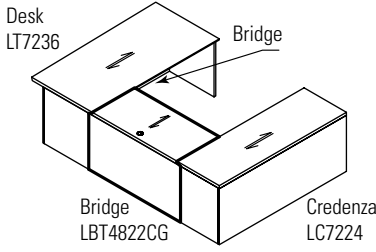

Required Specifications
Veneer Finish
Edge

Optional Specifications
Grommet

BRIDGES - LINKING

MODEL#

DIMENSIONS

FREIGHT CLASS

WT/LBS.

CUBIC FT.

LIST PRICE

D x W x H

- A linking bridge is used to connect corner components to a single pedestal desk, HA desk, single pedestal credenza, desk shell or credenza shell.
- When connecting HA desk, must specify LHASP spacer.
- Two modesty panel options - full modesty and 8" modesty.
- Includes GM1 grommet in the top center position.
- Hand of linking bridge is determined by location of half end panel from user side.
- Linking bridges are handed **left and right** (handedness is determined by connecting side with the self edge). The opposite connecting side features a reverse profile edge.

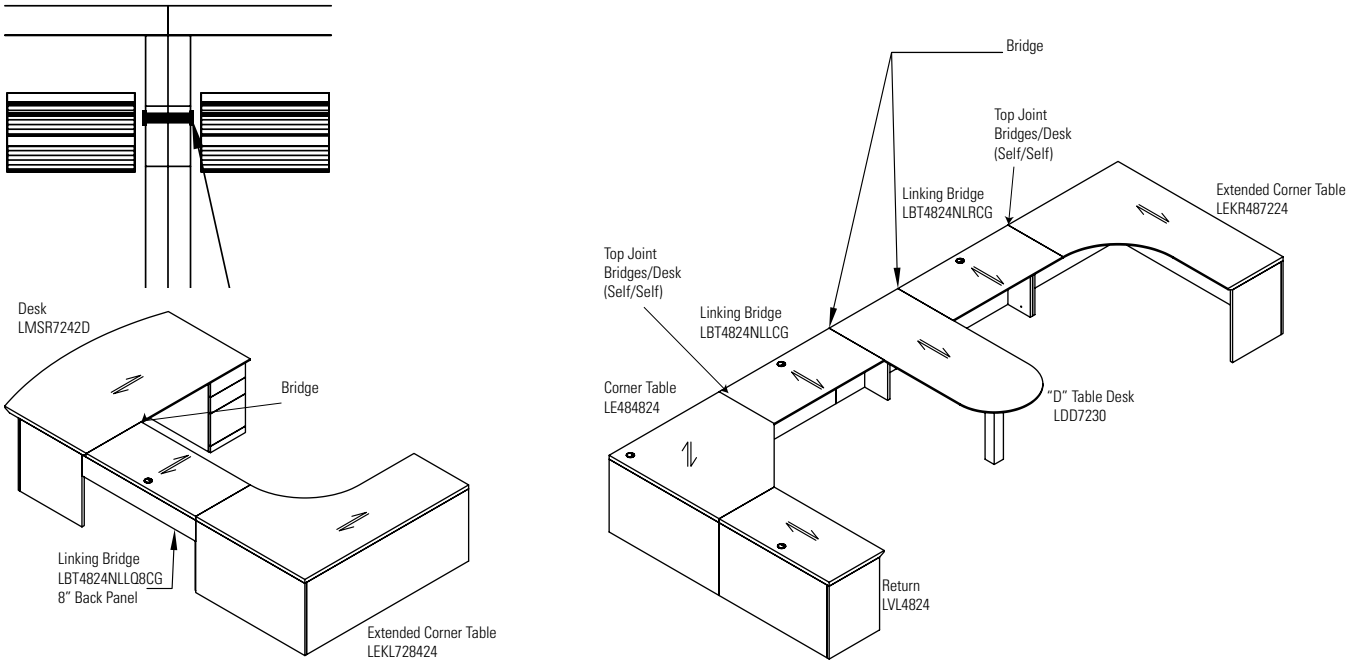

BRIDGES

MODEL#

DIMENSIONS

FREIGHT CLASS

WT/LBS.

CUBIC FT.

LIST PRICE

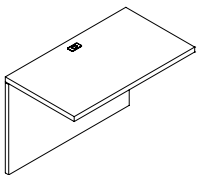

Flush Bridge

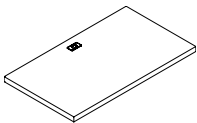

Flush Bridge Top

LBT6024CG	24 x 60 x 29	85	144	10	\$2018
LBT5424CG	24 x 54 x 29	85	129	9	\$1816
LBT4824CG	24 x 48 x 29	70	120	8	\$1619
LBT4224CG	24 x 42 x 29	70	105	7	\$1416
LBT6020CG	20 x 60 x 29	70	131	8	\$1660
LBT5420CG	20 x 54 x 29	85	118	8	\$1494
LBT4820CG	20 x 48 x 29	70	110	7	\$1324
LBT4220CG	20 x 42 x 29	70	96	6	\$1137

Top surface, back panel and hardware to create a "U" configuration with a single pedestal desk or credenza. **Cannot be used with corners.** Grommet in worksurface. Ships assembled in 1 carton.

- If linking to bookcase or open storage, add **/S** to end of model number

LBT5424TCG	24 x 54 x --	85	129	9	\$1422
LBT4824TCG	24 x 48 x --	70	120	8	\$1280
LBT4224TCG	24 x 42 x --	70	105	7	\$1125
LBT5420TCG	20 x 54 x --	85	118	8	\$1046
LBT4820TCG	20 x 48 x --	70	110	7	\$932
LBT4220TCG	20 x 42 x --	70	96	6	\$794

Top surface only to create a "U" configuration with a single pedestal desk or credenza. **Cannot be used with corners.** Grommet in worksurface. Ships assembled in 1 carton.

- If linking to bookcase or open storage, add **/S** to end of model number

Required Specifications

Veneer Finish
Edge

Optional Specifications

Grommet

BRIDGES **MODEL#** **DIMENSIONS** **FREIGHT CLASS** **WT/LBS.** **CUBIC FT.** **LIST PRICE**

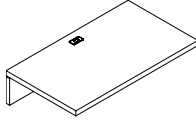

Flush Bridge Top, 8" Modesty Panel

	D x W x H					
LBT6024Q8CG	24 x 60 x --	85	144	10		\$1812
LBT5424Q8CG	24 x 54 x --	85	129	9		\$1641
LBT4824Q8CG	24 x 48 x --	70	120	8		\$1458
LBT4224Q8CG	24 x 42 x --	70	105	7		\$1274
LBT6020Q8CG	20 x 60 x --	70	131	8		\$1494
LBT5420Q8CG	20 x 54 x --	85	118	8		\$1342
LBT4820Q8CG	20 x 48 x --	70	110	7		\$1194
LBT4220Q8CG	20 x 42 x --	70	96	6		\$1022

Top surface with 8" modesty panel for utility access. Create a "U" configuration with a single pedestal desk or credenza. **Cannot be used with corners.** Grommet in worksurface. Ships assembled in 1 carton.

- If linking to bookcase or open storage, add **/S** to end of model number

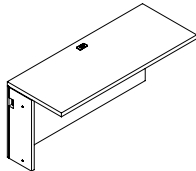

Linking Bridge - LEFT

LBT6024NLLCG	24 x 60 x 29	125	145	24	2002	
LBT5424NLLCG	24 x 54 x 29	150	131	22		\$1799
LBT4824NLLCG	24 x 48 x 29	125	116	19		\$1600
LBT4224NLLCG	24 x 42 x 29	125	102	17		\$1298
LBT3624NLLCG	24 x 36 x 29	150	87	15		\$1181
LBT3024NLLCG	24 x 30 x 29	125	73	12		\$1148
LBT6020NLLCG	22 x 60 x 29	150	131	22		\$1816
LBT5420NLLCG	22 x 54 x 29	150	118	20		\$1634
LBT4820NLLCG	22 x 48 x 29	125	110	18	1458	
LBT4220NLLCG	22 x 42 x 29	150	95	16	1181	
LBT3620NLLCG	22 x 36 x 29	125	80	13	1073	
LBT3020NLLCG	22 x 30 x 29	150	65	11	1046	

Top surface, back panel and hardware. **Left side** connects to a 5-Sided Corner, Extended Corner or Connectable Table. Right side connects to a single pedestal desk or credenza, "D" island, Boat shaped island, "P" island and Delta island with a "T" base. Grommet in worksurface. Ships assembled in 1 carton.

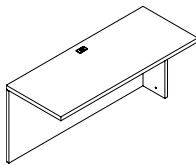

Linking Bridge - RIGHT

LBT6024NLR CG	24 x 60 x 29	125	145	24		\$2002
LBT5424NLR CG	24 x 54 x 29	150	131	22		\$1799
LBT4824NLR CG	24 x 48 x 29	125	116	19		\$1600
LBT4224NLR CG	24 x 42 x 29	125	102	17		\$1298
LBT3624NLR CG	24 x 36 x 29	150	87	15		\$1181
LBT3024NLR CG	24 x 30 x 29	125	73	12		\$1148
LBT6020NLR CG	22 x 60 x 29	150	131	22		\$1816
LBT5420NLR CG	22 x 54 x 29	150	118	20		\$1634
LBT4820NLR CG	22 x 48 x 29	125	110	18		\$1458
LBT4220NLR CG	22 x 42 x 29	150	95	16		\$1181
LBT3620NLR CG	22 x 36 x 29	125	80	13		\$1073
LBT3020NLR CG	22 x 30 x 29	150	65	11		\$1046

Top surface, back panel and hardware. **Right side** connects to a 5-Sided Corner, Extended Corner or Connectable Table. Right side connects to a single pedestal desk or credenza, "D" island, Boat shaped island, "P" island and Delta island with a "T" base. Grommet in worksurface. Ships assembled in 1 carton.

Required Specifications

Veneer Finish
Edge

Optional Specifications

Grommet

BRIDGES

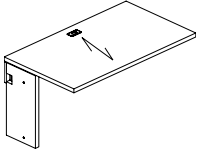

Linking Bridge, 8" Modesty Panel - LEFT

MODEL#	DIMENSIONS D x W x H	FREIGHT CLASS	WT/LBS.	CUBIC FT.	LIST PRICE
LBT6024NLLQ8CG	24 x 60 x 29	125	145	24	\$2207
LBT5424NLLQ8CG	24 x 54 x 29	150	131	22	\$1985
LBT4824NLLQ8CG	24 x 48 x 29	125	116	19	\$1744
LBT4224NLLQ8CG	24 x 42 x 29	125	102	17	\$1547
LBT3624NLLQ8CG	24 x 36 x 29	150	87	15	\$1280
LBT3024NLLQ8CG	24 x 30 x 29	125	73	12	\$1252
LBT6020NLLQ8CG	20 x 60 x 29	150	131	22	\$1634
LBT5420NLLQ8CG	20 x 54 x 29	150	118	20	\$1476
LBT4820NLLQ8CG	20 x 48 x 29	125	110	18	\$1316
LBT4220NLLQ8CG	20 x 42 x 29	150	95	16	\$1063
LBT3620NLLQ8CG	20 x 36 x 29	125	80	13	\$965
LBT3020NLLQ8CG	20 x 30 x 29	150	65	11	\$952

Top surface with 8" modesty panel for utility access and hardware. **Left side** connects to a 5-Sided Corner, Extended Corner or Connectable Table. Right side connects to a single pedestal desk or credenza, "D" island, Boat shaped island, "P" island and Delta island with a "T" base. Grommet in worksurface. Ships assembled in 1 carton.

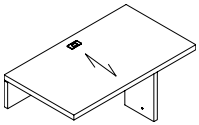

Linking Bridge, 8" Modesty Panel - RIGHT

LBT6024NLRQ8CG	24 x 60 x 29	125	145	24	\$2207
LBT5424NLRQ8CG	24 x 54 x 29	150	131	22	\$1985
LBT4824NLRQ8CG	24 x 48 x 29	125	116	19	\$1744
LBT4224NLRQ8CG	24 x 42 x 29	125	102	17	\$1547
LBT3624NLRQ8CG	24 x 36 x 29	150	87	15	\$1280
LBT3024NLRQ8CG	24 x 30 x 29	125	73	12	\$1252
LBT6020NLRQ8CG	20 x 60 x 29	150	131	22	\$1634
LBT5420NLRQ8CG	20 x 54 x 29	150	118	20	\$1476
LBT4820NLRQ8CG	20 x 48 x 29	125	110	18	\$1316
LBT4220NLRQ8CG	20 x 42 x 29	150	95	16	\$1063
LBT3620NLRQ8CG	20 x 36 x 29	125	80	13	\$965
LBT3020NLRQ8CG	20 x 30 x 29	150	65	11	\$952

Top surface with 8" modesty panel for utility access and hardware. **Right side** connects to a 5-Sided Corner, Extended Corner or Connectable Table. Right side connects to a single pedestal desk or credenza, "D" island, Boat shaped island, "P" island and Delta island with a "T" base. Grommet in worksurface. Ships assembled in 1 carton.

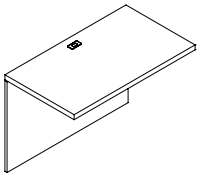

Bridge - Hinged Modesty

LHBT6024CG	24 x 60 x 29	85	144	10	\$2018
LHBT5424CG	24 x 54 x 29	85	129	9	\$1816
LHBT4824CG	24 x 48 x 29	70	120	8	\$1619
LHBT4224CG	24 x 42 x 29	70	105	7	\$1416
LHBT6020CG	20 x 60 x 29	70	131	8	\$1660
LHBT5420CG	20 x 54 x 29	85	118	8	\$1494
LHBT4820CG	20 x 48 x 29	70	110	7	\$1324
LHBT4220CG	20 x 42 x 29	70	96	6	\$1137

Executive Bridge Top and **Hinged Back Panel** to create a "U" configuration with a single pedestal desk or credenza. **Cannot be used with corners.** Grommet in worksurface. Ships assembled in 1 carton.

Required Specifications

Veneer Finish
Edge

Optional Specifications

Grommet

CREDENZAS **MODEL#** **DIMENSIONS** **FREIGHT CLASS** **WT/LBS.** **CUBIC FT.** **LIST PRICE**

D x W x H

LC10824	24 x 108 x 29	125	348	44	\$4521
LC10224	24 x 102 x 29	100	329	41	\$4311
LC9624	24 x 96 x 29	125	309	39	\$4082
LC9024	24 x 90 x 29	100	290	36	\$3870
LC8424	24 x 84 x 29	125	271	34	\$3652
LC7824	24 x 78 x 29	100	251	31	\$3424
LC7224	24 x 72 x 29	100	232	29	\$3213
LC6624	24 x 66 x 29	125	213	27	\$3109
LC6024	24 x 60 x 29	100	193	24	\$2880

LC10820	20 x 108 x 29	100	309	36	\$3607
LC10220	20 x 102 x 29	100	291	34	\$3420
LC9620	20 x 96 x 29	100	273	32	\$3222
LC9020	20 x 90 x 29	100	255	30	\$3029
LC8420	20 x 84 x 29	100	237	28	\$2841
LC7820	20 x 78 x 29	100	219	26	\$2645
LC7220	20 x 72 x 29	100	206	24	\$2453
LC6620	20 x 66 x 29	100	188	22	\$2367
LC6020	20 x 60 x 29	100	169	20	\$2166

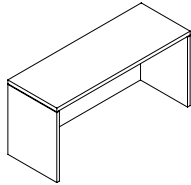

Credenza Shell

Standard with **no pedestals**. Flush full modesty panel. 96" w and larger includes a center support leg. If using storage component shells underneath to support the worksurface, **no more than 72" may be left unsupported**. Ships assembled in 1 carton.

LCK8424EE	24 x 84 x 29	92.5	348	34	\$6838
LCK7824EE	24 x 78 x 29	92.5	319	31	\$6618
LCK7224EE	24 x 72 x 29	100	280	29	\$6156
LCK6624EE	24 x 66 x 29	100	261	27	\$5659
LCK6024EE	24 x 60 x 29	100	238	24	\$5599

LCK8420EE	20 x 84 x 29	92.5	320	34	\$6777
LCK7820EE	20 x 78 x 29	92.5	298	31	\$6961
LCK7220EE	20 x 72 x 29	92.5	280	29	\$5692
LCK6620EE	20 x 66 x 29	92.5	257	27	\$5599
LCK6020EE	20 x 60 x 29	92.5	233	24	\$5533

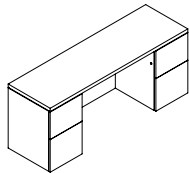

Kneespace Credenza

Standard with full to floor **file/file** pedestals on **left and right**. **Center is open**. Pedestals lock. Ships assembled in 1 carton.

LCK8424DD	24 x 84 x 29	92.5	348	34	\$6838
LCK7824DD	24 x 78 x 29	92.5	319	31	\$6618
LCK7224DD	24 x 72 x 29	100	280	29	\$5759
LCK6624DD	24 x 66 x 29	100	261	27	\$5659
LCK6024DD	24 x 60 x 29	100	238	24	\$5599

LCK8420DD	20 x 84 x 29	92.5	307	28	\$7093
LCK7820DD	20 x 78 x 29	92.5	285	26	\$6961
LCK7220DD	20 x 72 x 29	92.5	267	24	\$5692
LCK6620DD	20 x 66 x 29	92.5	244	22	\$5599
LCK6020DD	20 x 60 x 29	92.5	220	20	\$5533

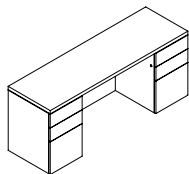

Kneespace Credenza

Standard with full to floor **box/box/file** pedestals on **left and right**. **Center is open**. Pedestals lock. Ships assembled in 1 carton.

Required Specifications

Veneer Finish
Edge

Optional Specifications

Grommet

CREDENZAS

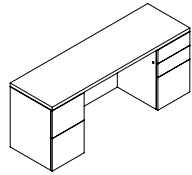

Kneespace Credenza

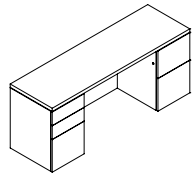

Kneespace Credenza

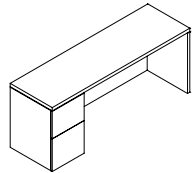

Single Pedestal Credenza - LEFT

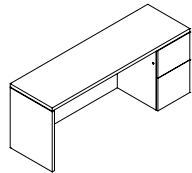

Single Pedestal Credenza - RIGHT

MODEL#	DIMENSIONS	FREIGHT CLASS	WT/LBS.	CUBIC FT.	LIST PRICE
--------	------------	---------------	---------	-----------	------------

D x W x H

LCK8424ED	24 x 84 x 29	92.5	348	34	\$6838
LCK7824ED	24 x 78 x 29	92.5	319	31	\$6618
LCK7224ED	24 x 72 x 29	100	280	29	\$6156
LCK6624ED	24 x 66 x 29	100	261	27	\$5659
LCK6024ED	24 x 60 x 29	100	238	24	\$5599
LCK8420ED	20 x 84 x 29	92.5	307	28	\$6777
LCK7820ED	20 x 78 x 29	92.5	285	26	\$6961
LCK7220ED	20 x 72 x 29	92.5	267	24	\$5692
LCK6620ED	20 x 66 x 29	92.5	244	22	\$5599
LCK6020ED	20 x 60 x 29	92.5	220	20	\$5533

Standard with full to floor **file/file** pedestal on **left** and **box/box/file** pedestal on **right**. **Center is open** Pedestals lock. One pencil tray. Ships assembled in 1 carton.

LCK8424DE	24 x 84 x 29	92.5	348	34	\$6838
LCK7824DE	24 x 78 x 29	92.5	319	31	\$6618
LCK7224DE	24 x 72 x 29	100	280	29	\$5759
LCK6624DE	24 x 66 x 29	100	261	27	\$5659
LCK6024DE	24 x 60 x 29	100	238	24	\$5599
LCK8420DE	20 x 84 x 29	92.5	307	28	\$6777
LCK7820DE	20 x 78 x 29	92.5	285	26	\$6961
LCK7220DE	20 x 72 x 29	92.5	267	24	\$5692
LCK6620DE	20 x 66 x 29	92.5	244	22	\$5599
LCK6020DE	20 x 60 x 29	92.5	220	20	\$5533

Standard with full to floor **box/box/file** pedestal on **left** and **file/file** pedestal on **right**. **Center is open** Pedestals lock. One pencil tray. Ships assembled in 1 carton.

LCL8424E	24 x 84 x 29	100	315	34	\$5492
LCL7824E	24 x 78 x 29	100	292	31	\$5137
LCL7224E	24 x 72 x 29	100	270	29	\$4789
LCL6624E	24 x 66 x 29	100	247	27	\$4634
LCL6024E	24 x 60 x 29	100	225	24	\$4270
LCL8420E	20 x 84 x 29	100	273	28	\$4888
LCL7820E	20 x 78 x 29	100	252	26	\$5232
LCL7220E	20 x 72 x 29	100	237	24	\$4246
LCL6620E	20 x 66 x 29	100	216	22	\$4092
LCL6020E	20 x 60 x 29	100	195	20	\$3778

Standard with full to floor **file/file** pedestal on **left**. Pedestal locks. Ships assembled in 1 carton.

LCR8424E	24 x 84 x 29	100	315	34	\$5492
LCR7824E	24 x 78 x 29	100	292	31	\$5137
LCR7224E	24 x 72 x 29	100	270	29	\$4789
LCR6624E	24 x 66 x 29	100	247	27	\$4634
LCR6024E	24 x 60 x 29	100	225	24	\$4270
LCR8420E	20 x 84 x 29	100	273	28	\$4888
LCR7820E	20 x 78 x 29	100	252	26	\$5232
LCR7220E	20 x 72 x 29	100	237	24	\$4246
LCR6620E	20 x 66 x 29	100	216	22	\$4092
LCR6020E	20 x 60 x 29	100	195	20	\$3778

Standard with full to floor **file/file** pedestal on **right**. Pedestal locks. Ships assembled in 1 carton.

Required Specifications

Veneer Finish
Edge

Optional Specifications

Grommet

CRENZAS MODEL# DIMENSIONS FREIGHT CLASS WT/LBS. CUBIC FT. LIST PRICE

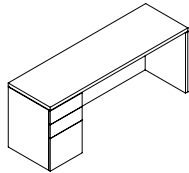

Single Pedestal Credenza - LEFT

	D x W x H					
LCL8424D	24 x 84 x 29	100	315	34	\$5492	
LCL7824D	24 x 78 x 29	100	292	31	\$5137	
LCL7224D	24 x 72 x 29	100	270	29	\$4789	
LCL6624D	24 x 66 x 29	100	247	27	\$4634	
LCL6024D	24 x 60 x 29	100	225	24	\$4270	
LCL8420D	20 x 84 x 29	100	273	28	\$4888	
LCL7820D	20 x 78 x 29	100	252	26	\$5232	
LCL7220D	20 x 72 x 29	100	237	24	\$4246	
LCL6620D	20 x 66 x 29	100	216	22	\$4092	
LCL6020D	20 x 60 x 29	100	195	20	\$3778	

Standard with full to floor **box/box/file** pedestal on **left**. Pedestal locks. Ships assembled in 1 carton.

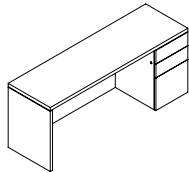

Single Pedestal Credenza - RIGHT

LCR8424D	24 x 84 x 29	100	315	34	\$5492
LCR7824D	24 x 78 x 29	100	292	31	\$5137
LCR7224D	24 x 72 x 29	100	270	29	\$4789
LCR6624D	24 x 66 x 29	100	247	27	\$4634
LCR6024D	24 x 60 x 29	100	225	24	\$4270
LCR8420D	20 x 84 x 29	100	273	28	\$4888
LCR7820D	20 x 78 x 29	100	252	26	\$5232
LCR7220D	20 x 72 x 29	100	237	24	\$4246
LCR6620D	20 x 66 x 29	100	216	22	\$4092
LCR6020D	20 x 60 x 29	100	195	20	\$3778

Standard with full to floor **box/box/file** pedestal on **right**. Pedestal locks. Ships assembled in 1 carton.

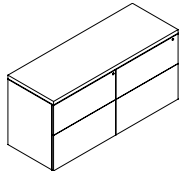

Lateral File Credenza

LC7224FF	24 x 72 x 29	92.5	328	29	\$7360
LC7220FF	20 x 72 x 29	92.5	287	24	\$6494
LC6024NN	24 x 60 x 29	92.5	273	24	\$6795
LC6020NN	20 x 60 x 29	92.5	205	20	\$5757

Two 2-drawer lateral files side-by-side. Locking drawers. Anti-lock tilt suspension. **Not for stacking materials on lateral file drawer bottom.** Ships assembled in 1 carton.

- "FF" models use two 36" wide lateral files, "NN" models use 30" wide.

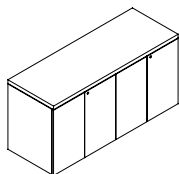

Storage Cabinet Credenza

LC7224GG	24 x 72 x 29	92.5	300	29	\$5629
LC7220GG	20 x 72 x 29	92.5	253	24	\$4977
LC6024MM	24 x 60 x 29	92.5	254	24	\$5195
LC6020MM	20 x 60 x 29	92.5	209	20	\$4435

Two 2-door storage cabinets side-by-side. Locking doors. Self-closing hinged doors cover one adjustable shelf. Ships assembled in 1 carton.

- "GG" models use two 36" wide storage cabinets, "MM" models use 30" wide.

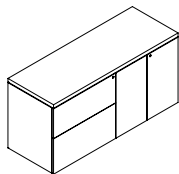

Lateral File/Storage Cabinet Credenza

LCF7224	24 x 72 x 29	92.5	305	29	\$5887
LCF7220	20 x 72 x 29	92.5	272	24	\$5212
LCF6024	24 x 60 x 29	92.5	254	24	\$5001
LCF6020	20 x 60 x 29	92.5	220	20	\$4435

One 2-drawer lateral file and one storage cabinet. Locking door/drawers. Storage cabinet includes one adjustable shelf. Anti-lock tilt suspension. **Not for stacking materials on lateral file drawer bottom.** Ships assembled in 1 carton.

Required Specifications

Veneer Finish
Edge

Optional Specifications

Grommet

CREDENZAS

MODEL#	DIMENSIONS	FREIGHT CLASS	WT/LBS.	CUBIC FT.	LIST PRICE
--------	------------	---------------	---------	-----------	------------

D x W x H

LCL8424F	24 x 84 x 29	100	305	34	\$5737
LCL7824F	24 x 78 x 29	100	285	31	\$5319
LCL7224F	24 x 72 x 29	100	261	29	\$4921
LCL6624F	24 x 66 x 29	100	239	27	\$4738
LCL6024F	24 x 60 x 29	100	218	24	\$4297
LCL8420F	20 x 84 x 29	100	273	28	\$5012
LCL7820F	20 x 78 x 29	100	252	26	\$4648
LCL7220F	20 x 72 x 29	100	237	24	\$4294
LCL6620F	20 x 66 x 29	100	216	22	\$4136
LCL6020F	20 x 60 x 29	100	195	20	\$3756

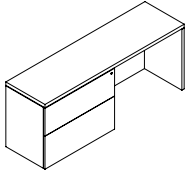

Kneespace Lateral File Credenza - LEFT

One 2-drawer lateral file on the **left**. Locking drawers. Anti-lock tilt suspension. **Not for stacking materials on lateral file drawer bottom.** Ships assembled in 1 carton.

LCR8424F	24 x 84 x 29	100	305	34	\$5737
LCR7824F	24 x 78 x 29	100	285	31	\$5319
LCR7224F	24 x 72 x 29	100	261	29	\$4921
LCR6624F	24 x 66 x 29	100	239	27	\$4738
LCR6024F	24 x 60 x 29	100	218	24	\$4297
LCR8420F	20 x 84 x 29	100	273	28	\$5012
LCR7820F	20 x 78 x 29	100	252	26	\$4648
LCR7220F	20 x 72 x 29	100	237	24	\$4294
LCR6620F	20 x 66 x 29	100	216	22	\$4136
LCR6020F	20 x 60 x 29	100	195	20	\$3756

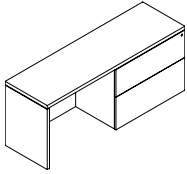

Kneespace Lateral File Credenza - RIGHT

One 2-drawer lateral file on the **right**. Locking drawers. Anti-lock tilt suspension. **Not for stacking materials on lateral file drawer bottom.** Ships assembled in 1 carton.

LCL8424Z	24 x 84 x 29	100	338	34	\$6836
LCL7824Z	24 x 78 x 29	100	314	31	\$6384
LCL7224Z	24 x 72 x 29	100	290	29	\$5944
LCL6624Z	24 x 66 x 29	100	266	27	\$5737
LCL6024Z	24 x 60 x 29	100	242	24	\$4692
LCL8420Z	20 x 84 x 29	100	273	28	\$6052
LCL7820Z	20 x 78 x 29	100	252	26	\$5669
LCL7220Z	20 x 72 x 29	100	237	24	\$5274
LCL6620Z	20 x 66 x 29	100	216	22	\$5097
LCL6020Z	20 x 60 x 29	100	195	20	\$4692

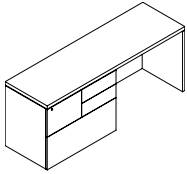

Mixed Storage Credenza - LEFT

Standard with two box drawers, one file drawer, and one 36"W lateral file drawer on the **left**. File drawer and lateral file drawer lock. **Not for stacking materials on lateral file drawer bottom.** Ships assembled in 1 carton.

LCR8424Z	24 x 84 x 29	100	338	34	\$6836
LCR7824Z	24 x 78 x 29	100	314	31	\$6384
LCR7224Z	24 x 72 x 29	100	290	29	\$5944
LCR6624Z	24 x 66 x 29	100	266	27	\$5737
LCR6024Z	24 x 60 x 29	100	242	24	\$4692
LCR8420Z	20 x 84 x 29	100	273	28	\$6052
LCR7820Z	20 x 78 x 29	100	252	26	\$5669
LCR7220Z	20 x 72 x 29	100	237	24	\$5274
LCR6620Z	20 x 66 x 29	100	216	22	\$5097
LCR6020Z	20 x 60 x 29	100	195	20	\$4692

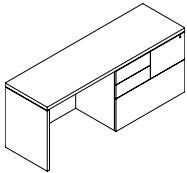

Mixed Storage Credenza - RIGHT

Standard with two box drawers, one file drawer, and one 36"W lateral file drawer on the **right**. File drawer and lateral file drawer lock. **Not for stacking materials on lateral file drawer bottom.** Ships assembled in 1 carton.

Required Specifications

Veneer Finish
Edge

Optional Specifications

Grommet

CREDENZAS **MODEL#** **DIMENSIONS** **FREIGHT CLASS** **WT/LBS.** **CUBIC FT.** **LIST PRICE**

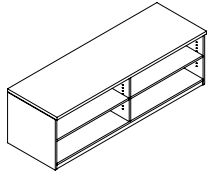

Credenza

	D x W x H					
LCO7224H23	24 x 72 x 23	92.5	305	29		\$3812
LCO7220H23	20 x 72 x 23	92.5	272	24		\$3332
LCO6024H23	24 x 60 x 23	92.5	254	24		\$3180
LCO6020H23	20 x 60 x 23	92.5	220	20		\$2779

Standard with open storage on **both sides**. Ships assembled in 1 carton.

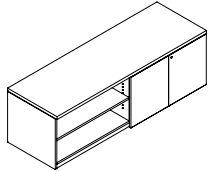

Credenza

LCOG7224H23	24 x 72 x 23	92.5	328	29		\$3840
LCOG7220H23	20 x 72 x 23	92.5	287	24		\$3360
LCOM6024H23	24 x 60 x 23	92.5	273	24		\$3529
LCOM6020H23	20 x 60 x 23	92.5	205	20		\$2938

Standard with open storage on the **left** and one storage cabinet on the **right**. Storage cabinet includes one adjustable shelf. Ships assembled in 1 carton.

- "G" model uses 36" wide storage cabinets, "M" model uses 30" wide.

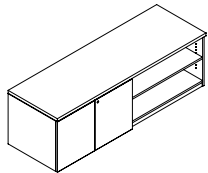

Credenza

LCG07224H23	24 x 72 x 23	92.5	328	29		\$3840
LCG07220H23	20 x 72 x 23	92.5	287	24		\$3360
LCM06024H23	24 x 60 x 23	92.5	273	24		\$3529
LCM06020H23	20 x 60 x 23	92.5	205	20		\$2938

Standard with open storage on the **right** and one storage cabinet on the **left**. Storage cabinet includes one adjustable shelf. Ships assembled in 1 carton.

- "G" model uses 36" wide storage cabinets, "M" model uses 30" wide.

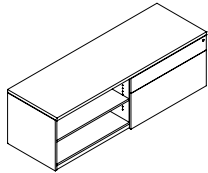

Credenza

LCOF7224H23	24 x 72 x 23	92.5	300	29		\$4677
LCOF7220H23	20 x 72 x 23	92.5	253	24		\$4082
LCON6024H23	24 x 60 x 23	92.5	254	24		\$4086
LCON6020H23	20 x 60 x 23	92.5	209	20		\$3565

Standard with one **box/file** drawer on **right** and open storage on the **left**. File drawer and lateral file drawer lock. Front-to-back and side-to-side filing. **Not for stacking materials on lateral file drawer bottom**. Ships assembled in 1 carton.

- "F" models use 36" wide lateral files, "N" models use 30" wide.

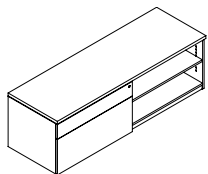

Credenza

LCF07224H23	24 x 72 x 23	92.5	300	29		\$4677
LCF07220H23	20 x 72 x 23	92.5	253	24		\$4082
LCN06024H23	24 x 60 x 23	92.5	254	24		\$4086
LCN06020H23	20 x 60 x 23	92.5	209	20		\$3565

Standard with one **box/file** drawer on **left** and open storage on the **right**. File drawer and lateral file drawer lock. Front-to-back and side-to-side filing. **Not for stacking materials on lateral file drawer bottom**. Ships assembled in 1 carton.

- "F" models use 36" wide lateral files, "N" models use 30" wide.

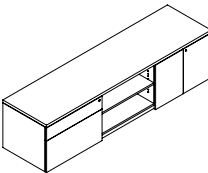

Credenza

LCNOM9024H23	24 x 90 x 23	92.5	300	29		\$8166
LCNOM9020H23	20 x 90 x 23	92.5	300	29		\$7754

Standard with one **box/file** drawer on **left**, open storage in the **center**, and one storage cabinet on the **right**. Storage cabinet includes one adjustable shelf. File drawer and lateral file drawer lock. Front-to-back and side-to-side filing. **Not for stacking materials on lateral file drawer bottom**. Ships assembled in 1 carton.

Required Specifications

Veneer Finish
Edge

Optional Specifications

Grommet

CREDENZAS

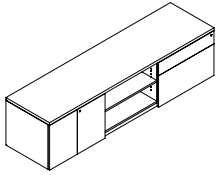

Credenza

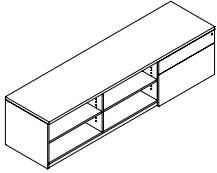

Credenza

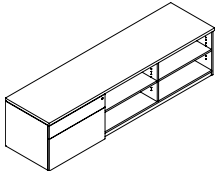

Credenza

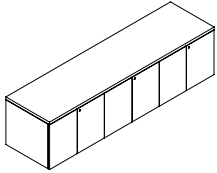

Credenza

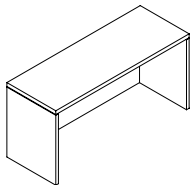

Credenza Shell

MODEL#	DIMENSIONS	FREIGHT CLASS	WT/LBS.	CUBIC FT.	LIST PRICE
LCMON9024H23	24 x 90 x 23	92.5	300	29	\$8166
LCMON9020H23	20 x 90 x 23	92.5	300	29	\$7754

Standard with one **box/file** drawer on **right**, open storage in the **center**, and one storage cabinet on the **left**. Storage cabinet includes one adjustable shelf. File drawer and lateral file drawer lock. Front-to-back and side-to-side filing. **Not for stacking materials on lateral file drawer bottom.** Ships assembled in 1 carton.

LCOON9024H23	24 x 90 x 23	92.5	300	29	\$7864
LCOON9020H23	20 x 90 x 23	92.5	300	29	\$7448

Standard with one **box/file** drawer on **right** and open storage in the **center** and **left**. File drawer and lateral file drawer lock. Front-to-back and side-to-side filing. **Not for stacking materials on lateral file drawer bottom.** Ships assembled in 1 carton.

LCN009024H23	24 x 90 x 23	92.5	300	29	\$7864
LCN009020H23	20 x 90 x 23	92.5	300	29	\$7448

Standard with one **box/file** drawer on **left** and open storage in the **center** and **right**. File drawer and lateral file drawer lock. Front-to-back and side-to-side filing. **Not for stacking materials on lateral file drawer bottom.** Ships assembled in 1 carton.

LCMMM9024H23	24 x 90 x 23	92.5	300	29	\$7562
LCMMM9020H23	20 x 90 x 23	92.5	300	29	\$6301

Standard with **three** storage cabinets. Storage cabinets include one adjustable shelf per cabinet. Ships assembled in 1 carton.

LC10824H23	24 x 108 x 23	125	348	44	\$4320
LC10224H23	24 x 102 x 23	100	329	41	\$4108
LC9624H23	24 x 96 x 23	125	309	39	\$3881
LC9024H23	24 x 90 x 23	100	290	36	\$3669
LC8424H23	24 x 84 x 23	125	271	34	\$3451
LC7824H23	24 x 78 x 23	100	251	31	\$3222
LC7224H23	24 x 72 x 23	100	232	29	\$3010
LC6624H23	24 x 66 x 23	125	213	27	\$2908
LC6024H23	24 x 60 x 23	100	193	24	\$2679
LC10820H23	20 x 108 x 23	100	309	36	\$3405
LC10220H23	20 x 102 x 23	100	291	34	\$3217
LC9620H23	20 x 96 x 23	100	273	32	\$3026
LC9020H23	20 x 90 x 23	100	255	30	\$2829
LC8420H23	20 x 84 x 23	100	237	28	\$2642
LC7820H23	20 x 78 x 23	100	219	26	\$2447
LC7220H23	20 x 72 x 23	100	206	24	\$2250
LC6620H23	20 x 66 x 23	100	188	22	\$2166
LC6020H23	20 x 60 x 23	100	169	20	\$1964

Standard with **no pedestals**. Flush full modesty panel. 96" w and larger includes a center support leg. If using storage component shells underneath to support the worksurface, **no more than 72" may be left unsupported.** Ships assembled in 1 carton.

Required Specifications

Veneer Finish
Edge

Optional Specifications

Grommet

CORNERS	MODEL#	DIMENSIONS D x W x H	FREIGHT CLASS	WT./LBS.	CUBIC FT.	LIST PRICE
---------	--------	-------------------------	---------------	----------	-----------	------------

- A Corner Desk is used to connect to a Linking Bridge and Linking Credenza, or Connectable Table
- Cable management tray is included.
- Full Modesty Panel option.
- 5-Sided Corners include a GM1 grommet in the top center position. Grommets are available as an option on Extended Corners.
- Hand of Linking Credenza is determined by location of full end panel from user side.
- Hand of Extended Corner is determined by location of long narrow end from user side.
- Connecting sides feature a self edge.

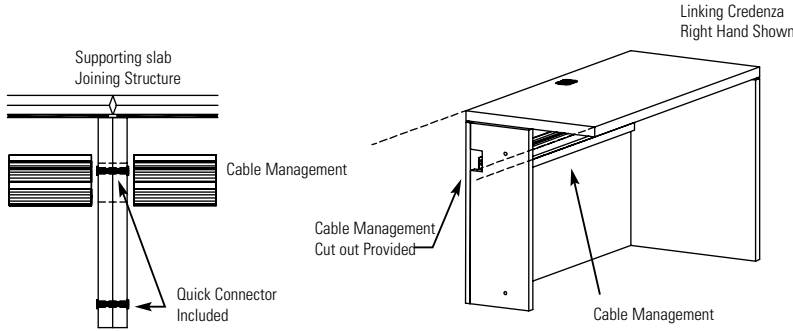

Code dimensions are actual

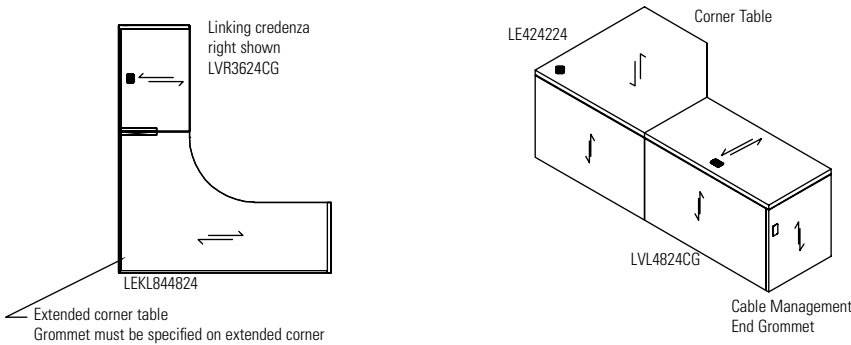

5-SIDED CORNERS	MODEL#	DIMENSIONS D x W x H	FREIGHT CLASS	WT./LBS.	CUBIC FT.	LIST PRICE
-----------------	--------	-------------------------	---------------	----------	-----------	------------

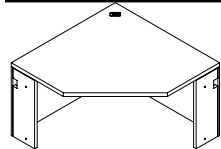

5-Sided Corner

LE484824	48 x 48 x 29	150	201	39	\$3412
LE424224	42 x 42 x 29	150	155	30	\$2718
LE363624	36 x 36 x 29	125	135	22	\$2600

Connects to **24" D** connectables, returns, extended corners, storage/lateral file credenzas, credenzas and bridges. Includes grommet and installed horizontal wire management. Narrow end panels on left and right. Ships assembled in 1 carton.

- *Not freestanding*

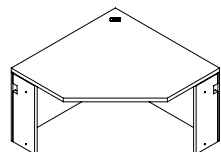

5-Sided Corner

LE484820	48 x 48 x 29	150	196	39	\$3412
LE424220	42 x 42 x 29	150	150	30	\$2718
LE363620	36 x 36 x 29	150	130	22	\$2600

Connects to **20" D** connectables, returns, extended corners, storage/lateral file credenzas, credenzas and bridges. Includes grommet and installed horizontal wire management. Narrow end panels on left and right. Ships assembled in 1 carton.

- *Not freestanding*

Required Specifications

Veneer Finish
Edge

Optional Specifications

Grommet

LEFT EXTENDED CORNERS

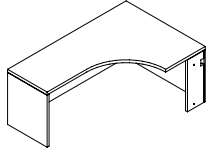

Left Extended Corner

MODEL#	DIMENSIONS D x W x H	FREIGHT CLASS	WT/LBS.	CUBIC FT.	LIST PRICE
LEKL844824	24-48 x 84 x 29	150	338	68	\$5035
LEKL784824	24-48 x 78 x 29	150	314	63	\$4967
LEKL724824	24-48 x 72 x 29	150	290	58	\$4684
LEKL664824	24-48 x 66 x 29	150	266	52	\$4450
LEKL604824	24-48 x 60 x 29	150	242	48	\$4158
LEKL844820	20-48 x 84 x 29	150	338	68	\$4954
LEKL784820	20-48 x 78 x 29	150	314	63	\$4851
LEKL724820	20-48 x 72 x 29	150	290	58	\$4573
LEKL664820	20-48 x 66 x 29	150	266	52	\$4338
LEKL604820	20-48 x 60 x 29	150	242	48	\$4047

Extended worksurface on **left**. **Full end panel on left, narrow end panel on right**. Connects to Linking Bridges, Extended Corners and Connectable Tables. Ships assembled in 1 carton.

RIGHT EXTENDED CORNERS

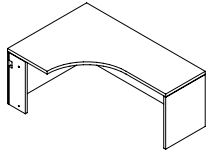

Right Extended Corner*

MODEL#	DIMENSIONS	FREIGHT CLASS	WT/LBS.	CUBIC FT.	LIST PRICE
LEKR488424	24-48 x 84 x 29	150	338	68	\$5035
LEKR487824	24-48 x 78 x 29	150	314	63	\$4967
LEKR487224	24-48 x 72 x 29	150	290	58	\$4684
LEKR486624	24-48 x 66 x 29	150	266	52	\$4450
LEKR486024	24-48 x 60 x 29	150	242	48	\$4158
LEKR488420	20-48 x 84 x 29	150	338	68	\$4954
LEKR487820	20-48 x 78 x 29	150	314	63	\$4851
LEKR487220	20-48 x 72 x 29	150	290	58	\$4573
LEKR486620	20-48 x 66 x 29	150	266	52	\$4338
LEKR486020	20-48 x 60 x 29	150	242	48	\$4047

Extended worksurface on **right**. **Full end panel on right, narrow end panel on left**. Connects to Linking Bridges, Extended Corners and Connectable Tables. Ships assembled in 1 carton.

CONNECTABLE TABLES - LEFT

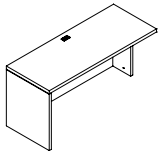

24" Deep Connectable Table - LEFT

MODEL#	DIMENSIONS	FREIGHT CLASS	WT/LBS.	CUBIC FT.	LIST PRICE
LVL9624CG	24 x 96 x 29	150	200	39	\$3702
LVL9024CG	24 x 90 x 29	150	187	36	\$3491
LVL8424CG	24 x 84 x 29	150	174	34	\$3291
LVL7824CG	24 x 78 x 29	150	162	31	\$3080
LVL7224CG	24 x 72 x 29	150	149	29	\$2880
LVL6624CG	24 x 66 x 29	150	141	27	\$2733
LVL6024CG	24 x 60 x 29	150	132	24	\$2583
LVL5424CG	24 x 54 x 29	150	121	22	\$2456
LVL4824CG	24 x 48 x 29	125	115	19	\$2343
LVL4224CG	24 x 42 x 29	150	99	17	\$2041
LVL3624CG	24 x 36 x 29	150	83	15	\$1985
LVL3024CG	24 x 30 x 29	125	77	12	\$1955
LVL2424CG	24 x 24 x 29	125	61	10	\$1708

Full end panel on left. Right narrow end panel connects to **24"D** center/right connectable table; **24"D** extended corners; **24"D** 5-sided corners; Grommet in worksurface. Ships assembled in 1 carton.

- To remove cross grain veneer pattern on top, **delete suffix "CG"** from the model number. Available as a special - no upcharge.

Required Specifications

Veneer Finish
Edge

Optional Specifications

Grommet*

CONNECTABLE TABLES - LEFT **MODEL#** **DIMENSIONS** **FREIGHT CLASS** **WT./LBS.** **CUBIC FT.** **LIST PRICE**

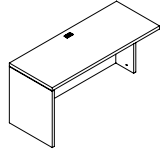

20" Deep Connectable Table - LEFT

	D x W x H					
LVL9620CG	20 x 96 x 29	150	187	39		\$3010
LVL9020CG	20 x 90 x 29	150	175	36		\$2822
LVL8420CG	20 x 84 x 29	150	163	34		\$2635
LVL7820CG	20 x 78 x 29	150	152	31		\$2447
LVL7220CG	20 x 72 x 29	150	140	29		\$2258
LVL6620CG	20 x 66 x 29	150	133	27		\$2119
LVL6020CG	20 x 60 x 29	150	125	24		\$1985
LVL5420CG	20 x 54 x 29	150	113	22		\$1870
LVL4820CG	20 x 48 x 29	150	110	19		\$1753
LVL4220CG	20 x 42 x 29	150	95	17		\$1484
LVL3620CG	20 x 36 x 29	150	80	15		\$1429
LVL3020CG	20 x 30 x 29	125	75	12		\$1405
LVL2420CG	20 x 24 x 29	125	60	10		\$1176

Full end panel on left. Right narrow end panel connects to **20"D** center/right connectable table; **20"D** 5-sided corners; Grommet in worksurface. Ships assembled in 1 carton.

- To remove cross grain veneer pattern on top, **delete suffix "CG"** from the model number. Available as a special - no upcharge.

CONNECTABLE TABLES - RIGHT **MODEL#** **DIMENSIONS** **FREIGHT CLASS** **WT./LBS.** **CUBIC FT.** **LIST PRICE**

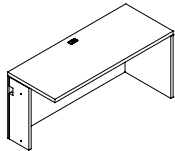

24" Deep Connectable Table - RIGHT

LVR9624CG	24 x 96 x 29	150	200	39		\$3702
LVR9024CG	24 x 90 x 29	150	187	36		\$3491
LVR8424CG	24 x 84 x 29	150	174	34		\$3291
LVR7824CG	24 x 78 x 29	150	162	31		\$3080
LVR7224CG	24 x 72 x 29	150	149	29		\$2880
LVR6624CG	24 x 66 x 29	150	141	27		\$2733
LVR6024CG	24 x 60 x 29	150	132	24		\$2583
LVR5424CG	24 x 54 x 29	150	121	22		\$2456
LVR4824CG	24 x 48 x 29	125	115	19		\$2343
LVR4224CG	24 x 42 x 29	150	99	17		\$2041
LVR3624CG	24 x 36 x 29	150	83	15		\$1985
LVR3024CG	24 x 30 x 29	125	77	12		\$1955
LVR2424CG	24 x 24 x 29	125	61	10		\$1708

Full end panel on right. Left narrow end panel connects to **24"D** center/left connectable table; **24"D** extended corners, **24"D** 5-sided corners; Grommet in worksurface. Ships assembled in 1 carton.

- To remove cross grain veneer pattern on top, **delete suffix "CG"** from the model number. Available as a special - no upcharge.

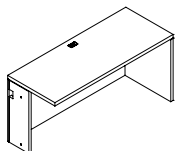

20" Deep Connectable Table - RIGHT

LVR9620CG	20 x 96 x 29	150	187	39		\$3010
LVR9020CG	20 x 90 x 29	150	175	36		\$2822
LVR8420CG	20 x 84 x 29	150	163	34		\$2635
LVR7820CG	20 x 78 x 29	150	152	31		\$2447
LVR7220CG	20 x 72 x 29	150	140	29		\$2258
LVR6620CG	20 x 66 x 29	150	133	27		\$2119
LVR6020CG	20 x 60 x 29	150	125	24		\$1985
LVR5420CG	20 x 54 x 29	150	113	22		\$1870
LVR4820CG	20 x 48 x 29	150	110	19		\$1753
LVR4220CG	20 x 42 x 29	150	95	17		\$1484
LVR3620CG	20 x 36 x 29	150	80	15		\$1429
LVR3020CG	20 x 30 x 29	125	75	12		\$1405
LVR2420CG	20 x 24 x 29	125	60	10		\$1176

Full end panel on right. Left narrow end panel connects to **20"D** center/left connectable table; **20"D** 5-sided corners; Grommet in worksurface. Ships assembled in 1 carton.

- To remove cross grain veneer pattern on top, **delete suffix "CG"** from the model number. Available as a special - no upcharge.

Required Specifications

Veneer Finish
Edge
Monopost Finish - D Islands

Optional Specifications

Modesty Upgrade
Modesty Panel
Monopost (Base) Upgrade - D Islands

CONNECTABLE TABLES

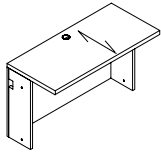

24" Deep Connectable Table

MODEL#	DIMENSIONS D x W x H	FREIGHT CLASS	WT/LBS.	CUBIC FT.	LIST PRICE
LV6024CG	24 x 60 x 29	150	132	24	\$2510
LV5424CG	24 x 54 x 29	150	121	22	\$2367
LV4824CG	24 x 48 x 29	125	115	19	\$2223
LV4224CG	24 x 42 x 29	150	99	17	\$1861
LV3624CG	24 x 36 x 29	150	83	15	\$1921
LV3024CG	24 x 30 x 29	125	77	12	\$1760
LV2424CG	24 x 24 x 29	125	61	10	\$1476

Narrow end panels on left and right connects to **24"D** connectable table; **24"D** extended corners, **24"D** 5-sided corners; Grommet in worksurface. Ships assembled in 1 carton.

- To remove cross grain veneer pattern on top, **delete suffix "CG"** from the model number. Available as a special - no upcharge.

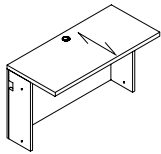

22" Deep Connectable Table

LV6020CG	20 x 60 x 29	150	125	24	\$1931
LV5420CG	20 x 54 x 29	150	113	22	\$1816
LV4820CG	20 x 48 x 29	150	110	19	\$1703
LV4220CG	20 x 42 x 29	150	95	17	\$1422
LV3620CG	20 x 36 x 29	150	80	15	\$1378
LV3020CG	20 x 30 x 29	125	75	12	\$1351
LV2420CG	20 x 24 x 29	125	60	10	\$1137

Narrow end panels on left and right connects to **22"D** connectable table; **22"D** extended corners, **22"D** 5-sided corners; Grommet in worksurface. Ships assembled in 1 carton.

- To remove cross grain veneer pattern on top, **delete suffix "CG"** from the model number. Available as a special - no upcharge.

"D" ISLANDS

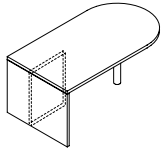

"D" Island - Full End Panel (T-Base) & Monopost

MODEL#	DIMENSIONS	FREIGHT CLASS	WT/LBS.	CUBIC FT.	LIST PRICE
LDD8430	30 x 84 x 29	125	343	51	\$5596
LDD7230	30 x 72 x 29	125	264	36	\$4446
LDD6630	30 x 66 x 29	125	245	40	\$4446
LDD6030	30 x 60 x 29	125	225	30	\$4282

Connects to Linking Bridges or Executive Returns. Attaching hardware included. **Not freestanding.** Shipped RTA - ready to assemble.

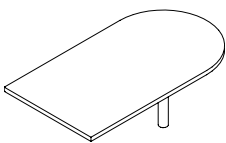

"D" Island with Monopost

LRD8430	30 x 84 x 29	125	135	51	\$3994
LRD7230	30 x 72 x 29	125	99	36	\$3180
LRD6630	30 x 66 x 29	125	99	40	\$3180
LRD6030	30 x 60 x 29	125	83	30	\$3057

Attaches to edge of worksurfaces with molding edge. Attaching hardware included. Shipped RTA - ready to assemble.

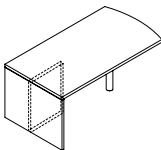

"D" Island - Full End Panel (T-Base) & Monopost, Bow End

LDDBE8430	30 x 84 x 29	125	343	51	\$5596
LDDBE7230	30 x 72 x 29	125	264	36	\$4446
LDDBE6630	30 x 66 x 29	125	245	40	\$4446
LDDBE6030	30 x 60 x 29	125	225	30	\$4275

Connects to Linking Bridges or Executive Returns. Attaching hardware included. **Not freestanding.** Shipped RTA - ready to assemble.

Required Specifications

Veneer Finish
Edge
Monopost Finish

Optional Specifications

Grommet
Monopost (Base) Upgrade

"D" ISLANDS **MODEL#** **DIMENSIONS** **FREIGHT CLASS** **WT/LBS.** **CUBIC FT.** **LIST PRICE**

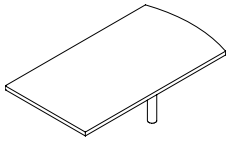

"D" Island with Monopost, Bow End

	D x W x H					
LRDBE8430	30 x 84 x 29	125	135	51	\$3994	
LRDBE7230	30 x 72 x 29	125	99	36	\$3180	
LRDBE6630	30 x 66 x 29	125	99	40	\$3180	
LRDBE6030	30 x 60 x 29	125	83	30	\$3057	

Attaches to edge of worksurfaces with molding edge. Attaching hardware included. Shipped RTA - ready to assemble.

PIANO DESKS

- Can be ordered as a shell or with pedestals.
- Components include a GM1 grommet in the top center position.
- Hand of Rectangular Desk is determined by location of pedestal from user side.
- Hand of "D" Top is determined by outward orientation of curved end from user projection.
- Hand of "P" Top is determined by outward orientation of conference end from user projection.
- Connectable Tables and Bridges - To remove cross grain veneer pattern on top, delete suffix "CG" from the model number. Available as a special - no upcharge.

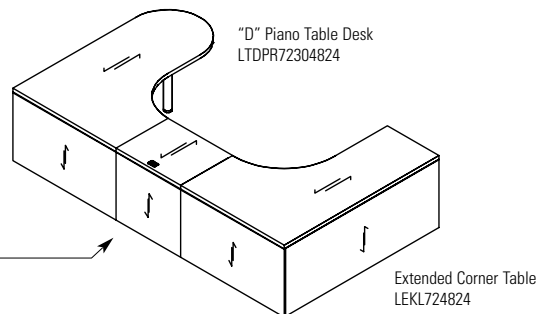
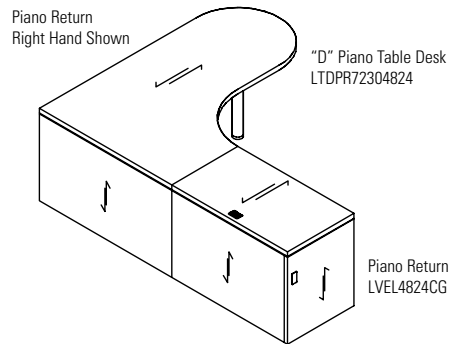
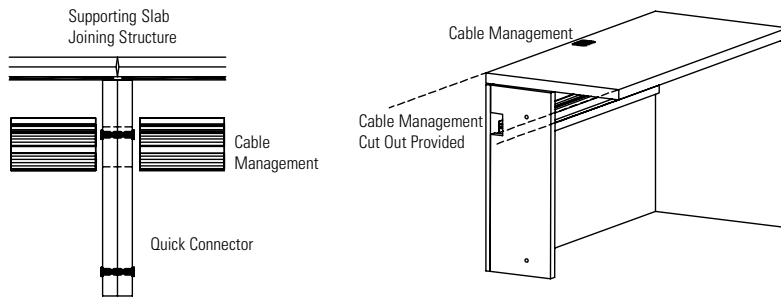

Required Specifications

- Veneer Finish
- Edge
- Monopost Finish

Optional Specifications

- Grommet
- Monopost (Base) Upgrade

PIANO DESKS

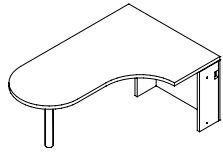

"D" Island LEFT - Full End Panel & Monopost, Piano Desk

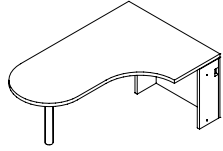

"D" Island LEFT - Full End Panel & Monopost, Piano Desk

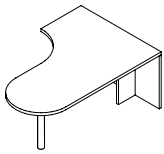

"D" Island RIGHT - Full End Panel & Monopost, Piano Desk

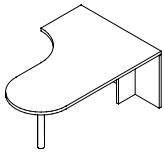

"D" Island RIGHT - Full End Panel & Monopost, Piano Desk

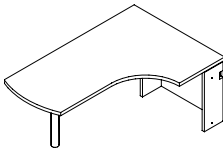

"D" Island LEFT - Full End Panel & Monopost, Piano Desk - Bow End

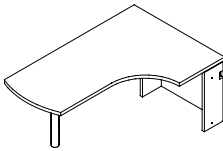

"D" Island LEFT - Full End Panel & Monopost, Piano Desk - Bow End

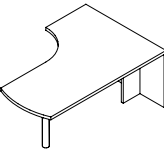

"D" Island RIGHT - Full End Panel & Monopost, Piano Desk - Bow End

MODEL#	DIMENSIONS D x W x H	FREIGHT CLASS	WT/LBS.	CUBIC FT.	LIST PRICE
LTDPL84304824	48 x 84 x 29	150	406	68	\$4634
LTDPL72304824	48 x 72 x 29	125	348	58	\$4063

Extended island worksurface on the **left**. Narrow end panel on right connects to **24"D** returns or bridges **for Piano Desks Only** (see page 303). **Not freestanding**. Includes installed horizontal wire management. Shipped RTA (ready to assemble).

LTDPL84304820	48 x 84 x 29	150	406	68	\$4521
LTDPL72304820	48 x 72 x 29	125	348	58	\$3947

Extended island worksurface on the **left**. Narrow end panel on right connects to **20"D** returns or bridges **for Piano Desks Only** (see page 303). **Not freestanding**. Includes installed horizontal wire management. Shipped RTA (ready to assemble).

LTDPR84304824	48 x 84 x 29	150	406	68	\$4634
LTDPR72304824	48 x 72 x 29	125	348	58	\$4063

Extended island worksurface on the **right**. Narrow end panel on left connects to **24"D** returns or bridges **for Piano Desks Only** (see page 303). **Not freestanding**. Includes installed horizontal wire management. Shipped RTA (ready to assemble).

LTDPR84304820	48 x 84 x 29	150	406	68	\$4521
LTDPR72304820	48 x 72 x 29	125	348	58	\$3947

Extended island worksurface on the **right**. Narrow end panel on left connects to **20"D** returns or bridges **for Piano Desks Only** (see page 303). **Not freestanding**. Includes installed horizontal wire management. Shipped RTA (ready to assemble).

LDBEPL84304824	48 x 84 x 29	150	406	68	\$4634
LDBEPL72304824	48 x 72 x 29	125	348	58	\$4063

Extended island worksurface on the **left**. Narrow end panel on right connects to **24"D** returns or bridges **for Piano Desks Only** (see page 303). **Not freestanding**. Includes installed horizontal wire management. Shipped RTA (ready to assemble).

LDBEPL84304820	48 x 84 x 29	150	406	68	\$4521
LDBEPL72304820	48 x 72 x 29	125	348	58	\$3947

Extended island worksurface on the **left**. Narrow end panel on right connects to **20"D** returns or bridges **for Piano Desks Only** (see page 303). **Not freestanding**. Includes installed horizontal wire management. Shipped RTA (ready to assemble).

LDBEPR84304824	48 x 84 x 29	150	406	68	\$4634
LDBEPR72304824	48 x 72 x 29	125	348	58	\$4063

Extended island worksurface on the **right**. Narrow end panel on left connects to **24"D** returns or bridges **for Piano Desks Only** (see page 303). **Not freestanding**. Includes installed horizontal wire management. Shipped RTA (ready to assemble).

Required Specifications

Veneer Finish
Edge
Monopost Finish - Piano Desk

Optional Specifications

Grommet
Monopost (Base) Upgrade - Piano Desk

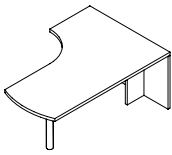
PIANO DESK	MODEL#	DIMENSIONS	FREIGHT CLASS	WT/LBS.	CUBIC FT.	LIST PRICE
		D x W x H				
	LDBEPR84304820	48 x 84 x 29	150	406	68	\$4521
	LDBEPR72304820	48 x 72 x 29	125	348	58	\$3947

"D" Island RIGHT - Full End Panel & Monopost, Piano Desk - Bow End

Extended island worksurface on the **right**. Narrow end panel on left connects to **20"D** returns or bridges **for Piano Desks Only** (see page 303). **Not freestanding**. Includes installed horizontal wire management. Shipped RTA (ready to assemble).

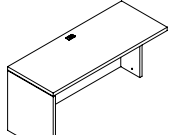
CONNECTABLE TABLES - FOR PIANO DESKS	MODEL#	DIMENSIONS	FREIGHT CLASS	WT/LBS.	CUBIC FT.	LIST PRICE
	LVEL8424CG	24 x 84 x 29	150	174	34	\$3405
	LVEL7824CG	24 x 78 x 29	150	162	31	\$3190
	LVEL7224CG	24 x 72 x 29	150	149	29	\$2984
	LVEL6624CG	24 x 66 x 29	150	141	27	\$2822
	LVEL6024CG	24 x 60 x 29	150	132	24	\$2668
	LVEL5424CG	24 x 54 x 29	150	121	22	\$2537
	LVEL4824CG	24 x 48 x 29	125	115	19	\$2418
	LVEL4224CG	24 x 42 x 29	150	99	17	\$2104
	LVEL3624CG	24 x 36 x 29	150	83	15	\$2045

24" Deep Connectable Table - LEFT For Piano Desk

Full end panel on left. Right narrow end panel connects to **24"D** right connectable table, "D" islands, Boat shaped islands, "P" islands or Delta islands with "T" bases **for Piano Desks Only**. Grommet in worksurface. Ships assembled in 1 carton.

- To remove cross grain veneer pattern on top, **delete suffix "CG"** from the model number. Available as a special - no upcharge.

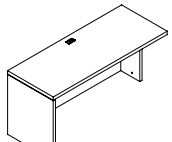
	LVEL8420CG	20 x 84 x 29	150	174	34	\$2635
	LVEL7820CG	20 x 78 x 29	150	162	31	\$2447
	LVEL7220CG	20 x 72 x 29	150	149	29	\$2258
	LVEL6620CG	20 x 66 x 29	150	141	27	\$2119
	LVEL6020CG	20 x 60 x 29	150	132	24	\$1985
	LVEL5420CG	20 x 54 x 29	150	121	22	\$1870
	LVEL4820CG	20 x 48 x 29	125	115	19	\$1753
	LVEL4220CG	20 x 42 x 29	150	99	17	\$1484
	LVEL3620CG	20 x 36 x 29	150	83	15	\$1429

20" Deep Connectable Table - LEFT For Piano Desk

Full end panel on left. Right narrow end panel connects to **20"D** right connectable table, "D" islands, Boat shaped islands, "P" islands or Delta islands with "T" bases **for Piano Desks Only**. Grommet in worksurface. Ships assembled in 1 carton.

- To remove cross grain veneer pattern on top, **delete suffix "CG"** from the model number. Available as a special - no upcharge.

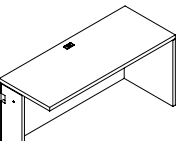
	LVER8424CG	24 x 84 x 29	150	174	34	\$3405
	LVER7824CG	24 x 78 x 29	150	162	31	\$3190
	LVER7224CG	24 x 72 x 29	150	149	29	\$2984
	LVER6624CG	24 x 66 x 29	150	141	27	\$2822
	LVER6024CG	24 x 60 x 29	150	132	24	\$2668
	LVER5424CG	24 x 54 x 29	150	121	22	\$2537
	LVER4824CG	24 x 48 x 29	125	115	19	\$2418
	LVER4224CG	24 x 42 x 29	150	99	17	\$2104
	LVER3624CG	24 x 36 x 29	150	83	15	\$2045

24" Deep Connectable Table - RIGHT For Piano Desk

Full end panel on right. Left narrow end panel connects to **24"D** left connectable table, "D" islands, Boat shaped islands, "P" islands or Delta islands with "T" bases **for Piano Desks Only**. Grommet in worksurface. Ships assembled in 1 carton.

- To remove cross grain veneer pattern on top, **delete suffix "CG"** from the model number. Available as a special - no upcharge.

Required Specifications

Veneer Finish
Edge
Monopost Finish - Piano Desk

Optional Specifications

Grommet
Monopost (Base) Upgrade - Piano Desk

CONNECTABLE TABLES - FOR PIANO DESKS

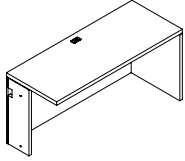

20" Deep Connectable Table - RIGHT For Piano Desk

MODEL#	DIMENSIONS D x W x H	FREIGHT CLASS	WT/LBS.	CUBIC FT.	LIST PRICE
LVER8420CG	20 x 84 x 29	150	174	34	\$2635
LVER7820CG	20 x 78 x 29	150	162	31	\$2447
LVER7220CG	20 x 72 x 29	150	149	29	\$2258
LVER6620CG	20 x 66 x 29	150	141	27	\$2119
LVER6020CG	20 x 60 x 29	150	132	24	\$1985
LVER5420CG	20 x 54 x 29	150	121	22	\$1870
LVER4820CG	20 x 48 x 29	125	115	19	\$1753
LVER4220CG	20 x 42 x 29	150	99	17	\$1484
LVER3620CG	20 x 36 x 29	150	83	15	\$1429

Full end panel on right. Left narrow end panel connects to **20"D** left connectable table, "D" islands, Boat shaped islands, "P" islands or Delta islands with "T" bases **for Piano Desks Only**. Grommet in worksurface. Ships assembled in 1 carton.

- To remove cross grain veneer pattern on top, **delete suffix "CG"** from the model number. Available as a special - no upcharge.

BRIDGES - FOR PIANO DESKS

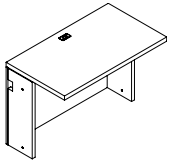

Flush Bridge

MODEL#	DIMENSIONS	FREIGHT CLASS	WT/LBS.	CUBIC FT.	LIST PRICE
LBTN4824CG	24 x 48 x 29	125	116	19	\$2139
LBTN4224CG	24 x 42 x 29	125	102	17	\$1861
LBTN3624CG	24 x 36 x 29	150	87	15	\$1805
LBTN3024CG	24 x 30 x 29	125	73	12	\$1772
LBTN2424CG	24 x 24 x 29	150	58	10	\$1562
LBTN1824CG	24 x 18 x 29	150	43	8	\$1280
LBTN1224CG	24 x 12 x 29	150	29	5	\$993

Full end panel on both sides connects to **24"D** worksurfaces, "D" islands, Boat shaped islands, "P" islands or Delta islands with "T" bases **for Piano Desks Only**. Grommet in worksurface. Ships assembled in 1 carton.

- To remove cross grain veneer pattern on top, **delete suffix "CG"** from the model number. Available as a special - no upcharge.

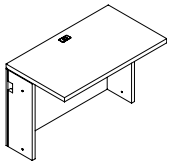

Flush Bridge

LBTN4820CG	20 x 48 x 29	125	116	19	\$1703
LBTN4220CG	20 x 42 x 29	125	102	17	\$1422
LBTN3620CG	20 x 36 x 29	150	87	15	\$1378
LBTN3020CG	20 x 30 x 29	125	73	12	\$1351
LBTN2420CG	20 x 24 x 29	150	58	10	\$1137
LBTN1820CG	20 x 18 x 29	150	43	8	\$1081
LBTN1220CG	20 x 12 x 29	150	29	5	\$1006

Full end panel on both sides connects to **20"D** worksurfaces, "D" islands, Boat shaped islands, "P" islands or Delta islands with "T" bases **for Piano Desks Only**. Grommet in worksurface. Ships assembled in 1 carton.

- To remove cross grain veneer pattern on top, **delete suffix "CG"** from the model number. Available as a special - no upcharge.

Required Specifications

Veneer Finish
Edge
Metal Finish - Modesty Panel

Optional Specifications

Grommet

MODESTY PANEL OPTIONS **MODEL#** **DIMENSIONS** **FREIGHT CLASS** **WT/LBS.** **CUBIC FT.** **LIST PRICE**

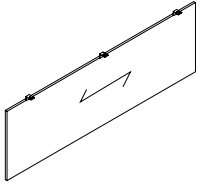

Veneer Modesty Panel Upgrade*

CMP72W	0.75 x 67 x 18	--	20	1	\$1728
CMP66W	0.75 x 61 x 18	--	18	1	\$1673
CMP60W	0.75 x 55 x 18	--	16	1	\$1647
CMP54W	0.75 x 49 x 18	--	14	1	\$1619
CMP48W	0.75 x 43 x 18	--	13	1	\$1594

Straight modesty panel. Attaches to underside of worksurface. **Can not be retrofitted in the field *Not sold individually - to be ordered as an upgrade option only.***

- CMP72W - Specify on "P" Top Islands or 96" x 48" Islands for Piano Desks.
- CMP66W - Specify on 84" x 36" "D" Top Islands.
- CMP60W - Specify on 84" x 42" "P" Top Islands or 84" x 48" Islands for Piano Desks.
- CMP54W - Specify on 72" x 30" "D" Top Islands.
- CMP48W - Specify on 66" x 36" , 60" x 30" "D" Top Islands, 72" x 42" "P" Top Islands or 72" x 48" Islands for Piano Desks.

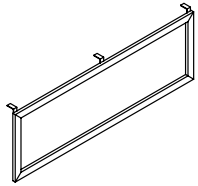

Glass Modesty Panel Upgrade

CMP72G	0.75 x 67 x 18	--	20	1	\$2647
CMP66G	0.75 x 61 x 18	--	18	1	\$2504
CMP60G	0.75 x 55 x 18	--	16	1	\$2289
CMP54G	0.75 x 49 x 18	--	14	1	\$2132
CMP48G	0.75 x 43 x 18	--	13	1	\$2036

Straight modesty panel. Translucent, screened glass. Aluminum box frame construction in Tungsten Only. Attaches to underside of worksurface. **Can not be retrofitted in the field. *Not sold individually - to be ordered as an upgrade option only.***

- CMP72G - Specify on "P" Top Islands or 96" x 48" Islands for Piano Desks.
- CMP66G - Specify on 84" x 36" "D" Top Islands.
- CMP60G - Specify on 84" x 42" "P" Top Islands or 84" x 48" Islands for Piano Desks.
- CMP54G - Specify on 72" x 30" "D" Top Islands.
- CMP48G - Specify on 66" x 36" , 60" x 30" "D" Top Islands, 72" x 42" "P" Top Islands or 72" x 48" Islands for Piano Desks.
- Tungsten finish on the aluminum box frame closely resembles the existing Tungsten finish.

Required Specifications

Metal finish

L LUFTON

SIDE-BY-SIDE COMPONENTS	MODEL#	DIMENSIONS	FREIGHT CLASS	WT/LBS.	CUBIC FT.	LIST PRICE
-------------------------	--------	------------	---------------	---------	-----------	------------

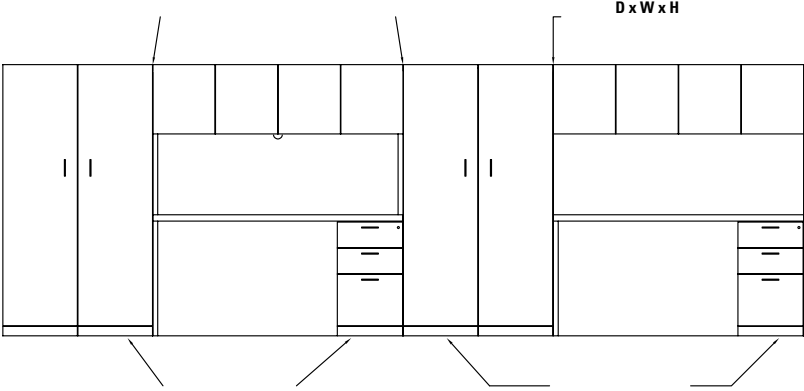

MODULAR PEDESTALS

- When using Storage Shells, laminate gables will show.
- Credenza shell cannot be completely filled up with storage shells to create a full storage credenza.
- Handle style must be specified.

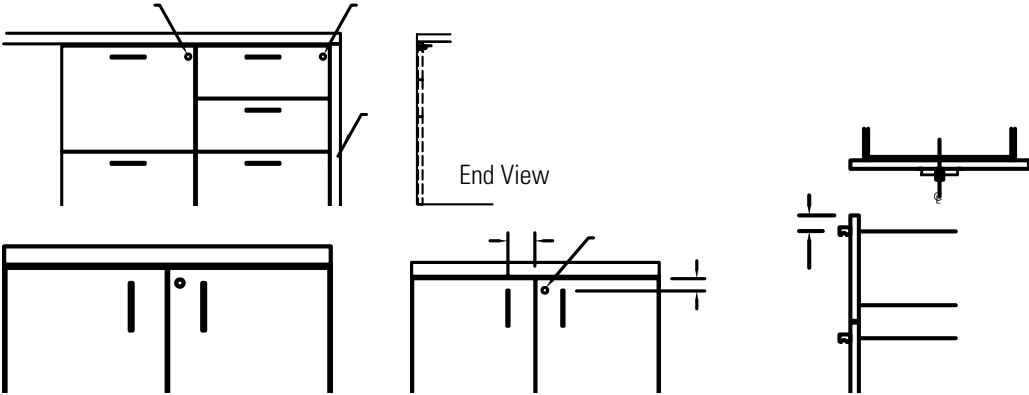

STORAGE SHELLS	MODEL#	DIMENSIONS	FREIGHT CLASS	WT/LBS.	CUBIC FT.	LIST PRICE
----------------	--------	------------	---------------	---------	-----------	------------

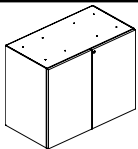

Storage Shell

	D x W x H					
LWG	18 x 35 x 28	92.5	115	11		\$1893
LWM	18 x 30 x 28	92.5	96	9		\$1703
LWG.5	18 x 34 x 28	92.5	115	11		\$1893

For use **under a freestanding worksurface (22", 24", 30" or 36"D)**. Top drilled to attach to worksurface. One adjustable shelf. Standard with lock. Ships assembled in 1 carton.

- **Specify LWG and LWM for kneespace applications**
- **Unfinished top and back**

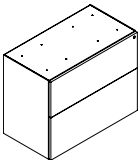

File/File Shell - Lateral

LWF	18 x 35 x 28	92.5	115	11		\$2668
LWN	18 x 30 x 28	92.5	96	9		\$2320
LWF.5	18 x 34 x 28	92.5	115	11		\$2668
LWN.5	18 x 29 x 28	92.5	96	9		\$2320

For use **under a freestanding worksurface (22", 24", 30" or 36"D)**. Top drilled to attach to worksurface. **Two lateral file drawers**. Lock secures all drawers. Side-to-side file bars included. Ships assembled in 1 carton.

- **Specify LWF and LWN for kneespace applications**
- **Unfinished top and back**

Required Specifications

Veneer Finish
Edge

STORAGE MODULES - FREESTANDING **MODEL#** **DIMENSIONS** **FREIGHT CLASS** **WT/LBS.** **CUBIC FT.** **LIST PRICE**

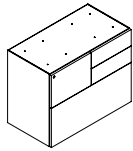

Mixed Storage Shell - LEFT

	D x W x H				
LWZL	18 x 35 x 28	92.5	115	11	\$3057
LWZL.5	18 x 34 x 28	92.5	115	11	\$3057

For use **under a freestanding worksurface (22", 24", 30" or 36"D)**. Top drilled to attach to worksurface. One file drawer on **left**, two box drawers on **right** and one lateral file drawer on bottom. File drawer and lateral file drawer lock. One pencil tray. **Not for stacking materials on lateral file drawer bottom.** Ships assembled in 1 carton.

- **Specify LWZL for kneespace applications**
- **Unfinished top and back**

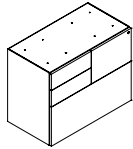

Mixed Storage Shell - RIGHT

LWZR	18 x 35 x 28	92.5	115	11	\$3057
LWZR.5	18 x 34 x 28	92.5	115	11	\$3057

For use **under a freestanding worksurface (22", 24", 30" or 36"D)**. Top drilled to attach to worksurface. One file drawer on **right**, two box drawers on **left** and one lateral file drawer on bottom. File drawer and lateral file drawer lock. One pencil tray. **Not for stacking materials on lateral file drawer bottom.** Ships assembled in 1 carton.

- **Specify LWZR for kneespace applications**
- **Unfinished top and back**

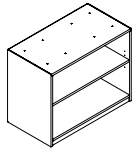

Open Shelving Shell

LWOB36	18 x 35 x 28	100	92	11	\$1462
LWOB30	18 x 30 x 28	100	77	9	\$1316

For use **under a freestanding worksurface (22", 24", 30" or 36"D)**. Top drilled to attach to worksurface. One adjustable veneer shelf. Ships assembled in 1 carton.

- **Unfinished top and back**

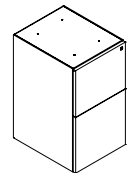

File/File Shell - Vertical

LETTER					
LWWE	23 x 16 x 28	92.5	72	6	\$2132
LWE	18 x 16 x 28	92.5	70	5	\$1893
LEGAL					
LWWLE	23 x 19 x 28	92.5	85	7	\$2492
LWLE	18 x 19 x 28	92.5	83	6	\$2207

For use **under a freestanding worksurface (22", 24", 30" or 36"D)**. Top drilled to attach to worksurface. **Two file drawers.** Lock secures all drawers. Ships assembled in 1 carton.

- *For 22" or 24"D worksurface, order **LWE or LWLE**. For 30" or 36"D worksurface, order **LWWE or LWWLE**.*
- **Unfinished top and back**

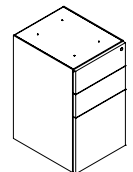

Box/Box/File Shell

LETTER					
LWWD	23 x 16 x 28	92.5	72	6	\$2132
LWD	19.1 x 16 x 28	92.5	70	5	\$1893
LEGAL					
LWWLD	23 x 19 x 28	92.5	85	7	\$2492
LWLD	19.1 x 19 x 28	92.5	83	6	\$2207

For use **under a freestanding worksurface (22", 24", 30" or 36"D)**. Top drilled to attach to worksurface. **Two box and one file drawers.** One pencil tray. Lock secures all drawers. Ships assembled in 1 carton.

- *For 22" or 24"D worksurface, order **LWD or LWLD**. For 30" or 36"D worksurface, order **LWWD or LWWLD**.*
- **Unfinished top and back**

Required Specifications

Veneer Finish
Edge

STORAGE MODULES - FREESTANDING

MODEL# DIMENSIONS FREIGHT CLASS WT/LBS. CUBIC FT. LIST PRICE

D x W x H

LWBM	18 x 16 x 21	85	70	5	\$1578
LWWBM	24 x 16 x 21	85	75	6	\$1851

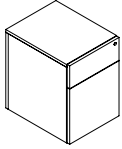

Box/File Freestanding Mobile Pedestal

One box and one file drawer. One pencil tray. Lock secures all drawers. Finished back. Ships assembled in 1 carton.

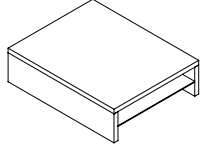

Spacer

LSPBOX1620	20 x 16 x 4.8	125	15	2	\$560
------------	---------------	-----	----	---	--------------

For use with 23" high credenzas to support an overlapping return. Includes shelf for paper management. Ships assembled in 1 carton.

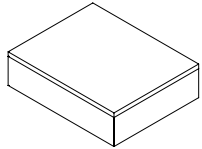

Spacer, Closed

LSPBOX1620C	20 x 16 x 4.8	125	15	2	\$618
-------------	---------------	-----	----	---	--------------

For use with 23" high credenzas to support an overlapping return. Ships assembled in 1 carton.

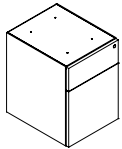

Box/File Pedestal

LWB15	19 x 16 x 19.5	70	50	3	\$1351
-------	----------------	----	----	---	---------------

One box and one file drawer. One pencil tray. Lock secures all drawers. Finished back. **For use with 23" high credenza shell.** Ships assembled in 1 carton.

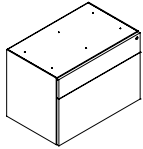

Box/Lateral File Pedestal

LWB36	19 x 36 x 19.5	92.5	115	11	\$2456
LWB30	19 x 30 x 19.5	92.5	96	9	\$2149

One box and one lateral file drawer. One pencil tray. Lock secures all drawers. Finished back. **For use with 23" high credenza shell.** Ships assembled in 1 carton.

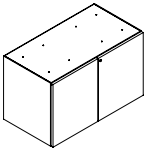

Storage Cabinet w/Doors

LWMH19.5	19 x 36 x 29	92.5	130	12	\$1520
LWGH19.5	19 x 30 x 29	92.5	107	10	\$1715

Includes one adjustable shelf. Standard with lock. **For use with 23" high credenza shell.** Ships assembled in 1 carton.

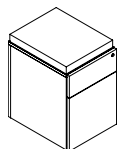

Box/File Freestanding Pedestal Mobile, with Cushion

					GRD 1/GRD 2	GRD 3	GRD 4
LWBMCU	20 x 16 x 24	85	70	5	\$2373	\$2889	\$2967
LWWBMCU	24 x 16 x 24	85	75	6	\$2709	\$3298	\$3387

One box and one file drawer. One pencil tray. Lock secures all drawers. Casters. Ships assembled in 1 carton. Pricing in grade 1 through 4. Pricing beyond grade 4 must be submitted as special.

Required Specifications

Veneer Finish
Edge

STORAGE MODULES - FREESTANDING **MODEL#** **DIMENSIONS** **FREIGHT CLASS** **WT/LBS.** **CUBIC FT.** **LIST PRICE**

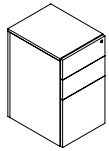

Box/Box/File Freestanding Pedestal

	D x W x H				
LWDB	19 x 16 x 28	85	70	5	\$1893
LWWDB	24 x 16 x 28	85	75	6	\$2176

Two box and one file drawer. One pencil tray. Lock secures all drawers. Finished back. Ships assembled in 1 carton.

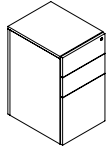

Box/Box/File Module, Mobile

LWDM	19 x 16 x 28	85	70	5	\$2036
LWWDM	24 x 16 x 28	85	75	6	\$2337

Two box and one file drawer. One pencil tray. Lock secures all drawers. Casters. Ships assembled in 1 carton.

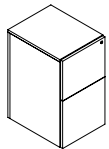

File/File Module, Mobile

LWEM	19 x 16 x 28	85	70	5	\$2207
LWWEM	24 x 16 x 28	85	75	6	\$2372

Two file drawer. Lock secures all drawers. Casters. Ships assembled in 1 carton. Ships assembled in 1 carton.

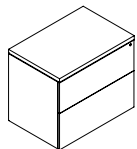

File/File Module, Lateral

LF3624	24 x 36 x 29	85	184	15	\$3491
LN3024	24 x 30 x 29	85	153	12	\$3057
LF3620	20 x 36 x 29	85	159	12	\$2621
LN3020	20 x 30 x 29	85	131	10	\$2292

Two lateral file drawers. Lock secures all drawers. Ships assembled in 1 carton.

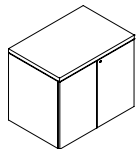

Storage Cabinet w/Doors

LBD3624	24 x 36 x 29	92.5	152	15	\$2375
LBD3024	24 x 30 x 29	92.5	127	12	\$2086
LBD3620	20 x 36 x 29	92.5	130	12	\$1875
LBD3020	20 x 30 x 29	92.5	107	10	\$1634

Includes one adjustable shelf. Standard with lock. Ships assembled in 1 carton.

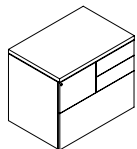

Mixed Storage Cabinet - LEFT

LZL3624	24 x 36 x 29	85	184	15	\$3791
LZL3620	20 x 36 x 29	85	170	13	\$2978

One file drawer on the **left**, two box drawers on the **right** and one lateral file drawer on the bottom. File drawer and lateral file drawer lock. One pencil tray. **Not for stacking materials on lateral file drawer bottom.** Ships assembled in 1 carton.

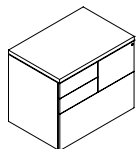

Mixed Storage Cabinet - RIGHT

LZR3624	24 x 36 x 29	85	184	15	\$3791
LZR3620	20 x 36 x 29	85	170	13	\$2978

One file drawer on the **right**, two box drawers on the **left** and one lateral file drawer on the bottom. File drawer and lateral file drawer lock. One pencil tray. **Not for stacking materials on lateral file drawer bottom.** Ships assembled in 1 carton.

Required Specifications

Veneer Finish
Edge

FREESTANDING STORAGE

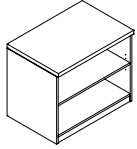

Open Storage Cabinet

MODEL#	DIMENSIONS D x W x H	FREIGHT CLASS	WT/LBS.	CUBIC FT.	LIST PRICE
LOB3624	24 x 36 x 29	100	123	15	\$1909
LOB3024	24 x 30 x 29	100	103	12	\$1668
LOB3620	20 x 36 x 29	100	115	13	\$1503
LOB3020	20 x 30 x 29	100	96	11	\$1308

One fixed and **one** adjustable veneer shelf. Shelves are 3/4" thick. Ships assembled in 1 carton.

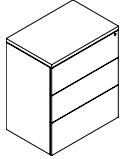

Three File Module

LF36243	24 x 36 x 42	92.5	231	21	\$4270
LN30243	24 x 30 x 42	92.5	193	18	\$3733
LF36203	20 x 36 x 42	92.5	212	19	\$3652
LN30203	20 x 30 x 42	92.5	176	16	\$3194

Three lateral file drawers. Lock secures all drawers. Ships assembled in 1 carton.

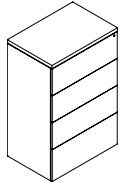

Four File Module

LF36244	24 x 36 x 54	92.5	297	27	\$5202
LN30244	24 x 30 x 54	92.5	248	23	\$4549
LF36204	20 x 36 x 54	92.5	270	25	\$4527
LN30204	20 x 30 x 54	92.5	225	21	\$3960

Four lateral file drawers. Lock secures all drawers. Ships assembled in 1 carton.

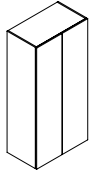

Storage Cabinet w/Doors*

L1D24H72	24 x 35 x 72	100	324	36	\$4544
L1D24W30H72	24 x 30 x 72	100	270	30	\$3968
L1D24W24H72	24 x 24 x 72	100	216	24	\$3389
L1H72	20 x 35 x 72	100	269	30	\$3968
L1W30H72	20 x 30 x 72	100	233	25	\$3311
L1W24H72	20 x 24 x 72	100	179	20	\$2645
L1D24	24 x 35 x 65	100	297	33	\$4167
L1D24W30	24 x 30 x 65	100	248	28	\$3647
L1D24W24	24 x 24 x 65	100	198	22	\$3127
L1W35	20 x 35 x 65	100	245	28	\$3640
L1W30	20 x 30 x 65	100	202	23	\$3034
L1W24	20 x 24 x 65	100	163	18	\$2430

Includes four adjustable shelves. Optional lock available. Ships assembled in 1 carton.

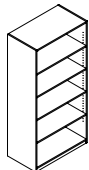

Open Storage Cabinet

L7D24H72	24 x 35 x 72	100	306	36	\$3640
L7D24W30H72	24 x 30 x 72	100	255	30	\$3184
L7H72	20 x 35 x 72	100	257	30	\$3180
L7W30H72	20 x 30 x 72	100	223	25	\$2645
L7D24	24 x 35 x 65	100	281	33	\$3339
L7D24W30	24 x 30 x 65	100	234	28	\$2920
L7	20 x 35 x 65	100	234	28	\$2914
L7W30	20 x 30 x 65	100	193	23	\$2430

Includes one fixed and **four** adjustable veneer shelves. Shelves are 3/4" thick. Ships assembled in 1 carton.

Required Specifications

Veneer finish
Edge (file modules)

Optional Specifications

Lock*

FREESTANDING STORAGE **MODEL#** **DIMENSIONS** **FREIGHT CLASS** **WT/LBS.** **CUBIC FT.** **LIST PRICE**

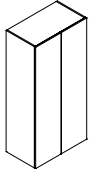

Wardrobe Cabinet

D x W x H						
L2D24H72	24 x 35 x 72	100	324	36	\$3873	
L2D24W30H72	24 x 30 x 72	100	270	30	\$3388	
L2D24W24H72	24 x 24 x 72	100	216	24	\$2902	
L2H72	20 x 35 x 72	100	269	30	\$3385	
L2W30H72	20 x 30 x 72	100	233	25	\$2876	
L2W24H72	20 x 24 x 72	100	179	20	\$2296	
L2D24	24 x 35 x 65	100	297	33	\$3550	
L2D24W30	24 x 30 x 65	100	246	28	\$3108	
L2D24W24	24 x 24 x 65	100	198	22	\$2666	
L2	20 x 35 x 65	100	245	28	\$3155	
L2W30	20 x 30 x 65	100	202	23	\$2635	
L2W24	20 x 24 x 65	100	163	18	\$2109	

Includes full length hanging rod and fixed hat shelf. Lock optional. Ships assembled in 1 carton.

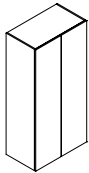

Wardrobe Cabinet/Shelving Combo

L25D24H72	24 x 35 x 72	100	324	36	\$5097	
L25D24W30H72	24 x 30 x 72	100	270	30	\$4460	
L25D24W24H72	24 x 24 x 72	100	216	24	\$3930	
L25H72	20 x 35 x 72	100	269	30	\$4446	
L25W30H72	20 x 30 x 72	100	233	25	\$3710	
L25W24H72	20 x 24 x 72	100	179	20	\$2972	
L25D24	24 x 35 x 65	100	297	33	\$4677	
L25D24W30	24 x 30 x 65	100	246	28	\$4086	
L25D24W24	24 x 24 x 65	100	198	22	\$3503	
L25	20 x 35 x 65	100	245	28	\$4075	
L25W30	20 x 30 x 65	100	202	23	\$3401	
L25W24	20 x 24 x 65	100	163	18	\$2726	

Wardrobe compartment on **left** includes hanging rod and fixed hat shelf. Storage compartment on **right** includes three adjustable shelves. Lock optional. Ships assembled in 1 carton.

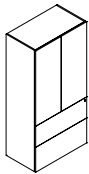

Two File Module w/Doors

L13D24H72	24 x 35 x 72	100	324	36	\$5623	
L13D24W30H72	24 x 30 x 72	100	270	30	\$4921	
L13H72	20 x 35 x 72	100	269	30	\$4911	
L13W30H72	20 x 30 x 72	100	233	25	\$4096	
L13D24	24 x 35 x 65	100	297	33	\$5157	
L13D24W30	24 x 30 x 65	100	248	28	\$4508	
L13	20 x 35 x 65	100	245	28	\$4503	
L13W30	20 x 30 x 65	100	202	23	\$3756	

Two lateral file drawers on bottom. Includes **two** adjustable shelves. Lower lock secures two file drawers. Optional lock available for upper storage compartment. **Not for stacking materials on lateral file drawer bottom.** Ships assembled in 1 carton.

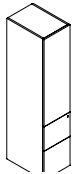

Two File Module w/Door - LEFT

L17D24H72L	24 x 16 x 72	125	99	15	\$3870
L17H72L	20 x 16 x 72	125	90	13	\$3291
L17D24L	24 x 16 x 65	125	91	13	\$3588
L17L	20 x 16 x 65	125	83	12	\$3018

Two file drawers on bottom. Includes two adjustable shelves. Lower lock secures two file drawers. Optional lock available for upper storage compartment. Handle is on the **right**, door opens to the **left**. Ships assembled in 1 carton.

Required Specifications
Veneer finish

Optional Specifications
Lock

FREESTANDING STORAGE

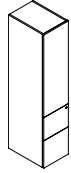

Two File Module w/Door - RIGHT

MODEL#	DIMENSIONS D x W x H	FREIGHT CLASS	WT/LBS.	CUBIC FT.	LIST PRICE
L17D24H72R	24 x 16 x 72	125	99	15	\$3870
L17H72R	20 x 16 x 72	125	90	13	\$3291
L17D24R	24 x 16 x 65	125	91	13	\$3588
L17R	20 x 16 x 65	125	83	12	\$3018

Two file drawers on bottom. Includes two adjustable shelves. Optional lock available on upper storage compartment. Lower lock secures two file drawers. Handle is on the **left**, door opens to the **right**. Ships assembled in 1 carton.

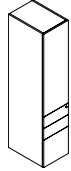

Box/Box/File Module w/Door - LEFT

L18D24H72L	24 x 16 x 72	125	99	15	\$3870
L18H72L	20 x 16 x 72	125	90	13	\$3291
L18D24L	24 x 16 x 65	125	91	13	\$3588
L18L	20 x 16 x 65	125	83	12	\$3018

Two box drawers and one file drawer on bottom. Includes two adjustable shelves. Optional lock available on upper storage compartment. Lower lock secures all drawers. Handle is on the **right**, door opens to the **left**. Ships assembled in 1 carton.

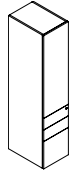

Box/Box/File Module w/Door - RIGHT

L18D24H72R	24 x 16 x 72	125	99	15	\$3870
L18H72R	20 x 16 x 72	125	90	13	\$3291
L18D24R	24 x 16 x 65	125	91	13	\$3588
L18R	20 x 16 x 65	125	83	12	\$3018

Two box drawers and one file drawer on bottom. Includes two adjustable shelves. Optional lock available on upper storage compartment. Lower lock secures all drawers. Handle is on the **left**, door opens to the **right**. Ships assembled in 1 carton.

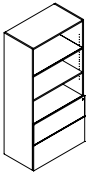

Two File Module w/Open Shelves

L12D24H72	24 x 35 x 72	100	324	36	\$4939
L12D24W30H72	24 x 30 x 72	100	270	30	\$4320
L12H72	20 x 35 x 72	100	269	30	\$4311
L12W30H72	20 x 30 x 72	100	233	25	\$3772
L12D24	24 x 35 x 65	100	297	33	\$4527
L12D24W30	24 x 30 x 65	100	248	28	\$3960
L12	20 x 35 x 65	100	245	28	\$3947
L12W30	20 x 30 x 65	100	239	23	\$3298

Three open veneer shelves and two lateral file drawers on bottom. Includes two adjustable shelves. Lock secures all drawers. Front-to-back and side-to-side filing. **Not for stacking materials on lateral file drawer bottom**. Ships assembled in 1 carton.

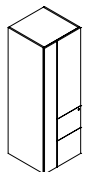

Personal Tower - LEFT

L29D24W24H72L	24 x 24 x 72	125	168	24	\$5757
L29W24H72L	20 x 24 x 72	125	140	20	\$4706
L29D24W24L	24 x 24 x 65	125	154	22	\$5167
L29W24L	20 x 24 x 65	125	128	18	\$4263

Two file drawers on bottom. Wardrobe compartment on **left** includes hanging rod. Storage compartment on **right** includes one adjustable shelf. Optional lock available on upper storage and wardrobe. Lower lock secures all drawers. Ships assembled in 1 carton.

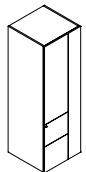

Personal Tower - RIGHT

L29D24W24H72R	24 x 24 x 72	125	168	24	\$5757
L29W24H72R	20 x 24 x 72	125	140	20	\$4706
L29D24W24R	24 x 24 x 65	125	154	22	\$5167
L29W24R	20 x 24 x 65	125	128	18	\$4263

Two file drawers on bottom. Wardrobe compartment on **right** includes hanging rod. Storage compartment on **left** includes one adjustable shelf. Optional lock available on upper storage and wardrobe. Lower lock secures all drawers. Ships assembled in 1 carton.

Required Specifications
Veneer Finish

Optional Specifications
Lock

FREESTANDING STORAGE **MODEL#** **DIMENSIONS** **FREIGHT CLASS** **WT/LBS.** **CUBIC FT.** **LIST PRICE**

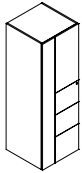

Personal Tower - LEFT

D x W x H						
L27D24W24H72L	24 x 24 x 72	125	168	24	\$6349	
L27W24H72L	20 x 24 x 72	125	140	20	\$5551	
L27D24W24L	24 x 24 x 65	125	154	22	\$5825	
L27W24L	20 x 24 x 65	125	128	18	\$5085	

Three file drawers on bottom. Wardrobe compartment on **left** includes hanging rod. Storage compartment on **right** includes one adjustable shelf. Optional lock available on upper storage and wardrobe. Lower lock secures all drawers. Ships assembled in 1 carton.

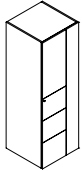

Personal Tower - RIGHT

L27D24W24H72R	24 x 24 x 72	125	168	24	\$6349
L27W24H72R	20 x 24 x 72	125	140	20	\$5551
L27D24W24R	24 x 24 x 65	125	154	22	\$5825
L27W24R	20 x 24 x 65	125	128	18	\$5085

Three file drawers on bottom. Wardrobe compartment on **right** includes hanging rod. Storage compartment on **left** includes one adjustable shelf. Optional lock available on upper storage and wardrobe. Lower lock secures all drawers. Ships assembled in 1 carton.

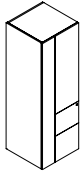

Personal Tower w/Open Bookcase - LEFT

L30D24W24H72L	24 x 24 x 72	125	168	24	\$5757
L30W24H72L	20 x 24 x 72	125	140	20	\$4706
L30D24W24L	24 x 24 x 65	125	154	22	\$5167
L30W24L	20 x 24 x 65	125	128	18	\$4263

Two file drawers on bottom. Wardrobe compartment on **left** includes hanging rod. Storage compartment on **right** includes one adjustable shelf. Open bookcase on **right** includes two adjustable shelves. Optional lock available on upper storage and wardrobe. Lower lock secures all drawers. Ships assembled in 1 carton.

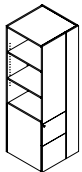

Personal Tower w/Open Bookcase - RIGHT

L30D24W24H72R	24 x 24 x 72	125	168	24	\$5757
L30W24H72R	20 x 24 x 72	125	140	20	\$4706
L30D24W24R	24 x 24 x 65	125	154	22	\$5167
L30W24R	20 x 24 x 65	125	128	18	\$4263

Two file drawers on bottom. Wardrobe compartment on **right** includes hanging rod. Storage compartment on **left** includes one adjustable shelf. Open bookcase on **left** includes two adjustable shelves. Upper lock secures storage and wardrobe compartments. Lower lock secures all drawers. Ships assembled in 1 carton.

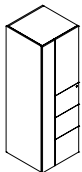

Personal Tower w/Open Bookcase - LEFT

L26D24W24H72L	24 x 24 x 72	125	168	24	\$6349
L26W24H72L	20 x 24 x 72	125	140	20	\$6285
L26D24W24L	24 x 24 x 65	125	154	22	\$5825
L26W24L	20 x 24 x 65	125	128	18	\$5807

Three file drawers on bottom. Wardrobe compartment on **left** includes hanging rod. Storage compartment on **right** includes one adjustable shelf. Open bookcase on **right** includes one adjustable shelf. Optional lock available on upper storage and wardrobe. Lower lock secures all drawers. Ships assembled in 1 carton.

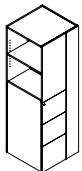

Personal Tower w/Open Bookcase - RIGHT

L26D24W24H72R	24 x 24 x 72	125	168	24	\$6349
L26W24H72R	20 x 24 x 72	125	140	20	\$6285
L26D24W24R	24 x 24 x 65	125	154	22	\$5825
L26W24R	20 x 24 x 65	125	128	18	\$5807

Three file drawers on bottom. Wardrobe compartment on **right** includes hanging rod. Storage compartment on **left** includes one adjustable shelf. Open bookcase on **left** includes one adjustable shelf. Optional lock available on upper storage and wardrobe. Lower lock secures all drawers. Ships assembled in 1 carton.

Required Specifications
Veneer Finish

Optional Specifications
Lock

FREESTANDING STORAGE

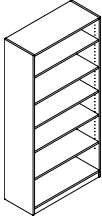

Bookcase



End Shelf - 72" High - Square

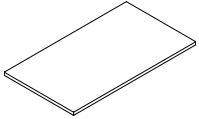

Shelf for Bookcase

MODEL#	DIMENSIONS D x W x H	FREIGHT CLASS	WT/LBS.	CUBIC FT.	LIST PRICE
LB73615	15 x 35 x 78	100	228	24	\$2590
LB63615	15 x 35 x 72	100	210	23	\$2389
LB53615	15 x 35 x 65	100	210	23	\$2200
LB73015	15 x 30 x 78	92.5	228	20	\$2265
LB63015	15 x 30 x 72	92.5	210	19	\$2086
LB53015	15 x 30 x 65	92.5	188	17	\$1925

Includes **adjustable** shelves. Shelf is ¾" thick. Ships assembled in 1 carton.

LB7S1515	15 x 15 x 78	100	95	10	\$2041
LB6S1515	15 x 15 x 72	100	83	9	\$1879
LB5S1515	15 x 15 x 65	100	81	9	\$1730
LB4S1515	15 x 15 x 48	100	59	6	\$1429

For use at end of **storage modules, wardrobe cabinets or personal towers**. Includes **adjustable** veneer shelves. Ships assembled in 1 carton.

MAG3624	24 x 35 x 1	92.5	112	10	\$183
MAG3620	20 x 35 x 1	92.5	92	9	\$156
MAG3615	15 x 35 x 1	92.5	81	8	\$131
MAG3024	24 x 30 x 1	92.5	94	9	\$156
MAG3020	20 x 30 x 1	100	76	8	\$124
MAG3015	15 x 30 x 1	100	67	8	\$109

Ships assembled in 1 carton.

Required Specifications

Veneer finish

FLOATING SHELVES

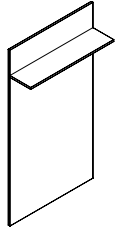

**Wall Mounted Panel,
One Floating Shelf**

MODEL#	DIMENSIONS	FREIGHT CLASS	WT/LBS.	CUBIC FT.	LIST PRICE
D x W x H					
TWF1S2466	11 x 24 x 66	250	42	13	\$1607
TWF1S3066	11 x 30 x 66	250	50	16	\$1874
TWF1S3666	11 x 36 x 66	250	58	19	\$2167
TWF1S4266	11 x 42 x 66	250	66	22	\$2489
TWF1S2472	11 x 24 x 72	250	45	14	\$1710
TWF1S3072	11 x 30 x 72	250	53	17	\$2012
TWF1S3672	11 x 36 x 72	250	62	20	\$2291
TWF1S4272	11 x 42 x 72	250	71	23	\$2624

Standard with pre-mounted "J" bracket for wall mount applications. End cap required at the end of a run of floating shelves. End cap sold separately. Shipped RTA - ready to assemble.

NOTE: Care should be taken to mount the units. Units should be mounted to wall studs using correct fasteners. Failure to do so may result in collapse of the unit and subsequent personal injury. **Fastening hardware not included.** Mounting hardware used should be based on wall material. Consult an installation professional for proper wall mounting.

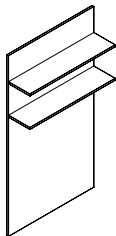

**Wall Mounted Panel,
Two Floating Shelves**

TWF2S2466	11 x 24 x 66	250	46	13	\$1645
TWF2S3066	11 x 30 x 66	250	56	16	\$1929
TWF2S3666	11 x 36 x 66	250	65	19	\$2219
TWF2S4266	11 x 42 x 66	250	74	21	\$2566
TWF2S2472	11 x 24 x 72	250	49	14	\$1756
TWF2S3072	11 x 30 x 72	250	59	17	\$2079
TWF2S3672	11 x 36 x 72	250	69	20	\$2343
TWF2S4272	11 x 42 x 72	250	79	23	\$2697

Standard with pre-mounted "J" bracket for wall mount applications. End cap required at the end of a run of floating shelves. End cap sold separately. Shipped RTA - ready to assemble.

NOTE: Care should be taken to mount the units. Units should be mounted to wall studs using correct fasteners. Failure to do so may result in collapse of the unit and subsequent personal injury. **Fastening hardware not included.** Mounting hardware used should be based on wall material. Consult an installation professional for proper wall mounting.



End Cap

ENDCAP66	.75 x 66 x 3	60	6	0.04	\$873
ENDCAP72	.75 x 72 x 3	60	8	0.05	\$942

For use with wall mounted panels.

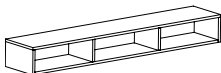

Wall Mounted Open Storage

CBYFO96D12H8	12 x 96 x 8	125	78	10	\$2863
CBYFO64D12H8	12 x 64 x 8	125	50	8	\$1873
CBYFO32D12H8	12 x 32 x 8	100	35	4	\$1697

To be used as a stand alone unit. Ships assembled in 1 carton.

Required Specifications

Veneer finish

WALLMOUNT STORAGE

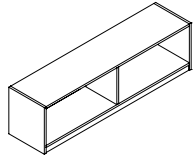

Open Front Overhead Storage

MODEL#	DIMENSIONS D x W x H	FREIGHT CLASS	WT/LBS.	CUBIC FT.	LIST PRICE
CSF072	15 x 72 x 17	92.5	100	10	\$1960
CSF066	15 x 66 x 17	100	83	9	\$1799
CSF060	15 x 60 x 17	100	75	8	\$1641
CSF054	15 x 54 x 17	100	68	7	\$1481
CSF048	15 x 48 x 17	100	60	7	\$1316
CSF042	15 x 42 x 17	100	55	6	\$1212
CSF036	15 x 36 x 17	92.5	50	5	\$1194
CSF030	15 x 30 x 17	92.5	45	4	\$1171

Includes pre-mounted "J" brackets for wall mount applications. Ships assembled in 1 carton.

- **NOTE:** Care should be taken to mount the units. Units should be mounted to wall studs using correct fasteners. Failure to do so may result in collapse of the unit and subsequent personal injury. **Mounting hardware not included.** Mounting hardware used should be based on wall material. Consult an installation professional for proper wall mounting.

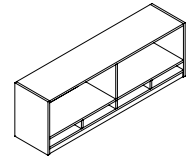

Open Front Overhead Storage - Pigeon-Hole Storage

CSFOP72	15 x 72 x 20	92.5	100	12	\$2354
CSFOP66	15 x 66 x 20	100	83	11	\$2162
CSFOP60	15 x 60 x 20	100	75	10	\$1964
CSFOP54	15 x 54 x 20	100	68	9	\$1772
CSFOP48	15 x 48 x 20	100	60	8	\$1569
CSFOP42	15 x 42 x 20	100	55	7	\$1476
CSFOP36	15 x 36 x 20	92.5	50	6	\$1434
CSFOP30	15 x 30 x 20	92.5	45	5	\$1413

Includes pre-mounted "J" brackets for wall mount applications. Horizontal pigeon-hole storage on bottom of overhead. Ships assembled in 1 carton.

- **NOTE:** Care should be taken to mount the units. Units should be mounted to wall studs using correct fasteners. Failure to do so may result in collapse of the unit and subsequent personal injury. **Mounting hardware not included.** Mounting hardware used should be based on wall material. Consult an installation professional for proper wall mounting.

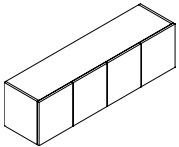

Closed Front Overhead Storage with Hinge Doors*

CSF72	15 x 72 x 17	92.5	100	10	\$2418
CSF66	15 x 66 x 17	100	83	9	\$2218
CSF60	15 x 60 x 17	100	75	8	\$2010
CSF54	15 x 54 x 17	100	68	7	\$1812
CSF48	15 x 48 x 17	100	60	7	\$1611
CSF42	15 x 42 x 17	100	55	6	\$1481
CSF36	15 x 36 x 17	92.5	50	5	\$1453
CSF30	15 x 30 x 17	92.5	45	4	\$1429

Includes pre-mounted "J" brackets for wall mount applications. Lock optional. Ships assembled in 1 carton.

- **NOTE:** Care should be taken to mount the units. Units should be mounted to wall studs using correct fasteners. Failure to do so may result in collapse of the unit and subsequent personal injury. **Mounting hardware not included.** Mounting hardware used should be based on wall material. Consult an installation professional for proper wall mounting.

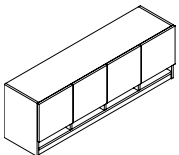

Closed Front Overhead Storage with Hinge Doors & Pigeon-Hole Storage*

CSFP72	15 x 72 x 20	92.5	100	12	\$2897
CSFP66	15 x 66 x 20	100	83	11	\$2658
CSFP60	15 x 60 x 20	100	75	10	\$2418
CSFP54	15 x 54 x 20	100	68	9	\$2176
CSFP48	15 x 48 x 20	100	60	8	\$1931
CSFP42	15 x 42 x 20	100	55	7	\$1832
CSFP36	15 x 36 x 20	92.5	50	6	\$1744
CSFP30	15 x 30 x 20	92.5	45	5	\$1715

Includes pre-mounted "J" brackets for wall mount applications. Horizontal pigeon-hole storage on bottom of overhead. Lock optional. Ships assembled in 1 carton.

- **NOTE:** Care should be taken to mount the units. Units should be mounted to wall studs using correct fasteners. Failure to do so may result in collapse of the unit and subsequent personal injury. **Mounting hardware not included.** Mounting hardware used should be based on wall material. Consult an installation professional for proper wall mounting.

Required Specifications
Veneer finish

Optional Specifications
Lock*

HUTCHES **MODEL#** **DIMENSIONS** **FREIGHT CLASS** **WT/LBS.** **CUBIC FT.** **LIST PRICE**

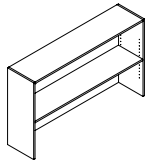

Open Hutch with Closed Back

	D x W x H					
L72CL36	14 x 72 x 36	125	155	23		\$2194
L66CL36	14 x 66 x 36	125	140	21		\$2036
L60CL36	14 x 60 x 36	125	130	19		\$1805
L48CL36	14 x 48 x 36	125	110	15		\$1720
L42CL36	14 x 42 x 36	125	95	13		\$1562
L36CL36	14 x 36 x 36	125	80	11		\$1458
L30CL36	14 x 30 x 36	125	67	9		\$1217

One adjustable shelf. Closed back. Ships assembled in 1 carton.
 • **A Tackboard cannot be used with this hutch.**

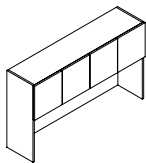

Closed Hutch w/Veneer Doors 36"H*

L108SH36	15 x 108 x 36	125	268	34		\$5337
L102SH36	15 x 102 x 36	125	254	32		\$5041
L96SH36	15 x 96 x 36	100	241	30		\$4742
L90SH36	15 x 90 x 36	100	227	28		\$4446
L84SH36	15 x 84 x 36	100	214	26		\$4154
L78SH36	15 x 78 x 36	100	200	24		\$3858
L72SH36	15 x 72 x 36	100	187	23		\$3560
L66SH36	15 x 66 x 36	100	173	21		\$3428
L60SH36	15 x 60 x 36	100	160	19		\$3263
L36SH36	15 x 36 x 36	100	94	11		\$2226
L30SH36	15 x 30 x 36	100	78	9		\$1951

One fixed shelf. Closed back features one grommet. Ships assembled in 1 carton. Lock optional.
 • Models 108" w have three fixed shelf dividers.
 • Models 84" w- 102" w have two fixed shelf dividers.
 • Models 60" w - 78" w have one fixed shelf divider.
 • *Clearance from worksurface to valance is 19.5".*

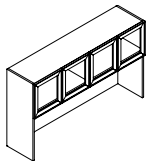

Closed Hutch w/Glass Doors 36"H

L108SH36G	15 x 108 x 36	125	268	34		\$7796
L102SH36G	15 x 102 x 36	125	254	32		\$7036
L96SH36G	15 x 96 x 36	100	241	30		\$6709
L90SH36G	15 x 90 x 36	100	227	28		\$6362
L84SH36G	15 x 84 x 36	100	214	26		\$6034
L78SH36G	15 x 78 x 36	100	200	24		\$5709
L72SH36G	15 x 72 x 36	100	187	23		\$4984
L66SH36G	15 x 66 x 36	100	173	21		\$4774
L60SH36G	15 x 60 x 36	100	160	19		\$4553
L36SH36G	15 x 36 x 36	100	94	11		\$2914
L30SH36G	15 x 30 x 36	100	78	9		\$2600

One fixed shelf. Closed back features one grommet. Aluminum frame available in Tungsten finish only. Ships assembled in 1 carton. Translucent, screened glass.
 • Models 108" w have three fixed shelf dividers.
 • Models 84" w- 102" w have two fixed shelf dividers.
 • Models 60" w - 78" w have one fixed shelf divider.
 • *Clearance from worksurface to valance is 19.5".*
 • **Locks are not available on hutches with Glass Doors.**

Required Specifications
 Veneer finish

Optional Specifications
 Lock*

HUTCHES

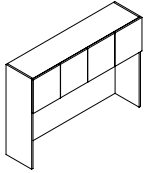

Closed Hutch w/Veneer Doors 42"H*

MODEL#	DIMENSIONS D x W x H	FREIGHT CLASS	WT/LBS.	CUBIC FT.	LIST PRICE
L108SH42	15 x 108 x 42	125	307	39	\$6224
L102SH42	15 x 102 x 42	125	290	37	\$5874
L96SH42	15 x 96 x 42	100	273	35	\$5533
L90SH42	15 x 90 x 42	100	256	33	\$5184
L84SH42	15 x 84 x 42	100	239	31	\$4841
L78SH42	15 x 78 x 42	100	222	38	\$4498
L72SH42	15 x 72 x 42	100	205	26	\$4151
L66SH42	15 x 66 x 42	100	188	24	\$4001
L60SH42	15 x 60 x 42	100	171	22	\$3805
L36SH42	15 x 36 x 42	100	102	13	\$2594
L30SH42	15 x 30 x 42	100	85	11	\$2273

One fixed shelf. Closed back features one grommet. Ships assembled in 1 carton. Lock optional.

- Models 108"w have three fixed shelf dividers.
- Models 84"w- 102"w have two fixed shelf dividers.
- Models 60"w - 78"w have one fixed shelf divider.
- *Clearance from worksurface to valance is 19.5".*

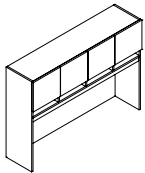

Closed Hutch w/Veneer Doors Pigeon-Hole Storage, 42"H*

L108SHP42	15 x 108 x 42	125	307	39	\$7468
L102SHP42	15 x 102 x 42	125	290	37	\$7053
L96SHP42	15 x 96 x 42	100	273	35	\$6637
L90SHP42	15 x 90 x 42	100	256	33	\$6224
L84SHP42	15 x 84 x 42	100	239	31	\$5807
L78SHP42	15 x 78 x 42	100	222	38	\$5394
L72SHP42	15 x 72 x 42	100	205	26	\$4977
L66SHP42	15 x 66 x 42	100	188	24	\$4794
L60SHP42	15 x 60 x 42	100	171	22	\$4567
L36SHP42	15 x 36 x 42	100	102	13	\$3113
L30SHP42	15 x 30 x 42	100	85	11	\$2726

One fixed shelf. Closed back features one grommet. Horizontal pigeon-hole storage top mounted to hutch. Ships assembled in 1 carton. Lock optional.

- Models 120"w- 108"w have three fixed shelf dividers.
- Models 84"w- 102"w have two fixed shelf dividers.
- Models 60"w - 78"w have one fixed shelf divider.
- *Clearance from worksurface to valance is 21.5".*

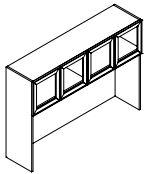

Closed Hutch w/Glass Doors 42" High

L108SH42G	15 x 108 x 42	125	307	39	\$8213
L102SH42G	15 x 102 x 42	125	290	37	\$7413
L96SH42G	15 x 96 x 42	100	273	35	\$7057
L90SH42G	15 x 90 x 42	100	256	33	\$6704
L84SH42G	15 x 84 x 42	100	239	31	\$6349
L78SH42G	15 x 78 x 42	100	222	38	\$6001
L72SH42G	15 x 72 x 42	100	205	26	\$5177
L66SH42G	15 x 66 x 42	100	188	24	\$5001
L60SH42G	15 x 60 x 42	100	171	22	\$4819
L36SH42G	15 x 36 x 42	100	102	13	\$3080
L30SH42G	15 x 30 x 42	100	85	11	\$2739

One fixed shelf. Closed back features one grommet. Aluminum frame available in Tungsten finish only. Ships assembled in 1 carton. Translucent, screened glass.

- Models 120"w- 108"w have three fixed shelf dividers.
- Models 84"w- 102"w have two fixed shelf dividers.
- Models 60"w - 78"w have one fixed shelf divider.
- *Clearance from worksurface to valance is 25.5".*
- **Locks are not available on hutches with Glass Doors.**

Required Specifications
Veneer Finish

Optional Specifications
Lock*

HUTCHES **MODEL#** **DIMENSIONS** **FREIGHT CLASS** **WT/LBS.** **CUBIC FT.** **LIST PRICE**

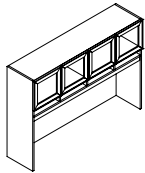

**Closed Hutch w/Glass Doors
Pigeon-Hole Storage, 42" High**

	D x W x H					
L108SHP42G	15 x 108 x 42	125	307	39	\$9344	
L102SHP42G	15 x 102 x 42	125	290	37	\$8481	
L96SHP42G	15 x 96 x 42	100	273	35	\$8083	
L90SHP42G	15 x 90 x 42	100	256	33	\$8207	
L84SHP42G	15 x 84 x 42	100	239	31	\$7219	
L78SHP42G	15 x 78 x 42	100	222	38	\$6807	
L72SHP42G	15 x 72 x 42	100	205	26	\$5934	
L66SHP42G	15 x 66 x 42	100	188	24	\$5737	
L60SHP42G	15 x 60 x 42	100	171	22	\$5470	
L36SHP42G	15 x 36 x 42	100	102	13	\$3553	
L30SHP42G	15 x 30 x 42	100	85	11	\$3171	

One fixed shelf. Closed back features one grommet. Aluminum frame available in Tungsten finish only. Horizontal pigeon-hole storage top mounted to hutch. Ships assembled in 1 carton. Translucent, screened glass.

- Models 120"w- 108"w have three fixed shelf dividers.
- Models 84"w- 102"w have two fixed shelf dividers.
- Models 60"w - 78"w have one fixed shelf divider.
- *Clearance from worksurface to valance is 21.5".*
- **Locks are not available on hutches with Glass Doors.**

Required Specifications
Veneer Finish

TACKBOARDS FOR OVERHEAD STORAGE

MODEL# DIMENSIONS FREIGHT CLASS WT/LBS. CUBIC FT. GR. 1-3 GR. 4-5

D x W x H

TACKBOARD Notes: Tackboards can be upholstered in all of the following fabrics:

Grade 1: Jenny, Quilt, Terrace, Urban, Waterfall

Grade 2: Imprint, Lola

Grade 3: Anchorage, Merge

LTS108	1 x 108 x 20	92.5	23	2	\$952	\$1193
LTS102	1 x 102 x 20	100	19	2	\$898	\$1125
LTS96	1 x 96 x 20	70	17	1	\$847	\$1063
LTS90	1 x 90 x 20	70	15	1	\$794	\$996
LTS84	1 x 84 x 20	85	14	1	\$744	\$935
LTS78	1 x 78 x 20	85	13	1	\$684	\$859
LTS72	1 x 72 x 20	85	12	1	\$636	\$799
LTS66	1 x 66 x 20	92.5	11	1	\$575	\$722
LTS60	1 x 60 x 20	92.5	10	1	\$532	\$668
LTS36	1 x 36 x 20	125	8	1	\$322	\$408
LTS30	1 x 30 x 20	150	5	1	\$269	\$338

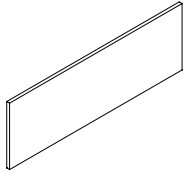

Tackboard for Hutch

For use on **36" H** hutches (**L_SH36, L_SH36G**). **Factory installed**, with velcro tape. Please specify hutch to be installed on. See "tackboard notes" exact fabric availability.

- **Not for use on non-Lufton hutches.**

LTS108H26	1 x 108 x 26	70	30	2	\$1234	\$1545
LTS102H26	1 x 102 x 26	85	24	2	\$1167	\$1463
LTS96H26	1 x 96 x 26	92.5	22	2	\$1097	\$1375
LTS90H26	1 x 90 x 26	92.5	20	2	\$1035	\$1296
LTS84H26	1 x 84 x 26	100	18	2	\$960	\$1203
LTS78H26	1 x 78 x 26	100	17	2	\$889	\$1114
LTS72H26	1 x 72 x 26	70	16	1	\$825	\$1035
LTS66H26	1 x 66 x 26	85	14	1	\$753	\$945
LTS60H26	1 x 60 x 26	85	13	1	\$684	\$859
LTS36H26	1 x 36 x 26	100	8	1	\$417	\$526
LTS30H26	1 x 30 x 26	150	5	1	\$349	\$439

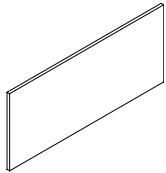

Tackboard for Hutch

For use on **42" H** hutches (**L_SH42, L_SH42**). **Factory installed**, with velcro tape. Please specify hutch to be installed on. See "tackboard notes" exact fabric availability.

- **Not for use on non-Lufton hutches.**

LTSP108H23	1 x 108 x 23	70	30	2	\$1067	\$1338
LTSP102H23	1 x 102 x 23	85	24	2	\$1022	\$1280
LTSP96H23	1 x 96 x 23	92.5	20	2	\$956	\$1198
LTSP90H23	1 x 90 x 23	92.5	20	1	\$898	\$1125
LTSP84H23	1 x 84 x 23	70	18	1	\$832	\$1043
LTSP78H23	1 x 78 x 23	70	17	1	\$777	\$974
LTSP72H23	1 x 72 x 23	70	16	1	\$720	\$903
LTSP66H23	1 x 66 x 23	85	14	1	\$655	\$825
LTSP60H23	1 x 60 x 23	85	13	1	\$616	\$757
LTSP36H23	1 x 36 x 23	100	8	1	\$360	\$453
LTSP30H23	1 x 30 x 23	150	5	1	\$304	\$382

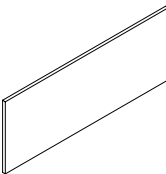

Tackboard for Hutch

For use on **42" H** hutches (**L_SHP42, L_SHP42G**) with Pigeon-Hole Storage. **Factory installed**, with velcro tape. Please specify hutch to be installed on. See "tackboard notes" exact fabric availability.

- **Not for use on non-Lufton hutches.**

Required Specifications

Fabric

TACKBOARDS FOR OVERHEAD STORAGE **MODEL#** **DIMENSIONS** **FREIGHT CLASS** **WT/LBS.** **CUBIC FT.** **GR. 1-3** **GR. 4-5**

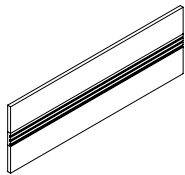

Tackboard for Hutch - Accessory Rail

	D x W x H						
LTSAS108	1 x 108 x 20	92.5	23	2		\$1681	\$2106
LTSAS102	1 x 102 x 20	100	19	2		\$1515	\$1896
LTSAS96	1 x 96 x 20	70	15	1		\$1494	\$1872
LTSAS90	1 x 90 x 20	70	15	1		\$1401	\$1756
LTSAS84	1 x 84 x 20	85	14	1		\$1308	\$1640
LTSAS78	1 x 78 x 20	85	13	1		\$1217	\$1525
LTSAS72	1 x 72 x 20	85	12	1		\$1119	\$1402
LTSAS66	1 x 66 x 20	92.5	11	1		\$1029	\$1289
LTSAS60	1 x 60 x 20	92.5	10	1		\$937	\$1174
LTSAS36	1 x 36 x 20	125	6	1		\$560	\$703
LTSAS30	1 x 30 x 20	150	4	1		\$468	\$588

For use on **36" H** hutches (**L_SH36, L_SH36G**). **Factory installed**, with velcro tape. Please specify hutch to be installed on. See "tackboard notes" exact fabric availability.

- **Must Specify Black (E) or Tungsten (K) Accessory Rail finish.**
- **Not for use on non-Lufton hutches.**

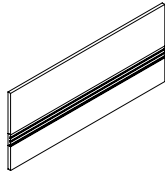

Tackboard for Hutch - Accessory Rail

LTSAS108H26	1 x 108 x 26	70	23	2		\$2022	\$2532
LTSAS102H26	1 x 102 x 26	85	19	2		\$1904	\$2383
LTSAS96H26	1 x 96 x 26	92.5	15	1		\$1796	\$2250
LTSAS90H26	1 x 90 x 26	92.5	15	1		\$1687	\$2115
LTSAS84H26	1 x 84 x 26	100	14	1		\$1556	\$1947
LTSAS78H26	1 x 78 x 26	100	13	1		\$1458	\$1825
LTSAS72H26	1 x 72 x 26	70	12	1		\$1324	\$1659
LTSAS66H26	1 x 66 x 26	85	11	1		\$1234	\$1545
LTSAS60H26	1 x 60 x 26	85	10	1		\$1119	\$1402
LTSAS36H26	1 x 36 x 26	100	6	1		\$674	\$846
LTSAS30H26	1 x 30 x 26	150	4	1		\$567	\$712

For use on **42" H** hutches (**L_SH42, L_SH42G**). **Factory installed**, with velcro tape. Please specify hutch to be installed on. See "tackboard notes" exact fabric availability.

- **Must Specify Black (E) or Tungsten (K) Accessory Rail finish.**
- **Not for use on non-Lufton hutches.**

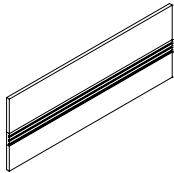

Tackboard for Hutch - Accessory Rail

LTSPAS108H23	1 x 108 x 23	92.5	30	2		\$1824	\$2284
LTSPAS102H23	1 x 102 x 23	100	24	2		\$2273	\$2844
LTSPAS96H23	1 x 96 x 23	70	20	2		\$1622	\$2031
LTSPAS90H23	1 x 90 x 23	70	20	2		\$1527	\$1910
LTSPAS84H23	1 x 84 x 23	85	18	2		\$1422	\$1782
LTSPAS78H23	1 x 78 x 23	85	17	2		\$1320	\$1653
LTSPAS72H23	1 x 72 x 23	85	16	1		\$1217	\$1525
LTSPAS66H23	1 x 66 x 23	92.5	14	1		\$1119	\$1402
LTSPAS60H23	1 x 60 x 23	92.5	13	1		\$1018	\$1274
LTSPAS36H23	1 x 36 x 23	125	6	1		\$613	\$769
LTSPAS30H23	1 x 30 x 23	150	4	1		\$514	\$645

For use on **42" H** hutches (**L_SHP42, L_SHP42G**) with Pigeon-Hole Storage. **Factory installed**, with velcro tape. Please specify hutch to be installed on. See "tackboard notes" exact fabric availability. List Price shown applies for all fabric grades.

- **Must Specify Black (E) or Tungsten (K) Accessory Rail finish.**
- **Not for use on non-Lufton hutches.**

Required Specifications

Fabric

WALLMOUNT TACKBOARDS

MODEL#	DIMENSIONS D x W x H	FREIGHT CLASS	WT/LBS.	CUBIC FT.	GR. 1-3	GR. 4-5
TS108	1 x 106 x 19	70	23	2	\$1460	\$1825
TS102	1 x 100 x 19	85	19	2	\$1383	\$1729
TS96	1 x 94 x 19	70	15	1	\$1293	\$1619
TS90	1 x 88 x 19	70	15	1	\$1216	\$1521
TS84	1 x 82 x 19	70	14	1	\$1139	\$1422
TS78	1 x 76 x 19	70	13	1	\$1055	\$1319
TS72	1 x 70 x 19	70	12	1	\$594	\$744
TS66	1 x 64 x 19	85	11	1	\$546	\$686
TS60	1 x 58 x 19	85	10	1	\$502	\$631
TS36	1 x 34 x 19	100	6	1	\$322	\$408
TS30	1 x 28 x 19	150	4	1	\$268	\$337

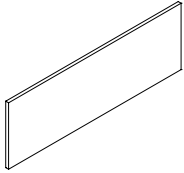

Tackboard - Wallmounted

For use on **16.5"H** overhead storage (CSFO_, CSF_, CSFF_) at a finished height of 66". See "tackboard notes" exact fabric availability. List Price shown applies for all fabric grades.

- **NOTE:** Care should be taken to mount the units. Units should be mounted to wall studs using correct fasteners. Failure to do so may result in collapse of the unit and subsequent personal injury. **Mounting hardware not included.** Mounting hardware used should be based on wall material. Consult an installation professional for proper wall mounting.

TS108H26	1 x 106 x 26	70	30	2	\$1898	\$2374
TS102H26	1 x 100 x 26	85	24	2	\$1788	\$2235
TS96H26	1 x 94 x 26	92.5	20	2	\$1691	\$2116
TS90H26	1 x 88 x 26	92.5	20	2	\$1585	\$1980
TS84H26	1 x 82 x 26	100	18	2	\$1473	\$1842
TS78H26	1 x 76 x 26	100	17	2	\$1370	\$1714
TS72H26	1 x 70 x 26	70	16	1	\$761	\$956
TS66H26	1 x 64 x 26	85	14	1	\$701	\$879
TS60H26	1 x 58 x 26	85	13	1	\$641	\$805
TS36H26	1 x 34 x 26	100	8	1	\$403	\$506
TS30H26	1 x 28 x 26	150	5	1	\$338	\$428

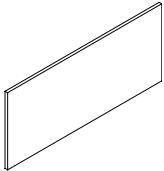

Tackboard - Wallmounted

For use on **16.5"H** overhead storage (CSFO_, CSF_) at a finished height of 72". See "tackboard notes" exact fabric availability. List Price shown applies for all fabric grades.

- **NOTE:** Care should be taken to mount the units. Units should be mounted to wall studs using correct fasteners. Failure to do so may result in collapse of the unit and subsequent personal injury. **Mounting hardware not included.** Mounting hardware used should be based on wall material. Consult an installation professional for proper wall mounting.

TSP108H23	1 x 106 x 23	70	30	2	\$1704	\$2045
TSP102H23	1 x 100 x 23	85	24	2	\$1625	\$1951
TSP96H23	1 x 94 x 23	92.5	20	2	\$1467	\$1832
TSP90H23	1 x 88 x 23	92.5	20	1	\$1370	\$1714
TSP84H23	1 x 82 x 23	70	18	1	\$1280	\$1599
TSP78H23	1 x 76 x 23	70	17	1	\$1047	\$1273
TSP72H23	1 x 70 x 23	70	16	1	\$973	\$1222
TSP66H23	1 x 64 x 23	85	14	1	\$884	\$1109
TSP60H23	1 x 58 x 23	85	13	1	\$641	\$805
TSP36H23	1 x 34 x 23	100	8	1	\$488	\$505
TSP30H23	1 x 28 x 23	150	5	1	\$404	\$430

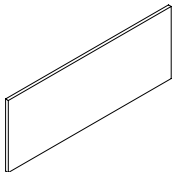

Tackboard - Wallmounted

For use on **19.5"H** overhead storage (CSFOP_, CSFP_) with Pigeon-Hole Storage at a finished height of 72". See "tackboard notes" exact fabric availability. List Price shown applies for all fabric grades.

- **NOTE:** Care should be taken to mount the units. Units should be mounted to wall studs using correct fasteners. Failure to do so may result in collapse of the unit and subsequent personal injury. **Mounting hardware not included.** Mounting hardware used should be based on wall material. Consult an installation professional for proper wall mounting.

Required Specifications

Fabric

WALLMOUNT TACKBOARDS **MODEL#** **DIMENSIONS** **FREIGHT CLASS** **WT/LBS.** **CUBIC FT.** **GR. 1-3** **GR. 4-5**

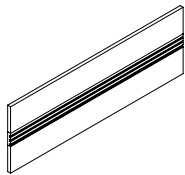

Tackboard - Accessory Rail, Wallmounted

	D x W x H						
TSAS108	1 x 106 x 20	92.5	23	2	\$2258	\$2826	
TSAS102	1 x 100 x 20	100	19	2	\$2138	\$2668	
TSAS96	1 x 94 x 20	70	15	1	\$2003	\$2509	
TSAS90	1 x 88 x 20	70	15	1	\$1880	\$2353	
TSAS84	1 x 82 x 20	85	14	1	\$1753	\$2194	
TSAS78	1 x 76 x 20	85	13	1	\$1633	\$2043	
TSAS72	1 x 70 x 20	85	12	1	\$1504	\$1884	
TSAS66	1 x 64 x 20	92.5	11	1	\$1383	\$1733	
TSAS60	1 x 58 x 20	92.5	10	1	\$1254	\$1569	
TSAS36	1 x 34 x 20	125	6	1	\$752	\$938	
TSAS30	1 x 28 x 20	150	4	1	\$584	\$732	

For use on **16.5"H** overhead storage (**CSFO_**, **CSF_**) at a finished height of **66"**. See "tackboard notes" exact fabric availability. List Price shown applies for all fabric grades.

- **Must Specify Black (E) or Tungsten (K) Accessory Rail finish.**
- **NOTE:** Care should be taken to mount the units. Units should be mounted to wall studs using correct fasteners. Failure to do so may result in collapse of the unit and subsequent personal injury. **Mounting hardware not included.** Mounting hardware used should be based on wall material. Consult an installation professional for proper wall mounting.

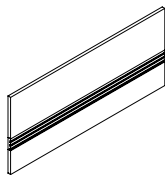

Tackboard - Accessory Rail, Wallmounted

TSAS108H26	1 x 106 x 26	70	23	2	\$2715	\$3395
TSAS102H26	1 x 100 x 26	85	19	2	\$2560	\$3201
TSAS96H26	1 x 94 x 26	92.5	15	1	\$2405	\$3010
TSAS90H26	1 x 88 x 26	92.5	15	1	\$2265	\$2833
TSAS78H26	1 x 76 x 26	100	13	1	\$1955	\$2445
TSAS72H26	1 x 70 x 26	70	12	1	\$1779	\$2226
TSAS66H26	1 x 64 x 26	85	11	1	\$1661	\$2072
TSAS60H26	1 x 58 x 26	85	10	1	\$1504	\$1884
TSAS36H26	1 x 34 x 26	100	6	1	\$907	\$1137
TSAS30H26	1 x 28 x 26	150	4	1	\$758	\$950

For use on **16.5"H** overhead storage (**CSFO_**, **CSF_**) at a finished height of **72"**. See "tackboard notes" exact fabric availability. List Price shown applies for all fabric grades.

- **Must Specify Black (E) or Tungsten (K) Accessory Rail finish.**
- **NOTE:** Care should be taken to mount the units. Units should be mounted to wall studs using correct fasteners. Failure to do so may result in collapse of the unit and subsequent personal injury. **Mounting hardware not included.** Mounting hardware used should be based on wall material. Consult an installation professional for proper wall mounting.

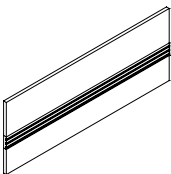

Tackboard - Accessory Rail, Wallmounted

TSPAS108H23	1 x 106 x 23	92.5	30	2	\$2447	\$3061
TSPAS102H23	1 x 100 x 23	100	24	2	\$2324	\$2909
TSPAS96H23	1 x 94 x 23	70	20	2	\$2185	\$2734
TSPAS90H23	1 x 88 x 23	70	20	2	\$2042	\$2555
TSPAS84H23	1 x 82 x 23	85	18	2	\$1908	\$2390
TSPAS78H23	1 x 76 x 23	85	17	2	\$1773	\$2217
TSPAS72H23	1 x 70 x 23	85	16	1	\$1640	\$2053
TSPAS66H23	1 x 64 x 23	92.5	14	1	\$1504	\$1884
TSPAS60H23	1 x 58 x 23	92.5	13	1	\$1363	\$1704
TSPAS36H23	1 x 34 x 23	125	8	1	\$682	\$856
TSPAS30H23	1 x 28 x 23	150	5	1	\$665	\$828

For use on **19.5"H** overhead storage (**CSFOP_**, **CSFP_**) with Pigeon-Hole Storage at a finished height of **72"**. See "tackboard notes" exact fabric availability. List Price shown applies for all fabric grades.

- **Must Specify Black (E) or Tungsten (K) Accessory Rail finish.**
- **NOTE:** Care should be taken to mount the units. Units should be mounted to wall studs using correct fasteners. Failure to do so may result in collapse of the unit and subsequent personal injury. **Mounting hardware not included.** Mounting hardware used should be based on wall material. Consult an installation professional for proper wall mounting.

Required Specifications

Fabric

WALLMOUNT TACKBOARDS

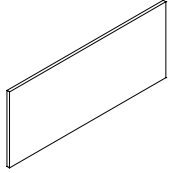

Tackboard - Wallmounted

MODEL#	DIMENSIONS D x W x H	FREIGHT CLASS	WT/LBS.	CUBIC FT.	GR. 1-3	GR. 4-5
TS108H25	1 x 106 x 25	92.5	23	2	\$1608	\$2007
TS102H25	1 x 100 x 25	100	19	2	\$1511	\$1892
TS96H25	1 x 94 x 25	70	17	1	\$1424	\$1777
TS90H25	1 x 88 x 25	70	15	1	\$1335	\$1671
TS84H25	1 x 82 x 25	85	14	1	\$1250	\$1564
TS78H25	1 x 76 x 25	85	13	1	\$1154	\$1444
TS72H25	1 x 70 x 25	85	12	1	\$1067	\$1338
TS66H25	1 x 64 x 25	92.5	11	1	\$980	\$1226
TS60H25	1 x 58 x 25	92.5	10	1	\$893	\$1120

For use on **16.5"H** overhead storage (CSFO_, CSF_) mounted above 23"H credenzas for a **finished height of 66"**. See "tackboard notes" exact fabric availability. List Price shown applies for all fabric grades

- **NOTE:** Care should be taken to mount the units. Units should be mounted to wall studs using correct fasteners. Failure to do so may result in collapse of the unit and subsequent personal injury. **Mounting hardware not included.** Mounting hardware used should be based on wall material. Consult an installation professional for proper wall mounting.

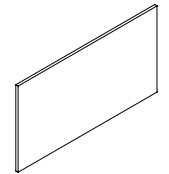

Tackboard - Wallmounted

TS108H32	1 x 106 x 32	70	30	2	\$2057	\$2566
TS102H32	1 x 100 x 32	85	24	2	\$1936	\$2422
TS96H32	1 x 94 x 32	92.5	20	2	\$1827	\$2288
TS90H32	1 x 88 x 32	92.5	20	2	\$1714	\$2145
TS84H32	1 x 82 x 32	100	18	2	\$1592	\$1995
TS78H32	1 x 76 x 32	100	17	2	\$1477	\$1849
TS72H32	1 x 70 x 32	70	16	1	\$1363	\$1704
TS66H32	1 x 64 x 32	85	14	1	\$1254	\$1569
TS60H32	1 x 58 x 32	85	13	1	\$1143	\$1430

For use on **16.5"H** overhead storage (CSFO_, CSF_) mounted above 23"H credenzas for a **finished height of 72"**. See "tackboard notes" exact fabric availability. List Price shown applies for all fabric grades

- **NOTE:** Care should be taken to mount the units. Units should be mounted to wall studs using correct fasteners. Failure to do so may result in collapse of the unit and subsequent personal injury. **Mounting hardware not included.** Mounting hardware used should be based on wall material. Consult an installation professional for proper wall mounting.

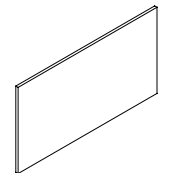

Tackboard - Wallmounted

TSP108H29	1 x 106 x 29	70	30	2	\$1859	\$2326
TSP102H29	1 x 100 x 29	85	24	2	\$1753	\$2194
TSP96H29	1 x 94 x 29	70	20	2	\$1651	\$2068
TSP90H29	1 x 88 x 29	70	20	2	\$1551	\$1940
TSP84H29	1 x 82 x 29	70	18	2	\$1444	\$1807
TSP78H29	1 x 76 x 29	70	17	2	\$1345	\$1676
TSP72H29	1 x 70 x 29	70	16	1	\$1236	\$1547
TSP66H29	1 x 64 x 29	85	14	1	\$1143	\$1430
TSP60H29	1 x 58 x 29	85	13	1	\$1034	\$1294

For use on **16.5"H** overhead storage (CSFO_, CSF_) mounted above 23"H credenzas for a **finished height of 72"**. See "tackboard notes" exact fabric availability. List Price shown applies for all fabric grades

- **NOTE:** Care should be taken to mount the units. Units should be mounted to wall studs using correct fasteners. Failure to do so may result in collapse of the unit and subsequent personal injury. **Mounting hardware not included.** Mounting hardware used should be based on wall material. Consult an installation professional for proper wall mounting.

Required Specifications

Fabric

WALLMOUNT TACKBOARDS

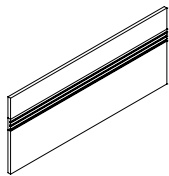

Tackboard - Accessory Rail, Wallmounted

MODEL#	DIMENSIONS D x W x H	FREIGHT CLASS	WT/LBS.	CUBIC FT.	GR. 1-3	GR. 4-5
TSAS108H25	1 x 106 x 25	92.5	23	2	\$2615	\$3270
TSAS102H25	1 x 100 x 25	100	19	2	\$2457	\$3075
TSAS96H25	1 x 94 x 25	70	15	1	\$2310	\$2893
TSAS90H25	1 x 88 x 25	70	15	1	\$2176	\$2724
TSAS78H25	1 x 76 x 25	85	13	1	\$1880	\$2353
TSAS72H25	1 x 70 x 25	85	12	1	\$1707	\$2137
TSAS66H25	1 x 64 x 25	92.5	11	1	\$1598	\$2003
TSAS60H25	1 x 58 x 25	92.5	10	1	\$1452	\$1817

For use on **16.5"H** overhead storage (**CSFO_**, **CSF_**) mounted above 23"H credenzas for a **finished height of 66"**. See "tackboard notes" exact fabric availability. List Price shown applies for all fabric grades

- **Must Specify Black (E) or Tungsten (K) Accessory Rail finish.**
- **NOTE:** Care should be taken to mount the units. Units should be mounted to wall studs using correct fasteners. Failure to do so may result in collapse of the unit and subsequent personal injury. **Mounting hardware not included.** Mounting hardware used should be based on wall material. Consult an installation professional for proper wall mounting.

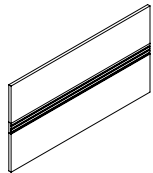

Tackboard - Accessory Rail, Wallmounted

TSAS108H32	1 x 106 x 32	70	23	2	\$3341	\$4178
TSAS102H32	1 x 100 x 32	85	19	2	\$3143	\$3930
TSAS96H32	1 x 94 x 32	92.5	15	1	\$2962	\$3707
TSAS90H32	1 x 88 x 32	92.5	15	1	\$2791	\$3485
TSAS78H32	1 x 76 x 32	100	13	1	\$2405	\$3010
TSAS72H32	1 x 70 x 32	70	12	1	\$2185	\$2734
TSAS66H32	1 x 64 x 32	85	11	1	\$2042	\$2555
TSAS60H32	1 x 58 x 32	85	10	1	\$1855	\$2320

For use on **16.5"H** overhead storage (**CSFO_**, **CSF_**) mounted above 23"H credenzas for a **finished height of 72"**. See "tackboard notes" exact fabric availability. List Price shown applies for all fabric grades

- **Must Specify Black (E) or Tungsten (K) Accessory Rail finish.**
- **NOTE:** Care should be taken to mount the units. Units should be mounted to wall studs using correct fasteners. Failure to do so may result in collapse of the unit and subsequent personal injury. **Mounting hardware not included.** Mounting hardware used should be based on wall material. Consult an installation professional for proper wall mounting.

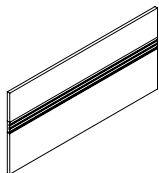

Tackboard - Accessory Rail, Wallmounted

TSPAS108H29	1 x 106 x 29	70	30	2	\$3031	\$3791
TSPAS102H29	1 x 100 x 29	85	24	2	\$2849	\$3559
TSPAS96H29	1 x 94 x 29	70	20	2	\$2682	\$3350
TSPAS90H29	1 x 88 x 29	70	20	2	\$2526	\$3161
TSPAS78H29	1 x 76 x 29	70	17	2	\$2185	\$2734
TSPAS72H29	1 x 70 x 29	70	16	1	\$1980	\$2480
TSPAS66H29	1 x 64 x 29	85	14	1	\$1855	\$2320
TSPAS60H29	1 x 58 x 29	85	13	1	\$1678	\$2103

For use on **16.5"H** overhead storage (**CSFO_**, **CSF_**) mounted above 23"H credenzas for a **finished height of 72"**. See "tackboard notes" exact fabric availability. List Price shown applies for all fabric grades

- **Must Specify Black (E) or Tungsten (K) Accessory Rail finish.**
- **NOTE:** Care should be taken to mount the units. Units should be mounted to wall studs using correct fasteners. Failure to do so may result in collapse of the unit and subsequent personal injury. **Mounting hardware not included.** Mounting hardware used should be based on wall material. Consult an installation professional for proper wall mounting.

Required Specifications

Fabric

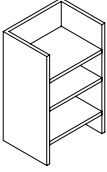
PIGEON-HOLE STORAGE	MODEL#	DIMENSIONS	FREIGHT CLASS	WT/LBS.	CUBIC FT.	LIST PRICE	
 <p>Vertical Pigeon-Hole Storage*</p>		D x W x H					
	CPH161226	12 x 16 x 26	125	20	3	\$753	
	CPH161223	12 x 16 x 23	125	18	3	\$639	
	CPH161219	12 x 16 x 19	125	15	2	\$486	
	CPH131226	12 x 13 x 26	100	16	2	\$613	
	CPH131223	12 x 13 x 23	125	15	2	\$520	
	CPH131219	12 x 13 x 19	125	12	2	\$392	
	Used in conjunction with overhead storage units and hutches that incorporate horizontal pigeon-hole storage. Not freestanding. Shipped RTA (ready to assemble).						

ACCESSORY RAIL/PANEL ORGANIZERS					
Available Finishes:	BLK	Black	SIL	Silver	
	CHR	Charcoal	TPE	Taupe	
	DWT	Designer White	TUN	Tungsten	
	NEV	Nevada			

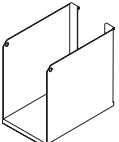
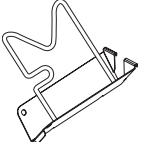
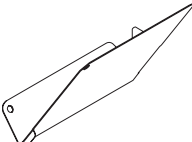
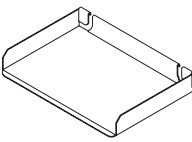
ACCESSORIES	MODEL#	DIMENSIONS	FREIGHT CLASS	WT/LBS.	CUBIC FT.	LIST PRICE
 <p>Binder Bin**</p>	BABB01	10.25 x 4 x 9	100	2	.21	\$75
	Load bar/accessory rail mounted metal binder bin.					
 <p>Flip Sorter**</p>	BAFS01	9.25 x 2.75 x 9.25	70	.06	.14	\$58
	Load bar/accessory rail mounted metal flip sorter. Comes with chrome wire.					
 <p>Slant Sorter</p>	BASS01L	10.25 x 5 x 9.5	70	1	.28	\$47
	(Left)					
	BASS01R	10.25 x 5 x 9.5	70	1	.28	\$47
(Right)						
Load bar/accessory rail mounted metal slant sorter.						
 <p>Letter Tray</p>	BALTO1	9.25 x 13.5 x 2	70	.50	.15	\$62
	Load bar/accessory rail mounted metal letter tray.					

Required Specifications

- Fabric
- Veneer finish*
- Metal finish**

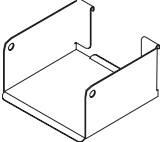
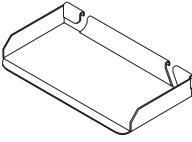
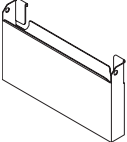
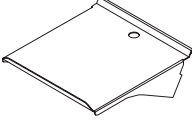
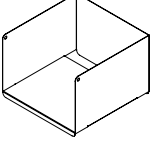
ACCESSORY RAIL/ PANEL ORGANIZERS	MODEL#	DIMENSIONS D x W x H	FREIGHT CLASS	WT/LBS.	CUBIC FT.	LIST PRICE
 <p>Media Bin</p>	BAMB01	5.25 x 5.75 x 3	70	.08	.05	\$62
Load bar/accessory rail mounted metal media bin.						
 <p>Utility Tray</p>	BAUT01	3.75 x 5.75 x 3	70	.05	.02	\$41
Load bar/accessory rail mounted metal utility tray.						
 <p>Mail Box</p>	BAPP01	2.75 x 16 x 9	100	2	.25	\$94
Load bar/accessory rail mounted metal mail box.						
 <p>Telephone Holder</p>	BATH01	10 x 9 x 2	125	2	.26	\$91
Load bar/accessory rail mounted metal telephone holder.						
 <p>Elevated Shelf Binder Bin</p>	BRTESBBIN	12 x 12 x 8	100	6	.66	\$193
Load bar/accessory rail mounted elevated shelf binder bin.						

Required Specifications
Metal finish

RECEPTION DESKS

MODEL#

DIMENSIONS

FREIGHT CLASS

WT./LBS.

CUBIC FT.

LIST PRICE

D x W x H

- To add storage use storage shells. See page 306 .
- Includes GM1 grommet.
- Transaction tops to be specified separately, handed by square edge from user side.
- Decorative Front Panels should be specified separately. Size chosen should be 12" less than desk dimensions. Available in Reverse Diamond, Vertical Rib, Vertical Grain and Horizontal Grain Patterns.

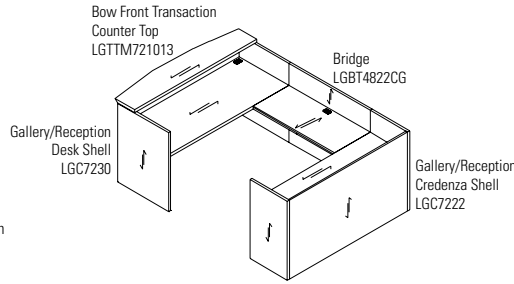
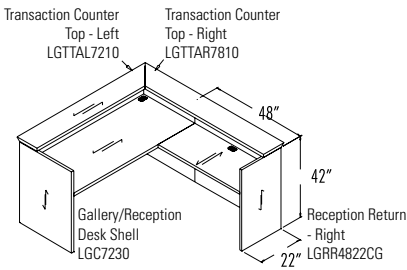

OPTION DETAILS

Decorative Front Panel (Reverse Diamond Pattern)
GFDP5430F

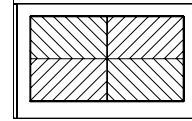

Decorative Front Panel (Vertical Rib Pattern)
GFDP5430RIB

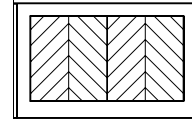

RECEPTION DESKS

MODEL#

DIMENSIONS

FREIGHT CLASS

WT./LBS.

CUBIC FT.

LIST PRICE

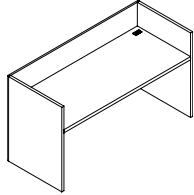

Gallery/Reception Desk Shell

LGC10836	36 x 108 x 42	150	533	95	\$7934
LGC10236	36 x 102 x 42	150	503	89	\$7493
LGC9636	36 x 96 x 42	150	473	84	\$7053
LGC9036	36 x 90 x 42	150	444	79	\$6612
LGC8436	36 x 84 x 42	150	414	74	\$6173
LGC7236	36 x 72 x 42	150	355	63	\$5291
LGC7230	30 x 72 x 42	150	315	53	\$5122
LGC6630	30 x 66 x 42	125	295	48	\$4612
LGC6030	30 x 60 x 42	125	275	44	\$4995

No pedestals. Two grommets in worksurface. For use with modular storage components. Ships assembled in 1 carton.

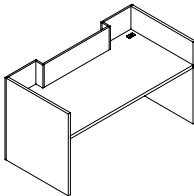

**Gallery/Reception Desk Shell
Breakfront Style**

LGIC10836	36 x 108 x 42	150	533	95	\$9757
LGIC10236	36 x 102 x 42	150	503	89	\$9205
LGIC9636	36 x 96 x 42	150	473	84	\$8675
LGIC9036	36 x 90 x 42	150	444	79	\$8128
LGIC8436	36 x 84 x 42	150	414	74	\$7595
LGIC7236	36 x 72 x 42	150	355	63	\$6497
LGIC7230	30 x 72 x 42	150	315	53	\$6291
LGIC6630	30 x 66 x 42	125	295	48	\$6132
LGIC6030	30 x 60 x 42	125	275	44	\$5779

No pedestals. Two grommets in worksurface. For use with modular storage components. Ships assembled in 1 carton.

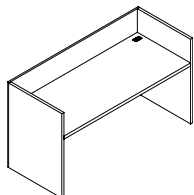

Gallery/Reception Credenza Shell

LGC10824	24 x 108 x 42	150	353	63	\$6219
LGC10224	24 x 102 x 42	150	333	60	\$5881
LGC9624	24 x 96 x 42	150	314	56	\$5526
LGC9024	24 x 90 x 42	150	294	53	\$5177
LGC8424	24 x 84 x 42	150	274	49	\$4841
LGC7224	24 x 72 x 42	150	235	42	\$4154
LGC6624	24 x 66 x 42	150	216	39	\$3898
LGC6024	24 x 60 x 42	150	196	35	\$3652

No pedestals. Two grommets in worksurface. For use with modular storage components. Ships assembled in 1 carton.

Required Specifications

- Metal Finish (Accessories)
- Veneer Finish
- Edge

RECEPTION DESKS **MODEL#** **DIMENSIONS** **FREIGHT CLASS** **WT/LBS.** **CUBIC FT.** **LIST PRICE**

D x W x H

LGBT5624CG	24 x 56 x 42	150	178	32	\$3485
LGBT5424CG	24 x 54 x 42	150	169	29	\$3485
LGBT5024CG	24 x 50 x 42	150	151	27	\$3091
LGBT4824CG	24 x 48 x 42	150	142	26	\$3091
LGBT4424CG	24 x 44 x 42	150	134	23	\$2715
LGBT4224CG	24 x 42 x 42	150	127	22	\$2715
LGBT3824CG	24 x 38 x 42	150	119	20	\$2440
LGBT3624CG	24 x 36 x 42	150	112	19	\$2440

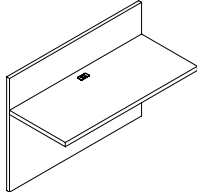

Bridge

Attaches between **Gallery Desk and Gallery Credenza Only**. One grommet in center of worksurface. Ships assembled in 1 carton.

- To remove cross-grain veneer pattern on top, **delete "CG"** from model number. Available as a special - no upcharge.

LGRL7224	24 x 72 x 42	125	273	42	\$5219
LGRL6624	24 x 66 x 42	125	250	39	\$4794
LGRL6024	24 x 60 x 42	125	228	35	\$4363
LGRL5424	24 x 54 x 42	125	205	32	\$3921
LGRL4824	24 x 48 x 42	125	182	28	\$3485
LGRL4224	24 x 42 x 42	125	159	25	\$3053
LGRL3624	24 x 36 x 42	125	137	21	\$2739

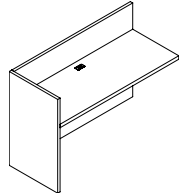

Reception Return - LEFT

No pedestal. One grommet in center of worksurface. For use with modular storage components. Ships assembled in 1 carton.

LGRR7224	24 x 72 x 42	125	273	42	\$5219
LGRR6624	24 x 66 x 42	125	250	39	\$4794
LGRR6024	24 x 60 x 42	125	228	35	\$4363
LGRR5424	24 x 54 x 42	125	205	32	\$3921
LGRR4824	24 x 48 x 42	125	182	28	\$3485
LGRR4224	24 x 42 x 42	125	159	25	\$3053
LGRR3624	24 x 36 x 42	125	137	21	\$2739

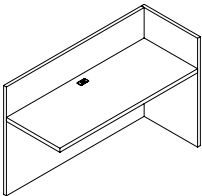

Reception Return - RIGHT

No pedestal. One grommet in center of worksurface. For use with modular storage components. Ships assembled in 1 carton.

LGTT10810	10 x 108 x 1.50	100	78	8	\$1476
LGTT10210	10 x 102 x 1.50	92.5	72	7	\$1398
LGTT9610	10 x 96 x 1.50	100	66	7	\$1316
LGTT9010	10 x 90 x 1.50	92.5	60	6	\$1234
LGTT8410	10 x 84 x 1.50	100	54	6	\$1154
LGTT7210	10 x 72 x 1.50	100	48	5	\$978
LGTT6610	10 x 66 x 1.50	100	42	5	\$898
LGTT6010	10 x 60 x 1.50	100	36	4	\$816

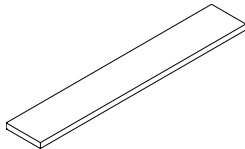

Transaction Counter Top

Rectangular top for main reception desk. Counter sits on top of Gallery panels. Does not overhang. **Factory installed - specify Gallery to be used on.** Size must match dimension of desk front or combined desk side and return length. Hardware included.

LGTTM1081013	10-13 x 108 x 1.50	125	78	10	\$2315
LGTTM1021013	10-13 x 102 x 1.50	100	72	9	\$2190
LGTTM961013	10-13 x 96 x 1.50	125	66	9	\$2058
LGTTM901013	10-13 x 90 x 1.50	125	60	8	\$1925
LGTTM841013	10-13 x 84 x 1.50	125	54	8	\$1799
LGTTM721013	10-13 x 72 x 1.50	125	48	7	\$1547
LGTTM661013	10-13 x 66 x 1.50	125	42	6	\$1416
LGTTM601013	10-13 x 60 x 1.50	125	36	5	\$1284

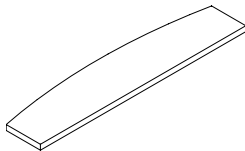

Bow Front Transaction Counter Top

Bow top for main reception desk. Counter sits on top of Gallery panels. Bow front overhangs 3". **Factory installed - specify Gallery to be used on.** Size must match dimension of desk front or combined desk side and return length. Hardware included.

Required Specifications

- Veneer Finish
- Edge

TRANSACTION COUNTERS

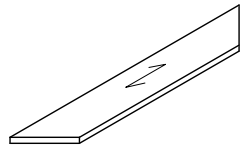

Trapezoid Transaction Counter Top

MODEL#	DIMENSIONS D x W x H	FREIGHT CLASS	WT./LBS.	CUBIC FT.	LIST PRICE
LGTTA10810	10 x 108 x 1.50	100	78	8	\$1859
LGTTA10210	10 x 102 x 1.50	92.5	72	7	\$1763
LGTTA9610	10 x 96 x 1.50	100	66	7	\$1672
LGTTA9010	10 x 90 x 1.50	92.5	60	6	\$1581
LGTTA8410	10 x 84 x 1.50	100	54	6	\$1490
LGTTA7210	10 x 72 x 1.50	100	48	5	\$1314
LGTTA6610	10 x 66 x 1.50	100	42	5	\$1218
LGTTA6010	10 x 60 x 1.50	100	36	4	\$1127

Trapezoid top for main reception desk. 45° mitered ends on left and right. For use with left and right 45° mitered return transaction counters. Counter sits on top of Gallery panels. Does not overhang. **Factory installed - specify Gallery to be used on.** Size must match dimension of desk front or combined desk side and return length. Hardware included.

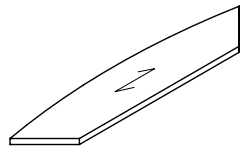

Bow Front Trapezoid Transaction Counter Top

LGTTMA1081013	10-13 x 108 x 1.50	125	78	10	\$2551
LGTTMA1021013	10-13 x 102 x 1.50	100	72	9	\$2455
LGTTMA961013	10-13 x 96 x 1.50	125	66	9	\$2364
LGTTMA901013	10-13 x 90 x 1.50	125	60	8	\$2273
LGTTMA841013	10-13 x 84 x 1.50	125	54	8	\$2182
LGTTMA721013	10-13 x 72 x 1.50	125	48	7	\$2000
LGTTMA661013	10-13 x 66 x 1.50	125	42	6	\$1910
LGTTMA601013	10-13 x 60 x 1.50	125	36	5	\$1819

Trapezoid bow top for main reception desk. 45° mitered ends on left and right. For use with left and right 45° mitered return transaction counters. Counter sits on top of Gallery panels. Bow front overhangs 3". **Factory installed - specify Gallery to be used on.** Size must match dimension of desk front or combined desk side and return length. Hardware included.

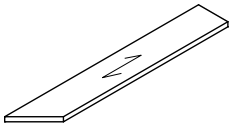

Transaction Counter Top - RIGHT

LGTTAR10810	10 x 108 x 1.50	100	78	8	\$1778
LGTTAR10210	10 x 102 x 1.50	92.5	72	7	\$1692
LGTTAR9610	10 x 96 x 1.50	100	66	7	\$1596
LGTTAR9010	10 x 90 x 1.50	92.5	60	6	\$1506
LGTTAR8410	10 x 84 x 1.50	100	54	6	\$1415
LGTTAR7210	10 x 72 x 1.50	100	48	5	\$1233
LGTTAR6610	10 x 66 x 1.50	100	42	5	\$1142
LGTTAR6010	10 x 60 x 1.50	100	36	4	\$1051

Rectangular top for main reception desk with 45° mitered end on **right**. For use with rectangular or bow front transaction counters with miters at both ends. **Factory installed - specify Gallery to be used on.** Size must match dimension of desk front or combined desk side and return length. Hardware included.

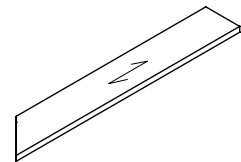

Transaction Counter Top - LEFT

LGTTAL10810	10 x 108 x 1.50	100	78	8	\$1778
LGTTAL10210	10 x 102 x 1.50	92.5	72	7	\$1692
LGTTAL9610	10 x 96 x 1.50	100	66	7	\$1596
LGTTAL9010	10 x 90 x 1.50	92.5	60	6	\$1506
LGTTAL8410	10 x 84 x 1.50	100	54	6	\$1415
LGTTAL7210	10 x 72 x 1.50	100	48	5	\$1233
LGTTAL6610	10 x 66 x 1.50	100	42	5	\$1142
LGTTAL6010	10 x 60 x 1.50	100	36	4	\$1051

Rectangular top for main reception desk with 45° mitered end on **left**. For use with rectangular or bow front transaction counters with miters at both ends. **Factory installed - specify Gallery to be used on.** Size must match dimension of desk front or combined desk side and return length. Hardware included.

Required Specifications

Veneer Finish
Edge

TRANSACTION COUNTERS **MODEL#** **DIMENSIONS** **FREIGHT CLASS** **WT/LBS.** **CUBIC FT.** **LIST PRICE**

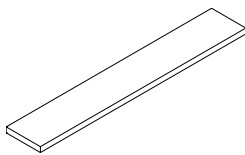

Transaction Counter Top - Glass

	D x W x H					
GTT10810G	10 x 108 x 1.50	100	78	8		\$3367
GTT10210G	10 x 102 x 1.50	92.5	72	7		\$3241
GTT9610G	10 x 96 x 1.50	100	66	7		\$3113
GTT9010G	10 x 90 x 1.50	92.5	60	6		\$2988
GTT8410G	10 x 84 x 1.50	100	54	6		\$2864
GTT7210G	10 x 72 x 1.50	100	48	5		\$2679
GTT6610G	10 x 66 x 1.50	100	42	5		\$2554
GTT6010G	10 x 60 x 1.50	100	36	4		\$2430

Rectangular top for main reception desk. Counter sits on top of Gallery panels. Does not overhang. **Factory installed - specify Gallery to be used on.** Size must match dimension of desk front or combined desk side and return length. Hardware included. 3/4" clear glass over wood subtop.

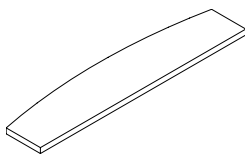

Bow Front Transaction Counter Top - Glass

GTTM1081013G	10-13 x 108 x 1.50	125	78	10		\$4154
GTTM1021013G	10-13 x 102 x 1.50	100	72	9		\$4075
GTTM961013G	10-13 x 96 x 1.50	125	66	9		\$4035
GTTM901013G	10-13 x 90 x 1.50	125	60	8		\$3858
GTTM841013G	10-13 x 84 x 1.50	125	54	8		\$3669
GTTM721013G	10-13 x 72 x 1.50	125	48	7		\$3372
GTTM661013G	10-13 x 66 x 1.50	125	42	6		\$3184
GTTM601013G	10-13 x 60 x 1.50	125	36	5		\$3006

Bow top for main reception desk. Counter sits on top of Gallery panels. Bow front overhangs 3". **Factory installed - specify Gallery to be used on.** Size must match dimension of desk front or combined desk side and return length. Hardware included. 3/4" clear glass over wood subtop.

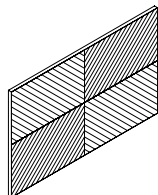

Decorative Front Panel Reverse Diamond Pattern

GFDP9630F	1 x 96 x 30	92.5	81	8		\$1904
GFDP9030F	1 x 90 x 30	100	78	8		\$1783
GFDP8430F	1 x 84 x 30	92.5	72	7		\$1663
GFDP7230F	1 x 72 x 30	100	66	7		\$1429
GFDP6030F	1 x 60 x 30	92.5	60	6		\$1194
GFDP5430F	1 x 54 x 30	100	54	6		\$1073
GFDP4830F	1 x 48 x 30	100	48	5		\$956

Raised decorative front panel for a reception desk. Size should be 12" less than desk dimensions. **Factory installed.** Hardware included.

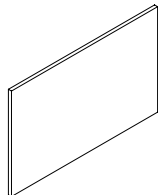

Decorative Front Panel Vertical Grain Pattern

GFDP9630V	1 x 96 x 30	92.5	81	8		\$1660
GFDP9030V	1 x 90 x 30	100	78	8		\$1556
GFDP8430V	1 x 84 x 30	92.5	72	7		\$1453
GFDP7230V	1 x 72 x 30	100	66	7		\$1241
GFDP6030V	1 x 60 x 30	92.5	60	6		\$1035
GFDP5430V	1 x 54 x 30	100	54	6		\$937
GFDP4830V	1 x 48 x 30	100	48	5		\$828

Raised decorative front panel for a reception desk. Size should be 12" less than desk dimensions. **Factory installed.** Hardware included.

Required Specifications

Veneer Finish*
Edge*

Optional Specifications

Grommet*

RECEPTION DESKS - CURVED

MODEL# DIMENSIONS FREIGHT CLASS WT/LBS. CUBIC FT. LIST PRICE

D x W x H

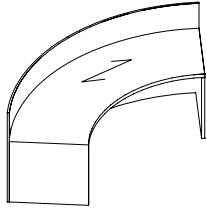

Gallery/Reception Curved Desk Shell**

LGCCUS10630H36	30 x 106 x 36	100	647	72	\$14621
LGCCUS10630H42	30 x 106 x 42	100	592	66	\$16815

No pedestals. For use with modular storage components. Ships assembled in 1 carton.

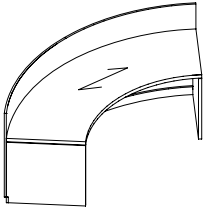

Gallery/Reception Curved Desk Shell**

LGCKCUS10630H36	30 x 106 x 36	100	647	72	\$15350
LGCKCUS10630H42	30 x 106 x 42	100	592	66	\$17655

Includes recessed kick plate. No pedestals. For use with modular storage components. Ships assembled in 1 carton.

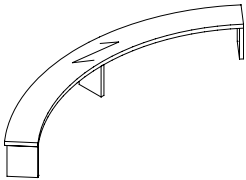

Wood Curved Transaction Counter*

LGTTMCUS10610	10 x 106 x 1.5	150	84	19	\$6633
---------------	----------------	-----	----	----	---------------

Curved wood transaction top. Ships assembled in 1 carton.

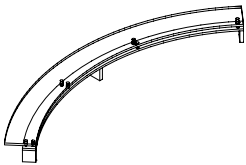

Glass Curved Transaction Counter

GCCCUS10610G	10 x 106 x 0.75	150	84	19	\$12166
--------------	-----------------	-----	----	----	----------------

¾" clear glass bow front transaction counter over wood subtop. Ships assembled in 1 carton.

Required Specifications

Veneer Finish*

Edge*

philadelphia

