



GLOBAL is pleased to introduce the **LUFTON** wood veneer series. This contemporary collection features an all wood veneer construction with a variety of features that emphasize a modern approach to the private office.

1" worksurfaces include a choice of four ¼" hardwood edges to choose from – Flat (L10), Radius (L20), Fluted (L30) and Soft Tail (L40). A black 5mm PVC inlay between the worksurface and gable provides a striking visual detail. Drawers and storage items feature eight handle options to choose from (where applicable) – storage options are available in 29", 66" and 72" heights. Various models include different types of storage configurations.

New 23" height credenzas allow for different visual planes – combined with a spacer unit, worksurfaces can be supported over this credenza.

Above worksurface storage selections include overhead storage and hutches with or without pigeon-hole storage. Hutch doors are available in a choice of veneer or glass with an aluminum frame. Tackboards are offered in all fabric or with a built-in accessory rail for organizing folders, binders, CDs and more!



Features and Benefits

- Choice of eight handle options for every door/drawer that features handles.
- Modesty panel options include metal (in Black or Tungsten), veneer, and glass.
- Base upgrades to replace standard monopost on islands are available in four styles.
- Drawers are standard vinyl wrapped construction with black drawer slides and bottom.
- 75 lb. box – 150 lb. file drawer weight capacity with full height sides – pencil tray included in box drawer.
- Lateral file drawers can accommodate legal or letter documents.
- Box drawers mounted on ¾ extension premium ball bearing slides.
- Power/Data accessories are available to be factory installed on any LUFTON unit, including Boardroom Tables to meet all today's technological requirements.
- A full array of complementary Boardroom and Reception area furnishings are available to coordinate the entire office.

GENERAL INFORMATION

- Lufton is a veneer desking system composed of hundreds of models, capable of furnishing executive suites, boardrooms and reception areas.
- 1" worksurfaces with 1/4" solid Wood Edge all around.
- 5MM Black PVC inlay between top and gables
- **Level 3 Certified**

FINISHES

- Conversion varnish (similar to catalyzed lacquer, but tougher), 35 to 40 degree sheen. Finishes are not buffed or rubbed.
- All Global wood casegood products are veneered and finished on the back sides (3600 finishing), except modular under-surface storage - tops and backs are unfinished.
- Touch up kits available, includes a touch up marker and fill crayon. Order **VTOUCHUPKIT, \$164** list. Specify finish when ordering.
- Global standard finish, on oak and walnut, is open pore and on cherry and maple is semi-closed pore. If a full finish is required for walnut, cherry, anigre and maple tops, add the suffix **"2"** to the finish code and add 5% to the base pricing for each product. Custom finish on standard veneer is available. Add 15% to the base pricing for each product.
- High Pressure laminate inlays are available at no upcharge. Contact Customer Care for specification information.
- Hanging file rails are pre-installed on file drawer perimeters and accommodate both legal and letter size filing. Legal filing can be achieved either as side-to-side or front-to-back. Letter filing can be achieved as front-to-back filing only.

WORKSURFACE TOP & DRAWER/DOOR FRONTS, BODY FINISHES

(INCLUDING PEDESTALS) - VENEER

Code	Finish	Veneer Type	Cut
AMW	Almond Cherry	Cherry	Flat Sliced
ACW	Amber Cherry	Cherry	Flat Sliced
BTW	Biscotti	White Oak	Rift
CAW	Cocoa Walnut	Walnut	Flat Sliced
CRW	Coral	White Oak	Rift
DCW	Dark Cherry	Cherry	Flat Sliced
DWW	Dark Walnut	Walnut	Flat Sliced
EWW	Espresso Walnut	Walnut	Flat Sliced
EVW	Evening Oak	White Oak	Rift
GRW	Grey on Oak	White Oak	Rift
HAW	Hazelnut	Maple	Flat Sliced
JAW	Java	White Oak	Rift
LTW	Latte Walnut	Walnut	Flat Sliced
MHW	Mahogany on Walnut	Walnut	Flat Sliced
MTW	Milestone	White Oak	Rift
MPW	Natural Maple	Maple	Flat Sliced
NLW	Natural Walnut	Walnut	Flat Sliced
RCW	Red Cherry	Cherry	Flat Sliced
VNW	Vintage Cherry	Cherry	Flat Sliced
ULW	Umber Walnut	Walnut	Flat Sliced
WLW	Walnut	Walnut	Flat Sliced
WCW	Warm Cherry	Cherry	Flat Sliced
WNW	White Maple	Maple	Flat Sliced

EDGES

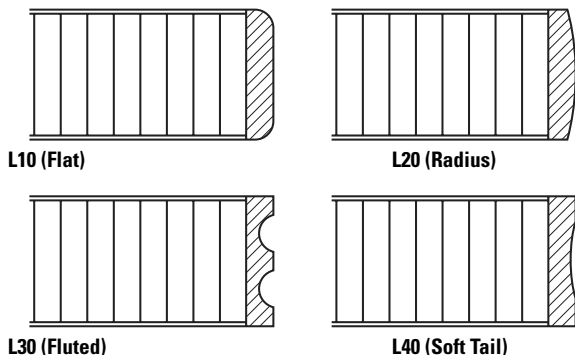

HANDLES

- Handles are standard on most drawers/storage modules. Each handle is identified by letters: **PL33, PL34, PL64, PL66, PL92, PL93, PL94, PL95, PL96, PL97, PL98, PL99, PLS7, and PLS8**. To specify a handle, specify the code after the model number and finish selections.

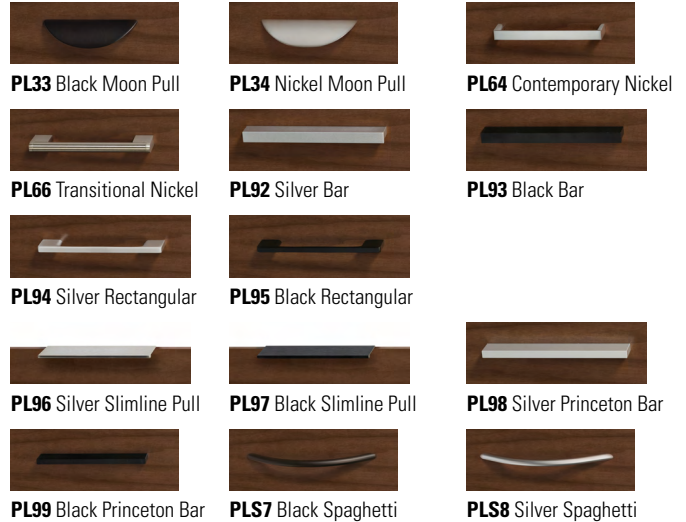

GROMMETS

- Standard grommet on all components is **GM5P**. Grommet is included with products where shown in line drawings in price book.
- Optional grommets may be ordered in standard worksurface locations (left, center or right). Order as **GM5PTL, GM5PTC or GM5PTR**. Add \$96.
- Grommet hole dimensions are 3.5" x 2".
- To order a grommet cover only, specify **GM5EP** for Black or **GM5KP** for Tungsten. Add \$57.
- Color of grommet will be automatically coordinated with handle color where applicable
- Components that come standard with grommet may be ordered without a grommet. Order as RSG - Add \$53.

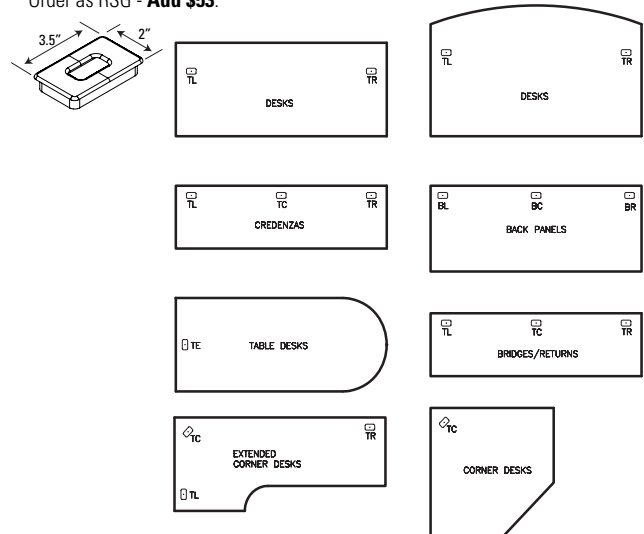

DOUBLE PEDESTAL DESKS

MODEL#

DIMENSIONS

FREIGHT CLASS

WT/LBS.

CUBIC FT.

LIST PRICE

- Can be ordered as a shell or with pedestals.
- Grommets are available as an option on Desks and most Credenzas.
- Hand of Rectangular Desk is determined by location of pedestal from user side.
- Hand of "D" Island is determined by outward orientation of conference end from user projection.

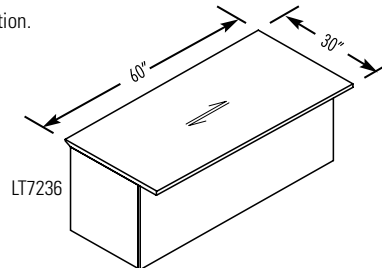
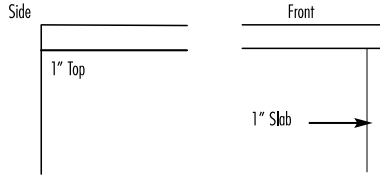
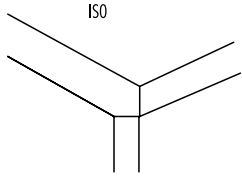

MODESTY PANEL CLEARANCE:

LT7236

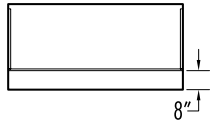

LT7230

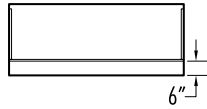

LMT7242

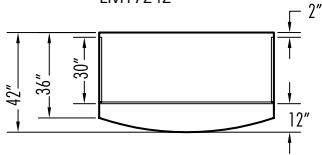

LMT7236

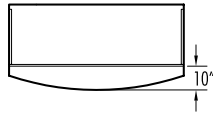

LISR7236D

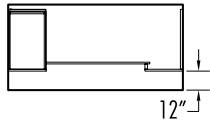

LISR7230D

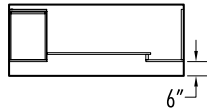

LDD7230

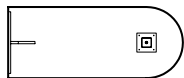

LDDBE7230

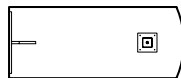

DESK MODESTY OPTIONS:

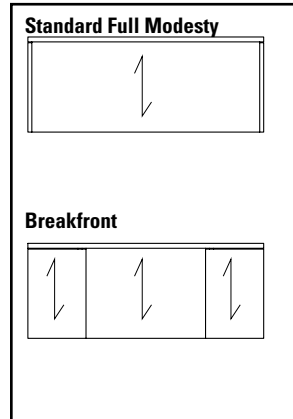

NOTE: Arrow indicates direction of grain.

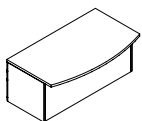
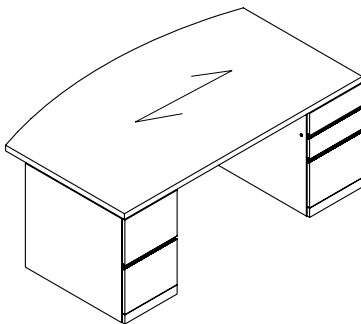

Flush Modesty

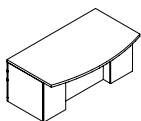

Breakfront

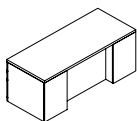

Recessed Modesty

DOUBLE PEDESTAL DESKS - RECESSED FRONT MODESTY MODEL# **DIMENSIONS** **FREIGHT CLASS** **WT/LBS.** **CUBIC FT.** **LIST PRICE**

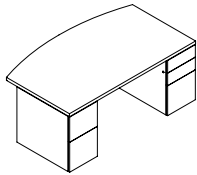

Double Pedestal Bow Top Desk

	D x W x H				
LMD8442ED	42 x 84 x 29	125	443	59	\$6949
LMD7842ED	42 x 78 x 29	125	412	55	\$6456
LMD7242ED	42 x 72 x 29	125	380	51	\$5956
LMD6636ED	36 x 66 x 29	125	240	40	\$5780

Standard with full to floor **file/file** pedestal on **left** and **box/box/file** pedestal on **right**. Bow top. Pedestals lock. One pencil tray. Refer to the Desks and Credenzas Notes Section above for overhang dimensions.

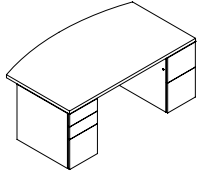

Double Pedestal Bow Top Desk

LMD8442DE	42 x 84 x 29	125	443	59	\$6949
LMD7842DE	42 x 78 x 29	125	412	55	\$6456
LMD7242DE	42 x 72 x 29	125	380	51	\$5956
LMD6636DE	36 x 66 x 29	125	240	40	\$5780

Standard with full to floor **box/box/file** pedestal on **left** and **file/file** pedestal on **right**. Bow top. Pedestals lock. One pencil tray. Refer to the Desks and Credenzas Notes Section on previous page for overhang dimensions.

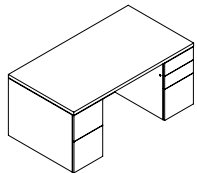

Double Pedestal Desk

LD8436ED	36 x 84 x 29	125	432	59	\$5907
LD7236ED	36 x 72 x 29	100	370	44	\$5064
LD7230ED	30 x 72 x 29	100	349	36	\$4990
LD6636ED	36 x 66 x 29	100	339	40	\$4990
LD6630ED	30 x 66 x 29	100	320	33	\$4910

Standard with full to floor **file/file** pedestal on **left** and **box/box/file** pedestal on **right**. Pedestals lock. Refer to the Desks and Credenzas Notes Section on previous page for overhang dimensions.

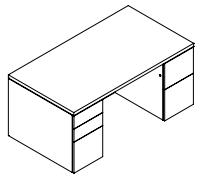

Double Pedestal Desk

LD8436DE	36 x 84 x 29	125	432	59	\$5907
LD7236DE	36 x 72 x 29	100	370	44	\$5064
LD7230DE	30 x 72 x 29	100	349	36	\$4990
LD6636DE	36 x 66 x 29	100	339	40	\$4990
LD6630DE	30 x 66 x 29	100	320	33	\$4910

Standard with full to floor **box/box/file** pedestal on **left** and **file/file** pedestal on **right**. Pedestals lock. Refer to the Desks and Credenzas Notes Section on previous page for overhang dimensions.

DOUBLE PEDESTAL DESKS - BREAKFRONT STYLE **MODEL#** **DIMENSIONS** **FREIGHT CLASS** **WT/LBS.** **CUBIC FT.** **LIST PRICE**

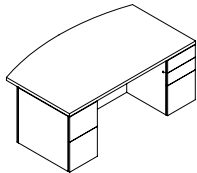

**Double Pedestal Bow Top Desk
Breakfront Style**

LMID8442ED	42 x 84 x 29	125	443	59	\$7772
LMID7842ED	42 x 78 x 29	125	412	55	\$7232
LMID7242ED	42 x 72 x 29	125	380	51	\$6687
LMID6636ED	36 x 66 x 29	125	240	40	\$6437

Standard with full to floor **file/file** pedestal on **left** and **box/box/file** pedestal on **right**. Bow top. Pedestals lock. One pencil tray. Refer to the Desks and Credenzas Notes Section on previous page for overhang dimensions.

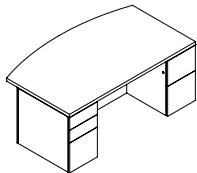

**Double Pedestal Bow Top Desk
Breakfront Style**

LMID8442DE	42 x 84 x 29	125	443	59	\$7772
LMID7842DE	42 x 78 x 29	125	412	55	\$7232
LMID7242DE	42 x 72 x 29	125	380	51	\$6687
LMID6636DE	36 x 66 x 29	125	240	40	\$6437

Standard with full to floor **box/box/file** pedestal on **left** and **file/file** pedestal on **right**. Bow top. Pedestals lock. One pencil tray. Refer to the Desks and Credenzas Notes Section on previous page for overhang dimensions.

Required Specifications

Veneer Finish
Edge

Optional Specifications

Grommet

DOUBLE PEDESTAL DESKS - BREAKFRONT STYLE

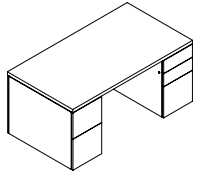

Double Pedestal Desk, Breakfront Style

MODEL#	DIMENSIONS D x W x H	FREIGHT CLASS	WT/LBS.	CUBIC FT.	LIST PRICE
LID8436ED	36 x 84 x 29	125	432	59	\$6099
LID7236ED	36 x 72 x 29	100	370	44	\$5662
LID7230ED	30 x 72 x 29	100	349	36	\$5574
LID6636ED	36 x 66 x 29	100	339	40	\$5574
LID6630ED	30 x 66 x 29	100	320	33	\$5489

Standard with full to floor **file/file** pedestal on **left** and **box/box/file** pedestal on **right**. Pedestals lock. Refer to the Desks and Credenzas Notes Section on previous page for overhang dimensions.

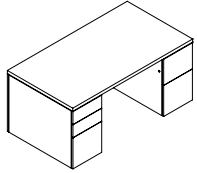

Double Pedestal Desk, Breakfront Style

LID8436DE	36 x 84 x 29	125	432	59	\$6099
LID7236DE	36 x 72 x 29	100	370	44	\$5662
LID7230DE	30 x 72 x 29	100	349	36	\$5574
LID6636DE	36 x 66 x 29	100	339	40	\$5574
LID6630DE	30 x 66 x 29	100	320	33	\$5489

Standard with full to floor **box/box/file** pedestal on **left** and **file/file** pedestal on **right**. Pedestals lock. Refer to the Desks and Credenzas Notes Section on page 268 for overhang dimensions.

SINGLE PEDESTAL DESKS

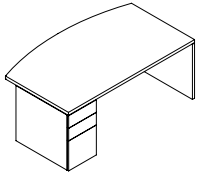

Single Pedestal Bow Top Desk - LEFT

MODEL#	DIMENSIONS	FREIGHT CLASS	WT/LBS.	CUBIC FT.	LIST PRICE
LMSL8442D	42 x 84 x 29	125	432	59	\$6654
LMSL7842D	42 x 78 x 29	125	401	55	\$6175
LMSL7242D	42 x 72 x 29	125	370	51	\$5707
LMSL6636D	36 x 66 x 29	150	230	40	\$5489

Standard with full to floor **box/box/file** pedestal on **left**. Bow top. Pedestal locks. Refer to the Desks and Credenzas Notes Section on page 268 for overhang dimensions.

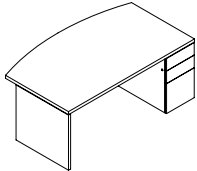

Single Pedestal Bow Top Desk - RIGHT

LMSR8442D	42 x 84 x 29	125	432	59	\$6654
LMSR7842D	42 x 78 x 29	125	401	55	\$6175
LMSR7242D	42 x 72 x 29	125	370	51	\$5707
LMSR6636D	36 x 66 x 29	150	230	40	\$5489

Standard with full to floor **box/box/file** pedestal on **right**. Bow top. Pedestal locks. Refer to the Desks and Credenzas Notes Section on page 268 for overhang dimensions.

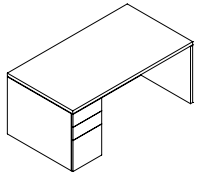

Single Pedestal Desk - LEFT

LSL8436D	42 x 84 x 29	125	463	59	\$4507
LSL7236D	36 x 72 x 29	125	340	44	\$3864
LSL7230D	30 x 72 x 29	125	283	36	\$3690
LSL6636D	36 x 66 x 29	125	312	40	\$3690
LSL6630D	30 x 66 x 29	100	295	33	\$3526

Standard with full to floor **box/box/file** pedestal on **left**. Pedestal locks. Refer to the Desks and Credenzas Notes Section on page 268 for overhang dimensions.

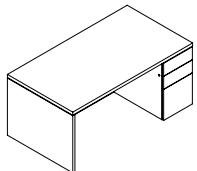

Single Pedestal Desk - RIGHT

LSR8436D	36 x 84 x 29	125	463	59	\$4507
LSR7236D	36 x 72 x 29	125	340	44	\$3864
LSR7230D	30 x 72 x 29	125	283	36	\$3690
LSR6636D	36 x 66 x 29	125	312	40	\$3690
LSR6630D	30 x 66 x 29	100	295	33	\$3526

Standard with full to floor **box/box/file** pedestal on **right**. Pedestal locks. Refer to the Desks and Credenzas Notes Section on page 268 for overhang dimensions.

Required Specifications

Veneer Finish
Edge

Optional Specifications

Grommet

ELECTRIC HEIGHT ADJUSTABLE UNITS	MODEL#	DIMENSIONS D x W x H	FREIGHT CLASS	WT./LBS.	CUBIC FT.	LIST PRICE
----------------------------------	--------	-------------------------	---------------	----------	-----------	------------

- All Height Adjustable (HA) units are shipped fully assembled.
- Simple Up / Down function enables the height adjustment of the worksurface.
- The height adjustment range for desks is 29" to 45", for table and bridge top 26" to 43" (including worksurface).
- Single stage HA mechanism with an electric motor in each column is used.
- The height adjustable mechanism operates at 1.5" per second.
- Max. weight / lift is 265 lbs.
- All columns are integrated into fully functional pedestals, or pedestal bases with the exception of the HA table and the HA bridge top.
- Height adjustable bases are available in three colors: **Black (BLK)**, **Tungsten (TUN)**, and **Designer White (DWT)**
- All desks include two (2) PVC wire management channels (L & R side) allowing for cabling through the pedestals.
- Hanging wood modesty panel on desk is standard.
- To avoid risk of pinching:
 - 4.9" / 124mm gap is kept between the pedestal and the lowest point of the worksurface.
 - Wood spacer HASP must be used to attach height adjustable unit in the "U" or "L" configuration. See assembly instructions.
 - 2" gap is required between the worksurfaces when using the HA Table or the HA Bridge Top.
 - Includes collision detector
- Optional grommet locations: **TL** - Top Left or **TR** - Top Right

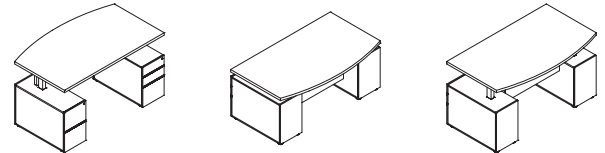
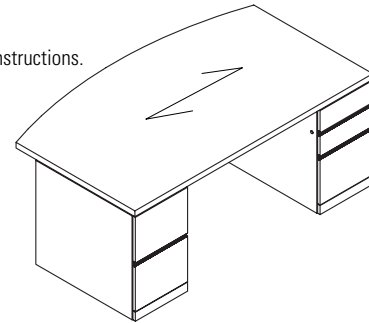

Note: Arrow indicates direction of grain.

HEIGHT ADJUSTABLE DOUBLE PEDESTAL DESKS	MODEL#	DIMENSIONS D x W x H	FREIGHT CLASS	WT./LBS.	CUBIC FT.	LIST PRICE
<p>Height Adj. Double Ped. Bow Top Desk Breakfront Style</p>	LHAMID8442ED	42 x 84 x 29	150	450	78	\$13691
	LHAMID7842ED	42 x 78 x 29	150	430	72	\$13112
	LHAMID7242ED	42 x 72 x 29	150	410	69	\$12534
	LHAMID6636ED	36 x 66 x 29	125	390	54	\$11889

Built-in electric height adjustable double pedestal, standard with full to floor **box/box/file** pedestal on **right** and **file/file** pedestal on **left**. Bow top. Pedestals lock. One pencil tray. Refer to the Desks and Credenzas Notes Section on page 268 for overhang dimensions.



<p>Height Adj. Double Ped. Bow Top Desk Breakfront Style</p>	LHAMID8442DE	42 x 84 x 29	150	450	78	\$13691
	LHAMID7842DE	42 x 78 x 29	150	430	72	\$13112
	LHAMID7242DE	42 x 72 x 29	150	410	69	\$12534
	LHAMID6636DE	36 x 66 x 29	125	390	54	\$11889

Built-in electric height adjustable double pedestal, standard with full to floor **box/box/file** pedestal on **left** and **file/file** pedestal on **right**. Bow top. Pedestals lock. One pencil tray. Refer to the Desks and Credenzas Notes Section on page 268 for overhang dimensions.

Required Specifications

- Top finish
- Edge
- Base finish
- Handle style

Optional Specifications

- Grommet
- Glass modesty

HEIGHT ADJUSTABLE DOUBLE PEDESTAL DESKS

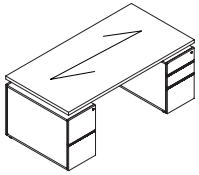

**Height Adj. Double Ped. Desk
Breakfront Style**

MODEL#	DIMENSIONS D x W x H	FREIGHT CLASS	WT/LBS.	CUBIC FT.	LIST PRICE
LHAID8436ED	36 x 84 x 29	125	440	68	\$11657
LHAID7836ED	36 x 78 x 29	125	420	63	\$11579
LHAID7236ED	36 x 72 x 29	125	400	58	\$11495
LHAID7230ED	30 x 72 x 29	125	390	49	\$11410
LHAID6630ED	30 x 66 x 29	100	380	46	\$11251

Built-in electric height adjustable double pedestal, standard with full to floor **box/box/file** pedestal on **right** and **file/file** pedestal on **left**. Pedestals lock. One pencil tray. Refer to the Desks and Credenzas Notes Section on page 268 for overhang dimensions.

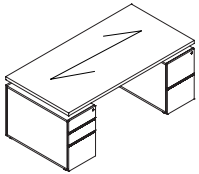

**Height Adj. Double Ped. Desk
Breakfront Style**

LHAID8436DE	36 x 84 x 29	125	440	68	\$11657
LHAID7836DE	36 x 78 x 29	125	420	63	\$11579
LHAID7236DE	36 x 72 x 29	125	400	58	\$11495
LHAID7230DE	30 x 72 x 29	125	390	49	\$11410
LHAID6630DE	30 x 66 x 29	100	380	46	\$11251

Built-in electric height adjustable double pedestal, standard with full to floor **box/box/file** pedestal on **left** and **file/file** pedestal on **right**. Pedestals lock. One pencil tray. Refer to the Desks and Credenzas Notes Section on page 268 for overhang dimensions.

HEIGHT ADJUSTABLE SINGLE PEDESTAL DESKS

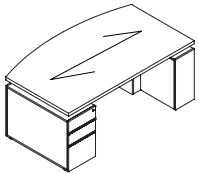

**Height Adj. Single Ped. Bow Top Desk
Breakfront Style - LEFT**

MODEL#	DIMENSIONS	FREIGHT CLASS	WT/LBS.	CUBIC FT.	LIST PRICE
LHAMISL8442D	42 x 84 x 29	150	440	81	\$12006
LHAMISL7842D	42 x 78 x 29	150	420	72	\$11554
LHAMISL7242D	42 x 72 x 29	150	400	67	\$11101
LHAMISL6636D	36 x 66 x 29	125	390	54	\$10535

Built-in electric height adjustable single pedestal bow top desk. Standard with full to floor locking **box/box/file** pedestal on **left** and support pedestal on **right**. Refer to the Desks and Credenzas Notes Section on page 268 for overhang dimensions.

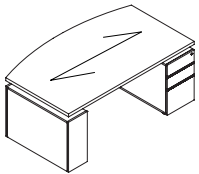

**Height Adj. Single Ped. Bow Top Desk
Breakfront Style - RIGHT**

LHAMISR8442D	42 x 84 x 29	150	440	81	\$12006
LHAMISR7842D	42 x 78 x 29	150	420	72	\$11554
LHAMISR7242D	42 x 72 x 29	150	400	67	\$11101
LHAMISR6636D	36 x 66 x 29	125	390	54	\$10535

Built-in electric height adjustable single pedestal bow top desk. Standard with full to floor locking **box/box/file** pedestal on **right** and support pedestal on **left**. Refer to the Desks and Credenzas Notes Section on page 268 for overhang dimensions.

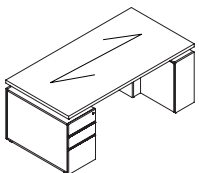

**Height Adjustable Single Ped. Desk
Breakfront Style - LEFT**

LHAISL8436D	36 x 84 x 29	125	430	68	\$10257
LHAISL7836D	36 x 78 x 29	125	410	63	\$10218
LHAISL7236D	36 x 72 x 29	125	390	58	\$10093
LHAISL7230D	30 x 72 x 29	125	380	49	\$9897
LHAISL6630D	30 x 66 x 29	125	360	46	\$9639
LHAISL6030D	30 x 60 x 29	100	340	42	\$9456

Built-in electric height adjustable single pedestal desk. Standard with full to floor locking **box/box/file** pedestal on **left** and support pedestal on **right**. Refer to the Desks and Credenzas Notes Section on page 268 for overhang dimensions.

Required Specifications

Top finish
Edge
Base finish
Handle style

Optional Specifications

Grommet
Glass modesty

HEIGHT ADJUSTABLE SINGLE PEDESTAL DESKS

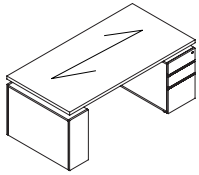

Height Adjustable Single Ped. Desk*
Breakfront Style - RIGHT

MODEL#	DIMENSIONS	FREIGHT CLASS	WT/LBS.	CUBIC FT.	LIST PRICE
D x W x H					
LHAISR8436D	36 x 84 x 29	125	430	68	\$10257
LHAISR7836D	36 x 78 x 29	125	410	63	\$10218
LHAISR7236D	36 x 72 x 29	125	390	58	\$10093
LHAISR7230D	30 x 72 x 29	125	380	49	\$9897
LHAISR6630D	30 x 66 x 29	125	360	46	\$9639
LHAISR6030D	30 x 60 x 29	100	340	42	\$9456

Built-in electric height adjustable single pedestal desk. Standard with full to floor locking **box/box/file** pedestal on **right** and support pedestal on **left**. Refer to the Desks and Credenzas Notes Section on page 268 for overhang dimensions.

HEIGHT ADJUSTABLE DESK SHELLS

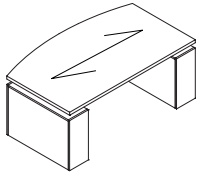

Height Adjustable Bow Top Desk Shell
Breakfront Style

MODEL#	DIMENSIONS	FREIGHT CLASS	WT/LBS.	CUBIC FT.	LIST PRICE
LHAMIT8442	42 x 84 x 29	150	350	81	\$11632
LHAMIT7842	42 x 78 x 29	150	330	72	\$11382
LHAMIT7242	42 x 72 x 29	150	310	67	\$11127
LHAMIT6636	36 x 66 x 29	150	280	54	\$10041

Built-in electric height adjustable bow top desk shell.
Refer to the Desks and Credenzas Notes Section on page 268 for overhang dimensions.

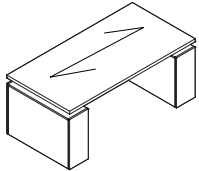

Height Adjustable Desk Shell
Breakfront Style

LHAIT8436	36 x 84 x 29	150	330	68	\$10349
LHAIT7836	36 x 78 x 29	150	310	63	\$10158
LHAIT7236	36 x 72 x 29	150	290	58	\$9954
LHAIT7230	30 x 72 x 29	150	280	49	\$9332
LHAIT6636	36 x 66 x 29	150	260	54	\$9561
LHAIT6630	30 x 66 x 29	150	250	46	\$9332
LHAIT6030	30 x 60 x 29	150	240	42	\$9166

Built-in electric height adjustable desk shell.
Refer to the Desks and Credenzas Notes Section on page 268 for overhang dimensions.

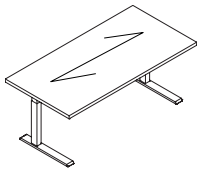

Height Adjustable Table

LHA8436	36 x 84 x 29	250	160	68	\$8376
LHA7836	36 x 78 x 29	250	150	63	\$8187
LHA7236	36 x 72 x 29	250	140	58	\$7982
LHA7230	30 x 72 x 29	250	130	49	\$7356
LHA6636	36 x 66 x 29	250	140	54	\$7587
LHA6630	30 x 66 x 29	250	120	46	\$7356
LHA6030	30 x 60 x 29	250	115	42	\$7193

Electric height adjustable table.

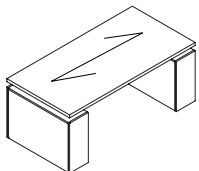

Height Adjustable Desk

LHA8436TP	36 x 84 x 29	150	320	68	\$10021
LHA7836TP	36 x 78 x 29	150	300	63	\$9830
LHA7236TP	36 x 72 x 29	150	280	58	\$9627
LHA7230TP	30 x 72 x 29	150	270	49	\$9001
LHA6636TP	36 x 66 x 29	150	250	54	\$9233
LHA6630TP	30 x 66 x 29	150	240	46	\$9001
LHA6030TP	30 x 60 x 29	150	230	42	\$8837

Built-in electric height adjustable desk on TP bases.

Required Specifications

Top finish
Edge
Base finish
Handle style*

Optional Specifications

Grommet
Glass modesty

HEIGHT ADJUSTABLE UNITS

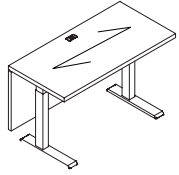

Height Adjustable Bridge Top

MODEL#	DIMENSIONS D x W x H	FREIGHT CLASS	WT/LBS.	CUBIC FT.	LIST PRICE
LHABT6024	24 x 60 x 29	150	150	35	\$7805
LHABT5424	24 x 54 x 29	150	140	31	\$7574
LHABT4824	24 x 48 x 29	150	130	28	\$7343
LHABT4224	24 x 42 x 29	150	120	26	\$7105

Electric height adjustable executive bridge top. Grommet in worksurface.

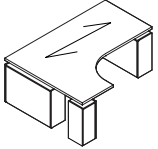

Height Adj. Right Extended Corner Desk*

LHAEKR60842436	24-36 x 60-84 x 29	150	450	108	\$15519
LHAEKR60782436	24-36 x 60-78 x 29	150	430	100	\$15481
LHAEKR60722436	24-36 x 60-72 x 29	150	410	93	\$15139
LHAEKR60662436	24-36 x 60-66 x 29	150	390	86	\$14698
LHAEKR60602436	24-36 x 60-60 x 29	150	370	79	\$14258

Built-in electric height adjustable right extended corner table desk with a 24" return connection. Extended worksurface on **right. Full end panel on right, narrow end panel on left.** Connects to Linking Bridges, Extended Corners and Connectable Tables.

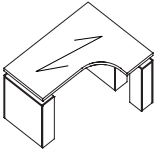

Height Adj. Left Extended Corner Desk*

LHAEKL84603624	24-36 x 60-84 x 29	150	450	108	\$15519
LHAEKL78603624	24-36 x 60-78 x 29	150	430	100	\$15481
LHAEKL72603624	24-36 x 60-72 x 29	150	410	93	\$15139
LHAEKL66603624	24-36 x 60-66 x 29	150	390	86	\$14698
LHAEKL60603624	24-36 x 60-60 x 29	150	370	79	\$14258

Built-in electric height adjustable right extended corner table desk with a 24" return connection. Extended worksurface on **left. Full end panel on left, narrow end panel on right.** Connects to Linking Bridges, Extended Corners and Connectable Tables.



Spacer

LHASP	2 x 8 x 23	70	15	.75	\$561
-------	------------	----	----	-----	--------------

Connects height adjustable desks with linking bridges and returns.

Required Specifications

Top finish
Edge
Base finish

Optional Specifications

Grommet*
Glass modesty

MODESTY PANEL OPTIONS

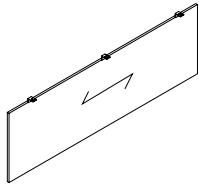

Veneer Modesty Panel Upgrade*

MODEL#	DIMENSIONS D x W x H	FREIGHT CLASS	WT./LBS.	CUBIC FT.	LIST PRICE
CMP72W	0.75 x 67 x 18	--	20	1	\$1622
CMP66W	0.75 x 61 x 18	--	18	1	\$1570
CMP60W	0.75 x 55 x 18	--	16	1	\$1546
CMP54W	0.75 x 49 x 18	--	14	1	\$1520
CMP48W	0.75 x 43 x 18	--	13	1	\$1496

Straight modesty panel. Attaches to underside of worksurface. **Can not be retrofitted in the field *Not sold individually - to be ordered as an upgrade option only.***

- CMP72W - Specify on "P" Top Islands or 96" x 48" Islands for Piano Desks.
- CMP66W - Specify on 84" x 36" "D" Top Islands.
- CMP60W - Specify on 84" x 42" "P" Top Islands or 84" x 48" Islands for Piano Desks.
- CMP54W - Specify on 72" x 30" "D" Top Islands.
- CMP48W - Specify on 66" x 36" , 60" x 30" "D" Top Islands, 72" x 42" "P" Top Islands or 72" x 48" Islands for Piano Desks.

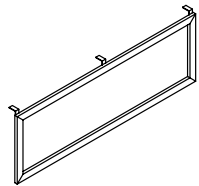

Glass Modesty Panel Upgrade

CMP72G	0.75 x 67 x 18	--	20	1	\$2485
CMP66G	0.75 x 61 x 18	--	18	1	\$2351
CMP60G	0.75 x 55 x 18	--	16	1	\$2149
CMP54G	0.75 x 49 x 18	--	14	1	\$2001
CMP48G	0.75 x 43 x 18	--	13	1	\$1911

Straight modesty panel. Translucent, screened glass. Aluminum box frame construction in Tungsten Only. Attaches to underside of worksurface. **Can not be retrofitted in the field. *Not sold individually - to be ordered as an upgrade option only.***

- CMP72G - Specify on "P" Top Islands or 96" x 48" Islands for Piano Desks.
- CMP66G - Specify on 84" x 36" "D" Top Islands.
- CMP60G - Specify on 84" x 42" "P" Top Islands or 84" x 48" Islands for Piano Desks.
- CMP54G - Specify on 72" x 30" "D" Top Islands.
- CMP48G - Specify on 66" x 36" , 60" x 30" "D" Top Islands, 72" x 42" "P" Top Islands or 72" x 48" Islands for Piano Desks.
- Tungsten finish on the aluminum box frame closely resembles the existing Tungsten finish.

SINGLE PEDESTAL DESKS - BREAKFRONT STYLE

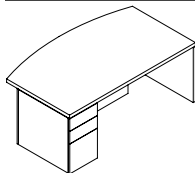

Single Pedestal Bow Top Desk - LEFT Breakfront Style*

MODEL#	DIMENSIONS	FREIGHT CLASS	WT./LBS.	CUBIC FT.	LIST PRICE
LMISL8442D	42 x 84 x 29	125	432	59	\$6790
LMISL7842D	42 x 78 x 29	125	401	55	\$6313
LMISL7242D	42 x 72 x 29	125	370	51	\$5847
LMISL6636D	36 x 66 x 29	150	230	40	\$5574

Standard with full to floor **box/box/file** pedestal on **left**. Bow top. Pedestal locks. Refer to the Desks and Credenzas Notes Section on page 268 for overhang dimensions.

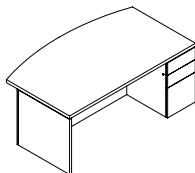

Single Pedestal Bow Top Desk - RIGHT Breakfront Style*

LMISR8442D	42 x 84 x 29	125	432	59	\$6790
LMISR7842D	42 x 78 x 29	125	401	55	\$6313
LMISR7242D	42 x 72 x 29	125	370	51	\$5847
LMISR6636D	36 x 66 x 29	150	230	40	\$5574

Standard with full to floor **box/box/file** pedestal on **right**. Bow top. Pedestal locks. Refer to the Desks and Credenzas Notes Section on page 268 for overhang dimensions.

Required Specifications

- Finish
- Veneer finish*
- Edge*

Optional Specifications

- Grommet*

SINGLE PEDESTAL DESKS - BREAKFRONT STYLE

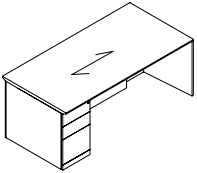

**Single Pedestal Desk - LEFT
Breakfront Style**

MODEL#	DIMENSIONS	FREIGHT CLASS	WT/LBS.	CUBIC FT.	LIST PRICE
LISL8436D	36 x 84 x 29	125	463	59	\$5923
LISL7236D	36 x 72 x 29	125	340	44	\$5045
LISL7230D	30 x 72 x 29	125	283	36	\$4153
LISL6636D	36 x 66 x 29	125	312	40	\$4153
LISL6630D	30 x 66 x 29	100	295	33	\$3967

Standard with full to floor **box/box/file** pedestal on **left**. Pedestal locks. Refer to the Desks and Credenzas Notes Section on page 268 for overhang dimensions.

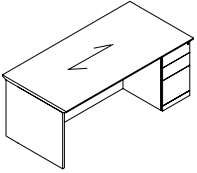

**Single Pedestal Desk - RIGHT
Breakfront Style**

LISR8436D	42 x 84 x 29	125	463	59	\$5923
LISR7236D	36 x 72 x 29	125	340	44	\$5045
LISR7230D	30 x 72 x 29	125	283	36	\$4153
LISR6636D	36 x 66 x 29	125	312	40	\$4153
LISR6630D	30 x 66 x 29	100	295	33	\$3967

Standard with full to floor **box/box/file** pedestal on **right**. Pedestal locks. Refer to the Desks and Credenzas Notes Section on page 268 for overhang dimensions.

DESK SHELLS

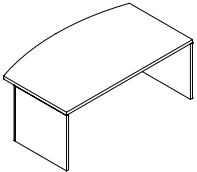

Bow Top Desk Shell

MODEL#	DIMENSIONS	FREIGHT CLASS	WT/LBS.	CUBIC FT.	LIST PRICE
LMT8442	42 x 84 x 29	125	380	59	\$5114
LMT7842	42 x 78 x 29	125	353	55	\$4744
LMT7242	42 x 72 x 29	125	331	51	\$4391
LMT6636	36 x 66 x 29	125	287	40	\$4178

Bow top and recessed modesty panel. Refer to the Desks and Credenzas Notes Section on page 268 for overhang dimensions.

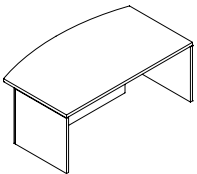

Bow Top Desk Shell, Breakfront Style

LMIT8442	42 x 84 x 29	125	380	59	\$5254
LMIT7842	42 x 78 x 29	125	353	55	\$4952
LMIT7242	42 x 72 x 29	125	331	51	\$4651
LMIT6636	36 x 66 x 29	125	287	40	\$4482

Bow top and recessed modesty panel. Refer to the Desks and Credenzas Notes Section on page 268 for overhang dimensions.

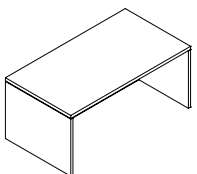

Desk Shell

LT8436	36 x 84 x 29	150	362	51	\$3678
LT7236	36 x 72 x 29	125	315	44	\$3498
LT7230	30 x 72 x 29	125	271	36	\$3297
LT6636	36 x 66 x 29	100	271	40	\$3297
LT6630	30 x 66 x 29	100	265	33	\$3090

Recessed modesty panel. Refer to the Desks and Credenzas Notes Section on page 268 for overhang dimensions.

Required Specifications

Veneer Finish
Edge

Optional Specifications

Grommet

RETURNS	MODEL#	DIMENSIONS D x W x H	FREIGHT CLASS	WT./LBS.	CUBIC FT.	LIST PRICE
---------	--------	-------------------------	---------------	----------	-----------	------------

- An Executive Return is used to attach to a Single Pedestal Desk, Single Pedestal Credenza, Desk Shell or Credenza Shell.
- Grommets are available as an option.
- Hand of Executive Return is determined by location of full end panel from user side.
- Hand of Desk or Credenza is determined by location of pedestal from user side.
- To remove cross grain veneer pattern on top, delete suffix "CG" from the model number. Available as a special - no upcharge.

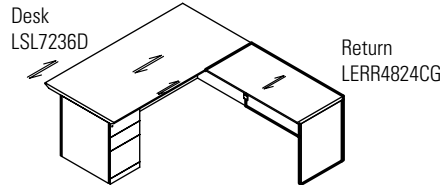
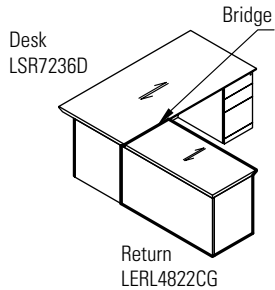

RETURNS	MODEL#	DIMENSIONS D x W x H	FREIGHT CLASS	WT./LBS.	CUBIC FT.	LIST PRICE
---------	--------	-------------------------	---------------	----------	-----------	------------

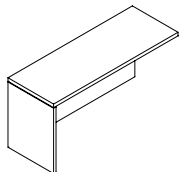

Flush Return - LEFT 24" Deep

LERL7224CG	24 x 72 x 29	150	135	29	\$2681
LERL6624CG	24 x 66 x 29	150	127	27	\$2505
LERL6024CG	24 x 60 x 29	150	120	24	\$2323
LERL5424CG	24 x 54 x 29	150	112	22	\$2149
LERL4824CG	24 x 48 x 29	150	105	19	\$1969
LERL4224CG	24 x 42 x 29	150	97	17	\$1787

Return has **no pedestal**. For use with right handed single pedestal desks, credenzas, desk shells, credenza shells, "D" islands or "P" islands.

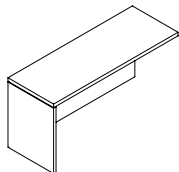

Flush Return - LEFT 20" Deep

LERL7220CG	20 x 72 x 29	150	130	27	\$1947
LERL6620CG	20 x 66 x 29	150	122	24	\$1787
LERL6020CG	20 x 60 x 29	150	115	22	\$1624
LERL5420CG	20 x 54 x 29	150	105	20	\$1466
LERL4820CG	20 x 48 x 29	150	100	18	\$1302
LERL4220CG	20 x 42 x 29	150	90	16	\$1142

Return has **no pedestal**. For use with right handed single pedestal desks, credenzas, desk shells, credenza shells, "D" islands or "P" islands.

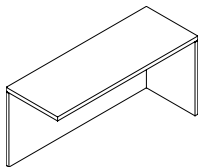

Flush Return - RIGHT 24" Deep

LERR7224CG	24 x 72 x 29	150	135	29	\$2681
LERR6624CG	24 x 66 x 29	150	127	27	\$2505
LERR6024CG	24 x 60 x 29	150	120	24	\$2323
LERR5424CG	24 x 54 x 29	150	112	22	\$2149
LERR4824CG	24 x 48 x 29	150	105	19	\$1969
LERR4224CG	24 x 42 x 29	150	97	17	\$1787

Return has **no pedestal**. For use with left handed single pedestal desks, credenzas, desk shells, credenza shells, "D" islands or "P" islands.

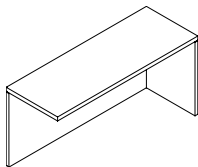

Flush Return - RIGHT 20" Deep

LERR7220CG	20 x 72 x 29	150	130	27	\$1947
LERR6620CG	20 x 66 x 29	150	122	24	\$1787
LERR6020CG	20 x 60 x 29	150	115	22	\$1624
LERR5420CG	20 x 54 x 29	150	105	20	\$1466
LERR4820CG	20 x 48 x 29	150	100	18	\$1302
LERR4220CG	20 x 42 x 29	150	90	16	\$1142

Return has **no pedestal**. For use with left handed single pedestal desks, credenzas, desk shells, credenza shells, "D" islands or "P" islands.

Required Specifications

Veneer Finish
Edge

Optional Specifications

Grommet

RETURNS

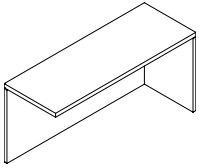

Non-Handed Return

MODEL#	DIMENSIONS D x W x H	FREIGHT CLASS	WT/LBS.	CUBIC FT.	LIST PRICE
LERR-L4824CG	24 x 48 x 29	150	105	19	\$2556
LERR-L4224CG	24 x 42 x 29	150	97	17	\$2313
LERR-L4820CG	20 x 48 x 29	150	100	19	\$1693
LERR-L4220CG	20 x 42 x 29	150	90	17	\$1483

Return has **no pedestal**. For use with left or right handed single pedestal desks, credenzas, desk shells, credenza shells, "D" islands or "P" islands.

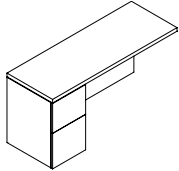

Flush Return - LEFT 24" Deep

LERR7224ECG	24 x 72 x 29	100	250	29	\$4474
LERR6624ECG	24 x 66 x 29	100	236	27	\$4326
LERR6024ECG	24 x 60 x 29	100	227	24	\$3973
LERR5424ECG	24 x 54 x 29	100	205	22	\$3842
LERR4824ECG	24 x 48 x 29	100	185	19	\$3462
LERR4224ECG	24 x 42 x 29	92.5	178	17	\$3347

Return has **file/file** pedestal on the **left**. Pedestal locks. For use with right handed single pedestal desks, credenzas, desk shells, credenza shells, "D" islands or "P" islands.

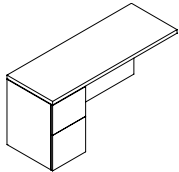

Flush Return - LEFT 20" Deep

LERR7220ECG	20 x 72 x 29	100	240	29	\$3470
LERR6620ECG	20 x 66 x 29	100	231	27	\$3342
LERR6020ECG	20 x 60 x 29	100	222	24	\$3038
LERR5420ECG	20 x 54 x 29	100	200	22	\$2929
LERR4820ECG	20 x 48 x 29	100	180	18	\$2609
LERR4220ECG	20 x 42 x 29	92.5	173	16	\$2505

Return has **file/file** pedestal on the **left**. Pedestal locks. For use with right handed single pedestal desks, credenzas, desk shells, credenza shells, "D" islands or "P" islands.

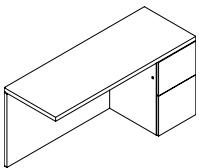

Flush Return - RIGHT 24" Deep

LERR7224ECG	24 x 72 x 29	100	250	29	\$4474
LERR6624ECG	24 x 66 x 29	100	236	27	\$4326
LERR6024ECG	24 x 60 x 29	100	227	24	\$3973
LERR5424ECG	24 x 54 x 29	100	205	22	\$3842
LERR4824ECG	24 x 48 x 29	100	185	19	\$3462
LERR4224ECG	24 x 42 x 29	92.5	178	17	\$3347

Return has **file/file** pedestal on the **right**. Pedestal locks. For use with left handed single pedestal desks, credenzas, desk shells, credenza shells, "D" islands or "P" islands.

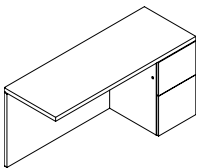

Flush Return - RIGHT 20" Deep

LERR7220ECG	20 x 72 x 29	100	240	29	\$3470
LERR6620ECG	20 x 66 x 29	100	231	27	\$3342
LERR6020ECG	20 x 60 x 29	100	222	24	\$3038
LERR5420ECG	20 x 54 x 29	100	200	22	\$2929
LERR4820ECG	20 x 48 x 29	100	180	18	\$2609
LERR4220ECG	20 x 42 x 29	92.5	173	16	\$2505

Return has **file/file** pedestal on the **right**. Pedestal locks. For use with left handed single pedestal desks, credenzas, desk shells, credenza shells, "D" islands or "P" islands.

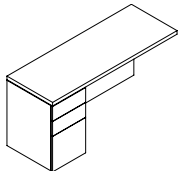

Flush Return - LEFT 24" Deep

LERR7224DCG	24 x 72 x 29	100	250	29	\$4474
LERR6624DCG	24 x 66 x 29	100	236	27	\$4326
LERR6024DCG	24 x 60 x 29	100	227	24	\$3973
LERR5424DCG	24 x 54 x 29	100	205	22	\$3842
LERR4824DCG	24 x 48 x 29	100	185	19	\$3462
LERR4224DCG	24 x 42 x 29	92.5	178	17	\$3347

Return has **box/box/file** pedestal on the **left**. Pedestal locks. For use with right handed single pedestal desks, credenzas, desk shells, credenza shells, "D" islands or "P" islands.

Required Specifications

Veneer Finish
Edge

Optional Specifications

Grommet

RETURNS **MODEL#** **DIMENSIONS** **FREIGHT CLASS** **WT./LBS.** **CUBIC FT.** **LIST PRICE**

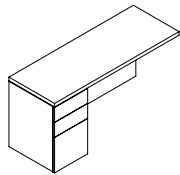

Flush Return - LEFT 20" Deep

MODEL#	DIMENSIONS D x W x H	FREIGHT CLASS	WT./LBS.	CUBIC FT.	LIST PRICE
LERL7220DCG	20 x 72 x 29	100	240	27	\$3470
LERL6620DCG	20 x 66 x 29	100	231	24	\$3342
LERL6020DCG	20 x 60 x 29	100	222	22	\$3038
LERL5420DCG	20 x 54 x 29	100	200	20	\$2929
LERL4820DCG	20 x 48 x 29	100	180	18	\$2609
LERL4220DCG	20 x 42 x 29	92.5	173	16	\$2505

Return has **box/box/file** pedestal on the **left**. Pedestal locks. For use with right handed single pedestal desks, credenzas, desk shells, credenza shells, "D" islands or "P" islands.

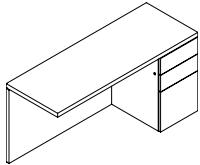

Flush Return - RIGHT 24" Deep

LERR7224DCG	24 x 72 x 29	100	250	29	\$4474
LERR6624DCG	24 x 66 x 29	100	236	27	\$4326
LERR6024DCG	24 x 60 x 29	100	227	24	\$3973
LERR5424DCG	24 x 54 x 29	100	205	22	\$3842
LERR4824DCG	24 x 48 x 29	100	185	19	\$3462
LERR4224DCG	24 x 42 x 29	92.5	178	17	\$3347

Return has **box/box/file** pedestal on the **right**. Pedestal locks. For use with left handed single pedestal desks, credenzas, desk shells, credenza shells, "D" islands or "P" islands.

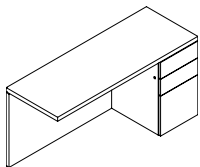

Flush Return - RIGHT 20" Deep

LERR7220DCG	20 x 72 x 29	100	240	27	\$3470
LERR6620DCG	20 x 66 x 29	100	231	24	\$3342
LERR6020DCG	20 x 60 x 29	100	222	22	\$3038
LERR5420DCG	20 x 54 x 29	100	200	20	\$2929
LERR4820DCG	20 x 48 x 29	100	180	18	\$2609
LERR4220DCG	20 x 42 x 29	92.5	173	16	\$2505

Return has **box/box/file** pedestal on the **right**. Pedestal locks. For use with left handed single pedestal desks, credenzas, desk shells, credenza shells, "D" islands or "P" islands.

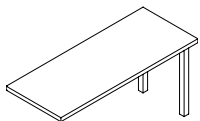

Return

LR8430CG	30 x 84 x 29	150	130	29	\$1947
LR7230CG	30 x 72 x 29	150	122	27	\$1720
LR6630CG	30 x 66 x 29	150	115	24	\$1620
LR6030CG	30 x 60 x 29	150	105	22	\$1509

Return has **no pedestal**. For use with single pedestal desks, credenzas, desk shells, credenza shells, "D" islands or "P" islands.

BRIDGES - EXECUTIVE

- An Executive Bridge is used to connect a Desk to a Credenza.
- Not to be used with Corner Components or Piano Desks,
- Three Modesty Panel options - Full Modesty, 8" Modesty and No Modesty (Flush Bridge Top).
- Modesty panel flush with end panels of Desk and Credenza.
- Includes GM1 grommet in the top center position.
- Both connecting sides of executive bridges feature a reverse profile edge

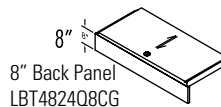
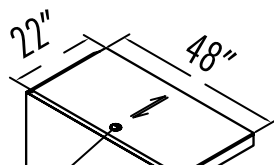
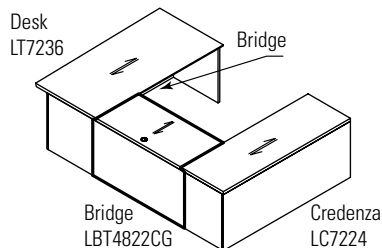

Required Specifications

Veneer Finish
Edge

Optional Specifications

Grommet

BRIDGES - LINKING

MODEL#

DIMENSIONS

FREIGHT CLASS

WT/LBS.

CUBIC FT.

LIST PRICE

D x W x H

- A linking bridge is used to connect corner components to a single pedestal desk, HA desk, single pedestal credenza, desk shell or credenza shell.
- When connecting HA desk, must specify LHASP spacer.
- Two modesty panel options - full modesty and 8" modesty.
- Includes GM1 grommet in the top center position.
- Hand of linking bridge is determined by location of half end panel from user side.
- Linking bridges are handed **left and right** (handedness is determined by connecting side with the self edge). The opposite connecting side features a reverse profile edge.

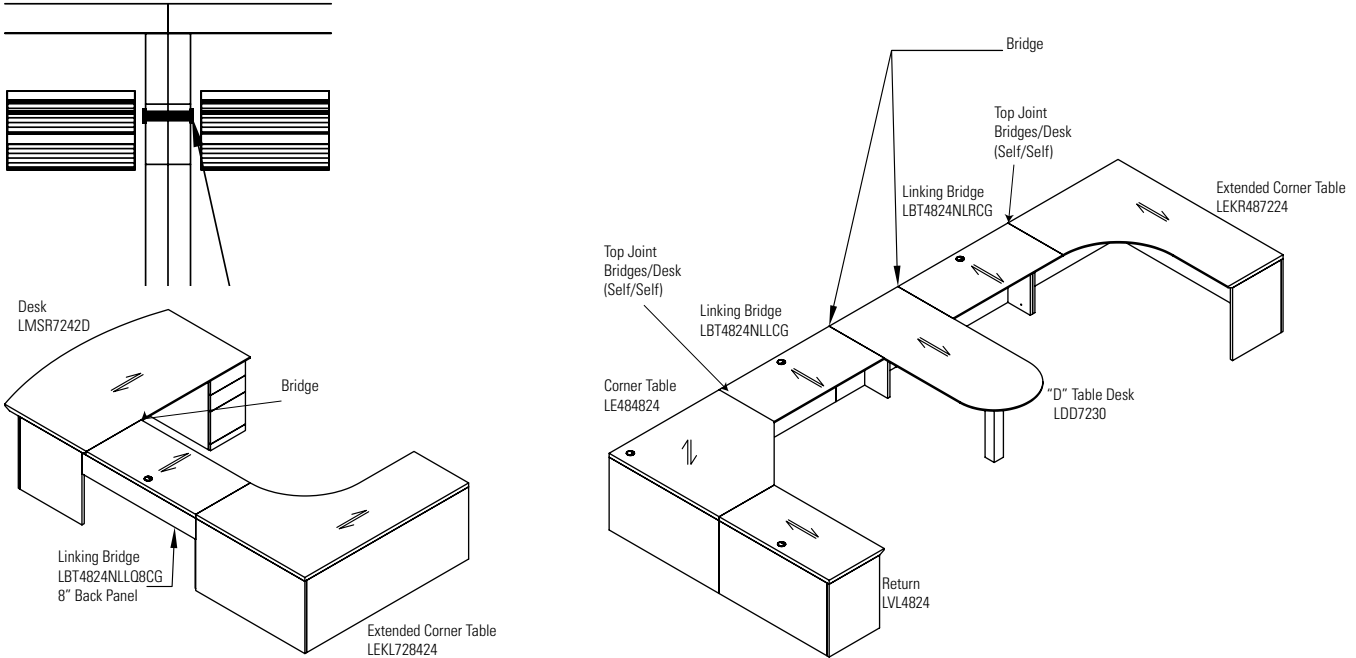

BRIDGES

MODEL#

DIMENSIONS

FREIGHT CLASS

WT/LBS.

CUBIC FT.

LIST PRICE

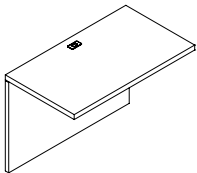

Flush Bridge

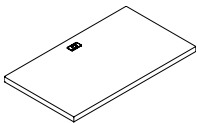

Flush Bridge Top

LBT6024CG	24 x 60 x 29	85	144	10	\$1894
LBT5424CG	24 x 54 x 29	85	129	9	\$1705
LBT4824CG	24 x 48 x 29	70	120	8	\$1520
LBT4224CG	24 x 42 x 29	70	105	7	\$1329
LBT6020CG	20 x 60 x 29	70	131	8	\$1558
LBT5420CG	20 x 54 x 29	85	118	8	\$1402
LBT4820CG	20 x 48 x 29	70	110	7	\$1243
LBT4220CG	20 x 42 x 29	70	96	6	\$1067

Top surface, back panel and hardware to create a "U" configuration with a single pedestal desk or credenza. **Cannot be used with corners.** Grommet in worksurface. Shipped RTA (ready to assemble).

- If linking to bookcase or open storage, add **/S** to end of model number

LBT5424TCG	24 x 54 x --	85	129	9	\$1335
LBT4824TCG	24 x 48 x --	70	120	8	\$1201
LBT4224TCG	24 x 42 x --	70	105	7	\$1056
LBT5420TCG	20 x 54 x --	85	118	8	\$982
LBT4820TCG	20 x 48 x --	70	110	7	\$875
LBT4220TCG	20 x 42 x --	70	96	6	\$745

Top surface only to create a "U" configuration with a single pedestal desk or credenza. **Cannot be used with corners.** Grommet in worksurface. Shipped RTA (ready to assemble).

- If linking to bookcase or open storage, add **/S** to end of model number

Required Specifications

Veneer Finish
Edge

Optional Specifications

Grommet

BRIDGES

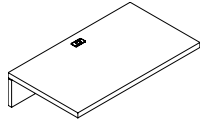

Flush Bridge Top, 8" Modesty Panel

MODEL# DIMENSIONS FREIGHT CLASS WT/LBS. CUBIC FT. LIST PRICE

D x W x H

LBT6024Q8CG	24 x 60 x --	85	144	10	\$1701
LBT5424Q8CG	24 x 54 x --	85	129	9	\$1540
LBT4824Q8CG	24 x 48 x --	70	120	8	\$1369
LBT4224Q8CG	24 x 42 x --	70	105	7	\$1196

LBT6020Q8CG	20 x 60 x --	70	131	8	\$1402
LBT5420Q8CG	20 x 54 x --	85	118	8	\$1260
LBT4820Q8CG	20 x 48 x --	70	110	7	\$1121
LBT4220Q8CG	20 x 42 x --	70	96	6	\$959

Top surface with 8" modesty panel for utility access. Create a "U" configuration with a single pedestal desk or credenza.

Cannot be used with corners. Grommet in worksurface. Shipped RTA (ready to assemble).

- If linking to bookcase or open storage, add **/S** to end of model number

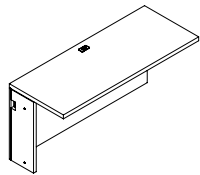

Linking Bridge - LEFT

LBT6024NLLCG	24 x 60 x 29	125	145	24	1879
LBT5424NLLCG	24 x 54 x 29	150	131	22	\$1689
LBT4824NLLCG	24 x 48 x 29	125	116	19	\$1502
LBT4224NLLCG	24 x 42 x 29	125	102	17	\$1218
LBT3624NLLCG	24 x 36 x 29	150	87	15	\$1108
LBT3024NLLCG	24 x 30 x 29	125	73	12	\$1077

LBT6020NLLCG	22 x 60 x 29	150	131	22	\$1705
LBT5420NLLCG	22 x 54 x 29	150	118	20	\$1534
LBT4820NLLCG	22 x 48 x 29	125	110	18	1369
LBT4220NLLCG	22 x 42 x 29	150	95	16	1108
LBT3620NLLCG	22 x 36 x 29	125	80	13	1007
LBT3020NLLCG	22 x 30 x 29	150	65	11	982

Top surface, back panel and hardware. **Left side** connects to a 5-Sided Corner, Extended Corner or Connectable Table. Right side connects to a single pedestal desk or credenza, "D" island, Boat shaped island, "P" island and Delta island with a "T" base. Grommet in worksurface.

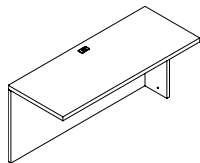

Linking Bridge - RIGHT

LBT6024NLRCG	24 x 60 x 29	125	145	24	\$1879
LBT5424NLRCG	24 x 54 x 29	150	131	22	\$1689
LBT4824NLRCG	24 x 48 x 29	125	116	19	\$1502
LBT4224NLRCG	24 x 42 x 29	125	102	17	\$1218
LBT3624NLRCG	24 x 36 x 29	150	87	15	\$1108
LBT3024NLRCG	24 x 30 x 29	125	73	12	\$1077

LBT6020NLRCG	22 x 60 x 29	150	131	22	\$1705
LBT5420NLRCG	22 x 54 x 29	150	118	20	\$1534
LBT4820NLRCG	22 x 48 x 29	125	110	18	\$1369
LBT4220NLRCG	22 x 42 x 29	150	95	16	\$1108
LBT3620NLRCG	22 x 36 x 29	125	80	13	\$1007
LBT3020NLRCG	22 x 30 x 29	150	65	11	\$982

Top surface, back panel and hardware. **Right side** connects to a 5-Sided Corner, Extended Corner or Connectable Table. Right side connects to a single pedestal desk or credenza, "D" island, Boat shaped island, "P" island and Delta island with a "T" base. Grommet in worksurface.

Required Specifications

Veneer Finish
Edge

Optional Specifications

Grommet

BRIDGES

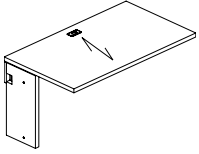

Linking Bridge, 8" Modesty Panel - LEFT

MODEL#	DIMENSIONS D x W x H	FREIGHT CLASS	WT/LBS.	CUBIC FT.	LIST PRICE
LBT6024NLLQ8CG	24 x 60 x 29	125	145	24	\$2072
LBT5424NLLQ8CG	24 x 54 x 29	150	131	22	\$1863
LBT4824NLLQ8CG	24 x 48 x 29	125	116	19	\$1637
LBT4224NLLQ8CG	24 x 42 x 29	125	102	17	\$1452
LBT3624NLLQ8CG	24 x 36 x 29	150	87	15	\$1201
LBT3024NLLQ8CG	24 x 30 x 29	125	73	12	\$1175
LBT6020NLLQ8CG	20 x 60 x 29	150	131	22	\$1534
LBT5420NLLQ8CG	20 x 54 x 29	150	118	20	\$1385
LBT4820NLLQ8CG	20 x 48 x 29	125	110	18	\$1235
LBT4220NLLQ8CG	20 x 42 x 29	150	95	16	\$998
LBT3620NLLQ8CG	20 x 36 x 29	125	80	13	\$906
LBT3020NLLQ8CG	20 x 30 x 29	150	65	11	\$893

Top surface with 8" modesty panel for utility access and hardware. **Left side** connects to a 5-Sided Corner, Extended Corner or Connectable Table. Right side connects to a single pedestal desk or credenza, "D" island, Boat shaped island, "P" island and Delta island with a "T" base. Grommet in worksurface. Shipped RTA (ready to assemble).

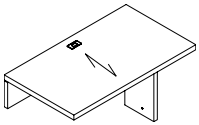

Linking Bridge, 8" Modesty Panel - RIGHT

LBT6024NLRQ8CG	24 x 60 x 29	125	145	24	\$2072
LBT5424NLRQ8CG	24 x 54 x 29	150	131	22	\$1863
LBT4824NLRQ8CG	24 x 48 x 29	125	116	19	\$1637
LBT4224NLRQ8CG	24 x 42 x 29	125	102	17	\$1452
LBT3624NLRQ8CG	24 x 36 x 29	150	87	15	\$1201
LBT3024NLRQ8CG	24 x 30 x 29	125	73	12	\$1175
LBT6020NLRQ8CG	20 x 60 x 29	150	131	22	\$1534
LBT5420NLRQ8CG	20 x 54 x 29	150	118	20	\$1385
LBT4820NLRQ8CG	20 x 48 x 29	125	110	18	\$1235
LBT4220NLRQ8CG	20 x 42 x 29	150	95	16	\$998
LBT3620NLRQ8CG	20 x 36 x 29	125	80	13	\$906
LBT3020NLRQ8CG	20 x 30 x 29	150	65	11	\$893

Top surface with 8" modesty panel for utility access and hardware. **Right side** connects to a 5-Sided Corner, Extended Corner or Connectable Table. Right side connects to a single pedestal desk or credenza, "D" island, Boat shaped island, "P" island and Delta island with a "T" base. Grommet in worksurface. Shipped RTA (ready to assemble).

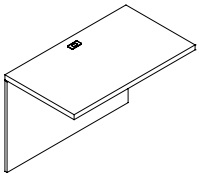

Bridge - Hinged Modesty

LHBT6024CG	24 x 60 x 29	85	144	10	\$1894
LHBT5424CG	24 x 54 x 29	85	129	9	\$1705
LHBT4824CG	24 x 48 x 29	70	120	8	\$1520
LHBT4224CG	24 x 42 x 29	70	105	7	\$1329
LHBT6020CG	20 x 60 x 29	70	131	8	\$1558
LHBT5420CG	20 x 54 x 29	85	118	8	\$1402
LHBT4820CG	20 x 48 x 29	70	110	7	\$1243
LHBT4220CG	20 x 42 x 29	70	96	6	\$1067

Executive Bridge Top and **Hinged Back Panel** to create a "U" configuration with a single pedestal desk or credenza. **Cannot be used with corners.** Grommet in worksurface. Shipped RTA (ready to assemble).

Required Specifications

Veneer Finish
Edge

Optional Specifications

Grommet

CRENZAS

MODEL# DIMENSIONS FREIGHT CLASS WT/LBS. CUBIC FT. LIST PRICE

D x W x H

LC10824	24 x 108 x 29	125	348	44	\$4245
LC10224	24 x 102 x 29	100	329	41	\$4047
LC9624	24 x 96 x 29	125	309	39	\$3832
LC9024	24 x 90 x 29	100	290	36	\$3633
LC8424	24 x 84 x 29	125	271	34	\$3429
LC7824	24 x 78 x 29	100	251	31	\$3215
LC7224	24 x 72 x 29	100	232	29	\$3016
LC6624	24 x 66 x 29	125	213	27	\$2919
LC6024	24 x 60 x 29	100	193	24	\$2704

LC10820	20 x 108 x 29	100	309	36	\$3386
LC10220	20 x 102 x 29	100	291	34	\$3211
LC9620	20 x 96 x 29	100	273	32	\$3025
LC9020	20 x 90 x 29	100	255	30	\$2844
LC8420	20 x 84 x 29	100	237	28	\$2667
LC7820	20 x 78 x 29	100	219	26	\$2483
LC7220	20 x 72 x 29	100	206	24	\$2303
LC6620	20 x 66 x 29	100	188	22	\$2222
LC6020	20 x 60 x 29	100	169	20	\$2033

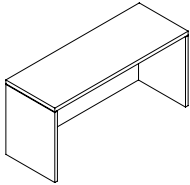

Credenza Shell

Standard with **no pedestals**. Flush full modesty panel. 96" w and larger includes a center support leg. If using storage component shells underneath to support the worksurface, **no more than 72" may be left unsupported**.

LCK8424EE	24 x 84 x 29	92.5	348	34	\$6420
LCK7824EE	24 x 78 x 29	92.5	319	31	\$6214
LCK7224EE	24 x 72 x 29	100	280	29	\$5780
LCK6624EE	24 x 66 x 29	100	261	27	\$5313
LCK6024EE	24 x 60 x 29	100	238	24	\$5257

LCK8420EE	20 x 84 x 29	92.5	320	34	\$6363
LCK7820EE	20 x 78 x 29	92.5	298	31	\$6536
LCK7220EE	20 x 72 x 29	92.5	280	29	\$5344
LCK6620EE	20 x 66 x 29	92.5	257	27	\$5257
LCK6020EE	20 x 60 x 29	92.5	233	24	\$5195

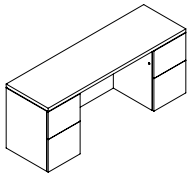

Kneespace Credenza

Standard with full to floor **file/file** pedestals on **left and right**. **Center is open** Pedestals lock.

LCK8424DD	24 x 84 x 29	92.5	348	34	\$6420
LCK7824DD	24 x 78 x 29	92.5	319	31	\$6214
LCK7224DD	24 x 72 x 29	100	280	29	\$5407
LCK6624DD	24 x 66 x 29	100	261	27	\$5313
LCK6024DD	24 x 60 x 29	100	238	24	\$5257

LCK8420DD	20 x 84 x 29	92.5	307	28	\$6660
LCK7820DD	20 x 78 x 29	92.5	285	26	\$6536
LCK7220DD	20 x 72 x 29	92.5	267	24	\$5344
LCK6620DD	20 x 66 x 29	92.5	244	22	\$5257
LCK6020DD	20 x 60 x 29	92.5	220	20	\$5195

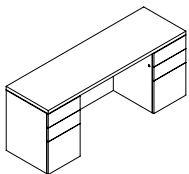

Kneespace Credenza

Standard with full to floor **box/box/file** pedestals on **left and right**. **Center is open** Pedestals lock.

Required Specifications

Veneer Finish
Edge

Optional Specifications

Grommet

CREDENZAS

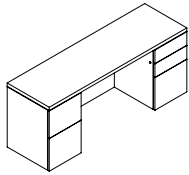

Kneespace Credenza

MODEL#	DIMENSIONS D x W x H	FREIGHT CLASS	WT/LBS.	CUBIC FT.	LIST PRICE
LCK8424ED	24 x 84 x 29	92.5	348	34	\$6420
LCK7824ED	24 x 78 x 29	92.5	319	31	\$6214
LCK7224ED	24 x 72 x 29	100	280	29	\$5780
LCK6624ED	24 x 66 x 29	100	261	27	\$5313
LCK6024ED	24 x 60 x 29	100	238	24	\$5257
LCK8420ED	20 x 84 x 29	92.5	307	28	\$6363
LCK7820ED	20 x 78 x 29	92.5	285	26	\$6536
LCK7220ED	20 x 72 x 29	92.5	267	24	\$5344
LCK6620ED	20 x 66 x 29	92.5	244	22	\$5257
LCK6020ED	20 x 60 x 29	92.5	220	20	\$5195

Standard with full to floor **file/file** pedestal on **left** and **box/box/file** pedestal on **right**. **Center is open** Pedestals lock. One pencil tray.

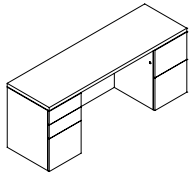

Kneespace Credenza

LCK8424DE	24 x 84 x 29	92.5	348	34	\$6420
LCK7824DE	24 x 78 x 29	92.5	319	31	\$6214
LCK7224DE	24 x 72 x 29	100	280	29	\$5407
LCK6624DE	24 x 66 x 29	100	261	27	\$5313
LCK6024DE	24 x 60 x 29	100	238	24	\$5257
LCK8420DE	20 x 84 x 29	92.5	307	28	\$6363
LCK7820DE	20 x 78 x 29	92.5	285	26	\$6536
LCK7220DE	20 x 72 x 29	92.5	267	24	\$5344
LCK6620DE	20 x 66 x 29	92.5	244	22	\$5257
LCK6020DE	20 x 60 x 29	92.5	220	20	\$5195

Standard with full to floor **box/box/file** pedestal on **left** and **file/file** pedestal on **right**. **Center is open** Pedestals lock. One pencil tray.

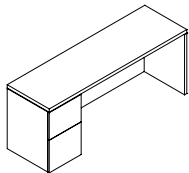

Single Pedestal Credenza - LEFT

LCL8424E	24 x 84 x 29	100	315	34	\$5156
LCL7824E	24 x 78 x 29	100	292	31	\$4823
LCL7224E	24 x 72 x 29	100	270	29	\$4496
LCL6624E	24 x 66 x 29	100	247	27	\$4351
LCL6024E	24 x 60 x 29	100	225	24	\$4009
LCL8420E	20 x 84 x 29	100	273	28	\$4589
LCL7820E	20 x 78 x 29	100	252	26	\$4912
LCL7220E	20 x 72 x 29	100	237	24	\$3986
LCL6620E	20 x 66 x 29	100	216	22	\$3842
LCL6020E	20 x 60 x 29	100	195	20	\$3547

Standard with full to floor **file/file** pedestal on **left**. Pedestal locks.

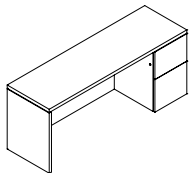

Single Pedestal Credenza - RIGHT

LCR8424E	24 x 84 x 29	100	315	34	\$5156
LCR7824E	24 x 78 x 29	100	292	31	\$4823
LCR7224E	24 x 72 x 29	100	270	29	\$4496
LCR6624E	24 x 66 x 29	100	247	27	\$4351
LCR6024E	24 x 60 x 29	100	225	24	\$4009
LCR8420E	20 x 84 x 29	100	273	28	\$4589
LCR7820E	20 x 78 x 29	100	252	26	\$4912
LCR7220E	20 x 72 x 29	100	237	24	\$3986
LCR6620E	20 x 66 x 29	100	216	22	\$3842
LCR6020E	20 x 60 x 29	100	195	20	\$3547

Standard with full to floor **file/file** pedestal on **right**. Pedestal locks.

Required Specifications

Veneer Finish
Edge

Optional Specifications

Grommet

CREDENZAS **MODEL#** **DIMENSIONS** **FREIGHT CLASS** **WT/LBS.** **CUBIC FT.** **LIST PRICE**

D x W x H

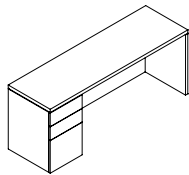

Single Pedestal Credenza - LEFT

LCL8424D	24 x 84 x 29	100	315	34	\$5156
LCL7824D	24 x 78 x 29	100	292	31	\$4823
LCL7224D	24 x 72 x 29	100	270	29	\$4496
LCL6624D	24 x 66 x 29	100	247	27	\$4351
LCL6024D	24 x 60 x 29	100	225	24	\$4009
LCL8420D	20 x 84 x 29	100	273	28	\$4589
LCL7820D	20 x 78 x 29	100	252	26	\$4912
LCL7220D	20 x 72 x 29	100	237	24	\$3986
LCL6620D	20 x 66 x 29	100	216	22	\$3842
LCL6020D	20 x 60 x 29	100	195	20	\$3547

Standard with full to floor **box/box/file** pedestal on **left**. Pedestal locks.

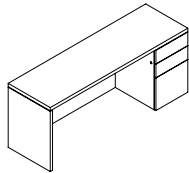

Single Pedestal Credenza - RIGHT

LCR8424D	24 x 84 x 29	100	315	34	\$5156
LCR7824D	24 x 78 x 29	100	292	31	\$4823
LCR7224D	24 x 72 x 29	100	270	29	\$4496
LCR6624D	24 x 66 x 29	100	247	27	\$4351
LCR6024D	24 x 60 x 29	100	225	24	\$4009
LCR8420D	20 x 84 x 29	100	273	28	\$4589
LCR7820D	20 x 78 x 29	100	252	26	\$4912
LCR7220D	20 x 72 x 29	100	237	24	\$3986
LCR6620D	20 x 66 x 29	100	216	22	\$3842
LCR6020D	20 x 60 x 29	100	195	20	\$3547

Standard with full to floor **box/box/file** pedestal on **right**. Pedestal locks.

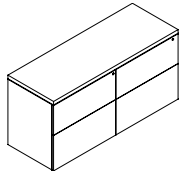

Lateral File Credenza

LC7224FF	24 x 72 x 29	92.5	328	29	\$6910
LC7220FF	20 x 72 x 29	92.5	287	24	\$6097
LC6024NN	24 x 60 x 29	92.5	273	24	\$6380
LC6020NN	20 x 60 x 29	92.5	205	20	\$5405

Two 2-drawer lateral files side-by-side. Locking drawers. Anti-lock tilt suspension. **Not for stacking materials on lateral file drawer bottom.**

- "FF" models use two 36" wide lateral files, "NN" models use 30" wide.

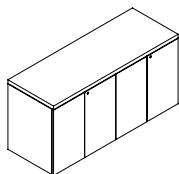

Storage Cabinet Credenza

LC7224GG	24 x 72 x 29	92.5	300	29	\$5285
LC7220GG	20 x 72 x 29	92.5	253	24	\$4673
LC6024MM	24 x 60 x 29	92.5	254	24	\$4877
LC6020MM	20 x 60 x 29	92.5	209	20	\$4164

Two 2-door storage cabinets side-by-side. Locking doors. Self-closing hinged doors cover one adjustable shelf.

- "GG" models use two 36" wide storage cabinets, "MM" models use 30" wide.

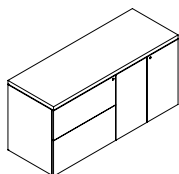

Lateral File/Storage Cabinet Credenza

LCF7224	24 x 72 x 29	92.5	305	29	\$5527
LCF7220	20 x 72 x 29	92.5	272	24	\$4893
LCF6024	24 x 60 x 29	92.5	254	24	\$4695
LCF6020	20 x 60 x 29	92.5	220	20	\$4164

One 2-drawer lateral file and one storage cabinet. Locking door/drawers. Storage cabinet includes one adjustable shelf. Anti-lock tilt suspension. **Not for stacking materials on lateral file drawer bottom.**

Required Specifications

Veneer Finish
Edge

Optional Specifications

Grommet

CREDENZAS

MODEL# DIMENSIONS FREIGHT CLASS WT/LBS. CUBIC FT. LIST PRICE

D x W x H

LCL8424F	24 x 84 x 29	100	305	34	\$5386
LCL7824F	24 x 78 x 29	100	285	31	\$4994
LCL7224F	24 x 72 x 29	100	261	29	\$4620
LCL6624F	24 x 66 x 29	100	239	27	\$4448
LCL6024F	24 x 60 x 29	100	218	24	\$4034
LCL8420F	20 x 84 x 29	100	273	28	\$4706
LCL7820F	20 x 78 x 29	100	252	26	\$4364
LCL7220F	20 x 72 x 29	100	237	24	\$4031
LCL6620F	20 x 66 x 29	100	216	22	\$3883
LCL6020F	20 x 60 x 29	100	195	20	\$3526

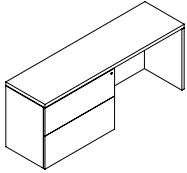

Kneespace Lateral File Credenza - LEFT

One 2-drawer lateral file on the **left**. Locking drawers. Anti-lock tilt suspension. **Not for stacking materials on lateral file drawer bottom.**

LCR8424F	24 x 84 x 29	100	305	34	\$5386
LCR7824F	24 x 78 x 29	100	285	31	\$4994
LCR7224F	24 x 72 x 29	100	261	29	\$4620
LCR6624F	24 x 66 x 29	100	239	27	\$4448
LCR6024F	24 x 60 x 29	100	218	24	\$4034
LCR8420F	20 x 84 x 29	100	273	28	\$4706
LCR7820F	20 x 78 x 29	100	252	26	\$4364
LCR7220F	20 x 72 x 29	100	237	24	\$4031
LCR6620F	20 x 66 x 29	100	216	22	\$3883
LCR6020F	20 x 60 x 29	100	195	20	\$3526

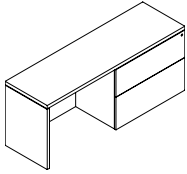

Kneespace Lateral File Credenza - RIGHT

One 2-drawer lateral file on the **right**. Locking drawers. Anti-lock tilt suspension. **Not for stacking materials on lateral file drawer bottom.**

LCL8424Z	24 x 84 x 29	100	338	34	\$6418
LCL7824Z	24 x 78 x 29	100	314	31	\$5994
LCL7224Z	24 x 72 x 29	100	290	29	\$5581
LCL6624Z	24 x 66 x 29	100	266	27	\$5386
LCL6024Z	24 x 60 x 29	100	242	24	\$4405
LCL8420Z	20 x 84 x 29	100	273	28	\$5682
LCL7820Z	20 x 78 x 29	100	252	26	\$5323
LCL7220Z	20 x 72 x 29	100	237	24	\$4952
LCL6620Z	20 x 66 x 29	100	216	22	\$4785
LCL6020Z	20 x 60 x 29	100	195	20	\$4405

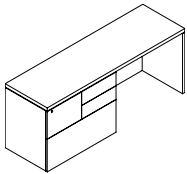

Mixed Storage Credenza - LEFT

Standard with two box drawers, one file drawer, and one 36"W lateral file drawer on the **left**. File drawer and lateral file drawer lock. **Not for stacking materials on lateral file drawer bottom.**

LCR8424Z	24 x 84 x 29	100	338	34	\$6418
LCR7824Z	24 x 78 x 29	100	314	31	\$5994
LCR7224Z	24 x 72 x 29	100	290	29	\$5581
LCR6624Z	24 x 66 x 29	100	266	27	\$5386
LCR6024Z	24 x 60 x 29	100	242	24	\$4405
LCR8420Z	20 x 84 x 29	100	273	28	\$5682
LCR7820Z	20 x 78 x 29	100	252	26	\$5323
LCR7220Z	20 x 72 x 29	100	237	24	\$4952
LCR6620Z	20 x 66 x 29	100	216	22	\$4785
LCR6020Z	20 x 60 x 29	100	195	20	\$4405

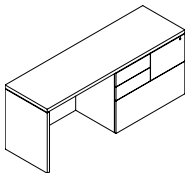

Mixed Storage Credenza - RIGHT

Standard with two box drawers, one file drawer, and one 36"W lateral file drawer on the **right**. File drawer and lateral file drawer lock. **Not for stacking materials on lateral file drawer bottom.**

Required Specifications

Veneer Finish
Edge

Optional Specifications

Grommet

CREDENZAS

MODEL# DIMENSIONS FREIGHT CLASS WT/LBS. CUBIC FT. LIST PRICE

D x W x H

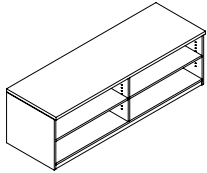

Credenza

LCO7224H23	24 x 72 x 23	92.5	305	29	\$3579
LCO7220H23	20 x 72 x 23	92.5	272	24	\$3128
LCO6024H23	24 x 60 x 23	92.5	254	24	\$2985
LCO6020H23	20 x 60 x 23	92.5	220	20	\$2609

Standard with open storage on **both sides**.

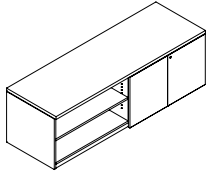

Credenza

LCOG7224H23	24 x 72 x 23	92.5	328	29	\$3605
LCOG7220H23	20 x 72 x 23	92.5	287	24	\$3154
LCOM6024H23	24 x 60 x 23	92.5	273	24	\$3313
LCOM6020H23	20 x 60 x 23	92.5	205	20	\$2758

Standard with open storage on the **left** and one storage cabinet on the **right**. Storage cabinet includes one adjustable shelf.

- "G" model uses 36" wide storage cabinets, "M" model uses 30" wide.

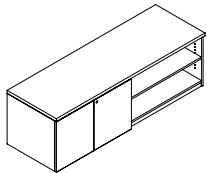

Credenza

LCG07224H23	24 x 72 x 23	92.5	328	29	\$3605
LCG07220H23	20 x 72 x 23	92.5	287	24	\$3154
LCM06024H23	24 x 60 x 23	92.5	273	24	\$3313
LCM06020H23	20 x 60 x 23	92.5	205	20	\$2758

Standard with open storage on the **right** and one storage cabinet on the **left**. Storage cabinet includes one adjustable shelf.

- "G" model uses 36" wide storage cabinets, "M" model uses 30" wide.

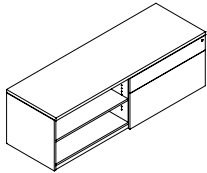

Credenza

LCOF7224H23	24 x 72 x 23	92.5	300	29	\$4391
LCOF7220H23	20 x 72 x 23	92.5	253	24	\$3832
LCON6024H23	24 x 60 x 23	92.5	254	24	\$3836
LCON6020H23	20 x 60 x 23	92.5	209	20	\$3347

Standard with one **box/file** drawer on **right** and open storage on the **left**. File drawer and lateral file drawer lock. Front-to-back and side-to-side filing. **Not for stacking materials on lateral file drawer bottom.**

- "F" models use 36" wide lateral files, "N" models use 30" wide.

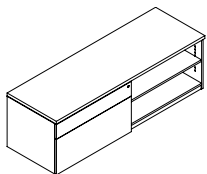

Credenza

LCF07224H23	24 x 72 x 23	92.5	300	29	\$4391
LCF07220H23	20 x 72 x 23	92.5	253	24	\$3832
LCN06024H23	24 x 60 x 23	92.5	254	24	\$3836
LCN06020H23	20 x 60 x 23	92.5	209	20	\$3347

Standard with one **box/file** drawer on **left** and open storage on the **right**. File drawer and lateral file drawer lock. Front-to-back and side-to-side filing. **Not for stacking materials on lateral file drawer bottom.**

- "F" models use 36" wide lateral files, "N" models use 30" wide.

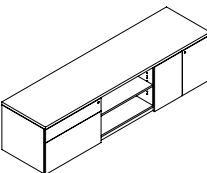

Credenza

LCNOM9024H23	24 x 90 x 23	92.5	300	29	\$7667
LCNOM9020H23	20 x 90 x 23	92.5	300	29	\$7280

Standard with one **box/file** drawer on **left**, open storage in the **center**, and one storage cabinet on the **right**. Storage cabinet includes one adjustable shelf. File drawer and lateral file drawer lock. Front-to-back and side-to-side filing. **Not for stacking materials on lateral file drawer bottom.**

Required Specifications

Veneer Finish
Edge

Optional Specifications

Grommet

CREDENZAS

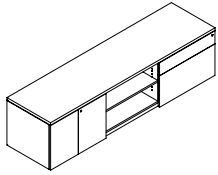

Credenza

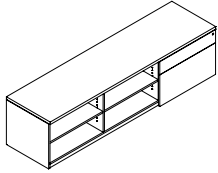

Credenza

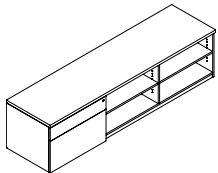

Credenza

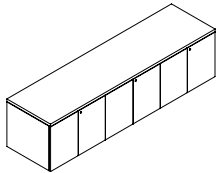

Credenza

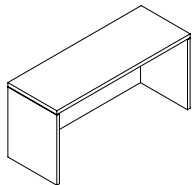

Credenza Shell

MODEL#	DIMENSIONS	FREIGHT CLASS	WT/LBS.	CUBIC FT.	LIST PRICE
LCMON9024H23	24 x 90 x 23	92.5	300	29	\$7667
LCMON9020H23	20 x 90 x 23	92.5	300	29	\$7280

Standard with one **box/file** drawer on **right**, open storage in the **center**, and one storage cabinet on the **left**. Storage cabinet includes one adjustable shelf. File drawer and lateral file drawer lock. Front-to-back and side-to-side filing. **Not for stacking materials on lateral file drawer bottom.**

LCOON9024H23	24 x 90 x 23	92.5	300	29	\$7384
LCOON9020H23	20 x 90 x 23	92.5	300	29	\$6993

Standard with one **box/file** drawer on **right** and open storage in the **center** and **left**. File drawer and lateral file drawer lock. Front-to-back and side-to-side filing. **Not for stacking materials on lateral file drawer bottom.**

LCN009024H23	24 x 90 x 23	92.5	300	29	\$7384
LCN009020H23	20 x 90 x 23	92.5	300	29	\$6993

Standard with one **box/file** drawer on **left** and open storage in the **center** and **right**. File drawer and lateral file drawer lock. Front-to-back and side-to-side filing. **Not for stacking materials on lateral file drawer bottom.**

LCMMM9024H23	24 x 90 x 23	92.5	300	29	\$7100
LCMMM9020H23	20 x 90 x 23	92.5	300	29	\$5916

Standard with **three** storage cabinets. Storage cabinets include one adjustable shelf per cabinet.

LC10824H23	24 x 108 x 23	125	348	44	\$4056
LC10224H23	24 x 102 x 23	100	329	41	\$3857
LC9624H23	24 x 96 x 23	125	309	39	\$3644
LC9024H23	24 x 90 x 23	100	290	36	\$3445
LC8424H23	24 x 84 x 23	125	271	34	\$3240
LC7824H23	24 x 78 x 23	100	251	31	\$3025
LC7224H23	24 x 72 x 23	100	232	29	\$2826
LC6624H23	24 x 66 x 23	125	213	27	\$2730
LC6024H23	24 x 60 x 23	100	193	24	\$2515
LC10820H23	20 x 108 x 23	100	309	36	\$3197
LC10220H23	20 x 102 x 23	100	291	34	\$3020
LC9620H23	20 x 96 x 23	100	273	32	\$2841
LC9020H23	20 x 90 x 23	100	255	30	\$2656
LC8420H23	20 x 84 x 23	100	237	28	\$2480
LC7820H23	20 x 78 x 23	100	219	26	\$2297
LC7220H23	20 x 72 x 23	100	206	24	\$2112
LC6620H23	20 x 66 x 23	100	188	22	\$2033
LC6020H23	20 x 60 x 23	100	169	20	\$1844

Standard with **no pedestals**. Flush full modesty panel. 96" w and larger includes a center support leg. If using storage component shells underneath to support the worksurface, **no more than 72" may be left unsupported.**

Required Specifications

Veneer Finish
Edge

Optional Specifications

Grommet

CORNERS	MODEL#	DIMENSIONS D x W x H	FREIGHT CLASS	WT/LBS.	CUBIC FT.	LIST PRICE
---------	--------	-------------------------	---------------	---------	-----------	------------

- A Corner Desk is used to connect to a Linking Bridge and Linking Credenza, or Connectable Table
- Cable management tray is included.
- Full Modesty Panel option.
- 5-Sided Corners include a GM1 grommet in the top center position. Grommets are available as an option on Extended Corners.
- Hand of Linking Credenza is determined by location of full end panel from user side.
- Hand of Extended Corner is determined by location of long narrow end from user side.
- Connecting sides feature a self edge.

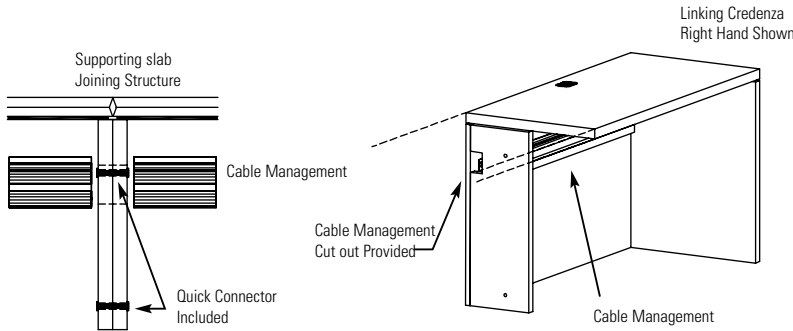

Code dimensions are actual

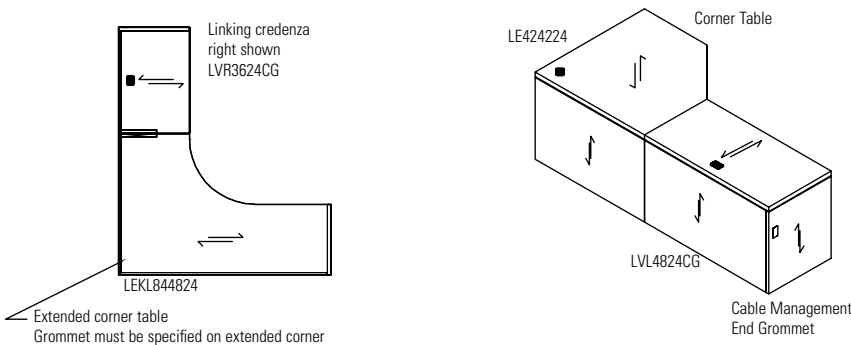

5-SIDED CORNERS	MODEL#	DIMENSIONS D x W x H	FREIGHT CLASS	WT/LBS.	CUBIC FT.	LIST PRICE
-----------------	--------	-------------------------	---------------	---------	-----------	------------

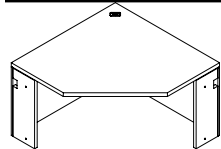

5-Sided Corner

LE484824	48 x 48 x 29	150	201	39	\$3203
LE424224	42 x 42 x 29	150	155	30	\$2552
LE363624	36 x 36 x 29	125	135	22	\$2441

Connects to **24" D** connectables, returns, extended corners, storage/lateral file credenzas, credenzas and bridges. Includes grommet and installed horizontal wire management. Narrow end panels on left and right.

- *Not freestanding*

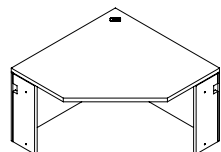

5-Sided Corner

LE484820	48 x 48 x 29	150	196	39	\$3203
LE424220	42 x 42 x 29	150	150	30	\$2552
LE363620	36 x 36 x 29	150	130	22	\$2441

Connects to **20" D** connectables, returns, extended corners, storage/lateral file credenzas, credenzas and bridges. Includes grommet and installed horizontal wire management. Narrow end panels on left and right.

- *Not freestanding*

Required Specifications

Veneer Finish
Edge

Optional Specifications

Grommet

LEFT EXTENDED CORNERS

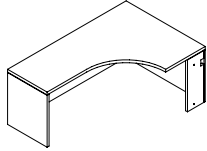

Left Extended Corner

MODEL#	DIMENSIONS D x W x H	FREIGHT CLASS	WT/LBS.	CUBIC FT.	LIST PRICE
LEKL844824	24-48 x 84 x 29	150	338	68	\$4727
LEKL784824	24-48 x 78 x 29	150	314	63	\$4663
LEKL724824	24-48 x 72 x 29	150	290	58	\$4398
LEKL664824	24-48 x 66 x 29	150	266	52	\$4178
LEKL604824	24-48 x 60 x 29	150	242	48	\$3904
LEKL844820	20-48 x 84 x 29	150	338	68	\$4651
LEKL784820	20-48 x 78 x 29	150	314	63	\$4554
LEKL724820	20-48 x 72 x 29	150	290	58	\$4293
LEKL664820	20-48 x 66 x 29	150	266	52	\$4073
LEKL604820	20-48 x 60 x 29	150	242	48	\$3800

Extended worksurface on **left**. **Full end panel on left, narrow end panel on right**. Connects to Linking Bridges, Extended Corners and Connectable Tables.

RIGHT EXTENDED CORNERS

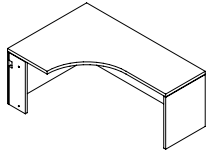

Right Extended Corner

MODEL#	DIMENSIONS	FREIGHT CLASS	WT/LBS.	CUBIC FT.	LIST PRICE
LEKR488424	24-48 x 84 x 29	150	338	68	\$4727
LEKR487824	24-48 x 78 x 29	150	314	63	\$4663
LEKR487224	24-48 x 72 x 29	150	290	58	\$4398
LEKR486624	24-48 x 66 x 29	150	266	52	\$4178
LEKR486024	24-48 x 60 x 29	150	242	48	\$3904
LEKR488420	20-48 x 84 x 29	150	338	68	\$4651
LEKR487820	20-48 x 78 x 29	150	314	63	\$4554
LEKR487220	20-48 x 72 x 29	150	290	58	\$4293
LEKR486620	20-48 x 66 x 29	150	266	52	\$4073
LEKR486020	20-48 x 60 x 29	150	242	48	\$3800

Extended worksurface on **right**. **Full end panel on right, narrow end panel on left**. Connects to Linking Bridges, Extended Corners and Connectable Tables.

CONNECTABLE TABLES - LEFT

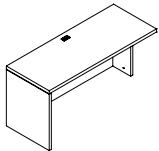

24" Deep Connectable Table - LEFT

MODEL#	DIMENSIONS	FREIGHT CLASS	WT/LBS.	CUBIC FT.	LIST PRICE
LVL9624CG	24 x 96 x 29	150	200	39	\$3476
LVL9024CG	24 x 90 x 29	150	187	36	\$3277
LVL8424CG	24 x 84 x 29	150	174	34	\$3090
LVL7824CG	24 x 78 x 29	150	162	31	\$2892
LVL7224CG	24 x 72 x 29	150	149	29	\$2704
LVL6624CG	24 x 66 x 29	150	141	27	\$2566
LVL6024CG	24 x 60 x 29	150	132	24	\$2425
LVL5424CG	24 x 54 x 29	150	121	22	\$2306
LVL4824CG	24 x 48 x 29	125	115	19	\$2200
LVL4224CG	24 x 42 x 29	150	99	17	\$1916
LVL3624CG	24 x 36 x 29	150	83	15	\$1863
LVL3024CG	24 x 30 x 29	125	77	12	\$1835
LVL2424CG	24 x 24 x 29	125	61	10	\$1603

Full end panel on left. Right narrow end panel connects to **24"D** center/right connectable table; **24"D** extended corners; **24"D** 5-sided corners; Grommet in worksurface.

- To remove cross grain veneer pattern on top, **delete suffix "CG"** from the model number. Available as a special - no upcharge.

Required Specifications

Veneer Finish
Edge

Optional Specifications

Grommet

CONNECTABLE TABLES - LEFT

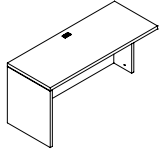

20" Deep Connectable Table - LEFT

MODEL#	DIMENSIONS	FREIGHT CLASS	WT./LBS.	CUBIC FT.	LIST PRICE
--------	------------	---------------	----------	-----------	------------

D x W x H

LVL9620CG	20 x 96 x 29	150	187	39	\$2826
LVL9020CG	20 x 90 x 29	150	175	36	\$2649
LVL8420CG	20 x 84 x 29	150	163	34	\$2474
LVL7820CG	20 x 78 x 29	150	152	31	\$2297
LVL7220CG	20 x 72 x 29	150	140	29	\$2120
LVL6620CG	20 x 66 x 29	150	133	27	\$1989
LVL6020CG	20 x 60 x 29	150	125	24	\$1863
LVL5420CG	20 x 54 x 29	150	113	22	\$1755
LVL4820CG	20 x 48 x 29	150	110	19	\$1646
LVL4220CG	20 x 42 x 29	150	95	17	\$1393
LVL3620CG	20 x 36 x 29	150	80	15	\$1341
LVL3020CG	20 x 30 x 29	125	75	12	\$1319
LVL2420CG	20 x 24 x 29	125	60	10	\$1104

Full end panel on left. Right narrow end panel connects to 20"D center/right connectable table; 20"D 5-sided corners; Grommet in worksurface.

- To remove cross grain veneer pattern on top, delete suffix "CG" from the model number. Available as a special - no upcharge.

CONNECTABLE TABLES - RIGHT

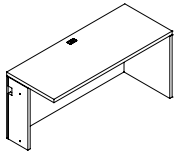

24" Deep Connectable Table - RIGHT

MODEL#	DIMENSIONS	FREIGHT CLASS	WT./LBS.	CUBIC FT.	LIST PRICE
--------	------------	---------------	----------	-----------	------------

LVR9624CG	24 x 96 x 29	150	200	39	\$3476
LVR9024CG	24 x 90 x 29	150	187	36	\$3277
LVR8424CG	24 x 84 x 29	150	174	34	\$3090
LVR7824CG	24 x 78 x 29	150	162	31	\$2892
LVR7224CG	24 x 72 x 29	150	149	29	\$2704
LVR6624CG	24 x 66 x 29	150	141	27	\$2566
LVR6024CG	24 x 60 x 29	150	132	24	\$2425
LVR5424CG	24 x 54 x 29	150	121	22	\$2306
LVR4824CG	24 x 48 x 29	125	115	19	\$2200
LVR4224CG	24 x 42 x 29	150	99	17	\$1916
LVR3624CG	24 x 36 x 29	150	83	15	\$1863
LVR3024CG	24 x 30 x 29	125	77	12	\$1835
LVR2424CG	24 x 24 x 29	125	61	10	\$1603

Full end panel on right. Left narrow end panel connects to 24"D center/left connectable table; 24"D extended corners, 24"D 5-sided corners; Grommet in worksurface.

- To remove cross grain veneer pattern on top, delete suffix "CG" from the model number. Available as a special - no upcharge.

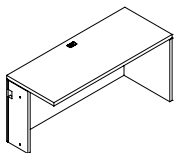

20" Deep Connectable Table - RIGHT

LVR9620CG	20 x 96 x 29	150	187	39	\$2826
LVR9020CG	20 x 90 x 29	150	175	36	\$2649
LVR8420CG	20 x 84 x 29	150	163	34	\$2474
LVR7820CG	20 x 78 x 29	150	152	31	\$2297
LVR7220CG	20 x 72 x 29	150	140	29	\$2120
LVR6620CG	20 x 66 x 29	150	133	27	\$1989
LVR6020CG	20 x 60 x 29	150	125	24	\$1863
LVR5420CG	20 x 54 x 29	150	113	22	\$1755
LVR4820CG	20 x 48 x 29	150	110	19	\$1646
LVR4220CG	20 x 42 x 29	150	95	17	\$1393
LVR3620CG	20 x 36 x 29	150	80	15	\$1341
LVR3020CG	20 x 30 x 29	125	75	12	\$1319
LVR2420CG	20 x 24 x 29	125	60	10	\$1104

Full end panel on right. Left narrow end panel connects to 20"D center/left connectable table; 20"D 5-sided corners; Grommet in worksurface.

- To remove cross grain veneer pattern on top, delete suffix "CG" from the model number. Available as a special - no upcharge.

Required Specifications

Veneer Finish
Edge
Monopost Finish - D Islands

Optional Specifications

Grommet
Modesty Upgrade
Modesty Panel
Monopost (Base) Upgrade - D Islands

CONNECTABLE TABLES

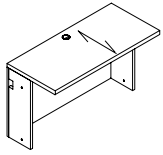

24" Deep Connectable Table

MODEL#	DIMENSIONS D x W x H	FREIGHT CLASS	WT/LBS.	CUBIC FT.	LIST PRICE
LV6024CG	24 x 60 x 29	150	132	24	\$2356
LV5424CG	24 x 54 x 29	150	121	22	\$2222
LV4824CG	24 x 48 x 29	125	115	19	\$2087
LV4224CG	24 x 42 x 29	150	99	17	\$1747
LV3624CG	24 x 36 x 29	150	83	15	\$1803
LV3024CG	24 x 30 x 29	125	77	12	\$1652
LV2424CG	24 x 24 x 29	125	61	10	\$1385

Narrow end panels on left and right connects to **24"D** connectable table; **24"D** extended corners, **24"D** 5-sided corners; Grommet in worksurface.

- To remove cross grain veneer pattern on top, **delete suffix "CG"** from the model number. Available as a special - no upcharge.

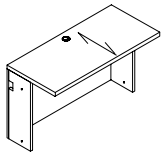

22" Deep Connectable Table

LV6020CG	20 x 60 x 29	150	125	24	\$1813
LV5420CG	20 x 54 x 29	150	113	22	\$1705
LV4820CG	20 x 48 x 29	150	110	19	\$1599
LV4220CG	20 x 42 x 29	150	95	17	\$1335
LV3620CG	20 x 36 x 29	150	80	15	\$1293
LV3020CG	20 x 30 x 29	125	75	12	\$1268
LV2420CG	20 x 24 x 29	125	60	10	\$1067

Narrow end panels on left and right connects to **22"D** connectable table; **22"D** extended corners, **22"D** 5-sided corners; Grommet in worksurface.

- To remove cross grain veneer pattern on top, **delete suffix "CG"** from the model number. Available as a special - no upcharge.

"D" ISLANDS

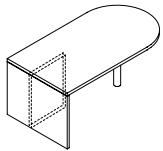

"D" Island - Full End Panel (T-Base) & Monopost

MODEL#	DIMENSIONS	FREIGHT CLASS	WT/LBS.	CUBIC FT.	LIST PRICE
LDD8430	30 x 84 x 29	125	343	51	\$5254
LDD7230	30 x 72 x 29	125	264	36	\$4174
LDD6630	30 x 66 x 29	125	245	40	\$4174
LDD6030	30 x 60 x 29	125	225	30	\$4020

Connects to Linking Bridges or Executive Returns. Attaching hardware included. **Not freestanding.**

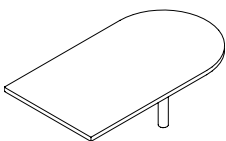

"D" Island with Monopost

LRD8430	30 x 84 x 29	125	135	51	\$3750
LRD7230	30 x 72 x 29	125	99	36	\$2985
LRD6630	30 x 66 x 29	125	99	40	\$2985
LRD6030	30 x 60 x 29	125	83	30	\$2870

Attaches to edge of worksurfaces with molding edge. Attaching hardware included. Shipped RTA (ready to assemble).

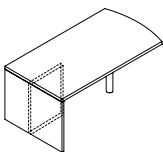

"D" Island - Full End Panel (T-Base) & Monopost, Bow End

LDDBE8430	30 x 84 x 29	125	343	51	\$5254
LDDBE7230	30 x 72 x 29	125	264	36	\$4174
LDDBE6630	30 x 66 x 29	125	245	40	\$4174
LDDBE6030	30 x 60 x 29	125	225	30	\$4014

Connects to Linking Bridges or Executive Returns. Attaching hardware included. **Not freestanding.**

Required Specifications

Veneer Finish
Edge
Monopost Finish

Optional Specifications

Grommet
Monopost (Base) Upgrade

"D" ISLANDS

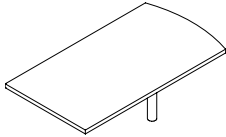

"D" Island with Monopost, Bow End

MODEL#	DIMENSIONS	FREIGHT CLASS	WT/LBS.	CUBIC FT.	LIST PRICE
--------	------------	---------------	---------	-----------	------------

	D x W x H				
LRDBE8430	30 x 84 x 29	125	135	51	\$3750
LRDBE7230	30 x 72 x 29	125	99	36	\$2985
LRDBE6630	30 x 66 x 29	125	99	40	\$2985
LRDBE6030	30 x 60 x 29	125	83	30	\$2870

Attaches to edge of worksurfaces with molding edge. Attaching hardware included. Shipped RTA (ready to assemble).

PIANO DESKS

- Can be ordered as a shell or with pedestals.
- Components include a GM1 grommet in the top center position.
- Hand of Rectangular Desk is determined by location of pedestal from user side.
- Hand of "D" Top is determined by outward orientation of curved end from user projection.
- Hand of "P" Top is determined by outward orientation of conference end from user projection.
- Connectable Tables and Bridges - To remove cross grain veneer pattern on top, delete suffix "CG" from the model number. Available as a special - no upcharge.

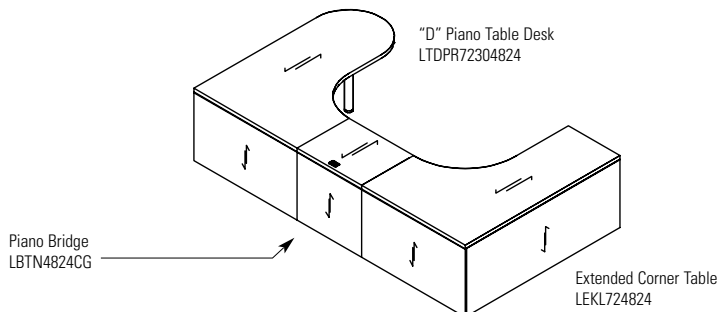
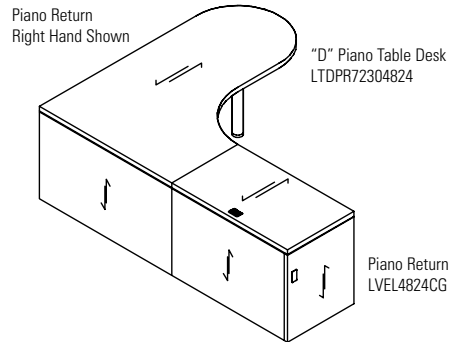
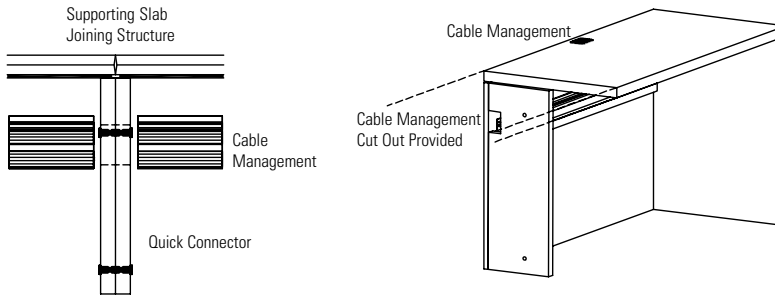

Required Specifications

Veneer Finish
Edge
Monopost Finish

Optional Specifications

Grommet
Monopost (Base) Upgrade

PIANO DESKS

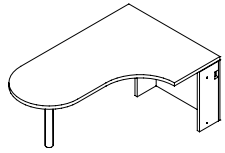

"D" Island LEFT - Full End Panel & Monopost, Piano Desk

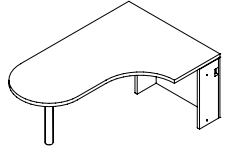

"D" Island LEFT - Full End Panel & Monopost, Piano Desk

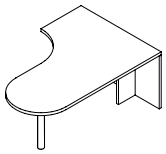

"D" Island RIGHT - Full End Panel & Monopost, Piano Desk

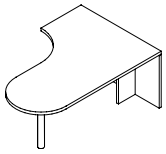

"D" Island RIGHT - Full End Panel & Monopost, Piano Desk

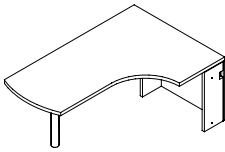

"D" Island LEFT - Full End Panel & Monopost, Piano Desk - Bow End

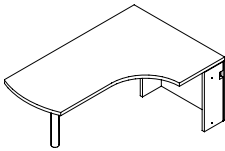

"D" Island LEFT - Full End Panel & Monopost, Piano Desk - Bow End

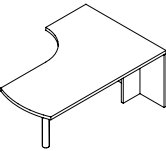

"D" Island RIGHT - Full End Panel & Monopost, Piano Desk - Bow End

MODEL#	DIMENSIONS D x W x H	FREIGHT CLASS	WT/LBS.	CUBIC FT.	LIST PRICE
LTDPL84304824	48 x 84 x 29	150	406	68	\$4351
LTDPL72304824	48 x 72 x 29	125	348	58	\$3815

Extended island worksurface on the **left**. Narrow end panel on right connects to **24"D** returns or bridges **for Piano Desks Only** (see pg. 107). **Not freestanding.** Includes installed horizontal wire management.

LTDPL84304820	48 x 84 x 29	150	406	68	\$4245
LTDPL72304820	48 x 72 x 29	125	348	58	\$3706

Extended island worksurface on the **left**. Narrow end panel on right connects to **20"D** returns or bridges **for Piano Desks Only** (see pg. 107). **Not freestanding.** Includes installed horizontal wire management.

LTDPR84304824	48 x 84 x 29	150	406	68	\$4351
LTDPR72304824	48 x 72 x 29	125	348	58	\$3815

Extended island worksurface on the **right**. Narrow end panel on left connects to **24"D** returns or bridges **for Piano Desks Only** (see pg. 107). **Not freestanding.** Includes installed horizontal wire management.

LTDPR84304820	48 x 84 x 29	150	406	68	\$4245
LTDPR72304820	48 x 72 x 29	125	348	58	\$3706

Extended island worksurface on the **right**. Narrow end panel on left connects to **20"D** returns or bridges **for Piano Desks Only** (see pg. 107). **Not freestanding.** Includes installed horizontal wire management.

LDBEPL84304824	48 x 84 x 29	150	406	68	\$4351
LDBEPL72304824	48 x 72 x 29	125	348	58	\$3815

Extended island worksurface on the **left**. Narrow end panel on right connects to **24"D** returns or bridges **for Piano Desks Only** (see pg. 107). **Not freestanding.** Includes installed horizontal wire management.

LDBEPL84304820	48 x 84 x 29	150	406	68	\$4245
LDBEPL72304820	48 x 72 x 29	125	348	58	\$3706

Extended island worksurface on the **left**. Narrow end panel on right connects to **20"D** returns or bridges **for Piano Desks Only** (see pg. 107). **Not freestanding.** Includes installed horizontal wire management.

LDBEPR84304824	48 x 84 x 29	150	406	68	\$4351
LDBEPR72304824	48 x 72 x 29	125	348	58	\$3815

Extended island worksurface on the **right**. Narrow end panel on left connects to **24"D** returns or bridges **for Piano Desks Only** (see pg. 107). **Not freestanding.** Includes installed horizontal wire management.

Required Specifications

Veneer Finish
Edge
Monopost Finish - Piano Desk

Optional Specifications

Grommet
Monopost (Base) Upgrade - Piano Desk

PIANO DESK

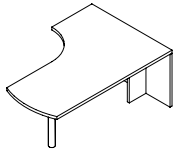

"D" Island RIGHT - Full End Panel & Monopost, Piano Desk - Bow End

MODEL#	DIMENSIONS D x W x H	FREIGHT CLASS	WT/LBS.	CUBIC FT.	LIST PRICE
LDBEPR84304820	48 x 84 x 29	150	406	68	\$4245
LDBEPR72304820	48 x 72 x 29	125	348	58	\$3706

Extended island worksurface on the **right**. Narrow end panel on left connects to **20"D** returns or bridges **for Piano Desks Only** (see pg. 107). **Not freestanding**. Includes installed horizontal wire management.

CONNECTABLE TABLES - FOR PIANO DESKS

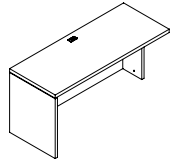

24" Deep Connectable Table - LEFT For Piano Desk

MODEL#	DIMENSIONS	FREIGHT CLASS	WT/LBS.	CUBIC FT.	LIST PRICE
LVEL8424CG	24 x 84 x 29	150	174	34	\$3197
LVEL7824CG	24 x 78 x 29	150	162	31	\$2995
LVEL7224CG	24 x 72 x 29	150	149	29	\$2801
LVEL6624CG	24 x 66 x 29	150	141	27	\$2649
LVEL6024CG	24 x 60 x 29	150	132	24	\$2505
LVEL5424CG	24 x 54 x 29	150	121	22	\$2382
LVEL4824CG	24 x 48 x 29	125	115	19	\$2270
LVEL4224CG	24 x 42 x 29	150	99	17	\$1975
LVEL3624CG	24 x 36 x 29	150	83	15	\$1920

Full end panel on left. Right narrow end panel connects to **24"D** right connectable table, "D" islands, Boat shaped islands, "P" islands or Delta islands with "T" bases **for Piano Desks Only**. Grommet in worksurface. Shipped RTA (ready to assemble).

- To remove cross grain veneer pattern on top, **delete suffix "CG"** from the model number. Available as a special - no upcharge.

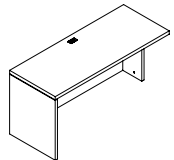

20" Deep Connectable Table - LEFT For Piano Desk

LVEL8420CG	20 x 84 x 29	150	174	34	\$2474
LVEL7820CG	20 x 78 x 29	150	162	31	\$2297
LVEL7220CG	20 x 72 x 29	150	149	29	\$2120
LVEL6620CG	20 x 66 x 29	150	141	27	\$1989
LVEL6020CG	20 x 60 x 29	150	132	24	\$1863
LVEL5420CG	20 x 54 x 29	150	121	22	\$1755
LVEL4820CG	20 x 48 x 29	125	115	19	\$1646
LVEL4220CG	20 x 42 x 29	150	99	17	\$1393
LVEL3620CG	20 x 36 x 29	150	83	15	\$1341

Full end panel on left. Right narrow end panel connects to **20"D** right connectable table, "D" islands, Boat shaped islands, "P" islands or Delta islands with "T" bases **for Piano Desks Only**. Grommet in worksurface. Shipped RTA (ready to assemble).

- To remove cross grain veneer pattern on top, **delete suffix "CG"** from the model number. Available as a special - no upcharge.

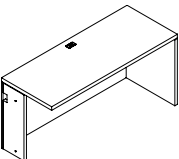

24" Deep Connectable Table - RIGHT For Piano Desk

LVER8424CG	24 x 84 x 29	150	174	34	\$3197
LVER7824CG	24 x 78 x 29	150	162	31	\$2995
LVER7224CG	24 x 72 x 29	150	149	29	\$2801
LVER6624CG	24 x 66 x 29	150	141	27	\$2649
LVER6024CG	24 x 60 x 29	150	132	24	\$2505
LVER5424CG	24 x 54 x 29	150	121	22	\$2382
LVER4824CG	24 x 48 x 29	125	115	19	\$2270
LVER4224CG	24 x 42 x 29	150	99	17	\$1975
LVER3624CG	24 x 36 x 29	150	83	15	\$1920

Full end panel on right. Left narrow end panel connects to **24"D** left connectable table, "D" islands, Boat shaped islands, "P" islands or Delta islands with "T" bases **for Piano Desks Only**. Grommet in worksurface. Shipped RTA (ready to assemble).

- To remove cross grain veneer pattern on top, **delete suffix "CG"** from the model number. Available as a special - no upcharge.

Required Specifications

Veneer Finish
Edge
Monopost Finish - Piano Desk

Optional Specifications

Grommet
Monopost (Base) Upgrade - Piano Desk

CONNECTABLE TABLES - FOR PIANO DESKS

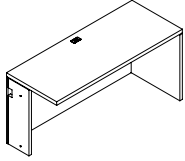

**20" Deep Connectable Table - RIGHT
For Piano Desk**

MODEL#	DIMENSIONS D x W x H	FREIGHT CLASS	WT/LBS.	CUBIC FT.	LIST PRICE
LVER8420CG	20 x 84 x 29	150	174	34	\$2474
LVER7820CG	20 x 78 x 29	150	162	31	\$2297
LVER7220CG	20 x 72 x 29	150	149	29	\$2120
LVER6620CG	20 x 66 x 29	150	141	27	\$1989
LVER6020CG	20 x 60 x 29	150	132	24	\$1863
LVER5420CG	20 x 54 x 29	150	121	22	\$1755
LVER4820CG	20 x 48 x 29	125	115	19	\$1646
LVER4220CG	20 x 42 x 29	150	99	17	\$1393
LVER3620CG	20 x 36 x 29	150	83	15	\$1341

Full end panel on right. Left narrow end panel connects to **20"D** left connectable table, "D" islands, Boat shaped islands, "P" islands or Delta islands with "T" bases **for Piano Desks Only**. Grommet in worksurface. Shipped RTA (ready to assemble).

- To remove cross grain veneer pattern on top, **delete suffix "CG"** from the model number. Available as a special - no upcharge.

BRIDGES - FOR PIANO DESKS

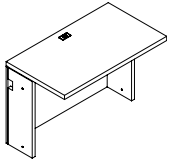

Flush Bridge

MODEL#	DIMENSIONS	FREIGHT CLASS	WT/LBS.	CUBIC FT.	LIST PRICE
LBTN4824CG	24 x 48 x 29	125	116	19	\$2008
LBTN4224CG	24 x 42 x 29	125	102	17	\$1747
LBTN3624CG	24 x 36 x 29	150	87	15	\$1694
LBTN3024CG	24 x 30 x 29	125	73	12	\$1663
LBTN2424CG	24 x 24 x 29	150	58	10	\$1466
LBTN1824CG	24 x 18 x 29	150	43	8	\$1201
LBTN1224CG	24 x 12 x 29	150	29	5	\$932

Full end panel on both sides connects to **24"D** worksurfaces, "D" islands, Boat shaped islands, "P" islands or Delta islands with "T" bases **for Piano Desks Only**. Grommet in worksurface. Shipped RTA (ready to assemble).

- To remove cross grain veneer pattern on top, **delete suffix "CG"** from the model number. Available as a special - no upcharge.

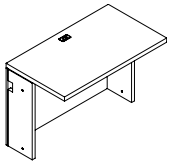

Flush Bridge

LBTN4820CG	20 x 48 x 29	125	116	19	\$1599
LBTN4220CG	20 x 42 x 29	125	102	17	\$1335
LBTN3620CG	20 x 36 x 29	150	87	15	\$1293
LBTN3020CG	20 x 30 x 29	125	73	12	\$1268
LBTN2420CG	20 x 24 x 29	150	58	10	\$1067
LBTN1820CG	20 x 18 x 29	150	43	8	\$1015
LBTN1220CG	20 x 12 x 29	150	29	5	\$944

Full end panel on both sides connects to **20"D** worksurfaces, "D" islands, Boat shaped islands, "P" islands or Delta islands with "T" bases **for Piano Desks Only**. Grommet in worksurface. Shipped RTA (ready to assemble).

- To remove cross grain veneer pattern on top, **delete suffix "CG"** from the model number. Available as a special - no upcharge.

Required Specifications

Veneer Finish
Edge
Metal Finish - Modesty Panel

Optional Specifications

Grommet

MODESTY PANEL OPTIONS

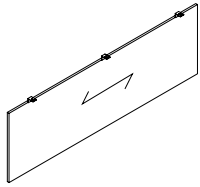

Veneer Modesty Panel Upgrade*

MODEL#	DIMENSIONS	FREIGHT CLASS	WT/LBS.	CUBIC FT.	LIST PRICE
CMP72W	0.75 x 67 x 18	--	20	1	\$1622
CMP66W	0.75 x 61 x 18	--	18	1	\$1570
CMP60W	0.75 x 55 x 18	--	16	1	\$1546
CMP54W	0.75 x 49 x 18	--	14	1	\$1520
CMP48W	0.75 x 43 x 18	--	13	1	\$1496

Straight modesty panel. Attaches to underside of worksurface. **Can not be retrofitted in the field. Not sold individually - to be ordered as an upgrade option only.**

- CMP72W - Specify on "P" Top Islands or 96" x 48" Islands for Piano Desks.
- CMP66W - Specify on 84" x 36" "D" Top Islands.
- CMP60W - Specify on 84" x 42" "P" Top Islands or 84" x 48" Islands for Piano Desks.
- CMP54W - Specify on 72" x 30" "D" Top Islands.
- CMP48W - Specify on 66" x 36" , 60" x 30" "D" Top Islands, 72" x 42" "P" Top Islands or 72" x 48" Islands for Piano Desks.

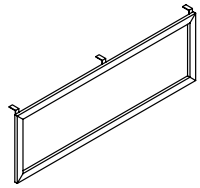

Glass Modesty Panel Upgrade

CMP72G	0.75 x 67 x 18	--	20	1	\$2485
CMP66G	0.75 x 61 x 18	--	18	1	\$2351
CMP60G	0.75 x 55 x 18	--	16	1	\$2149
CMP54G	0.75 x 49 x 18	--	14	1	\$2001
CMP48G	0.75 x 43 x 18	--	13	1	\$1911

Straight modesty panel. Translucent, screened glass. Aluminum box frame construction in Tungsten Only. Attaches to underside of worksurface. **Can not be retrofitted in the field. Not sold individually - to be ordered as an upgrade option only.**

- CMP72G - Specify on "P" Top Islands or 96" x 48" Islands for Piano Desks.
- CMP66G - Specify on 84" x 36" "D" Top Islands.
- CMP60G - Specify on 84" x 42" "P" Top Islands or 84" x 48" Islands for Piano Desks.
- CMP54G - Specify on 72" x 30" "D" Top Islands.
- CMP48G - Specify on 66" x 36" , 60" x 30" "D" Top Islands, 72" x 42" "P" Top Islands or 72" x 48" Islands for Piano Desks.
- Tungsten finish on the aluminum box frame closely resembles the existing Tungsten finish.

Required Specifications

Metal finish

SIDE-BY-SIDE COMPONENTS MODEL# DIMENSIONS FREIGHT CLASS WT/LBS. CUBIC FT. LIST PRICE

D x W x H

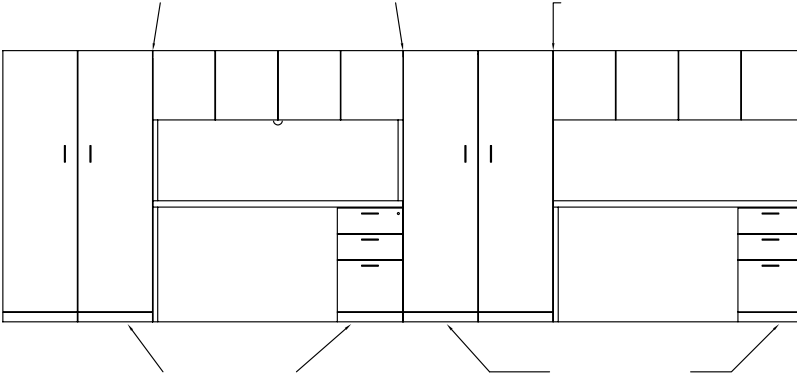

MODULAR PEDESTALS

- When using Storage Shells, laminate gables will show.
- Credenza shell cannot be completely filled up with storage shells to create a full storage credenza.
- Handle style must be specified.

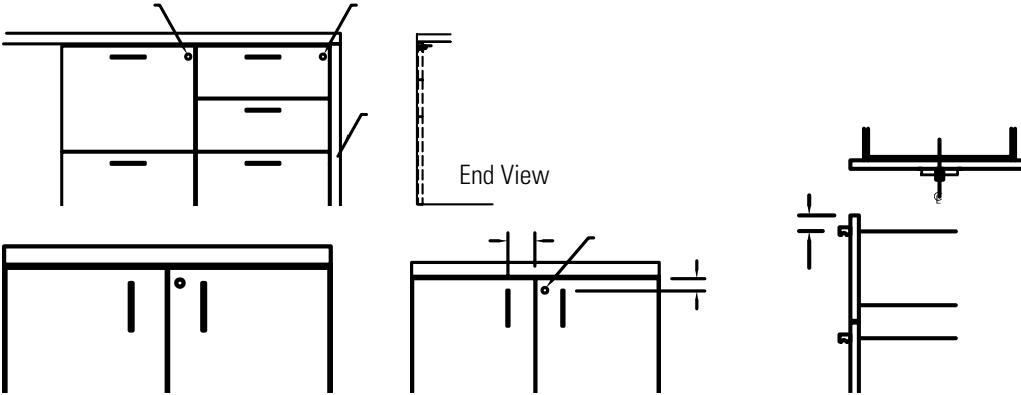

STORAGE SHELLS MODEL# DIMENSIONS FREIGHT CLASS WT/LBS. CUBIC FT. LIST PRICE

D x W x H

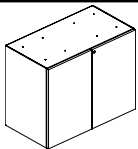

Storage Shell

LWG	18 x 35 x 28	92.5	115	11	\$1777
LWM	18 x 30 x 28	92.5	96	9	\$1599
LWG.5	18 x 34 x 28	92.5	115	11	\$1777

For use **under a freestanding worksurface (22", 24", 30" or 36"D)**. Top drilled to attach to worksurface. One adjustable shelf. Standard with lock.

- **Specify LWG and LWM for kneespace applications**
- **Unfinished top and back**

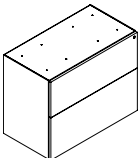

File/File Shell - Lateral

LWF	18 x 35 x 28	92.5	115	11	\$2505
LWN	18 x 30 x 28	92.5	96	9	\$2178
LWF.5	18 x 34 x 28	92.5	115	11	\$2505
LWN.5	18 x 29 x 28	92.5	96	9	\$2178

For use **under a freestanding worksurface (22", 24", 30" or 36"D)**. Top drilled to attach to worksurface. **Two lateral file drawers**. Lock secures all drawers. Side-to-side file bars included.

- **Specify LWF and LWN for kneespace applications**
- **Unfinished top and back**

Required Specifications

Veneer Finish
Edge

STORAGE MODULES - FREESTANDING

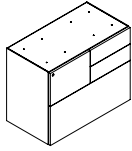

Mixed Storage Shell - LEFT

MODEL#	DIMENSIONS D x W x H	FREIGHT CLASS	WT/LBS.	CUBIC FT.	LIST PRICE
LWZL	18 x 35 x 28	92.5	115	11	\$2870
LWZL.5	18 x 34 x 28	92.5	115	11	\$2870

For use **under a freestanding worksurface (22", 24", 30" or 36"D)**. Top drilled to attach to worksurface. One file drawer on **left**, two box drawers on **right** and one lateral file drawer on bottom. File drawer and lateral file drawer lock. One pencil tray. **Not for stacking materials on lateral file drawer bottom.**

- Specify LWZL for kneespace applications
- Unfinished top and back

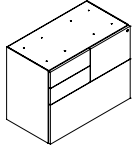

Mixed Storage Shell - RIGHT

LWZR	18 x 35 x 28	92.5	115	11	\$2870
LWZR.5	18 x 34 x 28	92.5	115	11	\$2870

For use **under a freestanding worksurface (22", 24", 30" or 36"D)**. Top drilled to attach to worksurface. One file drawer on **right**, two box drawers on **left** and one lateral file drawer on bottom. File drawer and lateral file drawer lock. One pencil tray. **Not for stacking materials on lateral file drawer bottom.**

- Specify LWZR for kneespace applications
- Unfinished top and back

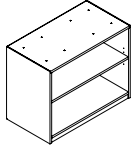

Open Shelving Shell

LWOB36	18 x 35 x 28	100	92	11	\$1372
LWOB30	18 x 30 x 28	100	77	9	\$1235

For use **under a freestanding worksurface (22", 24", 30" or 36"D)**. Top drilled to attach to worksurface. One adjustable veneer shelf.

- Unfinished top and back

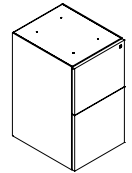

File/File Shell - Vertical

LETTER					
LWWE	23 x 16 x 28	92.5	72	6	\$2001
LWE	18 x 16 x 28	92.5	70	5	\$1777
LEGAL					
LWWLE	23 x 19 x 28	92.5	85	7	\$2339
LWLE	18 x 19 x 28	92.5	83	6	\$2072

For use **under a freestanding worksurface (22", 24", 30" or 36"D)**. Top drilled to attach to worksurface. **Two file drawers.** Lock secures all drawers.

- For 22" or 24"D worksurface, order **LWE or LWLE**. For 30" or 36"D worksurface, order **LWWE or LWWLE**.
- Unfinished top and back

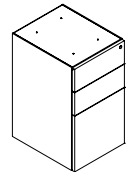

Box/Box/File Shell

LETTER					
LWWD	23 x 16 x 28	92.5	72	6	\$2001
LWD	19.1 x 16 x 28	92.5	70	5	\$1777
LEGAL					
LWWLD	23 x 19 x 28	92.5	85	7	\$2339
LWLD	19.1 x 19 x 28	92.5	83	6	\$2072

For use **under a freestanding worksurface (22", 24", 30" or 36"D)**. Top drilled to attach to worksurface. **Two box and one file drawers.** One pencil tray. Lock secures all drawers.

- For 22" or 24"D worksurface, order **LWD or LWLD**. For 30" or 36"D worksurface, order **LWWD or LWWLD**.
- Unfinished top and back

Required Specifications

Veneer Finish
Edge

STORAGE MODULES - FREESTANDING

MODEL#	DIMENSIONS	FREIGHT CLASS	WT/LBS.	CUBIC FT.	LIST PRICE
--------	------------	---------------	---------	-----------	------------

D x W x H

LWBM	18 x 16 x 21	85	70	5	\$1481
LWWBM	24 x 16 x 21	85	75	6	\$1738

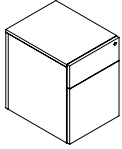

Box/File Freestanding Pedestal

One box and one file drawer. One pencil tray. Lock secures all drawers. Finished back.

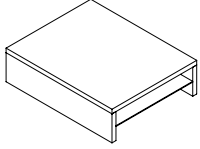

Spacer

LSPBOX1620	20 x 16 x 4.8	125	15	2	\$525
------------	---------------	-----	----	---	--------------

For use with 23" high credenzas to support an overlapping return. Includes shelf for paper management.

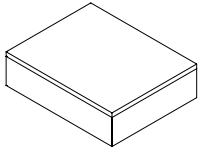

Spacer, Closed

LSPBOX1620C	20 x 16 x 4.8	125	15	2	\$580
-------------	---------------	-----	----	---	--------------

For use with 23" high credenzas to support an overlapping return.

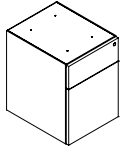

Box/File Pedestal

LWB15	18 x 16 x 19.5	70	50	3	\$1268
-------	----------------	----	----	---	---------------

One box and one file drawer. One pencil tray. Lock secures all drawers. Finished back. **For use with 23" high credenza shell.**

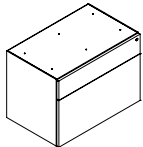

Box/Lateral File Pedestal

LWB36	18 x 36 x 19.5	92.5	115	11	\$2306
LWB30	18 x 30 x 19.5	92.5	96	9	\$2017

One box and one lateral file drawer. One pencil tray. Lock secures all drawers. Finished back. **For use with 23" high credenza shell.**

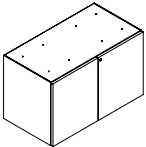

Storage Cabinet w/Doors

LWMH19.5	20 x 36 x 29	92.5	130	12	\$1427
LWGH19.5	20 x 30 x 29	92.5	107	10	\$1610

Includes one adjustable shelf. Standard with lock. **For use with 23" high credenza shell.**

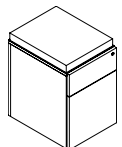

Box/File Freestanding Pedestal Mobile, with Cushion

LWBMCU	18 x 16 x 24	85	70	5	\$2228
LWWBMCU	24 x 16 x 24	85	75	6	\$2543

One box and one file drawer. One pencil tray. Lock secures all drawers. Casters.

Required Specifications

Veneer Finish
Edge

STORAGE MODULES - FREESTANDING

MODEL# DIMENSIONS FREIGHT CLASS WT/LBS. CUBIC FT. LIST PRICE

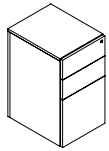

Box/Box/File Freestanding Pedestal

D x W x H						
LWDB	18 x 16 x 28	85	70	5		\$1777
LWWDB	24 x 16 x 28	85	75	6		\$2043

Two box and one file drawer. One pencil tray. Lock secures all drawers. Finished back.

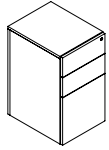

Box/Box/File Module, Mobile

LWDM	18 x 16 x 28	85	70	5		\$1911
LWWDM	24 x 16 x 28	85	75	6		\$2194

Two box and one file drawer. One pencil tray. Lock secures all drawers. Casters.

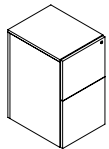

File/File Module, Mobile

LWEM	18 x 16 x 28	85	70	5		\$2072
LWWEM	24 x 16 x 28	85	75	6		\$2227

Two file drawer. Lock secures all drawers. Casters.

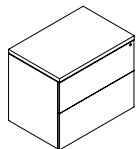

File/File Module, Lateral

LF3624	24 x 36 x 29	85	184	15		\$3277
LN3024	24 x 30 x 29	85	153	12		\$2870
LF3620	20 x 36 x 29	85	159	12		\$2461
LN3020	20 x 30 x 29	85	131	10		\$2152

Two lateral file drawers. Lock secures all drawers.

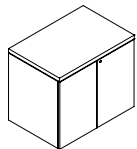

Storage Cabinet w/Doors

LBD3624	24 x 36 x 29	92.5	152	15		\$2230
LBD3024	24 x 30 x 29	92.5	127	12		\$1958
LBD3620	20 x 36 x 29	92.5	130	12		\$1760
LBD3020	20 x 30 x 29	92.5	107	10		\$1534

Includes one adjustable shelf. Standard with lock.

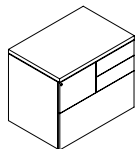

Mixed Storage Cabinet - LEFT

LZL3624	24 x 36 x 29	85	184	15		\$3559
LZL3620	20 x 36 x 29	85	170	13		\$2796

One file drawer on the **left**, two box drawers on the **right** and one lateral file drawer on the bottom. File drawer and lateral file drawer lock. One pencil tray. **Not for stacking materials on lateral file drawer bottom.**

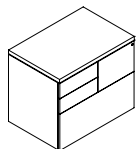

Mixed Storage Cabinet - RIGHT

LZR3624	24 x 36 x 29	85	184	15		\$3559
LZR3620	20 x 36 x 29	85	170	13		\$2796

One file drawer on the **right**, two box drawers on the **left** and one lateral file drawer on the bottom. File drawer and lateral file drawer lock. One pencil tray. **Not for stacking materials on lateral file drawer bottom.**

Required Specifications

Veneer Finish
Edge

FREESTANDING STORAGE

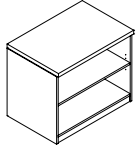

Open Storage Cabinet

MODEL#	DIMENSIONS D x W x H	FREIGHT CLASS	WT/LBS.	CUBIC FT.	LIST PRICE
LOB3624	24 x 36 x 29	100	123	15	\$1792
LOB3024	24 x 30 x 29	100	103	12	\$1566
LOB3620	20 x 36 x 29	100	115	13	\$1411
LOB3020	20 x 30 x 29	100	96	11	\$1228

One fixed and **one** adjustable veneer shelf. Shelves are ¾" thick.

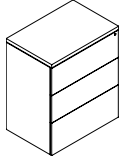

Three File Module

LF36243	24 x 36 x 42	92.5	231	21	\$4009
LN30243	24 x 30 x 42	92.5	193	18	\$3505
LF36203	20 x 36 x 42	92.5	212	19	\$3429
LN30203	20 x 30 x 42	92.5	176	16	\$2999

Three lateral file drawers. Lock secures all drawers.

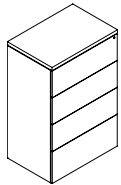

Four File Module

LF36244	24 x 36 x 54	92.5	297	27	\$4884
LN30244	24 x 30 x 54	92.5	248	23	\$4271
LF36204	20 x 36 x 54	92.5	270	25	\$4250
LN30204	20 x 30 x 54	92.5	225	21	\$3718

Four lateral file drawers. Lock secures all drawers.

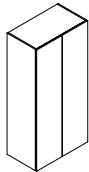

Storage Cabinet w/Doors

L1D24H72	24 x 35 x 72	100	324	36	\$4266
L1D24W30H72	24 x 30 x 72	100	270	30	\$3725
L1D24W24H72	24 x 24 x 72	100	216	24	\$3182
L1H72	20 x 35 x 72	100	269	30	\$3725
L1W30H72	20 x 30 x 72	100	233	25	\$3108
L1W24H72	20 x 24 x 72	100	179	20	\$2483
L1D24	24 x 35 x 65	100	297	33	\$3912
L1D24W30	24 x 30 x 65	100	248	28	\$3424
L1D24W24	24 x 24 x 65	100	198	22	\$2936
L1W35	20 x 35 x 65	100	245	28	\$3417
L1W30	20 x 30 x 65	100	202	23	\$2848
L1W24	20 x 24 x 65	100	163	18	\$2281

Includes four adjustable shelves. Standard with lock.

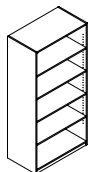

Open Storage Cabinet

L7D24H72	24 x 35 x 72	100	306	36	\$3417
L7D24W30H72	24 x 30 x 72	100	255	30	\$2989
L7H72	20 x 35 x 72	100	257	30	\$2985
L7W30H72	20 x 30 x 72	100	223	25	\$2483
L7D24	24 x 35 x 65	100	281	33	\$3135
L7D24W30	24 x 30 x 65	100	234	28	\$2741
L7	20 x 35 x 65	100	234	28	\$2736
L7W30	20 x 30 x 65	100	193	23	\$2281

Includes one fixed and **four** adjustable veneer shelves. Shelves are ¾" thick.

Required Specifications

Veneer Finish
Edge (file modules)

FREESTANDING STORAGE

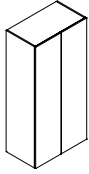

Wardrobe Cabinet

MODEL# DIMENSIONS FREIGHT CLASS WT/LBS. CUBIC FT. LIST PRICE

D x W x H

L2D24H72	24 x 35 x 72	100	324	36	\$3636
L2D24W30H72	24 x 30 x 72	100	270	30	\$3181
L2D24W24H72	24 x 24 x 72	100	216	24	\$2724
L2H72	20 x 35 x 72	100	269	30	\$3178
L2W30H72	20 x 30 x 72	100	233	25	\$2700
L2W24H72	20 x 24 x 72	100	179	20	\$2155

L2D24	24 x 35 x 65	100	297	33	\$3333
L2D24W30	24 x 30 x 65	100	246	28	\$2918
L2D24W24	24 x 24 x 65	100	198	22	\$2503
L2	20 x 35 x 65	100	245	28	\$2962
L2W30	20 x 30 x 65	100	202	23	\$2474
L2W24	20 x 24 x 65	100	163	18	\$1980

Includes full length hanging rod and fixed hat shelf.

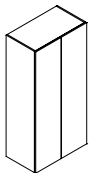

Wardrobe Cabinet/Shelving Combo

L25D24H72	24 x 35 x 72	100	324	36	\$4785
L25D24W30H72	24 x 30 x 72	100	270	30	\$4187
L25D24W24H72	24 x 24 x 72	100	216	24	\$3690
L25H72	20 x 35 x 72	100	269	30	\$4174
L25W30H72	20 x 30 x 72	100	233	25	\$3483
L25W24H72	20 x 24 x 72	100	179	20	\$2790

L25D24	24 x 35 x 65	100	297	33	\$4391
L25D24W30	24 x 30 x 65	100	246	28	\$3836
L25D24W24	24 x 24 x 65	100	198	22	\$3289
L25	20 x 35 x 65	100	245	28	\$3826
L25W30	20 x 30 x 65	100	202	23	\$3193
L25W24	20 x 24 x 65	100	163	18	\$2559

Wardrobe compartment on **left** includes hanging rod and fixed hat shelf. Storage compartment on **right** includes three adjustable shelves.

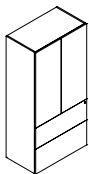

Two File Module w/Doors

L13D24H72	24 x 35 x 72	100	324	36	\$5279
L13D24W30H72	24 x 30 x 72	100	270	30	\$4620
L13H72	20 x 35 x 72	100	269	30	\$4611
L13W30H72	20 x 30 x 72	100	233	25	\$3846

L13D24	24 x 35 x 65	100	297	33	\$4842
L13D24W30	24 x 30 x 65	100	248	28	\$4232
L13	20 x 35 x 65	100	245	28	\$4228
L13W30	20 x 30 x 65	100	202	23	\$3526

Two lateral file drawers on bottom. Includes **two** adjustable shelves. Upper lock secures storage compartment. Lower lock secures two file drawers. **Not for stacking materials on lateral file drawer bottom.**

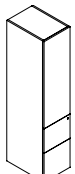

Two File Module w/Door - LEFT

L17D24H72L	24 x 16 x 72	125	99	15	\$3633
L17H72L	20 x 16 x 72	125	90	13	\$3090
L17D24L	24 x 16 x 65	125	91	13	\$3369
L17L	20 x 16 x 65	125	83	12	\$2833

Two file drawers on bottom. Includes two adjustable shelves. Upper lock secures storage compartment. Lower lock secures two file drawers. Handle is on the **right**, door opens to the **left**.

Required Specifications

Veneer Finish

FREESTANDING STORAGE

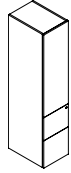

Two File Module w/Door - RIGHT

MODEL#	DIMENSIONS D x W x H	FREIGHT CLASS	WT/LBS.	CUBIC FT.	LIST PRICE
L17D24H72R	24 x 16 x 72	125	99	15	\$3633
L17H72R	20 x 16 x 72	125	90	13	\$3090
L17D24R	24 x 16 x 65	125	91	13	\$3369
L17R	20 x 16 x 65	125	83	12	\$2833

Two file drawers on bottom. Includes two adjustable shelves. Upper lock secures storage compartment. Lower lock secures two file drawers. Handle is on the **left**, door opens to the **right**.

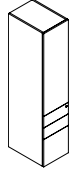

Box/Box/File Module w/Door - LEFT

L18D24H72L	24 x 16 x 72	125	99	15	\$3633
L18H72L	20 x 16 x 72	125	90	13	\$3090
L18D24L	24 x 16 x 65	125	91	13	\$3369
L18L	20 x 16 x 65	125	83	12	\$2833

Two box drawers and one file drawer on bottom. Includes two adjustable shelves. Upper lock secures storage compartment. Lower lock secures all drawers. Handle is on the **right**, door opens to the **left**.

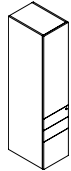

Box/Box/File Module w/Door - RIGHT

L18D24H72R	24 x 16 x 72	125	99	15	\$3633
L18H72R	20 x 16 x 72	125	90	13	\$3090
L18D24R	24 x 16 x 65	125	91	13	\$3369
L18R	20 x 16 x 65	125	83	12	\$2833

Two box drawers and one file drawer on bottom. Includes two adjustable shelves. Upper lock secures storage compartment. Lower lock secures all drawers. Handle is on the **left**, door opens to the **right**.

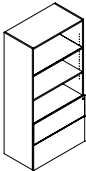

Two File Module w/Open Shelves

L12D24H72	24 x 35 x 72	100	324	36	\$4637
L12D24W30H72	24 x 30 x 72	100	270	30	\$4056
L12H72	20 x 35 x 72	100	269	30	\$4047
L12W30H72	20 x 30 x 72	100	233	25	\$3541
L12D24	24 x 35 x 65	100	297	33	\$4250
L12D24W30	24 x 30 x 65	100	248	28	\$3718
L12	20 x 35 x 65	100	245	28	\$3706
L12W30	20 x 30 x 65	100	239	23	\$3096

Three open veneer shelves and two lateral file drawers on bottom. Includes two adjustable shelves. Lock secures all drawers. Front-to-back and side-to-side filing. **Not for stacking materials on lateral file drawer bottom.**

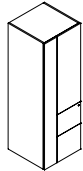

Personal Tower - LEFT

L29D24W24H72L	24 x 24 x 72	125	168	24	\$5405
L29W24H72L	20 x 24 x 72	125	140	20	\$4418
L29D24W24L	24 x 24 x 65	125	154	22	\$4851
L29W24L	20 x 24 x 65	125	128	18	\$4002

Two file drawers on bottom. Wardrobe compartment on **left** includes hanging rod. Storage compartment on **right** includes one adjustable shelf. Upper lock secures storage and wardrobe compartments. Lower lock secures all drawers.

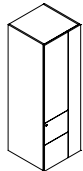

Personal Tower - RIGHT

L29D24W24H72R	24 x 24 x 72	125	168	24	\$5405
L29W24H72R	20 x 24 x 72	125	140	20	\$4418
L29D24W24R	24 x 24 x 65	125	154	22	\$4851
L29W24R	20 x 24 x 65	125	128	18	\$4002

Two file drawers on bottom. Wardrobe compartment on **right** includes hanging rod. Storage compartment on **left** includes one adjustable shelf. Upper lock secures storage and wardrobe compartments. Lower lock secures all drawers.

Required Specifications

Veneer Finish

FREESTANDING STORAGE

MODEL# DIMENSIONS FREIGHT CLASS WT/LBS. CUBIC FT. LIST PRICE

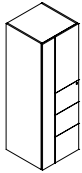

Personal Tower - LEFT

D x W x H						
L27D24W24H72L	24 x 24 x 72	125	168	24		\$5961
L27W24H72L	20 x 24 x 72	125	140	20		\$5212
L27D24W24L	24 x 24 x 65	125	154	22		\$5469
L27W24L	20 x 24 x 65	125	128	18		\$4774

Three file drawers on bottom. Wardrobe compartment on **left** includes hanging rod. Storage compartment on **right** includes one adjustable shelf. Upper lock secures storage and wardrobe compartments. Lower lock secures all drawers.

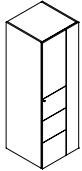

Personal Tower - RIGHT

L27D24W24H72R	24 x 24 x 72	125	168	24		\$5961
L27W24H72R	20 x 24 x 72	125	140	20		\$5212
L27D24W24R	24 x 24 x 65	125	154	22		\$5469
L27W24R	20 x 24 x 65	125	128	18		\$4774

Three file drawers on bottom. Wardrobe compartment on **right** includes hanging rod. Storage compartment on **left** includes one adjustable shelf. Upper lock secures storage and wardrobe compartments. Lower lock secures all drawers.

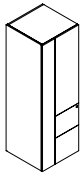

Personal Tower w/Open Bookcase - LEFT

L30D24W24H72L	24 x 24 x 72	125	168	24		\$5405
L30W24H72L	20 x 24 x 72	125	140	20		\$4418
L30D24W24L	24 x 24 x 65	125	154	22		\$4851
L30W24L	20 x 24 x 65	125	128	18		\$4002

Two file drawers on bottom. Wardrobe compartment on **left** includes hanging rod. Storage compartment on **right** includes one adjustable shelf. Open bookcase on **right** includes two adjustable shelves. Upper lock secures storage and wardrobe compartments. Lower lock secures all drawers.

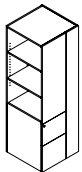

Personal Tower w/Open Bookcase - RIGHT

L30D24W24H72R	24 x 24 x 72	125	168	24		\$5405
L30W24H72R	20 x 24 x 72	125	140	20		\$4418
L30D24W24R	24 x 24 x 65	125	154	22		\$4851
L30W24R	20 x 24 x 65	125	128	18		\$4002

Two file drawers on bottom. Wardrobe compartment on **right** includes hanging rod. Storage compartment on **left** includes one adjustable shelf. Open bookcase on **left** includes two adjustable shelves. Upper lock secures storage and wardrobe compartments. Lower lock secures all drawers.

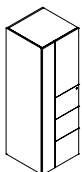

Personal Tower w/Open Bookcase - LEFT

L26D24W24H72L	24 x 24 x 72	125	168	24		\$5961
L26W24H72L	20 x 24 x 72	125	140	20		\$5901
L26D24W24L	24 x 24 x 65	125	154	22		\$5469
L26W24L	20 x 24 x 65	125	128	18		\$5452

Three file drawers on bottom. Wardrobe compartment on **left** includes hanging rod. Storage compartment on **right** includes one adjustable shelf. Open bookcase on **right** includes one adjustable shelf. Upper lock secures storage and wardrobe compartments. Lower lock secures all drawers.

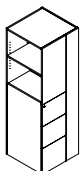

Personal Tower w/Open Bookcase - RIGHT

L26D24W24H72R	24 x 24 x 72	125	168	24		\$5961
L26W24H72R	20 x 24 x 72	125	140	20		\$5901
L26D24W24R	24 x 24 x 65	125	154	22		\$5469
L26W24R	20 x 24 x 65	125	128	18		\$5452

Three file drawers on bottom. Wardrobe compartment on **right** includes hanging rod. Storage compartment on **left** includes one adjustable shelf. Open bookcase on **left** includes one adjustable shelf. Upper lock secures storage and wardrobe compartments. Lower lock secures all drawers.

Required Specifications

Veneer Finish

FREESTANDING STORAGE

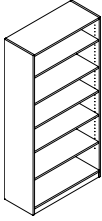

Bookcase



End Shelf - 72" High - Square

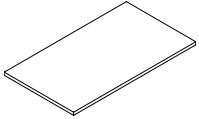

Shelf for Bookcase

MODEL#	DIMENSIONS D x W x H	FREIGHT CLASS	WT/LBS.	CUBIC FT.	LIST PRICE
LB73615	15 x 35 x 78	100	228	24	\$2431
LB63615	15 x 35 x 72	100	210	23	\$2243
LB53615	15 x 35 x 65	100	210	23	\$2065
LB73015	15 x 30 x 78	92.5	228	20	\$2126
LB63015	15 x 30 x 72	92.5	210	19	\$1958
LB53015	15 x 30 x 65	92.5	188	17	\$1807

Includes **adjustable** shelves. Shelf is 3/4" thick.

LB7S1515	15 x 15 x 78	100	95	10	\$1916
LB6S1515	15 x 15 x 72	100	83	9	\$1764
LB5S1515	15 x 15 x 65	100	81	9	\$1624
LB4S1515	15 x 15 x 48	100	59	6	\$1341

For use at end of **storage modules, wardrobe cabinets or personal towers**. Includes **adjustable** veneer shelves. Shipped RTA (ready to assemble).

MAG3624	24 x 35 x 1	92.5	112	10	\$171
MAG3620	20 x 35 x 1	92.5	92	9	\$146
MAG3615	15 x 35 x 1	92.5	81	8	\$123
MAG3024	24 x 30 x 1	92.5	94	9	\$146
MAG3020	20 x 30 x 1	100	76	8	\$116
MAG3015	15 x 30 x 1	100	67	8	\$102

Required Specifications

Veneer finish

FLOATING SHELVES

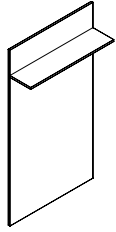

Wall Mounted Panel,
One Floating Shelf

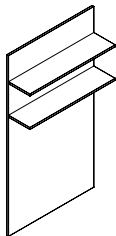

Wall Mounted Panel,
Two Floating Shelves



End Cap

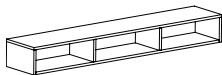

Wall Mounted Open Storage

MODEL#	DIMENSIONS	FREIGHT CLASS	WT/LBS.	CUBIC FT.	LIST PRICE
--------	------------	---------------	---------	-----------	------------

D x W x H

TWF1S2466	11 x 24 x 66	250	42	13	\$1508
TWF1S3066	11 x 30 x 66	250	50	16	\$1759
TWF1S3666	11 x 36 x 66	250	58	19	\$2034
TWF1S4266	11 x 42 x 66	250	66	22	\$2337
TWF1S2472	11 x 24 x 72	250	45	14	\$1605
TWF1S3072	11 x 30 x 72	250	53	17	\$1889
TWF1S3672	11 x 36 x 72	250	62	20	\$2151
TWF1S4272	11 x 42 x 72	250	71	23	\$2463

Standard with pre-mounted "J" bracket for wall mount applications. End cap required at the end of a run of floating shelves. End cap sold separately.

NOTE: Care should be taken to mount the units. Units should be mounted to wall studs using correct fasteners. Failure to do so may result in collapse of the unit and subsequent personal injury. **Fastening hardware not included.** Mounting hardware used should be based on wall material. Consult an installation professional for proper wall mounting.

TWF2S2466	11 x 24 x 66	250	46	13	\$1544
TWF2S3066	11 x 30 x 66	250	56	16	\$1811
TWF2S3666	11 x 36 x 66	250	65	19	\$2083
TWF2S4266	11 x 42 x 66	250	74	21	\$2409
TWF2S2472	11 x 24 x 72	250	49	14	\$1648
TWF2S3072	11 x 30 x 72	250	59	17	\$1952
TWF2S3672	11 x 36 x 72	250	69	20	\$2200
TWF2S4272	11 x 42 x 72	250	79	23	\$2532

Standard with pre-mounted "J" bracket for wall mount applications. End cap required at the end of a run of floating shelves. End cap sold separately.

NOTE: Care should be taken to mount the units. Units should be mounted to wall studs using correct fasteners. Failure to do so may result in collapse of the unit and subsequent personal injury. **Fastening hardware not included.** Mounting hardware used should be based on wall material. Consult an installation professional for proper wall mounting.

ENDCAP66	.75 x 66 x 3	60	6	0.04	\$819
ENDCAP72	.75 x 72 x 3	60	8	0.05	\$884

For use with wall mounted panels.

CBYFO96D12H8	12 x 96 x 8	125	78	10	\$2688
CBYFO64D12H8	12 x 64 x 8	125	50	8	\$1758
CBYFO32D12H8	12 x 32 x 8	100	35	4	\$1593

To be used as a stand alone unit.

Required Specifications

Veneer finish

WALLMOUNT STORAGE

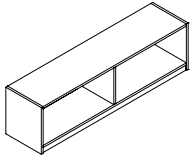

Open Front Overhead Storage

MODEL#	DIMENSIONS D x W x H	FREIGHT CLASS	WT/LBS.	CUBIC FT.	LIST PRICE
CSF072	15 x 72 x 17	92.5	100	10	\$1840
CSF066	15 x 66 x 17	100	83	9	\$1689
CSF060	15 x 60 x 17	100	75	8	\$1540
CSF054	15 x 54 x 17	100	68	7	\$1390
CSF048	15 x 48 x 17	100	60	7	\$1235
CSF042	15 x 42 x 17	100	55	6	\$1138
CSF036	15 x 36 x 17	92.5	50	5	\$1121
CSF030	15 x 30 x 17	92.5	45	4	\$1099

Includes pre-mounted "J" brackets for wall mount applications.

- **NOTE:** Care should be taken to mount the units. Units should be mounted to wall studs using correct fasteners. Failure to do so may result in collapse of the unit and subsequent personal injury. **Mounting hardware not included.** Mounting hardware used should be based on wall material. Consult an installation professional for proper wall mounting.

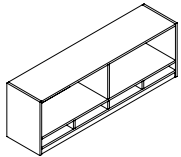

Open Front Overhead Storage - Pigeon-Hole Storage

CSFOP72	15 x 72 x 20	92.5	100	12	\$2210
CSFOP66	15 x 66 x 20	100	83	11	\$2030
CSFOP60	15 x 60 x 20	100	75	10	\$1844
CSFOP54	15 x 54 x 20	100	68	9	\$1663
CSFOP48	15 x 48 x 20	100	60	8	\$1473
CSFOP42	15 x 42 x 20	100	55	7	\$1385
CSFOP36	15 x 36 x 20	92.5	50	6	\$1346
CSFOP30	15 x 30 x 20	92.5	45	5	\$1326

Includes pre-mounted "J" brackets for wall mount applications. Horizontal pigeon-hole storage on bottom of overhead.

- **NOTE:** Care should be taken to mount the units. Units should be mounted to wall studs using correct fasteners. Failure to do so may result in collapse of the unit and subsequent personal injury. **Mounting hardware not included.** Mounting hardware used should be based on wall material. Consult an installation professional for proper wall mounting.

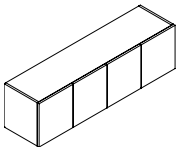

Closed Front Overhead Storage with Hinge Doors

CSF72	15 x 72 x 17	92.5	100	10	\$2270
CSF66	15 x 66 x 17	100	83	9	\$2082
CSF60	15 x 60 x 17	100	75	8	\$1887
CSF54	15 x 54 x 17	100	68	7	\$1701
CSF48	15 x 48 x 17	100	60	7	\$1512
CSF42	15 x 42 x 17	100	55	6	\$1390
CSF36	15 x 36 x 17	92.5	50	5	\$1364
CSF30	15 x 30 x 17	92.5	45	4	\$1341

Includes pre-mounted "J" brackets for wall mount applications.

- **NOTE:** Care should be taken to mount the units. Units should be mounted to wall studs using correct fasteners. Failure to do so may result in collapse of the unit and subsequent personal injury. **Mounting hardware not included.** Mounting hardware used should be based on wall material. Consult an installation professional for proper wall mounting.

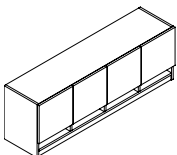

Closed Front Overhead Storage with Hinge Doors & Pigeon-Hole Storage

CSFP72	15 x 72 x 20	92.5	100	12	\$2720
CSFP66	15 x 66 x 20	100	83	11	\$2495
CSFP60	15 x 60 x 20	100	75	10	\$2270
CSFP54	15 x 54 x 20	100	68	9	\$2043
CSFP48	15 x 48 x 20	100	60	8	\$1813
CSFP42	15 x 42 x 20	100	55	7	\$1720
CSFP36	15 x 36 x 20	92.5	50	6	\$1637
CSFP30	15 x 30 x 20	92.5	45	5	\$1610

Includes pre-mounted "J" brackets for wall mount applications. Horizontal pigeon-hole storage on bottom of overhead.

- **NOTE:** Care should be taken to mount the units. Units should be mounted to wall studs using correct fasteners. Failure to do so may result in collapse of the unit and subsequent personal injury. **Mounting hardware not included.** Mounting hardware used should be based on wall material. Consult an installation professional for proper wall mounting.

Required Specifications

Veneer finish

HUTCHES

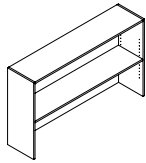

Open Hutch with Closed Back

MODEL# DIMENSIONS FREIGHT CLASS WT/LBS. CUBIC FT. LIST PRICE

	D x W x H				
L72CL36	14 x 72 x 36	125	155	23	\$2060
L66CL36	14 x 66 x 36	125	140	21	\$1911
L60CL36	14 x 60 x 36	125	130	19	\$1694
L48CL36	14 x 48 x 36	125	110	15	\$1615
L42CL36	14 x 42 x 36	125	95	13	\$1466
L36CL36	14 x 36 x 36	125	80	11	\$1369
L30CL36	14 x 30 x 36	125	67	9	\$1142

One adjustable shelf. Closed back. All hutches shipped pre-assembled.
 • **A Tackboard cannot be used with this hutch.**

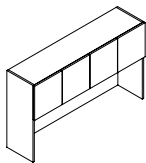

Closed Hutch w/Veneer Doors 36" High

L108SH36	15 x 108 x 36	125	268	34	\$5011
L102SH36	15 x 102 x 36	125	254	32	\$4733
L96SH36	15 x 96 x 36	100	241	30	\$4452
L90SH36	15 x 90 x 36	100	227	28	\$4174
L84SH36	15 x 84 x 36	100	214	26	\$3900
L78SH36	15 x 78 x 36	100	200	24	\$3622
L72SH36	15 x 72 x 36	100	187	23	\$3342
L66SH36	15 x 66 x 36	100	173	21	\$3218
L60SH36	15 x 60 x 36	100	160	19	\$3063
L36SH36	15 x 36 x 36	100	94	11	\$2090
L30SH36	15 x 30 x 36	100	78	9	\$1831

One fixed shelf. Closed back features one grommet. All hutches shipped pre-assembled.
 • Models 108" w have three fixed shelf dividers.
 • Models 84" w- 102" w have two fixed shelf dividers.
 • Models 60" w - 78" w have one fixed shelf divider.
 • Clearance from worksurface to valance is 19.5".

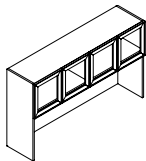

Closed Hutch w/Glass Doors 36" High

L108SH36G	15 x 108 x 36	125	268	34	\$7320
L102SH36G	15 x 102 x 36	125	254	32	\$6606
L96SH36G	15 x 96 x 36	100	241	30	\$6299
L90SH36G	15 x 90 x 36	100	227	28	\$5973
L84SH36G	15 x 84 x 36	100	214	26	\$5665
L78SH36G	15 x 78 x 36	100	200	24	\$5360
L72SH36G	15 x 72 x 36	100	187	23	\$4679
L66SH36G	15 x 66 x 36	100	173	21	\$4482
L60SH36G	15 x 60 x 36	100	160	19	\$4275
L36SH36G	15 x 36 x 36	100	94	11	\$2736
L30SH36G	15 x 30 x 36	100	78	9	\$2441

One fixed shelf. Closed back features one grommet. Aluminum frame available in Tungsten finish only. All hutches shipped pre-assembled. Translucent, screened glass.
 • Models 108" w have three fixed shelf dividers.
 • Models 84" w- 102" w have two fixed shelf dividers.
 • Models 60" w - 78" w have one fixed shelf divider.
 • Clearance from worksurface to valance is 19.5".
 • **Locks are not available on hutches with Glass Doors.**

Required Specifications

Veneer finish

HUTCHES

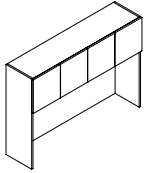

Closed Hutch w/Veneer Doors 42" H

MODEL#	DIMENSIONS D x W x H	FREIGHT CLASS	WT/LBS.	CUBIC FT.	LIST PRICE
L108SH42	15 x 108 x 42	125	307	39	\$5844
L102SH42	15 x 102 x 42	125	290	37	\$5515
L96SH42	15 x 96 x 42	100	273	35	\$5195
L90SH42	15 x 90 x 42	100	256	33	\$4867
L84SH42	15 x 84 x 42	100	239	31	\$4545
L78SH42	15 x 78 x 42	100	222	38	\$4223
L72SH42	15 x 72 x 42	100	205	26	\$3897
L66SH42	15 x 66 x 42	100	188	24	\$3756
L60SH42	15 x 60 x 42	100	171	22	\$3572
L36SH42	15 x 36 x 42	100	102	13	\$2435
L30SH42	15 x 30 x 42	100	85	11	\$2134

One fixed shelf. Closed back features one grommet. All hutches shipped pre-assembled.

- Models 108" w have three fixed shelf dividers.
- Models 84" w- 102" w have two fixed shelf dividers.
- Models 60" w - 78" w have one fixed shelf divider.
- *Clearance from worksurface to valance is 19.5".*

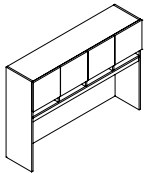

Closed Hutch w/Veneer Doors Pigeon-Hole Storage, 42" High

L108SHP42	15 x 108 x 42	125	307	39	\$7012
L102SHP42	15 x 102 x 42	125	290	37	\$6622
L96SHP42	15 x 96 x 42	100	273	35	\$6231
L90SHP42	15 x 90 x 42	100	256	33	\$5844
L84SHP42	15 x 84 x 42	100	239	31	\$5452
L78SHP42	15 x 78 x 42	100	222	38	\$5064
L72SHP42	15 x 72 x 42	100	205	26	\$4673
L66SHP42	15 x 66 x 42	100	188	24	\$4501
L60SHP42	15 x 60 x 42	100	171	22	\$4288
L36SHP42	15 x 36 x 42	100	102	13	\$2923
L30SHP42	15 x 30 x 42	100	85	11	\$2559

One fixed shelf. Closed back features one grommet. Horizontal pigeon-hole storage top mounted to hutch. All hutches shipped pre-assembled.

- Models 120" w- 108" w have three fixed shelf dividers.
- Models 84" w- 102" w have two fixed shelf dividers.
- Models 60" w - 78" w have one fixed shelf divider.
- *Clearance from worksurface to valance is 21.5".*

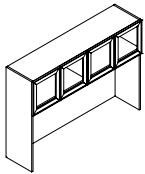

Closed Hutch w/Glass Doors 42" High

L108SH42G	15 x 108 x 42	125	307	39	\$7711
L102SH42G	15 x 102 x 42	125	290	37	\$6960
L96SH42G	15 x 96 x 42	100	273	35	\$6626
L90SH42G	15 x 90 x 42	100	256	33	\$6294
L84SH42G	15 x 84 x 42	100	239	31	\$5961
L78SH42G	15 x 78 x 42	100	222	38	\$5634
L72SH42G	15 x 72 x 42	100	205	26	\$4861
L66SH42G	15 x 66 x 42	100	188	24	\$4695
L60SH42G	15 x 60 x 42	100	171	22	\$4524
L36SH42G	15 x 36 x 42	100	102	13	\$2892
L30SH42G	15 x 30 x 42	100	85	11	\$2571

One fixed shelf. Closed back features one grommet. Aluminum frame available in Tungsten finish only. All hutches shipped pre-assembled. Translucent, screened glass.

- Models 120" w- 108" w have three fixed shelf dividers.
- Models 84" w- 102" w have two fixed shelf dividers.
- Models 60" w - 78" w have one fixed shelf divider.
- *Clearance from worksurface to valance is 25.5".*
- **Locks are not available on hutches with Glass Doors.**

Required Specifications

Veneer Finish

HUTCHES

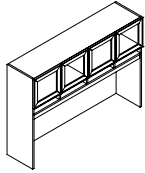

**Closed Hutch w/Glass Doors
Pigeon-Hole Storage, 42" High**

MODEL# DIMENSIONS FREIGHT CLASS WT/LBS. CUBIC FT. LIST PRICE

	D x W x H				
L108SHP42G	15 x 108 x 42	125	307	39	\$8773
L102SHP42G	15 x 102 x 42	125	290	37	\$7963
L96SHP42G	15 x 96 x 42	100	273	35	\$7589
L90SHP42G	15 x 90 x 42	100	256	33	\$7706
L84SHP42G	15 x 84 x 42	100	239	31	\$6778
L78SHP42G	15 x 78 x 42	100	222	38	\$6391
L72SHP42G	15 x 72 x 42	100	205	26	\$5571
L66SHP42G	15 x 66 x 42	100	188	24	\$5386
L60SHP42G	15 x 60 x 42	100	171	22	\$5136
L36SHP42G	15 x 36 x 42	100	102	13	\$3336
L30SHP42G	15 x 30 x 42	100	85	11	\$2977

One fixed shelf. Closed back features one grommet. Aluminum frame available in Tungsten finish only. Horizontal pigeon-hole storage top mounted to hutch. All hutches shipped pre-assembled. Translucent, screened glass.

- Models 120"w- 108"w have three fixed shelf dividers.
- Models 84"w- 102"w have two fixed shelf dividers.
- Models 60"w - 78"w have one fixed shelf divider.
- *Clearance from worksurface to valance is 21.5".*
- **Locks are not available on hutches with Glass Doors.**

Required Specifications

Veneer Finish

TACKBOARDS FOR OVERHEAD STORAGE

MODEL# DIMENSIONS FREIGHT CLASS WT/LBS. CUBIC FT. GR. 1-3 GR. 4-5

D x W x H

TACKBOARD Notes: Tackboards can be upholstered in all of the following fabrics:

Grade 1: Jenny, Quilt, Terrace, Urban, Waterfall

Grade 2: Imprint, Lola

Grade 3: Anchorage, Merge

LTS108	1 x 108 x 20	92.5	23	2	\$893	\$1120
LTS102	1 x 102 x 20	100	19	2	\$843	\$1056
LTS96	1 x 96 x 20	70	17	1	\$795	\$998
LTS90	1 x 90 x 20	70	15	1	\$745	\$935
LTS84	1 x 84 x 20	85	14	1	\$698	\$877
LTS78	1 x 78 x 20	85	13	1	\$642	\$806
LTS72	1 x 72 x 20	85	12	1	\$597	\$750
LTS66	1 x 66 x 20	92.5	11	1	\$539	\$677
LTS60	1 x 60 x 20	92.5	10	1	\$499	\$627
LTS36	1 x 36 x 20	125	8	1	\$302	\$383
LTS30	1 x 30 x 20	150	5	1	\$252	\$317

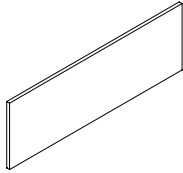

Tackboard for Hutch

For use on **36" H** hutches (**L_SH36, L_SH36G**). **Factory installed**, with velcro tape. Please specify hutch to be installed on. See "tackboard notes" exact fabric availability.

- **Not for use on non-Lufton hutches.**

LTS108H26	1 x 108 x 26	70	30	2	\$1158	\$1450
LTS102H26	1 x 102 x 26	85	24	2	\$1095	\$1373
LTS96H26	1 x 96 x 26	92.5	22	2	\$1030	\$1291
LTS90H26	1 x 90 x 26	92.5	20	2	\$971	\$1216
LTS84H26	1 x 84 x 26	100	18	2	\$901	\$1129
LTS78H26	1 x 78 x 26	100	17	2	\$834	\$1046
LTS72H26	1 x 72 x 26	70	16	1	\$774	\$971
LTS66H26	1 x 66 x 26	85	14	1	\$707	\$887
LTS60H26	1 x 60 x 26	85	13	1	\$642	\$806
LTS36H26	1 x 36 x 26	100	8	1	\$391	\$493
LTS30H26	1 x 30 x 26	150	5	1	\$327	\$412

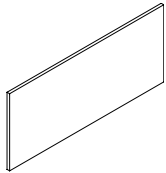

Tackboard for Hutch

For use on **42" H** hutches (**L_SH42, L_SH42**). **Factory installed**, with velcro tape. Please specify hutch to be installed on. See "tackboard notes" exact fabric availability.

- **Not for use on non-Lufton hutches.**

LTSP108H23	1 x 108 x 23	70	30	2	\$1001	\$1256
LTSP102H23	1 x 102 x 23	85	24	2	\$959	\$1201
LTSP96H23	1 x 96 x 23	92.5	20	2	\$897	\$1124
LTSP90H23	1 x 90 x 23	92.5	20	1	\$843	\$1056
LTSP84H23	1 x 84 x 23	70	18	1	\$781	\$979
LTSP78H23	1 x 78 x 23	70	17	1	\$729	\$914
LTSP72H23	1 x 72 x 23	70	16	1	\$676	\$847
LTSP66H23	1 x 66 x 23	85	14	1	\$615	\$774
LTSP60H23	1 x 60 x 23	85	13	1	\$578	\$710
LTSP36H23	1 x 36 x 23	100	8	1	\$338	\$425
LTSP30H23	1 x 30 x 23	150	5	1	\$285	\$358

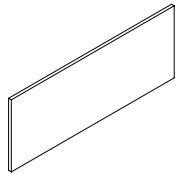

Tackboard for Hutch

For use on **42" H** hutches (**L_SHP42, L_SHP42G**) with Pigeon-Hole Storage. **Factory installed**, with velcro tape. Please specify hutch to be installed on. See "tackboard notes" exact fabric availability.

- **Not for use on non-Lufton hutches.**

Required Specifications

Fabric

TACKBOARDS FOR OVERHEAD STORAGE

MODEL#	DIMENSIONS	FREIGHT CLASS	WT/LBS.	CUBIC FT.	GR. 1-3	GR. 4-5
	D x W x H					
LTSAS108	1 x 108 x 20	92.5	23	2	\$1578	\$1977
LTSAS102	1 x 102 x 20	100	19	2	\$1422	\$1780
LTSAS96	1 x 96 x 20	70	15	1	\$1402	\$1757
LTSAS90	1 x 90 x 20	70	15	1	\$1315	\$1648
LTSAS84	1 x 84 x 20	85	14	1	\$1228	\$1539
LTSAS78	1 x 78 x 20	85	13	1	\$1142	\$1431
LTSAS72	1 x 72 x 20	85	12	1	\$1050	\$1316
LTSAS66	1 x 66 x 20	92.5	11	1	\$966	\$1210
LTSAS60	1 x 60 x 20	92.5	10	1	\$879	\$1102
LTSAS36	1 x 36 x 20	125	6	1	\$525	\$660
LTSAS30	1 x 30 x 20	150	4	1	\$439	\$552

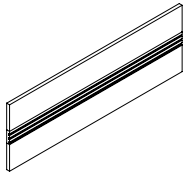

Tackboard for Hutch - Accessory Rail

For use on **36" H** hutches (**L_SH36, L_SH36G**). **Factory installed**, with velcro tape. Please specify hutch to be installed on. See "tackboard notes" exact fabric availability.

- **Must Specify Black (E) or Tungsten (K) Accessory Rail finish.**
- **Not for use on non-Lufton hutches.**

LTSAS108H26	1 x 108 x 26	70	23	2	\$1898	\$2377
LTSAS102H26	1 x 102 x 26	85	19	2	\$1787	\$2237
LTSAS96H26	1 x 96 x 26	92.5	15	1	\$1686	\$2112
LTSAS90H26	1 x 90 x 26	92.5	15	1	\$1584	\$1985
LTSAS84H26	1 x 84 x 26	100	14	1	\$1461	\$1828
LTSAS78H26	1 x 78 x 26	100	13	1	\$1369	\$1713
LTSAS72H26	1 x 72 x 26	70	12	1	\$1243	\$1557
LTSAS66H26	1 x 66 x 26	85	11	1	\$1158	\$1450
LTSAS60H26	1 x 60 x 26	85	10	1	\$1050	\$1316
LTSAS36H26	1 x 36 x 26	100	6	1	\$632	\$794
LTSAS30H26	1 x 30 x 26	150	4	1	\$532	\$668

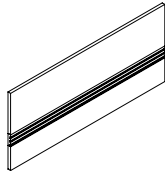

Tackboard for Hutch - Accessory Rail

For use on **42" H** hutches (**L_SH42, L_SH42G**). **Factory installed**, with velcro tape. Please specify hutch to be installed on. See "tackboard notes" exact fabric availability.

- **Must Specify Black (E) or Tungsten (K) Accessory Rail finish.**
- **Not for use on non-Lufton hutches.**

LTSPAS108H23	1 x 108 x 23	92.5	30	2	\$1712	\$2144
LTSPAS102H23	1 x 102 x 23	100	24	2	\$2134	\$2670
LTSPAS96H23	1 x 96 x 23	70	20	2	\$1523	\$1907
LTSPAS90H23	1 x 90 x 23	70	20	2	\$1433	\$1793
LTSPAS84H23	1 x 84 x 23	85	18	2	\$1335	\$1673
LTSPAS78H23	1 x 78 x 23	85	17	2	\$1239	\$1552
LTSPAS72H23	1 x 72 x 23	85	16	1	\$1142	\$1431
LTSPAS66H23	1 x 66 x 23	92.5	14	1	\$1050	\$1316
LTSPAS60H23	1 x 60 x 23	92.5	13	1	\$955	\$1196
LTSPAS36H23	1 x 36 x 23	125	6	1	\$575	\$722
LTSPAS30H23	1 x 30 x 23	150	4	1	\$482	\$605

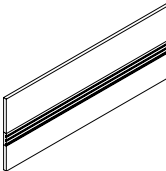

Tackboard for Hutch - Accessory Rail

For use on **42" H** hutches (**L_SHP42, L_SHP42G**) with Pigeon-Hole Storage. **Factory installed**, with velcro tape. Please specify hutch to be installed on. See "tackboard notes" exact fabric availability. List Price shown applies for all fabric grades.

- **Must Specify Black (E) or Tungsten (K) Accessory Rail finish.**
- **Not for use on non-Lufton hutches.**

Required Specifications

Fabric

WALLMOUNT TACKBOARDS

MODEL#	DIMENSIONS D x W x H	FREIGHT CLASS	WT/LBS.	CUBIC FT.	GR. 1-3	GR. 4-5
TS108	1 x 106 x 19	70	23	2	\$1370	\$1713
TS102	1 x 100 x 19	85	19	2	\$1298	\$1623
TS96	1 x 94 x 19	70	15	1	\$1214	\$1520
TS90	1 x 88 x 19	70	15	1	\$1141	\$1428
TS84	1 x 82 x 19	70	14	1	\$1069	\$1335
TS78	1 x 76 x 19	70	13	1	\$990	\$1238
TS72	1 x 70 x 19	70	12	1	\$557	\$698
TS66	1 x 64 x 19	85	11	1	\$512	\$644
TS60	1 x 58 x 19	85	10	1	\$471	\$592
TS36	1 x 34 x 19	100	6	1	\$302	\$383
TS30	1 x 28 x 19	150	4	1	\$251	\$316

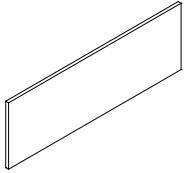

Tackboard - Wallmounted

For use on **16.5"H** overhead storage (CSFO_, CSF_, CSFF_) at a finished height of 66". See "tackboard notes" exact fabric availability. List Price shown applies for all fabric grades.

- **NOTE:** Care should be taken to mount the units. Units should be mounted to wall studs using correct fasteners. Failure to do so may result in collapse of the unit and subsequent personal injury. **Mounting hardware not included.** Mounting hardware used should be based on wall material. Consult an installation professional for proper wall mounting.

TS108H26	1 x 106 x 26	70	30	2	\$1782	\$2229
TS102H26	1 x 100 x 26	85	24	2	\$1678	\$2098
TS96H26	1 x 94 x 26	92.5	20	2	\$1587	\$1986
TS90H26	1 x 88 x 26	92.5	20	2	\$1488	\$1859
TS84H26	1 x 82 x 26	100	18	2	\$1383	\$1729
TS78H26	1 x 76 x 26	100	17	2	\$1286	\$1609
TS72H26	1 x 70 x 26	70	16	1	\$714	\$897
TS66H26	1 x 64 x 26	85	14	1	\$658	\$825
TS60H26	1 x 58 x 26	85	13	1	\$601	\$755
TS36H26	1 x 34 x 26	100	8	1	\$378	\$475
TS30H26	1 x 28 x 26	150	5	1	\$317	\$401

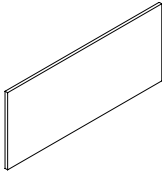

Tackboard - Wallmounted

For use on **16.5"H** overhead storage (CSFO_, CSF_) at a finished height of 72". See "tackboard notes" exact fabric availability. List Price shown applies for all fabric grades.

- **NOTE:** Care should be taken to mount the units. Units should be mounted to wall studs using correct fasteners. Failure to do so may result in collapse of the unit and subsequent personal injury. **Mounting hardware not included.** Mounting hardware used should be based on wall material. Consult an installation professional for proper wall mounting.

TSP108H23	1 x 106 x 23	70	30	2	\$1600	\$1920
TSP102H23	1 x 100 x 23	85	24	2	\$1525	\$1831
TSP96H23	1 x 94 x 23	92.5	20	2	\$1377	\$1720
TSP90H23	1 x 88 x 23	92.5	20	1	\$1286	\$1609
TSP84H23	1 x 82 x 23	70	18	1	\$1201	\$1501
TSP78H23	1 x 76 x 23	70	17	1	\$983	\$1195
TSP72H23	1 x 70 x 23	70	16	1	\$913	\$1147
TSP66H23	1 x 64 x 23	85	14	1	\$830	\$1041
TSP60H23	1 x 58 x 23	85	13	1	\$601	\$755
TSP36H23	1 x 34 x 23	100	8	1	\$458	\$474
TSP30H23	1 x 28 x 23	150	5	1	\$379	\$403

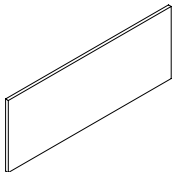

Tackboard - Wallmounted

For use on **19.5"H** overhead storage (CSFOP_, CSFP_) with Pigeon-Hole Storage at a finished height of 72". See "tackboard notes" exact fabric availability. List Price shown applies for all fabric grades.

- **NOTE:** Care should be taken to mount the units. Units should be mounted to wall studs using correct fasteners. Failure to do so may result in collapse of the unit and subsequent personal injury. **Mounting hardware not included.** Mounting hardware used should be based on wall material. Consult an installation professional for proper wall mounting.

Required Specifications
Fabric

WALLMOUNT TACKBOARDS

MODEL#	DIMENSIONS D x W x H	FREIGHT CLASS	WT/LBS.	CUBIC FT.	GR. 1-3	GR. 4-5
TSAS108	1 x 106 x 20	92.5	23	2	\$2120	\$2653
TSAS102	1 x 100 x 20	100	19	2	\$2007	\$2505
TSAS96	1 x 94 x 20	70	15	1	\$1880	\$2355
TSAS90	1 x 88 x 20	70	15	1	\$1765	\$2209
TSAS84	1 x 82 x 20	85	14	1	\$1646	\$2060
TSAS78	1 x 76 x 20	85	13	1	\$1533	\$1918
TSAS72	1 x 70 x 20	85	12	1	\$1412	\$1769
TSAS66	1 x 64 x 20	92.5	11	1	\$1298	\$1627
TSAS60	1 x 58 x 20	92.5	10	1	\$1177	\$1473
TSAS36	1 x 34 x 20	125	6	1	\$706	\$880
TSAS30	1 x 28 x 20	150	4	1	\$548	\$687

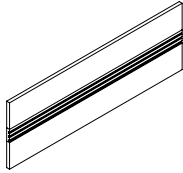

Tackboard - Accessory Rail, Wallmounted

For use on **16.5"H** overhead storage (**CSFO_**, **CSF_**) at a finished height of **66"**. See "tackboard notes" exact fabric availability. List Price shown applies for all fabric grades.

- **Must Specify Black (E) or Tungsten (K) Accessory Rail finish.**
- **NOTE:** Care should be taken to mount the units. Units should be mounted to wall studs using correct fasteners. Failure to do so may result in collapse of the unit and subsequent personal injury. **Mounting hardware not included.** Mounting hardware used should be based on wall material. Consult an installation professional for proper wall mounting.

TSAS108H26	1 x 106 x 26	70	23	2	\$2549	\$3187
TSAS102H26	1 x 100 x 26	85	19	2	\$2403	\$3005
TSAS96H26	1 x 94 x 26	92.5	15	1	\$2258	\$2826
TSAS90H26	1 x 88 x 26	92.5	15	1	\$2126	\$2660
TSAS78H26	1 x 76 x 26	100	13	1	\$1835	\$2295
TSAS72H26	1 x 70 x 26	70	12	1	\$1670	\$2090
TSAS66H26	1 x 64 x 26	85	11	1	\$1559	\$1945
TSAS60H26	1 x 58 x 26	85	10	1	\$1412	\$1769
TSAS36H26	1 x 34 x 26	100	6	1	\$851	\$1067
TSAS30H26	1 x 28 x 26	150	4	1	\$711	\$892

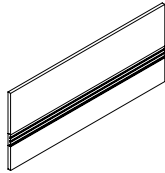

Tackboard - Accessory Rail, Wallmounted

For use on **16.5"H** overhead storage (**CSFO_**, **CSF_**) at a finished height of **72"**. See "tackboard notes" exact fabric availability. List Price shown applies for all fabric grades.

- **Must Specify Black (E) or Tungsten (K) Accessory Rail finish.**
- **NOTE:** Care should be taken to mount the units. Units should be mounted to wall studs using correct fasteners. Failure to do so may result in collapse of the unit and subsequent personal injury. **Mounting hardware not included.** Mounting hardware used should be based on wall material. Consult an installation professional for proper wall mounting.

TSPAS108H23	1 x 106 x 23	92.5	30	2	\$2297	\$2874
TSPAS102H23	1 x 100 x 23	100	24	2	\$2182	\$2731
TSPAS96H23	1 x 94 x 23	70	20	2	\$2051	\$2567
TSPAS90H23	1 x 88 x 23	70	20	2	\$1917	\$2399
TSPAS84H23	1 x 82 x 23	85	18	2	\$1791	\$2244
TSPAS78H23	1 x 76 x 23	85	17	2	\$1664	\$2081
TSPAS72H23	1 x 70 x 23	85	16	1	\$1539	\$1927
TSPAS66H23	1 x 64 x 23	92.5	14	1	\$1412	\$1769
TSPAS60H23	1 x 58 x 23	92.5	13	1	\$1279	\$1600
TSPAS36H23	1 x 34 x 23	125	8	1	\$640	\$803
TSPAS30H23	1 x 28 x 23	150	5	1	\$624	\$777

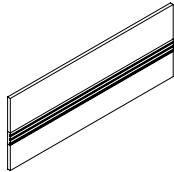

Tackboard - Accessory Rail, Wallmounted

For use on **19.5"H** overhead storage (**CSFOP_**, **CSFP_**) with Pigeon-Hole Storage at a finished height of **72"**. See "tackboard notes" exact fabric availability. List Price shown applies for all fabric grades.

- **Must Specify Black (E) or Tungsten (K) Accessory Rail finish.**
- **NOTE:** Care should be taken to mount the units. Units should be mounted to wall studs using correct fasteners. Failure to do so may result in collapse of the unit and subsequent personal injury. **Mounting hardware not included.** Mounting hardware used should be based on wall material. Consult an installation professional for proper wall mounting.

Required Specifications

Fabric

WALLMOUNT TACKBOARDS

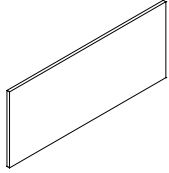

Tackboard - Wallmounted

MODEL#	DIMENSIONS D x W x H	FREIGHT CLASS	WT/LBS.	CUBIC FT.	GR. 1-3	GR. 4-5
TS108H25	1 x 106 x 25	92.5	23	2	\$1509	\$1884
TS102H25	1 x 100 x 25	100	19	2	\$1418	\$1776
TS96H25	1 x 94 x 25	70	17	1	\$1337	\$1668
TS90H25	1 x 88 x 25	70	15	1	\$1253	\$1569
TS84H25	1 x 82 x 25	85	14	1	\$1173	\$1468
TS78H25	1 x 76 x 25	85	13	1	\$1083	\$1355
TS72H25	1 x 70 x 25	85	12	1	\$1001	\$1256
TS66H25	1 x 64 x 25	92.5	11	1	\$920	\$1151
TS60H25	1 x 58 x 25	92.5	10	1	\$838	\$1051

For use on 16.5"H overhead storage (CSFO_, CSF_) mounted above 23"H credenzas for a finished height of 66". See "tackboard notes" exact fabric availability. List Price shown applies for all fabric grades

- **NOTE:** Care should be taken to mount the units. Units should be mounted to wall studs using correct fasteners. Failure to do so may result in collapse of the unit and subsequent personal injury. **Mounting hardware not included.** Mounting hardware used should be based on wall material. Consult an installation professional for proper wall mounting.

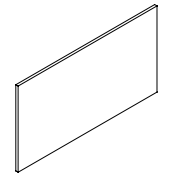

Tackboard - Wallmounted

TS108H32	1 x 106 x 32	70	30	2	\$1931	\$2409
TS102H32	1 x 100 x 32	85	24	2	\$1817	\$2274
TS96H32	1 x 94 x 32	92.5	20	2	\$1715	\$2148
TS90H32	1 x 88 x 32	92.5	20	2	\$1609	\$2014
TS84H32	1 x 82 x 32	100	18	2	\$1494	\$1873
TS78H32	1 x 76 x 32	100	17	2	\$1386	\$1736
TS72H32	1 x 70 x 32	70	16	1	\$1279	\$1600
TS66H32	1 x 64 x 32	85	14	1	\$1177	\$1473
TS60H32	1 x 58 x 32	85	13	1	\$1073	\$1342

For use on 16.5"H overhead storage (CSFO_, CSF_) mounted above 23"H credenzas for a finished height of 72". See "tackboard notes" exact fabric availability. List Price shown applies for all fabric grades

- **NOTE:** Care should be taken to mount the units. Units should be mounted to wall studs using correct fasteners. Failure to do so may result in collapse of the unit and subsequent personal injury. **Mounting hardware not included.** Mounting hardware used should be based on wall material. Consult an installation professional for proper wall mounting.

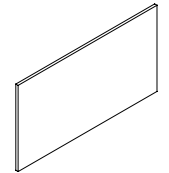

Tackboard - Wallmounted

TSP108H29	1 x 106 x 29	70	30	2	\$1745	\$2184
TSP102H29	1 x 100 x 29	85	24	2	\$1646	\$2060
TSP96H29	1 x 94 x 29	70	20	2	\$1550	\$1941
TSP90H29	1 x 88 x 29	70	20	2	\$1456	\$1821
TSP84H29	1 x 82 x 29	70	18	2	\$1355	\$1696
TSP78H29	1 x 76 x 29	70	17	2	\$1262	\$1573
TSP72H29	1 x 70 x 29	70	16	1	\$1160	\$1452
TSP66H29	1 x 64 x 29	85	14	1	\$1073	\$1342
TSP60H29	1 x 58 x 29	85	13	1	\$970	\$1215

For use on 16.5"H overhead storage (CSFO_, CSF_) mounted above 23"H credenzas for a finished height of 72". See "tackboard notes" exact fabric availability. List Price shown applies for all fabric grades

- **NOTE:** Care should be taken to mount the units. Units should be mounted to wall studs using correct fasteners. Failure to do so may result in collapse of the unit and subsequent personal injury. **Mounting hardware not included.** Mounting hardware used should be based on wall material. Consult an installation professional for proper wall mounting.

Required Specifications

Fabric

WALLMOUNT TACKBOARDS

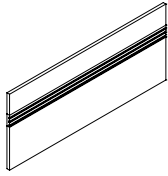

Tackboard - Accessory Rail, Wallmounted

MODEL#	DIMENSIONS D x W x H	FREIGHT CLASS	WT/LBS.	CUBIC FT.	GR. 1-3	GR. 4-5
TSAS108H25	1 x 106 x 25	92.5	23	2	\$2455	\$3070
TSAS102H25	1 x 100 x 25	100	19	2	\$2307	\$2887
TSAS96H25	1 x 94 x 25	70	15	1	\$2169	\$2716
TSAS90H25	1 x 88 x 25	70	15	1	\$2043	\$2557
TSAS78H25	1 x 76 x 25	85	13	1	\$1765	\$2209
TSAS72H25	1 x 70 x 25	85	12	1	\$1602	\$2006
TSAS66H25	1 x 64 x 25	92.5	11	1	\$1500	\$1880
TSAS60H25	1 x 58 x 25	92.5	10	1	\$1363	\$1706

For use on 16.5"H overhead storage (CSFO_, CSF_) mounted above 23"H credenzas for a finished height of 66". See "tackboard notes" exact fabric availability. List Price shown applies for all fabric grades

- **Must Specify Black (E) or Tungsten (K) Accessory Rail finish.**
- **NOTE:** Care should be taken to mount the units. Units should be mounted to wall studs using correct fasteners. Failure to do so may result in collapse of the unit and subsequent personal injury. **Mounting hardware not included.** Mounting hardware used should be based on wall material. Consult an installation professional for proper wall mounting.

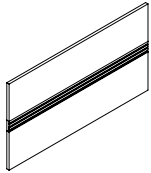

Tackboard - Accessory Rail, Wallmounted

TSAS108H32	1 x 106 x 32	70	23	2	\$3137	\$3923
TSAS102H32	1 x 100 x 32	85	19	2	\$2951	\$3690
TSAS96H32	1 x 94 x 32	92.5	15	1	\$2781	\$3480
TSAS90H32	1 x 88 x 32	92.5	15	1	\$2620	\$3272
TSAS78H32	1 x 76 x 32	100	13	1	\$2258	\$2826
TSAS72H32	1 x 70 x 32	70	12	1	\$2051	\$2567
TSAS66H32	1 x 64 x 32	85	11	1	\$1917	\$2399
TSAS60H32	1 x 58 x 32	85	10	1	\$1741	\$2178

For use on 16.5"H overhead storage (CSFO_, CSF_) mounted above 23"H credenzas for a finished height of 72". See "tackboard notes" exact fabric availability. List Price shown applies for all fabric grades

- **Must Specify Black (E) or Tungsten (K) Accessory Rail finish.**
- **NOTE:** Care should be taken to mount the units. Units should be mounted to wall studs using correct fasteners. Failure to do so may result in collapse of the unit and subsequent personal injury. **Mounting hardware not included.** Mounting hardware used should be based on wall material. Consult an installation professional for proper wall mounting.

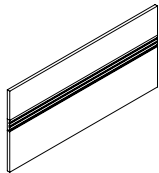

Tackboard - Accessory Rail, Wallmounted

TSPAS108H29	1 x 106 x 29	70	30	2	\$2846	\$3559
TSPAS102H29	1 x 100 x 29	85	24	2	\$2675	\$3341
TSPAS96H29	1 x 94 x 29	70	20	2	\$2518	\$3145
TSPAS90H29	1 x 88 x 29	70	20	2	\$2371	\$2968
TSPAS78H29	1 x 76 x 29	70	17	2	\$2051	\$2567
TSPAS72H29	1 x 70 x 29	70	16	1	\$1859	\$2328
TSPAS66H29	1 x 64 x 29	85	14	1	\$1741	\$2178
TSPAS60H29	1 x 58 x 29	85	13	1	\$1575	\$1974

For use on 16.5"H overhead storage (CSFO_, CSF_) mounted above 23"H credenzas for a finished height of 72". See "tackboard notes" exact fabric availability. List Price shown applies for all fabric grades

- **Must Specify Black (E) or Tungsten (K) Accessory Rail finish.**
- **NOTE:** Care should be taken to mount the units. Units should be mounted to wall studs using correct fasteners. Failure to do so may result in collapse of the unit and subsequent personal injury. **Mounting hardware not included.** Mounting hardware used should be based on wall material. Consult an installation professional for proper wall mounting.

Required Specifications

Fabric

PIGEON-HOLE STORAGE

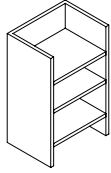

Vertical Pigeon-Hole Storage*

MODEL#	DIMENSIONS D x W x H	FREIGHT CLASS	WT/LBS.	CUBIC FT.	GR. 1-3	GR. 4-5
CPH161226	12 x 16 x 26	125	20	3	\$707	
CPH161223	12 x 16 x 23	125	18	3	\$600	
CPH161219	12 x 16 x 19	125	15	2	\$456	
CPH131226	12 x 13 x 26	100	16	2	\$575	
CPH131223	12 x 13 x 23	125	15	2	\$488	
CPH131219	12 x 13 x 19	125	12	2	\$368	

Used in conjunction with overhead storage units and hutches that incorporate horizontal pigeon-hole storage. Not freestanding. Shipped RTA (ready to assemble).

ACCESSORY RAIL/PANEL ORGANIZERS

Available Finishes:

BLK	Black	SIL	Silver
CHR	Charcoal	TPE	Taupe
DWT	Designer White	TUN	Tungsten
NEV	Nevada		

ACCESSORIES

MODEL#	DIMENSIONS	FREIGHT CLASS	WT/LBS.	CUBIC FT.	LIST PRICE
--------	------------	---------------	---------	-----------	------------

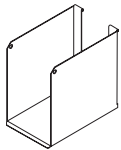

Binder Bin**

BABB01	10.25 x 4 x 9	100	2	.21	\$70
--------	---------------	-----	---	-----	-------------

Load bar/accessory rail mounted metal binder bin.

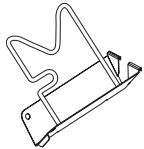

Flip Sorter**

BAFS01	9.25 x 2.75 x 9.25	70	.06	.14	\$54
--------	--------------------	----	-----	-----	-------------

Load bar/accessory rail mounted metal flip sorter. Comes with chrome wire.

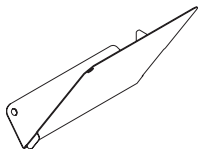

Slant Sorter

BASS01L (Left)	10.25 x 5 x 9.5	70	1	.28	\$44
BASS01R (Right)	10.25 x 5 x 9.5	70	1	.28	\$44

Load bar/accessory rail mounted metal slant sorter.

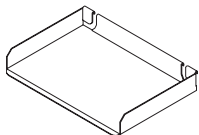

Letter Tray

BALTO1	9.25 x 13.5 x 2	70	.50	.15	\$58
--------	-----------------	----	-----	-----	-------------

Load bar/accessory rail mounted metal letter tray.

Required Specifications

- Fabric
- Veneer finish*
- Metal finish**

ACCESSORY RAIL/ PANEL ORGANIZERS **MODEL#** **DIMENSIONS** **FREIGHT CLASS** **WT/LBS.** **CUBIC FT.** **LIST PRICE**

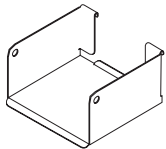

Media Bin

D x W x H						
BAMB01	5.25 x 5.75 x 3	70	.08	.05	\$58	

Load bar/accessory rail mounted metal media bin.

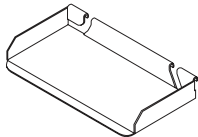

Utility Tray

BAUT01	3.75 x 5.75 x 3	70	.05	.02	\$38
--------	-----------------	----	-----	-----	-------------

Load bar/accessory rail mounted metal utility tray.

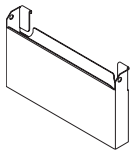

Mail Box

BAPP01	2.75 x 16 x 9	100	2	.25	\$88
--------	---------------	-----	---	-----	-------------

Load bar/accessory rail mounted metal mail box.

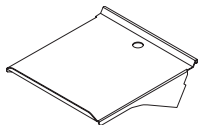

Telephone Holder

BATH01	10 x 9 x 2	125	2	.26	\$85
--------	------------	-----	---	-----	-------------

Load bar/accessory rail mounted metal telephone holder.

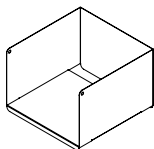

Elevated Shelf Binder Bin

BRTSBBIN	12 x 12 x 8	100	6	.66	\$181
----------	-------------	-----	---	-----	--------------

Load bar/accessory rail mounted elevated shelf binder bin.

Required Specifications
Metal finish

RECEPTION DESKS

MODEL#

DIMENSIONS

FREIGHT CLASS

WT./LBS.

CUBIC FT.

LIST PRICE

D x W x H

- To add storage use storage shells. See page 298 .
- Includes GM1 grommet.
- Transaction tops to be specified separately, handed by square edge from user side.
- Decorative Front Panels should be specified separately. Size chosen should be 12" less than desk dimensions. Available in Reverse Diamond, Vertical Rib, Vertical Grain and Horizontal Grain Patterns.

OPTION DETAILS

Decorative Front Panel (Reverse Diamond Pattern)
GFDP5430F

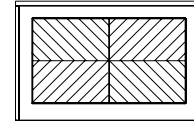

Decorative Front Panel (Vertical Rib Pattern)
GFDP5430RIB

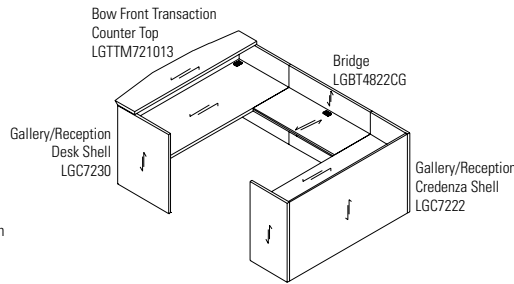
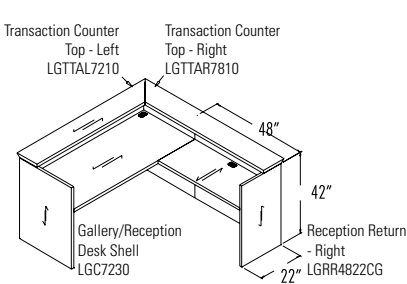
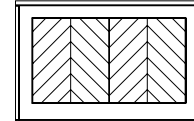

RECEPTION DESKS

MODEL#

DIMENSIONS

FREIGHT CLASS

WT./LBS.

CUBIC FT.

LIST PRICE

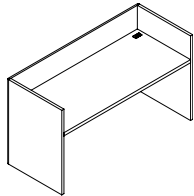

Gallery/Reception Desk Shell

LGC10836	36 x 108 x 42	150	533	95	\$7449
LGC10236	36 x 102 x 42	150	503	89	\$7035
LGC9636	36 x 96 x 42	150	473	84	\$6622
LGC9036	36 x 90 x 42	150	444	79	\$6208
LGC8436	36 x 84 x 42	150	414	74	\$5796
LGC7236	36 x 72 x 42	150	355	63	\$4968
LGC7230	30 x 72 x 42	150	315	53	\$4809
LGC6630	30 x 66 x 42	125	295	48	\$4330
LGC6030	30 x 60 x 42	125	275	44	\$4690

No pedestals. Two grommets in worksurface. For use with modular storage components.

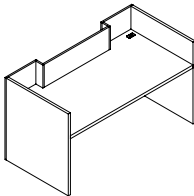

**Gallery/Reception Desk Shell
Breakfront Style**

LGIC10836	36 x 108 x 42	150	533	95	\$9161
LGIC10236	36 x 102 x 42	150	503	89	\$8643
LGIC9636	36 x 96 x 42	150	473	84	\$8145
LGIC9036	36 x 90 x 42	150	444	79	\$7631
LGIC8436	36 x 84 x 42	150	414	74	\$7131
LGIC7236	36 x 72 x 42	150	355	63	\$6100
LGIC7230	30 x 72 x 42	150	315	53	\$5907
LGIC6630	30 x 66 x 42	125	295	48	\$5757
LGIC6030	30 x 60 x 42	125	275	44	\$5426

No pedestals. Two grommets in worksurface. For use with modular storage components.

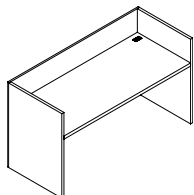

Gallery/Reception Credenza Shell

LGC10824	24 x 108 x 42	150	353	63	\$5839
LGC10224	24 x 102 x 42	150	333	60	\$5522
LGC9624	24 x 96 x 42	150	314	56	\$5188
LGC9024	24 x 90 x 42	150	294	53	\$4861
LGC8424	24 x 84 x 42	150	274	49	\$4545
LGC7224	24 x 72 x 42	150	235	42	\$3900
LGC6624	24 x 66 x 42	150	216	39	\$3660
LGC6024	24 x 60 x 42	150	196	35	\$3429

No pedestals. Two grommets in worksurface. For use with modular storage components.

Required Specifications

- Metal Finish (Accessories)
- Veneer Finish
- Edge

RECEPTION DESKS

MODEL# DIMENSIONS FREIGHT CLASS WT/LBS. CUBIC FT. LIST PRICE

D x W x H

LGBT5624CG	24 x 56 x 42	150	178	32	\$3272
LGBT5424CG	24 x 54 x 42	150	169	29	\$3272
LGBT5024CG	24 x 50 x 42	150	151	27	\$2902
LGBT4824CG	24 x 48 x 42	150	142	26	\$2902
LGBT4424CG	24 x 44 x 42	150	134	23	\$2549
LGBT4224CG	24 x 42 x 42	150	127	22	\$2549
LGBT3824CG	24 x 38 x 42	150	119	20	\$2291
LGBT3624CG	24 x 36 x 42	150	112	19	\$2291

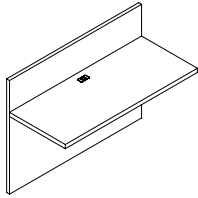

Bridge

Attaches between **Gallery Desk and Gallery Credenza Only**. One grommet in center of worksurface. Shipped RTA (ready to assemble).

- To remove cross-grain veneer pattern on top, **delete "CG"** from model number. Available as a special - no upcharge.

LGRL7224	24 x 72 x 42	125	273	42	\$4900
LGRL6624	24 x 66 x 42	125	250	39	\$4501
LGRL6024	24 x 60 x 42	125	228	35	\$4096
LGRL5424	24 x 54 x 42	125	205	32	\$3681
LGRL4824	24 x 48 x 42	125	182	28	\$3272
LGRL4224	24 x 42 x 42	125	159	25	\$2866
LGRL3624	24 x 36 x 42	125	137	21	\$2571

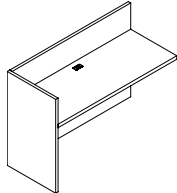

Reception Return - LEFT

No pedestal. One grommet in center of worksurface. For use with modular storage components.

LGRR7224	24 x 72 x 42	125	273	42	\$4900
LGRR6624	24 x 66 x 42	125	250	39	\$4501
LGRR6024	24 x 60 x 42	125	228	35	\$4096
LGRR5424	24 x 54 x 42	125	205	32	\$3681
LGRR4824	24 x 48 x 42	125	182	28	\$3272
LGRR4224	24 x 42 x 42	125	159	25	\$2866
LGRR3624	24 x 36 x 42	125	137	21	\$2571

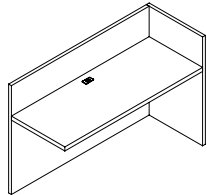

Reception Return - RIGHT

No pedestal. One grommet in center of worksurface. For use with modular storage components.

LGTT10810	10 x 108 x 1.50	100	78	8	\$1385
LGTT10210	10 x 102 x 1.50	92.5	72	7	\$1312
LGTT9610	10 x 96 x 1.50	100	66	7	\$1235
LGTT9010	10 x 90 x 1.50	92.5	60	6	\$1158
LGTT8410	10 x 84 x 1.50	100	54	6	\$1083
LGTT7210	10 x 72 x 1.50	100	48	5	\$918
LGTT6610	10 x 66 x 1.50	100	42	5	\$843
LGTT6010	10 x 60 x 1.50	100	36	4	\$766

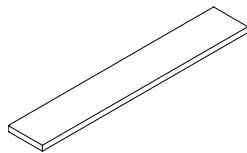

Transaction Counter Top

Rectangular top for main reception desk. Counter sits on top of Gallery panels. Does not overhang. **Factory installed - specify Gallery to be used on.** Size must match dimension of desk front or combined desk side and return length. Hardware included.

LGTTM1081013	10-13 x 108 x 1.50	125	78	10	\$2173
LGTTM1021013	10-13 x 102 x 1.50	100	72	9	\$2056
LGTTM961013	10-13 x 96 x 1.50	125	66	9	\$1932
LGTTM901013	10-13 x 90 x 1.50	125	60	8	\$1807
LGTTM841013	10-13 x 84 x 1.50	125	54	8	\$1689
LGTTM721013	10-13 x 72 x 1.50	125	48	7	\$1452
LGTTM661013	10-13 x 66 x 1.50	125	42	6	\$1329
LGTTM601013	10-13 x 60 x 1.50	125	36	5	\$1205

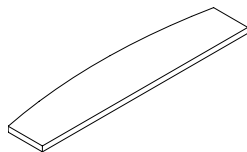

Bow Front Transaction Counter Top

Bow top for main reception desk. Counter sits on top of Gallery panels. Bow front overhangs 3". **Factory installed - specify Gallery to be used on.** Size must match dimension of desk front or combined desk side and return length. Hardware included.

Required Specifications

- Veneer Finish
- Edge

RECEPTION DESKS

MODEL# DIMENSIONS FREIGHT CLASS WT/LBS. CUBIC FT. LIST PRICE

D x W x H

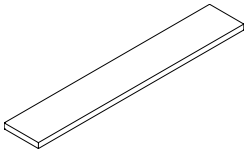

Transaction Counter Top - Glass

GTT10810G	10 x 108 x 1.50	100	78	8	\$3161
GTT10210G	10 x 102 x 1.50	92.5	72	7	\$3043
GTT9610G	10 x 96 x 1.50	100	66	7	\$2923
GTT9010G	10 x 90 x 1.50	92.5	60	6	\$2805
GTT8410G	10 x 84 x 1.50	100	54	6	\$2689
GTT7210G	10 x 72 x 1.50	100	48	5	\$2515
GTT6610G	10 x 66 x 1.50	100	42	5	\$2398
GTT6010G	10 x 60 x 1.50	100	36	4	\$2281

Rectangular top for main reception desk. Counter sits on top of Gallery panels. Does not overhang. **Factory installed - specify Gallery to be used on.** Size must match dimension of desk front or combined desk side and return length. Hardware included. 3/4" clear glass over wood subtop.

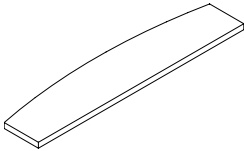

Bow Front Transaction Counter Top - Glass

GTTM1081013G	10-13 x 108 x 1.50	125	78	10	\$3900
GTTM1021013G	10-13 x 102 x 1.50	100	72	9	\$3826
GTTM961013G	10-13 x 96 x 1.50	125	66	9	\$3788
GTTM901013G	10-13 x 90 x 1.50	125	60	8	\$3622
GTTM841013G	10-13 x 84 x 1.50	125	54	8	\$3445
GTTM721013G	10-13 x 72 x 1.50	125	48	7	\$3166
GTTM661013G	10-13 x 66 x 1.50	125	42	6	\$2989
GTTM601013G	10-13 x 60 x 1.50	125	36	5	\$2822

Bow top for main reception desk. Counter sits on top of Gallery panels. Bow front overhangs 3". **Factory installed - specify Gallery to be used on.** Size must match dimension of desk front or combined desk side and return length. Hardware included. 3/4" clear glass over wood subtop.

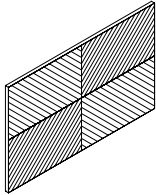

Decorative Front Panel Reverse Diamond Pattern

GFDP9630F	1 x 96 x 30	92.5	81	8	\$1787
GFDP9030F	1 x 90 x 30	100	78	8	\$1674
GFDP8430F	1 x 84 x 30	92.5	72	7	\$1561
GFDP7230F	1 x 72 x 30	100	66	7	\$1341
GFDP6030F	1 x 60 x 30	92.5	60	6	\$1121
GFDP5430F	1 x 54 x 30	100	54	6	\$1007
GFDP4830F	1 x 48 x 30	100	48	5	\$897

Raised decorative front panel for a reception desk. Size should be 12" less than desk dimensions. **Factory installed.** Hardware included.

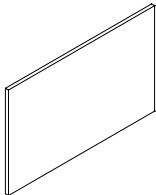

Decorative Front Panel Vertical Grain Pattern

GFDP9630V	1 x 96 x 30	92.5	81	8	\$1558
GFDP9030V	1 x 90 x 30	100	78	8	\$1461
GFDP8430V	1 x 84 x 30	92.5	72	7	\$1364
GFDP7230V	1 x 72 x 30	100	66	7	\$1165
GFDP6030V	1 x 60 x 30	92.5	60	6	\$971
GFDP5430V	1 x 54 x 30	100	54	6	\$879
GFDP4830V	1 x 48 x 30	100	48	5	\$777

Raised decorative front panel for a reception desk. Size should be 12" less than desk dimensions. **Factory installed.** Hardware included.

Required Specifications

- Metal Finish (Accessories)
- Veneer Finish
- Edge

RECEPTION DESKS - CURVED

MODEL# DIMENSIONS FREIGHT CLASS WT/LBS. CUBIC FT. LIST PRICE

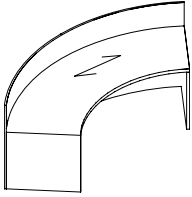

Gallery/Reception Curved Desk Shell**

D x W x H						
LGCCUS10630H36	30 x 106 x 36	100	647	72	\$13728	
LGCCUS10630H42	30 x 106 x 42	100	592	66	\$15788	

No pedestals. For use with modular storage components.

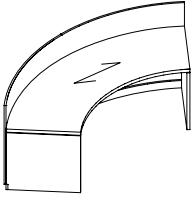

Gallery/Reception Curved Desk Shell**

LGCKCUS10630H36	30 x 106 x 36	100	647	72	\$14413	
LGCKCUS10630H42	30 x 106 x 42	100	592	66	\$16577	

Includes recessed kick plate. No pedestals. For use with modular storage components.

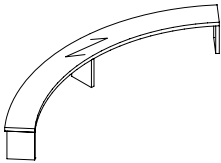

Wood Curved Transaction Counter*

LGTTMCUS10610	10 x 106 x 1.5	150	84	19	\$6228	
---------------	----------------	-----	----	----	--------	--

Curved wood transaction top.

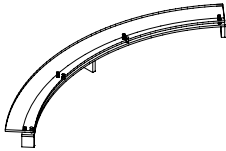

Glass Curved Transaction Counter

GCCCUS10610G	10 x 106 x 0.75	150	84	19	\$11423	
--------------	-----------------	-----	----	----	---------	--

3/4" clear glass bow front transaction counter over wood subtop.

Required Specifications

Veneer Finish*
Edge*

Optional Specifications

Grommet*

DESKS MODEL# DIMENSIONS FREIGHT CLASS WT./LBS. CUBIC FT. VENEER/LAMINATE ALL VENEER

D x W x H

Required Specifications

Veneer finish
Edge
Handle style

Optional Specifications

Grommet

philadelphia

