



Kingston is a modern expression of old world craftsmanship. The classic proportion, attentive detailing, exquisite hand-matched veneers and solid wood edge details convey refined elegance with timeless beauty. Designed to highlight the warmth and majestic nature of real wood, Kingston offers an impressive array of storage components, fixed and freestanding worksurfaces that can be arranged to meet virtually any functional requirement.

Kingston detailing is contemporary with a 1" overhang on all edges. Solid walnut, cherry, maple, oak that bands worksurface perimeter is 1" wide by 1-3/8" thick for an overall thickness of 1-3/8". Kingston is a "top over pedestal" detailed series with a 1/4" reveal between the top and end panel. Tops have a 1" overhang. Floor storage unit bases are integrated in drawer faces. Products that are normally positioned against walls, such as credenzas, have a self-edge veneered back edge detail.

Features and Benefits

- Choice of 15 handle options for every door/drawer that features handles.
- Choice of six edge options
- Wide selection of storage components, fixed and freestanding worksurfaces.
- Sleek design



Interior veneer drawer edge

Edge options



K16



K18



K21



K22



K29



K30

GENERAL INFORMATION

- Distinguished by an elegant overhang detailed edge, Kingston pairs sleek European styling with functional design features that address the needs of today's dynamic and tech-savvy executive office.
- Kingston offers six distinctive edge shapes, as well as a multitude of drawer pull options.
- For environmental certification, please visit globalfurnituregroup.com

CONSTRUCTION

- Number One select, architectural grade "A" oak, American black walnut, American black cherry or maple. Wood worksurface molded edges are solid oak, walnut, cherry, or maple.
- Contemporary detailing with 1" overhang on all edges.
- Solid walnut, cherry, maple, oak that bands worksurface perimeter is 1" wide by 1-3/8" thick for an overall thickness of 1-3/8".

FINISHES

- Conversion varnish (similar to catalyzed lacquer, but tougher), 25 degree sheen. Finishes are not buffed or rubbed.
- All Global wood casegood products are veneered and finished on the back sides (360° finishing), except modular under-surface storage - tops and backs are unfinished.
- Touch up kits available, includes a touch up marker and fill crayon. Order **VTOUCHUPKIT, \$164** list. Specify finish when ordering.
- Global standard finish, on oak and walnut, is open pore and on cherry and maple is semi-closed pore. If a full finish is required for walnut, cherry, anigre and maple tops, Add the suffix "2" to the finish code and Add 5% to the base pricing for each product. **CUSTOM FINISH IS AVAILABLE.**

PEDESTALS

- Full-to-the-floor. Pedestals are fully assembled units that are either installed into desk and credenza shells, or available as modular units. Undersurface storage units include locks.
- Pedestal drawer suspensions are metal ball bearing type. Both box and file drawers are full extension.
- Hanging file rails are pre-installed on file drawer perimeters and accommodate both legal and letter size filing. Legal filing can be achieved either as side-to-side or front-to-back. Letter filing can be achieved as front-to-back filing only.
- Drawers are standard vinyl-wrapped construction with black drawer sides and bottom.
- The drawer front is an applied element to a four sided drawer. Drawer fronts are veneered on all surfaces except the vertical edges, which are solid oak, walnut, cherry and maple then routed with series detailing. Drawer fronts can be removed or replaced in the field.
- Levelers have 1" range of adjustment.

LOCKS

- Locks are standard on all below worksurface level drawer and door storage units, with the exception of pull-out tray units and single lateral file drawer combination tray/slot units.
- Combination storage unit comes with lock for file and lateral file drawer only; box drawers cannot lock.
- Lock color will match the handle option.
- Locks are optional on all above worksurface level closed storage.
- For optional lock, specify **LO**. Add **\$134** per lock.

HANDLES

- If no handle is specified, there will be a routed finger pull in drawer fronts and touch latch mechanism for doors.
- See next page for options.

1. SPECIFY MODEL NUMBER

2. SPECIFY FINISH

WORKSURFACE TOP & DRAWER/DOOR FRONTS, BODY FINISHES (INCLUDING PEDESTALS) - VENEER

| Code | Finish | Veneer Type | Cut |
|------|--------------------|-------------|-------------|
| AMW | Almond Cherry | Cherry | Flat Sliced |
| ACW | Amber Cherry | Cherry | Flat Sliced |
| BTW | Biscotti | White Oak | Rift |
| CAW | Cocoa Walnut | Walnut | Flat Sliced |
| CRW | Coral | White Oak | Rift |
| DCW | Dark Cherry | Cherry | Flat Sliced |
| DWW | Dark Walnut | Walnut | Flat Sliced |
| EWV | Espresso Walnut | Walnut | Flat Sliced |
| EVW | Evening Oak | White Oak | Rift |
| GRW | Grey on Oak | White Oak | Rift |
| HAW | Hazelnut | Maple | Flat Sliced |
| JAW | Java | White Oak | Rift |
| LTW | Latte Walnut | Walnut | Flat Sliced |
| MHW | Mahogany on Walnut | Walnut | Flat Sliced |
| MTW | Milestone | White Oak | Rift |
| MPW | Natural Maple | Maple | Flat Sliced |
| NLW | Natural Walnut | Walnut | Flat Sliced |
| RCW | Red Cherry | Cherry | Flat Sliced |
| VNW | Vintage Cherry | Cherry | Flat Sliced |
| ULW | Umber Walnut | Walnut | Flat Sliced |
| WLW | Walnut | Walnut | Flat Sliced |
| WCW | Warm Cherry | Cherry | Flat Sliced |
| WMW | White Maple | Maple | Flat Sliced |

METAL FINISHES (see model # notes for available finish):

| | |
|-----|----------------|
| E | Black |
| K | Tungsten |
| DWT | Designer White |
| P | Brushed Chrome |

GLASS FINISHES (for Glass Doors and Modesty Panels):

- Frosted Glass (standard)
- White back painted glass - contact customer care

3. SPECIFY OPTIONS

EDGES

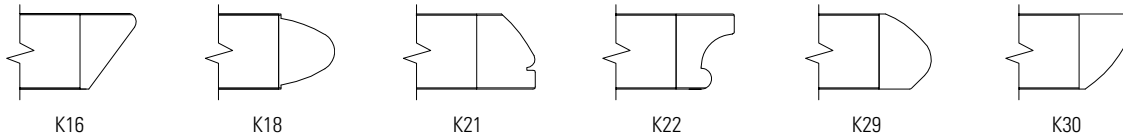

HANDLES

- If Handle is not specified Routed Pull, Black Lock & Grommet are standard
- If Handle is specified:
 - Black and Brass handle = Black Lock & Grommet
 - Silver, Nickel and Tungsten handle = Tungsten Lock & Grommet
- Handles are standard on most drawers/storage modules. Each handle is identified by letters: **PL33, PL34, PL64, PL66, PL92, PL93, PL94, PL95, PL96, PL97, PL98, PL99, PLS7, and PLS8**. To specify a handle, specify the code after the model number and finish selections.



PL33 Black Moon Pull, 4"



PL34 Nickel Moon Pull, 4"



PL64 Contemporary Nickel 5-3/8"



PL66 Transitional Nickel, 6-3/4"



PL92 Silver Bar, 5-3/8"



PL93 Black Bar, 5-3/8"



PL94 Silver Rectangular, 5-3/8"



PL95 Black Rectangular, 5-3/8"



PL96 Silver Slimline Pull, 5-3/8"



PL97 Black Slimline Pull, 5-3/8"



PL98 Silver Princeton Bar, 5-3/8"



PL99 Black Princeton Bar, 5-3/8"



PLS7 Black Spaghetti, 7-3/8"



PLS8 Silver Spaghetti, 7-3/8"

GROMMETS

- Standard grommet on all components is **GM5**. Grommet is included with products where shown in line drawings in price book.
- Optional grommets may be ordered in standard worksurface locations (left, center or right). Order as **GM5TL, GM5TC or GM5TR**. **Add \$96.**
- Grommet hole dimensions are 3.5" x 2". Specify **GM5E** for Black or **GM5K** for Tungsten.
- To order a grommet cover only, **Add \$57.**
- Color of grommet will be automatically coordinated with handle color where applicable
- Components that come standard with grommet may be ordered without a grommet. Order as RSG - **Add \$53.**

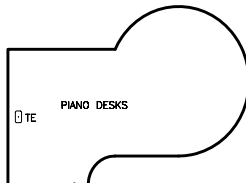
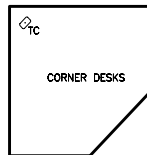
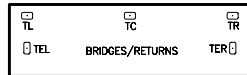
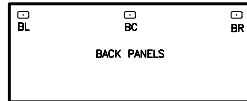
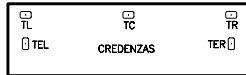
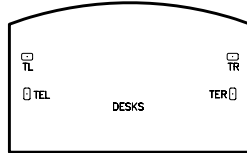
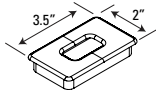

K KINGSTON - EDGE DETAILS

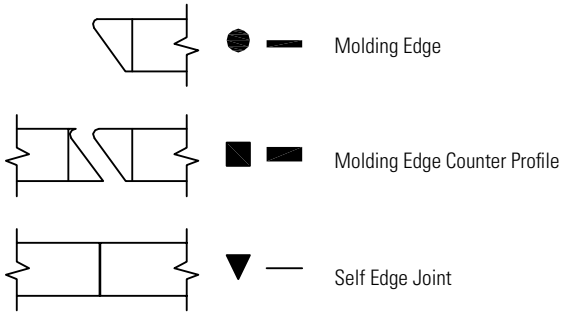

- D** - Desks and Credenzas
- B** - Executive Bridges
- E** - Executive Returns
- C** - Corner Components
- L** - Linking Bridges
- P** - Piano Desks

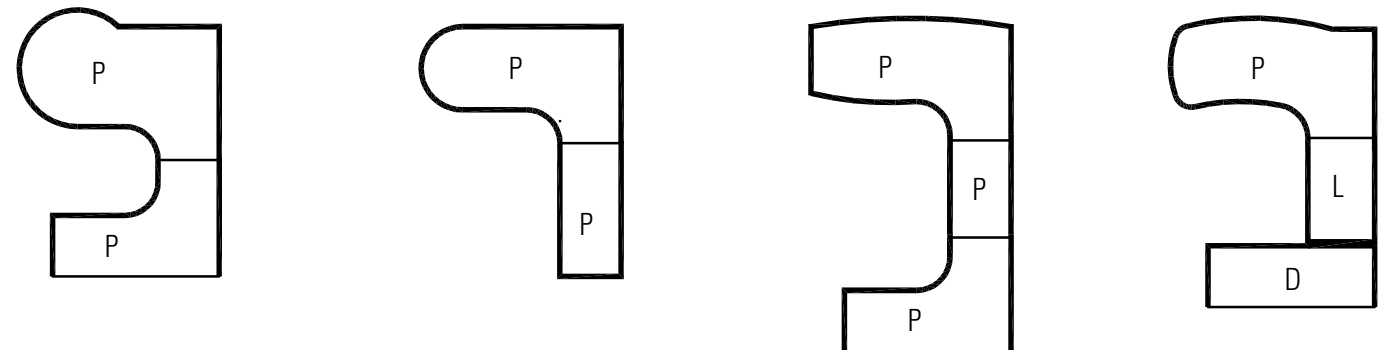
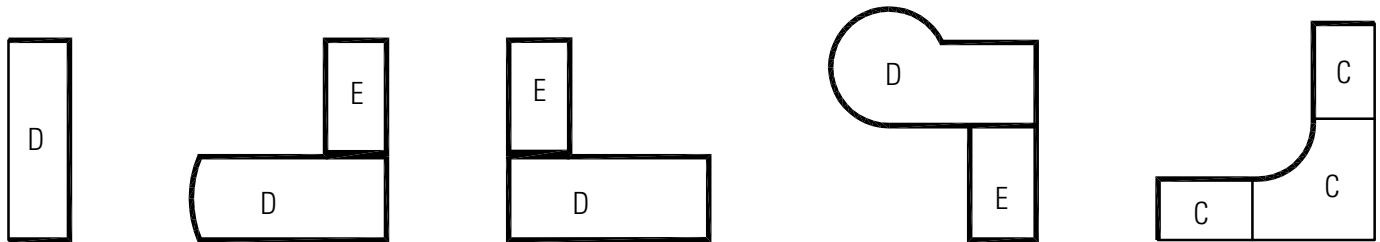
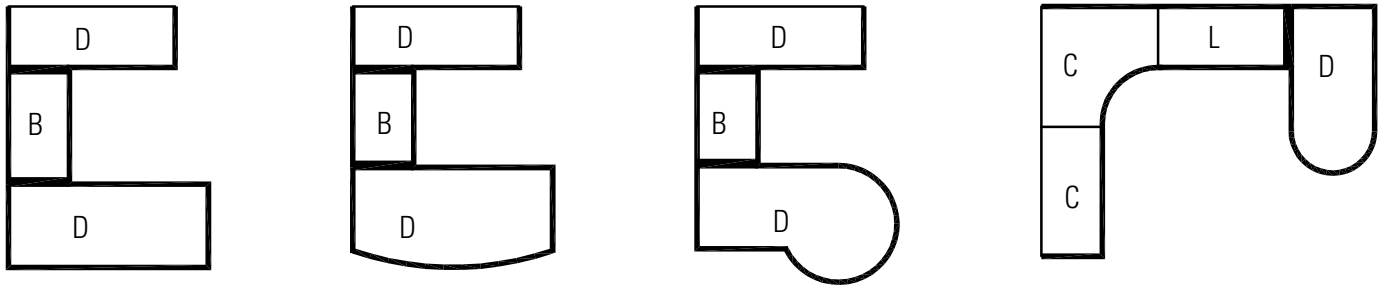
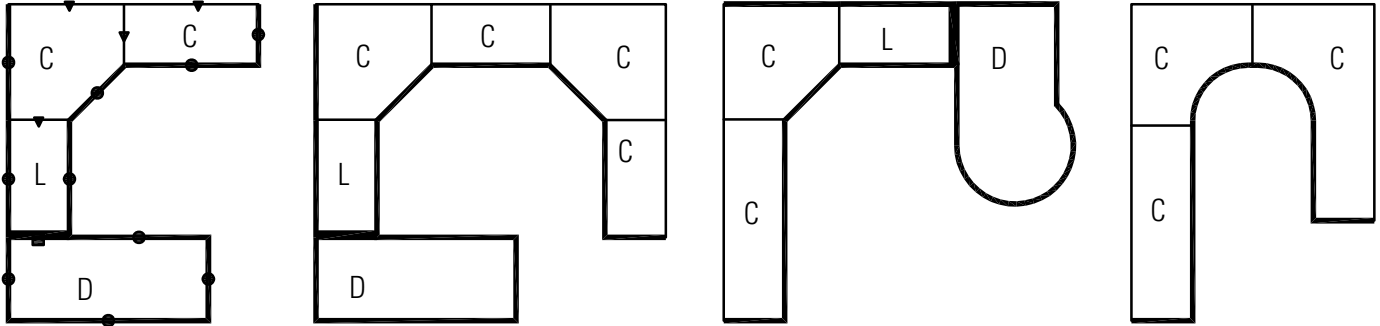

DESK AND CREDENZA NOTES

- Can be ordered as a shell or with pedestals
- Hand of Rectangular Desk is determined by location of pedestal from user side
- Hand of "D" Top is determined by outward orientation of curved end from user projection.
- Hand of "P" Top is determined by outward orientation of conference end from user projection.

Isometric View

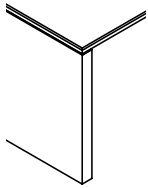

Side View
1-3/8" Top

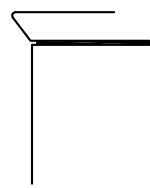

Front View
1-3/16" Slab

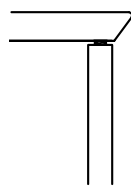

KT6030

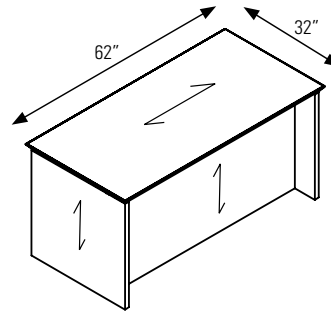

MODESTY PANEL CLEARANCE

KT7236

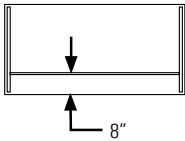

KMT7242

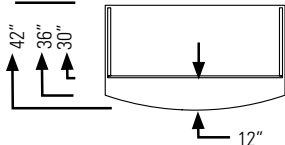

KiSR7230D

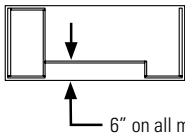

KDDCL7236

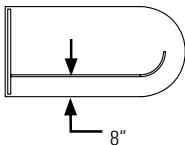

KT7236



Full Back Panel

KT7230

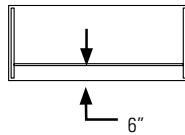

KMT7236

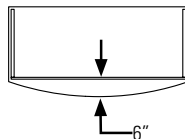

KDDF7230

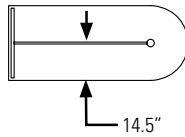

KDDCL7230

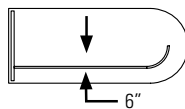

KTPL7242

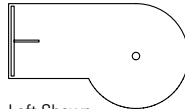

Left Shown

Field "punch out" to accommodate center drawer and keyboard

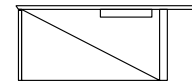

MODESTY PANEL OPTIONS

Standard Full Modesty

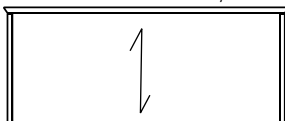

Glass Modesty

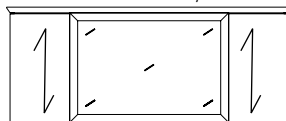

Breakfront

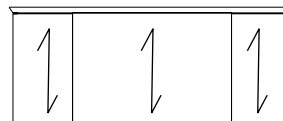

PIANO DESKS AND LINKING RETURNS

- All Desks are shipped assembled.
- Units include standard Grommets shown and installed horizontal wire management
- Unit is handed by Post Leg
- Not for use with regular Corner Units
- The standard grain direction is cross grain (**CG**). To remove cross grain veneer pattern on top, delete suffix "**CG**" from the model number (no upcharge)

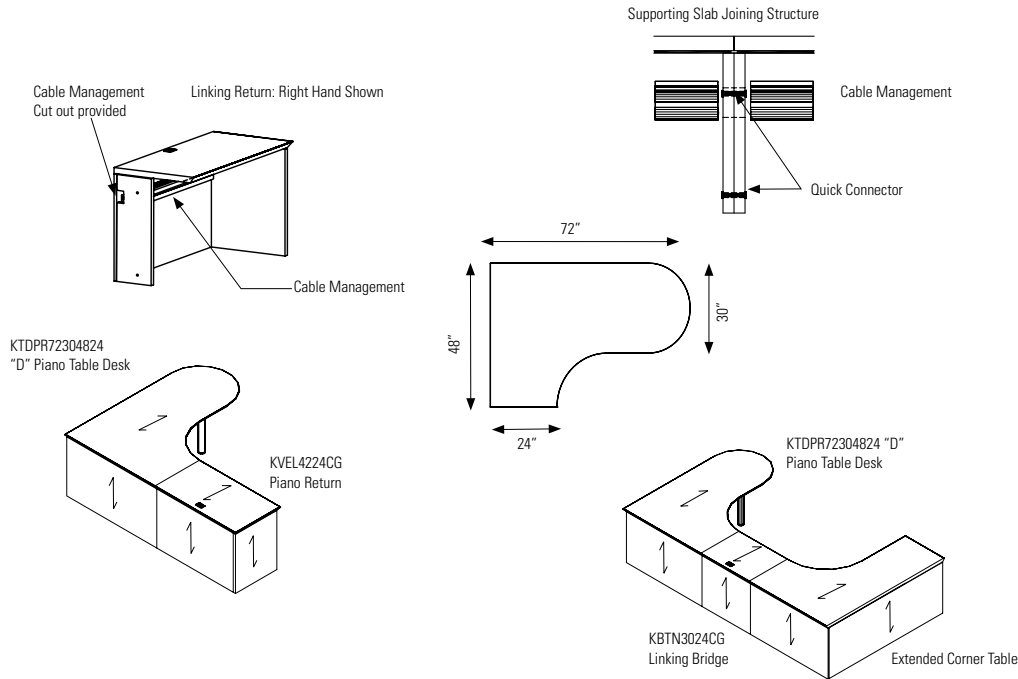

EXECUTIVE BRIDGES

- Executive Bridge is used to connect a Desk to a Credenza.
- Not to be used with Corner Components or Piano Desks.
- Three Back Panel options
- Back panel flush with end panels of Desk and Credenza
- Includes GM5 Grommet Top Center
- The standard grain direction is cross grain (**CG**). To remove cross grain veneer pattern on top, delete suffix "**CG**" from the model number (no upcharge)

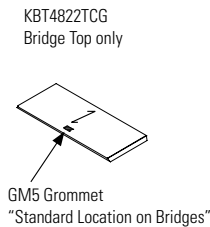
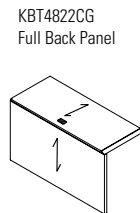
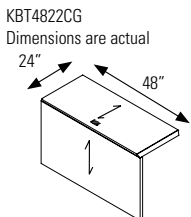
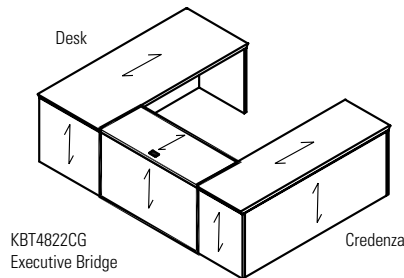

EXECUTIVE RETURNS

- Executive Return is used to attach to a Single Pedestal Desk, Single Pedestal Credenza, Desk Shell or Credenza Shell.
- Can be specified as a Shell or with a Pedestal.
- Back Panels are available as either full height or 8" from the underside of the worksurface.
- Hand of Executive Return is determined by location of full end panel from user side.
- Hand of Desk or Credenza is determined by location of pedestal from user side.
- The standard grain direction on return tops is cross grain (**CG**). To remove cross grain veneer pattern on top, delete suffix "**CG**" from the model number (no upcharge)

Executive Return attached to Desk or Credenza

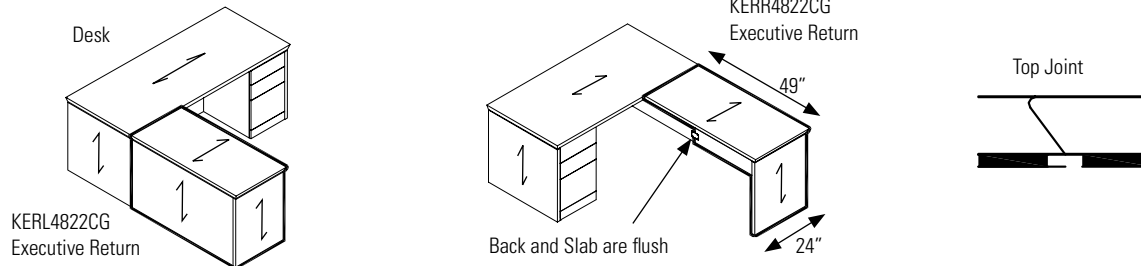

CORNER COMPONENTS

- Corner Table is used to connect to Linking Bridge and Linking Credenza.
- Cable management tray included.
- Back Panels are available as either full height or 8" from the underside of the worksurface.
- Hand of Linking Credenza is determined by location of full end panel from user side.
- Hand of Extended Corner is determined by location of long narrow end from user side
- The standard grain direction is cross grain (**CG**). To remove cross grain veneer pattern on top, delete suffix "**CG**" from the model number (no upcharge)

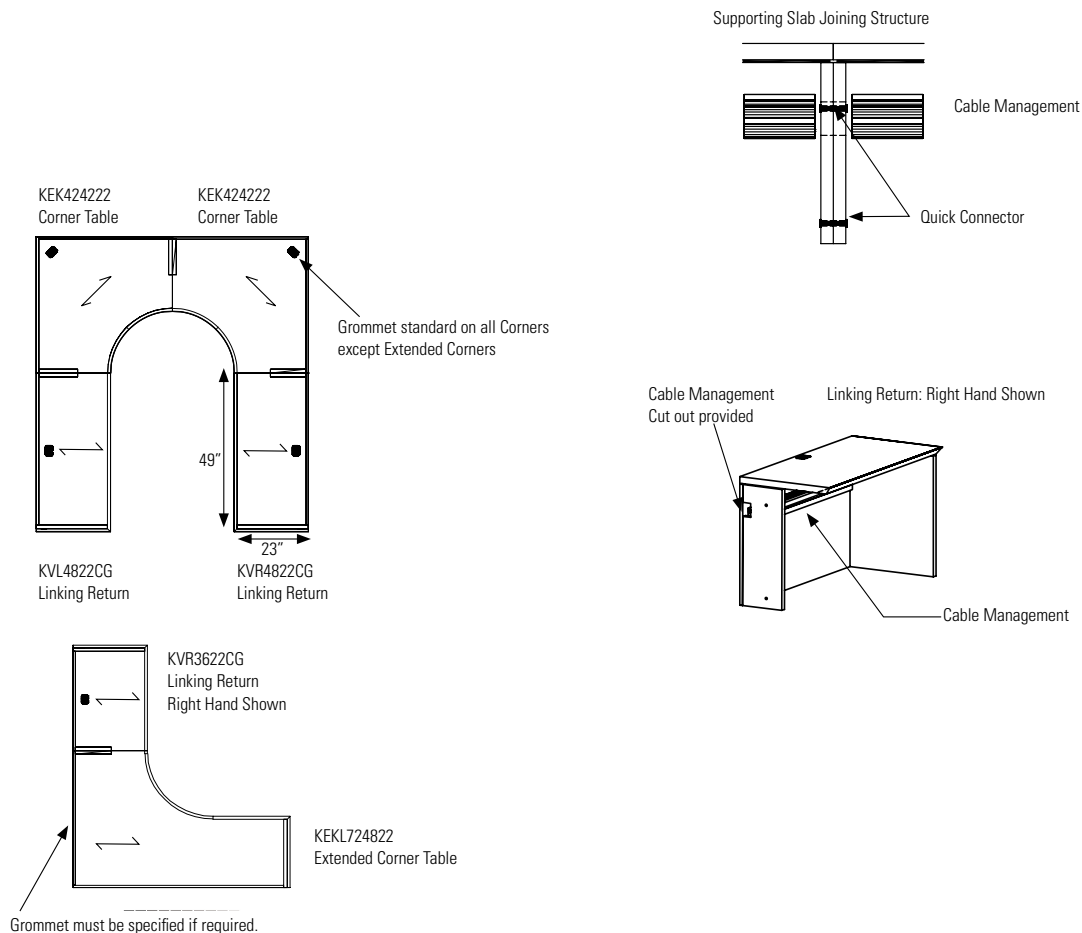

LINKING BRIDGES

- Linking Bridge is used to connect Corner Components to Single Pedestal Desk, Single Pedestal Credenza, Desk Shell or Credenza Shell.
- Back panels are available as either full height or 8" from the underside of the worksurface.
- Includes GM5 Grommet Top Center
- Hand of Linking Bridge is determined by location of half end panel from user side
- The standard grain direction is cross grain (**CG**). To remove cross grain veneer pattern on top, delete suffix "**CG**" from the model number (no upcharge)

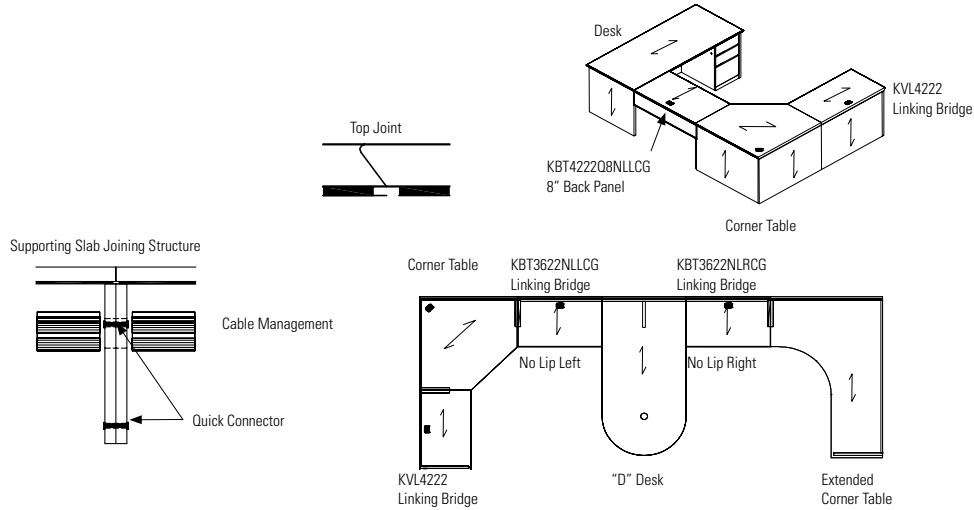

MODULAR PEDESTALS AND HANDLES

- Modular Pedestal for Kingston.
- Credenza Shells can only be completely filled with modular components that end in ".5" to create a full storage credenza.

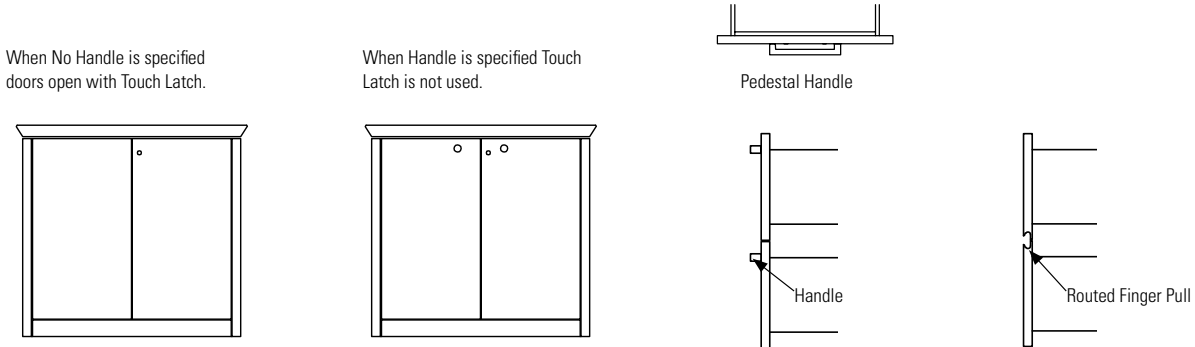

COPING AND SELF-EDGE OPTIONS

- Coping option provides an undercut on hutches only so that storage cabinets placed next to the hutch fit flush.
 - Specify **COP** for coping on both sides, **COPR** for coping on the right side and **COPL** for coping on the left side. No upcharge.
- Self edge options provide a flush fit when storage units are placed next to one another.
 - Specify **SE** for self-edge on both sides, **SER** for self-edge on the right side and **SEL** for self-edge on the left side. No upcharge.
 - Coping and self-edge handedness are from the users perspective. See diagram below.

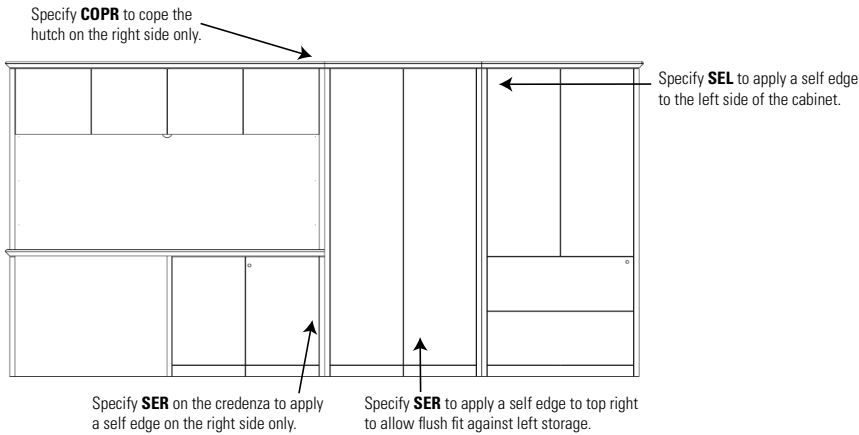

LOCKING

- Locks are standard on all below worksurface level drawer and door storage units with the exception of the pull-out tray units and single lateral file drawer combination tray/slot units.
- Locks are optional on all above worksurface level closed storage units. See Accessories Section (page 264) for lock specification details.

Standard Lock Positions

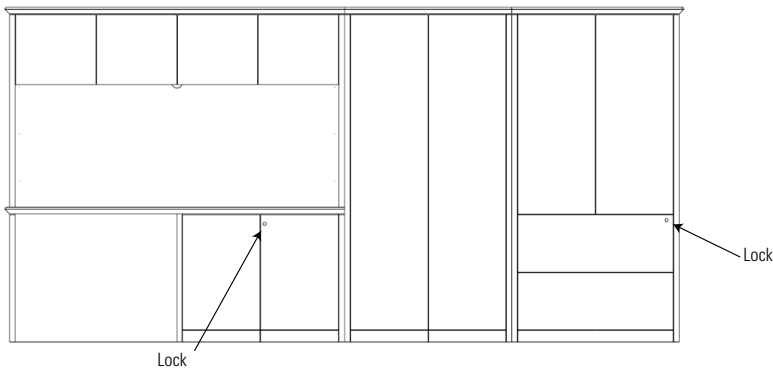

KZR
Combination Storage Unit:
Lock for File and Lateral File Drawer only,
Box Drawers do not lock.

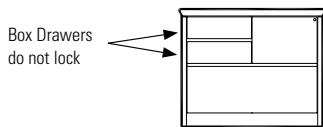

KD7236DE
Double Pedestal Desk/Credenza:
Lock for D and E Pedestals are on the inside Gable.

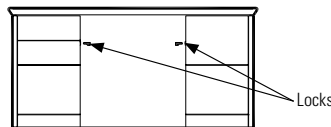

KCF7222
Full Storage Credenza: Locks are on the front.

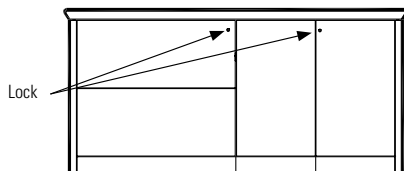

KWD
Modular Furniture:
Lock is on the front.

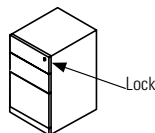

KWF
Modular Furniture:
Lock is on the front.

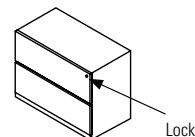

HUTCH POSITIONING

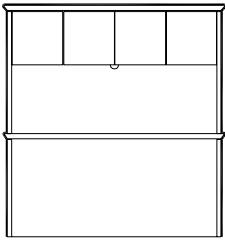

There must be an end panel under the hutch

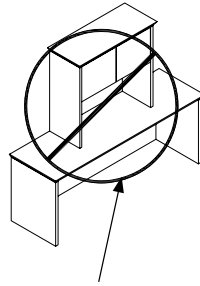
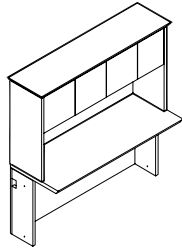

Missing Support
NOT Recommended

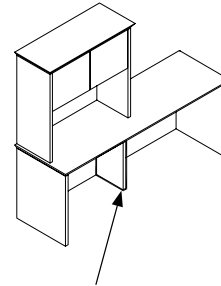

Add optional Support
SLAB12 (as Special)

TACKBOARDS

Tackboards for Storage Hutches

K72SH36

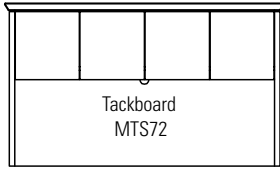

K72SHP42 and K72SHP42

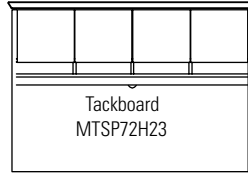

K72SH42 and K722SH54

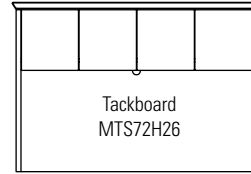

Tackboards with Accessory Rail

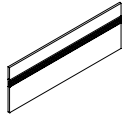

KTSAS72

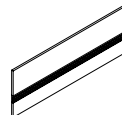

KTSPAS72H23

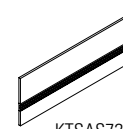

KTSAS72H26

Tackboards for Wall Mount Overheads



CSF36

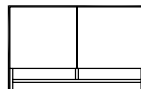

CSFP36

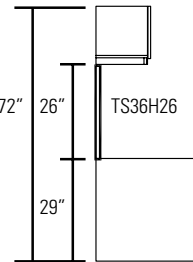
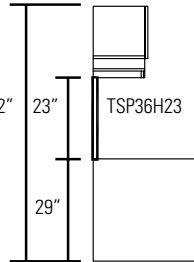
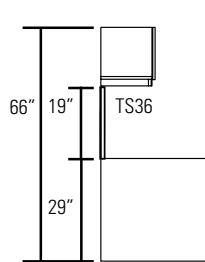

LIGHTING

For hutches and wall mount overheads

Wall Mount

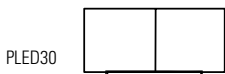

PLED30

30" and 36" units

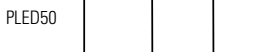

PLED50

42" and 48" units



PLED100

60" and longer units

Hutch

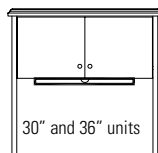

PLED30 on 30" and 36" units

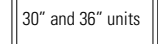

PLED50 on 42" units

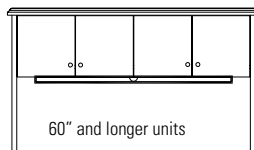

PLED50 on 48" units

PLED100 on 60" and longer unit

DESKS - NOTES

D x W x H

NOTE: Arrow indicates direction of grain

- All desks are shipped assembled
- Kneewell locking standard
- Desks available with a variety of modesty options: flush, breakfront, recessed and glass
- If Handle is not specified Routed Pull, Black Lock & Grommet are standard
- If Handle is specified:
 - Black and Brass handle = Black Lock & Grommet
 - Silver, Nickel and Tungsten handle = Tungsten Lock & Grommet
- Grommets are available as an option on Desks and most Credenzas.
- Edge options - must specify:

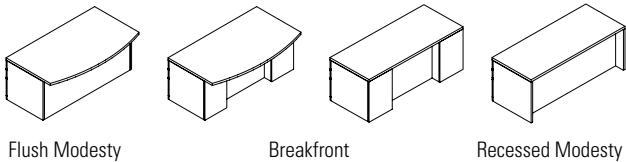
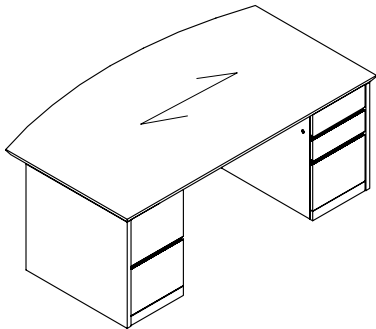
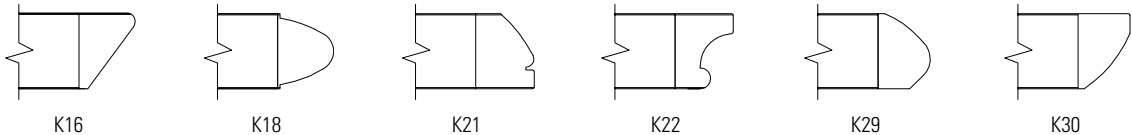

DOUBLE PEDESTAL DESKS

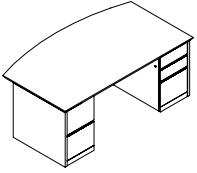

Double Pedestal Bow Top Desk

| MODEL# | DIMENSIONS D x W x H | FREIGHT CLASS | WT/LBS. | CUBIC FT. | LIST PRICE |
|-----------|-------------------------|---------------|---------|-----------|----------------|
| KMD8442ED | 44 x 86 x 29 | 125 | 407 | 59 | \$10120 |
| KMD7842ED | 44 x 80 x 29 | 125 | 392 | 55 | \$9398 |
| KMD7242ED | 44 x 74 x 29 | 125 | 377 | 51 | \$8672 |
| KMD6636ED | 38 x 68 x 29 | 100 | 340 | 40 | \$8412 |

Standard with full to floor **file/file** pedestal on **left** and **box/box/file** pedestal on **right**. Pedestals lock.
Full Height Modesty Panel.

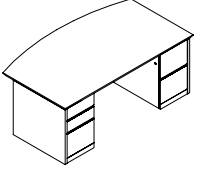

Double Pedestal Bow Top Desk

| | | | | | |
|-----------|--------------|-----|-----|----|----------------|
| KMD8442DE | 44 x 86 x 29 | 125 | 407 | 59 | \$10120 |
| KMD7842DE | 44 x 80 x 29 | 125 | 392 | 55 | \$9398 |
| KMD7242DE | 44 x 74 x 29 | 125 | 377 | 51 | \$8672 |
| KMD6636DE | 38 x 68 x 29 | 100 | 340 | 40 | \$8412 |

Standard with full to floor **file/file** pedestal on **right** and **box/box/file** pedestal on **left**. Pedestals lock.
Full Height Modesty Panel.

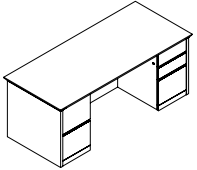

Double Pedestal Desk

| | | | | | |
|----------|--------------|------|-----|----|---------------|
| KD8442ED | 44 x 86 x 29 | 125 | 442 | 59 | \$8604 |
| KD7842ED | 44 x 80 x 29 | 125 | 421 | 55 | \$7992 |
| KD7236ED | 38 x 74 x 29 | 100 | 375 | 44 | \$7378 |
| KD7230ED | 32 x 74 x 29 | 100 | 345 | 36 | \$7266 |
| KD6636ED | 38 x 68 x 29 | 100 | 360 | 40 | \$7266 |
| KD6630ED | 32 x 68 x 29 | 92.5 | 330 | 33 | \$7149 |
| KD6030ED | 32 x 62 x 29 | 92.5 | 315 | 30 | \$6925 |

Standard with full to floor **file/file** pedestal on **left** and **box/box/file** pedestal on **right**. Pedestals lock.
Full height modesty panel.

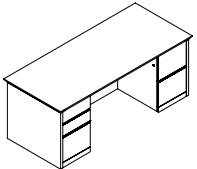

Double Pedestal Desk

| | | | | | |
|----------|--------------|------|-----|----|---------------|
| KD8442DE | 44 x 86 x 29 | 125 | 442 | 59 | \$8604 |
| KD7842DE | 44 x 80 x 29 | 125 | 421 | 55 | \$7992 |
| KD7236DE | 38 x 74 x 29 | 100 | 375 | 44 | \$7378 |
| KD7230DE | 32 x 74 x 29 | 100 | 345 | 36 | \$7266 |
| KD6636DE | 38 x 68 x 29 | 100 | 360 | 40 | \$7266 |
| KD6630DE | 32 x 68 x 29 | 92.5 | 330 | 33 | \$7149 |
| KD6030DE | 32 x 62 x 29 | 92.5 | 315 | 30 | \$6925 |

Standard with full to floor **file/file** pedestal on **right** and **box/box/file** pedestal on **left**. Pedestals lock.
Full height modesty panel.

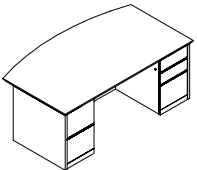

**Double Pedestal Bow Top Desk*
Breakfront Style**

| | | | | | |
|------------|--------------|-----|-----|----|----------------|
| KMID8442ED | 44 x 86 x 29 | 125 | 407 | 59 | \$11129 |
| KMID7842ED | 44 x 80 x 29 | 125 | 392 | 55 | \$10336 |
| KMID7242ED | 44 x 74 x 29 | 125 | 377 | 51 | \$9544 |
| KMID6636ED | 38 x 68 x 29 | 100 | 345 | 40 | \$9250 |

Standard with full to floor **file/file** pedestal on **left** and **box/box/file** pedestal on **right**. Pedestals lock.
Inset Full Height Modesty Panel.

- For Aluminum Framed Glass Modesty option on Breakfront Style add "G" to the end of the product code. Add **\$1776**.

Required Specifications

Finish
Edge

Optional Specifications

Handles
Additional grommet
Glass modesty panel*

DESKS

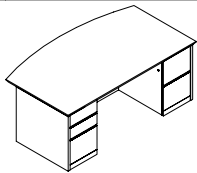

**Double Pedestal Bow Top Desk*
Breakfront Style**

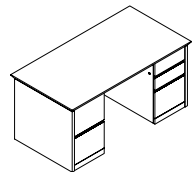

**Double Pedestal Desk*
Breakfront Style**

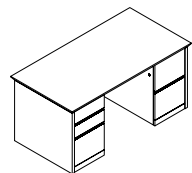

**Double Pedestal Desk*
Breakfront Style**

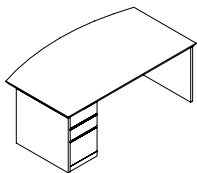

Single Pedestal Bow Top Desk - Left

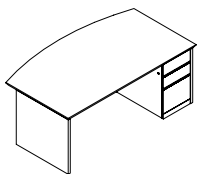

Single Pedestal Bow Top Desk - Right

MODEL# DIMENSIONS FREIGHT CLASS WT/LBS. CUBIC FT. LIST PRICE

D x W x H

| | | | | | |
|------------|--------------|-----|-----|----|----------------|
| KMID8442DE | 44 x 86 x 29 | 125 | 407 | 59 | \$11129 |
| KMID7842DE | 44 x 80 x 29 | 125 | 392 | 55 | \$10336 |
| KMID7242DE | 44 x 74 x 29 | 125 | 377 | 51 | \$9544 |
| KMID6636DE | 38 x 68 x 29 | 100 | 345 | 40 | \$9250 |

Standard with full to floor **box/box/file** pedestal on **left** and **file/file** pedestal on **right**. Pedestals lock.
Inset Full Height Modesty Panel.

- For Aluminum Framed Glass Modesty option on Breakfront Style add "G" to the end of the product code. Add **\$1776**.

| | | | | | |
|-----------|--------------|------|-----|----|---------------|
| KID8442ED | 44 x 86 x 29 | 125 | 442 | 59 | \$9469 |
| KID7842ED | 44 x 80 x 29 | 125 | 421 | 55 | \$8789 |
| KID7236ED | 38 x 74 x 29 | 100 | 375 | 44 | \$8115 |
| KID7230ED | 32 x 74 x 29 | 100 | 345 | 36 | \$7992 |
| KID6636ED | 38 x 68 x 29 | 100 | 360 | 40 | \$7992 |
| KID6630ED | 32 x 68 x 29 | 92.5 | 330 | 33 | \$7868 |
| KID6030ED | 32 x 62 x 29 | 92.5 | 315 | 30 | \$7615 |

Standard with full to floor **file/file** pedestal on **left** and **box/box/file** pedestal on **right**. Pedestals lock.
Inset Full Height Modesty Panel.

- For Aluminum Framed Glass Modesty option on Breakfront Style add "G" to the end of the product code. Add **\$1776**.

| | | | | | |
|-----------|--------------|------|-----|----|---------------|
| KID8442DE | 44 x 86 x 29 | 125 | 442 | 59 | \$9469 |
| KID7842DE | 44 x 80 x 29 | 125 | 421 | 55 | \$8789 |
| KID7236DE | 38 x 74 x 29 | 100 | 375 | 44 | \$8115 |
| KID7230DE | 32 x 74 x 29 | 100 | 345 | 36 | \$7992 |
| KID6636DE | 38 x 68 x 29 | 100 | 360 | 40 | \$7992 |
| KID6630DE | 32 x 68 x 29 | 92.5 | 330 | 33 | \$7868 |
| KID6030DE | 32 x 62 x 29 | 92.5 | 315 | 30 | \$7615 |

Standard with full to floor **box/box/file** pedestal on **left** and **file/file** pedestal on **right**. Pedestals lock.
Inset Full Height Modesty Panel.

- For Aluminum Framed Glass Modesty option on Breakfront Style add "G" to the end of the product code. Add **\$1776**.

| | | | | | |
|-----------|--------------|-----|-----|----|---------------|
| KMSL8442D | 44 x 86 x 29 | 150 | 352 | 59 | \$8019 |
| KMSL7842D | 44 x 80 x 29 | 125 | 337 | 55 | \$7447 |
| KMSL7242D | 44 x 74 x 29 | 125 | 322 | 51 | \$6874 |
| KMSL6636D | 38 x 68 x 29 | 125 | 290 | 40 | \$6611 |

Standard with full to floor **box/box/file** pedestal on **left**. Pedestal locks.
Full height modesty panel.

| | | | | | |
|-----------|--------------|-----|-----|----|---------------|
| KMSR8442D | 44 x 86 x 29 | 150 | 352 | 59 | \$8019 |
| KMSR7842D | 44 x 80 x 29 | 125 | 337 | 55 | \$7447 |
| KMSR7242D | 44 x 74 x 29 | 125 | 322 | 51 | \$6874 |
| KMSR6636D | 38 x 68 x 29 | 125 | 290 | 40 | \$6611 |

Standard with full to floor **box/box/file** pedestal on **right**. Pedestal locks.
Full height modesty panel.

Required Specifications

Finish
Edge

Optional Specifications

Handles
Additional grommet
Glass modesty panel*

DESKS

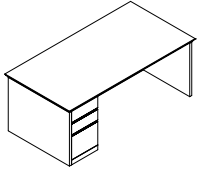

Single Pedestal Desk

| MODEL# | DIMENSIONS D x W x H | FREIGHT CLASS | WT./LBS. | CUBIC FT. | LIST PRICE |
|----------|-------------------------|---------------|----------|-----------|---------------|
| KSL8442D | 44 x 86 x 29 | 125 | 387 | 59 | \$7540 |
| KSL7842D | 44 x 80 x 29 | 125 | 366 | 55 | \$7103 |
| KSL7236D | 38 x 74 x 29 | 125 | 320 | 44 | \$5627 |
| KSL7230D | 32 x 74 x 29 | 100 | 290 | 36 | \$5374 |
| KSL6636D | 38 x 68 x 29 | 125 | 305 | 40 | \$5374 |
| KSL6630D | 32 x 68 x 29 | 100 | 275 | 33 | \$5129 |
| KSL6030D | 32 x 62 x 29 | 100 | 260 | 30 | \$4903 |

Standard with full to floor **box/box/file** pedestal on **left**. Pedestals lock.
Full Height Modesty Panel.

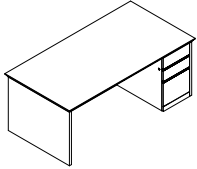

Single Pedestal Desk

| | | | | | |
|----------|--------------|-----|-----|----|---------------|
| KSR8442D | 44 x 86 x 29 | 125 | 387 | 59 | \$7540 |
| KSR7842D | 44 x 80 x 29 | 125 | 366 | 55 | \$7103 |
| KSR7236D | 38 x 74 x 29 | 125 | 320 | 44 | \$5627 |
| KSR7230D | 32 x 74 x 29 | 100 | 290 | 36 | \$5374 |
| KSR6636D | 38 x 68 x 29 | 125 | 305 | 40 | \$5374 |
| KSR6630D | 32 x 68 x 29 | 100 | 275 | 33 | \$5129 |
| KSR6030D | 32 x 62 x 29 | 100 | 260 | 30 | \$4903 |

Standard with full to floor **box/box/file** pedestal on **right**. Pedestals lock.
Full Height Modesty Panel.

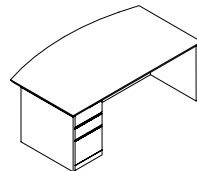

**Single Pedestal Desk - Left*
Breakfront Style**

| | | | | | |
|------------|--------------|-----|-----|----|---------------|
| KMISL8442D | 44 x 86 x 29 | 125 | 452 | 59 | \$8819 |
| KMISL7842D | 44 x 80 x 29 | 125 | 337 | 55 | \$8190 |
| KMISL7242D | 44 x 74 x 29 | 125 | 322 | 51 | \$7563 |
| KMISL6636D | 38 x 68 x 29 | 125 | 290 | 40 | \$7273 |

Standard with full to floor **box/box/file** pedestal on **left**. Pedestals lock.
Inset Full Height Modesty Panel.

- For Aluminum Framed Glass Modesty option on Breakfront Style add "**G**" to the end of the product code. Add **\$1776**.

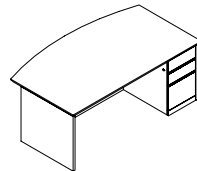

**Single Pedestal Desk - Right*
Breakfront Style**

| | | | | | |
|------------|--------------|-----|-----|----|---------------|
| KMISR8442D | 44 x 86 x 29 | 125 | 452 | 59 | \$8819 |
| KMISR7842D | 44 x 80 x 29 | 125 | 337 | 55 | \$8190 |
| KMISR7242D | 44 x 74 x 29 | 125 | 322 | 51 | \$7563 |
| KMISR6636D | 38 x 68 x 29 | 125 | 290 | 40 | \$7273 |

Standard with full to floor **box/box/file** pedestal on **right**. Pedestals lock.
Inset Full Height Modesty Panel.

- For Aluminum Framed Glass Modesty option on Breakfront Style add "**G**" to the end of the product code. Add **\$1776**.

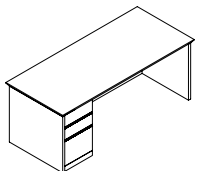

**Single Pedestal Desk - Left*
Breakfront Style**

| | | | | | |
|-----------|--------------|-----|-----|----|---------------|
| KISL8442D | 44 x 86 x 29 | 125 | 387 | 59 | \$8421 |
| KISL7842D | 44 x 80 x 29 | 125 | 366 | 55 | \$7820 |
| KISL7236D | 38 x 74 x 29 | 125 | 320 | 44 | \$6187 |
| KISL7230D | 32 x 74 x 29 | 100 | 290 | 36 | \$5911 |
| KISL6636D | 38 x 68 x 29 | 125 | 305 | 40 | \$5911 |
| KISL6630D | 32 x 68 x 29 | 100 | 275 | 33 | \$5642 |
| KISL6030D | 32 x 62 x 29 | 100 | 260 | 30 | \$5392 |

Standard with full to floor **box/box/file** pedestal on **left**. Pedestals lock.
Inset Full Height Modesty Panel.

- For Aluminum Framed Glass Modesty option on Breakfront Style add "**G**" to the end of the product code. Add **\$1776**.

Required Specifications

Finish
Edge

Optional Specifications

Handles
Additional grommet
Glass modesty panel*

DESKS

MODEL# DIMENSIONS FREIGHT CLASS WT/LBS. CUBIC FT. LIST PRICE

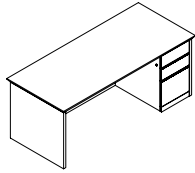

**Single Pedestal Desk - Right*
Breakfront Style**

| D x W x H | | | | | |
|-----------|--------------|-----|-----|----|---------------|
| KISR8442D | 44 x 86 x 29 | 125 | 387 | 59 | \$8421 |
| KISR7842D | 44 x 80 x 29 | 125 | 366 | 55 | \$7820 |
| KISR7236D | 38 x 74 x 29 | 125 | 320 | 44 | \$6187 |
| KISR7230D | 32 x 74 x 29 | 100 | 290 | 36 | \$5911 |
| KISR6636D | 38 x 68 x 29 | 125 | 305 | 40 | \$5911 |
| KISR6630D | 32 x 68 x 29 | 100 | 275 | 33 | \$5642 |
| KISR6030D | 32 x 62 x 29 | 100 | 260 | 30 | \$5392 |

Standard with full to floor **box/box/file** pedestal on **right**. Pedestals lock.
Inset Full Height Modesty Panel.

- For Aluminum Framed Glass Modesty option on Breakfront Style add "G" to the end of the product code. Add **\$1776**.

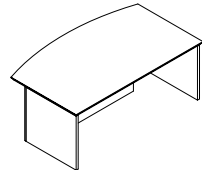

**Desk Shell, Bow Top
Breakfront Style**

| | | | | | |
|----------|--------------|-----|-----|----|---------------|
| KMIT8442 | 44 x 86 x 29 | 125 | 380 | 59 | \$6804 |
| KMIT7842 | 44 x 80 x 29 | 125 | 353 | 55 | \$6361 |
| KMIT7242 | 44 x 74 x 29 | 125 | 331 | 51 | \$5923 |
| KMIT6636 | 38 x 68 x 29 | 125 | 287 | 40 | \$5619 |

Inset Full Height Modesty Panel.

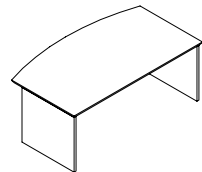

Desk Shell, Bow Top

| | | | | | |
|---------|--------------|-----|-----|----|---------------|
| KMT8442 | 44 x 86 x 29 | 150 | 297 | 59 | \$6164 |
| KMT7842 | 44 x 80 x 29 | 150 | 282 | 55 | \$5720 |
| KMT7242 | 44 x 74 x 29 | 150 | 267 | 51 | \$5283 |
| KMT6636 | 38 x 68 x 29 | 150 | 235 | 40 | \$4980 |

Recessed Modesty Panel.

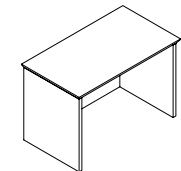

Desk Shell

| | | | | | |
|--------|--------------|-----|-----|----|---------------|
| KT8442 | 44 x 86 x 29 | 125 | 337 | 55 | \$5730 |
| KT7842 | 44 x 80 x 29 | 125 | 317 | 51 | \$5321 |
| KT8436 | 38 x 86 x 29 | 125 | 317 | 51 | \$4913 |
| KT7836 | 38 x 80 x 29 | 125 | 296 | 47 | \$4564 |
| KT7236 | 38 x 74 x 29 | 125 | 265 | 44 | \$4216 |
| KT7230 | 32 x 74 x 29 | 125 | 235 | 36 | \$3967 |
| KT6636 | 38 x 68 x 29 | 125 | 250 | 40 | \$3967 |
| KT6630 | 32 x 68 x 29 | 125 | 220 | 33 | \$3727 |
| KT6030 | 32 x 62 x 29 | 125 | 205 | 30 | \$3407 |

Recessed Modesty Panel.

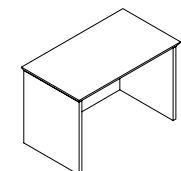

Desk Shell

| | | | | | |
|--------|--------------|-----|----|----|---------------|
| KT4822 | 24 x 50 x 29 | 150 | 95 | 17 | \$2440 |
| KT4222 | 24 x 44 x 29 | 150 | 85 | 15 | \$2044 |
| KT3622 | 24 x 38 x 29 | 150 | 75 | 13 | \$1972 |
| KT3022 | 24 x 32 x 29 | 150 | 65 | 11 | \$1933 |
| KT4820 | 22 x 50 x 29 | 150 | 95 | 17 | \$2222 |
| KT4220 | 22 x 44 x 29 | 150 | 85 | 15 | \$1858 |
| KT3620 | 22 x 38 x 29 | 125 | 75 | 12 | \$1795 |
| KT3020 | 22 x 32 x 29 | 125 | 65 | 10 | \$1760 |

Flush modesty panel.

Required Specifications

Finish
Edge

Optional Specifications

Handles
Additional grommet
Glass modesty panel*

DESKS

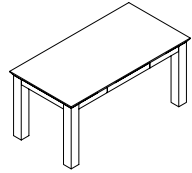
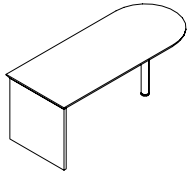

Table Desk*

| MODEL# | DIMENSIONS D x W x H | FREIGHT CLASS | WT/LBS. | CUBIC FT. | LIST PRICE |
|---------|-------------------------|---------------|---------|-----------|----------------|
| KTB8442 | 44 x 86 x 29 | 150 | 272 | 59 | \$10790 |
| KTB7842 | 44 x 80 x 29 | 150 | 253 | 55 | \$10021 |
| KTB7236 | 38 x 74 x 29 | 150 | 205 | 44 | \$7925 |
| KTB7230 | 32 x 74 x 29 | 150 | 192 | 36 | \$7782 |
| KTB6636 | 38 x 68 x 29 | 150 | 192 | 40 | \$7782 |
| KTB6630 | 32 x 68 x 29 | 150 | 188 | 33 | \$7630 |
| KTB6030 | 32 x 62 x 29 | 150 | 171 | 30 | \$7267 |

3" apron, center pencil drawer. 4" square legs.



"D" Shaped Connecting Table Desk*

| | | | | | |
|---------|--------------|-----|-----|----|---------------|
| KDD8436 | 36 x 84 x 29 | 125 | 343 | 51 | \$5497 |
| KDD7236 | 36 x 72 x 29 | 125 | 294 | 44 | \$4708 |
| KDD7230 | 30 x 72 x 29 | 125 | 264 | 36 | \$4377 |
| KDD6636 | 36 x 66 x 29 | 125 | 245 | 40 | \$4377 |
| KDD6030 | 30 x 60 x 29 | 125 | 225 | 30 | \$4206 |

3" wood post and full end panel.

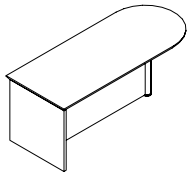

"D" Shaped Connecting Table Desk

| | | | | | |
|----------|--------------|-----|-----|----|---------------|
| KDDF8436 | 36 x 84 x 29 | 125 | 343 | 51 | \$6751 |
| KDDF7236 | 36 x 72 x 29 | 125 | 294 | 44 | \$5794 |
| KDDF7230 | 30 x 72 x 29 | 125 | 264 | 36 | \$5456 |
| KDDF6636 | 36 x 66 x 29 | 125 | 245 | 40 | \$5456 |
| KDDF6030 | 30 x 60 x 29 | 125 | 225 | 30 | \$5285 |

3" wood post, full modesty panel, and full end panel.

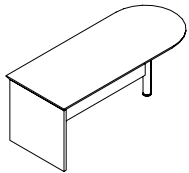

"D" Shaped Connecting Table Desk

| | | | | | |
|----------|--------------|-----|-----|----|---------------|
| KQDD8436 | 36 x 84 x 29 | 125 | 357 | 51 | \$6340 |
| KQDD7236 | 36 x 72 x 29 | 125 | 311 | 44 | \$5431 |
| KQDD7230 | 30 x 72 x 29 | 125 | 281 | 36 | \$5099 |
| KQDD6636 | 36 x 66 x 29 | 125 | 264 | 40 | \$5099 |
| KQDD6030 | 30 x 60 x 29 | 100 | 247 | 30 | \$4930 |

3" wood post, 3/4 modesty panel, and full end panel.

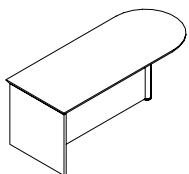

"D" Shaped Connecting Table Desk - Left

| | | | | | |
|-----------|--------------|-----|-----|----|---------------|
| KDDCL8436 | 36 x 84 x 29 | 125 | 368 | 51 | \$7178 |
| KDDCL7236 | 36 x 72 x 29 | 125 | 320 | 44 | \$6152 |
| KDDCL7230 | 30 x 72 x 29 | 100 | 290 | 36 | \$5815 |
| KDDCL6636 | 36 x 66 x 29 | 125 | 270 | 40 | \$5815 |
| KDDCL6030 | 30 x 60 x 29 | 100 | 242 | 30 | \$5648 |

Full height curved modesty panel, 3" wood post, and full end panel.

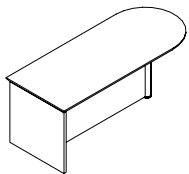

"D" Shaped Connecting Table Desk - Right

| | | | | | |
|-----------|--------------|-----|-----|----|---------------|
| KDDCR8436 | 36 x 84 x 29 | 125 | 368 | 51 | \$7178 |
| KDDCR7236 | 36 x 72 x 29 | 125 | 320 | 44 | \$6152 |
| KDDCR7230 | 30 x 72 x 29 | 100 | 290 | 36 | \$5815 |
| KDDCR6636 | 36 x 66 x 29 | 125 | 270 | 40 | \$5815 |
| KDDCR6030 | 30 x 60 x 29 | 100 | 242 | 30 | \$5648 |

Full height curved modesty panel, 3" wood post, and full end panel.

Required Specifications

Finish
Edge

Optional Specifications

Additional grommet
Base upgrade* (see accessories for options)

DESKS

MODEL# DIMENSIONS FREIGHT CLASS WT/LBS. CUBIC FT. LIST PRICE

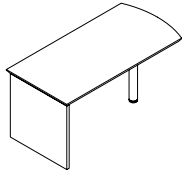

Connecting Bow End Table Desk*

| D x W x H | | | | | | |
|-----------|--------------|-----|-----|----|--|--------|
| KDDBE8436 | 36 x 84 x 29 | 125 | 343 | 51 | | \$5497 |
| KDDBE7236 | 36 x 72 x 29 | 125 | 294 | 44 | | \$4708 |
| KDDBE7230 | 30 x 72 x 29 | 125 | 264 | 36 | | \$4377 |
| KDDBE6636 | 36 x 66 x 29 | 125 | 245 | 40 | | \$4377 |
| KDDBE6030 | 30 x 60 x 29 | 125 | 225 | 30 | | \$4206 |

3" wood post and full end panel.

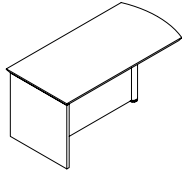

Connecting Bow End Table Desk

| | | | | | | |
|------------|--------------|-----|-----|----|--|--------|
| KDDBEF8436 | 36 x 84 x 29 | 125 | 368 | 51 | | \$6751 |
| KDDBEF7236 | 36 x 72 x 29 | 125 | 320 | 44 | | \$5791 |
| KDDBEF7230 | 30 x 72 x 29 | 100 | 290 | 36 | | \$5456 |
| KDDBEF6636 | 36 x 66 x 29 | 125 | 271 | 40 | | \$5456 |
| KDDBEF6030 | 30 x 60 x 29 | 100 | 247 | 30 | | \$5285 |

3" wood post, full modesty panel, and full end panel.

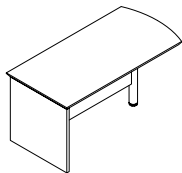

Connecting Bow End Table Desk

| | | | | | | |
|------------|--------------|-----|-----|----|--|--------|
| KQDDBE8436 | 36 x 84 x 29 | 125 | 357 | 51 | | \$6340 |
| KQDDBE7236 | 36 x 72 x 29 | 125 | 311 | 44 | | \$5431 |
| KQDDBE7230 | 30 x 72 x 29 | 125 | 281 | 36 | | \$5099 |
| KQDDBE6636 | 36 x 66 x 29 | 125 | 264 | 40 | | \$5099 |
| KQDDBE6030 | 30 x 60 x 29 | 100 | 247 | 30 | | \$4930 |

3" wood post, 3/4 modesty panel, and full end panel.

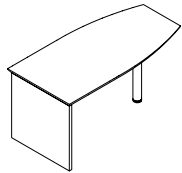

Connecting Boat Shaped Table Desk*

| | | | | | | |
|-----------|--------------|-----|-----|----|--|--------|
| KDDBS8442 | 42 x 84 x 29 | 125 | 414 | 59 | | \$6507 |
| KDDBS8436 | 36 x 84 x 29 | 125 | 343 | 51 | | \$5497 |
| KDDBS7236 | 36 x 72 x 29 | 125 | 314 | 44 | | \$4708 |
| KDDBS7230 | 30 x 72 x 29 | 125 | 284 | 36 | | \$4377 |
| KDDBS6636 | 36 x 66 x 29 | 125 | 265 | 40 | | \$4377 |
| KDDBS6030 | 30 x 60 x 29 | 100 | 245 | 30 | | \$4206 |

3" wood post and full end panel.

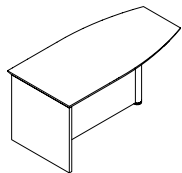

Connecting Boat Shaped Table Desk

| | | | | | | |
|------------|--------------|-----|-----|----|--|--------|
| KDDBSF8442 | 42 x 84 x 29 | 125 | 429 | 59 | | \$7879 |
| KDDBSF8436 | 36 x 84 x 29 | 125 | 368 | 51 | | \$6751 |
| KDDBSF7236 | 36 x 72 x 29 | 125 | 320 | 44 | | \$5791 |
| KDDBSF7230 | 30 x 72 x 29 | 100 | 290 | 36 | | \$5456 |
| KDDBSF6636 | 36 x 66 x 29 | 125 | 271 | 40 | | \$5456 |
| KDDBSF6030 | 30 x 60 x 29 | 100 | 247 | 30 | | \$5285 |

3" wood post, full modesty panel, and full end panel.

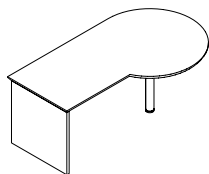

"P" Shaped Connecting Table - Left*

| | | | | | | |
|----------|--------------|-----|-----|----|--|--------|
| KTPL9642 | 42 x 96 x 29 | 125 | 440 | 68 | | \$6867 |
| KTPL8442 | 42 x 84 x 29 | 125 | 385 | 59 | | \$6008 |
| KTPL7242 | 42 x 72 x 29 | 125 | 319 | 51 | | \$5480 |

3" wood post and full end panel.

Required Specifications

Finish
Edge

Optional Specifications

Additional grommet
Base upgrade* (see accessories for options)

P-SHAPED CONNECTING TABLES

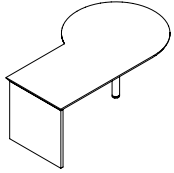

"P" Shaped Connecting Table - Right*

| MODEL# | DIMENSIONS D x W x H | FREIGHT CLASS | WT/LBS. | CUBIC FT. | LIST PRICE |
|----------|-------------------------|---------------|---------|-----------|---------------|
| KTPR9642 | 42 x 96 x 29 | 125 | 440 | 68 | \$6867 |
| KTPR8442 | 42 x 84 x 29 | 125 | 385 | 59 | \$6008 |
| KTPR7242 | 42 x 72 x 29 | 125 | 319 | 51 | \$5480 |

3" wood post and full end panel.

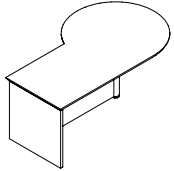

"P" Shaped Connecting Table - Left

| | | | | | |
|-----------|--------------|-----|-----|----|---------------|
| KTPFL9642 | 42 x 96 x 29 | 150 | 317 | 68 | \$8102 |
| KTPFL8442 | 42 x 84 x 29 | 150 | 277 | 59 | \$6250 |
| KTPFL7242 | 42 x 72 x 29 | 150 | 211 | 51 | \$6562 |

3" wood post, full height modesty panel, and full end panel.

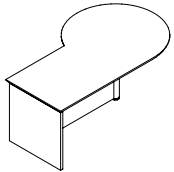

"P" Shaped Connecting Table - Right

| | | | | | |
|-----------|--------------|-----|-----|----|---------------|
| KTPFR9642 | 42 x 96 x 29 | 150 | 317 | 68 | \$8102 |
| KTPFR8442 | 42 x 84 x 29 | 150 | 277 | 59 | \$6250 |
| KTPFR7242 | 42 x 72 x 29 | 150 | 211 | 51 | \$6562 |

3" wood post, full height modesty panel, and full end panel.

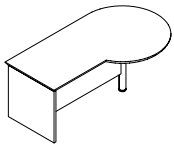

"P" Shaped Connecting Table - Left

| | | | | | |
|-----------|--------------|-----|-----|----|---------------|
| KQTPL9642 | 42 x 96 x 29 | 150 | 291 | 68 | \$7691 |
| KQTPL8442 | 42 x 84 x 29 | 150 | 255 | 59 | \$6730 |
| KQTPL7242 | 42 x 72 x 29 | 250 | 189 | 51 | \$6198 |

3" wood post, 3/4 height modesty panel, and full end panel.

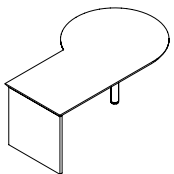

"P" Shaped Connecting Table - Right

| | | | | | |
|-----------|--------------|-----|-----|----|---------------|
| KQTPR9642 | 42 x 96 x 29 | 150 | 291 | 68 | \$7691 |
| KQTPR8442 | 42 x 84 x 29 | 150 | 255 | 59 | \$6730 |
| KQTPR7242 | 42 x 72 x 29 | 250 | 189 | 51 | \$6198 |

3" wood post, 3/4 height modesty panel, and full end panel.

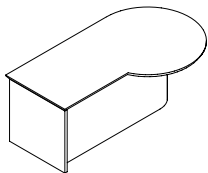

"P" Shaped Connecting Table - Left

| | | | | | |
|-----------|--------------|-----|-----|----|---------------|
| KTPCL9642 | 42 x 96 x 29 | 150 | 317 | 68 | \$8509 |
| KTPCL8442 | 42 x 84 x 29 | 150 | 277 | 59 | \$7451 |
| KTPCL7242 | 42 x 72 x 29 | 150 | 211 | 51 | \$6591 |

3" wood post, curved modesty panel, and full end panel.

Required Specifications

Finish
Edge

Optional Specifications

Additional grommet
Base upgrade* (see accessories for options)

P-SHAPED CONNECTING TABLES

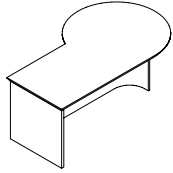

"P" Shaped Connecting Table - Right

| MODEL# | DIMENSIONS D x W x H | FREIGHT CLASS | WT/LBS. | CUBIC FT. | LIST PRICE |
|-----------|-------------------------|---------------|---------|-----------|------------|
| KTPCR9642 | 42 x 96 x 29 | 150 | 317 | 68 | \$8509 |
| KTPCR8442 | 42 x 84 x 29 | 150 | 277 | 59 | \$7451 |
| KTPCR7242 | 42 x 72 x 29 | 150 | 211 | 51 | \$6591 |

3" wood post, curved modesty panel, and full end panel.

RETURNS - NOTES

- All returns are shipped assembled
- Kneewell locking standard
- The standard grain direction on returns is cross grain (**CG**). To remove cross grain veneer pattern on top, delete suffix "**CG**" from the model number (no upcharge)
- If Handle is not specified Routed Pull, Black Lock & Grommet are standard
- If Handle is specified:
 - Black and Brass handle = Black Lock & Grommet
 - Silver, Nickel and Tungsten handle = Tungsten Lock & Grommet
- Grommets are available as an option on Desks and most Credenzas.
- Edge options - must specify:

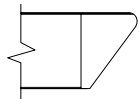

K16

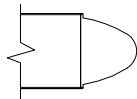

K18

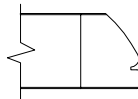

K21

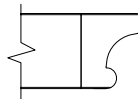

K22

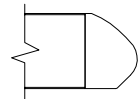

K29

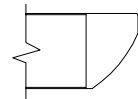

K30

• **NOTE:** Arrow indicates direction of grain

RETURNS

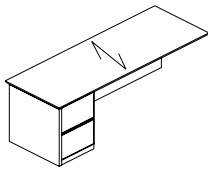

Executive Return - Left*

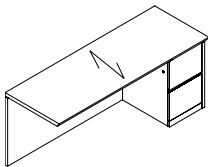

Executive Return - Right*

| MODEL# | DIMENSIONS | FREIGHT CLASS | WT/LBS. | CUBIC FT. | LIST PRICE |
|-------------|--------------|---------------|---------|-----------|------------|
| KERL7222ECG | 24 x 73 x 29 | 100 | 250 | 29 | \$5564 |
| KERL6622ECG | 24 x 67 x 29 | 100 | 236 | 27 | \$5360 |
| KERL6022ECG | 24 x 61 x 29 | 100 | 227 | 24 | \$4872 |
| KERL5422ECG | 24 x 55 x 29 | 100 | 205 | 22 | \$4699 |
| KERL4822ECG | 24 x 49 x 29 | 100 | 185 | 19 | \$4176 |
| KERL4222ECG | 24 x 43 x 29 | 92.5 | 178 | 17 | \$4020 |

Standard with full to floor **file/file** pedestal on **left**. Pedestal locks. Full height flush back panel.

| | | | | | |
|-------------|--------------|------|-----|----|--------|
| KERR7222ECG | 24 x 73 x 29 | 100 | 250 | 29 | \$5564 |
| KERR6622ECG | 24 x 67 x 29 | 100 | 236 | 27 | \$5360 |
| KERR6022ECG | 24 x 61 x 29 | 100 | 227 | 24 | \$4872 |
| KERR5422ECG | 24 x 55 x 29 | 100 | 205 | 22 | \$4699 |
| KERR4822ECG | 24 x 49 x 29 | 100 | 185 | 19 | \$4176 |
| KERR4222ECG | 24 x 43 x 29 | 92.5 | 178 | 17 | \$4020 |

Standard with full to floor **file/file** pedestal on **right**. Pedestal locks. Full height flush back panel.

Required Specifications

Finish
Edge

Optional Specifications

Handles*
Additional grommet

EXECUTIVE RETURNS

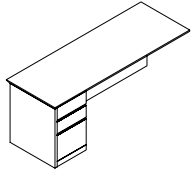

Executive Return - Left*

| MODEL# | DIMENSIONS D x W x H | FREIGHT CLASS | WT/LBS. | CUBIC FT. | LIST PRICE |
|-------------|-------------------------|---------------|---------|-----------|---------------|
| KERL7222DCG | 24 x 73 x 29 | 92.5 | 178 | 17 | \$5564 |
| KERL6622DCG | 24 x 67 x 29 | 100 | 236 | 27 | \$5360 |
| KERL6022DCG | 24 x 61 x 29 | 100 | 227 | 24 | \$4872 |
| KERL5422DCG | 24 x 55 x 29 | 100 | 205 | 22 | \$4699 |
| KERL4822DCG | 24 x 49 x 29 | 100 | 185 | 19 | \$4176 |
| KERL4222DCG | 24 x 43 x 29 | 92.5 | 178 | 17 | \$4020 |

Standard with full to floor **box/box/file** pedestal on **left**. Pedestal locks. Full height flush back panel.

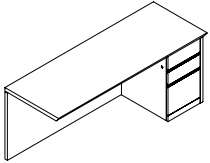

Executive Return - Right*

| | | | | | |
|-------------|--------------|------|-----|----|---------------|
| KERR7222DCG | 24 x 73 x 29 | 92.5 | 178 | 17 | \$5564 |
| KERR6622DCG | 24 x 67 x 29 | 100 | 236 | 27 | \$5360 |
| KERR6022DCG | 24 x 61 x 29 | 100 | 227 | 24 | \$4872 |
| KERR5422DCG | 24 x 55 x 29 | 100 | 205 | 22 | \$4699 |
| KERR4822DCG | 24 x 49 x 29 | 100 | 185 | 19 | \$4176 |
| KERR4222DCG | 24 x 43 x 29 | 92.5 | 178 | 17 | \$4020 |

Standard with full to floor **box/box/file** pedestal on **right**. Pedestal locks. Full height flush back panel.

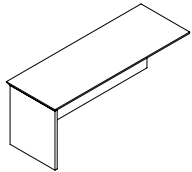

Executive Return - Left

| | | | | | |
|------------|--------------|-----|-----|----|---------------|
| KERL7222CG | 24 x 73 x 29 | 150 | 135 | 29 | \$3123 |
| KERL6622CG | 24 x 67 x 29 | 150 | 127 | 27 | \$2864 |
| KERL6022CG | 24 x 61 x 29 | 150 | 120 | 24 | \$2602 |
| KERL5422CG | 24 x 55 x 29 | 150 | 112 | 22 | \$2340 |
| KERL4822CG | 24 x 49 x 29 | 150 | 105 | 19 | \$2083 |
| KERL4222CG | 24 x 43 x 29 | 150 | 97 | 17 | \$1819 |

Full height flush back panel.

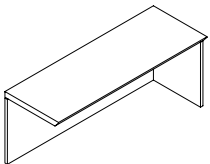

Executive Return - Right

| | | | | | |
|------------|--------------|-----|-----|----|---------------|
| KERR7222CG | 24 x 73 x 29 | 150 | 135 | 29 | \$3123 |
| KERR6622CG | 24 x 67 x 29 | 150 | 127 | 27 | \$2864 |
| KERR6022CG | 24 x 61 x 29 | 150 | 120 | 24 | \$2602 |
| KERR5422CG | 24 x 55 x 29 | 150 | 112 | 22 | \$2340 |
| KERR4822CG | 24 x 49 x 29 | 150 | 105 | 19 | \$2083 |
| KERR4222CG | 24 x 43 x 29 | 150 | 97 | 17 | \$1819 |

Full height flush back panel.

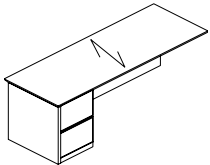

Executive Return - Left*

| | | | | | |
|-------------|--------------|------|-----|----|---------------|
| KERL7220ECG | 22 x 73 x 29 | 100 | 240 | 27 | \$5298 |
| KERL6620ECG | 22 x 67 x 29 | 100 | 231 | 24 | \$5103 |
| KERL6020ECG | 22 x 61 x 29 | 92.5 | 222 | 22 | \$4640 |
| KERL5420ECG | 22 x 55 x 29 | 92.5 | 200 | 20 | \$4473 |
| KERL4820ECG | 22 x 49 x 29 | 92.5 | 180 | 18 | \$3975 |
| KERL4220ECG | 22 x 43 x 29 | 92.5 | 173 | 16 | \$3831 |

Standard with full to floor **file/file** pedestal on **left**. Pedestal locks. Full height flush back panel.

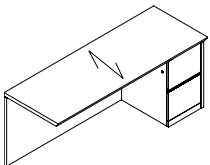

Executive Return - Right*

| | | | | | |
|-------------|--------------|------|-----|----|---------------|
| KERR7220ECG | 22 x 73 x 29 | 100 | 240 | 27 | \$5298 |
| KERR6620ECG | 22 x 67 x 29 | 100 | 231 | 24 | \$5103 |
| KERR6020ECG | 22 x 61 x 29 | 92.5 | 222 | 22 | \$4640 |
| KERR5420ECG | 22 x 55 x 29 | 92.5 | 200 | 20 | \$4473 |
| KERR4820ECG | 22 x 49 x 29 | 92.5 | 180 | 18 | \$3975 |
| KERR4220ECG | 22 x 43 x 29 | 92.5 | 173 | 16 | \$3831 |

Standard with full to floor **file/file** pedestal on **right**. Pedestal locks. Full height flush back panel.

Required Specifications

Finish
Edge

Optional Specifications

Handles*
Additional grommet

EXECUTIVE RETURNS

MODEL# DIMENSIONS FREIGHT CLASS WT/LBS. CUBIC FT. LIST PRICE

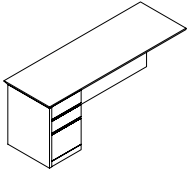

Executive Return - Left*

| | D x W x H | | | | |
|-------------|--------------|------|-----|----|--------|
| KERL7220DCG | 22 x 73 x 29 | 100 | 240 | 27 | \$5298 |
| KERL6620DCG | 22 x 67 x 29 | 100 | 231 | 24 | \$5103 |
| KERL6020DCG | 22 x 61 x 29 | 92.5 | 222 | 22 | \$4640 |
| KERL5420DCG | 22 x 55 x 29 | 92.5 | 200 | 20 | \$4473 |
| KERL4820DCG | 22 x 49 x 29 | 92.5 | 180 | 18 | \$3975 |
| KERL4220DCG | 22 x 43 x 29 | 92.5 | 173 | 16 | \$3831 |

Standard with full to floor **box/box/file** pedestal on **left**. Pedestal locks. Full height flush back panel.

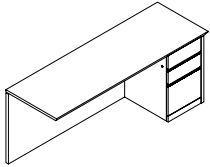

Executive Return - Right*

| | | | | | |
|-------------|--------------|------|-----|----|--------|
| KERR7220DCG | 22 x 73 x 29 | 100 | 240 | 27 | \$5298 |
| KERR6620DCG | 22 x 67 x 29 | 100 | 231 | 24 | \$5103 |
| KERR6020DCG | 22 x 61 x 29 | 92.5 | 222 | 22 | \$4640 |
| KERR5420DCG | 22 x 55 x 29 | 92.5 | 200 | 20 | \$4473 |
| KERR4820DCG | 22 x 49 x 29 | 92.5 | 180 | 18 | \$3975 |
| KERR4220DCG | 22 x 43 x 29 | 92.5 | 173 | 16 | \$3831 |

Standard with full to floor **box/box/file** pedestal on **right**. Pedestal locks. Full height flush back panel.

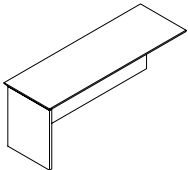

Executive Return - Left

| | | | | | |
|------------|--------------|-----|-----|----|--------|
| KERL7220CG | 22 x 73 x 29 | 150 | 130 | 27 | \$2974 |
| KERL6620CG | 22 x 67 x 29 | 150 | 122 | 24 | \$2728 |
| KERL6020CG | 22 x 61 x 29 | 150 | 115 | 22 | \$2479 |
| KERL5420CG | 22 x 55 x 29 | 150 | 105 | 20 | \$2229 |
| KERL4820CG | 22 x 49 x 29 | 150 | 100 | 18 | \$1985 |
| KERL4220CG | 22 x 43 x 29 | 150 | 90 | 16 | \$1733 |

Full height flush back panel.

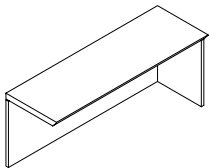

Executive Return - Right

| | | | | | |
|------------|--------------|-----|-----|----|--------|
| KERR7220CG | 22 x 73 x 29 | 150 | 130 | 27 | \$2974 |
| KERR6620CG | 22 x 67 x 29 | 150 | 122 | 24 | \$2728 |
| KERR6020CG | 22 x 61 x 29 | 150 | 115 | 22 | \$2479 |
| KERR5420CG | 22 x 55 x 29 | 150 | 105 | 20 | \$2229 |
| KERR4820CG | 22 x 49 x 29 | 150 | 100 | 18 | \$1985 |
| KERR4220CG | 22 x 43 x 29 | 150 | 90 | 16 | \$1733 |

Full height flush back panel.

Required Specifications

Finish
Edge

Optional Specifications

Handles*
Additional grommet

PIANO DESKS - NOTES

D x W x H

- All desks are shipped assembled
- Units include installed horizontal wire management
- Unit is handed by Post leg.
- Not for use with regular corner units
- If grommet (optional) color is not specified, Black grommet is standard.
- Grommets are available as an option on Desks and most Credenzas.
- Edge options - must specify:

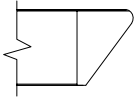

K16

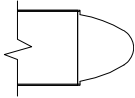

K18

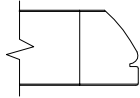

K21

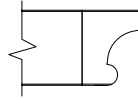

K22

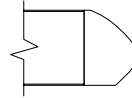

K29

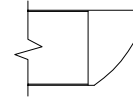

K30

- **NOTE:** Arrow indicates direction of grain
- For cross grain veneer pattern on top, add **(CG)**.

PIANO DESKS

MODEL#

DIMENSIONS

FREIGHT CLASS

WT./LBS.

CUBIC FT.

LIST PRICE

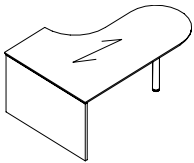

D-shaped Piano Desk - Left*

| | | | | | |
|----------------|--------------|-----|-----|----|---------------|
| KTDP L96304822 | 48 x 96 x 29 | 125 | 464 | 77 | \$7127 |
| KTDP L84304822 | 48 x 84 x 29 | 150 | 406 | 68 | \$6343 |
| KTDP L72304822 | 48 x 72 x 29 | 125 | 348 | 58 | \$5554 |

3" wood post and full end panel, 30"D worksurface and 24" return connection.

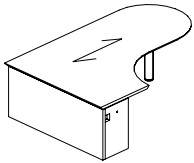

D-shaped Piano Desk - Right*

| | | | | | |
|----------------|--------------|-----|-----|----|---------------|
| KTDP R96304822 | 48 x 96 x 29 | 125 | 464 | 77 | \$7127 |
| KTDP R84304822 | 48 x 84 x 29 | 150 | 406 | 68 | \$6343 |
| KTDP R72304822 | 48 x 72 x 29 | 125 | 348 | 58 | \$5554 |

3" wood post and full end panel, 30"D worksurface and 24" return connection.

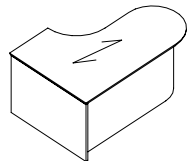

D-shaped Piano Desk - Left

| | | | | | |
|-----------------|--------------|-----|-----|----|---------------|
| KTDP CL96304822 | 48 x 96 x 29 | 125 | 479 | 77 | \$9046 |
| KTDP CL84304822 | 48 x 84 x 29 | 125 | 420 | 68 | \$8022 |
| KTDP CL72304822 | 48 x 72 x 29 | 125 | 360 | 58 | \$6995 |

Full height curved modesty panel, 3" wood post, and full end panel, 30"D worksurface and 24" return connection.

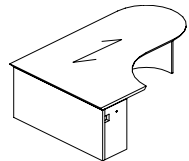

D-shaped Piano Desk - Right

| | | | | | |
|-----------------|--------------|-----|-----|----|---------------|
| KTDP CR96304822 | 48 x 96 x 29 | 125 | 479 | 77 | \$9046 |
| KTDP CR84304822 | 48 x 84 x 29 | 125 | 420 | 68 | \$8022 |
| KTDP CR72304822 | 48 x 72 x 29 | 125 | 360 | 58 | \$6995 |

Full height curved modesty panel, 3" wood post, and full end panel, 30"D worksurface and 24" return connection.

Required Specifications

Finish
Edge

Optional Specifications

Additional grommet
Base upgrade* (see accessories for options)

PIANO DESKS

MODEL# DIMENSIONS FREIGHT CLASS WT/LBS. CUBIC FT. LIST PRICE

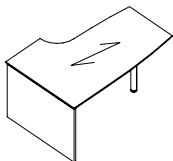

Boat-shaped Piano Desk - Left*

| D x W x H | | | | | | |
|----------------|--------------|-----|-----|----|--|---------------|
| KTBPPL96364822 | 48 x 96 x 29 | 125 | 522 | 87 | | \$8022 |
| KTBPPL84364822 | 48 x 84 x 29 | 125 | 457 | 76 | | \$7132 |
| KTBPPL72364822 | 48 x 72 x 29 | 125 | 392 | 65 | | \$6246 |

3" wood post and full end panel, with 36"/30"D worksurface and 24" return connection.

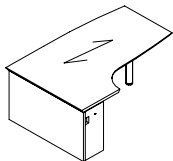

Boat-shaped Piano Desk - Right*

| | | | | | | |
|----------------|--------------|-----|-----|----|--|---------------|
| KTBPRL96364822 | 48 x 96 x 29 | 125 | 522 | 87 | | \$8022 |
| KTBPRL84364822 | 48 x 84 x 29 | 125 | 457 | 76 | | \$7132 |
| KTBPRL72364822 | 48 x 72 x 29 | 125 | 392 | 65 | | \$6246 |

3" wood post and full end panel, with 36"/30"D worksurface and 24" return connection.

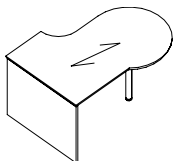

P-shaped Piano Desk - Left*

| | | | | | | |
|----------------|--------------|-----|-----|----|--|---------------|
| KTPPPL96424822 | 48 x 96 x 29 | 150 | 580 | 97 | | \$8133 |
| KTPPPL84424822 | 48 x 84 x 29 | 150 | 508 | 85 | | \$7276 |
| KTPPPL72424822 | 48 x 72 x 29 | 150 | 435 | 73 | | \$6742 |

3" wood post and full end panel, with 42"/30"D worksurface and 24" return connection.

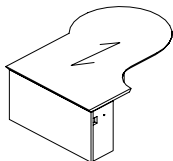

P-shaped Piano Desk - Right*

| | | | | | | |
|----------------|--------------|-----|-----|----|--|---------------|
| KTPPRL96424822 | 48 x 96 x 29 | 150 | 580 | 97 | | \$8133 |
| KTPPRL84424822 | 48 x 84 x 29 | 150 | 508 | 85 | | \$7276 |
| KTPPRL72424822 | 48 x 72 x 29 | 150 | 435 | 73 | | \$6742 |

3" wood post and full end panel, with 42"/30"D worksurface and 24" return connection.

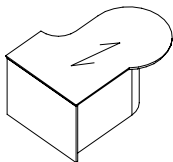

P-shaped Piano Desk - Left

| | | | | | | |
|----------------|--------------|-----|-----|----|--|---------------|
| KTPPCL96424822 | 48 x 96 x 29 | 125 | 590 | 97 | | \$9773 |
| KTPPCL84424822 | 48 x 84 x 29 | 125 | 516 | 85 | | \$8710 |
| KTPPCL72424822 | 48 x 72 x 29 | 125 | 442 | 73 | | \$8187 |

Full curved modesty panel, 3" wood post, and full end panel, with 42"/30"D worksurface and 24" return connection.

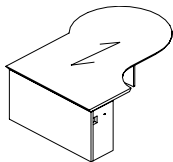

P-shaped Piano Desk - Right

| | | | | | | |
|----------------|--------------|-----|-----|----|--|---------------|
| KTPPCR96424822 | 48 x 96 x 29 | 125 | 590 | 97 | | \$9773 |
| KTPPCR84424822 | 48 x 84 x 29 | 125 | 516 | 85 | | \$8710 |
| KTPPCR72424822 | 48 x 72 x 29 | 125 | 442 | 73 | | \$8187 |

Full curved modesty panel, 3" wood post, and full end panel, with 42"/30"D worksurface and 24" return connection.

Required Specifications

Finish
Edge

Optional Specifications

Additional grommet
Base upgrade* (see accessories for options)

EXTENDED CORNERS

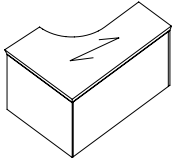

Extended Corner Table - Right

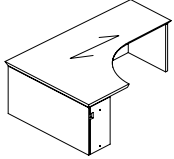

Extended Corner Table - Right

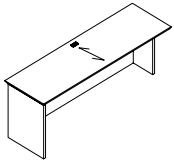

Linking Return - Left

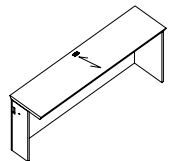

Linking Return - Right

| MODEL# | DIMENSIONS D x W x H | FREIGHT CLASS | WT/LBS. | CUBIC FT. | LIST PRICE |
|--------------|-------------------------|---------------|---------|-----------|---------------|
| KEKL964822MR | 98 x 48 x 29 | 150 | 387 | 77 | \$7744 |
| KEKL904822MR | 92 x 48 x 29 | 150 | 363 | 73 | \$7314 |
| KEKL844822MR | 86 x 48 x 29 | 150 | 338 | 68 | \$7225 |
| KEKL784822MR | 80 x 48 x 29 | 150 | 314 | 63 | \$7188 |
| KEKL724822MR | 74 x 48 x 29 | 150 | 290 | 58 | \$6209 |
| KEKL664822MR | 68 x 48 x 29 | 150 | 266 | 52 | \$6371 |
| KEKL604822MR | 62 x 48 x 29 | 150 | 242 | 48 | \$5901 |

Self edge on back edge, and 24" return connection.

| | | | | | |
|--------------|--------------|-----|-----|----|---------------|
| KEKR489622ML | 98 x 48 x 29 | 150 | 387 | 77 | \$7744 |
| KEKR489022ML | 92 x 48 x 29 | 150 | 363 | 73 | \$7314 |
| KEKR488422ML | 86 x 48 x 29 | 150 | 338 | 68 | \$7225 |
| KEKR487822ML | 80 x 48 x 29 | 150 | 314 | 63 | \$7188 |
| KEKR487222ML | 74 x 48 x 29 | 150 | 290 | 58 | \$6830 |
| KEKR486622ML | 68 x 48 x 29 | 150 | 266 | 52 | \$6371 |
| KEKR486022ML | 62 x 48 x 29 | 150 | 242 | 48 | \$5901 |

Self edge on back edge, and 24" return connection.

| | | | | | |
|------------|--------------|-----|-----|----|---------------|
| KVEL9622CG | 24 x 97 x 29 | 150 | 200 | 39 | \$4706 |
| KVEL9022CG | 24 x 91 x 29 | 150 | 187 | 36 | \$4411 |
| KVEL8422CG | 24 x 85 x 29 | 150 | 174 | 34 | \$4118 |
| KVEL7822CG | 24 x 79 x 29 | 150 | 162 | 31 | \$3823 |
| KVEL7222CG | 24 x 73 x 29 | 150 | 149 | 29 | \$3533 |
| KVEL6622CG | 24 x 67 x 29 | 150 | 141 | 27 | \$3316 |
| KVEL6022CG | 24 x 61 x 29 | 150 | 132 | 24 | \$2948 |
| KVEL5422CG | 24 x 55 x 29 | 150 | 121 | 22 | \$2924 |
| KVEL4822CG | 24 x 47 x 29 | 125 | 115 | 19 | \$2748 |
| KVEL4222CG | 24 x 43 x 29 | 150 | 99 | 17 | \$2312 |
| KVEL3622CG | 24 x 37 x 29 | 150 | 83 | 15 | \$2231 |
| KVEL3022CG | 24 x 31 x 29 | 125 | 77 | 12 | \$2220 |
| KVEL2422CG | 24 x 25 x 29 | 125 | 61 | 10 | \$1839 |

Used in conjunction with Extended Corner Units or Piano Table Desks

| | | | | | |
|------------|--------------|-----|-----|----|---------------|
| KVER9622CG | 24 x 97 x 29 | 150 | 200 | 39 | \$4706 |
| KVER9022CG | 24 x 91 x 29 | 150 | 187 | 36 | \$4411 |
| KVER8422CG | 24 x 85 x 29 | 150 | 174 | 34 | \$4118 |
| KVER7822CG | 24 x 79 x 29 | 150 | 162 | 31 | \$3823 |
| KVER7222CG | 24 x 73 x 29 | 150 | 149 | 29 | \$3533 |
| KVER6622CG | 24 x 67 x 29 | 150 | 141 | 27 | \$3316 |
| KVER6022CG | 24 x 61 x 29 | 150 | 132 | 24 | \$2948 |
| KVER5422CG | 24 x 55 x 29 | 150 | 121 | 22 | \$2924 |
| KVER4822CG | 24 x 47 x 29 | 125 | 115 | 19 | \$2748 |
| KVER4222CG | 24 x 43 x 29 | 150 | 99 | 17 | \$2312 |
| KVER3622CG | 24 x 37 x 29 | 150 | 83 | 15 | \$2231 |
| KVER3022CG | 24 x 31 x 29 | 125 | 77 | 12 | \$2220 |
| KVER2422CG | 24 x 25 x 29 | 125 | 61 | 10 | \$1839 |

Used in conjunction with Extended Corner Units or Piano Table Desks

Required Specifications

Finish
Edge

Optional Specifications

Additional grommet

EXTENDED CORNERS

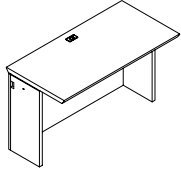

Bridge

MODEL# DIMENSIONS FREIGHT CLASS WT/LBS. CUBIC FT. LIST PRICE

| | D x W x H | | | | |
|------------|--------------|-----|-----|----|--------|
| KBTN4822CG | 24 x 48 x 29 | 125 | 116 | 19 | \$2662 |
| KBTN4222CG | 24 x 42 x 29 | 125 | 102 | 17 | \$2231 |
| KBTN3622CG | 24 x 36 x 29 | 150 | 87 | 15 | \$2152 |
| KBTN3022CG | 24 x 30 x 29 | 125 | 73 | 12 | \$2107 |
| KBTN2422CG | 24 x 24 x 29 | 150 | 58 | 10 | \$1768 |
| KBTN1822CG | 24 x 18 x 29 | 150 | 43 | 8 | \$1330 |
| KBTN1222CG | 24 x 12 x 29 | 150 | 29 | 5 | \$885 |

For Extended Corner Units or Piano Table Desks, with full back panel and recessed end panels.

BRIDGES

- All bridges are shipped knockdown.
- Not for use with corner units.
- The standard grain direction is cross grain (CG). To remove cross grain veneer pattern on top, delete suffix "CG" from the model number (no upcharge).
- GM5 TC location is standard. If grommet color is not specified, Black grommet is standard.
- Edge options - must specify:

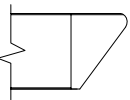

K16

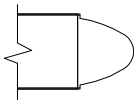

K18

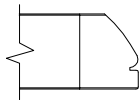

K21

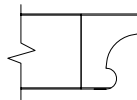

K22

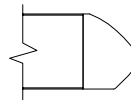

K29

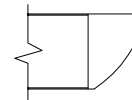

K30

• NOTE: Arrow indicates direction of grain

BRIDGES

MODEL# DIMENSIONS FREIGHT CLASS WT/LBS. CUBIC FT. LIST PRICE

| | | | | | |
|-----------|--------------|----|-----|---|--------|
| KBT6022CG | 24 x 60 x 29 | 85 | 108 | 9 | \$2479 |
| KBT5422CG | 24 x 54 x 29 | 85 | 99 | 8 | \$2231 |
| KBT4822CG | 24 x 48 x 29 | 85 | 90 | 7 | \$1985 |
| KBT4222CG | 24 x 42 x 29 | 85 | 81 | 6 | \$1735 |
| KBT6020CG | 22 x 60 x 29 | 85 | 105 | 8 | \$2258 |
| KBT5420CG | 22 x 54 x 29 | 85 | 96 | 8 | \$2031 |
| KBT4820CG | 22 x 48 x 29 | 85 | 87 | 7 | \$1804 |
| KBT4220CG | 22 x 42 x 29 | 85 | 78 | 6 | \$1547 |

With full back panel.

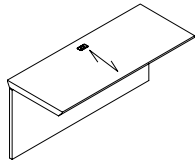

Executive Bridge Top

| | | | | | |
|-------------|---------------|-----|----|---|--------|
| KBT6022Q8CG | 24 x 60 x 9.5 | 100 | 83 | 9 | \$2231 |
| KBT5422Q8CG | 24 x 54 x 9.5 | 100 | 74 | 8 | \$2010 |
| KBT4822Q8CG | 24 x 48 x 9.5 | 100 | 65 | 7 | \$1780 |
| KBT4222Q8CG | 24 x 42 x 9.5 | 100 | 56 | 6 | \$1561 |

| | | | | | |
|-------------|---------------|------|----|---|--------|
| KBT6020Q8CG | 22 x 60 x 9.5 | 92.5 | 80 | 8 | \$2031 |
| KBT5420Q8CG | 22 x 54 x 9.5 | 100 | 71 | 8 | \$1833 |
| KBT4820Q8CG | 22 x 48 x 9.5 | 100 | 62 | 7 | \$1630 |
| KBT4220Q8CG | 22 x 42 x 9.5 | 100 | 53 | 6 | \$1393 |

With 8" back panel.

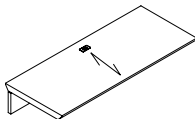

Executive Bridge Top

Required Specifications

Finish
Edge

Optional Specifications

Additional grommet

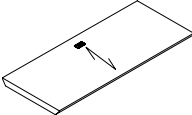
| DESKS | MODEL# | DIMENSIONS D x W x H | FREIGHT CLASS | WT./LBS. | CUBIC FT. | LIST PRICE |
|--|------------|-------------------------|---------------|----------|-----------|---------------|
|  | KBT5422TCG | 24 x 54 x 1.5 | 100 | 64 | 8 | \$1335 |
| | KBT4822TCG | 24 x 48 x 1.5 | 125 | 55 | 7 | \$1192 |
| | KBT4222TCG | 24 x 42 x 1.5 | 125 | 46 | 6 | \$1045 |
| | KBT5420TCG | 22 x 54 x 1.5 | 125 | 61 | 8 | \$1223 |
| | KBT4820TCG | 22 x 48 x 1.5 | 125 | 52 | 7 | \$1086 |
| | KBT4220TCG | 22 x 42 x 1.5 | 125 | 43 | 6 | \$930 |

Executive Bridge Top

No back panel.

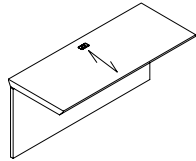

Executive Bridge Top

| | | | | | |
|------------|--------------|----|-----|---|---------------|
| KHBT6022CG | 24 x 60 x 29 | 85 | 108 | 9 | \$2848 |
| KHBT5422CG | 24 x 54 x 29 | 85 | 99 | 8 | \$2607 |
| KHBT4822CG | 24 x 48 x 29 | 85 | 90 | 7 | \$2358 |
| KHBT4222CG | 24 x 42 x 29 | 85 | 81 | 6 | \$2108 |
| KHBT6020CG | 22 x 60 x 29 | 85 | 105 | 8 | \$2631 |
| KHBT5420CG | 22 x 54 x 29 | 85 | 96 | 8 | \$2405 |
| KHBT4820CG | 22 x 48 x 29 | 85 | 87 | 7 | \$2180 |
| KHBT4220CG | 22 x 42 x 29 | 85 | 78 | 6 | \$1920 |

With hinged back panel, for U configurations.

CREDENZA NOTES

- All credenzas are shipped assembled.
- All Storage Cabinets include one adjustable shelf per set of doors.
- "F" and "G" depict 36", and "M" and "N" depict 30".
- "F" and "N" indicate lateral file drawers and "G" and "M" indicate storage cabinets with doors.
- Credenza shells accept modular storage. Use modular storage for top support, allowing no more than 72" unsupported.
- Credenza shells with a width of 96" and more will have a 12" center support gable.
- Credenza shells can only be completely filled with modular storage units with ".5" at the end of the model number.
- If Handle is not specified Routed Pull, Black Lock & Grommet are standard
- If Handle is specified:
 - Black and Brass handle = Black Lock & Grommet
 - Silver, Nickel and Tungsten handle = Tungsten Lock & Grommet
- **NOTE:** Arrow indicates direction of grain
- Edge options - must specify:

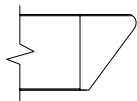
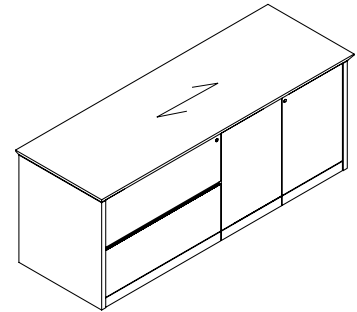

K16

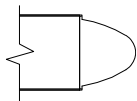

K18

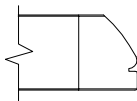

K21

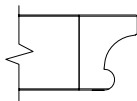

K22

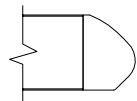

K29

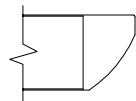

K30

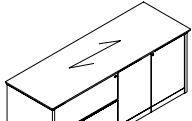
| CREDENZAS | MODEL# | DIMENSIONS | FREIGHT CLASS | WT./LBS. | CUBIC FT. | LIST PRICE |
|--|----------|--------------|---------------|----------|-----------|---------------|
|  | KC7222FG | 23 x 74 x 29 | 92.5 | 285 | 27 | \$6676 |
| | KC6022NM | 23 x 62 x 29 | 92.5 | 233 | 22 | \$5563 |
| | KC7220FG | 21 x 74 x 29 | 92.5 | 272 | 24 | \$6355 |
| | KC6020NM | 21 x 62 x 29 | 92.5 | 220 | 20 | \$5294 |

Full Storage Credenza*

Standard with **lateral box/file** on **left** and **storage cabinet** on **right**.

- For Aluminum Framed Glass Door option, contact Customer Care.

Required Specifications

Finish
Edge

Optional Specifications

Handles*
Additional grommet

CRENZAS

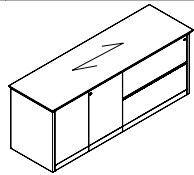

Full Storage Credenza

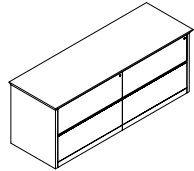

Full Storage Credenza

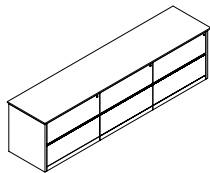

Full Storage Credenza

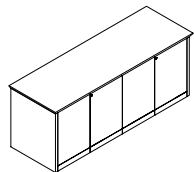

Full Storage Credenza

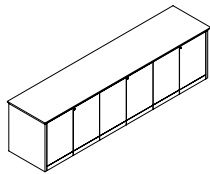

Full Storage Credenza

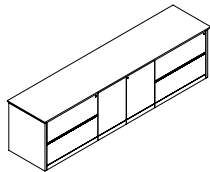

Full Storage Credenza

MODEL# DIMENSIONS FREIGHT CLASS WT/LBS. CUBIC FT. LIST PRICE

D x W x H

| | | | | | |
|----------|--------------|------|-----|----|--------|
| KC7222GF | 23 x 74 x 29 | 92.5 | 285 | 27 | \$6676 |
| KC6022MN | 23 x 62 x 29 | 92.5 | 233 | 22 | \$5563 |
| KC7220GF | 21 x 74 x 29 | 92.5 | 272 | 24 | \$6355 |
| KC6020MN | 21 x 62 x 29 | 92.5 | 220 | 20 | \$5294 |

Standard with **lateral box/file** on **right** and **storage cabinet** on **left**.

- For Aluminum Framed Glass Door option, contact Customer Care.

| | | | | | |
|----------|--------------|------|-----|----|--------|
| KC7222FF | 23 x 74 x 29 | 92.5 | 300 | 27 | \$8535 |
| KC6022NN | 23 x 62 x 29 | 100 | 218 | 22 | \$7828 |
| KC7220FF | 21 x 74 x 29 | 92.5 | 287 | 24 | \$8128 |
| KC6020NN | 21 x 62 x 29 | 92.5 | 205 | 20 | \$7119 |

Standard with **lateral box/file** on **left** and **right**.

| | | | | | |
|------------|---------------|------|-----|----|---------|
| KC10822FFF | 23 x 110 x 29 | 92.5 | 435 | 40 | \$15014 |
| KC9022NNN | 23 x 92 x 29 | 92.5 | 372 | 33 | \$12512 |
| KC10820FFF | 21 x 110 x 29 | 92.5 | 412 | 36 | \$13648 |
| KC9020NNN | 21 x 92 x 29 | 92.5 | 337 | 30 | \$11376 |

Standard with **lateral box/file** on **left, center** and **right**.

| | | | | | |
|----------|--------------|------|-----|----|--------|
| KC7222GG | 23 x 74 x 29 | 92.5 | 277 | 27 | \$6335 |
| KC6022MM | 23 x 62 x 29 | 92.5 | 232 | 22 | \$5808 |
| KC7220GG | 21 x 74 x 29 | 92.5 | 253 | 24 | \$6034 |
| KC6020MM | 21 x 62 x 29 | 92.5 | 209 | 20 | \$5280 |

Standard with **storage cabinets** on **left** and **right**.

| | | | | | |
|------------|---------------|-----|-----|----|---------|
| KC10822GGG | 23 x 110 x 29 | 100 | 348 | 40 | \$11973 |
| KC9022MMM | 23 x 92 x 29 | 100 | 302 | 33 | \$9977 |
| KC10820GGG | 21 x 110 x 29 | 125 | 278 | 36 | \$10881 |
| KC9020MMM | 21 x 92 x 29 | 125 | 228 | 30 | \$9011 |

Standard with **storage cabinets** on **left, center** and **right**.

| | | | | | |
|------------|---------------|-----|-----|----|---------|
| KC10822FGF | 23 x 110 x 29 | 100 | 348 | 40 | \$14001 |
| KC9022NMN | 23 x 92 x 29 | 100 | 302 | 33 | \$11669 |
| KC10820FGF | 21 x 110 x 29 | 125 | 278 | 36 | \$12726 |
| KC9020NMN | 21 x 92 x 29 | 125 | 228 | 30 | \$10606 |

Lateral files on **left** and **right**; **storage cabinet** in **center**

Required Specifications

Finish
Edge

Optional Specifications

Handles
Additional grommet

CRENZAS

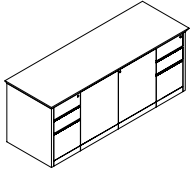

Full Storage Credenza

| MODEL# | DIMENSIONS D x W x H | FREIGHT CLASS | WT/LBS. | CUBIC FT. | LIST PRICE |
|-----------|-------------------------|---------------|---------|-----------|---------------|
| KC7222DGD | 23 x 74 x 29 | 92.5 | 319 | 29 | \$7828 |
| KC6022DMD | 23 x 62 x 29 | 92.5 | 266 | 24 | \$7176 |
| KC7220DGD | 21 x 74 x 29 | 85 | 298 | 24 | \$7452 |
| KC6020DMD | 21 x 62 x 29 | 85 | 246 | 20 | \$6523 |

Standard with **box/box/file** on **left** and **right**; **storage cabinet** in **center**.

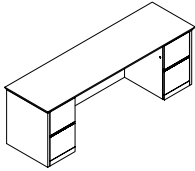

Double Pedestal Credenza

| | | | | | |
|-----------|--------------|------|-----|----|---------------|
| KCK8422EE | 23 x 86 x 29 | 100 | 320 | 34 | \$8179 |
| KCK7822EE | 23 x 80 x 29 | 100 | 298 | 31 | \$7596 |
| KCK7222EE | 23 x 74 x 29 | 100 | 280 | 29 | \$7014 |
| KCK6622EE | 23 x 68 x 29 | 100 | 257 | 27 | \$6907 |
| KCK6022EE | 23 x 62 x 29 | 100 | 233 | 24 | \$6426 |
| KCK8420EE | 21 x 86 x 29 | 92.5 | 307 | 28 | \$7795 |
| KCK7820EE | 21 x 80 x 29 | 92.5 | 285 | 26 | \$7238 |
| KCK7220EE | 21 x 74 x 29 | 92.5 | 267 | 24 | \$6679 |
| KCK6620EE | 21 x 68 x 29 | 92.5 | 244 | 22 | \$6122 |
| KCK6020EE | 21 x 62 x 29 | 92.5 | 220 | 20 | \$5566 |

File/file pedestals on **left** and **right**. Full height back panel. Kneespace in center.

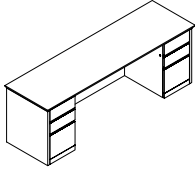

Double Pedestal Credenza

| | | | | | |
|-----------|--------------|------|-----|----|---------------|
| KCK8422DD | 23 x 86 x 29 | 100 | 320 | 34 | \$8179 |
| KCK7822DD | 23 x 80 x 29 | 100 | 298 | 31 | \$7596 |
| KCK7222DD | 23 x 74 x 29 | 100 | 280 | 29 | \$7014 |
| KCK6622DD | 23 x 68 x 29 | 100 | 257 | 27 | \$6907 |
| KCK6022DD | 23 x 62 x 29 | 100 | 233 | 24 | \$6426 |
| KCK8420DD | 21 x 86 x 29 | 92.5 | 307 | 28 | \$7795 |
| KCK7820DD | 21 x 80 x 29 | 92.5 | 285 | 26 | \$7238 |
| KCK7220DD | 21 x 74 x 29 | 92.5 | 267 | 24 | \$6679 |
| KCK6620DD | 21 x 68 x 29 | 92.5 | 244 | 22 | \$6122 |
| KCK6020DD | 21 x 62 x 29 | 92.5 | 220 | 20 | \$5566 |

Box/box/file pedestals on **left** and **right**. Full height back panel. Kneespace in center.

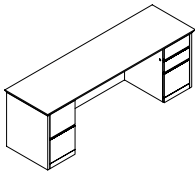

Double Pedestal Credenza

| | | | | | |
|-----------|--------------|------|-----|----|---------------|
| KCK8422ED | 23 x 86 x 29 | 100 | 320 | 34 | \$8179 |
| KCK7822ED | 23 x 80 x 29 | 100 | 298 | 31 | \$7596 |
| KCK7222ED | 23 x 74 x 29 | 100 | 280 | 29 | \$7014 |
| KCK6622ED | 23 x 68 x 29 | 100 | 257 | 27 | \$6907 |
| KCK6022ED | 23 x 62 x 29 | 100 | 233 | 24 | \$6426 |
| KCK8420ED | 21 x 86 x 29 | 92.5 | 307 | 28 | \$7795 |
| KCK7820ED | 21 x 80 x 29 | 92.5 | 285 | 26 | \$7238 |
| KCK7220ED | 21 x 74 x 29 | 92.5 | 267 | 24 | \$6679 |
| KCK6620ED | 21 x 68 x 29 | 92.5 | 244 | 22 | \$6122 |
| KCK6020ED | 21 x 62 x 29 | 92.5 | 220 | 20 | \$5566 |

File/file pedestal on **left**, **box/box/file** pedestal on **right**. Full height back panel. Kneespace in center.

Required Specifications

Finish
Edge

Optional Specifications

Handles
Additional grommet

CREENZAS

MODEL# DIMENSIONS FREIGHT CLASS WT/LBS. CUBIC FT. LIST PRICE

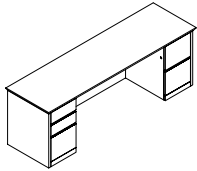

Double Pedestal Credenza

| | D x W x H | | | | |
|-----------|--------------|------|-----|----|--------|
| KCK8422DE | 23 x 86 x 29 | 100 | 320 | 34 | \$8179 |
| KCK7822DE | 23 x 80 x 29 | 100 | 298 | 31 | \$7596 |
| KCK7222DE | 23 x 74 x 29 | 100 | 280 | 29 | \$7014 |
| KCK6622DE | 23 x 68 x 29 | 100 | 257 | 27 | \$6907 |
| KCK6022DE | 23 x 62 x 29 | 100 | 233 | 24 | \$6426 |
| KCK8420DE | 21 x 86 x 29 | 92.5 | 307 | 28 | \$7795 |
| KCK7820DE | 21 x 80 x 29 | 92.5 | 285 | 26 | \$7238 |
| KCK7220DE | 21 x 74 x 29 | 92.5 | 267 | 24 | \$6679 |
| KCK6620DE | 21 x 68 x 29 | 92.5 | 244 | 22 | \$6122 |
| KCK6020DE | 21 x 62 x 29 | 92.5 | 220 | 20 | \$5566 |

Box/box/file pedestal on left and file/file pedestal on right. Full height back panel. Kneespace in center.

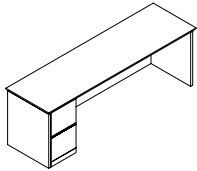

Single Pedestal Credenza - Left

| | | | | | |
|----------|--------------|-----|-----|----|--------|
| KCL8422E | 23 x 86 x 29 | 100 | 286 | 34 | \$6184 |
| KCL7822E | 23 x 80 x 29 | 100 | 265 | 31 | \$5745 |
| KCL7222E | 23 x 74 x 29 | 100 | 250 | 29 | \$5298 |
| KCL6622E | 23 x 68 x 29 | 100 | 229 | 27 | \$5103 |
| KCL6022E | 23 x 62 x 29 | 100 | 208 | 24 | \$4640 |
| KCL8420E | 21 x 86 x 29 | 100 | 273 | 28 | \$5892 |
| KCL7820E | 21 x 80 x 29 | 100 | 252 | 26 | \$5473 |
| KCL7220E | 21 x 74 x 29 | 100 | 237 | 24 | \$5049 |
| KCL6620E | 21 x 68 x 29 | 100 | 216 | 22 | \$4860 |
| KCL6020E | 21 x 62 x 29 | 100 | 195 | 20 | \$4422 |

File/file pedestal on left. Full height back panel.

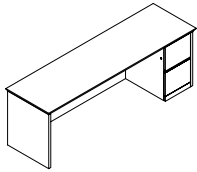

Single Pedestal Credenza - Right

| | | | | | |
|----------|--------------|-----|-----|----|--------|
| KCR8422E | 23 x 86 x 29 | 100 | 286 | 34 | \$6184 |
| KCR7822E | 23 x 80 x 29 | 100 | 265 | 31 | \$5745 |
| KCR7222E | 23 x 74 x 29 | 100 | 250 | 29 | \$5298 |
| KCR6622E | 23 x 68 x 29 | 100 | 229 | 27 | \$5103 |
| KCR6022E | 23 x 62 x 29 | 100 | 208 | 24 | \$4640 |
| KCR8420E | 21 x 86 x 29 | 100 | 273 | 28 | \$5892 |
| KCR7820E | 21 x 80 x 29 | 100 | 252 | 26 | \$5473 |
| KCR7220E | 21 x 74 x 29 | 100 | 237 | 24 | \$5049 |
| KCR6620E | 21 x 68 x 29 | 100 | 216 | 22 | \$4860 |
| KCR6020E | 21 x 62 x 29 | 100 | 195 | 20 | \$4422 |

File/file pedestal on right. Full height back panel.

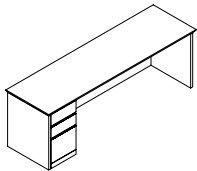

Single Pedestal Credenza - Left

| | | | | | |
|----------|--------------|-----|-----|----|--------|
| KCL8422D | 23 x 86 x 29 | 100 | 286 | 34 | \$6184 |
| KCL7822D | 23 x 80 x 29 | 100 | 265 | 31 | \$5745 |
| KCL7222D | 23 x 74 x 29 | 100 | 250 | 29 | \$5298 |
| KCL6622D | 23 x 68 x 29 | 100 | 229 | 27 | \$5103 |
| KCL6022D | 23 x 62 x 29 | 100 | 208 | 24 | \$4640 |
| KCL8420D | 21 x 86 x 29 | 100 | 273 | 28 | \$5892 |
| KCL7820D | 21 x 80 x 29 | 100 | 252 | 26 | \$5473 |
| KCL7220D | 21 x 74 x 29 | 100 | 237 | 24 | \$5049 |
| KCL6620D | 21 x 68 x 29 | 100 | 216 | 22 | \$4860 |
| KCL6020D | 21 x 62 x 29 | 100 | 195 | 20 | \$4422 |

Box/box/file pedestal on left. Full height back panel.

Required Specifications

Finish
Edge

Optional Specifications

Handles
Additional grommet

CREDENZAS

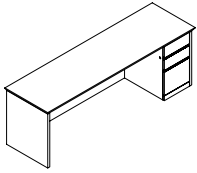

Single Pedestal Credenza - Right

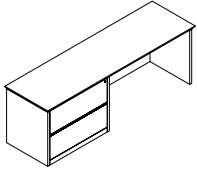

Single Pedestal Credenza - Left

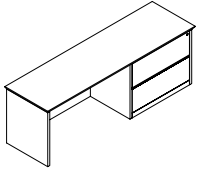

Single Pedestal Credenza - Right

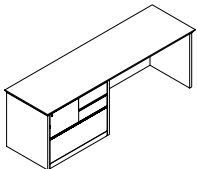

Single Pedestal Credenza - Left

| MODEL# | DIMENSIONS D x W x H | FREIGHT CLASS | WT./LBS. | CUBIC FT. | LIST PRICE |
|----------|-------------------------|---------------|----------|-----------|---------------|
| KCR8422D | 23 x 86 x 29 | 100 | 286 | 34 | \$6184 |
| KCR7822D | 23 x 80 x 29 | 100 | 265 | 31 | \$5745 |
| KCR7222D | 23 x 74 x 29 | 100 | 250 | 29 | \$5298 |
| KCR6622D | 23 x 68 x 29 | 100 | 229 | 27 | \$5103 |
| KCR6022D | 23 x 62 x 29 | 100 | 208 | 24 | \$4640 |
| KCR8420D | 21 x 86 x 29 | 100 | 273 | 28 | \$5892 |
| KCR7820D | 21 x 80 x 29 | 100 | 252 | 26 | \$5473 |
| KCR7220D | 21 x 74 x 29 | 100 | 237 | 24 | \$5049 |
| KCR6620D | 21 x 68 x 29 | 100 | 216 | 22 | \$4860 |
| KCR6020D | 21 x 62 x 29 | 100 | 195 | 20 | \$4422 |

Box/box/file pedestal on **right**. Full height back panel.

| | | | | | |
|----------|--------------|-----|-----|----|---------------|
| KCL8422F | 23 x 86 x 29 | 100 | 266 | 31 | \$7188 |
| KCL7822F | 23 x 80 x 29 | 100 | 245 | 29 | \$6674 |
| KCL7222F | 23 x 74 x 29 | 100 | 230 | 27 | \$6164 |
| KCL6622F | 23 x 68 x 29 | 100 | 209 | 24 | \$5933 |
| KCL6022F | 23 x 62 x 29 | 100 | 188 | 22 | \$5385 |
| KCL8420F | 21 x 86 x 29 | 100 | 253 | 28 | \$6844 |
| KCL7820F | 21 x 80 x 29 | 100 | 233 | 26 | \$6353 |
| KCL7220F | 21 x 74 x 29 | 100 | 218 | 24 | \$5865 |
| KCL6620F | 21 x 68 x 29 | 100 | 197 | 22 | \$5649 |
| KCL6020F | 21 x 62 x 29 | 100 | 176 | 20 | \$5129 |

36" lateral file pedestal on **left**. Full height back panel.

| | | | | | |
|----------|--------------|-----|-----|----|---------------|
| KCR8422F | 23 x 86 x 29 | 100 | 266 | 31 | \$7188 |
| KCR7822F | 23 x 80 x 29 | 100 | 245 | 29 | \$6674 |
| KCR7222F | 23 x 74 x 29 | 100 | 230 | 27 | \$6164 |
| KCR6622F | 23 x 68 x 29 | 100 | 209 | 24 | \$5933 |
| KCR6022F | 23 x 62 x 29 | 100 | 188 | 22 | \$5385 |
| KCR8420F | 21 x 86 x 29 | 100 | 253 | 28 | \$6844 |
| KCR7820F | 21 x 80 x 29 | 100 | 233 | 26 | \$6353 |
| KCR7220F | 21 x 74 x 29 | 100 | 218 | 24 | \$5865 |
| KCR6620F | 21 x 68 x 29 | 100 | 197 | 22 | \$5649 |
| KCR6020F | 21 x 62 x 29 | 100 | 176 | 20 | \$5129 |

36" lateral file pedestal on **right**. Full height back panel.

| | | | | | |
|----------|--------------|------|-----|----|---------------|
| KCL8422Z | 23 x 86 x 29 | 100 | 309 | 31 | \$7846 |
| KCL7822Z | 23 x 80 x 29 | 100 | 287 | 29 | \$7288 |
| KCL7222Z | 23 x 74 x 29 | 92.5 | 270 | 27 | \$6730 |
| KCL6622Z | 23 x 68 x 29 | 92.5 | 248 | 24 | \$6472 |
| KCL6022Z | 23 x 62 x 29 | 92.5 | 225 | 22 | \$5891 |
| KCL8420Z | 21 x 86 x 29 | 92.5 | 296 | 28 | \$7477 |
| KCL7820Z | 21 x 80 x 29 | 92.5 | 274 | 26 | \$6943 |
| KCL7220Z | 21 x 74 x 29 | 92.5 | 257 | 24 | \$6104 |
| KCL6620Z | 21 x 68 x 29 | 92.5 | 235 | 22 | \$6166 |
| KCL6020Z | 21 x 62 x 29 | 92.5 | 212 | 20 | \$5606 |

Modular combination storage pedestal with 1 lateral file, 1 file drawer on top left, and two box drawers on top right.

Required Specifications

Finish
Edge

Optional Specifications

Handles
Additional grommet

CREENZAS

MODEL# DIMENSIONS FREIGHT CLASS WT/LBS. CUBIC FT. LIST PRICE

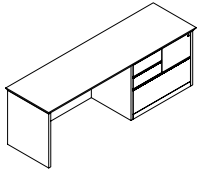

Single Pedestal Credenza - Right

| | D x W x H | | | | |
|----------|--------------|------|-----|----|--------|
| KCR8422Z | 23 x 86 x 29 | 100 | 309 | 31 | \$7846 |
| KCR7822Z | 23 x 80 x 29 | 100 | 287 | 29 | \$7288 |
| KCR7222Z | 23 x 74 x 29 | 92.5 | 270 | 27 | \$6730 |
| KCR6622Z | 23 x 68 x 29 | 92.5 | 248 | 24 | \$6472 |
| KCR6022Z | 23 x 62 x 29 | 92.5 | 225 | 22 | \$5891 |
| KCR8420Z | 21 x 86 x 29 | 92.5 | 296 | 28 | \$7477 |
| KCR7820Z | 21 x 80 x 29 | 92.5 | 274 | 26 | \$6943 |
| KCR7220Z | 21 x 74 x 29 | 92.5 | 257 | 24 | \$6104 |
| KCR6620Z | 21 x 68 x 29 | 92.5 | 235 | 22 | \$6166 |
| KCR6020Z | 21 x 62 x 29 | 92.5 | 212 | 20 | \$5606 |

Modular combination storage pedestal with 1 lateral file, 1 file drawer on top right, and two box drawers on top left.

96" and larger:

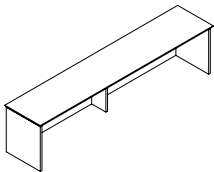

Less than 96":

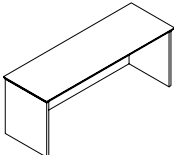

Credenza Shell

| | | | | | |
|---------|---------------|-----|-----|----|--------|
| KC10822 | 23 x 108 x 29 | 125 | 320 | 41 | \$4967 |
| KC10222 | 23 x 104 x 29 | 100 | 305 | 38 | \$4692 |
| KC9622 | 23 x 98 x 29 | 100 | 287 | 35 | \$4417 |
| KC9022 | 23 x 92 x 29 | 100 | 269 | 33 | \$3942 |
| KC8422 | 23 x 86 x 29 | 100 | 251 | 31 | \$3866 |
| KC7822 | 23 x 80 x 29 | 100 | 233 | 29 | \$3588 |
| KC7222 | 23 x 74 x 29 | 125 | 215 | 27 | \$3316 |
| KC6622 | 23 x 68 x 29 | 100 | 197 | 24 | \$3189 |
| KC6022 | 23 x 62 x 29 | 100 | 179 | 22 | \$2902 |
| KC5422 | 23 x 56 x 29 | 100 | 161 | 20 | \$2748 |
| KC4822 | 23 x 50 x 29 | 125 | 143 | 18 | \$2598 |
| KC4222 | 23 x 44 x 29 | 125 | 125 | 16 | \$2198 |
| KC10820 | 21 x 108 x 29 | 100 | 310 | 36 | \$4734 |
| KC10220 | 21 x 104 x 29 | 100 | 291 | 34 | \$4472 |
| KC9620 | 21 x 98 x 29 | 100 | 273 | 32 | \$4208 |
| KC9020 | 21 x 92 x 29 | 100 | 255 | 30 | \$3948 |
| KC8420 | 21 x 86 x 29 | 100 | 237 | 28 | \$3684 |
| KC7820 | 21 x 80 x 29 | 100 | 219 | 26 | \$3418 |
| KC7220 | 21 x 74 x 29 | 100 | 206 | 24 | \$3153 |
| KC6620 | 21 x 68 x 29 | 100 | 188 | 22 | \$3036 |
| KC6020 | 21 x 62 x 29 | 100 | 169 | 20 | \$2764 |
| KC5420 | 21 x 56 x 29 | 100 | 147 | 18 | \$2614 |
| KC4820 | 21 x 50 x 29 | 125 | 101 | 16 | \$2472 |
| KC4220 | 21 x 44 x 29 | 125 | 86 | 14 | \$2094 |

With full back panel.

Required Specifications

Finish
Edge

Optional Specifications

Handles
Additional grommet

CORNERS - NOTES

NOTE: Arrow indicates direction of grain

Corners

- All units are shipped assembled
- Unit includes grommets shown and installed horizontal wire management
- Corner units and extended corner units must be used exclusively with linking bridges and linking returns
- Edge options - must specify:

- **Linking bridges** are handed by recessed end panel
- **Extended corner tables** have no molding on back side.
- **Linking returns** include grommets shown and installed horizontal wire management. Handed by full end panel.
- **Tables** include grommets shown and installed horizontal wire management.

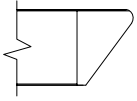

K16

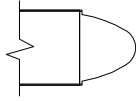

K18

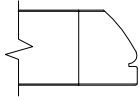

K21

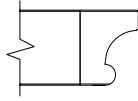

K22

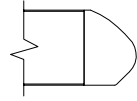

K29

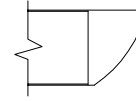

K30

CORNERS AND COMPONENTS

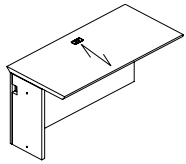

Linking Bridge - Left

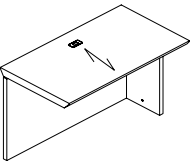

Linking Bridge - Right

| MODEL# | DIMENSIONS | FREIGHT CLASS | WT/LBS. | CUBIC FT. | LIST PRICE |
|--------|------------|---------------|---------|-----------|------------|
|--------|------------|---------------|---------|-----------|------------|

D x W x H

| | | | | | |
|--------------|--------------|-----|-----|----|---------------|
| KBT6022NLLCG | 24 x 60 x 29 | 125 | 145 | 24 | \$2733 |
| KBT5422NLLCG | 24 x 54 x 29 | 150 | 131 | 22 | \$2462 |
| KBT4822NLLCG | 24 x 48 x 29 | 125 | 116 | 19 | \$2189 |
| KBT4222NLLCG | 24 x 42 x 29 | 125 | 102 | 17 | \$1770 |
| KBT3622NLLCG | 24 x 36 x 29 | 150 | 87 | 15 | \$1611 |
| KBT3022NLLCG | 24 x 30 x 29 | 125 | 73 | 12 | \$1570 |
| KBT6020NLLCG | 22 x 60 x 29 | 150 | 131 | 22 | \$2602 |
| KBT5420NLLCG | 22 x 54 x 29 | 150 | 118 | 20 | \$2343 |
| KBT4820NLLCG | 22 x 48 x 29 | 125 | 110 | 18 | \$2083 |
| KBT4220NLLCG | 22 x 42 x 29 | 150 | 95 | 16 | \$1686 |
| KBT3620NLLCG | 22 x 36 x 29 | 125 | 80 | 13 | \$1531 |
| KBT3020NLLCG | 22 x 30 x 29 | 150 | 65 | 11 | \$1495 |

To join corner worksurface to desk or credenza. Full back panel.

| | | | | | |
|---------------|--------------|-----|-----|----|---------------|
| KBT6022NLR CG | 24 x 60 x 29 | 125 | 145 | 24 | \$2733 |
| KBT5422NLR CG | 24 x 54 x 29 | 150 | 131 | 22 | \$2462 |
| KBT4822NLR CG | 24 x 48 x 29 | 125 | 116 | 19 | \$2189 |
| KBT4222NLR CG | 24 x 42 x 29 | 125 | 102 | 17 | \$1770 |
| KBT3622NLR CG | 24 x 36 x 29 | 150 | 87 | 15 | \$1611 |
| KBT3022NLR CG | 24 x 30 x 29 | 125 | 73 | 12 | \$1570 |

| | | | | | |
|---------------|--------------|-----|-----|----|---------------|
| KBT6020NLR CG | 22 x 60 x 29 | 150 | 131 | 22 | \$2602 |
| KBT5420NLR CG | 22 x 54 x 29 | 150 | 118 | 20 | \$2343 |
| KBT4820NLR CG | 22 x 48 x 29 | 125 | 110 | 18 | \$2083 |
| KBT4220NLR CG | 22 x 42 x 29 | 150 | 95 | 16 | \$1686 |
| KBT3620NLR CG | 22 x 36 x 29 | 125 | 80 | 13 | \$1531 |
| KBT3020NLR CG | 22 x 30 x 29 | 150 | 65 | 11 | \$1495 |

To join corner worksurface to desk or credenza. Full back panel.

Required Specifications

Finish
Edge

Optional Specifications

Additional grommet

CORNER COMPONENTS

MODEL# DIMENSIONS FREIGHT CLASS WT/LBS. CUBIC FT. LIST PRICE

D x W x H

| | | | | | |
|----------------|---------------|-----|-----|----|--------|
| KBT6022NLLQ8CG | 24 x 60 x 9.5 | 125 | 145 | 24 | \$2462 |
| KBT5422NLLQ8CG | 24 x 54 x 9.5 | 150 | 131 | 22 | \$2220 |
| KBT4822NLLQ8CG | 24 x 48 x 9.5 | 125 | 116 | 19 | \$1972 |
| KBT4222NLLQ8CG | 24 x 42 x 9.5 | 125 | 102 | 17 | \$1591 |
| KBT3622NLLQ8CG | 24 x 36 x 9.5 | 150 | 87 | 15 | \$1449 |
| KBT3022NLLQ8CG | 24 x 30 x 9.5 | 125 | 73 | 12 | \$1417 |

| | | | | | |
|----------------|---------------|-----|-----|----|--------|
| KBT6020NLLQ8CG | 22 x 60 x 9.5 | 150 | 131 | 22 | \$2343 |
| KBT5420NLLQ8CG | 22 x 54 x 9.5 | 150 | 118 | 20 | \$2111 |
| KBT4820NLLQ8CG | 22 x 48 x 9.5 | 125 | 110 | 18 | \$1877 |
| KBT4220NLLQ8CG | 22 x 42 x 9.5 | 150 | 95 | 16 | \$1520 |
| KBT3620NLLQ8CG | 22 x 36 x 9.5 | 125 | 80 | 13 | \$1380 |
| KBT3020NLLQ8CG | 22 x 30 x 9.5 | 150 | 65 | 11 | \$1350 |

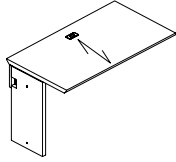

Linking Bridge - Left

To join corner worksurface to desk or credenza. 8" back panel.

| | | | | | |
|----------------|---------------|-----|-----|----|--------|
| KBT6022NLRQ8CG | 24 x 60 x 9.5 | 125 | 145 | 24 | \$2462 |
| KBT5422NLRQ8CG | 24 x 54 x 9.5 | 150 | 131 | 22 | \$2220 |
| KBT4822NLRQ8CG | 24 x 48 x 9.5 | 125 | 116 | 19 | \$1972 |
| KBT4222NLRQ8CG | 24 x 42 x 9.5 | 125 | 102 | 17 | \$1591 |
| KBT3622NLRQ8CG | 24 x 36 x 9.5 | 150 | 87 | 15 | \$1449 |
| KBT3022NLRQ8CG | 24 x 30 x 9.5 | 125 | 73 | 12 | \$1417 |

| | | | | | |
|----------------|---------------|-----|-----|----|--------|
| KBT6020NLRQ8CG | 22 x 60 x 9.5 | 150 | 131 | 22 | \$2343 |
| KBT5420NLRQ8CG | 22 x 54 x 9.5 | 150 | 118 | 20 | \$2111 |
| KBT4820NLRQ8CG | 22 x 48 x 9.5 | 125 | 110 | 18 | \$1877 |
| KBT4220NLRQ8CG | 22 x 42 x 9.5 | 150 | 95 | 16 | \$1520 |
| KBT3620NLRQ8CG | 22 x 36 x 9.5 | 125 | 80 | 13 | \$1380 |
| KBT3020NLRQ8CG | 22 x 30 x 9.5 | 150 | 65 | 11 | \$1350 |

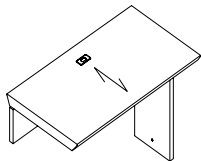

Linking Bridge - Right

To join corner worksurface to desk or credenza. 8" back panel.

| | | | | | |
|----------|--------------|-----|-----|----|--------|
| KE484822 | 48 x 48 x 29 | 150 | 201 | 39 | \$3932 |
| KE424222 | 42 x 42 x 29 | 150 | 155 | 30 | \$3018 |
| KE363622 | 36 x 36 x 29 | 125 | 135 | 22 | \$2866 |

| | | | | | |
|----------|--------------|-----|-----|----|--------|
| KE484820 | 48 x 48 x 29 | 150 | 196 | 39 | \$3932 |
| KE424220 | 42 x 42 x 29 | 150 | 150 | 30 | \$3018 |
| KE363620 | 36 x 36 x 29 | 150 | 130 | 22 | \$2866 |

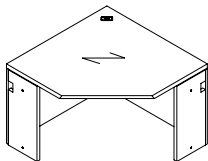

Corner Table

Connects to linking returns and linking bridges. 2 recessed end panels.

| | | | | | |
|-----------|--------------|-----|-----|----|--------|
| KEK484822 | 48 x 48 x 29 | 150 | 201 | 39 | \$4527 |
| KEK424222 | 42 x 42 x 29 | 150 | 155 | 30 | \$3464 |
| KEK363622 | 36 x 36 x 29 | 125 | 135 | 22 | \$3292 |

| | | | | | |
|-----------|--------------|-----|-----|----|--------|
| KEK484820 | 48 x 48 x 29 | 150 | 196 | 39 | \$4527 |
| KEK424220 | 42 x 42 x 29 | 150 | 150 | 30 | \$3464 |
| KEK363620 | 36 x 36 x 29 | 150 | 130 | 22 | \$3292 |

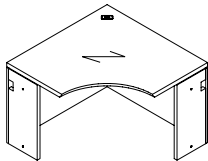

Corner Table

Connects to linking returns and linking bridges. 2 recessed end panels and inner curve.

Required Specifications

Finish
Edge

Optional Specifications

Additional grommet

CORNER COMPONENTS

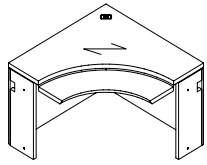

Corner Table

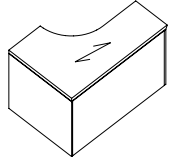

Extended Corner Table - Left

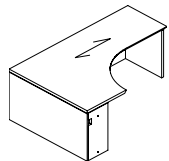

Extended Corner Table - Right

| MODEL# | DIMENSIONS D x W x H | FREIGHT CLASS | WT./LBS. | CUBIC FT. | LIST PRICE |
|------------|-------------------------|---------------|----------|-----------|---------------|
| KEKS484822 | 48 x 48 x 29 | 150 | 201 | 39 | \$7516 |
| KEKS424222 | 42 x 42 x 29 | 150 | 155 | 30 | \$6296 |
| KEKS363622 | 36 x 36 x 29 | 125 | 135 | 22 | \$6096 |
| KEKS484820 | 48 x 48 x 29 | 150 | 196 | 39 | \$7516 |
| KEKS424220 | 42 x 42 x 29 | 150 | 150 | 30 | \$6296 |
| KEKS363620 | 36 x 36 x 29 | 150 | 130 | 22 | \$6096 |

Connects to linking returns and linking bridges. 2 recessed end panels and inner curve. Adjustable keyboard tray and an articulating arm.

| | | | | | |
|------------|--------------|-----|-----|----|---------------|
| KEKL964822 | 48 x 97 x 29 | 150 | 387 | 77 | \$7039 |
| KEKL904822 | 48 x 91 x 29 | 150 | 363 | 73 | \$6644 |
| KEKL844822 | 48 x 85 x 29 | 150 | 338 | 68 | \$6566 |
| KEKL784822 | 48 x 79 x 29 | 150 | 314 | 63 | \$6534 |
| KEKL724822 | 48 x 73 x 29 | 150 | 290 | 58 | \$6208 |
| KEKL664822 | 48 x 67 x 29 | 150 | 266 | 52 | \$5789 |
| KEKL604822 | 48 x 61 x 29 | 150 | 242 | 48 | \$5113 |

24" return connection.

| | | | | | |
|------------|--------------|-----|-----|----|---------------|
| KEKR489622 | 48 x 97 x 29 | 150 | 387 | 77 | \$7039 |
| KEKR489022 | 48 x 91 x 29 | 150 | 363 | 73 | \$6644 |
| KEKR488422 | 48 x 85 x 29 | 150 | 338 | 68 | \$6566 |
| KEKR487822 | 48 x 79 x 29 | 150 | 314 | 63 | \$6534 |
| KEKR487222 | 48 x 73 x 29 | 150 | 290 | 58 | \$6208 |
| KEKR486622 | 48 x 67 x 29 | 150 | 266 | 52 | \$5789 |
| KEKR486022 | 48 x 61 x 29 | 150 | 242 | 48 | \$5113 |

24" return connection.

Required Specifications

Finish
Edge

Optional Specifications

Additional grommet

LINKING RETURNS

MODEL# DIMENSIONS FREIGHT CLASS WT/LBS. CUBIC FT. LIST PRICE

D x W x H

| | | | | | |
|-----------|--------------|-----|-----|----|--------|
| KVL9622CG | 23 x 97 x 29 | 150 | 200 | 39 | \$4532 |
| KVL9022CG | 23 x 91 x 29 | 150 | 187 | 36 | \$4246 |
| KVL8422CG | 23 x 85 x 29 | 150 | 174 | 34 | \$3964 |
| KVL7822CG | 23 x 79 x 29 | 150 | 162 | 31 | \$3682 |
| KVL7222CG | 23 x 73 x 29 | 150 | 149 | 29 | \$3398 |
| KVL6622CG | 23 x 67 x 29 | 150 | 141 | 27 | \$3186 |
| KVL6022CG | 23 x 61 x 29 | 150 | 132 | 24 | \$2980 |
| KVL5422CG | 23 x 55 x 29 | 150 | 121 | 22 | \$2812 |
| KVL4822CG | 23 x 49 x 29 | 125 | 115 | 19 | \$2642 |
| KVL4222CG | 23 x 43 x 29 | 150 | 99 | 17 | \$2229 |
| KVL3622CG | 23 x 37 x 29 | 150 | 83 | 15 | \$2150 |
| KVL3022CG | 23 x 31 x 29 | 125 | 77 | 12 | \$2111 |
| KVL2422CG | 23 x 23 x 29 | 125 | 61 | 10 | \$1768 |

| | | | | | |
|-----------|--------------|-----|-----|----|--------|
| KVL9620CG | 21 x 97 x 29 | 150 | 187 | 39 | \$4315 |
| KVL9020CG | 21 x 91 x 29 | 150 | 175 | 36 | \$4044 |
| KVL8420CG | 21 x 85 x 29 | 150 | 163 | 34 | \$3778 |
| KVL7820CG | 21 x 79 x 29 | 150 | 152 | 31 | \$3506 |
| KVL7220CG | 21 x 73 x 29 | 150 | 140 | 29 | \$3239 |
| KVL6620CG | 21 x 67 x 29 | 150 | 133 | 27 | \$3036 |
| KVL6020CG | 21 x 61 x 29 | 150 | 125 | 24 | \$2840 |
| KVL5420CG | 21 x 55 x 29 | 150 | 113 | 22 | \$2678 |
| KVL4820CG | 21 x 49 x 29 | 150 | 110 | 19 | \$2514 |
| KVL4220CG | 21 x 43 x 29 | 150 | 95 | 17 | \$2123 |
| KVL3620CG | 21 x 37 x 29 | 150 | 80 | 15 | \$2044 |
| KVL3020CG | 21 x 31 x 29 | 125 | 75 | 12 | \$2010 |
| KVL2420CG | 21 x 23 x 29 | 125 | 60 | 10 | \$1686 |

To be used with corner unit.

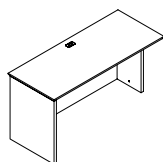

Linking Return - Left

| | | | | | |
|-----------|--------------|-----|-----|----|--------|
| KVR9622CG | 23 x 97 x 29 | 150 | 200 | 39 | \$4532 |
| KVR9022CG | 23 x 91 x 29 | 150 | 187 | 36 | \$4246 |
| KVR8422CG | 23 x 85 x 29 | 150 | 174 | 34 | \$3964 |
| KVR7822CG | 23 x 79 x 29 | 150 | 162 | 31 | \$3682 |
| KVR7222CG | 23 x 73 x 29 | 150 | 149 | 29 | \$3398 |
| KVR6622CG | 23 x 67 x 29 | 150 | 141 | 27 | \$3186 |
| KVR6022CG | 23 x 61 x 29 | 150 | 132 | 24 | \$2980 |
| KVR5422CG | 23 x 55 x 29 | 150 | 121 | 22 | \$2812 |
| KVR4822CG | 23 x 49 x 29 | 125 | 115 | 19 | \$2642 |
| KVR4222CG | 23 x 43 x 29 | 150 | 99 | 17 | \$2229 |
| KVR3622CG | 23 x 37 x 29 | 150 | 83 | 15 | \$2150 |
| KVR3022CG | 23 x 31 x 29 | 125 | 77 | 12 | \$2111 |
| KVR2422CG | 23 x 23 x 29 | 125 | 61 | 10 | \$1768 |

| | | | | | |
|-----------|--------------|-----|-----|----|--------|
| KVR9620CG | 21 x 97 x 29 | 150 | 187 | 39 | \$4315 |
| KVR9020CG | 21 x 91 x 29 | 150 | 175 | 36 | \$4044 |
| KVR8420CG | 21 x 85 x 29 | 150 | 163 | 34 | \$3778 |
| KVR7820CG | 21 x 79 x 29 | 150 | 152 | 31 | \$3506 |
| KVR7220CG | 21 x 73 x 29 | 150 | 140 | 29 | \$3239 |
| KVR6620CG | 21 x 67 x 29 | 150 | 133 | 27 | \$3036 |
| KVR6020CG | 21 x 61 x 29 | 150 | 125 | 24 | \$2840 |
| KVR5420CG | 21 x 55 x 29 | 150 | 113 | 22 | \$2678 |
| KVR4820CG | 21 x 49 x 29 | 150 | 110 | 19 | \$2514 |
| KVR4220CG | 21 x 43 x 29 | 150 | 95 | 17 | \$2123 |
| KVR3620CG | 21 x 37 x 29 | 150 | 80 | 15 | \$2044 |
| KVR3020CG | 21 x 31 x 29 | 125 | 75 | 12 | \$2010 |
| KVR2420CG | 21 x 23 x 29 | 125 | 60 | 10 | \$1686 |

To be used with corner unit.

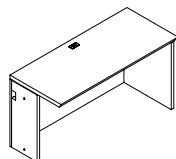

Linking Return - Right

Required Specifications

Finish
Edge

Optional Specifications

Additional grommet

CORNER COMPONENTS

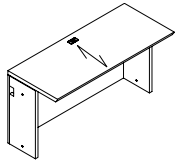

Center Surface*

| MODEL# | DIMENSIONS D x W x H | FREIGHT CLASS | WT/LBS. | CUBIC FT. | LIST PRICE |
|----------|-------------------------|---------------|---------|-----------|------------|
| KV9622CG | 24 x 96 x 29 | 150 | 197 | 39 | \$4426 |
| KV9022CG | 24 x 90 x 29 | 150 | 185 | 36 | \$4152 |
| KV8422CG | 24 x 84 x 29 | 150 | 173 | 34 | \$3871 |
| KV7822CG | 24 x 78 x 29 | 150 | 160 | 31 | \$3592 |
| KV7222CG | 24 x 72 x 29 | 150 | 145 | 29 | \$3318 |
| KV6622CG | 24 x 66 x 29 | 150 | 136 | 27 | \$3111 |
| KV6022CG | 24 x 60 x 29 | 150 | 123 | 24 | \$2904 |
| KV5422CG | 24 x 54 x 29 | 150 | 119 | 22 | \$2733 |
| KV4822CG | 24 x 48 x 29 | 150 | 107 | 19 | \$2565 |
| KV4222CG | 24 x 42 x 29 | 150 | 91 | 17 | \$2363 |
| KV3622CG | 24 x 36 x 29 | 150 | 76 | 15 | \$2150 |
| KV3022CG | 24 x 30 x 29 | 150 | 70 | 12 | \$2028 |
| KV2422CG | 24 x 24 x 29 | 150 | 53 | 10 | \$1704 |
| | | | | | |
| KV9620CG | 22 x 96 x 29 | 150 | 181 | 35 | \$4219 |
| KV9020CG | 22 x 90 x 29 | 150 | 169 | 33 | \$3956 |
| KV8420CG | 22 x 84 x 29 | 150 | 157 | 31 | \$3689 |
| KV7820CG | 22 x 78 x 29 | 150 | 145 | 29 | \$3425 |
| KV7220CG | 22 x 72 x 29 | 150 | 133 | 27 | \$3161 |
| KV6620CG | 22 x 66 x 29 | 150 | 126 | 24 | \$2964 |
| KV6020CG | 22 x 60 x 29 | 150 | 118 | 22 | \$2767 |
| KV5420CG | 22 x 54 x 29 | 150 | 111 | 20 | \$2602 |
| KV4820CG | 22 x 48 x 29 | 150 | 103 | 18 | \$2440 |
| KV4220CG | 22 x 42 x 29 | 150 | 88 | 16 | \$2044 |
| KV3620CG | 22 x 36 x 29 | 150 | 73 | 13 | \$1972 |
| KV3020CG | 22 x 30 x 29 | 125 | 68 | 11 | \$1933 |
| KV2420CG | 22 x 24 x 29 | 150 | 52 | 9 | \$1622 |

With recessed end panels.

MODULAR STORAGE - NOTES

- All storage components are shipped assembled
- Components 28" high are intended for use with a desk, credenza or return shell
- Backs on 28" high pedestals and cabinets are unfinished. If finished back is required, see page 241.
- If a profiled top is required, see "Freestanding Storage" on page 250.
- If Handle is not specified Routed Pull, Black Lock & Grommet are standard
- If Handle is specified:
 - Black and Brass handle = Black Lock & Grommet
 - Silver, Nickel and Tungsten handle = Tungsten Lock & Grommet

MODULAR STORAGE

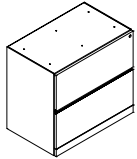

Modular Lateral File**

| MODEL# | DIMENSIONS | FREIGHT CLASS | WT/LBS. | CUBIC FT. | LIST PRICE |
|--------|----------------|---------------|---------|-----------|------------|
| KWF | 19 x 35.1 x 28 | 92.5 | 115 | 11 | \$3201 |
| KWN | 19 x 30 x 28 | 92.5 | 96 | 9 | \$2801 |
| KWF.5 | 19 x 34.5 x 28 | 92.5 | 115 | 11 | \$3201 |

Units with ".5" at end of code are intended to be used if a Full Storage Credenza is to be created. For Single Pedestal installations either style can be used.

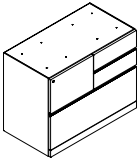

Modular Combination Storage - Left**

| | | | | | |
|--------|----------------|------|-----|----|--------|
| KWZL | 19 x 35.1 x 28 | 92.5 | 115 | 11 | \$3717 |
| KWZL.5 | 19 x 34.5 x 28 | 92.5 | 115 | 11 | \$3717 |

1 lateral file, 2 box drawers top right, and 1 file top left.

- Units with ".5" at end of code are intended to be used if a Full Storage Credenza is to be created. For Single Pedestal installations either style can be used.

Required Specifications

Finish
Edge*

Optional Specifications

Handles**
Additional grommet

DESKS

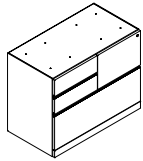

Modular Combination Storage - Right*

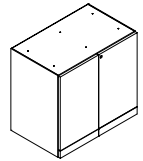

Modular Storage Cabinet w/Doors*

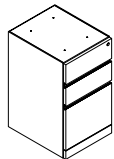

Modular Pedestal*

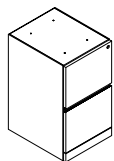

Modular Pedestal*

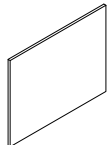

Finished Back

| MODEL# | DIMENSIONS | FREIGHT CLASS | WT/LBS. | CUBIC FT. | LIST PRICE |
|--------|------------|---------------|---------|-----------|------------|
|--------|------------|---------------|---------|-----------|------------|

D x W x H

| | | | | | |
|--------|----------------|------|-----|----|---------------|
| KWZR | 19 x 35.1 x 28 | 92.5 | 115 | 11 | \$3717 |
| KWZR.5 | 19 x 34.5 x 28 | 92.5 | 115 | 11 | \$3717 |

1 lateral file, 2 box drawers top left, and 1 file top right.

- Units with ".5" at end of code are intended to be used if a Full Storage Credenza is to be created. For Single Pedestal installations either style can be used.

| | | | | | |
|-------|----------------|------|-----|----|---------------|
| KWG | 19 x 35.1 x 28 | 92.5 | 115 | 11 | \$2231 |
| KWM | 19 x 30 x 28 | 92.5 | 96 | 9 | \$1881 |
| KWG.5 | 19 x 34.5 x 28 | 92.5 | 115 | 11 | \$2231 |

Storage with 1 adjustable shelf.

- Units with ".5" at end of code are intended to be used if a Full Storage Credenza is to be created. For Single Pedestal installations either style can be used.

Letter width:

| | | | | | |
|------|----------------|----|----|---|---------------|
| KWWD | 23 x 15.6 x 28 | 85 | 72 | 6 | \$2472 |
| KWD | 19 x 15.6 x 28 | 85 | 70 | 5 | \$2153 |

Legal width:

| | | | | | |
|-------|----------------|----|----|---|---------------|
| KWWLD | 23 x 18.5 x 28 | 85 | 85 | 7 | \$2967 |
| KWLD | 19 x 18.5 x 28 | 85 | 83 | 6 | \$2581 |

Box/box/file pedestal.

Letter width:

| | | | | | |
|------|----------------|----|----|---|---------------|
| KWWE | 23 x 15.6 x 28 | 85 | 72 | 6 | \$2472 |
| KWE | 19 x 15.6 x 28 | 85 | 70 | 5 | \$2153 |

Legal width:

| | | | | | |
|-------|----------------|----|----|---|---------------|
| KWWLE | 23 x 18.5 x 28 | 85 | 85 | 7 | \$2967 |
| KWLE | 19 x 18.5 x 28 | 85 | 83 | 6 | \$2581 |

File/file pedestal.

| | | | | | |
|-------|-------------------|-----|----|---|--------------|
| KBA36 | 0.8 x 35 x 27.5 | 125 | 18 | 3 | \$467 |
| KBA30 | 0.8 x 30 x 27.5 | 150 | 15 | 3 | \$388 |
| KBA18 | 0.8 x 18.5 x 27.5 | 150 | 10 | 2 | \$226 |
| KBA15 | 0.8 x 15.5 x 27.5 | 150 | 8 | 2 | \$196 |

For modular pedestals.

Required Specifications

Finish

Optional Specifications

Handles*

HUTCHES & WALL MOUNTED STORAGE NOTES

Hutches

- All hutches are shipped assembled
- Handles can be specified for hutches with wood doors.
- Handles cannot be specified on Aluminum framed glass doors.
- Frosted glass door is standard. White back painted clear glass is available, please contact customer care.

Closed pigeon hole storage hutch

- 42" unit has 21.5" of clearance

NOTE: Arrow indicates direction of grain

Edge options - must specify:

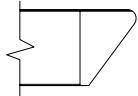

K16

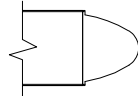

K18

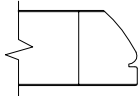

K21

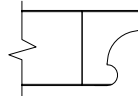

K22

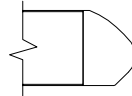

K29

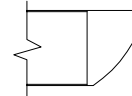

K30

Closed storage hutch

- 36" unit has 19.5" of clearance.
- 42" and 54" units have 25.5" of clearance
- For lock option, see page 264

Tasklight

- For proper size, see page 264.
- If Handle is specified:
 - Black and Brass handle = Black Lock & Grommet
 - Silver, Nickel and Tungsten handle = Tungsten Lock & Grommet

HUTCHES & WALL MOUNTED STORAGE

MODEL#

DIMENSIONS

FREIGHT CLASS

WT/LBS.

CUBIC FT.

LIST PRICE

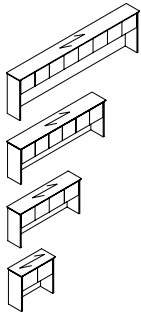

36" H Storage Hutch w/Wood Doors*

| | | | | | |
|----------|---------------|-----|-----|----|---------------|
| K108SH36 | 16 x 110 x 36 | 125 | 268 | 34 | \$7296 |
| K102SH36 | 16 x 104 x 36 | 125 | 254 | 32 | \$6891 |
| K96SH36 | 16 x 98 x 36 | 100 | 241 | 30 | \$6378 |
| K90SH36 | 16 x 92 x 36 | 100 | 227 | 28 | \$6078 |
| K84SH36 | 16 x 86 x 36 | 100 | 214 | 26 | \$5673 |
| K78SH36 | 16 x 80 x 36 | 100 | 200 | 24 | \$5269 |
| K72SH36 | 16 x 74 x 36 | 100 | 187 | 23 | \$4861 |
| K66SH36 | 16 x 68 x 36 | 100 | 173 | 21 | \$4677 |
| K60SH36 | 16 x 62 x 36 | 100 | 160 | 19 | \$4459 |
| K36SH36 | 16 x 38 x 36 | 100 | 94 | 11 | \$3040 |
| K30SH36 | 16 x 32 x 36 | 100 | 78 | 9 | \$2661 |

Hutches longer than 102" have 8 doors, hutches between 102" and 86" have 6 doors, hutches between 80" and 62" have 4 doors, and 32" and 38" hutches have 2 doors. Locks are optional.

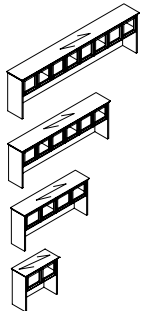

36" H Storage Hutch w/Glass Doors

| | | | | | |
|-----------|---------------|-----|-----|----|----------------|
| K108SH36G | 16 x 110 x 36 | 125 | 268 | 34 | \$10607 |
| K102SH36G | 16 x 104 x 36 | 125 | 254 | 32 | \$9521 |
| K96SH36G | 16 x 98 x 36 | 100 | 241 | 30 | \$9079 |
| K90SH36G | 16 x 92 x 36 | 100 | 227 | 28 | \$8633 |
| K84SH36G | 16 x 86 x 36 | 100 | 214 | 26 | \$8194 |
| K78SH36G | 16 x 80 x 36 | 100 | 200 | 24 | \$7759 |
| K72SH36G | 16 x 74 x 36 | 100 | 187 | 23 | \$6643 |
| K66SH36G | 16 x 68 x 36 | 100 | 173 | 21 | \$6462 |
| K60SH36G | 16 x 62 x 36 | 100 | 160 | 19 | \$6134 |
| K36SH36G | 16 x 38 x 36 | 100 | 94 | 11 | \$3923 |
| K30SH36G | 16 x 32 x 36 | 100 | 78 | 9 | \$3496 |

Aluminum framed glass doors. Hutches longer than 102" have 8 doors, hutches between 102" and 86" have 6 doors, hutches between 80" and 62" have 4 doors, and 32" and 38" hutches have 2 doors. No lock option available.

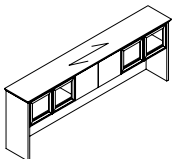

36" H Storage Hutch w/Doors*

| | | | | | |
|-------------|--------------|-----|-----|----|---------------|
| K102SH36GDG | 16 x 104 x 3 | 125 | 254 | 32 | \$8563 |
| K96SH36GDG | 16 x 98 x 36 | 100 | 241 | 30 | \$8157 |
| K90SH36GDG | 16 x 92 x 36 | 100 | 227 | 28 | \$7751 |
| K84SH36GDG | 16 x 86 x 36 | 100 | 214 | 26 | \$7000 |

Wood doors in the center and Aluminum framed glass doors on left and right. Locks are optional on wood doors.

Required Specifications

Finish
Edge

Optional Specifications

Handles* (wood doors only)
Locks* (wood doors only)

HUTCHES & WALL MOUNTED STORAGE

MODEL# DIMENSIONS FREIGHT CLASS WT/LBS. CUBIC FT. LIST PRICE

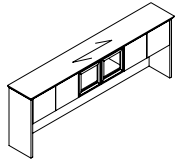

36" H Storage Hutch w/Doors*

| | D x W x H | | | | | |
|-------------|--------------|-----|-----|----|---------------|--|
| K102SH36DGD | 16 x 104 x 3 | 125 | 254 | 32 | \$8563 | |
| K96SH36DGD | 16 x 98 x 36 | 100 | 241 | 30 | \$7105 | |
| K90SH36DGD | 16 x 92 x 36 | 100 | 227 | 28 | \$6910 | |
| K84SH36DGD | 16 x 86 x 36 | 100 | 214 | 26 | \$6507 | |

Aluminum framed glass doors in the center and wood doors on left and right. Locks are optional on wood doors.

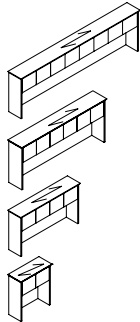

42" H Storage Hutch w/Wood Doors*

| | | | | | | |
|----------|---------------|-----|-----|----|---------------|--|
| K108SH42 | 16 x 110 x 43 | 125 | 307 | 39 | \$8507 | |
| K102SH42 | 16 x 104 x 43 | 125 | 290 | 37 | \$8030 | |
| K96SH42 | 16 x 98 x 43 | 125 | 273 | 35 | \$7563 | |
| K90SH42 | 16 x 92 x 43 | 125 | 256 | 33 | \$7089 | |
| K84SH42 | 16 x 86 x 43 | 125 | 239 | 31 | \$6614 | |
| K78SH42 | 16 x 80 x 43 | 150 | 222 | 38 | \$6148 | |
| K72SH42 | 16 x 74 x 43 | 125 | 205 | 26 | \$5673 | |
| K66SH42 | 16 x 68 x 43 | 125 | 188 | 24 | \$5458 | |
| K60SH42 | 16 x 62 x 43 | 125 | 171 | 22 | \$5200 | |
| K36SH42 | 16 x 38 x 43 | 125 | 102 | 13 | \$3549 | |
| K30SH42 | 16 x 32 x 43 | 125 | 85 | 11 | \$3105 | |

Hutches longer than 102" have 8 doors, hutches between 102" and 86" have 6 doors, hutches between 80" and 62" have 4 doors, and 32" and 38" hutches have 2 doors. Locks are optional.

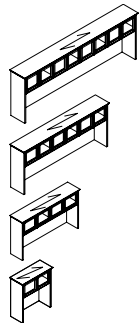

42" H Storage Hutch w/Glass Doors

| | | | | | | |
|-----------|---------------|-----|-----|----|----------------|--|
| K108SH42G | 16 x 110 x 43 | 125 | 307 | 39 | \$11821 | |
| K102SH42G | 16 x 104 x 43 | 125 | 290 | 37 | \$10665 | |
| K96SH42G | 16 x 98 x 43 | 125 | 273 | 35 | \$10156 | |
| K90SH42G | 16 x 92 x 43 | 125 | 256 | 33 | \$9649 | |
| K84SH42G | 16 x 86 x 43 | 125 | 239 | 31 | \$9140 | |
| K78SH42G | 16 x 80 x 43 | 150 | 222 | 38 | \$8632 | |
| K72SH42G | 16 x 74 x 43 | 125 | 205 | 26 | \$7453 | |
| K66SH42G | 16 x 68 x 43 | 125 | 188 | 24 | \$7190 | |
| K60SH42G | 16 x 62 x 43 | 125 | 171 | 22 | \$6934 | |
| K36SH42G | 16 x 38 x 43 | 125 | 102 | 13 | \$4431 | |
| K30SH42G | 16 x 32 x 43 | 125 | 85 | 11 | \$3941 | |

Aluminum framed glass doors. Hutches longer than 102" have 8 doors, hutches between 102" and 86" have 6 doors, hutches between 80" and 62" have 4 doors, and 32" and 38" hutches have 2 doors. Lock option not available.

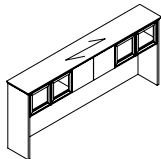

42" H Storage Hutch w/Doors*

| | | | | | | |
|-------------|---------------|-----|-----|----|----------------|--|
| K102SH42GDG | 16 x 104 x 43 | 125 | 290 | 37 | \$11126 | |
| K96SH42GDG | 16 x 98 x 43 | 125 | 273 | 35 | \$10472 | |
| K90SH42GDG | 16 x 92 x 43 | 125 | 256 | 33 | \$9819 | |
| K84SH42GDG | 16 x 86 x 43 | 125 | 239 | 31 | \$9163 | |

Wood doors in the center and Aluminum framed glass doors on left and right. Locks are optional on wood doors.

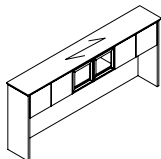

42" H Storage Hutch w/Doors*

| | | | | | | |
|-------------|---------------|-----|-----|----|---------------|--|
| K102SH42DGD | 16 x 104 x 43 | 125 | 290 | 37 | \$9313 | |
| K96SH42DGD | 16 x 98 x 43 | 125 | 273 | 35 | \$8396 | |
| K90SH42DGD | 16 x 92 x 43 | 125 | 256 | 33 | \$7923 | |
| K84SH42DGD | 16 x 86 x 43 | 125 | 239 | 31 | \$7453 | |

Aluminum framed glass doors in the center and wood doors on left and right. Locks are optional on wood doors.

Required Specifications

Finish
Edge

Optional Specifications

Handles* (wood doors only)
Locks* (wood doors only)

HUTCHES & WALL MOUNTED STORAGE

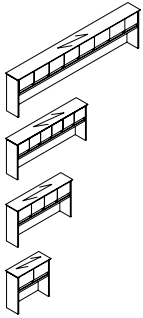

42" H Storage Hutch w/Wood Doors & Pigeon-Holes

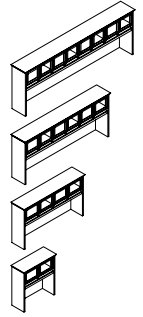

42" H Storage Hutch w/Glass Doors & Pigeon-Holes

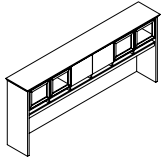

42" H Storage Hutch w/Doors & Pigeon-Holes

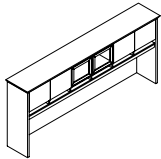

42" H Storage Hutch w/Doors & Pigeon-Holes

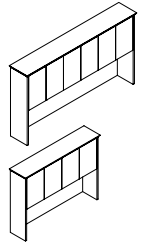

54" H Storage Hutch w/Wood Doors*

| MODEL# | DIMENSIONS D x W x H | FREIGHT CLASS | WT/LBS. | CUBIC FT. | LIST PRICE |
|-----------|-------------------------|---------------|---------|-----------|----------------|
| K108SHP42 | 16 x 110 x 43 | 125 | 307 | 39 | \$10203 |
| K102SHP42 | 16 x 104 x 43 | 125 | 290 | 37 | \$9641 |
| K96SHP42 | 16 x 98 x 43 | 125 | 273 | 35 | \$9072 |
| K90SHP42 | 16 x 92 x 43 | 125 | 256 | 33 | \$8507 |
| K84SHP42 | 16 x 86 x 43 | 125 | 239 | 31 | \$7939 |
| K78SHP42 | 16 x 80 x 43 | 150 | 222 | 38 | \$7370 |
| K72SHP42 | 16 x 74 x 43 | 125 | 205 | 26 | \$6806 |
| K66SHP42 | 16 x 68 x 43 | 125 | 188 | 24 | \$6554 |
| K60SHP42 | 16 x 62 x 43 | 125 | 171 | 22 | \$6239 |
| K36SHP42 | 16 x 38 x 43 | 125 | 102 | 13 | \$4259 |
| K30SHP42 | 16 x 32 x 43 | 125 | 85 | 11 | \$3727 |

Hutches longer than 102" have 8 doors, hutches between 102" and 86" have 6 doors, hutches between 80" and 62" have 4 doors, and 32" and 38" hutches have 2 doors. Locks are optional.

| | | | | | |
|------------|---------------|-----|-----|----|----------------|
| K108SHP42G | 16 x 110 x 43 | 125 | 307 | 39 | \$13445 |
| K102SHP42G | 16 x 104 x 43 | 125 | 290 | 37 | \$12208 |
| K96SHP42G | 16 x 98 x 43 | 125 | 273 | 35 | \$11633 |
| K90SHP42G | 16 x 92 x 43 | 125 | 256 | 33 | \$11598 |
| K84SHP42G | 16 x 86 x 43 | 125 | 239 | 31 | \$10387 |
| K78SHP42G | 16 x 80 x 43 | 150 | 222 | 38 | \$9792 |
| K72SHP42G | 16 x 74 x 43 | 125 | 205 | 26 | \$8539 |
| K66SHP42G | 16 x 68 x 43 | 125 | 188 | 24 | \$8269 |
| K60SHP42G | 16 x 62 x 43 | 125 | 171 | 22 | \$7870 |
| K36SHP42G | 16 x 38 x 43 | 125 | 102 | 13 | \$5113 |
| K30SHP42G | 16 x 32 x 43 | 125 | 85 | 11 | \$4563 |

Aluminum framed glass doors. Hutches longer than 102" have 8 doors, hutches between 102" and 86" have 6 doors, hutches between 80" and 62" have 4 doors, and 32" and 38" hutches have 2 doors. No lock option available.

| | | | | | |
|--------------|---------------|-----|-----|----|----------------|
| K102SHP42GDG | 16 x 104 x 43 | 125 | 290 | 37 | \$11269 |
| K96SHP42GDG | 16 x 98 x 43 | 125 | 273 | 35 | \$10700 |
| K90SHP42GDG | 16 x 92 x 43 | 125 | 256 | 33 | \$10139 |
| K84SHP42GDG | 16 x 86 x 43 | 125 | 239 | 31 | \$9114 |

Wood doors in the center and Aluminum framed glass doors on left and right. Locks are optional on wood doors.

| | | | | | |
|--------------|---------------|-----|-----|----|----------------|
| K102SHP42DGD | 16 x 104 x 43 | 125 | 290 | 37 | \$10477 |
| K96SHP42DGD | 16 x 98 x 43 | 125 | 273 | 35 | \$9415 |
| K90SHP42DGD | 16 x 92 x 43 | 125 | 256 | 33 | \$8978 |
| K84SHP42DGD | 16 x 86 x 43 | 125 | 239 | 31 | \$8755 |

Aluminum framed glass doors in the center and wood doors on left and right. Locks are optional on wood doors.

| | | | | | |
|----------|--------------|-----|-----|----|---------------|
| K962SH54 | 16 x 98 x 55 | 125 | 351 | 45 | \$9723 |
| K902SH54 | 16 x 92 x 55 | 125 | 329 | 42 | \$9114 |
| K842SH54 | 16 x 86 x 55 | 125 | 307 | 39 | \$8507 |
| K782SH54 | 16 x 80 x 55 | 125 | 285 | 37 | \$7898 |
| K722SH54 | 16 x 74 x 55 | 125 | 263 | 34 | \$7290 |
| K662SH54 | 16 x 68 x 55 | 125 | 241 | 31 | \$7017 |
| K602SH54 | 16 x 62 x 55 | 125 | 219 | 28 | \$6682 |

Hutches between 98" and 86" have 6 doors; hutches less than 86" have 4 doors. One adjustable shelf. Locks are optional.

Required Specifications

Finish
Edge

Optional Specifications

Handles* (wood doors only)
Locks* (wood doors only)

HUTCHES & WALL MOUNTED STORAGE

MODEL# DIMENSIONS FREIGHT CLASS WT/LBS. CUBIC FT. LIST PRICE

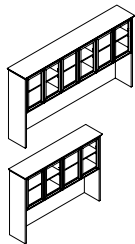

54" H Storage Hutch w/Glass Doors

| D x W x H | | | | | | |
|-----------|--------------|-----|-----|----|--|----------------|
| K962SH54G | 16 x 98 x 55 | 125 | 351 | 45 | | \$12972 |
| K902SH54G | 16 x 92 x 55 | 125 | 329 | 42 | | \$12082 |
| K842SH54G | 16 x 86 x 55 | 125 | 307 | 39 | | \$11187 |
| K782SH54G | 16 x 80 x 55 | 125 | 285 | 37 | | \$10291 |
| K722SH54G | 16 x 74 x 55 | 125 | 263 | 34 | | \$9402 |
| K662SH54G | 16 x 68 x 55 | 125 | 241 | 31 | | \$9063 |
| K602SH54G | 16 x 62 x 55 | 125 | 219 | 28 | | \$8663 |

Aluminum framed glass doors. Hutches between 98" and 86" have 6 doors; hutches less than 86" have 4 doors. One adjustable shelf. No lock option available.

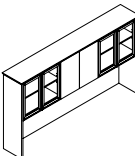

54" H Storage Hutch w/Doors*

| | | | | | | |
|-------------|--------------|-----|-----|----|--|----------------|
| K962SH54GDG | 16 x 98 x 55 | 125 | 351 | 45 | | \$11702 |
| K902SH54GDG | 16 x 92 x 55 | 125 | 329 | 42 | | \$11091 |
| K842SH54GDG | 16 x 86 x 55 | 125 | 309 | 39 | | \$10485 |

Wood doors in the center and Aluminum framed glass doors on left and right. One adjustable shelf. Locks are optional on wood doors.

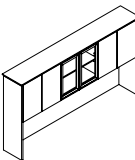

54" H Storage Hutch w/Doors*

| | | | | | | |
|-------------|--------------|-----|-----|----|--|----------------|
| K962SH54DGD | 16 x 98 x 55 | 125 | 351 | 45 | | \$10708 |
| K902SH54DGD | 16 x 92 x 55 | 125 | 329 | 42 | | \$10103 |
| K842SH54DGD | 16 x 86 x 55 | 125 | 307 | 39 | | \$9497 |

Aluminum framed glass doors in the center and wood doors on left and right. One adjustable shelf. Locks are optional on wood doors.

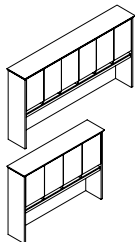

54" H Storage Hutch w/Wood Doors & Pigeon-Holes

| | | | | | | |
|-----------|--------------|-----|-----|----|--|----------------|
| K962SHP54 | 16 x 98 x 55 | 125 | 351 | 45 | | \$11669 |
| K902SHP54 | 16 x 92 x 55 | 125 | 329 | 42 | | \$10933 |
| K842SHP54 | 16 x 86 x 55 | 125 | 307 | 39 | | \$10201 |
| K782SHP54 | 16 x 80 x 55 | 125 | 285 | 37 | | \$10201 |
| K722SHP54 | 16 x 74 x 55 | 125 | 263 | 34 | | \$8744 |
| K662SHP54 | 16 x 68 x 55 | 125 | 241 | 31 | | \$8422 |
| K602SHP54 | 16 x 62 x 55 | 125 | 219 | 28 | | \$8023 |

Hutches between 98" and 86" have 6 doors; hutches less than 86" have 4 doors. One adjustable shelf. Locks are optional.

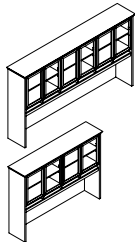

54" H Storage Hutch w/Glass Doors & Pigeon-Holes

| | | | | | | |
|------------|--------------|-----|-----|----|--|----------------|
| K962SHP54G | 16 x 98 x 55 | 125 | 351 | 45 | | \$14918 |
| K902SHP54G | 16 x 92 x 55 | 125 | 329 | 42 | | \$13903 |
| K842SHP54G | 16 x 86 x 55 | 125 | 307 | 39 | | \$12885 |
| K782SHP54G | 16 x 80 x 55 | 125 | 285 | 37 | | \$11873 |
| K722SHP54G | 16 x 74 x 55 | 125 | 263 | 34 | | \$10860 |
| K662SHP54G | 16 x 68 x 55 | 125 | 241 | 34 | | \$10469 |
| K602SHP54G | 16 x 62 x 55 | 125 | 219 | 28 | | \$10002 |

Aluminum framed glass doors. Hutches between 98" and 86" have 6 doors; hutches less than 86" have 4 doors. One adjustable shelf. No lock option available.

Required Specifications

Finish
Edge

Optional Specifications

Handles* (wood doors only)
Locks* (wood doors only)

HUTCHES & WALL MOUNTED STORAGE

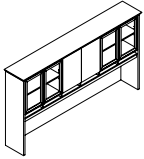

54" H Storage Hutch w/Doors & Pigeon-Holes

| MODEL# | DIMENSIONS D x W x H | FREIGHT CLASS | WT/LBS. | CUBIC FT. | LIST PRICE |
|--------------|-------------------------|---------------|---------|-----------|----------------|
| K962SHP54GDG | 16 x 98 x 55 | 125 | 351 | 45 | \$12656 |
| K902SHP54GDG | 16 x 92 x 55 | 125 | 329 | 42 | \$11926 |
| K842SHP54GDG | 16 x 86 x 55 | 125 | 307 | 39 | \$11193 |

Wood doors in the center and Aluminum framed glass doors on left and right. One adjustable shelf. Locks are optional on wood doors.

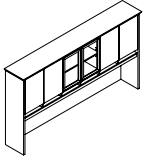

54" H Storage Hutch w/Doors &* Pigeon-Holes

| | | | | | |
|--------------|--------------|-----|-----|----|----------------|
| K962SHP54DGD | 16 x 98 x 55 | 125 | 351 | 45 | \$13645 |
| K902SHP54DGD | 16 x 92 x 55 | 125 | 329 | 42 | \$12916 |
| K842SHP54DGD | 16 x 86 x 55 | 125 | 307 | 39 | \$12184 |

Aluminum framed glass doors in the center and wood doors on left and right. One adjustable shelf. Locks are optional on wood doors.

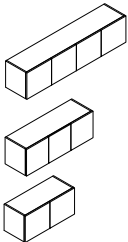

Wall Mount Storage w/Wood Doors*

| | | | | | |
|-------|------------------|------|-----|----|---------------|
| CSF72 | 15.5 x 72 x 16.5 | 92.5 | 100 | 10 | \$2270 |
| CSF66 | 15.5 x 66 x 16.5 | 100 | 83 | 9 | \$2082 |
| CSF60 | 15.5 x 60 x 16.5 | 100 | 75 | 8 | \$1887 |
| CSF54 | 15.5 x 54 x 16.5 | 100 | 68 | 7 | \$1701 |
| CSF48 | 15.5 x 48 x 16.5 | 100 | 60 | 7 | \$1512 |
| CSF42 | 15.5 x 42 x 16.5 | 100 | 55 | 6 | \$1390 |
| CSF36 | 15.5 x 36 x 16.5 | 92.5 | 50 | 5 | \$1364 |
| CSF30 | 15.5 x 30 x 16.5 | 92.5 | 45 | 4 | \$1341 |

Locks are optional.

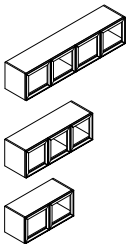

Wall Mount Storage w/Glass Doors

| | | | | | |
|--------|------------------|------|-----|----|---------------|
| CSF72G | 15.5 x 72 x 16.5 | 92.5 | 100 | 10 | \$4776 |
| CSF66G | 15.5 x 66 x 16.5 | 100 | 83 | 9 | \$4436 |
| CSF60G | 15.5 x 60 x 16.5 | 100 | 75 | 8 | \$4158 |
| CSF54G | 15.5 x 54 x 16.5 | 100 | 68 | 7 | \$3725 |
| CSF48G | 15.5 x 48 x 16.5 | 100 | 60 | 7 | \$3291 |
| CSF42G | 15.5 x 42 x 16.5 | 100 | 55 | 6 | \$2921 |
| CSF36G | 15.5 x 36 x 16.5 | 92.5 | 50 | 5 | \$2700 |
| CSF30G | 15.5 x 30 x 16.5 | 92.5 | 45 | 4 | \$2621 |

Aluminum framed glass doors. No lock option available.

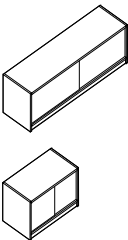

Wall Mount Storage w/Sliding Glass Doors

| | | | | | |
|----------|----------------|------|-----|----|---------------|
| CSF72GSL | 18 x 72 x 16.5 | 92.5 | 100 | 10 | \$4776 |
| CSF66GSL | 18 x 66 x 16.5 | 100 | 83 | 9 | \$4436 |
| CSF60GSL | 18 x 60 x 16.5 | 100 | 75 | 8 | \$4158 |
| CSF54GSL | 18 x 54 x 16.5 | 100 | 68 | 7 | \$3725 |
| CSF48GSL | 18 x 48 x 16.5 | 100 | 60 | 7 | \$3291 |
| CSF42GSL | 18 x 42 x 16.5 | 100 | 55 | 6 | \$2921 |
| CSF36GSL | 18 x 36 x 16.5 | 92.5 | 50 | 5 | \$2700 |
| CSF30GSL | 18 x 30 x 16.5 | 92.5 | 45 | 4 | \$2621 |

Frameless sliding glass doors. No lock option available.

Required Specifications

Finish
Edge

Optional Specifications

Handles* (wood doors only)
Locks* (wood doors only)

HUTCHES & WALL MOUNTED STORAGE

MODEL# DIMENSIONS FREIGHT CLASS WT./LBS. CUBIC FT. LIST PRICE

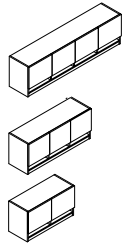

Wall Mount Storage w/Wood Doors &* Pigeon-Holes

| | D x W x H | | | | | |
|--------|----------------|------|-----|----|--|--------|
| CSFP72 | 15.5 x 72 x 20 | 92.5 | 100 | 10 | | \$2720 |
| CSFP66 | 15.5 x 66 x 20 | 100 | 83 | 9 | | \$2495 |
| CSFP60 | 15.5 x 60 x 20 | 100 | 75 | 8 | | \$2270 |
| CSFP54 | 15.5 x 54 x 20 | 100 | 68 | 7 | | \$2043 |
| CSFP48 | 15.5 x 48 x 20 | 100 | 60 | 7 | | \$1813 |
| CSFP42 | 15.5 x 42 x 20 | 100 | 55 | 6 | | \$1720 |
| CSFP36 | 15.5 x 36 x 20 | 92.5 | 50 | 5 | | \$1637 |
| CSFP30 | 15.5 x 30 x 20 | 92.5 | 45 | 4 | | \$1610 |

Locks are optional.

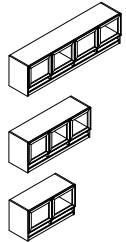

Wall Mount Storage w/Glass Doors & Pigeon-Holes

| | | | | | | |
|---------|----------------|-----|-----|----|--|--------|
| CSFP72G | 15.5 x 72 x 20 | 100 | 100 | 12 | | \$5255 |
| CSFP66G | 15.5 x 66 x 20 | 125 | 83 | 11 | | \$5025 |
| CSFP60G | 15.5 x 60 x 20 | 125 | 75 | 10 | | \$4630 |
| CSFP54G | 15.5 x 54 x 20 | 125 | 68 | 9 | | \$4319 |
| CSFP48G | 15.5 x 48 x 20 | 125 | 60 | 8 | | \$3665 |
| CSFP42G | 15.5 x 42 x 20 | 125 | 55 | 7 | | \$3192 |
| CSFP36G | 15.5 x 36 x 20 | 100 | 50 | 6 | | \$3045 |
| CSFP30G | 15.5 x 30 x 20 | 100 | 45 | 5 | | \$2966 |

Aluminum framed glass doors. No lock option available.

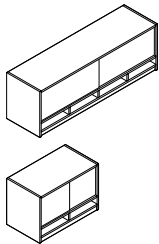

Wall Mount Storage w/Sliding Glass Doors & Pigeon-Holes

| | | | | | | |
|-----------|--------------|-----|-----|----|--|--------|
| CSFP72GSL | 18 x 72 x 20 | 100 | 100 | 12 | | \$5255 |
| CSFP66GSL | 18 x 66 x 20 | 125 | 83 | 11 | | \$5025 |
| CSFP60GSL | 18 x 60 x 20 | 125 | 75 | 10 | | \$4630 |
| CSFP54GSL | 18 x 54 x 20 | 125 | 68 | 9 | | \$4319 |
| CSFP48GSL | 18 x 48 x 20 | 125 | 60 | 8 | | \$3665 |
| CSFP42GSL | 18 x 42 x 20 | 125 | 55 | 7 | | \$3192 |
| CSFP36GSL | 18 x 36 x 20 | 100 | 50 | 6 | | \$3045 |
| CSFP30GSL | 18 x 30 x 20 | 100 | 45 | 5 | | \$2966 |

Frameless sliding glass doors. Locks are optional.

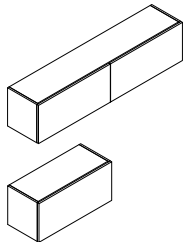

Wall Mount Storage w/Wood Flipper Doors

| | | | | | | |
|--------|------------------|------|-----|----|--|--------|
| CSFF72 | 15.5 x 72 x 16.5 | 92.5 | 100 | 10 | | \$3346 |
| CSFF66 | 15.5 x 66 x 16.5 | 100 | 83 | 9 | | \$3068 |
| CSFF60 | 15.5 x 60 x 16.5 | 100 | 75 | 8 | | \$2787 |
| CSFF54 | 15.5 x 54 x 16.5 | 100 | 68 | 7 | | \$2511 |
| CSFF48 | 15.5 x 48 x 16.5 | 100 | 60 | 7 | | \$2232 |
| CSFF42 | 15.5 x 42 x 16.5 | 100 | 55 | 6 | | \$2071 |
| CSFF36 | 15.5 x 36 x 16.5 | 92.5 | 50 | 5 | | \$2033 |
| CSFF30 | 15.5 x 30 x 16.5 | 92.5 | 45 | 4 | | \$2001 |

Locks are optional.

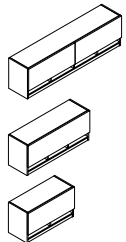

Wall Mount Storage w/Pigeon-Holes & Wood Flipper Doors

| | | | | | | |
|---------|----------------|-----|-----|----|--|--------|
| CSFFP72 | 15.5 x 72 x 20 | 100 | 100 | 12 | | \$4018 |
| CSFFP66 | 15.5 x 66 x 20 | 125 | 83 | 11 | | \$3681 |
| CSFFP60 | 15.5 x 60 x 20 | 125 | 75 | 10 | | \$3348 |
| CSFFP54 | 15.5 x 54 x 20 | 125 | 68 | 9 | | \$3010 |
| CSFFP48 | 15.5 x 48 x 20 | 125 | 60 | 8 | | \$2680 |
| CSFFP42 | 15.5 x 42 x 20 | 125 | 55 | 7 | | \$2482 |
| CSFFP36 | 15.5 x 36 x 20 | 100 | 50 | 6 | | \$2440 |
| CSFFP30 | 15.5 x 30 x 20 | 100 | 45 | 5 | | \$2397 |

Locks are optional.

Required Specifications

Finish
Edge

Optional Specifications

Handles* (wood doors only)
Locks* (wood doors only)

HUTCHES & WALL MOUNTED STORAGE

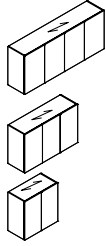

**Double High Wall Mount Storage*
w/Wood Doors**

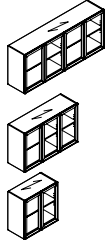

**Double High Wall Mount Storage
w/Glass Doors**

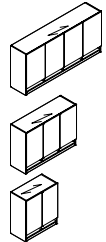

**Double High Wall Mount Storage*
w/Pigeon-Holes & Wood Doors**

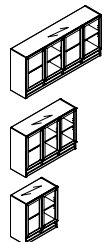

**Double High Wall Mount Storage
w/Pigeon-Holes & Glass Doors**

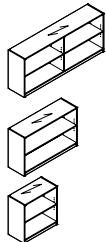

Double High Open Wall Mount Storage

| MODEL# | DIMENSIONS D x W x H | FREIGHT CLASS | WT/LBS. | CUBIC FT. | LIST PRICE |
|----------|-------------------------|---------------|---------|-----------|---------------|
| CSF72H30 | 15.5 x 72 x 30 | 100 | 140 | 17 | \$5964 |
| CSF66H30 | 15.5 x 66 x 30 | 125 | 116 | 16 | \$5473 |
| CSF60H30 | 15.5 x 60 x 30 | 125 | 105 | 14 | \$4967 |
| CSF54H30 | 15.5 x 54 x 30 | 125 | 95 | 13 | \$4470 |
| CSF48H30 | 15.5 x 48 x 30 | 125 | 85 | 12 | \$3975 |
| CSF42H30 | 15.5 x 42 x 30 | 125 | 77 | 10 | \$3650 |
| CSF36H30 | 15.5 x 36 x 30 | 125 | 70 | 9 | \$3583 |
| CSF30H30 | 15.5 x 30 x 30 | 100 | 63 | 7 | \$3520 |

Locks are optional.

| | | | | | |
|-----------|----------------|-----|------|----|---------------|
| CSF72H30G | 15.5 x 72 x 30 | 100 | 140 | 17 | \$8675 |
| CSF66H30G | 15.5 x 66 x 30 | 125 | 116 | 16 | \$8562 |
| CSF60H30G | 15.5 x 60 x 30 | 60 | 1045 | 14 | \$8029 |
| CSF54H30G | 15.5 x 54 x 30 | 125 | 95 | 13 | \$7190 |
| CSF48H30G | 15.5 x 48 x 30 | 125 | 85 | 12 | \$6352 |
| CSF42H30G | 15.5 x 42 x 30 | 125 | 77 | 10 | \$5642 |
| CSF36H30G | 15.5 x 36 x 30 | 125 | 70 | 9 | \$5213 |
| CSF30H30G | 15.5 x 30 x 30 | 100 | 63 | 7 | \$5059 |

Aluminum framed glass doors. No lock option available.

| | | | | | |
|-----------|----------------|-----|-----|----|---------------|
| CSFP72H34 | 15.5 x 72 x 34 | 100 | 140 | 17 | \$6487 |
| CSFP66H34 | 15.5 x 66 x 34 | 125 | 116 | 16 | \$5949 |
| CSFP60H34 | 15.5 x 60 x 34 | 125 | 105 | 14 | \$5414 |
| CSFP54H34 | 15.5 x 54 x 34 | 125 | 95 | 13 | \$4868 |
| CSFP48H34 | 15.5 x 48 x 34 | 125 | 85 | 12 | \$4323 |
| CSFP42H34 | 15.5 x 42 x 34 | 125 | 77 | 10 | \$4108 |
| CSFP36H34 | 15.5 x 36 x 34 | 125 | 70 | 9 | \$3897 |
| CSFP30H34 | 15.5 x 30 x 34 | 100 | 63 | 7 | \$3833 |

Locks are optional.

| | | | | | |
|------------|----------------|-----|-----|----|---------------|
| CSFP72H34G | 15.5 x 72 x 34 | 100 | 140 | 17 | \$9202 |
| CSFP66H34G | 15.5 x 66 x 34 | 125 | 116 | 16 | \$8797 |
| CSFP60H34G | 15.5 x 60 x 34 | 125 | 105 | 14 | \$8102 |
| CSFP54H34G | 15.5 x 54 x 34 | 125 | 95 | 13 | \$7557 |
| CSFP48H34G | 15.5 x 48 x 34 | 125 | 85 | 12 | \$6417 |
| CSFP42H34G | 15.5 x 42 x 34 | 125 | 77 | 10 | \$5588 |
| CSFP36H34G | 15.5 x 36 x 34 | 125 | 70 | 9 | \$5588 |
| CSFP30H34G | 15.5 x 30 x 34 | 100 | 63 | 7 | \$5188 |

Aluminum framed glass doors. No lock option available.

| | | | | | |
|-----------|----------------|-----|-----|----|---------------|
| CSFO72H30 | 15.5 x 72 x 30 | 100 | 140 | 17 | \$4845 |
| CSFO66H30 | 15.5 x 66 x 30 | 125 | 116 | 16 | \$4448 |
| CSFO60H30 | 15.5 x 60 x 30 | 125 | 105 | 14 | \$4040 |
| CSFO54H30 | 15.5 x 54 x 30 | 125 | 95 | 13 | \$3644 |
| CSFO48H30 | 15.5 x 48 x 30 | 125 | 85 | 12 | \$3241 |
| CSFO42H30 | 15.5 x 42 x 30 | 125 | 77 | 10 | \$2984 |
| CSFO36H30 | 15.5 x 36 x 30 | 125 | 70 | 9 | \$2948 |
| CSFO30H30 | 15.5 x 30 x 30 | 100 | 63 | 7 | \$2893 |

Required Specifications

Finish
Edge

Optional Specifications

Handles* (wood doors only)
Locks* (wood doors only)

HUTCHES **MODEL#** **DIMENSIONS** **FREIGHT CLASS** **WT./LBS.** **CUBIC FT.** **LIST PRICE**

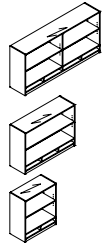

Double High Open Wall Mount Storage w/Pigeon-Holes

| | D x W x H | | | | | |
|------------|------------------|-----|-----|----|---------------|--|
| CSFOP72H34 | 15.5 x 72 x 34 | 100 | 140 | 17 | \$5275 | |
| CSFOP66H34 | 15.5 x 66 x 34 | 125 | 116 | 16 | \$4836 | |
| CSFOP60H34 | 15.5 x 60 x 34 | 125 | 105 | 14 | \$4396 | |
| CSFOP54H34 | 15.5 x 54 x 34 | 125 | 95 | 13 | \$3962 | |
| CSFOP48H34 | 15.5 x 48 x 34 | 125 | 85 | 12 | \$3514 | |
| CSFOP42H34 | 15.5 x 42 x 34 | 125 | 77 | 10 | \$3297 | |
| CSFOP36H34 | 15.5 x 36 x 34 | 125 | 70 | 9 | \$3200 | |
| CSFOP30H34 | 15.5 x 30 x 34 | 100 | 63 | 7 | \$3153 | |

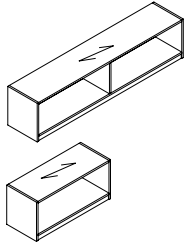

Open Wall Mount Storage

| | | | | | | |
|--------|------------------|------|-----|----|---------------|--|
| CSFO72 | 14.5 x 72 x 16.5 | 92.5 | 100 | 10 | \$1840 | |
| CSFO66 | 14.5 x 66 x 16.5 | 100 | 83 | 9 | \$1689 | |
| CSFO60 | 14.5 x 60 x 16.5 | 100 | 75 | 8 | \$1540 | |
| CSFO54 | 14.5 x 54 x 16.5 | 100 | 68 | 7 | \$1390 | |
| CSFO48 | 14.5 x 48 x 16.5 | 100 | 60 | 7 | \$1235 | |
| CSFO42 | 14.5 x 42 x 16.5 | 100 | 55 | 6 | \$1138 | |
| CSFO36 | 14.5 x 36 x 16.5 | 92.5 | 50 | 5 | \$1121 | |
| CSFO30 | 14.5 x 30 x 16.5 | 92.5 | 45 | 4 | \$1099 | |

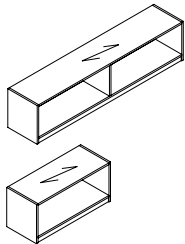

16" D Open Wall Mount Storage

| | | | | | | |
|-----------|----------------|------|-----|----|---------------|--|
| CSFO72D16 | 16 x 72 x 16.5 | 92.5 | 100 | 10 | \$2792 | |
| CSFO66D16 | 16 x 66 x 16.5 | 100 | 83 | 9 | \$2592 | |
| CSFO60D16 | 16 x 60 x 16.5 | 100 | 75 | 8 | \$2389 | |
| CSFO54D16 | 16 x 54 x 16.5 | 100 | 68 | 7 | \$2189 | |
| CSFO48D16 | 16 x 48 x 16.5 | 100 | 60 | 7 | \$1987 | |
| CSFO42D16 | 16 x 42 x 16.5 | 100 | 55 | 6 | \$1858 | |
| CSFO36D16 | 16 x 36 x 16.5 | 92.5 | 50 | 5 | \$1840 | |
| CSFO30D16 | 16 x 30 x 16.5 | 92.5 | 45 | 4 | \$1810 | |

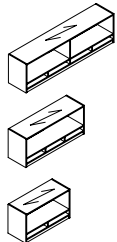

Open Wall Mount Storage w/Pigeon-Holes

| | | | | | | |
|---------|------------------|------|-----|----|---------------|--|
| CSFOP72 | 14.5 x 72 x 19.5 | 92.5 | 100 | 10 | \$2210 | |
| CSFOP66 | 14.5 x 66 x 19.5 | 100 | 83 | 9 | \$2030 | |
| CSFOP60 | 14.5 x 60 x 19.5 | 100 | 75 | 8 | \$1844 | |
| CSFOP54 | 14.5 x 54 x 19.5 | 100 | 68 | 7 | \$1663 | |
| CSFOP48 | 14.5 x 48 x 19.5 | 100 | 60 | 7 | \$1473 | |
| CSFOP42 | 14.5 x 42 x 19.5 | 100 | 55 | 6 | \$1385 | |
| CSFOP36 | 14.5 x 36 x 19.5 | 92.5 | 50 | 5 | \$1346 | |
| CSFOP30 | 14.5 x 30 x 19.5 | 92.5 | 45 | 4 | \$1326 | |

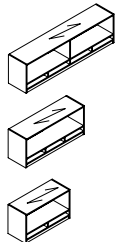

16" D Open Wall Mount Storage w/Pigeon-Holes

| | | | | | | |
|------------|----------------|-----|-----|----|---------------|--|
| CSFOP72D16 | 16 x 72 x 19.5 | 100 | 100 | 12 | \$3379 | |
| CSFOP66D16 | 16 x 66 x 19.5 | 125 | 83 | 11 | \$3128 | |
| CSFOP60D16 | 16 x 60 x 19.5 | 125 | 75 | 10 | \$2878 | |
| CSFOP54D16 | 16 x 54 x 19.5 | 125 | 68 | 9 | \$2629 | |
| CSFOP48D16 | 16 x 48 x 19.5 | 125 | 60 | 8 | \$2374 | |
| CSFOP42D16 | 16 x 42 x 19.5 | 125 | 55 | 7 | \$2253 | |
| CSFOP36D16 | 16 x 36 x 19.5 | 100 | 50 | 6 | \$2194 | |
| CSFOP30D16 | 16 x 30 x 19.5 | 100 | 45 | 5 | \$2166 | |

Required Specifications

Finish
Edge

FREESTANDING STORAGE NOTES

NOTE: Arrow indicates direction of grain

Pedestals

- All units are shipped assembled.
- Standard face locking.

Combination Storage

- All units are shipped assembled.
- No modifications accepted for this unit.
- Box drawers do not lock.
- Standard face locking.

Storage Cabinets

- Units include adjustable shelves.
- If Handle is specified:
 - Black and Brass handle = Black Lock & Grommet
 - Silver, Nickel and Tungsten handle = Tungsten Lock & Grommet

Edge options - must specify:

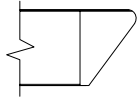

K16

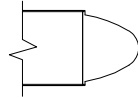

K18

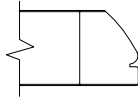

K21

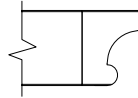

K22

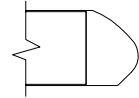

K29

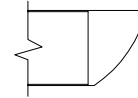

K30

| FREESTANDING STORAGE | MODEL# | DIMENSIONS | FREIGHT CLASS | WT/LBS. | CUBIC FT. | LIST PRICE |
|----------------------|--------|------------|---------------|---------|-----------|------------|
| D x W x H | | | | | | |

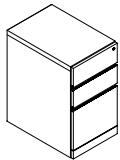

Freestanding Pedestal

| | | | | | |
|-------|------------------|----|----|---|---------------|
| KWDB | 19.8 x 15.5 x 28 | 85 | 70 | 5 | \$2348 |
| KWWDB | 23.8 x 15.5 x 28 | 85 | 75 | 6 | \$2703 |

Box/box/file.

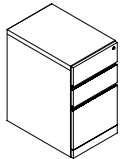

Freestanding Mobile Pedestal

| | | | | | |
|-------|------------------|----|----|---|---------------|
| KWDM | 19.8 x 15.5 x 28 | 85 | 70 | 5 | \$2525 |
| KWWDM | 23.8 x 15.5 x 28 | 85 | 75 | 6 | \$2906 |

Box/box/file.

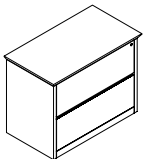

Lateral File - 2 high

| | | | | | |
|--------|----------------|----|-----|----|---------------|
| KF3622 | 23 x 38 x 29 | 85 | 170 | 13 | \$4377 |
| KF3620 | 21 x 38 x 29 | 85 | 159 | 12 | \$3980 |
| KN3022 | 23 x 32.9 x 29 | 85 | 142 | 11 | \$3831 |
| KN3020 | 21 x 32.9 x 29 | 85 | 131 | 10 | \$3481 |

Two lateral file drawers.

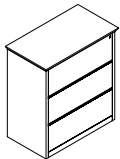

Lateral File - 3 high

| | | | | | |
|---------|----------------|------|-----|----|---------------|
| KF36223 | 23 x 38 x 42 | 92.5 | 212 | 19 | \$5344 |
| KF36203 | 21 x 38 x 42 | 92.5 | 193 | 18 | \$4992 |
| KN30223 | 23 x 32.9 x 42 | 92.5 | 176 | 16 | \$4675 |
| KN30203 | 21 x 32.9 x 42 | 92.5 | 160 | 15 | \$4365 |

Three lateral file drawers.

Required Specifications

Finish
Edge

Optional Specifications

Handles

FREESTANDING STORAGE

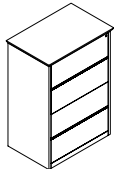

Lateral File - 4 high

| MODEL# | DIMENSIONS D x W x H | FREIGHT CLASS | WT/LBS. | CUBIC FT. | LIST PRICE |
|---------|-------------------------|---------------|---------|-----------|---------------|
| KF36224 | 23 x 38 x 54 | 92.5 | 270 | 25 | \$6509 |
| KF36204 | 21 x 38 x 54 | 92.5 | 259 | 23 | \$6184 |
| KN30224 | 23 x 32.9 x 54 | 92.5 | 225 | 21 | \$5698 |
| KN30204 | 21 x 32.9 x 54 | 92.5 | 214 | 19 | \$5414 |

Four lateral file drawers.

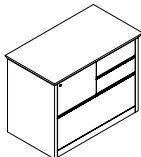

Combination Storage - Left

| | | | | | |
|---------|--------------|----|-----|----|---------------|
| KZL3622 | 23 x 38 x 29 | 85 | 170 | 13 | \$4744 |
| KZL3620 | 21 x 38 x 29 | 85 | 160 | 12 | \$4518 |

With 1 lateral file, 2 box drawers in the top right, and 1 file drawer in the top left.

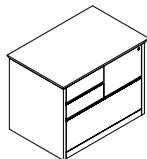

Combination Storage - Right

| | | | | | |
|---------|--------------|----|-----|----|---------------|
| KZR3622 | 23 x 38 x 29 | 85 | 170 | 13 | \$4744 |
| KZR3620 | 21 x 38 x 29 | 85 | 160 | 12 | \$4518 |

With 1 lateral file, 2 box drawers in the top left, and 1 file drawer in the top right.

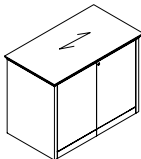

Storage Cabinet w/Doors

| | | | | | |
|---------|----------------|------|-----|----|---------------|
| KBD3622 | 23 x 38 x 29 | 92.5 | 140 | 13 | \$2979 |
| KBD3620 | 21 x 38 x 29 | 92.5 | 129 | 12 | \$2837 |
| KBD3022 | 23 x 32.9 x 29 | 92.5 | 117 | 11 | \$2609 |
| KBD3020 | 21 x 32.9 x 29 | 92.5 | 106 | 10 | \$2479 |

Storage with 1 adjustable shelf. For Aluminum framed glass door option, contact Customer Care.

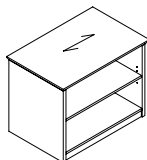

Open Storage Cabinet

| | | | | | |
|---------|-----------------|-----|-----|----|---------------|
| KOB3622 | 23 x 38.75 x 29 | 100 | 115 | 13 | \$2393 |
| KOB3620 | 21 x 38.75 x 29 | 100 | 104 | 12 | \$2277 |
| KOB3022 | 23 x 33.63 x 29 | 100 | 96 | 11 | \$2089 |
| KOB3020 | 21 x 33.63 x 29 | 100 | 85 | 10 | \$1987 |

Storage with 1 adjustable shelf.

Required Specifications

Finish
Edge

Optional Specifications

Handles

FREESTANDING STORAGE

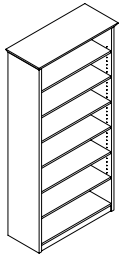

Open Bookcase

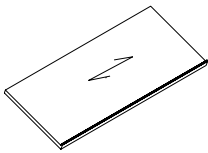

Additional Shelf

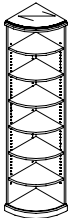

Quarter Round Open Bookcase

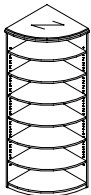

Quarter Round Open Bookcase

| MODEL# | DIMENSIONS D x W x H | FREIGHT CLASS | WT/LBS. | CUBIC FT. | LIST PRICE |
|---------|-------------------------|---------------|---------|-----------|---------------|
| KB73615 | 16 x 38 x 78 | 100 | 228 | 24 | \$3717 |
| KB63615 | 16 x 38 x 72 | 100 | 210 | 23 | \$3432 |
| KB53615 | 16 x 38 x 65 | 100 | 188 | 21 | \$3161 |
| KB43615 | 16 x 38 x 48 | 100 | 140 | 15 | \$2602 |
| KB23615 | 16 x 38 x 29 | 92.5 | 90 | 9 | \$2086 |
| KB73015 | 16 x 32.9 x 78 | 92.5 | 228 | 20 | \$3254 |
| KB63015 | 16 x 32.9 x 72 | 92.5 | 210 | 19 | \$3002 |
| KB53015 | 16 x 32.9 x 65 | 92.5 | 188 | 17 | \$2768 |
| KB43015 | 16 x 32.9 x 48 | 92.5 | 140 | 13 | \$2277 |
| KB23015 | 16 x 32.9 x 29 | 92.5 | 90 | 8 | \$1826 |

78" high models have 6 adjustable shelves, 72" has 5 adjustable shelves, 65" has 4 adjustable shelves, 48" has 3 adjustable shelves, 29" has 1 adjustable shelves.

| | | | | | |
|----------|-------------|------|-----|----|--------------|
| KMAG3624 | 24 x 36 x 1 | 92.5 | 112 | 10 | \$225 |
| KMAG3622 | 22 x 36 x 1 | 92.5 | 104 | 10 | \$204 |
| KMAG3620 | 20 x 36 x 1 | 92.5 | 92 | 9 | \$184 |
| KMAG3615 | 15 x 36 x 1 | 92.5 | 81 | 8 | \$162 |
| KMAG3024 | 24 x 30 x 1 | 92.5 | 94 | 9 | \$189 |
| KMAG3022 | 22 x 30 x 1 | 100 | 87 | 9 | \$172 |
| KMAG3020 | 20 x 30 x 1 | 100 | 76 | 8 | \$152 |
| KMAG3015 | 15 x 30 x 1 | 100 | 67 | 8 | \$134 |

For use with open bookcase. Can be specified for each shelf in an open bookcase.

| | | | | | |
|----------|--------------|-----|----|----|---------------|
| KB7R1515 | 16 x 16 x 78 | 100 | 95 | 10 | \$2928 |
| KB6R1515 | 16 x 16 x 72 | 100 | 83 | 9 | \$2700 |
| KB5R1515 | 16 x 16 x 65 | 100 | 81 | 9 | \$2486 |
| KB4R1515 | 16 x 16 x 48 | 100 | 59 | 6 | \$2046 |
| KB2R1515 | 16 x 16 x 29 | 100 | 37 | 4 | \$1646 |

84" and 78" high models have 6 adjustable shelves, 72" has 5 adjustable shelves, 65" has 4 adjustable shelves, 48" has 3 adjustable shelves, 29" has 1 adjustable shelf.

| | | | | | |
|-------------|--------------|-----|-----|----|---------------|
| KB7R2222H84 | 23 x 23 x 84 | 100 | 191 | 23 | \$5036 |
| KB7R2222H72 | 23 x 23 x 72 | 100 | 171 | 20 | \$4319 |
| KB7R2222H65 | 23 x 23 x 65 | 100 | 157 | 18 | \$5037 |
| KB7R2020H84 | 21 x 21 x 84 | 100 | 163 | 19 | \$4798 |
| KB7R2020H72 | 21 x 21 x 72 | 100 | 142 | 17 | \$4112 |
| KB7R2020H65 | 21 x 21 x 65 | 100 | 130 | 15 | \$4798 |

84" high models have 6 adjustable shelves, 72" has 5 adjustable shelves, and 65" has 4 adjustable shelves

Required Specifications

Finish
Edge

Optional Specifications

Handles

FREESTANDING STORAGE

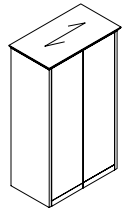

Storage Cabinet w/Wood Doors

MODEL# DIMENSIONS FREIGHT CLASS WT/LBS. CUBIC FT. LIST PRICE

| | D x W x H | | | | |
|-------------|----------------|------|-----|----|--------|
| K1D22W36H84 | 23 x 38 x 84 | 125 | 304 | 42 | \$6993 |
| K1D22W36H72 | 23 x 38 x 72 | 100 | 283 | 33 | \$5995 |
| K1D22W36H65 | 23 x 38 x 65 | 100 | 259 | 30 | \$5493 |
| K1D22W30H84 | 23 x 32.9 x 84 | 125 | 304 | 42 | \$6118 |
| K1D22W30H72 | 23 x 32.9 x 72 | 100 | 283 | 33 | \$5245 |
| K1D22W30H65 | 23 x 32.9 x 65 | 100 | 259 | 30 | \$4810 |
| K1D22W24H84 | 23 x 26 x 84 | 92.5 | 320 | 28 | \$5242 |
| K1D22W24H72 | 23 x 26 x 72 | 92.5 | 255 | 24 | \$4494 |
| K1D22W24H65 | 23 x 26 x 65 | 125 | 173 | 22 | \$4128 |
| | | | | | |
| K1D20W36H84 | 21 x 38 x 84 | 100 | 297 | 35 | \$6664 |
| K1D20W36H72 | 21 x 38 x 72 | 100 | 269 | 30 | \$5712 |
| K1D20W36H65 | 21 x 38 x 65 | 100 | 245 | 28 | \$5236 |
| K1D20W30H84 | 21 x 32.9 x 84 | 100 | 257 | 29 | \$5550 |
| K1D20W30H72 | 21 x 32.9 x 72 | 100 | 233 | 25 | \$4758 |
| K1D20W30H65 | 21 x 32.9 x 65 | 100 | 202 | 23 | \$4361 |
| K1D20W24H84 | 21 x 26 x 84 | 100 | 198 | 23 | \$4442 |
| K1D20W24H72 | 21 x 26 x 72 | 100 | 179 | 20 | \$3806 |
| K1D20W24H65 | 21 x 26 x 65 | 100 | 163 | 18 | \$3485 |

84" high models have 6 adjustable shelves, 72" has 5 adjustable shelves, 65" has 4 adjustable shelves. For Aluminum framed glass door option, please contact customer care. Locks are optional.

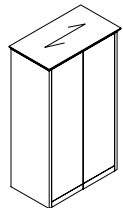

Wardrobe Cabinet

| | | | | | |
|-------------|----------------|------|-----|----|--------|
| K2D22W36H84 | 23 x 38 x 84 | 125 | 304 | 42 | \$6067 |
| K2D22W36H72 | 23 x 38 x 72 | 100 | 283 | 33 | \$5202 |
| K2D22W36H65 | 23 x 38 x 65 | 100 | 259 | 30 | \$4769 |
| K2D22W30H84 | 23 x 32.9 x 84 | 125 | 304 | 42 | \$5310 |
| K2D22W30H72 | 23 x 32.9 x 72 | 100 | 283 | 33 | \$4550 |
| K2D22W30H65 | 23 x 32.9 x 65 | 100 | 259 | 30 | \$4169 |
| K2D22W24H84 | 23 x 26 x 84 | 92.5 | 320 | 28 | \$4550 |
| K2D22W24H72 | 23 x 26 x 72 | 92.5 | 255 | 24 | \$3902 |
| K2D22W24H65 | 23 x 26 x 65 | 125 | 173 | 22 | \$3574 |
| | | | | | |
| K2D20W36H84 | 21 x 38 x 84 | 100 | 297 | 35 | \$5779 |
| K2D20W36H72 | 21 x 38 x 72 | 100 | 269 | 30 | \$4954 |
| K2D20W36H65 | 21 x 38 x 65 | 100 | 245 | 28 | \$4541 |
| K2D20W30H84 | 21 x 32.9 x 84 | 100 | 257 | 29 | \$4816 |
| K2D20W30H72 | 21 x 32.9 x 72 | 100 | 233 | 25 | \$4129 |
| K2D20W30H65 | 21 x 32.9 x 65 | 100 | 202 | 23 | \$3783 |
| K2D20W24H84 | 21 x 26 x 84 | 100 | 198 | 23 | \$3853 |
| K2D20W24H72 | 21 x 26 x 72 | 100 | 179 | 20 | \$3299 |
| K2D20W24H65 | 21 x 26 x 65 | 100 | 163 | 18 | \$3025 |

Doors, coat rack and hat shelf. 84" high models have 6 adjustable shelves, 72" has 5 adjustable shelves, 65" has 4 adjustable shelves. For Aluminum framed glass door option, please contact customer care. Locks are optional.

Required Specifications

Finish
Edge

Optional Specifications

Handles
Locks

FREESTANDING STORAGE

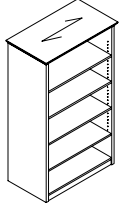

Open Bookcase

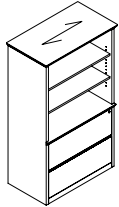

Open Cabinet

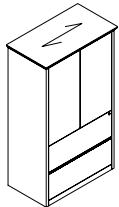

Storage Cabinet w/Doors*

| MODEL# | DIMENSIONS | FREIGHT CLASS | WT/LBS. | CUBIC FT. | LIST PRICE |
|-------------|----------------|---------------|---------|-----------|---------------|
| D x W x H | | | | | |
| K7D22W36H84 | 23 x 38 x 84 | 125 | 331 | 43 | \$5596 |
| K7D22W36H72 | 23 x 38 x 72 | 100 | 306 | 36 | \$4798 |
| K7D22W36H65 | 23 x 38 x 65 | 100 | 281 | 33 | \$4398 |
| K7D22W30H84 | 23 x 32.9 x 84 | 125 | 280 | 36 | \$4895 |
| K7D22W30H72 | 23 x 32.9 x 72 | 100 | 255 | 30 | \$4263 |
| K7D22W30H65 | 23 x 32.9 x 65 | 100 | 234 | 28 | \$3847 |
| | | | | | |
| K7D20W36H84 | 21 x 38 x 84 | 125 | 282 | 36 | \$5332 |
| K7D20W36H72 | 21 x 38 x 72 | 100 | 257 | 30 | \$4572 |
| K7D20W36H65 | 21 x 38 x 65 | 100 | 234 | 28 | \$4190 |
| K7D20W30H84 | 21 x 32.9 x 84 | 100 | 248 | 29 | \$4441 |
| K7D20W30H72 | 21 x 32.9 x 72 | 100 | 223 | 25 | \$3805 |
| K7D20W30H65 | 21 x 32.9 x 65 | 100 | 193 | 23 | \$3487 |

84" high models have 6 adjustable shelves, 72" has 5 adjustable shelves, 65" has 4 adjustable shelves.

| | | | | | |
|--------------|----------------|------|-----|----|---------------|
| K12D22W36H84 | 23 x 38 x 84 | 92.5 | 364 | 36 | \$7593 |
| K12D22W36H72 | 23 x 38 x 72 | 92.5 | 336 | 33 | \$6508 |
| K12D22W36H65 | 23 x 38 x 65 | 92.5 | 308 | 30 | \$5970 |
| K12D22W30H84 | 23 x 32.9 x 84 | 92.5 | 330 | 31 | \$6643 |
| K12D22W30H72 | 23 x 32.9 x 72 | 92.5 | 294 | 28 | \$5698 |
| K12D22W30H65 | 23 x 32.9 x 65 | 92.5 | 257 | 25 | \$5221 |
| | | | | | |
| K12D20W36H84 | 21 x 38 x 84 | 92.5 | 348 | 33 | \$7234 |
| K12D20W36H72 | 21 x 38 x 72 | 92.5 | 322 | 30 | \$6199 |
| K12D20W36H65 | 21 x 38 x 65 | 92.5 | 294 | 28 | \$5682 |
| K12D20W30H84 | 21 x 32.9 x 84 | 92.5 | 317 | 28 | \$6329 |
| K12D20W30H72 | 21 x 32.9 x 72 | 92.5 | 280 | 25 | \$5422 |
| K12D20W30H65 | 21 x 32.9 x 65 | 92.5 | 243 | 23 | \$4738 |

Above two lateral file drawers. 84" high models have 6 adjustable shelves, 72" has 5 adjustable shelves, 65" has 4 adjustable shelves.

| | | | | | |
|--------------|----------------|------|-----|----|---------------|
| K13D22W36H84 | 23 x 38 x 84 | 92.5 | 364 | 36 | \$8654 |
| K13D22W36H72 | 23 x 38 x 72 | 92.5 | 341 | 33 | \$7417 |
| K13D22W36H65 | 23 x 38 x 65 | 92.5 | 313 | 30 | \$6801 |
| K13D22W30H84 | 23 x 32.9 x 84 | 92.5 | 330 | 31 | \$7572 |
| K13D22W30H72 | 23 x 32.9 x 72 | 92.5 | 299 | 28 | \$6490 |
| K13D22W30H65 | 23 x 32.9 x 65 | 92.5 | 261 | 25 | \$5950 |
| | | | | | |
| K13D20W36H84 | 21 x 38 x 84 | 92.5 | 365 | 35 | \$8242 |
| K13D20W36H72 | 21 x 38 x 72 | 92.5 | 327 | 30 | \$7064 |
| K13D20W36H65 | 21 x 38 x 65 | 92.5 | 299 | 28 | \$6472 |
| K13D20W30H84 | 21 x 32.9 x 84 | 92.5 | 305 | 29 | \$6870 |
| K13D20W30H72 | 21 x 32.9 x 72 | 92.5 | 285 | 25 | \$5891 |
| K13D20W30H65 | 21 x 32.9 x 65 | 92.5 | 247 | 23 | \$5396 |

Above two lateral file drawers. 84" high models have 6 adjustable shelves, 72" has 5 adjustable shelves, 65" has 4 adjustable shelves. For Aluminum framed glass door option, please contact customer care. Lock for upper storage is optional.

Required Specifications

Finish
Edge

Optional Specifications

Handles
Lock*

FREESTANDING STORAGE

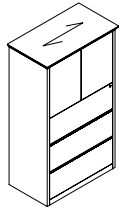

Storage Cabinet w/Doors*

MODEL# DIMENSIONS FREIGHT CLASS WT/LBS. CUBIC FT. LIST PRICE

D x W x H

| | | | | | |
|--------------|----------------|------|-----|----|---------------|
| K14D22W36H84 | 23 x 38 x 84 | 100 | 340 | 42 | \$9303 |
| K14D22W36H72 | 23 x 38 x 72 | 100 | 312 | 33 | \$7974 |
| K14D22W36H65 | 23 x 38 x 65 | 100 | 286 | 30 | \$7312 |
| K14D22W30H84 | 23 x 32.9 x 84 | 100 | 308 | 35 | \$8138 |
| K14D22W30H72 | 23 x 32.9 x 72 | 100 | 273 | 28 | \$6977 |
| K14D22W30H65 | 23 x 32.9 x 65 | 100 | 238 | 25 | \$6396 |
| K14D20W36H84 | 21 x 38 x 84 | 100 | 330 | 35 | \$8860 |
| K14D20W36H72 | 21 x 38 x 72 | 100 | 298 | 30 | \$7596 |
| K14D20W36H65 | 21 x 38 x 65 | 100 | 272 | 28 | \$6963 |
| K14D20W30H84 | 21 x 32.9 x 84 | 92.5 | 298 | 29 | \$7384 |
| K14D20W30H72 | 21 x 32.9 x 72 | 92.5 | 259 | 25 | \$6330 |
| K14D20W30H65 | 21 x 32.9 x 65 | 100 | 224 | 23 | \$5802 |

Above three lateral file drawers. 84" high models have 2 adjustable shelves, 72" and 65" have 1 adjustable shelf. For Aluminum framed glass door option, please contact customer care. Lock for upper storage is optional

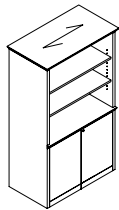

Open Storage*

| | | | | | |
|--------------|----------------|------|-----|----|---------------|
| K22D22W36H84 | 23 x 38 x 84 | 125 | 325 | 42 | \$6373 |
| K22D22W36H72 | 23 x 38 x 72 | 100 | 300 | 33 | \$5460 |
| K22D22W36H65 | 23 x 38 x 65 | 100 | 275 | 30 | \$5008 |
| K22D22W30H84 | 23 x 32.9 x 84 | 100 | 304 | 35 | \$5577 |
| K22D22W30H72 | 23 x 32.9 x 72 | 100 | 279 | 28 | \$4781 |
| K22D22W30H65 | 23 x 32.9 x 65 | 100 | 243 | 25 | \$4383 |
| K22D20W36H84 | 21 x 38 x 84 | 100 | 327 | 33 | \$6067 |
| K22D20W36H72 | 21 x 38 x 72 | 92.5 | 305 | 30 | \$5202 |
| K22D20W36H65 | 21 x 38 x 65 | 100 | 278 | 28 | \$4769 |
| K22D20W30H84 | 21 x 32.9 x 84 | 92.5 | 301 | 28 | \$5063 |
| K22D20W30H72 | 21 x 32.9 x 72 | 92.5 | 265 | 25 | \$4339 |
| K22D20W30H65 | 21 x 32.9 x 65 | 100 | 229 | 23 | \$3973 |

Above storage cabinet. 84" high models have 4 adjustable shelves, 72" has 3 adjustable shelves, 65" has 3 adjustable shelves. For Aluminum framed glass door option, please contact customer care.

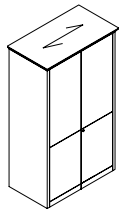

Closed Storage Cabinet*

| | | | | | |
|--------------|----------------|------|-----|----|---------------|
| K23D22W36H84 | 23 x 38 x 84 | 100 | 340 | 42 | \$7469 |
| K23D22W36H72 | 23 x 38 x 72 | 100 | 319 | 33 | \$6401 |
| K23D22W36H65 | 23 x 38 x 65 | 100 | 292 | 30 | \$5862 |
| K23D22W30H84 | 23 x 32.9 x 84 | 100 | 308 | 33 | \$6221 |
| K23D22W30H72 | 23 x 32.9 x 72 | 100 | 279 | 28 | \$5332 |
| K23D22W30H65 | 23 x 32.9 x 65 | 100 | 243 | 25 | \$4891 |
| K23D20W36H84 | 21 x 38 x 84 | 100 | 330 | 35 | \$7111 |
| K23D20W36H72 | 21 x 38 x 72 | 92.5 | 305 | 30 | \$6096 |
| K23D20W36H65 | 21 x 38 x 65 | 100 | 278 | 28 | \$5586 |
| K23D20W30H84 | 21 x 32.9 x 84 | 92.5 | 298 | 29 | \$5925 |
| K23D20W30H72 | 21 x 32.9 x 72 | 92.5 | 265 | 25 | \$5080 |
| K23D20W30H65 | 21 x 32.9 x 65 | 100 | 229 | 23 | \$4657 |

With upper and lower split doors. 1 fixed shelf and 2 adjustable shelves. Lock for upper storage is optional. For Aluminum framed glass door option, please contact customer care.

Required Specifications

Finish
Edge

Optional Specifications

Handles
Lock*

FREESTANDING STORAGE

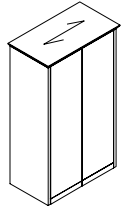

Cabinet w/Doors and Storage

| MODEL# | DIMENSIONS D x W x H | FREIGHT CLASS | WT/LBS. | CUBIC FT. | LIST PRICE |
|--------------|-------------------------|---------------|---------|-----------|---------------|
| K25D22W36H84 | 23 x 38 x 84 | 100 | 348 | 42 | \$7843 |
| K25D22W36H72 | 23 x 38 x 72 | 100 | 319 | 33 | \$6726 |
| K25D22W36H65 | 23 x 38 x 65 | 100 | 292 | 30 | \$6164 |
| K25D22W30H84 | 23 x 32.9 x 84 | 100 | 307 | 35 | \$6862 |
| K25D22W30H72 | 23 x 32.9 x 72 | 100 | 279 | 28 | \$5884 |
| K25D22W30H65 | 23 x 32.9 x 65 | 100 | 243 | 25 | \$5392 |
| K25D22W24H84 | 23 x 26 x 84 | 100 | 254 | 28 | \$5882 |
| K25D22W24H72 | 23 x 26 x 72 | 100 | 213 | 24 | \$5041 |
| K25D22W24H65 | 23 x 26 x 65 | 100 | 195 | 22 | \$4617 |
| | | | | | |
| K25D20W36H84 | 21 x 38 x 84 | 100 | 330 | 35 | \$7468 |
| K25D20W36H72 | 21 x 38 x 72 | 92.5 | 305 | 30 | \$6398 |
| K25D20W36H65 | 21 x 38 x 65 | 100 | 278 | 28 | \$5865 |
| K25D20W30H84 | 21 x 32.9 x 84 | 92.5 | 300 | 29 | \$6222 |
| K25D20W30H72 | 21 x 32.9 x 72 | 92.5 | 265 | 25 | \$5333 |
| K25D20W30H65 | 21 x 32.9 x 65 | 100 | 229 | 23 | \$4891 |
| K25D20W24H84 | 21 x 26 x 84 | 100 | 235 | 28 | \$4980 |
| K25D20W24H72 | 21 x 26 x 72 | 100 | 203 | 24 | \$4268 |
| K25D20W24H65 | 21 x 26 x 65 | 100 | 185 | 22 | \$3916 |

Wardrobe with coat rack and hat shelf on left. Storage with adjustable shelves on right. 84" high models have 5 adjustable shelves, 72" and 65" have 4 adjustable shelves. For Aluminum framed glass door option, please contact customer care. Lock is optional.

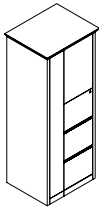

Tower Unit - Left

| | | | | | |
|---------------|--------------|-----|-----|----|---------------|
| K27D22W24H84L | 23 x 26 x 84 | 125 | 167 | 24 | \$9287 |
| K27D22W24H72L | 23 x 26 x 72 | 125 | 154 | 22 | \$7960 |
| K27D22W24H65L | 23 x 26 x 65 | 125 | 141 | 20 | \$7303 |
| | | | | | |
| K27D20W24H84L | 21 x 26 x 84 | 125 | 152 | 22 | \$8846 |
| K27D20W24H72L | 21 x 26 x 72 | 125 | 140 | 20 | \$7585 |
| K27D20W24H65L | 21 x 26 x 65 | 125 | 128 | 18 | \$6952 |

Wardrobe with coat rack and hat shelf on left. Three file drawers and storage with adjustable shelf on right. 84" high models have 2 adjustable shelves, 72" and 65" have 1 adjustable shelf. For Aluminum framed glass door option on right, please contact customer care. Lock for upper storage and wardrobe is optional.

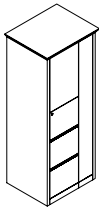

Tower Unit - Right

| | | | | | |
|---------------|--------------|-----|-----|----|---------------|
| K27D22W24H84R | 23 x 26 x 84 | 125 | 167 | 24 | \$9287 |
| K27D22W24H72R | 23 x 26 x 72 | 125 | 154 | 22 | \$7960 |
| K27D22W24H65R | 23 x 26 x 65 | 125 | 141 | 20 | \$7303 |
| | | | | | |
| K27D20W24H84R | 21 x 26 x 84 | 125 | 152 | 22 | \$8846 |
| K27D20W24H72R | 21 x 26 x 72 | 125 | 140 | 20 | \$7585 |
| K27D20W24H65R | 21 x 26 x 65 | 125 | 128 | 18 | \$6952 |

Wardrobe with coat rack and hat shelf on right. Three file drawers and storage with adjustable shelf on left. 84" high models have 2 adjustable shelves, 72" and 65" have 1 adjustable shelf. For Aluminum framed glass door option on left, please contact customer care. Lock for upper storage and wardrobe is optional.

Required Specifications

Finish
Edge

Optional Specifications

Handles
Locks

MODESTY PANELS

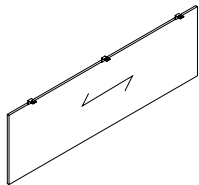

Veneer Modesty Panel*

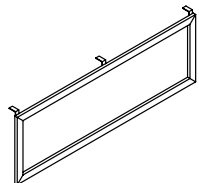

Glass Modesty Panel

| MODEL# | DIMENSIONS D x W x H | FREIGHT CLASS | WT/LBS. | CUBIC FT. | LIST PRICE |
|--------|-------------------------|---------------|---------|-----------|---------------|
| CMP72W | 0.75 x 67 x 18 | -- | 20 | 1 | \$1622 |
| CMP66W | 0.75 x 61 x 18 | -- | 18 | 1 | \$1570 |
| CMP60W | 0.75 x 55 x 18 | -- | 16 | 1 | \$1546 |
| CMP54W | 0.75 x 49 x 18 | -- | 14 | 1 | \$1520 |
| CMP48W | 0.75 x 43 x 18 | -- | 13 | 1 | \$1496 |

Straight modesty panel. Attaches to underside of worksurface. **Cannot be retrofitted in the field. Not sold individually - to be ordered as an upgrade option only.**

- CMP72W - Specify on 96" Piano desk: Boat, D or P
- CMP66W - Specify on 84" Piano desk: Boat or D
- CMP60W - For use on 84" Piano desk: P
- CMP54W - For use on 72" Piano desk: Boat or D/D table desk
- CMP48W - For use on 66" and 60" Piano desk: D or P/D table desk

| | | | | | |
|--------|----------------|----|----|---|---------------|
| CMP72G | 0.75 x 67 x 18 | -- | 20 | 1 | \$2485 |
| CMP66G | 0.75 x 61 x 18 | -- | 18 | 1 | \$2351 |
| CMP60G | 0.75 x 55 x 18 | -- | 16 | 1 | \$2149 |
| CMP54G | 0.75 x 49 x 18 | -- | 14 | 1 | \$2001 |
| CMP48G | 0.75 x 43 x 18 | -- | 13 | 1 | \$1911 |

Straight modesty panel. Translucent, screened glass. Aluminum box frame construction in Tungsten Only. Attaches to underside of worksurface. **Cannot be retrofitted in the field. Not sold individually - to be ordered as an upgrade option only.**

- CMP72G - Specify on 96" Piano desk: Boat, D or P
- CMP66G - Specify on 84" Piano desk: Boat or D
- CMP60G - For use on 84" Piano desk: P
- CMP54G - For use on 72" Piano desk: Boat or D/D table desk
- CMP48G - For use on 66" and 60" Piano desk: D or P/D table desk
- Tungsten finish on the aluminum box frame closely resembles the existing Tungsten finish.

ACCESSORIES

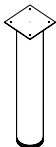

Metal Post Upgrade

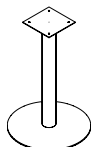

Metal Flat Plate Base Upgrade

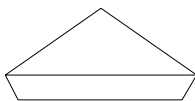

Corner Filler Top

| MODEL# | DIMENSIONS | FREIGHT CLASS | WT/LBS. | CUBIC FT. | LIST PRICE |
|--------|------------|---------------|---------|-----------|---------------|
| SM06 | 6 x 6 x 28 | -- | -- | -- | \$1037 |
| SM04 | 4 x 4 x 28 | -- | -- | -- | \$572 |
| SM03 | 3 x 3 x 28 | -- | -- | -- | \$407 |

Must specify at time of order. **Cannot be retrofitted in the field.**
Available in Black (E), Tungsten (K) and Brushed Chrome (P).

| | | | | | |
|-------|--------------|----|----|----|---------------|
| F3P18 | 18 x 18 x 28 | -- | -- | -- | \$1538 |
|-------|--------------|----|----|----|---------------|

Must specify at time of order. **Can not be retrofitted in the field.**
Available in Black (E), Tungsten (K) and Brushed Chrome (P).

| | | | | | |
|----------|---------------|-----|---|---|--------------|
| KV1212CT | 12 x 12 x 1.5 | 150 | 5 | 1 | \$981 |
|----------|---------------|-----|---|---|--------------|

Required Specifications

Finish*

TACKBOARDS FOR HUTCHES

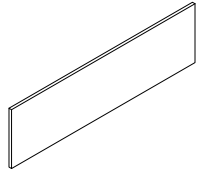

**Tackboard for 36" H
Non-Pigeon Hole Hutches**

| MODEL# | DIMENSIONS D x W x H | FREIGHT CLASS | WT/LBS. | CUBIC FT. | GR. 1-3 | GR. 4-5 |
|--------|-------------------------|---------------|---------|-----------|---------|---------|
| KTS108 | 1 x 105 x 20 | 92.5 | 23 | 2 | \$1232 | \$1480 |
| KTS102 | 1 x 99 x 20 | 100 | 19 | 2 | \$1166 | \$1402 |
| KTS96 | 1 x 93 x 20 | 70 | 15 | 1 | \$1097 | \$1319 |
| KTS90 | 1 x 87 x 20 | 70 | 15 | 1 | \$1030 | \$1238 |
| KTS84 | 1 x 81 x 20 | 85 | 14 | 1 | \$965 | \$1161 |
| KTS78 | 1 x 75 x 20 | 85 | 13 | 1 | \$893 | \$1073 |
| KTS72 | 1 x 69 x 20 | 85 | 12 | 1 | \$821 | \$986 |
| KTS66 | 1 x 63 x 20 | 92.5 | 11 | 1 | \$751 | \$902 |
| KTS60 | 1 x 57 x 20 | 92.5 | 10 | 1 | \$688 | \$827 |
| KTS36 | 1 x 33 x 20 | 60 | 6 | 0.01 | \$412 | \$496 |
| KTS30 | 1 x 27 x 20 | 60 | 4 | 0.01 | \$343 | \$414 |

Factory installed hutch tackboard.

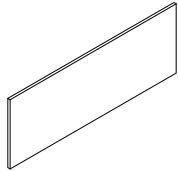

**Tackboard for 42" H & 54" H
Pigeon-Hole Hutches**

| | | | | | | |
|------------|--------------|------|----|------|--------|--------|
| KTSP108H23 | 1 x 105 x 23 | 70 | 30 | 2 | \$1393 | \$1673 |
| KTSP102H23 | 1 x 99 x 23 | 85 | 24 | 2 | \$1328 | \$1595 |
| KTSP96H23 | 1 x 93 x 23 | 92.5 | 20 | 2 | \$1240 | \$1490 |
| KTSP90H23 | 1 x 87 x 23 | 70 | 20 | 1 | \$1162 | \$1396 |
| KTSP84H23 | 1 x 81 x 23 | 70 | 18 | 1 | \$1085 | \$1303 |
| KTSP78H23 | 1 x 75 x 23 | 70 | 17 | 1 | \$1008 | \$1211 |
| KTSP72H23 | 1 x 69 x 23 | 70 | 16 | 1 | \$937 | \$1126 |
| KTSP66H23 | 1 x 63 x 23 | 85 | 14 | 1 | \$852 | \$1024 |
| KTSP60H23 | 1 x 57 x 23 | 85 | 13 | 1 | \$779 | \$938 |
| KTSP36H23 | 1 x 33 x 23 | 60 | 8 | 0.01 | \$466 | \$561 |
| KTSP30H23 | 1 x 27 x 23 | 60 | 5 | 0.01 | \$388 | \$469 |

Factory installed hutch tackboard.

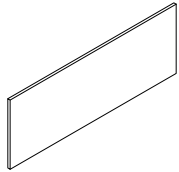

**Tackboard for 42" H & 54" H
Non-Pigeon Hole Hutches**

| | | | | | | |
|-----------|--------------|------|----|------|--------|--------|
| KTS108H26 | 1 x 105 x 26 | 70 | 30 | 2 | \$1611 | \$1935 |
| KTS102H26 | 1 x 99 x 26 | 85 | 24 | 2 | \$1518 | \$1823 |
| KTS96H26 | 1 x 93 x 26 | 92.5 | 20 | 2 | \$1427 | \$1715 |
| KTS90H26 | 1 x 87 x 26 | 92.5 | 20 | 2 | \$1344 | \$1614 |
| KTS84H26 | 1 x 81 x 26 | 100 | 18 | 2 | \$1249 | \$1500 |
| KTS78H26 | 1 x 75 x 26 | 100 | 17 | 2 | \$1160 | \$1394 |
| KTS72H26 | 1 x 69 x 26 | 70 | 16 | 1 | \$1071 | \$1287 |
| KTS66H26 | 1 x 63 x 26 | 85 | 14 | 1 | \$982 | \$1180 |
| KTS60H26 | 1 x 57 x 26 | 85 | 13 | 1 | \$893 | \$1073 |
| KTS36H26 | 1 x 33 x 26 | 60 | 8 | 0.01 | \$538 | \$647 |
| KTS30H26 | 1 x 27 x 26 | 60 | 5 | 0.01 | \$447 | \$538 |

Factory installed hutch tackboard.

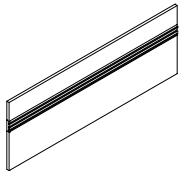

**Tackboard w/Rail for 36" H
Non-Pigeon Hole Hutches***

| | | | | | | |
|----------|--------------|------|----|------|--------|--------|
| KTSAS108 | 1 x 105 x 20 | 92.5 | 23 | 2 | \$2187 | \$2626 |
| KTSAS102 | 1 x 99 x 20 | 100 | 19 | 2 | \$1973 | \$2369 |
| KTSAS96 | 1 x 93 x 20 | 70 | 15 | 1 | \$1942 | \$2333 |
| KTSAS90 | 1 x 87 x 20 | 70 | 15 | 1 | \$1826 | \$2193 |
| KTSAS84 | 1 x 81 x 20 | 85 | 14 | 1 | \$1702 | \$2045 |
| KTSAS78 | 1 x 75 x 20 | 85 | 13 | 1 | \$1582 | \$1900 |
| KTSAS72 | 1 x 69 x 20 | 85 | 12 | 1 | \$1457 | \$1749 |
| KTSAS66 | 1 x 63 x 20 | 92.5 | 11 | 1 | \$1335 | \$1603 |
| KTSAS60 | 1 x 57 x 20 | 92.5 | 10 | 1 | \$1218 | \$1486 |
| KTSAS36 | 1 x 33 x 20 | 60 | 6 | 0.01 | \$728 | \$876 |
| KTSAS30 | 1 x 27 x 20 | 60 | 4 | 0.01 | \$607 | \$731 |

Factory installed hutch tackboard.

- Specify Black (**E**), Tungsten (**K**), or Designer White (**DWT**) accessory rail finish.

Required Specifications

Fabric
Metal finish*

TACKBOARDS FOR HUTCHES

| MODEL# | DIMENSIONS | FREIGHT CLASS | WT/LBS. | CUBIC FT. | GR.1-3 | GR. 4-5 |
|--------------|------------------|---------------|---------|-----------|--------|---------|
| | D x W x H | | | | | |
| KTSPAS108H23 | 1 x 105 x 23 | 70 | 30 | 2 | \$2374 | \$2850 |
| KTSPAS102H23 | 1 x 99 x 23 | 85 | 24 | 2 | \$2258 | \$2734 |
| KTSPAS96H23 | 1 x 93 x 23 | 92.5 | 20 | 2 | \$2120 | \$2546 |
| KTSPAS90H23 | 1 x 87 x 23 | 92.5 | 20 | 2 | \$1985 | \$2384 |
| KTSPAS84H23 | 1 x 81 x 23 | 100 | 18 | 2 | \$1851 | \$2223 |
| KTSPAS78H23 | 1 x 75 x 23 | 100 | 17 | 2 | \$1719 | \$2064 |
| KTSPAS72H23 | 1 x 69 x 23 | 70 | 16 | 1 | \$1586 | \$1904 |
| KTSPAS66H23 | 1 x 63 x 23 | 85 | 14 | 1 | \$1454 | \$1746 |
| KTSPAS60H23 | 1 x 57 x 23 | 85 | 13 | 1 | \$1322 | \$1588 |
| KTSPAS36H23 | 1 x 33 x 23 | 100 | 8 | 1 | \$795 | \$956 |
| KTSPAS30H23 | 1 x 27 x 23 | 150 | 5 | 1 | \$667 | \$802 |

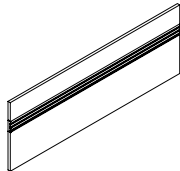

**Tackboard w/Rail for 42" H & 54" H*
Pigeon-Hole Hutch**

Factory installed hutch tackboard.
 • Specify Black (E), Tungsten (K), or Designer White (DWT) accessory rail finish.

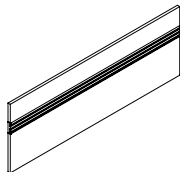

**Tackboard w/Rail for 42" H & 54" H*
Non-Pigeon Hole Hutch**

| | | | | | | |
|-------------|--------------|------|----|------|--------|--------|
| KTSAS108H26 | 1 x 105 x 26 | 92.5 | 23 | 2 | \$2635 | \$3165 |
| KTSAS102H26 | 1 x 99 x 26 | 100 | 19 | 2 | \$2480 | \$2978 |
| KTSAS96H26 | 1 x 93 x 26 | 70 | 15 | 1 | \$2335 | \$2804 |
| KTSAS90H26 | 1 x 87 x 26 | 70 | 15 | 1 | \$2198 | \$2640 |
| KTSAS84H26 | 1 x 81 x 26 | 85 | 14 | 1 | \$2023 | \$2429 |
| KTSAS78H26 | 1 x 75 x 26 | 85 | 13 | 1 | \$1898 | \$2279 |
| KTSAS72H26 | 1 x 69 x 26 | 85 | 12 | 1 | \$1723 | \$2069 |
| KTSAS66H26 | 1 x 63 x 26 | 92.5 | 11 | 1 | \$1611 | \$1935 |
| KTSAS60H26 | 1 x 57 x 26 | 92.5 | 10 | 1 | \$1458 | \$1752 |
| KTSAS36H26 | 1 x 33 x 26 | 60 | 6 | 0.01 | \$875 | \$1053 |
| KTSAS30H26 | 1 x 27 x 26 | 60 | 4 | 0.01 | \$735 | \$884 |

Factory installed hutch tackboard.
 • Specify Black (E), Tungsten (K), or Designer White (DWT) accessory rail finish.

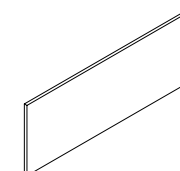

**Tackboard for 65" H Non-Pigeon Hole
Wall Mount Cabinets**

| | | | | | | |
|-------|----------------|-----|----|---|--------|--------|
| TS120 | 1 x 120 x 19.2 | 70 | 26 | 2 | \$1522 | \$1902 |
| TS114 | 1 x 114 x 19.2 | 70 | 25 | 2 | \$1449 | \$1814 |
| TS108 | 1 x 108 x 19.2 | 70 | 23 | 2 | \$1370 | \$1713 |
| TS102 | 1 x 102 x 19.2 | 85 | 19 | 2 | \$1298 | \$1623 |
| TS96 | 1 x 96 x 19.2 | 70 | 17 | 1 | \$1214 | \$1520 |
| TS90 | 1 x 90 x 19.2 | 70 | 15 | 1 | \$1141 | \$1428 |
| TS84 | 1 x 84 x 19.2 | 70 | 14 | 1 | \$1069 | \$1335 |
| TS78 | 1 x 78 x 19.2 | 70 | 13 | 1 | \$990 | \$1238 |
| TS72 | 1 x 72 x 19.2 | 70 | 12 | 1 | \$557 | \$698 |
| TS66 | 1 x 66 x 19.2 | 85 | 11 | 1 | \$512 | \$644 |
| TS60 | 1 x 60 x 19.2 | 85 | 10 | 1 | \$471 | \$592 |
| TS54 | 1 x 54 x 19.2 | 85 | 10 | 1 | \$427 | \$537 |
| TS48 | 1 x 48 x 19.2 | 85 | 10 | 1 | \$382 | \$479 |
| TS42 | 1 x 42 x 19.2 | 85 | 10 | 1 | \$338 | \$425 |
| TS36 | 1 x 36 x 19.2 | 100 | 8 | 1 | \$302 | \$383 |
| TS30 | 1 x 30 x 19.2 | 150 | 5 | 1 | \$251 | \$316 |

Factory installed tackboard for wall mount cabinets.

Required Specifications

Fabric
 Metal finish*

TACKBOARDS FOR WALL MOUNT CABINETS

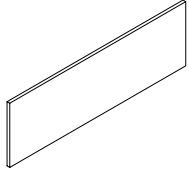

Tackboard for 72" H Pigeon-Hole Wall Mount Cabinets

| MODEL# | DIMENSIONS D x W x H | FREIGHT CLASS | WT./LBS. | CUBIC FT. | GR. 1-3 | GR. 4-5 |
|-----------|-------------------------|---------------|----------|-----------|---------|---------|
| TSP120H23 | 1 x 120 x 23 | 70 | 34 | 2 | \$1718 | \$2148 |
| TSP114H23 | 1 x 114 x 23 | 70 | 32 | 2 | \$1632 | \$2039 |
| TSP108H23 | 1 x 108 x 23 | 70 | 30 | 2 | \$1600 | \$1920 |
| TSP102H23 | 1 x 102 x 23 | 85 | 24 | 2 | \$1525 | \$1831 |
| TSP96H23 | 1 x 96 x 23 | 92.5 | 20 | 2 | \$1377 | \$1720 |
| TSP90H23 | 1 x 90 x 23 | 92.5 | 20 | 1 | \$1286 | \$1609 |
| TSP84H23 | 1 x 84 x 23 | 70 | 18 | 1 | \$1201 | \$1501 |
| TSP78H23 | 1 x 78 x 23 | 70 | 17 | 1 | \$983 | \$1195 |
| TSP72H23 | 1 x 72 x 23 | 70 | 16 | 1 | \$913 | \$1147 |
| TSP66H23 | 1 x 66 x 23 | 85 | 14 | 1 | \$830 | \$1041 |
| TSP60H23 | 1 x 60 x 23 | 85 | 13 | 1 | \$601 | \$755 |
| TSP54H23 | 1 x 54 x 23 | 85 | 13 | 1 | \$762 | \$955 |
| TSP48H23 | 1 x 48 x 23 | 85 | 13 | 1 | \$602 | \$613 |
| TSP42H23 | 1 x 42 x 23 | 85 | 13 | 1 | \$530 | \$538 |
| TSP36H23 | 1 x 36 x 23 | 100 | 8 | 1 | \$458 | \$474 |
| TSP30H23 | 1 x 30 x 23 | 150 | 5 | 1 | \$379 | \$403 |

Factory installed tackboard for wall mount cabinets.

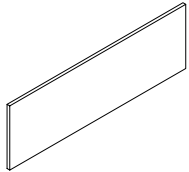

Tackboard for 72" H Non-Pigeon-Hole Wall Mount Cabinets

| | | | | | | |
|----------|--------------|------|----|---|--------|--------|
| TS120H26 | 1 x 120 x 26 | 70 | 34 | 2 | \$1979 | \$2474 |
| TS114H26 | 1 x 114 x 26 | 70 | 32 | 2 | \$1880 | \$2351 |
| TS108H26 | 1 x 108 x 26 | 70 | 30 | 2 | \$1782 | \$2229 |
| TS102H26 | 1 x 102 x 26 | 85 | 24 | 2 | \$1678 | \$2098 |
| TS96H26 | 1 x 96 x 26 | 92.5 | 22 | 2 | \$1587 | \$1986 |
| TS90H26 | 1 x 90 x 26 | 92.5 | 20 | 2 | \$1488 | \$1859 |
| TS84H26 | 1 x 84 x 26 | 100 | 18 | 2 | \$1383 | \$1729 |
| TS78H26 | 1 x 78 x 26 | 100 | 17 | 2 | \$1286 | \$1609 |
| TS72H26 | 1 x 72 x 26 | 70 | 16 | 1 | \$714 | \$897 |
| TS66H26 | 1 x 66 x 26 | 85 | 14 | 1 | \$658 | \$825 |
| TS60H26 | 1 x 60 x 26 | 85 | 13 | 1 | \$601 | \$755 |
| TS54H26 | 1 x 54 x 26 | 85 | 13 | 1 | \$552 | \$692 |
| TS48H26 | 1 x 48 x 26 | 85 | 13 | 1 | \$488 | \$613 |
| TS42H26 | 1 x 42 x 26 | 85 | 13 | 1 | \$433 | \$538 |
| TS36H26 | 1 x 36 x 26 | 100 | 8 | 1 | \$378 | \$475 |
| TS30H26 | 1 x 30 x 26 | 150 | 5 | 1 | \$317 | \$401 |

Factory installed tackboard for wall mount cabinets.

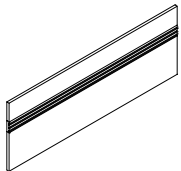

Tackboard w/Rail for 65" H* Non-Pigeon Hole Wall Mount Cabinets

| | | | | | | |
|---------|----------------|------|----|---|--------|--------|
| TSAS120 | 1 x 120 x 19.2 | 85 | 26 | 1 | \$2353 | \$2942 |
| TSAS114 | 1 x 114 x 19.2 | 85 | 25 | 2 | \$2239 | \$2799 |
| TSAS108 | 1 x 108 x 19.2 | 92.5 | 23 | 2 | \$2120 | \$2653 |
| TSAS102 | 1 x 102 x 19.2 | 100 | 19 | 2 | \$2007 | \$2505 |
| TSAS96 | 1 x 96 x 19.2 | 70 | 17 | 1 | \$1880 | \$2355 |
| TSAS90 | 1 x 90 x 19.2 | 70 | 15 | 1 | \$1765 | \$2209 |
| TSAS84 | 1 x 84 x 19.2 | 85 | 14 | 1 | \$1646 | \$2060 |
| TSAS78 | 1 x 78 x 19.2 | 85 | 13 | 1 | \$1533 | \$1918 |
| TSAS72 | 1 x 72 x 19.2 | 85 | 12 | 1 | \$1412 | \$1769 |
| TSAS66 | 1 x 66 x 19.2 | 92.5 | 11 | 1 | \$1298 | \$1627 |
| TSAS60 | 1 x 60 x 19.2 | 92.5 | 10 | 1 | \$1177 | \$1473 |
| TSAS54 | 1 x 54 x 19.2 | 92.5 | 10 | 1 | \$1064 | \$1329 |
| TSAS48 | 1 x 48 x 19.2 | 92.5 | 10 | 1 | \$945 | \$1180 |
| TSAS42 | 1 x 42 x 19.2 | 92.5 | 10 | 1 | \$825 | \$1030 |
| TSAS36 | 1 x 36 x 19.2 | 100 | 8 | 1 | \$706 | \$880 |
| TSAS30 | 1 x 30 x 19.2 | 150 | 5 | 1 | \$548 | \$687 |

Factory installed tackboard for wall mount cabinets.

- Specify Black (E), Tungsten (K), or Designer White (DWT) accessory rail finish.

Required Specifications

Fabric
Metal finish*

TACKBOARDS FOR WALL MOUNT CABINETS

MODEL# DIMENSIONS FREIGHT CLASS WT/LBS. CUBIC FT. GR. 1-3 GR. 4-5

D x W x H

| | | | | | | |
|-------------|----------------|-----|----|---|--------|--------|
| TSPAS120H23 | 1 x 120 x 22.3 | 70 | 34 | 2 | \$2554 | \$3193 |
| TSPAS114H23 | 1 x 114 x 22.3 | 70 | 32 | 2 | \$2429 | \$3038 |
| TSPAS108H23 | 1 x 108 x 22.3 | 70 | 30 | 2 | \$2297 | \$2874 |
| TSPAS102H23 | 1 x 102 x 22.3 | 85 | 24 | 2 | \$2182 | \$2731 |
| TSPAS96H23 | 1 x 96 x 22.3 | 70 | 22 | 1 | \$2051 | \$2567 |
| TSPAS90H23 | 1 x 90 x 22.3 | 70 | 20 | 1 | \$1917 | \$2399 |
| TSPAS84H23 | 1 x 84 x 22.3 | 70 | 18 | 1 | \$1791 | \$2244 |
| TSPAS78H23 | 1 x 78 x 22.3 | 70 | 17 | 1 | \$1664 | \$2081 |
| TSPAS72H23 | 1 x 72 x 22.3 | 70 | 16 | 1 | \$1539 | \$1927 |
| TSPAS66H23 | 1 x 66 x 22.3 | 85 | 14 | 1 | \$1412 | \$1769 |
| TSPAS60H23 | 1 x 60 x 22.3 | 85 | 13 | 1 | \$1279 | \$1600 |
| TSPAS54H23 | 1 x 54 x 22.3 | 85 | 13 | 1 | \$1133 | \$1417 |
| TSPAS48H23 | 1 x 48 x 22.3 | 85 | 13 | 1 | \$1027 | \$1286 |
| TSPAS42H23 | 1 x 42 x 22.3 | 85 | 13 | 1 | \$901 | \$1125 |
| TSPAS36H23 | 1 x 36 x 22.3 | 100 | 8 | 1 | \$640 | \$803 |
| TSPAS30H23 | 1 x 30 x 22.3 | 150 | 5 | 1 | \$624 | \$777 |

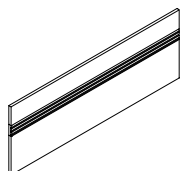

Tackboard w/Rail for 72" H*
Pigeon-Hole Wall Mount Cabinets

Factory installed tackboard for wall mount cabinets.

- Specify Black (E), Tungsten (K), or Designer White (DWT) accessory rail finish.

| | | | | | | |
|------------|--------------|------|----|---|--------|--------|
| TSAS120H26 | 1 x 120 x 26 | 70 | 34 | 2 | \$2826 | \$3533 |
| TSAS114H26 | 1 x 114 x 26 | 70 | 32 | 2 | \$2679 | \$3351 |
| TSAS108H26 | 1 x 108 x 26 | 70 | 30 | 2 | \$2549 | \$3187 |
| TSAS102H26 | 1 x 102 x 26 | 85 | 24 | 2 | \$2403 | \$3005 |
| TSAS96H26 | 1 x 96 x 26 | 92.5 | 22 | 2 | \$2258 | \$2826 |
| TSAS90H26 | 1 x 90 x 26 | 92.5 | 20 | 2 | \$2126 | \$2660 |
| TSAS84H26 | 1 x 84 x 26 | 100 | 18 | 2 | \$1961 | \$2451 |
| TSAS78H26 | 1 x 78 x 26 | 100 | 17 | 2 | \$1835 | \$2295 |
| TSAS72H26 | 1 x 72 x 26 | 70 | 16 | 1 | \$1670 | \$2090 |
| TSAS66H26 | 1 x 66 x 26 | 85 | 14 | 1 | \$1559 | \$1945 |
| TSAS60H26 | 1 x 60 x 26 | 85 | 13 | 1 | \$1412 | \$1769 |
| TSAS54H26 | 1 x 54 x 26 | 85 | 13 | 1 | \$1273 | \$1590 |
| TSAS48H26 | 1 x 48 x 26 | 85 | 13 | 1 | \$1133 | \$1417 |
| TSAS42H26 | 1 x 42 x 26 | 85 | 13 | 1 | \$996 | \$1242 |
| TSAS36H26 | 1 x 36 x 26 | 100 | 8 | 1 | \$851 | \$1067 |
| TSAS30H26 | 1 x 30 x 26 | 150 | 5 | 1 | \$711 | \$892 |

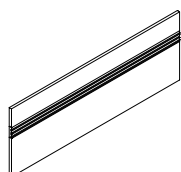

Tackboard w/Rail for 72" H*
Non-Pigeon-Hole Wall Mount Cabinets

Factory installed tackboard for wall mount cabinets.

- Specify Black (E), Tungsten (K), or Designer White (DWT) accessory rail finish.

| | | | | | | |
|-----------|--------------|------|----|---|--------|--------|
| TSP120H21 | 1 x 120 x 21 | 70 | 35 | 2 | \$1656 | \$1989 |
| TSP114H21 | 1 x 114 x 21 | 70 | 32 | 2 | \$1573 | \$1890 |
| TSP108H21 | 1 x 108 x 21 | 70 | 30 | 2 | \$1489 | \$1789 |
| TSP102H21 | 1 x 102 x 21 | 85 | 24 | 2 | \$1411 | \$1694 |
| TSP96H21 | 1 x 96 x 21 | 92.5 | 20 | 2 | \$1322 | \$1588 |
| TSP90H21 | 1 x 90 x 21 | 70 | 1 | 1 | \$1243 | \$1493 |
| TSP84H21 | 1 x 84 x 21 | 70 | 18 | 1 | \$1162 | \$1396 |
| TSP78H21 | 1 x 78 x 21 | 70 | 17 | 1 | \$1074 | \$1291 |
| TSP72H21 | 1 x 72 x 21 | 70 | 16 | 1 | \$992 | \$1193 |
| TSP66H21 | 1 x 66 x 21 | 85 | 14 | 1 | \$907 | \$1091 |
| TSP60H21 | 1 x 60 x 21 | 85 | 13 | 1 | \$829 | \$996 |
| TSP54H21 | 1 x 54 x 21 | 85 | 13 | 1 | \$747 | \$898 |
| TSP48H21 | 1 x 48 x 21 | 85 | 13 | 1 | \$667 | \$802 |
| TSP42H21 | 1 x 42 x 21 | 125 | 6 | 1 | \$582 | \$701 |
| TSP36H21 | 1 x 36 x 21 | 150 | 4 | 1 | \$498 | \$600 |
| TSP30H21 | 1 x 30 x 21 | 250 | 3 | 1 | \$417 | \$502 |

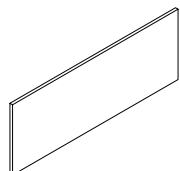

Tackboard for 84" H Double Height
Pigeon-Hole Wall Mount Cabinets

Factory installed tackboard for wall mount cabinets.

Required Specifications

Fabric
Metal finish*

TACKBOARDS

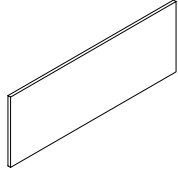

Tackboard for 84" H Double Height Non Pigeon-Hole Wall Mount Cabinets

| MODEL# | DIMENSIONS D x W x H | FREIGHT CLASS | WT/LBS. | CUBIC FT. | GR. 3 | GR. 4-5 |
|----------|-------------------------|---------------|---------|-----------|--------|---------|
| TS120H25 | 1 x 120 x 25 | 85 | 27 | 2 | \$1975 | \$2371 |
| TS114H25 | 1 x 114 x 25 | 85 | 25 | 2 | \$1878 | \$2256 |
| TS108H25 | 1 x 108 x 25 | 92.5 | 23 | 2 | \$1509 | \$1884 |
| TS102H25 | 1 x 102 x 25 | 100 | 19 | 2 | \$1418 | \$1776 |
| TS96H25 | 1 x 96 x 25 | 70 | 17 | 1 | \$1337 | \$1668 |
| TS90H25 | 1 x 90 x 25 | 70 | 15 | 1 | \$1253 | \$1569 |
| TS84H25 | 1 x 84 x 25 | 85 | 14 | 1 | \$1173 | \$1468 |
| TS78H25 | 1 x 78 x 25 | 85 | 13 | 1 | \$1083 | \$1355 |
| TS72H25 | 1 x 72 x 25 | 85 | 12 | 1 | \$1001 | \$1256 |
| TS66H25 | 1 x 66 x 25 | 92.5 | 11 | 1 | \$920 | \$1151 |
| TS60H25 | 1 x 60 x 25 | 92.5 | 10 | 1 | \$838 | \$1051 |
| TS54H25 | 1 x 54 x 25 | 92.5 | 10 | 1 | \$889 | \$1069 |
| TS48H25 | 1 x 48 x 25 | 92.5 | 10 | 1 | \$787 | \$947 |
| TS42H25 | 1 x 42 x 25 | 92.5 | 10 | 1 | \$690 | \$830 |
| TS36H25 | 1 x 36 x 25 | 125 | 6 | 1 | \$591 | \$711 |
| TS30H25 | 1 x 30 x 25 | 150 | 4 | 1 | \$495 | \$596 |

Factory installed tackboard for wall mount cabinets.

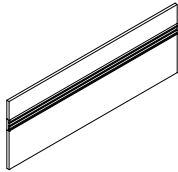

Tackboard w/Rail for 84" H Double Ht.* Pigeon-Hole Wall Mount Cabinets

| | | | | | | |
|-------------|--------------|----|----|------|--------|--------|
| TSPAS120H21 | 1 x 120 x 21 | 70 | 33 | 2 | \$2912 | \$3495 |
| TSPAS114H21 | 1 x 114 x 21 | 70 | 32 | 2 | \$2769 | \$3325 |
| TSPAS108H21 | 1 x 108 x 21 | 70 | 30 | 2 | \$2622 | \$3147 |
| TSPAS102H21 | 1 x 102 x 21 | 85 | 24 | 2 | \$2485 | \$2984 |
| TSPAS96H21 | 1 x 96 x 21 | 70 | 20 | 1 | \$2329 | \$2796 |
| TSPAS90H21 | 1 x 90 x 21 | 70 | 20 | 1 | \$2192 | \$2632 |
| TSPAS84H21 | 1 x 84 x 21 | 70 | 18 | 1 | \$2043 | \$2454 |
| TSPAS78H21 | 1 x 78 x 21 | 70 | 17 | 1 | \$1897 | \$2278 |
| TSPAS72H21 | 1 x 72 x 21 | 70 | 16 | 1 | \$1748 | \$2100 |
| TSPAS66H21 | 1 x 66 x 21 | 85 | 14 | 1 | \$1604 | \$1926 |
| TSPAS60H21 | 1 x 60 x 21 | 85 | 13 | 1 | \$1457 | \$1748 |
| TSPAS54H21 | 1 x 54 x 21 | 85 | 13 | 1 | \$1317 | \$1583 |
| TSPAS48H21 | 1 x 48 x 21 | 85 | 13 | 1 | \$1172 | \$1409 |
| TSPAS42H21 | 1 x 42 x 21 | 85 | 13 | 1 | \$1022 | \$1228 |
| TSPAS36H21 | 1 x 36 x 21 | 60 | 6 | 0.01 | \$872 | \$1047 |
| TSPAS30H21 | 1 x 30 x 21 | 60 | 4 | 0.01 | \$677 | \$815 |

Factory installed tackboard for wall mount cabinets.

- Specify Black (E), Tungsten (K), or Designer White (DWT) accessory rail finish.

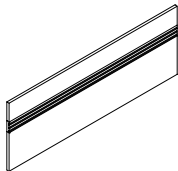

Tackboard w/Rail for 84" H Double Ht.* Non Pigeon-Hole Wall Mount Cabinets

| | | | | | | |
|------------|--------------|------|----|------|--------|--------|
| TSAS120H25 | 1 x 120 x 25 | 85 | 27 | 2 | \$3332 | \$4000 |
| TSAS114H25 | 1 x 114 x 25 | 85 | 25 | 2 | \$3163 | \$3797 |
| TSAS108H25 | 1 x 108 x 25 | 92.5 | 23 | 2 | \$2455 | \$3070 |
| TSAS102H25 | 1 x 102 x 25 | 100 | 19 | 2 | \$2307 | \$2887 |
| TSAS96H25 | 1 x 96 x 25 | 70 | 17 | 1 | \$2169 | \$2716 |
| TSAS90H25 | 1 x 90 x 25 | 70 | 15 | 1 | \$2043 | \$2557 |
| TSAS84H25 | 1 x 84 x 25 | 85 | 14 | 1 | \$1885 | \$2357 |
| TSAS78H25 | 1 x 78 x 25 | 85 | 13 | 1 | \$1765 | \$2209 |
| TSAS72H25 | 1 x 72 x 25 | 85 | 12 | 1 | \$1602 | \$2006 |
| TSAS66H25 | 1 x 66 x 25 | 92.5 | 11 | 1 | \$1500 | \$1880 |
| TSAS60H25 | 1 x 60 x 25 | 92.5 | 10 | 1 | \$1363 | \$1706 |
| TSAS54H25 | 1 x 54 x 25 | 92.5 | 10 | 1 | \$1504 | \$1807 |
| TSAS48H25 | 1 x 48 x 25 | 92.5 | 10 | 1 | \$1341 | \$1610 |
| TSAS42H25 | 1 x 42 x 25 | 92.5 | 10 | 1 | \$1175 | \$1412 |
| TSAS36H25 | 1 x 36 x 25 | 60 | 6 | 0.01 | \$1004 | \$1207 |
| TSAS30H25 | 1 x 30 x 25 | 60 | 4 | 0.01 | \$838 | \$1008 |

Factory installed tackboard for wall mount cabinets.

- Specify Black (E), Tungsten (K), or Designer White (DWT) accessory rail finish.

Required Specifications

Fabric
Metal finish*

ACCESSORIES

MODEL# DIMENSIONS FREIGHT CLASS WT/LBS. CUBIC FT. LIST PRICE

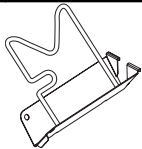

Flip Sorter

| | D x W x H | | | | |
|--------|--------------------|----|-----|------|------|
| BAFS01 | 9.25 x 2.75 x 9.25 | 70 | 0.6 | 0.14 | \$54 |

Load bar/accessory rail mounted metal flip sorter. Comes with chrome wire.
 • Specify Black (E), Tungsten (K), or Designer White (DWT) accessory finish.

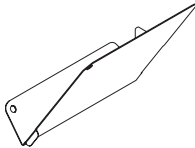

Slant Sorter

| | | | | | |
|--------------------|-----------------|----|---|------|------|
| BASS01L (Left) | 10.25 x 5 x 9.5 | 70 | 1 | 0.28 | \$44 |
| BASS01R (Right) | 10.25 x 5 x 9.5 | 70 | 1 | 0.28 | \$44 |

Load bar/accessory rail mounted metal slant sorter.
 • Specify Black (E), Tungsten (K), or Designer White (DWT) accessory finish.

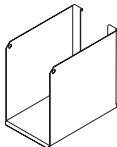

Binder Bin

| | | | | | |
|--------|---------------|----|------|------|------|
| BABB01 | 10.25 x 4 x 9 | 70 | 1.85 | 0.21 | \$70 |
|--------|---------------|----|------|------|------|

Load bar/accessory rail mounted metal binder bin.
 • Specify Black (E), Tungsten (K), or Designer White (DWT) accessory finish.

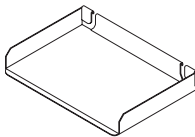

Letter Tray

| | | | | | |
|--------|-----------------|----|-----|------|------|
| BALTO1 | 9.25 x 13.5 x 2 | 70 | 0.5 | 0.15 | \$58 |
|--------|-----------------|----|-----|------|------|

Load bar/accessory rail mounted metal letter tray.
 • Specify Black (E), Tungsten (K), or Designer White (DWT) accessory finish.

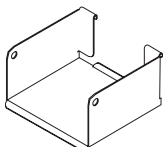

Media Bin

| | | | | | |
|--------|-----------------|----|------|------|------|
| BAMB01 | 5.25 x 5.75 x 3 | 70 | 1.85 | 0.21 | \$58 |
|--------|-----------------|----|------|------|------|

Load bar/accessory rail mounted metal media bin.
 • Specify Black (E), Tungsten (K), or Designer White (DWT) accessory finish.

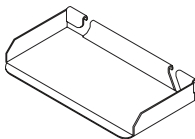

Utility Tray

| | | | | | |
|--------|-----------------|----|-----|------|------|
| BAUT01 | 3.75 x 5.75 x 3 | 70 | 0.5 | 0.02 | \$38 |
|--------|-----------------|----|-----|------|------|

Load bar/accessory rail mounted metal utility tray.
 • Specify Black (E), Tungsten (K), or Designer White (DWT) accessory finish.

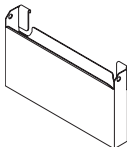

Mail Box

| | | | | | |
|--------|---------------|-----|---|------|------|
| BAPP01 | 2.75 x 16 x 9 | 100 | 2 | 0.25 | \$88 |
|--------|---------------|-----|---|------|------|

Load bar/accessory rail mounted metal mail box.
 • Specify Black (E), Tungsten (K), or Designer White (DWT) accessory finish.

Required Specifications

Fabric
 Metal finish*



ACCESSORIES

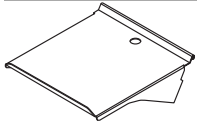

Telephone Holder

| MODEL# | DIMENSIONS D x W x H | FREIGHT CLASS | WT./LBS. | CUBIC FT. | LIST PRICE |
|--------|-------------------------|---------------|----------|-----------|-------------|
| BATH01 | 10 x 9 x 2 | 125 | 2 | 0.26 | \$85 |

Load bar/accessory rail mounted metal telephone holder.

- Specify Black (**E**), Tungsten (**K**), or Designer White (**DWT**) accessory finish.

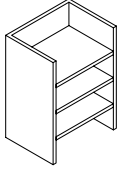

Paper Organizer, Letter & Legal Format

| | | | | | |
|------------|--------------|-----|----|---|--------------|
| KCPH161226 | 12 x 16 x 27 | 125 | 20 | 3 | \$981 |
| KCPH161223 | 12 x 16 x 23 | 125 | 18 | 3 | \$829 |
| KCPH161219 | 12 x 16 x 20 | 125 | 15 | 2 | \$632 |
| KCPH131226 | 12 x 13 x 27 | 100 | 16 | 2 | \$795 |
| KCPH131223 | 12 x 13 x 23 | 125 | 15 | 2 | \$675 |
| KCPH131219 | 12 x 13 x 20 | 125 | 12 | 2 | \$512 |

- Specify Black (**E**), Tungsten (**K**), or Designer White (**DWT**) accessory finish.

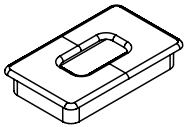

Grommet

| | | | | | |
|------|--------------|----|----|----|--------------|
| GM5C | 2 x 3.5 x -- | 70 | -- | -- | \$107 |
|------|--------------|----|----|----|--------------|

Rectangular grommet in metal, tungsten finish.

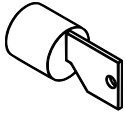

Lock Assembly

| | | | | | |
|--------|----|----|----|----|--------------|
| Black: | | | | | |
| LO | -- | 70 | -- | -- | \$106 |

| | | | | | |
|-----------|----|----|----|----|--------------|
| Tungsten: | | | | | |
| LO/C | -- | 70 | -- | -- | \$106 |

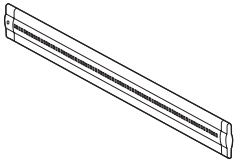

LED Task Light

| | | | | | |
|---------|-----------------|-----|---|-----|--------------|
| PLED30 | 1.5 x 15.5 x .5 | 150 | 2 | 0.5 | \$494 |
| PLED50 | 1.5 x 23.5 x .5 | 150 | 2 | 0.5 | \$569 |
| PLED100 | 1.5 x 43.5 x .5 | 125 | 3 | 0.5 | \$660 |

Energy efficient LED. Ultra slim design. Suitable for hanging under Hutch or Wallhung units. 6' power cord.

Required Specifications

Metal finish