



Kingston is a modern expression of old world craftsmanship. The classic proportion, attentive detailing, exquisite hand-matched veneers and solid wood edge details convey refined elegance with timeless beauty. Designed to highlight the warmth and majestic nature of real wood, Kingston offers an impressive array of storage components, fixed and freestanding worksurfaces that can be arranged to meet virtually any functional requirement.

Kingston detailing is contemporary with a 1" overhang on all edges. Solid walnut, cherry, maple, oak that bands worksurface perimeter is 1" wide by 1-3/8" thick for an overall thickness of 1-3/8". Kingston is a "top over pedestal" detailed series with a 1/4" reveal between the top and end panel. Tops have a 1" overhang. Floor storage unit bases are integrated in drawer faces. Products that are normally positioned against walls, such as credenzas, have a self-edge veneered back edge detail.

Features and Benefits

- Choice of 15 handle options for every door/drawer that features handles.
- Choice of six edge options
- Wide selection of storage components, fixed and freestanding worksurfaces.
- Sleek design



Interior veneer drawer edge

Edge options



K16



K18



K21



K22



K29



K30

GENERAL INFORMATION

- Distinguished by an elegant overhang detailed edge, Kingston pairs sleek European styling with functional design features that address the needs of today's dynamic and tech-savvy executive office.
- Kingston offers six distinctive edge shapes, as well as a multitude of drawer pull options.
- For environmental certification, please visit globalfurnituregroup.com

CONSTRUCTION

- Number One select, architectural grade "A" oak, American black walnut, American black cherry or maple. Wood worksurface molded edges are solid oak, walnut, cherry, or maple.
- Contemporary detailing with 1" overhang on all edges.
- Solid walnut, cherry, maple, oak that bands worksurface perimeter is 1" wide by 1-3/8" thick for an overall thickness of 1-3/8".

FINISHES

- Conversion varnish (similar to catalyzed lacquer, but tougher), 25 degree sheen. Finishes are not buffed or rubbed.
- All Global wood casegood products are veneered and finished on the back sides (360° finishing), except modular under-surface storage - tops and backs are unfinished.
- Touch up kits available, includes a touch up marker and fill crayon. Order **VTOUCHUPKIT, \$164** list. Specify finish when ordering.
- Global standard finish, on oak and walnut, is open pore and on cherry and maple is semi-closed pore. If a full finish is required for walnut, cherry, anigre and maple tops, Add the suffix "2" to the finish code and Add 5% to the base pricing for each product. **CUSTOM FINISH IS AVAILABLE.**

PEDESTALS

- Full-to-the-floor. Pedestals are fully assembled units that are either installed into desk and credenza shells, or available as modular units. Undersurface storage units include locks.
- Pedestal drawer suspensions are metal ball bearing type. Both box and file drawers are full extension.
- Hanging file rails are pre-installed on file drawer perimeters and accommodate both legal and letter size filing. Legal filing can be achieved either as side-to-side or front-to-back. Letter filing can be achieved as front-to-back filing only.
- Drawers are standard vinyl-wrapped construction with black drawer sides and bottom.
- The drawer front is an applied element to a four sided drawer. Drawer fronts are veneered on all surfaces except the vertical edges, which are solid oak, walnut, cherry and maple then routed with series detailing. Drawer fronts can be removed or replaced in the field.
- Levelers have 1" range of adjustment.

LOCKS

- Locks are standard on all below worksurface level drawer and door storage units, with the exception of pull-out tray units and single lateral file drawer combination tray/slot units.
- Combination storage unit comes with lock for file and lateral file drawer only; box drawers cannot lock.
- Lock color will match the handle option.
- Locks are optional on all above worksurface level closed storage

HANDLES

- If no handle is specified, there will be a routed finger pull in drawer fronts and touch latch mechanism for doors.
- See next page for options.

1. SPECIFY MODEL NUMBER

2. SPECIFY FINISH

WORKSURFACE TOP & DRAWER/DOOR FRONTS, BODY FINISHES (INCLUDING PEDESTALS) - VENEER

Code	Finish	Veneer Type	Cut
AMW	Almond Cherry	Cherry	Flat Sliced
ACW	Amber Cherry	Cherry	Flat Sliced
BTW	Biscotti	White Oak	Rift
CAW	Cocoa Walnut	Walnut	Flat Sliced
CRW	Coral	White Oak	Rift
DCW	Dark Cherry	Cherry	Flat Sliced
DWW	Dark Walnut	Walnut	Flat Sliced
EWV	Espresso Walnut	Walnut	Flat Sliced
EVW	Evening Oak	White Oak	Rift
GRW	Grey on Oak	White Oak	Rift
HAW	Hazelnut	Maple	Flat Sliced
JAW	Java	White Oak	Rift
LTW	Latte Walnut	Walnut	Flat Sliced
MHW	Mahogany on Walnut	Walnut	Flat Sliced
MTW	Milestone	White Oak	Rift
MPW	Natural Maple	Maple	Flat Sliced
NLW	Natural Walnut	Walnut	Flat Sliced
RCW	Red Cherry	Cherry	Flat Sliced
VNW	Vintage Cherry	Cherry	Flat Sliced
ULW	Umber Walnut	Walnut	Flat Sliced
WLW	Walnut	Walnut	Flat Sliced
WCW	Warm Cherry	Cherry	Flat Sliced
WMW	White Maple	Maple	Flat Sliced

METAL FINISHES (see model # notes for available finish):

E	Black
K	Tungsten
DWT	Designer White
P	Brushed Chrome

GLASS FINISHES (for Glass Doors and Modesty Panels):

- Frosted Glass (standard)
- White back painted glass - contact customer care

3. SPECIFY OPTIONS

EDGES

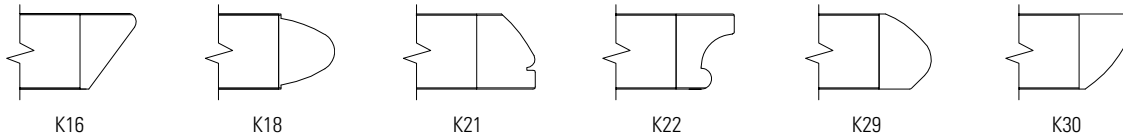

HANDLES

- If Handle is not specified Routed Pull, Black Lock & Grommet are standard
- If Handle is specified:
 - Black and Brass handle = Black Lock & Grommet
 - Silver, Nickel and Tungsten handle = Tungsten Lock & Grommet
- Handles are standard on most drawers/storage modules. Each handle is identified by letters: **PL33, PL34, PL64, PL66, PL92, PL93, PL94, PL95, PL96, PL97, PL98, PL99, PLS7, and PLS8**. To specify a handle, specify the code after the model number and finish selections.



PL33 Black Moon Pull, 4"



PL34 Nickel Moon Pull, 4"



PL64 Contemporary Nickel 5-3/8"



PL66 Transitional Nickel, 6-3/4"



PL92 Silver Bar, 5-3/8"



PL93 Black Bar, 5-3/8"



PL94 Silver Rectangular, 5-3/8"



PL95 Black Rectangular, 5-3/8"



PL96 Silver Slimline Pull, 5-3/8"



PL97 Black Slimline Pull, 5-3/8"



PL98 Silver Princeton Bar, 5-3/8"



PL99 Black Princeton Bar, 5-3/8"



PLS7 Black Spaghetti, 7-3/8"



PLS8 Silver Spaghetti, 7-3/8"

GROMMETS

- Standard grommet on all components is **GM5**. Grommet is included with products where shown in line drawings in price book.
- Optional grommets may be ordered in standard worksurface locations (left, center or right). Order as **GM5TL, GM5TC or GM5TR**. **Add \$96.**
- Grommet hole dimensions are 3.5" x 2". Specify **GM5E** for Black or **GM5K** for Tungsten.
- To order a grommet cover only, **Add \$57.**
- Color of grommet will be automatically coordinated with handle color where applicable
- Components that come standard with grommet may be ordered without a grommet. Order as RSG - **Add \$53.**

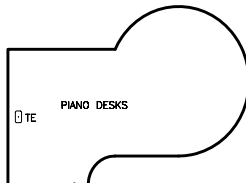
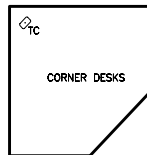
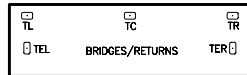
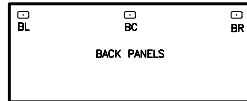
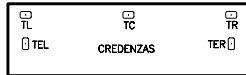
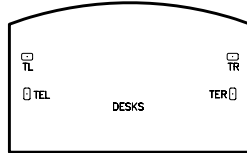
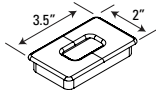

K KINGSTON - EDGE DETAILS

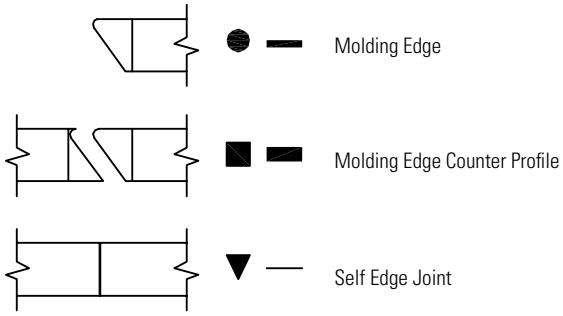

- D** - Desks and Credenzas
- B** - Executive Bridges
- E** - Executive Returns
- C** - Corner Components
- L** - Linking Bridges
- P** - Piano Desks

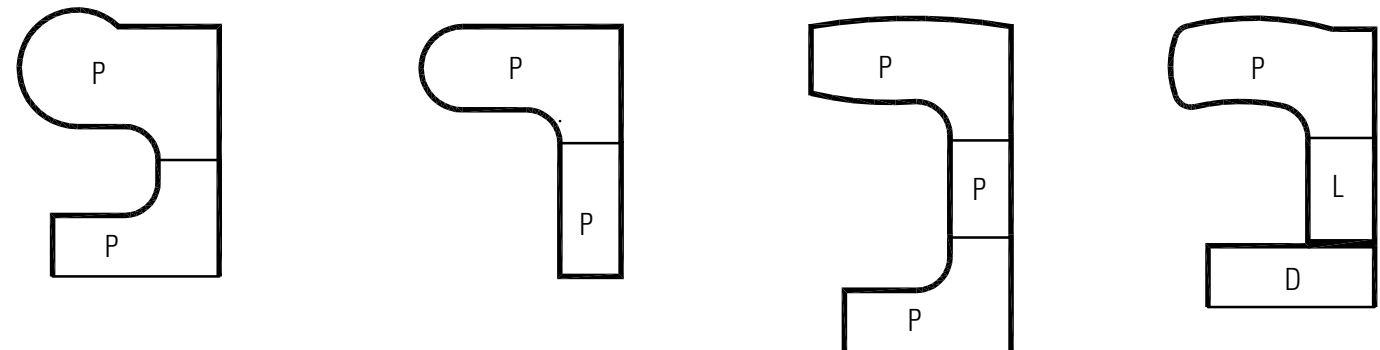
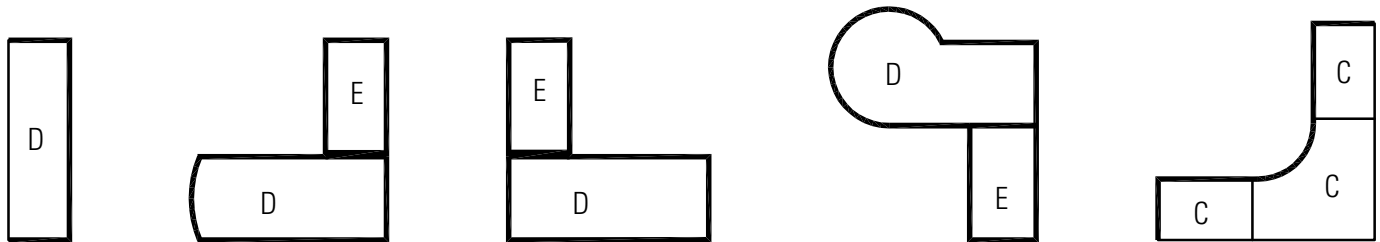
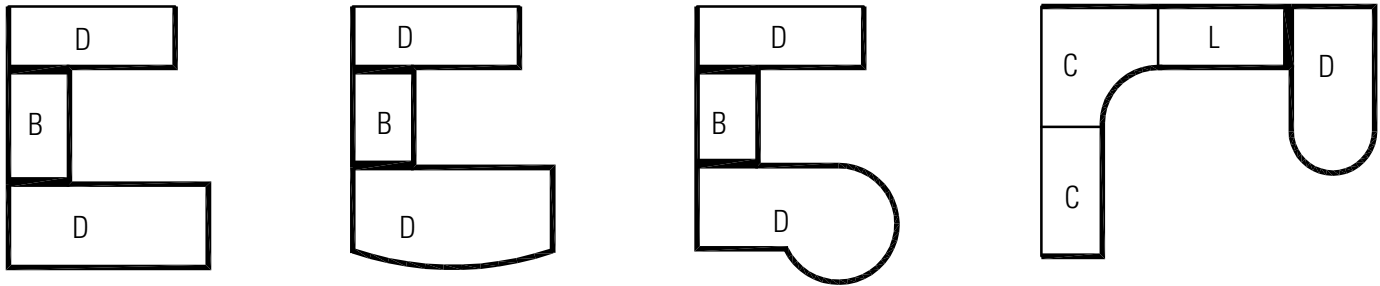
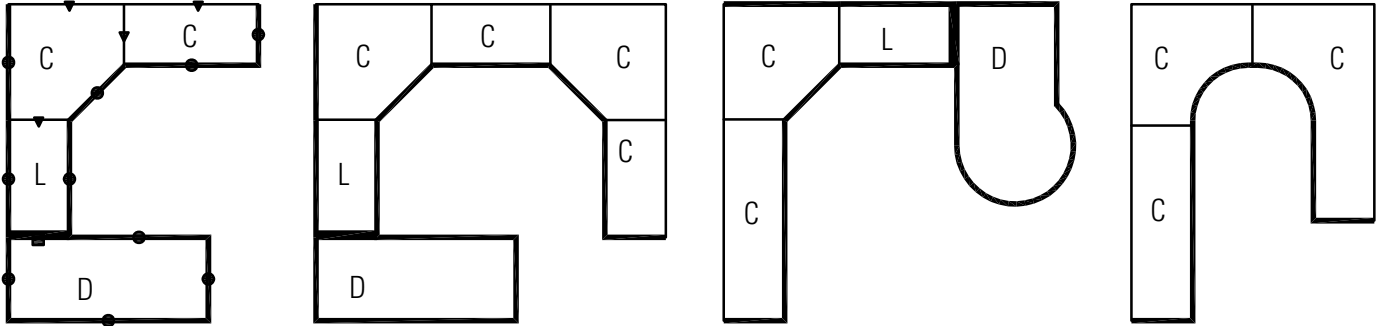

DESK AND CREDENZA NOTES

- Can be ordered as a shell or with pedestals
- Hand of Rectangular Desk is determined by location of pedestal from user side
- Hand of "D" Top is determined by outward orientation of curved end from user projection.
- Hand of "P" Top is determined by outward orientation of conference end from user projection.

Isometric View

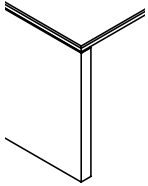

Side View
1-3/8" Top

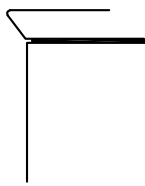

Front View
1-3/16" Slab

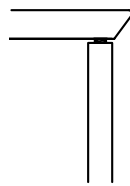

KT6030

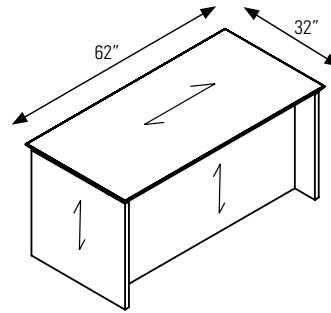

MODESTY PANEL CLEARANCE

KT7236

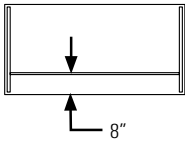

KMT7242

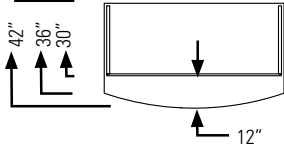

KiSR7230D

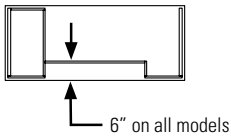

KDDCL7236

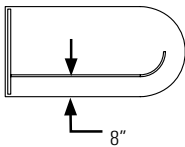

KT7236



Full Back Panel

KT7230

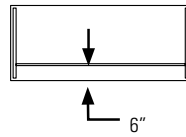

KMT7236

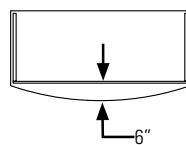

KDDF7230

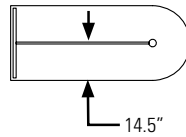

KDDCL7230

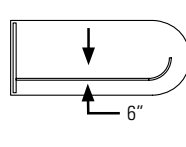

KTPL7242

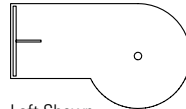

Left Shown

Field "punch out" to accommodate center drawer and keyboard

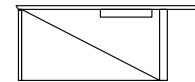

MODESTY PANEL OPTIONS

Standard Full Modesty

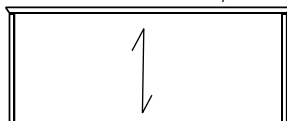

Glass Modesty

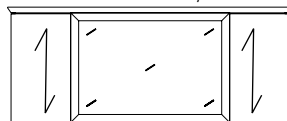

Breakfront

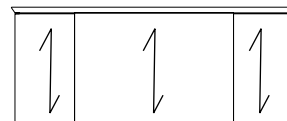

PIANO DESKS AND LINKING RETURNS

- All Desks are shipped assembled.
- Units include standard Grommets shown and installed horizontal wire management
- Unit is handed by Post Leg
- Not for use with regular Corner Units
- The standard grain direction is cross grain (**CG**). To remove cross grain veneer pattern on top, delete suffix "**CG**" from the model number (no upcharge)

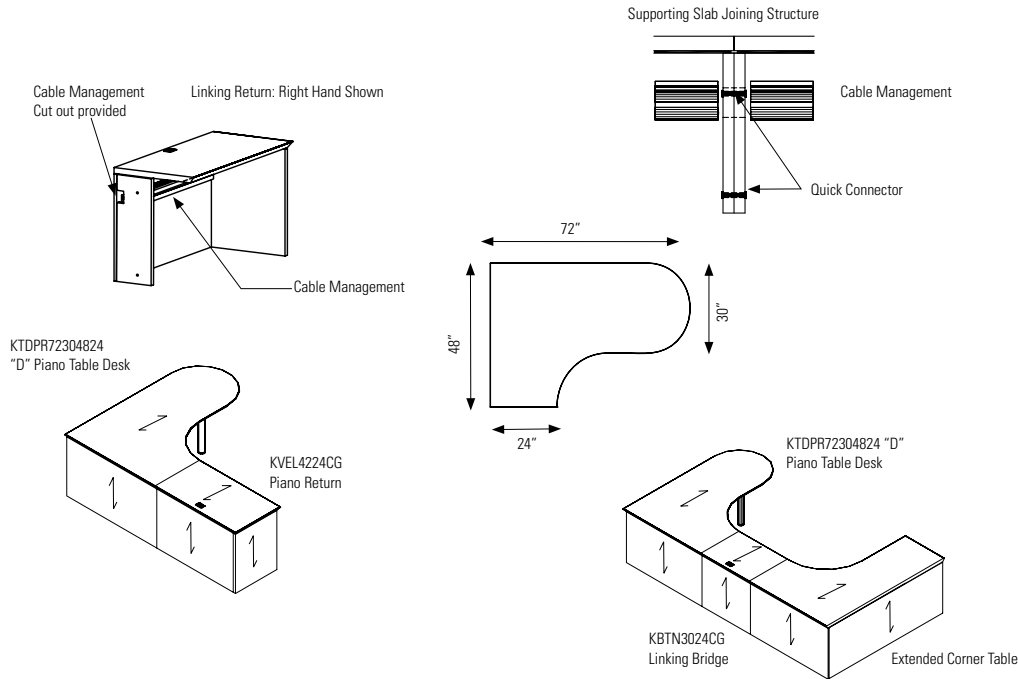

EXECUTIVE BRIDGES

- Executive Bridge is used to connect a Desk to a Credenza.
- Not to be used with Corner Components or Piano Desks.
- Three Back Panel options
- Back panel flush with end panels of Desk and Credenza
- Includes GM5 Grommet Top Center
- The standard grain direction is cross grain (**CG**). To remove cross grain veneer pattern on top, delete suffix "**CG**" from the model number (no upcharge)

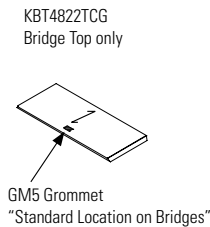
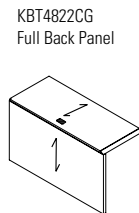
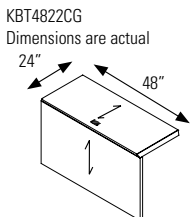
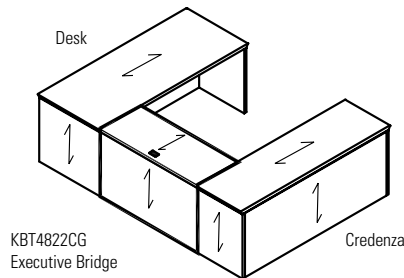

EXECUTIVE RETURNS

- Executive Return is used to attach to a Single Pedestal Desk, Single Pedestal Credenza, Desk Shell or Credenza Shell.
- Can be specified as a Shell or with a Pedestal.
- Back Panels are available as either full height or 8" from the underside of the worksurface.
- Hand of Executive Return is determined by location of full end panel from user side.
- Hand of Desk or Credenza is determined by location of pedestal from user side.
- The standard grain direction on return tops is cross grain (**CG**). To remove cross grain veneer pattern on top, delete suffix "**CG**" from the model number (no upcharge)

Executive Return attached to Desk or Credenza

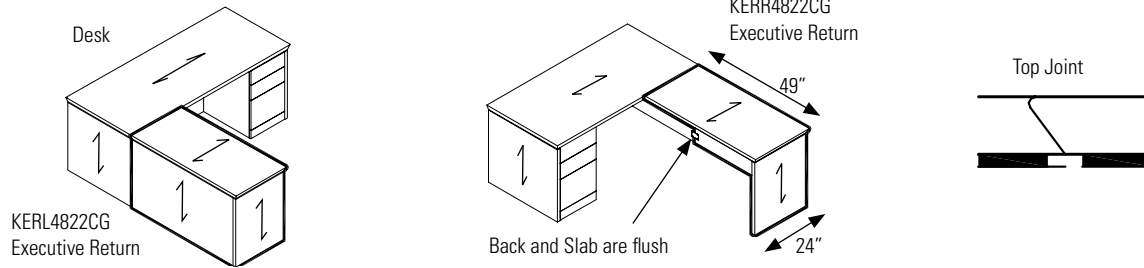

CORNER COMPONENTS

- Corner Table is used to connect to Linking Bridge and Linking Credenza.
- Cable management tray included.
- Back Panels are available as either full height or 8" from the underside of the worksurface.
- Hand of Linking Credenza is determined by location of full end panel from user side.
- Hand of Extended Corner is determined by location of long narrow end from user side
- The standard grain direction is cross grain (**CG**). To remove cross grain veneer pattern on top, delete suffix "**CG**" from the model number (no upcharge)

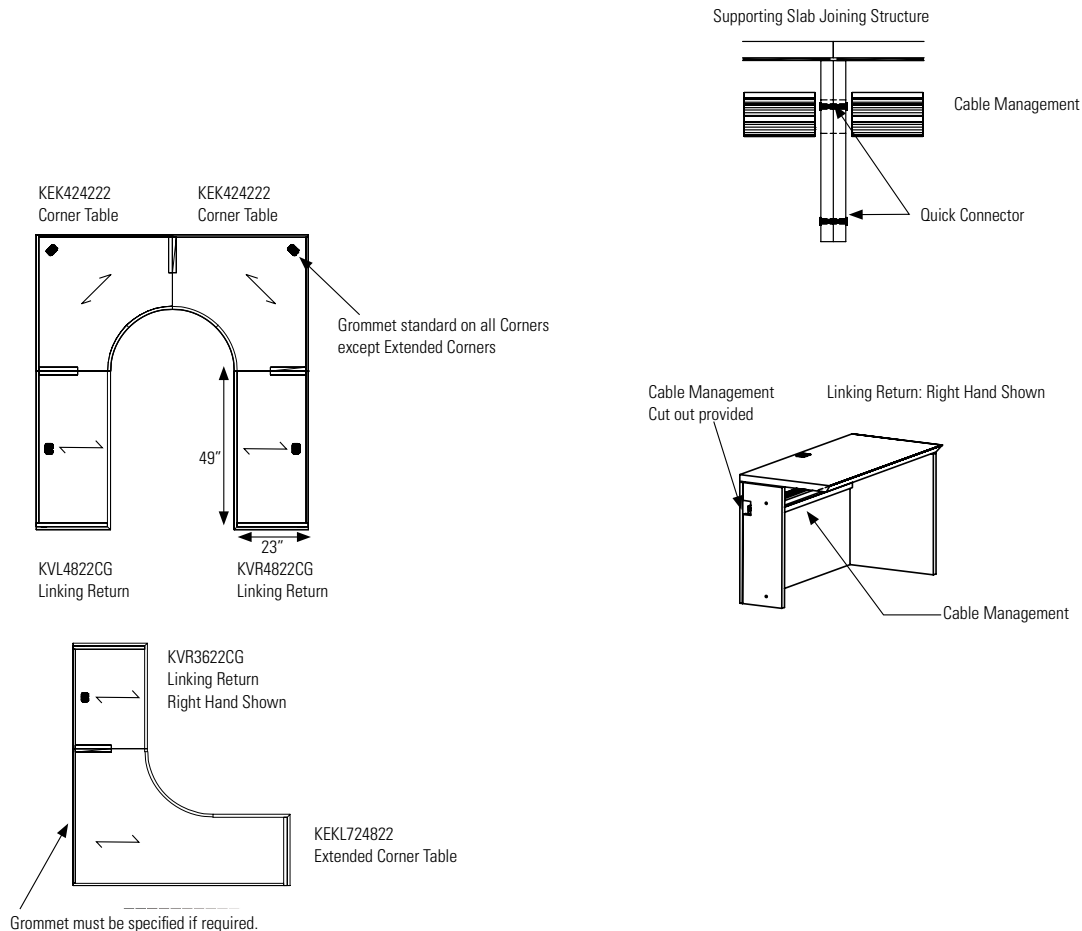

LINKING BRIDGES

- Linking Bridge is used to connect Corner Components to Single Pedestal Desk, Single Pedestal Credenza, Desk Shell or Credenza Shell.
- Back panels are available as either full height or 8" from the underside of the worksurface.
- Includes GM5 Grommet Top Center
- Hand of Linking Bridge is determined by location of half end panel from user side
- The standard grain direction is cross grain (**CG**). To remove cross grain veneer pattern on top, delete suffix "**CG**" from the model number (no upcharge)

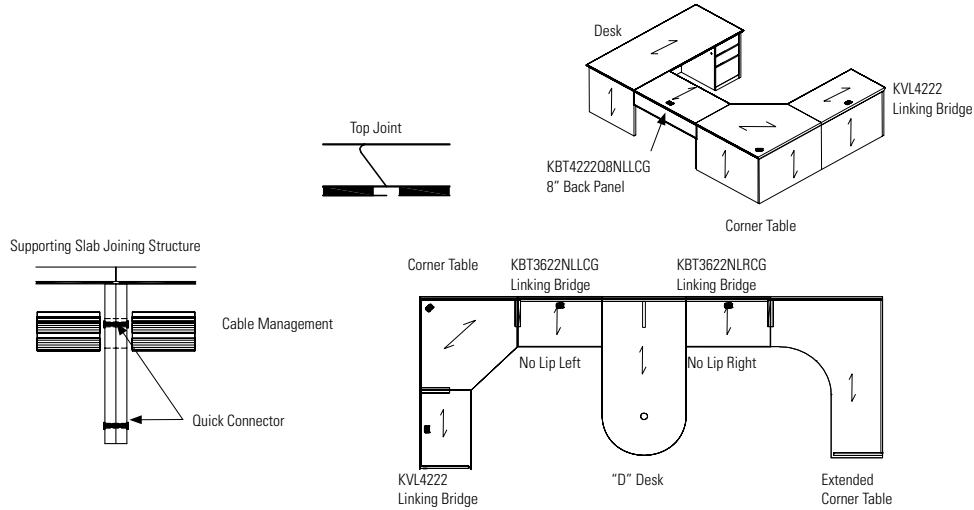

MODULAR PEDESTALS AND HANDLES

- Modular Pedestal for Kingston.
- Credenza Shells can only be completely filled with modular components that end in ".5" to create a full storage credenza.

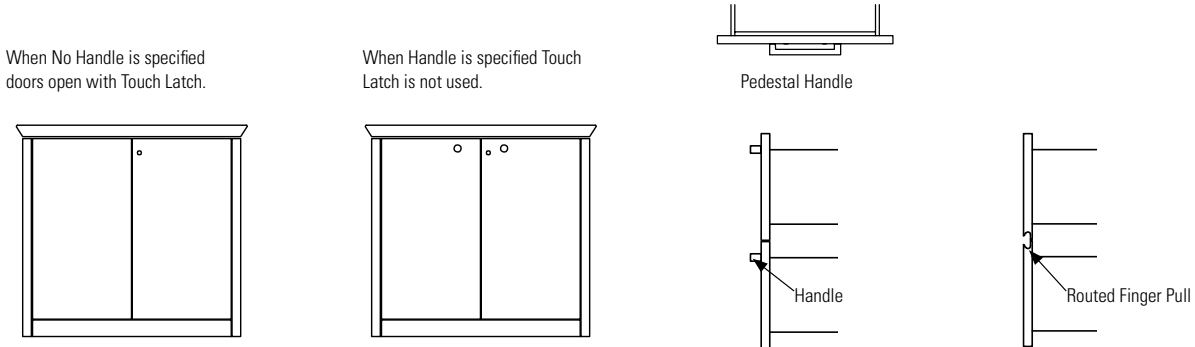

COPING AND SELF-EDGE OPTIONS

- Coping option provides an undercut on hutches only so that storage cabinets placed next to the hutch fit flush.
 - Specify **COP** for coping on both sides, **COPR** for coping on the right side and **COPL** for coping on the left side. No upcharge.
- Self edge options provide a flush fit when storage units are placed next to one another.
 - Specify **SE** for self-edge on both sides, **SER** for self-edge on the right side and **SEL** for self-edge on the left side. No upcharge.
 - Coping and self-edge handedness are from the users perspective. See diagram below.

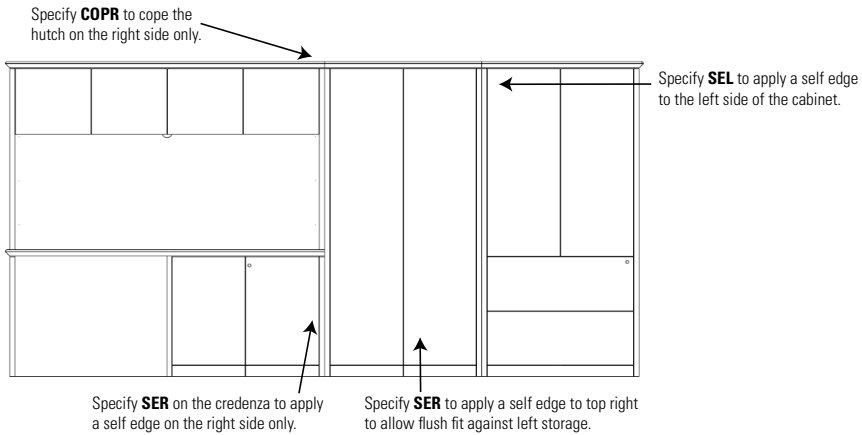

LOCKING

- Locks are standard on all below worksurface level drawer and door storage units with the exception of the pull-out tray units and single lateral file drawer combination tray/slot units.
- Locks are optional on all above worksurface level closed storage units. See Accessories Section (page 264) for lock specification details.

Standard Lock Positions

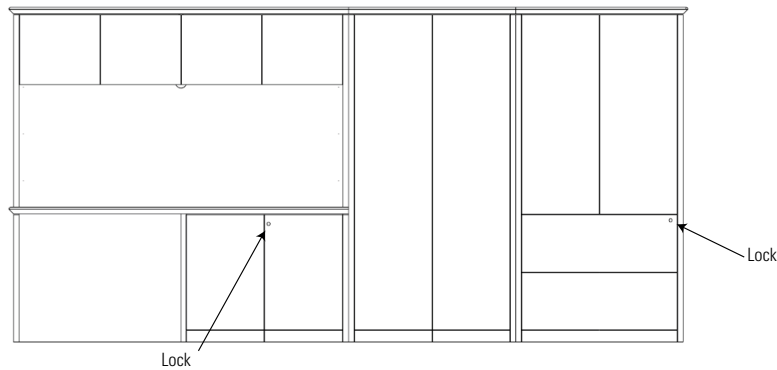

KZR
Combination Storage Unit:
Lock for File and Lateral File Drawer only,
Box Drawers do not lock.

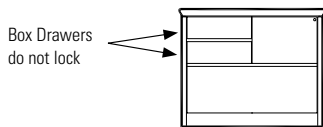

KD7236DE
Double Pedestal Desk/Credenza:
Lock for D and E Pedestals are on the inside Gable.

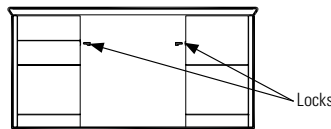

KCF7222
Full Storage Credenza: Locks are on the front.

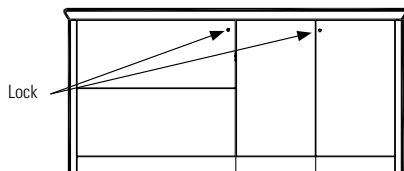

KWD
Modular Furniture:
Lock is on the front.

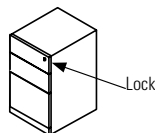

KWF
Modular Furniture:
Lock is on the front.

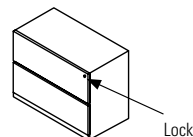

HUTCH POSITIONING

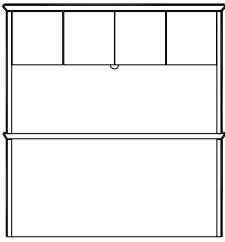

There must be an end panel under the hutch

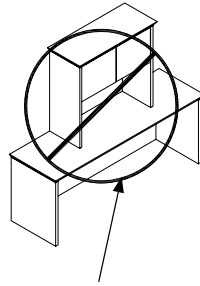
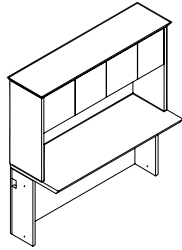

Missing Support
NOT Recommended

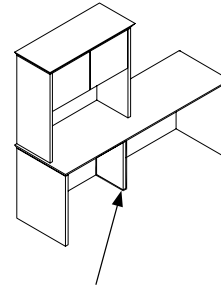

Add optional Support
SLAB12 (as Special)

TACKBOARDS

Tackboards for Storage Hutches

K72SH36

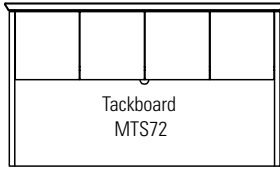

K72SHP42 and K72SHP42

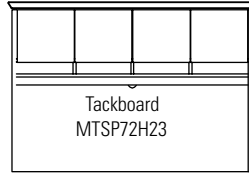

K72SH42 and K722SH54

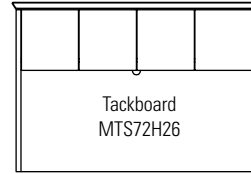

Tackboards with Accessory Rail

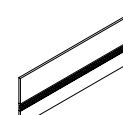
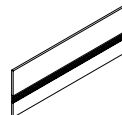
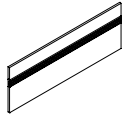

Tackboards for Wall Mount Overheads

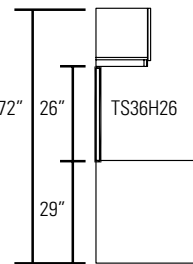
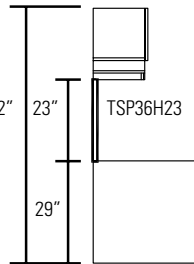
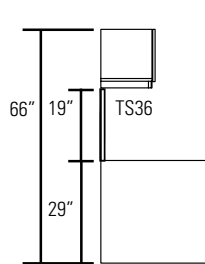

LIGHTING

For hutches and wall mount overheads

Wall Mount

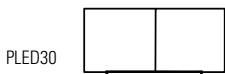

30" and 36" units



42" and 48" units



60" and longer units

Hutch

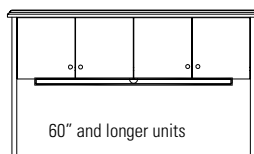
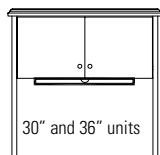

DESKS - NOTES

D x W x H

NOTE: Arrow indicates direction of grain

- All desks are shipped assembled
- Kneewell locking standard
- Desks available with a variety of modesty options: flush, breakfront, recessed and glass
- If Handle is not specified Routed Pull, Black Lock & Grommet are standard
- If Handle is specified:
 - Black and Brass handle = Black Lock & Grommet
 - Silver, Nickel and Tungsten handle = Tungsten Lock & Grommet
- Grommets are available as an option on Desks and most Credenzas.
- Edge options - must specify:

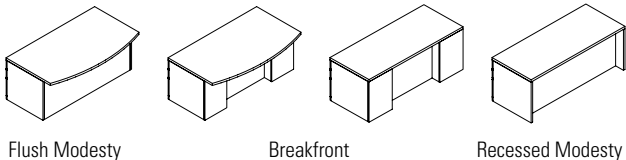
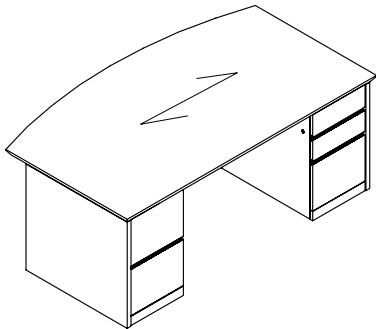
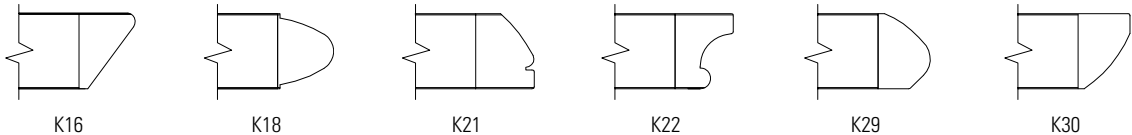

DOUBLE PEDESTAL DESKS

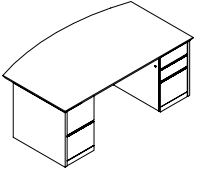

Double Pedestal Bow Top Desk

MODEL#	DIMENSIONS D x W x H	FREIGHT CLASS	WT/LBS.	CUBIC FT.	LIST PRICE
KMD8442ED	44 x 86 x 29	125	407	59	\$10120
KMD7842ED	44 x 80 x 29	125	392	55	\$9398
KMD7242ED	44 x 74 x 29	125	377	51	\$8672
KMD6636ED	38 x 68 x 29	100	340	40	\$8412

Standard with full to floor **file/file** pedestal on **left** and **box/box/file** pedestal on **right**. Pedestals lock.
Full Height Modesty Panel.

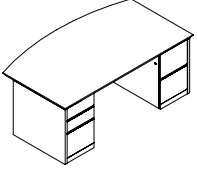

Double Pedestal Bow Top Desk

KMD8442DE	44 x 86 x 29	125	407	59	\$10120
KMD7842DE	44 x 80 x 29	125	392	55	\$9398
KMD7242DE	44 x 74 x 29	125	377	51	\$8672
KMD6636DE	38 x 68 x 29	100	340	40	\$8412

Standard with full to floor **file/file** pedestal on **right** and **box/box/file** pedestal on **left**. Pedestals lock.
Full Height Modesty Panel.

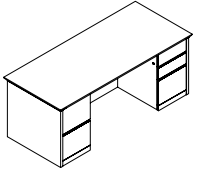

Double Pedestal Desk

KD8442ED	44 x 86 x 29	125	442	59	\$8604
KD7842ED	44 x 80 x 29	125	421	55	\$7992
KD7236ED	38 x 74 x 29	100	375	44	\$7378
KD7230ED	32 x 74 x 29	100	345	36	\$7266
KD6636ED	38 x 68 x 29	100	360	40	\$7266
KD6630ED	32 x 68 x 29	92.5	330	33	\$7149
KD6030ED	32 x 62 x 29	92.5	315	30	\$6925

Standard with full to floor **file/file** pedestal on **left** and **box/box/file** pedestal on **right**. Pedestals lock.
Full height modesty panel.

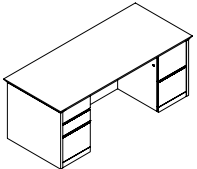

Double Pedestal Desk

KD8442DE	44 x 86 x 29	125	442	59	\$8604
KD7842DE	44 x 80 x 29	125	421	55	\$7992
KD7236DE	38 x 74 x 29	100	375	44	\$7378
KD7230DE	32 x 74 x 29	100	345	36	\$7266
KD6636DE	38 x 68 x 29	100	360	40	\$7266
KD6630DE	32 x 68 x 29	92.5	330	33	\$7149
KD6030DE	32 x 62 x 29	92.5	315	30	\$6925

Standard with full to floor **file/file** pedestal on **right** and **box/box/file** pedestal on **left**. Pedestals lock.
Full height modesty panel.

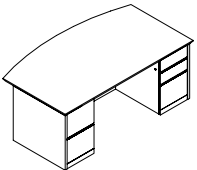

**Double Pedestal Bow Top Desk*
Breakfront Style**

KMID8442ED	44 x 86 x 29	125	407	59	\$11129
KMID7842ED	44 x 80 x 29	125	392	55	\$10336
KMID7242ED	44 x 74 x 29	125	377	51	\$9544
KMID6636ED	38 x 68 x 29	100	345	40	\$9250

Standard with full to floor **file/file** pedestal on **left** and **box/box/file** pedestal on **right**. Pedestals lock.
Inset Full Height Modesty Panel.

- For Aluminum Framed Glass Modesty option on Breakfront Style add "G" to the end of the product code. Add **\$1776**.

Required Specifications

Finish
Edge

Optional Specifications

Handles
Additional grommet
Glass modesty panel*

DESKS

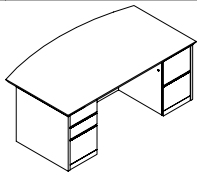

**Double Pedestal Bow Top Desk*
Breakfront Style**

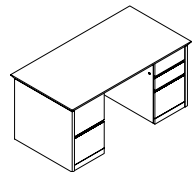

**Double Pedestal Desk*
Breakfront Style**

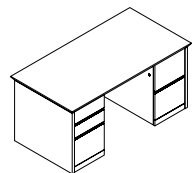

**Double Pedestal Desk*
Breakfront Style**

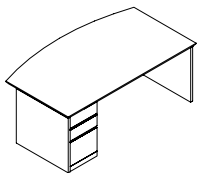

Single Pedestal Bow Top Desk - Left

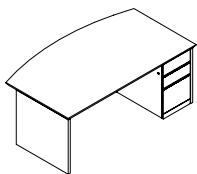

Single Pedestal Bow Top Desk - Right

MODEL# DIMENSIONS FREIGHT CLASS WT/LBS. CUBIC FT. LIST PRICE

D x W x H

KMID8442DE	44 x 86 x 29	125	407	59	\$11129
KMID7842DE	44 x 80 x 29	125	392	55	\$10336
KMID7242DE	44 x 74 x 29	125	377	51	\$9544
KMID6636DE	38 x 68 x 29	100	345	40	\$9250

Standard with full to floor **box/box/file** pedestal on **left** and **file/file** pedestal on **right**. Pedestals lock.
Inset Full Height Modesty Panel.

- For Aluminum Framed Glass Modesty option on Breakfront Style add "G" to the end of the product code. Add **\$1776**.

KID8442ED	44 x 86 x 29	125	442	59	\$9469
KID7842ED	44 x 80 x 29	125	421	55	\$8789
KID7236ED	38 x 74 x 29	100	375	44	\$8115
KID7230ED	32 x 74 x 29	100	345	36	\$7992
KID6636ED	38 x 68 x 29	100	360	40	\$7992
KID6630ED	32 x 68 x 29	92.5	330	33	\$7868
KID6030ED	32 x 62 x 29	92.5	315	30	\$7615

Standard with full to floor **file/file** pedestal on **left** and **box/box/file** pedestal on **right**. Pedestals lock.
Inset Full Height Modesty Panel.

- For Aluminum Framed Glass Modesty option on Breakfront Style add "G" to the end of the product code. Add **\$1776**.

KID8442DE	44 x 86 x 29	125	442	59	\$9469
KID7842DE	44 x 80 x 29	125	421	55	\$8789
KID7236DE	38 x 74 x 29	100	375	44	\$8115
KID7230DE	32 x 74 x 29	100	345	36	\$7992
KID6636DE	38 x 68 x 29	100	360	40	\$7992
KID6630DE	32 x 68 x 29	92.5	330	33	\$7868
KID6030DE	32 x 62 x 29	92.5	315	30	\$7615

Standard with full to floor **box/box/file** pedestal on **left** and **file/file** pedestal on **right**. Pedestals lock.
Inset Full Height Modesty Panel.

- For Aluminum Framed Glass Modesty option on Breakfront Style add "G" to the end of the product code. Add **\$1776**.

KMSL8442D	44 x 86 x 29	150	352	59	\$8019
KMSL7842D	44 x 80 x 29	125	337	55	\$7447
KMSL7242D	44 x 74 x 29	125	322	51	\$6874
KMSL6636D	38 x 68 x 29	125	290	40	\$6611

Standard with full to floor **box/box/file** pedestal on **left**. Pedestal locks.
Full height modesty panel.

KMSR8442D	44 x 86 x 29	150	352	59	\$8019
KMSR7842D	44 x 80 x 29	125	337	55	\$7447
KMSR7242D	44 x 74 x 29	125	322	51	\$6874
KMSR6636D	38 x 68 x 29	125	290	40	\$6611

Standard with full to floor **box/box/file** pedestal on **right**. Pedestal locks.
Full height modesty panel.

Required Specifications

Finish
Edge

Optional Specifications

Handles
Additional grommet
Glass modesty panel*

DESKS

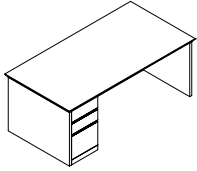

Single Pedestal Desk

MODEL#	DIMENSIONS D x W x H	FREIGHT CLASS	WT./LBS.	CUBIC FT.	LIST PRICE
KSL8442D	44 x 86 x 29	125	387	59	\$7540
KSL7842D	44 x 80 x 29	125	366	55	\$7103
KSL7236D	38 x 74 x 29	125	320	44	\$5627
KSL7230D	32 x 74 x 29	100	290	36	\$5374
KSL6636D	38 x 68 x 29	125	305	40	\$5374
KSL6630D	32 x 68 x 29	100	275	33	\$5129
KSL6030D	32 x 62 x 29	100	260	30	\$4903

Standard with full to floor **box/box/file** pedestal on **left**. Pedestals lock.
Full Height Modesty Panel.

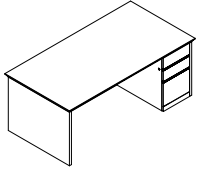

Single Pedestal Desk

KSR8442D	44 x 86 x 29	125	387	59	\$7540
KSR7842D	44 x 80 x 29	125	366	55	\$7103
KSR7236D	38 x 74 x 29	125	320	44	\$5627
KSR7230D	32 x 74 x 29	100	290	36	\$5374
KSR6636D	38 x 68 x 29	125	305	40	\$5374
KSR6630D	32 x 68 x 29	100	275	33	\$5129
KSR6030D	32 x 62 x 29	100	260	30	\$4903

Standard with full to floor **box/box/file** pedestal on **right**. Pedestals lock.
Full Height Modesty Panel.

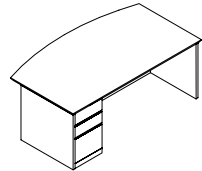

**Single Pedestal Desk - Left*
Breakfront Style**

KMISL8442D	44 x 86 x 29	125	452	59	\$8819
KMISL7842D	44 x 80 x 29	125	337	55	\$8190
KMISL7242D	44 x 74 x 29	125	322	51	\$7563
KMISL6636D	38 x 68 x 29	125	290	40	\$7273

Standard with full to floor **box/box/file** pedestal on **left**. Pedestals lock.
Inset Full Height Modesty Panel.

- For Aluminum Framed Glass Modesty option on Breakfront Style add "**G**" to the end of the product code. Add **\$1776**.

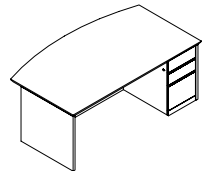

**Single Pedestal Desk - Right*
Breakfront Style**

KMISR8442D	44 x 86 x 29	125	452	59	\$8819
KMISR7842D	44 x 80 x 29	125	337	55	\$8190
KMISR7242D	44 x 74 x 29	125	322	51	\$7563
KMISR6636D	38 x 68 x 29	125	290	40	\$7273

Standard with full to floor **box/box/file** pedestal on **right**. Pedestals lock.
Inset Full Height Modesty Panel.

- For Aluminum Framed Glass Modesty option on Breakfront Style add "**G**" to the end of the product code. Add **\$1776**.

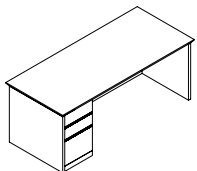

**Single Pedestal Desk - Left*
Breakfront Style**

KISL8442D	44 x 86 x 29	125	387	59	\$8421
KISL7842D	44 x 80 x 29	125	366	55	\$7820
KISL7236D	38 x 74 x 29	125	320	44	\$6187
KISL7230D	32 x 74 x 29	100	290	36	\$5911
KISL6636D	38 x 68 x 29	125	305	40	\$5911
KISL6630D	32 x 68 x 29	100	275	33	\$5642
KISL6030D	32 x 62 x 29	100	260	30	\$5392

Standard with full to floor **box/box/file** pedestal on **left**. Pedestals lock.
Inset Full Height Modesty Panel.

- For Aluminum Framed Glass Modesty option on Breakfront Style add "**G**" to the end of the product code. Add **\$1776**.

Required Specifications

Finish
Edge

Optional Specifications

Handles
Additional grommet
Glass modesty panel*

DESKS

MODEL# DIMENSIONS FREIGHT CLASS WT/LBS. CUBIC FT. LIST PRICE

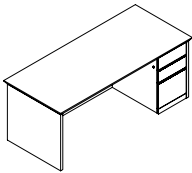

Single Pedestal Desk - Right*
Breakfront Style

	D x W x H				
KISR8442D	44 x 86 x 29	125	387	59	\$8421
KISR7842D	44 x 80 x 29	125	366	55	\$7820
KISR7236D	38 x 74 x 29	125	320	44	\$6187
KISR7230D	32 x 74 x 29	100	290	36	\$5911
KISR6636D	38 x 68 x 29	125	305	40	\$5911
KISR6630D	32 x 68 x 29	100	275	33	\$5642
KISR6030D	32 x 62 x 29	100	260	30	\$5392

Standard with full to floor **box/box/file** pedestal on **right**. Pedestals lock.
Inset Full Height Modesty Panel.

- For Aluminum Framed Glass Modesty option on Breakfront Style add "G" to the end of the product code. Add **\$1776**.

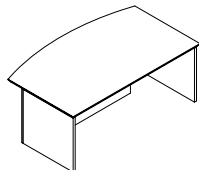

Desk Shell, Bow Top
Breakfront Style

KMIT8442	44 x 86 x 29	125	380	59	\$6804
KMIT7842	44 x 80 x 29	125	353	55	\$6361
KMIT7242	44 x 74 x 29	125	331	51	\$5923
KMIT6636	38 x 68 x 29	125	287	40	\$5619

Inset Full Height Modesty Panel.

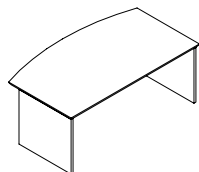

Desk Shell, Bow Top

KMT8442	44 x 86 x 29	150	297	59	\$6164
KMT7842	44 x 80 x 29	150	282	55	\$5720
KMT7242	44 x 74 x 29	150	267	51	\$5283
KMT6636	38 x 68 x 29	150	235	40	\$4980

Recessed Modesty Panel.

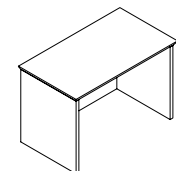

Desk Shell

KT8442	44 x 86 x 29	125	337	55	\$5730
KT7842	44 x 80 x 29	125	317	51	\$5321
KT8436	38 x 86 x 29	125	317	51	\$4913
KT7836	38 x 80 x 29	125	296	47	\$4564
KT7236	38 x 74 x 29	125	265	44	\$4216
KT7230	32 x 74 x 29	125	235	36	\$3967
KT6636	38 x 68 x 29	125	250	40	\$3967
KT6630	32 x 68 x 29	125	220	33	\$3727
KT6030	32 x 62 x 29	125	205	30	\$3407

Recessed Modesty Panel.

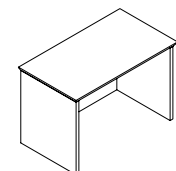

Desk Shell

KT4822	24 x 50 x 29	150	95	17	\$2440
KT4222	24 x 44 x 29	150	85	15	\$2044
KT3622	24 x 38 x 29	150	75	13	\$1972
KT3022	24 x 32 x 29	150	65	11	\$1933
KT4820	22 x 50 x 29	150	95	17	\$2222
KT4220	22 x 44 x 29	150	85	15	\$1858
KT3620	22 x 38 x 29	125	75	12	\$1795
KT3020	22 x 32 x 29	125	65	10	\$1760

Flush modesty panel.

Required Specifications

Finish
Edge

Optional Specifications

Handles
Additional grommet
Glass modesty panel*

DESKS

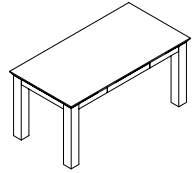
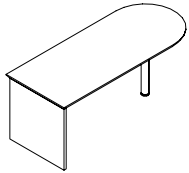

Table Desk*

MODEL#	DIMENSIONS D x W x H	FREIGHT CLASS	WT/LBS.	CUBIC FT.	LIST PRICE
KTB8442	44 x 86 x 29	150	272	59	\$10790
KTB7842	44 x 80 x 29	150	253	55	\$10021
KTB7236	38 x 74 x 29	150	205	44	\$7925
KTB7230	32 x 74 x 29	150	192	36	\$7782
KTB6636	38 x 68 x 29	150	192	40	\$7782
KTB6630	32 x 68 x 29	150	188	33	\$7630
KTB6030	32 x 62 x 29	150	171	30	\$7267

3" apron, center pencil drawer. 4" square legs.



"D" Shaped Connecting Table Desk*

KDD8436	36 x 84 x 29	125	343	51	\$5497
KDD7236	36 x 72 x 29	125	294	44	\$4708
KDD7230	30 x 72 x 29	125	264	36	\$4377
KDD6636	36 x 66 x 29	125	245	40	\$4377
KDD6030	30 x 60 x 29	125	225	30	\$4206

3" wood post and full end panel.

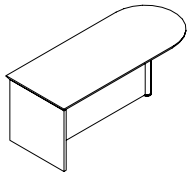

"D" Shaped Connecting Table Desk

KDDF8436	36 x 84 x 29	125	343	51	\$6751
KDDF7236	36 x 72 x 29	125	294	44	\$5794
KDDF7230	30 x 72 x 29	125	264	36	\$5456
KDDF6636	36 x 66 x 29	125	245	40	\$5456
KDDF6030	30 x 60 x 29	125	225	30	\$5285

3" wood post, full modesty panel, and full end panel.

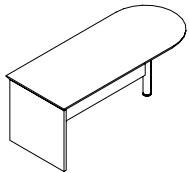

"D" Shaped Connecting Table Desk

KQDD8436	36 x 84 x 29	125	357	51	\$6340
KQDD7236	36 x 72 x 29	125	311	44	\$5431
KQDD7230	30 x 72 x 29	125	281	36	\$5099
KQDD6636	36 x 66 x 29	125	264	40	\$5099
KQDD6030	30 x 60 x 29	100	247	30	\$4930

3" wood post, 3/4 modesty panel, and full end panel.

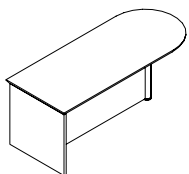

"D" Shaped Connecting Table Desk - Left

KDDCL8436	36 x 84 x 29	125	368	51	\$7178
KDDCL7236	36 x 72 x 29	125	320	44	\$6152
KDDCL7230	30 x 72 x 29	100	290	36	\$5815
KDDCL6636	36 x 66 x 29	125	270	40	\$5815
KDDCL6030	30 x 60 x 29	100	242	30	\$5648

Full height curved modesty panel, 3" wood post, and full end panel.

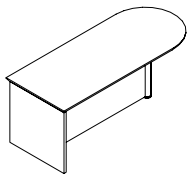

"D" Shaped Connecting Table Desk - Right

KDDCR8436	36 x 84 x 29	125	368	51	\$7178
KDDCR7236	36 x 72 x 29	125	320	44	\$6152
KDDCR7230	30 x 72 x 29	100	290	36	\$5815
KDDCR6636	36 x 66 x 29	125	270	40	\$5815
KDDCR6030	30 x 60 x 29	100	242	30	\$5648

Full height curved modesty panel, 3" wood post, and full end panel.

Required Specifications

Finish
Edge

Optional Specifications

Additional grommet
Base upgrade* (see accessories for options)

DESKS

MODEL# DIMENSIONS FREIGHT CLASS WT/LBS. CUBIC FT. LIST PRICE

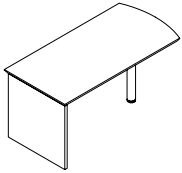

Connecting Bow End Table Desk*

D x W x H						
KDDBE8436	36 x 84 x 29	125	343	51		\$5497
KDDBE7236	36 x 72 x 29	125	294	44		\$4708
KDDBE7230	30 x 72 x 29	125	264	36		\$4377
KDDBE6636	36 x 66 x 29	125	245	40		\$4377
KDDBE6030	30 x 60 x 29	125	225	30		\$4206

3" wood post and full end panel.

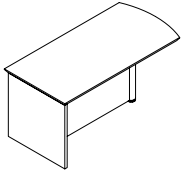

Connecting Bow End Table Desk

KDDBEF8436	36 x 84 x 29	125	368	51		\$6751
KDDBEF7236	36 x 72 x 29	125	320	44		\$5791
KDDBEF7230	30 x 72 x 29	100	290	36		\$5456
KDDBEF6636	36 x 66 x 29	125	271	40		\$5456
KDDBEF6030	30 x 60 x 29	100	247	30		\$5285

3" wood post, full modesty panel, and full end panel.

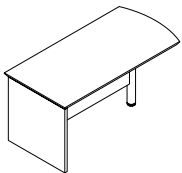

Connecting Bow End Table Desk

KQDDBE8436	36 x 84 x 29	125	357	51		\$6340
KQDDBE7236	36 x 72 x 29	125	311	44		\$5431
KQDDBE7230	30 x 72 x 29	125	281	36		\$5099
KQDDBE6636	36 x 66 x 29	125	264	40		\$5099
KQDDBE6030	30 x 60 x 29	100	247	30		\$4930

3" wood post, 3/4 modesty panel, and full end panel.

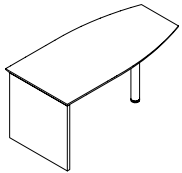

Connecting Boat Shaped Table Desk*

KDDBS8442	42 x 84 x 29	125	414	59		\$6507
KDDBS8436	36 x 84 x 29	125	343	51		\$5497
KDDBS7236	36 x 72 x 29	125	314	44		\$4708
KDDBS7230	30 x 72 x 29	125	284	36		\$4377
KDDBS6636	36 x 66 x 29	125	265	40		\$4377
KDDBS6030	30 x 60 x 29	100	245	30		\$4206

3" wood post and full end panel.

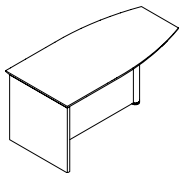

Connecting Boat Shaped Table Desk

KDDBSF8442	42 x 84 x 29	125	429	59		\$7879
KDDBSF8436	36 x 84 x 29	125	368	51		\$6751
KDDBSF7236	36 x 72 x 29	125	320	44		\$5791
KDDBSF7230	30 x 72 x 29	100	290	36		\$5456
KDDBSF6636	36 x 66 x 29	125	271	40		\$5456
KDDBSF6030	30 x 60 x 29	100	247	30		\$5285

3" wood post, full modesty panel, and full end panel.

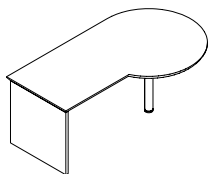

"P" Shaped Connecting Table - Left*

KTPL9642	42 x 96 x 29	125	440	68		\$6867
KTPL8442	42 x 84 x 29	125	385	59		\$6008
KTPL7242	42 x 72 x 29	125	319	51		\$5480

3" wood post and full end panel.

Required Specifications

Finish
Edge

Optional Specifications

Additional grommet
Base upgrade* (see accessories for options)

P-SHAPED CONNECTING TABLES

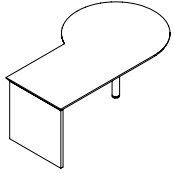

"P" Shaped Connecting Table - Right*

MODEL#	DIMENSIONS D x W x H	FREIGHT CLASS	WT/LBS.	CUBIC FT.	LIST PRICE
KTPR9642	42 x 96 x 29	125	440	68	\$6867
KTPR8442	42 x 84 x 29	125	385	59	\$6008
KTPR7242	42 x 72 x 29	125	319	51	\$5480

3" wood post and full end panel.

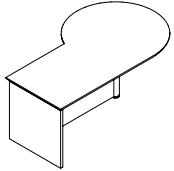

"P" Shaped Connecting Table - Left

KTPFL9642	42 x 96 x 29	150	317	68	\$8102
KTPFL8442	42 x 84 x 29	150	277	59	\$6250
KTPFL7242	42 x 72 x 29	150	211	51	\$6562

3" wood post, full height modesty panel, and full end panel.

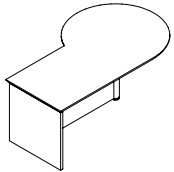

"P" Shaped Connecting Table - Right

KTPFR9642	42 x 96 x 29	150	317	68	\$8102
KTPFR8442	42 x 84 x 29	150	277	59	\$6250
KTPFR7242	42 x 72 x 29	150	211	51	\$6562

3" wood post, full height modesty panel, and full end panel.

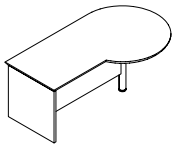

"P" Shaped Connecting Table - Left

KQTPL9642	42 x 96 x 29	150	291	68	\$7691
KQTPL8442	42 x 84 x 29	150	255	59	\$6730
KQTPL7242	42 x 72 x 29	250	189	51	\$6198

3" wood post, 3/4 height modesty panel, and full end panel.

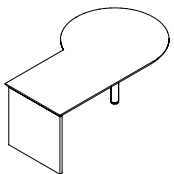

"P" Shaped Connecting Table - Right

KQTPR9642	42 x 96 x 29	150	291	68	\$7691
KQTPR8442	42 x 84 x 29	150	255	59	\$6730
KQTPR7242	42 x 72 x 29	250	189	51	\$6198

3" wood post, 3/4 height modesty panel, and full end panel.

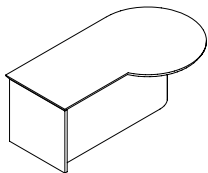

"P" Shaped Connecting Table - Left

KTPCL9642	42 x 96 x 29	150	317	68	\$8509
KTPCL8442	42 x 84 x 29	150	277	59	\$7451
KTPCL7242	42 x 72 x 29	150	211	51	\$6591

3" wood post, curved modesty panel, and full end panel.

Required Specifications

Finish
Edge

Optional Specifications

Additional grommet
Base upgrade* (see accessories for options)

P-SHAPED CONNECTING TABLES

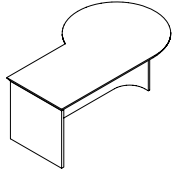

"P" Shaped Connecting Table - Right

MODEL#	DIMENSIONS D x W x H	FREIGHT CLASS	WT/LBS.	CUBIC FT.	LIST PRICE
KTPCR9642	42 x 96 x 29	150	317	68	\$8509
KTPCR8442	42 x 84 x 29	150	277	59	\$7451
KTPCR7242	42 x 72 x 29	150	211	51	\$6591

3" wood post, curved modesty panel, and full end panel.

RETURNS - NOTES

- All returns are shipped assembled
- Kneewell locking standard
- The standard grain direction on returns is cross grain (**CG**). To remove cross grain veneer pattern on top, delete suffix "**CG**" from the model number (no upcharge)
- If Handle is not specified Routed Pull, Black Lock & Grommet are standard
- If Handle is specified:
 - Black and Brass handle = Black Lock & Grommet
 - Silver, Nickel and Tungsten handle = Tungsten Lock & Grommet
- Grommets are available as an option on Desks and most Credenzas.
- Edge options - must specify:

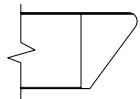

K16

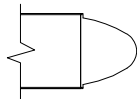

K18

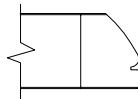

K21

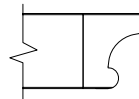

K22

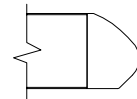

K29

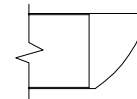

K30

• **NOTE:** Arrow indicates direction of grain

RETURNS

MODEL# DIMENSIONS FREIGHT CLASS WT/LBS. CUBIC FT. LIST PRICE

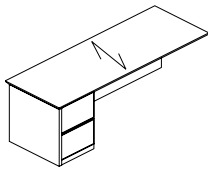

Executive Return - Left*

KERL7222ECG	24 x 73 x 29	100	250	29	\$5564
KERL6622ECG	24 x 67 x 29	100	236	27	\$5360
KERL6022ECG	24 x 61 x 29	100	227	24	\$4872
KERL5422ECG	24 x 55 x 29	100	205	22	\$4699
KERL4822ECG	24 x 49 x 29	100	185	19	\$4176
KERL4222ECG	24 x 43 x 29	92.5	178	17	\$4020

Standard with full to floor **file/file** pedestal on **left**. Pedestal locks. Full height flush back panel.

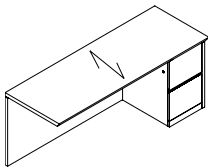

Executive Return - Right*

KERR7222ECG	24 x 73 x 29	100	250	29	\$5564
KERR6622ECG	24 x 67 x 29	100	236	27	\$5360
KERR6022ECG	24 x 61 x 29	100	227	24	\$4872
KERR5422ECG	24 x 55 x 29	100	205	22	\$4699
KERR4822ECG	24 x 49 x 29	100	185	19	\$4176
KERR4222ECG	24 x 43 x 29	92.5	178	17	\$4020

Standard with full to floor **file/file** pedestal on **right**. Pedestal locks. Full height flush back panel.

Required Specifications

Finish
Edge

Optional Specifications

Handles*
Additional grommet

EXECUTIVE RETURNS

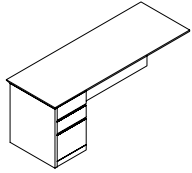

Executive Return - Left*

MODEL#	DIMENSIONS	FREIGHT CLASS	WT/LBS.	CUBIC FT.	LIST PRICE
--------	------------	---------------	---------	-----------	------------

D x W x H

KERL7222DCG	24 x 73 x 29	92.5	178	17	\$5564
KERL6622DCG	24 x 67 x 29	100	236	27	\$5360
KERL6022DCG	24 x 61 x 29	100	227	24	\$4872
KERL5422DCG	24 x 55 x 29	100	205	22	\$4699
KERL4822DCG	24 x 49 x 29	100	185	19	\$4176
KERL4222DCG	24 x 43 x 29	92.5	178	17	\$4020

Standard with full to floor **box/box/file** pedestal on **left**. Pedestal locks. Full height flush back panel.

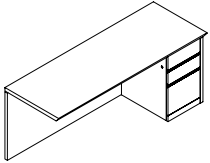

Executive Return - Right*

KERR7222DCG	24 x 73 x 29	92.5	178	17	\$5564
KERR6622DCG	24 x 67 x 29	100	236	27	\$5360
KERR6022DCG	24 x 61 x 29	100	227	24	\$4872
KERR5422DCG	24 x 55 x 29	100	205	22	\$4699
KERR4822DCG	24 x 49 x 29	100	185	19	\$4176
KERR4222DCG	24 x 43 x 29	92.5	178	17	\$4020

Standard with full to floor **box/box/file** pedestal on **right**. Pedestal locks. Full height flush back panel.

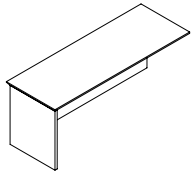

Executive Return - Left

KERL7222CG	24 x 73 x 29	150	135	29	\$3123
KERL6622CG	24 x 67 x 29	150	127	27	\$2864
KERL6022CG	24 x 61 x 29	150	120	24	\$2602
KERL5422CG	24 x 55 x 29	150	112	22	\$2340
KERL4822CG	24 x 49 x 29	150	105	19	\$2083
KERL4222CG	24 x 43 x 29	150	97	17	\$1819

Full height flush back panel.

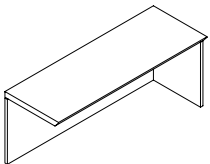

Executive Return - Right

KERR7222CG	24 x 73 x 29	150	135	29	\$3123
KERR6622CG	24 x 67 x 29	150	127	27	\$2864
KERR6022CG	24 x 61 x 29	150	120	24	\$2602
KERR5422CG	24 x 55 x 29	150	112	22	\$2340
KERR4822CG	24 x 49 x 29	150	105	19	\$2083
KERR4222CG	24 x 43 x 29	150	97	17	\$1819

Full height flush back panel.

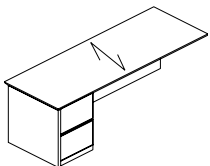

Executive Return - Left*

KERL7220ECG	22 x 73 x 29	100	240	27	\$5298
KERL6620ECG	22 x 67 x 29	100	231	24	\$5103
KERL6020ECG	22 x 61 x 29	92.5	222	22	\$4640
KERL5420ECG	22 x 55 x 29	92.5	200	20	\$4473
KERL4820ECG	22 x 49 x 29	92.5	180	18	\$3975
KERL4220ECG	22 x 43 x 29	92.5	173	16	\$3831

Standard with full to floor **file/file** pedestal on **left**. Pedestal locks. Full height flush back panel.

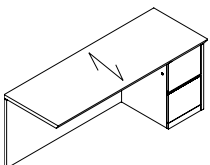

Executive Return - Right*

KERR7220ECG	22 x 73 x 29	100	240	27	\$5298
KERR6620ECG	22 x 67 x 29	100	231	24	\$5103
KERR6020ECG	22 x 61 x 29	92.5	222	22	\$4640
KERR5420ECG	22 x 55 x 29	92.5	200	20	\$4473
KERR4820ECG	22 x 49 x 29	92.5	180	18	\$3975
KERR4220ECG	22 x 43 x 29	92.5	173	16	\$3831

Standard with full to floor **file/file** pedestal on **right**. Pedestal locks. Full height flush back panel.

Required Specifications

Finish
Edge

Optional Specifications

Handles*
Additional grommet

EXECUTIVE RETURNS

MODEL# DIMENSIONS FREIGHT CLASS WT/LBS. CUBIC FT. LIST PRICE

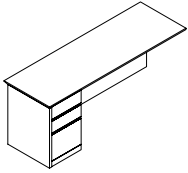

Executive Return - Left*

	D x W x H				
KERL7220DCG	22 x 73 x 29	100	240	27	\$5298
KERL6620DCG	22 x 67 x 29	100	231	24	\$5103
KERL6020DCG	22 x 61 x 29	92.5	222	22	\$4640
KERL5420DCG	22 x 55 x 29	92.5	200	20	\$4473
KERL4820DCG	22 x 49 x 29	92.5	180	18	\$3975
KERL4220DCG	22 x 43 x 29	92.5	173	16	\$3831

Standard with full to floor **box/box/file** pedestal on **left**. Pedestal locks. Full height flush back panel.

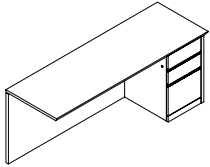

Executive Return - Right*

KERR7220DCG	22 x 73 x 29	100	240	27	\$5298
KERR6620DCG	22 x 67 x 29	100	231	24	\$5103
KERR6020DCG	22 x 61 x 29	92.5	222	22	\$4640
KERR5420DCG	22 x 55 x 29	92.5	200	20	\$4473
KERR4820DCG	22 x 49 x 29	92.5	180	18	\$3975
KERR4220DCG	22 x 43 x 29	92.5	173	16	\$3831

Standard with full to floor **box/box/file** pedestal on **right**. Pedestal locks. Full height flush back panel.

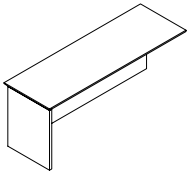

Executive Return - Left

KERL7220CG	22 x 73 x 29	150	130	27	\$2974
KERL6620CG	22 x 67 x 29	150	122	24	\$2728
KERL6020CG	22 x 61 x 29	150	115	22	\$2479
KERL5420CG	22 x 55 x 29	150	105	20	\$2229
KERL4820CG	22 x 49 x 29	150	100	18	\$1985
KERL4220CG	22 x 43 x 29	150	90	16	\$1733

Full height flush back panel.

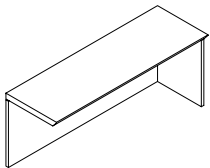

Executive Return - Right

KERR7220CG	22 x 73 x 29	150	130	27	\$2974
KERR6620CG	22 x 67 x 29	150	122	24	\$2728
KERR6020CG	22 x 61 x 29	150	115	22	\$2479
KERR5420CG	22 x 55 x 29	150	105	20	\$2229
KERR4820CG	22 x 49 x 29	150	100	18	\$1985
KERR4220CG	22 x 43 x 29	150	90	16	\$1733

Full height flush back panel.

Required Specifications

Finish
Edge

Optional Specifications

Handles*
Additional grommet

PIANO DESKS - NOTES

D x W x H

- All desks are shipped assembled
- Units include installed horizontal wire management
- Unit is handed by Post leg.
- Not for use with regular corner units
- If grommet (optional) color is not specified, Black grommet is standard.
- Grommets are available as an option on Desks and most Credenzas.
- Edge options - must specify:

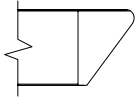

K16

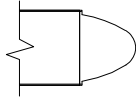

K18

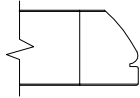

K21

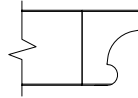

K22

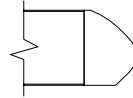

K29

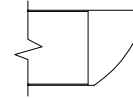

K30

- **NOTE:** Arrow indicates direction of grain
- For cross grain veneer pattern on top, add **(CG)**.

PIANO DESKS

MODEL#

DIMENSIONS

FREIGHT CLASS

WT./LBS.

CUBIC FT.

LIST PRICE

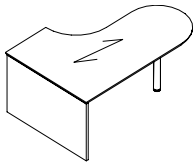

D-shaped Piano Desk - Left*

KTDP L96304822	48 x 96 x 29	125	464	77	\$7127
KTDP L84304822	48 x 84 x 29	150	406	68	\$6343
KTDP L72304822	48 x 72 x 29	125	348	58	\$5554

3" wood post and full end panel, 30"D worksurface and 24" return connection.

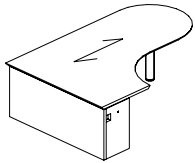

D-shaped Piano Desk - Right*

KTDP R96304822	48 x 96 x 29	125	464	77	\$7127
KTDP R84304822	48 x 84 x 29	150	406	68	\$6343
KTDP R72304822	48 x 72 x 29	125	348	58	\$5554

3" wood post and full end panel, 30"D worksurface and 24" return connection.

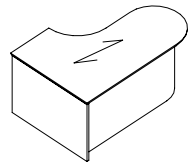

D-shaped Piano Desk - Left

KTDP CL96304822	48 x 96 x 29	125	479	77	\$9046
KTDP CL84304822	48 x 84 x 29	125	420	68	\$8022
KTDP CL72304822	48 x 72 x 29	125	360	58	\$6995

Full height curved modesty panel, 3" wood post, and full end panel, 30"D worksurface and 24" return connection.

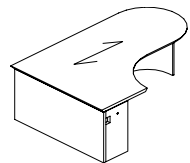

D-shaped Piano Desk - Right

KTDP CR96304822	48 x 96 x 29	125	479	77	\$9046
KTDP CR84304822	48 x 84 x 29	125	420	68	\$8022
KTDP CR72304822	48 x 72 x 29	125	360	58	\$6995

Full height curved modesty panel, 3" wood post, and full end panel, 30"D worksurface and 24" return connection.

Required Specifications

Finish
Edge

Optional Specifications

Additional grommet
Base upgrade* (see accessories for options)

PIANO DESKS

MODEL# DIMENSIONS FREIGHT CLASS WT/LBS. CUBIC FT. LIST PRICE

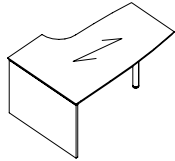

Boat-shaped Piano Desk - Left*

	D x W x H				
KTBPPL96364822	48 x 96 x 29	125	522	87	\$8022
KTBPPL84364822	48 x 84 x 29	125	457	76	\$7132
KTBPPL72364822	48 x 72 x 29	125	392	65	\$6246

3" wood post and full end panel, with 36"/30"D worksurface and 24" return connection.

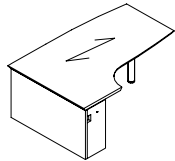

Boat-shaped Piano Desk - Right*

KTBPRL96364822	48 x 96 x 29	125	522	87	\$8022
KTBPRL84364822	48 x 84 x 29	125	457	76	\$7132
KTBPRL72364822	48 x 72 x 29	125	392	65	\$6246

3" wood post and full end panel, with 36"/30"D worksurface and 24" return connection.

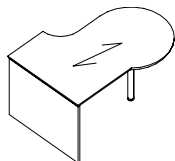

P-shaped Piano Desk - Left*

KTPPPL96424822	48 x 96 x 29	150	580	97	\$8133
KTPPPL84424822	48 x 84 x 29	150	508	85	\$7276
KTPPPL72424822	48 x 72 x 29	150	435	73	\$6742

3" wood post and full end panel, with 42"/30"D worksurface and 24" return connection.

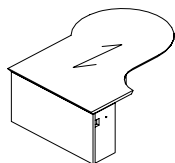

P-shaped Piano Desk - Right*

KTPPRL96424822	48 x 96 x 29	150	580	97	\$8133
KTPPRL84424822	48 x 84 x 29	150	508	85	\$7276
KTPPRL72424822	48 x 72 x 29	150	435	73	\$6742

3" wood post and full end panel, with 42"/30"D worksurface and 24" return connection.

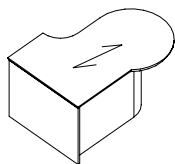

P-shaped Piano Desk - Left

KTPPCL96424822	48 x 96 x 29	125	590	97	\$9773
KTPPCL84424822	48 x 84 x 29	125	516	85	\$8710
KTPPCL72424822	48 x 72 x 29	125	442	73	\$8187

Full curved modesty panel, 3" wood post, and full end panel, with 42"/30"D worksurface and 24" return connection.

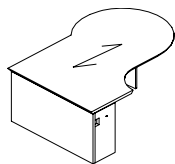

P-shaped Piano Desk - Right

KTPPCR96424822	48 x 96 x 29	125	590	97	\$9773
KTPPCR84424822	48 x 84 x 29	125	516	85	\$8710
KTPPCR72424822	48 x 72 x 29	125	442	73	\$8187

Full curved modesty panel, 3" wood post, and full end panel, with 42"/30"D worksurface and 24" return connection.

Required Specifications

Finish
Edge

Optional Specifications

Additional grommet
Base upgrade* (see accessories for options)

EXTENDED CORNERS

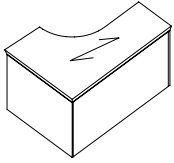

Extended Corner Table - Right

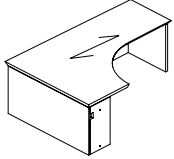

Extended Corner Table - Right

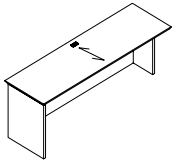

Linking Return - Left

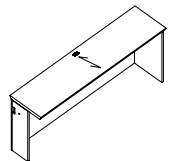

Linking Return - Right

MODEL#	DIMENSIONS D x W x H	FREIGHT CLASS	WT/LBS.	CUBIC FT.	LIST PRICE
KEKL964822MR	98 x 48 x 29	150	387	77	\$7744
KEKL904822MR	92 x 48 x 29	150	363	73	\$7314
KEKL844822MR	86 x 48 x 29	150	338	68	\$7225
KEKL784822MR	80 x 48 x 29	150	314	63	\$7188
KEKL724822MR	74 x 48 x 29	150	290	58	\$6209
KEKL664822MR	68 x 48 x 29	150	266	52	\$6371
KEKL604822MR	62 x 48 x 29	150	242	48	\$5901

Self edge on back edge, and 24" return connection.

KEKR489622ML	98 x 48 x 29	150	387	77	\$7744
KEKR489022ML	92 x 48 x 29	150	363	73	\$7314
KEKR488422ML	86 x 48 x 29	150	338	68	\$7225
KEKR487822ML	80 x 48 x 29	150	314	63	\$7188
KEKR487222ML	74 x 48 x 29	150	290	58	\$6830
KEKR486622ML	68 x 48 x 29	150	266	52	\$6371
KEKR486022ML	62 x 48 x 29	150	242	48	\$5901

Self edge on back edge, and 24" return connection.

KVEL9622CG	24 x 97 x 29	150	200	39	\$4706
KVEL9022CG	24 x 91 x 29	150	187	36	\$4411
KVEL8422CG	24 x 85 x 29	150	174	34	\$4118
KVEL7822CG	24 x 79 x 29	150	162	31	\$3823
KVEL7222CG	24 x 73 x 29	150	149	29	\$3533
KVEL6622CG	24 x 67 x 29	150	141	27	\$3316
KVEL6022CG	24 x 61 x 29	150	132	24	\$2948
KVEL5422CG	24 x 55 x 29	150	121	22	\$2924
KVEL4822CG	24 x 47 x 29	125	115	19	\$2748
KVEL4222CG	24 x 43 x 29	150	99	17	\$2312
KVEL3622CG	24 x 37 x 29	150	83	15	\$2231
KVEL3022CG	24 x 31 x 29	125	77	12	\$2220
KVEL2422CG	24 x 25 x 29	125	61	10	\$1839

Used in conjunction with Extended Corner Units or Piano Table Desks

KVER9622CG	24 x 97 x 29	150	200	39	\$4706
KVER9022CG	24 x 91 x 29	150	187	36	\$4411
KVER8422CG	24 x 85 x 29	150	174	34	\$4118
KVER7822CG	24 x 79 x 29	150	162	31	\$3823
KVER7222CG	24 x 73 x 29	150	149	29	\$3533
KVER6622CG	24 x 67 x 29	150	141	27	\$3316
KVER6022CG	24 x 61 x 29	150	132	24	\$2948
KVER5422CG	24 x 55 x 29	150	121	22	\$2924
KVER4822CG	24 x 47 x 29	125	115	19	\$2748
KVER4222CG	24 x 43 x 29	150	99	17	\$2312
KVER3622CG	24 x 37 x 29	150	83	15	\$2231
KVER3022CG	24 x 31 x 29	125	77	12	\$2220
KVER2422CG	24 x 25 x 29	125	61	10	\$1839

Used in conjunction with Extended Corner Units or Piano Table Desks

Required Specifications

Finish
Edge

Optional Specifications

Additional grommet

EXTENDED CORNERS

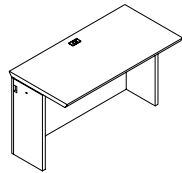

Bridge

MODEL# DIMENSIONS FREIGHT CLASS WT/LBS. CUBIC FT. LIST PRICE

	D x W x H				
KBTN4822CG	24 x 48 x 29	125	116	19	\$2662
KBTN4222CG	24 x 42 x 29	125	102	17	\$2231
KBTN3622CG	24 x 36 x 29	150	87	15	\$2152
KBTN3022CG	24 x 30 x 29	125	73	12	\$2107
KBTN2422CG	24 x 24 x 29	150	58	10	\$1768
KBTN1822CG	24 x 18 x 29	150	43	8	\$1330
KBTN1222CG	24 x 12 x 29	150	29	5	\$885

For Extended Corner Units or Piano Table Desks, with full back panel and recessed end panels.

BRIDGES

- All bridges are shipped knockdown.
- Not for use with corner units.
- The standard grain direction is cross grain (CG). To remove cross grain veneer pattern on top, delete suffix "CG" from the model number (no upcharge).
- GM5 TC location is standard. If grommet color is not specified, Black grommet is standard.
- Edge options - must specify:

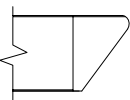

K16

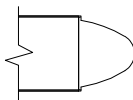

K18

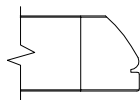

K21

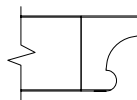

K22

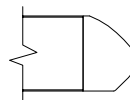

K29

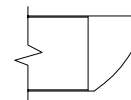

K30

• NOTE: Arrow indicates direction of grain

BRIDGES

MODEL# DIMENSIONS FREIGHT CLASS WT/LBS. CUBIC FT. LIST PRICE

KBT6022CG	24 x 60 x 29	85	108	9	\$2479
KBT5422CG	24 x 54 x 29	85	99	8	\$2231
KBT4822CG	24 x 48 x 29	85	90	7	\$1985
KBT4222CG	24 x 42 x 29	85	81	6	\$1735
KBT6020CG	22 x 60 x 29	85	105	8	\$2258
KBT5420CG	22 x 54 x 29	85	96	8	\$2031
KBT4820CG	22 x 48 x 29	85	87	7	\$1804
KBT4220CG	22 x 42 x 29	85	78	6	\$1547

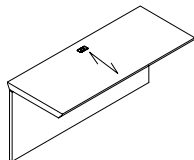

Executive Bridge Top

With full back panel.

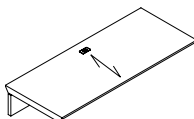

Executive Bridge Top

KBT6022Q8CG	24 x 60 x 9.5	100	83	9	\$2231
KBT5422Q8CG	24 x 54 x 9.5	100	74	8	\$2010
KBT4822Q8CG	24 x 48 x 9.5	100	65	7	\$1780
KBT4222Q8CG	24 x 42 x 9.5	100	56	6	\$1561
KBT6020Q8CG	22 x 60 x 9.5	92.5	80	8	\$2031
KBT5420Q8CG	22 x 54 x 9.5	100	71	8	\$1833
KBT4820Q8CG	22 x 48 x 9.5	100	62	7	\$1630
KBT4220Q8CG	22 x 42 x 9.5	100	53	6	\$1393

With 8" back panel.

Required Specifications

Finish
Edge

Optional Specifications

Additional grommet

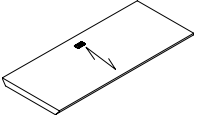
DESKS	MODEL#	DIMENSIONS	FREIGHT CLASS	WT/LBS.	CUBIC FT.	LIST PRICE
		D x W x H				
	KBT5422TCG	24 x 54 x 1.5	100	64	8	\$1335
	KBT4822TCG	24 x 48 x 1.5	125	55	7	\$1192
	KBT4222TCG	24 x 42 x 1.5	125	46	6	\$1045
	KBT5420TCG	22 x 54 x 1.5	125	61	8	\$1223
	KBT4820TCG	22 x 48 x 1.5	125	52	7	\$1086
	KBT4220TCG	22 x 42 x 1.5	125	43	6	\$930

Executive Bridge Top

No back panel.

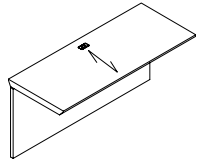

Executive Bridge Top

KHBT6022CG	24 x 60 x 29	85	108	9	\$2848
KHBT5422CG	24 x 54 x 29	85	99	8	\$2607
KHBT4822CG	24 x 48 x 29	85	90	7	\$2358
KHBT4222CG	24 x 42 x 29	85	81	6	\$2108
KHBT6020CG	22 x 60 x 29	85	105	8	\$2631
KHBT5420CG	22 x 54 x 29	85	96	8	\$2405
KHBT4820CG	22 x 48 x 29	85	87	7	\$2180
KHBT4220CG	22 x 42 x 29	85	78	6	\$1920

With hinged back panel, for U configurations.

CREDENZA NOTES

- All credenzas are shipped assembled.
- All Storage Cabinets include one adjustable shelf per set of doors.
- "F" and "G" depict 36", and "M" and "N" depict 30".
- "F" and "N" indicate lateral file drawers and "G" and "M" indicate storage cabinets with doors.
- Credenza shells accept modular storage. Use modular storage for top support, allowing no more than 72" unsupported.
- Credenza shells with a width of 96" and more will have a 12" center support gable.
- Credenza shells can only be completely filled with modular storage units with ".5" at the end of the model number.
- If Handle is not specified Routed Pull, Black Lock & Grommet are standard
- If Handle is specified:
 - Black and Brass handle = Black Lock & Grommet
 - Silver, Nickel and Tungsten handle = Tungsten Lock & Grommet
- **NOTE:** Arrow indicates direction of grain
- Edge options - must specify:

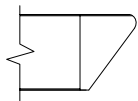
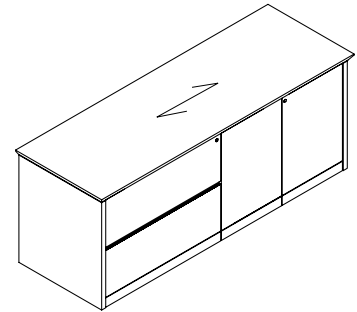

K16

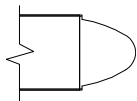

K18

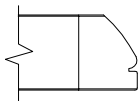

K21

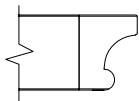

K22

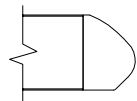

K29

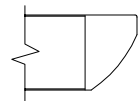

K30

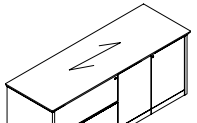
CREDENZAS	MODEL#	DIMENSIONS	FREIGHT CLASS	WT/LBS.	CUBIC FT.	LIST PRICE
	KC7222FG	23 x 74 x 29	92.5	285	27	\$6676
	KC6022NM	23 x 62 x 29	92.5	233	22	\$5563
	KC7220FG	21 x 74 x 29	92.5	272	24	\$6355
	KC6020NM	21 x 62 x 29	92.5	220	20	\$5294

Full Storage Credenza*

Standard with **lateral box/file** on left and **storage cabinet** on right.

- For Aluminum Framed Glass Door option, contact Customer Care.

Required Specifications

Finish
Edge

Optional Specifications

Handles*
Additional grommet

CRENZAS

MODEL# DIMENSIONS FREIGHT CLASS WT/LBS. CUBIC FT. LIST PRICE

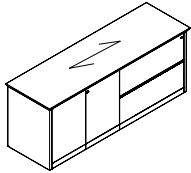

Full Storage Credenza

	D x W x H				
KC7222GF	23 x 74 x 29	92.5	285	27	\$6676
KC6022MN	23 x 62 x 29	92.5	233	22	\$5563
KC7220GF	21 x 74 x 29	92.5	272	24	\$6355
KC6020MN	21 x 62 x 29	92.5	220	20	\$5294

Standard with **lateral box/file** on **right** and **storage cabinet** on **left**.

- For Aluminum Framed Glass Door option, contact Customer Care.

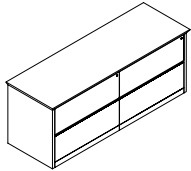

Full Storage Credenza

KC7222FF	23 x 74 x 29	92.5	300	27	\$8535
KC6022NN	23 x 62 x 29	100	218	22	\$7828
KC7220FF	21 x 74 x 29	92.5	287	24	\$8128
KC6020NN	21 x 62 x 29	92.5	205	20	\$7119

Standard with **lateral box/file** on **left** and **right**.

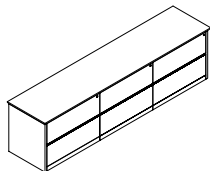

Full Storage Credenza

KC10822FFF	23 x 110 x 29	92.5	435	40	\$15014
KC9022NNN	23 x 92 x 29	92.5	372	33	\$12512
KC10820FFF	21 x 110 x 29	92.5	412	36	\$13648
KC9020NNN	21 x 92 x 29	92.5	337	30	\$11376

Standard with **lateral box/file** on **left, center** and **right**.

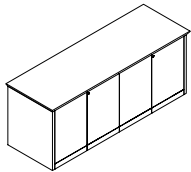

Full Storage Credenza

KC7222GG	23 x 74 x 29	92.5	277	27	\$6335
KC6022MM	23 x 62 x 29	92.5	232	22	\$5808
KC7220GG	21 x 74 x 29	92.5	253	24	\$6034
KC6020MM	21 x 62 x 29	92.5	209	20	\$5280

Standard with **storage cabinets** on **left** and **right**.

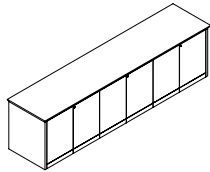

Full Storage Credenza

KC10822GGG	23 x 110 x 29	100	348	40	\$11973
KC9022MMM	23 x 92 x 29	100	302	33	\$9977
KC10820GGG	21 x 110 x 29	125	278	36	\$10881
KC9020MMM	21 x 92 x 29	125	228	30	\$9011

Standard with **storage cabinets** on **left, center** and **right**.

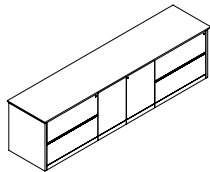

Full Storage Credenza

KC10822FGF	23 x 110 x 29	100	348	40	\$14001
KC9022NMN	23 x 92 x 29	100	302	33	\$11669
KC10820FGF	21 x 110 x 29	125	278	36	\$12726
KC9020NMN	21 x 92 x 29	125	228	30	\$10606

Lateral files on **left** and **right**; **storage cabinet** in **center**

Required Specifications

Finish
Edge

Optional Specifications

Handles
Additional grommet

CRENZAS

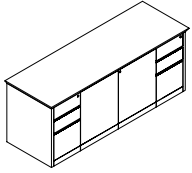

Full Storage Credenza

MODEL#	DIMENSIONS D x W x H	FREIGHT CLASS	WT/LBS.	CUBIC FT.	LIST PRICE
KC7222DGD	23 x 74 x 29	92.5	319	29	\$7828
KC6022DMD	23 x 62 x 29	92.5	266	24	\$7176
KC7220DGD	21 x 74 x 29	85	298	24	\$7452
KC6020DMD	21 x 62 x 29	85	246	20	\$6523

Standard with **box/box/file** on **left** and **right**; **storage cabinet** in **center**.

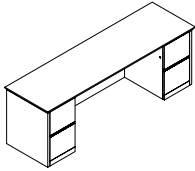

Double Pedestal Credenza

KCK8422EE	23 x 86 x 29	100	320	34	\$8179
KCK7822EE	23 x 80 x 29	100	298	31	\$7596
KCK7222EE	23 x 74 x 29	100	280	29	\$7014
KCK6622EE	23 x 68 x 29	100	257	27	\$6907
KCK6022EE	23 x 62 x 29	100	233	24	\$6426
KCK8420EE	21 x 86 x 29	92.5	307	28	\$7795
KCK7820EE	21 x 80 x 29	92.5	285	26	\$7238
KCK7220EE	21 x 74 x 29	92.5	267	24	\$6679
KCK6620EE	21 x 68 x 29	92.5	244	22	\$6122
KCK6020EE	21 x 62 x 29	92.5	220	20	\$5566

File/file pedestals on **left** and **right**. Full height back panel. Kneespace in center.

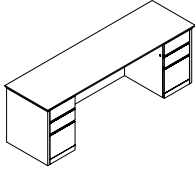

Double Pedestal Credenza

KCK8422DD	23 x 86 x 29	100	320	34	\$8179
KCK7822DD	23 x 80 x 29	100	298	31	\$7596
KCK7222DD	23 x 74 x 29	100	280	29	\$7014
KCK6622DD	23 x 68 x 29	100	257	27	\$6907
KCK6022DD	23 x 62 x 29	100	233	24	\$6426
KCK8420DD	21 x 86 x 29	92.5	307	28	\$7795
KCK7820DD	21 x 80 x 29	92.5	285	26	\$7238
KCK7220DD	21 x 74 x 29	92.5	267	24	\$6679
KCK6620DD	21 x 68 x 29	92.5	244	22	\$6122
KCK6020DD	21 x 62 x 29	92.5	220	20	\$5566

Box/box/file pedestals on **left** and **right**. Full height back panel. Kneespace in center.

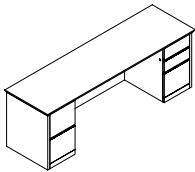

Double Pedestal Credenza

KCK8422ED	23 x 86 x 29	100	320	34	\$8179
KCK7822ED	23 x 80 x 29	100	298	31	\$7596
KCK7222ED	23 x 74 x 29	100	280	29	\$7014
KCK6622ED	23 x 68 x 29	100	257	27	\$6907
KCK6022ED	23 x 62 x 29	100	233	24	\$6426
KCK8420ED	21 x 86 x 29	92.5	307	28	\$7795
KCK7820ED	21 x 80 x 29	92.5	285	26	\$7238
KCK7220ED	21 x 74 x 29	92.5	267	24	\$6679
KCK6620ED	21 x 68 x 29	92.5	244	22	\$6122
KCK6020ED	21 x 62 x 29	92.5	220	20	\$5566

File/file pedestal on **left**, **box/box/file** pedestal on **right**. Full height back panel. Kneespace in center.

Required Specifications

Finish
Edge

Optional Specifications

Handles
Additional grommet

CREENZAS

MODEL# DIMENSIONS FREIGHT CLASS WT/LBS. CUBIC FT. LIST PRICE

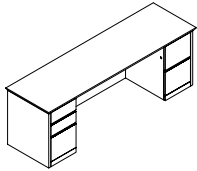

Double Pedestal Credenza

	D x W x H				
KCK8422DE	23 x 86 x 29	100	320	34	\$8179
KCK7822DE	23 x 80 x 29	100	298	31	\$7596
KCK7222DE	23 x 74 x 29	100	280	29	\$7014
KCK6622DE	23 x 68 x 29	100	257	27	\$6907
KCK6022DE	23 x 62 x 29	100	233	24	\$6426
KCK8420DE	21 x 86 x 29	92.5	307	28	\$7795
KCK7820DE	21 x 80 x 29	92.5	285	26	\$7238
KCK7220DE	21 x 74 x 29	92.5	267	24	\$6679
KCK6620DE	21 x 68 x 29	92.5	244	22	\$6122
KCK6020DE	21 x 62 x 29	92.5	220	20	\$5566

Box/box/file pedestal on left and file/file pedestal on right. Full height back panel. Kneespace in center.

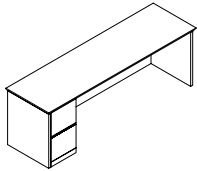

Single Pedestal Credenza - Left

KCL8422E	23 x 86 x 29	100	286	34	\$6184
KCL7822E	23 x 80 x 29	100	265	31	\$5745
KCL7222E	23 x 74 x 29	100	250	29	\$5298
KCL6622E	23 x 68 x 29	100	229	27	\$5103
KCL6022E	23 x 62 x 29	100	208	24	\$4640
KCL8420E	21 x 86 x 29	100	273	28	\$5892
KCL7820E	21 x 80 x 29	100	252	26	\$5473
KCL7220E	21 x 74 x 29	100	237	24	\$5049
KCL6620E	21 x 68 x 29	100	216	22	\$4860
KCL6020E	21 x 62 x 29	100	195	20	\$4422

File/file pedestal on left. Full height back panel.

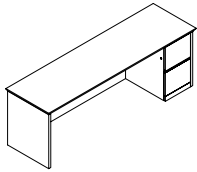

Single Pedestal Credenza - Right

KCR8422E	23 x 86 x 29	100	286	34	\$6184
KCR7822E	23 x 80 x 29	100	265	31	\$5745
KCR7222E	23 x 74 x 29	100	250	29	\$5298
KCR6622E	23 x 68 x 29	100	229	27	\$5103
KCR6022E	23 x 62 x 29	100	208	24	\$4640
KCR8420E	21 x 86 x 29	100	273	28	\$5892
KCR7820E	21 x 80 x 29	100	252	26	\$5473
KCR7220E	21 x 74 x 29	100	237	24	\$5049
KCR6620E	21 x 68 x 29	100	216	22	\$4860
KCR6020E	21 x 62 x 29	100	195	20	\$4422

File/file pedestal on right. Full height back panel.

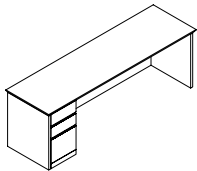

Single Pedestal Credenza - Left

KCL8422D	23 x 86 x 29	100	286	34	\$6184
KCL7822D	23 x 80 x 29	100	265	31	\$5745
KCL7222D	23 x 74 x 29	100	250	29	\$5298
KCL6622D	23 x 68 x 29	100	229	27	\$5103
KCL6022D	23 x 62 x 29	100	208	24	\$4640
KCL8420D	21 x 86 x 29	100	273	28	\$5892
KCL7820D	21 x 80 x 29	100	252	26	\$5473
KCL7220D	21 x 74 x 29	100	237	24	\$5049
KCL6620D	21 x 68 x 29	100	216	22	\$4860
KCL6020D	21 x 62 x 29	100	195	20	\$4422

Box/box/file pedestal on left. Full height back panel.

Required Specifications

Finish
Edge

Optional Specifications

Handles
Additional grommet

CREDENZAS

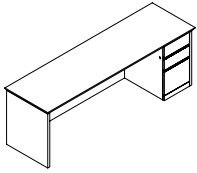

Single Pedestal Credenza - Right

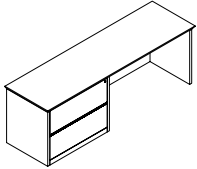

Single Pedestal Credenza - Left

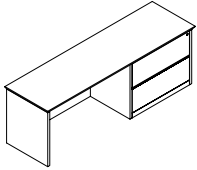

Single Pedestal Credenza - Right

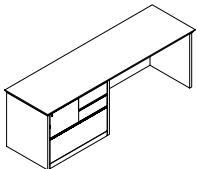

Single Pedestal Credenza - Left

MODEL#	DIMENSIONS D x W x H	FREIGHT CLASS	WT/LBS.	CUBIC FT.	LIST PRICE
KCR8422D	23 x 86 x 29	100	286	34	\$6184
KCR7822D	23 x 80 x 29	100	265	31	\$5745
KCR7222D	23 x 74 x 29	100	250	29	\$5298
KCR6622D	23 x 68 x 29	100	229	27	\$5103
KCR6022D	23 x 62 x 29	100	208	24	\$4640
KCR8420D	21 x 86 x 29	100	273	28	\$5892
KCR7820D	21 x 80 x 29	100	252	26	\$5473
KCR7220D	21 x 74 x 29	100	237	24	\$5049
KCR6620D	21 x 68 x 29	100	216	22	\$4860
KCR6020D	21 x 62 x 29	100	195	20	\$4422

Box/box/file pedestal on **right**. Full height back panel.

KCL8422F	23 x 86 x 29	100	266	31	\$7188
KCL7822F	23 x 80 x 29	100	245	29	\$6674
KCL7222F	23 x 74 x 29	100	230	27	\$6164
KCL6622F	23 x 68 x 29	100	209	24	\$5933
KCL6022F	23 x 62 x 29	100	188	22	\$5385
KCL8420F	21 x 86 x 29	100	253	28	\$6844
KCL7820F	21 x 80 x 29	100	233	26	\$6353
KCL7220F	21 x 74 x 29	100	218	24	\$5865
KCL6620F	21 x 68 x 29	100	197	22	\$5649
KCL6020F	21 x 62 x 29	100	176	20	\$5129

36" lateral file pedestal on **left**. Full height back panel.

KCR8422F	23 x 86 x 29	100	266	31	\$7188
KCR7822F	23 x 80 x 29	100	245	29	\$6674
KCR7222F	23 x 74 x 29	100	230	27	\$6164
KCR6622F	23 x 68 x 29	100	209	24	\$5933
KCR6022F	23 x 62 x 29	100	188	22	\$5385
KCR8420F	21 x 86 x 29	100	253	28	\$6844
KCR7820F	21 x 80 x 29	100	233	26	\$6353
KCR7220F	21 x 74 x 29	100	218	24	\$5865
KCR6620F	21 x 68 x 29	100	197	22	\$5649
KCR6020F	21 x 62 x 29	100	176	20	\$5129

36" lateral file pedestal on **right**. Full height back panel.

KCL8422Z	23 x 86 x 29	100	309	31	\$7846
KCL7822Z	23 x 80 x 29	100	287	29	\$7288
KCL7222Z	23 x 74 x 29	92.5	270	27	\$6730
KCL6622Z	23 x 68 x 29	92.5	248	24	\$6472
KCL6022Z	23 x 62 x 29	92.5	225	22	\$5891
KCL8420Z	21 x 86 x 29	92.5	296	28	\$7477
KCL7820Z	21 x 80 x 29	92.5	274	26	\$6943
KCL7220Z	21 x 74 x 29	92.5	257	24	\$6104
KCL6620Z	21 x 68 x 29	92.5	235	22	\$6166
KCL6020Z	21 x 62 x 29	92.5	212	20	\$5606

Modular combination storage pedestal with 1 lateral file, 1 file drawer on top left, and two box drawers on top right.

Required Specifications

Finish
Edge

Optional Specifications

Handles
Additional grommet

CREENZAS

MODEL# DIMENSIONS FREIGHT CLASS WT/LBS. CUBIC FT. LIST PRICE

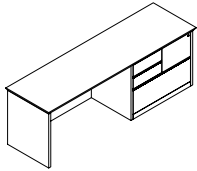

Single Pedestal Credenza - Right

	D x W x H				
KCR8422Z	23 x 86 x 29	100	309	31	\$7846
KCR7822Z	23 x 80 x 29	100	287	29	\$7288
KCR7222Z	23 x 74 x 29	92.5	270	27	\$6730
KCR6622Z	23 x 68 x 29	92.5	248	24	\$6472
KCR6022Z	23 x 62 x 29	92.5	225	22	\$5891
KCR8420Z	21 x 86 x 29	92.5	296	28	\$7477
KCR7820Z	21 x 80 x 29	92.5	274	26	\$6943
KCR7220Z	21 x 74 x 29	92.5	257	24	\$6104
KCR6620Z	21 x 68 x 29	92.5	235	22	\$6166
KCR6020Z	21 x 62 x 29	92.5	212	20	\$5606

Modular combination storage pedestal with 1 lateral file, 1 file drawer on top right, and two box drawers on top left.

96" and larger:

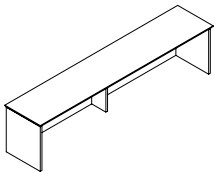

Less than 96":

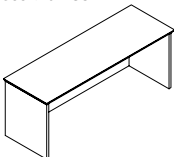

Credenza Shell

KC10822	23 x 108 x 29	125	320	41	\$4967
KC10222	23 x 104 x 29	100	305	38	\$4692
KC9622	23 x 98 x 29	100	287	35	\$4417
KC9022	23 x 92 x 29	100	269	33	\$3942
KC8422	23 x 86 x 29	100	251	31	\$3866
KC7822	23 x 80 x 29	100	233	29	\$3588
KC7222	23 x 74 x 29	125	215	27	\$3316
KC6622	23 x 68 x 29	100	197	24	\$3189
KC6022	23 x 62 x 29	100	179	22	\$2902
KC5422	23 x 56 x 29	100	161	20	\$2748
KC4822	23 x 50 x 29	125	143	18	\$2598
KC4222	23 x 44 x 29	125	125	16	\$2198
KC10820	21 x 108 x 29	100	310	36	\$4734
KC10220	21 x 104 x 29	100	291	34	\$4472
KC9620	21 x 98 x 29	100	273	32	\$4208
KC9020	21 x 92 x 29	100	255	30	\$3948
KC8420	21 x 86 x 29	100	237	28	\$3684
KC7820	21 x 80 x 29	100	219	26	\$3418
KC7220	21 x 74 x 29	100	206	24	\$3153
KC6620	21 x 68 x 29	100	188	22	\$3036
KC6020	21 x 62 x 29	100	169	20	\$2764
KC5420	21 x 56 x 29	100	147	18	\$2614
KC4820	21 x 50 x 29	125	101	16	\$2472
KC4220	21 x 44 x 29	125	86	14	\$2094

With full back panel.

Required Specifications

Finish
Edge

Optional Specifications

Handles
Additional grommet

CORNERS - NOTES

NOTE: Arrow indicates direction of grain

Corners

- All units are shipped assembled
- Unit includes grommets shown and installed horizontal wire management
- Corner units and extended corner units must be used exclusively with linking bridges and linking returns
- Edge options - must specify:

- **Linking bridges** are handed by recessed end panel
- **Extended corner tables** have no molding on back side.
- **Linking returns** include grommets shown and installed horizontal wire management. Handed by full end panel.
- **Tables** include grommets shown and installed horizontal wire management.

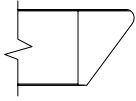

K16

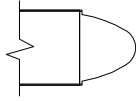

K18

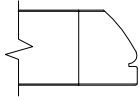

K21

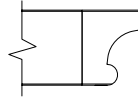

K22

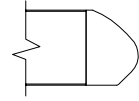

K29

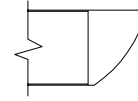

K30

CORNERS AND COMPONENTS

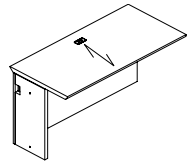

Linking Bridge - Left

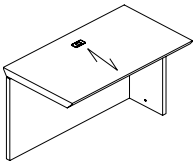

Linking Bridge - Right

MODEL#	DIMENSIONS	FREIGHT CLASS	WT/LBS.	CUBIC FT.	LIST PRICE
--------	------------	---------------	---------	-----------	------------

D x W x H

KBT6022NLLCG	24 x 60 x 29	125	145	24	\$2733
KBT5422NLLCG	24 x 54 x 29	150	131	22	\$2462
KBT4822NLLCG	24 x 48 x 29	125	116	19	\$2189
KBT4222NLLCG	24 x 42 x 29	125	102	17	\$1770
KBT3622NLLCG	24 x 36 x 29	150	87	15	\$1611
KBT3022NLLCG	24 x 30 x 29	125	73	12	\$1570
KBT6020NLLCG	22 x 60 x 29	150	131	22	\$2602
KBT5420NLLCG	22 x 54 x 29	150	118	20	\$2343
KBT4820NLLCG	22 x 48 x 29	125	110	18	\$2083
KBT4220NLLCG	22 x 42 x 29	150	95	16	\$1686
KBT3620NLLCG	22 x 36 x 29	125	80	13	\$1531
KBT3020NLLCG	22 x 30 x 29	150	65	11	\$1495

To join corner worksurface to desk or credenza. Full back panel.

KBT6022NLR CG	24 x 60 x 29	125	145	24	\$2733
KBT5422NLR CG	24 x 54 x 29	150	131	22	\$2462
KBT4822NLR CG	24 x 48 x 29	125	116	19	\$2189
KBT4222NLR CG	24 x 42 x 29	125	102	17	\$1770
KBT3622NLR CG	24 x 36 x 29	150	87	15	\$1611
KBT3022NLR CG	24 x 30 x 29	125	73	12	\$1570

KBT6020NLR CG	22 x 60 x 29	150	131	22	\$2602
KBT5420NLR CG	22 x 54 x 29	150	118	20	\$2343
KBT4820NLR CG	22 x 48 x 29	125	110	18	\$2083
KBT4220NLR CG	22 x 42 x 29	150	95	16	\$1686
KBT3620NLR CG	22 x 36 x 29	125	80	13	\$1531
KBT3020NLR CG	22 x 30 x 29	150	65	11	\$1495

To join corner worksurface to desk or credenza. Full back panel.

Required Specifications

Finish
Edge

Optional Specifications

Additional grommet

CORNER COMPONENTS

MODEL# DIMENSIONS FREIGHT CLASS WT./LBS. CUBIC FT. LIST PRICE

D x W x H

KBT6022NLLQ8CG	24 x 60 x 9.5	125	145	24	\$2462
KBT5422NLLQ8CG	24 x 54 x 9.5	150	131	22	\$2220
KBT4822NLLQ8CG	24 x 48 x 9.5	125	116	19	\$1972
KBT4222NLLQ8CG	24 x 42 x 9.5	125	102	17	\$1591
KBT3622NLLQ8CG	24 x 36 x 9.5	150	87	15	\$1449
KBT3022NLLQ8CG	24 x 30 x 9.5	125	73	12	\$1417

KBT6020NLLQ8CG	22 x 60 x 9.5	150	131	22	\$2343
KBT5420NLLQ8CG	22 x 54 x 9.5	150	118	20	\$2111
KBT4820NLLQ8CG	22 x 48 x 9.5	125	110	18	\$1877
KBT4220NLLQ8CG	22 x 42 x 9.5	150	95	16	\$1520
KBT3620NLLQ8CG	22 x 36 x 9.5	125	80	13	\$1380
KBT3020NLLQ8CG	22 x 30 x 9.5	150	65	11	\$1350

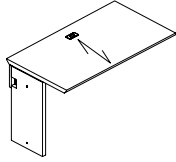

Linking Bridge - Left

To join corner worksurface to desk or credenza. 8" back panel.

KBT6022NLRQ8CG	24 x 60 x 9.5	125	145	24	\$2462
KBT5422NLRQ8CG	24 x 54 x 9.5	150	131	22	\$2220
KBT4822NLRQ8CG	24 x 48 x 9.5	125	116	19	\$1972
KBT4222NLRQ8CG	24 x 42 x 9.5	125	102	17	\$1591
KBT3622NLRQ8CG	24 x 36 x 9.5	150	87	15	\$1449
KBT3022NLRQ8CG	24 x 30 x 9.5	125	73	12	\$1417

KBT6020NLRQ8CG	22 x 60 x 9.5	150	131	22	\$2343
KBT5420NLRQ8CG	22 x 54 x 9.5	150	118	20	\$2111
KBT4820NLRQ8CG	22 x 48 x 9.5	125	110	18	\$1877
KBT4220NLRQ8CG	22 x 42 x 9.5	150	95	16	\$1520
KBT3620NLRQ8CG	22 x 36 x 9.5	125	80	13	\$1380
KBT3020NLRQ8CG	22 x 30 x 9.5	150	65	11	\$1350

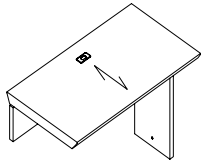

Linking Bridge - Right

To join corner worksurface to desk or credenza. 8" back panel.

KE484822	48 x 48 x 29	150	201	39	\$3932
KE424222	42 x 42 x 29	150	155	30	\$3018
KE363622	36 x 36 x 29	125	135	22	\$2866

KE484820	48 x 48 x 29	150	196	39	\$3932
KE424220	42 x 42 x 29	150	150	30	\$3018
KE363620	36 x 36 x 29	150	130	22	\$2866

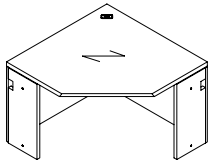

Corner Table

Connects to linking returns and linking bridges. 2 recessed end panels.

KEK484822	48 x 48 x 29	150	201	39	\$4527
KEK424222	42 x 42 x 29	150	155	30	\$3464
KEK363622	36 x 36 x 29	125	135	22	\$3292

KEK484820	48 x 48 x 29	150	196	39	\$4527
KEK424220	42 x 42 x 29	150	150	30	\$3464
KEK363620	36 x 36 x 29	150	130	22	\$3292

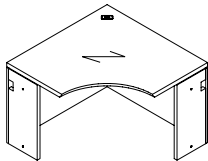

Corner Table

Connects to linking returns and linking bridges. 2 recessed end panels and inner curve.

Required Specifications

Finish
Edge

Optional Specifications

Additional grommet

CORNER COMPONENTS

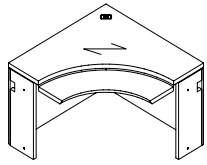

Corner Table

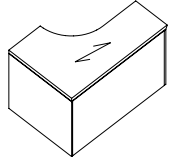

Extended Corner Table - Left

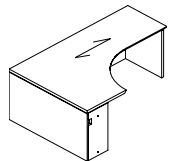

Extended Corner Table - Right

MODEL#	DIMENSIONS D x W x H	FREIGHT CLASS	WT./LBS.	CUBIC FT.	LIST PRICE
KEKS484822	48 x 48 x 29	150	201	39	\$7516
KEKS424222	42 x 42 x 29	150	155	30	\$6296
KEKS363622	36 x 36 x 29	125	135	22	\$6096
KEKS484820	48 x 48 x 29	150	196	39	\$7516
KEKS424220	42 x 42 x 29	150	150	30	\$6296
KEKS363620	36 x 36 x 29	150	130	22	\$6096

Connects to linking returns and linking bridges. 2 recessed end panels and inner curve. Adjustable keyboard tray and an articulating arm.

KEKL964822	48 x 97 x 29	150	387	77	\$7039
KEKL904822	48 x 91 x 29	150	363	73	\$6644
KEKL844822	48 x 85 x 29	150	338	68	\$6566
KEKL784822	48 x 79 x 29	150	314	63	\$6534
KEKL724822	48 x 73 x 29	150	290	58	\$6208
KEKL664822	48 x 67 x 29	150	266	52	\$5789
KEKL604822	48 x 61 x 29	150	242	48	\$5113

24" return connection.

KEKR489622	48 x 97 x 29	150	387	77	\$7039
KEKR489022	48 x 91 x 29	150	363	73	\$6644
KEKR488422	48 x 85 x 29	150	338	68	\$6566
KEKR487822	48 x 79 x 29	150	314	63	\$6534
KEKR487222	48 x 73 x 29	150	290	58	\$6208
KEKR486622	48 x 67 x 29	150	266	52	\$5789
KEKR486022	48 x 61 x 29	150	242	48	\$5113

24" return connection.

Required Specifications

Finish
Edge

Optional Specifications

Additional grommet

LINKING RETURNS

MODEL# DIMENSIONS FREIGHT CLASS WT/LBS. CUBIC FT. LIST PRICE

D x W x H

KVL9622CG	23 x 97 x 29	150	200	39	\$4532
KVL9022CG	23 x 91 x 29	150	187	36	\$4246
KVL8422CG	23 x 85 x 29	150	174	34	\$3964
KVL7822CG	23 x 79 x 29	150	162	31	\$3682
KVL7222CG	23 x 73 x 29	150	149	29	\$3398
KVL6622CG	23 x 67 x 29	150	141	27	\$3186
KVL6022CG	23 x 61 x 29	150	132	24	\$2980
KVL5422CG	23 x 55 x 29	150	121	22	\$2812
KVL4822CG	23 x 49 x 29	125	115	19	\$2642
KVL4222CG	23 x 43 x 29	150	99	17	\$2229
KVL3622CG	23 x 37 x 29	150	83	15	\$2150
KVL3022CG	23 x 31 x 29	125	77	12	\$2111
KVL2422CG	23 x 23 x 29	125	61	10	\$1768

KVL9620CG	21 x 97 x 29	150	187	39	\$4315
KVL9020CG	21 x 91 x 29	150	175	36	\$4044
KVL8420CG	21 x 85 x 29	150	163	34	\$3778
KVL7820CG	21 x 79 x 29	150	152	31	\$3506
KVL7220CG	21 x 73 x 29	150	140	29	\$3239
KVL6620CG	21 x 67 x 29	150	133	27	\$3036
KVL6020CG	21 x 61 x 29	150	125	24	\$2840
KVL5420CG	21 x 55 x 29	150	113	22	\$2678
KVL4820CG	21 x 49 x 29	150	110	19	\$2514
KVL4220CG	21 x 43 x 29	150	95	17	\$2123
KVL3620CG	21 x 37 x 29	150	80	15	\$2044
KVL3020CG	21 x 31 x 29	125	75	12	\$2010
KVL2420CG	21 x 23 x 29	125	60	10	\$1686

To be used with corner unit.

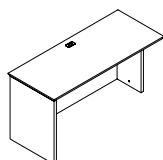

Linking Return - Left

KVR9622CG	23 x 97 x 29	150	200	39	\$4532
KVR9022CG	23 x 91 x 29	150	187	36	\$4246
KVR8422CG	23 x 85 x 29	150	174	34	\$3964
KVR7822CG	23 x 79 x 29	150	162	31	\$3682
KVR7222CG	23 x 73 x 29	150	149	29	\$3398
KVR6622CG	23 x 67 x 29	150	141	27	\$3186
KVR6022CG	23 x 61 x 29	150	132	24	\$2980
KVR5422CG	23 x 55 x 29	150	121	22	\$2812
KVR4822CG	23 x 49 x 29	125	115	19	\$2642
KVR4222CG	23 x 43 x 29	150	99	17	\$2229
KVR3622CG	23 x 37 x 29	150	83	15	\$2150
KVR3022CG	23 x 31 x 29	125	77	12	\$2111
KVR2422CG	23 x 23 x 29	125	61	10	\$1768

KVR9620CG	21 x 97 x 29	150	187	39	\$4315
KVR9020CG	21 x 91 x 29	150	175	36	\$4044
KVR8420CG	21 x 85 x 29	150	163	34	\$3778
KVR7820CG	21 x 79 x 29	150	152	31	\$3506
KVR7220CG	21 x 73 x 29	150	140	29	\$3239
KVR6620CG	21 x 67 x 29	150	133	27	\$3036
KVR6020CG	21 x 61 x 29	150	125	24	\$2840
KVR5420CG	21 x 55 x 29	150	113	22	\$2678
KVR4820CG	21 x 49 x 29	150	110	19	\$2514
KVR4220CG	21 x 43 x 29	150	95	17	\$2123
KVR3620CG	21 x 37 x 29	150	80	15	\$2044
KVR3020CG	21 x 31 x 29	125	75	12	\$2010
KVR2420CG	21 x 23 x 29	125	60	10	\$1686

To be used with corner unit.

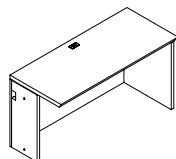

Linking Return - Right

Required Specifications

Finish
Edge

Optional Specifications

Additional grommet

CORNER COMPONENTS

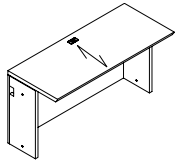

Center Surface*

MODEL#	DIMENSIONS D x W x H	FREIGHT CLASS	WT/LBS.	CUBIC FT.	LIST PRICE
KV9622CG	24 x 96 x 29	150	197	39	\$4426
KV9022CG	24 x 90 x 29	150	185	36	\$4152
KV8422CG	24 x 84 x 29	150	173	34	\$3871
KV7822CG	24 x 78 x 29	150	160	31	\$3592
KV7222CG	24 x 72 x 29	150	145	29	\$3318
KV6622CG	24 x 66 x 29	150	136	27	\$3111
KV6022CG	24 x 60 x 29	150	123	24	\$2904
KV5422CG	24 x 54 x 29	150	119	22	\$2733
KV4822CG	24 x 48 x 29	150	107	19	\$2565
KV4222CG	24 x 42 x 29	150	91	17	\$2363
KV3622CG	24 x 36 x 29	150	76	15	\$2150
KV3022CG	24 x 30 x 29	150	70	12	\$2028
KV2422CG	24 x 24 x 29	150	53	10	\$1704
KV9620CG	22 x 96 x 29	150	181	35	\$4219
KV9020CG	22 x 90 x 29	150	169	33	\$3956
KV8420CG	22 x 84 x 29	150	157	31	\$3689
KV7820CG	22 x 78 x 29	150	145	29	\$3425
KV7220CG	22 x 72 x 29	150	133	27	\$3161
KV6620CG	22 x 66 x 29	150	126	24	\$2964
KV6020CG	22 x 60 x 29	150	118	22	\$2767
KV5420CG	22 x 54 x 29	150	111	20	\$2602
KV4820CG	22 x 48 x 29	150	103	18	\$2440
KV4220CG	22 x 42 x 29	150	88	16	\$2044
KV3620CG	22 x 36 x 29	150	73	13	\$1972
KV3020CG	22 x 30 x 29	125	68	11	\$1933
KV2420CG	22 x 24 x 29	150	52	9	\$1622

With recessed end panels.

MODULAR STORAGE - NOTES

- All storage components are shipped assembled
- Components 28" high are intended for use with a desk, credenza or return shell
- Backs on 28" high pedestals and cabinets are unfinished. If finished back is required, see page 241.
- If a profiled top is required, see "Freestanding Storage" on page 250.
- If Handle is not specified Routed Pull, Black Lock & Grommet are standard
- If Handle is specified:
 - Black and Brass handle = Black Lock & Grommet
 - Silver, Nickel and Tungsten handle = Tungsten Lock & Grommet

MODULAR STORAGE

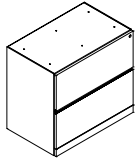

Modular Lateral File**

MODEL#	DIMENSIONS	FREIGHT CLASS	WT/LBS.	CUBIC FT.	LIST PRICE
KWF	19 x 35.1 x 28	92.5	115	11	\$3201
KWN	19 x 30 x 28	92.5	96	9	\$2801
KWF.5	19 x 34.5 x 28	92.5	115	11	\$3201

Units with ".5" at end of code are intended to be used if a Full Storage Credenza is to be created. For Single Pedestal installations either style can be used.

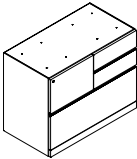

Modular Combination Storage - Left**

KWZL	19 x 35.1 x 28	92.5	115	11	\$3717
KWZL.5	19 x 34.5 x 28	92.5	115	11	\$3717

1 lateral file, 2 box drawers top right, and 1 file top left.

- Units with ".5" at end of code are intended to be used if a Full Storage Credenza is to be created. For Single Pedestal installations either style can be used.

Required Specifications

Finish
Edge*

Optional Specifications

Handles**
Additional grommet

DESKS

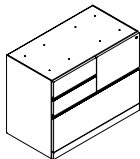

Modular Combination Storage - Right*

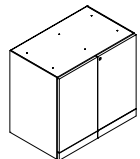

Modular Storage Cabinet w/Doors*

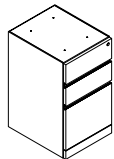

Modular Pedestal*

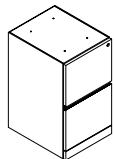

Modular Pedestal*

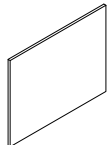

Finished Back

MODEL#	DIMENSIONS	FREIGHT CLASS	WT/LBS.	CUBIC FT.	LIST PRICE
--------	------------	---------------	---------	-----------	------------

D x W x H

KWZR	19 x 35.1 x 28	92.5	115	11	\$3717
KWZR.5	19 x 34.5 x 28	92.5	115	11	\$3717

1 lateral file, 2 box drawers top left, and 1 file top right.

- Units with ".5" at end of code are intended to be used if a Full Storage Credenza is to be created. For Single Pedestal installations either style can be used.

KWG	19 x 35.1 x 28	92.5	115	11	\$2231
KWM	19 x 30 x 28	92.5	96	9	\$1881
KWG.5	19 x 34.5 x 28	92.5	115	11	\$2231

Storage with 1 adjustable shelf.

- Units with ".5" at end of code are intended to be used if a Full Storage Credenza is to be created. For Single Pedestal installations either style can be used.

Letter width:

KWWD	23 x 15.6 x 28	85	72	6	\$2472
KWD	19 x 15.6 x 28	85	70	5	\$2153

Legal width:

KWWLD	23 x 18.5 x 28	85	85	7	\$2967
KWLD	19 x 18.5 x 28	85	83	6	\$2581

Box/box/file pedestal.

Letter width:

KWWE	23 x 15.6 x 28	85	72	6	\$2472
KWE	19 x 15.6 x 28	85	70	5	\$2153

Legal width:

KWWLE	23 x 18.5 x 28	85	85	7	\$2967
KWLE	19 x 18.5 x 28	85	83	6	\$2581

File/file pedestal.

KBA36	0.8 x 35 x 27.5	125	18	3	\$467
KBA30	0.8 x 30 x 27.5	150	15	3	\$388
KBA18	0.8 x 18.5 x 27.5	150	10	2	\$226
KBA15	0.8 x 15.5 x 27.5	150	8	2	\$196

For modular pedestals.

Required Specifications

Finish

Optional Specifications

Handles*

HUTCHES & WALL MOUNTED STORAGE NOTES

Hutches

- All hutches are shipped assembled
- Handles can be specified for hutches with wood doors.
- Handles cannot be specified on Aluminum framed glass doors.
- Frosted glass door is standard. White back painted clear glass is available, please contact customer care.

Closed pigeon hole storage hutch

- 42" unit has 21.5" of clearance

NOTE: Arrow indicates direction of grain

Edge options - must specify:

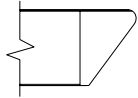

K16

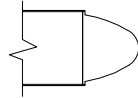

K18

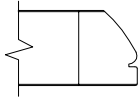

K21

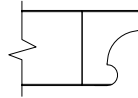

K22

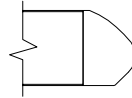

K29

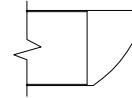

K30

Closed storage hutch

- 36" unit has 19.5" of clearance.
- 42" and 54" units have 25.5" of clearance
- For lock option, see page 264

Tasklight

- For proper size, see page 264.
- If Handle is specified:
 - Black and Brass handle = Black Lock & Grommet
 - Silver, Nickel and Tungsten handle = Tungsten Lock & Grommet

HUTCHES & WALL MOUNTED STORAGE

MODEL#

DIMENSIONS

FREIGHT CLASS

WT/LBS.

CUBIC FT.

LIST PRICE

K108SH36	16 x 110 x 36	125	268	34	\$7296
K102SH36	16 x 104 x 36	125	254	32	\$6891
K96SH36	16 x 98 x 36	100	241	30	\$6378
K90SH36	16 x 92 x 36	100	227	28	\$6078
K84SH36	16 x 86 x 36	100	214	26	\$5673
K78SH36	16 x 80 x 36	100	200	24	\$5269
K72SH36	16 x 74 x 36	100	187	23	\$4861
K66SH36	16 x 68 x 36	100	173	21	\$4677
K60SH36	16 x 62 x 36	100	160	19	\$4459
K36SH36	16 x 38 x 36	100	94	11	\$3040
K30SH36	16 x 32 x 36	100	78	9	\$2661

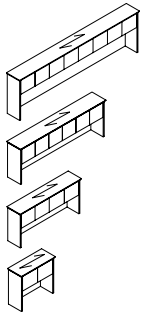

36" H Storage Hutch w/Wood Doors*

Hutches longer than 102" have 8 doors, hutches between 102" and 86" have 6 doors, hutches between 80" and 62" have 4 doors, and 32" and 38" hutches have 2 doors

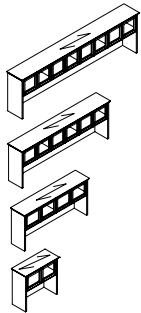

36" H Storage Hutch w/Glass Doors

K108SH36G	16 x 110 x 36	125	268	34	\$10607
K102SH36G	16 x 104 x 36	125	254	32	\$9521
K96SH36G	16 x 98 x 36	100	241	30	\$9079
K90SH36G	16 x 92 x 36	100	227	28	\$8633
K84SH36G	16 x 86 x 36	100	214	26	\$8194
K78SH36G	16 x 80 x 36	100	200	24	\$7759
K72SH36G	16 x 74 x 36	100	187	23	\$6643
K66SH36G	16 x 68 x 36	100	173	21	\$6462
K60SH36G	16 x 62 x 36	100	160	19	\$6134
K36SH36G	16 x 38 x 36	100	94	11	\$3923
K30SH36G	16 x 32 x 36	100	78	9	\$3496

Aluminum framed glass doors. Hutches longer than 102" have 8 doors, hutches between 102" and 86" have 6 doors, hutches between 80" and 62" have 4 doors, and 32" and 38" hutches have 2 doors.

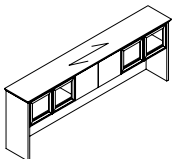

36" H Storage Hutch w/Doors*

K102SH36GDG	16 x 104 x 3	125	254	32	\$8563
K96SH36GDG	16 x 98 x 36	100	241	30	\$8157
K90SH36GDG	16 x 92 x 36	100	227	28	\$7751
K84SH36GDG	16 x 86 x 36	100	214	26	\$7000

Wood doors in the center and Aluminum framed glass doors on left and right.

Required Specifications

Finish
Edge

Optional Specifications

Handles* (wood doors only)

HUTCHES & WALL MOUNTED STORAGE

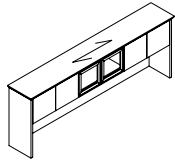

36" H Storage Hutch w/Doors*

MODEL#	DIMENSIONS D x W x H	FREIGHT CLASS	WT./LBS.	CUBIC FT.	LIST PRICE
K102SH36DGD	16 x 104 x 3	125	254	32	\$8563
K96SH36DGD	16 x 98 x 36	100	241	30	\$7105
K90SH36DGD	16 x 92 x 36	100	227	28	\$6910
K84SH36DGD	16 x 86 x 36	100	214	26	\$6507

Aluminum framed glass doors in the center and wood doors on left and right.

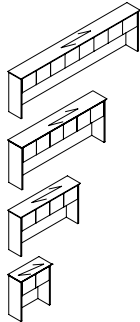

42" H Storage Hutch w/Wood Doors*

K108SH42	16 x 110 x 43	125	307	39	\$8507
K102SH42	16 x 104 x 43	125	290	37	\$8030
K96SH42	16 x 98 x 43	125	273	35	\$7563
K90SH42	16 x 92 x 43	125	256	33	\$7089
K84SH42	16 x 86 x 43	125	239	31	\$6614
K78SH42	16 x 80 x 43	150	222	38	\$6148
K72SH42	16 x 74 x 43	125	205	26	\$5673
K66SH42	16 x 68 x 43	125	188	24	\$5458
K60SH42	16 x 62 x 43	125	171	22	\$5200
K36SH42	16 x 38 x 43	125	102	13	\$3549
K30SH42	16 x 32 x 43	125	85	11	\$3105

Hutches longer than 102" have 8 doors, hutches between 102" and 86" have 6 doors, hutches between 80" and 62" have 4 doors, and 32" and 38" hutches have 2 doors.

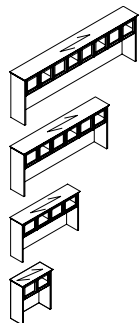

42" H Storage Hutch w/Glass Doors

K108SH42G	16 x 110 x 43	125	307	39	\$11821
K102SH42G	16 x 104 x 43	125	290	37	\$10665
K96SH42G	16 x 98 x 43	125	273	35	\$10156
K90SH42G	16 x 92 x 43	125	256	33	\$9649
K84SH42G	16 x 86 x 43	125	239	31	\$9140
K78SH42G	16 x 80 x 43	150	222	38	\$8632
K72SH42G	16 x 74 x 43	125	205	26	\$7453
K66SH42G	16 x 68 x 43	125	188	24	\$7190
K60SH42G	16 x 62 x 43	125	171	22	\$6934
K36SH42G	16 x 38 x 43	125	102	13	\$4431
K30SH42G	16 x 32 x 43	125	85	11	\$3941

Aluminum framed glass doors. Hutches longer than 102" have 8 doors, hutches between 102" and 86" have 6 doors, hutches between 80" and 62" have 4 doors, and 32" and 38" hutches have 2 doors.

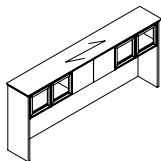

42" H Storage Hutch w/Doors*

K102SH42GDG	16 x 104 x 43	125	290	37	\$11126
K96SH42GDG	16 x 98 x 43	125	273	35	\$10472
K90SH42GDG	16 x 92 x 43	125	256	33	\$9819
K84SH42GDG	16 x 86 x 43	125	239	31	\$9163

Wood doors in the center and Aluminum framed glass doors on left and right.

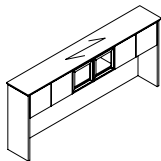

42" H Storage Hutch w/Doors*

K102SH42DGD	16 x 104 x 43	125	290	37	\$9313
K96SH42DGD	16 x 98 x 43	125	273	35	\$8396
K90SH42DGD	16 x 92 x 43	125	256	33	\$7923
K84SH42DGD	16 x 86 x 43	125	239	31	\$7453

Aluminum framed glass doors in the center and wood doors on left and right.

Required Specifications

Finish
Edge

Optional Specifications

Handles* (wood doors only)

HUTCHES & WALL MOUNTED STORAGE

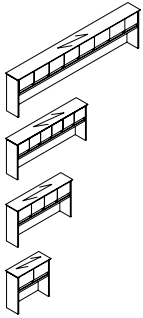

42" H Storage Hutch w/Wood Doors & Pigeon-Holes

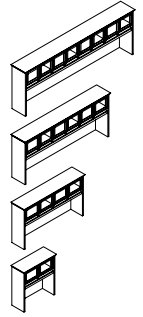

42" H Storage Hutch w/Glass Doors & Pigeon-Holes

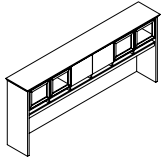

42" H Storage Hutch w/Doors & Pigeon-Holes

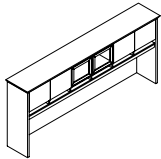

42" H Storage Hutch w/Doors & Pigeon-Holes

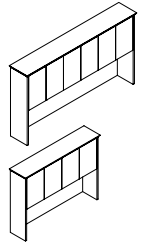

54" H Storage Hutch w/Wood Doors*

MODEL#	DIMENSIONS D x W x H	FREIGHT CLASS	WT./LBS.	CUBIC FT.	LIST PRICE
K108SHP42	16 x 110 x 43	125	307	39	\$10203
K102SHP42	16 x 104 x 43	125	290	37	\$9641
K96SHP42	16 x 98 x 43	125	273	35	\$9072
K90SHP42	16 x 92 x 43	125	256	33	\$8507
K84SHP42	16 x 86 x 43	125	239	31	\$7939
K78SHP42	16 x 80 x 43	150	222	38	\$7370
K72SHP42	16 x 74 x 43	125	205	26	\$6806
K66SHP42	16 x 68 x 43	125	188	24	\$6554
K60SHP42	16 x 62 x 43	125	171	22	\$6239
K36SHP42	16 x 38 x 43	125	102	13	\$4259
K30SHP42	16 x 32 x 43	125	85	11	\$3727

Hutches longer than 102" have 8 doors, hutches between 102" and 86" have 6 doors, hutches between 80" and 62" have 4 doors, and 32" and 38" hutches have 2 doors.

K108SHP42G	16 x 110 x 43	125	307	39	\$13445
K102SHP42G	16 x 104 x 43	125	290	37	\$12208
K96SHP42G	16 x 98 x 43	125	273	35	\$11633
K90SHP42G	16 x 92 x 43	125	256	33	\$11598
K84SHP42G	16 x 86 x 43	125	239	31	\$10387
K78SHP42G	16 x 80 x 43	150	222	38	\$9792
K72SHP42G	16 x 74 x 43	125	205	26	\$8539
K66SHP42G	16 x 68 x 43	125	188	24	\$8269
K60SHP42G	16 x 62 x 43	125	171	22	\$7870
K36SHP42G	16 x 38 x 43	125	102	13	\$5113
K30SHP42G	16 x 32 x 43	125	85	11	\$4563

Aluminum framed glass doors. Hutches longer than 102" have 8 doors, hutches between 102" and 86" have 6 doors, hutches between 80" and 62" have 4 doors, and 32" and 38" hutches have 2 doors.

K102SHP42GDG	16 x 104 x 43	125	290	37	\$11269
K96SHP42GDG	16 x 98 x 43	125	273	35	\$10700
K90SHP42GDG	16 x 92 x 43	125	256	33	\$10139
K84SHP42GDG	16 x 86 x 43	125	239	31	\$9114

Wood doors in the center and Aluminum framed glass doors on left and right.

K102SHP42DGD	16 x 104 x 43	125	290	37	\$10477
K96SHP42DGD	16 x 98 x 43	125	273	35	\$9415
K90SHP42DGD	16 x 92 x 43	125	256	33	\$8978
K84SHP42DGD	16 x 86 x 43	125	239	31	\$8755

Aluminum framed glass doors in the center and wood doors on left and right.

K962SH54	16 x 98 x 55	125	351	45	\$9723
K902SH54	16 x 92 x 55	125	329	42	\$9114
K842SH54	16 x 86 x 55	125	307	39	\$8507
K782SH54	16 x 80 x 55	125	285	37	\$7898
K722SH54	16 x 74 x 55	125	263	34	\$7290
K662SH54	16 x 68 x 55	125	241	31	\$7017
K602SH54	16 x 62 x 55	125	219	28	\$6682

Hutches between 98" and 86" have 6 doors; hutches less than 86" have 4 doors. One adjustable shelf.

Required Specifications

Finish
Edge

Optional Specifications

Handles* (wood doors only)

HUTCHES & WALL MOUNTED STORAGE

MODEL# DIMENSIONS FREIGHT CLASS WT./LBS. CUBIC FT. LIST PRICE

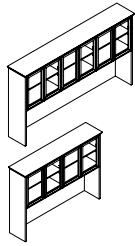

54" H Storage Hutch w/Glass Doors

D x W x H						
K962SH54G	16 x 98 x 55	125	351	45	\$12972	
K902SH54G	16 x 92 x 55	125	329	42	\$12082	
K842SH54G	16 x 86 x 55	125	307	39	\$11187	
K782SH54G	16 x 80 x 55	125	285	37	\$10291	
K722SH54G	16 x 74 x 55	125	263	34	\$9402	
K662SH54G	16 x 68 x 55	125	241	31	\$9063	
K602SH54G	16 x 62 x 55	125	219	28	\$8663	

Aluminum framed glass doors. Hutches between 98" and 86" have 6 doors; hutches less than 86" have 4 doors. One adjustable shelf.

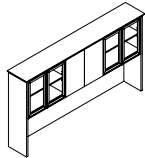

54" H Storage Hutch w/Doors*

K962SH54GDG	16 x 98 x 55	125	351	45	\$11702
K902SH54GDG	16 x 92 x 55	125	329	42	\$11091
K842SH54GDG	16 x 86 x 55	125	309	39	\$10485

Wood doors in the center and Aluminum framed glass doors on left and right. One adjustable shelf.

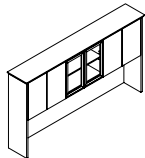

54" H Storage Hutch w/Doors*

K962SH54DGD	16 x 98 x 55	125	351	45	\$10708
K902SH54DGD	16 x 92 x 55	125	329	42	\$10103
K842SH54DGD	16 x 86 x 55	125	307	39	\$9497

Aluminum framed glass doors in the center and wood doors on left and right. One adjustable shelf.

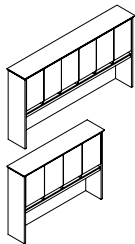

54" H Storage Hutch w/Wood Doors & Pigeon-Holes

K962SHP54	16 x 98 x 55	125	351	45	\$11669
K902SHP54	16 x 92 x 55	125	329	42	\$10933
K842SHP54	16 x 86 x 55	125	307	39	\$10201
K782SHP54	16 x 80 x 55	125	285	37	\$10201
K722SHP54	16 x 74 x 55	125	263	34	\$8744
K662SHP54	16 x 68 x 55	125	241	31	\$8422
K602SHP54	16 x 62 x 55	125	219	28	\$8023

Hutches between 98" and 86" have 6 doors; hutches less than 86" have 4 doors. One adjustable shelf.

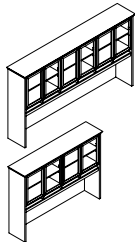

54" H Storage Hutch w/Glass Doors & Pigeon-Holes

K962SHP54G	16 x 98 x 55	125	351	45	\$14918
K902SHP54G	16 x 92 x 55	125	329	42	\$13903
K842SHP54G	16 x 86 x 55	125	307	39	\$12885
K782SHP54G	16 x 80 x 55	125	285	37	\$11873
K722SHP54G	16 x 74 x 55	125	263	34	\$10860
K662SHP54G	16 x 68 x 55	125	241	34	\$10469
K602SHP54G	16 x 62 x 55	125	219	28	\$10002

Aluminum framed glass doors. Hutches between 98" and 86" have 6 doors; hutches less than 86" have 4 doors. One adjustable shelf.

Required Specifications

Finish
Edge

Optional Specifications

Handles* (wood doors only)

HUTCHES & WALL MOUNTED STORAGE

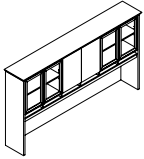

54" H Storage Hutch w/Doors & Pigeon-Holes

MODEL#	DIMENSIONS D x W x H	FREIGHT CLASS	WT/LBS.	CUBIC FT.	LIST PRICE
K962SHP54GDG	16 x 98 x 55	125	351	45	\$12656
K902SHP54GDG	16 x 92 x 55	125	329	42	\$11926
K842SHP54GDG	16 x 86 x 55	125	307	39	\$11193

Wood doors in the center and Aluminum framed glass doors on left and right. One adjustable shelf.

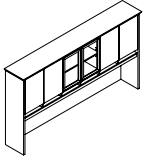

54" H Storage Hutch w/Doors &* Pigeon-Holes

K962SHP54DGD	16 x 98 x 55	125	351	45	\$13645
K902SHP54DGD	16 x 92 x 55	125	329	42	\$12916
K842SHP54DGD	16 x 86 x 55	125	307	39	\$12184

Aluminum framed glass doors in the center and wood doors on left and right. One adjustable shelf.

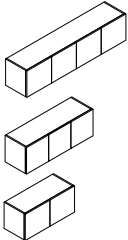

Wall Mount Storage w/Wood Doors*

CSF72	15.5 x 72 x 16.5	92.5	100	10	\$2270
CSF66	15.5 x 66 x 16.5	100	83	9	\$2082
CSF60	15.5 x 60 x 16.5	100	75	8	\$1887
CSF54	15.5 x 54 x 16.5	100	68	7	\$1701
CSF48	15.5 x 48 x 16.5	100	60	7	\$1512
CSF42	15.5 x 42 x 16.5	100	55	6	\$1390
CSF36	15.5 x 36 x 16.5	92.5	50	5	\$1364
CSF30	15.5 x 30 x 16.5	92.5	45	4	\$1341

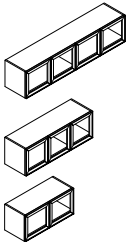

Wall Mount Storage w/Glass Doors

CSF72G	15.5 x 72 x 16.5	92.5	100	10	\$4776
CSF66G	15.5 x 66 x 16.5	100	83	9	\$4436
CSF60G	15.5 x 60 x 16.5	100	75	8	\$4158
CSF54G	15.5 x 54 x 16.5	100	68	7	\$3725
CSF48G	15.5 x 48 x 16.5	100	60	7	\$3291
CSF42G	15.5 x 42 x 16.5	100	55	6	\$2921
CSF36G	15.5 x 36 x 16.5	92.5	50	5	\$2700
CSF30G	15.5 x 30 x 16.5	92.5	45	4	\$2621

Aluminum framed glass doors.

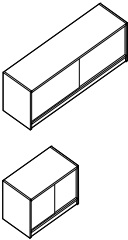

Wall Mount Storage w/Sliding Glass Doors

CSF72GSL	18 x 72 x 16.5	92.5	100	10	\$4776
CSF66GSL	18 x 66 x 16.5	100	83	9	\$4436
CSF60GSL	18 x 60 x 16.5	100	75	8	\$4158
CSF54GSL	18 x 54 x 16.5	100	68	7	\$3725
CSF48GSL	18 x 48 x 16.5	100	60	7	\$3291
CSF42GSL	18 x 42 x 16.5	100	55	6	\$2921
CSF36GSL	18 x 36 x 16.5	92.5	50	5	\$2700
CSF30GSL	18 x 30 x 16.5	92.5	45	4	\$2621

Frameless sliding glass doors.

Required Specifications

Finish
Edge

Optional Specifications

Handles* (wood doors only)

HUTCHES & WALL MOUNTED STORAGE

MODEL# DIMENSIONS FREIGHT CLASS WT./LBS. CUBIC FT. LIST PRICE

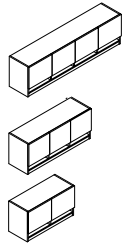

Wall Mount Storage w/Wood Doors &* Pigeon-Holes

	D x W x H					
CSFP72	15.5 x 72 x 20	92.5	100	10		\$2720
CSFP66	15.5 x 66 x 20	100	83	9		\$2495
CSFP60	15.5 x 60 x 20	100	75	8		\$2270
CSFP54	15.5 x 54 x 20	100	68	7		\$2043
CSFP48	15.5 x 48 x 20	100	60	7		\$1813
CSFP42	15.5 x 42 x 20	100	55	6		\$1720
CSFP36	15.5 x 36 x 20	92.5	50	5		\$1637
CSFP30	15.5 x 30 x 20	92.5	45	4		\$1610

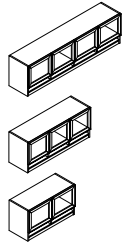

Wall Mount Storage w/Glass Doors & Pigeon-Holes

CSFP72G	15.5 x 72 x 20	100	100	12		\$5255
CSFP66G	15.5 x 66 x 20	125	83	11		\$5025
CSFP60G	15.5 x 60 x 20	125	75	10		\$4630
CSFP54G	15.5 x 54 x 20	125	68	9		\$4319
CSFP48G	15.5 x 48 x 20	125	60	8		\$3665
CSFP42G	15.5 x 42 x 20	125	55	7		\$3192
CSFP36G	15.5 x 36 x 20	100	50	6		\$3045
CSFP30G	15.5 x 30 x 20	100	45	5		\$2966

Aluminum framed glass doors.

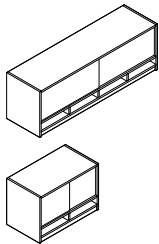

Wall Mount Storage w/Sliding Glass Doors & Pigeon-Holes

CSFP72GSL	18 x 72 x 20	100	100	12		\$5255
CSFP66GSL	18 x 66 x 20	125	83	11		\$5025
CSFP60GSL	18 x 60 x 20	125	75	10		\$4630
CSFP54GSL	18 x 54 x 20	125	68	9		\$4319
CSFP48GSL	18 x 48 x 20	125	60	8		\$3665
CSFP42GSL	18 x 42 x 20	125	55	7		\$3192
CSFP36GSL	18 x 36 x 20	100	50	6		\$3045
CSFP30GSL	18 x 30 x 20	100	45	5		\$2966

Frameless sliding glass doors.

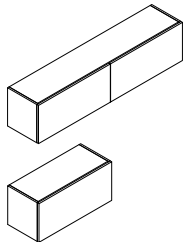

Wall Mount Storage w/Wood Flipper Doors

CSFF72	15.5 x 72 x 16.5	92.5	100	10		\$3346
CSFF66	15.5 x 66 x 16.5	100	83	9		\$3068
CSFF60	15.5 x 60 x 16.5	100	75	8		\$2787
CSFF54	15.5 x 54 x 16.5	100	68	7		\$2511
CSFF48	15.5 x 48 x 16.5	100	60	7		\$2232
CSFF42	15.5 x 42 x 16.5	100	55	6		\$2071
CSFF36	15.5 x 36 x 16.5	92.5	50	5		\$2033
CSFF30	15.5 x 30 x 16.5	92.5	45	4		\$2001

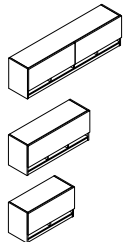

Wall Mount Storage w/Pigeon-Holes & Wood Flipper Doors

CSFFP72	15.5 x 72 x 20	100	100	12		\$4018
CSFFP66	15.5 x 66 x 20	125	83	11		\$3681
CSFFP60	15.5 x 60 x 20	125	75	10		\$3348
CSFFP54	15.5 x 54 x 20	125	68	9		\$3010
CSFFP48	15.5 x 48 x 20	125	60	8		\$2680
CSFFP42	15.5 x 42 x 20	125	55	7		\$2482
CSFFP36	15.5 x 36 x 20	100	50	6		\$2440
CSFFP30	15.5 x 30 x 20	100	45	5		\$2397

Required Specifications

Finish
Edge

Optional Specifications

Handles* (wood doors only)

DESKS

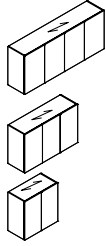

**Double High Wall Mount Storage*
w/Wood Doors**

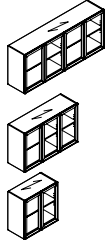

**Double High Wall Mount Storage
w/Glass Doors**

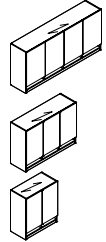

**Double High Wall Mount Storage*
w/Pigeon-Holes & Wood Doors**

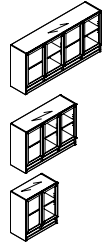

**Double High Wall Mount Storage
w/Pigeon-Holes & Glass Doors**

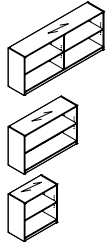

Double High Open Wall Mount Storage

MODEL#	DIMENSIONS D x W x H	FREIGHT CLASS	WT/LBS.	CUBIC FT.	LIST PRICE
CSF72H30	15.5 x 72 x 30	100	140	17	\$5964
CSF66H30	15.5 x 66 x 30	125	116	16	\$5473
CSF60H30	15.5 x 60 x 30	125	105	14	\$4967
CSF54H30	15.5 x 54 x 30	125	95	13	\$4470
CSF48H30	15.5 x 48 x 30	125	85	12	\$3975
CSF42H30	15.5 x 42 x 30	125	77	10	\$3650
CSF36H30	15.5 x 36 x 30	125	70	9	\$3583
CSF30H30	15.5 x 30 x 30	100	63	7	\$3520

CSF72H30G	15.5 x 72 x 30	100	140	17	\$8675
CSF66H30G	15.5 x 66 x 30	125	116	16	\$8562
CSF60H30G	15.5 x 60 x 30	60	1045	14	\$8029
CSF54H30G	15.5 x 54 x 30	125	95	13	\$7190
CSF48H30G	15.5 x 48 x 30	125	85	12	\$6352
CSF42H30G	15.5 x 42 x 30	125	77	10	\$5642
CSF36H30G	15.5 x 36 x 30	125	70	9	\$5213
CSF30H30G	15.5 x 30 x 30	100	63	7	\$5059

Aluminum framed glass doors.

CSFP72H34	15.5 x 72 x 34	100	140	17	\$6487
CSFP66H34	15.5 x 66 x 34	125	116	16	\$5949
CSFP60H34	15.5 x 60 x 34	125	105	14	\$5414
CSFP54H34	15.5 x 54 x 34	125	95	13	\$4868
CSFP48H34	15.5 x 48 x 34	125	85	12	\$4323
CSFP42H34	15.5 x 42 x 34	125	77	10	\$4108
CSFP36H34	15.5 x 36 x 34	125	70	9	\$3897
CSFP30H34	15.5 x 30 x 34	100	63	7	\$3833

CSFP72H34G	15.5 x 72 x 34	100	140	17	\$9202
CSFP66H34G	15.5 x 66 x 34	125	116	16	\$8797
CSFP60H34G	15.5 x 60 x 34	125	105	14	\$8102
CSFP54H34G	15.5 x 54 x 34	125	95	13	\$7557
CSFP48H34G	15.5 x 48 x 34	125	85	12	\$6417
CSFP42H34G	15.5 x 42 x 34	125	77	10	\$5588
CSFP36H34G	15.5 x 36 x 34	125	70	9	\$5588
CSFP30H34G	15.5 x 30 x 34	100	63	7	\$5188

Aluminum framed glass doors.

CSFO72H30	15.5 x 72 x 30	100	140	17	\$4845
CSFO66H30	15.5 x 66 x 30	125	116	16	\$4448
CSFO60H30	15.5 x 60 x 30	125	105	14	\$4040
CSFO54H30	15.5 x 54 x 30	125	95	13	\$3644
CSFO48H30	15.5 x 48 x 30	125	85	12	\$3241
CSFO42H30	15.5 x 42 x 30	125	77	10	\$2984
CSFO36H30	15.5 x 36 x 30	125	70	9	\$2948
CSFO30H30	15.5 x 30 x 30	100	63	7	\$2893

Required Specifications

Finish
Edge

Optional Specifications

Handles* (wood doors only)

DESKS

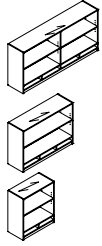

Double High Open Wall Mount Storage w/Pigeon-Holes

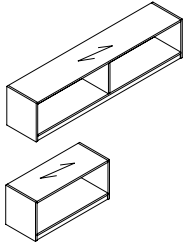

Open Wall Mount Storage

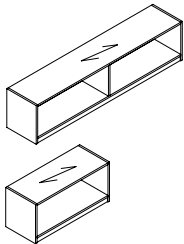

16\"/>

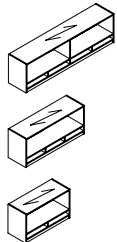

Open Wall Mount Storage w/Pigeon-Holes

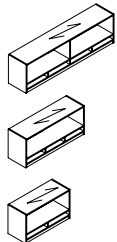

16\"/>

MODEL#	DIMENSIONS	FREIGHT CLASS	WT./LBS.	CUBIC FT.	LIST PRICE
--------	------------	---------------	----------	-----------	------------

D x W x H

CSFOP72H34	15.5 x 72 x 34	100	140	17	\$5275
CSFOP66H34	15.5 x 66 x 34	125	116	16	\$4836
CSFOP60H34	15.5 x 60 x 34	125	105	14	\$4396
CSFOP54H34	15.5 x 54 x 34	125	95	13	\$3962
CSFOP48H34	15.5 x 48 x 34	125	85	12	\$3514
CSFOP42H34	15.5 x 42 x 34	125	77	10	\$3297
CSFOP36H34	15.5 x 36 x 34	125	70	9	\$3200
CSFOP30H34	15.5 x 30 x 34	100	63	7	\$3153

CSFO72	14.5 x 72 x 16.5	92.5	100	10	\$1840
CSFO66	14.5 x 66 x 16.5	100	83	9	\$1689
CSFO60	14.5 x 60 x 16.5	100	75	8	\$1540
CSFO54	14.5 x 54 x 16.5	100	68	7	\$1390
CSFO48	14.5 x 48 x 16.5	100	60	7	\$1235
CSFO42	14.5 x 42 x 16.5	100	55	6	\$1138
CSFO36	14.5 x 36 x 16.5	92.5	50	5	\$1121
CSFO30	14.5 x 30 x 16.5	92.5	45	4	\$1099

CSFO72D16	16 x 72 x 16.5	92.5	100	10	\$2792
CSFO66D16	16 x 66 x 16.5	100	83	9	\$2592
CSFO60D16	16 x 60 x 16.5	100	75	8	\$2389
CSFO54D16	16 x 54 x 16.5	100	68	7	\$2189
CSFO48D16	16 x 48 x 16.5	100	60	7	\$1987
CSFO42D16	16 x 42 x 16.5	100	55	6	\$1858
CSFO36D16	16 x 36 x 16.5	92.5	50	5	\$1840
CSFO30D16	16 x 30 x 16.5	92.5	45	4	\$1810

CSFOP72	14.5 x 72 x 19.5	92.5	100	10	\$2210
CSFOP66	14.5 x 66 x 19.5	100	83	9	\$2030
CSFOP60	14.5 x 60 x 19.5	100	75	8	\$1844
CSFOP54	14.5 x 54 x 19.5	100	68	7	\$1663
CSFOP48	14.5 x 48 x 19.5	100	60	7	\$1473
CSFOP42	14.5 x 42 x 19.5	100	55	6	\$1385
CSFOP36	14.5 x 36 x 19.5	92.5	50	5	\$1346
CSFOP30	14.5 x 30 x 19.5	92.5	45	4	\$1326

CSFOP72D16	16 x 72 x 19.5	100	100	12	\$3379
CSFOP66D16	16 x 66 x 19.5	125	83	11	\$3128
CSFOP60D16	16 x 60 x 19.5	125	75	10	\$2878
CSFOP54D16	16 x 54 x 19.5	125	68	9	\$2629
CSFOP48D16	16 x 48 x 19.5	125	60	8	\$2374
CSFOP42D16	16 x 42 x 19.5	125	55	7	\$2253
CSFOP36D16	16 x 36 x 19.5	100	50	6	\$2194
CSFOP30D16	16 x 30 x 19.5	100	45	5	\$2166

Required Specifications

Finish
Edge

FREESTANDING STORAGE NOTES

NOTE: Arrow indicates direction of grain

Pedestals

- All units are shipped assembled.
- Standard face locking.

Combination Storage

- All units are shipped assembled.
- No modifications accepted for this unit.
- Box drawers do not lock.
- Standard face locking.

Storage Cabinets

- Units include adjustable shelves.
- If Handle is specified:
 - Black and Brass handle = Black Lock & Grommet
 - Silver, Nickel and Tungsten handle = Tungsten Lock & Grommet

Edge options - must specify:

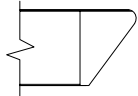

K16

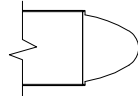

K18

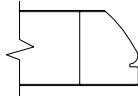

K21

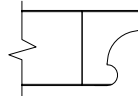

K22

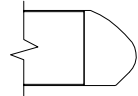

K29

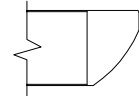

K30

FREESTANDING STORAGE

MODEL#

DIMENSIONS

FREIGHT CLASS

WT/LBS.

CUBIC FT.

LIST PRICE

D x W x H

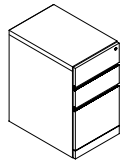

Freestanding Pedestal

KWDB	19.8 x 15.5 x 28	85	70	5	\$2348
KWWDB	23.8 x 15.5 x 28	85	75	6	\$2703

Box/box/file.

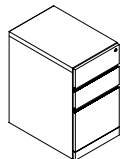

Freestanding Mobile Pedestal

KWDM	19.8 x 15.5 x 28	85	70	5	\$2525
KWWDM	23.8 x 15.5 x 28	85	75	6	\$2906

Box/box/file.

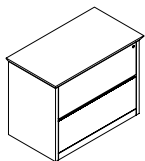

Lateral File - 2 high

KF3622	23 x 38 x 29	85	170	13	\$4377
KF3620	21 x 38 x 29	85	159	12	\$3980
KN3022	23 x 32.9 x 29	85	142	11	\$3831
KN3020	21 x 32.9 x 29	85	131	10	\$3481

Two lateral file drawers.

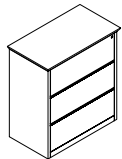

Lateral File - 3 high

KF36223	23 x 38 x 42	92.5	212	19	\$5344
KF36203	21 x 38 x 42	92.5	193	18	\$4992
KN30223	23 x 32.9 x 42	92.5	176	16	\$4675
KN30203	21 x 32.9 x 42	92.5	160	15	\$4365

Three lateral file drawers.

Required Specifications

Finish
Edge

Optional Specifications

Handles

FREESTANDING STORAGE

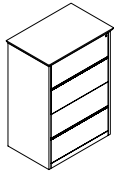

Lateral File - 4 high

MODEL#	DIMENSIONS D x W x H	FREIGHT CLASS	WT/LBS.	CUBIC FT.	LIST PRICE
KF36224	23 x 38 x 54	92.5	270	25	\$6509
KF36204	21 x 38 x 54	92.5	259	23	\$6184
KN30224	23 x 32.9 x 54	92.5	225	21	\$5698
KN30204	21 x 32.9 x 54	92.5	214	19	\$5414

Four lateral file drawers.

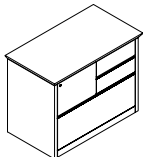

Combination Storage - Left

KZL3622	23 x 38 x 29	85	170	13	\$4744
KZL3620	21 x 38 x 29	85	160	12	\$4518

With 1 lateral file, 2 box drawers in the top right, and 1 file drawer in the top left.

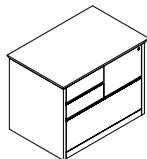

Combination Storage - Right

KZR3622	23 x 38 x 29	85	170	13	\$4744
KZR3620	21 x 38 x 29	85	160	12	\$4518

With 1 lateral file, 2 box drawers in the top left, and 1 file drawer in the top right.

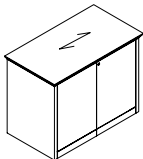

Storage Cabinet w/Doors

KBD3622	23 x 38 x 29	92.5	140	13	\$2979
KBD3620	21 x 38 x 29	92.5	129	12	\$2837
KBD3022	23 x 32.9 x 29	92.5	117	11	\$2609
KBD3020	21 x 32.9 x 29	92.5	106	10	\$2479

Storage with 1 adjustable shelf. For Aluminum framed glass door option, contact Customer Care.

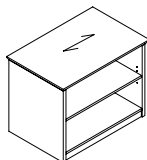

Open Storage Cabinet

KOB3622	23 x 38.75 x 29	100	115	13	\$2393
KOB3620	21 x 38.75 x 29	100	104	12	\$2277
KOB3022	23 x 33.63 x 29	100	96	11	\$2089
KOB3020	21 x 33.63 x 29	100	85	10	\$1987

Storage with 1 adjustable shelf.

Required Specifications

Finish
Edge

Optional Specifications

Handles

FREESTANDING STORAGE

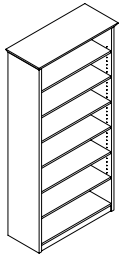

Open Bookcase

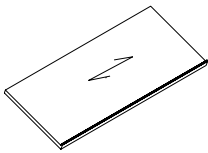

Additional Shelf

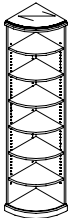

Quarter Round Open Bookcase

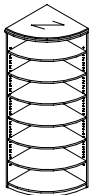

Quarter Round Open Bookcase

MODEL#	DIMENSIONS D x W x H	FREIGHT CLASS	WT/LBS.	CUBIC FT.	LIST PRICE
KB73615	16 x 38 x 78	100	228	24	\$3717
KB63615	16 x 38 x 72	100	210	23	\$3432
KB53615	16 x 38 x 65	100	188	21	\$3161
KB43615	16 x 38 x 48	100	140	15	\$2602
KB23615	16 x 38 x 29	92.5	90	9	\$2086
KB73015	16 x 32.9 x 78	92.5	228	20	\$3254
KB63015	16 x 32.9 x 72	92.5	210	19	\$3002
KB53015	16 x 32.9 x 65	92.5	188	17	\$2768
KB43015	16 x 32.9 x 48	92.5	140	13	\$2277
KB23015	16 x 32.9 x 29	92.5	90	8	\$1826

78" high models have 6 adjustable shelves, 72" has 5 adjustable shelves, 65" has 4 adjustable shelves, 48" has 3 adjustable shelves, 29" has 1 adjustable shelves.

KMAG3624	24 x 36 x 1	92.5	112	10	\$225
KMAG3622	22 x 36 x 1	92.5	104	10	\$204
KMAG3620	20 x 36 x 1	92.5	92	9	\$184
KMAG3615	15 x 36 x 1	92.5	81	8	\$162
KMAG3024	24 x 30 x 1	92.5	94	9	\$189
KMAG3022	22 x 30 x 1	100	87	9	\$172
KMAG3020	20 x 30 x 1	100	76	8	\$152
KMAG3015	15 x 30 x 1	100	67	8	\$134

For use with open bookcase. Can be specified for each shelf in an open bookcase.

KB7R1515	16 x 16 x 78	100	95	10	\$2928
KB6R1515	16 x 16 x 72	100	83	9	\$2700
KB5R1515	16 x 16 x 65	100	81	9	\$2486
KB4R1515	16 x 16 x 48	100	59	6	\$2046
KB2R1515	16 x 16 x 29	100	37	4	\$1646

84" and 78" high models have 6 adjustable shelves, 72" has 5 adjustable shelves, 65" has 4 adjustable shelves, 48" has 3 adjustable shelves, 29" has 1 adjustable shelf.

KB7R2222H84	23 x 23 x 84	100	191	23	\$5036
KB7R2222H72	23 x 23 x 72	100	171	20	\$4319
KB7R2222H65	23 x 23 x 65	100	157	18	\$5037
KB7R2020H84	21 x 21 x 84	100	163	19	\$4798
KB7R2020H72	21 x 21 x 72	100	142	17	\$4112
KB7R2020H65	21 x 21 x 65	100	130	15	\$4798

84" high models have 6 adjustable shelves, 72" has 5 adjustable shelves, and 65" has 4 adjustable shelves

Required Specifications

Finish
Edge

Optional Specifications

Handles

FREESTANDING STORAGE

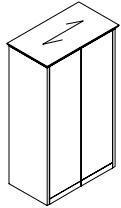

Storage Cabinet w/Wood Doors

MODEL# DIMENSIONS FREIGHT CLASS WT/LBS. CUBIC FT. LIST PRICE

D x W x H

K1D22W36H84	23 x 38 x 84	125	304	42	\$6993
K1D22W36H72	23 x 38 x 72	100	283	33	\$5995
K1D22W36H65	23 x 38 x 65	100	259	30	\$5493
K1D22W30H84	23 x 32.9 x 84	125	304	42	\$6118
K1D22W30H72	23 x 32.9 x 72	100	283	33	\$5245
K1D22W30H65	23 x 32.9 x 65	100	259	30	\$4810
K1D22W24H84	23 x 26 x 84	92.5	320	28	\$5242
K1D22W24H72	23 x 26 x 72	92.5	255	24	\$4494
K1D22W24H65	23 x 26 x 65	125	173	22	\$4128
K1D20W36H84	21 x 38 x 84	100	297	35	\$6664
K1D20W36H72	21 x 38 x 72	100	269	30	\$5712
K1D20W36H65	21 x 38 x 65	100	245	28	\$5236
K1D20W30H84	21 x 32.9 x 84	100	257	29	\$5550
K1D20W30H72	21 x 32.9 x 72	100	233	25	\$4758
K1D20W30H65	21 x 32.9 x 65	100	202	23	\$4361
K1D20W24H84	21 x 26 x 84	100	198	23	\$4442
K1D20W24H72	21 x 26 x 72	100	179	20	\$3806
K1D20W24H65	21 x 26 x 65	100	163	18	\$3485

84" high models have 6 adjustable shelves, 72" has 5 adjustable shelves, 65" has 4 adjustable shelves. For Aluminum framed glass door option, please contact customer care.

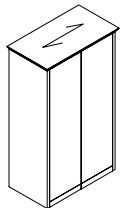

Wardrobe Cabinet

K2D22W36H84	23 x 38 x 84	125	304	42	\$6067
K2D22W36H72	23 x 38 x 72	100	283	33	\$5202
K2D22W36H65	23 x 38 x 65	100	259	30	\$4769
K2D22W30H84	23 x 32.9 x 84	125	304	42	\$5310
K2D22W30H72	23 x 32.9 x 72	100	283	33	\$4550
K2D22W30H65	23 x 32.9 x 65	100	259	30	\$4169
K2D22W24H84	23 x 26 x 84	92.5	320	28	\$4550
K2D22W24H72	23 x 26 x 72	92.5	255	24	\$3902
K2D22W24H65	23 x 26 x 65	125	173	22	\$3574
K2D20W36H84	21 x 38 x 84	100	297	35	\$5779
K2D20W36H72	21 x 38 x 72	100	269	30	\$4954
K2D20W36H65	21 x 38 x 65	100	245	28	\$4541
K2D20W30H84	21 x 32.9 x 84	100	257	29	\$4816
K2D20W30H72	21 x 32.9 x 72	100	233	25	\$4129
K2D20W30H65	21 x 32.9 x 65	100	202	23	\$3783
K2D20W24H84	21 x 26 x 84	100	198	23	\$3853
K2D20W24H72	21 x 26 x 72	100	179	20	\$3299
K2D20W24H65	21 x 26 x 65	100	163	18	\$3025

Doors, coat rack and hat shelf. 84" high models have 6 adjustable shelves, 72" has 5 adjustable shelves, 65" has 4 adjustable shelves. For Aluminum framed glass door option, please contact customer care.

Required Specifications

Finish
Edge

Optional Specifications

Handles

FREESTANDING STORAGE

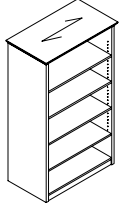

Open Bookcase

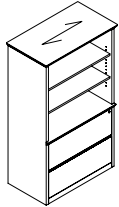

Open Cabinet

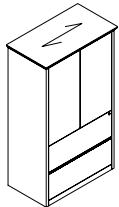

Storage Cabinet w/Doors

MODEL#	DIMENSIONS	FREIGHT CLASS	WT/LBS.	CUBIC FT.	LIST PRICE
D x W x H					
K7D22W36H84	23 x 38 x 84	125	331	43	\$5596
K7D22W36H72	23 x 38 x 72	100	306	36	\$4798
K7D22W36H65	23 x 38 x 65	100	281	33	\$4398
K7D22W30H84	23 x 32.9 x 84	125	280	36	\$4895
K7D22W30H72	23 x 32.9 x 72	100	255	30	\$4263
K7D22W30H65	23 x 32.9 x 65	100	234	28	\$3847
K7D20W36H84	21 x 38 x 84	125	282	36	\$5332
K7D20W36H72	21 x 38 x 72	100	257	30	\$4572
K7D20W36H65	21 x 38 x 65	100	234	28	\$4190
K7D20W30H84	21 x 32.9 x 84	100	248	29	\$4441
K7D20W30H72	21 x 32.9 x 72	100	223	25	\$3805
K7D20W30H65	21 x 32.9 x 65	100	193	23	\$3487

84" high models have 6 adjustable shelves, 72" has 5 adjustable shelves, 65" has 4 adjustable shelves.

K12D22W36H84	23 x 38 x 84	92.5	364	36	\$7593
K12D22W36H72	23 x 38 x 72	92.5	336	33	\$6508
K12D22W36H65	23 x 38 x 65	92.5	308	30	\$5970
K12D22W30H84	23 x 32.9 x 84	92.5	330	31	\$6643
K12D22W30H72	23 x 32.9 x 72	92.5	294	28	\$5698
K12D22W30H65	23 x 32.9 x 65	92.5	257	25	\$5221
K12D20W36H84	21 x 38 x 84	92.5	348	33	\$7234
K12D20W36H72	21 x 38 x 72	92.5	322	30	\$6199
K12D20W36H65	21 x 38 x 65	92.5	294	28	\$5682
K12D20W30H84	21 x 32.9 x 84	92.5	317	28	\$6329
K12D20W30H72	21 x 32.9 x 72	92.5	280	25	\$5422
K12D20W30H65	21 x 32.9 x 65	92.5	243	23	\$4738

Above two lateral file drawers. 84" high models have 6 adjustable shelves, 72" has 5 adjustable shelves, 65" has 4 adjustable shelves.

K13D22W36H84	23 x 38 x 84	92.5	364	36	\$8654
K13D22W36H72	23 x 38 x 72	92.5	341	33	\$7417
K13D22W36H65	23 x 38 x 65	92.5	313	30	\$6801
K13D22W30H84	23 x 32.9 x 84	92.5	330	31	\$7572
K13D22W30H72	23 x 32.9 x 72	92.5	299	28	\$6490
K13D22W30H65	23 x 32.9 x 65	92.5	261	25	\$5950
K13D20W36H84	21 x 38 x 84	92.5	365	35	\$8242
K13D20W36H72	21 x 38 x 72	92.5	327	30	\$7064
K13D20W36H65	21 x 38 x 65	92.5	299	28	\$6472
K13D20W30H84	21 x 32.9 x 84	92.5	305	29	\$6870
K13D20W30H72	21 x 32.9 x 72	92.5	285	25	\$5891
K13D20W30H65	21 x 32.9 x 65	92.5	247	23	\$5396

Above two lateral file drawers. 84" high models have 6 adjustable shelves, 72" has 5 adjustable shelves, 65" has 4 adjustable shelves. For Aluminum framed glass door option, please contact customer care.

Required Specifications

Finish
Edge

Optional Specifications

Handles

FREESTANDING STORAGE

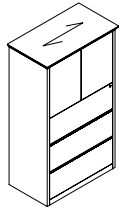

Storage Cabinet w/Doors

MODEL# DIMENSIONS FREIGHT CLASS WT/LBS. CUBIC FT. LIST PRICE

D x W x H

K14D22W36H84	23 x 38 x 84	100	340	42	\$9303
K14D22W36H72	23 x 38 x 72	100	312	33	\$7974
K14D22W36H65	23 x 38 x 65	100	286	30	\$7312
K14D22W30H84	23 x 32.9 x 84	100	308	35	\$8138
K14D22W30H72	23 x 32.9 x 72	100	273	28	\$6977
K14D22W30H65	23 x 32.9 x 65	100	238	25	\$6396

K14D20W36H84	21 x 38 x 84	100	330	35	\$8860
K14D20W36H72	21 x 38 x 72	100	298	30	\$7596
K14D20W36H65	21 x 38 x 65	100	272	28	\$6963
K14D20W30H84	21 x 32.9 x 84	92.5	298	29	\$7384
K14D20W30H72	21 x 32.9 x 72	92.5	259	25	\$6330
K14D20W30H65	21 x 32.9 x 65	100	224	23	\$5802

Above three lateral file drawers. 84" high models have 2 adjustable shelves, 72" and 65" have 1 adjustable shelf. For Aluminum framed glass door option, please contact customer care.

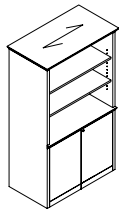

Open Storage

K22D22W36H84	23 x 38 x 84	125	325	42	\$6373
K22D22W36H72	23 x 38 x 72	100	300	33	\$5460
K22D22W36H65	23 x 38 x 65	100	275	30	\$5008
K22D22W30H84	23 x 32.9 x 84	100	304	35	\$5577
K22D22W30H72	23 x 32.9 x 72	100	279	28	\$4781
K22D22W30H65	23 x 32.9 x 65	100	243	25	\$4383

K22D20W36H84	21 x 38 x 84	100	327	33	\$6067
K22D20W36H72	21 x 38 x 72	92.5	305	30	\$5202
K22D20W36H65	21 x 38 x 65	100	278	28	\$4769
K22D20W30H84	21 x 32.9 x 84	92.5	301	28	\$5063
K22D20W30H72	21 x 32.9 x 72	92.5	265	25	\$4339
K22D20W30H65	21 x 32.9 x 65	100	229	23	\$3973

Above storage cabinet. 84" high models have 4 adjustable shelves, 72" has 3 adjustable shelves, 65" has 3 adjustable shelves. For Aluminum framed glass door option, please contact customer care.

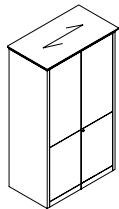

Closed Storage Cabinet

K23D22W36H84	23 x 38 x 84	100	340	42	\$7469
K23D22W36H72	23 x 38 x 72	100	319	33	\$6401
K23D22W36H65	23 x 38 x 65	100	292	30	\$5862
K23D22W30H84	23 x 32.9 x 84	100	308	33	\$6221
K23D22W30H72	23 x 32.9 x 72	100	279	28	\$5332
K23D22W30H65	23 x 32.9 x 65	100	243	25	\$4891

K23D20W36H84	21 x 38 x 84	100	330	35	\$7111
K23D20W36H72	21 x 38 x 72	92.5	305	30	\$6096
K23D20W36H65	21 x 38 x 65	100	278	28	\$5586
K23D20W30H84	21 x 32.9 x 84	92.5	298	29	\$5925
K23D20W30H72	21 x 32.9 x 72	92.5	265	25	\$5080
K23D20W30H65	21 x 32.9 x 65	100	229	23	\$4657

With upper and lower split doors. 1 fixed shelf and 2 adjustable shelves. For Aluminum framed glass door option, please contact customer care.

Required Specifications

Finish
Edge

Optional Specifications

Handles

FREESTANDING STORAGE

MODEL# DIMENSIONS FREIGHT CLASS WT/LBS. CUBIC FT. LIST PRICE

D x W x H

K25D22W36H84	23 x 38 x 84	100	348	42	\$7843
K25D22W36H72	23 x 38 x 72	100	319	33	\$6726
K25D22W36H65	23 x 38 x 65	100	292	30	\$6164
K25D22W30H84	23 x 32.9 x 84	100	307	35	\$6862
K25D22W30H72	23 x 32.9 x 72	100	279	28	\$5884
K25D22W30H65	23 x 32.9 x 65	100	243	25	\$5392
K25D22W24H84	23 x 26 x 84	100	254	28	\$5882
K25D22W24H72	23 x 26 x 72	100	213	24	\$5041
K25D22W24H65	23 x 26 x 65	100	195	22	\$4617

K25D20W36H84	21 x 38 x 84	100	330	35	\$7468
K25D20W36H72	21 x 38 x 72	92.5	305	30	\$6398
K25D20W36H65	21 x 38 x 65	100	278	28	\$5865
K25D20W30H84	21 x 32.9 x 84	92.5	300	29	\$6222
K25D20W30H72	21 x 32.9 x 72	92.5	265	25	\$5333
K25D20W30H65	21 x 32.9 x 65	100	229	23	\$4891
K25D20W24H84	21 x 26 x 84	100	235	28	\$4980
K25D20W24H72	21 x 26 x 72	100	203	24	\$4268
K25D20W24H65	21 x 26 x 65	100	185	22	\$3916

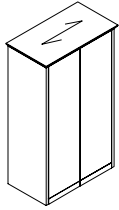

Cabinet w/Doors and Storage

Wardrobe with coat rack and hat shelf on left. Storage with adjustable shelves on right. 84" high models have 5 adjustable shelves, 72" and 65" have 4 adjustable shelves. For Aluminum framed glass door option, please contact customer care.

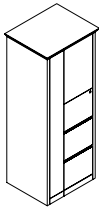

Tower Unit - Left

K27D22W24H84L	23 x 26 x 84	125	167	24	\$9287
K27D22W24H72L	23 x 26 x 72	125	154	22	\$7960
K27D22W24H65L	23 x 26 x 65	125	141	20	\$7303

K27D20W24H84L	21 x 26 x 84	125	152	22	\$8846
K27D20W24H72L	21 x 26 x 72	125	140	20	\$7585
K27D20W24H65L	21 x 26 x 65	125	128	18	\$6952

Wardrobe with coat rack and hat shelf on left. Three file drawers and storage with adjustable shelf on right. 84" high models have 2 adjustable shelves, 72" and 65" have 1 adjustable shelf. For Aluminum framed glass door option on right, please contact customer care.

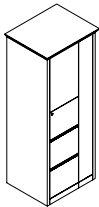

Tower Unit - Right

K27D22W24H84R	23 x 26 x 84	125	167	24	\$9287
K27D22W24H72R	23 x 26 x 72	125	154	22	\$7960
K27D22W24H65R	23 x 26 x 65	125	141	20	\$7303

K27D20W24H84R	21 x 26 x 84	125	152	22	\$8846
K27D20W24H72R	21 x 26 x 72	125	140	20	\$7585
K27D20W24H65R	21 x 26 x 65	125	128	18	\$6952

Wardrobe with coat rack and hat shelf on right. Three file drawers and storage with adjustable shelf on left. 84" high models have 2 adjustable shelves, 72" and 65" have 1 adjustable shelf. For Aluminum framed glass door option on left, please contact customer care.

Required Specifications

Finish
Edge

Optional Specifications

Handles

MODESTY PANELS

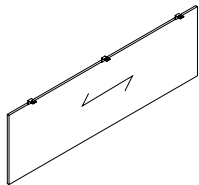

Veneer Modesty Panel*

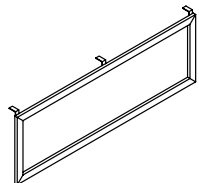

Glass Modesty Panel

MODEL# DIMENSIONS FREIGHT CLASS WT/LBS. CUBIC FT. LIST PRICE

D x W x H

CMP72W	0.75 x 67 x 18	--	20	1	\$1622
CMP66W	0.75 x 61 x 18	--	18	1	\$1570
CMP60W	0.75 x 55 x 18	--	16	1	\$1546
CMP54W	0.75 x 49 x 18	--	14	1	\$1520
CMP48W	0.75 x 43 x 18	--	13	1	\$1496

Straight modesty panel. Attaches to underside of worksurface. **Cannot be retrofitted in the field. Not sold individually - to be ordered as an upgrade option only.**

- CMP72W - Specify on 96" Piano desk: Boat, D or P
- CMP66W - Specify on 84" Piano desk: Boat or D
- CMP60W - For use on 84" Piano desk: P
- CMP54W - For use on 72" Piano desk: Boat or D/D table desk
- CMP48W - For use on 66" and 60" Piano desk: D or P/D table desk

CMP72G	0.75 x 67 x 18	--	20	1	\$2485
CMP66G	0.75 x 61 x 18	--	18	1	\$2351
CMP60G	0.75 x 55 x 18	--	16	1	\$2149
CMP54G	0.75 x 49 x 18	--	14	1	\$2001
CMP48G	0.75 x 43 x 18	--	13	1	\$1911

Straight modesty panel. Translucent, screened glass. Aluminum box frame construction in Tungsten Only. Attaches to underside of worksurface. **Cannot be retrofitted in the field. Not sold individually - to be ordered as an upgrade option only.**

- CMP72G - Specify on 96" Piano desk: Boat, D or P
- CMP66G - Specify on 84" Piano desk: Boat or D
- CMP60G - For use on 84" Piano desk: P
- CMP54G - For use on 72" Piano desk: Boat or D/D table desk
- CMP48G - For use on 66" and 60" Piano desk: D or P/D table desk
- Tungsten finish on the aluminum box frame closely resembles the existing Tungsten finish.

ACCESSORIES

MODEL# DIMENSIONS FREIGHT CLASS WT/LBS. CUBIC FT. LIST PRICE

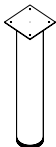

Metal Post Upgrade

SM06	6 x 6 x 28	--	--	--	\$1037
SM04	4 x 4 x 28	--	--	--	\$572
SM03	3 x 3 x 28	--	--	--	\$407

Must specify at time of order. **Cannot be retrofitted in the field.**
Available in Black (E), Tungsten (K) and Brushed Chrome (P).

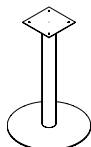

Metal Flat Plate Base Upgrade

F3P18	18 x 18 x 28	--	--	--	\$1538
-------	--------------	----	----	----	---------------

Must specify at time of order. **Can not be retrofitted in the field.**
Available in Black (E), Tungsten (K) and Brushed Chrome (P).

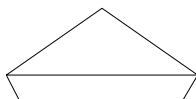

Corner Filler Top

KV1212CT	12 x 12 x 1.5	150	5	1	\$981
----------	---------------	-----	---	---	--------------

Required Specifications

Finish*

TACKBOARDS FOR HUTCHES

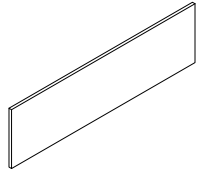

**Tackboard for 36" H
Non-Pigeon Hole Hutches**

MODEL#	DIMENSIONS D x W x H	FREIGHT CLASS	WT/LBS.	CUBIC FT.	GR.1-3	GR. 4-5
KTS108	1 x 105 x 20	92.5	23	2	\$1232	\$1480
KTS102	1 x 99 x 20	100	19	2	\$1166	\$1402
KTS96	1 x 93 x 20	70	15	1	\$1097	\$1319
KTS90	1 x 87 x 20	70	15	1	\$1030	\$1238
KTS84	1 x 81 x 20	85	14	1	\$965	\$1161
KTS78	1 x 75 x 20	85	13	1	\$893	\$1073
KTS72	1 x 69 x 20	85	12	1	\$821	\$986
KTS66	1 x 63 x 20	92.5	11	1	\$751	\$902
KTS60	1 x 57 x 20	92.5	10	1	\$688	\$827
KTS36	1 x 33 x 20	60	6	0.01	\$412	\$496
KTS30	1 x 27 x 20	60	4	0.01	\$343	\$414

Factory installed hutch tackboard.

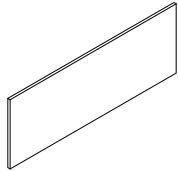

**Tackboard for 42" H & 54" H
Pigeon-Hole Hutches**

KTSP108H23	1 x 105 x 23	70	30	2	\$1393	\$1673
KTSP102H23	1 x 99 x 23	85	24	2	\$1328	\$1595
KTSP96H23	1 x 93 x 23	92.5	20	2	\$1240	\$1490
KTSP90H23	1 x 87 x 23	70	20	1	\$1162	\$1396
KTSP84H23	1 x 81 x 23	70	18	1	\$1085	\$1303
KTSP78H23	1 x 75 x 23	70	17	1	\$1008	\$1211
KTSP72H23	1 x 69 x 23	70	16	1	\$937	\$1126
KTSP66H23	1 x 63 x 23	85	14	1	\$852	\$1024
KTSP60H23	1 x 57 x 23	85	13	1	\$779	\$938
KTSP36H23	1 x 33 x 23	60	8	0.01	\$466	\$561
KTSP30H23	1 x 27 x 23	60	5	0.01	\$388	\$469

Factory installed hutch tackboard.

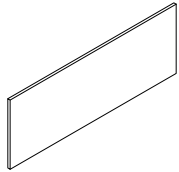

**Tackboard for 42" H & 54" H
Non-Pigeon Hole Hutches**

KTS108H26	1 x 105 x 26	70	30	2	\$1611	\$1935
KTS102H26	1 x 99 x 26	85	24	2	\$1518	\$1823
KTS96H26	1 x 93 x 26	92.5	20	2	\$1427	\$1715
KTS90H26	1 x 87 x 26	92.5	20	2	\$1344	\$1614
KTS84H26	1 x 81 x 26	100	18	2	\$1249	\$1500
KTS78H26	1 x 75 x 26	100	17	2	\$1160	\$1394
KTS72H26	1 x 69 x 26	70	16	1	\$1071	\$1287
KTS66H26	1 x 63 x 26	85	14	1	\$982	\$1180
KTS60H26	1 x 57 x 26	85	13	1	\$893	\$1073
KTS36H26	1 x 33 x 26	60	8	0.01	\$538	\$647
KTS30H26	1 x 27 x 26	60	5	0.01	\$447	\$538

Factory installed hutch tackboard.

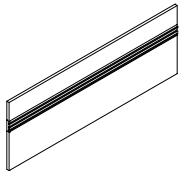

**Tackboard w/Rail for 36" H
Non-Pigeon Hole Hutches***

KTSAS108	1 x 105 x 20	92.5	23	2	\$2187	\$2626
KTSAS102	1 x 99 x 20	100	19	2	\$1973	\$2369
KTSAS96	1 x 93 x 20	70	15	1	\$1942	\$2333
KTSAS90	1 x 87 x 20	70	15	1	\$1826	\$2193
KTSAS84	1 x 81 x 20	85	14	1	\$1702	\$2045
KTSAS78	1 x 75 x 20	85	13	1	\$1582	\$1900
KTSAS72	1 x 69 x 20	85	12	1	\$1457	\$1749
KTSAS66	1 x 63 x 20	92.5	11	1	\$1335	\$1603
KTSAS60	1 x 57 x 20	92.5	10	1	\$1218	\$1486
KTSAS36	1 x 33 x 20	60	6	0.01	\$728	\$876
KTSAS30	1 x 27 x 20	60	4	0.01	\$607	\$731

Factory installed hutch tackboard.

- Specify Black (**E**), Tungsten (**K**), or Designer White (**DWT**) accessory rail finish.

Required Specifications

Fabric
Metal finish*

TACKBOARDS FOR HUTCHES

MODEL#	DIMENSIONS	FREIGHT CLASS	WT/LBS.	CUBIC FT.	GR.1-3	GR. 4-5
	D x W x H					
KTSPAS108H23	1 x 105 x 23	70	30	2	\$2374	\$2850
KTSPAS102H23	1 x 99 x 23	85	24	2	\$2258	\$2734
KTSPAS96H23	1 x 93 x 23	92.5	20	2	\$2120	\$2546
KTSPAS90H23	1 x 87 x 23	92.5	20	2	\$1985	\$2384
KTSPAS84H23	1 x 81 x 23	100	18	2	\$1851	\$2223
KTSPAS78H23	1 x 75 x 23	100	17	2	\$1719	\$2064
KTSPAS72H23	1 x 69 x 23	70	16	1	\$1586	\$1904
KTSPAS66H23	1 x 63 x 23	85	14	1	\$1454	\$1746
KTSPAS60H23	1 x 57 x 23	85	13	1	\$1322	\$1588
KTSPAS36H23	1 x 33 x 23	100	8	1	\$795	\$956
KTSPAS30H23	1 x 27 x 23	150	5	1	\$667	\$802

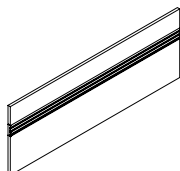

Tackboard w/Rail for 42”H & 54”H*
Pigeon-Hole Hutches

Factory installed hutch tackboard.
 • Specify Black (E), Tungsten (K), or Designer White (DWT) accessory rail finish.

KTSAS108H26	1 x 105 x 26	92.5	23	2	\$2635	\$3165
KTSAS102H26	1 x 99 x 26	100	19	2	\$2480	\$2978
KTSAS96H26	1 x 93 x 26	70	15	1	\$2335	\$2804
KTSAS90H26	1 x 87 x 26	70	15	1	\$2198	\$2640
KTSAS84H26	1 x 81 x 26	85	14	1	\$2023	\$2429
KTSAS78H26	1 x 75 x 26	85	13	1	\$1898	\$2279
KTSAS72H26	1 x 69 x 26	85	12	1	\$1723	\$2069
KTSAS66H26	1 x 63 x 26	92.5	11	1	\$1611	\$1935
KTSAS60H26	1 x 57 x 26	92.5	10	1	\$1458	\$1752
KTSAS36H26	1 x 33 x 26	60	6	0.01	\$875	\$1053
KTSAS30H26	1 x 27 x 26	60	4	0.01	\$735	\$884

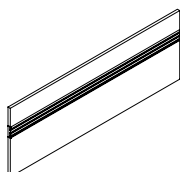

Tackboard w/Rail for 42”H & 54”H*
Non-Pigeon Hole Hutches

Factory installed hutch tackboard.
 • Specify Black (E), Tungsten (K), or Designer White (DWT) accessory rail finish.

TS120	1 x 120 x 19.2	70	26	2	\$1522	\$1902
TS114	1 x 114 x 19.2	70	25	2	\$1449	\$1814
TS108	1 x 108 x 19.2	70	23	2	\$1370	\$1713
TS102	1 x 102 x 19.2	85	19	2	\$1298	\$1623
TS96	1 x 96 x 19.2	70	17	1	\$1214	\$1520
TS90	1 x 90 x 19.2	70	15	1	\$1141	\$1428
TS84	1 x 84 x 19.2	70	14	1	\$1069	\$1335
TS78	1 x 78 x 19.2	70	13	1	\$990	\$1238
TS72	1 x 72 x 19.2	70	12	1	\$557	\$698
TS66	1 x 66 x 19.2	85	11	1	\$512	\$644
TS60	1 x 60 x 19.2	85	10	1	\$471	\$592
TS54	1 x 54 x 19.2	85	10	1	\$427	\$537
TS48	1 x 48 x 19.2	85	10	1	\$382	\$479
TS42	1 x 42 x 19.2	85	10	1	\$338	\$425
TS36	1 x 36 x 19.2	100	8	1	\$302	\$383
TS30	1 x 30 x 19.2	150	5	1	\$251	\$316

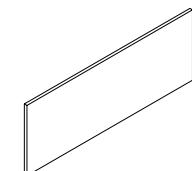

Tackboard for 65”H Non-Pigeon Hole
Wall Mount Cabinets

Factory installed tackboard for wall mount cabinets.

Required Specifications

Fabric
 Metal finish*

TACKBOARDS FOR WALL MOUNT CABINETS

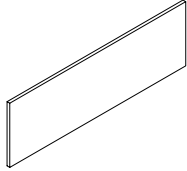

Tackboard for 72" H Pigeon-Hole Wall Mount Cabinets

MODEL#	DIMENSIONS D x W x H	FREIGHT CLASS	WT./LBS.	CUBIC FT.	GR. 1-3	GR. 4-5
TSP120H23	1 x 120 x 23	70	34	2	\$1718	\$2148
TSP114H23	1 x 114 x 23	70	32	2	\$1632	\$2039
TSP108H23	1 x 108 x 23	70	30	2	\$1600	\$1920
TSP102H23	1 x 102 x 23	85	24	2	\$1525	\$1831
TSP96H23	1 x 96 x 23	92.5	20	2	\$1377	\$1720
TSP90H23	1 x 90 x 23	92.5	20	1	\$1286	\$1609
TSP84H23	1 x 84 x 23	70	18	1	\$1201	\$1501
TSP78H23	1 x 78 x 23	70	17	1	\$983	\$1195
TSP72H23	1 x 72 x 23	70	16	1	\$913	\$1147
TSP66H23	1 x 66 x 23	85	14	1	\$830	\$1041
TSP60H23	1 x 60 x 23	85	13	1	\$601	\$755
TSP54H23	1 x 54 x 23	85	13	1	\$762	\$955
TSP48H23	1 x 48 x 23	85	13	1	\$602	\$613
TSP42H23	1 x 42 x 23	85	13	1	\$530	\$538
TSP36H23	1 x 36 x 23	100	8	1	\$458	\$474
TSP30H23	1 x 30 x 23	150	5	1	\$379	\$403

Factory installed tackboard for wall mount cabinets.

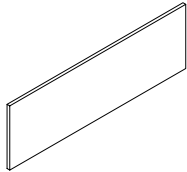

Tackboard for 72" H Non-Pigeon-Hole Wall Mount Cabinets

TS120H26	1 x 120 x 26	70	34	2	\$1979	\$2474
TS114H26	1 x 114 x 26	70	32	2	\$1880	\$2351
TS108H26	1 x 108 x 26	70	30	2	\$1782	\$2229
TS102H26	1 x 102 x 26	85	24	2	\$1678	\$2098
TS96H26	1 x 96 x 26	92.5	22	2	\$1587	\$1986
TS90H26	1 x 90 x 26	92.5	20	2	\$1488	\$1859
TS84H26	1 x 84 x 26	100	18	2	\$1383	\$1729
TS78H26	1 x 78 x 26	100	17	2	\$1286	\$1609
TS72H26	1 x 72 x 26	70	16	1	\$714	\$897
TS66H26	1 x 66 x 26	85	14	1	\$658	\$825
TS60H26	1 x 60 x 26	85	13	1	\$601	\$755
TS54H26	1 x 54 x 26	85	13	1	\$552	\$692
TS48H26	1 x 48 x 26	85	13	1	\$488	\$613
TS42H26	1 x 42 x 26	85	13	1	\$433	\$538
TS36H26	1 x 36 x 26	100	8	1	\$378	\$475
TS30H26	1 x 30 x 26	150	5	1	\$317	\$401

Factory installed tackboard for wall mount cabinets.

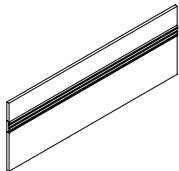

Tackboard w/Rail for 65" H* Non-Pigeon Hole Wall Mount Cabinets

TSAS120	1 x 120 x 19.2	85	26	1	\$2353	\$2942
TSAS114	1 x 114 x 19.2	85	25	2	\$2239	\$2799
TSAS108	1 x 108 x 19.2	92.5	23	2	\$2120	\$2653
TSAS102	1 x 102 x 19.2	100	19	2	\$2007	\$2505
TSAS96	1 x 96 x 19.2	70	17	1	\$1880	\$2355
TSAS90	1 x 90 x 19.2	70	15	1	\$1765	\$2209
TSAS84	1 x 84 x 19.2	85	14	1	\$1646	\$2060
TSAS78	1 x 78 x 19.2	85	13	1	\$1533	\$1918
TSAS72	1 x 72 x 19.2	85	12	1	\$1412	\$1769
TSAS66	1 x 66 x 19.2	92.5	11	1	\$1298	\$1627
TSAS60	1 x 60 x 19.2	92.5	10	1	\$1177	\$1473
TSAS54	1 x 54 x 19.2	92.5	10	1	\$1064	\$1329
TSAS48	1 x 48 x 19.2	92.5	10	1	\$945	\$1180
TSAS42	1 x 42 x 19.2	92.5	10	1	\$825	\$1030
TSAS36	1 x 36 x 19.2	100	8	1	\$706	\$880
TSAS30	1 x 30 x 19.2	150	5	1	\$548	\$687

Factory installed tackboard for wall mount cabinets.

- Specify Black (E), Tungsten (K), or Designer White (DWT) accessory rail finish.

Required Specifications

Fabric
Metal finish*

TACKBOARDS FOR WALL MOUNT CABINETS

MODEL#	DIMENSIONS	FREIGHT CLASS	WT./LBS.	CUBIC FT.	GR. 1-3	GR. 4-5
	D x W x H					
TSPAS120H23	1 x 120 x 22.3	70	34	2	\$2554	\$3193
TSPAS114H23	1 x 114 x 22.3	70	32	2	\$2429	\$3038
TSPAS108H23	1 x 108 x 22.3	70	30	2	\$2297	\$2874
TSPAS102H23	1 x 102 x 22.3	85	24	2	\$2182	\$2731
TSPAS96H23	1 x 96 x 22.3	70	22	1	\$2051	\$2567
TSPAS90H23	1 x 90 x 22.3	70	20	1	\$1917	\$2399
TSPAS84H23	1 x 84 x 22.3	70	18	1	\$1791	\$2244
TSPAS78H23	1 x 78 x 22.3	70	17	1	\$1664	\$2081
TSPAS72H23	1 x 72 x 22.3	70	16	1	\$1539	\$1927
TSPAS66H23	1 x 66 x 22.3	85	14	1	\$1412	\$1769
TSPAS60H23	1 x 60 x 22.3	85	13	1	\$1279	\$1600
TSPAS54H23	1 x 54 x 22.3	85	13	1	\$1133	\$1417
TSPAS48H23	1 x 48 x 22.3	85	13	1	\$1027	\$1286
TSPAS42H23	1 x 42 x 22.3	85	13	1	\$901	\$1125
TSPAS36H23	1 x 36 x 22.3	100	8	1	\$640	\$803
TSPAS30H23	1 x 30 x 22.3	150	5	1	\$624	\$777

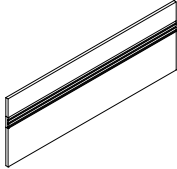

Tackboard w/Rail for 72" H*
Pigeon-Hole Wall Mount Cabinets

Factory installed tackboard for wall mount cabinets.

- Specify Black (E), Tungsten (K), or Designer White (DWT) accessory rail finish.

TSAS120H26	1 x 120 x 26	70	34	2	\$2826	\$3533
TSAS114H26	1 x 114 x 26	70	32	2	\$2679	\$3351
TSAS108H26	1 x 108 x 26	70	30	2	\$2549	\$3187
TSAS102H26	1 x 102 x 26	85	24	2	\$2403	\$3005
TSAS96H26	1 x 96 x 26	92.5	22	2	\$2258	\$2826
TSAS90H26	1 x 90 x 26	92.5	20	2	\$2126	\$2660
TSAS84H26	1 x 84 x 26	100	18	2	\$1961	\$2451
TSAS78H26	1 x 78 x 26	100	17	2	\$1835	\$2295
TSAS72H26	1 x 72 x 26	70	16	1	\$1670	\$2090
TSAS66H26	1 x 66 x 26	85	14	1	\$1559	\$1945
TSAS60H26	1 x 60 x 26	85	13	1	\$1412	\$1769
TSAS54H26	1 x 54 x 26	85	13	1	\$1273	\$1590
TSAS48H26	1 x 48 x 26	85	13	1	\$1133	\$1417
TSAS42H26	1 x 42 x 26	85	13	1	\$996	\$1242
TSAS36H26	1 x 36 x 26	100	8	1	\$851	\$1067
TSAS30H26	1 x 30 x 26	150	5	1	\$711	\$892

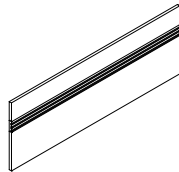

Tackboard w/Rail for 72" H*
Non-Pigeon-Hole Wall Mount Cabinets

Factory installed tackboard for wall mount cabinets.

- Specify Black (E), Tungsten (K), or Designer White (DWT) accessory rail finish.

TSP120H21	1 x 120 x 21	70	35	2	\$1656	\$1989
TSP114H21	1 x 114 x 21	70	32	2	\$1573	\$1890
TSP108H21	1 x 108 x 21	70	30	2	\$1489	\$1789
TSP102H21	1 x 102 x 21	85	24	2	\$1411	\$1694
TSP96H21	1 x 96 x 21	92.5	20	2	\$1322	\$1588
TSP90H21	1 x 90 x 21	70	1	1	\$1243	\$1493
TSP84H21	1 x 84 x 21	70	18	1	\$1162	\$1396
TSP78H21	1 x 78 x 21	70	17	1	\$1074	\$1291
TSP72H21	1 x 72 x 21	70	16	1	\$992	\$1193
TSP66H21	1 x 66 x 21	85	14	1	\$907	\$1091
TSP60H21	1 x 60 x 21	85	13	1	\$829	\$996
TSP54H21	1 x 54 x 21	85	13	1	\$747	\$898
TSP48H21	1 x 48 x 21	85	13	1	\$667	\$802
TSP42H21	1 x 42 x 21	125	6	1	\$582	\$701
TSP36H21	1 x 36 x 21	150	4	1	\$498	\$600
TSP30H21	1 x 30 x 21	250	3	1	\$417	\$502

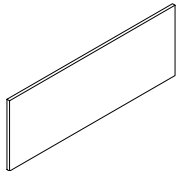

Tackboard for 84" H Double Height
Pigeon-Hole Wall Mount Cabinets

Factory installed tackboard for wall mount cabinets.

Required Specifications

- Fabric
- Metal finish*

TACKBOARDS

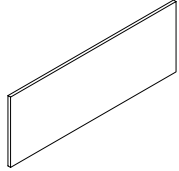

Tackboard for 84" H Double Height Non Pigeon-Hole Wall Mount Cabinets

MODEL#	DIMENSIONS D x W x H	FREIGHT CLASS	WT/LBS.	CUBIC FT.	GR. 3	GR. 4-5
TS120H25	1 x 120 x 25	85	27	2	\$1975	\$2371
TS114H25	1 x 114 x 25	85	25	2	\$1878	\$2256
TS108H25	1 x 108 x 25	92.5	23	2	\$1509	\$1884
TS102H25	1 x 102 x 25	100	19	2	\$1418	\$1776
TS96H25	1 x 96 x 25	70	17	1	\$1337	\$1668
TS90H25	1 x 90 x 25	70	15	1	\$1253	\$1569
TS84H25	1 x 84 x 25	85	14	1	\$1173	\$1468
TS78H25	1 x 78 x 25	85	13	1	\$1083	\$1355
TS72H25	1 x 72 x 25	85	12	1	\$1001	\$1256
TS66H25	1 x 66 x 25	92.5	11	1	\$920	\$1151
TS60H25	1 x 60 x 25	92.5	10	1	\$838	\$1051
TS54H25	1 x 54 x 25	92.5	10	1	\$889	\$1069
TS48H25	1 x 48 x 25	92.5	10	1	\$787	\$947
TS42H25	1 x 42 x 25	92.5	10	1	\$690	\$830
TS36H25	1 x 36 x 25	125	6	1	\$591	\$711
TS30H25	1 x 30 x 25	150	4	1	\$495	\$596

Factory installed tackboard for wall mount cabinets.

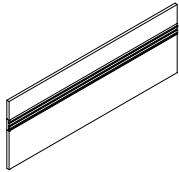

Tackboard w/Rail for 84" H Double Ht.* Pigeon-Hole Wall Mount Cabinets

TSPAS120H21	1 x 120 x 21	70	33	2	\$2912	\$3495
TSPAS114H21	1 x 114 x 21	70	32	2	\$2769	\$3325
TSPAS108H21	1 x 108 x 21	70	30	2	\$2622	\$3147
TSPAS102H21	1 x 102 x 21	85	24	2	\$2485	\$2984
TSPAS96H21	1 x 96 x 21	70	20	1	\$2329	\$2796
TSPAS90H21	1 x 90 x 21	70	20	1	\$2192	\$2632
TSPAS84H21	1 x 84 x 21	70	18	1	\$2043	\$2454
TSPAS78H21	1 x 78 x 21	70	17	1	\$1897	\$2278
TSPAS72H21	1 x 72 x 21	70	16	1	\$1748	\$2100
TSPAS66H21	1 x 66 x 21	85	14	1	\$1604	\$1926
TSPAS60H21	1 x 60 x 21	85	13	1	\$1457	\$1748
TSPAS54H21	1 x 54 x 21	85	13	1	\$1317	\$1583
TSPAS48H21	1 x 48 x 21	85	13	1	\$1172	\$1409
TSPAS42H21	1 x 42 x 21	85	13	1	\$1022	\$1228
TSPAS36H21	1 x 36 x 21	60	6	0.01	\$872	\$1047
TSPAS30H21	1 x 30 x 21	60	4	0.01	\$677	\$815

Factory installed tackboard for wall mount cabinets.

- Specify Black (E), Tungsten (K), or Designer White (DWT) accessory rail finish.

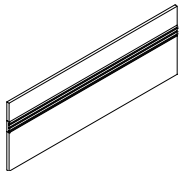

Tackboard w/Rail for 84" H Double Ht.* Non Pigeon-Hole Wall Mount Cabinets

TSAS120H25	1 x 120 x 25	85	27	2	\$3332	\$4000
TSAS114H25	1 x 114 x 25	85	25	2	\$3163	\$3797
TSAS108H25	1 x 108 x 25	92.5	23	2	\$2455	\$3070
TSAS102H25	1 x 102 x 25	100	19	2	\$2307	\$2887
TSAS96H25	1 x 96 x 25	70	17	1	\$2169	\$2716
TSAS90H25	1 x 90 x 25	70	15	1	\$2043	\$2557
TSAS84H25	1 x 84 x 25	85	14	1	\$1885	\$2357
TSAS78H25	1 x 78 x 25	85	13	1	\$1765	\$2209
TSAS72H25	1 x 72 x 25	85	12	1	\$1602	\$2006
TSAS66H25	1 x 66 x 25	92.5	11	1	\$1500	\$1880
TSAS60H25	1 x 60 x 25	92.5	10	1	\$1363	\$1706
TSAS54H25	1 x 54 x 25	92.5	10	1	\$1504	\$1807
TSAS48H25	1 x 48 x 25	92.5	10	1	\$1341	\$1610
TSAS42H25	1 x 42 x 25	92.5	10	1	\$1175	\$1412
TSAS36H25	1 x 36 x 25	60	6	0.01	\$1004	\$1207
TSAS30H25	1 x 30 x 25	60	4	0.01	\$838	\$1008

Factory installed tackboard for wall mount cabinets.

- Specify Black (E), Tungsten (K), or Designer White (DWT) accessory rail finish.

Required Specifications

Fabric
Metal finish*

ACCESSORIES

MODEL# DIMENSIONS FREIGHT CLASS WT/LBS. CUBIC FT. LIST PRICE

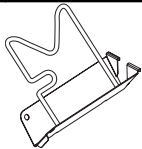

Flip Sorter

	D x W x H				
BAFS01	9.25 x 2.75 x 9.25	70	0.6	0.14	\$54

Load bar/accessory rail mounted metal flip sorter. Comes with chrome wire.
 • Specify Black (E), Tungsten (K), or Designer White (DWT) accessory finish.

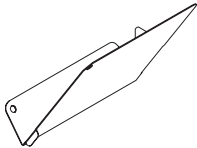

Slant Sorter

BASS01L (Left)	10.25 x 5 x 9.5	70	1	0.28	\$44
BASS01R (Right)	10.25 x 5 x 9.5	70	1	0.28	\$44

Load bar/accessory rail mounted metal slant sorter.
 • Specify Black (E), Tungsten (K), or Designer White (DWT) accessory finish.

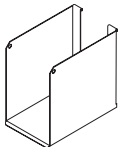

Binder Bin

BABB01	10.25 x 4 x 9	70	1.85	0.21	\$70
--------	---------------	----	------	------	------

Load bar/accessory rail mounted metal binder bin.
 • Specify Black (E), Tungsten (K), or Designer White (DWT) accessory finish.

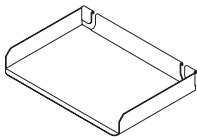

Letter Tray

BALTO1	9.25 x 13.5 x 2	70	0.5	0.15	\$58
--------	-----------------	----	-----	------	------

Load bar/accessory rail mounted metal letter tray.
 • Specify Black (E), Tungsten (K), or Designer White (DWT) accessory finish.

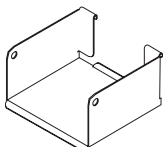

Media Bin

BAMB01	5.25 x 5.75 x 3	70	1.85	0.21	\$58
--------	-----------------	----	------	------	------

Load bar/accessory rail mounted metal media bin.
 • Specify Black (E), Tungsten (K), or Designer White (DWT) accessory finish.

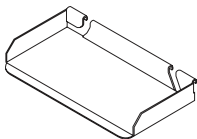

Utility Tray

BAUT01	3.75 x 5.75 x 3	70	0.5	0.02	\$38
--------	-----------------	----	-----	------	------

Load bar/accessory rail mounted metal utility tray.
 • Specify Black (E), Tungsten (K), or Designer White (DWT) accessory finish.

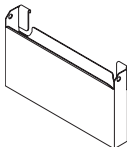

Mail Box

BAPP01	2.75 x 16 x 9	100	2	0.25	\$88
--------	---------------	-----	---	------	------

Load bar/accessory rail mounted metal mail box.
 • Specify Black (E), Tungsten (K), or Designer White (DWT) accessory finish.

Required Specifications

Fabric
 Metal finish*



ACCESSORIES

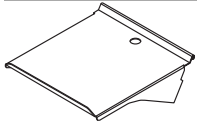

Telephone Holder

MODEL#	DIMENSIONS D x W x H	FREIGHT CLASS	WT./LBS.	CUBIC FT.	LIST PRICE
BATH01	10 x 9 x 2	125	2	0.26	\$85

Load bar/accessory rail mounted metal telephone holder.

- Specify Black (**E**), Tungsten (**K**), or Designer White (**DWT**) accessory finish.

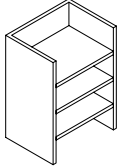

Paper Organizer, Letter & Legal Format

KCPH161226	12 x 16 x 27	125	20	3	\$981
KCPH161223	12 x 16 x 23	125	18	3	\$829
KCPH161219	12 x 16 x 20	125	15	2	\$632
KCPH131226	12 x 13 x 27	100	16	2	\$795
KCPH131223	12 x 13 x 23	125	15	2	\$675
KCPH131219	12 x 13 x 20	125	12	2	\$512

- Specify Black (**E**), Tungsten (**K**), or Designer White (**DWT**) accessory finish.

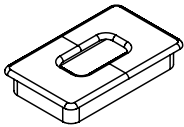

Grommet

GM5C	2 x 3.5 x --	70	--	--	\$107
------	--------------	----	----	----	--------------

Rectangular grommet in metal, tungsten finish.

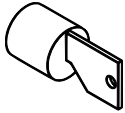

Lock Assembly

Black: LO	--	70	--	--	\$106
--------------	----	----	----	----	--------------

Tungsten: LO/C	--	70	--	--	\$106
-------------------	----	----	----	----	--------------

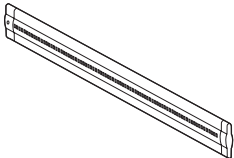

LED Task Light

PLED30	1.5 x 15.5 x .5	150	2	0.5	\$494
PLED50	1.5 x 23.5 x .5	150	2	0.5	\$569
PLED100	1.5 x 43.5 x .5	125	3	0.5	\$660

Energy efficient LED. Ultra slim design. Suitable for hanging under Hutch or Wallhung units. 6' power cord.

Required Specifications

Metal finish