



Kingston is a modern expression of old world craftsmanship. The classic proportion, attentive detailing, exquisite hand-matched veneers and solid wood edge details convey refined elegance with timeless beauty. Designed to highlight the warmth and majestic nature of real wood, Kingston offers an impressive array of storage components, fixed and freestanding worksurfaces that can be arranged to meet virtually any functional requirement.

Kingston detailing is contemporary with a 1" overhang on all edges. Solid walnut, cherry, maple, oak that bands worksurface perimeter is 1" wide by 1-3/8" thick for an overall thickness of 1-3/8". Kingston is a "top over pedestal" detailed series with a 1/4" reveal between the top and end panel. Tops have a 1" overhang. Floor storage unit bases are integrated in drawer faces. Products that are normally positioned against walls, such as credenzas, have a self-edge veneered back edge detail.

Features and Benefits

- Choice of 15 handle options for every door/drawer that features handles.
- Choice of six edge options
- Wide selection of storage components, fixed and freestanding worksurfaces.
- Sleek design



Interior veneer drawer edge

Edge options



K16



K18



K21



K22



K29



K30

GENERAL INFORMATION

- Distinguished by an elegant overhang detailed edge, Kingston pairs sleek European styling with functional design features that address the needs of today's dynamic and tech-savvy executive office.
- Kingston offers six distinctive edge shapes, as well as a multitude of drawer pull options.
- For environmental certification, please visit globalfurnituregroup.com

CONSTRUCTION

- Number One select, architectural grade "A" oak, American black walnut, American black cherry or maple. Wood worksurface molded edges are solid oak, walnut, cherry, or maple.
- Contemporary detailing with 1" overhang on all edges.
- Solid walnut, cherry, maple, oak that bands worksurface perimeter is 1" wide by 1-3/8" thick for an overall thickness of 1-3/8".

FINISHES

- Conversion varnish (similar to catalyzed lacquer, but tougher), 25 degree sheen. Finishes are not buffed or rubbed.
- All Global wood casegood products are veneered and finished on the back sides (360° finishing), except modular under-surface storage - tops and backs are unfinished.
- Touch up kits available, includes a touch up marker and fill crayon. Order **VTOUCHUPKIT, \$175** list. Specify finish when ordering.
- Global standard finish, on oak and walnut, is open pore and on cherry and maple is semi-closed pore. If a full finish is required for walnut, cherry, anigre and maple tops, Add the suffix "2" to the finish code and Add 5% to the base pricing for each product. **CUSTOM FINISH IS AVAILABLE.**

PEDESTALS

- Full-to-the-floor. Pedestals are fully assembled units that are either installed into desk and credenza shells, or available as modular units. Undersurface storage units include locks.
- Pedestal drawer suspensions are metal ball bearing type. Both box and file drawers are full extension.
- Hanging file rails are pre-installed on file drawer perimeters and accommodate both legal and letter size filing. Legal filing can be achieved either as side-to-side or front-to-back. Letter filing can be achieved as front-to-back filing only.
- Drawers are standard vinyl-wrapped construction with black drawer sides and bottom.
- The drawer front is an applied element to a four sided drawer. Drawer fronts are veneered on all surfaces except the vertical edges, which are solid oak, walnut, cherry and maple then routed with series detailing. Drawer fronts can be removed or replaced in the field.
- Levelers have 1" range of adjustment.

LOCKS

- Locks are standard on all below worksurface level drawer and door storage units, with the exception of pull-out tray units and single lateral file drawer combination tray/slot units.
- Combination storage unit comes with lock for file and lateral file drawer only; box drawers cannot lock.
- Lock color will match the handle option.
- Locks are optional on all above worksurface level closed storage.
- For optional lock, specify **LO. Add \$143** per lock.

HANDLES

- If no handle is specified, there will be a routed finger pull in drawer fronts and touch latch mechanism for doors.
- See next page for options.

1. SPECIFY MODEL NUMBER

2. SPECIFY FINISH

WORKSURFACE TOP & DRAWER/DOOR FRONTS, BODY FINISHES (INCLUDING PEDESTALS) - VENEER

Code	Finish	Veneer Type	Cut
AMW	Almond Cherry	Cherry	Flat Sliced
ACW	Amber Cherry	Cherry	Flat Sliced
BTW	Biscotti	White Oak	Rift
CAW	Cocoa Walnut	Walnut	Flat Sliced
CRW	Coral	White Oak	Rift
DCW	Dark Cherry	Cherry	Flat Sliced
DWW	Dark Walnut	Walnut	Flat Sliced
EWV	Espresso Walnut	Walnut	Flat Sliced
EVW	Evening Oak	White Oak	Rift
GRW	Grey on Oak	White Oak	Rift
HAW	Hazelnut	Maple	Flat Sliced
JAW	Java	White Oak	Rift
LTW	Latte Walnut	Walnut	Flat Sliced
MHW	Mahogany on Walnut	Walnut	Flat Sliced
MTW	Milestone	White Oak	Rift
MPW	Natural Maple	Maple	Flat Sliced
NLW	Natural Walnut	Walnut	Flat Sliced
RCW	Red Cherry	Cherry	Flat Sliced
VNW	Vintage Cherry	Cherry	Flat Sliced
ULW	Umber Walnut	Walnut	Flat Sliced
WLW	Walnut	Walnut	Flat Sliced
WCW	Warm Cherry	Cherry	Flat Sliced
WMW	White Maple	Maple	Flat Sliced

METAL FINISHES (see model # notes for available finish):

E	Black
K	Tungsten
DWT	Designer White
P	Brushed Chrome

GLASS FINISHES (for Glass Doors and Modesty Panels):

- Frosted Glass (standard)
- White back painted glass - contact customer care

3. SPECIFY OPTIONS

EDGES

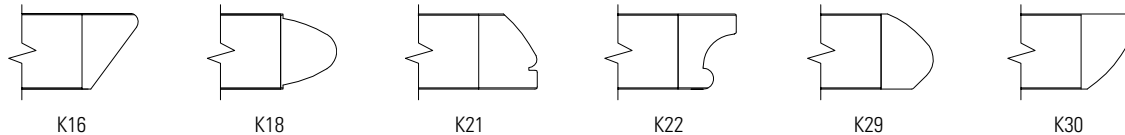

HANDLES

- If Handle is not specified Routed Pull, Black Lock & Grommet are standard
- If Handle is specified:
 - Black and Brass handle = Black Lock & Grommet
 - Silver, Nickel and Tungsten handle = Tungsten Lock & Grommet
- Handles are standard on most drawers/storage modules. Each handle is identified by letters: **PL33, PL34, PL64, PL66, PL92, PL93, PL94, PL95, PL96, PL97, PL98, PL99, PLS7, and PLS8**. To specify a handle, specify the code after the model number and finish selections.



PL33 Black Moon Pull, 4"



PL34 Nickel Moon Pull, 4"



PL64 Contemporary Nickel 5-3/8"



PL66 Transitional Nickel, 6-3/4"



PL92 Silver Bar, 5-3/8"



PL93 Black Bar, 5-3/8"



PL94 Silver Rectangular, 5-3/8"



PL95 Black Rectangular, 5-3/8"



PL96 Silver Slimline Pull, 5-3/8"



PL97 Black Slimline Pull, 5-3/8"



PL98 Silver Princeton Bar, 5-3/8"



PL99 Black Princeton Bar, 5-3/8"



PLS7 Black Spaghetti, 7-3/8"



PLS8 Silver Spaghetti, 7-3/8"

GROMMETS

- Standard grommet on all components is **GM5**. Grommet is included with products where shown in line drawings in price book.
- Optional grommets may be ordered in standard worksurface locations (left, center or right). Order as **GM5TL, GM5TC or GM5TR**. Add \$103.
- Grommet hole dimensions are 3.5" x 2". Specify **GM5E** for Black or **GM5K** for Tungsten.
- To order a grommet cover only, Add \$61.
- Components that come standard with grommet may be ordered without a grommet. Order as RSG - Add \$57.

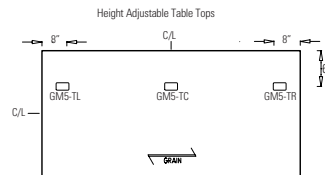
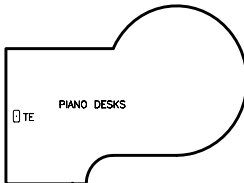
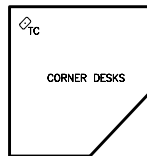
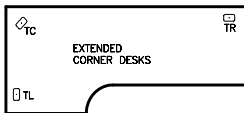
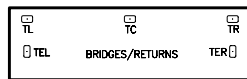
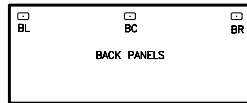
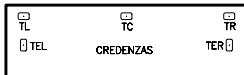
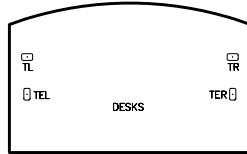
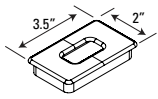

K KINGSTON - EDGE DETAILS

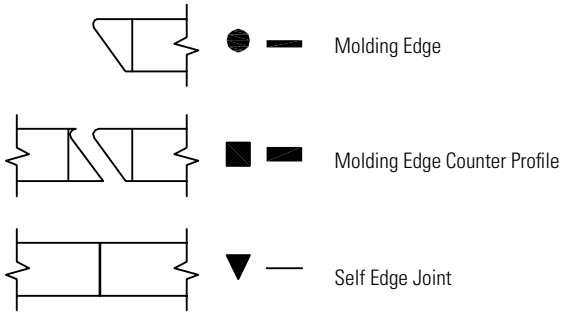

- D** - Desks and Credenzas
- B** - Executive Bridges
- E** - Executive Returns
- C** - Corner Components
- L** - Linking Bridges
- P** - Piano Desks

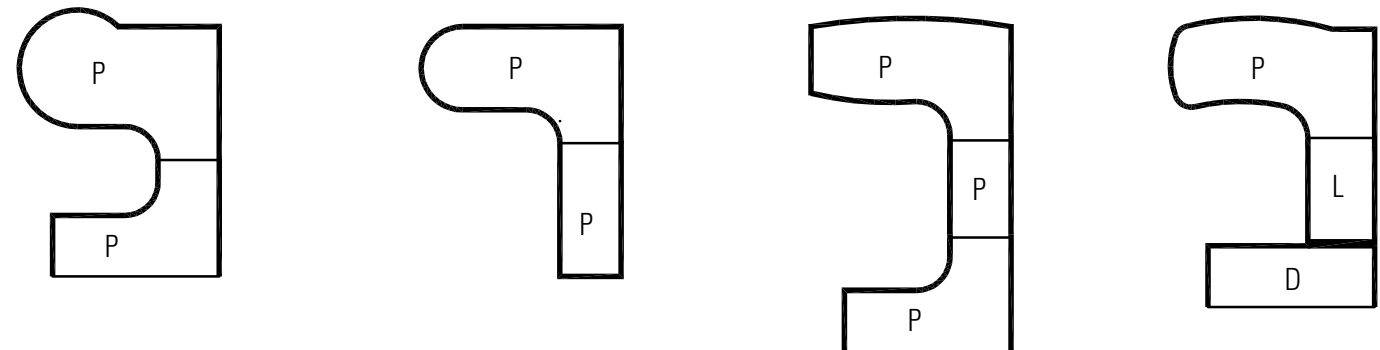
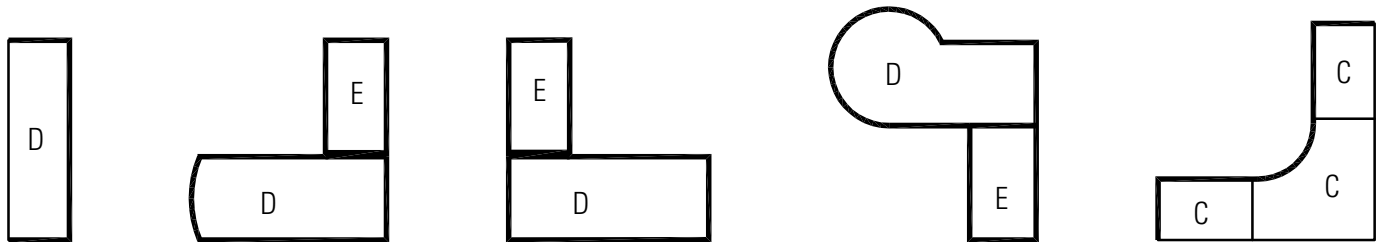
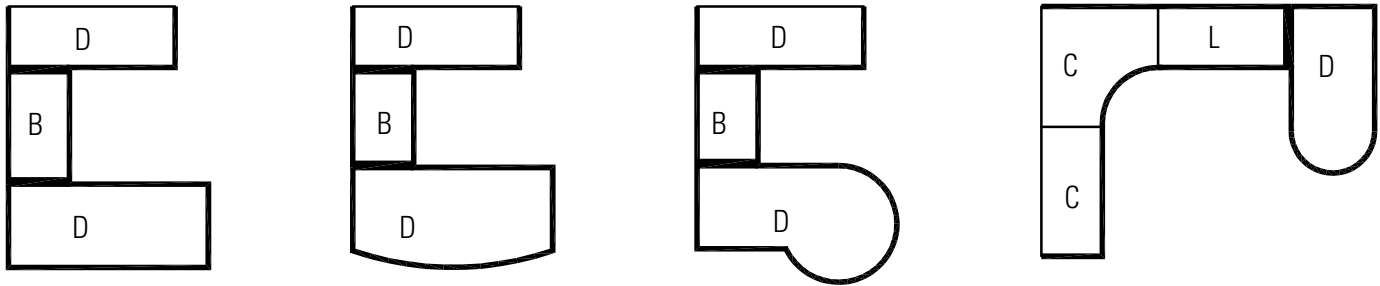
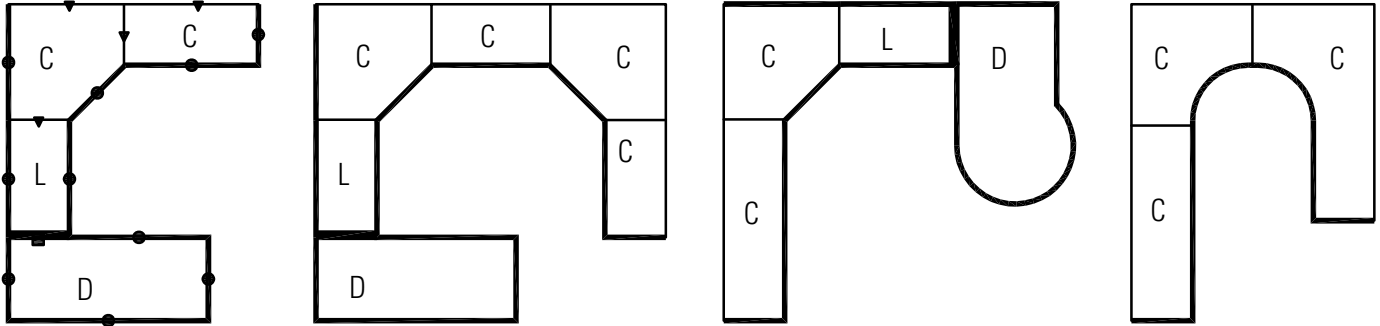

DESK AND CREDENZA NOTES

- Can be ordered as a shell or with pedestals
- Hand of Rectangular Desk is determined by location of pedestal from user side
- Hand of "D" Top is determined by outward orientation of curved end from user projection.
- Hand of "P" Top is determined by outward orientation of conference end from user projection.

Isometric View

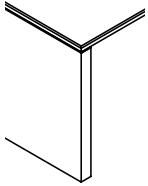

Side View
1-3/8" Top

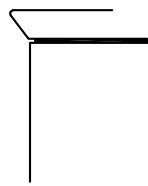

Front View
1-3/16" Slab

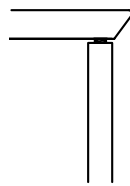

KT6030

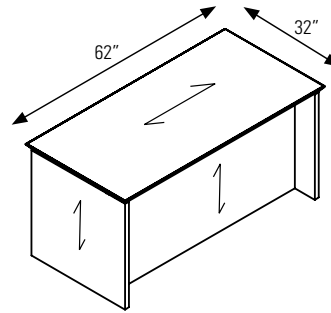

MODESTY PANEL CLEARANCE

KT7236

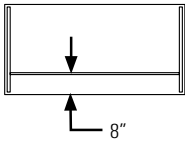

KMT7242

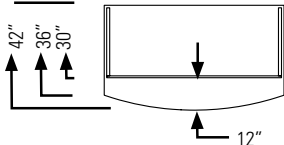

KiSR7230D

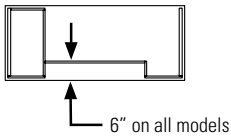

KDDCL7236

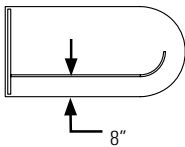

KT7236



Full Back Panel

KT7230

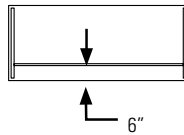

KMT7236

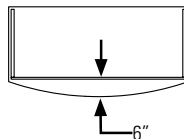

KDDF7230

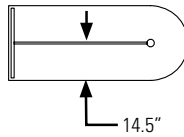

KDDCL7230

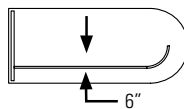

KTPL7242

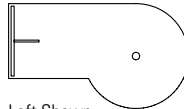

Left Shown

Field "punch out" to accommodate center drawer and keyboard

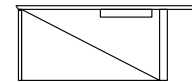

MODESTY PANEL OPTIONS

Standard Full Modesty

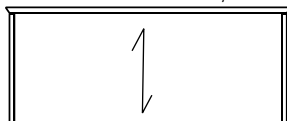

Glass Modesty

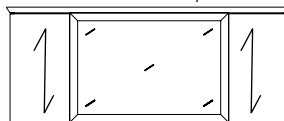

Breakfront

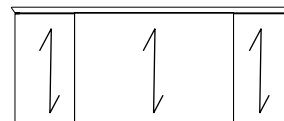

PIANO DESKS AND LINKING RETURNS

- All Desks are shipped assembled.
- Units include standard Grommets shown and installed horizontal wire management
- Unit is handed by Post Leg
- Not for use with regular Corner Units
- The standard grain direction is cross grain (**CG**). To remove cross grain veneer pattern on top, delete suffix "**CG**" from the model number (no upcharge)

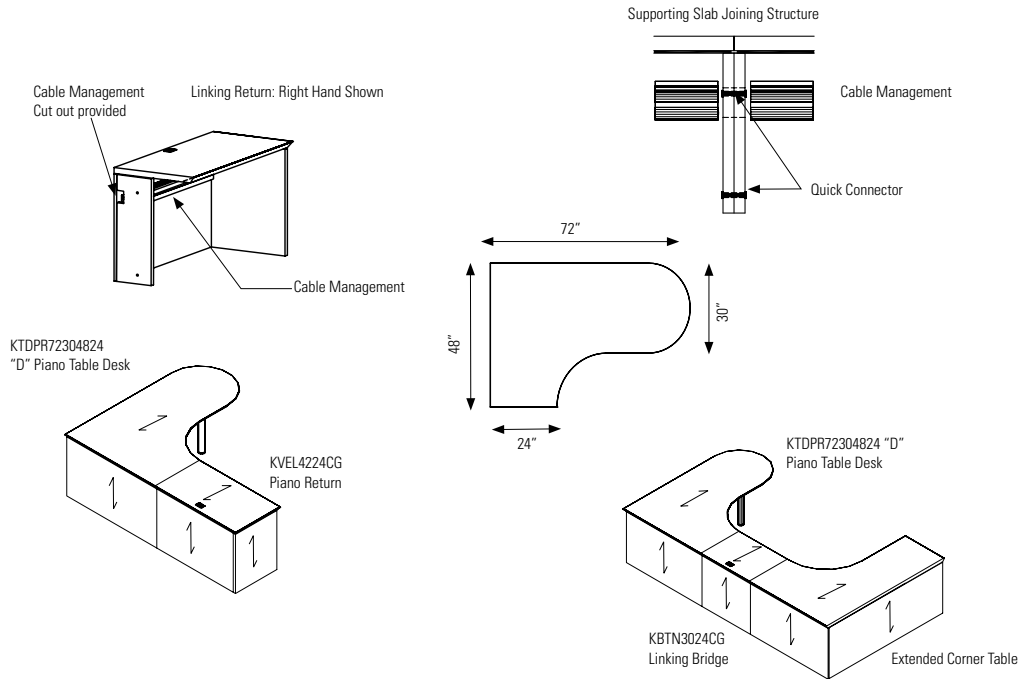

EXECUTIVE BRIDGES

- Executive Bridge is used to connect a Desk to a Credenza.
- Not to be used with Corner Components or Piano Desks.
- Three Back Panel options
- Back panel flush with end panels of Desk and Credenza
- Includes GM5 Grommet Top Center
- The standard grain direction is cross grain (**CG**). To remove cross grain veneer pattern on top, delete suffix "**CG**" from the model number (no upcharge)

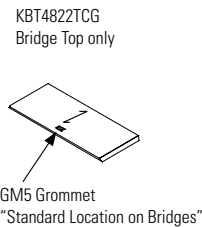
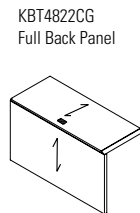
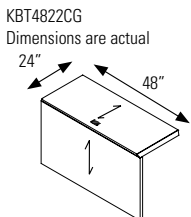
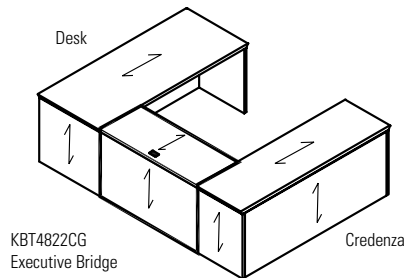

EXECUTIVE RETURNS

- Executive Return is used to attach to a Single Pedestal Desk, Single Pedestal Credenza, Desk Shell or Credenza Shell.
- Can be specified as a Shell or with a Pedestal.
- Back Panels are available as either full height or 8" from the underside of the worksurface.
- Hand of Executive Return is determined by location of full end panel from user side.
- Hand of Desk or Credenza is determined by location of pedestal from user side.
- The standard grain direction on return tops is cross grain (**CG**). To remove cross grain veneer pattern on top, delete suffix "**CG**" from the model number (no upcharge)

Executive Return attached to Desk or Credenza

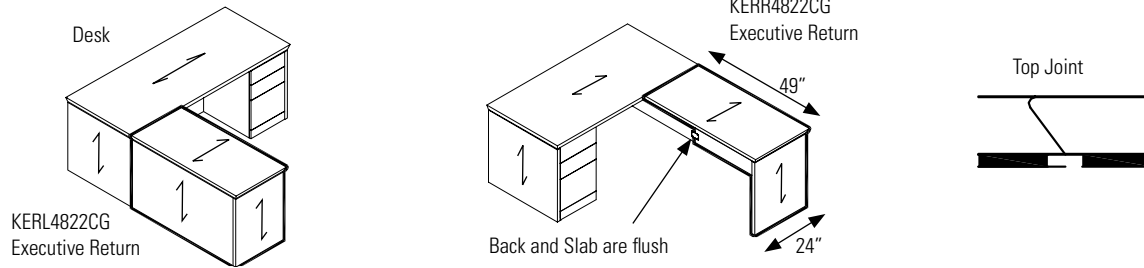

CORNER COMPONENTS

- Corner Table is used to connect to Linking Bridge and Linking Credenza.
- Cable management tray included.
- Back Panels are available as either full height or 8" from the underside of the worksurface.
- Hand of Linking Credenza is determined by location of full end panel from user side.
- Hand of Extended Corner is determined by location of long narrow end from user side
- The standard grain direction is cross grain (**CG**). To remove cross grain veneer pattern on top, delete suffix "**CG**" from the model number (no upcharge)

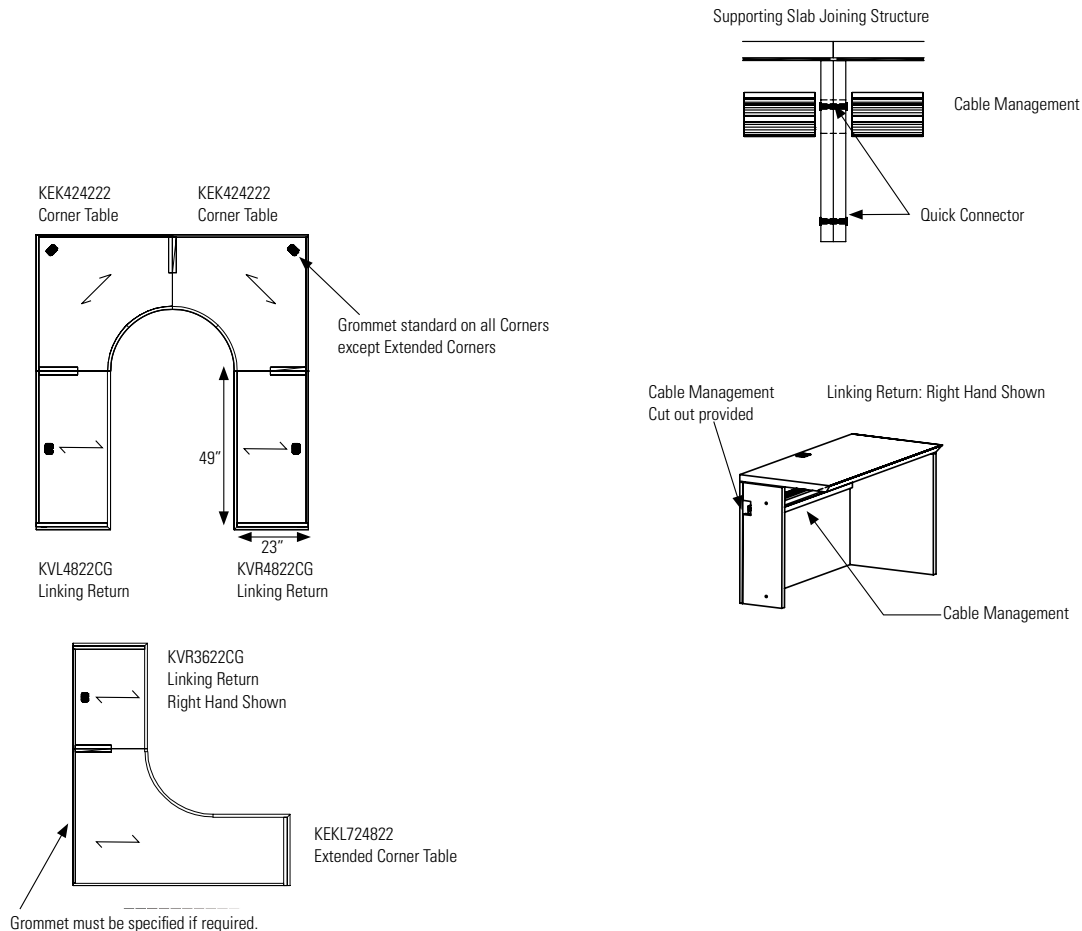

LINKING BRIDGES

- Linking Bridge is used to connect Corner Components to Single Pedestal Desk, Single Pedestal Credenza, Desk Shell or Credenza Shell.
- Back panels are available as either full height or 8" from the underside of the worksurface.
- Includes GM5 Grommet Top Center
- Hand of Linking Bridge is determined by location of half end panel from user side
- The standard grain direction is cross grain (**CG**). To remove cross grain veneer pattern on top, delete suffix "**CG**" from the model number (no upcharge)

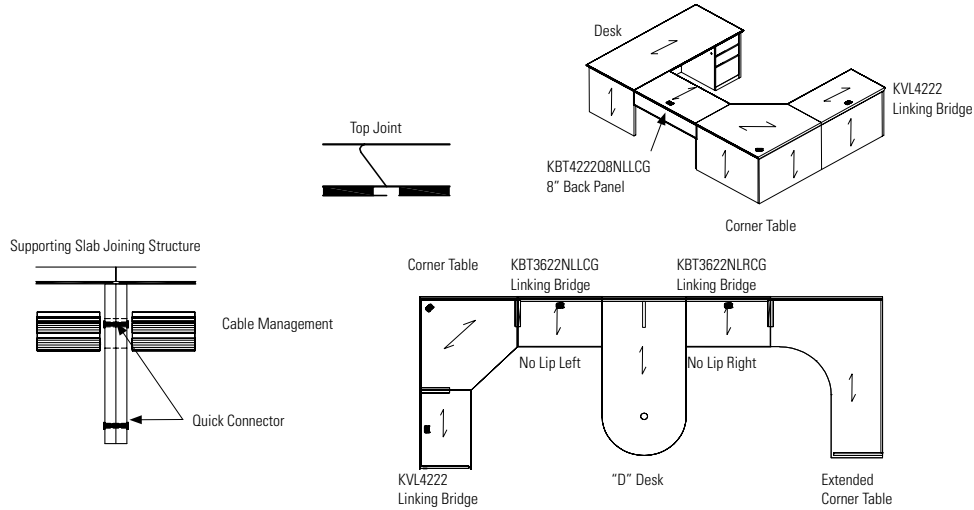

MODULAR PEDESTALS AND HANDLES

- Modular Pedestal for Kingston.
- Credenza Shells can only be completely filled with modular components that end in ".5" to create a full storage credenza.

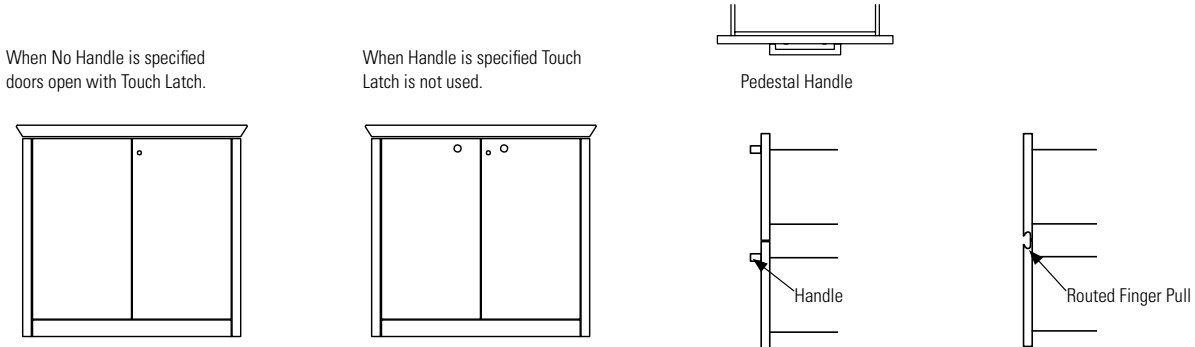

COPING AND SELF-EDGE OPTIONS

- Coping option provides an undercut on hutches only so that storage cabinets placed next to the hutch fit flush.
 - Specify **COP** for coping on both sides, **COPR** for coping on the right side and **COPL** for coping on the left side. No upcharge.
- Self edge options provide a flush fit when storage units are placed next to one another.
 - Specify **SE** for self-edge on both sides, **SER** for self-edge on the right side and **SEL** for self-edge on the left side. No upcharge.
 - Coping and self-edge handedness are from the users perspective. See diagram below.

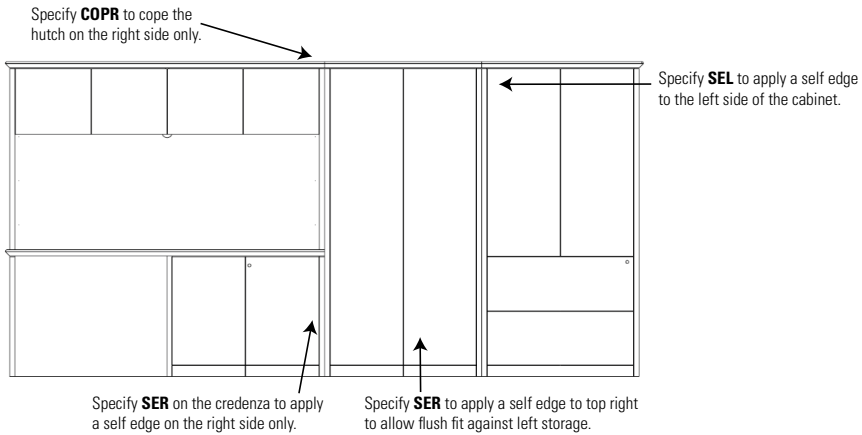

LOCKING

- Locks are standard on all below worksurface level drawer and door storage units with the exception of the pull-out tray units and single lateral file drawer combination tray/slot units.
- Locks are optional on all above worksurface level closed storage units. See Accessories Section (page 270) for lock specification details.

Standard Lock Positions

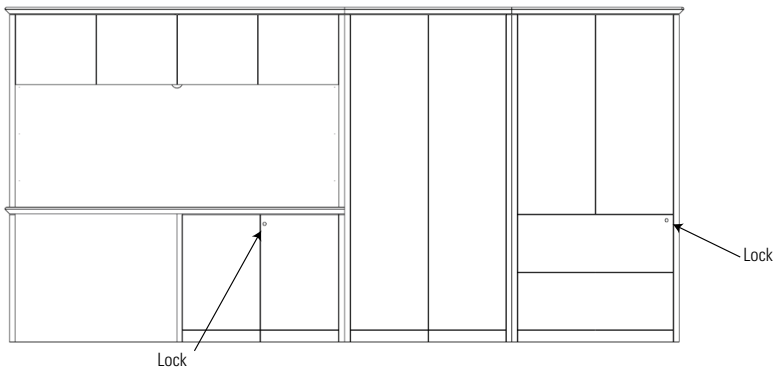

KZR
Combination Storage Unit:
Lock for File and Lateral File Drawer only,
Box Drawers do not lock.

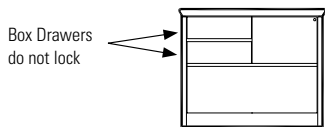

KD7236DE
Double Pedestal Desk/Credenza:
Lock for D and E Pedestals are on the inside Gable.

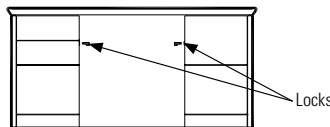

KCF7222
Full Storage Credenza: Locks are on the front.

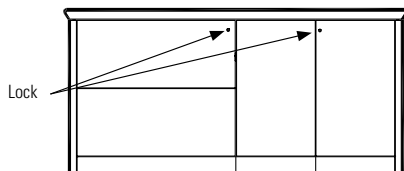

KWD
Modular Furniture:
Lock is on the front.

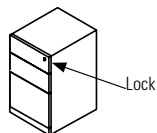

KWF
Modular Furniture:
Lock is on the front.

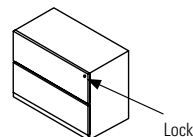

HUTCH POSITIONING

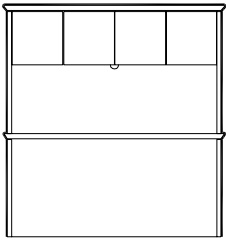

There must be an end panel under the hutch

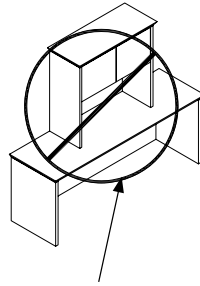
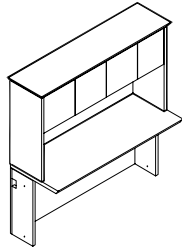

Missing Support
NOT Recommended

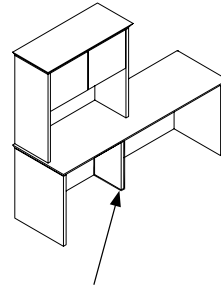

Add optional Support
SLAB12 (as Special)

TACKBOARDS

Tackboards for Storage Hutches

K72SH36

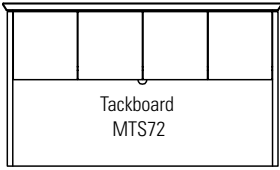

K72SHP42 and K72SHP42

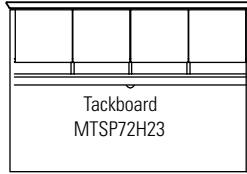

K72SH42 and K722SH54

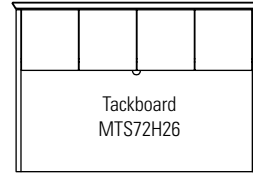

Tackboards with Accessory Rail

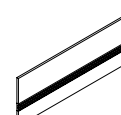
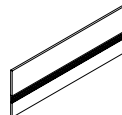
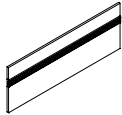

Tackboards for Wall Mount Overheads

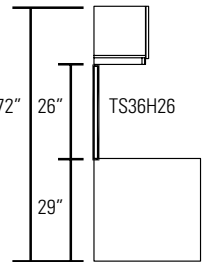
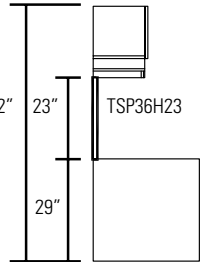
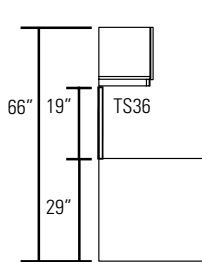

LIGHTING

For hutches and wall mount overheads

Wall Mount

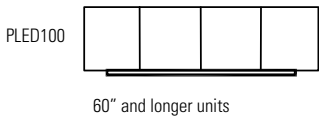
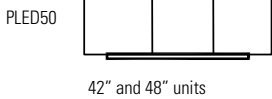
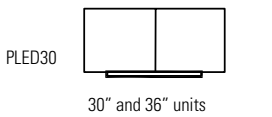

Hutch

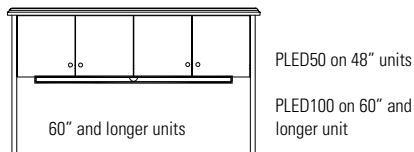
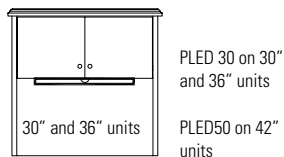

DESKS - NOTES

D x W x H

NOTE: Arrow indicates direction of grain

- All desks are shipped assembled
- Kneewell locking standard
- Desks available with a variety of modesty options: flush, breakfront, recessed and glass
- If Handle is not specified Routed Pull, Black Lock & Grommet are standard
- If Handle is specified:
 - Black and Brass handle = Black Lock & Grommet
 - Silver, Nickel and Tungsten handle = Tungsten Lock & Grommet
- Grommets are available as an option on Desks and most Credenzas.
- Edge options - must specify:

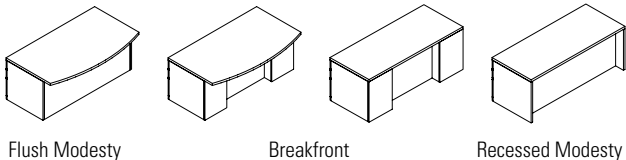
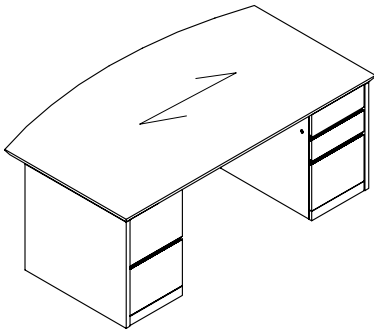
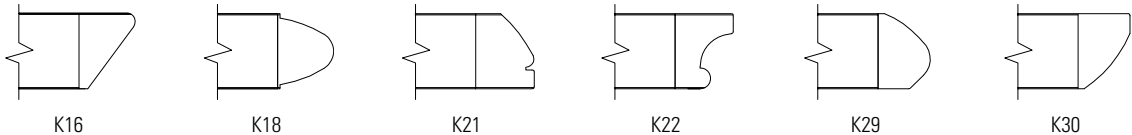

DOUBLE PEDESTAL DESKS

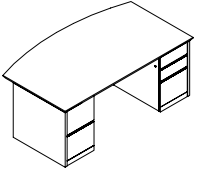

Double Pedestal Bow Top Desk

MODEL#	DIMENSIONS D x W x H	FREIGHT CLASS	WT/LBS.	CUBIC FT.	LIST PRICE
KMD8442ED	44 x 86 x 29	125	407	59	\$10778
KMD7842ED	44 x 80 x 29	125	392	55	\$10009
KMD7242ED	44 x 74 x 29	125	377	51	\$9236
KMD6636ED	38 x 68 x 29	100	340	40	\$8959

Standard with full to floor **file/file** pedestal on **left** and **box/box/file** pedestal on **right**. Pedestals lock.
Full Height Modesty Panel.

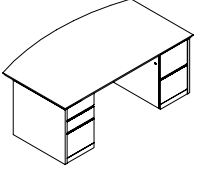

Double Pedestal Bow Top Desk

KMD8442DE	44 x 86 x 29	125	407	59	\$10778
KMD7842DE	44 x 80 x 29	125	392	55	\$10009
KMD7242DE	44 x 74 x 29	125	377	51	\$9236
KMD6636DE	38 x 68 x 29	100	340	40	\$8959

Standard with full to floor **file/file** pedestal on **right** and **box/box/file** pedestal on **left**. Pedestals lock.
Full Height Modesty Panel.

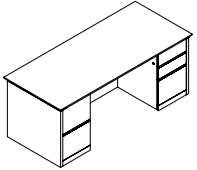

Double Pedestal Desk

KD8442ED	44 x 86 x 29	125	442	59	\$9164
KD7842ED	44 x 80 x 29	125	421	55	\$8512
KD7236ED	38 x 74 x 29	100	375	44	\$7858
KD7230ED	32 x 74 x 29	100	345	36	\$7739
KD6636ED	38 x 68 x 29	100	360	40	\$7739
KD6630ED	32 x 68 x 29	92.5	330	33	\$7614
KD6030ED	32 x 62 x 29	92.5	315	30	\$7376

Standard with full to floor **file/file** pedestal on **left** and **box/box/file** pedestal on **right**. Pedestals lock.
Full height modesty panel.

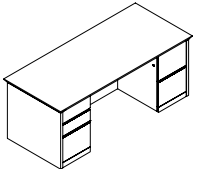

Double Pedestal Desk

KD8442DE	44 x 86 x 29	125	442	59	\$9164
KD7842DE	44 x 80 x 29	125	421	55	\$8512
KD7236DE	38 x 74 x 29	100	375	44	\$7858
KD7230DE	32 x 74 x 29	100	345	36	\$7739
KD6636DE	38 x 68 x 29	100	360	40	\$7739
KD6630DE	32 x 68 x 29	92.5	330	33	\$7614
KD6030DE	32 x 62 x 29	92.5	315	30	\$7376

Standard with full to floor **file/file** pedestal on **right** and **box/box/file** pedestal on **left**. Pedestals lock.
Full height modesty panel.

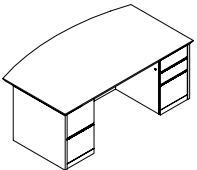

**Double Pedestal Bow Top Desk*
Breakfront Style**

KMID8442ED	44 x 86 x 29	125	407	59	\$11853
KMID7842ED	44 x 80 x 29	125	392	55	\$11008
KMID7242ED	44 x 74 x 29	125	377	51	\$10165
KMID6636ED	38 x 68 x 29	100	345	40	\$9852

Standard with full to floor **file/file** pedestal on **left** and **box/box/file** pedestal on **right**. Pedestals lock.
Inset Full Height Modesty Panel.

- For Aluminum Framed Glass Modesty option on Breakfront Style add "G" to the end of the product code. Add **\$1892**.

Required Specifications

Finish
Edge

Optional Specifications

Handles
Additional grommet
Glass modesty panel*

DESKS

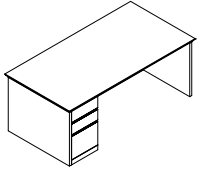

Single Pedestal Desk

MODEL#	DIMENSIONS D x W x H	FREIGHT CLASS	WT./LBS.	CUBIC FT.	LIST PRICE
KSL8442D	44 x 86 x 29	125	387	59	\$8031
KSL7842D	44 x 80 x 29	125	366	55	\$7565
KSL7236D	38 x 74 x 29	125	320	44	\$5993
KSL7230D	32 x 74 x 29	100	290	36	\$5724
KSL6636D	38 x 68 x 29	125	305	40	\$5724
KSL6630D	32 x 68 x 29	100	275	33	\$5463
KSL6030D	32 x 62 x 29	100	260	30	\$5222

Standard with full to floor **box/box/file** pedestal on **left**. Pedestals lock.
Full Height Modesty Panel.

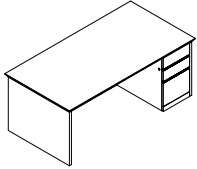

Single Pedestal Desk

KSR8442D	44 x 86 x 29	125	387	59	\$8031
KSR7842D	44 x 80 x 29	125	366	55	\$7565
KSR7236D	38 x 74 x 29	125	320	44	\$5993
KSR7230D	32 x 74 x 29	100	290	36	\$5724
KSR6636D	38 x 68 x 29	125	305	40	\$5724
KSR6630D	32 x 68 x 29	100	275	33	\$5463
KSR6030D	32 x 62 x 29	100	260	30	\$5222

Standard with full to floor **box/box/file** pedestal on **right**. Pedestals lock.
Full Height Modesty Panel.

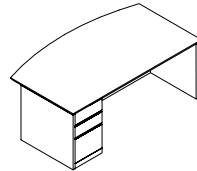

**Single Pedestal Desk - Left*
Breakfront Style**

KMISL8442D	44 x 86 x 29	125	452	59	\$9393
KMISL7842D	44 x 80 x 29	125	337	55	\$8723
KMISL7242D	44 x 74 x 29	125	322	51	\$8055
KMISL6636D	38 x 68 x 29	125	290	40	\$7746

Standard with full to floor **box/box/file** pedestal on **left**. Pedestals lock.
Inset Full Height Modesty Panel.

- For Aluminum Framed Glass Modesty option on Breakfront Style add "G" to the end of the product code. Add **\$1892**.

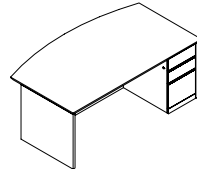

**Single Pedestal Desk - Right*
Breakfront Style**

KMISR8442D	44 x 86 x 29	125	452	59	\$9393
KMISR7842D	44 x 80 x 29	125	337	55	\$8723
KMISR7242D	44 x 74 x 29	125	322	51	\$8055
KMISR6636D	38 x 68 x 29	125	290	40	\$7746

Standard with full to floor **box/box/file** pedestal on **right**. Pedestals lock.
Inset Full Height Modesty Panel.

- For Aluminum Framed Glass Modesty option on Breakfront Style add "G" to the end of the product code. Add **\$1892**.

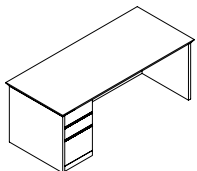

**Single Pedestal Desk - Left*
Breakfront Style**

KISL8442D	44 x 86 x 29	125	387	59	\$8969
KISL7842D	44 x 80 x 29	125	366	55	\$8329
KISL7236D	38 x 74 x 29	125	320	44	\$6590
KISL7230D	32 x 74 x 29	100	290	36	\$6296
KISL6636D	38 x 68 x 29	125	305	40	\$6296
KISL6630D	32 x 68 x 29	100	275	33	\$6009
KISL6030D	32 x 62 x 29	100	260	30	\$5743

Standard with full to floor **box/box/file** pedestal on **left**. Pedestals lock.
Inset Full Height Modesty Panel.

- For Aluminum Framed Glass Modesty option on Breakfront Style add "G" to the end of the product code. Add **\$1892**.

Required Specifications

Finish
Edge

Optional Specifications

Handles
Additional grommet
Glass modesty panel*

DESKS

MODEL# DIMENSIONS FREIGHT CLASS WT/LBS. CUBIC FT. LIST PRICE

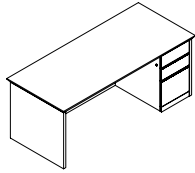

**Single Pedestal Desk - Right*
Breakfront Style**

	D x W x H				
KISR8442D	44 x 86 x 29	125	387	59	\$8969
KISR7842D	44 x 80 x 29	125	366	55	\$8329
KISR7236D	38 x 74 x 29	125	320	44	\$6590
KISR7230D	32 x 74 x 29	100	290	36	\$6296
KISR6636D	38 x 68 x 29	125	305	40	\$6296
KISR6630D	32 x 68 x 29	100	275	33	\$6009
KISR6030D	32 x 62 x 29	100	260	30	\$5743

Standard with full to floor **box/box/file** pedestal on **right**. Pedestals lock.
Inset Full Height Modesty Panel.

- For Aluminum Framed Glass Modesty option on Breakfront Style add "G" to the end of the product code. Add **\$1892**.

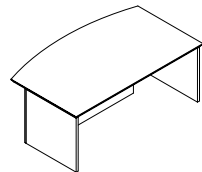

**Desk Shell, Bow Top
Breakfront Style**

KMIT8442	44 x 86 x 29	125	380	59	\$7247
KMIT7842	44 x 80 x 29	125	353	55	\$6775
KMIT7242	44 x 74 x 29	125	331	51	\$6308
KMIT6636	38 x 68 x 29	125	287	40	\$5985

Inset Full Height Modesty Panel.

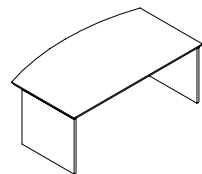

Desk Shell, Bow Top

KMT8442	44 x 86 x 29	150	297	59	\$6565
KMT7842	44 x 80 x 29	150	282	55	\$6092
KMT7242	44 x 74 x 29	150	267	51	\$5627
KMT6636	38 x 68 x 29	150	235	40	\$5304

Recessed Modesty Panel.

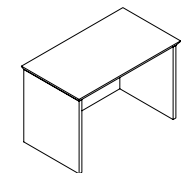

Desk Shell

KT8442	44 x 86 x 29	125	337	55	\$6103
KT7842	44 x 80 x 29	125	317	51	\$5667
KT8436	38 x 86 x 29	125	317	51	\$5233
KT7836	38 x 80 x 29	125	296	47	\$4861
KT7236	38 x 74 x 29	125	265	44	\$4491
KT7230	32 x 74 x 29	125	235	36	\$4225
KT6636	38 x 68 x 29	125	250	40	\$4225
KT6630	32 x 68 x 29	125	220	33	\$3970
KT6030	32 x 62 x 29	125	205	30	\$3629

Recessed Modesty Panel.

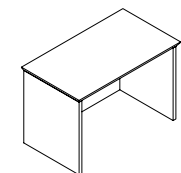

Desk Shell

KT4822	24 x 50 x 29	150	95	17	\$2599
KT4222	24 x 44 x 29	150	85	15	\$2177
KT3622	24 x 38 x 29	150	75	13	\$2101
KT3022	24 x 32 x 29	150	65	11	\$2059
KT4820	22 x 50 x 29	150	95	17	\$2367
KT4220	22 x 44 x 29	150	85	15	\$1979
KT3620	22 x 38 x 29	125	75	12	\$1912
KT3020	22 x 32 x 29	125	65	10	\$1875

Flush modesty panel.

Required Specifications

Finish
Edge

Optional Specifications

Handles
Additional grommet
Glass modesty panel*

DESKS

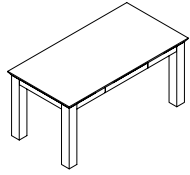
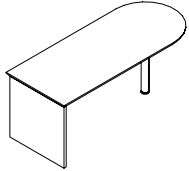

Table Desk*

MODEL#	DIMENSIONS D x W x H	FREIGHT CLASS	WT/LBS.	CUBIC FT.	LIST PRICE
KTB8442	44 x 86 x 29	150	272	59	\$11492
KTB7842	44 x 80 x 29	150	253	55	\$10673
KTB7236	38 x 74 x 29	150	205	44	\$8441
KTB7230	32 x 74 x 29	150	192	36	\$8288
KTB6636	38 x 68 x 29	150	192	40	\$8288
KTB6630	32 x 68 x 29	150	188	33	\$8126
KTB6030	32 x 62 x 29	150	171	30	\$7740

3" apron, center pencil drawer. 4" square legs.



"D" Shaped Connecting Table Desk*

KDD8436	36 x 84 x 29	125	343	51	\$5855
KDD7236	36 x 72 x 29	125	294	44	\$5015
KDD7230	30 x 72 x 29	125	264	36	\$4662
KDD6636	36 x 66 x 29	125	245	40	\$4662
KDD6030	30 x 60 x 29	125	225	30	\$4480

3" wood post and full end panel.

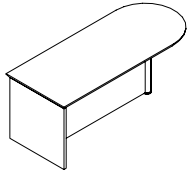

"D" Shaped Connecting Table Desk

KDDF8436	36 x 84 x 29	125	343	51	\$7190
KDDF7236	36 x 72 x 29	125	294	44	\$6171
KDDF7230	30 x 72 x 29	125	264	36	\$5811
KDDF6636	36 x 66 x 29	125	245	40	\$5811
KDDF6030	30 x 60 x 29	125	225	30	\$5629

3" wood post, full modesty panel, and full end panel.

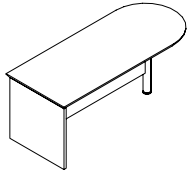

"D" Shaped Connecting Table Desk

KQDD8436	36 x 84 x 29	125	357	51	\$6753
KQDD7236	36 x 72 x 29	125	311	44	\$5785
KQDD7230	30 x 72 x 29	125	281	36	\$5431
KQDD6636	36 x 66 x 29	125	264	40	\$5431
KQDD6030	30 x 60 x 29	100	247	30	\$5251

3" wood post, 3/4 modesty panel, and full end panel.

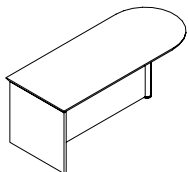

"D" Shaped Connecting Table Desk - Left

KDDCL8436	36 x 84 x 29	125	368	51	\$7645
KDDCL7236	36 x 72 x 29	125	320	44	\$6552
KDDCL7230	30 x 72 x 29	100	290	36	\$6193
KDDCL6636	36 x 66 x 29	125	270	40	\$6193
KDDCL6030	30 x 60 x 29	100	242	30	\$6016

Full height curved modesty panel, 3" wood post, and full end panel.

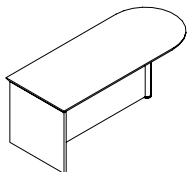

"D" Shaped Connecting Table Desk - Right

KDDCR8436	36 x 84 x 29	125	368	51	\$7645
KDDCR7236	36 x 72 x 29	125	320	44	\$6552
KDDCR7230	30 x 72 x 29	100	290	36	\$6193
KDDCR6636	36 x 66 x 29	125	270	40	\$6193
KDDCR6030	30 x 60 x 29	100	242	30	\$6016

Full height curved modesty panel, 3" wood post, and full end panel.

Required Specifications

Finish
Edge

Optional Specifications

Additional grommet
Base upgrade* (see accessories for options)

DESKS

MODEL# DIMENSIONS FREIGHT CLASS WT/LBS. CUBIC FT. LIST PRICE

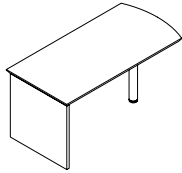

Connecting Bow End Table Desk*

D x W x H						
KDDBE8436	36 x 84 x 29	125	343	51		\$5855
KDDBE7236	36 x 72 x 29	125	294	44		\$5015
KDDBE7230	30 x 72 x 29	125	264	36		\$4662
KDDBE6636	36 x 66 x 29	125	245	40		\$4662
KDDBE6030	30 x 60 x 29	125	225	30		\$4480

3" wood post and full end panel.

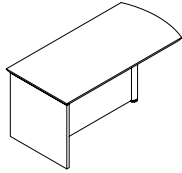

Connecting Bow End Table Desk

KDDBEF8436	36 x 84 x 29	125	368	51		\$7190
KDDBEF7236	36 x 72 x 29	125	320	44		\$6168
KDDBEF7230	30 x 72 x 29	100	290	36		\$5811
KDDBEF6636	36 x 66 x 29	125	271	40		\$5811
KDDBEF6030	30 x 60 x 29	100	247	30		\$5629

3" wood post, full modesty panel, and full end panel.

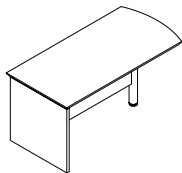

Connecting Bow End Table Desk

KQDDBE8436	36 x 84 x 29	125	357	51		\$6753
KQDDBE7236	36 x 72 x 29	125	311	44		\$5785
KQDDBE7230	30 x 72 x 29	125	281	36		\$5431
KQDDBE6636	36 x 66 x 29	125	264	40		\$5431
KQDDBE6030	30 x 60 x 29	100	247	30		\$5251

3" wood post, 3/4 modesty panel, and full end panel.

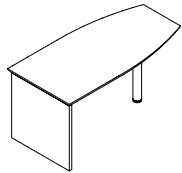

Connecting Boat Shaped Table Desk*

KDDBS8442	42 x 84 x 29	125	414	59		\$6930
KDDBS8436	36 x 84 x 29	125	343	51		\$5855
KDDBS7236	36 x 72 x 29	125	314	44		\$5015
KDDBS7230	30 x 72 x 29	125	284	36		\$4662
KDDBS6636	36 x 66 x 29	125	265	40		\$4662
KDDBS6030	30 x 60 x 29	100	245	30		\$4480

3" wood post and full end panel.

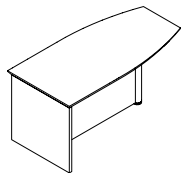

Connecting Boat Shaped Table Desk

KDDBSF8442	42 x 84 x 29	125	429	59		\$8392
KDDBSF8436	36 x 84 x 29	125	368	51		\$7190
KDDBSF7236	36 x 72 x 29	125	320	44		\$6168
KDDBSF7230	30 x 72 x 29	100	290	36		\$5811
KDDBSF6636	36 x 66 x 29	125	271	40		\$5811
KDDBSF6030	30 x 60 x 29	100	247	30		\$5629

3" wood post, full modesty panel, and full end panel.

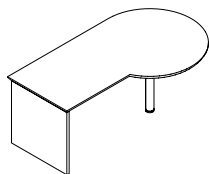

"P" Shaped Connecting Table - Left*

KTPL9642	42 x 96 x 29	125	440	68		\$7314
KTPL8442	42 x 84 x 29	125	385	59		\$6399
KTPL7242	42 x 72 x 29	125	319	51		\$5837

3" wood post and full end panel.

Required Specifications

Finish
Edge

Optional Specifications

Additional grommet
Base upgrade* (see accessories for options)

P-SHAPED CONNECTING TABLES

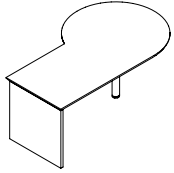

"P" Shaped Connecting Table - Right*

MODEL#	DIMENSIONS D x W x H	FREIGHT CLASS	WT/LBS.	CUBIC FT.	LIST PRICE
KTPR9642	42 x 96 x 29	125	440	68	\$7314
KTPR8442	42 x 84 x 29	125	385	59	\$6399
KTPR7242	42 x 72 x 29	125	319	51	\$5837

3" wood post and full end panel.

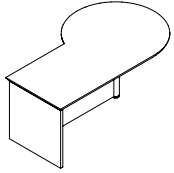

"P" Shaped Connecting Table - Left

KTPFL9642	42 x 96 x 29	150	317	68	\$8629
KTPFL8442	42 x 84 x 29	150	277	59	\$6657
KTPFL7242	42 x 72 x 29	150	211	51	\$6989

3" wood post, full height modesty panel, and full end panel.

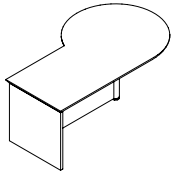

"P" Shaped Connecting Table - Right

KTPFR9642	42 x 96 x 29	150	317	68	\$8629
KTPFR8442	42 x 84 x 29	150	277	59	\$6657
KTPFR7242	42 x 72 x 29	150	211	51	\$6989

3" wood post, full height modesty panel, and full end panel.

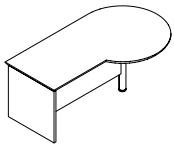

"P" Shaped Connecting Table - Left

KQTPL9642	42 x 96 x 29	150	291	68	\$8191
KQTPL8442	42 x 84 x 29	150	255	59	\$7168
KQTPL7242	42 x 72 x 29	250	189	51	\$6601

3" wood post, 3/4 height modesty panel, and full end panel.

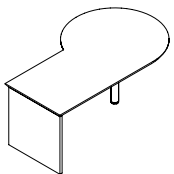

"P" Shaped Connecting Table - Right

KQTPR9642	42 x 96 x 29	150	291	68	\$8191
KQTPR8442	42 x 84 x 29	150	255	59	\$7168
KQTPR7242	42 x 72 x 29	250	189	51	\$6601

3" wood post, 3/4 height modesty panel, and full end panel.

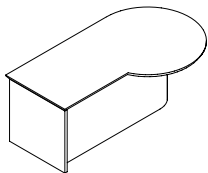

"P" Shaped Connecting Table - Left

KTPCL9642	42 x 96 x 29	150	317	68	\$9063
KTPCL8442	42 x 84 x 29	150	277	59	\$7936
KTPCL7242	42 x 72 x 29	150	211	51	\$7020

3" wood post, curved modesty panel, and full end panel.

Required Specifications

Finish
Edge

Optional Specifications

Additional grommet
Base upgrade* (see accessories for options)

P-SHAPED CONNECTING TABLES

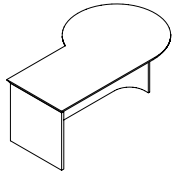

"P" Shaped Connecting Table - Right

MODEL#	DIMENSIONS	FREIGHT CLASS	WT/LBS.	CUBIC FT.	LIST PRICE
--------	------------	---------------	---------	-----------	------------

D x W x H					
KTPCR9642	42 x 96 x 29	150	317	68	\$9063
KTPCR8442	42 x 84 x 29	150	277	59	\$7936
KTPCR7242	42 x 72 x 29	150	211	51	\$7020

3" wood post, curved modesty panel, and full end panel.

HEIGHT ADJUSTABLE TOPS

HEIGHT ADJUSTABLE TOPS

MODEL#	DIMENSIONS	FREIGHT CLASS	WT/LBS.	CUBIC FT.	LIST PRICE
--------	------------	---------------	---------	-----------	------------

KRE8224T	24 x 82 x 1.18	92.5	85	7.7	\$2749
KRE8024T	24 x 80 x 1.18	92.5	84	7.5	\$2680
KRE7624T	24 x 76 x 1.18	92.5	80	7	\$2550
KRE6424T	24 x 64 x 1.18	92.5	69	6	\$2148
KRE5224T	24 x 52 x 1.18	92.5	58	5	\$1744
KRE4624T	24 x 46 x 1.18	92.5	53	4.5	\$1539
KRE4024T	24 x 40 x 1.18	100	37	4	\$1346
KRE8229T	29 x 82 x 1.18	92.5	101	9	\$3061
KRE7629T	29 x 76 x 1.18	92.5	99	8.5	\$2841
KRE7029T	29 x 70 x 1.18	92.5	94	8	\$2615
KRE6429T	29 x 64 x 1.18	92.5	81	7	\$2395
KRE5229T	29 x 52 x 1.18	92.5	68	6	\$1943
KRE4629T	29 x 46 x 1.18	85	61	5	\$1723
KRE4029T	29 x 40 x 1.18	85	55	4.5	\$1497
KRE8235T	35 x 82 x 1.18	92.5	120	10.5	\$3701
KRE7635T	35 x 76 x 1.18	92.5	117	10	\$3428
KRE7235T	35 x 72 x 1.18	300	12	9.5	\$3250
KRE6435T	35 x 64 x 1.18	92.5	96	9	\$2890
KRE5235T	35 x 52 x 1.18	85	80	6.5	\$2347
KRE4635T	35 x 46 x 1.18	85	72	6	\$2072
KRE4035T	35 x 40 x 1.18	85	64	5	\$1808

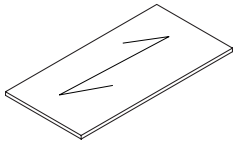

Height Adjustable Top

Kingston tops with Kingston edge on three sides, for use with FreeFit height adjustable table mechanisms, sold separately (FTxxxxx, see page 713 of the Desking price list for information).

- 26" deep tops accommodate FTxxxx24 mechanisms. Depth is exact to accommodate the Kingston edge + the Freefit mechanism. *Cannot be made smaller.*
- 29" and 35" deep tops accommodate FTxxxx30 mechanisms.



HA Return Tops

Left:

KRE6024CGCOPLT	24 x 60 x 1.18	92.5	65	5.5	\$2012
KRE5424CGCOPLT	24 x 54 x 1.18	85	60	5	\$1814
KRE4824CGCOPLT	24 x 48 x 1.18	85	54	4.5	\$1610
KRE4224CGCOPLT	24 x 42 x 1.18	85	49	4	\$1405

Right:

KRE6024CGCOPRT	24 x 60 x 1.18	92.5	65	5.5	\$2012
KRE5424CGCOPRT	24 x 54 x 1.18	85	60	5	\$1814
KRE4824CGCOPRT	24 x 48 x 1.18	85	54	4.5	\$1610
KRE4224CGCOPRT	24 x 42 x 1.18	85	49	4	\$1405

Kingston return tops with Kingston edge on three sides, for use with FreeFit height adjustable table mechanisms, sold separately (FTxxxxx, see page 713 of the Desking price list for information).

- 26" deep tops accommodate FTxxxx24 mechanisms. Depth is exact to accommodate the Kingston edge + the Freefit mechanism. *Cannot be made smaller.*

Required Specifications

Finish
Edge

Optional Specifications

Handles*
Additional grommet

RETURNS - NOTES

- All returns are shipped assembled
- Kneewell locking standard
- The standard grain direction on returns is cross grain (**CG**). To remove cross grain veneer pattern on top, delete suffix "**CG**" from the model number (no upcharge)
- If Handle is not specified Routed Pull, Black Lock & Grommet are standard
- If Handle is specified:
 - Black and Brass handle = Black Lock & Grommet
 - Silver, Nickel and Tungsten handle = Tungsten Lock & Grommet
- Grommets are available as an option on Desks and most Credenzas.
- Edge options - must specify:

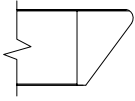

K16

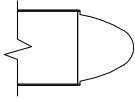

K18

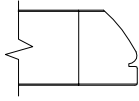

K21

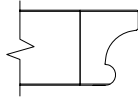

K22

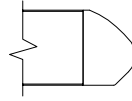

K29

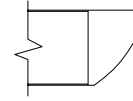

K30

- **NOTE:** Arrow indicates direction of grain

EXECUTIVE RETURNS

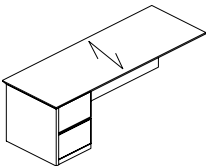

Executive Return - Left*

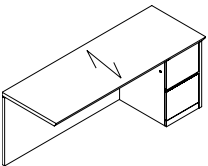

Executive Return - Right*

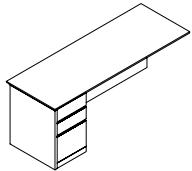

Executive Return - Left*

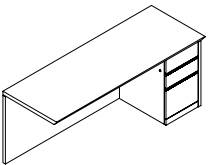

Executive Return - Right*

MODEL#	DIMENSIONS	FREIGHT CLASS	WT/LBS.	CUBIC FT.	LIST PRICE
KERL7222ECG	24 x 73 x 29	100	250	29	\$5926
KERL6622ECG	24 x 67 x 29	100	236	27	\$5709
KERL6022ECG	24 x 61 x 29	100	227	24	\$5189
KERL5422ECG	24 x 55 x 29	100	205	22	\$5005
KERL4822ECG	24 x 49 x 29	100	185	19	\$4448
KERL4222ECG	24 x 43 x 29	92.5	178	17	\$4282

Standard with full to floor **file/file** pedestal on **left**. Pedestal locks. Full height flush back panel.

KERR7222ECG	24 x 73 x 29	100	250	29	\$5926
KERR6622ECG	24 x 67 x 29	100	236	27	\$5709
KERR6022ECG	24 x 61 x 29	100	227	24	\$5189
KERR5422ECG	24 x 55 x 29	100	205	22	\$5005
KERR4822ECG	24 x 49 x 29	100	185	19	\$4448
KERR4222ECG	24 x 43 x 29	92.5	178	17	\$4282

Standard with full to floor **file/file** pedestal on **right**. Pedestal locks. Full height flush back panel.

KERL7222DCG	24 x 73 x 29	92.5	178	17	\$5926
KERL6622DCG	24 x 67 x 29	100	236	27	\$5709
KERL6022DCG	24 x 61 x 29	100	227	24	\$5189
KERL5422DCG	24 x 55 x 29	100	205	22	\$5005
KERL4822DCG	24 x 49 x 29	100	185	19	\$4448
KERL4222DCG	24 x 43 x 29	92.5	178	17	\$4282

Standard with full to floor **box/box/file** pedestal on **left**. Pedestal locks. Full height flush back panel.

KERR7222DCG	24 x 73 x 29	92.5	178	17	\$5926
KERR6622DCG	24 x 67 x 29	100	236	27	\$5709
KERR6022DCG	24 x 61 x 29	100	227	24	\$5189
KERR5422DCG	24 x 55 x 29	100	205	22	\$5005
KERR4822DCG	24 x 49 x 29	100	185	19	\$4448
KERR4222DCG	24 x 43 x 29	92.5	178	17	\$4282

Standard with full to floor **box/box/file** pedestal on **right**. Pedestal locks. Full height flush back panel.

Required Specifications

Finish
Edge

Optional Specifications

Additional grommet
Base upgrade* (see accessories for options)

EXECUTIVE RETURNS

MODEL# DIMENSIONS FREIGHT CLASS WT/LBS. CUBIC FT. LIST PRICE

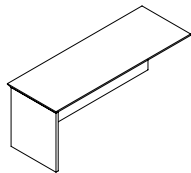

Executive Return - Left

	D x W x H					
KERL7222CG	24 x 73 x 29	150	135	29		\$3326
KERL6622CG	24 x 67 x 29	150	127	27		\$3051
KERL6022CG	24 x 61 x 29	150	120	24		\$2772
KERL5422CG	24 x 55 x 29	150	112	22		\$2493
KERL4822CG	24 x 49 x 29	150	105	19		\$2219
KERL4222CG	24 x 43 x 29	150	97	17		\$1938

Full height flush back panel.

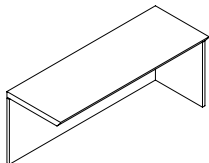

Executive Return - Right

KERR7222CG	24 x 73 x 29	150	135	29		\$3326
KERR6622CG	24 x 67 x 29	150	127	27		\$3051
KERR6022CG	24 x 61 x 29	150	120	24		\$2772
KERR5422CG	24 x 55 x 29	150	112	22		\$2493
KERR4822CG	24 x 49 x 29	150	105	19		\$2219
KERR4222CG	24 x 43 x 29	150	97	17		\$1938

Full height flush back panel.

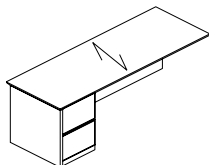

Executive Return - Left*

KERL7220ECG	22 x 73 x 29	100	240	27		\$5643
KERL6620ECG	22 x 67 x 29	100	231	24		\$5435
KERL6020ECG	22 x 61 x 29	92.5	222	22		\$4942
KERL5420ECG	22 x 55 x 29	92.5	200	20		\$4764
KERL4820ECG	22 x 49 x 29	92.5	180	18		\$4234
KERL4220ECG	22 x 43 x 29	92.5	173	16		\$4081

Standard with full to floor **file/file** pedestal on **left**. Pedestal locks. Full height flush back panel.

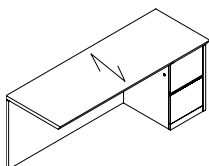

Executive Return - Right*

KERR7220ECG	22 x 73 x 29	100	240	27		\$5643
KERR6620ECG	22 x 67 x 29	100	231	24		\$5435
KERR6020ECG	22 x 61 x 29	92.5	222	22		\$4942
KERR5420ECG	22 x 55 x 29	92.5	200	20		\$4764
KERR4820ECG	22 x 49 x 29	92.5	180	18		\$4234
KERR4220ECG	22 x 43 x 29	92.5	173	16		\$4081

Standard with full to floor **file/file** pedestal on **right**. Pedestal locks. Full height flush back panel.

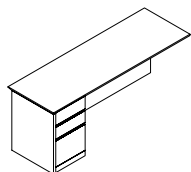

Executive Return - Left*

KERL7220DCG	22 x 73 x 29	100	240	27		\$5643
KERL6620DCG	22 x 67 x 29	100	231	24		\$5435
KERL6020DCG	22 x 61 x 29	92.5	222	22		\$4942
KERL5420DCG	22 x 55 x 29	92.5	200	20		\$4764
KERL4820DCG	22 x 49 x 29	92.5	180	18		\$4234
KERL4220DCG	22 x 43 x 29	92.5	173	16		\$4081

Standard with full to floor **box/box/file** pedestal on **left**. Pedestal locks. Full height flush back panel.

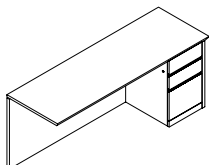

Executive Return - Right*

KERR7220DCG	22 x 73 x 29	100	240	27		\$5643
KERR6620DCG	22 x 67 x 29	100	231	24		\$5435
KERR6020DCG	22 x 61 x 29	92.5	222	22		\$4942
KERR5420DCG	22 x 55 x 29	92.5	200	20		\$4764
KERR4820DCG	22 x 49 x 29	92.5	180	18		\$4234
KERR4220DCG	22 x 43 x 29	92.5	173	16		\$4081

Standard with full to floor **box/box/file** pedestal on **right**. Pedestal locks. Full height flush back panel.

Required Specifications

Finish
Edge

Optional Specifications

Handles*
Additional grommet

EXECUTIVE RETURNS

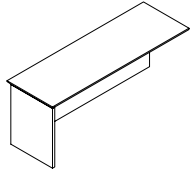

Executive Return - Left

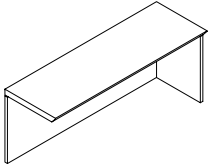

Executive Return - Right

MODEL#	DIMENSIONS	FREIGHT CLASS	WT/LBS.	CUBIC FT.	LIST PRICE
--------	------------	---------------	---------	-----------	------------

D x W x H

KERL7220CG	22 x 73 x 29	150	130	27	\$3168
KERL6620CG	22 x 67 x 29	150	122	24	\$2906
KERL6020CG	22 x 61 x 29	150	115	22	\$2641
KERL5420CG	22 x 55 x 29	150	105	20	\$2374
KERL4820CG	22 x 49 x 29	150	100	18	\$2115
KERL4220CG	22 x 43 x 29	150	90	16	\$1846

Full height flush back panel.

KERR7220CG	22 x 73 x 29	150	130	27	\$3168
KERR6620CG	22 x 67 x 29	150	122	24	\$2906
KERR6020CG	22 x 61 x 29	150	115	22	\$2641
KERR5420CG	22 x 55 x 29	150	105	20	\$2374
KERR4820CG	22 x 49 x 29	150	100	18	\$2115
KERR4220CG	22 x 43 x 29	150	90	16	\$1846

Full height flush back panel.

Required Specifications

Finish
Edge

Optional Specifications

Handles*
Additional grommet

PIANO DESKS - NOTES

- All desks are shipped assembled
- Units include installed horizontal wire management
- Unit is handed by Post leg.
- Not for use with regular corner units
- If grommet (optional) color is not specified, Black grommet is standard.
- Grommets are available as an option on Desks and most Credenzas.
- Edge options - must specify:

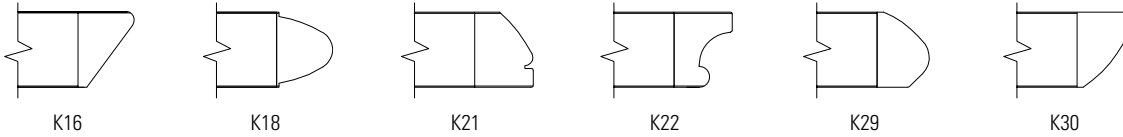

- **NOTE:** Arrow indicates direction of grain
- For cross grain veneer pattern on top, add **(CG)**.

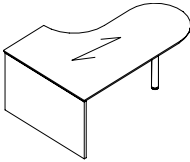
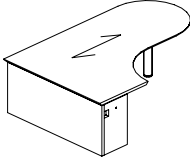
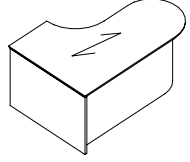
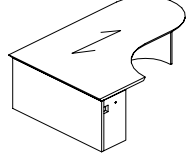
PIANO DESKS	MODEL#	DIMENSIONS	FREIGHT CLASS	WT/LBS.	CUBIC FT.	LIST PRICE
 <p>D-shaped Piano Desk - Left*</p>	KTDPPL96304822	48 x 96 x 29	125	464	77	\$7591
	KTDPPL84304822	48 x 84 x 29	150	406	68	\$6756
	KTDPPL72304822	48 x 72 x 29	125	348	58	\$5916
3" wood post and full end panel, 30"D worksurface and 24" return connection.						
 <p>D-shaped Piano Desk - Right*</p>	KTDPDR96304822	48 x 96 x 29	125	464	77	\$7591
	KTDPDR84304822	48 x 84 x 29	150	406	68	\$6756
	KTDPDR72304822	48 x 72 x 29	125	348	58	\$5916
3" wood post and full end panel, 30"D worksurface and 24" return connection.						
 <p>D-shaped Piano Desk - Left</p>	KTDPCL96304822	48 x 96 x 29	125	479	77	\$9634
	KTDPCL84304822	48 x 84 x 29	125	420	68	\$8544
	KTDPCL72304822	48 x 72 x 29	125	360	58	\$7450
Full height curved modesty panel, 3" wood post, and full end panel, 30"D worksurface and 24" return connection.						
 <p>D-shaped Piano Desk - Right</p>	KTDPDR96304822	48 x 96 x 29	125	479	77	\$9634
	KTDPDR84304822	48 x 84 x 29	125	420	68	\$8544
	KTDPDR72304822	48 x 72 x 29	125	360	58	\$7450
Full height curved modesty panel, 3" wood post, and full end panel, 30"D worksurface and 24" return connection.						

Required Specifications

Finish
Edge

Optional Specifications

Handles*
Additional grommet

PIANO DESKS - NOTES

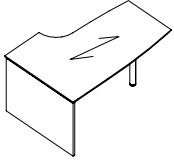

Boat-shaped Piano Desk - Left*

	D x W x H					
KTBPPL96364822	48 x 96 x 29	125	522	87		\$8544
KTBPPL84364822	48 x 84 x 29	125	457	76		\$7596
KTBPPL72364822	48 x 72 x 29	125	392	65		\$6652

3" wood post and full end panel, with 36"/30"D worksurface and 24" return connection.

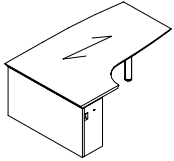

Boat-shaped Piano Desk - Right*

KTBPR96364822	48 x 96 x 29	125	522	87		\$8544
KTBPR84364822	48 x 84 x 29	125	457	76		\$7596
KTBPR72364822	48 x 72 x 29	125	392	65		\$6652

3" wood post and full end panel, with 36"/30"D worksurface and 24" return connection.

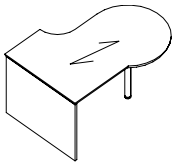

P-shaped Piano Desk - Left*

KTPLL96424822	48 x 96 x 29	150	580	97		\$8662
KTPLL84424822	48 x 84 x 29	150	508	85		\$7749
KTPLL72424822	48 x 72 x 29	150	435	73		\$7181

3" wood post and full end panel, with 42"/30"D worksurface and 24" return connection.

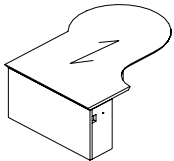

P-shaped Piano Desk - Right*

KTPPR96424822	48 x 96 x 29	150	580	97		\$8662
KTPPR84424822	48 x 84 x 29	150	508	85		\$7749
KTPPR72424822	48 x 72 x 29	150	435	73		\$7181

3" wood post and full end panel, with 42"/30"D worksurface and 24" return connection.

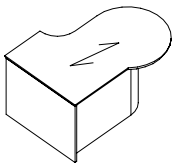

P-shaped Piano Desk - Left

KTPPCL96424822	48 x 96 x 29	125	590	97		\$10409
KTPPCL84424822	48 x 84 x 29	125	516	85		\$9277
KTPPCL72424822	48 x 72 x 29	125	442	73		\$8720

Full curved modesty panel, 3" wood post, and full end panel, with 42"/30"D worksurface and 24" return connection.

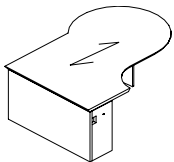

P-shaped Piano Desk - Right

KTPPCR96424822	48 x 96 x 29	125	590	97		\$10409
KTPPCR84424822	48 x 84 x 29	125	516	85		\$9277
KTPPCR72424822	48 x 72 x 29	125	442	73		\$8720

Full curved modesty panel, 3" wood post, and full end panel, with 42"/30"D worksurface and 24" return connection.

Required Specifications

Finish
Edge

Optional Specifications

Additional grommet
Base upgrade* (see accessories for options)

PIANO DESKS

MODEL# DIMENSIONS FREIGHT CLASS WT/LBS. CUBIC FT. LIST PRICE

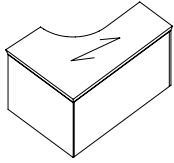

Extended Corner Table - Right

	D x W x H					
KEKL964822MR	98 x 48 x 29	150	387	77	\$8248	
KEKL904822MR	92 x 48 x 29	150	363	73	\$7790	
KEKL844822MR	86 x 48 x 29	150	338	68	\$7695	
KEKL784822MR	80 x 48 x 29	150	314	63	\$7656	
KEKL724822MR	74 x 48 x 29	150	290	58	\$6613	
KEKL664822MR	68 x 48 x 29	150	266	52	\$6786	
KEKL604822MR	62 x 48 x 29	150	242	48	\$6285	

Self edge on back edge, and 24" return connection.

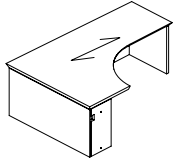

Extended Corner Table - Right

KEKR489622ML	98 x 48 x 29	150	387	77	\$8248	
KEKR489022ML	92 x 48 x 29	150	363	73	\$7790	
KEKR488422ML	86 x 48 x 29	150	338	68	\$7695	
KEKR487822ML	80 x 48 x 29	150	314	63	\$7656	
KEKR487222ML	74 x 48 x 29	150	290	58	\$7274	
KEKR486622ML	68 x 48 x 29	150	266	52	\$6786	
KEKR486022ML	62 x 48 x 29	150	242	48	\$6285	

Self edge on back edge, and 24" return connection.

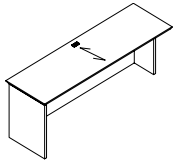

Linking Return - Left

KVEL9622CG	24 x 97 x 29	150	200	39	\$5012	
KVEL9022CG	24 x 91 x 29	150	187	36	\$4698	
KVEL8422CG	24 x 85 x 29	150	174	34	\$4386	
KVEL7822CG	24 x 79 x 29	150	162	31	\$4072	
KVEL7222CG	24 x 73 x 29	150	149	29	\$3763	
KVEL6622CG	24 x 67 x 29	150	141	27	\$3532	
KVEL6022CG	24 x 61 x 29	150	132	24	\$3140	
KVEL5422CG	24 x 55 x 29	150	121	22	\$3115	
KVEL4822CG	24 x 47 x 29	125	115	19	\$2927	
KVEL4222CG	24 x 43 x 29	150	99	17	\$2463	
KVEL3622CG	24 x 37 x 29	150	83	15	\$2377	
KVEL3022CG	24 x 31 x 29	125	77	12	\$2365	
KVEL2422CG	24 x 25 x 29	125	61	10	\$1959	

Used in conjunction with Extended Corner Units or Piano Table Desks

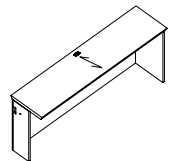

Linking Return - Right

KVER9622CG	24 x 97 x 29	150	200	39	\$5012	
KVER9022CG	24 x 91 x 29	150	187	36	\$4698	
KVER8422CG	24 x 85 x 29	150	174	34	\$4386	
KVER7822CG	24 x 79 x 29	150	162	31	\$4072	
KVER7222CG	24 x 73 x 29	150	149	29	\$3763	
KVER6622CG	24 x 67 x 29	150	141	27	\$3532	
KVER6022CG	24 x 61 x 29	150	132	24	\$3140	
KVER5422CG	24 x 55 x 29	150	121	22	\$3115	
KVER4822CG	24 x 47 x 29	125	115	19	\$2927	
KVER4222CG	24 x 43 x 29	150	99	17	\$2463	
KVER3622CG	24 x 37 x 29	150	83	15	\$2377	
KVER3022CG	24 x 31 x 29	125	77	12	\$2365	
KVER2422CG	24 x 25 x 29	125	61	10	\$1959	

Used in conjunction with Extended Corner Units or Piano Table Desks

Required Specifications

Finish
Edge

Optional Specifications

Additional grommet
Base upgrade* (see accessories for options)

EXTENDED CORNERS

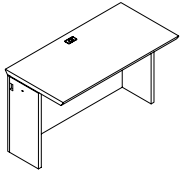

Bridge

MODEL#	DIMENSIONS	FREIGHT CLASS	WT./LBS.	CUBIC FT.	LIST PRICE
--------	------------	---------------	----------	-----------	------------

D x W x H

KBTN4822CG	24 x 48 x 29	125	116	19	\$2836
KBTN4222CG	24 x 42 x 29	125	102	17	\$2377
KBTN3622CG	24 x 36 x 29	150	87	15	\$2292
KBTN3022CG	24 x 30 x 29	125	73	12	\$2244
KBTN2422CG	24 x 24 x 29	150	58	10	\$1883
KBTN1822CG	24 x 18 x 29	150	43	8	\$1417
KBTN1222CG	24 x 12 x 29	150	29	5	\$943

For Extended Corner Units or Piano Table Desks, with full back panel and recessed end panels.

BRIDGES

- All bridges are shipped knockdown.
- Not for use with corner units.
- The standard grain direction is cross grain (**CG**). To remove cross grain veneer pattern on top, delete suffix "**CG**" from the model number (no upcharge).
- GM5 TC location is standard. If grommet color is not specified, Black grommet is standard.
- Edge options - must specify:

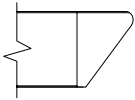

K16

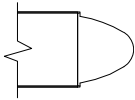

K18

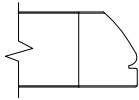

K21

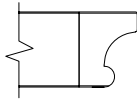

K22

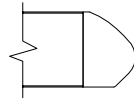

K29

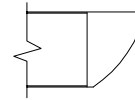

K30

- **NOTE:** Arrow indicates direction of grain

BRIDGES

MODEL#	DIMENSIONS	FREIGHT CLASS	WT./LBS.	CUBIC FT.	LIST PRICE
--------	------------	---------------	----------	-----------	------------

KBT6022CG	24 x 60 x 29	85	108	9	\$2641
KBT5422CG	24 x 54 x 29	85	99	8	\$2377
KBT4822CG	24 x 48 x 29	85	90	7	\$2115
KBT4222CG	24 x 42 x 29	85	81	6	\$1848
KBT6020CG	22 x 60 x 29	85	105	8	\$2405
KBT5420CG	22 x 54 x 29	85	96	8	\$2164
KBT4820CG	22 x 48 x 29	85	87	7	\$1922
KBT4220CG	22 x 42 x 29	85	78	6	\$1648

With full back panel.

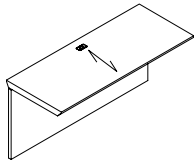

Executive Bridge Top

KBT6022Q8CG	24 x 60 x 9.5	100	83	9	\$2377
KBT5422Q8CG	24 x 54 x 9.5	100	74	8	\$2141
KBT4822Q8CG	24 x 48 x 9.5	100	65	7	\$1896
KBT4222Q8CG	24 x 42 x 9.5	100	56	6	\$1663

KBT6020Q8CG	22 x 60 x 9.5	92.5	80	8	\$2164
KBT5420Q8CG	22 x 54 x 9.5	100	71	8	\$1953
KBT4820Q8CG	22 x 48 x 9.5	100	62	7	\$1736
KBT4220Q8CG	22 x 42 x 9.5	100	53	6	\$1484

With 8" back panel.

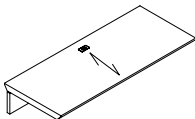

Executive Bridge Top

Required Specifications

Finish
Edge

Optional Specifications

Additional grommet

EXTENDED CORNERS

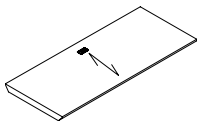

Executive Bridge Top

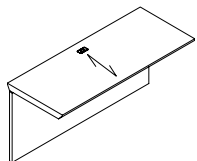

Executive Bridge Top

MODEL# DIMENSIONS FREIGHT CLASS WT./LBS. CUBIC FT. LIST PRICE

	D x W x H				
KBT5422TCG	24 x 54 x 1.5	100	64	8	\$1422
KBT4822TCG	24 x 48 x 1.5	125	55	7	\$1270
KBT4222TCG	24 x 42 x 1.5	125	46	6	\$1113
KBT5420TCG	22 x 54 x 1.5	125	61	8	\$1303
KBT4820TCG	22 x 48 x 1.5	125	52	7	\$1157
KBT4220TCG	22 x 42 x 1.5	125	43	6	\$991

No back panel.

KHBT6022CG	24 x 60 x 29	85	108	9	\$3034
KHBT5422CG	24 x 54 x 29	85	99	8	\$2777
KHBT4822CG	24 x 48 x 29	85	90	7	\$2512
KHBT4222CG	24 x 42 x 29	85	81	6	\$2246

KHBT6020CG	22 x 60 x 29	85	105	8	\$2803
KHBT5420CG	22 x 54 x 29	85	96	8	\$2562
KHBT4820CG	22 x 48 x 29	85	87	7	\$2322
KHBT4220CG	22 x 42 x 29	85	78	6	\$2045

With hinged back panel, for U configurations.

CREDENZA NOTES

- All credenzas are shipped assembled.
- All Storage Cabinets include one adjustable shelf per set of doors.
- "F" and "G" depict 36", and "M" and "N" depict 30".
- "F" and "N" indicate lateral file drawers and "G" and "M" indicate storage cabinets with doors.
- Credenza shells accept modular storage. Use modular storage for top support, allowing no more than 72" unsupported.
- Credenza shells with a width of 96" and more will have a 12" center support gable.
- Credenza shells can only be completely filled with modular storage units with ".5" at the end of the model number.
- If Handle is not specified Routed Pull, Black Lock & Grommet are standard
- If Handle is specified:
 - Black and Brass handle = Black Lock & Grommet
 - Silver, Nickel and Tungsten handle = Tungsten Lock & Grommet
- **NOTE:** Arrow indicates direction of grain
- Edge options - must specify:

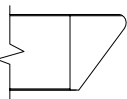
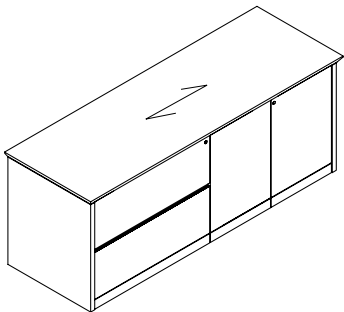

K16

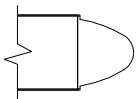

K18

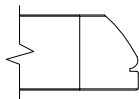

K21

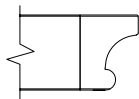

K22

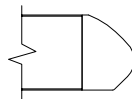

K29

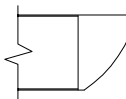

K30

CREDENZAS

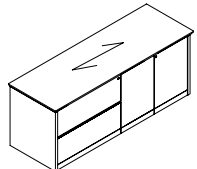

Full Storage Credenza*

MODEL# DIMENSIONS FREIGHT CLASS WT./LBS. CUBIC FT. LIST PRICE

KC7222FG	23 x 74 x 29	92.5	285	27	\$7110
KC6022NM	23 x 62 x 29	92.5	233	22	\$5925
KC7220FG	21 x 74 x 29	92.5	272	24	\$6769
KC6020NM	21 x 62 x 29	92.5	220	20	\$5639

Standard with lateral box/file on left and storage cabinet on right.

- For Aluminum Framed Glass Door option, contact Customer Care.

Required Specifications

Finish
Edge

Optional Specifications

Additional grommet

DESKS

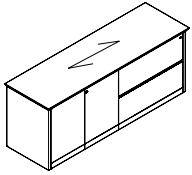

Full Storage Credenza

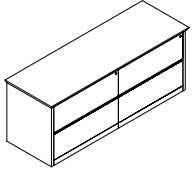

Full Storage Credenza

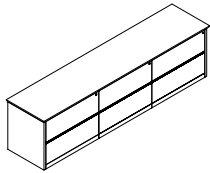

Full Storage Credenza

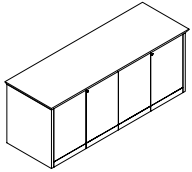

Full Storage Credenza

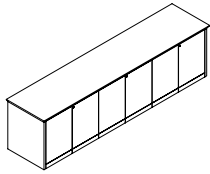

Full Storage Credenza

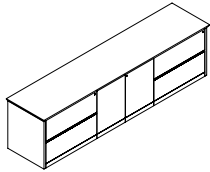

Full Storage Credenza

MODEL# DIMENSIONS FREIGHT CLASS WT/LBS. CUBIC FT. LIST PRICE

D x W x H

KC7222GF	23 x 74 x 29	92.5	285	27	\$7110
KC6022MN	23 x 62 x 29	92.5	233	22	\$5925
KC7220GF	21 x 74 x 29	92.5	272	24	\$6769
KC6020MN	21 x 62 x 29	92.5	220	20	\$5639

Standard with **lateral box/file** on **right** and **storage cabinet** on **left**.

- For Aluminum Framed Glass Door option, contact Customer Care.

KC7222FF	23 x 74 x 29	92.5	300	27	\$9090
KC6022NN	23 x 62 x 29	100	218	22	\$8337
KC7220FF	21 x 74 x 29	92.5	287	24	\$8657
KC6020NN	21 x 62 x 29	92.5	205	20	\$7582

Standard with **lateral box/file** on **left** and **right**.

KC10822FFF	23 x 110 x 29	92.5	435	40	\$15990
KC9022NNN	23 x 92 x 29	92.5	372	33	\$13326
KC10820FFF	21 x 110 x 29	92.5	412	36	\$14536
KC9020NNN	21 x 92 x 29	92.5	337	30	\$12116

Standard with **lateral box/file** on **left, center** and **right**.

KC7222GG	23 x 74 x 29	92.5	277	27	\$6747
KC6022MM	23 x 62 x 29	92.5	232	22	\$6186
KC7220GG	21 x 74 x 29	92.5	253	24	\$6427
KC6020MM	21 x 62 x 29	92.5	209	20	\$5624

Standard with **storage cabinets** on **left** and **right**.

KC10822GGG	23 x 110 x 29	100	348	40	\$12752
KC9022MMM	23 x 92 x 29	100	302	33	\$10626
KC10820GGG	21 x 110 x 29	125	278	36	\$11589
KC9020MMM	21 x 92 x 29	125	228	30	\$9597

Standard with **storage cabinets** on **left, center** and **right**.

KC10822FGF	23 x 110 x 29	100	348	40	\$14912
KC9022NMN	23 x 92 x 29	100	302	33	\$12428
KC10820FGF	21 x 110 x 29	125	278	36	\$13554
KC9020NMN	21 x 92 x 29	125	228	30	\$11296

Lateral files on **left** and **right**; **storage cabinet** in **center**

Required Specifications

Finish
Edge

Optional Specifications

Handles*
Additional grommet

CREDENZAS

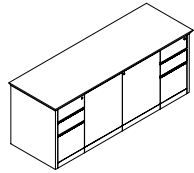

Full Storage Credenza

MODEL# DIMENSIONS FREIGHT CLASS WT/LBS. CUBIC FT. LIST PRICE

D x W x H

KC7222DGD	23 x 74 x 29	92.5	319	29	\$8337
KC6022DMD	23 x 62 x 29	92.5	266	24	\$7643
KC7220DGD	21 x 74 x 29	85	298	24	\$7937
KC6020DMD	21 x 62 x 29	85	246	20	\$6947

Standard with **box/box/file** on **left** and **right**; **storage cabinet** in **center**.

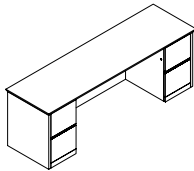

Double Pedestal Credenza

KCK8422EE	23 x 86 x 29	100	320	34	\$8711
KCK7822EE	23 x 80 x 29	100	298	31	\$8090
KCK7222EE	23 x 74 x 29	100	280	29	\$7470
KCK6622EE	23 x 68 x 29	100	257	27	\$7356
KCK6022EE	23 x 62 x 29	100	233	24	\$6844

KCK8420EE	21 x 86 x 29	92.5	307	28	\$8302
KCK7820EE	21 x 80 x 29	92.5	285	26	\$7709
KCK7220EE	21 x 74 x 29	92.5	267	24	\$7114
KCK6620EE	21 x 68 x 29	92.5	244	22	\$6520
KCK6020EE	21 x 62 x 29	92.5	220	20	\$5928

File/file pedestals on **left** and **right**. Full height back panel. Kneespace in center.

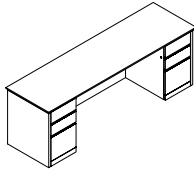

Double Pedestal Credenza

KCK8422DD	23 x 86 x 29	100	320	34	\$8711
KCK7822DD	23 x 80 x 29	100	298	31	\$8090
KCK7222DD	23 x 74 x 29	100	280	29	\$7470
KCK6622DD	23 x 68 x 29	100	257	27	\$7356
KCK6022DD	23 x 62 x 29	100	233	24	\$6844

KCK8420DD	21 x 86 x 29	92.5	307	28	\$8302
KCK7820DD	21 x 80 x 29	92.5	285	26	\$7709
KCK7220DD	21 x 74 x 29	92.5	267	24	\$7114
KCK6620DD	21 x 68 x 29	92.5	244	22	\$6520
KCK6020DD	21 x 62 x 29	92.5	220	20	\$5928

Box/box/file pedestals on **left** and **right**. Full height back panel. Kneespace in center.

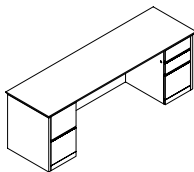

Double Pedestal Credenza

KCK8422ED	23 x 86 x 29	100	320	34	\$8711
KCK7822ED	23 x 80 x 29	100	298	31	\$8090
KCK7222ED	23 x 74 x 29	100	280	29	\$7470
KCK6622ED	23 x 68 x 29	100	257	27	\$7356
KCK6022ED	23 x 62 x 29	100	233	24	\$6844

KCK8420ED	21 x 86 x 29	92.5	307	28	\$8302
KCK7820ED	21 x 80 x 29	92.5	285	26	\$7709
KCK7220ED	21 x 74 x 29	92.5	267	24	\$7114
KCK6620ED	21 x 68 x 29	92.5	244	22	\$6520
KCK6020ED	21 x 62 x 29	92.5	220	20	\$5928

File/file pedestal on **left**, **box/box/file** pedestal on **right**. Full height back panel. Kneespace in center.

Required Specifications

Finish
Edge

Optional Specifications

Handles
Additional grommet

CREDENZAS

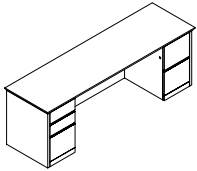

Double Pedestal Credenza

MODEL#	DIMENSIONS D x W x H	FREIGHT CLASS	WT./LBS.	CUBIC FT.	LIST PRICE
KCK8422DE	23 x 86 x 29	100	320	34	\$8711
KCK7822DE	23 x 80 x 29	100	298	31	\$8090
KCK7222DE	23 x 74 x 29	100	280	29	\$7470
KCK6622DE	23 x 68 x 29	100	257	27	\$7356
KCK6022DE	23 x 62 x 29	100	233	24	\$6844
KCK8420DE	21 x 86 x 29	92.5	307	28	\$8302
KCK7820DE	21 x 80 x 29	92.5	285	26	\$7709
KCK7220DE	21 x 74 x 29	92.5	267	24	\$7114
KCK6620DE	21 x 68 x 29	92.5	244	22	\$6520
KCK6020DE	21 x 62 x 29	92.5	220	20	\$5928

Box/box/file pedestal on **left** and **file/file** pedestal on **right**. Full height back panel. Kneespace in center.

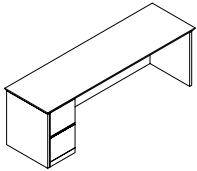

Single Pedestal Credenza - Left

KCL8422E	23 x 86 x 29	100	286	34	\$6586
KCL7822E	23 x 80 x 29	100	265	31	\$6119
KCL7222E	23 x 74 x 29	100	250	29	\$5643
KCL6622E	23 x 68 x 29	100	229	27	\$5435
KCL6022E	23 x 62 x 29	100	208	24	\$4942
KCL8420E	21 x 86 x 29	100	273	28	\$6275
KCL7820E	21 x 80 x 29	100	252	26	\$5829
KCL7220E	21 x 74 x 29	100	237	24	\$5378
KCL6620E	21 x 68 x 29	100	216	22	\$5176
KCL6020E	21 x 62 x 29	100	195	20	\$4710

File/file pedestal on **left**. Full height back panel.

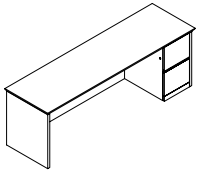

Single Pedestal Credenza - Right

KCR8422E	23 x 86 x 29	100	286	34	\$6586
KCR7822E	23 x 80 x 29	100	265	31	\$6119
KCR7222E	23 x 74 x 29	100	250	29	\$5643
KCR6622E	23 x 68 x 29	100	229	27	\$5435
KCR6022E	23 x 62 x 29	100	208	24	\$4942
KCR8420E	21 x 86 x 29	100	273	28	\$6275
KCR7820E	21 x 80 x 29	100	252	26	\$5829
KCR7220E	21 x 74 x 29	100	237	24	\$5378
KCR6620E	21 x 68 x 29	100	216	22	\$5176
KCR6020E	21 x 62 x 29	100	195	20	\$4710

File/file pedestal on **right**. Full height back panel.

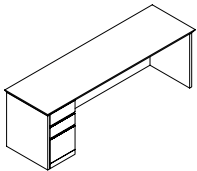

Single Pedestal Credenza - Left

KCL8422D	23 x 86 x 29	100	286	34	\$6586
KCL7822D	23 x 80 x 29	100	265	31	\$6119
KCL7222D	23 x 74 x 29	100	250	29	\$5643
KCL6622D	23 x 68 x 29	100	229	27	\$5435
KCL6022D	23 x 62 x 29	100	208	24	\$4942
KCL8420D	21 x 86 x 29	100	273	28	\$6275
KCL7820D	21 x 80 x 29	100	252	26	\$5829
KCL7220D	21 x 74 x 29	100	237	24	\$5378
KCL6620D	21 x 68 x 29	100	216	22	\$5176
KCL6020D	21 x 62 x 29	100	195	20	\$4710

Box/box/file pedestal on **left**. Full height back panel.

Required Specifications

Finish
Edge

Optional Specifications

Handles
Additional grommet

CREENZAS

MODEL# DIMENSIONS FREIGHT CLASS WT/LBS. CUBIC FT. LIST PRICE

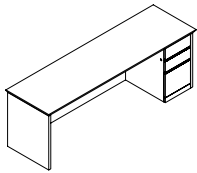

Single Pedestal Credenza - Right

	D x W x H				
KCR8422D	23 x 86 x 29	100	286	34	\$6586
KCR7822D	23 x 80 x 29	100	265	31	\$6119
KCR7222D	23 x 74 x 29	100	250	29	\$5643
KCR6622D	23 x 68 x 29	100	229	27	\$5435
KCR6022D	23 x 62 x 29	100	208	24	\$4942
KCR8420D	21 x 86 x 29	100	273	28	\$6275
KCR7820D	21 x 80 x 29	100	252	26	\$5829
KCR7220D	21 x 74 x 29	100	237	24	\$5378
KCR6620D	21 x 68 x 29	100	216	22	\$5176
KCR6020D	21 x 62 x 29	100	195	20	\$4710

Box/box/file pedestal on right. Full height back panel.

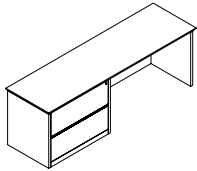

Single Pedestal Credenza - Left

KCL8422F	23 x 86 x 29	100	266	31	\$7656
KCL7822F	23 x 80 x 29	100	245	29	\$7108
KCL7222F	23 x 74 x 29	100	230	27	\$6565
KCL6622F	23 x 68 x 29	100	209	24	\$6319
KCL6022F	23 x 62 x 29	100	188	22	\$5736
KCL8420F	21 x 86 x 29	100	253	28	\$7289
KCL7820F	21 x 80 x 29	100	233	26	\$6766
KCL7220F	21 x 74 x 29	100	218	24	\$6247
KCL6620F	21 x 68 x 29	100	197	22	\$6017
KCL6020F	21 x 62 x 29	100	176	20	\$5463

36" lateral file pedestal on left. Full height back panel.

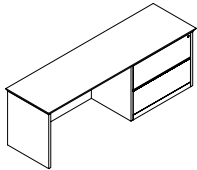

Single Pedestal Credenza - Right

KCR8422F	23 x 86 x 29	100	266	31	\$7656
KCR7822F	23 x 80 x 29	100	245	29	\$7108
KCR7222F	23 x 74 x 29	100	230	27	\$6565
KCR6622F	23 x 68 x 29	100	209	24	\$6319
KCR6022F	23 x 62 x 29	100	188	22	\$5736
KCR8420F	21 x 86 x 29	100	253	28	\$7289
KCR7820F	21 x 80 x 29	100	233	26	\$6766
KCR7220F	21 x 74 x 29	100	218	24	\$6247
KCR6620F	21 x 68 x 29	100	197	22	\$6017
KCR6020F	21 x 62 x 29	100	176	20	\$5463

36" lateral file pedestal on right. Full height back panel.

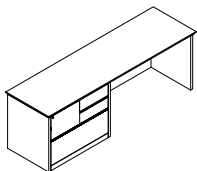

Single Pedestal Credenza - Left

KCL8422Z	23 x 86 x 29	100	309	31	\$8356
KCL7822Z	23 x 80 x 29	100	287	29	\$7762
KCL7222Z	23 x 74 x 29	92.5	270	27	\$7168
KCL6622Z	23 x 68 x 29	92.5	248	24	\$6893
KCL6022Z	23 x 62 x 29	92.5	225	22	\$6274
KCL8420Z	21 x 86 x 29	92.5	296	28	\$7964
KCL7820Z	21 x 80 x 29	92.5	274	26	\$7395
KCL7220Z	21 x 74 x 29	92.5	257	24	\$6501
KCL6620Z	21 x 68 x 29	92.5	235	22	\$6567
KCL6020Z	21 x 62 x 29	92.5	212	20	\$5971

Modular combination storage pedestal with 1 lateral file, 1 file drawer on top left, and two box drawers on top right.

Required Specifications

Finish
Edge

Optional Specifications

Handles
Additional grommet

CREENZAS

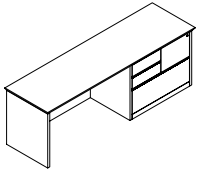

Single Pedestal Credenza - Right

96" and larger:

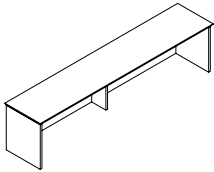

Less than 96":

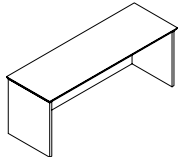

Credenza Shell

MODEL#	DIMENSIONS	FREIGHT CLASS	WT./LBS.	CUBIC FT.	LIST PRICE
--------	------------	---------------	----------	-----------	------------

D x W x H

KCR8422Z	23 x 86 x 29	100	309	31	\$8356
KCR7822Z	23 x 80 x 29	100	287	29	\$7762
KCR7222Z	23 x 74 x 29	92.5	270	27	\$7168
KCR6622Z	23 x 68 x 29	92.5	248	24	\$6893
KCR6022Z	23 x 62 x 29	92.5	225	22	\$6274
KCR8420Z	21 x 86 x 29	92.5	296	28	\$7964
KCR7820Z	21 x 80 x 29	92.5	274	26	\$7395
KCR7220Z	21 x 74 x 29	92.5	257	24	\$6501
KCR6620Z	21 x 68 x 29	92.5	235	22	\$6567
KCR6020Z	21 x 62 x 29	92.5	212	20	\$5971

Modular combination storage pedestal with 1 lateral file, 1 file drawer on top right, and two box drawers on top left.

KC10822	23 x 108 x 29	125	320	41	\$5290
KC10222	23 x 104 x 29	100	305	38	\$4997
KC9622	23 x 98 x 29	100	287	35	\$4705
KC9022	23 x 92 x 29	100	269	33	\$4199
KC8422	23 x 86 x 29	100	251	31	\$4118
KC7822	23 x 80 x 29	100	233	29	\$3822
KC7222	23 x 74 x 29	125	215	27	\$3532
KC6622	23 x 68 x 29	100	197	24	\$3397
KC6022	23 x 62 x 29	100	179	22	\$3091
KC5422	23 x 56 x 29	100	161	20	\$2927
KC4822	23 x 50 x 29	125	143	18	\$2767
KC4222	23 x 44 x 29	125	125	16	\$2341

KC10820	21 x 108 x 29	100	310	36	\$5042
KC10220	21 x 104 x 29	100	291	34	\$4763
KC9620	21 x 98 x 29	100	273	32	\$4482
KC9020	21 x 92 x 29	100	255	30	\$4205
KC8420	21 x 86 x 29	100	237	28	\$3924
KC7820	21 x 80 x 29	100	219	26	\$3641
KC7220	21 x 74 x 29	100	206	24	\$3358
KC6620	21 x 68 x 29	100	188	22	\$3234
KC6020	21 x 62 x 29	100	169	20	\$2944
KC5420	21 x 56 x 29	100	147	18	\$2784
KC4820	21 x 50 x 29	125	101	16	\$2633
KC4220	21 x 44 x 29	125	86	14	\$2231

With full back panel.

Required Specifications

Finish
Edge

Optional Specifications

Handles
Additional grommet

CRENZAS MODEL# DIMENSIONS FREIGHT CLASS WT./LBS. CUBIC FT. LIST PRICE

NOTE: Arrow indicates direction of grain

Corners

- All units are shipped assembled
- Unit includes grommets shown and installed horizontal wire management
- Corner units and extended corner units must be used exclusively with linking bridges and linking returns
- Edge options - must specify:

- **Linking bridges** are handed by recessed end panel
- **Extended corner tables** have no molding on back side.
- **Linking returns** include grommets shown and installed horizontal wire management. Handed by full end panel.
- **Tables** include grommets shown and installed horizontal wire management.

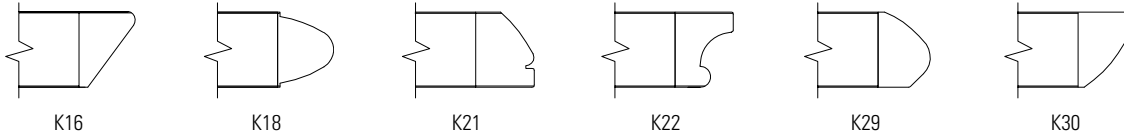

CORNERS AND COMPONENTS MODEL# DIMENSIONS FREIGHT CLASS WT./LBS. CUBIC FT. LIST PRICE

D x W x H

KBT6022NLLCG	24 x 60 x 29	125	145	24	\$2911
KBT5422NLLCG	24 x 54 x 29	150	131	22	\$2623
KBT4822NLLCG	24 x 48 x 29	125	116	19	\$2332
KBT4222NLLCG	24 x 42 x 29	125	102	17	\$1886
KBT3622NLLCG	24 x 36 x 29	150	87	15	\$1716
KBT3022NLLCG	24 x 30 x 29	125	73	12	\$1673
KBT6020NLLCG	22 x 60 x 29	150	131	22	\$2772
KBT5420NLLCG	22 x 54 x 29	150	118	20	\$2496
KBT4820NLLCG	22 x 48 x 29	125	110	18	\$2219
KBT4220NLLCG	22 x 42 x 29	150	95	16	\$1796
KBT3620NLLCG	22 x 36 x 29	125	80	13	\$1631
KBT3020NLLCG	22 x 30 x 29	150	65	11	\$1593

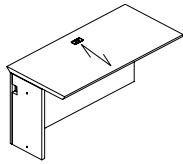

Linking Bridge - Left

To join corner worksurface to desk or credenza. Full back panel.

KBT6022NLRCG	24 x 60 x 29	125	145	24	\$2911
KBT5422NLRCG	24 x 54 x 29	150	131	22	\$2623
KBT4822NLRCG	24 x 48 x 29	125	116	19	\$2332
KBT4222NLRCG	24 x 42 x 29	125	102	17	\$1886
KBT3622NLRCG	24 x 36 x 29	150	87	15	\$1716
KBT3022NLRCG	24 x 30 x 29	125	73	12	\$1673
KBT6020NLRCG	22 x 60 x 29	150	131	22	\$2772
KBT5420NLRCG	22 x 54 x 29	150	118	20	\$2496
KBT4820NLRCG	22 x 48 x 29	125	110	18	\$2219
KBT4220NLRCG	22 x 42 x 29	150	95	16	\$1796
KBT3620NLRCG	22 x 36 x 29	125	80	13	\$1631
KBT3020NLRCG	22 x 30 x 29	150	65	11	\$1593

To join corner worksurface to desk or credenza. Full back panel.

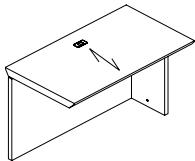

Linking Bridge - Right

Required Specifications

Finish
Edge

Optional Specifications

Handles
Additional grommet

CORNERS - NOTES

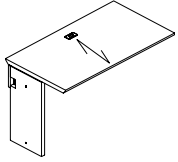

Linking Bridge - Left

	D x W x H				
KBT6022NLLQ8CG	24 x 60 x 9.5	125	145	24	\$2623
KBT5422NLLQ8CG	24 x 54 x 9.5	150	131	22	\$2365
KBT4822NLLQ8CG	24 x 48 x 9.5	125	116	19	\$2101
KBT4222NLLQ8CG	24 x 42 x 9.5	125	102	17	\$1695
KBT3622NLLQ8CG	24 x 36 x 9.5	150	87	15	\$1544
KBT3022NLLQ8CG	24 x 30 x 9.5	125	73	12	\$1510
KBT6020NLLQ8CG	22 x 60 x 9.5	150	131	22	\$2496
KBT5420NLLQ8CG	22 x 54 x 9.5	150	118	20	\$2249
KBT4820NLLQ8CG	22 x 48 x 9.5	125	110	18	\$2000
KBT4220NLLQ8CG	22 x 42 x 9.5	150	95	16	\$1619
KBT3620NLLQ8CG	22 x 36 x 9.5	125	80	13	\$1470
KBT3020NLLQ8CG	22 x 30 x 9.5	150	65	11	\$1438

To join corner worksurface to desk or credenza. 8" back panel.

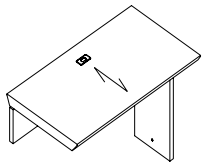

Linking Bridge - Right

KBT6022NLRQ8CG	24 x 60 x 9.5	125	145	24	\$2623
KBT5422NLRQ8CG	24 x 54 x 9.5	150	131	22	\$2365
KBT4822NLRQ8CG	24 x 48 x 9.5	125	116	19	\$2101
KBT4222NLRQ8CG	24 x 42 x 9.5	125	102	17	\$1695
KBT3622NLRQ8CG	24 x 36 x 9.5	150	87	15	\$1544
KBT3022NLRQ8CG	24 x 30 x 9.5	125	73	12	\$1510
KBT6020NLRQ8CG	22 x 60 x 9.5	150	131	22	\$2496
KBT5420NLRQ8CG	22 x 54 x 9.5	150	118	20	\$2249
KBT4820NLRQ8CG	22 x 48 x 9.5	125	110	18	\$2000
KBT4220NLRQ8CG	22 x 42 x 9.5	150	95	16	\$1619
KBT3620NLRQ8CG	22 x 36 x 9.5	125	80	13	\$1470
KBT3020NLRQ8CG	22 x 30 x 9.5	150	65	11	\$1438

To join corner worksurface to desk or credenza. 8" back panel.

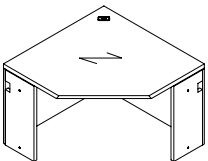

Corner Table

KE484822	48 x 48 x 29	150	201	39	\$4188
KE424222	42 x 42 x 29	150	155	30	\$3215
KE363622	36 x 36 x 29	125	135	22	\$3053
KE484820	48 x 48 x 29	150	196	39	\$4188
KE424220	42 x 42 x 29	150	150	30	\$3215
KE363620	36 x 36 x 29	150	130	22	\$3053

Connects to linking returns and linking bridges. 2 recessed end panels.

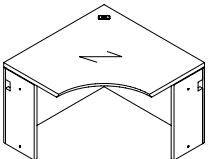

Corner Table

KEK484822	48 x 48 x 29	150	201	39	\$4822
KEK424222	42 x 42 x 29	150	155	30	\$3690
KEK363622	36 x 36 x 29	125	135	22	\$3506
KEK484820	48 x 48 x 29	150	196	39	\$4822
KEK424220	42 x 42 x 29	150	150	30	\$3690
KEK363620	36 x 36 x 29	150	130	22	\$3506

Connects to linking returns and linking bridges. 2 recessed end panels and inner curve.

Required Specifications

Finish
Edge

Optional Specifications

Additional grommet

CORNER COMPONENTS

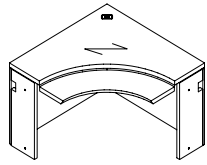

Corner Table

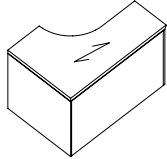

Extended Corner Table - Left

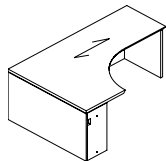

Extended Corner Table - Right

MODEL#	DIMENSIONS	FREIGHT CLASS	WT/LBS.	CUBIC FT.	LIST PRICE
D x W x H					
KEKS484822	48 x 48 x 29	150	201	39	\$8005
KEKS424222	42 x 42 x 29	150	155	30	\$6706
KEKS363622	36 x 36 x 29	125	135	22	\$6493
KEKS484820	48 x 48 x 29	150	196	39	\$8005
KEKS424220	42 x 42 x 29	150	150	30	\$6706
KEKS363620	36 x 36 x 29	150	130	22	\$6493

Connects to linking returns and linking bridges. 2 recessed end panels and inner curve. Adjustable keyboard tray and an articulating arm.

KEKL964822	48 x 97 x 29	150	387	77	\$7497
KEKL904822	48 x 91 x 29	150	363	73	\$7076
KEKL844822	48 x 85 x 29	150	338	68	\$6993
KEKL784822	48 x 79 x 29	150	314	63	\$6959
KEKL724822	48 x 73 x 29	150	290	58	\$6612
KEKL664822	48 x 67 x 29	150	266	52	\$6166
KEKL604822	48 x 61 x 29	150	242	48	\$5446

24" return connection.

KEKR489622	48 x 97 x 29	150	387	77	\$7497
KEKR489022	48 x 91 x 29	150	363	73	\$7076
KEKR488422	48 x 85 x 29	150	338	68	\$6993
KEKR487822	48 x 79 x 29	150	314	63	\$6959
KEKR487222	48 x 73 x 29	150	290	58	\$6612
KEKR486622	48 x 67 x 29	150	266	52	\$6166
KEKR486022	48 x 61 x 29	150	242	48	\$5446

24" return connection.

Required Specifications

Finish
Edge

Optional Specifications

Additional grommet

CORNER COMPONENTS

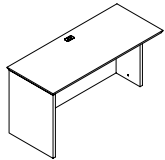

Linking Return - Left

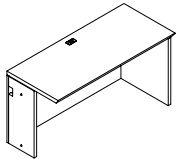

Linking Return - Right

MODEL#	DIMENSIONS	FREIGHT CLASS	WT./LBS.	CUBIC FT.	LIST PRICE
--------	------------	---------------	----------	-----------	------------

D x W x H

KVL9622CG	23 x 97 x 29	150	200	39	\$4827
KVL9022CG	23 x 91 x 29	150	187	36	\$4522
KVL8422CG	23 x 85 x 29	150	174	34	\$4222
KVL7822CG	23 x 79 x 29	150	162	31	\$3922
KVL7222CG	23 x 73 x 29	150	149	29	\$3619
KVL6622CG	23 x 67 x 29	150	141	27	\$3394
KVL6022CG	23 x 61 x 29	150	132	24	\$3174
KVL5422CG	23 x 55 x 29	150	121	22	\$2995
KVL4822CG	23 x 49 x 29	125	115	19	\$2814
KVL4222CG	23 x 43 x 29	150	99	17	\$2374
KVL3622CG	23 x 37 x 29	150	83	15	\$2290
KVL3022CG	23 x 31 x 29	125	77	12	\$2249
KVL2422CG	23 x 23 x 29	125	61	10	\$1883
KVL9620CG	21 x 97 x 29	150	187	39	\$4596
KVL9020CG	21 x 91 x 29	150	175	36	\$4307
KVL8420CG	21 x 85 x 29	150	163	34	\$4024
KVL7820CG	21 x 79 x 29	150	152	31	\$3734
KVL7220CG	21 x 73 x 29	150	140	29	\$3450
KVL6620CG	21 x 67 x 29	150	133	27	\$3234
KVL6020CG	21 x 61 x 29	150	125	24	\$3025
KVL5420CG	21 x 55 x 29	150	113	22	\$2853
KVL4820CG	21 x 49 x 29	150	110	19	\$2678
KVL4220CG	21 x 43 x 29	150	95	17	\$2261
KVL3620CG	21 x 37 x 29	150	80	15	\$2177
KVL3020CG	21 x 31 x 29	125	75	12	\$2141
KVL2420CG	21 x 23 x 29	125	60	10	\$1796

To be used with corner unit.

KVR9622CG	23 x 97 x 29	150	200	39	\$4827
KVR9022CG	23 x 91 x 29	150	187	36	\$4522
KVR8422CG	23 x 85 x 29	150	174	34	\$4222
KVR7822CG	23 x 79 x 29	150	162	31	\$3922
KVR7222CG	23 x 73 x 29	150	149	29	\$3619
KVR6622CG	23 x 67 x 29	150	141	27	\$3394
KVR6022CG	23 x 61 x 29	150	132	24	\$3174
KVR5422CG	23 x 55 x 29	150	121	22	\$2995
KVR4822CG	23 x 49 x 29	125	115	19	\$2814
KVR4222CG	23 x 43 x 29	150	99	17	\$2374
KVR3622CG	23 x 37 x 29	150	83	15	\$2290
KVR3022CG	23 x 31 x 29	125	77	12	\$2249
KVR2422CG	23 x 23 x 29	125	61	10	\$1883
KVR9620CG	21 x 97 x 29	150	187	39	\$4596
KVR9020CG	21 x 91 x 29	150	175	36	\$4307
KVR8420CG	21 x 85 x 29	150	163	34	\$4024
KVR7820CG	21 x 79 x 29	150	152	31	\$3734
KVR7220CG	21 x 73 x 29	150	140	29	\$3450
KVR6620CG	21 x 67 x 29	150	133	27	\$3234
KVR6020CG	21 x 61 x 29	150	125	24	\$3025
KVR5420CG	21 x 55 x 29	150	113	22	\$2853
KVR4820CG	21 x 49 x 29	150	110	19	\$2678
KVR4220CG	21 x 43 x 29	150	95	17	\$2261
KVR3620CG	21 x 37 x 29	150	80	15	\$2177
KVR3020CG	21 x 31 x 29	125	75	12	\$2141
KVR2420CG	21 x 23 x 29	125	60	10	\$1796

To be used with corner unit.

Required Specifications

Finish
Edge

Optional Specifications

Additional grommet

LINKING RETURNS

MODEL# DIMENSIONS FREIGHT CLASS WT/LBS. CUBIC FT. LIST PRICE

D x W x H

KV9622CG	24 x 96 x 29	150	197	39	\$4714
KV9022CG	24 x 90 x 29	150	185	36	\$4422
KV8422CG	24 x 84 x 29	150	173	34	\$4123
KV7822CG	24 x 78 x 29	150	160	31	\$3826
KV7222CG	24 x 72 x 29	150	145	29	\$3534
KV6622CG	24 x 66 x 29	150	136	27	\$3314
KV6022CG	24 x 60 x 29	150	123	24	\$3093
KV5422CG	24 x 54 x 29	150	119	22	\$2911
KV4822CG	24 x 48 x 29	150	107	19	\$2732
KV4222CG	24 x 42 x 29	150	91	17	\$2517
KV3622CG	24 x 36 x 29	150	76	15	\$2290
KV3022CG	24 x 30 x 29	150	70	12	\$2160
KV2422CG	24 x 24 x 29	150	53	10	\$1815
KV9620CG	22 x 96 x 29	150	181	35	\$4494
KV9020CG	22 x 90 x 29	150	169	33	\$4214
KV8420CG	22 x 84 x 29	150	157	31	\$3929
KV7820CG	22 x 78 x 29	150	145	29	\$3648
KV7220CG	22 x 72 x 29	150	133	27	\$3367
KV6620CG	22 x 66 x 29	150	126	24	\$3157
KV6020CG	22 x 60 x 29	150	118	22	\$2947
KV5420CG	22 x 54 x 29	150	111	20	\$2772
KV4820CG	22 x 48 x 29	150	103	18	\$2599
KV4220CG	22 x 42 x 29	150	88	16	\$2177
KV3620CG	22 x 36 x 29	150	73	13	\$2101
KV3020CG	22 x 30 x 29	125	68	11	\$2059
KV2420CG	22 x 24 x 29	150	52	9	\$1728

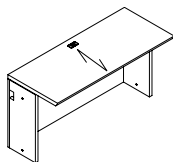

Center Surface*

With recessed end panels.

Required Specifications

Finish
Edge

Optional Specifications

Additional grommet

MODULAR STORAGE - NOTES

- All storage components are shipped assembled
- Components 28" high are intended for use with a desk, credenza or return shell
- Backs on 28" high pedestals and cabinets are unfinished. If finished back is required, see page 247.
- If a profiled top is required, see "Freestanding Storage" on page 256.
- If Handle is not specified Routed Pull, Black Lock & Grommet are standard
- If Handle is specified:
 - Black and Brass handle = Black Lock & Grommet
 - Silver, Nickel and Tungsten handle = Tungsten Lock & Grommet

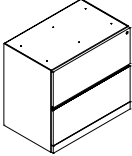
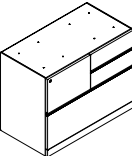
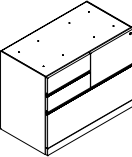
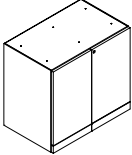
MODULAR STORAGE	MODEL#	DIMENSIONS	FREIGHT CLASS	WT/LBS.	CUBIC FT.	LIST PRICE
 <p>Modular Lateral File**</p>	D x W x H					
	KWF	19 x 35.1 x 28	92.5	115	11	\$3410
	KWN	19 x 30 x 28	92.5	96	9	\$2984
	KWF.5	19 x 34.5 x 28	92.5	115	11	\$3410
Units with ".5" at end of code are intended to be used if a Full Storage Credenza is to be created. For Single Pedestal installations either style can be used.						
 <p>Modular Combination Storage - Left**</p>	KWZL	19 x 35.1 x 28	92.5	115	11	\$3959
	KWZL.5	19 x 34.5 x 28	92.5	115	11	\$3959
1 lateral file, 2 box drawers top right, and 1 file top left.						
• Units with ".5" at end of code are intended to be used if a Full Storage Credenza is to be created. For Single Pedestal installations either style can be used.						
 <p>Modular Combination Storage - Right*</p>	KWZR	19 x 35.1 x 28	92.5	115	11	\$3959
	KWZR.5	19 x 34.5 x 28	92.5	115	11	\$3959
1 lateral file, 2 box drawers top left, and 1 file top right.						
• Units with ".5" at end of code are intended to be used if a Full Storage Credenza is to be created. For Single Pedestal installations either style can be used.						
 <p>Modular Storage Cabinet w/Doors*</p>	KWG	19 x 35.1 x 28	92.5	115	11	\$2377
	KWM	19 x 30 x 28	92.5	96	9	\$2004
	KWG.5	19 x 34.5 x 28	92.5	115	11	\$2377
Storage with 1 adjustable shelf.						
• Units with ".5" at end of code are intended to be used if a Full Storage Credenza is to be created. For Single Pedestal installations either style can be used.						

Required Specifications

Finish
Edge*

Optional Specifications

Handles**
Additional grommet

MODULAR STORAGE **MODEL#** **DIMENSIONS** **FREIGHT CLASS** **WT./LBS.** **CUBIC FT.** **LIST PRICE**

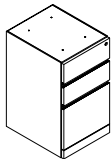

Modular Pedestal*

D x W x H

Letter width:

KWWD	23 x 15.6 x 28	85	72	6	\$2633
KWD	19 x 15.6 x 28	85	70	5	\$2293

Legal width:

KWWLD	23 x 18.5 x 28	85	85	7	\$3160
KWLD	19 x 18.5 x 28	85	83	6	\$2749

Box/box/file pedestal.

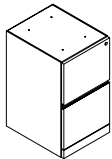

Modular Pedestal*

Letter width:

KWWE	23 x 15.6 x 28	85	72	6	\$2633
KWE	19 x 15.6 x 28	85	70	5	\$2293

Legal width:

KWWLE	23 x 18.5 x 28	85	85	7	\$3160
KWLE	19 x 18.5 x 28	85	83	6	\$2749

File/file pedestal.

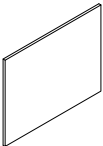

Finished Back

KBA36	0.8 x 35 x 27.5	125	18	3	\$498
KBA30	0.8 x 30 x 27.5	150	15	3	\$414
KBA18	0.8 x 18.5 x 27.5	150	10	2	\$241
KBA15	0.8 x 15.5 x 27.5	150	8	2	\$209

For modular pedestals.

Required Specifications **Optional Specifications**
 Finish Handles*

HUTCHES & WALL MOUNTED STORAGE NOTES

Hutches

- All hutches are shipped assembled
- Handles can be specified for hutches with wood doors.
- Handles cannot be specified on Aluminum framed glass doors.
- Frosted glass door is standard. White back painted clear glass is available, please contact customer care.

Closed pigeon hole storage hutch

- 42" unit has 21.5" of clearance

NOTE: Arrow indicates direction of grain

Edge options - must specify:

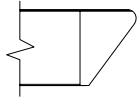

K16

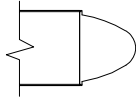

K18

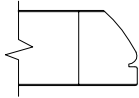

K21

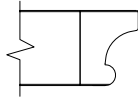

K22

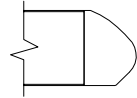

K29

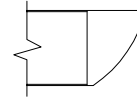

K30

Closed storage hutch

- 36" unit has 19.5" of clearance.
- 42" and 54" units have 25.5" of clearance
- For lock option, see page 270

Tasklight

- For proper size, see page 270.

• If Handle is specified:

- Black and Brass handle = Black Lock & Grommet
- Silver, Nickel and Tungsten handle = Tungsten Lock & Grommet

HUTCHES & WALL MOUNTED STORAGE

MODEL#

DIMENSIONS

FREIGHT CLASS

WT/LBS.

CUBIC FT.

LIST PRICE

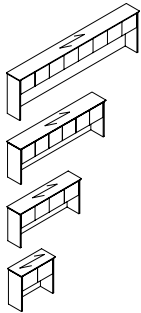

36" H Storage Hutch w/Wood Doors*

K108SH36	16 x 110 x 36	125	268	34	\$7771
K102SH36	16 x 104 x 36	125	254	32	\$7339
K96SH36	16 x 98 x 36	100	241	30	\$6793
K90SH36	16 x 92 x 36	100	227	28	\$6474
K84SH36	16 x 86 x 36	100	214	26	\$6042
K78SH36	16 x 80 x 36	100	200	24	\$5612
K72SH36	16 x 74 x 36	100	187	23	\$5177
K66SH36	16 x 68 x 36	100	173	21	\$4982
K60SH36	16 x 62 x 36	100	160	19	\$4749
K36SH36	16 x 38 x 36	100	94	11	\$3238
K30SH36	16 x 32 x 36	100	78	9	\$2834

Hutches longer than 102" have 8 doors, hutches between 102" and 86" have 6 doors, hutches between 80" and 62" have 4 doors, and 32" and 38" hutches have 2 doors. Locks are optional.

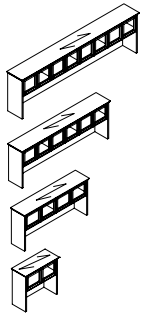

36" H Storage Hutch w/Glass Doors

K108SH36G	16 x 110 x 36	125	268	34	\$11297
K102SH36G	16 x 104 x 36	125	254	32	\$10140
K96SH36G	16 x 98 x 36	100	241	30	\$9670
K90SH36G	16 x 92 x 36	100	227	28	\$9195
K84SH36G	16 x 86 x 36	100	214	26	\$8727
K78SH36G	16 x 80 x 36	100	200	24	\$8264
K72SH36G	16 x 74 x 36	100	187	23	\$7075
K66SH36G	16 x 68 x 36	100	173	21	\$6883
K60SH36G	16 x 62 x 36	100	160	19	\$6533
K36SH36G	16 x 38 x 36	100	94	11	\$4178
K30SH36G	16 x 32 x 36	100	78	9	\$3724

Aluminum framed glass doors. Hutches longer than 102" have 8 doors, hutches between 102" and 86" have 6 doors, hutches between 80" and 62" have 4 doors, and 32" and 38" hutches have 2 doors. No lock option available.

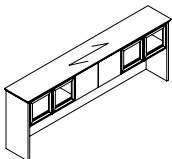

36" H Storage Hutch w/Doors*

K102SH36GDG	16 x 104 x 3	125	254	32	\$9120
K96SH36GDG	16 x 98 x 36	100	241	30	\$8688
K90SH36GDG	16 x 92 x 36	100	227	28	\$8255
K84SH36GDG	16 x 86 x 36	100	214	26	\$7455

Wood doors in the center and Aluminum framed glass doors on left and right. Locks are optional on wood doors.

Required Specifications

Finish
Edge

Optional Specifications

Handles* (wood doors only)
Locks* (wood doors only)

HUTCHES & WALL MOUNTED STORAGE

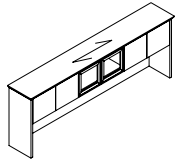

36" H Storage Hutch w/Doors*

MODEL#	DIMENSIONS D x W x H	FREIGHT CLASS	WT/LBS.	CUBIC FT.	LIST PRICE
K102SH36DGD	16 x 104 x 3	125	254	32	\$9120
K96SH36DGD	16 x 98 x 36	100	241	30	\$7567
K90SH36DGD	16 x 92 x 36	100	227	28	\$7360
K84SH36DGD	16 x 86 x 36	100	214	26	\$6930

Aluminum framed glass doors in the center and wood doors on left and right. Locks are optional on wood doors.

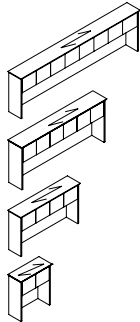

42" H Storage Hutch w/Wood Doors*

K108SH42	16 x 110 x 43	125	307	39	\$9060
K102SH42	16 x 104 x 43	125	290	37	\$8552
K96SH42	16 x 98 x 43	125	273	35	\$8055
K90SH42	16 x 92 x 43	125	256	33	\$7550
K84SH42	16 x 86 x 43	125	239	31	\$7044
K78SH42	16 x 80 x 43	150	222	38	\$6548
K72SH42	16 x 74 x 43	125	205	26	\$6042
K66SH42	16 x 68 x 43	125	188	24	\$5813
K60SH42	16 x 62 x 43	125	171	22	\$5538
K36SH42	16 x 38 x 43	125	102	13	\$3780
K30SH42	16 x 32 x 43	125	85	11	\$3307

Hutches longer than 102" have 8 doors, hutches between 102" and 86" have 6 doors, hutches between 80" and 62" have 4 doors, and 32" and 38" hutches have 2 doors. Locks are optional.



42" H Storage Hutch w/Glass Doors

K108SH42G	16 x 110 x 43	125	307	39	\$12590
K102SH42G	16 x 104 x 43	125	290	37	\$11359
K96SH42G	16 x 98 x 43	125	273	35	\$10817
K90SH42G	16 x 92 x 43	125	256	33	\$10277
K84SH42G	16 x 86 x 43	125	239	31	\$9735
K78SH42G	16 x 80 x 43	150	222	38	\$9194
K72SH42G	16 x 74 x 43	125	205	26	\$7938
K66SH42G	16 x 68 x 43	125	188	24	\$7658
K60SH42G	16 x 62 x 43	125	171	22	\$7385
K36SH42G	16 x 38 x 43	125	102	13	\$4720
K30SH42G	16 x 32 x 43	125	85	11	\$4198

Aluminum framed glass doors. Hutches longer than 102" have 8 doors, hutches between 102" and 86" have 6 doors, hutches between 80" and 62" have 4 doors, and 32" and 38" hutches have 2 doors. Lock option not available.

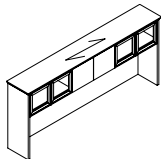

42" H Storage Hutch w/Doors*

K102SH42GDG	16 x 104 x 43	125	290	37	\$11850
K96SH42GDG	16 x 98 x 43	125	273	35	\$11153
K90SH42GDG	16 x 92 x 43	125	256	33	\$10458
K84SH42GDG	16 x 86 x 43	125	239	31	\$9759

Wood doors in the center and Aluminum framed glass doors on left and right. Locks are optional on wood doors.

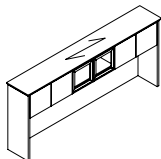

42" H Storage Hutch w/Doors*

K102SH42DGD	16 x 104 x 43	125	290	37	\$9919
K96SH42DGD	16 x 98 x 43	125	273	35	\$8942
K90SH42DGD	16 x 92 x 43	125	256	33	\$8438
K84SH42DGD	16 x 86 x 43	125	239	31	\$7938

Aluminum framed glass doors in the center and wood doors on left and right. Locks are optional on wood doors.

Required Specifications

Finish
Edge

Optional Specifications

Handles* (wood doors only)
Locks* (wood doors only)

HUTCHES & WALL MOUNTED STORAGE

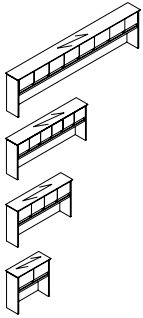

42" H Storage Hutch w/Wood Doors & Pigeon-Holes

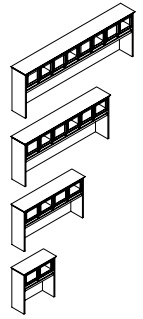

42" H Storage Hutch w/Glass Doors & Pigeon-Holes

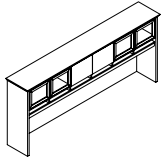

42" H Storage Hutch w/Doors & Pigeon-Holes

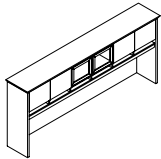

42" H Storage Hutch w/Doors & Pigeon-Holes

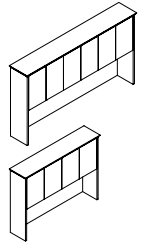

54" H Storage Hutch w/Wood Doors*

MODEL#	DIMENSIONS D x W x H	FREIGHT CLASS	WT./LBS.	CUBIC FT.	LIST PRICE
K108SHP42	16 x 110 x 43	125	307	39	\$10867
K102SHP42	16 x 104 x 43	125	290	37	\$10268
K96SHP42	16 x 98 x 43	125	273	35	\$9662
K90SHP42	16 x 92 x 43	125	256	33	\$9060
K84SHP42	16 x 86 x 43	125	239	31	\$8456
K78SHP42	16 x 80 x 43	150	222	38	\$7850
K72SHP42	16 x 74 x 43	125	205	26	\$7249
K66SHP42	16 x 68 x 43	125	188	24	\$6981
K60SHP42	16 x 62 x 43	125	171	22	\$6645
K36SHP42	16 x 38 x 43	125	102	13	\$4536
K30SHP42	16 x 32 x 43	125	85	11	\$3970

Hutches longer than 102" have 8 doors, hutches between 102" and 86" have 6 doors, hutches between 80" and 62" have 4 doors, and 32" and 38" hutches have 2 doors. Locks are optional.

K108SHP42G	16 x 110 x 43	125	307	39	\$14319
K102SHP42G	16 x 104 x 43	125	290	37	\$13002
K96SHP42G	16 x 98 x 43	125	273	35	\$12390
K90SHP42G	16 x 92 x 43	125	256	33	\$12352
K84SHP42G	16 x 86 x 43	125	239	31	\$11063
K78SHP42G	16 x 80 x 43	150	222	38	\$10429
K72SHP42G	16 x 74 x 43	125	205	26	\$9095
K66SHP42G	16 x 68 x 43	125	188	24	\$8807
K60SHP42G	16 x 62 x 43	125	171	22	\$8382
K36SHP42G	16 x 38 x 43	125	102	13	\$5446
K30SHP42G	16 x 32 x 43	125	85	11	\$4860

Aluminum framed glass doors. Hutches longer than 102" have 8 doors, hutches between 102" and 86" have 6 doors, hutches between 80" and 62" have 4 doors, and 32" and 38" hutches have 2 doors. No lock option available.

K102SHP42GDG	16 x 104 x 43	125	290	37	\$12002
K96SHP42GDG	16 x 98 x 43	125	273	35	\$11396
K90SHP42GDG	16 x 92 x 43	125	256	33	\$10799
K84SHP42GDG	16 x 86 x 43	125	239	31	\$9707

Wood doors in the center and Aluminum framed glass doors on left and right. Locks are optional on wood doors.

K102SHP42DGD	16 x 104 x 43	125	290	37	\$11159
K96SHP42DGD	16 x 98 x 43	125	273	35	\$10027
K90SHP42DGD	16 x 92 x 43	125	256	33	\$9562
K84SHP42DGD	16 x 86 x 43	125	239	31	\$9325

Aluminum framed glass doors in the center and wood doors on left and right. Locks are optional on wood doors.

K962SH54	16 x 98 x 55	125	351	45	\$10355
K902SH54	16 x 92 x 55	125	329	42	\$9707
K842SH54	16 x 86 x 55	125	307	39	\$9060
K782SH54	16 x 80 x 55	125	285	37	\$8412
K722SH54	16 x 74 x 55	125	263	34	\$7764
K662SH54	16 x 68 x 55	125	241	31	\$7474
K602SH54	16 x 62 x 55	125	219	28	\$7117

Hutches between 98" and 86" have 6 doors; hutches less than 86" have 4 doors. One adjustable shelf. Locks are optional.

Required Specifications

Finish
Edge

Optional Specifications

Handles* (wood doors only)
Locks* (wood doors only)

HUTCHES & WALL MOUNTED STORAGE **MODEL#** **DIMENSIONS** **FREIGHT CLASS** **WT/LBS.** **CUBIC FT.** **LIST PRICE**

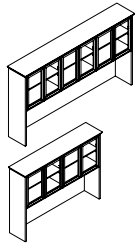

54" H Storage Hutch w/Glass Doors

D x W x H						
K962SH54G	16 x 98 x 55	125	351	45	\$13816	
K902SH54G	16 x 92 x 55	125	329	42	\$12868	
K842SH54G	16 x 86 x 55	125	307	39	\$11915	
K782SH54G	16 x 80 x 55	125	285	37	\$10960	
K722SH54G	16 x 74 x 55	125	263	34	\$10014	
K662SH54G	16 x 68 x 55	125	241	31	\$9653	
K602SH54G	16 x 62 x 55	125	219	28	\$9227	

Aluminum framed glass doors. Hutches between 98" and 86" have 6 doors; hutches less than 86" have 4 doors. One adjustable shelf. No lock option available.

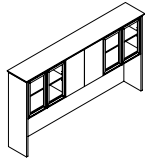

54" H Storage Hutch w/Doors*

K962SH54GDG	16 x 98 x 55	125	351	45	\$12463
K902SH54GDG	16 x 92 x 55	125	329	42	\$11812
K842SH54GDG	16 x 86 x 55	125	309	39	\$11167

Wood doors in the center and Aluminum framed glass doors on left and right. One adjustable shelf. Locks are optional on wood doors.

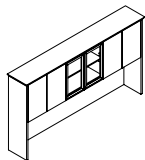

54" H Storage Hutch w/Doors*

K962SH54DGD	16 x 98 x 55	125	351	45	\$11405
K902SH54DGD	16 x 92 x 55	125	329	42	\$10760
K842SH54DGD	16 x 86 x 55	125	307	39	\$10115

Aluminum framed glass doors in the center and wood doors on left and right. One adjustable shelf. Locks are optional on wood doors.

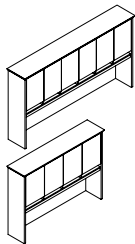

54" H Storage Hutch w/Wood Doors & Pigeon-Holes

K962SHP54	16 x 98 x 55	125	351	45	\$12428
K902SHP54	16 x 92 x 55	125	329	42	\$11644
K842SHP54	16 x 86 x 55	125	307	39	\$10865
K782SHP54	16 x 80 x 55	125	285	37	\$10865
K722SHP54	16 x 74 x 55	125	263	34	\$9313
K662SHP54	16 x 68 x 55	125	241	31	\$8970
K602SHP54	16 x 62 x 55	125	219	28	\$8545

Hutches between 98" and 86" have 6 doors; hutches less than 86" have 4 doors. One adjustable shelf. Locks are optional.

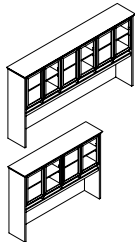

54" H Storage Hutch w/Glass Doors & Pigeon-Holes

K962SHP54G	16 x 98 x 55	125	351	45	\$15888
K902SHP54G	16 x 92 x 55	125	329	42	\$14807
K842SHP54G	16 x 86 x 55	125	307	39	\$13723
K782SHP54G	16 x 80 x 55	125	285	37	\$12645
K722SHP54G	16 x 74 x 55	125	263	34	\$11566
K662SHP54G	16 x 68 x 55	125	241	34	\$11150
K602SHP54G	16 x 62 x 55	125	219	28	\$10653

Aluminum framed glass doors. Hutches between 98" and 86" have 6 doors; hutches less than 86" have 4 doors. One adjustable shelf. No lock option available.

Required Specifications

Finish
Edge

Optional Specifications

Handles* (wood doors only)
Locks* (wood doors only)

HUTCHES & WALL MOUNTED STORAGE

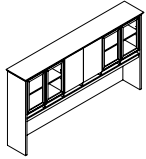

54" H Storage Hutch w/Doors & Pigeon-Holes

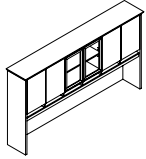

54" H Storage Hutch w/Doors &* Pigeon-Holes

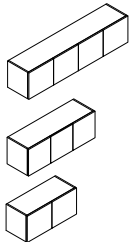

Wall Mount Storage w/Wood Doors*

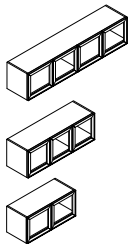

Wall Mount Storage w/Glass Doors

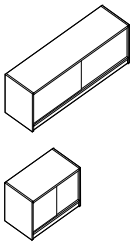

Wall Mount Storage w/Sliding Glass Doors

MODEL#	DIMENSIONS D x W x H	FREIGHT CLASS	WT/LBS.	CUBIC FT.	LIST PRICE
K962SHP54GDG	16 x 98 x 55	125	351	45	\$13479
K902SHP54GDG	16 x 92 x 55	125	329	42	\$12702
K842SHP54GDG	16 x 86 x 55	125	307	39	\$11921

Wood doors in the center and Aluminum framed glass doors on left and right. One adjustable shelf. Locks are optional on wood doors.

K962SHP54DGD	16 x 98 x 55	125	351	45	\$14532
K902SHP54DGD	16 x 92 x 55	125	329	42	\$13756
K842SHP54DGD	16 x 86 x 55	125	307	39	\$12976

Aluminum framed glass doors in the center and wood doors on left and right. One adjustable shelf. Locks are optional on wood doors.

CSF72	15.5 x 72 x 16.5	92.5	100	10	\$2418
CSF66	15.5 x 66 x 16.5	100	83	9	\$2218
CSF60	15.5 x 60 x 16.5	100	75	8	\$2010
CSF54	15.5 x 54 x 16.5	100	68	7	\$1812
CSF48	15.5 x 48 x 16.5	100	60	7	\$1611
CSF42	15.5 x 42 x 16.5	100	55	6	\$1481
CSF36	15.5 x 36 x 16.5	92.5	50	5	\$1453
CSF30	15.5 x 30 x 16.5	92.5	45	4	\$1429

Locks are optional.

CSF72G	15.5 x 72 x 16.5	92.5	100	10	\$5087
CSF66G	15.5 x 66 x 16.5	100	83	9	\$4725
CSF60G	15.5 x 60 x 16.5	100	75	8	\$4429
CSF54G	15.5 x 54 x 16.5	100	68	7	\$3968
CSF48G	15.5 x 48 x 16.5	100	60	7	\$3505
CSF42G	15.5 x 42 x 16.5	100	55	6	\$3111
CSF36G	15.5 x 36 x 16.5	92.5	50	5	\$2876
CSF30G	15.5 x 30 x 16.5	92.5	45	4	\$2792

Aluminum framed glass doors. No lock option available.

CSF72GSL	18 x 72 x 16.5	92.5	100	10	\$5087
CSF66GSL	18 x 66 x 16.5	100	83	9	\$4725
CSF60GSL	18 x 60 x 16.5	100	75	8	\$4429
CSF54GSL	18 x 54 x 16.5	100	68	7	\$3968
CSF48GSL	18 x 48 x 16.5	100	60	7	\$3505
CSF42GSL	18 x 42 x 16.5	100	55	6	\$3111
CSF36GSL	18 x 36 x 16.5	92.5	50	5	\$2876
CSF30GSL	18 x 30 x 16.5	92.5	45	4	\$2792

Frameless sliding glass doors. No lock option available.

Required Specifications

Finish
Edge

Optional Specifications

Handles* (wood doors only)
Locks* (wood doors only)

HUTCHES & WALL MOUNTED STORAGE

MODEL# DIMENSIONS FREIGHT CLASS WT./LBS. CUBIC FT. LIST PRICE

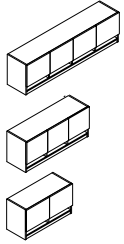

Wall Mount Storage w/Wood Doors &* Pigeon-Holes

	D x W x H					
CSFP72	15.5 x 72 x 20	92.5	100	10		\$2897
CSFP66	15.5 x 66 x 20	100	83	9		\$2658
CSFP60	15.5 x 60 x 20	100	75	8		\$2418
CSFP54	15.5 x 54 x 20	100	68	7		\$2176
CSFP48	15.5 x 48 x 20	100	60	7		\$1931
CSFP42	15.5 x 42 x 20	100	55	6		\$1832
CSFP36	15.5 x 36 x 20	92.5	50	5		\$1744
CSFP30	15.5 x 30 x 20	92.5	45	4		\$1715

Locks are optional.

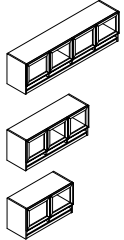

Wall Mount Storage w/Glass Doors & Pigeon-Holes

CSFP72G	15.5 x 72 x 20	100	100	12		\$5597
CSFP66G	15.5 x 66 x 20	125	83	11		\$5352
CSFP60G	15.5 x 60 x 20	125	75	10		\$4931
CSFP54G	15.5 x 54 x 20	125	68	9		\$4600
CSFP48G	15.5 x 48 x 20	125	60	8		\$3904
CSFP42G	15.5 x 42 x 20	125	55	7		\$3400
CSFP36G	15.5 x 36 x 20	100	50	6		\$3243
CSFP30G	15.5 x 30 x 20	100	45	5		\$3159

Aluminum framed glass doors. No lock option available.

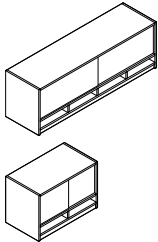

Wall Mount Storage w/Sliding Glass Doors & Pigeon-Holes

CSFP72GSL	18 x 72 x 20	100	100	12		\$5597
CSFP66GSL	18 x 66 x 20	125	83	11		\$5352
CSFP60GSL	18 x 60 x 20	125	75	10		\$4931
CSFP54GSL	18 x 54 x 20	125	68	9		\$4600
CSFP48GSL	18 x 48 x 20	125	60	8		\$3904
CSFP42GSL	18 x 42 x 20	125	55	7		\$3400
CSFP36GSL	18 x 36 x 20	100	50	6		\$3243
CSFP30GSL	18 x 30 x 20	100	45	5		\$3159

Frameless sliding glass doors. Locks are optional.

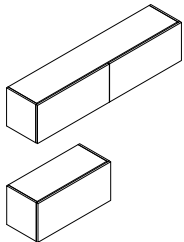

Wall Mount Storage w/Wood Flipper Doors

CSFF72	15.5 x 72 x 16.5	92.5	100	10		\$3564
CSFF66	15.5 x 66 x 16.5	100	83	9		\$3268
CSFF60	15.5 x 60 x 16.5	100	75	8		\$2969
CSFF54	15.5 x 54 x 16.5	100	68	7		\$2675
CSFF48	15.5 x 48 x 16.5	100	60	7		\$2378
CSFF42	15.5 x 42 x 16.5	100	55	6		\$2206
CSFF36	15.5 x 36 x 16.5	92.5	50	5		\$2166
CSFF30	15.5 x 30 x 16.5	92.5	45	4		\$2132

Locks are optional.

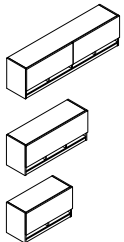

Wall Mount Storage w/Pigeon-Holes & Wood Flipper Doors

CSFFP72	15.5 x 72 x 20	100	100	12		\$4280
CSFFP66	15.5 x 66 x 20	125	83	11		\$3921
CSFFP60	15.5 x 60 x 20	125	75	10		\$3566
CSFFP54	15.5 x 54 x 20	125	68	9		\$3206
CSFFP48	15.5 x 48 x 20	125	60	8		\$2855
CSFFP42	15.5 x 42 x 20	125	55	7		\$2644
CSFFP36	15.5 x 36 x 20	100	50	6		\$2599
CSFFP30	15.5 x 30 x 20	100	45	5		\$2553

Locks are optional.

Required Specifications

Finish
Edge

Optional Specifications

Handles* (wood doors only)
Locks* (wood doors only)

HUTCHES & WALL MOUNTED STORAGE

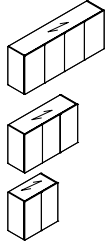

**Double High Wall Mount Storage*
w/Wood Doors**

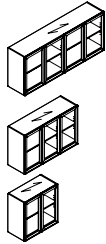

**Double High Wall Mount Storage
w/Glass Doors**

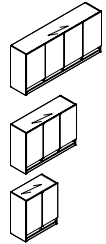

**Double High Wall Mount Storage*
w/Pigeon-Holes & Wood Doors**

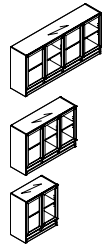

**Double High Wall Mount Storage
w/Pigeon-Holes & Glass Doors**

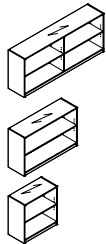

Double High Open Wall Mount Storage

MODEL#	DIMENSIONS D x W x H	FREIGHT CLASS	WT/LBS.	CUBIC FT.	LIST PRICE
CSF72H30	15.5 x 72 x 30	100	140	17	\$6352
CSF66H30	15.5 x 66 x 30	125	116	16	\$5829
CSF60H30	15.5 x 60 x 30	125	105	14	\$5290
CSF54H30	15.5 x 54 x 30	125	95	13	\$4761
CSF48H30	15.5 x 48 x 30	125	85	12	\$4234
CSF42H30	15.5 x 42 x 30	125	77	10	\$3888
CSF36H30	15.5 x 36 x 30	125	70	9	\$3816
CSF30H30	15.5 x 30 x 30	100	63	7	\$3749

Locks are optional.

CSF72H30G	15.5 x 72 x 30	100	140	17	\$9239
CSF66H30G	15.5 x 66 x 30	125	116	16	\$9119
CSF60H30G	15.5 x 60 x 30	60	1045	14	\$8551
CSF54H30G	15.5 x 54 x 30	125	95	13	\$7658
CSF48H30G	15.5 x 48 x 30	125	85	12	\$6765
CSF42H30G	15.5 x 42 x 30	125	77	10	\$6009
CSF36H30G	15.5 x 36 x 30	125	70	9	\$5552
CSF30H30G	15.5 x 30 x 30	100	63	7	\$5388

Aluminum framed glass doors. No lock option available.

CSFP72H34	15.5 x 72 x 34	100	140	17	\$6909
CSFP66H34	15.5 x 66 x 34	125	116	16	\$6336
CSFP60H34	15.5 x 60 x 34	125	105	14	\$5766
CSFP54H34	15.5 x 54 x 34	125	95	13	\$5185
CSFP48H34	15.5 x 48 x 34	125	85	12	\$4604
CSFP42H34	15.5 x 42 x 34	125	77	10	\$4376
CSFP36H34	15.5 x 36 x 34	125	70	9	\$4151
CSFP30H34	15.5 x 30 x 34	100	63	7	\$4083

Locks are optional.

CSFP72H34G	15.5 x 72 x 34	100	140	17	\$9801
CSFP66H34G	15.5 x 66 x 34	125	116	16	\$9369
CSFP60H34G	15.5 x 60 x 34	125	105	14	\$8629
CSFP54H34G	15.5 x 54 x 34	125	95	13	\$8049
CSFP48H34G	15.5 x 48 x 34	125	85	12	\$6835
CSFP42H34G	15.5 x 42 x 34	125	77	10	\$5952
CSFP36H34G	15.5 x 36 x 34	125	70	9	\$5952
CSFP30H34G	15.5 x 30 x 34	100	63	7	\$5526

Aluminum framed glass doors. No lock option available.

CSFO72H30	15.5 x 72 x 30	100	140	17	\$5160
CSFO66H30	15.5 x 66 x 30	125	116	16	\$4738
CSFO60H30	15.5 x 60 x 30	125	105	14	\$4303
CSFO54H30	15.5 x 54 x 30	125	95	13	\$3881
CSFO48H30	15.5 x 48 x 30	125	85	12	\$3452
CSFO42H30	15.5 x 42 x 30	125	77	10	\$3178
CSFO36H30	15.5 x 36 x 30	125	70	9	\$3140
CSFO30H30	15.5 x 30 x 30	100	63	7	\$3082

Required Specifications

Finish
Edge

Optional Specifications

Handles* (wood doors only)
Locks* (wood doors only)

HUTCHES **MODEL#** **DIMENSIONS** **FREIGHT CLASS** **WT./LBS.** **CUBIC FT.** **LIST PRICE**

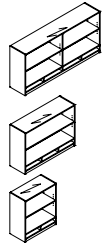

Double High Open Wall Mount Storage w/Pigeon-Holes

	D x W x H					
CSFOP72H34	15.5 x 72 x 34	100	140	17	\$5618	
CSFOP66H34	15.5 x 66 x 34	125	116	16	\$5151	
CSFOP60H34	15.5 x 60 x 34	125	105	14	\$4682	
CSFOP54H34	15.5 x 54 x 34	125	95	13	\$4220	
CSFOP48H34	15.5 x 48 x 34	125	85	12	\$3743	
CSFOP42H34	15.5 x 42 x 34	125	77	10	\$3512	
CSFOP36H34	15.5 x 36 x 34	125	70	9	\$3408	
CSFOP30H34	15.5 x 30 x 34	100	63	7	\$3358	

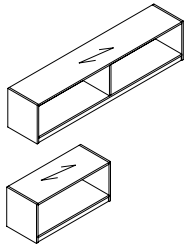

Open Wall Mount Storage

CSFO72	14.5 x 72 x 16.5	92.5	100	10	\$1960	
CSFO66	14.5 x 66 x 16.5	100	83	9	\$1799	
CSFO60	14.5 x 60 x 16.5	100	75	8	\$1641	
CSFO54	14.5 x 54 x 16.5	100	68	7	\$1481	
CSFO48	14.5 x 48 x 16.5	100	60	7	\$1316	
CSFO42	14.5 x 42 x 16.5	100	55	6	\$1212	
CSFO36	14.5 x 36 x 16.5	92.5	50	5	\$1194	
CSFO30	14.5 x 30 x 16.5	92.5	45	4	\$1171	

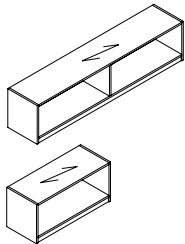

16" D Open Wall Mount Storage

CSFO72D16	16 x 72 x 16.5	92.5	100	10	\$2974	
CSFO66D16	16 x 66 x 16.5	100	83	9	\$2761	
CSFO60D16	16 x 60 x 16.5	100	75	8	\$2545	
CSFO54D16	16 x 54 x 16.5	100	68	7	\$2332	
CSFO48D16	16 x 48 x 16.5	100	60	7	\$2117	
CSFO42D16	16 x 42 x 16.5	100	55	6	\$1979	
CSFO36D16	16 x 36 x 16.5	92.5	50	5	\$1960	
CSFO30D16	16 x 30 x 16.5	92.5	45	4	\$1928	

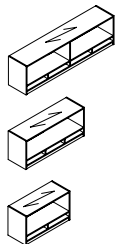

Open Wall Mount Storage w/Pigeon-Holes

CSFOP72	14.5 x 72 x 19.5	92.5	100	10	\$2354	
CSFOP66	14.5 x 66 x 19.5	100	83	9	\$2162	
CSFOP60	14.5 x 60 x 19.5	100	75	8	\$1964	
CSFOP54	14.5 x 54 x 19.5	100	68	7	\$1772	
CSFOP48	14.5 x 48 x 19.5	100	60	7	\$1569	
CSFOP42	14.5 x 42 x 19.5	100	55	6	\$1476	
CSFOP36	14.5 x 36 x 19.5	92.5	50	5	\$1434	
CSFOP30	14.5 x 30 x 19.5	92.5	45	4	\$1413	

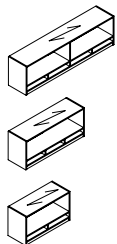

16" D Open Wall Mount Storage w/Pigeon-Holes

CSFOP72D16	16 x 72 x 19.5	100	100	12	\$3599	
CSFOP66D16	16 x 66 x 19.5	125	83	11	\$3332	
CSFOP60D16	16 x 60 x 19.5	125	75	10	\$3066	
CSFOP54D16	16 x 54 x 19.5	125	68	9	\$2800	
CSFOP48D16	16 x 48 x 19.5	125	60	8	\$2529	
CSFOP42D16	16 x 42 x 19.5	125	55	7	\$2400	
CSFOP36D16	16 x 36 x 19.5	100	50	6	\$2337	
CSFOP30D16	16 x 30 x 19.5	100	45	5	\$2307	

Required Specifications

Finish
Edge

FREESTANDING STORAGE NOTES

NOTE: Arrow indicates direction of grain

Pedestals

- All units are shipped assembled.
- Standard face locking.

Combination Storage

- All units are shipped assembled.
- No modifications accepted for this unit.
- Box drawers do not lock.
- Standard face locking.

Storage Cabinets

- Units include adjustable shelves.
- If Handle is specified:
 - Black and Brass handle = Black Lock & Grommet
 - Silver, Nickel and Tungsten handle = Tungsten Lock & Grommet

Edge options - must specify:

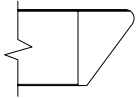

K16

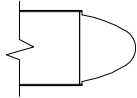

K18

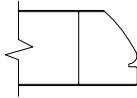

K21

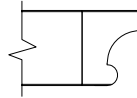

K22

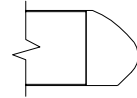

K29

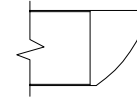

K30

FREESTANDING STORAGE

MODEL#

DIMENSIONS

FREIGHT CLASS

WT/LBS.

CUBIC FT.

LIST PRICE

D x W x H

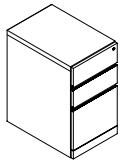

Freestanding Pedestal

KWDB	19.8 x 15.5 x 28	85	70	5	\$2501
KWWDB	23.8 x 15.5 x 28	85	75	6	\$2879

Box/box/file.

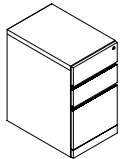

Freestanding Mobile Pedestal

KWDM	19.8 x 15.5 x 28	85	70	5	\$2690
KWWDM	23.8 x 15.5 x 28	85	75	6	\$3095

Box/box/file.

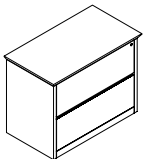

Lateral File - 2 high

KF3622	23 x 38 x 29	85	170	13	\$4662
KF3620	21 x 38 x 29	85	159	12	\$4239
KN3022	23 x 32.9 x 29	85	142	11	\$4081
KN3020	21 x 32.9 x 29	85	131	10	\$3708

Two lateral file drawers.

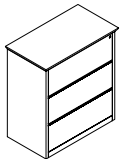

Lateral File - 3 high

KF36223	23 x 38 x 42	92.5	212	19	\$5692
KF36203	21 x 38 x 42	92.5	193	18	\$5317
KN30223	23 x 32.9 x 42	92.5	176	16	\$4979
KN30203	21 x 32.9 x 42	92.5	160	15	\$4649

Three lateral file drawers.

Required Specifications

Finish
Edge

Optional Specifications

Handles

FREESTANDING STORAGE

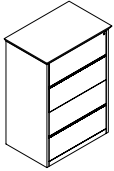

Lateral File - 4 high

MODEL#	DIMENSIONS D x W x H	FREIGHT CLASS	WT/LBS.	CUBIC FT.	LIST PRICE
KF36224	23 x 38 x 54	92.5	270	25	\$6933
KF36204	21 x 38 x 54	92.5	259	23	\$6586
KN30224	23 x 32.9 x 54	92.5	225	21	\$6069
KN30204	21 x 32.9 x 54	92.5	214	19	\$5766

Four lateral file drawers.

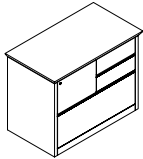

Combination Storage - Left

KZL3622	23 x 38 x 29	85	170	13	\$5053
KZL3620	21 x 38 x 29	85	160	12	\$4812

With 1 lateral file, 2 box drawers in the top right, and 1 file drawer in the top left.

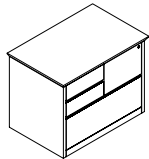

Combination Storage - Right

KZR3622	23 x 38 x 29	85	170	13	\$5053
KZR3620	21 x 38 x 29	85	160	12	\$4812

With 1 lateral file, 2 box drawers in the top left, and 1 file drawer in the top right.

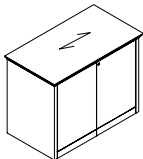

Storage Cabinet w/Doors

KBD3622	23 x 38 x 29	92.5	140	13	\$3173
KBD3620	21 x 38 x 29	92.5	129	12	\$3022
KBD3022	23 x 32.9 x 29	92.5	117	11	\$2779
KBD3020	21 x 32.9 x 29	92.5	106	10	\$2641

Storage with 1 adjustable shelf. For Aluminum framed glass door option, contact Customer Care.

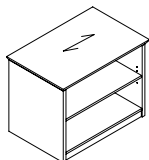

Open Storage Cabinet

KOB3622	23 x 38.75 x 29	100	115	13	\$2549
KOB3620	21 x 38.75 x 29	100	104	12	\$2426
KOB3022	23 x 33.63 x 29	100	96	11	\$2225
KOB3020	21 x 33.63 x 29	100	85	10	\$2117

Storage with 1 adjustable shelf.

Required Specifications

Finish
Edge

Optional Specifications

Handles

FREESTANDING STORAGE

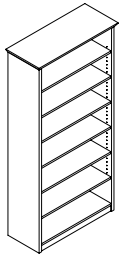

Open Bookcase

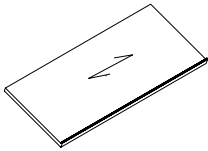

Additional Shelf

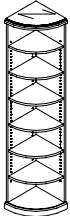

Quarter Round Open Bookcase

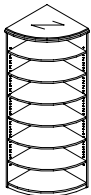

Quarter Round Open Bookcase

MODEL#	DIMENSIONS D x W x H	FREIGHT CLASS	WT/LBS.	CUBIC FT.	LIST PRICE
KB73615	16 x 38 x 78	100	228	24	\$3959
KB63615	16 x 38 x 72	100	210	23	\$3656
KB53615	16 x 38 x 65	100	188	21	\$3367
KB43615	16 x 38 x 48	100	140	15	\$2772
KB23615	16 x 38 x 29	92.5	90	9	\$2222
KB73015	16 x 32.9 x 78	92.5	228	20	\$3466
KB63015	16 x 32.9 x 72	92.5	210	19	\$3198
KB53015	16 x 32.9 x 65	92.5	188	17	\$2948
KB43015	16 x 32.9 x 48	92.5	140	13	\$2426
KB23015	16 x 32.9 x 29	92.5	90	8	\$1945

78" high models have 6 adjustable shelves, 72" has 5 adjustable shelves, 65" has 4 adjustable shelves, 48" has 3 adjustable shelves, 29" has 1 adjustable shelves.

KMAG3624	24 x 36 x 1	92.5	112	10	\$240
KMAG3622	22 x 36 x 1	92.5	104	10	\$218
KMAG3620	20 x 36 x 1	92.5	92	9	\$196
KMAG3615	15 x 36 x 1	92.5	81	8	\$173
KMAG3024	24 x 30 x 1	92.5	94	9	\$202
KMAG3022	22 x 30 x 1	100	87	9	\$184
KMAG3020	20 x 30 x 1	100	76	8	\$162
KMAG3015	15 x 30 x 1	100	67	8	\$143

For use with open bookcase. Can be specified for each shelf in an open bookcase.

KB7R1515	16 x 16 x 78	100	95	10	\$3119
KB6R1515	16 x 16 x 72	100	83	9	\$2876
KB5R1515	16 x 16 x 65	100	81	9	\$2648
KB4R1515	16 x 16 x 48	100	59	6	\$2179
KB2R1515	16 x 16 x 29	100	37	4	\$1753

84" and 78" high models have 6 adjustable shelves, 72" has 5 adjustable shelves, 65" has 4 adjustable shelves, 48" has 3 adjustable shelves, 29" has 1 adjustable shelf.

KB7R2222H84	23 x 23 x 84	100	191	23	\$5364
KB7R2222H72	23 x 23 x 72	100	171	20	\$4600
KB7R2222H65	23 x 23 x 65	100	157	18	\$5365
KB7R2020H84	21 x 21 x 84	100	163	19	\$5110
KB7R2020H72	21 x 21 x 72	100	142	17	\$4380
KB7R2020H65	21 x 21 x 65	100	130	15	\$5110

84" high models have 6 adjustable shelves, 72" has 5 adjustable shelves, and 65" has 4 adjustable shelves

Required Specifications

Finish
Edge

Optional Specifications

Handles

FREESTANDING STORAGE

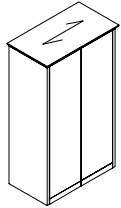

Storage Cabinet w/Wood Doors

MODEL# DIMENSIONS FREIGHT CLASS WT/LBS. CUBIC FT. LIST PRICE

D x W x H

K1D22W36H84	23 x 38 x 84	125	304	42	\$7448
K1D22W36H72	23 x 38 x 72	100	283	33	\$6385
K1D22W36H65	23 x 38 x 65	100	259	30	\$5851
K1D22W30H84	23 x 32.9 x 84	125	304	42	\$6516
K1D22W30H72	23 x 32.9 x 72	100	283	33	\$5586
K1D22W30H65	23 x 32.9 x 65	100	259	30	\$5123
K1D22W24H84	23 x 26 x 84	92.5	320	28	\$5583
K1D22W24H72	23 x 26 x 72	92.5	255	24	\$4787
K1D22W24H65	23 x 26 x 65	125	173	22	\$4397

K1D20W36H84	21 x 38 x 84	100	297	35	\$7098
K1D20W36H72	21 x 38 x 72	100	269	30	\$6084
K1D20W36H65	21 x 38 x 65	100	245	28	\$5577
K1D20W30H84	21 x 32.9 x 84	100	257	29	\$5911
K1D20W30H72	21 x 32.9 x 72	100	233	25	\$5068
K1D20W30H65	21 x 32.9 x 65	100	202	23	\$4645
K1D20W24H84	21 x 26 x 84	100	198	23	\$4731
K1D20W24H72	21 x 26 x 72	100	179	20	\$4054
K1D20W24H65	21 x 26 x 65	100	163	18	\$3712

84" high models have 6 adjustable shelves, 72" has 5 adjustable shelves, 65" has 4 adjustable shelves. For Aluminum framed glass door option, please contact customer care. Locks are optional.

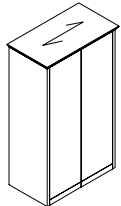

Wardrobe Cabinet

K2D22W36H84	23 x 38 x 84	125	304	42	\$6462
K2D22W36H72	23 x 38 x 72	100	283	33	\$5541
K2D22W36H65	23 x 38 x 65	100	259	30	\$5079
K2D22W30H84	23 x 32.9 x 84	125	304	42	\$5656
K2D22W30H72	23 x 32.9 x 72	100	283	33	\$4846
K2D22W30H65	23 x 32.9 x 65	100	259	30	\$4440
K2D22W24H84	23 x 26 x 84	92.5	320	28	\$4846
K2D22W24H72	23 x 26 x 72	92.5	255	24	\$4156
K2D22W24H65	23 x 26 x 65	125	173	22	\$3807

K2D20W36H84	21 x 38 x 84	100	297	35	\$6155
K2D20W36H72	21 x 38 x 72	100	269	30	\$5277
K2D20W36H65	21 x 38 x 65	100	245	28	\$4837
K2D20W30H84	21 x 32.9 x 84	100	257	29	\$5130
K2D20W30H72	21 x 32.9 x 72	100	233	25	\$4398
K2D20W30H65	21 x 32.9 x 65	100	202	23	\$4029
K2D20W24H84	21 x 26 x 84	100	198	23	\$4104
K2D20W24H72	21 x 26 x 72	100	179	20	\$3514
K2D20W24H65	21 x 26 x 65	100	163	18	\$3222

Doors, coat rack and hat shelf. 84" high models have 6 adjustable shelves, 72" has 5 adjustable shelves, 65" has 4 adjustable shelves. For Aluminum framed glass door option, please contact customer care. Locks are optional.

Required Specifications

Finish
Edge

Optional Specifications

Handles
Locks

FREESTANDING STORAGE

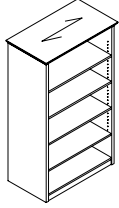

Open Bookcase

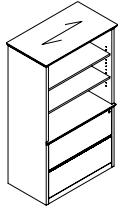

Open Cabinet

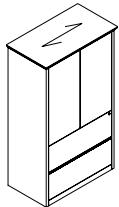

Storage Cabinet w/Doors*

MODEL#	DIMENSIONS	FREIGHT CLASS	WT/LBS.	CUBIC FT.	LIST PRICE
D x W x H					
K7D22W36H84	23 x 38 x 84	125	331	43	\$5960
K7D22W36H72	23 x 38 x 72	100	306	36	\$5110
K7D22W36H65	23 x 38 x 65	100	281	33	\$4684
K7D22W30H84	23 x 32.9 x 84	125	280	36	\$5214
K7D22W30H72	23 x 32.9 x 72	100	255	30	\$4541
K7D22W30H65	23 x 32.9 x 65	100	234	28	\$4098
K7D20W36H84	21 x 38 x 84	125	282	36	\$5679
K7D20W36H72	21 x 38 x 72	100	257	30	\$4870
K7D20W36H65	21 x 38 x 65	100	234	28	\$4463
K7D20W30H84	21 x 32.9 x 84	100	248	29	\$4730
K7D20W30H72	21 x 32.9 x 72	100	223	25	\$4053
K7D20W30H65	21 x 32.9 x 65	100	193	23	\$3714

84" high models have 6 adjustable shelves, 72" has 5 adjustable shelves, 65" has 4 adjustable shelves.

K12D22W36H84	23 x 38 x 84	92.5	364	36	\$8087
K12D22W36H72	23 x 38 x 72	92.5	336	33	\$6932
K12D22W36H65	23 x 38 x 65	92.5	308	30	\$6359
K12D22W30H84	23 x 32.9 x 84	92.5	330	31	\$7075
K12D22W30H72	23 x 32.9 x 72	92.5	294	28	\$6069
K12D22W30H65	23 x 32.9 x 65	92.5	257	25	\$5561
K12D20W36H84	21 x 38 x 84	92.5	348	33	\$7705
K12D20W36H72	21 x 38 x 72	92.5	322	30	\$6602
K12D20W36H65	21 x 38 x 65	92.5	294	28	\$6052
K12D20W30H84	21 x 32.9 x 84	92.5	317	28	\$6741
K12D20W30H72	21 x 32.9 x 72	92.5	280	25	\$5775
K12D20W30H65	21 x 32.9 x 65	92.5	243	23	\$5046

Above two lateral file drawers. 84" high models have 6 adjustable shelves, 72" has 5 adjustable shelves, 65" has 4 adjustable shelves.

K13D22W36H84	23 x 38 x 84	92.5	364	36	\$9217
K13D22W36H72	23 x 38 x 72	92.5	341	33	\$7900
K13D22W36H65	23 x 38 x 65	92.5	313	30	\$7244
K13D22W30H84	23 x 32.9 x 84	92.5	330	31	\$8065
K13D22W30H72	23 x 32.9 x 72	92.5	299	28	\$6912
K13D22W30H65	23 x 32.9 x 65	92.5	261	25	\$6337
K13D20W36H84	21 x 38 x 84	92.5	365	35	\$8778
K13D20W36H72	21 x 38 x 72	92.5	327	30	\$7524
K13D20W36H65	21 x 38 x 65	92.5	299	28	\$6893
K13D20W30H84	21 x 32.9 x 84	92.5	305	29	\$7317
K13D20W30H72	21 x 32.9 x 72	92.5	285	25	\$6274
K13D20W30H65	21 x 32.9 x 65	92.5	247	23	\$5747

Above two lateral file drawers. 84" high models have 6 adjustable shelves, 72" has 5 adjustable shelves, 65" has 4 adjustable shelves. For Aluminum framed glass door option, please contact customer care. Lock for upper storage is optional.

Required Specifications

Finish
Edge

Optional Specifications

Handles
Lock*

FREESTANDING STORAGE

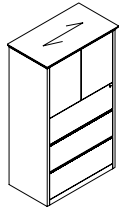

Storage Cabinet w/Doors*

MODEL# DIMENSIONS FREIGHT CLASS WT/LBS. CUBIC FT. LIST PRICE

D x W x H

K14D22W36H84	23 x 38 x 84	100	340	42	\$9908
K14D22W36H72	23 x 38 x 72	100	312	33	\$8493
K14D22W36H65	23 x 38 x 65	100	286	30	\$7788
K14D22W30H84	23 x 32.9 x 84	100	308	35	\$8667
K14D22W30H72	23 x 32.9 x 72	100	273	28	\$7431
K14D22W30H65	23 x 32.9 x 65	100	238	25	\$6812

K14D20W36H84	21 x 38 x 84	100	330	35	\$9436
K14D20W36H72	21 x 38 x 72	100	298	30	\$8090
K14D20W36H65	21 x 38 x 65	100	272	28	\$7416
K14D20W30H84	21 x 32.9 x 84	92.5	298	29	\$7864
K14D20W30H72	21 x 32.9 x 72	92.5	259	25	\$6742
K14D20W30H65	21 x 32.9 x 65	100	224	23	\$6180

Above three lateral file drawers. 84" high models have 2 adjustable shelves, 72" and 65" have 1 adjustable shelf. For Aluminum framed glass door option, please contact customer care. Lock for upper storage is optional

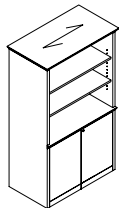

Open Storage*

K22D22W36H84	23 x 38 x 84	125	325	42	\$6788
K22D22W36H72	23 x 38 x 72	100	300	33	\$5815
K22D22W36H65	23 x 38 x 65	100	275	30	\$5334
K22D22W30H84	23 x 32.9 x 84	100	304	35	\$5940
K22D22W30H72	23 x 32.9 x 72	100	279	28	\$5092
K22D22W30H65	23 x 32.9 x 65	100	243	25	\$4668

K22D20W36H84	21 x 38 x 84	100	327	33	\$6462
K22D20W36H72	21 x 38 x 72	92.5	305	30	\$5541
K22D20W36H65	21 x 38 x 65	100	278	28	\$5079
K22D20W30H84	21 x 32.9 x 84	92.5	301	28	\$5393
K22D20W30H72	21 x 32.9 x 72	92.5	265	25	\$4622
K22D20W30H65	21 x 32.9 x 65	100	229	23	\$4232

Above storage cabinet. 84" high models have 4 adjustable shelves, 72" has 3 adjustable shelves, 65" has 3 adjustable shelves. For Aluminum framed glass door option, please contact customer care.

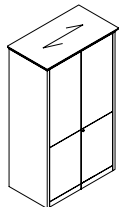

Closed Storage Cabinet*

K23D22W36H84	23 x 38 x 84	100	340	42	\$7955
K23D22W36H72	23 x 38 x 72	100	319	33	\$6818
K23D22W36H65	23 x 38 x 65	100	292	30	\$6244
K23D22W30H84	23 x 32.9 x 84	100	308	33	\$6626
K23D22W30H72	23 x 32.9 x 72	100	279	28	\$5679
K23D22W30H65	23 x 32.9 x 65	100	243	25	\$5209

K23D20W36H84	21 x 38 x 84	100	330	35	\$7574
K23D20W36H72	21 x 38 x 72	92.5	305	30	\$6493
K23D20W36H65	21 x 38 x 65	100	278	28	\$5950
K23D20W30H84	21 x 32.9 x 84	92.5	298	29	\$6311
K23D20W30H72	21 x 32.9 x 72	92.5	265	25	\$5411
K23D20W30H65	21 x 32.9 x 65	100	229	23	\$4960

With upper and lower split doors. 1 fixed shelf and 2 adjustable shelves. Lock for upper storage is optional. For Aluminum framed glass door option, please contact customer care.

Required Specifications

Finish
Edge

Optional Specifications

Handles
Lock*

FREESTANDING STORAGE

MODEL# DIMENSIONS FREIGHT CLASS WT/LBS. CUBIC FT. LIST PRICE

D x W x H

K25D22W36H84	23 x 38 x 84	100	348	42	\$8353
K25D22W36H72	23 x 38 x 72	100	319	33	\$7164
K25D22W36H65	23 x 38 x 65	100	292	30	\$6565
K25D22W30H84	23 x 32.9 x 84	100	307	35	\$7309
K25D22W30H72	23 x 32.9 x 72	100	279	28	\$6267
K25D22W30H65	23 x 32.9 x 65	100	243	25	\$5743
K25D22W24H84	23 x 26 x 84	100	254	28	\$6265
K25D22W24H72	23 x 26 x 72	100	213	24	\$5369
K25D22W24H65	23 x 26 x 65	100	195	22	\$4918

K25D20W36H84	21 x 38 x 84	100	330	35	\$7954
K25D20W36H72	21 x 38 x 72	92.5	305	30	\$6814
K25D20W36H65	21 x 38 x 65	100	278	28	\$6247
K25D20W30H84	21 x 32.9 x 84	92.5	300	29	\$6627
K25D20W30H72	21 x 32.9 x 72	92.5	265	25	\$5680
K25D20W30H65	21 x 32.9 x 65	100	229	23	\$5209
K25D20W24H84	21 x 26 x 84	100	235	28	\$5304
K25D20W24H72	21 x 26 x 72	100	203	24	\$4546
K25D20W24H65	21 x 26 x 65	100	185	22	\$4171

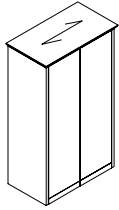

Cabinet w/Doors and Storage

Wardrobe with coat rack and hat shelf on left. Storage with adjustable shelves on right. 84" high models have 5 adjustable shelves, 72" and 65" have 4 adjustable shelves. For Aluminum framed glass door option, please contact customer care. Lock is optional.

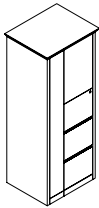

Tower Unit - Left

K27D22W24H84L	23 x 26 x 84	125	167	24	\$9891
K27D22W24H72L	23 x 26 x 72	125	154	22	\$8478
K27D22W24H65L	23 x 26 x 65	125	141	20	\$7778
K27D20W24H84L	21 x 26 x 84	125	152	22	\$9421
K27D20W24H72L	21 x 26 x 72	125	140	20	\$8079
K27D20W24H65L	21 x 26 x 65	125	128	18	\$7404

Wardrobe with coat rack and hat shelf on left. Three file drawers and storage with adjustable shelf on right. 84" high models have 2 adjustable shelves, 72" and 65" have 1 adjustable shelf. For Aluminum framed glass door option on right, please contact customer care. Lock for upper storage and wardrobe is optional.

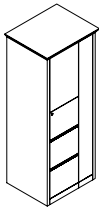

Tower Unit - Right

K27D22W24H84R	23 x 26 x 84	125	167	24	\$9891
K27D22W24H72R	23 x 26 x 72	125	154	22	\$8478
K27D22W24H65R	23 x 26 x 65	125	141	20	\$7778
K27D20W24H84R	21 x 26 x 84	125	152	22	\$9421
K27D20W24H72R	21 x 26 x 72	125	140	20	\$8079
K27D20W24H65R	21 x 26 x 65	125	128	18	\$7404

Wardrobe with coat rack and hat shelf on right. Three file drawers and storage with adjustable shelf on left. 84" high models have 2 adjustable shelves, 72" and 65" have 1 adjustable shelf. For Aluminum framed glass door option on left, please contact customer care. Lock for upper storage and wardrobe is optional.

Required Specifications

Finish
Edge

Optional Specifications

Handles
Locks

MODESTY PANELS

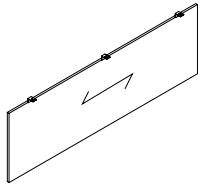

Veneer Modesty Panel*

MODEL#	DIMENSIONS D x W x H	FREIGHT CLASS	WT./LBS.	CUBIC FT.	LIST PRICE
CMP72W	0.75 x 67 x 18	--	20	1	\$1728
CMP66W	0.75 x 61 x 18	--	18	1	\$1728
CMP60W	0.75 x 55 x 18	--	16	1	\$1728
CMP54W	0.75 x 49 x 18	--	14	1	\$1673
CMP48W	0.75 x 43 x 18	--	13	1	\$1619

Straight modesty panel. Attaches to underside of worksurface. **Cannot be retrofitted in the field. Not sold individually - to be ordered as an upgrade option only.**

- CMP72W - Specify on 96" Piano desk: Boat, D or P
- CMP66W - Specify on 84" Piano desk: Boat or D
- CMP60W - For use on 84" Piano desk: P
- CMP54W - For use on 72" Piano desk: Boat or D/D table desk
- CMP48W - For use on 66" and 60" Piano desk: D or P/D table desk

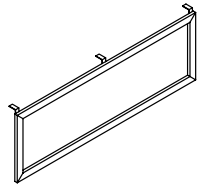

Glass Modesty Panel

CMP72G	0.75 x 67 x 18	--	20	1	\$2647
CMP66G	0.75 x 61 x 18	--	18	1	\$2647
CMP60G	0.75 x 55 x 18	--	16	1	\$2647
CMP54G	0.75 x 49 x 18	--	14	1	\$2504
CMP48G	0.75 x 43 x 18	--	13	1	\$2132

Straight modesty panel. Translucent, screened glass. Aluminum box frame construction in Tungsten Only. Attaches to underside of worksurface. **Cannot be retrofitted in the field. Not sold individually - to be ordered as an upgrade option only.**

- CMP72G - Specify on 96" Piano desk: Boat, D or P
- CMP66G - Specify on 84" Piano desk: Boat or D
- CMP60G - For use on 84" Piano desk: P
- CMP54G - For use on 72" Piano desk: Boat or D/D table desk
- CMP48G - For use on 66" and 60" Piano desk: D or P/D table desk
- Tungsten finish on the aluminum box frame closely resembles the existing Tungsten finish.

ACCESSORIES

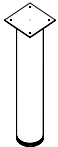

Metal Post Upgrade

MODEL#	DIMENSIONS	FREIGHT CLASS	WT./LBS.	CUBIC FT.	LIST PRICE
SM06	6 x 6 x 28	--	--	--	\$1105
SM04	4 x 4 x 28	--	--	--	\$610
SM03	3 x 3 x 28	--	--	--	\$434

Must specify at time of order. **Cannot be retrofitted in the field.**
Available in Black (E), Tungsten (K) and Brushed Chrome (P).

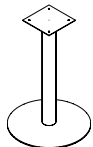

Metal Flat Plate Base Upgrade

F3P18	18 x 18 x 28	--	--	--	\$1638
-------	--------------	----	----	----	---------------

Must specify at time of order. **Can not be retrofitted in the field.**
Available in Black (E), Tungsten (K) and Brushed Chrome (P).

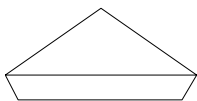

Corner Filler Top

KV1212CT	12 x 12 x 1.5	150	5	1	\$1045
----------	---------------	-----	---	---	---------------

Required Specifications

Finish*

TACKBOARDS FOR HUTCHES

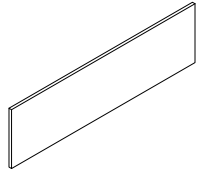

**Tackboard for 36" H
Non-Pigeon Hole Hutches**

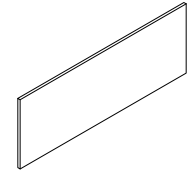

**Tackboard for 42" H & 54" H
Pigeon-Hole Hutches**

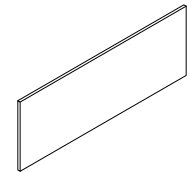

**Tackboard for 42" H & 54" H
Non-Pigeon Hole Hutches**

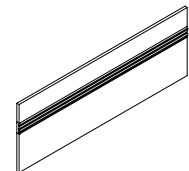

**Tackboard w/Rail for 36" H
Non-Pigeon Hole Hutches***

MODEL#	DIMENSIONS D x W x H	FREIGHT CLASS	WT/LBS.	CUBIC FT.	GR. 1-3	GR. 4-5
KTS108	1 x 105 x 20	92.5	23	2	\$1313	\$1578
KTS102	1 x 99 x 20	100	19	2	\$1242	\$1494
KTS96	1 x 93 x 20	70	15	1	\$1169	\$1406
KTS90	1 x 87 x 20	70	15	1	\$1097	\$1319
KTS84	1 x 81 x 20	85	14	1	\$1028	\$1237
KTS78	1 x 75 x 20	85	13	1	\$952	\$1144
KTS72	1 x 69 x 20	85	12	1	\$875	\$1051
KTS66	1 x 63 x 20	92.5	11	1	\$800	\$961
KTS60	1 x 57 x 20	92.5	10	1	\$733	\$882
KTS36	1 x 33 x 20	60	6	0.01	\$439	\$529
KTS30	1 x 27 x 20	60	4	0.01	\$366	\$442

Factory installed hutch tackboard.

KTSP108H23	1 x 105 x 23	70	30	2	\$1484	\$1783
KTSP102H23	1 x 99 x 23	85	24	2	\$1415	\$1700
KTSP96H23	1 x 93 x 23	92.5	20	2	\$1321	\$1588
KTSP90H23	1 x 87 x 23	70	20	1	\$1238	\$1488
KTSP84H23	1 x 81 x 23	70	18	1	\$1156	\$1389
KTSP78H23	1 x 75 x 23	70	17	1	\$1074	\$1291
KTSP72H23	1 x 69 x 23	70	16	1	\$998	\$1200
KTSP66H23	1 x 63 x 23	85	14	1	\$908	\$1092
KTSP60H23	1 x 57 x 23	85	13	1	\$830	\$1000
KTSP36H23	1 x 33 x 23	60	8	0.01	\$497	\$599
KTSP30H23	1 x 27 x 23	60	5	0.01	\$414	\$501

Factory installed hutch tackboard.

KTS108H26	1 x 105 x 26	70	30	2	\$1716	\$2062
KTS102H26	1 x 99 x 26	85	24	2	\$1617	\$1942
KTS96H26	1 x 93 x 26	92.5	20	2	\$1520	\$1827
KTS90H26	1 x 87 x 26	92.5	20	2	\$1432	\$1720
KTS84H26	1 x 81 x 26	100	18	2	\$1331	\$1599
KTS78H26	1 x 75 x 26	100	17	2	\$1236	\$1486
KTS72H26	1 x 69 x 26	70	16	1	\$1141	\$1372
KTS66H26	1 x 63 x 26	85	14	1	\$1046	\$1257
KTS60H26	1 x 57 x 26	85	13	1	\$952	\$1144
KTS36H26	1 x 33 x 26	60	8	0.01	\$573	\$690
KTS30H26	1 x 27 x 26	60	5	0.01	\$477	\$574

Factory installed hutch tackboard.

KTSAS108	1 x 105 x 20	92.5	23	2	\$2330	\$2798
KTSAS102	1 x 99 x 20	100	19	2	\$2102	\$2524
KTSAS96	1 x 93 x 20	70	15	1	\$2069	\$2486
KTSAS90	1 x 87 x 20	70	15	1	\$1945	\$2336
KTSAS84	1 x 81 x 20	85	14	1	\$1813	\$2179
KTSAS78	1 x 75 x 20	85	13	1	\$1685	\$2024
KTSAS72	1 x 69 x 20	85	12	1	\$1552	\$1863
KTSAS66	1 x 63 x 20	92.5	11	1	\$1422	\$1708
KTSAS60	1 x 57 x 20	92.5	10	1	\$1298	\$1584
KTSAS36	1 x 33 x 20	60	6	0.01	\$776	\$934
KTSAS30	1 x 27 x 20	60	4	0.01	\$647	\$780

Factory installed hutch tackboard.

- Specify Black (**E**), Tungsten (**K**), or Designer White (**DWT**) accessory rail finish.

Required Specifications

Fabric
Metal finish*

TACKBOARDS FOR HUTCHES

MODEL#	DIMENSIONS	FREIGHT CLASS	WT./LBS.	CUBIC FT.	GR.1-3	GR. 4-5
	D x W x H					
KTSPAS108H23	1 x 105 x 23	70	30	2	\$2529	\$3036
KTSPAS102H23	1 x 99 x 23	85	24	2	\$2405	\$2912
KTSPAS96H23	1 x 93 x 23	92.5	20	2	\$2258	\$2712
KTSPAS90H23	1 x 87 x 23	92.5	20	2	\$2115	\$2540
KTSPAS84H23	1 x 81 x 23	100	18	2	\$1972	\$2369
KTSPAS78H23	1 x 75 x 23	100	17	2	\$1831	\$2199
KTSPAS72H23	1 x 69 x 23	70	16	1	\$1690	\$2029
KTSPAS66H23	1 x 63 x 23	85	14	1	\$1549	\$1860
KTSPAS60H23	1 x 57 x 23	85	13	1	\$1408	\$1692
KTSPAS36H23	1 x 33 x 23	100	8	1	\$847	\$1019
KTSPAS30H23	1 x 27 x 23	150	5	1	\$711	\$855

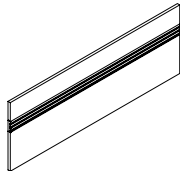

Tackboard w/Rail for 42”H & 54”H*
Pigeon-Hole Hutches

Factory installed hutch tackboard.
 • Specify Black (E), Tungsten (K), or Designer White (DWT) accessory rail finish.

KTSAS108H26	1 x 105 x 26	92.5	23	2	\$2807	\$3372
KTSAS102H26	1 x 99 x 26	100	19	2	\$2642	\$3173
KTSAS96H26	1 x 93 x 26	70	15	1	\$2487	\$2987
KTSAS90H26	1 x 87 x 26	70	15	1	\$2341	\$2812
KTSAS84H26	1 x 81 x 26	85	14	1	\$2155	\$2588
KTSAS78H26	1 x 75 x 26	85	13	1	\$2022	\$2428
KTSAS72H26	1 x 69 x 26	85	12	1	\$1835	\$2204
KTSAS66H26	1 x 63 x 26	92.5	11	1	\$1716	\$2062
KTSAS60H26	1 x 57 x 26	92.5	10	1	\$1553	\$1867
KTSAS36H26	1 x 33 x 26	60	6	0.01	\$932	\$1122
KTSAS30H26	1 x 27 x 26	60	4	0.01	\$783	\$942

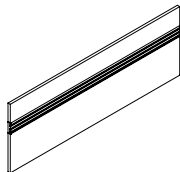

Tackboard w/Rail for 42”H & 54”H*
Non-Pigeon Hole Hutches

Factory installed hutch tackboard.
 • Specify Black (E), Tungsten (K), or Designer White (DWT) accessory rail finish.

TS120	1 x 120 x 19.2	70	26	2	\$1621	\$2026
TS114	1 x 114 x 19.2	70	25	2	\$1544	\$1932
TS108	1 x 108 x 19.2	70	23	2	\$1460	\$1825
TS102	1 x 102 x 19.2	85	19	2	\$1383	\$1729
TS96	1 x 96 x 19.2	70	17	1	\$1293	\$1619
TS90	1 x 90 x 19.2	70	15	1	\$1216	\$1521
TS84	1 x 84 x 19.2	70	14	1	\$1139	\$1422
TS78	1 x 78 x 19.2	70	13	1	\$1055	\$1319
TS72	1 x 72 x 19.2	70	12	1	\$594	\$744
TS66	1 x 66 x 19.2	85	11	1	\$546	\$686
TS60	1 x 60 x 19.2	85	10	1	\$502	\$631
TS54	1 x 54 x 19.2	85	10	1	\$455	\$572
TS48	1 x 48 x 19.2	85	10	1	\$407	\$511
TS42	1 x 42 x 19.2	85	10	1	\$360	\$453
TS36	1 x 36 x 19.2	100	8	1	\$322	\$408
TS30	1 x 30 x 19.2	150	5	1	\$268	\$337

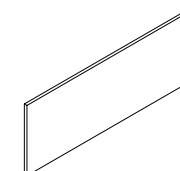

Tackboard for 65”H Non-Pigeon Hole
Wall Mount Cabinets

Factory installed tackboard for wall mount cabinets.

Required Specifications

Fabric
 Metal finish*

TACKBOARDS FOR WALL MOUNT CABINETS

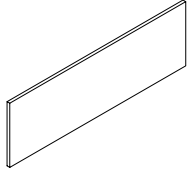

Tackboard for 72" H Pigeon-Hole Wall Mount Cabinets

MODEL#	DIMENSIONS D x W x H	FREIGHT CLASS	WT./LBS.	CUBIC FT.	GR. 1-3	GR. 4-5
TSP120H23	1 x 120 x 23	70	34	2	\$1830	\$2288
TSP114H23	1 x 114 x 23	70	32	2	\$1739	\$2172
TSP108H23	1 x 108 x 23	70	30	2	\$1704	\$2045
TSP102H23	1 x 102 x 23	85	24	2	\$1625	\$1951
TSP96H23	1 x 96 x 23	92.5	20	2	\$1467	\$1832
TSP90H23	1 x 90 x 23	92.5	20	1	\$1370	\$1714
TSP84H23	1 x 84 x 23	70	18	1	\$1280	\$1599
TSP78H23	1 x 78 x 23	70	17	1	\$1047	\$1273
TSP72H23	1 x 72 x 23	70	16	1	\$973	\$1222
TSP66H23	1 x 66 x 23	85	14	1	\$884	\$1109
TSP60H23	1 x 60 x 23	85	13	1	\$641	\$805
TSP54H23	1 x 54 x 23	85	13	1	\$812	\$1018
TSP48H23	1 x 48 x 23	85	13	1	\$642	\$653
TSP42H23	1 x 42 x 23	85	13	1	\$565	\$573
TSP36H23	1 x 36 x 23	100	8	1	\$488	\$505
TSP30H23	1 x 30 x 23	150	5	1	\$404	\$430

Factory installed tackboard for wall mount cabinets.

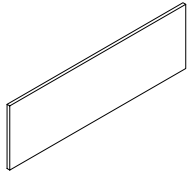

Tackboard for 72" H Non-Pigeon-Hole Wall Mount Cabinets

TS120H26	1 x 120 x 26	70	34	2	\$2108	\$2635
TS114H26	1 x 114 x 26	70	32	2	\$2003	\$2504
TS108H26	1 x 108 x 26	70	30	2	\$1898	\$2374
TS102H26	1 x 102 x 26	85	24	2	\$1788	\$2235
TS96H26	1 x 96 x 26	92.5	22	2	\$1691	\$2116
TS90H26	1 x 90 x 26	92.5	20	2	\$1585	\$1980
TS84H26	1 x 84 x 26	100	18	2	\$1473	\$1842
TS78H26	1 x 78 x 26	100	17	2	\$1370	\$1714
TS72H26	1 x 72 x 26	70	16	1	\$761	\$956
TS66H26	1 x 66 x 26	85	14	1	\$701	\$879
TS60H26	1 x 60 x 26	85	13	1	\$641	\$805
TS54H26	1 x 54 x 26	85	13	1	\$588	\$737
TS48H26	1 x 48 x 26	85	13	1	\$520	\$653
TS42H26	1 x 42 x 26	85	13	1	\$462	\$573
TS36H26	1 x 36 x 26	100	8	1	\$403	\$506
TS30H26	1 x 30 x 26	150	5	1	\$338	\$428

Factory installed tackboard for wall mount cabinets.

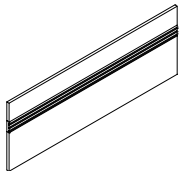

Tackboard w/Rail for 65" H* Non-Pigeon Hole Wall Mount Cabinets

TSAS120	1 x 120 x 19.2	85	26	1	\$2506	\$3134
TSAS114	1 x 114 x 19.2	85	25	2	\$2385	\$2981
TSAS108	1 x 108 x 19.2	92.5	23	2	\$2258	\$2826
TSAS102	1 x 102 x 19.2	100	19	2	\$2138	\$2668
TSAS96	1 x 96 x 19.2	70	17	1	\$2003	\$2509
TSAS90	1 x 90 x 19.2	70	15	1	\$1880	\$2353
TSAS84	1 x 84 x 19.2	85	14	1	\$1753	\$2194
TSAS78	1 x 78 x 19.2	85	13	1	\$1633	\$2043
TSAS72	1 x 72 x 19.2	85	12	1	\$1504	\$1884
TSAS66	1 x 66 x 19.2	92.5	11	1	\$1383	\$1733
TSAS60	1 x 60 x 19.2	92.5	10	1	\$1254	\$1569
TSAS54	1 x 54 x 19.2	92.5	10	1	\$1134	\$1416
TSAS48	1 x 48 x 19.2	92.5	10	1	\$1007	\$1257
TSAS42	1 x 42 x 19.2	92.5	10	1	\$879	\$1097
TSAS36	1 x 36 x 19.2	100	8	1	\$752	\$938
TSAS30	1 x 30 x 19.2	150	5	1	\$584	\$732

Factory installed tackboard for wall mount cabinets.

- Specify Black (E), Tungsten (K), or Designer White (DWT) accessory rail finish.

Required Specifications

Fabric
Metal finish*

TACKBOARDS FOR WALL MOUNT CABINETS

MODEL#	DIMENSIONS	FREIGHT CLASS	WT./LBS.	CUBIC FT.	GR. 1-3	GR. 4-5
	D x W x H					
TSPAS120H23	1 x 120 x 22.3	70	34	2	\$2721	\$3401
TSPAS114H23	1 x 114 x 22.3	70	32	2	\$2587	\$3236
TSPAS108H23	1 x 108 x 22.3	70	30	2	\$2447	\$3061
TSPAS102H23	1 x 102 x 22.3	85	24	2	\$2324	\$2909
TSPAS96H23	1 x 96 x 22.3	70	22	1	\$2185	\$2734
TSPAS90H23	1 x 90 x 22.3	70	20	1	\$2042	\$2555
TSPAS84H23	1 x 84 x 22.3	70	18	1	\$1908	\$2390
TSPAS78H23	1 x 78 x 22.3	70	17	1	\$1773	\$2217
TSPAS72H23	1 x 72 x 22.3	70	16	1	\$1640	\$2053
TSPAS66H23	1 x 66 x 22.3	85	14	1	\$1504	\$1884
TSPAS60H23	1 x 60 x 22.3	85	13	1	\$1363	\$1704
TSPAS54H23	1 x 54 x 22.3	85	13	1	\$1207	\$1510
TSPAS48H23	1 x 48 x 22.3	85	13	1	\$1094	\$1370
TSPAS42H23	1 x 42 x 22.3	85	13	1	\$960	\$1199
TSPAS36H23	1 x 36 x 22.3	100	8	1	\$682	\$856
TSPAS30H23	1 x 30 x 22.3	150	5	1	\$665	\$828

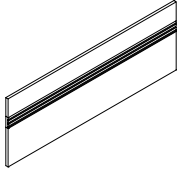

Tackboard w/Rail for 72"H*
Pigeon-Hole Wall Mount Cabinets

Factory installed tackboard for wall mount cabinets.

- Specify Black (E), Tungsten (K), or Designer White (DWT) accessory rail finish.

TSAS120H26	1 x 120 x 26	70	34	2	\$3010	\$3763
TSAS114H26	1 x 114 x 26	70	32	2	\$2854	\$3569
TSAS108H26	1 x 108 x 26	70	30	2	\$2715	\$3395
TSAS102H26	1 x 102 x 26	85	24	2	\$2560	\$3201
TSAS96H26	1 x 96 x 26	92.5	22	2	\$2405	\$3010
TSAS90H26	1 x 90 x 26	92.5	20	2	\$2265	\$2833
TSAS84H26	1 x 84 x 26	100	18	2	\$2089	\$2611
TSAS78H26	1 x 78 x 26	100	17	2	\$1955	\$2445
TSAS72H26	1 x 72 x 26	70	16	1	\$1779	\$2226
TSAS66H26	1 x 66 x 26	85	14	1	\$1661	\$2072
TSAS60H26	1 x 60 x 26	85	13	1	\$1504	\$1884
TSAS54H26	1 x 54 x 26	85	13	1	\$1356	\$1694
TSAS48H26	1 x 48 x 26	85	13	1	\$1207	\$1510
TSAS42H26	1 x 42 x 26	85	13	1	\$1061	\$1323
TSAS36H26	1 x 36 x 26	100	8	1	\$907	\$1137
TSAS30H26	1 x 30 x 26	150	5	1	\$758	\$950

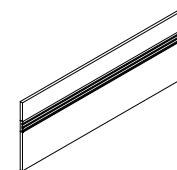

Tackboard w/Rail for 72"H*
Non-Pigeon-Hole Wall Mount Cabinets

Factory installed tackboard for wall mount cabinets.

- Specify Black (E), Tungsten (K), or Designer White (DWT) accessory rail finish.

TSP120H21	1 x 120 x 21	70	35	2	\$1764	\$2119
TSP114H21	1 x 114 x 21	70	32	2	\$1676	\$2013
TSP108H21	1 x 108 x 21	70	30	2	\$1586	\$1906
TSP102H21	1 x 102 x 21	85	24	2	\$1503	\$1805
TSP96H21	1 x 96 x 21	92.5	20	2	\$1408	\$1692
TSP90H21	1 x 90 x 21	70	1	1	\$1324	\$1591
TSP84H21	1 x 84 x 21	70	18	1	\$1238	\$1487
TSP78H21	1 x 78 x 21	70	17	1	\$1144	\$1375
TSP72H21	1 x 72 x 21	70	16	1	\$1057	\$1271
TSP66H21	1 x 66 x 21	85	14	1	\$966	\$1162
TSP60H21	1 x 60 x 21	85	13	1	\$883	\$1061
TSP54H21	1 x 54 x 21	85	13	1	\$796	\$957
TSP48H21	1 x 48 x 21	85	13	1	\$711	\$855
TSP42H21	1 x 42 x 21	125	6	1	\$620	\$747
TSP36H21	1 x 36 x 21	150	4	1	\$531	\$639
TSP30H21	1 x 30 x 21	250	3	1	\$445	\$535

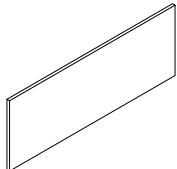

Tackboard for 84"H Double Height
Pigeon-Hole Wall Mount Cabinets

Factory installed tackboard for wall mount cabinets.

Required Specifications

- Fabric
- Metal finish*

TACKBOARDS

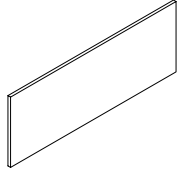

Tackboard for 84" H Double Height Non Pigeon-Hole Wall Mount Cabinets

MODEL#	DIMENSIONS D x W x H	FREIGHT CLASS	WT/LBS.	CUBIC FT.	GR. 3	GR. 4-5
TS120H25	1 x 120 x 25	85	27	2	\$2104	\$2526
TS114H25	1 x 114 x 25	85	25	2	\$2001	\$2403
TS108H25	1 x 108 x 25	92.5	23	2	\$1608	\$2007
TS102H25	1 x 102 x 25	100	19	2	\$1511	\$1892
TS96H25	1 x 96 x 25	70	17	1	\$1424	\$1777
TS90H25	1 x 90 x 25	70	15	1	\$1335	\$1671
TS84H25	1 x 84 x 25	85	14	1	\$1250	\$1564
TS78H25	1 x 78 x 25	85	13	1	\$1154	\$1444
TS72H25	1 x 72 x 25	85	12	1	\$1067	\$1338
TS66H25	1 x 66 x 25	92.5	11	1	\$980	\$1226
TS60H25	1 x 60 x 25	92.5	10	1	\$893	\$1120
TS54H25	1 x 54 x 25	92.5	10	1	\$947	\$1139
TS48H25	1 x 48 x 25	92.5	10	1	\$839	\$1009
TS42H25	1 x 42 x 25	92.5	10	1	\$735	\$884
TS36H25	1 x 36 x 25	125	6	1	\$630	\$758
TS30H25	1 x 30 x 25	150	4	1	\$528	\$635

Factory installed tackboard for wall mount cabinets.

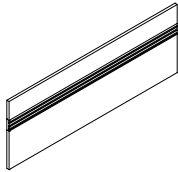

Tackboard w/Rail for 84" H Double Ht.* Pigeon-Hole Wall Mount Cabinets

TSPAS120H21	1 x 120 x 21	70	33	2	\$3102	\$3723
TSPAS114H21	1 x 114 x 21	70	32	2	\$2949	\$3542
TSPAS108H21	1 x 108 x 21	70	30	2	\$2793	\$3352
TSPAS102H21	1 x 102 x 21	85	24	2	\$2647	\$3178
TSPAS96H21	1 x 96 x 21	70	20	1	\$2481	\$2978
TSPAS90H21	1 x 90 x 21	70	20	1	\$2335	\$2804
TSPAS84H21	1 x 84 x 21	70	18	1	\$2176	\$2614
TSPAS78H21	1 x 78 x 21	70	17	1	\$2021	\$2427
TSPAS72H21	1 x 72 x 21	70	16	1	\$1862	\$2237
TSPAS66H21	1 x 66 x 21	85	14	1	\$1709	\$2052
TSPAS60H21	1 x 60 x 21	85	13	1	\$1552	\$1862
TSPAS54H21	1 x 54 x 21	85	13	1	\$1403	\$1686
TSPAS48H21	1 x 48 x 21	85	13	1	\$1249	\$1501
TSPAS42H21	1 x 42 x 21	85	13	1	\$1089	\$1308
TSPAS36H21	1 x 36 x 21	60	6	0.01	\$929	\$1116
TSPAS30H21	1 x 30 x 21	60	4	0.01	\$722	\$868

Factory installed tackboard for wall mount cabinets.

- Specify Black (E), Tungsten (K), or Designer White (DWT) accessory rail finish.

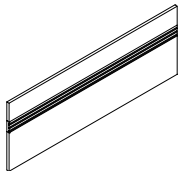

Tackboard w/Rail for 84" H Double Ht.* Non Pigeon-Hole Wall Mount Cabinets

TSAS120H25	1 x 120 x 25	85	27	2	\$3549	\$4260
TSAS114H25	1 x 114 x 25	85	25	2	\$3369	\$4044
TSAS108H25	1 x 108 x 25	92.5	23	2	\$2615	\$3270
TSAS102H25	1 x 102 x 25	100	19	2	\$2457	\$3075
TSAS96H25	1 x 96 x 25	70	17	1	\$2310	\$2893
TSAS90H25	1 x 90 x 25	70	15	1	\$2176	\$2724
TSAS84H25	1 x 84 x 25	85	14	1	\$2008	\$2511
TSAS78H25	1 x 78 x 25	85	13	1	\$1880	\$2353
TSAS72H25	1 x 72 x 25	85	12	1	\$1707	\$2137
TSAS66H25	1 x 66 x 25	92.5	11	1	\$1598	\$2003
TSAS60H25	1 x 60 x 25	92.5	10	1	\$1452	\$1817
TSAS54H25	1 x 54 x 25	92.5	10	1	\$1602	\$1925
TSAS48H25	1 x 48 x 25	92.5	10	1	\$1429	\$1715
TSAS42H25	1 x 42 x 25	92.5	10	1	\$1252	\$1504
TSAS36H25	1 x 36 x 25	60	6	0.01	\$1070	\$1286
TSAS30H25	1 x 30 x 25	60	4	0.01	\$893	\$1074

Factory installed tackboard for wall mount cabinets.

- Specify Black (E), Tungsten (K), or Designer White (DWT) accessory rail finish.

Required Specifications

Fabric
Metal finish*

ACCESSORIES

MODEL# DIMENSIONS FREIGHT CLASS WT/LBS. CUBIC FT. LIST PRICE

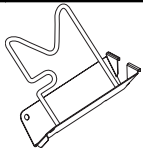

Flip Sorter

	D x W x H				
BAFS01	9.25 x 2.75 x 9.25	70	0.6	0.14	\$58

Load bar/accessory rail mounted metal flip sorter. Comes with chrome wire.
 • Specify Black (E), Tungsten (K), or Designer White (DWT) accessory finish.

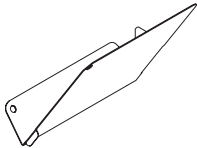

Slant Sorter

BASS01L (Left)	10.25 x 5 x 9.5	70	1	0.28	\$47
BASS01R (Right)	10.25 x 5 x 9.5	70	1	0.28	\$47

Load bar/accessory rail mounted metal slant sorter.
 • Specify Black (E), Tungsten (K), or Designer White (DWT) accessory finish.

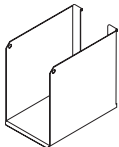

Binder Bin

BABB01	10.25 x 4 x 9	70	1.85	0.21	\$75
--------	---------------	----	------	------	------

Load bar/accessory rail mounted metal binder bin.
 • Specify Black (E), Tungsten (K), or Designer White (DWT) accessory finish.

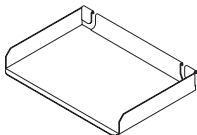

Letter Tray

BALTO1	9.25 x 13.5 x 2	70	0.5	0.15	\$62
--------	-----------------	----	-----	------	------

Load bar/accessory rail mounted metal letter tray.
 • Specify Black (E), Tungsten (K), or Designer White (DWT) accessory finish.

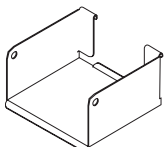

Media Bin

BAMB01	5.25 x 5.75 x 3	70	1.85	0.21	\$62
--------	-----------------	----	------	------	------

Load bar/accessory rail mounted metal media bin.
 • Specify Black (E), Tungsten (K), or Designer White (DWT) accessory finish.

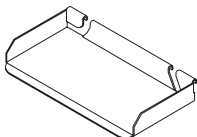

Utility Tray

BAUT01	3.75 x 5.75 x 3	70	0.5	0.02	\$41
--------	-----------------	----	-----	------	------

Load bar/accessory rail mounted metal utility tray.
 • Specify Black (E), Tungsten (K), or Designer White (DWT) accessory finish.

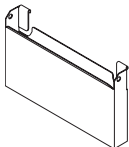

Mail Box

BAPP01	2.75 x 16 x 9	100	2	0.25	\$94
--------	---------------	-----	---	------	------

Load bar/accessory rail mounted metal mail box.
 • Specify Black (E), Tungsten (K), or Designer White (DWT) accessory finish.

Required Specifications

Fabric
 Metal finish*



ACCESSORIES

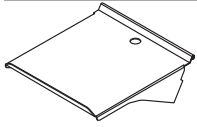

Telephone Holder

MODEL#	DIMENSIONS D x W x H	FREIGHT CLASS	WT./LBS.	CUBIC FT.	LIST PRICE
BATH01	10 x 9 x 2	125	2	0.26	\$91

Load bar/accessory rail mounted metal telephone holder.

- Specify Black (**E**), Tungsten (**K**), or Designer White (**DWT**) accessory finish.

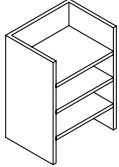

Paper Organizer, Letter & Legal Format

KCPH161226	12 x 16 x 27	125	20	3	\$1045
KCPH161223	12 x 16 x 23	125	18	3	\$883
KCPH161219	12 x 16 x 20	125	15	2	\$674
KCPH131226	12 x 13 x 27	100	16	2	\$847
KCPH131223	12 x 13 x 23	125	15	2	\$719
KCPH131219	12 x 13 x 20	125	12	2	\$546

- Specify Black (**E**), Tungsten (**K**), or Designer White (**DWT**) accessory finish.

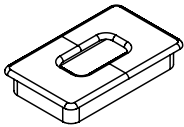

Grommet

GM5C	2 x 3.5 x --	70	--	--	\$114
------	--------------	----	----	----	--------------

Rectangular grommet in metal, tungsten finish.

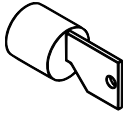

Lock Assembly

Black:					
LO	--	70	--	--	\$113
Tungsten:					
LO/C	--	70	--	--	\$113

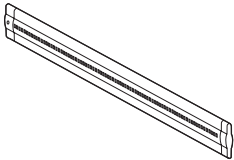

LED Task Light

PLED30	1.5 x 15.5 x .5	150	2	0.5	\$522
PLED50	1.5 x 23.5 x .5	150	2	0.5	\$601
PLED100	1.5 x 43.5 x .5	125	3	0.5	\$697

Energy efficient LED. Ultra slim design. Suitable for hanging under Hutch or Wallhung units. 6' power cord.

Required Specifications

Metal finish

lufton

