



Contemporary. Minimal. Inspirational. **Foundations** desking draws upon a contemporary minimal aesthetic, paring down furniture structure and surface to its essence to reveal an architecture of simple horizontal and vertical planar elements.

Each piece is designed to serve the needs of a changing office landscape, elevating the look and function of the private office and taking into account the diverse uses of meeting rooms in the modern work environment. Designed by Christopher Wright.

Foundations components for the private office include modular desks, credenzas and wall storage units punctuated by niches set into the vertical plane of the unit. Personal items or work tools can be stored in niches, desks and storage components that combine to suit individual work styles.

#### Features and Benefits

- Workwalls support configurations or function as display backdrops
- Niches are designed to accept tackboards, remote-controlled LED lighting and flat screen monitors
- Wall units can be specified with LED lighting.
- Power, data and cable management accessories are available on any Foundations unit, including boardroom tables to meet exact requirements.
- A full array of complementary conference room furnishings are available to coordinate the entire office.



Open frame leg



Workwall niche offers a surface, storage or display.



Workwall with integrated storage credenza.

**GENERAL INFORMATION**

- Foundations includes workwalls, single- and double-pedestal desks and executive desk extensions, bridges and transaction counters
- Storage components include credenzas, bench storage, wall-mounted and freestanding storage
- Two- or three-tone finish options allow for a distinctive aesthetic
- Executive desk extensions are supported by an open frame leg or elevated pedestals
- Modular wall units, pedestals and credenzas allow for scalable storage solutions; components accommodate L- and U-shaped configurations, as well as desk and workwall/credenza combinations.
- For environmental certification, please visit [globalfurnituregroup.com](http://globalfurnituregroup.com)

**CONSTRUCTION**

- Engineered veneer is real wood that through a manufacturing process of slicing, dyeing, gluing and re-slicing achieves consistent wood grain and color structure.
- Veneer is purchased by the block and sliced into a rift cut slip matched pattern to a thickness of 0.6mm (1/42"). Global lays up rift cut veneers in a slip match method.

**FINISHES**

- Conversion varnish (similar to catalyzed lacquer, but tougher), 25 degree sheen. Finishes are not buffed or rubbed.
- All Global wood casegood products are veneered and finished on the back sides (360° finishing), except modular under-surface storage - tops and backs are unfinished.
- Touch up kits available, includes a touch up marker and fill crayon. Order **VTOUCHUPKIT, \$164** list. Specify finish when ordering.
- Global standard finish, on oak and walnut, is open pore and on cherry and maple is semi-closed pore. If a full finish is required for walnut, cherry, anigre and maple tops, Add the suffix "2" to the finish code and Add 5% to the base pricing for each product.

**CUSTOM FINISH IS AVAILABLE.****PEDESTALS AND CRENZAS**

- Suspended 7.5" off the floor by an open framed aluminum leg
- Locks are always located on the side panel.
- Handle placement is offset from the center, towards the lock
- Overall height is 26.5"
- Pedestal drawer suspensions are metal ball bearing type. Both box and file drawers are full extension.
- Hanging file rails are pre-installed on file drawer perimeters. The back rail in a lateral file drawer is designed for both letter and legal size filing.
- Drawer sides and bottoms are wrapped black vinyl.
- Drawer front is an applied element to a four sided drawer. Drawer fronts are veneered on all surfaces. Drawer fronts can be removed or replaced in the field.
- Leveling glides have 1" range of adjustment.

**HARDWARE**

- All necessary hardware to assemble the furniture is included in the shipment. Actual wall-attachment fasteners for wall cabinets and tackboards are not included due to variable site conditions.
- Hanging file rails are pre-installed on file drawer perimeters and accommodate both legal and letter size filing. Legal filing can be achieved either as side-to-side or front-to-back. Letter filing can be achieved as front-to-back filing only.
- Connecting brackets are used to attached bridges and returns to desk, and are shipped pre-attached to the bottom of the bridge or return. Additional screws are shipped in a plastic bag.

**INSTALLATION**

- **Wall-mounted cabinets and tackboards** are shipped with preattached horizontal wall rails at the back of each unit. The wall-side components must be detached from the unit and fastened to the wall accordingly. Wall fasteners are not included due to the variable site conditions. Securing the wall rail to a vertical structural member is the required manner of installation. The cabinet or tackboard is then lowered on to the wall rail. It is important to level the wall rail before installation. Wall cabinets are equipped with levelers at the bottom of the back panels for proper cabinet alignment. Units with doors are equipped with adjustable European door hinges to assist in door alignment. It is required to use a #8 wood screw through the back of the cabinet and the wall-mounted rail, to further secure the wall attachment. Tackboards have vertical grooves in the back for tasklight wiring.
- **Transaction counter and decorative panels** are shipped knock down. To assemble it follow the assembly instruction sheet included. To secure the transaction counter to the desk, double sided tape is applied to the bottom of the end panels. Included screws must be used to attach the decorative panel to the desk.
- **Modular storage units:** Have pre-drilled holes through the tops for securing to the bottom of the work surfaces. Screws and lock keys are included in a plastic bag fastened inside the pedestal. Pedestals may be installed flush or offset. Disassemble the modular unit first before relocating the entire unit to avoid damage or bodily injuries.
- **Work Walls:** Incorporate storage units, credenzas and niches of different sizes, attached to the base with connecting bolts. Upper units are installed with plastic dowels. Small connectors are supplied to secure the units thru the side panels. Complete assembly instruction is included with the wall unit. All necessary connectors and dowels are shipped in a plastic bag.
- **Credenza backpanels and display walls:** Optional credenza backpanels and display walls are attached to the units with supplied quick connectors. To assemble the display wall follow the assembly instructions included. All connectors and screws are shipped in a plastic bag.
- **Tables:** All table components are shipped in multiple boxes. Screws and table connectors are packed in a separate box identified with the label "Hardware Enclosed". Assembly instructions for specific tables are included.

# F FOUNDATIONS - HOW TO SPECIFY

## 1. SPECIFY MODEL NUMBER

## 2. SPECIFY FINISH

### WORKSURFACE TOP & DRAWER/DOOR FRONTS, BODY FINISHES (INCLUDING PEDESTALS) - VENEER

#### Foundations Engineered Veneer Finishes (Horizontal Grain Standard):

Code	Finish	Veneer Type	Cut
NTF	Natural	Maple Reconstituted	Rift
TLF	Twilight	Maple Reconstituted	Rift
CIF	Chai	White Oak Reconstituted	Rift
FGF	Fig	White Oak Reconstituted	Rift
STF	Sumatra	White Oak Reconstituted	Rift
MTF	Metro	White Oak Reconstituted	Rift
MSF	Mesa	White Oak Reconstituted	Rift
CHF	Cashmere	White Oak Reconstituted	Rift
SNF	Sienna	White Oak Reconstituted	Rift
WIF	Winter	White Oak Reconstituted	Rift

#### METAL LEG FINISH (Casegoods):

SGR Silver Glimmer

#### METAL LEG FINISHES (Conference Tables):

BLKT Black Textured  
TUNT Tungsten Textured  
DWTT Designer White Textured

## 3. SPECIFY OPTIONS

### Handle

- Handles are standard on most drawers/storage modules.

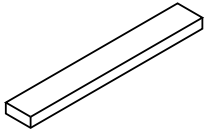

PL83 Anodized Aluminum, 7.2"

### Edges

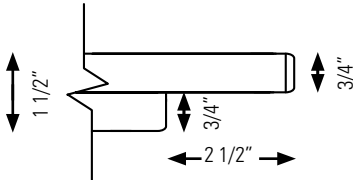

Edge Detail - Casegoods

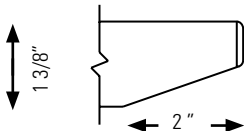

Edge Detail - Conference Tables

### Grommets

- Standard grommet on all components is **GM5K**. Grommet is included with products where shown in line drawings in price book.
- Optional grommets may be ordered in standard worksurface locations (left, center or right). Order as **GM5KL, GM5KC or GM5KR**. Add \$96.
- Grommet hole dimensions are 2 3/4" in diameter. Specify **GM1E** for **Black** or **GM1K** for **Tungsten**.
- Color of grommet will be automatically coordinated with handle color where applicable



- Components that come standard with grommet may be ordered without a grommet. Order as RSG - Add \$53.
- View diagrams on the following pages for additional details.

For tops up to 24"D

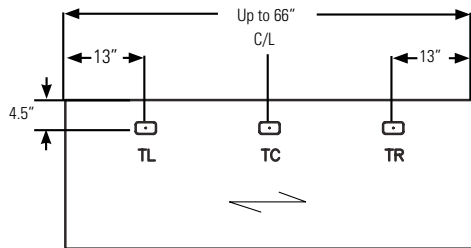
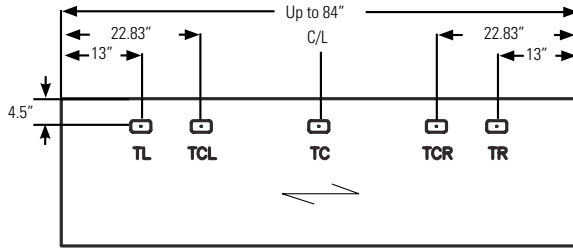

For tops 30" to 36"D

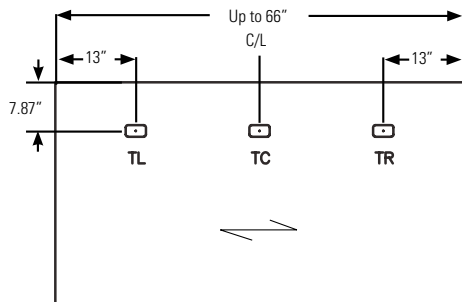
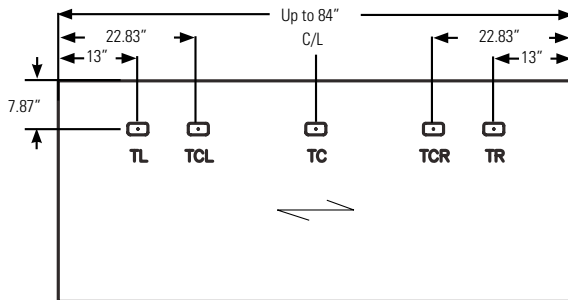

# F FOUNDATIONS - NOTES

## Optional Grommet Locations on Work Walls

Grommets and Grommet Locations must be specified.

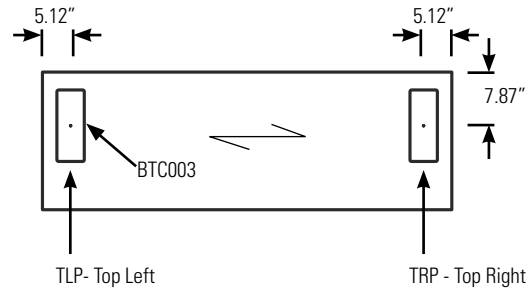
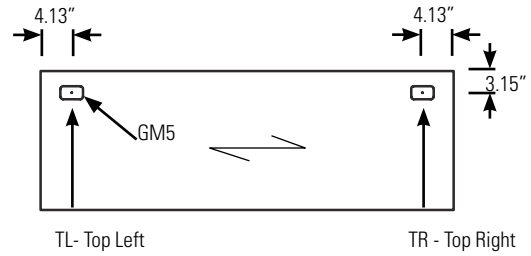
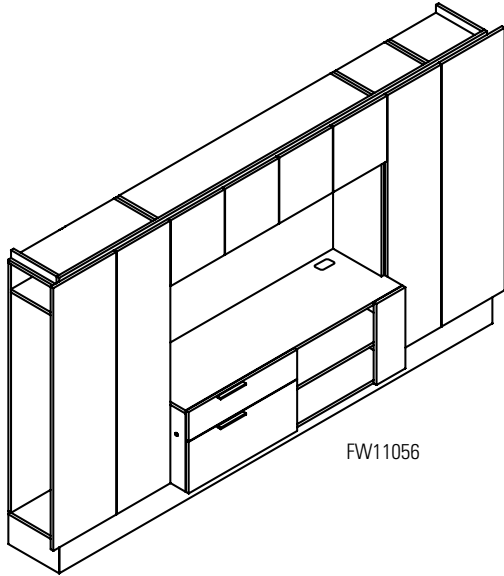

## Standard Grommet Locations on Work Walls

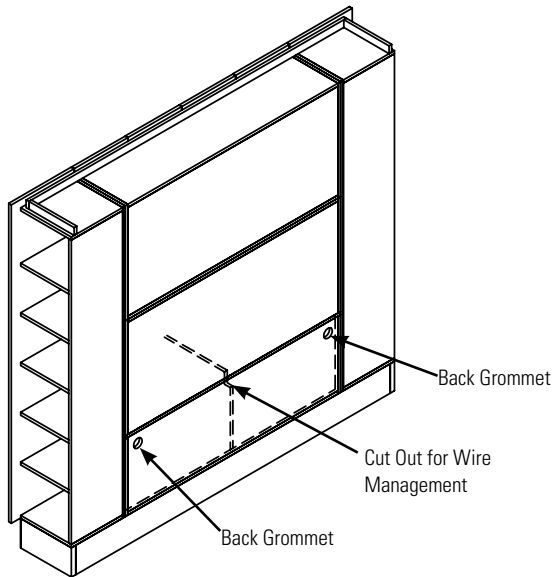

FW9570-IR Back View

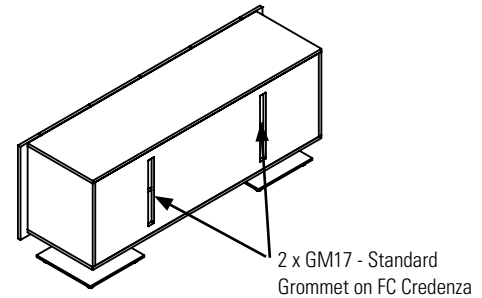
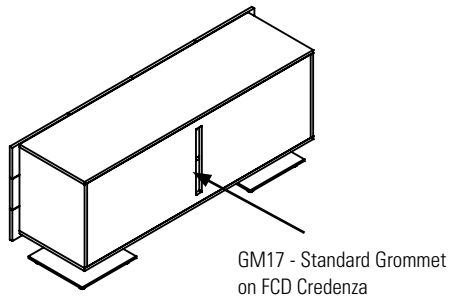
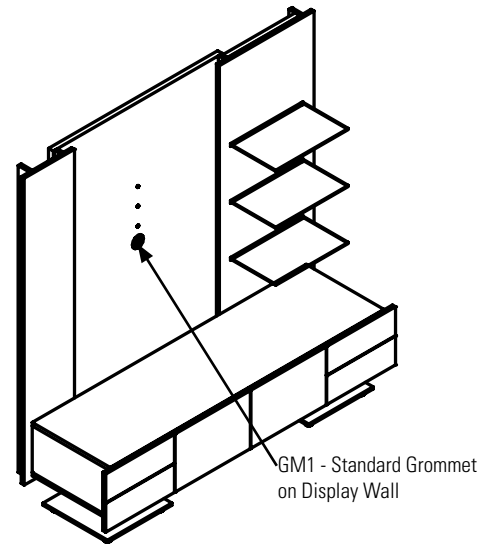

**Work Wall Display Niches**

- Available widths 15", 30", 45", 60" wide.
- Available heights 14", 28", 42" high.
- Maximum niche dimension 60" wide is 42" high.
- Maximum niche dimension 75" wide is 28" high.

When a niche is placed on 20" cantilevered storage there is no bottom. When a niche is placed between storage components it always has a bottom.

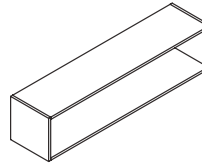
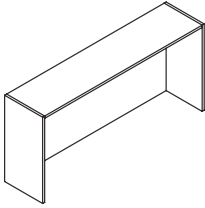

**Work Wall Lighting**

- LED lights for niches must be specified at time of manufacture. When more than one LED light is required in a work wall configuration, a single remote switch is included. Up to four LED lights can work off a single transformer.

Four sided niche with routed upper panel for LED light.

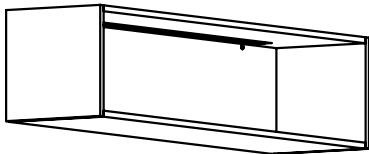

Niche is routed on inside top panel & back is drilled for wire pass through.

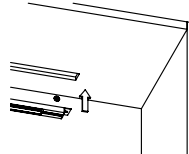

Open bottom niche with routed upper panel for LED light.

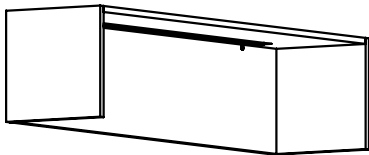

LED lights available in 12", 24", 36" and 48" widths.



# F FOUNDATIONS - NOTES

## CONFERENCE TABLES DETAILS

### Optional Grommet Locations for Conference Table Tops

Grommets and Grommet Locations must be specified.

For tables that are 48" wide and 96", 120", 144" or 168" long:

**TCL** - Top Center Left

**TCR** - Top Right

**TC** - Top Center

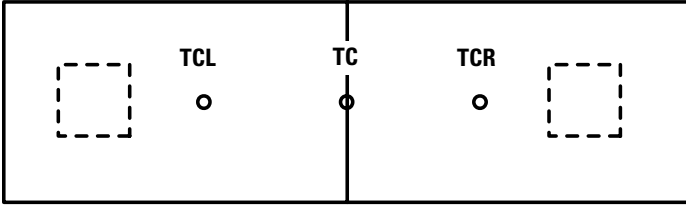

For tables that are 48" wide and 192" or 216" long and tables that are 60" wide and 168", 192", 216" or 240" long:

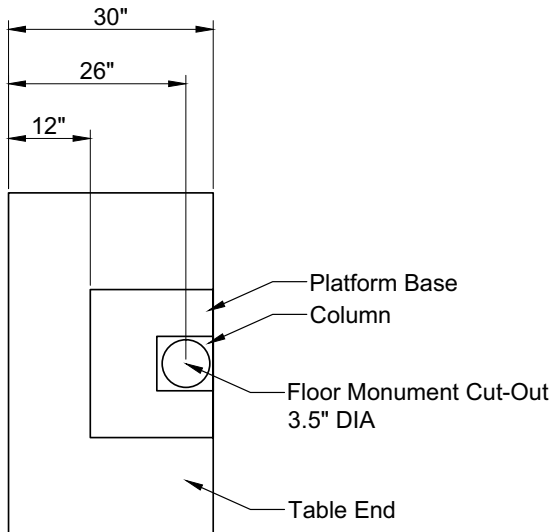
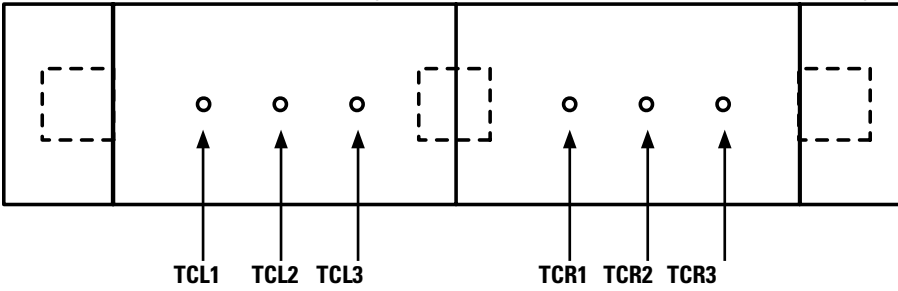

**Conference Table Top and Base Guide**

**Conference Table, two piece Top with 3 Bases**

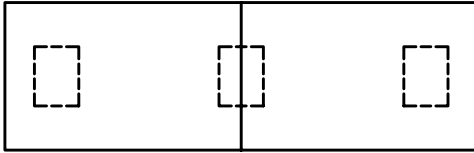

**Sectional Conference Table with 3 Bases**

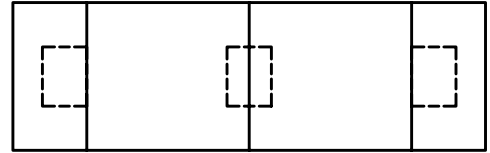

**Conference Table, two piece Top with 2 Bases**

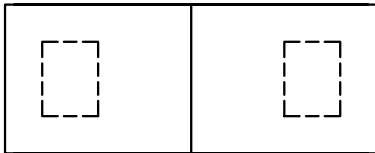

**Sectional Conference Table with 2 Bases**



**Conference Table, one piece Top with 2 Bases**



**Square Table Top with Mono Base**

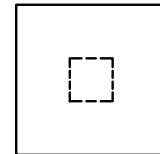

**Sectional Conference Table with Technology Trough and 3 Bases**

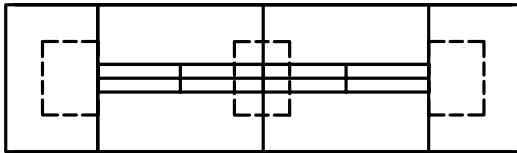

**Round Table Top with Mono Base**

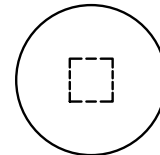

**Sectional Conference Table with Technology Trough and 2 Bases**

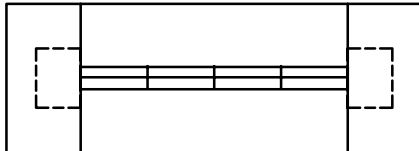

**Sectional Conference Table with Technology Trough and 2 Bases**



**Note:** Different Table Shapes are available.



## Technology Trough Details

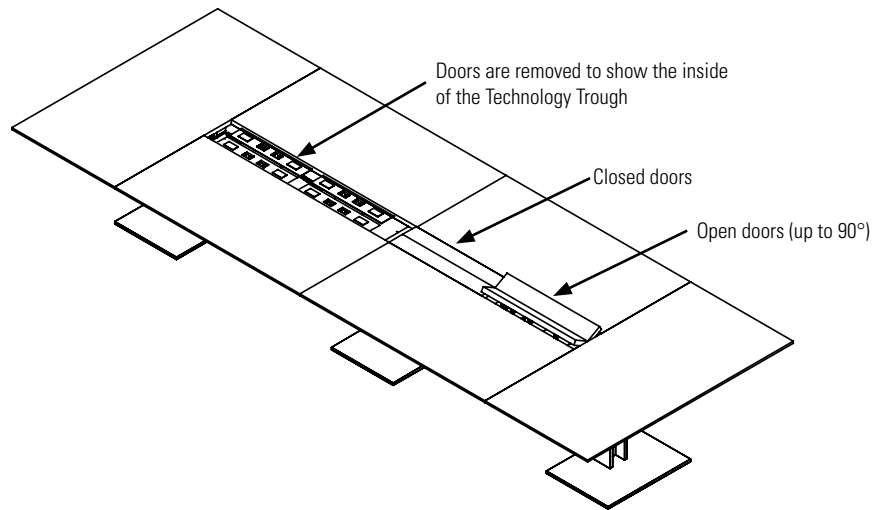

**Side View**

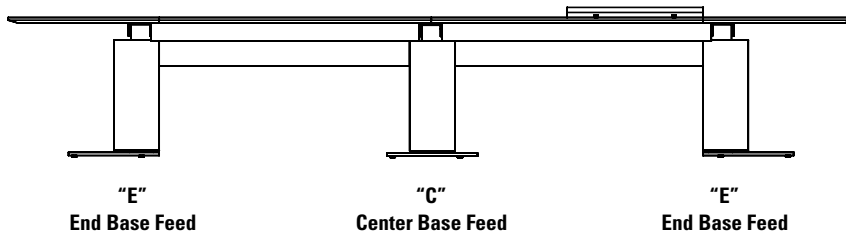

**End View**

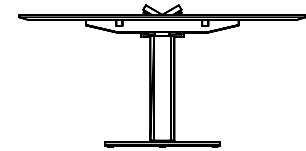

Power kits are included.  
 Two power receptacles and two telecom knockouts per door are standard.  
 Telecom plates will be shipped separately.  
 If no telecom plate is specified, blank coverplate will be included.

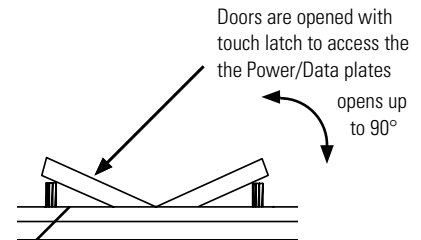
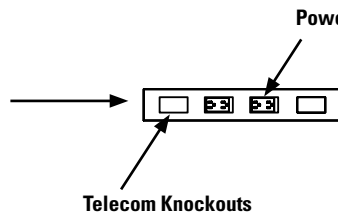

**End View Detail**

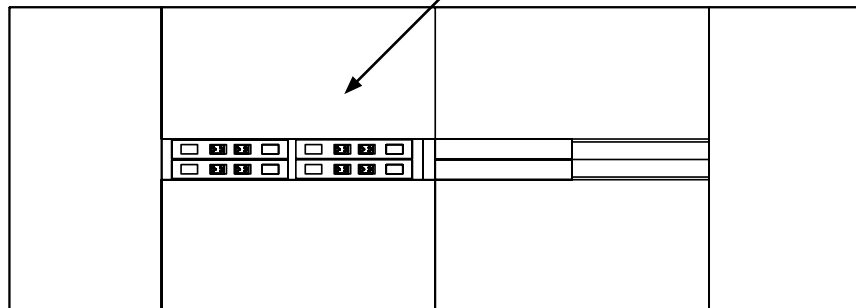

**FINISH SPECIFICATIONS**

**Double and Single Pedestal Desks**

- For desks two finishes can be specified.
- The first finish in the product string, indicated as #1.
- The second finish in the product string indicated as #2.
- If only one finish is indicated, the entire unit will be monotone.
- **Note:** Horizontal grain direction is standard on all engineered finishes. If natural veneer is required, the grain direction will be vertical. Arrow indicates direction of grain.

**User Side**

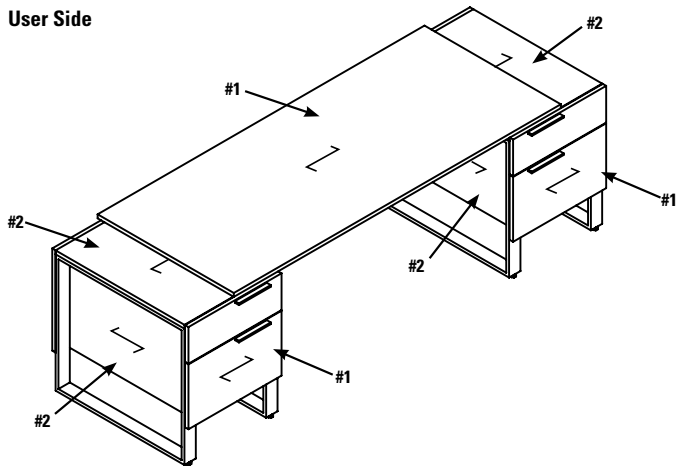

**Back View**

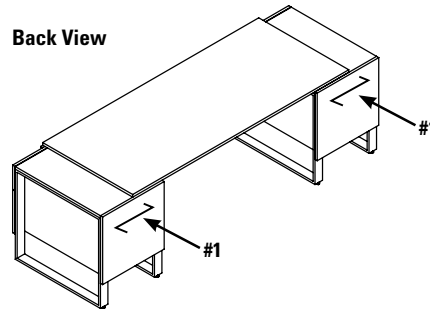

**Transaction Counter and Decorative Panel**

- For Transaction Counter and Decorative Panel, only one finish can be specified.
- Arrow indicates direction of grain

**User Side**

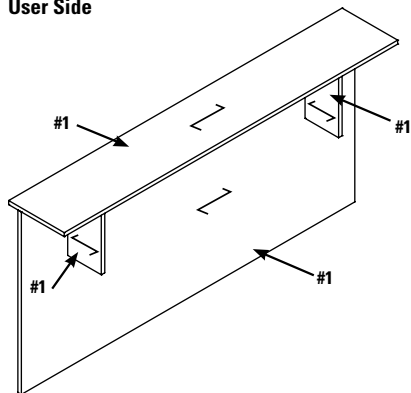

**Back View**

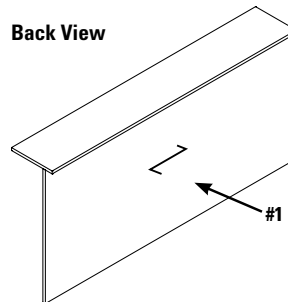

**Pedestals**

- For Pedestals, two finishes can be specified.
- The first finish in the product string, indicated as #1.
- The second finish in the product string indicated as #2.
- If only one finish is indicated, the entire unit will be monotone.

**User Side**

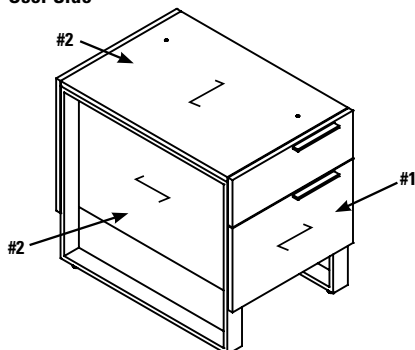

**Back View**

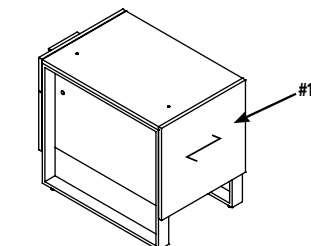

# F FOUNDATIONS - NOTES

## Lateral Files

- For Lateral Files two finishes can be specified.
- The first finish in the product string, indicated as **#1**.
- The second finish in the product string indicated as **#2**.
- If only one finish is indicated, the entire unit will be monotone.
- Arrow indicates direction of grain

### User Side

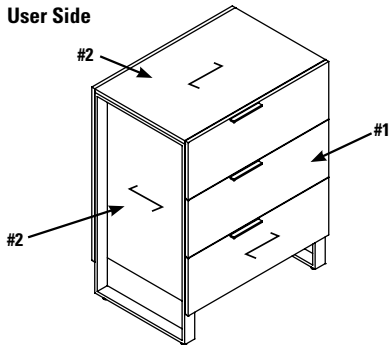

### Back View

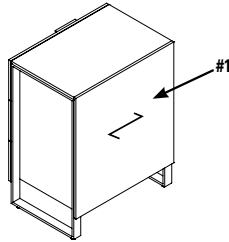

## Mobile Pedestals

- For Mobile Pedestals, two finishes can be specified.
- The first finish in the product string, indicated as **#1**.
- The second finish in the product string indicated as **#2**.
- If only one finish is indicated, the entire unit will be monotone.
- Arrow indicates direction of grain

### User Side

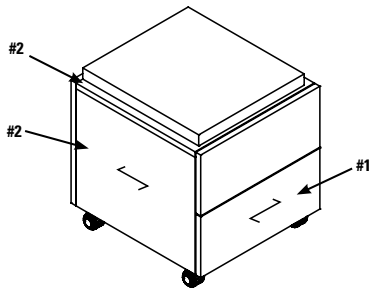

### Back View

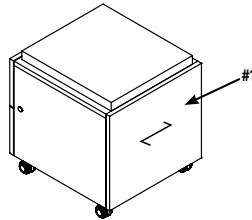

## Benches

- For Benches, two finishes can be specified.
- The first finish in the product string, indicated as **#1**.
- The second finish in the product string indicated as **#2**.
- If only one finish is indicated, the entire unit will be monotone.
- Arrow indicates direction of grain

### User Side

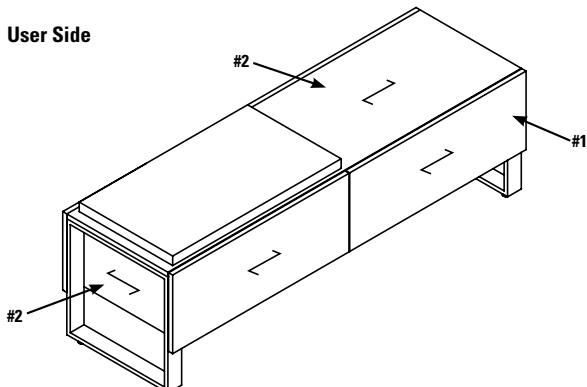

### Back View

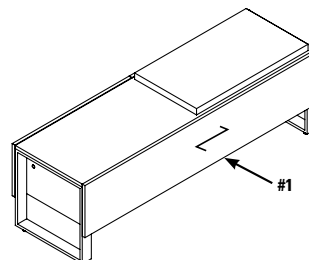

**Credenzas**

- For Credenzas, two finishes can be specified.
- The first finish in the product string, indicated as **#1**.
- The second finish in the product string indicated as **#2**.
- If only one finish is indicated, the entire unit will be monotone.
- Arrow indicates direction of grain

**User Side**

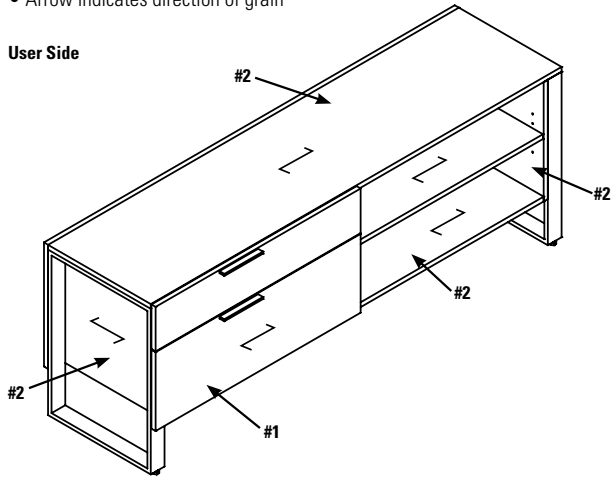

**Back View**

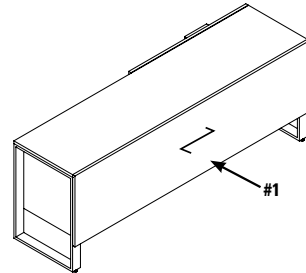

**Modular Tops**

- For Modular Tops, only one finish can be specified.
- Arrow indicates direction of grain

**Isometric View**

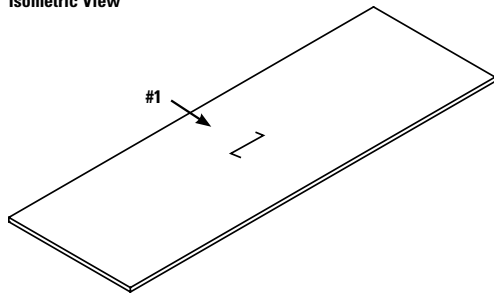

**End View**

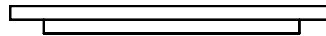

**Wall Mounted Overheads**

- For wall mounted overheads, two finishes can be specified.
- The first finish in the product string, indicated as **#1**.
- The second finish in the product string indicated as **#2**.
- If only one finish is indicated, the entire unit will be monotone.
- Arrow indicates direction of grain

**User Side**

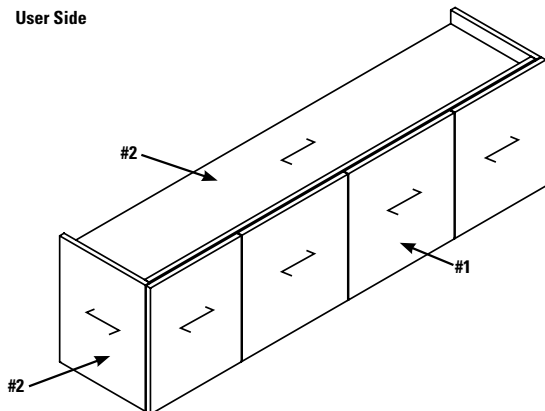

**Back View**

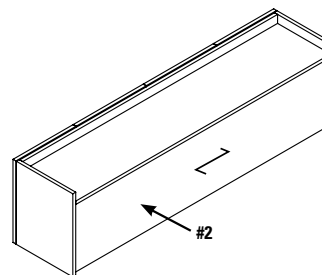

# F FOUNDATIONS - NOTES

## Work Wall Credenzas

- Two finishes can be specified.
- The first finish in the product string, indicated as **#1**.
- The second finish in the product string indicated as **#2**.
- If only one finish is indicated, the entire unit will be monotone.
- Arrow indicates direction of grain

User Side

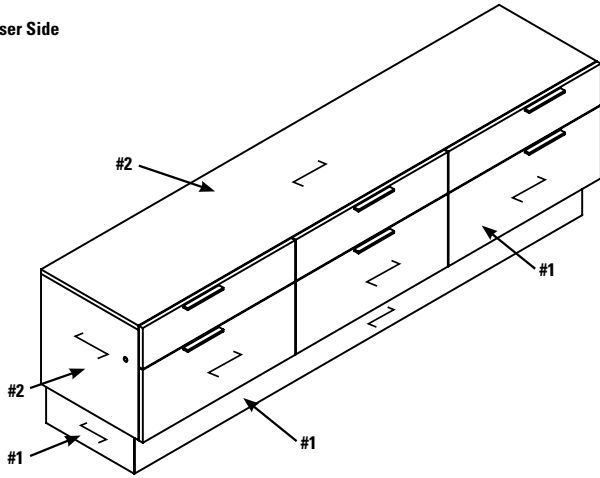

Back View

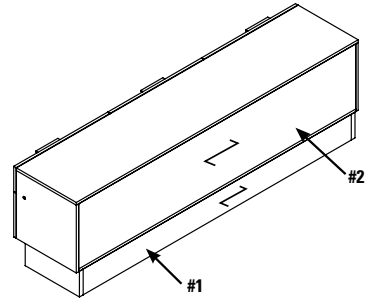

**Work Wall Credenzas**

- Three finishes can be specified.
- The first finish in the product string, indicated as **#1**.
- The second finish in the product string indicated as **#2**.
- The third finish in the product string indicated as **#3**.
- If only one finish is indicated, the entire unit will be monotone.
- Horizontal grain direction is standard on all engineered finishes. If natural veneer is required, the grain direction will be vertical. Arrow indicates direction of grain

**Front View**

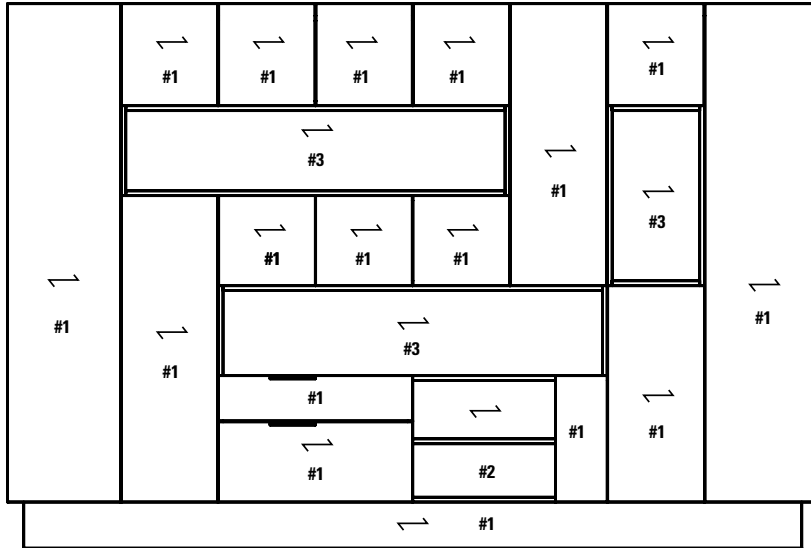

**Side View**

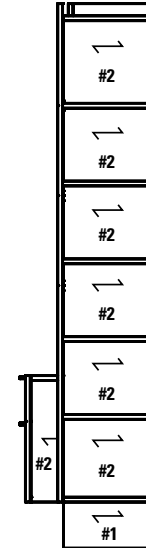

**Isometric View**

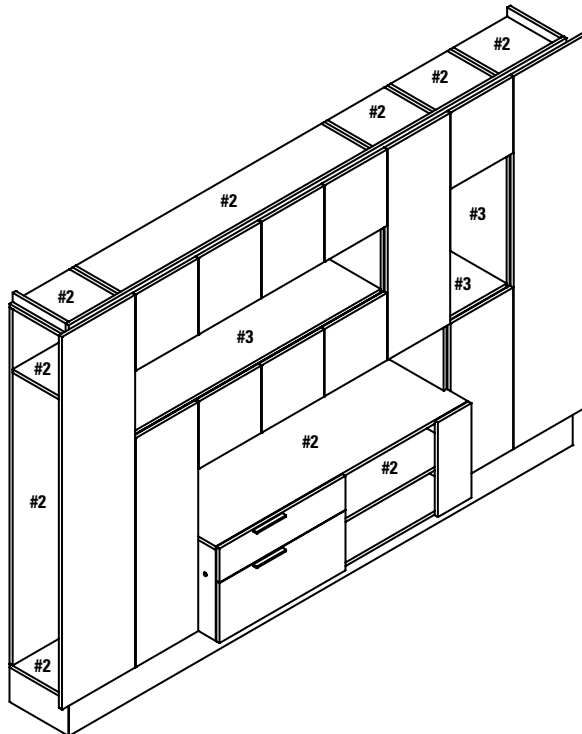

# F FOUNDATIONS - NOTES

## Sectional Top with two bases

- Two finishes can be specified.
- The first finish in the product string, indicated as #1.
- The second finish in the product string indicated as #2.
- If only one finish is indicated, the entire unit will be monotone.
- Arrow indicates direction of grain

Top View

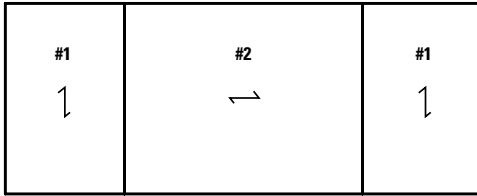

Side View

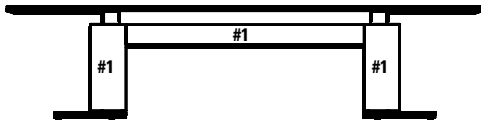

End View

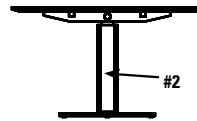

## Sectional Top with Technology Trough and bases

- Three finishes can be specified.
- The first finish in the product string, indicated as #1.
- The second finish in the product string indicated as #2.
- The third finish in the product string indicated as #3.
- If only one finish is indicated, the entire unit will be monotone.
- Arrow indicates direction of grain

Top View

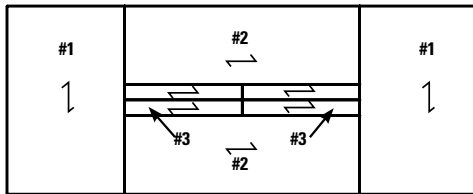

Side View

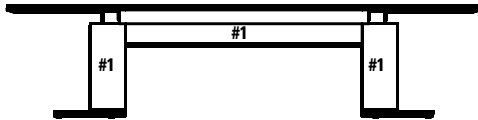

End View

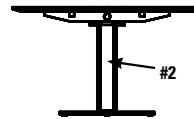

**Full Storage Credenza with two sets of Storage Cabinets and Display Wall**

- Two finishes can be specified.
- The first finish in the product string, indicated as #1.
- The second finish in the product string indicated as #2.
- If only one finish is indicated, the entire unit will be monotone.
- Arrow indicates direction of grain

Front View

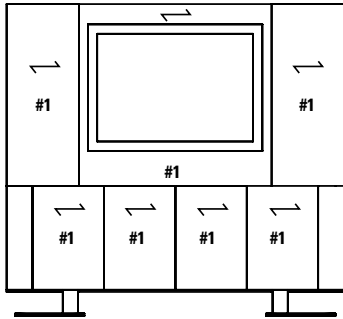

Side View

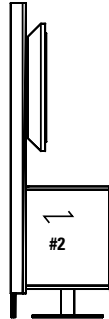

Top View

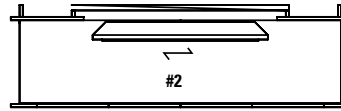

**Full Storage Credenza with BBB, Storage Cabinet, BBB and Display Wall**

- Two finishes can be specified.
- The first finish in the product string, indicated as #1.
- The second finish in the product string indicated as #2.
- If only one finish is indicated, the entire unit will be monotone.
- Arrow indicates direction of grain

Front View

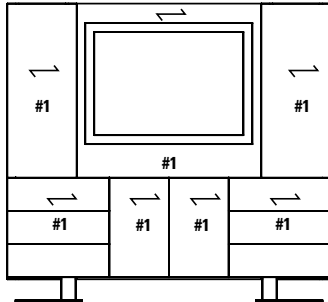

Side View

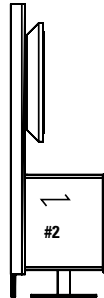

Top View

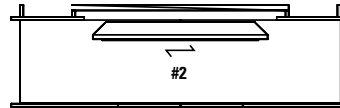

**Full Storage Credenza with BB, Storage Cabinet, BB and Display Wall**

- Two finishes can be specified.
- The first finish in the product string, indicated as #1.
- The second finish in the product string indicated as #2.
- If only one finish is indicated, the entire unit will be monotone.
- Arrow indicates direction of grain

Front View

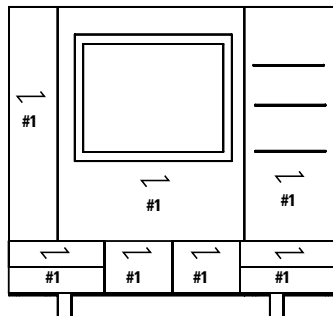

Side View

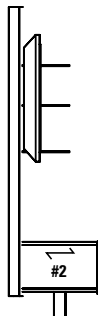

Top View

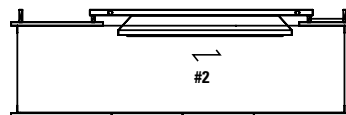



## Lectern

- Two finishes can be specified.
- The first finish in the product string, indicated as **#1**.
- The second finish in the product string indicated as **#2**.
- If only one finish is indicated, the entire unit will be monotone.
- Arrow indicates direction of grain

### FLEC-36 Lectern

Front View

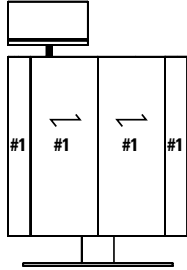

Side View

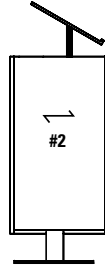

Top View

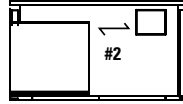

### FLEC-24 Lectern

Front View

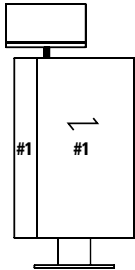

Side View

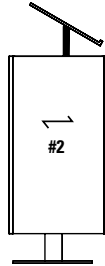

Top View

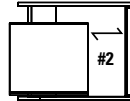

**Mobile Units**

- Two finishes can be specified.
- The first finish in the product string, indicated as **#1**.
- The second finish in the product string indicated as **#2**.
- If only one finish is indicated, the entire unit will be monotone.
- Arrow indicates direction of grain

**Mobile Lectern**

**Front View**

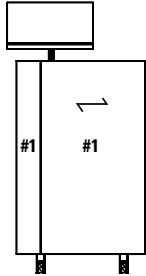

**Side View**

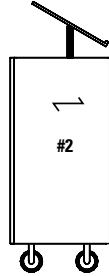

**Top View**

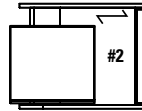

**Mobile Tech Cart**

**Front View**

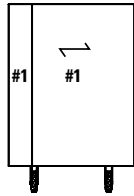

**Side View**

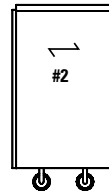

**Top View**

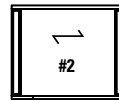

**Mobile Server**

**Front View**

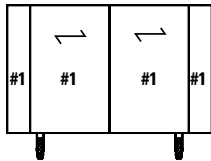

**Side View**

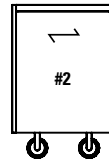

**Top View**

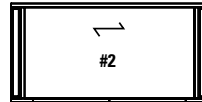

## DESKS - NOTES

- Horizontal grain direction is standard on all engineered finishes.
- Tops are constructed with two 3/4" thick panels, laminated together to create a total thickness of 1.5".
- All pedestals are suspended 7.5" off the floor by an open framed leg, and can be installed flush or offset
- Pedestals are handed:
  - Left pedestals have the handle offset from the center to the right, and the lock is placed on the right end panel
  - Right pedestals have the handle offset from the center to the left, and the lock is placed on the left end panel
- Modesty panels are available as an optional upgrade in wood or glass on Desks
- Grommets are available as an option on Desks and most Credenzas.
- **NOTE:** Arrow indicates direction of grain

Double Pedestal Desk with Box/File installed flush.

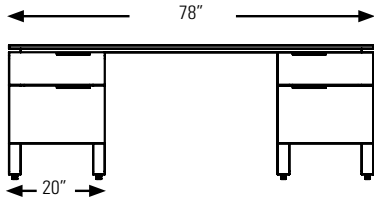

Double Pedestal Desk with Box/File installed offset.  
Add 20" to the overall width of the top.

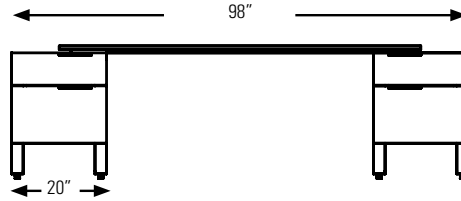

Single Pedestal Desk with Box/File installed flush.

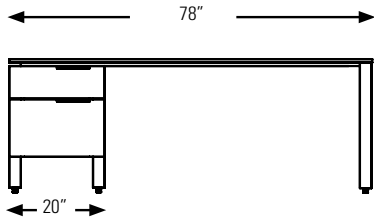

Single Pedestal Desk with Box/File installed offset.  
Add 10" to the overall width of the top.

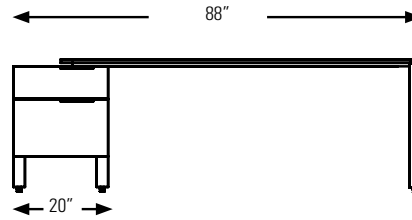

By adding a Transaction Counter Top with Decorative Front Panel (**FGTT**) to a Desk, the Desk can be used as a Reception Desk:

**User View**

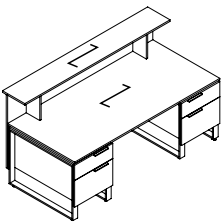

**Guest View**

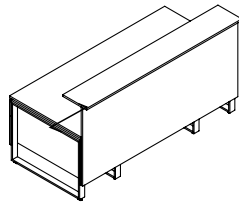

### Required Specifications

Veneer Finish  
Edge

### Optional Specifications

Grommet

## DOUBLE PEDESTAL DESKS

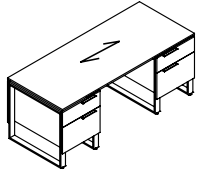

**Double Pedestal Desk**

MODEL#	DIMENSIONS	FREIGHT CLASS	WT/LBS.	CUBIC FT.	LIST PRICE
--------	------------	---------------	---------	-----------	------------

**D x W x H**

FD8436BB	36 x 84 x 28	85	201	15	<b>\$11450</b>
FD7836BB	36 x 78 x 28	85	192	15	<b>\$11227</b>
FD7236BB	36 x 72 x 28	92.5	177	15	<b>\$10948</b>
FD8430BB	30 x 84 x 28	85	184	15	<b>\$10879</b>
FD7830BB	30 x 78 x 28	92.5	176	15	<b>\$10701</b>
FD7230BB	30 x 72 x 28	92.5	163	14	<b>\$10446</b>

Standard with **flush box/file** pedestals on **left** and **right**.

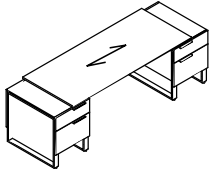

**Double Pedestal Desk**

FD8436BBOS	36 x 84 x 28	85	201	15	<b>\$11810</b>
FD7836BBOS	36 x 78 x 28	85	192	15	<b>\$11590</b>
FD7236BBOS	36 x 72 x 28	92.5	177	15	<b>\$11307</b>
FD8430BBOS	30 x 84 x 28	85	184	15	<b>\$11244</b>
FD7830BBOS	30 x 78 x 28	92.5	176	15	<b>\$11063</b>
FD7230BBOS	30 x 72 x 28	92.5	163	14	<b>\$10808</b>

Standard with **offset box/file** pedestals on **left** and **right**.

## SINGLE PEDESTAL DESKS

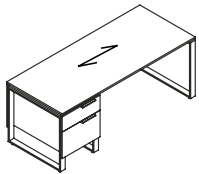

**Single Pedestal Desk - LEFT**

MODEL#	DIMENSIONS	FREIGHT CLASS	WT/LBS.	CUBIC FT.	LIST PRICE
--------	------------	---------------	---------	-----------	------------

FSL8436B	36 x 84 x 28	85	201	15	<b>\$8330</b>
FSL7836B	36 x 78 x 28	85	192	15	<b>\$8107</b>
FSL7236B	36 x 72 x 28	92.5	177	15	<b>\$7802</b>
FSL8430B	30 x 84 x 28	85	184	15	<b>\$7760</b>
FSL7830B	30 x 78 x 28	92.5	176	15	<b>\$7578</b>
FSL7230B	30 x 78 x 28	92.5	163	14	<b>\$7326</b>

Standard with **flush box/file** pedestal on **left**.

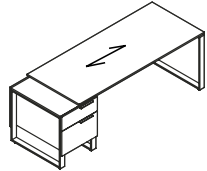

**Single Pedestal Desk - LEFT**

FSL8436BOS	36 x 84 x 28	85	201	15	<b>\$8693</b>
FSL7836BOS	36 x 78 x 28	85	192	15	<b>\$8469</b>
FSL7236BOS	36 x 72 x 28	92.5	177	15	<b>\$8162</b>
FSL8430BOS	30 x 84 x 28	85	184	15	<b>\$8122</b>
FSL7830BOS	30 x 78 x 28	92.5	176	15	<b>\$7944</b>
FSL7230BOS	30 x 78 x 28	92.5	163	14	<b>\$7688</b>

Standard with **offset box/file** pedestal on **left**.

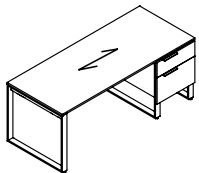

**Single Pedestal Desk - RIGHT**

FSR8436B	36 x 84 x 28	85	201	15	<b>\$8330</b>
FSR7836B	36 x 78 x 28	85	192	15	<b>\$8107</b>
FSR7236B	36 x 72 x 28	92.5	177	15	<b>\$7802</b>
FSR8430B	30 x 84 x 28	85	184	15	<b>\$7760</b>
FSR7830B	30 x 78 x 28	92.5	176	15	<b>\$7578</b>
FSR7230B	30 x 78 x 28	92.5	163	14	<b>\$7326</b>

Standard with **flush box/file** pedestal on **right**.

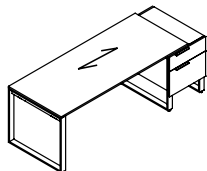

**Single Pedestal Desk - RIGHT**

FSR8436BOS	36 x 84 x 28	85	201	15	<b>\$8693</b>
FSR7836BOS	36 x 78 x 28	85	192	15	<b>\$8469</b>
FSR7236BOS	36 x 72 x 28	92.5	177	15	<b>\$8162</b>
FSR8430BOS	30 x 84 x 28	85	184	15	<b>\$8122</b>
FSR7830BOS	30 x 78 x 28	92.5	176	15	<b>\$7944</b>
FSR7230BOS	30 x 78 x 28	92.5	163	14	<b>\$7688</b>

Standard with **offset box/file** pedestal on **right**.

### Required Specifications

Top finish  
Body finish

### Optional Specifications

Grommet  
Modesty Panel

# F FOUNDATIONS

## DESK SHELL

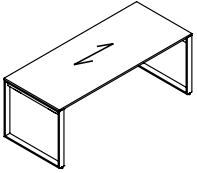

Desk Shell\*

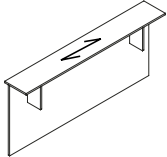

Transaction Counter

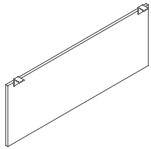

Hanging Wood Modesty Panel

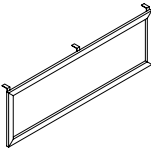

Hanging Glass Modesty Panel

MODEL#	DIMENSIONS	FREIGHT CLASS	WT/LBS.	CUBIC FT.	LIST PRICE
--------	------------	---------------	---------	-----------	------------

D x W x H

FT7236	36 x 72 x 28	85	201	15	\$5493
FT6636	36 x 66 x 28	85	192	15	\$5244
FT6036	36 x 60 x 28	92.5	177	15	\$5011
FT7230	30 x 72 x 28	85	184	15	\$4828
FT6630	30 x 66 x 28	92.5	176	15	\$4636
FT6030	30 x 60 x 28	92.5	163	14	\$4448

FGTT8412	12 x 84 x 42	250	73	21	\$3666
FGTT7812	12 x 78 x 42	250	68	19	\$3514
FGTT7212	12 x 72 x 42	250	63	18	\$3281

Rectangular transaction counter with decorative panel.

FCMP70W	0.75 x 70 x 18	--	25	1	\$1639
FCMP66W	0.75 x 66 x 18	--	24	1	\$1602
FCMP64W	0.75 x 64 x 18	--	23	1	\$1589
FCMP62W	0.75 x 62 x 18	--	22	1	\$1571
FCMP60W	0.75 x 60 x 18	--	22	1	\$1562
FCMP58W	0.75 x 58 x 18	--	21	1	\$1551
FCMP56W	0.75 x 56 x 18	--	20	1	\$1545
FCMP54W	0.75 x 54 x 18	--	20	1	\$1537
FCMP50W	0.75 x 50 x 18	--	18	1	\$1522
FCMP48W	0.75 x 48 x 18	--	18	1	\$1514
FCMP42W	0.75 x 42 x 18	--	16	1	\$1412
FCMP36W	0.75 x 36 x 18	--	14	1	\$1213
FCMP30W	0.75 x 30 x 18	--	12	1	\$1014

Hanging wood modesty panel. Attaches to underside of worksurface. **Cannot be retrofitted in the field.**

**Not sold individually - to be ordered as an upgrade option only.**

FCMP70G	0.75 x 70 x 18	--	25	1	\$2640
FCMP66G	0.75 x 66 x 18	--	24	1	\$1602
FCMP64G	0.75 x 64 x 18	--	23	1	\$2496
FCMP62G	0.75 x 62 x 18	--	22	1	\$2357
FCMP60G	0.75 x 60 x 18	--	22	1	\$2281
FCMP58G	0.75 x 58 x 18	--	21	1	\$2222
FCMP56G	0.75 x 56 x 18	--	20	1	\$2204
FCMP54G	0.75 x 54 x 18	--	20	1	\$2127
FCMP50G	0.75 x 50 x 18	--	18	1	\$2070
FCMP48G	0.75 x 48 x 18	--	18	1	\$2032
FCMP42G	0.75 x 42 x 18	--	16	1	\$2010
FCMP36G	0.75 x 36 x 18	--	14	1	\$1994
FCMP30G	0.75 x 30 x 18	--	12	1	\$1972

Aluminum framed glass modesty panel with frosted glass (standard). Attaches to underside of worksurface. **Cannot be retrofitted in the field. Not sold individually - to be ordered as an upgrade option only.**

• For white back painted glass, please contact Customer Care for pricing.

### Required Specifications

Top finish  
Body finish

### Optional Specifications

Grommet  
Modesty Panel\*

**CRENZAS - NOTES**

D x W x H

- Horizontal grain direction is standard on all engineered finishes.
- Tops are constructed with two 3/4" thick panels, laminated together to create a total thickness of 1.5".
- All pedestals are suspended 7.5" off the floor by an open framed leg, and can be installed flush or offset
- Pedestals are handed:
  - Left pedestals have the handle offset from the center to the right, and the lock is placed on the right end panel
  - Right pedestals have the handle offset from the center to the left, and the lock is placed on the left end panel
- Modesty panels are available in wood or glass
- Grommets can be specified on Credenza Tops.
- **NOTE:** Arrow indicates direction of grain

Single Pedestal Credenza with 35" Lat. Box/File installed flush

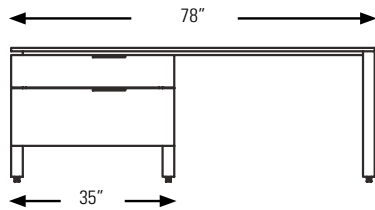

Single Pedestal Credenza with 35" Lat. Box/File installed offset  
Adds 10" to overall width

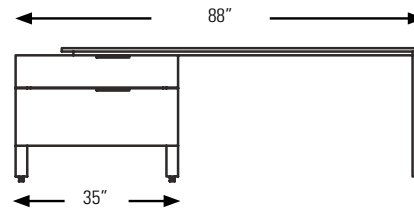

Single Pedestal Credenza with 40" Lat. Box/File installed flush.

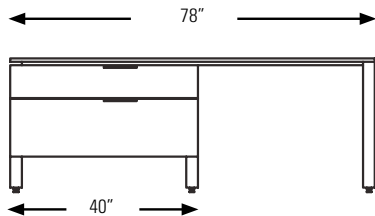

Double Pedestal Credenza with 40" Lat. Box/File installed offset.  
Adds 10" to overall width

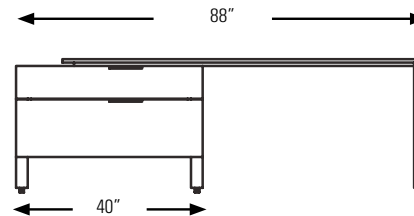

SINGLE PEDESTAL CRENZAS	MODEL#	DIMENSIONS	FREIGHT CLASS	WT/LBS.	CUBIC FT.	LIST PRICE
-------------------------	--------	------------	---------------	---------	-----------	------------

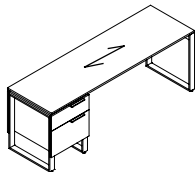

**Single Pedestal Credenza - LEFT**

FCCL7824B	24 x 78 x 28	85	160	12	<b>\$7520</b>
FCCL7224B	24 x 72 x 28	85	151	12	<b>\$7279</b>
FCCL7820B	20 x 78 x 28	85	153	11	<b>\$7061</b>
FCCL7220B	20 x 72 x 28	85	144	11	<b>\$6839</b>

Standard with **flush box/file** pedestal on **left**.

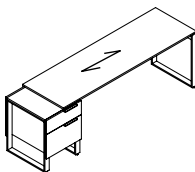

**Single Pedestal Credenza - LEFT**

FCCL7824BOS	24 x 88 x 28	85	160	12	<b>\$7567</b>
FCCL7224BOS	24 x 82 x 28	85	151	12	<b>\$7279</b>
FCCL7820BOS	20 x 88 x 28	85	153	11	<b>\$7110</b>
FCCL7220BOS	20 x 82 x 28	85	144	11	<b>\$6839</b>

Standard with **offset box/file** pedestal on **left**.

**Required Specifications**

Top finish  
Body finish

**Optional Specifications**

Grommet

# F FOUNDATIONS

## SINGLE PEDESTAL CREDENZAS

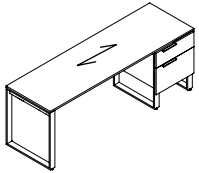

Single Pedestal Credenza - RIGHT

MODEL#	DIMENSIONS D x W x H	FREIGHT CLASS	WT/LBS.	CUBIC FT.	LIST PRICE
FCCR7824B	24 x 78 x 28	85	160	12	<b>\$7520</b>
FCCR7224B	24 x 72 x 28	85	151	12	<b>\$7279</b>
FCCR7820B	20 x 78 x 28	85	153	11	<b>\$7061</b>
FCCR7220B	20 x 72 x 28	85	144	11	<b>\$6839</b>

Standard with **flush box/file** pedestal on **right**.

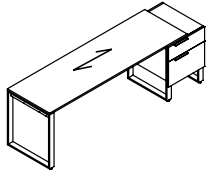

Single Pedestal Credenza - RIGHT

FCCR7824BOS	24 x 88 x 28	85	160	12	<b>\$7567</b>
FCCR7224BOS	24 x 82 x 28	85	151	12	<b>\$7279</b>
FCCR7820BOS	20 x 88 x 28	85	153	11	<b>\$7110</b>
FCCR7220BOS	20 x 82 x 28	85	144	11	<b>\$6839</b>

Standard with **offset box/file** pedestal on **right**.

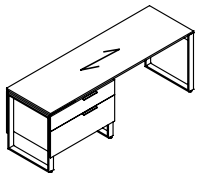

Single Pedestal Credenza - LEFT

FCC35L7824H	24 x 78 x 28	92.5	188	18	<b>\$8111</b>
FCC35L7224H	24 x 72 x 28	100	179	18	<b>\$7869</b>
FCC35L7820H	20 x 78 x 28	92.5	179	15	<b>\$7611</b>
FCC35L7220H	20 x 72 x 28	92.5	170	15	<b>\$7387</b>

Standard with **flush 35" lateral box/file** pedestal on **left**.

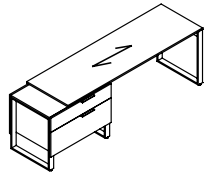

Single Pedestal Credenza - LEFT

FCC35L7824HOS	24 x 88 x 28	92.5	188	18	<b>\$8436</b>
FCC35L7224HOS	24 x 82 x 28	100	179	18	<b>\$8192</b>
FCC35L7820HOS	20 x 88 x 28	92.5	179	15	<b>\$7938</b>
FCC35L7220HOS	20 x 82 x 28	92.5	170	15	<b>\$7713</b>

Standard with **offset 35" lateral box/file** pedestal on **left**.

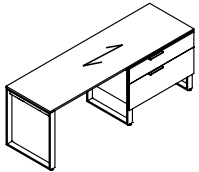

Single Pedestal Credenza - RIGHT

FCC35R7824H	24 x 78 x 28	92.5	188	18	<b>\$8111</b>
FCC35R7224H	24 x 72 x 28	100	179	18	<b>\$7869</b>
FCC35R7820H	20 x 78 x 28	92.5	179	15	<b>\$7611</b>
FCC35R7220H	20 x 72 x 28	92.5	170	15	<b>\$7387</b>

Standard with **flush 35" lateral box/file** pedestal on **right**.

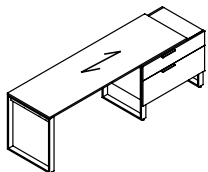

Single Pedestal Credenza - RIGHT

FCC35R7824HOS	24 x 88 x 28	92.5	188	18	<b>\$8436</b>
FCC35R7224HOS	24 x 82 x 28	100	179	18	<b>\$8192</b>
FCC35R7820HOS	20 x 88 x 28	92.5	179	15	<b>\$7938</b>
FCC35R7220HOS	20 x 82 x 28	92.5	170	15	<b>\$7713</b>

Standard with **offset 35" lateral box/file** pedestal on **right**.

### Required Specifications

Top finish  
Body finish

### Optional Specifications

Grommet

**SINGLE PEDESTAL CREDENZAS**

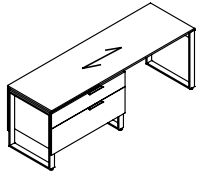

**Single Pedestal Credenza - LEFT**

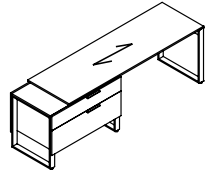

**Single Pedestal Credenza - LEFT**

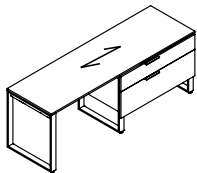

**Single Pedestal Credenza - RIGHT**

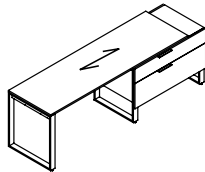

**Single Pedestal Credenza - RIGHT**

MODEL#	DIMENSIONS	FREIGHT CLASS	WT/LBS.	CUBIC FT.	LIST PRICE
	<b>D x W x H</b>				
FCC40L7824H	24 x 78 x 28	100	198	20	<b>\$8393</b>
FCC40L7224H	24 x 72 x 28	100	189	20	<b>\$8477</b>
FCC40L7820H	20 x 78 x 28	92.5	188	17	<b>\$7974</b>
FCC40L7220H	20 x 72 x 28	92.5	179	17	<b>\$7748</b>

Standard with **flush 40" lateral box/file** pedestal on **left**.

FCC40L7824HOS	24 x 88 x 28	100	198	20	<b>\$8717</b>
FCC40L7224HOS	24 x 82 x 28	100	189	20	<b>\$8477</b>
FCC40L7820HOS	20 x 88 x 28	92.5	188	17	<b>\$8297</b>
FCC40L7220HOS	20 x 82 x 28	92.5	179	17	<b>\$8074</b>

Standard with **offset 40" lateral box/file** pedestal on **left**.

FCC40R7824H	24 x 78 x 28	100	198	20	<b>\$8393</b>
FCC40R7224H	24 x 72 x 28	100	189	20	<b>\$8477</b>
FCC40R7820H	20 x 78 x 28	92.5	188	17	<b>\$7974</b>
FCC40R7220H	20 x 72 x 28	92.5	179	17	<b>\$7748</b>

Standard with **flush 40" lateral box/file** pedestal on **right**.

FCC40R7824HOS	24 x 88 x 28	100	198	20	<b>\$8717</b>
FCC40R7224HOS	24 x 82 x 28	100	189	20	<b>\$8477</b>
FCC40R7820HOS	20 x 88 x 28	92.5	188	17	<b>\$8297</b>
FCC40R7220HOS	20 x 82 x 28	92.5	179	17	<b>\$8074</b>

Standard with **offset 40" lateral box/file** pedestal on **right**.

**Required Specifications**

Top finish  
Body finish

**Optional Specifications**

Grommet



## FULL STORAGE CREDENZAS - NOTES

D x W x H

- Horizontal grain direction is standard on all engineered finishes.
- Tops are 3/4" thick with flat edge.
- All pedestals are suspended 7.5" off the floor by an open framed leg, and can be installed flush or offset
- Handles are standard on all drawer fronts
- Doors will open with touch latch.
- Units placed on the Left have the handle offset from the center to the left, and the lock is placed on the left side panel.
- Units placed on the right have the handle offset from the center to the right, and the lock is placed on the right side panel
- Modesty panels are available in wood or glass
- **NOTE:** Arrow indicates direction of grain

### FULL STORAGE CREDENZAS

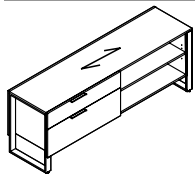

Storage Credenza

MODEL#	DIMENSIONS	FREIGHT CLASS	WT/LBS.	CUBIC FT.	LIST PRICE
FCC7424HO	24 x 74.5 x 26.75	125	203	29	<b>\$7332</b>
FCC6424HO	24 x 64.5 x 26.75	125	186	25	<b>\$6463</b>
FCC7420HO	20 x 74.5 x 26.75	125	187	24	<b>\$6985</b>
FCC6420HO	20 x 64.5 x 26.75	100	171	21	<b>\$6145</b>

Standard with **lateral box/file** on **left** and **open storage** on **right**. Handle and lock on left.

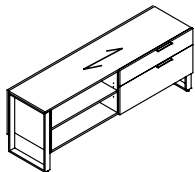

Storage Credenza

FCC7424OH	24 x 74.5 x 26.75	125	203	29	<b>\$7332</b>
FCC6424OH	24 x 64.5 x 26.75	125	186	25	<b>\$6463</b>
FCC7420OH	20 x 74.5 x 26.75	125	187	24	<b>\$6985</b>
FCC6420OH	20 x 64.5 x 26.75	100	171	21	<b>\$6145</b>

Standard with **open storage** on **left** and **lateral box/file** on **right**. Handle and lock on right.

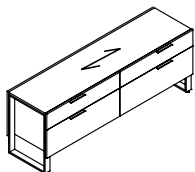

Storage Credenza

FCC7424HH	24 x 74.5 x 26.75	100	265	29	<b>\$8321</b>
FCC6424HH	24 x 64.5 x 26.75	100	238	25	<b>\$7291</b>
FCC7420HH	20 x 74.5 x 26.75	92.5	251	24	<b>\$7924</b>
FCC6420HH	20 x 64.5 x 26.75	92.5	226	21	<b>\$6947</b>

Standard with **lateral box/file** on **left** and **right**. Handles and locks on left and right.

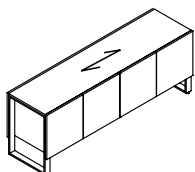

Storage Credenza

FCC7424GG	24 x 74.5 x 26.75	150	171	29	<b>\$7282</b>
FCC6424MM	24 x 64.5 x 26.75	125	152	25	<b>\$6599</b>
FCC7420GG	20 x 74.5 x 26.75	125	153	24	<b>\$6691</b>
FCC6420MM	20 x 64.5 x 26.75	125	136	21	<b>\$6068</b>

Standard with **four doors and adjustable shelves** on **left** and **right**.

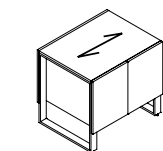

Storage Credenza

FCC3624G	24 x 36 x 26.75	150	171	29	<b>\$4553</b>
FCC3024M	24 x 30 x 26.75	125	152	25	<b>\$3795</b>
FCC3620G	20 x 36 x 26.75	125	153	24	<b>\$4069</b>
FCC3020M	20 x 30 x 26.75	125	136	21	<b>\$3391</b>

Standard with **two doors and adjustable shelves**.

#### Required Specifications

Top finish  
Body finish

#### Optional Specifications

Grommet

## MODULAR STORAGE - NOTES

D x W x H

- Horizontal grain direction is standard on all engineered finishes.
- All pedestals are suspended 7.5" off the floor by an open framed leg, and can be installed flush or offset
- Pedestals are handed:
  - Left pedestals have the handle offset from the center to the right, and the lock is placed on the right gable
  - Right pedestals have the handle offset from the center to the left, and the lock is placed on the left gable
- All modular pedestals have pre-drilled holes on the top for easy connection to worksurface.
- **NOTE:** Arrow indicates direction of grain

MODULAR STORAGE	MODEL#	DIMENSIONS	FREIGHT CLASS	WT./LBS.	CUBIC FT.	LIST PRICE
-----------------	--------	------------	---------------	----------	-----------	------------

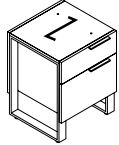

**Box/File Pedestal - LEFT**

F2036BL	36 x 20.5 x 26.75	100	99	11	<b>\$4384</b>
F2030BL	30 x 20.5 x 26.75	100	90	10	<b>\$4177</b>
F2024BL	24 x 20.5 x 26.75	92.5	83	8	<b>\$3936</b>
F2020BL	20 x 20.5 x 26.75	92.5	78	7	<b>\$3744</b>

For use under a freestanding desk or credenza. Top pre-drilled to attach to worksurface. One **box/file** drawer.

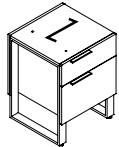

**Box/File Pedestal - RIGHT**

F2036BR	36 x 20.5 x 26.75	100	99	11	<b>\$4384</b>
F2030BR	30 x 20.5 x 26.75	100	90	10	<b>\$4177</b>
F2024BR	24 x 20.5 x 26.75	92.5	83	8	<b>\$3936</b>
F2020BR	20 x 20.5 x 26.75	92.5	78	7	<b>\$3744</b>

For use under a freestanding desk or credenza. Top pre-drilled to attach to worksurface. One **box/file** drawer.

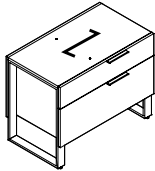

**Lateral Box/File Pedestal - LEFT**

F4024HL	24 x 40 x 26.75	125	121	16	<b>\$5154</b>
F3524HL	24 x 35 x 26.75	125	111	14	<b>\$4869</b>
F4020HL	20 x 40 x 26.75	100	113	13	<b>\$5000</b>
F3520HL	20 x 35 x 26.75	100	104	11	<b>\$4636</b>

For use under a freestanding desk or credenza. Top pre-drilled to attach to worksurface. One **lateral box/file** drawer.

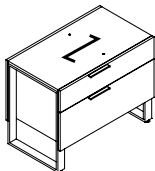

**Lateral Box/File Pedestal - RIGHT**

F4024HR	24 x 40 x 26.75	125	121	16	<b>\$5154</b>
F3524HR	24 x 35 x 26.75	125	111	14	<b>\$4869</b>
F4020HR	20 x 40 x 26.75	100	113	13	<b>\$5000</b>
F3520HR	20 x 35 x 26.75	100	104	11	<b>\$4636</b>

For use under a freestanding desk or credenza. Top pre-drilled to attach to worksurface. One **lateral box/file** drawer.

### Required Specifications

Front finish  
Top/body finish

### Optional Specifications

Grommet

# F FOUNDATIONS

## MODULAR STORAGE

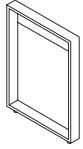

Frame Leg

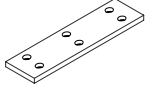

Top Connecting Bracket

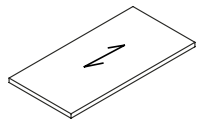

Modular Top\*

MODEL#	DIMENSIONS D x W x H	FREIGHT CLASS	WT/LBS.	CUBIC FT.	LIST PRICE
FLEG36	2.5 x 36 x 27.5	250	6	3	<b>\$1183</b>
FLEG30	2.5 x 30 x 27.5	250	6	3	<b>\$1084</b>
FLEG24	2.5 x 24 x 27.5	250	5	2	<b>\$1004</b>
FLEG20	2.5 x 20 x 27.5	250	5	2	<b>\$919</b>

FCON36	31 x 10 x .75	150	4	1	<b>\$249</b>
FCON30	25 x 10 x .75	150	4	1	<b>\$230</b>
FCON24	19 x 10 x .75	250	3	1	<b>\$225</b>
FCON20	15 x 10 x .75	250	3	1	<b>\$208</b>

F8436T	36 x 84 x 1.5	60	95	3	<b>\$3251</b>
F7836T	36 x 78 x 1.5	65	88	3	<b>\$3025</b>
F7236T	36 x 72 x 1.5	65	82	3	<b>\$2791</b>
F8430T	30 x 84 x 1.5	65	80	3	<b>\$2720</b>
F7830T	30 x 78 x 1.5	65	73	3	<b>\$2536</b>
F7230T	30 x 72 x 1.5	60	67	2	<b>\$2321</b>
F6630T	30 x 66 x 1.5	60	62	2	<b>\$2149</b>
F6030T	30 x 60 x 1.5	65	56	2	<b>\$1960</b>
F5430T	30 x 54 x 1.5	65	51	2	<b>\$1771</b>
F8424T	24 x 84 x 1.5	60	67	2	<b>\$2417</b>
F7824T	24 x 78 x 1.5	60	62	2	<b>\$2244</b>
F7424T	24 x 74 x 1.5	65	58	2	<b>\$2129</b>
F7224T	24 x 72 x 1.5	65	53	2	<b>\$2005</b>
F6624T	24 x 66 x 1.5	65	51	2	<b>\$1929</b>
F6424T	24 x 64 x 1.5	65	49	2	<b>\$1807</b>
F6024T	24 x 60 x 1.5	65	47	2	<b>\$1689</b>
F5424T	24 x 54 x 1.5	70	42	2	<b>\$1566</b>
F4824T	24 x 48 x 1.5	60	38	1	<b>\$1447</b>
F4224T	24 x 42 x 1.5	60	34	1	<b>\$1269</b>
F8420T	20 x 84 x 1.5	60	64	2	<b>\$2226</b>
F7820T	20 x 78 x 1.5	60	60	2	<b>\$2064</b>
F7420T	20 x 74 x 1.5	65	51	2	<b>\$1960</b>
F7220T	20 x 72 x 1.5	65	51	2	<b>\$1841</b>
F6620T	20 x 66 x 1.5	65	49	2	<b>\$1782</b>
F6420T	20 x 64 x 1.5	65	47	2	<b>\$1680</b>
F6020T	20 x 60 x 1.5	65	45	2	<b>\$1561</b>
F5420T	20 x 54 x 1.5	60	40	1	<b>\$1444</b>
F4820T	20 x 48 x 1.5	60	36	1	<b>\$1328</b>
F4220T	20 x 42 x 1.5	60	31	1	<b>\$1163</b>

3/4" top with flat edge. 3/4" subtop inset 2.5" all around. For crossgrain veneer pattern, add **(CG)** to the end of the product code. When connecting two tops together, a connecting bracket must be specified. Use the width of the smallest top to determine the correct bracket size (i.e. for a 20"D top, order FCON20). Optional grommet may be specified.



**Required Specifications**  
Top finish\*

**Optional Specifications**  
Grommet\*

## FREESTANDING STORAGE - NOTES

D x W x H

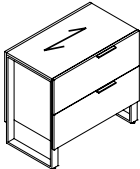
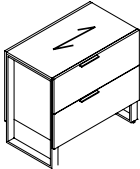
- Horizontal grain direction is standard on all engineered finishes.
- All pedestals are suspended 7.5" off the floor by an open framed leg, and can be installed flush or offset
- Pedestals are handed:
  - Left pedestals have the handle offset from the center to the right, and the lock is placed on the right gable
  - Right pedestals have the handle offset from the center to the left, and the lock is placed on the left gable
- Bench drawers do not come with a handle. They open by pulling the bottom edge of the drawer.
- Cushions will be field installed. On double width benches, the cushion can either be installed left or right.
- On mobile pedestals, the lock will be placed on the right gable.
- **NOTE:** Arrow indicates direction of grain

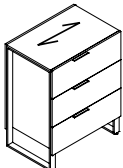
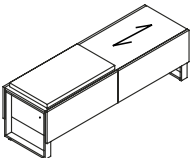
FREESTANDING STORAGE	MODEL#	DIMENSIONS	FREIGHT CLASS	WT./LBS.	CUBIC FT.	LIST PRICE
 <p><b>2H Lateral File Pedestal - LEFT</b></p>	FN3524L	24 x 35 x 32	100	152	17	<b>\$5348</b>
	FN3520L	20 x 35 x 32	100	144	15	<b>\$5089</b>
 <p><b>2H Lateral File Pedestal - RIGHT</b></p>	FN3524R	24 x 35 x 32	100	152	17	<b>\$5348</b>
	FN3520R	20 x 35 x 32	100	144	15	<b>\$5089</b>
 <p><b>3H Lateral File Pedestal - LEFT</b></p>	FN35243L	24 x 35 x 44.5	92.5	220	22	<b>\$6808</b>
	FN35203L	20 x 35 x 44.5	92.5	212	19	<b>\$6506</b>
 <p><b>3H Lateral File Pedestal - RIGHT</b></p>	FN35243R	24 x 35 x 44.5	92.5	220	22	<b>\$6808</b>
	FN35203R	20 x 35 x 44.5	92.5	212	19	<b>\$6506</b>
 <p><b>Bench, Two File Drawers w/Cushion*</b></p>	FBENKK6420	20 x 64.5 x 21	100	167	17	<b>\$5836</b>
<p>With <b>two file drawers</b> and <b>cushion</b>. Standard in grade 2 seating fabric. Locks on left and right.</p>						

### Required Specifications

Front finish  
Top/body finish  
Fabric\*

# F FOUNDATIONS

## FREESTANDING STORAGE

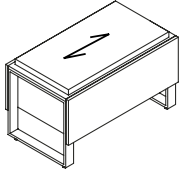

**Bench, One File Drawer w/Cushion**

MODEL#	DIMENSIONS	FREIGHT CLASS	WT/LBS.	CUBIC FT.	LIST PRICE
	<b>D x W x H</b>				
FBENK3520	20 x 35 x 21	92.5	99	9	<b>\$4239</b>

With **one file drawer** and **cushion**. Standard in grade 2 seating fabric. Lock on right.

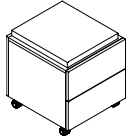

**Mobile Box/Box Pedestal w/Cushion**

F20BMCU	20 x 20.5 x 20.5	70	87	5	<b>\$2878</b>
---------	------------------	----	----	---	---------------

With **two box drawers** and **cushion**. Standard in grade 2 seating fabric. Lock on right. Casters are locking.

### Required Specifications

Front finish  
Top/body finish  
Fabric

## RETURNS - NOTES

D x W x H

- Horizontal grain direction is standard on all engineered finishes.
- Tops are constructed with two 3/4" thick panels, laminated together to create a total thickness of 1.5".
- Returns can be connected to wall credenzas and single pedestal desks
- All pedestals are suspended 7.5" off the floor by an open framed leg, and can be installed flush or offset
- Pedestals are handed:
  - Left pedestals have the handle offset from the center to the right, and the lock is placed on the left gable.
  - Right pedestals have the handle offset from the center to the left, and the lock is placed on the right gable.
- The standard grain direction on return tops is cross grain (**CG**). To remove cross grain veneer pattern on top, delete suffix "**CG**" from the model number (no upcharge)
- One Connecting Bracket is included.
- **NOTE:** Arrow indicates direction of grain

### RETURNS

**MODEL#**      **DIMENSIONS**      **FREIGHT CLASS**      **WT./LBS.**      **CUBIC FT.**      **LIST PRICE**

D x W x H

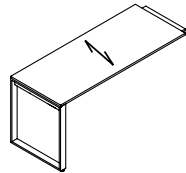

**Executive Return - LEFT**

FERL6624CG	24 x 66 x 28	85	59	4	<b>\$3603</b>
FERL6024CG	24 x 60 x 28	85	55	4	<b>\$3361</b>
FERL5424CG	24 x 54 x 28	85	50	4	<b>\$3177</b>
FERL4824CG	24 x 48 x 28	70	46	3	<b>\$3047</b>
FERL4224CG	24 x 42 x 28	85	42	3	<b>\$2511</b>
FERL6620CG	20 x 66 x 28	85	57	4	<b>\$3276</b>
FERL6020CG	20 x 60 x 28	85	53	4	<b>\$3056</b>
FERL5420CG	20 x 54 x 28	70	48	3	<b>\$2887</b>
FERL4820CG	20 x 48 x 28	85	44	3	<b>\$2770</b>
FERL4220CG	20 x 42 x 28	85	39	3	<b>\$2281</b>

Return has **no pedestal**. For use with right handed single pedestal desks, credenzas, or desk shells.

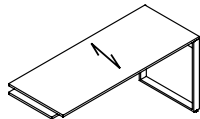

**Executive Return - RIGHT**

FERR6624CG	24 x 66 x 28	85	59	4	<b>\$3603</b>
FERR6024CG	24 x 60 x 28	85	55	4	<b>\$3361</b>
FERR5424CG	24 x 54 x 28	85	50	4	<b>\$3177</b>
FERR4824CG	24 x 48 x 28	70	46	3	<b>\$3047</b>
FERR4224CG	24 x 42 x 28	85	42	3	<b>\$2511</b>
FERR6620CG	20 x 66 x 28	85	57	4	<b>\$3276</b>
FERR6020CG	20 x 60 x 28	85	53	4	<b>\$3056</b>
FERR5420CG	20 x 54 x 28	70	48	3	<b>\$2887</b>
FERR4820CG	20 x 48 x 28	85	44	3	<b>\$2770</b>
FERR4220CG	20 x 42 x 28	85	39	3	<b>\$2281</b>

Return has **no pedestal**. For use with left handed single pedestal desks, credenzas, or desk shells.

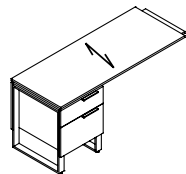

**Executive Return - LEFT**

FERL6624BCG	24 x 66 x 28	85	137	10	<b>\$6014</b>
FERL6024BCG	24 x 60 x 28	85	133	10	<b>\$5781</b>
FERL5424BCG	24 x 54 x 28	85	128	10	<b>\$5656</b>
FERL4824BCG	24 x 48 x 28	85	124	9	<b>\$5537</b>
FERL4224BCG	24 x 42 x 28	85	120	9	<b>\$5362</b>
FERL6620BCG	20 x 66 x 28	85	130	9	<b>\$5729</b>
FERL6020BCG	20 x 60 x 28	85	126	9	<b>\$5508</b>
FERL5420BCG	20 x 54 x 28	70	121	8	<b>\$5388</b>
FERL4820BCG	20 x 48 x 28	85	117	8	<b>\$5275</b>
FERL4220BCG	20 x 42 x 28	85	112	8	<b>\$5108</b>

Return has **flush box/file pedestal** on the **left**. For use with right handed single pedestal desks, credenzas, or desk shells.

#### Required Specifications

Top finish  
Body finish

#### Optional Specifications

Grommet

## EXECUTIVE RETURNS

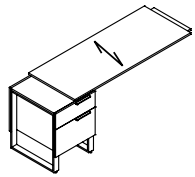

**Executive Return - LEFT**

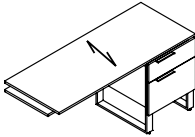

**Executive Return - RIGHT**

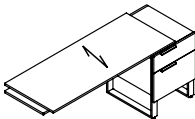

**Executive Return - RIGHT**

MODEL#	DIMENSIONS D x W x H	FREIGHT CLASS	WT/LBS.	CUBIC FT.	LIST PRICE
FERL6624BOSCG	24 x 76 x 28	85	137	10	<b>\$6661</b>
FERL6024BOSCG	24 x 70 x 28	85	133	10	<b>\$5781</b>
FERL5424BOSCG	24 x 64 x 28	85	128	10	<b>\$5656</b>
FERL4824BOSCG	24 x 58 x 28	85	124	9	<b>\$5537</b>
FERL4224BOSCG	24 x 52 x 28	85	120	9	<b>\$5362</b>
FERL6620BOSCG	20 x 76 x 28	85	130	9	<b>\$6053</b>
FERL6020BOSCG	20 x 70 x 28	85	126	9	<b>\$5508</b>
FERL5420BOSCG	20 x 64 x 28	70	121	8	<b>\$5388</b>
FERL4820BOSCG	20 x 58 x 28	85	117	8	<b>\$5275</b>
FERL4220BOSCG	20 x 52 x 28	85	112	8	<b>\$5108</b>

Return has **offset box/file pedestal** on the **left**. For use with right handed single pedestal desks, credenzas, or desk shells.

FERR6624BCG	24 x 66 x 28	85	137	10	<b>\$6014</b>
FERR6024BCG	24 x 60 x 28	85	133	10	<b>\$5781</b>
FERR5424BCG	24 x 54 x 28	85	128	10	<b>\$5656</b>
FERR4824BCG	24 x 48 x 28	85	124	9	<b>\$5537</b>
FERR4224BCG	24 x 42 x 28	85	120	9	<b>\$5362</b>
FERR6620BCG	20 x 66 x 28	85	130	9	<b>\$5729</b>
FERR6020BCG	20 x 60 x 28	85	126	9	<b>\$5508</b>
FERR5420BCG	20 x 54 x 28	70	121	8	<b>\$5388</b>
FERR4820BCG	20 x 48 x 28	85	117	8	<b>\$5275</b>
FERR4220BCG	20 x 42 x 28	85	112	8	<b>\$5108</b>

Return has **flush box/file pedestal** on the **right**. For use with left-handed single pedestal desks, credenzas, or desk shells.

FERR6624BOSCG	24 x 76 x 28	85	137	10	<b>\$6661</b>
FERR6024BOSCG	24 x 70 x 28	85	133	10	<b>\$5781</b>
FERR5424BOSCG	24 x 64 x 28	85	128	10	<b>\$5656</b>
FERR4824BOSCG	24 x 58 x 28	85	124	9	<b>\$5537</b>
FERR4224BOSCG	24 x 52 x 28	85	120	9	<b>\$5362</b>
FERR6620BOSCG	20 x 76 x 28	85	130	9	<b>\$6053</b>
FERR6020BOSCG	20 x 70 x 28	85	126	9	<b>\$5508</b>
FERR5420BOSCG	20 x 64 x 28	70	121	8	<b>\$5388</b>
FERR4820BOSCG	20 x 58 x 28	85	117	8	<b>\$5275</b>
FERR4220BOSCG	20 x 52 x 28	85	112	8	<b>\$5108</b>

Return has **offset box/file pedestal** on the **right**. For use with left-handed single pedestal desks, credenzas, or desk shells.

### Required Specifications

Top finish  
Body finish

### Optional Specifications

Grommet

DESKS	MODEL#	DIMENSIONS	FREIGHT CLASS	WT/LBS.	CUBIC FT.	LIST PRICE
-------	--------	------------	---------------	---------	-----------	------------

D x W x H

- Horizontal grain direction is standard on all engineered finishes.
- Tops are constructed with two 3/4" thick panels, laminated together to create a total thickness of 1.5".
- All pedestals are suspended 7.5" off the floor by an open framed leg, and can be installed flush or offset
- The standard grain direction on Bridge tops is cross grain (**CG**). To remove cross grain veneer pattern on top, delete suffix "**CG**" from the model number (no upcharge)
- Two Connecting Brackets are included.
- GM5K (Tungsten) TC grommet location is standard
- **NOTE:** Arrow indicates direction of grain

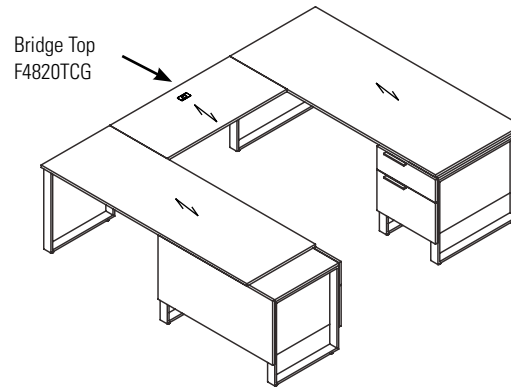

BRIDGES	MODEL#	DIMENSIONS	FREIGHT CLASS	WT/LBS.	CUBIC FT.	LIST PRICE
---------	--------	------------	---------------	---------	-----------	------------

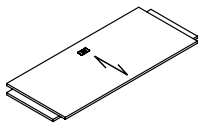

**Bridge Top**

FBT6624CG	24 x 66 x 1.5	65	57	2	<b>\$2879</b>
FBT6024CG	24 x 60 x 1.5	65	53	2	<b>\$2638</b>
FBT5424CG	24 x 54 x 1.5	65	48	2	<b>\$2502</b>
FBT4824CG	24 x 48 x 1.5	60	44	1	<b>\$2030</b>
FBT4224CG	24 x 42 x 1.5	60	40	1	<b>\$1840</b>
FBT6620CG	20 x 66 x 1.5	65	55	2	<b>\$2617</b>
FBT6020CG	20 x 60 x 1.5	65	51	2	<b>\$2396</b>
FBT5420CG	20 x 54 x 1.5	60	46	1	<b>\$2279</b>
FBT4820CG	20 x 48 x 1.5	60	42	1	<b>\$1840</b>
FBT4220CG	20 x 42 x 1.5	60	37	1	<b>\$1671</b>

Top surface only to create a "U" configuration with a single pedestal desk or credenza. **Cannot be used with corners.** Grommet in worksurface. Shipped RTA (ready to assemble).

**Required Specifications**  
Top finish

**Optional Specifications**  
Grommet



# F FOUNDATIONS

## WALL-MOUNTED STORAGE - NOTES

D x W x H

- Horizontal grain direction is standard on all engineered finishes.
- Wall Mount Overheads have a 2" deep valance on top and bottom and it can accommodate LED or T5 lighting in either location
- Tackboards are installed flush.
- Standard Heights for Tackboards are:
  - 19.2" (overall height above worksurface = 36.5")
  - 26" (overall height above worksurface = 42.5")
- **NOTE:** Arrow indicates direction of grain

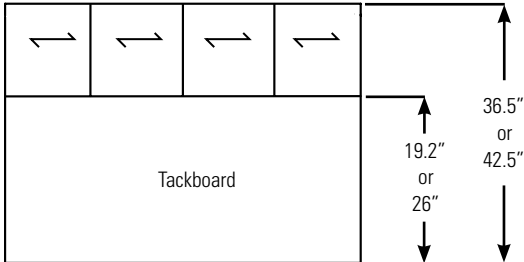

## WALL-MOUNTED STORAGE

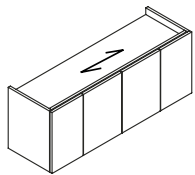

Wall Mount Storage w/Doors

MODEL# DIMENSIONS FREIGHT CLASS WT/LBS. CUBIC FT. LIST PRICE

FSF74	15 x 74.5 x 18.5	125	103	13	<b>\$3904</b>
FSF72	15 x 72 x 18.5	100	101	12	<b>\$3746</b>
FSF66	15 x 66 x 18.5	100	94	11	<b>\$3523</b>
FSF64	15 x 64.5 x 18.5	100	92	11	<b>\$3449</b>
FSF60	15 x 60 x 18.5	100	87	10	<b>\$3304</b>
FSF54	15 x 54 x 18.5	100	80	9	<b>\$3148</b>
FSF48	15 x 48 x 18.5	100	74	8	<b>\$2862</b>

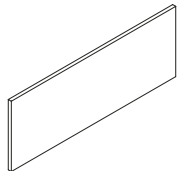

Wall Mount Tackboard\*

FTS74H26	.75 x 74.5 x 26	100	17	2	<b>\$1183</b>
FTS72H26	.75 x 72 x 26	70	16	1	<b>\$1092</b>
FTS66H26	.75 x 66 x 26	85	14	1	<b>\$1004</b>
FTS64H26	.75 x 64.5 x 26	85	13	1	<b>\$972</b>
FTS60H26	.75 x 60 x 26	85	13	1	<b>\$909</b>
FTS54H26	.75 x 54 x 26	85	13	1	<b>\$820</b>
FTS48H26	.75 x 48 x 26	85	13	1	<b>\$729</b>
FTS74	.75 x 74.5 x 19.2	85	13	1	<b>\$908</b>
FTS72	.75 x 72 x 19.2	85	12	1	<b>\$839</b>
FTS66	.75 x 66 x 19.2	92.5	11	1	<b>\$765</b>
FTS64	.75 x 64.5 x 19.2	92.5	11	1	<b>\$726</b>
FTS60	.75 x 60 x 19.2	92.5	10	1	<b>\$699</b>
FTS54	.75 x 54 x 19.2	92.5	10	1	<b>\$633</b>
FTS48	.75 x 48 x 19.2	92.5	10	1	<b>\$564</b>

### Required Specifications

Front finish  
Top/body finish  
Fabric\*

## WORK WALLS - NOTES

D x W x H

- Horizontal grain direction is standard on all engineered finishes.
- Tackboards and tasklights must be specified
- When the tackboard option is specified, the price includes a tackboard for each niche of the Work Wall.
- When the Task Light option is specified, the price includes LED Tasklight installed in the top of each niche. If more than one niche is needed in the configuration, remote on/off switch is included for simultaneous operation.
- All Storage Doors open with touch latch
- Side access to open storage or wardrobe - front panels are fixed.
- Standard heights are 26.5", 56", 70" and 84"
- Walls are available in 15" increments starting at 95" (i.e. 110", 125" 140", 155")
- Wall credenzas are only available in 90" width
- Cantilevered storage units are side locking
- For modifications to the wall configurations, size or finish, please contact customer care.

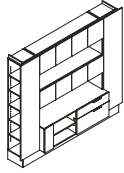
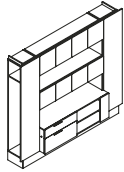
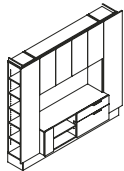
WORK WALLS - 84" H	MODEL#	DIMENSIONS	FREIGHT CLASS	WT/LBS.	CUBIC FT.	LIST PRICE
 <p><b>Work Wall - 95"W</b></p>	FW9584-1L	20 x 95 x 84	100	634	79	<b>\$25919</b>
		Vertical storage with 5 adjustable shelves, 60" wide wall credenza with adjustable shelf and box/file, 60" wide niche, 60" wide single height storage, 60" wide niche, 60" wide single height storage, wardrobe with coat hook and hat shelf.				<ul style="list-style-type: none"> <li>• To add tackboard to niche, add <b>TB</b> to end of product code. <b>Add \$1930</b> to list price for grades 1-3. Add <b>\$2316</b> for grades 4-5.</li> <li>• To add LED light to niche, add <b>LT</b> to end of product code. <b>Add \$2027</b> to list price.</li> </ul>
 <p><b>Work Wall - 95"W</b></p>	FW9584-1R	20 x 95 x 84	100	634	79	<b>\$25919</b>
		Wardrobe with coat hook and hat shelf, 60" wide wall credenza with box/file and adjustable shelf, 60" wide niche, 60" wide single height storage, 60" wide niche, 60" wide single height storage, vertical storage with 5 adjustable shelves..				<ul style="list-style-type: none"> <li>• To add tackboard to niche, add <b>TB</b> to end of product code. <b>Add \$1930</b> to list price for grades 1-3. Add <b>\$2316</b> for grades 4-5.</li> <li>• To add LED light to niche, add <b>LT</b> to end of product code. <b>Add \$2027</b> to list price.</li> </ul>
 <p><b>Work Wall - 95"W</b></p>	FW9584-2L	20 x 95 x 84	125	568	77	<b>\$22787</b>
		Vertical storage with 5 adjustable shelves, 60" wide wall credenza with adjustable shelf and box/file, 60" wide double height niche, 60" wide double height storage, wardrobe with coat hook and hat shelf.				<ul style="list-style-type: none"> <li>• To add tackboard to niche, add <b>TB</b> to end of product code. <b>Add \$1198</b> to list price for grades 1-3. Add <b>\$1438</b> for grades 4-5.</li> <li>• To add LED light to niche, add <b>LT</b> to end of product code. <b>Add \$819</b> to list price.</li> </ul>

### Required Specifications

Front finish  
Top/body finish  
Cubby interior finish

### Optional Specifications

Grommet  
LED light  
Tackboard

**WORK WALLS - 84" H**

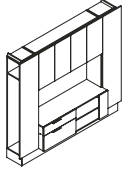

**Work Wall - 95" W**

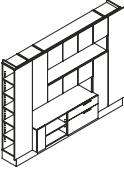

**Work Wall - 110" W**

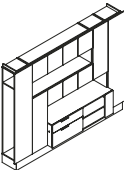

**Work Wall - 110" W**

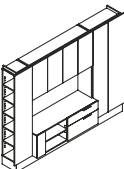

**Work Wall - 110" W**

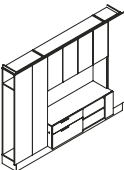

**Work Wall - 110" W**

MODEL#	DIMENSIONS	FREIGHT CLASS	WT/LBS.	CUBIC FT.	LIST PRICE
--------	------------	---------------	---------	-----------	------------

	D x W x H				
FW9584-2R	20 x 95 x 84	125	568	77	<b>\$22787</b>

Wardrobe with coat hook and hat shelf, 60" wide wall credenza with box/file and adjustable shelf, 60" wide double height niche, 60" wide double height storage, vertical storage with 5 adjustable shelves.

- To add tackboard to niche, add **TB** to end of product code. **Add \$1198** to list price for grades 1-3. Add **\$1438** for grades 4-5.
- To add LED light to niche, add **LT** to end of product code. **Add \$819** to list price.

FW11084-1L	20 x 110 x 84	100	741	91	<b>\$29510</b>
------------	---------------	-----	-----	----	----------------

Vertical storage with 5 adjustable shelves, 60" wide wall credenza with adjustable shelf and box/file, 60" wide niche, triple height storage, 45" wide single height storage, 60" wide niche, 60" wide single height storage, triple height storage, wardrobe with coat hook and hat shelf.

- To add tackboard to niche, add **TB** to end of product code. **Add \$1924** to list price for grades 1-3. Add **\$2309** for grades 4-5.
- To add LED light to niche, add **LT** to end of product code. **Add \$2030** to list price.

FW11084-1R	20 x 110 x 84	100	741	91	<b>\$29510</b>
------------	---------------	-----	-----	----	----------------

Wardrobe with coat hook and hat shelf, triple height storage, 60" wide niche, 60" wide single height storage, 60" wide wall credenza with box/file and adjustable shelf, 60" wide niche, 45" wide single height storage, triple height storage, vertical storage with 5 adjustable shelves.

- To add tackboard to niche, add **TB** to end of product code. **Add \$1924** to list price for grades 1-3. Add **\$2309** for grades 4-5.
- To add LED light to niche, add **LT** to end of product code. **Add \$2030** to list price.

FW11084-2L	20 x 110 x 84	125	628	88	<b>\$25185</b>
------------	---------------	-----	-----	----	----------------

Vertical storage with 5 adjustable shelves, 60" wide wall credenza with adjustable shelf and box/file, 60" wide double height niche, 60" wide double height storage, double depth wardrobe with coat rod and hat shelf.

- To add tackboard to niche, add **TB** to end of product code. **Add \$1196** to list price for grades 1-3. Add **\$1435** for grades 4-5.
- To add LED light to niche, add **LT** to end of product code. **Add \$819** to list price.

FW11084-2R	20 x 110 x 84	125	628	88	<b>\$25185</b>
------------	---------------	-----	-----	----	----------------

Double depth wardrobe with coat rod and hat shelf, 60" wide wall credenza with adjustable shelf and box/file, 60" wide double height niche, 60" wide double height storage, vertical storage with 5 adjustable shelves.

- To add tackboard to niche, add **TB** to end of product code. **Add \$1196** to list price for grades 1-3. Add **\$1435** for grades 4-5.
- To add LED light to niche, add **LT** to end of product code. **Add \$819** to list price.

**Required Specifications**

Front finish  
Top/body finish  
Cubby interior finish

**Optional Specifications**

Grommet  
LED light  
Tackboard

## WORK WALLS - 84"H

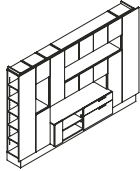

**Work Wall - 125"W**

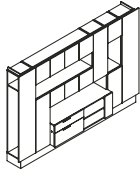

**Work Wall - 125"W**

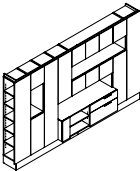

**Work Wall - 140"W**

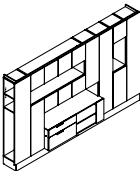

**Work Wall - 140"W**

MODEL#	DIMENSIONS	FREIGHT CLASS	WT/LBS.	CUBIC FT.	LIST PRICE
--------	------------	---------------	---------	-----------	------------

D x W x H

FW12584-1L	20 x 125 x 84	100	858	103	<b>\$33132</b>
------------	---------------	-----	-----	-----	----------------

Vertical storage with 5 adjustable shelves, 15" wide double height niche, single height storage, 60" wide wall credenza with adjustable shelf and box/file, 60" wide niche, triple height storage, 45" wide single height storage, 60" wide niche, 60" wide single height storage, triple height storage, wardrobe with coat hook and hat shelf.

- To add tackboard to niche, add **TB** to end of product code. **Add \$2350** to list price for grades 1-3. Add **\$2821** for grades 4-5.
- To add LED light to niche, add **LT** to end of product code. **Add \$2358** to list price.

FW12584-1R	20 x 125 x 84	100	858	103	<b>\$33132</b>
------------	---------------	-----	-----	-----	----------------

Wardrobe with coat hook and hat shelf, triple height storage, 60" wide niche, 60" wide single height storage, 60" wide wall credenza with box/file and adjustable shelf, 60" wide niche, 45" wide single height storage, triple height storage, 15" wide double height niche, single height storage, vertical storage with 5 adjustable shelves.

- To add tackboard to niche, add **TB** to end of product code. **Add \$2350** to list price for grades 1-3. Add **\$2821** for grades 4-5.
- To add LED light to niche, add **LT** to end of product code. **Add \$2358** to list price.

FW14084-1L	20 x 140 x 84	100	936	115	<b>\$35732</b>
------------	---------------	-----	-----	-----	----------------

Vertical storage with 5 adjustable shelves, triple height storage, 15" wide double height niche, single height storage, vertical storage with 5 adjustable shelves, 60" wide wall credenza with adjustable shelf and box/file, 60" wide niche, triple height storage cabinet, 45" wide single height storage, 60" wide niche, 60" wide single height storage, double depth wardrobe with coat rod and two shelves.

- To add tackboard to niche, add **TB** to end of product code. **Add \$2350** to list price for grades 1-3. Add **\$2821** for grades 4-5.
- To add LED light to niche, add **LT** to end of product code. **Add \$2357** to list price.

FW14084-1R	20 x 125 x 84	100	936	115	<b>\$35732</b>
------------	---------------	-----	-----	-----	----------------

Double depth wardrobe with coat rod and two shelves, 60" wide niche, 60" wide single height storage, 60" wide wall credenza with box/file and adjustable shelf, 60" wide niche, 45" wide single height storage, triple height storage, vertical storage with 5 adjustable shelves, triple height storage, 15" wide double height niche, single height storage, vertical storage with 5 adjustable shelves.

- To add tackboard to niche, add **TB** to end of product code. **Add \$2350** to list price for grades 1-3. Add **\$2821** for grades 4-5.
- To add LED light to niche, add **LT** to end of product code. **Add \$2357** to list price.

### Required Specifications

Front finish  
Top/body finish  
Cubby interior finish

### Optional Specifications

Grommet  
LED light  
Tackboard

## WORK WALLS - 70"W

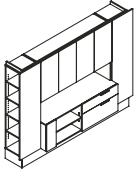

**Work Wall - 95"W**

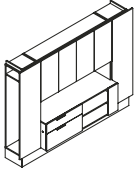

**Work Wall - 95"W**

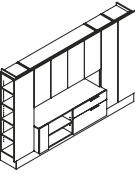

**Work Wall - 110"W**

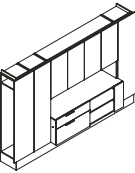

**Work Wall - 110"W**

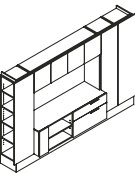

**Work Wall - 110"W**

MODEL#	DIMENSIONS	FREIGHT CLASS	WT./LBS.	CUBIC FT.	LIST PRICE
--------	------------	---------------	----------	-----------	------------

D x W x H

FW9570-1L	20 x 95 x 70	125	523	66	<b>\$21754</b>
-----------	--------------	-----	-----	----	----------------

Vertical storage with 4 adjustable shelves, 60" wide wall credenza with adjustable shelf and box/file, 60" wide niche, 60" wide double height storage, wardrobe with coat hook and hat shelf.

- To add tackboard to niche, add **TB** to end of product code. **Add \$966** to list price for grades 1-3. Add **\$1160** for grades 4-5.
- To add LED light to niche, add **LT** to end of product code. **Add \$817** to list price.

FW9570-1R	20 x 95 x 70	125	523	66	<b>\$21754</b>
-----------	--------------	-----	-----	----	----------------

Wardrobe with coat hook and hat shelf, 60" wide wall credenza with box/file and adjustable shelf, 60" wide niche, 60" wide double height storage, vertical storage with 4 adjustable shelves.

- To add tackboard to niche, add **TB** to end of product code. **Add \$966** to list price for grades 1-3. Add **\$1160** for grades 4-5.
- To add LED light to niche, add **LT** to end of product code. **Add \$817** to list price.

FW11070-1L	20 x 110 x 70	100	618	76	<b>\$23751</b>
------------	---------------	-----	-----	----	----------------

Vertical storage with 4 adjustable shelves, 60" wide wall credenza with adjustable shelf and box/file, 60" wide niche, 60" wide double height storage, vertical storage with 4 adjustable shelves, wardrobe with coat hook and hat shelf.

- To add tackboard to niche, add **TB** to end of product code. **Add \$963** to list price for grades 1-3. Add **\$1155** for grades 4-5.
- To add LED light to niche, add **LT** to end of product code. **Add \$817** to list price.

FW11070-1R	20 x 110 x 70	100	618	76	<b>\$23751</b>
------------	---------------	-----	-----	----	----------------

Wardrobe with coat hook and hat shelf, vertical storage with 4 adjustable shelves, 60" wide wall credenza with box/file and adjustable shelf, 60" wide niche, 60" wide double height storage, vertical storage with 4 adjustable shelves.

- To add tackboard to niche, add **TB** to end of product code. **Add \$963** to list price for grades 1-3. Add **\$1155** for grades 4-5.
- To add LED light to niche, add **LT** to end of product code. **Add \$817** to list price.

FW11070-2L	20 x 110 x 70	125	586	76	<b>\$22383</b>
------------	---------------	-----	-----	----	----------------

Vertical storage with 4 adjustable shelves, 60" wide wall credenza with adjustable shelf and box/file, 60" wide double height niche, 60" wide single height storage, vertical storage with 4 adjustable shelves, wardrobe with coat hook and hat shelf.

- To add tackboard to niche, add **TB** to end of product code. **Add \$1193** to list price for grades 1-3. Add **\$1432** for grades 4-5.
- To add LED light to niche, add **LT** to end of product code. **Add \$819** to list price.

### Required Specifications

Front finish  
Top/body finish  
Cubby interior finish

### Optional Specifications

Grommet  
LED light  
Tackboard

## WORK WALLS - 70"H

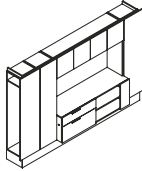

**Work Wall - 110"W**

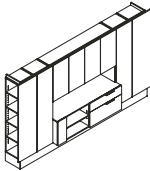

**Work Wall - 125"W**

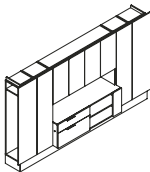

**Work Wall - 125"W**

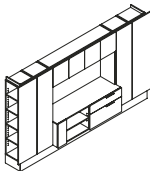

**Work Wall - 125"W**

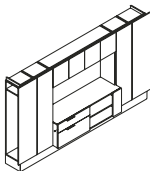

**Work Wall - 125"W**

MODEL#	DIMENSIONS	FREIGHT CLASS	WT/LBS.	CUBIC FT.	LIST PRICE
--------	------------	---------------	---------	-----------	------------

**D x W x H**

FW11070-2R	20 x 110 x 70	125	586	76	<b>\$22383</b>
------------	---------------	-----	-----	----	----------------

Wardrobe with coat hook and hat shelf, vertical storage with 4 adjustable shelves, 60" wide wall credenza with box/file and adjustable shelf, 60" wide double height niche, 60" wide single height storage, vertical storage with 4 adjustable shelves.

- To add tackboard to niche, add **TB** to end of product code. **Add \$1193** to list price for grades 1-3. Add **\$1432** for grades 4-5.
- To add LED light to niche, add **LT** to end of product code. **Add \$819** to list price.

FW12570-1L	20 x 125 x 70	100	713	85	<b>\$24955</b>
------------	---------------	-----	-----	----	----------------

Vertical storage with 4 adjustable shelves, vertical storage with 4 adjustable shelves, 60" wide wall credenza with adjustable shelf and box/file, 60" wide niche, 60" wide double height storage, vertical storage with 4 adjustable shelves, wardrobe with coat hook and hat shelf.

- To add tackboard to niche, add **TB** to end of product code. **Add \$966** to list price for grades 1-3. Add **\$1160** for grades 4-5.
- To add LED light to niche, add **LT** to end of product code. **Add \$819** to list price.

FW12570-1R	20 x 125 x 70	100	713	85	<b>\$24955</b>
------------	---------------	-----	-----	----	----------------

Wardrobe with coat hook and hat shelf, vertical storage with 4 adjustable shelves, 60" wide wall credenza with box/file and adjustable shelf, 60" wide niche, 60" wide double height storage, vertical storage with 4 adjustable shelves, vertical storage with 4 adjustable shelves.

- To add tackboard to niche, add **TB** to end of product code. **Add \$966** to list price for grades 1-3. Add **\$1160** for grades 4-5.
- To add LED light to niche, add **LT** to end of product code. **Add \$819** to list price.

FW12570-2L	20 x 125 x 70	100	681	85	<b>\$23583</b>
------------	---------------	-----	-----	----	----------------

Vertical storage with 4 adjustable shelves, vertical storage with 4 adjustable shelves, 60" wide wall credenza with adjustable shelf and box/file, 60" wide double height niche, 60" wide single height storage, vertical storage with 4 adjustable shelves, wardrobe with coat hook and hat shelf.

- To add tackboard to niche, add **TB** to end of product code. **Add \$1196** to list price for grades 1-3. Add **\$1435** for grades 4-5.
- To add LED light to niche, add **LT** to end of product code. **Add \$819** to list price.

FW12570-2R	20 x 125 x 70	100	681	85	<b>\$23583</b>
------------	---------------	-----	-----	----	----------------

Wardrobe with coat hook and hat shelf, vertical storage with 4 adjustable shelves, 60" wide wall credenza with box/file and adjustable shelf, 60" wide double height niche, 60" wide single height storage, vertical storage with 4 adjustable shelves, vertical storage with 4 adjustable shelves.

- To add tackboard to niche, add **TB** to end of product code. **Add \$1196** to list price for grades 1-3. Add **\$1435** for grades 4-5.
- To add LED light to niche, add **LT** to end of product code. **Add \$819** to list price.

### Required Specifications

Front finish  
Top/body finish  
Cubby interior finish

### Optional Specifications

Grommet  
LED light  
Tackboard

## WORK WALLS - 70"H

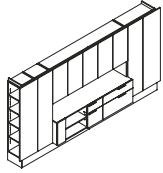

**Work Wall - 140"W**

MODEL#	DIMENSIONS	FREIGHT CLASS	WT/LBS.	CUBIC FT.	LIST PRICE
--------	------------	---------------	---------	-----------	------------

D x W x H

FW14070-1L	20 x 140 x 70	125	750	95	<b>\$26997</b>
------------	---------------	-----	-----	----	----------------

Vertical storage with 4 adjustable shelves, vertical storage with 4 adjustable shelves, 75" wide wall credenza with adjustable shelf, narrow box/file and box file, 75" wide single height niche, 75" wide double height storage, double depth wardrobe with coat rod and hat shelf.

- To add tackboard to niche, add **TB** to end of product code. **Add \$1210** to list price for grades 1-3. Add **\$1452** for grades 4-5.
- To add LED light to niche, add **LT** to end of product code. **Add \$1851** to list price.

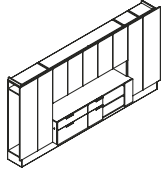

**Work Wall - 140"W**

FW14070-1R	20 x 140 x 70	125	750	95	<b>\$26997</b>
------------	---------------	-----	-----	----	----------------

Double depth wardrobe with coat rod and hat shelf, 75" wide wall credenza with box/file, narrow box/file and adjustable shelf, 75" wide single height niche, 75" wide double height storage, vertical storage with 4 adjustable shelves, vertical storage with 4 adjustable shelves.

- To add tackboard to niche, add **TB** to end of product code. **Add \$1210** to list price for grades 1-3. Add **\$1452** for grades 4-5.
- To add LED light to niche, add **LT** to end of product code. **Add \$1851** to list price.

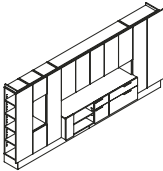

**Work Wall - 155"W**

FW15570-1L	20 x 155 x 70	125	849	107	<b>\$32612</b>
------------	---------------	-----	-----	-----	----------------

Vertical storage with 4 adjustable shelves, double height storage, 15" wide double height niche, single height storage, vertical storage with 4 adjustable shelves, 75" wide wall credenza with adjustable shelf, narrow box/file and box file, 75" wide niche, 75" wide double height storage, double depth wardrobe with coat rod and hat shelf.

- To add tackboard to niche, add **TB** to end of product code. **Add \$1630** to list price for grades 1-3. Add **\$1956** for grades 4-5.
- To add LED light to niche, add **LT** to end of product code. **Add \$2176** to list price.

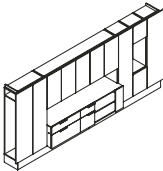

**Work Wall - 155"W**

FW15570-1R	20 x 155 x 70	125	849	107	<b>\$32612</b>
------------	---------------	-----	-----	-----	----------------

Double depth wardrobe with coat rod and hat shelf, 75" wide wall credenza with box/file, narrow box/file and adjustable shelf, 75" wide niche, 75" wide double height storage, vertical storage with 4 adjustable shelves, double height storage, 15" wide double height niche, single height storage, vertical storage with 4 adjustable shelves.

- To add tackboard to niche, add **TB** to end of product code. **Add \$1630** to list price for grades 1-3. Add **\$1956** for grades 4-5.
- To add LED light to niche, add **LT** to end of product code. **Add \$2176** to list price.

### Required Specifications

Front finish  
Top/body finish  
Cubby interior finish

### Optional Specifications

Grommet  
LED light  
Tackboard

## WORK WALLS - 56"H

MODEL#	DIMENSIONS	FREIGHT CLASS	WT/LBS.	CUBIC FT.	LIST PRICE
--------	------------	---------------	---------	-----------	------------

D x W x H

FW9556-1	20 x 95 x 56	100	488	55	<b>\$20156</b>
----------	--------------	-----	-----	----	----------------

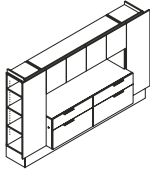

**Work Wall - 95"W**

Vertical storage with 3 adjustable shelves, 60" wide wall credenza with two box/files, 60" wide single height niche, 60" wide single height storage, vertical storage with 3 adjustable shelves.

- To add tackboard to niche, add **TB** to end of product code. **Add \$965** to list price for grades 1-3. Add **\$1159** for grades 4-5.
- To add LED light to niche, add **LT** to end of product code. **Add \$817** to list price.

FW9556-2	20 x 95 x 56	125	420	55	<b>\$18157</b>
----------	--------------	-----	-----	----	----------------

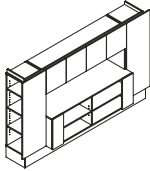

**Work Wall - 95"W**

Vertical storage with 3 adjustable shelves, 60" wide wall open credenza with two adjustable shelves, 60" wide single height niche, 60" wide single height storage, vertical storage with 3 adjustable shelves.

- To add tackboard to niche, add **TB** to end of product code. **Add \$965** to list price for grades 1-3. Add **\$1159** for grades 4-5.
- To add LED light to niche, add **LT** to end of product code. **Add \$819** to list price.

FW11056-1L	20 x 110 x 56	100	533	63	<b>\$19755</b>
------------	---------------	-----	-----	----	----------------

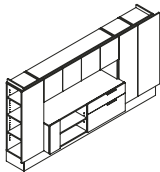

**Work Wall - 110"W**

Vertical storage with 3 adjustable shelves, 60" wide wall credenza with adjustable shelf and box/file, 60" wide niche, 60" wide single height storage, vertical storage with 3 adjustable shelves, wardrobe with coat hook and hat shelf.

- To add tackboard to niche, add **TB** to end of product code. **Add \$965** to list price for grades 1-3. Add **\$1159** for grades 4-5.
- To add LED light to niche, add **LT** to end of product code. **Add \$817** to list price.

FW11056-1R	20 x 110 x 56	100	533	63	<b>\$19755</b>
------------	---------------	-----	-----	----	----------------

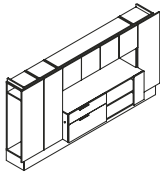

**Work Wall - 110"W**

Wardrobe with coat hook and hat shelf, vertical storage with 3 adjustable shelves, 60" wide wall credenza with box/file and adjustable shelf, 60" wide single height niche, 60" wide single height storage, vertical storage with 3 adjustable shelves.

- To add tackboard to niche, add **TB** to end of product code. **Add \$965** to list price for grades 1-3. Add **\$1159** for grades 4-5.
- To add LED light to niche, add **LT** to end of product code. **Add \$817** to list price.

FW11056-2L	20 x 110 x 56	100	549	62	<b>\$21753</b>
------------	---------------	-----	-----	----	----------------

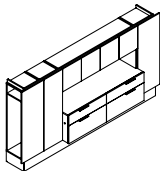

**Work Wall - 110"W**

Wardrobe with coat hook and hat shelf, vertical storage with 3 adjustable shelves, 60" wide wall credenza with two box/files, 60" wide niche, 60" wide single height storage, vertical storage with 3 adjustable shelves.

- To add tackboard to niche, add **TB** to end of product code. **Add \$965** to list price for grades 1-3. Add **\$1160** for grades 4-5.
- To add LED light to niche, add **LT** to end of product code. **Add \$817** to list price.

### Required Specifications

Front finish  
Top/body finish  
Cubby interior finish

### Optional Specifications

Grommet  
LED light  
Tackboard



**WORK WALLS - 56"H**

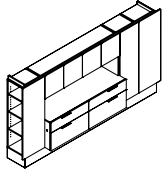

**Work Wall - 110"W\***

MODEL#	DIMENSIONS D x W x H	FREIGHT CLASS	WT/LBS.	CUBIC FT.	LIST PRICE
FW11056-2R	20 x 110 x 56	100	549	62	<b>\$21753</b>

Vertical storage with 3 adjustable shelves, 60" wide wall credenza with two box/files, 60" wide niche, 60" wide single height storage, vertical storage with 3 adjustable shelves, wardrobe with coat hook and hat shelf.

- To add tackboard to niche, add **TB** to end of product code. **Add \$965** to list price for grades 1-3. Add **\$1160** for grades 4-5.
- To add LED light to niche, add **LT** to end of product code. **Add \$817** to list price.

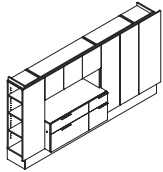

**Work Wall - 110"W\***

FW11056-3L	20 x 110 x 56	100	538	62	<b>\$21558</b>
------------	---------------	-----	-----	----	----------------

Vertical storage with 3 adjustable shelves, 45" wide wall credenza with box/file and narrow box/file, 45" wide niche, 45" wide single height storage, double width vertical storage with 3 adjustable shelves, wardrobe with coat hook and hat shelf.

- To add tackboard to niche, add **TB** to end of product code. **Add \$968** to list price for grades 1-3. Add **\$1162** for grades 4-5.
- To add LED light to niche, add **LT** to end of product code. **Add \$664** to list price.

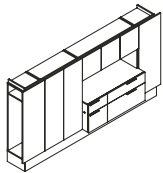

**Work Wall - 110"W\***

FW11056-3R	20 x 110 x 56	100	538	62	<b>\$21558</b>
------------	---------------	-----	-----	----	----------------

Wardrobe with coat hook and hat shelf, double width vertical storage with 3 adjustable shelves, 45" wide wall credenza with narrow box/file and box/file, 45" wide niche, 45" wide single height storage, vertical storage with 3 adjustable shelves.

- To add tackboard to niche, add **TB** to end of product code. **Add \$968** to list price for grades 1-3. Add **\$1162** for grades 4-5.
- To add LED light to niche, add **LT** to end of product code. **Add \$664** to list price.

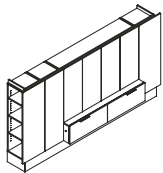

**Work Wall - 110"W**

FW11056-4L	20 x 110 x 56	100	530	61	<b>\$20691</b>
------------	---------------	-----	-----	----	----------------

Vertical storage with 3 adjustable shelves, vertical storage with 3 adjustable shelves, 60" wide single height wall credenza with two files, 60" wide triple height storage with 2 adjustable shelves, wardrobe with coat hook and hat shelf.

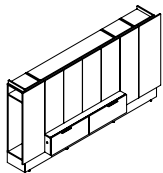

**Work Wall - 110"W**

FW11056-4R	20 x 110 x 56	100	530	61	<b>\$20691</b>
------------	---------------	-----	-----	----	----------------

Wardrobe with coat hook and hat shelf, single height 60" wide wall credenza with two files, 60" wide triple height storage with 2 adjustable shelves, vertical storage with 3 adjustable shelves, vertical storage with 3 adjustable shelves.

**Required Specifications**

Front finish  
Top/body finish  
Cubby interior finish

**Optional Specifications**

Grommet  
LED light\*  
Tackboard\*

## WORK WALLS - 84"H

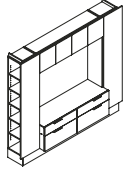

**Work Wall - 95"W**

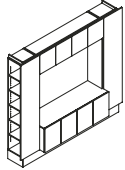

**Work Wall - 95"W**

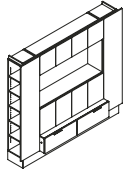

**Work Wall - 95"W**

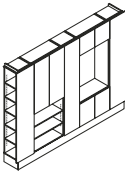

**Work Wall - 110"W**

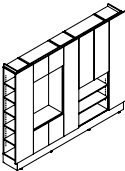

**Work Wall - 110"W**

MODEL#	DIMENSIONS	FREIGHT CLASS	WT/LBS.	CUBIC FT.	LIST PRICE
--------	------------	---------------	---------	-----------	------------

**D x W x H**

FW9584-20	20 x 95 x 84	125	565	77	<b>\$25182</b>
-----------	--------------	-----	-----	----	----------------

Vertical storage with 5 adjustable shelves, 60" wide wall credenza with two box/files, 60" wide triple height niche, 60" wide single height storage, vertical storage with 5 adjustable shelves.

- To add tackboard to niche, add **TB** to end of product code. **Add \$1793** to list price for grades 1-3. Add **\$2152** for grades 4-5.
- To add LED light to niche, add **LT** to end of product code. **Add \$817** to list price.

FW9584-21	20 x 95 x 84	125	512	77	<b>\$23182</b>
-----------	--------------	-----	-----	----	----------------

Vertical storage with 5 adjustable shelves, 60" wide wall credenza with two cabinets with adjustable shelves, 60" wide triple height niche, 60" wide single height storage, vertical storage with 5 adjustable shelves.

- To add tackboard to niche, add **TB** to end of product code. **Add \$1793** to list price for grades 1-3. Add **\$2152** for grades 4-5.
- To add LED light to niche, add **LT** to end of product code. **Add \$820** to list price.

FW9584-22	20 x 95 x 84	125	611	77	<b>\$24181</b>
-----------	--------------	-----	-----	----	----------------

Vertical storage with 5 adjustable shelves, 60" wide single height wall credenza with two files, 60" wide double height storage, 60" wide double height niche, 60" wide single height storage, vertical storage with 5 adjustable shelves.

- To add tackboard to niche, add **TB** to end of product code. **Add \$1193** to list price for grades 1-3. Add **\$1432** for grades 4-5.
- To add LED light to niche, add **LT** to end of product code. **Add \$817** to list price.

FW11084-20L	15 x 110 x 84	125	659	87	<b>\$23685</b>
-------------	---------------	-----	-----	----	----------------

Vertical storage with 5 adjustable shelves, 30" wide triple height open bookcase, 30" wide triple height double width storage, vertical storage with 5 adjustable shelves, 30" wide and double height storage, 30" triple height niche, 30" wide single height storage, vertical storage with 5 adjustable shelves.

- To add tackboard to niche, add **TB** to end of product code. **Add \$897** to list price for grades 1-3. Add **\$1076** for grades 4-5.
- To add LED light to niche, add **LT** to end of product code. **Add \$500** to list price.

FW11084-20R	15 x 110 x 84	125	659	87	<b>\$23685</b>
-------------	---------------	-----	-----	----	----------------

Vertical storage with 5 adjustable shelves, 30" wide double height storage, 30" wide triple height niche, 30" wide single height storage, vertical storage with 5 adjustable shelves, 30" wide triple height open bookcase, 30" wide triple height double width storage, vertical storage with 5 adjustable shelves.

- To add tackboard to niche, add **TB** to end of product code. **Add \$897** to list price for grades 1-3. Add **\$1076** for grades 4-5.
- To add LED light to niche, add **LT** to end of product code. **Add \$500** to list price.

**Required Specifications**

Front finish  
Top/body finish  
Cubby interior finish

**Optional Specifications**

Grommet  
LED light  
Tackboard

## WORK WALLS - 84"H

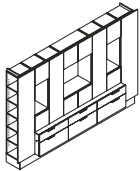

**Work Wall - 125"W**

MODEL#	DIMENSIONS D x W x H	FREIGHT CLASS	WT/LBS.	CUBIC FT.	LIST PRICE
FW12584-20	20 x 125 x 84	100	962	101	<b>\$36610</b>

Vertical storage with 5 adjustable shelves, 90" wide wall credenza with three box/files, single height storage, 15" wide double height niche, single height storage, four-fold height vertical storage with 3 adjustable shelves, double width single height storage, 30" wide double height niche, double width single height storage, fourfold height vertical storage with 3 adjustable shelves, single height storage, 15" wide double height niche, single height storage, vertical storage with 5 adjustable shelves.

- To add tackboard to niche, add **TB** to end of product code. **Add \$1630** to list price for grades 1-3. **Add \$1956** for grades 4-5.
- To add LED light to niche, add **LT** to end of product code. **Add \$1635** to list price.

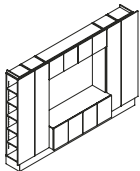

**Work Wall - 125"W**

FW12584-21	20 x 125 x 84	125	738	100	<b>\$27777</b>
------------	---------------	-----	-----	-----	----------------

Vertical storage with 5 adjustable shelves, vertical storage with 5 adjustable shelves, 60" wide wall credenza with two cabinets and adjustable shelf, 60" wide triple height niche, 60" wide single height storage, vertical storage with 5 adjustable shelves, vertical storage with 5 adjustable shelves.

- To add tackboard to niche, add **TB** to end of product code. **Add \$1788** to list price for grades 1-3. **Add \$2147** for grades 4-5.
- To add LED light to niche, add **LT** to end of product code. **Add \$819** to list price.

## WORK WALLS - 70"H

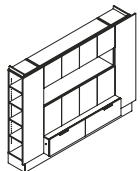

**Work Wall - 95"W**

MODEL#	DIMENSIONS	FREIGHT CLASS	WT/LBS.	CUBIC FT.	LIST PRICE
FW9570-20	20 x 95 x 70	100	563	66	<b>\$21754</b>

Vertical storage with 4 adjustable shelves, 60" wide single height wall credenza with two files, 60" wide double height storage, 60" wide niche, 60" wide single height storage, vertical storage with 4 adjustable shelves.

- To add tackboard to niche, add **TB** to end of product code. **Add \$966** to list price for grades 1-3. **Add \$1160** for grades 4-5.
- To add LED light to niche, add **LT** to end of product code. **Add \$817** to list price.

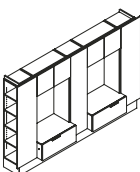

**Work Wall - 110"W**

FW11070-20	20 x 110 x 70	125	602	78	<b>\$24977</b>
------------	---------------	-----	-----	----	----------------

Vertical storage with 4 adjustable shelves, 30" wide single height wall credenza with file, 30" wide triple height niche, 30" wide single height storage, vertical storage with 4 adjustable shelves, 30" wide single height wall credenza with file, 30" wide triple height niche, 30" wide single height storage, vertical storage with 4 adjustable shelves.

- To add tackboard to niche, add **TB** to end of product code. **Add \$1791** to list price for grades 1-3. **Add \$2149** for grades 4-5.
- To add LED light to niche, add **LT** to end of product code. **Add \$1296** to list price.

### Required Specifications

Front finish  
Top/body finish  
Cubby interior finish

### Optional Specifications

Grommet  
LED light  
Tackboard

## WORK WALLS - 70"H

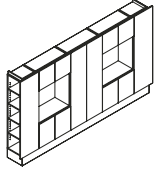

**Work Wall - 125"W**

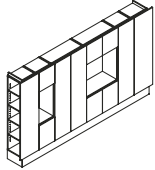

**Work Wall - 125"W**

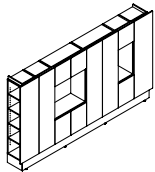

**Work Wall - 125"W**

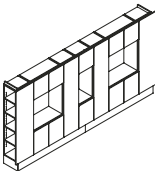

**Work Wall - 140"W**

MODEL#	DIMENSIONS	FREIGHT CLASS	WT/LBS.	CUBIC FT.	LIST PRICE
--------	------------	---------------	---------	-----------	------------

**D x W x H**

FW12570-20	20 x 125 x 70	125	645	84	<b>\$25185</b>
------------	---------------	-----	-----	----	----------------

Vertical storage with 4 adjustable shelves, 30" wide double height storage, 30" wide double height niche, 30" wide single height storage, double width vertical storage with 4 adjustable shelves, 30" wide double height storage, 30" wide double height niche, 30" wide single height storage, vertical storage with 4 adjustable shelves.

- To add tackboard to niche, add **TB** to end of product code. **Add \$1196** to list price for grades 1-3. Add **\$1435** for grades 4-5.
- To add LED light to niche, add **LT** to end of product code. **Add \$1295** to list price.

FW12570-21L	20 x 125 x 70	100	685	84	<b>\$26403</b>
-------------	---------------	-----	-----	----	----------------

Vertical storage with 4 adjustable shelves, 15" wide double height storage, 15" wide double height niche, 15" wide single height storage, double width vertical storage with 4 adjustable shelves, 30" wide double height storage, 30" wide double height niche, 30" wide single height storage, vertical storage with 4 adjustable shelves, vertical storage with 4 adjustable shelves.

- To add tackboard to niche, add **TB** to end of product code. **Add \$817** to list price for grades 1-3. Add **\$981** for grades 4-5.
- To add LED light to niche, add **LT** to end of product code. **Add \$981** to list price.

FW12570-21R	20 x 125 x 70	100	685	84	<b>\$26403</b>
-------------	---------------	-----	-----	----	----------------

Vertical storage with 4 adjustable shelves, vertical storage with 4 adjustable shelves, 30" wide double height storage, 30" wide double height niche, 30" wide single height storage, double width vertical storage with 4 adjustable shelves, 15" wide double height storage, 15" wide double height niche, 15" wide single height storage, vertical storage with 4 adjustable shelves.

- To add tackboard to niche, add **TB** to end of product code. **Add \$817** to list price for grades 1-3. Add **\$981** for grades 4-5.
- To add LED light to niche, add **LT** to end of product code. **Add \$981** to list price.

FW14070-20	20 x 140 x 70	100	779	96	<b>\$29802</b>
------------	---------------	-----	-----	----	----------------

Vertical storage with 4 adjustable shelves, 30" wide double height storage, 30" wide double height niche, 30" wide single height storage, vertical storage cabinet with 4 adjustable shelves, 15" wide double height storage, 15" wide double height niche, 15" wide single height storage, vertical storage with 4 adjustable shelves, 30" wide double height storage, 30" wide double height niche, 30" wide single height storage, vertical storage with 4 adjustable shelves.

- To add tackboard to niche, add **TB** to end of product code. **Add \$1616** to list price for grades 1-3. Add **\$1939** for grades 4-5.
- To add LED light to niche, add **LT** to end of product code. **Add \$1638** to list price.

**Required Specifications**

Front finish  
Top/body finish  
Cubby interior finish

**Optional Specifications**

Grommet  
LED light  
Tackboard

## WORK WALLS - 70"H

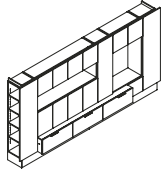

**Work Wall - 140"W**

MODEL#	DIMENSIONS D x W x H	FREIGHT CLASS	WT/LBS.	CUBIC FT.	LIST PRICE
FW14070-21L	20 x 140 x 70	100	832	96	<b>\$29802</b>

Vertical storage with 4 adjustable shelves, 60" wide double height storage, 60" wide niche, 60" wide single height storage, 15" wide triple height storage, 15" wide single height storage, 30" wide double height niche, 30" wide single height storage, 90" wide single height wall credenza with three files, vertical storage with 4 adjustable shelves.

- To add tackboard to niche, add **TB** to end of product code. **Add \$1901** to list price for grades 1-3. Add **\$2282** for grades 4-5.
- To add LED light to niche, add **LT** to end of product code. **Add \$1703** to list price.

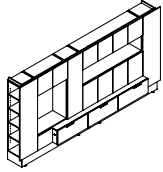

**Work Wall - 140"W**

FW14070-21R	20 x 140 x 70	100	832	96	<b>\$29802</b>
-------------	---------------	-----	-----	----	----------------

Vertical storage with 4 adjustable shelves, 15" wide single height storage, 30" wide double height niche, 30" wide single height storage, 90" wide single height wall credenza with three files, 15" wide triple height storage, 60" wide double height storage, 60" wide niche, 60" wide single height storage, vertical storage with 4 adjustable shelves.

- To add tackboard to niche, add **TB** to end of product code. **Add \$1901** to list price for grades 1-3. Add **\$2282** for grades 4-5.
- To add LED light to niche, add **LT** to end of product code. **Add \$1703** to list price.

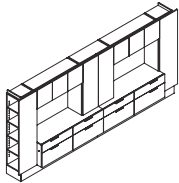

**Work Wall - 155"W**

FW15570-20	20 x 155 x 70	100	900	108	<b>\$29802</b>
------------	---------------	-----	-----	-----	----------------

Vertical storage with 4 adjustable shelves, 60" wide wall credenza with two box/files, 45" wide double height niche, 45" wide single height storage, 30" wide double width storage with 2 adj. shelves, 60" wide wall credenza with two box/files, 45" wide double height niche, 45" wide single height storage, vertical storage with 4 adjustable

- To add tackboard to niche, add **TB** to end of product code. **Add \$2436** to list price for grades 1-3. Add **\$2923** for grades 4-5.
- To add LED light to niche, add **LT** to end of product code. **Add \$1744** to list price.

## WORK WALLS - 84"H

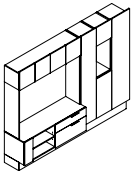

**Work Wall - 107"W**

MODEL#	DIMENSIONS	FREIGHT CLASS	WT/LBS.	CUBIC FT.	LIST PRICE
FW10784L	20 x 95 x 84	100	832	96	<b>\$27643</b>

60" wide wall credenza with adjustable shelf and box/file, 60" wide triple height niche, 60" wide single height storage, vertical storage with 5 adjustable shelves, triple height storage, 15" wide double height niche, single height storage, vertical storage with 5 adjustable shelves.

- To add tackboard to niche, add **TB** to end of product code. **Add \$1218** to list price for grades 1-3. Add **\$1462** for grades 4-5.
- To add LED light to niche, add **LT** to end of product code. **Add \$1218** to list price.

### Required Specifications

Front finish  
Top/body finish  
Cubby interior finish

### Optional Specifications

Grommet  
LED light  
Tackboard

## OPEN KNEE SPACE WORK WALLS

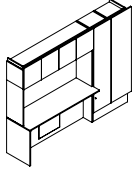

**Open Knee Space Work Wall - 92"W**

MODEL#	DIMENSIONS D x W x H	FREIGHT CLASS	WT/LBS.	CUBIC FT.	LIST PRICE
FW927002R	20 x 92.5 x 84	100	832	96	<b>\$16297</b>

60" wide work surface wall credenza, 60" wide double height niche, 60" wide single height storage, vertical storage with 4 adjustable shelves, wardrobe with coat hook and hat shelf.

- To add tackboard to niche, add **TB** to end of product code. **Add \$1218** to list price for grades 1-3. Add **\$1462** for grades 4-5.
- To add LED light to niche, add **LT** to end of product code. **Add \$1218** to list price.

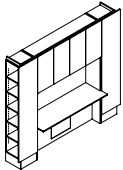

**Open Knee Space Work Wall - 95"W**

FW95840WR	20 x 95 x 84	100	832	96	<b>\$17021</b>
-----------	--------------	-----	-----	----	----------------

Vertical storage with 5 adjustable shelves, 60" wide work surface wall credenza, 60" wide double height niche, 60" wide double height storage, wardrobe with coat hook and hat shelf.

- To add tackboard to niche, add **TB** to end of product code. **Add \$1218** to list price for grades 1-3. Add **\$1462** for grades 4-5.
- To add LED light to niche, add **LT** to end of product code. **Add \$834** to list price.

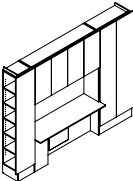

**Open Knee Space Work Wall - 110"W**

FW110840W2R	20 x 110 x 84	100	832	96	<b>\$19495</b>
-------------	---------------	-----	-----	----	----------------

Vertical storage with 5 adjustable shelves, 60" wide work surface wall credenza, 60" wide double height niche, 60" wide double height storage, double depth wardrobe with coat rod and hat shelf.

- To add tackboard to niche, add **TB** to end of product code. **Add \$1219** to list price for grades 1-3. Add **\$1463** for grades 4-5.
- To add LED light to niche, add **LT** to end of product code. **Add \$839** to list price.

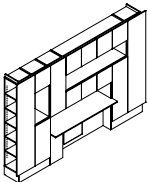

**Open Knee Space Work Wall - 125"W**

FW125840IL	20 x 110 x 84	100	832	96	<b>\$27471</b>
------------	---------------	-----	-----	----	----------------

Vertical storage with 5 adjustable shelves, triple height storage, 15" wide triple height storage, 15" wide double height niche, single high storage, 60" wide work surface wall credenza, 60" wide single height niche, triple height storage, 45" wide single height storage, 60" wide single height niche, 60" wide single height storage, triple height storage, wardrobe with coat hook and hat shelf.

- To add tackboard to niche, add **TB** to end of product code. **Add \$2398** to list price for grades 1-3. Add **\$2879** for grades 4-5.
- To add LED light to niche, add **LT** to end of product code. **Add \$2406** to list price.

### Required Specifications

Front finish  
Top/body finish  
Cubby interior finish

### Optional Specifications

Grommet  
LED light  
Tackboard

# F FOUNDATIONS

## WORK WALL CREDENZAS

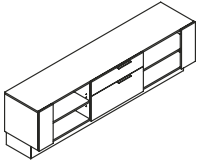

**Work Wall Credenza**

MODEL#	DIMENSIONS D x W x H	FREIGHT CLASS	WT/LBS.	CUBIC FT.	LIST PRICE
FW9026-1	20 x 90 x 26	100	254	27	<b>\$9397</b>

Standard with adjustable shelf, box/file and adjustable shelf.

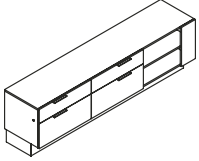

**Work Wall Credenza**

FW9026-2	20 x 90 x 26	92.5	270	27	<b>\$9798</b>
----------	--------------	------	-----	----	---------------

Standard with box/file, box/file and adjustable shelf.

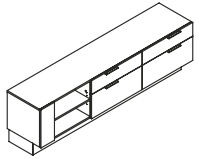

**Work Wall Credenza**

FW9026-3	20 x 90 x 26	92.5	270	27	<b>\$9798</b>
----------	--------------	------	-----	----	---------------

Standard with adjustable shelf, box/file and box/file.

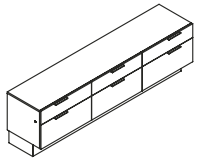

**Work Wall Credenza**

FW9026-4	20 x 90 x 26	92.5	310	27	<b>\$10395</b>
----------	--------------	------	-----	----	----------------

Standard with three box/file drawers. Center pedestal does not lock.

### Required Specifications

Front finish  
Top/body finish

### Optional Specifications

Grommet

## CONFERENCE ROOM FURNITURE - NOTES

D x W x H

- Horizontal grain direction is standard on all engineered finishes.
- Full Storage Credenza backs include GM17 vertical cut out
- Optional decorative credenza back panels (**FBP**) are available as a factory installed upgrade on FC/FCD models only.
- Doors open with touch latch
- To open the drawer, pull drawer front overhang - no handles available
- Display Wall can be purchased with optional monitor mount installed
- Mobile and stationary lecterns are available.
- Two Connecting Brackets are included.
- For optional light and microphone, see page 201 in the accessories section
- **Metal Leg finishes (conference furniture):**
  - BLKT Black Textured
  - TUNT Tungsten Textured
  - DWTT Designer White Textured
- **NOTE:** Arrow indicates direction of grain

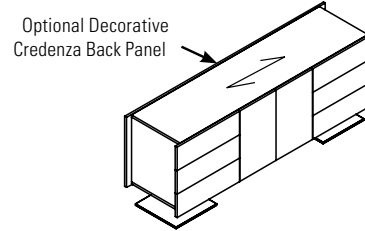

CONFERENCE ROOM FURNITURE	MODEL#	DIMENSIONS	FREIGHT CLASS	WT/LBS.	CUBIC FT.	LIST PRICE
---------------------------	--------	------------	---------------	---------	-----------	------------

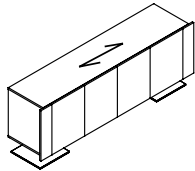

**Full Storage Credenza**

FC9020GG	20 x 90 x 29	125	241	36	<b>\$10595</b>
FC8420GG	20 x 84 x 29	125	232	33	<b>\$10175</b>
FC7820GG	20 x 78 x 29	125	223	31	<b>\$9445</b>
FC7220GG	20 x 72 x 29	125	213	29	<b>\$9189</b>
FC6020MM	20 x 60 x 29	125	194	26	<b>\$8528</b>

Standard with two sets of storage cabinets.

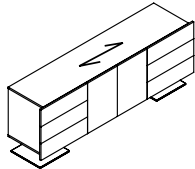

**Full Storage Credenza**

FCD9020A	20 x 90 x 29	125	249	36	<b>\$11226</b>
FCD8420A	20 x 84 x 29	125	240	33	<b>\$10809</b>
FCD7820A	20 x 78 x 29	125	230	31	<b>\$10036</b>
FCD7220A	20 x 72 x 29	125	221	29	<b>\$9820</b>
FCD6020A	20 x 60 x 29	125	202	26	<b>\$9167</b>

Standard with three box drawers on left, storage cabinets in center, and three box drawers on right.

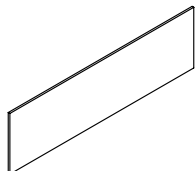

**Decorative Back Panel**

FBP9020	20 x 90 x 29	92.5	41	4	<b>\$1806</b>
FBP8420	20 x 84 x 29	100	38	4	<b>\$1715</b>
FBP7820	20 x 78 x 29	85	36	3	<b>\$1597</b>
FBP7220	20 x 72 x 29	92.5	33	3	<b>\$1391</b>
FBP6020	20 x 60 x 29	100	27	3	<b>\$1177</b>

For FC/FCD credenza models only. Not sold individually. Must be ordered as an upgrade option only.

### Required Specifications

- Front finish
- Top/body finish
- Leg finish



## CONFERENCE ROOM FURNITURE

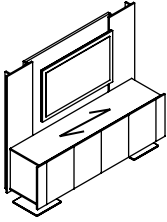

**Display Wall Storage Credenza**

MODEL#	DIMENSIONS D x W x H	FREIGHT CLASS	WT/LBS.	CUBIC FT.	LIST PRICE
FC9024GGTWH72	24 x 90 x 72	100	463	47	<b>\$16421</b>
FC8424GGTWH72	24 x 84 x 72	92.5	460	45	<b>\$15642</b>
FC7824GGTWH72	24 x 78 x 72	125	286	41	<b>\$14526</b>
FC7224GGTWH72	24 x 72 x 72	92.5	418	39	<b>\$14088</b>
FC9024GGTWH66	24 x 90 x 66	100	444	48	<b>\$15851</b>
FC8424GGTWH66	24 x 84 x 66	100	422	45	<b>\$15228</b>
FC7824GGTWH66	24 x 78 x 66	100	402	42	<b>\$14138</b>
FC7224GGTWH66	24 x 72 x 66	100	381	39	<b>\$13701</b>

With two sets of storage cabinets and display wall. Monitors and TV mounts are not included. Display wall includes GM1 grommet.

Monitor size chart based on display wall size:

Display Wall Width	Monitor Size
90"	54"
84"	50"
78"	46"
72"	42"

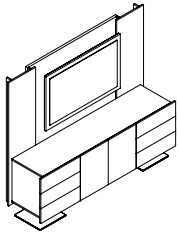

**Display Wall Storage Credenza**

FCD9024ATWH72	24 x 90 x 72	92.5	481	48	<b>\$16673</b>
FCD8424ATWH72	24 x 84 x 72	92.5	460	45	<b>\$15895</b>
FCD7824ATWH72	24 x 78 x 72	92.5	439	42	<b>\$13259</b>
FCD7224ATWH72	24 x 72 x 72	100	381	39	<b>\$14293</b>
FCD9024ATWH66	24 x 90 x 66	100	444	48	<b>\$16106</b>
FCD8424ATWH66	24 x 84 x 66	100	422	45	<b>\$15479</b>
FCD7824ATWH66	24 x 78 x 66	100	402	42	<b>\$14394</b>
FCD7224ATWH66	24 x 72 x 66	100	381	39	<b>\$13955</b>

With three box drawers on left, storage cabinets in center, and three box drawers on right, and display wall. Monitors and TV mounts are not included. Display wall includes GM1 grommet.

Monitor size chart based on display wall size:

Display Wall Width	Monitor Size
90"	54"
84"	50"
78"	46"
72"	42"

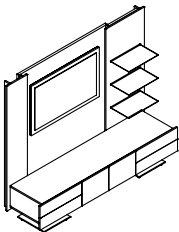

**Display Wall Storage Credenza**

FFTWA90WH72	24 x 90 x 72	92.5	482	41	<b>\$17453</b>
FFTWA84WH72	24 x 84 x 72	85	462	38	<b>\$16857</b>
FFTWA78WH72	24 x 78 x 72	85	442	35	<b>\$15986</b>
FFTWA72WH72	24 x 72 x 72	85	421	32	<b>\$15030</b>
FFTWA90WH66	24 x 90 x 66	92.5	462	40	<b>\$16887</b>
FFTWA84WH66	24 x 84 x 66	92.5	443	37	<b>\$16290</b>
FFTWA78WH66	24 x 78 x 66	85	424	34	<b>\$15453</b>
FFTWA72WH66	24 x 72 x 66	85	404	31	<b>\$14586</b>

With two box drawers on left, storage cabinets in center, and two box drawers on right, and display wall with shelves. Monitors and TV mounts are not included. Display wall includes GM1 grommet.

Monitor size chart based on display wall size:

Display Wall Width	Monitor Size
90"	54"
84"	50"
78"	46"
72"	42"

### Required Specifications

Front/wall finish  
Top/body finish  
Leg finish

## CONFERENCE ROOM ACCESSORIES

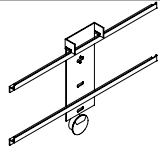

**Flat Screen Monitor Mount**

MODEL#	DIMENSIONS	FREIGHT CLASS	WT/LBS.	CUBIC FT.	LIST PRICE
FVMED	D x W x H 2 x 28 x 17	70	14	0.7	<b>\$735</b>

Flat screen monitor mount up to 50". To be used on Foundations display wall storage credenzas. GM1K (tungsten) grommet on the back panel is included.

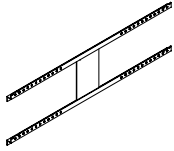

**Flat Screen Monitor Mount**

FVLRG	2 x 38 x 21	60	25	0.75	<b>\$611</b>
-------	-------------	----	----	------	--------------

Flat screen monitor mount for over 50". To be used on Foundations display wall storage credenzas.

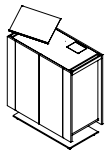

**Lectern\***

FLEC36	20 x 36 x 42	125	166	22	<b>\$10140</b>
--------	--------------	-----	-----	----	----------------

With pop-up door to reveal concealed power/data monument (power duplex, 15 pin VGA, data and telephone connectors). Optional light and/or microphone to be specified. Metal finish on base, book rest and handles must be specified. Includes 1 adjustable shelf.

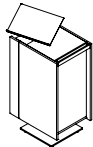

**Lectern\***

FLEC24	20 x 24 x 42	100	135	15	<b>\$8367</b>
--------	--------------	-----	-----	----	---------------

With laptop pull-out tray to reveal concealed power/data monument (power duplex, 15 pin VGA, data and telephone connectors). Optional light and/or microphone to be specified. Metal finish on base, book rest and handles must be specified. Includes 1 adjustable shelf.

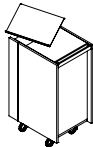

**Mobile Lectern\***

FLEC24M	20 x 24 x 42	100	135	15	<b>\$6198</b>
---------	--------------	-----	-----	----	---------------

With laptop pull-out tray. Optional light and/or microphone to be specified. Metal finish on base, book rest and handles must be specified. Includes 1 adjustable shelf. Locking casters (Tungsten only).

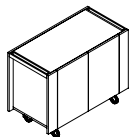

**Mobile Server\***

FSM4020	20 x 40 x 30	150	108	21	<b>\$6753</b>
---------	--------------	-----	-----	----	---------------

With cutlery drawer and adjustable shelf. Metal finish on handles must be specified. Locking casters (Tungsten only).

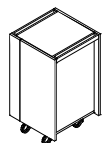

**Mobile Tech Cart**

FTCM2020H42	20 x 20 x 42	150	67	13.5	<b>\$4921</b>
FTCM2020H36	20 x 20 x 36	150	54	10.5	<b>\$4219</b>

Metal finish on handles must be specified. Includes 1 adjustable shelf. Locking casters (Tungsten only).

**Required Specifications**

Front finish  
Top/body finish  
Metal finish\*

**Optional Specifications**

Light\*  
Microphone\*

## BOARDROOM TABLES - NOTES

D x W x H

- Table tops are 1.5" thick with a 2" undercut knife edge.

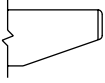

- All tops have a 1/8" (3mm) solid edge of walnut, cherry, maple and oak
- See notes section for optional grommet locations on tables without technology trough
- See "Technology Trough Details" on page 150
- For tables with 3 bases and technology trough, add **C** (for center base feed) or **E** (for end base feed) to the end of the model number (Example: FRESTCT19298**C**)
- **NOTE:** Arrow indicates direction of grain

### BOARDROOM TABLES - RECTANGULAR

MODEL# DIMENSIONS FREIGHT CLASS WT/LBS. CUBIC FT. LIST PRICE

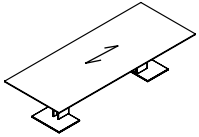

Rectangular Table

FRE12048	48 x 120 x 29	100	450	54	<b>\$14359</b>
FRE9648	48 x 96 x 29	125	390	49	<b>\$13001</b>

One piece top. Two bases.

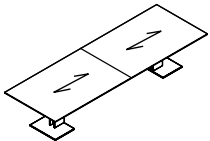

Rectangular Table

FRE16848	48 x 168 x 29	100	571	65	<b>\$17540</b>
FRE14448	48 x 144 x 29	100	511	60	<b>\$15880</b>
FRE12048-2	48 x 120 x 29	100	450	56	<b>\$14549</b>

Two piece top. Two bases.

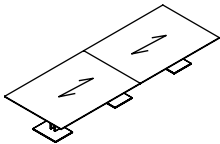

Rectangular Table

FRE24060	60 x 240 x 29	100	965	109	<b>\$27998</b>
FRE21660	60 x 216 x 29	100	893	104	<b>\$26428</b>
FRE19260	60 x 192 x 29	100	821	99	<b>\$24805</b>
FRE16860	60 x 168 x 29	100	748	93	<b>\$23201</b>
FRE21648	48 x 216 x 29	92.5	872	87	<b>\$24252</b>
FRE19248	48 x 192 x 29	100	744	82	<b>\$22812</b>

Two piece top. Three bases.

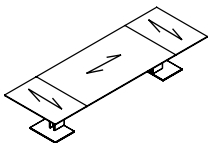

Rectangular Table, Sectional\*

FREST16848	48 x 168 x 29	100	571	65	<b>\$17875</b>
FREST14448	48 x 144 x 29	100	511	60	<b>\$16459</b>
FREST12048	48 x 120 x 29	100	450	54	<b>\$15031</b>

Three piece top. Two bases.

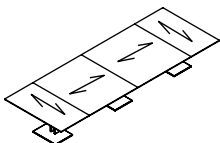

Rectangular Table, Sectional\*

FREST24060	60 x 240 x 29	100	965	109	<b>\$27998</b>
FREST21660	60 x 216 x 29	100	893	104	<b>\$26428</b>
FREST19260	60 x 192 x 29	100	821	99	<b>\$24805</b>
FREST16860	60 x 168 x 29	100	748	93	<b>\$23201</b>
FREST21648	48 x 216 x 29	92.5	872	87	<b>\$24252</b>
FREST19248	48 x 192 x 29	100	744	82	<b>\$22812</b>

Four piece top. Three bases.  
 • 168"W table - midsection is one piece

#### Required Specifications

Top finish/base side finish  
 Base end finish  
 Metal finish

#### Optional Specifications

Grommet

## BOARDROOM TABLES - RECTANGULAR

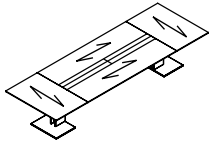

**Rectangular Table, Sectional**

MODEL#	DIMENSIONS	FREIGHT CLASS	WT/LBS.	CUBIC FT.	LIST PRICE
--------	------------	---------------	---------	-----------	------------

**D x W x H**

FRESTCT16848	48 x 168 x 29	100	659	69	<b>\$27276</b>
FRESTCT14448	48 x 144 x 29	100	584	63	<b>\$21852</b>
FRESTCT12048	48 x 120 x 29	100	508	57	<b>\$20259</b>

Four piece top. Two bases / power kit included.

- 168"W table includes technology trough with 8 doors
- 144"W and 120" tables include technology trough with 4 doors

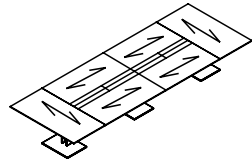

**Rectangular Table, Sectional**

FRESTCT24060	60 x 240 x 29	100	1113	116	<b>\$39872</b>
FRESTCT21660	60 x 216 x 29	100	1021	109	<b>\$37755</b>
FRESTCT19260	60 x 192 x 29	100	920	103	<b>\$35464</b>
FRESTCT16860	60 x 168 x 29	100	836	96	<b>\$33101</b>
FRESTCT21648	48 x 216 x 29	92.5	1000	92	<b>\$35770</b>
FRESTCT19248	48 x 192 x 29	100	843	87	<b>\$33691</b>

Six piece top. Three bases. Add **C** or **E** to end of model number to specify base feed location. Includes technology trough with 8 doors.

- 168"W table - midsection is one piece

## BOARDROOM TABLES - BOW END

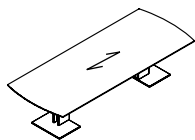

**Bow End Table**

MODEL#	DIMENSIONS	FREIGHT CLASS	WT/LBS.	CUBIC FT.	LIST PRICE
--------	------------	---------------	---------	-----------	------------

FREBE12048	48 x 120 x 29	100	450	54	<b>\$15076</b>
FREBE9648	48 x 96 x 29	125	390	49	<b>\$13651</b>

One piece top. Two bases.

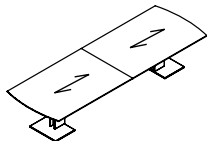

**Bow End Table**

FREBE16848	48 x 168 x 29	100	571	65	<b>\$18414</b>
FREBE14448	48 x 144 x 29	100	511	60	<b>\$16674</b>
FREBE12048-2	48 x 120 x 29	100	450	56	<b>\$15277</b>

Two piece top. Two bases.

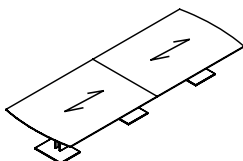

**Bow End Table**

FREBE24060	60 x 240 x 29	100	965	109	<b>\$29396</b>
FREBE21660	60 x 216 x 29	100	893	104	<b>\$27748</b>
FREBE19260	60 x 192 x 29	100	821	99	<b>\$26045</b>
FREBE16860	60 x 168 x 29	100	748	93	<b>\$24361</b>
FREBE21648	48 x 216 x 29	92.5	872	87	<b>\$25464</b>
FREBE19248	48 x 192 x 29	100	744	82	<b>\$23951</b>

Two piece top. Three bases.

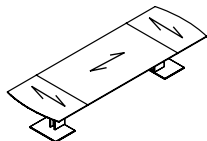

**Bow End Table, Sectional**

FREBEST16848	48 x 168 x 29	100	571	65	<b>\$18770</b>
FREBEST14448	48 x 144 x 29	100	511	60	<b>\$17281</b>
FREBEST12048	48 x 120 x 29	100	450	54	<b>\$15784</b>

Three piece top. Two bases.

### Required Specifications

Top finish/base side finish  
Base end finish  
Metal finish

### Optional Specifications

Grommet

# F FOUNDATIONS

## BOARDROOM TABLES - BOW END

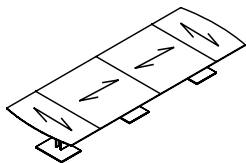

**Bow End Table, Sectional**

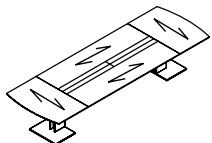

**Bow End Table, Sectional**

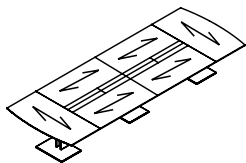

**Bow End Table, Sectional**

MODEL#	DIMENSIONS D x W x H	FREIGHT CLASS	WT/LBS.	CUBIC FT.	LIST PRICE
FREBEST24060	60 x 240 x 29	100	965	109	<b>\$30030</b>
FREBEST21660	60 x 216 x 29	100	893	104	<b>\$28349</b>
FREBEST19260	60 x 192 x 29	100	821	99	<b>\$26459</b>
FREBEST16860	60 x 168 x 29	100	748	93	<b>\$24646</b>
FREBEST21648	48 x 216 x 29	92.5	872	87	<b>\$26160</b>
FREBEST19248	48 x 192 x 29	100	744	82	<b>\$24545</b>

Four piece top. Three bases.  
 • 168"W table - midsection is one piece

FREBESTCT16848	48 x 168 x 29	100	659	69	<b>\$28640</b>
FREBESTCT14448	48 x 144 x 29	100	584	63	<b>\$22942</b>
FREBESTCT12048	48 x 120 x 29	100	508	57	<b>\$21271</b>

Four piece top. Two bases / power kit included.  
 • 168"W table includes technology trough with 8 doors  
 • 144"W and 120" tables include technology trough with 4 doors

FREBESTCT24060	60 x 240 x 29	100	1113	116	<b>\$41863</b>
FREBESTCT21660	60 x 216 x 29	100	1021	109	<b>\$39640</b>
FREBESTCT19260	60 x 192 x 29	100	920	103	<b>\$37238</b>
FREBESTCT16860	60 x 168 x 29	100	836	96	<b>\$34755</b>
FREBESTCT21648	48 x 216 x 29	92.5	1000	92	<b>\$37558</b>
FREBESTCT19248	48 x 192 x 29	100	843	87	<b>\$35373</b>

Six piece top. Three bases. Add **C** or **E** to end of model number to specify base feed location. Includes technology trough with 8 doors.  
 • 168"W table - midsection is one piece

## BOARDROOM TABLES - BOAT SHAPED

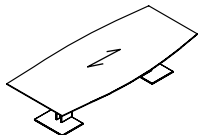

**Boat Shaped Table**

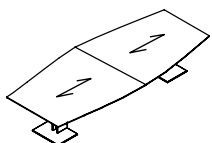

**Boat Shaped Table**

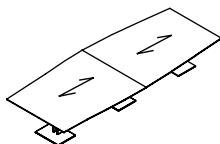

**Boat Shaped Table**

MODEL#	DIMENSIONS	FREIGHT CLASS	WT/LBS.	CUBIC FT.	LIST PRICE
FBO12048	48 x 120 x 29	100	450	54	<b>\$15827</b>
FBO9648	48 x 96 x 29	125	390	49	<b>\$14332</b>

One piece top. Two bases.

FBO16848	48 x 168 x 29	100	571	65	<b>\$19333</b>
FBO14448	48 x 144 x 29	100	511	60	<b>\$17506</b>
FBO12048-2	48 x 120 x 29	100	450	56	<b>\$16038</b>

Two piece top. Two bases.

FBO24060	60 x 240 x 29	100	965	109	<b>\$30864</b>
FBO21660	60 x 216 x 29	100	893	104	<b>\$29134</b>
FBO19260	60 x 192 x 29	100	821	99	<b>\$27346</b>
FBO16860	60 x 168 x 29	100	748	93	<b>\$25574</b>
FBO21648	48 x 216 x 29	92.5	872	87	<b>\$26735</b>
FBO19248	48 x 192 x 29	100	744	82	<b>\$25149</b>

Two piece top. Three bases.

### Required Specifications

Top finish/base side finish  
 Base end finish  
 Metal finish

### Optional Specifications

Grommet

## BOARDROOM TABLES - BOAT SHAPED

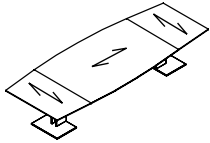

**Boat Shaped Table, Sectional**

MODEL#	DIMENSIONS	FREIGHT CLASS	WT./LBS.	CUBIC FT.	LIST PRICE
--------	------------	---------------	----------	-----------	------------

D x W x H

FBOST16848	48 x 168 x 29	100	571	65	<b>\$19709</b>
FBOST14448	48 x 144 x 29	100	511	60	<b>\$18145</b>
FBOST12048	48 x 120 x 29	100	450	54	<b>\$16572</b>

Three piece top. Two bases.

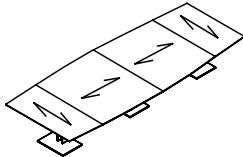

**Boat Shaped Table, Sectional**

FBOST24060	60 x 240 x 29	100	965	109	<b>\$31532</b>
FBOST21660	60 x 216 x 29	100	893	104	<b>\$29765</b>
FBOST19260	60 x 192 x 29	100	821	99	<b>\$27781</b>
FBOST16860	60 x 168 x 29	100	748	93	<b>\$25876</b>
FBOST21648	48 x 216 x 29	92.5	872	87	<b>\$27464</b>
FBOST19248	48 x 192 x 29	100	744	82	<b>\$25771</b>

Four piece top. Three bases.

- 168"W table - midsection is one piece

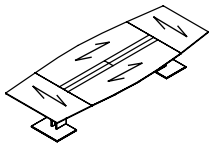

**Boat Shaped Table, Sectional**

FBOSTCT16848	48 x 168 x 29	100	659	69	<b>\$30072</b>
FBOSTCT14448	48 x 144 x 29	100	584	63	<b>\$24086</b>
FBOSTCT12048	48 x 120 x 29	100	508	57	<b>\$22335</b>

Four piece top. Two bases / power kit included.

- 168"W table includes technology trough with 8 doors
- 144"W and 120" tables include technology trough with 4 doors

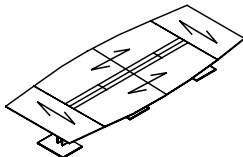

**Boat Shaped Table, Sectional**

FBOSTCT24060	60 x 240 x 29	100	1113	116	<b>\$43954</b>
FBOSTCT21660	60 x 216 x 29	92.5	1021	91	<b>\$41619</b>
FBOSTCT19260	60 x 192 x 29	100	920	103	<b>\$39099</b>
FBOSTCT16860	60 x 168 x 29	100	836	96	<b>\$36491</b>
FBOSTCT21648	48 x 216 x 29	92.5	1000	92	<b>\$38925</b>
FBOSTCT19248	48 x 192 x 29	100	843	87	<b>\$37141</b>

Six piece top. Three bases. Add **C** or **E** to end of model number to specify base feed location. Includes technology trough with 8 doors.

- 168"W table - midsection is one piece

## BOARDROOM TABLES - BOAT SHAPED, BOW END

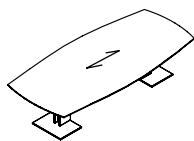

**Boat Shaped Table, Bow End**

MODEL#	DIMENSIONS	FREIGHT CLASS	WT./LBS.	CUBIC FT.	LIST PRICE
--------	------------	---------------	----------	-----------	------------

FBOBE12048	48 x 120 x 29	100	450	54	<b>\$16362</b>
FBOBE9648	48 x 96 x 29	125	390	49	<b>\$14795</b>

One piece top. Two bases.

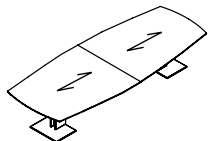

**Boat Shaped Table, Bow End**

FBOBE16848	48 x 168 x 29	100	571	65	<b>\$20044</b>
FBOBE14448	48 x 144 x 29	100	511	60	<b>\$18130</b>
FBOBE12048-2	48 x 120 x 29	100	450	56	<b>\$16585</b>

Two piece top. Two bases.

### Required Specifications

Top finish/base side finish  
Base end finish  
Metal finish

### Optional Specifications

Grommet

# F FOUNDATIONS

## BOARDROOM TABLES - BOAT SHAPED, BOW END

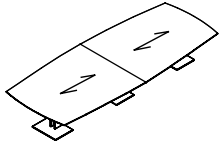

**Boat Shaped Table, Bow End**

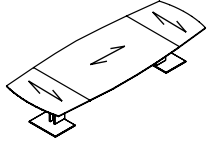

**Boat Shaped Table, Bow End, Sectional**

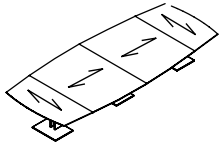

**Boat Shaped Table, Bow End, Sectional**

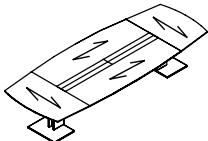

**Boat Shaped Table, Bow End, Sectional**

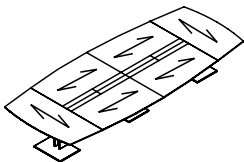

**Boat Shaped Table, Bow End, Sectional**

MODEL#	DIMENSIONS D x W x H	FREIGHT CLASS	WT/LBS.	CUBIC FT.	LIST PRICE
FBOBE24060	60 x 240 x 29	100	965	109	<b>\$32155</b>
FBOBE21660	60 x 216 x 29	100	893	104	<b>\$30332</b>
FBOBE19260	60 x 192 x 29	100	821	99	<b>\$28459</b>
FBOBE16860	60 x 168 x 29	100	748	93	<b>\$26600</b>
FBOBE21648	48 x 216 x 29	92.5	872	87	<b>\$27814</b>
FBOBE19248	48 x 192 x 29	100	744	82	<b>\$26152</b>

Two piece top. Three bases.

FBOBEST16848	48 x 168 x 29	100	571	65	<b>\$20438</b>
FBOBEST14448	48 x 144 x 29	100	511	60	<b>\$18798</b>
FBOBEST12048	48 x 120 x 29	100	450	54	<b>\$17135</b>

Three piece top. Two bases.

FBOBEST24060	60 x 240 x 29	100	965	109	<b>\$32856</b>
FBOBEST21660	60 x 216 x 29	100	893	104	<b>\$30996</b>
FBOBEST19260	60 x 192 x 29	100	821	99	<b>\$28650</b>
FBOBEST16860	60 x 168 x 29	100	748	93	<b>\$26917</b>
FBOBEST21648	48 x 216 x 29	92.5	872	87	<b>\$28585</b>
FBOBEST19248	48 x 192 x 29	100	744	82	<b>\$26802</b>

Four piece top. Three bases.

- 168"W table - midsection is one piece

FBOBESTCT16848	48 x 168 x 29	100	659	69	<b>\$31320</b>
FBOBESTCT14448	48 x 144 x 29	100	584	63	<b>\$25038</b>
FBOBESTCT12048	48 x 120 x 29	100	508	57	<b>\$23196</b>

Four piece top. Two bases / power kit included.

- 168"W table includes technology trough with 8 doors
- 144"W and 120" tables include technology trough with 4 doors

FBOBESTCT24060	60 x 240 x 29	100	1113	116	<b>\$45897</b>
FBOBESTCT21660	60 x 216 x 29	100	1021	109	<b>\$43446</b>
FBOBESTCT19260	60 x 192 x 29	100	920	103	<b>\$40797</b>
FBOBESTCT16860	60 x 168 x 29	100	836	96	<b>\$38075</b>
FBOBESTCT21648	48 x 216 x 29	92.5	1000	92	<b>\$40618</b>
FBOBESTCT19248	48 x 192 x 29	100	843	87	<b>\$38741</b>

Six piece top. Three bases. Add **C** or **E** to end of model number to specify base feed location. Includes technology trough with 8 doors.

- 168"W table - midsection is one piece

### Required Specifications

Top finish/base side finish  
Base end finish  
Metal finish

### Optional Specifications

Grommet

## BOARDROOM TABLES - RACETRACK

MODEL#	DIMENSIONS	FREIGHT CLASS	WT/LBS.	CUBIC FT.	LIST PRICE
--------	------------	---------------	---------	-----------	------------

**D x W x H**

FRA12048	48 x 120 x 29	100	450	54	<b>\$16619</b>
FRA9648	48 x 96 x 29	125	390	49	<b>\$15050</b>

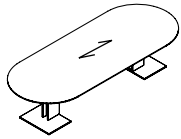

**Racetrack Table**

One piece top. Two bases.

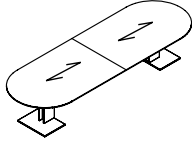

**Racetrack Table**

FRA16848	48 x 168 x 29	100	571	65	<b>\$20298</b>
FRA14448	48 x 144 x 29	100	511	60	<b>\$18380</b>
FRA12048-2	48 x 120 x 29	100	450	56	<b>\$16840</b>

Two piece top. Two bases.

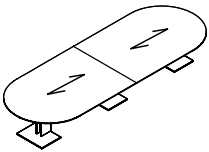

**Racetrack Table**

FRA24060	60 x 240 x 29	100	965	109	<b>\$32409</b>
FRA21660	60 x 216 x 29	100	893	104	<b>\$30587</b>
FRA19260	60 x 192 x 29	100	821	99	<b>\$28713</b>
FRA16860	60 x 168 x 29	100	748	93	<b>\$26851</b>
FRA21648	48 x 216 x 29	92.5	872	87	<b>\$28070</b>
FRA19248	48 x 192 x 29	100	744	82	<b>\$26404</b>

Two piece top. Three bases.

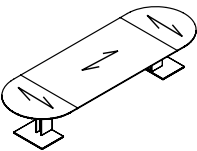

**Racetrack Table, Sectional**

FRAST16848	48 x 168 x 29	100	571	65	<b>\$20689</b>
FRAST14448	48 x 144 x 29	100	511	60	<b>\$19052</b>
FRAST12048	48 x 120 x 29	100	450	54	<b>\$17391</b>

Three piece top. Two bases.

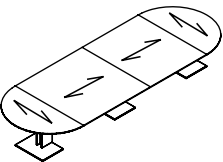

**Racetrack Table, Sectional**

FRAST24060	60 x 240 x 29	100	965	109	<b>\$33108</b>
FRAST21660	60 x 216 x 29	100	893	104	<b>\$31253</b>
FRAST19260	60 x 192 x 29	100	821	99	<b>\$28904</b>
FRAST16860	60 x 168 x 29	100	748	93	<b>\$27170</b>
FRAST21648	48 x 216 x 29	92.5	872	87	<b>\$28839</b>
FRAST19248	48 x 192 x 29	100	744	82	<b>\$27058</b>

Four piece top. Three bases.

- 168"W table - midsection is one piece

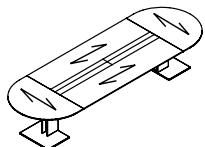

**Racetrack Table, Sectional**

FRASTCT16848	48 x 168 x 29	100	659	69	<b>\$31574</b>
FRASTCT14448	48 x 144 x 29	100	584	63	<b>\$25291</b>
FRASTCT12048	48 x 120 x 29	100	508	57	<b>\$23449</b>

Four piece top. Two bases / power kit included.

- 168"W table includes technology trough with 8 doors
- 144"W and 120" tables include technology trough with 4 doors

### Required Specifications

Top finish/base side finish  
Base end finish  
Metal finish

### Optional Specifications

Grommet



# F FOUNDATIONS

## BOARDROOM TABLES - RACETRACK

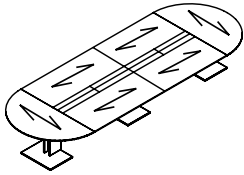

**Racetrack Table, Sectional**

MODEL#	DIMENSIONS D x W x H	FREIGHT CLASS	WT/LBS.	CUBIC FT.	LIST PRICE
FRASTCT24060	60 x 240 x 29	100	1113	116	<b>\$46152</b>
FRASTCT21660	60 x 216 x 29	100	1021	109	<b>\$43698</b>
FRASTCT19260	60 x 192 x 29	100	920	103	<b>\$41052</b>
FRASTCT16860	60 x 168 x 29	100	836	96	<b>\$38311</b>
FRASTCT21648	48 x 216 x 29	92.5	1000	92	<b>\$40872</b>
FRASTCT19248	48 x 192 x 29	100	843	87	<b>\$38998</b>

Six piece top. Three bases. Add **C** or **E** to end of model number to specify base feed location. Includes technology trough with 8 doors.

- 168"W table - midsection is one piece

## BOARDROOM TABLES - WEDGE

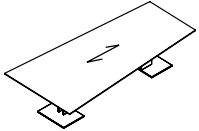

**Wedge Table**

MODEL#	DIMENSIONS	FREIGHT CLASS	WT/LBS.	CUBIC FT.	LIST PRICE
FWE1206048	60-48 x 120 x 29	100	511	60	<b>\$14610</b>

One piece top. Two bases.

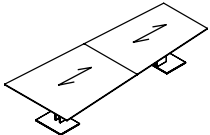

**Wedge Table**

FWE1446048	48 x 144 x 29	100	571	65	<b>\$17793</b>
FWE1206048-2	48 x 120 x 29	100	511	60	<b>\$16134</b>

Two piece top. Two bases.

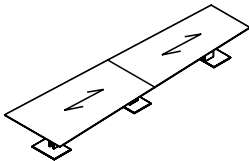

**Wedge Table**

FWE2406048	60-48 x 240 x 29	100	1037	114	<b>\$28252</b>
FWE2166048	60-48 x 216 x 29	100	965	109	<b>\$26679</b>
FWE1926048	60-48 x 192 x 29	100	893	104	<b>\$25058</b>
FWE1686048	60-48 x 168 x 29	100	630	70	<b>\$23452</b>

Two piece top. Three bases.

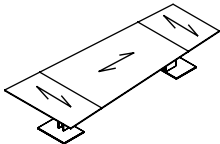

**Wedge Table, Sectional**

FWEST1446048	60-48 x 144 x 29	100	571	65	<b>\$18132</b>
FWEST1206048	60-48 x 120 x 29	100	511	60	<b>\$16716</b>

Three piece top. Two bases.

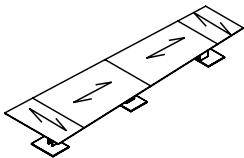

**Wedge Table, Sectional**

FWEST2406048	60-48 x 240 x 29	100	1037	114	<b>\$28351</b>
FWEST2166048	60-48 x 216 x 29	100	965	109	<b>\$27254</b>
FWEST1926048	60-48 x 192 x 29	100	893	104	<b>\$26459</b>
FWEST1686048	60-48 x 168 x 29	100	630	70	<b>\$23726</b>

Four piece top. Three bases.

- 168"W table - midsection is one piece

### Required Specifications

Top finish/base side finish  
Base end finish  
Metal finish

### Optional Specifications

Grommet

## BOARDROOM TABLES - WEDGE

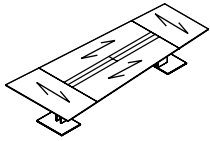

**Wedge Table, Sectional\***

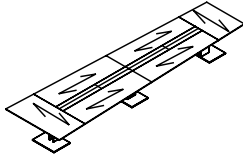

**Wedge Table, Sectional\***

MODEL#	DIMENSIONS	FREIGHT CLASS	WT/LBS.	CUBIC FT.	LIST PRICE
--------	------------	---------------	---------	-----------	------------

**D x W x H**

FWESTCT1446048	60-48 x 144 x 29	100	571	65	<b>\$27541</b>
FWESTCT1206048	60-48 x 120 x 29	100	511	60	<b>\$22105</b>

Four piece top. Two bases / power kit included. Includes technology trough with 4 doors

FWESTCT2406048	60 x 240 x 29	100	1037	114	<b>\$40125</b>
FWESTCT2166048	60 x 216 x 29	100	965	109	<b>\$38007</b>
FWESTCT1926048	60 x 192 x 29	100	893	104	<b>\$35464</b>
FWESTCT1686048	60 x 168 x 29	100	823	99	<b>\$33352</b>

Six piece top. Three bases. Add **C** or **E** to end of model number to specify base feed location. Includes technology trough with 8 doors.

- 168"W table - midsection is one piece

## BOARDROOM TABLES - SQUARE

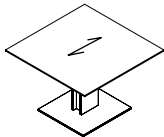

**Square Table**

MODEL#	DIMENSIONS	FREIGHT CLASS	WT/LBS.	CUBIC FT.	LIST PRICE
--------	------------	---------------	---------	-----------	------------

FRE6060	60 x 60 x 29	150	261	44	<b>\$8518</b>
FRE5454	54 x 54 x 29	150	233	42	<b>\$7950</b>
FRE4848	48 x 48 x 29	150	207	40	<b>\$7354</b>
FRE4242	42 x 42 x 29	150	185	39	<b>\$6906</b>

One base. No grommet option available.

## BOARDROOM TABLES - ROUND

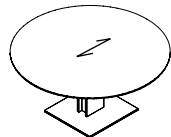

**Round Table**

MODEL#	DIMENSIONS	FREIGHT CLASS	WT/LBS.	CUBIC FT.	LIST PRICE
--------	------------	---------------	---------	-----------	------------

FRO60	60 x 60 x 29	150	261	44	<b>\$8943</b>
FRO54	54 x 54 x 29	150	233	42	<b>\$8348</b>
FRO48	48 x 48 x 29	150	207	40	<b>\$7721</b>
FRO42	42 x 42 x 29	150	185	39	<b>\$7252</b>

One base. No grommet option available.

**Required Specifications**

Top finish/base side finish  
Base end finish  
Metal finish

**Optional Specifications**

Grommet\*

POWER/DATA



Single Sided Recessed Power Block

MODEL#	DIMENSIONS D x W x H	FREIGHT CLASS	WT/LBS.	CUBIC FT.	LIST PRICE
PRTMCS401B	4.22 x 10.78 x 4.86	100	4.3	0.51	<b>\$456</b>
PRTMCS401T	4.22 x 10.78 x 4.86	100	4.3	0.51	<b>\$456</b>
PRTMCS401W	4.22 x 10.78 x 4.86	100	4.3	0.51	<b>\$456</b>

Single-sided recessed power block with **one regular duplex and one telecom knockout on top; one power duplex on bottom**. 10' power cord with straight plug. Specify telecom options separately. Available in Black (**B**), Tungsten (**T**) or Designer White (**W**) as indicated by the last letter of model number. Duplexes always Grey. Corresponding cut-out options are **R1, R2** or **R3**. Units are not approved for daisy chaining. UL listed: UL 1363.



Single Sided Recessed Power Block - USB-A + USB-C

PRTMCS421B	4.22 x 10.78 x 4.86	100	4.3	0.51	<b>\$599</b>
PRTMCS421T	4.22 x 10.78 x 4.86	100	4.3	0.51	<b>\$599</b>
PRTMCS421W	4.22 x 10.78 x 4.86	100	4.3	0.51	<b>\$599</b>

Single-sided recessed power block with **one power/USB-A/USB-C duplex and one telecom knockout on top; one power duplex on bottom**. USB-A port charges max 2.4 amps at 5V and USB-C port charges max 3 amps at 5V. 10' power cord with straight plug. Specify telecom options separately. Available in Black (**B**), Tungsten (**T**) or Designer White (**W**) as indicated by the last letter of model number. Duplexes always Grey (duplex with USB ports is glossy finish). Corresponding cut-out options are **R1, R2** or **R3**. Units are not approved for daisy chaining. UL listed: UL 1363.



Double Sided Recessed Power Block

PRTMCD602B	6.22 x 10.78 x 4.86	92.5	5.9	0.51	<b>\$521</b>
PRTMCD602T	6.22 x 10.78 x 4.86	92.5	5.9	0.51	<b>\$521</b>
PRTMCD602W	6.22 x 10.78 x 4.86	92.5	5.9	0.51	<b>\$521</b>

Double-sided recessed power block with **two regular power duplexes and two telecom knockouts on top; one power duplex on bottom**. 10' power cord with straight plug. Specify telecom options separately. Available in Black (**B**), Tungsten (**T**) or Designer White (**W**) as indicated by last letter of model number. Duplexes always Grey. Corresponding cut-out options are **T1, T2** or **T3**. Units are not approved for daisy chaining. UL listed: UL 1363.



Double Sided Recessed Power Block - USB-A + USB-C

PRTMCD622B	6.22 x 10.78 x 4.86	92.5	6.1	0.51	<b>\$656</b>
PRTMCD622T	6.22 x 10.78 x 4.86	92.5	6.1	0.51	<b>\$656</b>
PRTMCD622W	6.22 x 10.78 x 4.86	92.5	6.1	0.51	<b>\$656</b>

Double-sided recessed power block with **one regular power duplex, one power/USB-A/USB-C duplex and two telecom knockouts on top; one power duplex on bottom**. USB-A port charges max 2.4 amps at 5V and USB-C port charges max 3 amps at 5V. 10' power cord with straight plug. Specify telecom options separately. Available in Black (**B**), Tungsten (**T**) or Designer White (**W**) as indicated by last letter of model number. Duplexes always Grey (duplex with USB ports is glossy finish). Corresponding cut-out options are **T1, T2** or **T3**. Units are not approved for daisy chaining. UL listed: UL 1363.



Double Sided Recessed Power Block - USB-A + USB-C

PRTMCD642B	6.22 x 10.78 x 4.86	85	6.3	0.51	<b>\$790</b>
PRTMCD642T	6.22 x 10.78 x 4.86	85	6.3	0.51	<b>\$790</b>
PRTMCD642W	6.22 x 10.78 x 4.86	85	6.3	0.51	<b>\$790</b>

Double-sided recessed power block with **two power/USB-A/USB-C duplexes and two telecom knockouts on top; one power duplex on bottom**. USB-A port charges max 2.4 amps at 5V and USB-C port charges max 3 amps at 5V. 10' power cord with straight plug. Specify telecom options separately. Available in Black (**B**), Tungsten (**T**) or Designer White (**W**) as indicated by last letter of model number. Duplexes always Grey (duplex with USB ports is glossy finish). Corresponding cut-out options are **T1, T2** or **T3**. Units are not approved for daisy chaining. UL listed: UL 1363.

**Required Specifications**

Finish

## ACCESSORIES

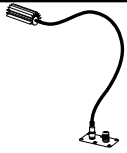

**LED Snake Light with Dimmer**

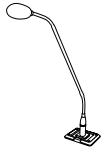

**Microphone**

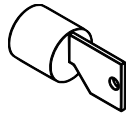

**Lock Assembly**

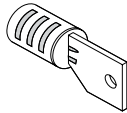

**Lock Drum with Key**

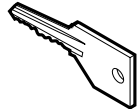

**Extra Key**



**Grommet Cover Round**

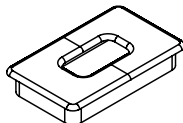

**Grommet**

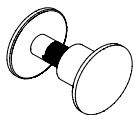

**Quick Connector**

MODEL#	DIMENSIONS	FREIGHT CLASS	WT/LBS.	CUBIC FT.	LIST PRICE
--------	------------	---------------	---------	-----------	------------

**D x W x H**

LIG400	2.5 x 6.5 x 13	70	1	1	<b>\$381</b>
--------	----------------	----	---	---	--------------

MIC400	2 x 2 x 24	70	1	1	<b>\$995</b>
--------	------------	----	---	---	--------------

LO/C	--	70	--	--	<b>\$106</b>
------	----	----	----	----	--------------

Tungsten.

LOB/C	--	70	--	--	<b>\$44</b>
-------	----	----	----	----	-------------

Tungsten.

LOCK	--	70	--	--	<b>\$43</b>
------	----	----	----	----	-------------

Specify key #. Key range 401 - 420.

GM1	2 dia x --	70	--	--	<b>\$65</b>
-----	------------	----	----	----	-------------

GM1K	2 dia x --	70	--	--	<b>\$65</b>
------	------------	----	----	----	-------------

2.75" diameter.

• **Specify GM1 for Black or GM1K for Tungsten.**

GM5C	2 x 3.5 x --	70	--	--	<b>\$107</b>
------	--------------	----	----	----	--------------

Rectangular grommet in metal, tungsten finish.

QC50	--	70	.01	.01	<b>\$10</b>
------	----	----	-----	-----	-------------

QC30	--	70	.01	.01	<b>\$10</b>
------	----	----	-----	-----	-------------

**Required Specifications**

Top finish  
Body finish

**Optional Specifications**

Grommet  
Modesty Panel

# F FOUNDATIONS

ACCESSORIES

MODEL#

DIMENSIONS

FREIGHT CLASS

WT/LBS.

CUBIC FT.

LIST PRICE

D x W x H

kingston

