



Contemporary. Minimal. Inspirational. **Foundations** desking draws upon a contemporary minimal aesthetic, paring down furniture structure and surface to its essence to reveal an architecture of simple horizontal and vertical planar elements.

Each piece is designed to serve the needs of a changing office landscape, elevating the look and function of the private office and taking into account the diverse uses of meeting rooms in the modern work environment. Designed by Christopher Wright.

Foundations components for the private office include modular desks, credenzas and wall storage units punctuated by niches set into the vertical plane of the unit. Personal items or work tools can be stored in niches, desks and storage components that combine to suit individual work styles.

Features and Benefits

- Workwalls support configurations or function as display backdrops
- Niches are designed to accept tackboards, remote-controlled LED lighting and flat screen monitors
- Wall units can be specified with LED lighting.
- Power, data and cable management accessories are available on any Foundations unit, including boardroom tables to meet exact requirements.
- A full array of complementary conference room furnishings are available to coordinate the entire office.



Open frame leg



Workwall niche offers a surface, storage or display.



Workwall with integrated storage credenza.

GENERAL INFORMATION

- Foundations includes workwalls, single- and double-pedestal desks and executive desk extensions, bridges and transaction counters
- Storage components include credenzas, bench storage, wall-mounted and freestanding storage
- Two- or three-tone finish options allow for a distinctive aesthetic
- Executive desk extensions are supported by an open frame leg or elevated pedestals
- Modular wall units, pedestals and credenzas allow for scalable storage solutions; components accommodate L- and U-shaped configurations, as well as desk and workwall/credenza combinations.
- For environmental certification, please visit globalfurnituregroup.com

CONSTRUCTION

- Engineered veneer is real wood that through a manufacturing process of slicing, dyeing, gluing and re-slicing achieves consistent wood grain and color structure.
- Veneer is purchased by the block and sliced into a rift cut slip matched pattern to a thickness of 0.6mm (1/42"). Global lays up rift cut veneers in a slip match method.

FINISHES

- Conversion varnish (similar to catalyzed lacquer, but tougher), 25 degree sheen. Finishes are not buffed or rubbed.
- All Global wood casegood products are veneered and finished on the back sides (360° finishing), except modular under-surface storage - tops and backs are unfinished.
- Touch up kits available, includes a touch up marker and fill crayon. Order **VTOUCHUPKIT, \$164** list. Specify finish when ordering.
- Global standard finish, on oak and walnut, is open pore and on cherry and maple is semi-closed pore. If a full finish is required for walnut, cherry, anigre and maple tops, Add the suffix "2" to the finish code and Add 5% to the base pricing for each product.

CUSTOM FINISH IS AVAILABLE.**PEDESTALS AND CRENZAS**

- Suspended 7.5" off the floor by an open framed aluminum leg
- Locks are always located on the side panel.
- Handle placement is offset from the center, towards the lock
- Overall height is 26.5"
- Pedestal drawer suspensions are metal ball bearing type. Both box and file drawers are full extension.
- Hanging file rails are pre-installed on file drawer perimeters. The back rail in a lateral file drawer is designed for both letter and legal size filing.
- Drawer sides and bottoms are wrapped black vinyl.
- Drawer front is an applied element to a four sided drawer. Drawer fronts are veneered on all surfaces. Drawer fronts can be removed or replaced in the field.
- Leveling glides have 1" range of adjustment.

HARDWARE

- All necessary hardware to assemble the furniture is included in the shipment. Actual wall-attachment fasteners for wall cabinets and tackboards are not included due to variable site conditions.
- Hanging file rails are pre-installed on file drawer perimeters and accommodate both legal and letter size filing. Legal filing can be achieved either as side-to-side or front-to-back. Letter filing can be achieved as front-to-back filing only.
- Connecting brackets are used to attached bridges and returns to desk, and are shipped pre-attached to the bottom of the bridge or return. Additional screws are shipped in a plastic bag.

INSTALLATION

- **Wall-mounted cabinets and tackboards** are shipped with preattached horizontal wall rails at the back of each unit. The wall-side components must be detached from the unit and fastened to the wall accordingly. Wall fasteners are not included due to the variable site conditions. Securing the wall rail to a vertical structural member is the required manner of installation. The cabinet or tackboard is then lowered on to the wall rail. It is important to level the wall rail before installation. Wall cabinets are equipped with levelers at the bottom of the back panels for proper cabinet alignment. Units with doors are equipped with adjustable European door hinges to assist in door alignment. It is required to use a #8 wood screw through the back of the cabinet and the wall-mounted rail, to further secure the wall attachment. Tackboards have vertical grooves in the back for tasklight wiring.
- **Transaction counter and decorative panels** are shipped knock down. To assemble it follow the assembly instruction sheet included. To secure the transaction counter to the desk, double sided tape is applied to the bottom of the end panels. Included screws must be used to attach the decorative panel to the desk.
- **Modular storage units:** Have pre-drilled holes through the tops for securing to the bottom of the work surfaces. Screws and lock keys are included in a plastic bag fastened inside the pedestal. Pedestals may be installed flush or offset. Disassemble the modular unit first before relocating the entire unit to avoid damage or bodily injuries.
- **Work Walls:** Incorporate storage units, credenzas and niches of different sizes, attached to the base with connecting bolts. Upper units are installed with plastic dowels. Small connectors are supplied to secure the units thru the side panels. Complete assembly instruction is included with the wall unit. All necessary connectors and dowels are shipped in a plastic bag.
- **Credenza backpanels and display walls:** Optional credenza backpanels and display walls are attached to the units with supplied quick connectors. To assemble the display wall follow the assembly instructions included. All connectors and screws are shipped in a plastic bag.
- **Tables:** All table components are shipped in multiple boxes. Screws and table connectors are packed in a separate box identified with the label "Hardware Enclosed". Assembly instructions for specific tables are included.

F FOUNDATIONS - HOW TO SPECIFY

1. SPECIFY MODEL NUMBER

2. SPECIFY FINISH

WORKSURFACE TOP & DRAWER/DOOR FRONTS, BODY FINISHES (INCLUDING PEDESTALS) - VENEER

Foundations Engineered Finishes (Horizontal Grain Standard)

Code	Finish	Veneer Type	Cut
NTF	Natural	Maple Reconstituted	Rift
TLF	Twilight	Maple Reconstituted	Rift
CIF	Chai	White Oak Reconstituted	Rift
FGF	Fig	White Oak Reconstituted	Rift
RVF	Riviera	White Oak Reconstituted	Rift
STF	Sumatra	White Oak Reconstituted	Rift
WHF	Wheat	White Oak Reconstituted	Rift
MTF	Metro	White Oak Reconstituted	Rift
MSF	Mesa	White Oak Reconstituted	Rift
CHF	Cashmere	White Oak Reconstituted	Rift
SNF	Sienna	White Oak Reconstituted	Rift
WIF	Winter	White Oak Reconstituted	Rift

METAL LEG FINISH (Casegoods):

SGR Silver Glimmer

METAL LEG FINISHES (Conference Tables):

BLKT Black Textured
TUNT Tungsten Textured
DWTT Designer White Textured

3. SPECIFY OPTIONS

Handle

- Handles are standard on most drawers/storage modules.

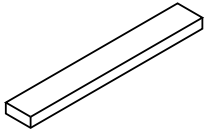

PL83 Anodized Aluminum, 7.2"

Edges

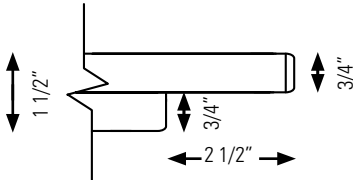

Edge Detail - Casegoods

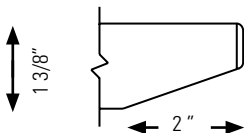

Edge Detail - Conference Tables

Grommets

- Standard grommet on all components is **GM5K**. Grommet is included with products where shown in line drawings in price book.
- Optional grommets may be ordered in standard worksurface locations (left, center or right). Order as **GM5KL, GM5KC or GM5KR**. Add \$96.
- Grommet hole dimensions are 2 3/4" in diameter. Specify **GM1E** for **Black** or **GM1K** for **Tungsten**.
- Color of grommet will be automatically coordinated with handle color where applicable



- Components that come standard with grommet may be ordered without a grommet. Order as RSG - Add \$53.
- View diagrams on the following pages for additional details.

For tops up to 24"D

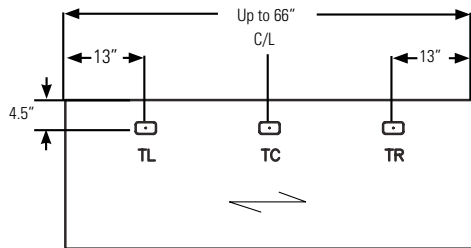
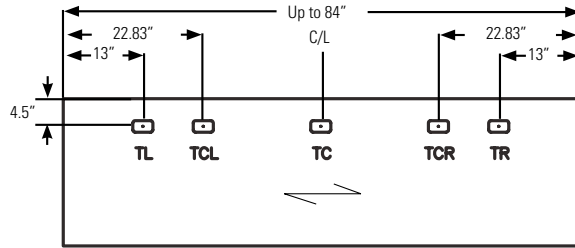

For tops 30" to 36"D

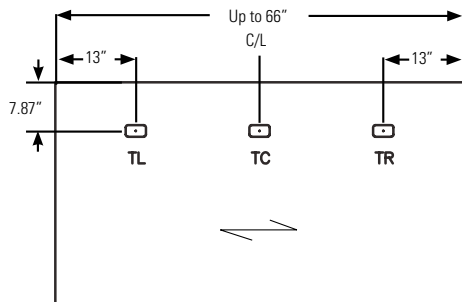
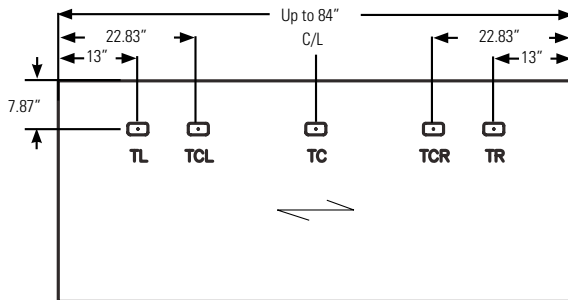

F FOUNDATIONS - NOTES

Optional Grommet Locations on Work Walls

Grommets and Grommet Locations must be specified.

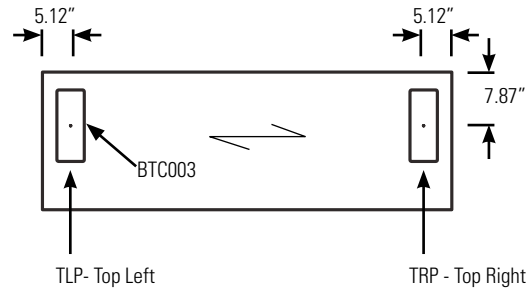
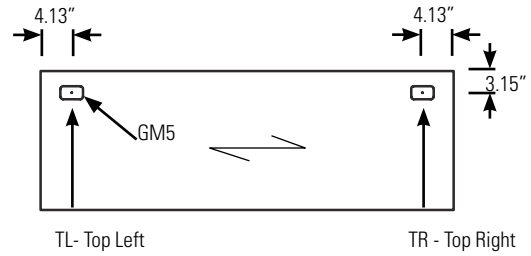
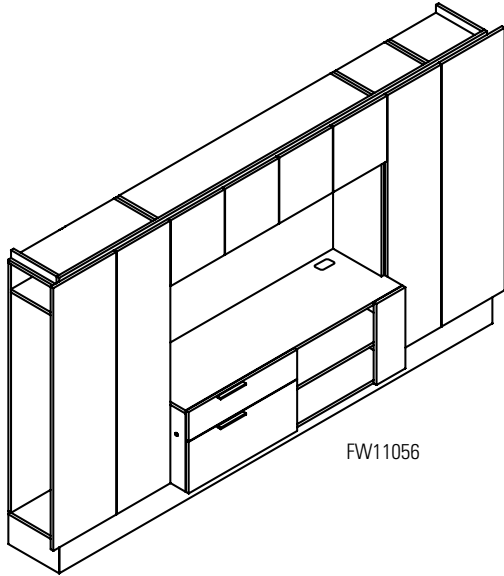

Standard Grommet Locations on Work Walls

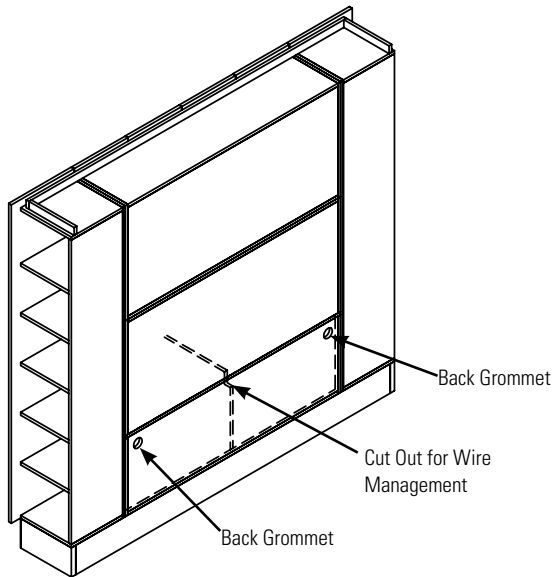

FW9570-IR Back View

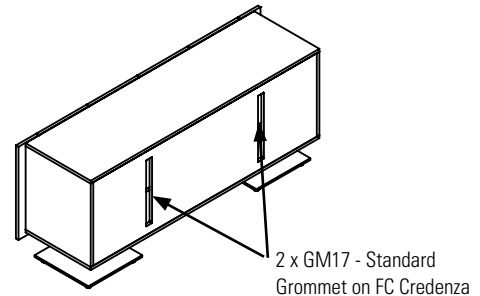
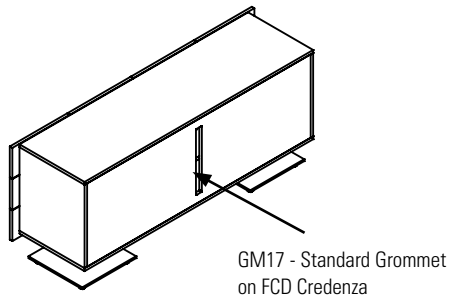
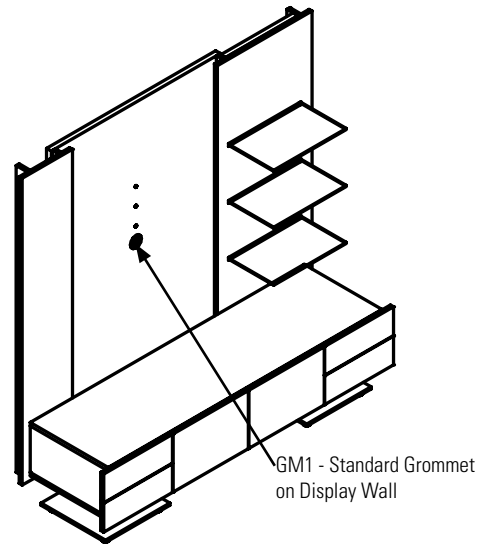

Work Wall Display Niches

- Available widths 15", 30", 45", 60" wide.
- Available heights 14", 28", 42" high.
- Maximum niche dimension 60" wide is 42" high.
- Maximum niche dimension 75" wide is 28" high.

When a niche is placed on 20" cantilevered storage there is no bottom. When a niche is placed between storage components it always has a bottom.

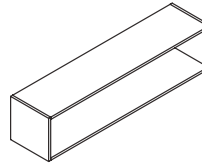
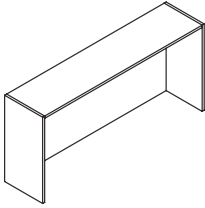

Work Wall Lighting

- LED lights for niches must be specified at time of manufacture. When more than one LED light is required in a work wall configuration, a single remote switch is included. Up to four LED lights can work off a single transformer.

Four sided niche with routed upper panel for LED light.

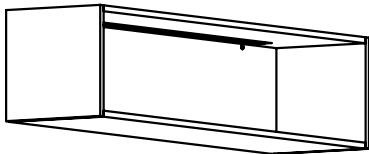

Niche is routed on inside top panel & back is drilled for wire pass through.

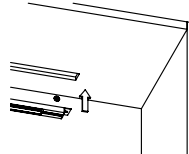

Open bottom niche with routed upper panel for LED light.

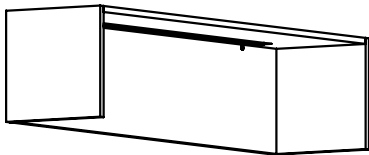

LED lights available in 12", 24", 36" and 48" widths.



F FOUNDATIONS - NOTES

CONFERENCE TABLES DETAILS

Optional Grommet Locations for Conference Table Tops

Grommets and Grommet Locations must be specified.

For tables that are 48" wide and 96", 120", 144" or 168" long:

TCL - Top Center Left

TCR - Top Right

TC - Top Center

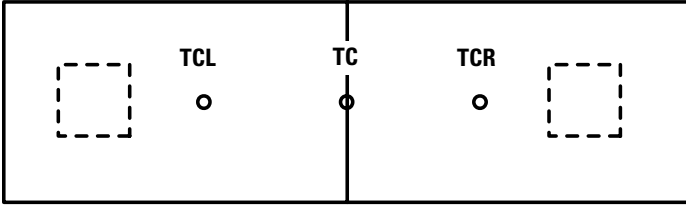

For tables that are 48" wide and 192" or 216" long and tables that are 60" wide and 168", 192", 216" or 240" long:

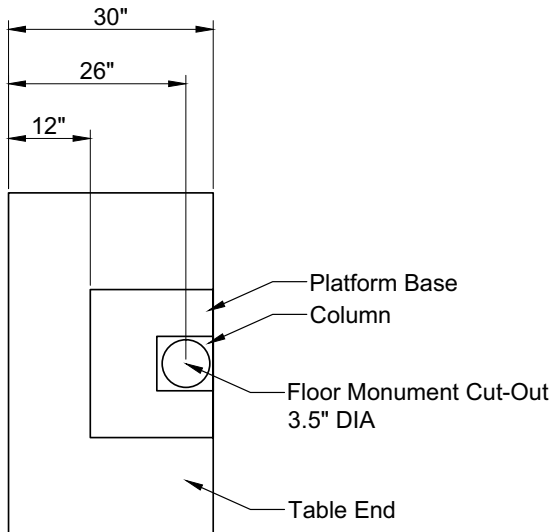
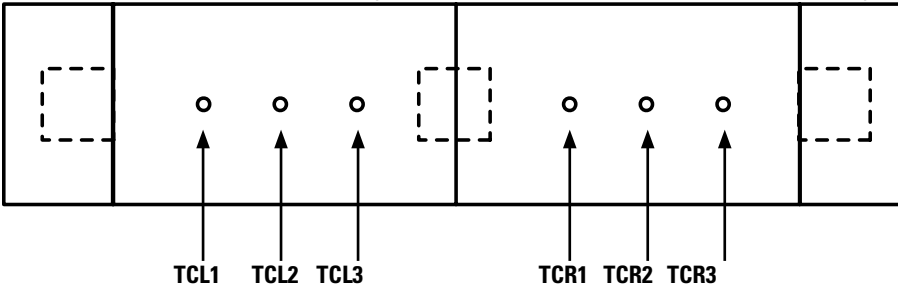

Conference Table Top and Base Guide

Conference Table, two piece Top with 3 Bases

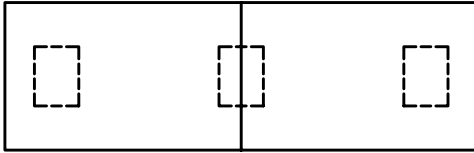

Sectional Conference Table with 3 Bases

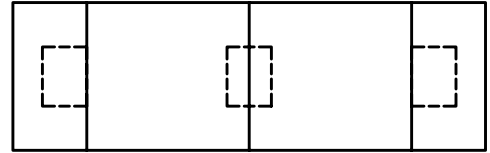

Conference Table, two piece Top with 2 Bases

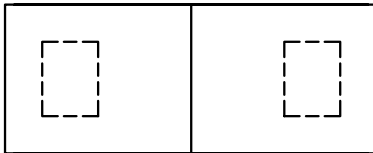

Sectional Conference Table with 2 Bases



Conference Table, one piece Top with 2 Bases

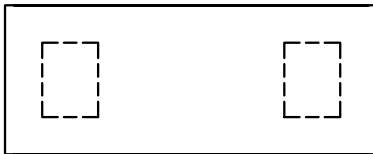

Square Table Top with Mono Base

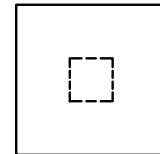

Sectional Conference Table with Technology Trough and 3 Bases

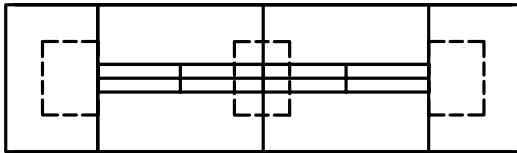

Round Table Top with Mono Base

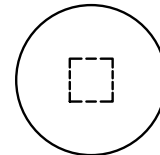

Sectional Conference Table with Technology Trough and 2 Bases

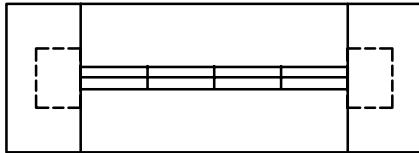

Sectional Conference Table with Technology Trough and 2 Bases



Note: Different Table Shapes are available.

Technology Trough Details

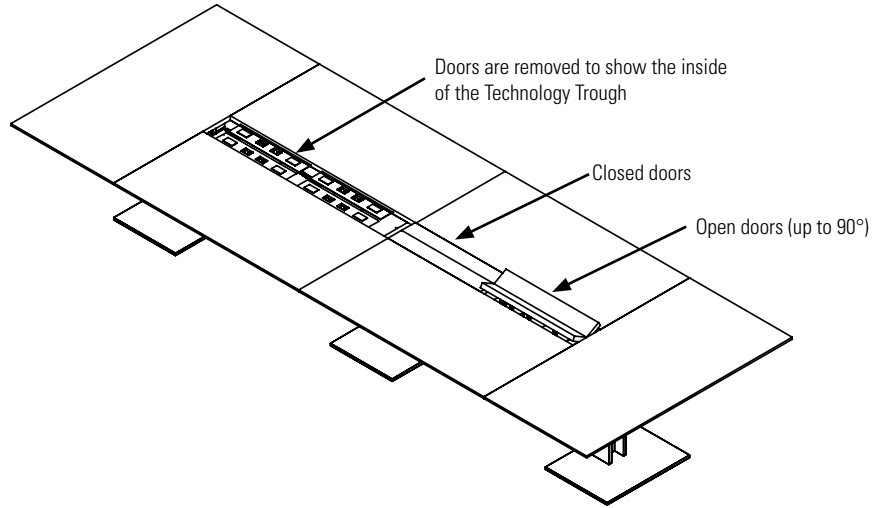

Side View

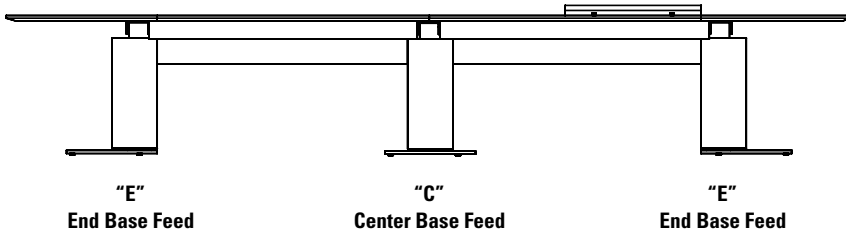

End View

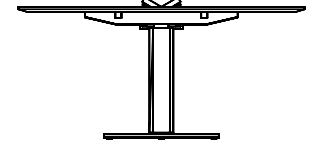

Power kits are included.

Two power receptacles and two telecom knockouts per door are standard.

Telecom plates will be shipped separately. If no telecom plate is specified, blank coverplate will be included.

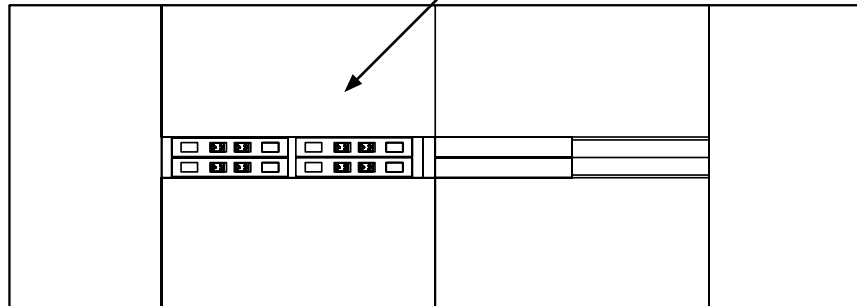
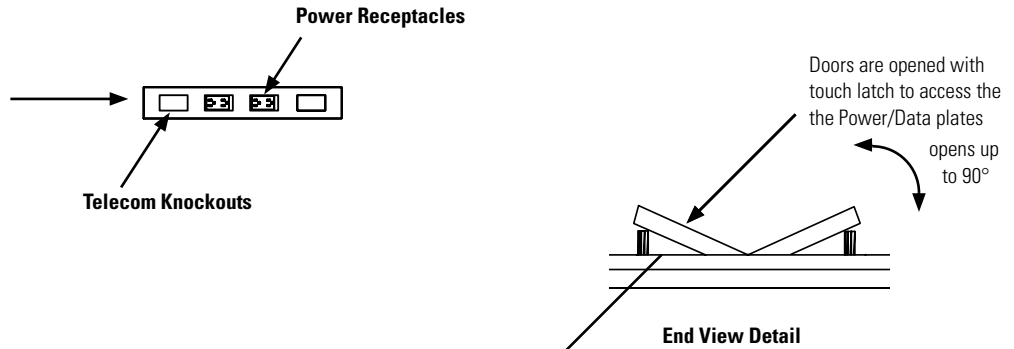

FINISH SPECIFICATIONS

Double and Single Pedestal Desks

- For desks two finishes can be specified.
- The first finish in the product string, indicated as #1.
- The second finish in the product string indicated as #2.
- If only one finish is indicated, the entire unit will be monotone.
- **Note:** Horizontal grain direction is standard on all engineered finishes. If natural veneer is required, the grain direction will be vertical. Arrow indicates direction of grain.

User Side

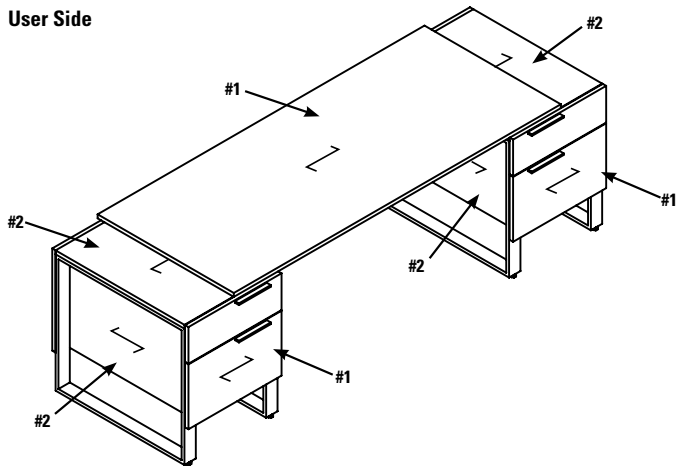

Back View

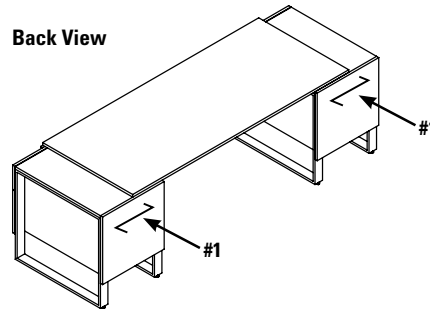

Transaction Counter and Decorative Panel

- For Transaction Counter and Decorative Panel, only one finish can be specified.
- Arrow indicates direction of grain

User Side

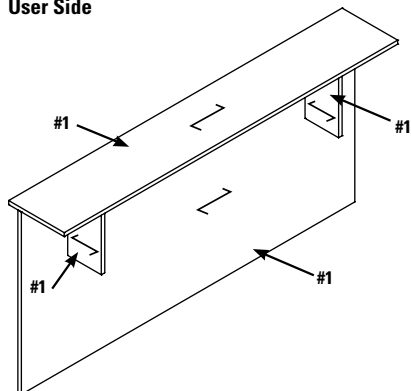

Back View

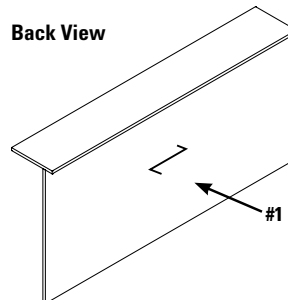

Pedestals

- For Pedestals, two finishes can be specified.
- The first finish in the product string, indicated as #1.
- The second finish in the product string indicated as #2.
- If only one finish is indicated, the entire unit will be monotone.

User Side

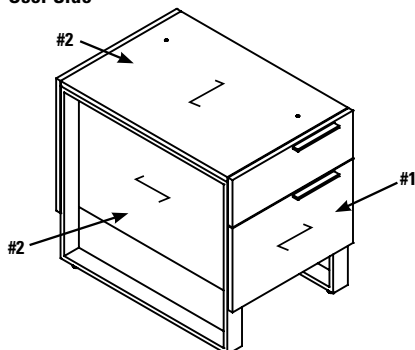

Back View

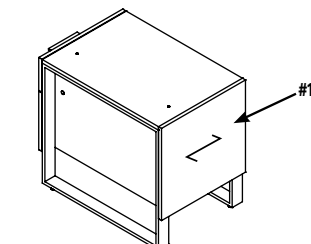

F FOUNDATIONS - NOTES

Lateral Files

- For Lateral Files two finishes can be specified.
- The first finish in the product string, indicated as **#1**.
- The second finish in the product string indicated as **#2**.
- If only one finish is indicated, the entire unit will be monotone.
- Arrow indicates direction of grain

User Side

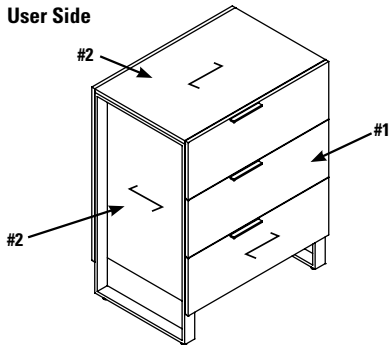

Back View

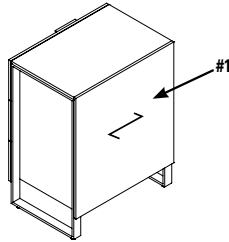

Mobile Pedestals

- For Mobile Pedestals, two finishes can be specified.
- The first finish in the product string, indicated as **#1**.
- The second finish in the product string indicated as **#2**.
- If only one finish is indicated, the entire unit will be monotone.
- Arrow indicates direction of grain

User Side

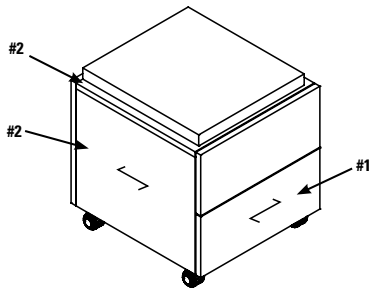

Back View

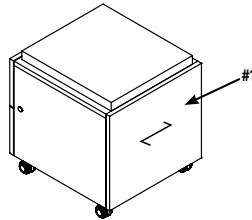

Benches

- For Benches, two finishes can be specified.
- The first finish in the product string, indicated as **#1**.
- The second finish in the product string indicated as **#2**.
- If only one finish is indicated, the entire unit will be monotone.
- Arrow indicates direction of grain

User Side

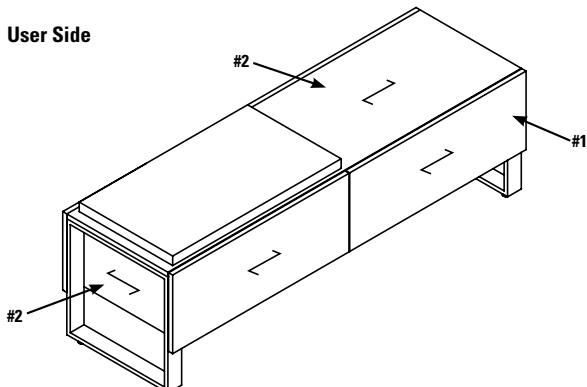

Back View

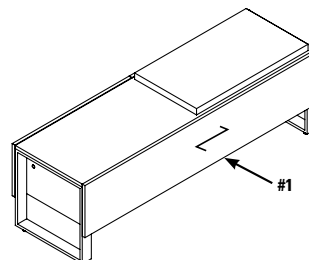

Credenzas

- For Credenzas, two finishes can be specified.
- The first finish in the product string, indicated as **#1**.
- The second finish in the product string indicated as **#2**.
- If only one finish is indicated, the entire unit will be monotone.
- Arrow indicates direction of grain

User Side

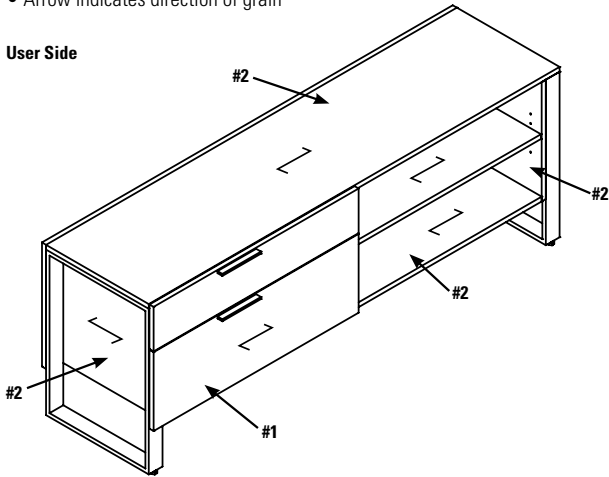

Back View

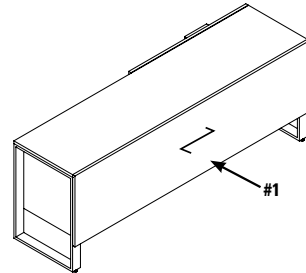

Modular Tops

- For Modular Tops, only one finish can be specified.
- Arrow indicates direction of grain

Isometric View

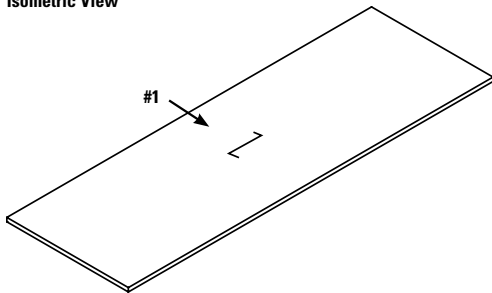

End View

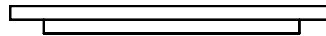

Wall Mounted Overheads

- For wall mounted overheads, two finishes can be specified.
- The first finish in the product string, indicated as **#1**.
- The second finish in the product string indicated as **#2**.
- If only one finish is indicated, the entire unit will be monotone.
- Arrow indicates direction of grain

User Side

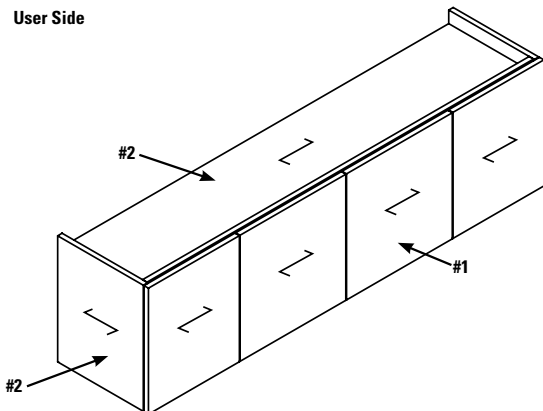

Back View

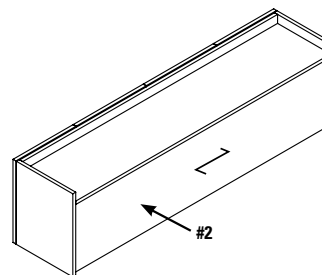

F FOUNDATIONS - NOTES

Work Wall Credenzas

- Two finishes can be specified.
- The first finish in the product string, indicated as **#1**.
- The second finish in the product string indicated as **#2**.
- If only one finish is indicated, the entire unit will be monotone.
- Arrow indicates direction of grain

User Side

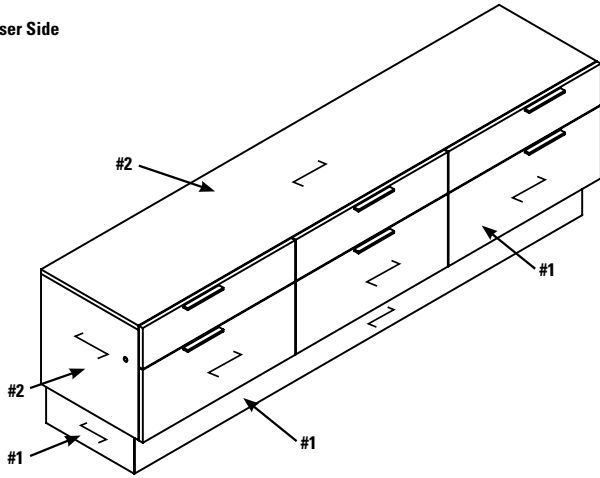

Back View

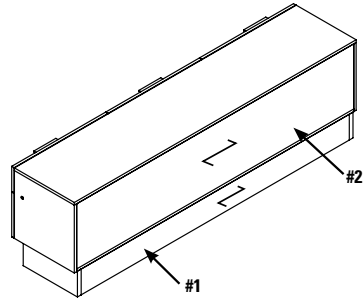

Work Wall Credenzas

- Three finishes can be specified.
- The first finish in the product string, indicated as **#1**.
- The second finish in the product string indicated as **#2**.
- The third finish in the product string indicated as **#3**.
- If only one finish is indicated, the entire unit will be monotone.
- Horizontal grain direction is standard on all engineered finishes. If natural veneer is required, the grain direction will be vertical. Arrow indicates direction of grain

Front View

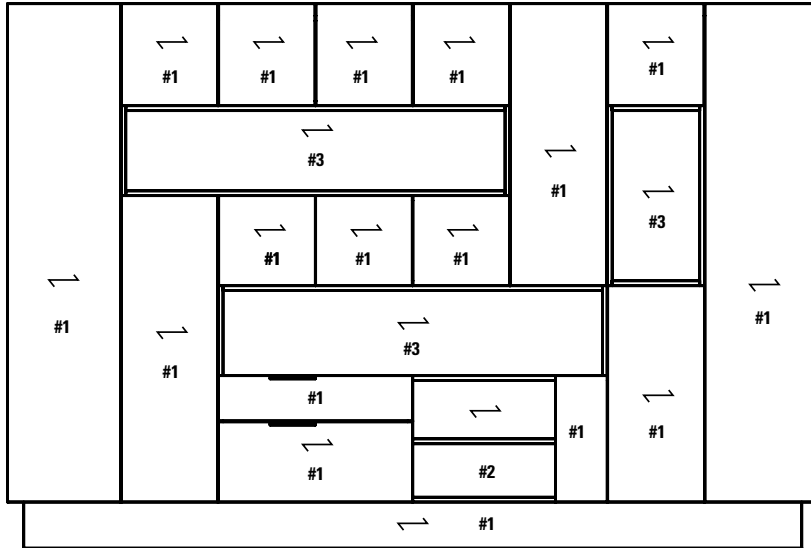

Side View

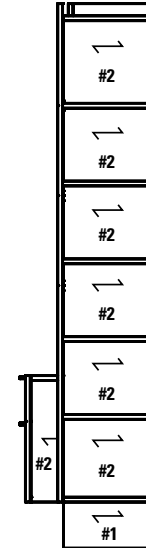

Isometric View

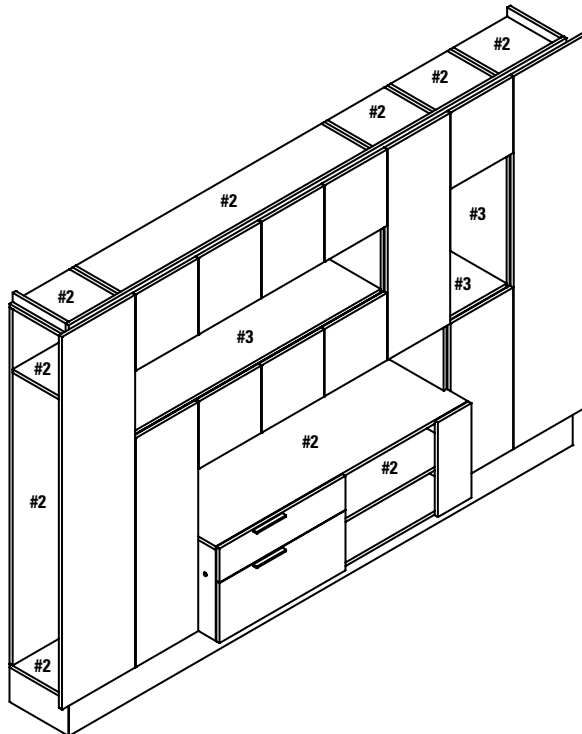

F FOUNDATIONS - NOTES

Sectional Top with two bases

- Two finishes can be specified.
- The first finish in the product string, indicated as #1.
- The second finish in the product string indicated as #2.
- If only one finish is indicated, the entire unit will be monotone.
- Arrow indicates direction of grain

Top View

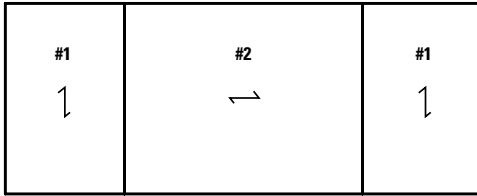

Side View

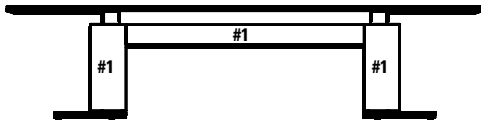

End View

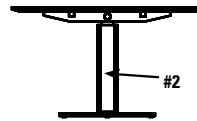

Sectional Top with Technology Trough and bases

- Three finishes can be specified.
- The first finish in the product string, indicated as #1.
- The second finish in the product string indicated as #2.
- The third finish in the product string indicated as #3.
- If only one finish is indicated, the entire unit will be monotone.
- Arrow indicates direction of grain

Top View

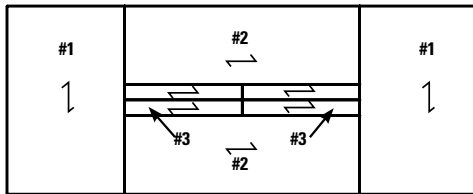

Side View

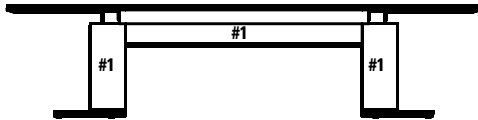

End View

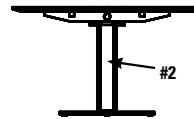

Full Storage Credenza with two sets of Storage Cabinets and Display Wall

- Two finishes can be specified.
- The first finish in the product string, indicated as #1.
- The second finish in the product string indicated as #2.
- If only one finish is indicated, the entire unit will be monotone.
- Arrow indicates direction of grain

Front View

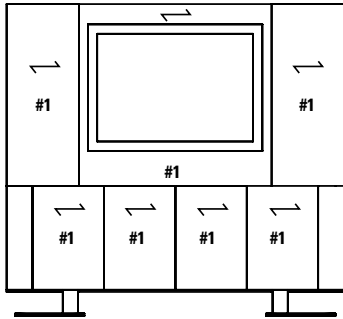

Side View

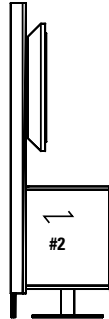

Top View

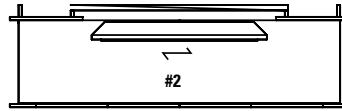

Full Storage Credenza with BBB, Storage Cabinet, BBB and Display Wall

- Two finishes can be specified.
- The first finish in the product string, indicated as #1.
- The second finish in the product string indicated as #2.
- If only one finish is indicated, the entire unit will be monotone.
- Arrow indicates direction of grain

Front View

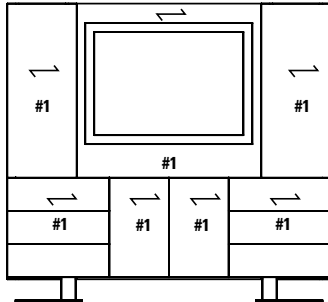

Side View

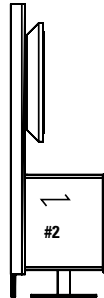

Top View

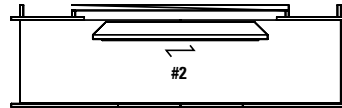

Full Storage Credenza with BB, Storage Cabinet, BB and Display Wall

- Two finishes can be specified.
- The first finish in the product string, indicated as #1.
- The second finish in the product string indicated as #2.
- If only one finish is indicated, the entire unit will be monotone.
- Arrow indicates direction of grain

Front View

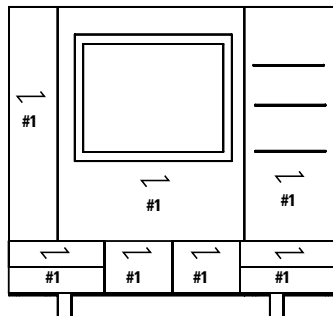

Side View

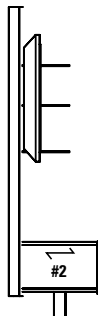

Top View

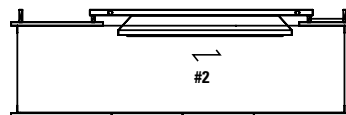

F FOUNDATIONS - NOTES

Lectern

- Two finishes can be specified.
- The first finish in the product string, indicated as **#1**.
- The second finish in the product string indicated as **#2**.
- If only one finish is indicated, the entire unit will be monotone.
- Arrow indicates direction of grain

FLEC-36 Lectern

Front View

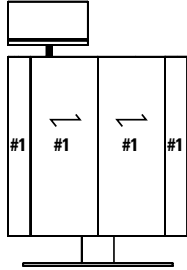

Side View

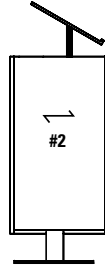

Top View

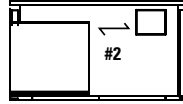

FLEC-24 Lectern

Front View

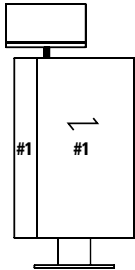

Side View

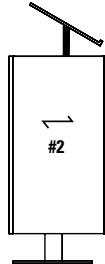

Top View



Mobile Units

- Two finishes can be specified.
- The first finish in the product string, indicated as **#1**.
- The second finish in the product string indicated as **#2**.
- If only one finish is indicated, the entire unit will be monotone.
- Arrow indicates direction of grain

Mobile Lectern

Front View

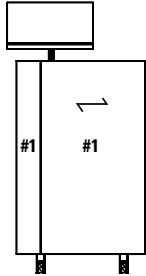

Side View

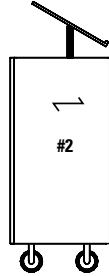

Top View

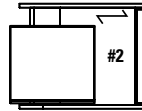

Mobile Tech Cart

Front View

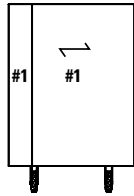

Side View

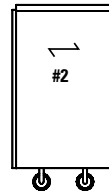

Top View

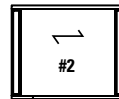

Mobile Server

Front View

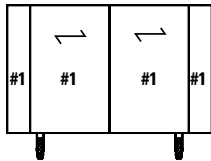

Side View

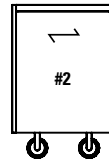

Top View

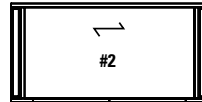

DESKS - NOTES

- Horizontal grain direction is standard on all engineered finishes.
- Tops are constructed with two 3/4" thick panels, laminated together to create a total thickness of 1.5".
- All pedestals are suspended 7.5" off the floor by an open framed leg, and can be installed flush or offset
- Pedestals are handed:
 - Left pedestals have the handle offset from the center to the right, and the lock is placed on the right end panel
 - Right pedestals have the handle offset from the center to the left, and the lock is placed on the left end panel
- Modesty panels are available as an optional upgrade in wood or glass on Desks
- Grommets are available as an option on Desks and most Credenzas.
- **NOTE:** Arrow indicates direction of grain

Double Pedestal Desk with Box/File installed flush.

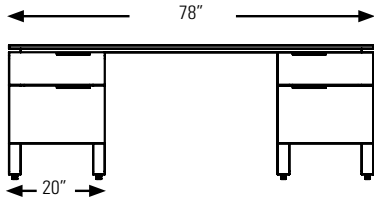

Double Pedestal Desk with Box/File installed offset.
Add 20" to the overall width of the top.

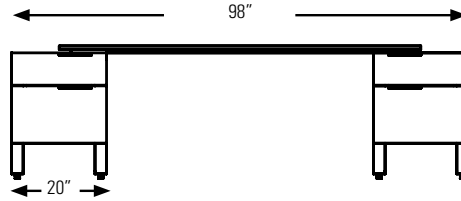

Single Pedestal Desk with Box/File installed flush.

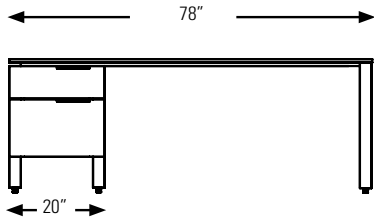

Single Pedestal Desk with Box/File installed offset.
Add 10" to the overall width of the top.

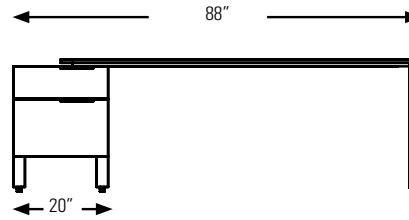

By adding a Transaction Counter Top with Decorative Front Panel (**FGTT**) to a Desk, the Desk can be used as a Reception Desk:

User View

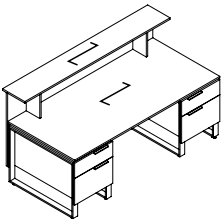

Guest View

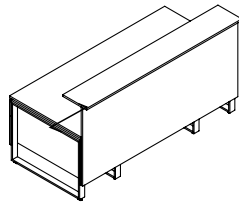

Required Specifications

Veneer Finish
Edge

Optional Specifications

Grommet

DOUBLE PEDESTAL DESKS

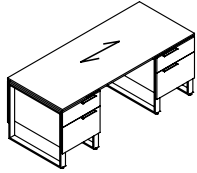

Double Pedestal Desk

MODEL#	DIMENSIONS	FREIGHT CLASS	WT/LBS.	CUBIC FT.	LIST PRICE
--------	------------	---------------	---------	-----------	------------

D x W x H

FD8436BB	36 x 84 x 28	85	201	15	\$11450
FD7836BB	36 x 78 x 28	85	192	15	\$11227
FD7236BB	36 x 72 x 28	92.5	177	15	\$10948
FD8430BB	30 x 84 x 28	85	184	15	\$10879
FD7830BB	30 x 78 x 28	92.5	176	15	\$10701
FD7230BB	30 x 72 x 28	92.5	163	14	\$10446

Standard with **flush box/file** pedestals on **left** and **right**.

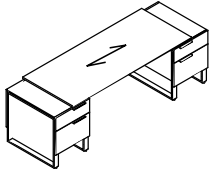

Double Pedestal Desk

FD8436BBOS	36 x 84 x 28	85	201	15	\$11810
FD7836BBOS	36 x 78 x 28	85	192	15	\$11590
FD7236BBOS	36 x 72 x 28	92.5	177	15	\$11307
FD8430BBOS	30 x 84 x 28	85	184	15	\$11244
FD7830BBOS	30 x 78 x 28	92.5	176	15	\$11063
FD7230BBOS	30 x 72 x 28	92.5	163	14	\$10808

Standard with **offset box/file** pedestals on **left** and **right**.

SINGLE PEDESTAL DESKS

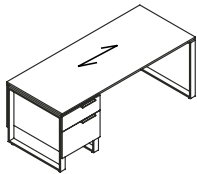

Single Pedestal Desk - LEFT

MODEL#	DIMENSIONS	FREIGHT CLASS	WT/LBS.	CUBIC FT.	LIST PRICE
--------	------------	---------------	---------	-----------	------------

FSL8436B	36 x 84 x 28	85	201	15	\$8330
FSL7836B	36 x 78 x 28	85	192	15	\$8107
FSL7236B	36 x 72 x 28	92.5	177	15	\$7802
FSL8430B	30 x 84 x 28	85	184	15	\$7760
FSL7830B	30 x 78 x 28	92.5	176	15	\$7578
FSL7230B	30 x 78 x 28	92.5	163	14	\$7326

Standard with **flush box/file** pedestal on **left**.

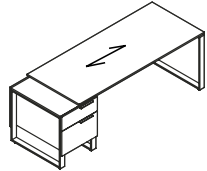

Single Pedestal Desk - LEFT

FSL8436BOS	36 x 84 x 28	85	201	15	\$8693
FSL7836BOS	36 x 78 x 28	85	192	15	\$8469
FSL7236BOS	36 x 72 x 28	92.5	177	15	\$8162
FSL8430BOS	30 x 84 x 28	85	184	15	\$8122
FSL7830BOS	30 x 78 x 28	92.5	176	15	\$7944
FSL7230BOS	30 x 78 x 28	92.5	163	14	\$7688

Standard with **offset box/file** pedestal on **left**.

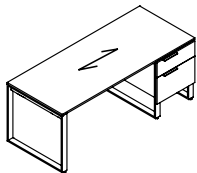

Single Pedestal Desk - RIGHT

FSR8436B	36 x 84 x 28	85	201	15	\$8330
FSR7836B	36 x 78 x 28	85	192	15	\$8107
FSR7236B	36 x 72 x 28	92.5	177	15	\$7802
FSR8430B	30 x 84 x 28	85	184	15	\$7760
FSR7830B	30 x 78 x 28	92.5	176	15	\$7578
FSR7230B	30 x 78 x 28	92.5	163	14	\$7326

Standard with **flush box/file** pedestal on **right**.

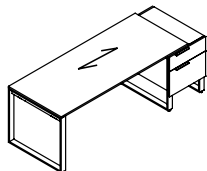

Single Pedestal Desk - RIGHT

FSR8436BOS	36 x 84 x 28	85	201	15	\$8693
FSR7836BOS	36 x 78 x 28	85	192	15	\$8469
FSR7236BOS	36 x 72 x 28	92.5	177	15	\$8162
FSR8430BOS	30 x 84 x 28	85	184	15	\$8122
FSR7830BOS	30 x 78 x 28	92.5	176	15	\$7944
FSR7230BOS	30 x 78 x 28	92.5	163	14	\$7688

Standard with **offset box/file** pedestal on **right**.

Required Specifications

Top finish
Body finish

Optional Specifications

Grommet
Modesty Panel

F FOUNDATIONS

DESK SHELL

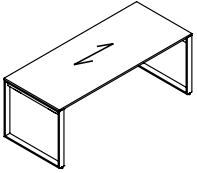

Desk Shell*

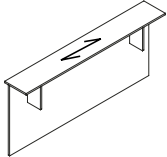

Transaction Counter

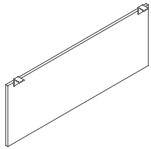

Hanging Wood Modesty Panel

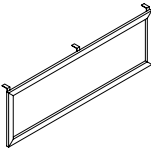

Hanging Glass Modesty Panel

MODEL#	DIMENSIONS	FREIGHT CLASS	WT/LBS.	CUBIC FT.	LIST PRICE
--------	------------	---------------	---------	-----------	------------

D x W x H

FT7236	36 x 72 x 28	85	201	15	\$5493
FT6636	36 x 66 x 28	85	192	15	\$5244
FT6036	36 x 60 x 28	92.5	177	15	\$5011
FT7230	30 x 72 x 28	85	184	15	\$4828
FT6630	30 x 66 x 28	92.5	176	15	\$4636
FT6030	30 x 60 x 28	92.5	163	14	\$4448

FGTT8412	12 x 84 x 42	250	73	21	\$3666
FGTT7812	12 x 78 x 42	250	68	19	\$3514
FGTT7212	12 x 72 x 42	250	63	18	\$3281

Rectangular transaction counter with decorative panel.

FCMP70W	0.75 x 70 x 18	--	25	1	\$1639
FCMP66W	0.75 x 66 x 18	--	24	1	\$1602
FCMP64W	0.75 x 64 x 18	--	23	1	\$1589
FCMP62W	0.75 x 62 x 18	--	22	1	\$1571
FCMP60W	0.75 x 60 x 18	--	22	1	\$1562
FCMP58W	0.75 x 58 x 18	--	21	1	\$1551
FCMP56W	0.75 x 56 x 18	--	20	1	\$1545
FCMP54W	0.75 x 54 x 18	--	20	1	\$1537
FCMP50W	0.75 x 50 x 18	--	18	1	\$1522
FCMP48W	0.75 x 48 x 18	--	18	1	\$1514
FCMP42W	0.75 x 42 x 18	--	16	1	\$1412
FCMP36W	0.75 x 36 x 18	--	14	1	\$1213
FCMP30W	0.75 x 30 x 18	--	12	1	\$1014

Hanging wood modesty panel. Attaches to underside of worksurface. **Cannot be retrofitted in the field.**

Not sold individually - to be ordered as an upgrade option only.

FCMP70G	0.75 x 70 x 18	--	25	1	\$2640
FCMP66G	0.75 x 66 x 18	--	24	1	\$1602
FCMP64G	0.75 x 64 x 18	--	23	1	\$2496
FCMP62G	0.75 x 62 x 18	--	22	1	\$2357
FCMP60G	0.75 x 60 x 18	--	22	1	\$2281
FCMP58G	0.75 x 58 x 18	--	21	1	\$2222
FCMP56G	0.75 x 56 x 18	--	20	1	\$2204
FCMP54G	0.75 x 54 x 18	--	20	1	\$2127
FCMP50G	0.75 x 50 x 18	--	18	1	\$2070
FCMP48G	0.75 x 48 x 18	--	18	1	\$2032
FCMP42G	0.75 x 42 x 18	--	16	1	\$2010
FCMP36G	0.75 x 36 x 18	--	14	1	\$1994
FCMP30G	0.75 x 30 x 18	--	12	1	\$1972

Aluminum framed glass modesty panel with frosted glass (standard). Attaches to underside of worksurface. **Cannot be retrofitted in the field. Not sold individually - to be ordered as an upgrade option only.**

- For white back painted glass, please contact Customer Care for pricing.

Required Specifications

Top finish
Body finish

Optional Specifications

Grommet
Modesty Panel*

CRENZAS - NOTES

D x W x H

- Horizontal grain direction is standard on all engineered finishes.
- Tops are constructed with two 3/4" thick panels, laminated together to create a total thickness of 1.5".
- All pedestals are suspended 7.5" off the floor by an open framed leg, and can be installed flush or offset
- Pedestals are handed:
 - Left pedestals have the handle offset from the center to the right, and the lock is placed on the right end panel
 - Right pedestals have the handle offset from the center to the left, and the lock is placed on the left end panel
- Modesty panels are available in wood or glass
- Grommets can be specified on Credenza Tops.
- **NOTE:** Arrow indicates direction of grain

Single Pedestal Credenza with 35" Lat. Box/File installed flush

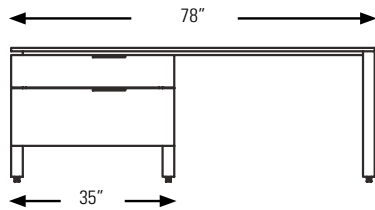

Single Pedestal Credenza with 35" Lat. Box/File installed offset
Adds 10" to overall width

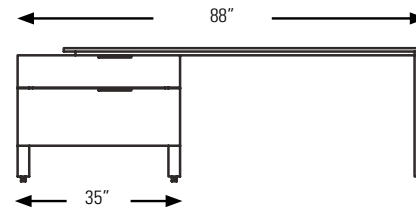

Single Pedestal Credenza with 40" Lat. Box/File installed flush.

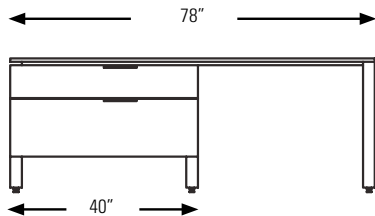

Double Pedestal Credenza with 40" Lat. Box/File installed offset.
Adds 10" to overall width

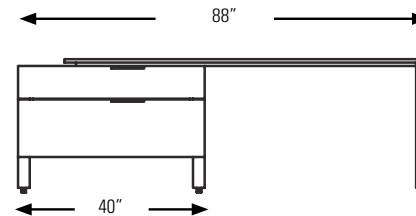

SINGLE PEDESTAL CRENZAS	MODEL#	DIMENSIONS	FREIGHT CLASS	WT/LBS.	CUBIC FT.	LIST PRICE
-------------------------	--------	------------	---------------	---------	-----------	------------

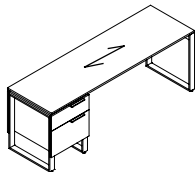

Single Pedestal Credenza - LEFT

Standard with **flush box/file** pedestal on **left**.

FCCL7824B	24 x 78 x 28	85	160	12	\$7520
FCCL7224B	24 x 72 x 28	85	151	12	\$7279
FCCL7820B	20 x 78 x 28	85	153	11	\$7061
FCCL7220B	20 x 72 x 28	85	144	11	\$6839

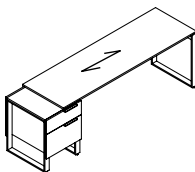

Single Pedestal Credenza - LEFT

Standard with **offset box/file** pedestal on **left**.

FCCL7824BOS	24 x 88 x 28	85	160	12	\$7567
FCCL7224BOS	24 x 82 x 28	85	151	12	\$7279
FCCL7820BOS	20 x 88 x 28	85	153	11	\$7110
FCCL7220BOS	20 x 82 x 28	85	144	11	\$6839

Required Specifications

Top finish
Body finish

Optional Specifications

Grommet

F FOUNDATIONS

SINGLE PEDESTAL CREDENZAS

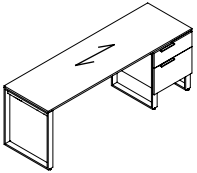

Single Pedestal Credenza - RIGHT

MODEL#	DIMENSIONS D x W x H	FREIGHT CLASS	WT/LBS.	CUBIC FT.	LIST PRICE
FCCR7824B	24 x 78 x 28	85	160	12	\$7520
FCCR7224B	24 x 72 x 28	85	151	12	\$7279
FCCR7820B	20 x 78 x 28	85	153	11	\$7061
FCCR7220B	20 x 72 x 28	85	144	11	\$6839

Standard with **flush box/file** pedestal on **right**.

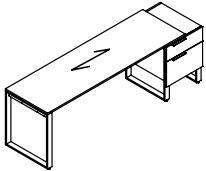

Single Pedestal Credenza - RIGHT

FCCR7824BOS	24 x 88 x 28	85	160	12	\$7567
FCCR7224BOS	24 x 82 x 28	85	151	12	\$7279
FCCR7820BOS	20 x 88 x 28	85	153	11	\$7110
FCCR7220BOS	20 x 82 x 28	85	144	11	\$6839

Standard with **offset box/file** pedestal on **right**.

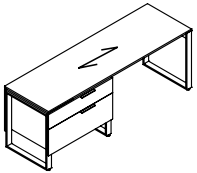

Single Pedestal Credenza - LEFT

FCC35L7824H	24 x 78 x 28	92.5	188	18	\$8111
FCC35L7224H	24 x 72 x 28	100	179	18	\$7869
FCC35L7820H	20 x 78 x 28	92.5	179	15	\$7611
FCC35L7220H	20 x 72 x 28	92.5	170	15	\$7387

Standard with **flush 35" lateral box/file** pedestal on **left**.

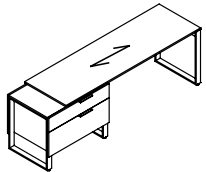

Single Pedestal Credenza - LEFT

FCC35L7824HOS	24 x 88 x 28	92.5	188	18	\$8436
FCC35L7224HOS	24 x 82 x 28	100	179	18	\$8192
FCC35L7820HOS	20 x 88 x 28	92.5	179	15	\$7938
FCC35L7220HOS	20 x 82 x 28	92.5	170	15	\$7713

Standard with **offset 35" lateral box/file** pedestal on **left**.

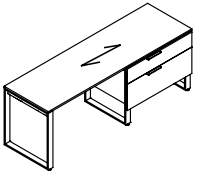

Single Pedestal Credenza - RIGHT

FCC35R7824H	24 x 78 x 28	92.5	188	18	\$8111
FCC35R7224H	24 x 72 x 28	100	179	18	\$7869
FCC35R7820H	20 x 78 x 28	92.5	179	15	\$7611
FCC35R7220H	20 x 72 x 28	92.5	170	15	\$7387

Standard with **flush 35" lateral box/file** pedestal on **right**.

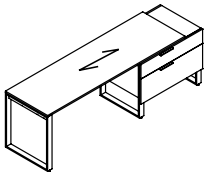

Single Pedestal Credenza - RIGHT

FCC35R7824HOS	24 x 88 x 28	92.5	188	18	\$8436
FCC35R7224HOS	24 x 82 x 28	100	179	18	\$8192
FCC35R7820HOS	20 x 88 x 28	92.5	179	15	\$7938
FCC35R7220HOS	20 x 82 x 28	92.5	170	15	\$7713

Standard with **offset 35" lateral box/file** pedestal on **right**.

Required Specifications

Top finish
Body finish

Optional Specifications

Grommet

SINGLE PEDESTAL CREDENZAS

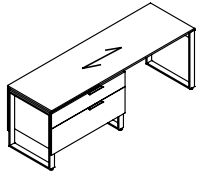

Single Pedestal Credenza - LEFT

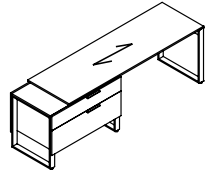

Single Pedestal Credenza - LEFT

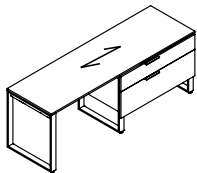

Single Pedestal Credenza - RIGHT

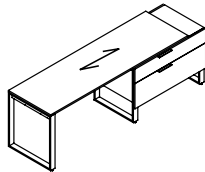

Single Pedestal Credenza - RIGHT

MODEL# DIMENSIONS FREIGHT CLASS WT/LBS. CUBIC FT. LIST PRICE

D x W x H

FCC40L7824H	24 x 78 x 28	100	198	20	\$8393
FCC40L7224H	24 x 72 x 28	100	189	20	\$8477
FCC40L7820H	20 x 78 x 28	92.5	188	17	\$7974
FCC40L7220H	20 x 72 x 28	92.5	179	17	\$7748

Standard with **flush 40" lateral box/file** pedestal on **left**.

FCC40L7824HOS	24 x 88 x 28	100	198	20	\$8717
FCC40L7224HOS	24 x 82 x 28	100	189	20	\$8477
FCC40L7820HOS	20 x 88 x 28	92.5	188	17	\$8297
FCC40L7220HOS	20 x 82 x 28	92.5	179	17	\$8074

Standard with **offset 40" lateral box/file** pedestal on **left**.

FCC40R7824H	24 x 78 x 28	100	198	20	\$8393
FCC40R7224H	24 x 72 x 28	100	189	20	\$8477
FCC40R7820H	20 x 78 x 28	92.5	188	17	\$7974
FCC40R7220H	20 x 72 x 28	92.5	179	17	\$7748

Standard with **flush 40" lateral box/file** pedestal on **right**.

FCC40R7824HOS	24 x 88 x 28	100	198	20	\$8717
FCC40R7224HOS	24 x 82 x 28	100	189	20	\$8477
FCC40R7820HOS	20 x 88 x 28	92.5	188	17	\$8297
FCC40R7220HOS	20 x 82 x 28	92.5	179	17	\$8074

Standard with **offset 40" lateral box/file** pedestal on **right**.

Required Specifications

Top finish
Body finish

Optional Specifications

Grommet

FULL STORAGE CREDENZAS - NOTES

D x W x H

- Horizontal grain direction is standard on all engineered finishes.
- Tops are 3/4" thick with flat edge.
- All pedestals are suspended 7.5" off the floor by an open framed leg, and can be installed flush or offset
- Handles are standard on all drawer fronts
- Doors will open with touch latch.
- Units placed on the Left have the handle offset from the center to the left, and the lock is placed on the left side panel.
- Units placed on the right have the handle offset from the center to the right, and the lock is placed on the right side panel
- Modesty panels are available in wood or glass
- **NOTE:** Arrow indicates direction of grain

FULL STORAGE CREDENZAS

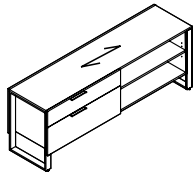

Storage Credenza

MODEL#	DIMENSIONS	FREIGHT CLASS	WT/LBS.	CUBIC FT.	LIST PRICE
FCC7424HO	24 x 74.5 x 26.75	125	203	29	\$7332
FCC6424HO	24 x 64.5 x 26.75	125	186	25	\$6463
FCC7420HO	20 x 74.5 x 26.75	125	187	24	\$6985
FCC6420HO	20 x 64.5 x 26.75	100	171	21	\$6145

Standard with **lateral box/file** on **left** and **open storage** on **right**. Handle and lock on left.

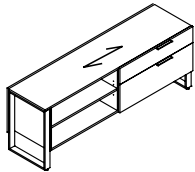

Storage Credenza

FCC7424OH	24 x 74.5 x 26.75	125	203	29	\$7332
FCC6424OH	24 x 64.5 x 26.75	125	186	25	\$6463
FCC7420OH	20 x 74.5 x 26.75	125	187	24	\$6985
FCC6420OH	20 x 64.5 x 26.75	100	171	21	\$6145

Standard with **open storage** on **left** and **lateral box/file** on **right**. Handle and lock on right.

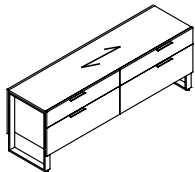

Storage Credenza

FCC7424HH	24 x 74.5 x 26.75	100	265	29	\$8321
FCC6424HH	24 x 64.5 x 26.75	100	238	25	\$7291
FCC7420HH	20 x 74.5 x 26.75	92.5	251	24	\$7924
FCC6420HH	20 x 64.5 x 26.75	92.5	226	21	\$6947

Standard with **lateral box/file** on **left** and **right**. Handles and locks on left and right.

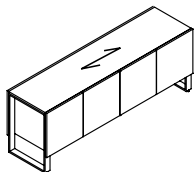

Storage Credenza

FCC7424GG	24 x 74.5 x 26.75	150	171	29	\$7282
FCC6424MM	24 x 64.5 x 26.75	125	152	25	\$6599
FCC7420GG	20 x 74.5 x 26.75	125	153	24	\$6691
FCC6420MM	20 x 64.5 x 26.75	125	136	21	\$6068

Standard with **four doors and adjustable shelves** on **left** and **right**.

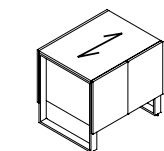

Storage Credenza

FCC3624G	24 x 36 x 26.75	150	171	29	\$4553
FCC3024M	24 x 30 x 26.75	125	152	25	\$3795
FCC3620G	20 x 36 x 26.75	125	153	24	\$4069
FCC3020M	20 x 30 x 26.75	125	136	21	\$3391

Standard with **two doors and adjustable shelves**.

Required Specifications

Top finish
Body finish

Optional Specifications

Grommet

MODULAR STORAGE - NOTES

D x W x H

- Horizontal grain direction is standard on all engineered finishes.
- All pedestals are suspended 7.5" off the floor by an open framed leg, and can be installed flush or offset
- Pedestals are handed:
 - Left pedestals have the handle offset from the center to the right, and the lock is placed on the right gable
 - Right pedestals have the handle offset from the center to the left, and the lock is placed on the left gable
- All modular pedestals have pre-drilled holes on the top for easy connection to worksurface.
- **NOTE:** Arrow indicates direction of grain

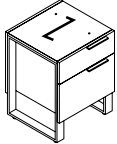
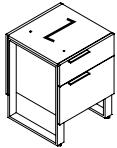
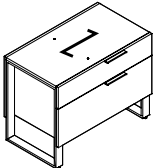
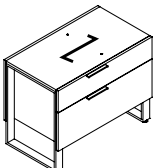
MODULAR STORAGE	MODEL#	DIMENSIONS	FREIGHT CLASS	WT./LBS.	CUBIC FT.	LIST PRICE
 <p>Box/File Pedestal - LEFT</p>	F2036BL	36 x 20.5 x 26.75	100	99	11	\$4384
	F2030BL	30 x 20.5 x 26.75	100	90	10	\$4177
	F2024BL	24 x 20.5 x 26.75	92.5	83	8	\$3936
	F2020BL	20 x 20.5 x 26.75	92.5	78	7	\$3744
For use under a freestanding desk or credenza. Top pre-drilled to attach to worksurface. One box/file drawer.						
 <p>Box/File Pedestal - RIGHT</p>	F2036BR	36 x 20.5 x 26.75	100	99	11	\$4384
	F2030BR	30 x 20.5 x 26.75	100	90	10	\$4177
	F2024BR	24 x 20.5 x 26.75	92.5	83	8	\$3936
	F2020BR	20 x 20.5 x 26.75	92.5	78	7	\$3744
For use under a freestanding desk or credenza. Top pre-drilled to attach to worksurface. One box/file drawer.						
 <p>Lateral Box/File Pedestal - LEFT</p>	F4024HL	24 x 40 x 26.75	125	121	16	\$5154
	F3524HL	24 x 35 x 26.75	125	111	14	\$4869
	F4020HL	20 x 40 x 26.75	100	113	13	\$5000
	F3520HL	20 x 35 x 26.75	100	104	11	\$4636
For use under a freestanding desk or credenza. Top pre-drilled to attach to worksurface. One lateral box/file drawer.						
 <p>Lateral Box/File Pedestal - RIGHT</p>	F4024HR	24 x 40 x 26.75	125	121	16	\$5154
	F3524HR	24 x 35 x 26.75	125	111	14	\$4869
	F4020HR	20 x 40 x 26.75	100	113	13	\$5000
	F3520HR	20 x 35 x 26.75	100	104	11	\$4636
For use under a freestanding desk or credenza. Top pre-drilled to attach to worksurface. One lateral box/file drawer.						

Required Specifications

Front finish
Top/body finish

Optional Specifications

Grommet

F FOUNDATIONS

MODULAR STORAGE

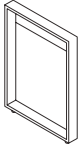

Frame Leg

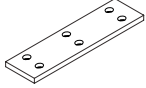

Top Connecting Bracket

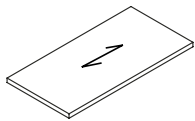

Modular Top*

MODEL#	DIMENSIONS D x W x H	FREIGHT CLASS	WT/LBS.	CUBIC FT.	LIST PRICE
FLEG36	2.5 x 36 x 27.5	250	6	3	\$1183
FLEG30	2.5 x 30 x 27.5	250	6	3	\$1084
FLEG24	2.5 x 24 x 27.5	250	5	2	\$1004
FLEG20	2.5 x 20 x 27.5	250	5	2	\$919

FCON36	31 x 10 x .75	150	4	1	\$249
FCON30	25 x 10 x .75	150	4	1	\$230
FCON24	19 x 10 x .75	250	3	1	\$225
FCON20	15 x 10 x .75	250	3	1	\$208

F8436T	36 x 84 x 1.5	60	95	3	\$3251
F7836T	36 x 78 x 1.5	65	88	3	\$3025
F7236T	36 x 72 x 1.5	65	82	3	\$2791
F8430T	30 x 84 x 1.5	65	80	3	\$2720
F7830T	30 x 78 x 1.5	65	73	3	\$2536
F7230T	30 x 72 x 1.5	60	67	2	\$2321
F6630T	30 x 66 x 1.5	60	62	2	\$2149
F6030T	30 x 60 x 1.5	65	56	2	\$1960
F5430T	30 x 54 x 1.5	65	51	2	\$1771
F8424T	24 x 84 x 1.5	60	67	2	\$2417
F7824T	24 x 78 x 1.5	60	62	2	\$2244
F7424T	24 x 74 x 1.5	65	58	2	\$2129
F7224T	24 x 72 x 1.5	65	53	2	\$2005
F6624T	24 x 66 x 1.5	65	51	2	\$1929
F6424T	24 x 64 x 1.5	65	49	2	\$1807
F6024T	24 x 60 x 1.5	65	47	2	\$1689
F5424T	24 x 54 x 1.5	70	42	2	\$1566
F4824T	24 x 48 x 1.5	60	38	1	\$1447
F4224T	24 x 42 x 1.5	60	34	1	\$1269
F8420T	20 x 84 x 1.5	60	64	2	\$2226
F7820T	20 x 78 x 1.5	60	60	2	\$2064
F7420T	20 x 74 x 1.5	65	51	2	\$1960
F7220T	20 x 72 x 1.5	65	51	2	\$1841
F6620T	20 x 66 x 1.5	65	49	2	\$1782
F6420T	20 x 64 x 1.5	65	47	2	\$1680
F6020T	20 x 60 x 1.5	65	45	2	\$1561
F5420T	20 x 54 x 1.5	60	40	1	\$1444
F4820T	20 x 48 x 1.5	60	36	1	\$1328
F4220T	20 x 42 x 1.5	60	31	1	\$1163

3/4" top with flat edge. 3/4" subtop inset 2.5" all around. For crossgrain veneer pattern, add **(CG)** to the end of the product code. When connecting two tops together, a connecting bracket must be specified. Use the width of the smallest top to determine the correct bracket size (i.e. for a 20"D top, order FCON20). Optional grommet may be specified.



Required Specifications
Top finish*

Optional Specifications
Grommet*

FREESTANDING STORAGE - NOTES

D x W x H

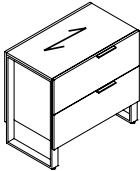
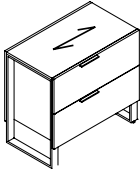
- Horizontal grain direction is standard on all engineered finishes.
- All pedestals are suspended 7.5" off the floor by an open framed leg, and can be installed flush or offset
- Pedestals are handed:
 - Left pedestals have the handle offset from the center to the right, and the lock is placed on the right gable
 - Right pedestals have the handle offset from the center to the left, and the lock is placed on the left gable
- Bench drawers do not come with a handle. They open by pulling the bottom edge of the drawer.
- Cushions will be field installed. On double width benches, the cushion can either be installed left or right.
- On mobile pedestals, the lock will be placed on the right gable.
- **NOTE:** Arrow indicates direction of grain

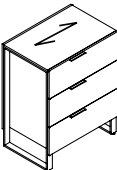
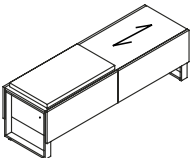
FREESTANDING STORAGE	MODEL#	DIMENSIONS	FREIGHT CLASS	WT./LBS.	CUBIC FT.	LIST PRICE
 <p>2H Lateral File Pedestal - LEFT</p>	FN3524L	24 x 35 x 32	100	152	17	\$5348
	FN3520L	20 x 35 x 32	100	144	15	\$5089
 <p>2H Lateral File Pedestal - RIGHT</p>	FN3524R	24 x 35 x 32	100	152	17	\$5348
	FN3520R	20 x 35 x 32	100	144	15	\$5089
 <p>3H Lateral File Pedestal - LEFT</p>	FN35243L	24 x 35 x 44.5	92.5	220	22	\$6808
	FN35203L	20 x 35 x 44.5	92.5	212	19	\$6506
 <p>3H Lateral File Pedestal - RIGHT</p>	FN35243R	24 x 35 x 44.5	92.5	220	22	\$6808
	FN35203R	20 x 35 x 44.5	92.5	212	19	\$6506
 <p>Bench, Two File Drawers w/Cushion*</p>	FBENKK6420	20 x 64.5 x 21	100	167	17	\$5836
<p>With two file drawers and cushion. Standard in grade 2 seating fabric. Locks on left and right.</p>						

Required Specifications

- Front finish
- Top/body finish
- Fabric*

F FOUNDATIONS

FREESTANDING STORAGE

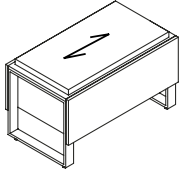

Bench, One File Drawer w/Cushion

MODEL#	DIMENSIONS	FREIGHT CLASS	WT/LBS.	CUBIC FT.	LIST PRICE
--------	------------	---------------	---------	-----------	------------

D x W x H

FBENK3520	20 x 35 x 21	92.5	99	9	\$4239
-----------	--------------	------	----	---	---------------

With **one file drawer** and **cushion**. Standard in grade 2 seating fabric. Lock on right.

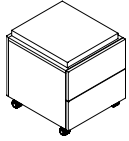

Mobile Box/Box Pedestal w/Cushion

F20BMCU	20 x 20.5 x 20.5	70	87	5	\$2878
---------	------------------	----	----	---	---------------

With **two box drawers** and **cushion**. Standard in grade 2 seating fabric. Lock on right. Casters are locking.

Required Specifications

Front finish
Top/body finish
Fabric

RETURNS - NOTES

D x W x H

- Horizontal grain direction is standard on all engineered finishes.
- Tops are constructed with two 3/4" thick panels, laminated together to create a total thickness of 1.5".
- Returns can be connected to wall credenzas and single pedestal desks
- All pedestals are suspended 7.5" off the floor by an open framed leg, and can be installed flush or offset
- Pedestals are handed:
 - Left pedestals have the handle offset from the center to the right, and the lock is placed on the left gable.
 - Right pedestals have the handle offset from the center to the left, and the lock is placed on the right gable.
- The standard grain direction on return tops is cross grain (**CG**). To remove cross grain veneer pattern on top, delete suffix "**CG**" from the model number (no upcharge)
- One Connecting Bracket is included.
- **NOTE:** Arrow indicates direction of grain

RETURNS	MODEL#	DIMENSIONS	FREIGHT CLASS	WT./LBS.	CUBIC FT.	LIST PRICE
---------	--------	------------	---------------	----------	-----------	------------

D x W x H

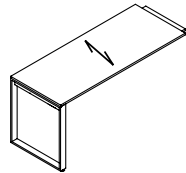

Executive Return - LEFT

FERL6624CG	24 x 66 x 28	85	59	4	\$3603
FERL6024CG	24 x 60 x 28	85	55	4	\$3361
FERL5424CG	24 x 54 x 28	85	50	4	\$3177
FERL4824CG	24 x 48 x 28	70	46	3	\$3047
FERL4224CG	24 x 42 x 28	85	42	3	\$2511
FERL6620CG	20 x 66 x 28	85	57	4	\$3276
FERL6020CG	20 x 60 x 28	85	53	4	\$3056
FERL5420CG	20 x 54 x 28	70	48	3	\$2887
FERL4820CG	20 x 48 x 28	85	44	3	\$2770
FERL4220CG	20 x 42 x 28	85	39	3	\$2281

Return has **no pedestal**. For use with right handed single pedestal desks, credenzas, or desk shells.

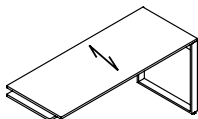

Executive Return - RIGHT

FERR6624CG	24 x 66 x 28	85	59	4	\$3603
FERR6024CG	24 x 60 x 28	85	55	4	\$3361
FERR5424CG	24 x 54 x 28	85	50	4	\$3177
FERR4824CG	24 x 48 x 28	70	46	3	\$3047
FERR4224CG	24 x 42 x 28	85	42	3	\$2511
FERR6620CG	20 x 66 x 28	85	57	4	\$3276
FERR6020CG	20 x 60 x 28	85	53	4	\$3056
FERR5420CG	20 x 54 x 28	70	48	3	\$2887
FERR4820CG	20 x 48 x 28	85	44	3	\$2770
FERR4220CG	20 x 42 x 28	85	39	3	\$2281

Return has **no pedestal**. For use with left handed single pedestal desks, credenzas, or desk shells.

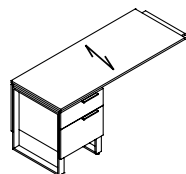

Executive Return - LEFT

FERL6624BCG	24 x 66 x 28	85	137	10	\$6014
FERL6024BCG	24 x 60 x 28	85	133	10	\$5781
FERL5424BCG	24 x 54 x 28	85	128	10	\$5656
FERL4824BCG	24 x 48 x 28	85	124	9	\$5537
FERL4224BCG	24 x 42 x 28	85	120	9	\$5362
FERL6620BCG	20 x 66 x 28	85	130	9	\$5729
FERL6020BCG	20 x 60 x 28	85	126	9	\$5508
FERL5420BCG	20 x 54 x 28	70	121	8	\$5388
FERL4820BCG	20 x 48 x 28	85	117	8	\$5275
FERL4220BCG	20 x 42 x 28	85	112	8	\$5108

Return has **flush box/file pedestal** on the **left**. For use with right handed single pedestal desks, credenzas, or desk shells.

Required Specifications

Top finish
Body finish

Optional Specifications

Grommet

EXECUTIVE RETURNS

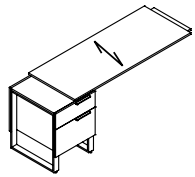

Executive Return - LEFT

MODEL#	DIMENSIONS D x W x H	FREIGHT CLASS	WT/LBS.	CUBIC FT.	LIST PRICE
FERL6624BOSCG	24 x 76 x 28	85	137	10	\$6661
FERL6024BOSCG	24 x 70 x 28	85	133	10	\$5781
FERL5424BOSCG	24 x 64 x 28	85	128	10	\$5656
FERL4824BOSCG	24 x 58 x 28	85	124	9	\$5537
FERL4224BOSCG	24 x 52 x 28	85	120	9	\$5362
FERL6620BOSCG	20 x 76 x 28	85	130	9	\$6053
FERL6020BOSCG	20 x 70 x 28	85	126	9	\$5508
FERL5420BOSCG	20 x 64 x 28	70	121	8	\$5388
FERL4820BOSCG	20 x 58 x 28	85	117	8	\$5275
FERL4220BOSCG	20 x 52 x 28	85	112	8	\$5108

Return has **offset box/file pedestal** on the **left**. For use with right handed single pedestal desks, credenzas, or desk shells.

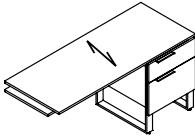

Executive Return - RIGHT

FERR6624BCG	24 x 66 x 28	85	137	10	\$6014
FERR6024BCG	24 x 60 x 28	85	133	10	\$5781
FERR5424BCG	24 x 54 x 28	85	128	10	\$5656
FERR4824BCG	24 x 48 x 28	85	124	9	\$5537
FERR4224BCG	24 x 42 x 28	85	120	9	\$5362
FERR6620BCG	20 x 66 x 28	85	130	9	\$5729
FERR6020BCG	20 x 60 x 28	85	126	9	\$5508
FERR5420BCG	20 x 54 x 28	70	121	8	\$5388
FERR4820BCG	20 x 48 x 28	85	117	8	\$5275
FERR4220BCG	20 x 42 x 28	85	112	8	\$5108

Return has **flush box/file pedestal** on the **right**. For use with left-handed single pedestal desks, credenzas, or desk shells.

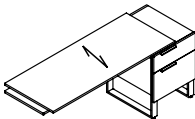

Executive Return - RIGHT

FERR6624BOSCG	24 x 76 x 28	85	137	10	\$6661
FERR6024BOSCG	24 x 70 x 28	85	133	10	\$5781
FERR5424BOSCG	24 x 64 x 28	85	128	10	\$5656
FERR4824BOSCG	24 x 58 x 28	85	124	9	\$5537
FERR4224BOSCG	24 x 52 x 28	85	120	9	\$5362
FERR6620BOSCG	20 x 76 x 28	85	130	9	\$6053
FERR6020BOSCG	20 x 70 x 28	85	126	9	\$5508
FERR5420BOSCG	20 x 64 x 28	70	121	8	\$5388
FERR4820BOSCG	20 x 58 x 28	85	117	8	\$5275
FERR4220BOSCG	20 x 52 x 28	85	112	8	\$5108

Return has **offset box/file pedestal** on the **right**. For use with left-handed single pedestal desks, credenzas, or desk shells.

Required Specifications

Top finish
Body finish

Optional Specifications

Grommet

DESKS	MODEL#	DIMENSIONS	FREIGHT CLASS	WT/LBS.	CUBIC FT.	LIST PRICE
-------	--------	------------	---------------	---------	-----------	------------

D x W x H

- Horizontal grain direction is standard on all engineered finishes.
- Tops are constructed with two 3/4" thick panels, laminated together to create a total thickness of 1.5".
- All pedestals are suspended 7.5" off the floor by an open framed leg, and can be installed flush or offset
- The standard grain direction on Bridge tops is cross grain (**CG**). To remove cross grain veneer pattern on top, delete suffix "**CG**" from the model number (no upcharge)
- Two Connecting Brackets are included.
- GM5K (Tungsten) TC grommet location is standard
- **NOTE:** Arrow indicates direction of grain

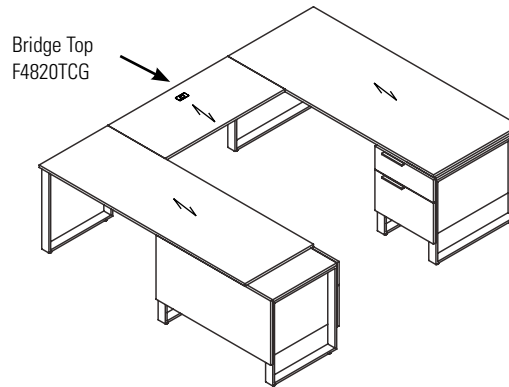

BRIDGES	MODEL#	DIMENSIONS	FREIGHT CLASS	WT/LBS.	CUBIC FT.	LIST PRICE
---------	--------	------------	---------------	---------	-----------	------------

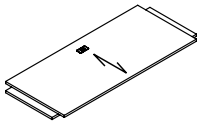

Bridge Top

FBT6624CG	24 x 66 x 1.5	65	57	2	\$2879
FBT6024CG	24 x 60 x 1.5	65	53	2	\$2638
FBT5424CG	24 x 54 x 1.5	65	48	2	\$2502
FBT4824CG	24 x 48 x 1.5	60	44	1	\$2030
FBT4224CG	24 x 42 x 1.5	60	40	1	\$1840
FBT6620CG	20 x 66 x 1.5	65	55	2	\$2617
FBT6020CG	20 x 60 x 1.5	65	51	2	\$2396
FBT5420CG	20 x 54 x 1.5	60	46	1	\$2279
FBT4820CG	20 x 48 x 1.5	60	42	1	\$1840
FBT4220CG	20 x 42 x 1.5	60	37	1	\$1671

Top surface only to create a "U" configuration with a single pedestal desk or credenza. **Cannot be used with corners.** Grommet in worksurface. Shipped RTA (ready to assemble).

Required Specifications
Top finish

Optional Specifications
Grommet

F FOUNDATIONS

WALL-MOUNTED STORAGE - NOTES

D x W x H

- Horizontal grain direction is standard on all engineered finishes.
- Wall Mount Overheads have a 2" deep valance on top and bottom and it can accommodate LED or T5 lighting in either location
- Tackboards are installed flush.
- Standard Heights for Tackboards are:
 - 19.2" (overall height above worksurface = 36.5")
 - 26" (overall height above worksurface = 42.5")
- **NOTE:** Arrow indicates direction of grain

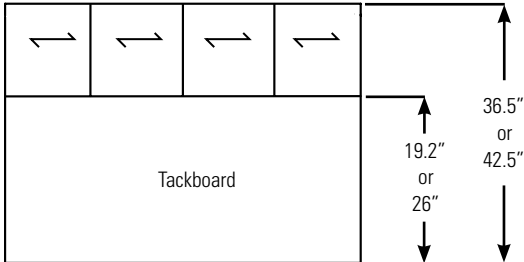

WALL-MOUNTED STORAGE

MODEL# DIMENSIONS FREIGHT CLASS WT/LBS. CUBIC FT. LIST PRICE

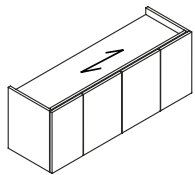

Wall Mount Storage w/Doors

FSF74	15 x 74.5 x 18.5	125	103	13	\$3904
FSF72	15 x 72 x 18.5	100	101	12	\$3746
FSF66	15 x 66 x 18.5	100	94	11	\$3523
FSF64	15 x 64.5 x 18.5	100	92	11	\$3449
FSF60	15 x 60 x 18.5	100	87	10	\$3304
FSF54	15 x 54 x 18.5	100	80	9	\$3148
FSF48	15 x 48 x 18.5	100	74	8	\$2862

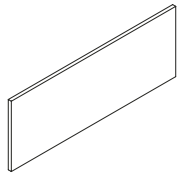

Wall Mount Tackboard*

FTS74H26	.75 x 74.5 x 26	100	17	2	\$1183
FTS72H26	.75 x 72 x 26	70	16	1	\$1092
FTS66H26	.75 x 66 x 26	85	14	1	\$1004
FTS64H26	.75 x 64.5 x 26	85	13	1	\$972
FTS60H26	.75 x 60 x 26	85	13	1	\$909
FTS54H26	.75 x 54 x 26	85	13	1	\$820
FTS48H26	.75 x 48 x 26	85	13	1	\$729
FTS74	.75 x 74.5 x 19.2	85	13	1	\$908
FTS72	.75 x 72 x 19.2	85	12	1	\$839
FTS66	.75 x 66 x 19.2	92.5	11	1	\$765
FTS64	.75 x 64.5 x 19.2	92.5	11	1	\$726
FTS60	.75 x 60 x 19.2	92.5	10	1	\$699
FTS54	.75 x 54 x 19.2	92.5	10	1	\$633
FTS48	.75 x 48 x 19.2	92.5	10	1	\$564

Required Specifications

Front finish
Top/body finish
Fabric*

WORK WALLS - NOTES

D x W x H

- Horizontal grain direction is standard on all engineered finishes.
- Tackboards and tasklights must be specified
- When the tackboard option is specified, the price includes a tackboard for each niche of the Work Wall.
- When the Task Light option is specified, the price includes LED Tasklight installed in the top of each niche. If more than one niche is needed in the configuration, remote on/off switch is included for simultaneous operation.
- All Storage Doors open with touch latch
- Side access to open storage or wardrobe - front panels are fixed.
- Standard heights are 26.5", 56", 70" and 84"
- Walls are available in 15" increments starting at 95" (i.e. 110", 125" 140", 155")
- Wall credenzas are only available in 90" width
- Cantilevered storage units are side locking
- For modifications to the wall configurations, size or finish, please contact customer care.

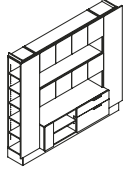
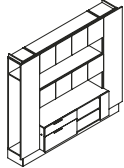
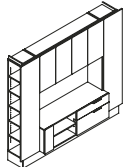
WORK WALLS - 84" H	MODEL#	DIMENSIONS	FREIGHT CLASS	WT/LBS.	CUBIC FT.	LIST PRICE
 <p>Work Wall - 95"W</p>	FW9584-1L	20 x 95 x 84	100	634	79	\$25919
		Vertical storage with 5 adjustable shelves, 60" wide wall credenza with adjustable shelf and box/file, 60" wide niche, 60" wide single height storage, 60" wide niche, 60" wide single height storage, wardrobe with coat hook and hat shelf.				<ul style="list-style-type: none"> • To add tackboard to niche, add TB to end of product code. Add \$1930 to list price for grades 1-3. Add \$2316 for grades 4-5. • To add LED light to niche, add LT to end of product code. Add \$2027 to list price.
 <p>Work Wall - 95"W</p>	FW9584-1R	20 x 95 x 84	100	634	79	\$25919
		Wardrobe with coat hook and hat shelf, 60" wide wall credenza with box/file and adjustable shelf, 60" wide niche, 60" wide single height storage, 60" wide niche, 60" wide single height storage, vertical storage with 5 adjustable shelves..				<ul style="list-style-type: none"> • To add tackboard to niche, add TB to end of product code. Add \$1930 to list price for grades 1-3. Add \$2316 for grades 4-5. • To add LED light to niche, add LT to end of product code. Add \$2027 to list price.
 <p>Work Wall - 95"W</p>	FW9584-2L	20 x 95 x 84	125	568	77	\$22787
		Vertical storage with 5 adjustable shelves, 60" wide wall credenza with adjustable shelf and box/file, 60" wide double height niche, 60" wide double height storage, wardrobe with coat hook and hat shelf.				<ul style="list-style-type: none"> • To add tackboard to niche, add TB to end of product code. Add \$1198 to list price for grades 1-3. Add \$1438 for grades 4-5. • To add LED light to niche, add LT to end of product code. Add \$819 to list price.

Required Specifications

Front finish
Top/body finish
Cubby interior finish

Optional Specifications

Grommet
LED light
Tackboard

WORK WALLS - 84"H

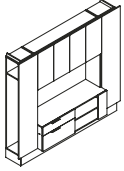

Work Wall - 95\"/>

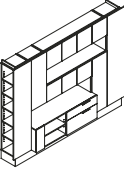

Work Wall - 110\"/>

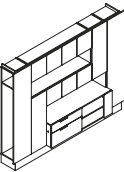

Work Wall - 110\"/>

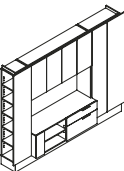

Work Wall - 110\"/>

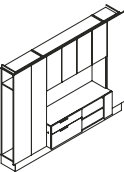

Work Wall - 110\"/>

MODEL#	DIMENSIONS	FREIGHT CLASS	WT/LBS.	CUBIC FT.	LIST PRICE
--------	------------	---------------	---------	-----------	------------

	D x W x H				
FW9584-2R	20 x 95 x 84	125	568	77	\$22787

Wardrobe with coat hook and hat shelf, 60" wide wall credenza with box/file and adjustable shelf, 60" wide double height niche, 60" wide double height storage, vertical storage with 5 adjustable shelves.

- To add tackboard to niche, add **TB** to end of product code. **Add \$1198** to list price for grades 1-3. Add **\$1438** for grades 4-5.
- To add LED light to niche, add **LT** to end of product code. **Add \$819** to list price.

FW11084-1L	20 x 110 x 84	100	741	91	\$29510
------------	---------------	-----	-----	----	----------------

Vertical storage with 5 adjustable shelves, 60" wide wall credenza with adjustable shelf and box/file, 60" wide niche, triple height storage, 45" wide single height storage, 60" wide niche, 60" wide single height storage, triple height storage, wardrobe with coat hook and hat shelf.

- To add tackboard to niche, add **TB** to end of product code. **Add \$1924** to list price for grades 1-3. Add **\$2309** for grades 4-5.
- To add LED light to niche, add **LT** to end of product code. **Add \$2030** to list price.

FW11084-1R	20 x 110 x 84	100	741	91	\$29510
------------	---------------	-----	-----	----	----------------

Wardrobe with coat hook and hat shelf, triple height storage, 60" wide niche, 60" wide single height storage, 60" wide wall credenza with box/file and adjustable shelf, 60" wide niche, 45" wide single height storage, triple height storage, vertical storage with 5 adjustable shelves.

- To add tackboard to niche, add **TB** to end of product code. **Add \$1924** to list price for grades 1-3. Add **\$2309** for grades 4-5.
- To add LED light to niche, add **LT** to end of product code. **Add \$2030** to list price.

FW11084-2L	20 x 110 x 84	125	628	88	\$25185
------------	---------------	-----	-----	----	----------------

Vertical storage with 5 adjustable shelves, 60" wide wall credenza with adjustable shelf and box/file, 60" wide double height niche, 60" wide double height storage, double depth wardrobe with coat rod and hat shelf.

- To add tackboard to niche, add **TB** to end of product code. **Add \$1196** to list price for grades 1-3. Add **\$1435** for grades 4-5.
- To add LED light to niche, add **LT** to end of product code. **Add \$819** to list price.

FW11084-2R	20 x 110 x 84	125	628	88	\$25185
------------	---------------	-----	-----	----	----------------

Double depth wardrobe with coat rod and hat shelf, 60" wide wall credenza with adjustable shelf and box/file, 60" wide double height niche, 60" wide double height storage, vertical storage with 5 adjustable shelves.

- To add tackboard to niche, add **TB** to end of product code. **Add \$1196** to list price for grades 1-3. Add **\$1435** for grades 4-5.
- To add LED light to niche, add **LT** to end of product code. **Add \$819** to list price.

Required Specifications

Front finish
Top/body finish
Cubby interior finish

Optional Specifications

Grommet
LED light
Tackboard

WORK WALLS - 84"H

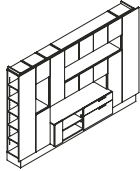

Work Wall - 125"W

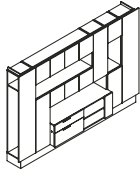

Work Wall - 125"W

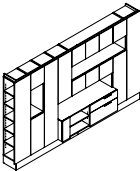

Work Wall - 140"W

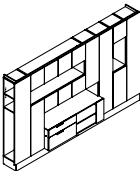

Work Wall - 140"W

MODEL#	DIMENSIONS	FREIGHT CLASS	WT/LBS.	CUBIC FT.	LIST PRICE
--------	------------	---------------	---------	-----------	------------

D x W x H

FW12584-1L	20 x 125 x 84	100	858	103	\$33132
------------	---------------	-----	-----	-----	----------------

Vertical storage with 5 adjustable shelves, 15" wide double height niche, single height storage, 60" wide wall credenza with adjustable shelf and box/file, 60" wide niche, triple height storage, 45" wide single height storage, 60" wide niche, 60" wide single height storage, triple height storage, wardrobe with coat hook and hat shelf.

- To add tackboard to niche, add **TB** to end of product code. **Add \$2350** to list price for grades 1-3. Add **\$2821** for grades 4-5.
- To add LED light to niche, add **LT** to end of product code. **Add \$2358** to list price.

FW12584-1R	20 x 125 x 84	100	858	103	\$33132
------------	---------------	-----	-----	-----	----------------

Wardrobe with coat hook and hat shelf, triple height storage, 60" wide niche, 60" wide single height storage, 60" wide wall credenza with box/file and adjustable shelf, 60" wide niche, 45" wide single height storage, triple height storage, 15" wide double height niche, single height storage, vertical storage with 5 adjustable shelves.

- To add tackboard to niche, add **TB** to end of product code. **Add \$2350** to list price for grades 1-3. Add **\$2821** for grades 4-5.
- To add LED light to niche, add **LT** to end of product code. **Add \$2358** to list price.

FW14084-1L	20 x 140 x 84	100	936	115	\$35732
------------	---------------	-----	-----	-----	----------------

Vertical storage with 5 adjustable shelves, triple height storage, 15" wide double height niche, single height storage, vertical storage with 5 adjustable shelves, 60" wide wall credenza with adjustable shelf and box/file, 60" wide niche, triple height storage cabinet, 45" wide single height storage, 60" wide niche, 60" wide single height storage, double depth wardrobe with coat rod and two shelves.

- To add tackboard to niche, add **TB** to end of product code. **Add \$2350** to list price for grades 1-3. Add **\$2821** for grades 4-5.
- To add LED light to niche, add **LT** to end of product code. **Add \$2357** to list price.

FW14084-1R	20 x 125 x 84	100	936	115	\$35732
------------	---------------	-----	-----	-----	----------------

Double depth wardrobe with coat rod and two shelves, 60" wide niche, 60" wide single height storage, 60" wide wall credenza with box/file and adjustable shelf, 60" wide niche, 45" wide single height storage, triple height storage, vertical storage with 5 adjustable shelves, triple height storage, 15" wide double height niche, single height storage, vertical storage with 5 adjustable shelves.

- To add tackboard to niche, add **TB** to end of product code. **Add \$2350** to list price for grades 1-3. Add **\$2821** for grades 4-5.
- To add LED light to niche, add **LT** to end of product code. **Add \$2357** to list price.

Required Specifications

Front finish
Top/body finish
Cubby interior finish

Optional Specifications

Grommet
LED light
Tackboard

WORK WALLS - 70"H

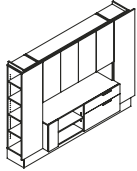

Work Wall - 95"W

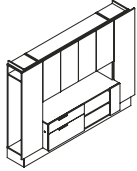

Work Wall - 95"W

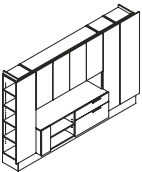

Work Wall - 110"W

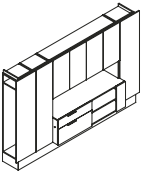

Work Wall - 110"W

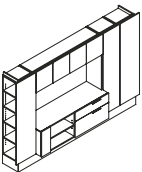

Work Wall - 110"W

MODEL#	DIMENSIONS	FREIGHT CLASS	WT./LBS.	CUBIC FT.	LIST PRICE
--------	------------	---------------	----------	-----------	------------

D x W x H

FW9570-1L	20 x 95 x 70	125	523	66	\$21754
-----------	--------------	-----	-----	----	----------------

Vertical storage with 4 adjustable shelves, 60" wide wall credenza with adjustable shelf and box/file, 60" wide niche, 60" wide double height storage, wardrobe with coat hook and hat shelf.

- To add tackboard to niche, add **TB** to end of product code. **Add \$966** to list price for grades 1-3. Add **\$1160** for grades 4-5.
- To add LED light to niche, add **LT** to end of product code. **Add \$817** to list price.

FW9570-1R	20 x 95 x 70	125	523	66	\$21754
-----------	--------------	-----	-----	----	----------------

Wardrobe with coat hook and hat shelf, 60" wide wall credenza with box/file and adjustable shelf, 60" wide niche, 60" wide double height storage, vertical storage with 4 adjustable shelves.

- To add tackboard to niche, add **TB** to end of product code. **Add \$966** to list price for grades 1-3. Add **\$1160** for grades 4-5.
- To add LED light to niche, add **LT** to end of product code. **Add \$817** to list price.

FW11070-1L	20 x 110 x 70	100	618	76	\$23751
------------	---------------	-----	-----	----	----------------

Vertical storage with 4 adjustable shelves, 60" wide wall credenza with adjustable shelf and box/file, 60" wide niche, 60" wide double height storage, vertical storage with 4 adjustable shelves, wardrobe with coat hook and hat shelf.

- To add tackboard to niche, add **TB** to end of product code. **Add \$963** to list price for grades 1-3. Add **\$1155** for grades 4-5.
- To add LED light to niche, add **LT** to end of product code. **Add \$817** to list price.

FW11070-1R	20 x 110 x 70	100	618	76	\$23751
------------	---------------	-----	-----	----	----------------

Wardrobe with coat hook and hat shelf, vertical storage with 4 adjustable shelves, 60" wide wall credenza with box/file and adjustable shelf, 60" wide niche, 60" wide double height storage, vertical storage with 4 adjustable shelves.

- To add tackboard to niche, add **TB** to end of product code. **Add \$963** to list price for grades 1-3. Add **\$1155** for grades 4-5.
- To add LED light to niche, add **LT** to end of product code. **Add \$817** to list price.

FW11070-2L	20 x 110 x 70	125	586	76	\$22383
------------	---------------	-----	-----	----	----------------

Vertical storage with 4 adjustable shelves, 60" wide wall credenza with adjustable shelf and box/file, 60" wide double height niche, 60" wide single height storage, vertical storage with 4 adjustable shelves, wardrobe with coat hook and hat shelf.

- To add tackboard to niche, add **TB** to end of product code. **Add \$1193** to list price for grades 1-3. Add **\$1432** for grades 4-5.
- To add LED light to niche, add **LT** to end of product code. **Add \$819** to list price.

Required Specifications

Front finish
Top/body finish
Cubby interior finish

Optional Specifications

Grommet
LED light
Tackboard

WORK WALLS - 70"H

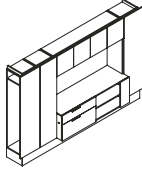

Work Wall - 110"W

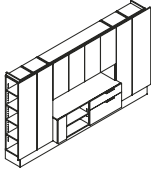

Work Wall - 125"W

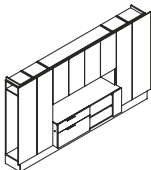

Work Wall - 125"W

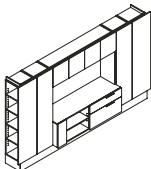

Work Wall - 125"W

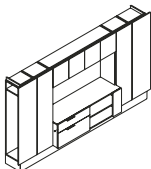

Work Wall - 125"W

MODEL#	DIMENSIONS	FREIGHT CLASS	WT/LBS.	CUBIC FT.	LIST PRICE
--------	------------	---------------	---------	-----------	------------

D x W x H

FW11070-2R	20 x 110 x 70	125	586	76	\$22383
------------	---------------	-----	-----	----	----------------

Wardrobe with coat hook and hat shelf, vertical storage with 4 adjustable shelves, 60" wide wall credenza with box/file and adjustable shelf, 60" wide double height niche, 60" wide single height storage, vertical storage with 4 adjustable shelves.

- To add tackboard to niche, add **TB** to end of product code. **Add \$1193** to list price for grades 1-3. Add **\$1432** for grades 4-5.
- To add LED light to niche, add **LT** to end of product code. **Add \$819** to list price.

FW12570-1L	20 x 125 x 70	100	713	85	\$24955
------------	---------------	-----	-----	----	----------------

Vertical storage with 4 adjustable shelves, vertical storage with 4 adjustable shelves, 60" wide wall credenza with adjustable shelf and box/file, 60" wide niche, 60" wide double height storage, vertical storage with 4 adjustable shelves, wardrobe with coat hook and hat shelf.

- To add tackboard to niche, add **TB** to end of product code. **Add \$966** to list price for grades 1-3. Add **\$1160** for grades 4-5.
- To add LED light to niche, add **LT** to end of product code. **Add \$819** to list price.

FW12570-1R	20 x 125 x 70	100	713	85	\$24955
------------	---------------	-----	-----	----	----------------

Wardrobe with coat hook and hat shelf, vertical storage with 4 adjustable shelves, 60" wide wall credenza with box/file and adjustable shelf, 60" wide niche, 60" wide double height storage, vertical storage with 4 adjustable shelves, vertical storage with 4 adjustable shelves.

- To add tackboard to niche, add **TB** to end of product code. **Add \$966** to list price for grades 1-3. Add **\$1160** for grades 4-5.
- To add LED light to niche, add **LT** to end of product code. **Add \$819** to list price.

FW12570-2L	20 x 125 x 70	100	681	85	\$23583
------------	---------------	-----	-----	----	----------------

Vertical storage with 4 adjustable shelves, vertical storage with 4 adjustable shelves, 60" wide wall credenza with adjustable shelf and box/file, 60" wide double height niche, 60" wide single height storage, vertical storage with 4 adjustable shelves, wardrobe with coat hook and hat shelf.

- To add tackboard to niche, add **TB** to end of product code. **Add \$1196** to list price for grades 1-3. Add **\$1435** for grades 4-5.
- To add LED light to niche, add **LT** to end of product code. **Add \$819** to list price.

FW12570-2R	20 x 125 x 70	100	681	85	\$23583
------------	---------------	-----	-----	----	----------------

Wardrobe with coat hook and hat shelf, vertical storage with 4 adjustable shelves, 60" wide wall credenza with box/file and adjustable shelf, 60" wide double height niche, 60" wide single height storage, vertical storage with 4 adjustable shelves, vertical storage with 4 adjustable shelves.

- To add tackboard to niche, add **TB** to end of product code. **Add \$1196** to list price for grades 1-3. Add **\$1435** for grades 4-5.
- To add LED light to niche, add **LT** to end of product code. **Add \$819** to list price.

Required Specifications

Front finish
Top/body finish
Cubby interior finish

Optional Specifications

Grommet
LED light
Tackboard

WORK WALLS - 70"H

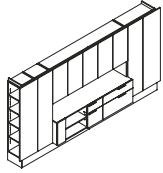

Work Wall - 140"W

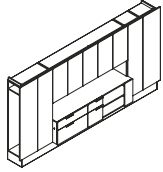

Work Wall - 140"W

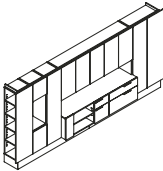

Work Wall - 155"W

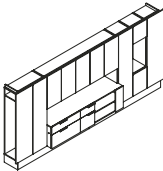

Work Wall - 155"W

MODEL#	DIMENSIONS	FREIGHT CLASS	WT/LBS.	CUBIC FT.	LIST PRICE
--------	------------	---------------	---------	-----------	------------

D x W x H

FW14070-1L	20 x 140 x 70	125	750	95	\$26997
------------	---------------	-----	-----	----	----------------

Vertical storage with 4 adjustable shelves, vertical storage with 4 adjustable shelves, 75" wide wall credenza with adjustable shelf, narrow box/file and box file, 75" wide single height niche, 75" wide double height storage, double depth wardrobe with coat rod and hat shelf.

- To add tackboard to niche, add **TB** to end of product code. **Add \$1210** to list price for grades 1-3. Add **\$1452** for grades 4-5.
- To add LED light to niche, add **LT** to end of product code. **Add \$1851** to list price.

FW14070-1R	20 x 140 x 70	125	750	95	\$26997
------------	---------------	-----	-----	----	----------------

Double depth wardrobe with coat rod and hat shelf, 75" wide wall credenza with box/file, narrow box/file and adjustable shelf, 75" wide single height niche, 75" wide double height storage, vertical storage with 4 adjustable shelves, vertical storage with 4 adjustable shelves.

- To add tackboard to niche, add **TB** to end of product code. **Add \$1210** to list price for grades 1-3. Add **\$1452** for grades 4-5.
- To add LED light to niche, add **LT** to end of product code. **Add \$1851** to list price.

FW15570-1L	20 x 155 x 70	125	849	107	\$32612
------------	---------------	-----	-----	-----	----------------

Vertical storage with 4 adjustable shelves, double height storage, 15" wide double height niche, single height storage, vertical storage with 4 adjustable shelves, 75" wide wall credenza with adjustable shelf, narrow box/file and box file, 75" wide niche, 75" wide double height storage, double depth wardrobe with coat rod and hat shelf.

- To add tackboard to niche, add **TB** to end of product code. **Add \$1630** to list price for grades 1-3. Add **\$1956** for grades 4-5.
- To add LED light to niche, add **LT** to end of product code. **Add \$2176** to list price.

FW15570-1R	20 x 155 x 70	125	849	107	\$32612
------------	---------------	-----	-----	-----	----------------

Double depth wardrobe with coat rod and hat shelf, 75" wide wall credenza with box/file, narrow box/file and adjustable shelf, 75" wide niche, 75" wide double height storage, vertical storage with 4 adjustable shelves, double height storage, 15" wide double height niche, single height storage, vertical storage with 4 adjustable shelves.

- To add tackboard to niche, add **TB** to end of product code. **Add \$1630** to list price for grades 1-3. Add **\$1956** for grades 4-5.
- To add LED light to niche, add **LT** to end of product code. **Add \$2176** to list price.

Required Specifications

Front finish
Top/body finish
Cubby interior finish

Optional Specifications

Grommet
LED light
Tackboard

WORK WALLS - 56"H

MODEL#	DIMENSIONS	FREIGHT CLASS	WT/LBS.	CUBIC FT.	LIST PRICE
--------	------------	---------------	---------	-----------	------------

D x W x H

FW9556-1	20 x 95 x 56	100	488	55	\$20156
----------	--------------	-----	-----	----	----------------

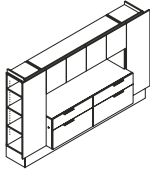

Work Wall - 95"W

Vertical storage with 3 adjustable shelves, 60" wide wall credenza with two box/files, 60" wide single height niche, 60" wide single height storage, vertical storage with 3 adjustable shelves.

- To add tackboard to niche, add **TB** to end of product code. **Add \$965** to list price for grades 1-3. Add **\$1159** for grades 4-5.
- To add LED light to niche, add **LT** to end of product code. **Add \$817** to list price.

FW9556-2	20 x 95 x 56	125	420	55	\$18157
----------	--------------	-----	-----	----	----------------

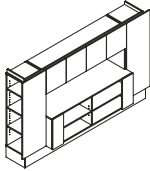

Work Wall - 95"W

Vertical storage with 3 adjustable shelves, 60" wide wall open credenza with two adjustable shelves, 60" wide single height niche, 60" wide single height storage, vertical storage with 3 adjustable shelves.

- To add tackboard to niche, add **TB** to end of product code. **Add \$965** to list price for grades 1-3. Add **\$1159** for grades 4-5.
- To add LED light to niche, add **LT** to end of product code. **Add \$819** to list price.

FW11056-1L	20 x 110 x 56	100	533	63	\$19755
------------	---------------	-----	-----	----	----------------

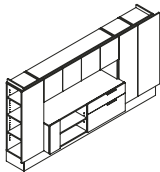

Work Wall - 110"W

Vertical storage with 3 adjustable shelves, 60" wide wall credenza with adjustable shelf and box/file, 60" wide niche, 60" wide single height storage, vertical storage with 3 adjustable shelves, wardrobe with coat hook and hat shelf.

- To add tackboard to niche, add **TB** to end of product code. **Add \$965** to list price for grades 1-3. Add **\$1159** for grades 4-5.
- To add LED light to niche, add **LT** to end of product code. **Add \$817** to list price.

FW11056-1R	20 x 110 x 56	100	533	63	\$19755
------------	---------------	-----	-----	----	----------------

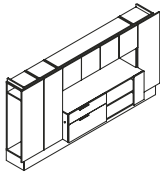

Work Wall - 110"W

Wardrobe with coat hook and hat shelf, vertical storage with 3 adjustable shelves, 60" wide wall credenza with box/file and adjustable shelf, 60" wide single height niche, 60" wide single height storage, vertical storage with 3 adjustable shelves.

- To add tackboard to niche, add **TB** to end of product code. **Add \$965** to list price for grades 1-3. Add **\$1159** for grades 4-5.
- To add LED light to niche, add **LT** to end of product code. **Add \$817** to list price.

FW11056-2L	20 x 110 x 56	100	549	62	\$21753
------------	---------------	-----	-----	----	----------------

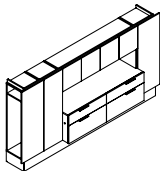

Work Wall - 110"W

Wardrobe with coat hook and hat shelf, vertical storage with 3 adjustable shelves, 60" wide wall credenza with two box/files, 60" wide niche, 60" wide single height storage, vertical storage with 3 adjustable shelves.

- To add tackboard to niche, add **TB** to end of product code. **Add \$965** to list price for grades 1-3. Add **\$1160** for grades 4-5.
- To add LED light to niche, add **LT** to end of product code. **Add \$817** to list price.

Required Specifications

Front finish
Top/body finish
Cubby interior finish

Optional Specifications

Grommet
LED light
Tackboard

WORK WALLS - 56"H

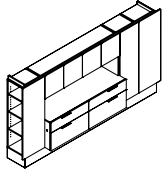

Work Wall - 110"W*

MODEL#	DIMENSIONS D x W x H	FREIGHT CLASS	WT/LBS.	CUBIC FT.	LIST PRICE
FW11056-2R	20 x 110 x 56	100	549	62	\$21753

Vertical storage with 3 adjustable shelves, 60" wide wall credenza with two box/files, 60" wide niche, 60" wide single height storage, vertical storage with 3 adjustable shelves, wardrobe with coat hook and hat shelf.

- To add tackboard to niche, add **TB** to end of product code. **Add \$965** to list price for grades 1-3. Add **\$1160** for grades 4-5.
- To add LED light to niche, add **LT** to end of product code. **Add \$817** to list price.

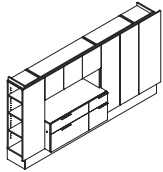

Work Wall - 110"W*

FW11056-3L	20 x 110 x 56	100	538	62	\$21558
------------	---------------	-----	-----	----	----------------

Vertical storage with 3 adjustable shelves, 45" wide wall credenza with box/file and narrow box/file, 45" wide niche, 45" wide single height storage, double width vertical storage with 3 adjustable shelves, wardrobe with coat hook and hat shelf.

- To add tackboard to niche, add **TB** to end of product code. **Add \$968** to list price for grades 1-3. Add **\$1162** for grades 4-5.
- To add LED light to niche, add **LT** to end of product code. **Add \$664** to list price.

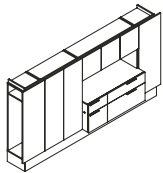

Work Wall - 110"W*

FW11056-3R	20 x 110 x 56	100	538	62	\$21558
------------	---------------	-----	-----	----	----------------

Wardrobe with coat hook and hat shelf, double width vertical storage with 3 adjustable shelves, 45" wide wall credenza with narrow box/file and box/file, 45" wide niche, 45" wide single height storage, vertical storage with 3 adjustable shelves.

- To add tackboard to niche, add **TB** to end of product code. **Add \$968** to list price for grades 1-3. Add **\$1162** for grades 4-5.
- To add LED light to niche, add **LT** to end of product code. **Add \$664** to list price.

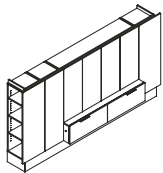

Work Wall - 110"W

FW11056-4L	20 x 110 x 56	100	530	61	\$20691
------------	---------------	-----	-----	----	----------------

Vertical storage with 3 adjustable shelves, vertical storage with 3 adjustable shelves, 60" wide single height wall credenza with two files, 60" wide triple height storage with 2 adjustable shelves, wardrobe with coat hook and hat shelf.

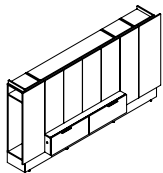

Work Wall - 110"W

FW11056-4R	20 x 110 x 56	100	530	61	\$20691
------------	---------------	-----	-----	----	----------------

Wardrobe with coat hook and hat shelf, single height 60" wide wall credenza with two files, 60" wide triple height storage with 2 adjustable shelves, vertical storage with 3 adjustable shelves, vertical storage with 3 adjustable shelves.

Required Specifications

Front finish
Top/body finish
Cubby interior finish

Optional Specifications

Grommet
LED light*
Tackboard*

WORK WALLS - 84"H

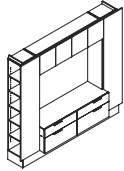

Work Wall - 95"W

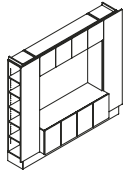

Work Wall - 95"W

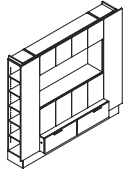

Work Wall - 95"W

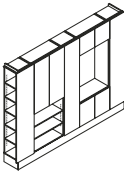

Work Wall - 110"W

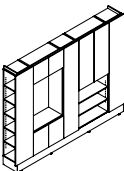

Work Wall - 110"W

MODEL#	DIMENSIONS	FREIGHT CLASS	WT/LBS.	CUBIC FT.	LIST PRICE
--------	------------	---------------	---------	-----------	------------

D x W x H

FW9584-20	20 x 95 x 84	125	565	77	\$25182
-----------	--------------	-----	-----	----	----------------

Vertical storage with 5 adjustable shelves, 60" wide wall credenza with two box/files, 60" wide triple height niche, 60" wide single height storage, vertical storage with 5 adjustable shelves.

- To add tackboard to niche, add **TB** to end of product code. **Add \$1793** to list price for grades 1-3. Add **\$2152** for grades 4-5.
- To add LED light to niche, add **LT** to end of product code. **Add \$817** to list price.

FW9584-21	20 x 95 x 84	125	512	77	\$23182
-----------	--------------	-----	-----	----	----------------

Vertical storage with 5 adjustable shelves, 60" wide wall credenza with two cabinets with adjustable shelves, 60" wide triple height niche, 60" wide single height storage, vertical storage with 5 adjustable shelves.

- To add tackboard to niche, add **TB** to end of product code. **Add \$1793** to list price for grades 1-3. Add **\$2152** for grades 4-5.
- To add LED light to niche, add **LT** to end of product code. **Add \$820** to list price.

FW9584-22	20 x 95 x 84	125	611	77	\$24181
-----------	--------------	-----	-----	----	----------------

Vertical storage with 5 adjustable shelves, 60" wide single height wall credenza with two files, 60" wide double height storage, 60" wide double height niche, 60" wide single height storage, vertical storage with 5 adjustable shelves.

- To add tackboard to niche, add **TB** to end of product code. **Add \$1193** to list price for grades 1-3. Add **\$1432** for grades 4-5.
- To add LED light to niche, add **LT** to end of product code. **Add \$817** to list price.

FW11084-20L	15 x 110 x 84	125	659	87	\$23685
-------------	---------------	-----	-----	----	----------------

Vertical storage with 5 adjustable shelves, 30" wide triple height open bookcase, 30" wide triple height double width storage, vertical storage with 5 adjustable shelves, 30" wide and double height storage, 30" triple height niche, 30" wide single height storage, vertical storage with 5 adjustable shelves.

- To add tackboard to niche, add **TB** to end of product code. **Add \$897** to list price for grades 1-3. Add **\$1076** for grades 4-5.
- To add LED light to niche, add **LT** to end of product code. **Add \$500** to list price.

FW11084-20R	15 x 110 x 84	125	659	87	\$23685
-------------	---------------	-----	-----	----	----------------

Vertical storage with 5 adjustable shelves, 30" wide double height storage, 30" wide triple height niche, 30" wide single height storage, vertical storage with 5 adjustable shelves, 30" wide triple height open bookcase, 30" wide triple height double width storage, vertical storage with 5 adjustable shelves.

- To add tackboard to niche, add **TB** to end of product code. **Add \$897** to list price for grades 1-3. Add **\$1076** for grades 4-5.
- To add LED light to niche, add **LT** to end of product code. **Add \$500** to list price.

Required Specifications

Front finish
Top/body finish
Cubby interior finish

Optional Specifications

Grommet
LED light
Tackboard

WORK WALLS - 84"H

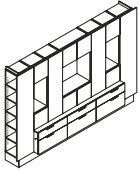

Work Wall - 125"W

MODEL#	DIMENSIONS D x W x H	FREIGHT CLASS	WT/LBS.	CUBIC FT.	LIST PRICE
FW12584-20	20 x 125 x 84	100	962	101	\$36610

Vertical storage with 5 adjustable shelves, 90" wide wall credenza with three box/files, single height storage, 15" wide double height niche, single height storage, four-fold height vertical storage with 3 adjustable shelves, double width single height storage, 30" wide double height niche, double width single height storage, fourfold height vertical storage with 3 adjustable shelves, single height storage, 15" wide double height niche, single height storage, vertical storage with 5 adjustable shelves.

- To add tackboard to niche, add **TB** to end of product code. **Add \$1630** to list price for grades 1-3. **Add \$1956** for grades 4-5.
- To add LED light to niche, add **LT** to end of product code. **Add \$1635** to list price.

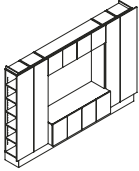

Work Wall - 125"W

FW12584-21	20 x 125 x 84	125	738	100	\$27777
------------	---------------	-----	-----	-----	----------------

Vertical storage with 5 adjustable shelves, vertical storage with 5 adjustable shelves, 60" wide wall credenza with two cabinets and adjustable shelf, 60" wide triple height niche, 60" wide single height storage, vertical storage with 5 adjustable shelves, vertical storage with 5 adjustable shelves.

- To add tackboard to niche, add **TB** to end of product code. **Add \$1788** to list price for grades 1-3. **Add \$2147** for grades 4-5.
- To add LED light to niche, add **LT** to end of product code. **Add \$819** to list price.

WORK WALLS - 70"H

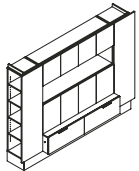

Work Wall - 95"W

MODEL#	DIMENSIONS	FREIGHT CLASS	WT/LBS.	CUBIC FT.	LIST PRICE
FW9570-20	20 x 95 x 70	100	563	66	\$21754

Vertical storage with 4 adjustable shelves, 60" wide single height wall credenza with two files, 60" wide double height storage, 60" wide niche, 60" wide single height storage, vertical storage with 4 adjustable shelves.

- To add tackboard to niche, add **TB** to end of product code. **Add \$966** to list price for grades 1-3. **Add \$1160** for grades 4-5.
- To add LED light to niche, add **LT** to end of product code. **Add \$817** to list price.

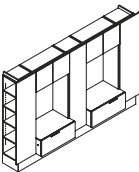

Work Wall - 110"W

FW11070-20	20 x 110 x 70	125	602	78	\$24977
------------	---------------	-----	-----	----	----------------

Vertical storage with 4 adjustable shelves, 30" wide single height wall credenza with file, 30" wide triple height niche, 30" wide single height storage, vertical storage with 4 adjustable shelves, 30" wide single height wall credenza with file, 30" wide triple height niche, 30" wide single height storage, vertical storage with 4 adjustable shelves.

- To add tackboard to niche, add **TB** to end of product code. **Add \$1791** to list price for grades 1-3. **Add \$2149** for grades 4-5.
- To add LED light to niche, add **LT** to end of product code. **Add \$1296** to list price.

Required Specifications

Front finish
Top/body finish
Cubby interior finish

Optional Specifications

Grommet
LED light
Tackboard

WORK WALLS - 70"H

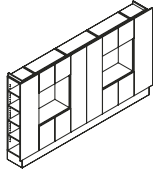

Work Wall - 125"W

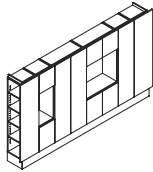

Work Wall - 125"W

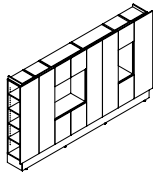

Work Wall - 125"W

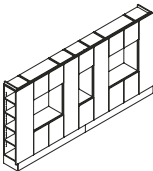

Work Wall - 140"W

MODEL#	DIMENSIONS	FREIGHT CLASS	WT/LBS.	CUBIC FT.	LIST PRICE
--------	------------	---------------	---------	-----------	------------

D x W x H

FW12570-20	20 x 125 x 70	125	645	84	\$25185
------------	---------------	-----	-----	----	----------------

Vertical storage with 4 adjustable shelves, 30" wide double height storage, 30" wide double height niche, 30" wide single height storage, double width vertical storage with 4 adjustable shelves, 30" wide double height storage, 30" wide double height niche, 30" wide single height storage, vertical storage with 4 adjustable shelves.

- To add tackboard to niche, add **TB** to end of product code. **Add \$1196** to list price for grades 1-3. Add **\$1435** for grades 4-5.
- To add LED light to niche, add **LT** to end of product code. **Add \$1295** to list price.

FW12570-21L	20 x 125 x 70	100	685	84	\$26403
-------------	---------------	-----	-----	----	----------------

Vertical storage with 4 adjustable shelves, 15" wide double height storage, 15" wide double height niche, 15" wide single height storage, double width vertical storage with 4 adjustable shelves, 30" wide double height storage, 30" wide double height niche, 30" wide single height storage, vertical storage with 4 adjustable shelves, vertical storage with 4 adjustable shelves.

- To add tackboard to niche, add **TB** to end of product code. **Add \$817** to list price for grades 1-3. Add **\$981** for grades 4-5.
- To add LED light to niche, add **LT** to end of product code. **Add \$981** to list price.

FW12570-21R	20 x 125 x 70	100	685	84	\$26403
-------------	---------------	-----	-----	----	----------------

Vertical storage with 4 adjustable shelves, vertical storage with 4 adjustable shelves, 30" wide double height storage, 30" wide double height niche, 30" wide single height storage, double width vertical storage with 4 adjustable shelves, 15" wide double height storage, 15" wide double height niche, 15" wide single height storage, vertical storage with 4 adjustable shelves.

- To add tackboard to niche, add **TB** to end of product code. **Add \$817** to list price for grades 1-3. Add **\$981** for grades 4-5.
- To add LED light to niche, add **LT** to end of product code. **Add \$981** to list price.

FW14070-20	20 x 140 x 70	100	779	96	\$29802
------------	---------------	-----	-----	----	----------------

Vertical storage with 4 adjustable shelves, 30" wide double height storage, 30" wide double height niche, 30" wide single height storage, vertical storage cabinet with 4 adjustable shelves, 15" wide double height storage, 15" wide double height niche, 15" wide single height storage, vertical storage with 4 adjustable shelves, 30" wide double height storage, 30" wide double height niche, 30" wide single height storage, vertical storage with 4 adjustable shelves.

- To add tackboard to niche, add **TB** to end of product code. **Add \$1616** to list price for grades 1-3. Add **\$1939** for grades 4-5.
- To add LED light to niche, add **LT** to end of product code. **Add \$1638** to list price.

Required Specifications

Front finish
Top/body finish
Cubby interior finish

Optional Specifications

Grommet
LED light
Tackboard

WORK WALLS - 70"H

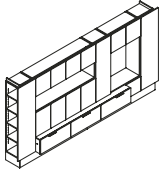

Work Wall - 140"W

MODEL#	DIMENSIONS D x W x H	FREIGHT CLASS	WT/LBS.	CUBIC FT.	LIST PRICE
FW14070-21L	20 x 140 x 70	100	832	96	\$29802

Vertical storage with 4 adjustable shelves, 60" wide double height storage, 60" wide niche, 60" wide single height storage, 15" wide triple height storage, 15" wide single height storage, 30" wide double height niche, 30" wide single height storage, 90" wide single height wall credenza with three files, vertical storage with 4 adjustable shelves.

- To add tackboard to niche, add **TB** to end of product code. **Add \$1901** to list price for grades 1-3. Add **\$2282** for grades 4-5.
- To add LED light to niche, add **LT** to end of product code. **Add \$1703** to list price.

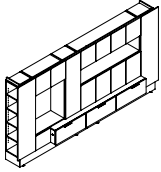

Work Wall - 140"W

FW14070-21R	20 x 140 x 70	100	832	96	\$29802
-------------	---------------	-----	-----	----	----------------

Vertical storage with 4 adjustable shelves, 15" wide single height storage, 30" wide double height niche, 30" wide single height storage, 90" wide single height wall credenza with three files, 15" wide triple height storage, 60" wide double height storage, 60" wide niche, 60" wide single height storage, vertical storage with 4 adjustable shelves.

- To add tackboard to niche, add **TB** to end of product code. **Add \$1901** to list price for grades 1-3. Add **\$2282** for grades 4-5.
- To add LED light to niche, add **LT** to end of product code. **Add \$1703** to list price.

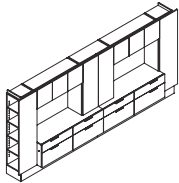

Work Wall - 155"W

FW15570-20	20 x 155 x 70	100	900	108	\$29802
------------	---------------	-----	-----	-----	----------------

Vertical storage with 4 adjustable shelves, 60" wide wall credenza with two box/files, 45" wide double height niche, 45" wide single height storage, 30" wide double width storage with 2 adj. shelves, 60" wide wall credenza with two box/files, 45" wide double height niche, 45" wide single height storage, vertical storage with 4 adjustable

- To add tackboard to niche, add **TB** to end of product code. **Add \$2436** to list price for grades 1-3. Add **\$2923** for grades 4-5.
- To add LED light to niche, add **LT** to end of product code. **Add \$1744** to list price.

WORK WALLS - 84"H

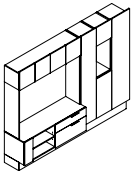

Work Wall - 107"W

MODEL#	DIMENSIONS	FREIGHT CLASS	WT/LBS.	CUBIC FT.	LIST PRICE
FW10784L	20 x 95 x 84	100	832	96	\$27643

60" wide wall credenza with adjustable shelf and box/file, 60" wide triple height niche, 60" wide single height storage, vertical storage with 5 adjustable shelves, triple height storage, 15" wide double height niche, single height storage, vertical storage with 5 adjustable shelves.

- To add tackboard to niche, add **TB** to end of product code. **Add \$1218** to list price for grades 1-3. Add **\$1462** for grades 4-5.
- To add LED light to niche, add **LT** to end of product code. **Add \$1218** to list price.

Required Specifications

Front finish
Top/body finish
Cubby interior finish

Optional Specifications

Grommet
LED light
Tackboard

OPEN KNEE SPACE WORK WALLS

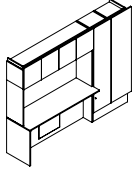

Open Knee Space Work Wall - 92"W

MODEL#	DIMENSIONS	FREIGHT CLASS	WT/LBS.	CUBIC FT.	LIST PRICE
	D x W x H				
FW927002R	20 x 92.5 x 84	100	832	96	\$16297

60" wide worksurface wall credenza, 60" wide double height niche, 60" wide single height storage, vertical storage with 4 adjustable shelves, wardrobe with coat hook and hat shelf.

- To add tackboard to niche, add **TB** to end of product code. **Add \$1218** to list price for grades 1-3. Add **\$1462** for grades 4-5.
- To add LED light to niche, add **LT** to end of product code. **Add \$1218** to list price.

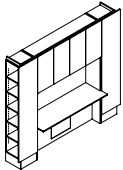

Open Knee Space Work Wall - 95"W

FW95840WR	20 x 95 x 84	100	832	96	\$17021
-----------	--------------	-----	-----	----	----------------

Vertical storage with 5 adjustable shelves, 60" wide worksurface wall credenza, 60" wide double height niche, 60" wide double height storage, wardrobe with coat hook and hat shelf.

- To add tackboard to niche, add **TB** to end of product code. **Add \$1218** to list price for grades 1-3. Add **\$1462** for grades 4-5.
- To add LED light to niche, add **LT** to end of product code. **Add \$834** to list price.

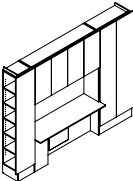

Open Knee Space Work Wall - 110"W

FW110840W2R	20 x 110 x 84	100	832	96	\$19495
-------------	---------------	-----	-----	----	----------------

Vertical storage with 5 adjustable shelves, 60" wide worksurface wall credenza, 60" wide double height niche, 60" wide double height storage, double depth wardrobe with coat rod and hat shelf.

- To add tackboard to niche, add **TB** to end of product code. **Add \$1219** to list price for grades 1-3. Add **\$1463** for grades 4-5.
- To add LED light to niche, add **LT** to end of product code. **Add \$839** to list price.

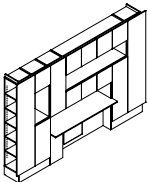

Open Knee Space Work Wall - 125"W

FW125840IL	20 x 110 x 84	100	832	96	\$27471
------------	---------------	-----	-----	----	----------------

Vertical storage with 5 adjustable shelves, triple height storage, 15" wide triple height storage, 15" wide double height niche, single high storage, 60" wide worksurface wall credenza, 60" wide single height niche, triple height storage, 45" wide single height storage, 60" wide single height niche, 60" wide single height storage, triple height storage, wardrobe with coat hook and hat shelf.

- To add tackboard to niche, add **TB** to end of product code. **Add \$2398** to list price for grades 1-3. Add **\$2879** for grades 4-5.
- To add LED light to niche, add **LT** to end of product code. **Add \$2406** to list price.

Required Specifications

Front finish
Top/body finish
Cubby interior finish

Optional Specifications

Grommet
LED light
Tackboard

F FOUNDATIONS

WORK WALL CREDENZAS

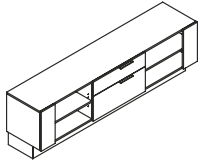

Work Wall Credenza

MODEL#	DIMENSIONS D x W x H	FREIGHT CLASS	WT./LBS.	CUBIC FT.	LIST PRICE
FW9026-1	20 x 90 x 26	100	254	27	\$9397

Standard with adjustable shelf, box/file and adjustable shelf.

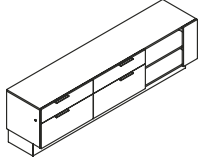

Work Wall Credenza

FW9026-2	20 x 90 x 26	92.5	270	27	\$9798
----------	--------------	------	-----	----	---------------

Standard with box/file, box/file and adjustable shelf.

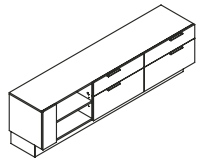

Work Wall Credenza

FW9026-3	20 x 90 x 26	92.5	270	27	\$9798
----------	--------------	------	-----	----	---------------

Standard with adjustable shelf, box/file and box/file.

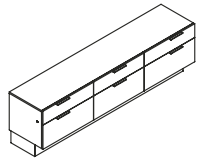

Work Wall Credenza

FW9026-4	20 x 90 x 26	92.5	310	27	\$10395
----------	--------------	------	-----	----	----------------

Standard with three box/file drawers. Center pedestal does not lock.

Required Specifications

Front finish
Top/body finish

Optional Specifications

Grommet

CONFERENCE ROOM FURNITURE - NOTES

D x W x H

- Horizontal grain direction is standard on all engineered finishes.
- Full Storage Credenza backs include GM17 vertical cut out
- Optional decorative credenza back panels (**FBP**) are available as a factory installed upgrade on FC/FCD models only.
- Doors open with touch latch
- To open the drawer, pull drawer front overhang - no handles available
- Display Wall can be purchased with optional monitor mount installed
- Mobile and stationary lecterns are available.
- Two Connecting Brackets are included.
- For optional light and microphone, see page 201 in the accessories section
- **Metal Leg finishes (conference furniture):**
 - BLKT Black Textured
 - TUNT Tungsten Textured
 - DWTT Designer White Textured
- **NOTE:** Arrow indicates direction of grain

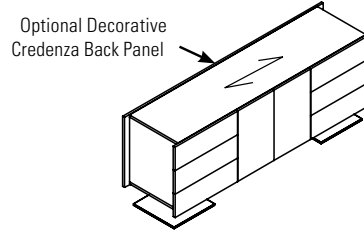

CONFERENCE ROOM FURNITURE MODEL# DIMENSIONS FREIGHT CLASS WT/LBS. CUBIC FT. LIST PRICE

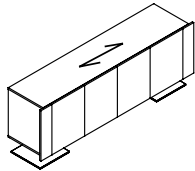

Full Storage Credenza

FC9020GG	20 x 90 x 29	125	241	36	\$10595
FC8420GG	20 x 84 x 29	125	232	33	\$10175
FC7820GG	20 x 78 x 29	125	223	31	\$9445
FC7220GG	20 x 72 x 29	125	213	29	\$9189
FC6020MM	20 x 60 x 29	125	194	26	\$8528

Standard with two sets of storage cabinets.

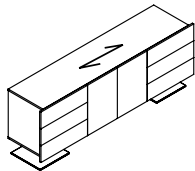

Full Storage Credenza

FCD9020A	20 x 90 x 29	125	249	36	\$11226
FCD8420A	20 x 84 x 29	125	240	33	\$10809
FCD7820A	20 x 78 x 29	125	230	31	\$10036
FCD7220A	20 x 72 x 29	125	221	29	\$9820
FCD6020A	20 x 60 x 29	125	202	26	\$9167

Standard with three box drawers on left, storage cabinets in center, and three box drawers on right.

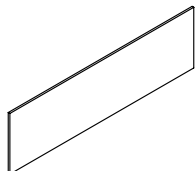

Decorative Back Panel

FBP9020	20 x 90 x 29	92.5	41	4	\$1806
FBP8420	20 x 84 x 29	100	38	4	\$1715
FBP7820	20 x 78 x 29	85	36	3	\$1597
FBP7220	20 x 72 x 29	92.5	33	3	\$1391
FBP6020	20 x 60 x 29	100	27	3	\$1177

For FC/FCD credenza models only. Not sold individually. Must be ordered as an upgrade option only.

Required Specifications

- Front finish
- Top/body finish
- Leg finish

CONFERENCE ROOM FURNITURE

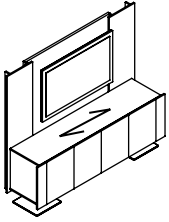

Display Wall Storage Credenza

MODEL#	DIMENSIONS D x W x H	FREIGHT CLASS	WT/LBS.	CUBIC FT.	LIST PRICE
FC9024GGTWH72	24 x 90 x 72	100	463	47	\$16421
FC8424GGTWH72	24 x 84 x 72	92.5	460	45	\$15642
FC7824GGTWH72	24 x 78 x 72	125	286	41	\$14526
FC7224GGTWH72	24 x 72 x 72	92.5	418	39	\$14088

FC9024GGTWH66	24 x 90 x 66	100	444	48	\$15851
FC8424GGTWH66	24 x 84 x 66	100	422	45	\$15228
FC7824GGTWH66	24 x 78 x 66	100	402	42	\$14138
FC7224GGTWH66	24 x 72 x 66	100	381	39	\$13701

With two sets of storage cabinets and display wall. Monitors and TV mounts are not included. Display wall includes GM1 grommet.

Monitor size chart based on display wall size:

Display Wall Width	Monitor Size
90"	54"
84"	50"
78"	46"
72"	42"

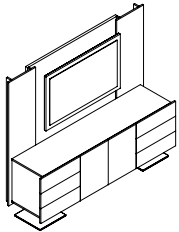

Display Wall Storage Credenza

FCD9024ATWH72	24 x 90 x 72	92.5	481	48	\$16673
FCD8424ATWH72	24 x 84 x 72	92.5	460	45	\$15895
FCD7824ATWH72	24 x 78 x 72	92.5	439	42	\$13259
FCD7224ATWH72	24 x 72 x 72	100	381	39	\$14293

FCD9024ATWH66	24 x 90 x 66	100	444	48	\$16106
FCD8424ATWH66	24 x 84 x 66	100	422	45	\$15479
FCD7824ATWH66	24 x 78 x 66	100	402	42	\$14394
FCD7224ATWH66	24 x 72 x 66	100	381	39	\$13955

With three box drawers on left, storage cabinets in center, and three box drawers on right, and display wall. Monitors and TV mounts are not included. Display wall includes GM1 grommet.

Monitor size chart based on display wall size:

Display Wall Width	Monitor Size
90"	54"
84"	50"
78"	46"
72"	42"

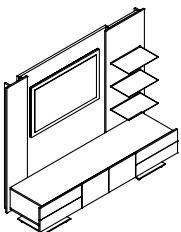

Display Wall Storage Credenza

FFTWA90WH72	24 x 90 x 72	92.5	482	41	\$17453
FFTWA84WH72	24 x 84 x 72	85	462	38	\$16857
FFTWA78WH72	24 x 78 x 72	85	442	35	\$15986
FFTWA72WH72	24 x 72 x 72	85	421	32	\$15030

FFTWA90WH66	24 x 90 x 66	92.5	462	40	\$16887
FFTWA84WH66	24 x 84 x 66	92.5	443	37	\$16290
FFTWA78WH66	24 x 78 x 66	85	424	34	\$15453
FFTWA72WH66	24 x 72 x 66	85	404	31	\$14586

With two box drawers on left, storage cabinets in center, and two box drawers on right, and display wall with shelves. Monitors and TV mounts are not included. Display wall includes GM1 grommet.

Monitor size chart based on display wall size:

Display Wall Width	Monitor Size
90"	54"
84"	50"
78"	46"
72"	42"

Required Specifications

Front/wall finish
Top/body finish
Leg finish

CONFERENCE ROOM ACCESSORIES

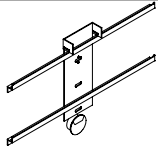

Flat Screen Monitor Mount

MODEL#	DIMENSIONS	FREIGHT CLASS	WT/LBS.	CUBIC FT.	LIST PRICE
FVMED	D x W x H 2 x 28 x 17	70	14	0.7	\$735

Flat screen monitor mount up to 50". To be used on Foundations display wall storage credenzas. GM1K (tungsten) grommet on the back panel is included.

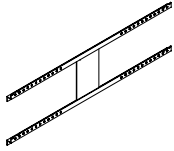

Flat Screen Monitor Mount

FVLRG	2 x 38 x 21	60	25	0.75	\$611
-------	-------------	----	----	------	--------------

Flat screen monitor mount for over 50". To be used on Foundations display wall storage credenzas.

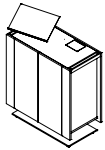

Lectern*

FLEC36	20 x 36 x 42	125	166	22	\$10140
--------	--------------	-----	-----	----	----------------

With pop-up door to reveal concealed power/data monument (power duplex, 15 pin VGA, data and telephone connectors). Optional light and/or microphone to be specified. Metal finish on base, book rest and handles must be specified. Includes 1 adjustable shelf.

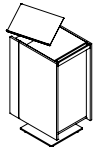

Lectern*

FLEC24	20 x 24 x 42	100	135	15	\$8367
--------	--------------	-----	-----	----	---------------

With laptop pull-out tray to reveal concealed power/data monument (power duplex, 15 pin VGA, data and telephone connectors). Optional light and/or microphone to be specified. Metal finish on base, book rest and handles must be specified. Includes 1 adjustable shelf.

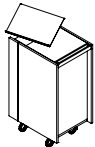

Mobile Lectern*

FLEC24M	20 x 24 x 42	100	135	15	\$6198
---------	--------------	-----	-----	----	---------------

With laptop pull-out tray. Optional light and/or microphone to be specified. Metal finish on base, book rest and handles must be specified. Includes 1 adjustable shelf. Locking casters (Tungsten only).

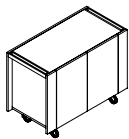

Mobile Server*

FSM4020	20 x 40 x 30	150	108	21	\$6753
---------	--------------	-----	-----	----	---------------

With cutlery drawer and adjustable shelf. Metal finish on handles must be specified. Locking casters (Tungsten only).

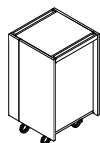

Mobile Tech Cart

FTCM2020H42	20 x 20 x 42	150	67	13.5	\$4921
FTCM2020H36	20 x 20 x 36	150	54	10.5	\$4219

Metal finish on handles must be specified. Includes 1 adjustable shelf. Locking casters (Tungsten only).

Required Specifications

Front finish
Top/body finish
Metal finish*

Optional Specifications

Light*
Microphone*

F FOUNDATIONS

BOARDROOM TABLES - NOTES

D x W x H

- Table tops are 1.5" thick with a 2" undercut knife edge.

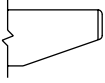

- All tops have a 1/8" (3mm) solid edge of walnut, cherry, maple and oak
- See notes section for optional grommet locations on tables without technology trough
- See "Technology Trough Details" on page 150
- For tables with 3 bases and technology trough, add **C** (for center base feed) or **E** (for end base feed) to the end of the model number (Example: FRESTCT19298**C**)
- **NOTE:** Arrow indicates direction of grain

BOARDROOM TABLES - RECTANGULAR

MODEL# DIMENSIONS FREIGHT CLASS WT/LBS. CUBIC FT. LIST PRICE

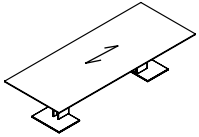

Rectangular Table

FRE12048	48 x 120 x 29	100	450	54	\$14359
FRE9648	48 x 96 x 29	125	390	49	\$13001

One piece top. Two bases.

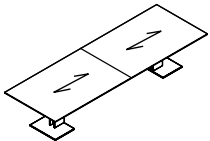

Rectangular Table

FRE16848	48 x 168 x 29	100	571	65	\$17540
FRE14448	48 x 144 x 29	100	511	60	\$15880
FRE12048-2	48 x 120 x 29	100	450	56	\$14549

Two piece top. Two bases.

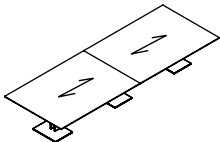

Rectangular Table

FRE24060	60 x 240 x 29	100	965	109	\$27998
FRE21660	60 x 216 x 29	100	893	104	\$26428
FRE19260	60 x 192 x 29	100	821	99	\$24805
FRE16860	60 x 168 x 29	100	748	93	\$23201
FRE21648	48 x 216 x 29	92.5	872	87	\$24252
FRE19248	48 x 192 x 29	100	744	82	\$22812

Two piece top. Three bases.

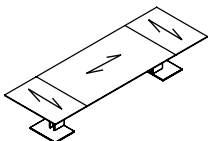

Rectangular Table, Sectional*

FREST16848	48 x 168 x 29	100	571	65	\$17875
FREST14448	48 x 144 x 29	100	511	60	\$16459
FREST12048	48 x 120 x 29	100	450	54	\$15031

Three piece top. Two bases.

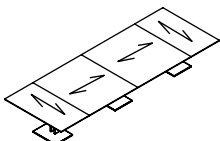

Rectangular Table, Sectional*

FREST24060	60 x 240 x 29	100	965	109	\$27998
FREST21660	60 x 216 x 29	100	893	104	\$26428
FREST19260	60 x 192 x 29	100	821	99	\$24805
FREST16860	60 x 168 x 29	100	748	93	\$23201
FREST21648	48 x 216 x 29	92.5	872	87	\$24252
FREST19248	48 x 192 x 29	100	744	82	\$22812

Four piece top. Three bases.
 • 168"W table - midsection is one piece

Required Specifications

Top finish/base side finish
 Base end finish
 Metal finish

Optional Specifications

Grommet

BOARDROOM TABLES - RECTANGULAR

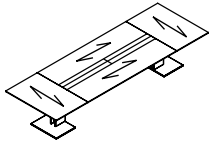

Rectangular Table, Sectional

MODEL#	DIMENSIONS	FREIGHT CLASS	WT/LBS.	CUBIC FT.	LIST PRICE
--------	------------	---------------	---------	-----------	------------

D x W x H

FRESTCT16848	48 x 168 x 29	100	659	69	\$27276
FRESTCT14448	48 x 144 x 29	100	584	63	\$21852
FRESTCT12048	48 x 120 x 29	100	508	57	\$20259

Four piece top. Two bases / power kit included.

- 168"W table includes technology trough with 8 doors
- 144"W and 120" tables include technology trough with 4 doors

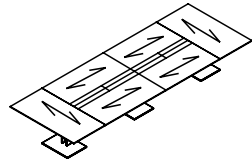

Rectangular Table, Sectional

FRESTCT24060	60 x 240 x 29	100	1113	116	\$39872
FRESTCT21660	60 x 216 x 29	100	1021	109	\$37755
FRESTCT19260	60 x 192 x 29	100	920	103	\$35464
FRESTCT16860	60 x 168 x 29	100	836	96	\$33101
FRESTCT21648	48 x 216 x 29	92.5	1000	92	\$35770
FRESTCT19248	48 x 192 x 29	100	843	87	\$33691

Six piece top. Three bases. Add **C** or **E** to end of model number to specify base feed location. Includes technology trough with 8 doors.

- 168"W table - midsection is one piece

BOARDROOM TABLES - BOW END

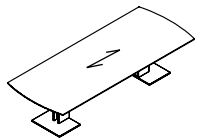

Bow End Table

MODEL#	DIMENSIONS	FREIGHT CLASS	WT/LBS.	CUBIC FT.	LIST PRICE
--------	------------	---------------	---------	-----------	------------

FREBE12048	48 x 120 x 29	100	450	54	\$15076
FREBE9648	48 x 96 x 29	125	390	49	\$13651

One piece top. Two bases.

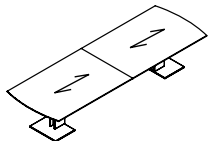

Bow End Table

FREBE16848	48 x 168 x 29	100	571	65	\$18414
FREBE14448	48 x 144 x 29	100	511	60	\$16674
FREBE12048-2	48 x 120 x 29	100	450	56	\$15277

Two piece top. Two bases.

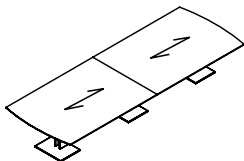

Bow End Table

FREBE24060	60 x 240 x 29	100	965	109	\$29396
FREBE21660	60 x 216 x 29	100	893	104	\$27748
FREBE19260	60 x 192 x 29	100	821	99	\$26045
FREBE16860	60 x 168 x 29	100	748	93	\$24361
FREBE21648	48 x 216 x 29	92.5	872	87	\$25464
FREBE19248	48 x 192 x 29	100	744	82	\$23951

Two piece top. Three bases.

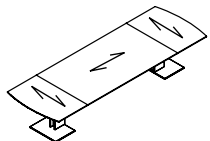

Bow End Table, Sectional

FREBEST16848	48 x 168 x 29	100	571	65	\$18770
FREBEST14448	48 x 144 x 29	100	511	60	\$17281
FREBEST12048	48 x 120 x 29	100	450	54	\$15784

Three piece top. Two bases.

Required Specifications

Top finish/base side finish
Base end finish
Metal finish

Optional Specifications

Grommet

BOARDROOM TABLES - BOW END

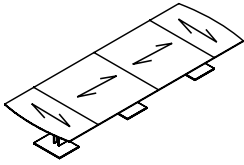

Bow End Table, Sectional

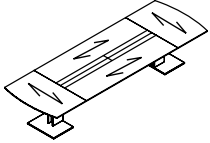

Bow End Table, Sectional

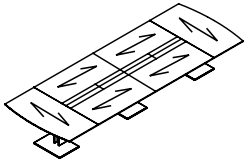

Bow End Table, Sectional

MODEL#	DIMENSIONS D x W x H	FREIGHT CLASS	WT/LBS.	CUBIC FT.	LIST PRICE
FREBEST24060	60 x 240 x 29	100	965	109	\$30030
FREBEST21660	60 x 216 x 29	100	893	104	\$28349
FREBEST19260	60 x 192 x 29	100	821	99	\$26459
FREBEST16860	60 x 168 x 29	100	748	93	\$24646
FREBEST21648	48 x 216 x 29	92.5	872	87	\$26160
FREBEST19248	48 x 192 x 29	100	744	82	\$24545

Four piece top. Three bases.
 • 168"W table - midsection is one piece

FREBESTCT16848	48 x 168 x 29	100	659	69	\$28640
FREBESTCT14448	48 x 144 x 29	100	584	63	\$22942
FREBESTCT12048	48 x 120 x 29	100	508	57	\$21271

Four piece top. Two bases / power kit included.
 • 168"W table includes technology trough with 8 doors
 • 144"W and 120" tables include technology trough with 4 doors

FREBESTCT24060	60 x 240 x 29	100	1113	116	\$41863
FREBESTCT21660	60 x 216 x 29	100	1021	109	\$39640
FREBESTCT19260	60 x 192 x 29	100	920	103	\$37238
FREBESTCT16860	60 x 168 x 29	100	836	96	\$34755
FREBESTCT21648	48 x 216 x 29	92.5	1000	92	\$37558
FREBESTCT19248	48 x 192 x 29	100	843	87	\$35373

Six piece top. Three bases. Add **C** or **E** to end of model number to specify base feed location. Includes technology trough with 8 doors.
 • 168"W table - midsection is one piece

BOARDROOM TABLES - BOAT SHAPED

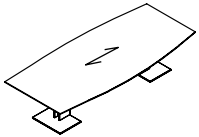

Boat Shaped Table

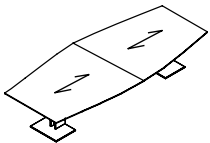

Boat Shaped Table

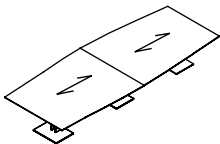

Boat Shaped Table

MODEL#	DIMENSIONS	FREIGHT CLASS	WT/LBS.	CUBIC FT.	LIST PRICE
FBO12048	48 x 120 x 29	100	450	54	\$15827
FBO9648	48 x 96 x 29	125	390	49	\$14332

One piece top. Two bases.

FBO16848	48 x 168 x 29	100	571	65	\$19333
FBO14448	48 x 144 x 29	100	511	60	\$17506
FBO12048-2	48 x 120 x 29	100	450	56	\$16038

Two piece top. Two bases.

FBO24060	60 x 240 x 29	100	965	109	\$30864
FBO21660	60 x 216 x 29	100	893	104	\$29134
FBO19260	60 x 192 x 29	100	821	99	\$27346
FBO16860	60 x 168 x 29	100	748	93	\$25574
FBO21648	48 x 216 x 29	92.5	872	87	\$26735
FBO19248	48 x 192 x 29	100	744	82	\$25149

Two piece top. Three bases.

Required Specifications

Top finish/base side finish
 Base end finish
 Metal finish

Optional Specifications

Grommet

BOARDROOM TABLES - BOAT SHAPED

MODEL# DIMENSIONS FREIGHT CLASS WT./LBS. CUBIC FT. LIST PRICE

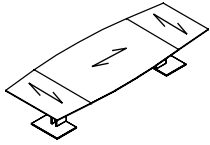

Boat Shaped Table, Sectional

	D x W x H				
FBOST16848	48 x 168 x 29	100	571	65	\$19709
FBOST14448	48 x 144 x 29	100	511	60	\$18145
FBOST12048	48 x 120 x 29	100	450	54	\$16572

Three piece top. Two bases.

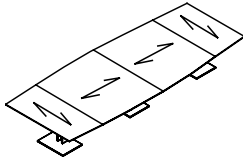

Boat Shaped Table, Sectional

FBOST24060	60 x 240 x 29	100	965	109	\$31532
FBOST21660	60 x 216 x 29	100	893	104	\$29765
FBOST19260	60 x 192 x 29	100	821	99	\$27781
FBOST16860	60 x 168 x 29	100	748	93	\$25876
FBOST21648	48 x 216 x 29	92.5	872	87	\$27464
FBOST19248	48 x 192 x 29	100	744	82	\$25771

Four piece top. Three bases.
 • 168"W table - midsection is one piece

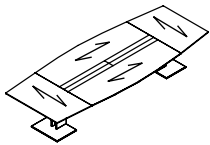

Boat Shaped Table, Sectional

FBOSTCT16848	48 x 168 x 29	100	659	69	\$30072
FBOSTCT14448	48 x 144 x 29	100	584	63	\$24086
FBOSTCT12048	48 x 120 x 29	100	508	57	\$22335

Four piece top. Two bases / power kit included.
 • 168"W table includes technology trough with 8 doors
 • 144"W and 120" tables include technology trough with 4 doors

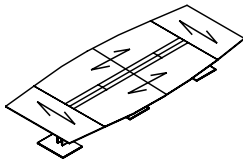

Boat Shaped Table, Sectional

FBOSTCT24060	60 x 240 x 29	100	1113	116	\$43954
FBOSTCT21660	60 x 216 x 29	92.5	1021	91	\$41619
FBOSTCT19260	60 x 192 x 29	100	920	103	\$39099
FBOSTCT16860	60 x 168 x 29	100	836	96	\$36491
FBOSTCT21648	48 x 216 x 29	92.5	1000	92	\$38925
FBOSTCT19248	48 x 192 x 29	100	843	87	\$37141

Six piece top. Three bases. Add **C** or **E** to end of model number to specify base feed location. Includes technology trough with 8 doors.
 • 168"W table - midsection is one piece

BOARDROOM TABLES - BOAT SHAPED, BOW END

MODEL# DIMENSIONS FREIGHT CLASS WT./LBS. CUBIC FT. LIST PRICE

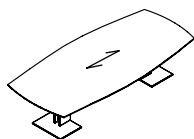

Boat Shaped Table, Bow End

FBOBE12048	48 x 120 x 29	100	450	54	\$16362
FBOBE9648	48 x 96 x 29	125	390	49	\$14795

One piece top. Two bases.

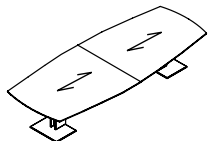

Boat Shaped Table, Bow End

FBOBE16848	48 x 168 x 29	100	571	65	\$20044
FBOBE14448	48 x 144 x 29	100	511	60	\$18130
FBOBE12048-2	48 x 120 x 29	100	450	56	\$16585

Two piece top. Two bases.

Required Specifications

Top finish/base side finish
 Base end finish
 Metal finish

Optional Specifications

Grommet

F FOUNDATIONS

BOARDROOM TABLES - BOAT SHAPED, BOW END

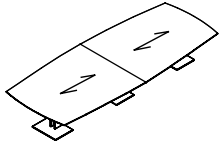

Boat Shaped Table, Bow End

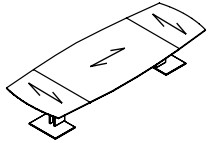

Boat Shaped Table, Bow End, Sectional

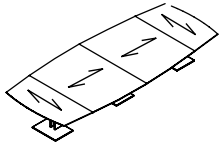

Boat Shaped Table, Bow End, Sectional

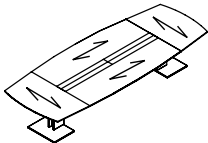

Boat Shaped Table, Bow End, Sectional

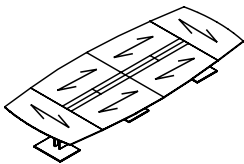

Boat Shaped Table, Bow End, Sectional

MODEL#	DIMENSIONS D x W x H	FREIGHT CLASS	WT/LBS.	CUBIC FT.	LIST PRICE
FBOBE24060	60 x 240 x 29	100	965	109	\$32155
FBOBE21660	60 x 216 x 29	100	893	104	\$30332
FBOBE19260	60 x 192 x 29	100	821	99	\$28459
FBOBE16860	60 x 168 x 29	100	748	93	\$26600
FBOBE21648	48 x 216 x 29	92.5	872	87	\$27814
FBOBE19248	48 x 192 x 29	100	744	82	\$26152

Two piece top. Three bases.

FBOBEST16848	48 x 168 x 29	100	571	65	\$20438
FBOBEST14448	48 x 144 x 29	100	511	60	\$18798
FBOBEST12048	48 x 120 x 29	100	450	54	\$17135

Three piece top. Two bases.

FBOBEST24060	60 x 240 x 29	100	965	109	\$32856
FBOBEST21660	60 x 216 x 29	100	893	104	\$30996
FBOBEST19260	60 x 192 x 29	100	821	99	\$28650
FBOBEST16860	60 x 168 x 29	100	748	93	\$26917
FBOBEST21648	48 x 216 x 29	92.5	872	87	\$28585
FBOBEST19248	48 x 192 x 29	100	744	82	\$26802

Four piece top. Three bases.

- 168"W table - midsection is one piece

FBOBESTCT16848	48 x 168 x 29	100	659	69	\$31320
FBOBESTCT14448	48 x 144 x 29	100	584	63	\$25038
FBOBESTCT12048	48 x 120 x 29	100	508	57	\$23196

Four piece top. Two bases / power kit included.

- 168"W table includes technology trough with 8 doors
- 144"W and 120" tables include technology trough with 4 doors

FBOBESTCT24060	60 x 240 x 29	100	1113	116	\$45897
FBOBESTCT21660	60 x 216 x 29	100	1021	109	\$43446
FBOBESTCT19260	60 x 192 x 29	100	920	103	\$40797
FBOBESTCT16860	60 x 168 x 29	100	836	96	\$38075
FBOBESTCT21648	48 x 216 x 29	92.5	1000	92	\$40618
FBOBESTCT19248	48 x 192 x 29	100	843	87	\$38741

Six piece top. Three bases. Add **C** or **E** to end of model number to specify base feed location. Includes technology trough with 8 doors.

- 168"W table - midsection is one piece

Required Specifications

Top finish/base side finish
Base end finish
Metal finish

Optional Specifications

Grommet

BOARDROOM TABLES - RACETRACK

MODEL#	DIMENSIONS	FREIGHT CLASS	WT/LBS.	CUBIC FT.	LIST PRICE
--------	------------	---------------	---------	-----------	------------

D x W x H

FRA12048	48 x 120 x 29	100	450	54	\$16619
FRA9648	48 x 96 x 29	125	390	49	\$15050

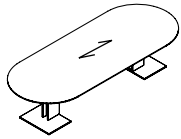

Racetrack Table

One piece top. Two bases.

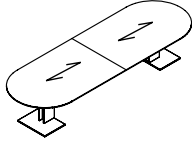

Racetrack Table

FRA16848	48 x 168 x 29	100	571	65	\$20298
FRA14448	48 x 144 x 29	100	511	60	\$18380
FRA12048-2	48 x 120 x 29	100	450	56	\$16840

Two piece top. Two bases.

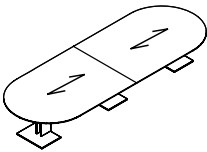

Racetrack Table

FRA24060	60 x 240 x 29	100	965	109	\$32409
FRA21660	60 x 216 x 29	100	893	104	\$30587
FRA19260	60 x 192 x 29	100	821	99	\$28713
FRA16860	60 x 168 x 29	100	748	93	\$26851
FRA21648	48 x 216 x 29	92.5	872	87	\$28070
FRA19248	48 x 192 x 29	100	744	82	\$26404

Two piece top. Three bases.

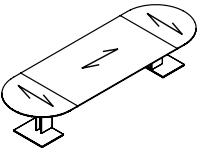

Racetrack Table, Sectional

FRAST16848	48 x 168 x 29	100	571	65	\$20689
FRAST14448	48 x 144 x 29	100	511	60	\$19052
FRAST12048	48 x 120 x 29	100	450	54	\$17391

Three piece top. Two bases.

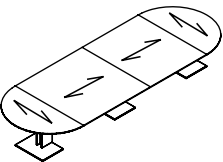

Racetrack Table, Sectional

FRAST24060	60 x 240 x 29	100	965	109	\$33108
FRAST21660	60 x 216 x 29	100	893	104	\$31253
FRAST19260	60 x 192 x 29	100	821	99	\$28904
FRAST16860	60 x 168 x 29	100	748	93	\$27170
FRAST21648	48 x 216 x 29	92.5	872	87	\$28839
FRAST19248	48 x 192 x 29	100	744	82	\$27058

Four piece top. Three bases.

- 168"W table - midsection is one piece

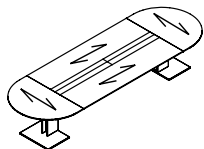

Racetrack Table, Sectional

FRASTCT16848	48 x 168 x 29	100	659	69	\$31574
FRASTCT14448	48 x 144 x 29	100	584	63	\$25291
FRASTCT12048	48 x 120 x 29	100	508	57	\$23449

Four piece top. Two bases / power kit included.

- 168"W table includes technology trough with 8 doors
- 144"W and 120" tables include technology trough with 4 doors

Required Specifications

Top finish/base side finish
Base end finish
Metal finish

Optional Specifications

Grommet

BOARDROOM TABLES - RACETRACK

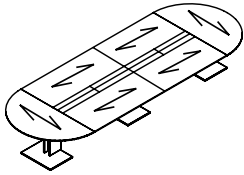

Racetrack Table, Sectional

MODEL#	DIMENSIONS D x W x H	FREIGHT CLASS	WT/LBS.	CUBIC FT.	LIST PRICE
FRASTCT24060	60 x 240 x 29	100	1113	116	\$46152
FRASTCT21660	60 x 216 x 29	100	1021	109	\$43698
FRASTCT19260	60 x 192 x 29	100	920	103	\$41052
FRASTCT16860	60 x 168 x 29	100	836	96	\$38311
FRASTCT21648	48 x 216 x 29	92.5	1000	92	\$40872
FRASTCT19248	48 x 192 x 29	100	843	87	\$38998

Six piece top. Three bases. Add **C** or **E** to end of model number to specify base feed location. Includes technology trough with 8 doors.

- 168"W table - midsection is one piece

BOARDROOM TABLES - WEDGE

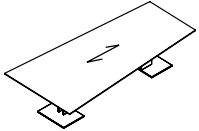

Wedge Table

MODEL#	DIMENSIONS	FREIGHT CLASS	WT/LBS.	CUBIC FT.	LIST PRICE
FWE1206048	60-48 x 120 x 29	100	511	60	\$14610

One piece top. Two bases.

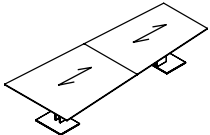

Wedge Table

FWE1446048	48 x 144 x 29	100	571	65	\$17793
FWE1206048-2	48 x 120 x 29	100	511	60	\$16134

Two piece top. Two bases.

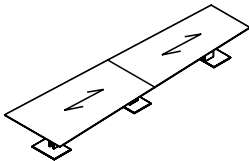

Wedge Table

FWE2406048	60-48 x 240 x 29	100	1037	114	\$28252
FWE2166048	60-48 x 216 x 29	100	965	109	\$26679
FWE1926048	60-48 x 192 x 29	100	893	104	\$25058
FWE1686048	60-48 x 168 x 29	100	630	70	\$23452

Two piece top. Three bases.

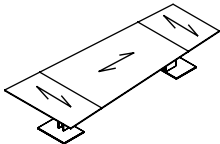

Wedge Table, Sectional

FWEST1446048	60-48 x 144 x 29	100	571	65	\$18132
FWEST1206048	60-48 x 120 x 29	100	511	60	\$16716

Three piece top. Two bases.

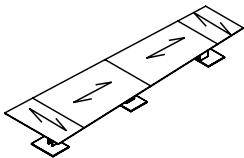

Wedge Table, Sectional

FWEST2406048	60-48 x 240 x 29	100	1037	114	\$28351
FWEST2166048	60-48 x 216 x 29	100	965	109	\$27254
FWEST1926048	60-48 x 192 x 29	100	893	104	\$26459
FWEST1686048	60-48 x 168 x 29	100	630	70	\$23726

Four piece top. Three bases.

- 168"W table - midsection is one piece

Required Specifications

Top finish/base side finish
Base end finish
Metal finish

Optional Specifications

Grommet

BOARDROOM TABLES - WEDGE

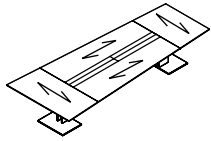

Wedge Table, Sectional*

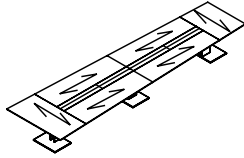

Wedge Table, Sectional*

MODEL#	DIMENSIONS	FREIGHT CLASS	WT/LBS.	CUBIC FT.	LIST PRICE
--------	------------	---------------	---------	-----------	------------

D x W x H

FWESTCT1446048	60-48 x 144 x 29	100	571	65	\$27541
FWESTCT1206048	60-48 x 120 x 29	100	511	60	\$22105

Four piece top. Two bases / power kit included. Includes technology trough with 4 doors

FWESTCT2406048	60 x 240 x 29	100	1037	114	\$40125
FWESTCT2166048	60 x 216 x 29	100	965	109	\$38007
FWESTCT1926048	60 x 192 x 29	100	893	104	\$35464
FWESTCT1686048	60 x 168 x 29	100	823	99	\$33352

Six piece top. Three bases. Add **C** or **E** to end of model number to specify base feed location. Includes technology trough with 8 doors.

- 168"W table - midsection is one piece

BOARDROOM TABLES - SQUARE

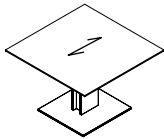

Square Table

MODEL#	DIMENSIONS	FREIGHT CLASS	WT/LBS.	CUBIC FT.	LIST PRICE
--------	------------	---------------	---------	-----------	------------

FRE6060	60 x 60 x 29	150	261	44	\$8518
FRE5454	54 x 54 x 29	150	233	42	\$7950
FRE4848	48 x 48 x 29	150	207	40	\$7354
FRE4242	42 x 42 x 29	150	185	39	\$6906

One base. No grommet option available.

BOARDROOM TABLES - ROUND

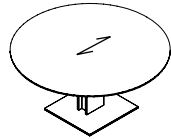

Round Table

MODEL#	DIMENSIONS	FREIGHT CLASS	WT/LBS.	CUBIC FT.	LIST PRICE
--------	------------	---------------	---------	-----------	------------

FRO60	60 x 60 x 29	150	261	44	\$8943
FRO54	54 x 54 x 29	150	233	42	\$8348
FRO48	48 x 48 x 29	150	207	40	\$7721
FRO42	42 x 42 x 29	150	185	39	\$7252

One base. No grommet option available.

Required Specifications

Top finish/base side finish
Base end finish
Metal finish

Optional Specifications

Grommet*

POWER/DATA



Single Sided Recessed Power Block

MODEL#	DIMENSIONS D x W x H	FREIGHT CLASS	WT/LBS.	CUBIC FT.	LIST PRICE
PRTMCS401B	4.22 x 10.78 x 4.86	100	4.3	0.51	\$456
PRTMCS401T	4.22 x 10.78 x 4.86	100	4.3	0.51	\$456
PRTMCS401W	4.22 x 10.78 x 4.86	100	4.3	0.51	\$456

Single-sided recessed power block with **one regular duplex and one telecom knockout on top; one power duplex on bottom**. 10' power cord with straight plug. Specify telecom options separately. Available in Black (**B**), Tungsten (**T**) or Designer White (**W**) as indicated by the last letter of model number. Duplexes always Grey. Corresponding cut-out options are **R1, R2** or **R3**. Units are not approved for daisy chaining. UL listed: UL 1363.



Single Sided Recessed Power Block - USB-A + USB-C

PRTMCS421B	4.22 x 10.78 x 4.86	100	4.3	0.51	\$599
PRTMCS421T	4.22 x 10.78 x 4.86	100	4.3	0.51	\$599
PRTMCS421W	4.22 x 10.78 x 4.86	100	4.3	0.51	\$599

Single-sided recessed power block with **one power/USB-A/USB-C duplex and one telecom knockout on top; one power duplex on bottom**. USB-A port charges max 2.4 amps at 5V and USB-C port charges max 3 amps at 5V. 10' power cord with straight plug. Specify telecom options separately. Available in Black (**B**), Tungsten (**T**) or Designer White (**W**) as indicated by the last letter of model number. Duplexes always Grey (duplex with USB ports is glossy finish). Corresponding cut-out options are **R1, R2** or **R3**. Units are not approved for daisy chaining. UL listed: UL 1363.



Double Sided Recessed Power Block

PRTMCD602B	6.22 x 10.78 x 4.86	92.5	5.9	0.51	\$521
PRTMCD602T	6.22 x 10.78 x 4.86	92.5	5.9	0.51	\$521
PRTMCD602W	6.22 x 10.78 x 4.86	92.5	5.9	0.51	\$521

Double-sided recessed power block with **two regular power duplexes and two telecom knockouts on top; one power duplex on bottom**. 10' power cord with straight plug. Specify telecom options separately. Available in Black (**B**), Tungsten (**T**) or Designer White (**W**) as indicated by last letter of model number. Duplexes always Grey. Corresponding cut-out options are **T1, T2** or **T3**. Units are not approved for daisy chaining. UL listed: UL 1363.



Double Sided Recessed Power Block - USB-A + USB-C

PRTMCD622B	6.22 x 10.78 x 4.86	92.5	6.1	0.51	\$656
PRTMCD622T	6.22 x 10.78 x 4.86	92.5	6.1	0.51	\$656
PRTMCD622W	6.22 x 10.78 x 4.86	92.5	6.1	0.51	\$656

Double-sided recessed power block with **one regular power duplex, one power/USB-A/USB-C duplex and two telecom knockouts on top; one power duplex on bottom**. USB-A port charges max 2.4 amps at 5V and USB-C port charges max 3 amps at 5V. 10' power cord with straight plug. Specify telecom options separately. Available in Black (**B**), Tungsten (**T**) or Designer White (**W**) as indicated by last letter of model number. Duplexes always Grey (duplex with USB ports is glossy finish). Corresponding cut-out options are **T1, T2** or **T3**. Units are not approved for daisy chaining. UL listed: UL 1363.



Double Sided Recessed Power Block - USB-A + USB-C

PRTMCD642B	6.22 x 10.78 x 4.86	85	6.3	0.51	\$790
PRTMCD642T	6.22 x 10.78 x 4.86	85	6.3	0.51	\$790
PRTMCD642W	6.22 x 10.78 x 4.86	85	6.3	0.51	\$790

Double-sided recessed power block with **two power/USB-A/USB-C duplexes and two telecom knockouts on top; one power duplex on bottom**. USB-A port charges max 2.4 amps at 5V and USB-C port charges max 3 amps at 5V. 10' power cord with straight plug. Specify telecom options separately. Available in Black (**B**), Tungsten (**T**) or Designer White (**W**) as indicated by last letter of model number. Duplexes always Grey (duplex with USB ports is glossy finish). Corresponding cut-out options are **T1, T2** or **T3**. Units are not approved for daisy chaining. UL listed: UL 1363.

Required Specifications

Finish

ACCESSORIES

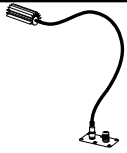

LED Snake Light with Dimmer

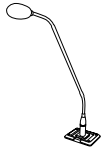

Microphone

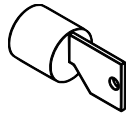

Lock Assembly

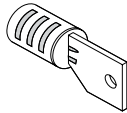

Lock Drum with Key

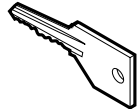

Extra Key



Grommet Cover Round

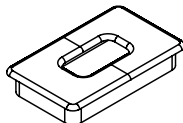

Grommet

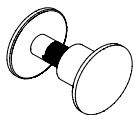

Quick Connector

MODEL#	DIMENSIONS	FREIGHT CLASS	WT/LBS.	CUBIC FT.	LIST PRICE
--------	------------	---------------	---------	-----------	------------

D x W x H

LIG400	2.5 x 6.5 x 13	70	1	1	\$381
--------	----------------	----	---	---	--------------

MIC400	2 x 2 x 24	70	1	1	\$995
--------	------------	----	---	---	--------------

LO/C	--	70	--	--	\$106
------	----	----	----	----	--------------

Tungsten.

LOB/C	--	70	--	--	\$44
-------	----	----	----	----	-------------

Tungsten.

LOCK	--	70	--	--	\$43
------	----	----	----	----	-------------

Specify key #. Key range 401 - 420.

GM1	2 dia x --	70	--	--	\$65
-----	------------	----	----	----	-------------

GM1K	2 dia x --	70	--	--	\$65
------	------------	----	----	----	-------------

2.75" diameter.

• **Specify GM1 for Black or GM1K for Tungsten.**

GM5C	2 x 3.5 x --	70	--	--	\$107
------	--------------	----	----	----	--------------

Rectangular grommet in metal, tungsten finish.

QC50	--	70	.01	.01	\$10
------	----	----	-----	-----	-------------

QC30	--	70	.01	.01	\$10
------	----	----	-----	-----	-------------

Required Specifications

Top finish
Body finish

Optional Specifications

Grommet
Modesty Panel

F FOUNDATIONS

ACCESSORIES

MODEL#

DIMENSIONS

FREIGHT CLASS

WT/LBS.

CUBIC FT.

LIST PRICE

D x W x H