



The **Dufferin** series is a unique entity in that it integrates wood veneer and laminate. Worksurfaces, drawer and cabinet fronts use genuine wood veneer while the chassis and cabinets are finished in your choice of laminate or wood veneer. The result is a rich, two tone appearance to coordinate with any contemporary business interior.

Key features include a two inch knife edge providing clean, crisp detailing, grommets, a reverse profile/self edge edge on connecting worksurfaces, square or round post leg on islands, base and modesty panel upgrades and endless electrical options.

Storage options are available in 29", 48", 54", 66", 72" and 84" heights. Various models include storage cabinets, file modules, mixed storage cabinets, open shelving, wardrobe cabinets and personal towers.

Above worksurface storage selections include overhead storage and hutches with or without pigeon-hole storage. Hutch doors are available in a choice of veneer or glass with an aluminum frame. Tackboards are offered in all fabric or with a built-in accessory rail for organizing folders, binders, cds and more!



Contemporary **two inch overhang knife edge** on user and guest sides. Self-edge veneer on ends and wall sides.



Optional **base upgrades** include a rectangular two tone base (shown) and elliptical base. Available on most islands.

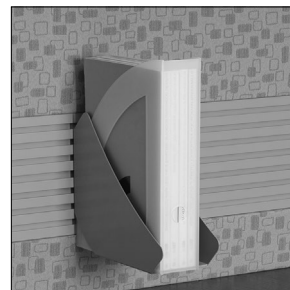

Tackboards with **accessory rails** accommodate letter trays, binder bins and file holders.



**Features and Benefits**

- Choice of ten handle options on every door/drawer that features handles
- Modesty panel options include veneer and straight glass (translucent) tungsten frame.
- Base upgrades to replace standard monopost on islands are available in four styles
- Drawers are standard vinyl-wrapped construction with black drawer sides and bottom.
- 75 lb box - 150 lb. file drawer weight capacity with full height sides with pencil tray included in box drawer
- Lateral file drawers can accommodate legal or letter documents
- Premium full extension progressive ball bearing slides on file drawers
- Box drawers mounted on 3/4 extension premium ball bearing slides.
- Power / Data accessories are available to be factory installed on any Dufferin unit, including Boardroom Tables, to meet all today's technological requirements
- A full array of complementary Boardroom and Reception area furnishings are available to coordinate the entire office

**GENERAL INFORMATION**

- Dufferin is a veneer and laminate desking system composed of hundreds of models, capable of furnishing executive suites, boardrooms and reception areas.
- 1 3/16" thick worksurfaces utilizing pedestal and panel construction with top over side panel design.
- Full modesty panels on desks are available in either a straight or breakfront style
- For environmental certification, please visit [globalfurnituregroup.com](http://globalfurnituregroup.com)

**WORKSURFACES**

- Standard with 1 3/16" top thickness
- All surfaces constructed from grade "A" veneers
- All top surfaces feature a contemporary 2" overhang knife edge on user and guest sides. Self-edge veneer on ends and wall sides.

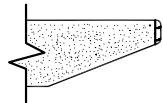

Contemporary 2" overhanging knife edge

**CONSTRUCTION**

- "Number one select, architectural grade A" oak, American black walnut, American black cherry, hard maple and lyptus. Wood worksurface molded edges are solid oak, walnut, cherry, maple or lyptus (except where square self-edges exist, i.e. credenza and computer worksurface back edges that are most commonly against walls).

**FINISHES**

- Conversion varnish (similar to catalyzed lacquer, but tougher), 35 to 40 degree sheen. Finishes are not buffed or rubbed.
- All Global wood casegood products are veneered and finished on the back sides (360° finishing), except modular under-surface storage - tops and backs are unfinished.
- Touch up kits available, includes a touch up marker and fill crayon. Order **VTUCHUPKIT, \$164** list. Specify finish when ordering.
- Global standard finish, on oak and walnut, is open pore and on cherry and maple is semi-closed pore. If a full finish is required for walnut, cherry, anigre and maple tops, Add the suffix "2" to the finish code and Add 5% to the base pricing for each product. **CUSTOM FINISH IS AVAILABLE.**
- High Pressure laminate inlays are available at no upcharge. Contact Customer Care for specification information.

**PEDESTALS**

- Black embossed vinyl-wrapped construction drawer sides and bottom are standard.
- All pedestals are full to floor and locking.
- Double pedestal models feature a choice of four drawer configurations: two file/file pedestals (EE), two box/box/file pedestals (DD), file/file on left, box/box/file on right (ED), or file/file on right, box/box/file on left (DE).
- Single pedestal models feature a choice of two drawer configurations: one file/file pedestal (E) or one box/box/file pedestal (D) on the left or right.

**HARDWARE**

- All necessary hardware items for attaching furniture items are included in the shipment. Actual wall attachment fasteners for wall cabinets, tackboards and visualboards are not included due to variation between site conditions.
- **Leveling glides** are shipped in a plastic bag attached to the bottom of the item or inside the pedestal. It is important to install leveling glides to ensure the unit is level. Levelers have a 1" range of adjustment.

- **Hanging file rails** are pre-installed on file drawer perimeters with additional front-to-back rails found in the bottom of the filing drawers. These rails hang onto plastic clips and do not require any tools to install. Legal filing can be achieved either as side-to-side or front-to-back. Letter filing can be achieved as front-to-back filing only.
- **Flat plates** for attaching bridge and return to desk are shipped pre-attached to the bottom of the bridge or return. **Mini flat plates** for securing bridge modesty panels to desk or credenza end panels, and quick connectors for securing modular corner units to adjacent pieces (Dufferin Series) are shipped along with screws in a plastic bag attached to the bottom of the bridge or return. **CAUTION:** using screws other than those supplied by Global could result in damage to finished tops.

**LOCKS**

- Locks are standard on all "below worksurface level" drawer and door storage units with the exception of the stationary organizer, pull-out tray units and single lateral file drawer combination tray/slot units. Combination storage unit comes with lock for file and lateral file drawer only, box drawers cannot lock.
- Optional locks may be ordered on all "above worksurface level" closed storage, Factory Installed. Please specify **LO, add \$134.**

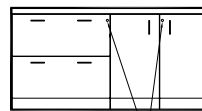
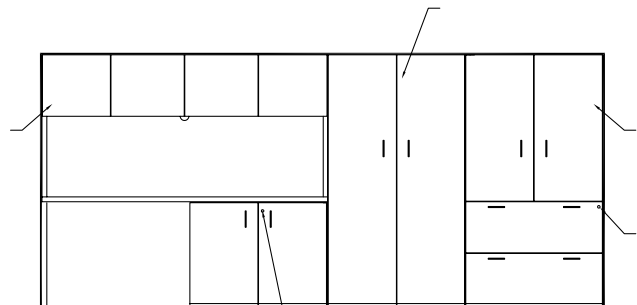

**DCF7224**

Style Credenza: File lock is on the inside gable behind the bookcase door. Lock for doors is on the front.

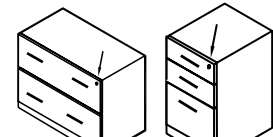

**DWF**

**DWD**

Modular Furniture: Lock is on the front

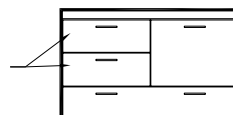

**DZ3622**

Combination storage unit Z comes with lock for file and lateral file drawer only, box drawers cannot lock.

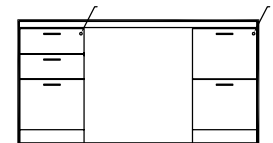

**DD7236DE**

Fully assembled furniture: Lock for D and E pedestals are inside the gable.

## 1. SPECIFY MODEL NUMBER

## 2. SPECIFY FINISH

### WORKSURFACE TOP & DRAWER/DOOR FRONTS, BODY FINISHES (including pedestals)

#### VENEER:

Code	Finish	Veneer Type	Cut
AMW	Almond Cherry	Cherry	Flat Sliced
ACW	Amber Cherry	Cherry	Flat Sliced
BTW	Biscotti	White Oak	Rift
CAW	Cocoa Walnut	Walnut	Flat Sliced
CRW	Coral	White Oak	Rift
DCW	Dark Cherry	Cherry	Flat Sliced
DWW	Dark Walnut	Walnut	Flat Sliced
EWV	Espresso Walnut	Walnut	Flat Sliced
EVW	Evening Oak	White Oak	Rift
GRW	Grey on Oak	White Oak	Rift
HAW	Hazelnut	Maple	Flat Sliced
JAW	Java	White Oak	Rift
LTW	Latte Walnut	Walnut	Flat Sliced
MHW	Mahogany on Walnut	Walnut	Flat Sliced
MTW	Milestone	White Oak	Rift
MPW	Natural Maple	Maple	Flat Sliced
NLW	Natural Walnut	Walnut	Flat Sliced
RCW	Red Cherry	Cherry	Flat Sliced
VNW	Vintage Cherry	Cherry	Flat Sliced
ULW	Umber Walnut	Walnut	Flat Sliced
WLW	Walnut	Walnut	Flat Sliced
WCW	Warm Cherry	Cherry	Flat Sliced
WMW	White Maple	Maple	Flat Sliced

#### BODY FINISHES (INCLUDING PEDESTALS) - LAMINATE:

BLK	Black
BZD	Blizzard
CGY	Custom Grey
DWT	Designer White
SDT	Stonedust
STG	String
SOG	Storm Grey

#### MONOPOST FINISHES:

E	Black
K	Tungsten

## 3. SPECIFY OPTIONS

### Handles

- Handles are standard on most drawers/storage modules. Each handle is identified by letters: **PL33, PL34, PL64, PL66, PL92, PL93, PL94, PL95, PL96, PL97, PL98, PL99, PLS7, and PLS8**. To specify a handle, specify the code after the model number and finish selections.



**PL33** Black Moon Pull



**PL34** Nickel Moon Pull



**PL64** Contemporary Nickel



**PL66** Transitional Nickel



**PL92** Silver Bar

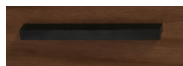

**PL93** Black Bar



**PL94** Silver Rectangular



**PL95** Black Rectangular



**PL96** Silver Slimline Pull



**PL97** Black Slimline Pull



**PL98** Silver Princeton Bar



**PL99** Black Princeton Bar



**PLS7** Black Spaghetti



**PLS8** Silver Spaghetti

### Grommets

- Standard grommet on all components is GM1. Grommet is included with products where shown in line drawings in price book.
- Optional grommets may be ordered in standard worksurface locations (left, center or right). Order as **GM1TL, GM1TC or GM1TR**. Add \$96.
- Grommet hole dimensions are 2 3/4" in diameter. Specify **GM1E** for **Black** or **GM1K** for **Tungsten**.
- Color of grommet will be automatically coordinated with handle color where applicable

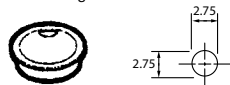

- Components that come standard with grommet may be ordered without a grommet. Order as RSG - Add \$53.

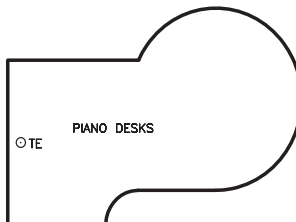
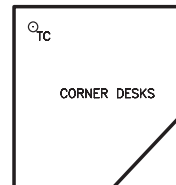
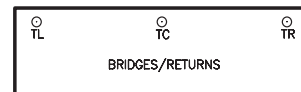
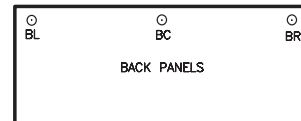
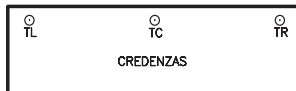
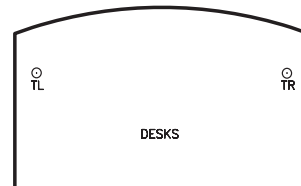

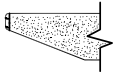

● Molding Edge

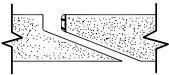

■ Reverse Profile / Molding Edge



▼ Self Edge Joint

- D - Desks and Credenzas
- B - Executive Bridges
- E - Executive Returns
- C - Corner Components
- L - Linking Bridges
- P - Piano Desks

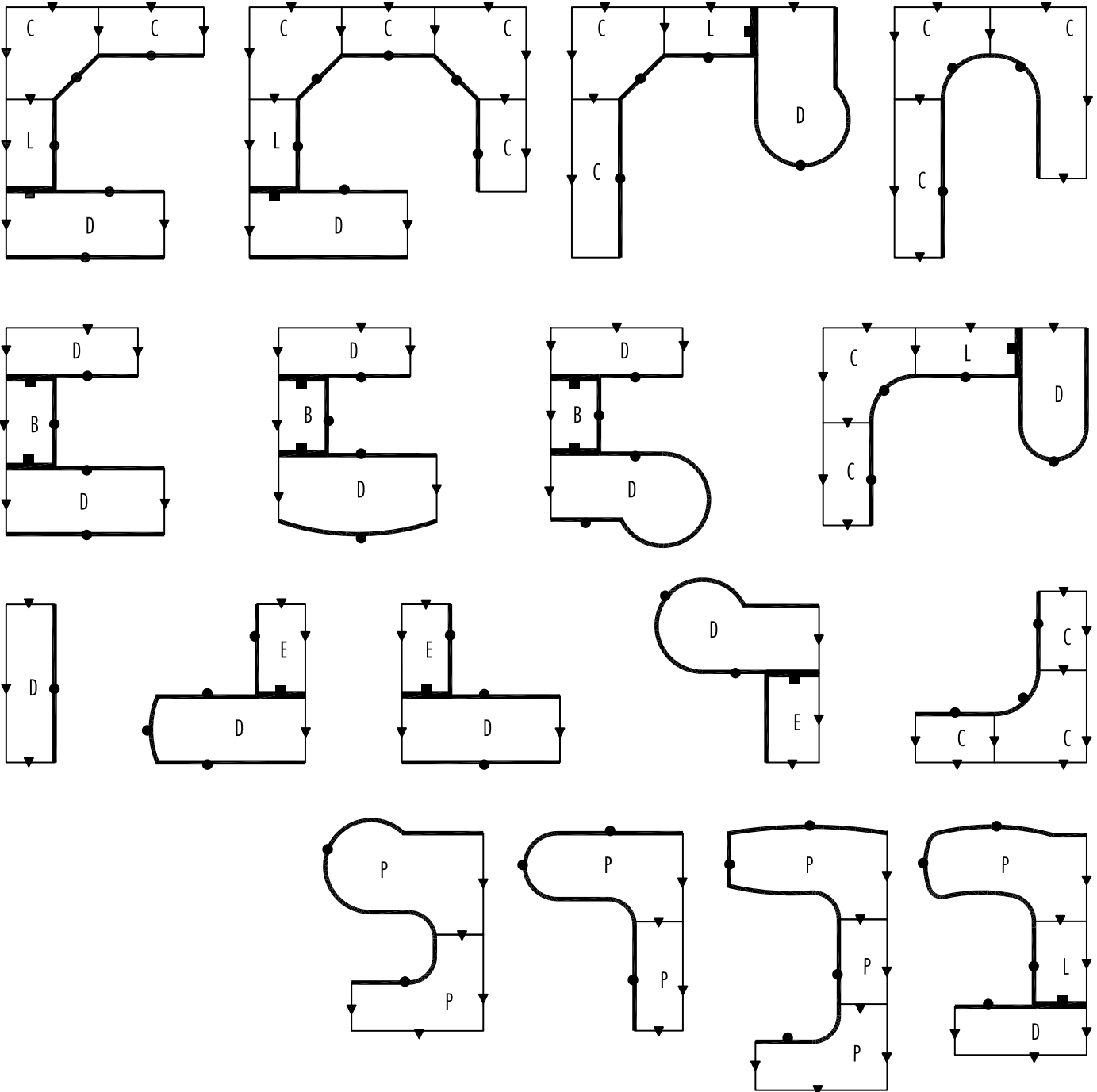

# D DUFFERIN

## DOUBLE PEDESTAL DESKS

### MODEL#

### DIMENSIONS

### FREIGHT CLASS

### WT/LBS.

### CUBIC FT.

### VENEER/LAMINATE

### ALL VENEER

D x W x H

- Can be ordered as a shell or with pedestals.
- Grommets are available an option on Desks and most Credenzas.
- Hand of Rectangular Desk is determined by location of pedestal from user side.
- Hand of "P" Top is determined by outward orientation of conference end from user projection.

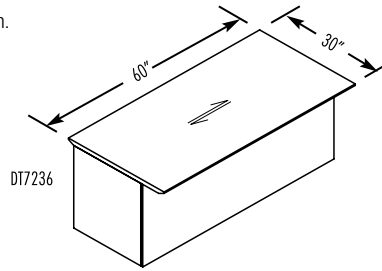
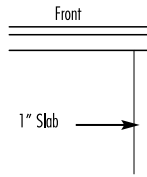
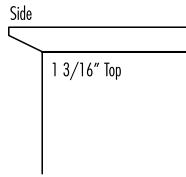
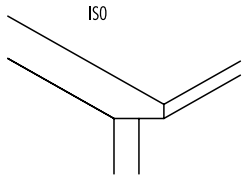

### MODESTY PANEL CLEARANCE:

DT7236

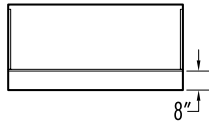

DT7230

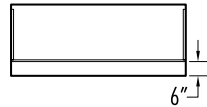

DMT7242

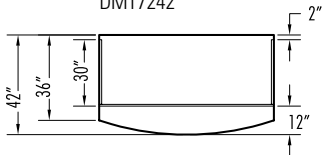

DMT6636

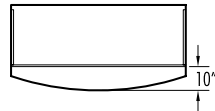

DISR8442D

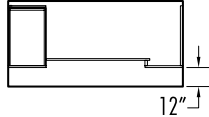

DISR7230D

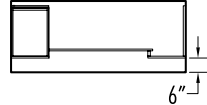

DDD7236



DDDBE7236



DDDBS7236



DTPL7242 (left shown)

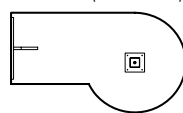

### DESK MODESTY OPTIONS:

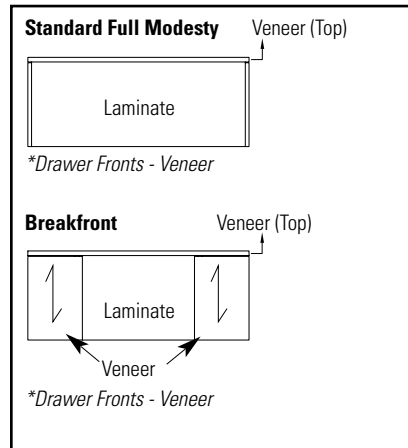

### Breakfront Style - Modesty

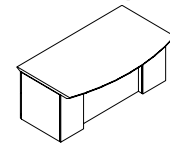

view from guest side

### Standard Full Modesty

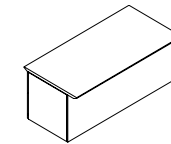

view from guest side

## DOUBLE PEDESTAL DESKS - RECESSED FRONT MODESTY

### DIMENSIONS

### FREIGHT CLASS

### WT/LBS.

### CUBIC FT.

### VENEER/LAMINATE

### ALL VENEER

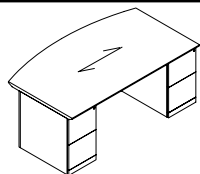

### Double Pedestal Bow Top Desk

MODEL#	DIMENSIONS	FREIGHT CLASS	WT/LBS.	CUBIC FT.	VENEER/LAMINATE	ALL VENEER
DMD8442EE	42 x 84 x 29	125	443	59	<b>\$6132</b>	<b>\$7359</b>
DMD7842EE	42 x 78 x 29	125	412	55	<b>\$5691</b>	<b>\$6829</b>
DMD7242EE	42 x 72 x 29	125	380	51	<b>\$5256</b>	<b>\$6306</b>
DMD6636EE	36 x 66 x 29	125	240	40	<b>\$5098</b>	<b>\$6116</b>

Standard with full to floor **file/file** pedestals on **left and right**. Bow top. Pedestals lock. Refer to the Desks and Credenzas Notes above for overhang dimensions.

### Required Specifications

Veneer Finish  
Laminate Finish  
Handle Style

### Optional Specifications

Grommet

**DOUBLE PEDESTAL DESKS**

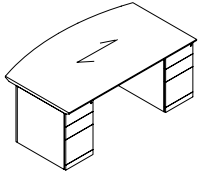

**Double Pedestal Bow Top Desk**

MODEL#	DIMENSIONS	FREIGHT CLASS	WT./LBS.	CUBIC FT.	VENEER/LAMINATE	ALL VENEER
<b>D x W x H</b>						
DMD8442DD	42 x 84 x 29	125	443	59	<b>\$6132</b>	<b>\$7359</b>
DMD7842DD	42 x 78 x 29	125	412	55	<b>\$5691</b>	<b>\$6829</b>
DMD7242DD	42 x 72 x 29	125	380	51	<b>\$5256</b>	<b>\$6306</b>
DMD6636DD	36 x 66 x 29	125	240	40	<b>\$5098</b>	<b>\$6116</b>

Standard with full to floor **box/box/file** pedestals on **left** and **right**. Bow top. Pedestals lock. One pencil tray. Refer to the Desks and Credenzas Notes Section on previous page for overhang dimensions.

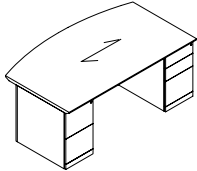

**Double Pedestal Bow Top Desk**

DMD8442ED	42 x 84 x 29	125	443	59	<b>\$6132</b>	<b>\$7359</b>
DMD7842ED	42 x 78 x 29	125	412	55	<b>\$5691</b>	<b>\$6829</b>
DMD7242ED	42 x 72 x 29	125	380	51	<b>\$5256</b>	<b>\$6306</b>
DMD6636ED	36 x 66 x 29	125	240	40	<b>\$5098</b>	<b>\$6116</b>

Standard with full to floor **file/file** pedestal on **left** and **box/box/file** pedestal on **right**. Bow top. Pedestals lock. One pencil tray. Refer to the Desks and Credenzas Notes Section on previous page for overhang dimensions.

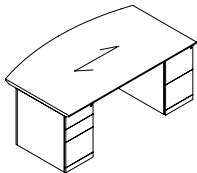

**Double Pedestal Bow Top Desk**

DMD8442DE	42 x 84 x 29	125	443	59	<b>\$6132</b>	<b>\$7359</b>
DMD7842DE	42 x 78 x 29	125	412	55	<b>\$5691</b>	<b>\$6829</b>
DMD7242DE	42 x 72 x 29	125	380	51	<b>\$5256</b>	<b>\$6306</b>
DMD6636DE	36 x 66 x 29	125	240	40	<b>\$5098</b>	<b>\$6116</b>

Standard with full to floor **box/box/file** pedestal on **left** and **file/file** pedestal on **right**. Bow top. Pedestals lock. One pencil tray. Refer to the Desks and Credenzas Notes Section on previous page for overhang dimensions.

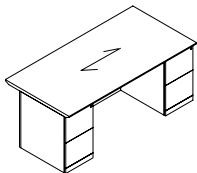

**Double Pedestal Desk**

DD8442EE	42 x 84 x 29	125	432	59	<b>\$5213</b>	<b>\$6255</b>
DD7842EE	42 x 78 x 29	125	401	55	<b>\$4843</b>	<b>\$5808</b>
DD7236EE	36 x 72 x 29	100	370	44	<b>\$4470</b>	<b>\$5362</b>
DD7230EE	30 x 72 x 29	100	349	36	<b>\$4399</b>	<b>\$5280</b>
DD6636EE	36 x 66 x 29	100	339	40	<b>\$4399</b>	<b>\$5280</b>
DD6630EE	30 x 66 x 29	100	320	33	<b>\$4330</b>	<b>\$5196</b>
DD6030EE	30 x 60 x 29	92.5	305	30	<b>\$4195</b>	<b>\$5035</b>

Standard with full to floor **file/file** pedestals on **left** and **right**. Pedestals lock. Refer to the Desks and Credenzas Notes Section on previous page for overhang dimensions.

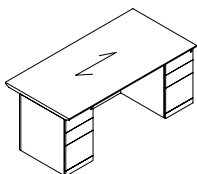

**Double Pedestal Desk**

DD8442DD	42 x 84 x 29	125	432	59	<b>\$5213</b>	<b>\$6255</b>
DD7842DD	42 x 78 x 29	125	401	55	<b>\$4843</b>	<b>\$5808</b>
DD7236DD	36 x 72 x 29	100	370	44	<b>\$4470</b>	<b>\$5362</b>
DD7230DD	30 x 72 x 29	100	349	36	<b>\$4399</b>	<b>\$5280</b>
DD6636DD	36 x 66 x 29	100	339	40	<b>\$4399</b>	<b>\$5280</b>
DD6630DD	30 x 66 x 29	100	320	33	<b>\$4330</b>	<b>\$5196</b>
DD6030DD	30 x 60 x 29	92.5	305	30	<b>\$4195</b>	<b>\$5035</b>

Standard with full to floor **box/box/file** pedestals on **left** and **right**. Pedestals lock. Refer to the Desks and Credenzas Notes Section on previous page for overhang dimensions.

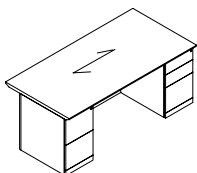

**Double Pedestal Desk**

DD8442ED	42 x 84 x 29	125	432	59	<b>\$5213</b>	<b>\$6255</b>
DD7842ED	42 x 78 x 29	125	401	55	<b>\$4843</b>	<b>\$5808</b>
DD7236ED	36 x 72 x 29	100	370	44	<b>\$4470</b>	<b>\$5362</b>
DD7230ED	30 x 72 x 29	100	349	36	<b>\$4399</b>	<b>\$5280</b>
DD6636ED	36 x 66 x 29	100	339	40	<b>\$4399</b>	<b>\$5280</b>
DD6630ED	30 x 66 x 29	100	320	33	<b>\$4330</b>	<b>\$5196</b>
DD6030ED	30 x 60 x 29	92.5	305	30	<b>\$4195</b>	<b>\$5035</b>

Standard with full to floor **file/file** pedestal on **left** and **box/box/file** pedestal on **right**. Pedestals lock. Refer to the Desks and Credenzas Notes Section on previous page for overhang dimensions.

**Required Specifications**

Veneer Finish  
Laminate Finish  
Handle Style

**Optional Specifications**

Grommet

DOUBLE PEDESTAL DESKS

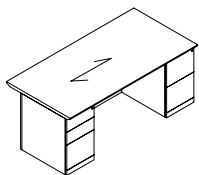

Double Pedestal Desk

MODEL#	DIMENSIONS	FREIGHT CLASS	WT/LBS.	CUBIC FT.	VENEER/LAMINATE	ALL VENEER
	<b>D x W x H</b>					
DD8442DE	42 x 84 x 29	125	432	59	\$5213	\$6255
DD7842DE	42 x 78 x 29	125	401	55	\$4843	\$5808
DD7236DE	36 x 72 x 29	100	370	44	\$4470	\$5362
DD7230DE	30 x 72 x 29	100	349	36	\$4399	\$5280
DD6636DE	36 x 66 x 29	100	339	40	\$4399	\$5280
DD6630DE	30 x 66 x 29	100	320	33	\$4330	\$5196
DD6030DE	30 x 60 x 29	92.5	305	30	\$4195	\$5035

Standard with full to floor **box/box/file** pedestal on **left** and **file/file** pedestal on **right**. Pedestals lock. Refer to the Desks and Credenzas Notes Section on page 64 for overhang dimensions.

DOUBLE PEDESTAL DESKS - BREAKFRONT STYLE

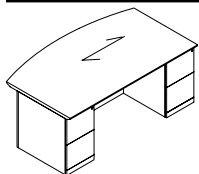

Double Pedestal Bow Top Desk Breakfront Style

MODEL#	DIMENSIONS	FREIGHT CLASS	WT/LBS.	CUBIC FT.	VENEER/LAMINATE	ALL VENEER
DMID8442EE	42 x 84 x 29	125	443	59	\$7279	\$8733
DMID7842EE	42 x 78 x 29	125	412	55	\$6758	\$8111
DMID7242EE	42 x 72 x 29	125	380	51	\$6241	\$7488
DMID6636EE	36 x 66 x 29	125	240	40	\$5609	\$6731

Standard with full to floor **file/file** pedestals on **left** and **right**. Bow top. Pedestals lock. Refer to the Desks and Credenzas Notes Section on page 64. for overhang dimensions.

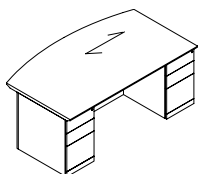

Double Pedestal Bow Top Desk Breakfront Style

DMID8442DD	42 x 84 x 29	125	443	59	\$7279	\$8733
DMID7842DD	42 x 78 x 29	125	412	55	\$6758	\$8111
DMID7242DD	42 x 72 x 29	125	380	51	\$6241	\$7488
DMID6636DD	36 x 66 x 29	125	240	40	\$5609	\$6731

Standard with full to floor **box/box/file** pedestals on **left** and **right**. Bow top. Pedestals lock. Refer to the Desks and Credenzas Notes Section on page 64. for overhang dimensions.

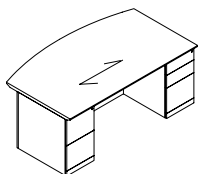

Double Pedestal Bow Top Desk Breakfront Style

DMID8442ED	42 x 84 x 29	125	443	59	\$7279	\$8733
DMID7842ED	42 x 78 x 29	125	412	55	\$6758	\$8111
DMID7242ED	42 x 72 x 29	125	380	51	\$6241	\$7488
DMID6636ED	36 x 66 x 29	125	240	40	\$5609	\$6731

Standard with full to floor **file/file** pedestal on **left** and **box/box/file** pedestal on **right**. Bow top. Pedestals lock. One pencil tray. Refer to the Desks and Credenzas Notes Section on page 64 for overhang dimensions.

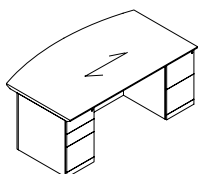

Double Pedestal Bow Top Desk Breakfront Style

DMID8442DE	42 x 84 x 29	125	443	59	\$7279	\$8733
DMID7842DE	42 x 78 x 29	125	412	55	\$6758	\$8111
DMID7242DE	42 x 72 x 29	125	380	51	\$6566	\$7881
DMID6636DE	36 x 66 x 29	125	240	40	\$5609	\$6731

Standard with full to floor **box/box/file** pedestal on **left** and **file/file** pedestal on **right**. Bow top. Pedestals lock. One pencil tray. Refer to the Desks and Credenzas Notes Section on page 64 for overhang dimensions.

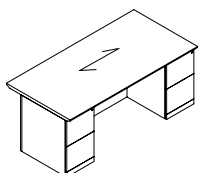

Double Pedestal Desk, Breakfront Style

DID8442EE	42 x 84 x 29	125	432	59	\$7160	\$8591
DID7842EE	42 x 78 x 29	125	401	55	\$6643	\$7975
DID7236EE	36 x 72 x 29	100	370	44	\$5308	\$6368
DID7230EE	30 x 72 x 29	100	349	36	\$5227	\$6269
DID6636EE	36 x 66 x 29	100	339	40	\$5227	\$6269
DID6630EE	30 x 66 x 29	100	320	33	\$5142	\$6170
DID6030EE	30 x 60 x 29	92.5	305	30	\$4982	\$5976

Standard with full to floor **file/file** pedestals on **left** and **right**. Pedestals lock. Refer to the Desks and Credenzas Notes Section on page 64 for overhang dimensions.

Required Specifications

Veneer Finish  
Laminate Finish  
Handle Style

Optional Specifications

Grommet

**DOUBLE PEDESTAL DESKS - BREAKFRONT STYLE**

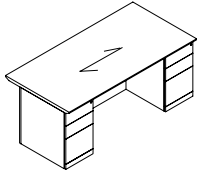

**Double Pedestal Desk, Breakfront Style**

MODEL#	DIMENSIONS	FREIGHT CLASS	WT/LBS.	CUBIC FT.	veneer/LAMINATE	ALL VENEER
	<b>D x W x H</b>					
DID8442DD	42 x 84 x 29	125	432	59	<b>\$7160</b>	<b>\$8591</b>
DID7842DD	42 x 78 x 29	125	401	55	<b>\$6643</b>	<b>\$7975</b>
DID7236DD	36 x 72 x 29	100	370	44	<b>\$5308</b>	<b>\$6368</b>
DID7230DD	30 x 72 x 29	100	349	36	<b>\$5227</b>	<b>\$6269</b>
DID6636DD	36 x 66 x 29	100	339	40	<b>\$5227</b>	<b>\$6269</b>
DID6630DD	30 x 66 x 29	100	320	33	<b>\$5142</b>	<b>\$6170</b>
DID6030DD	30 x 60 x 29	92.5	305	30	<b>\$4982</b>	<b>\$5976</b>

Standard with full to floor **box/box/file** pedestals on **left** and **right**. Pedestals lock. Refer to the Desks and Credenzas Notes Section on page 64 for overhang dimensions.

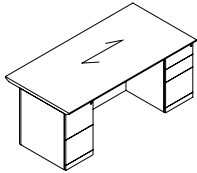

**Double Pedestal Desk, Breakfront Style**

DID8442ED	42 x 84 x 29	125	432	59	<b>\$7160</b>	<b>\$8591</b>
DID7842ED	42 x 78 x 29	125	401	55	<b>\$6643</b>	<b>\$7975</b>
DID7236ED	36 x 72 x 29	100	370	44	<b>\$5308</b>	<b>\$6368</b>
DID7230ED	30 x 72 x 29	100	349	36	<b>\$5227</b>	<b>\$6269</b>
DID6636ED	36 x 66 x 29	100	339	40	<b>\$5308</b>	<b>\$6368</b>
DID6630ED	30 x 66 x 29	100	320	33	<b>\$5142</b>	<b>\$6170</b>
DID6030ED	30 x 60 x 29	92.5	305	30	<b>\$4982</b>	<b>\$5976</b>

Standard with full to floor **file/file** pedestal on **left** and **box/box/file** pedestal on **right**. Pedestals lock. Refer to the Desks and Credenzas Notes Section on page 64 for overhang dimensions.

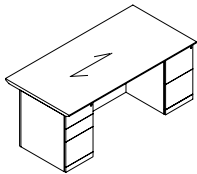

**Double Pedestal Desk, Breakfront Style**

DID8442DE	42 x 84 x 29	125	432	59	<b>\$7160</b>	<b>\$8591</b>
DID7842DE	42 x 78 x 29	125	401	55	<b>\$6643</b>	<b>\$7975</b>
DID7236DE	36 x 72 x 29	100	370	44	<b>\$5308</b>	<b>\$6368</b>
DID7230DE	30 x 72 x 29	100	349	36	<b>\$5227</b>	<b>\$6269</b>
DID6636DE	36 x 66 x 29	100	339	40	<b>\$5227</b>	<b>\$6269</b>
DID6630DE	30 x 66 x 29	100	320	33	<b>\$5142</b>	<b>\$6170</b>
DID6030DE	30 x 60 x 29	92.5	305	30	<b>\$4982</b>	<b>\$5976</b>

Standard with full to floor **box/box/file** pedestal on **left** and **file/file** pedestal on **right**. Pedestals lock. Refer to the Desks and Credenzas Notes Section on page 64 for overhang dimensions.

**SINGLE PEDESTAL DESKS - RECESSED FRONT MODESTY**

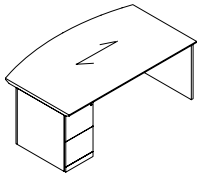

**Single Pedestal Bow Top Desk - LEFT**

	DIMENSIONS	FREIGHT CLASS	WT/LBS.	CUBIC FT.	veneer/LAMINATE	ALL VENEER
DMSL8442E	42 x 84 x 29	125	432	59	<b>\$5769</b>	<b>\$6922</b>
DMSL7842E	42 x 78 x 29	125	401	55	<b>\$5360</b>	<b>\$6434</b>
DMSL7242E	42 x 72 x 29	125	370	51	<b>\$4948</b>	<b>\$5938</b>
DMSL6636E	36 x 66 x 29	150	230	40	<b>\$4759</b>	<b>\$5708</b>

Standard with full to floor **file/file** pedestal on **left**. Bow top. Pedestal locks. Refer to the Desks and Credenzas Notes Section on page 64 for overhang dimensions.

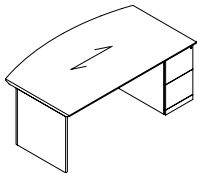

**Single Pedestal Bow Top Desk - RIGHT**

DMSR8442E	42 x 84 x 29	125	432	59	<b>\$5769</b>	<b>\$6922</b>
DMSR7842E	42 x 78 x 29	125	401	55	<b>\$5360</b>	<b>\$6434</b>
DMSR7242E	42 x 72 x 29	125	370	51	<b>\$4948</b>	<b>\$5938</b>
DMSR6636E	36 x 66 x 29	150	230	40	<b>\$4759</b>	<b>\$5708</b>

Standard with full to floor **file/file** pedestal on **right**. Bow top. Pedestal locks. Refer to the Desks and Credenzas Notes Section on page 64 for overhang dimensions.

**Required Specifications**

Veneer Finish  
Laminate Finish  
Handle Style

**Optional Specifications**

Grommet



SINGLE PEDESTAL DESKS

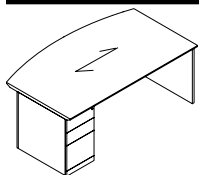

Single Pedestal Bow Top Desk - LEFT

MODEL#	DIMENSIONS D x W x H	FREIGHT CLASS	WT/LBS.	CUBIC FT.	VENEER/LAMINATE	ALL VENEER
DMSL8442D	42 x 84 x 29	125	432	59	<b>\$5769</b>	<b>\$6922</b>
DMSL7842D	42 x 78 x 29	125	401	55	<b>\$5360</b>	<b>\$6434</b>
DMSL7242D	42 x 72 x 29	125	370	51	<b>\$4948</b>	<b>\$5938</b>
DMSL6636D	36 x 66 x 29	150	230	40	<b>\$4759</b>	<b>\$5708</b>

Standard with full to floor **box/box/file** pedestal on **left**. Bow top. Pedestal locks. Refer to the Desks and Credenzas Notes Section on page 64 for overhang dimensions.

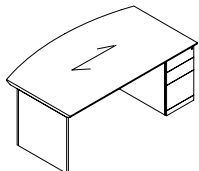

Single Pedestal Bow Top Desk - RIGHT

DMSR8442D	42 x 84 x 29	125	432	59	<b>\$5769</b>	<b>\$6922</b>
DMSR7842D	42 x 78 x 29	125	401	55	<b>\$5360</b>	<b>\$6434</b>
DMSR7242D	42 x 72 x 29	125	370	51	<b>\$4948</b>	<b>\$5938</b>
DMSR6636D	36 x 66 x 29	150	230	40	<b>\$4759</b>	<b>\$5708</b>

Standard with full to floor **box/box/file** pedestal on **right**. Bow top. Pedestal locks. Refer to the Desks and Credenzas Notes Section on page 64 for overhang dimensions.

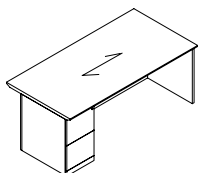

Single Pedestal Desk - LEFT

DSL8442E	42 x 84 x 29	125	463	59	<b>\$4636</b>	<b>\$5561</b>
DSL7842E	42 x 78 x 29	125	430	55	<b>\$4304</b>	<b>\$5165</b>
DSL7236E	36 x 72 x 29	125	340	44	<b>\$3407</b>	<b>\$4086</b>
DSL7230E	30 x 72 x 29	125	283	36	<b>\$3258</b>	<b>\$3909</b>
DSL6636E	36 x 66 x 29	125	312	40	<b>\$3258</b>	<b>\$3909</b>
DSL6630E	30 x 66 x 29	100	295	33	<b>\$3109</b>	<b>\$3731</b>
DSL6030E	30 x 60 x 29	100	265	30	<b>\$2969</b>	<b>\$3563</b>

Standard with full to floor **file/file** pedestal on **left**. Pedestal locks. Refer to the Desks and Credenzas Notes Section on page 64 for overhang dimensions.

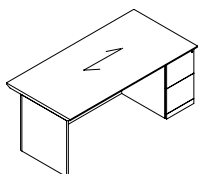

Single Pedestal Desk - RIGHT

DSR8442E	42 x 84 x 29	125	463	59	<b>\$4636</b>	<b>\$5561</b>
DSR7842E	42 x 78 x 29	125	430	55	<b>\$4304</b>	<b>\$5165</b>
DSR7236E	36 x 72 x 29	125	340	44	<b>\$3407</b>	<b>\$4086</b>
DSR7230E	30 x 72 x 29	125	283	36	<b>\$3258</b>	<b>\$3909</b>
DSR6636E	36 x 66 x 29	125	312	40	<b>\$3258</b>	<b>\$3909</b>
DSR6630E	30 x 66 x 29	100	295	33	<b>\$3109</b>	<b>\$3731</b>
DSR6030E	30 x 60 x 29	100	265	30	<b>\$2969</b>	<b>\$3563</b>

Standard with full to floor **file/file** pedestal on **right**. Pedestal locks. Refer to the Desks and Credenzas Notes Section on page 64 for overhang dimensions.

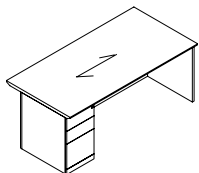

Single Pedestal Desk - LEFT

DSL8442D	42 x 84 x 29	125	463	59	<b>\$4636</b>	<b>\$5561</b>
DSL7842D	42 x 78 x 29	125	430	55	<b>\$4304</b>	<b>\$5165</b>
DSL7236D	36 x 72 x 29	125	340	44	<b>\$3407</b>	<b>\$4086</b>
DSL7230D	30 x 72 x 29	125	283	36	<b>\$3258</b>	<b>\$3909</b>
DSL6636D	36 x 66 x 29	125	312	40	<b>\$3258</b>	<b>\$3909</b>
DSL6630D	30 x 66 x 29	100	295	33	<b>\$3109</b>	<b>\$3731</b>
DSL6030D	30 x 60 x 29	100	265	30	<b>\$2969</b>	<b>\$3563</b>

Standard with full to floor **box/box/file** pedestal on **left**. Pedestal locks. Refer to the Desks and Credenzas Notes Section on page 64 for overhang dimensions.

**Required Specifications**

Veneer Finish  
Laminate Finish  
Handle Style

**Optional Specifications**

Grommet

**SINGLE PEDESTAL DESKS**

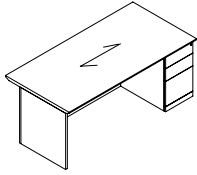

**Single Pedestal Desk - RIGHT**

MODEL#	DIMENSIONS	FREIGHT CLASS	WT/LBS.	CUBIC FT.	VENEER/LAMINATE	ALL VENEER
<b>D x W x H</b>						
DSR8442D	42 x 84 x 29	125	463	59	<b>\$4636</b>	<b>\$5561</b>
DSR7842D	42 x 78 x 29	125	430	55	<b>\$4304</b>	<b>\$5165</b>
DSR7236D	36 x 72 x 29	125	340	44	<b>\$3407</b>	<b>\$4086</b>
DSR7230D	30 x 72 x 29	125	283	36	<b>\$3258</b>	<b>\$3909</b>
DSR6636D	36 x 66 x 29	125	312	40	<b>\$3258</b>	<b>\$3909</b>
DSR6630D	30 x 66 x 29	100	295	33	<b>\$3109</b>	<b>\$3731</b>
DSR6030D	30 x 60 x 29	100	265	30	<b>\$2969</b>	<b>\$3563</b>

Standard with full to floor **box/box/file** pedestal on **right**. Pedestal locks. Refer to the Desks and Credenzas Notes Section on page 64 for overhang dimensions.

**SINGLE PEDESTAL DESKS - BREAKFRONT STYLE**

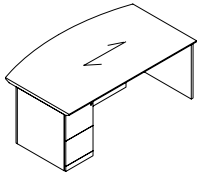

**Single Pedestal Bow Top Desk - LEFT Breakfront Style**

MODEL#	DIMENSIONS	FREIGHT CLASS	WT/LBS.	CUBIC FT.	VENEER/LAMINATE	ALL VENEER
DMISL8442E	42 x 84 x 29	125	432	59	<b>\$5769</b>	<b>\$6922</b>
DMISL7842E	42 x 78 x 29	125	401	55	<b>\$5357</b>	<b>\$6429</b>
DMISL7242E	42 x 72 x 29	125	370	51	<b>\$4946</b>	<b>\$5936</b>
DMISL6636E	36 x 66 x 29	150	230	40	<b>\$4758</b>	<b>\$5707</b>

Standard with full to floor **file/file** pedestal on **left**. Bow top. Pedestal locks. Refer to the Desks and Credenzas Notes Section on page 64 for overhang dimensions.

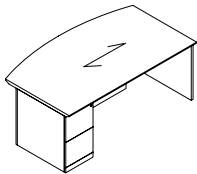

**Single Pedestal Bow Top Desk - RIGHT Breakfront Style**

DMISR8442E	42 x 84 x 29	125	432	59	<b>\$5769</b>	<b>\$6922</b>
DMISR7842E	42 x 78 x 29	125	401	55	<b>\$5357</b>	<b>\$6429</b>
DMISR7242E	42 x 72 x 29	125	370	51	<b>\$4946</b>	<b>\$5936</b>
DMISR6636E	36 x 66 x 29	150	230	40	<b>\$4758</b>	<b>\$5707</b>

Standard with full to floor **file/file** pedestal on **right**. Bow top. Pedestal locks. Refer to the Desks and Credenzas Notes Section on page 64 for overhang dimensions.

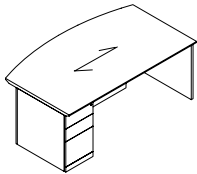

**Single Pedestal Bow Top Desk - LEFT Breakfront Style**

DMISL8442D	42 x 84 x 29	125	432	59	<b>\$5769</b>	<b>\$6922</b>
DMISL7842D	42 x 78 x 29	125	401	55	<b>\$5357</b>	<b>\$6429</b>
DMISL7242D	42 x 72 x 29	125	370	51	<b>\$4946</b>	<b>\$5936</b>
DMISL6636D	36 x 66 x 29	150	230	40	<b>\$4758</b>	<b>\$5707</b>

Standard with full to floor **box/box/file** pedestal on **left**. Bow top. Pedestal locks. Refer to the Desks and Credenzas Notes Section on page 64 for overhang dimensions.

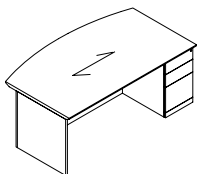

**Single Pedestal Bow Top Desk - RIGHT Breakfront Style**

DMISR8442D	42 x 84 x 29	125	432	59	<b>\$5769</b>	<b>\$6922</b>
DMISR7842D	42 x 78 x 29	125	401	55	<b>\$5357</b>	<b>\$6429</b>
DMISR7242D	42 x 72 x 29	125	370	51	<b>\$4946</b>	<b>\$5936</b>
DMISR6636D	36 x 66 x 29	150	230	40	<b>\$4758</b>	<b>\$5707</b>

Standard with full to floor **box/box/file** pedestal on **right**. Bow top. Pedestal locks. Refer to the Desks and Credenzas Notes Section on page 64 for overhang dimensions.

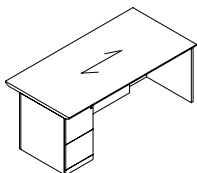

**Single Pedestal Desk - LEFT Breakfront Style**

DISL8442E	42 x 84 x 29	125	463	59	<b>\$5504</b>	<b>\$6605</b>
DISL7842E	42 x 78 x 29	125	430	55	<b>\$5111</b>	<b>\$6134</b>
DISL7236E	36 x 72 x 29	125	340	44	<b>\$4047</b>	<b>\$4856</b>
DISL7230E	30 x 72 x 29	125	283	36	<b>\$3867</b>	<b>\$4639</b>
DISL6636E	36 x 66 x 29	125	312	40	<b>\$3867</b>	<b>\$4639</b>
DISL6630E	30 x 66 x 29	100	295	33	<b>\$3690</b>	<b>\$4429</b>
DISL6030E	30 x 60 x 29	100	265	30	<b>\$3528</b>	<b>\$4235</b>

Standard with full to floor **file/file** pedestal on **left**. Pedestal locks. Refer to the Desks and Credenzas Notes Section on page 64 for overhang dimensions.

**Required Specifications**

- Veneer Finish
- Laminate Finish
- Handle Style

**Optional Specifications**

- Grommet

# D DUFFERIN

ELECTRIC HEIGHT ADJUSTABLE UNITS      MODEL#      DIMENSIONS      FREIGHT CLASS      WT/LBS.      CUBIC FT.      LIST PRICE

D x W x H

- All Height Adjustable (HA) units are shipped fully assembled.
- Simple Up / Down function enables the height adjustment of the worksurface.
- The height adjustment range for desks is 29" to 45", for table and bridge top 26" to 43" (including worksurface).
- Single stage HA mechanism with an electric motor in each column is used.
- The height adjustable mechanism operates at 1.5" per second.
- Max. weight / lift is 265 lbs.
- All columns are integrated into fully functional pedestals, or pedestal bases with the exception of the HA table and the HA bridge top.
- Height adjustable bases are available in three colors: **Black (BLK)**, **Tungsten (TUN)**, and **Designer White (DWT)**
- All desks include two (2) PVC wire management channels (L & R side) allowing for cabling through the pedestals.
- Hanging wood modesty panel on desk is standard. Hanging glass (aluminum framed) modesty panel is optional.
- To avoid risk of pinching:
  - 4.9" / 124mm gap is kept between the pedestal and the lowest point of the worksurface.
  - Wood spacer HASP must be used to attach height adjustable unit in the "U" or "L" configuration. See assembly instructions.
  - 2" gap is required between the worksurfaces when using the HA Table or the HA Bridge Top.
  - Includes collision detector
- Optional grommet locations: **TL** - Top Left or **TR** - Top Right

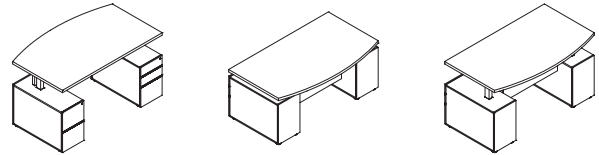
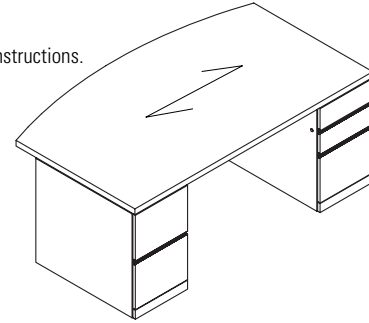

**Note:** Arrow indicates direction of grain.

HEIGHT ADJUSTABLE DOUBLE PEDESTAL DESKS      MODEL#      DIMENSIONS      FREIGHT CLASS      WT/LBS.      CUBIC FT.      VENEER/LAMINATE      ALL VENEER

D x W x H

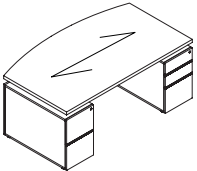

**Height Adj. Double Ped. Bow Top Desk  
Breakfront Style**

Built-in electric height adjustable double pedestal, standard with full to floor **box/box/file** pedestal on **right** and **file/file** pedestal on **left**. Bow top. Pedestals lock. One pencil tray. Refer to the Desks and Credenzas Notes Section on page 64 for overhang dimensions.

DHAMID8442ED	42 x 84 x 29	150	450	81	<b>\$12323</b>	<b>\$13691</b>
DHAMID7842ED	42 x 78 x 29	150	430	72	<b>\$11801</b>	<b>\$13112</b>
DHAMID7242ED	42 x 72 x 29	125	410	67	<b>\$11281</b>	<b>\$12532</b>
DHAMID6636ED	36 x 66 x 29	125	390	54	<b>\$10700</b>	<b>\$11889</b>

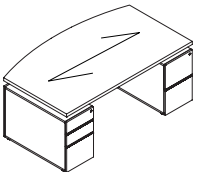

**Height Adj. Double Ped. Bow Top Desk  
Breakfront Style**

Built-in electric height adjustable double pedestal, standard with full to floor **box/box/file** pedestal on **left** and **file/file** pedestal on **right**. Bow top. Pedestals lock. One pencil tray. Refer to the Desks and Credenzas Notes Section on page 64 for overhang dimensions.

DHAMID8442DE	42 x 84 x 29	150	450	81	<b>\$12323</b>	<b>\$13691</b>
DHAMID7842DE	42 x 78 x 29	150	430	72	<b>\$11801</b>	<b>\$13112</b>
DHAMID7242DE	42 x 72 x 29	125	410	67	<b>\$11281</b>	<b>\$12532</b>
DHAMID6636DE	36 x 66 x 29	125	390	54	<b>\$10700</b>	<b>\$11889</b>

**Required Specifications**

Top Finish  
Edge  
Base finish  
Handle style

**Optional Specifications**

Grommet  
Glass modesty

**HEIGHT ADJUSTABLE DOUBLE PEDESTAL DESKS**    **MODEL#**    **DIMENSIONS**    **FREIGHT CLASS**    **WT./LBS.**    **CUBIC FT.**    **VENEER/LAMINATE**    **ALL VENEER**

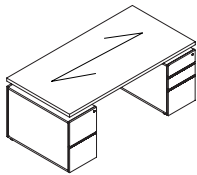

**Height Adj. Double Ped. Desk  
Breakfront Style**

	<b>D x W x H</b>						
DHAID8436ED	36 x 84 x 29	125	440	68	<b>\$10492</b>	<b>\$11658</b>	
DHAID7836ED	36 x 78 x 29	125	420	63	<b>\$10422</b>	<b>\$11579</b>	
DHAID7236ED	36 x 72 x 29	125	400	58	<b>\$10345</b>	<b>\$11495</b>	
DHAID7230ED	30 x 72 x 29	125	390	49	<b>\$10269</b>	<b>\$11410</b>	
DHAID6630ED	30 x 66 x 29	100	380	46	<b>\$10127</b>	<b>\$11251</b>	

Built-in electric height adjustable double pedestal, standard with full to floor **box/box/file** pedestal on **right** and **file/file** pedestal on **left**. Pedestals lock. One pencil tray. Refer to the Desks and Credenzas Notes Section on page 64 for overhang dimensions.

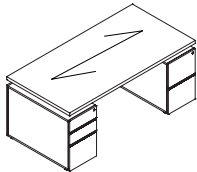

**Height Adj. Double Ped. Desk  
Breakfront Style**

DHAID8436DE	36 x 84 x 29	125	440	68	<b>\$10492</b>	<b>\$11658</b>	
DHAID7836DE	36 x 78 x 29	125	420	63	<b>\$10422</b>	<b>\$11579</b>	
DHAID7236DE	36 x 72 x 29	125	400	58	<b>\$10345</b>	<b>\$11495</b>	
DHAID7230DE	30 x 72 x 29	125	390	49	<b>\$10269</b>	<b>\$11410</b>	
DHAID6630DE	30 x 66 x 29	100	380	46	<b>\$10127</b>	<b>\$11251</b>	

Built-in electric height adjustable double pedestal, standard with full to floor **box/box/file** pedestal on **left** and **file/file** pedestal on **right**. Pedestals lock. One pencil tray. Refer to the Desks and Credenzas Notes Section on page 64 for overhang dimensions.

**HEIGHT ADJUSTABLE SINGLE PEDESTAL DESKS**    **MODEL#**    **DIMENSIONS**    **FREIGHT CLASS**    **WT./LBS.**    **CUBIC FT.**    **VENEER/LAMINATE**    **ALL VENEER**

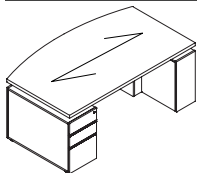

**Height Adj. Single Ped. Bow Top Desk  
Breakfront Style - LEFT**

DHAMISL8442D	42 x 84 x 29	150	440	59	<b>\$10808</b>	<b>\$12006</b>	
DHAMISL7842D	42 x 78 x 29	150	420	55	<b>\$10399</b>	<b>\$11554</b>	
DHAMISL7242D	42 x 72 x 29	150	400	51	<b>\$9988</b>	<b>\$11101</b>	
DHAMISL6636D	36 x 66 x 29	125	390	40	<b>\$9481</b>	<b>\$10535</b>	

Built-in electric height adjustable single pedestal bow top desk. Standard with full to floor locking **box/box/file** pedestal on **left** and support pedestal on **right**. Refer to the Desks and Credenzas Notes Section on page 64 for overhang dimensions.

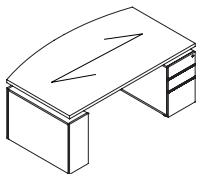

**Height Adj. Single Ped. Bow Top Desk  
Breakfront Style - RIGHT**

DHAMISR8442D	42 x 84 x 29	150	440	59	<b>\$10808</b>	<b>\$12006</b>	
DHAMISR7842D	42 x 78 x 29	150	420	55	<b>\$10399</b>	<b>\$11554</b>	
DHAMISR7242D	42 x 72 x 29	150	400	51	<b>\$9988</b>	<b>\$11101</b>	
DHAMISR6636D	36 x 66 x 29	125	390	40	<b>\$9481</b>	<b>\$10535</b>	

Built-in electric height adjustable single pedestal bow top desk. Standard with full to floor locking **box/box/file** pedestal on **right** and support pedestal on **left**. Refer to the Desks and Credenzas Notes Section on page 64 for overhang dimensions.

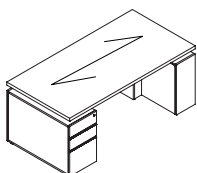

**Height Adjustable Single Ped. Desk  
Breakfront Style - LEFT**

DHAISL8436D	36 x 84 x 29	125	430	55	<b>\$9233</b>	<b>\$10257</b>	
DHAISL7836D	36 x 78 x 29	125	410	50	<b>\$9196</b>	<b>\$10218</b>	
DHAISL7236D	36 x 72 x 29	125	390	44	<b>\$9085</b>	<b>\$10094</b>	
DHAISL7230D	30 x 72 x 29	125	380	40	<b>\$8907</b>	<b>\$10031</b>	
DHAISL6630D	30 x 66 x 29	125	360	36	<b>\$8676</b>	<b>\$9639</b>	
DHAISL6030D	30 x 60 x 29	100	340	35	<b>\$8510</b>	<b>\$9456</b>	

Built-in electric height adjustable single pedestal desk. Standard with full to floor locking **box/box/file** pedestal on **left** and support pedestal on **right**. Refer to the Desks and Credenzas Notes Section on page 64 for overhang dimensions.

**Required Specifications**

- Top Finish
- Edge
- Base finish
- Handle style

**Optional Specifications**

- Grommet
- Glass modesty

HEIGHT ADJUSTABLE SINGLE PEDESTAL DESKS

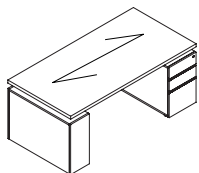

Height Adjustable Single Ped. Desk\*  
Breakfront Style - RIGHT

MODEL#	DIMENSIONS D x W x H	FREIGHT CLASS	WT./LBS.	CUBIC FT.	VENEER/LAMINATE	ALL VENEER
DHAISR8436D	36 x 84 x 29	125	430	55	\$9233	\$10257
DHAISR7836D	36 x 78 x 29	125	410	50	\$9196	\$10218
DHAISR7236D	36 x 72 x 29	125	390	44	\$9085	\$10094
DHAISR7230D	30 x 72 x 29	125	380	40	\$8907	\$9897
DHAISR6630D	30 x 66 x 29	125	360	36	\$8676	\$9639
DHAISR6030D	30 x 60 x 29	100	340	35	\$8510	\$9456

Built-in electric height adjustable single pedestal desk. Standard with full to floor locking **box/box/file** pedestal on **right** and support pedestal on **left**. Refer to the Desks and Credenzas Notes Section on page 64 for overhang dimensions.

HEIGHT ADJUSTABLE DESK SHELLS

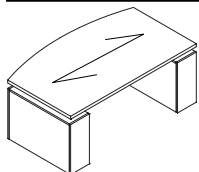

Height Adjustable Bow Top Desk Shell  
Breakfront Style

MODEL#	DIMENSIONS	FREIGHT CLASS	WT./LBS.	CUBIC FT.	VENEER/LAMINATE	ALL VENEER
DHAMIT8442	42 x 84 x 29	150	350	59	\$10470	\$11632
DHAMIT7842	42 x 78 x 29	150	330	55	\$10245	\$11382
DHAMIT7242	42 x 72 x 29	150	310	51	\$10014	\$11127
DHAMIT6636	36 x 66 x 29	150	280	40	\$9036	\$10041

Built-in electric height adjustable bow top desk shell.  
Refer to the Desks and Credenzas Notes Section on page 64 for overhang dimensions.

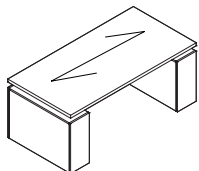

Height Adjustable Desk Shell  
Breakfront Style

DHAIT8436	36 x 84 x 29	150	330	68	\$9315	\$10349
DHAIT7836	36 x 78 x 29	150	310	63	\$9143	\$10158
DHAIT7236	36 x 72 x 29	150	290	44	\$8961	\$9957
DHAIT7230	30 x 72 x 29	150	280	40	\$8398	\$9332
DHAIT6636	36 x 66 x 29	150	260	36	\$8604	\$9561
DHAIT6630	30 x 66 x 29	150	250	35	\$8398	\$9332
DHAIT6030	30 x 60 x 29	150	240	42	\$8250	\$9166

Built-in electric height adjustable desk shell.  
Refer to the Desks and Credenzas Notes Section on page 64 for overhang dimensions.

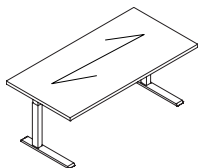

Height Adjustable Table

DHA8436	36 x 84 x 29	250	160	68	\$7539	\$8376
DHA7836	36 x 78 x 29	250	150	63	\$7368	\$8184
DHA7236	36 x 72 x 29	250	140	58	\$7182	\$7982
DHA7230	30 x 72 x 29	250	130	49	\$6621	\$7356
DHA6636	36 x 66 x 29	250	140	54	\$6829	\$7587
DHA6630	30 x 66 x 29	250	120	46	\$6621	\$7356
DHA6030	30 x 60 x 29	250	115	42	\$6474	\$7192

Electric height adjustable table.

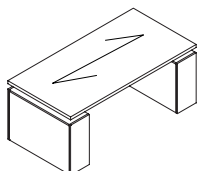

Height Adjustable Desk

DHA8436TP	36 x 84 x 29	150	320	68	\$9020	\$10035
DHA7836TP	36 x 78 x 29	150	300	63	\$8848	\$9830
DHA7236TP	36 x 72 x 29	150	280	58	\$8664	\$9627
DHA7230TP	30 x 72 x 29	150	270	49	\$8101	\$9001
DHA6636TP	36 x 66 x 29	150	250	54	\$8309	\$9231
DHA6630TP	30 x 66 x 29	150	240	46	\$8101	\$9001
DHA6030TP	30 x 60 x 29	150	230	42	\$7953	\$8837

Built-in electric height adjustable desk on TP bases.

Required Specifications

- Top Finish
- Edge
- Base finish
- Handle style

Optional Specifications

- Grommet
- Glass modesty

HEIGHT ADJUSTABLE

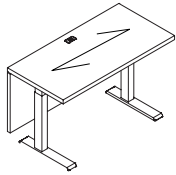

Height Adjustable Bridge Top

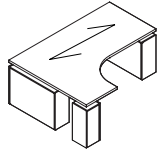

Height Adj. Right Extended Corner Desk\*

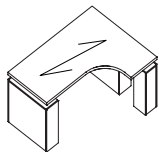

Height Adj. Left Extended Corner Desk\*



Spacer

MODEL#	DIMENSIONS	FREIGHT CLASS	WT/LBS.	CUBIC FT.	veneer/LAMINATE	ALL VENEER
	<b>D x W x H</b>					
DHABT6024	24 x 60 x 29	150	150	35	<b>\$7025</b>	<b>\$7805</b>
DHABT5424	24 x 54 x 29	150	140	31	<b>\$6816</b>	<b>\$7574</b>
DHABT4824	24 x 48 x 29	150	130	28	<b>\$6610</b>	<b>\$7344</b>
DHABT4224	24 x 42 x 29	300	29	26	<b>\$6396</b>	<b>\$7105</b>

Electric height adjustable executive bridge top. Grommet in worksurface.

DHAEKR60842436	24-36 x 60-84 x 29	150	450	108	<b>\$13967</b>	<b>\$15519</b>
DHAEKR60782436	24-36 x 60-78 x 29	150	430	100	<b>\$13933</b>	<b>\$15481</b>
DHAEKR60722436	24-36 x 60-72 x 29	150	410	93	<b>\$13626</b>	<b>\$15139</b>
DHAEKR60662436	24-36 x 60-66 x 29	150	390	86	<b>\$13228</b>	<b>\$14699</b>
DHAEKR60602436	24-36 x 60-60 x 29	150	370	79	<b>\$12832</b>	<b>\$14256</b>

Built-in electric height adjustable right extended corner table desk with a 24" return connection. Extended worksurface on **right. Full end panel on right, narrow end panel on left.** Connects to Linking Bridges, Extended Corners and Connectable Tables.

DHAEKL84603624	24-36 x 60-84 x 29	150	450	108	<b>\$13967</b>	<b>\$15519</b>
DHAEKL78603624	24-36 x 60-78 x 29	150	430	100	<b>\$13933</b>	<b>\$15481</b>
DHAEKL72603624	24-36 x 60-72 x 29	150	410	93	<b>\$13626</b>	<b>\$15139</b>
DHAEKL66603624	24-36 x 60-66 x 29	150	390	86	<b>\$13228</b>	<b>\$14699</b>
DHAEKL60603624	24-36 x 60-60 x 29	150	370	79	<b>\$12832</b>	<b>\$14256</b>

Built-in electric height adjustable right extended corner table desk with a 24" return connection. Extended worksurface on **left. Full end panel on left, narrow end panel on right.** Connects to Linking Bridges, Extended Corners and Connectable Tables.

DHASP	2 x 8 x 23	70	15	.75	<b>\$505</b>	<b>\$561</b>
-------	------------	----	----	-----	--------------	--------------

Connects height adjustable desks with linking bridges and returns.

**Required Specifications**

Top Finish  
Edge  
Base finish

**Optional Specifications**

Grommet\*  
Glass modesty

MODESTY PANEL OPTIONS

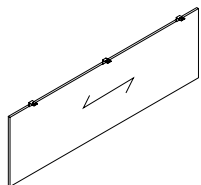

Veneer Modesty Panel Upgrade\*

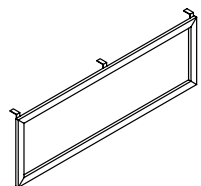

Glass Modesty Panel Upgrade

MODEL#	DIMENSIONS D x W x H	FREIGHT CLASS	WT/LBS.	CUBIC FT.	LIST PRICE
CMP72W	0.75 x 67 x 18	--	20	1	<b>\$1622</b>
CMP66W	0.75 x 61 x 18	--	18	1	<b>\$1570</b>
CMP60W	0.75 x 55 x 18	--	16	1	<b>\$1546</b>
CMP54W	0.75 x 49 x 18	--	14	1	<b>\$1520</b>
CMP48W	0.75 x 43 x 18	--	13	1	<b>\$1496</b>

Straight modesty panel. Attaches to underside of worksurface. **Cannot be retrofitted in the field. Not sold individually - to be ordered as an upgrade option only.**

- CMP72W - Specify on "P" Top Islands or 96" x 48" Islands for Piano Desks.
- CMP66W - Specify on 84" x 36" "D" Top Islands.
- CMP60W - Specify on 84" x 42" "P" Top Islands or 84" x 48" Islands for Piano Desks.
- CMP54W - Specify on 72" x 30" "D" Top Islands.
- CMP48W - Specify on 66" x 36" , 60" x 30" "D" Top Islands, 72" x 42" "P" Top Islands or 72" x 48" Islands for Piano Desks.

CMP72G	0.75 x 67 x 18	--	20	1	<b>\$2485</b>
CMP66G	0.75 x 61 x 18	--	18	1	<b>\$2351</b>
CMP60G	0.75 x 55 x 18	--	16	1	<b>\$2149</b>
CMP54G	0.75 x 49 x 18	--	14	1	<b>\$2001</b>
CMP48G	0.75 x 43 x 18	--	13	1	<b>\$1911</b>

Straight modesty panel. Translucent, screened glass. Aluminum box frame construction in Tungsten Only. Attaches to underside of worksurface. **Cannot be retrofitted in the field. Not sold individually - to be ordered as an upgrade option only.**

- CMP72G - Specify on "P" Top Islands or 96" x 48" Islands for Piano Desks.
- CMP66G - Specify on 84" x 36" "D" Top Islands.
- CMP60G - Specify on 84" x 42" "P" Top Islands or 84" x 48" Islands for Piano Desks.
- CMP54G - Specify on 72" x 30" "D" Top Islands.
- CMP48G - Specify on 66" x 36" , 60" x 30" "D" Top Islands, 72" x 42" "P" Top Islands or 72" x 48" Islands for Piano Desks.
- Tungsten finish on the aluminum box frame closely resembles the existing Tungsten finish.

**SINGLE PEDESTAL DESKS - BREAKFRONT STYLE**

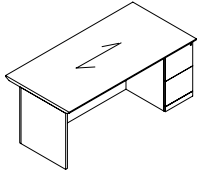

**Single Pedestal Desk - RIGHT  
Breakfront Style**

MODEL#	DIMENSIONS	FREIGHT CLASS	WT/LBS.	CUBIC FT.	VENEER/LAMINATE	ALL VENEER
<b>D x W x H</b>						
DISR8442E	42 x 84 x 29	125	463	59	<b>\$5504</b>	<b>\$6605</b>
DISR7842E	42 x 78 x 29	125	430	55	<b>\$5111</b>	<b>\$6134</b>
DISR7236E	36 x 72 x 29	125	340	44	<b>\$4047</b>	<b>\$4856</b>
DISR7230E	30 x 72 x 29	125	283	36	<b>\$3867</b>	<b>\$4639</b>
DISR6636E	36 x 66 x 29	125	312	40	<b>\$3867</b>	<b>\$4639</b>
DISR6630E	30 x 66 x 29	100	295	33	<b>\$3690</b>	<b>\$4429</b>
DISR6030E	30 x 60 x 29	100	265	30	<b>\$3528</b>	<b>\$4235</b>

Standard with full to floor **file/file** pedestal on **right**. Pedestal locks. Refer to the Desks and Credenzas Notes Section on page 64 for overhang dimensions.

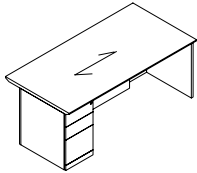

**Single Pedestal Desk - LEFT  
Breakfront Style**

DISL8442D	42 x 84 x 29	125	463	59	<b>\$5504</b>	<b>\$6605</b>
DISL7842D	42 x 78 x 29	125	430	55	<b>\$5111</b>	<b>\$6134</b>
DISL7236D	36 x 72 x 29	125	340	44	<b>\$4047</b>	<b>\$4856</b>
DISL7230D	30 x 72 x 29	125	283	36	<b>\$3867</b>	<b>\$4639</b>
DISL6636D	36 x 66 x 29	125	312	40	<b>\$3867</b>	<b>\$4639</b>
DISL6630D	30 x 66 x 29	100	295	33	<b>\$3690</b>	<b>\$4429</b>
DISL6030D	30 x 60 x 29	100	265	30	<b>\$3528</b>	<b>\$4235</b>

Standard with full to floor **box/box/file** pedestal on **left**. Pedestal locks. Refer to the Desks and Credenzas Notes Section on page 64 for overhang dimensions.

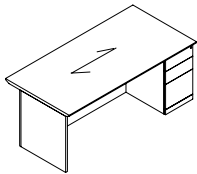

**Single Pedestal Desk - RIGHT  
Breakfront Style**

DISR8442D	42 x 84 x 29	125	463	59	<b>\$5504</b>	<b>\$6605</b>
DISR7842D	42 x 78 x 29	125	430	55	<b>\$5111</b>	<b>\$6134</b>
DISR7236D	36 x 72 x 29	125	340	44	<b>\$4047</b>	<b>\$4856</b>
DISR7230D	30 x 72 x 29	125	283	36	<b>\$3867</b>	<b>\$4639</b>
DISR6636D	36 x 66 x 29	125	312	40	<b>\$3867</b>	<b>\$4639</b>
DISR6630D	30 x 66 x 29	100	295	33	<b>\$3690</b>	<b>\$4429</b>
DISR6030D	30 x 60 x 29	100	265	30	<b>\$3528</b>	<b>\$4235</b>

Standard with full to floor **box/box/file** pedestal on **right**. Pedestal locks. Refer to the Desks and Credenzas Notes Section on page 64 for overhang dimensions.

**DESK SHELLS WITH RECESSED FRONT**

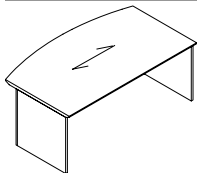

**Bow Top Desk Shell**

MODEL#	DIMENSIONS	FREIGHT CLASS	WT/LBS.	CUBIC FT.	VENEER/LAMINATE	ALL VENEER
DMT8442	42 x 84 x 29	125	380	59	<b>\$4436</b>	<b>\$5321</b>
DMT7842	42 x 78 x 29	125	353	55	<b>\$4117</b>	<b>\$4939</b>
DMT7242	42 x 72 x 29	125	331	51	<b>\$3803</b>	<b>\$4564</b>
DMT6636	36 x 66 x 29	125	287	40	<b>\$3626</b>	<b>\$4351</b>

Bow top and recessed modesty panel. Refer to the Desks and Credenzas Notes Section on page 64 for overhang dimensions.

**Required Specifications**

Veneer Finish  
Laminate Finish  
Handle Style (Single Pedestal Desks)

**Optional Specifications**

Grommet



## DESK SHELLS

MODEL#	DIMENSIONS D x W x H	FREIGHT CLASS	WT/LBS.	CUBIC FT.	VENEER/LAMINATE	ALL VENEER
DT8436	36 x 84 x 29	125	362	51	\$3536	\$4244
DT7836	36 x 78 x 29	125	336	47	\$3284	\$3942
DT7236	36 x 72 x 29	125	315	44	\$3031	\$3637
DT6636	36 x 66 x 29	125	271	40	\$2855	\$3429
DT7230	30 x 72 x 29	125	271	36	\$2855	\$3429
DT6630	30 x 66 x 29	100	265	33	\$2680	\$3218
DT6030	30 x 60 x 29	100	241	30	\$2453	\$2944
DT4824	24 x 48 x 29	125	123	20	\$1615	\$1938
DT4224	24 x 42 x 29	150	98	17	\$1353	\$1623
DT3624	24 x 36 x 29	150	82	14	\$1302	\$1564
DT3024	24 x 30 x 29	125	76	12	\$1278	\$1534
DT4822	22 x 48 x 29	150	105	18	\$1481	\$1777
DT4222	22 x 42 x 29	150	90	16	\$1240	\$1488
DT3622	22 x 36 x 29	150	75	13	\$1197	\$1436
DT3022	22 x 30 x 29	150	65	11	\$1173	\$1407
DT4820	20 x 48 x 29	125	105	18	\$1347	\$1616
DT4220	20 x 42 x 29	125	90	16	\$1126	\$1351
DT3620	20 x 36 x 29	125	75	13	\$1091	\$1307
DT3020	20 x 30 x 29	125	65	11	\$1065	\$1278

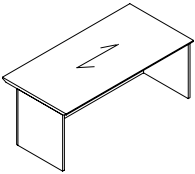

Desk Shell

Recessed modesty panel. Refer to the Desks and Credenzas Notes Section on page 64 for overhang dimensions.

## RETURNS

- An Executive Return is used to attach to a Single Pedestal Desk, Single Pedestal Credenza, Desk Shell or Credenza Shell.
- Grommets are available as an option.
- Hand of Executive Return is determined by location of full end panel from user side.
- Hand of Desk or Credenza is determined by location of pedestal from user side.
- To remove cross grain veneer pattern on top, delete suffix "CG" from the model number. Available as a special - no upcharge.

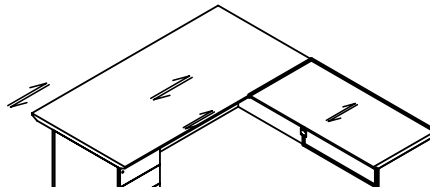
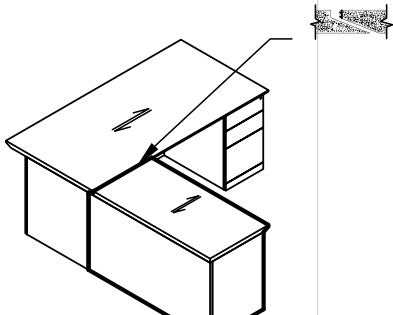

## RETURNS

MODEL#	DIMENSIONS	FREIGHT CLASS	WT/LBS.	CUBIC FT.	VENEER/LAMINATE	ALL VENEER
DERL7224CG	24 x 72 x 29	150	135	29	\$2336	\$2803
DERL6624CG	24 x 66 x 29	150	127	27	\$2137	\$2566
DERL6024CG	24 x 60 x 29	150	120	24	\$1945	\$2335
DERL5424CG	24 x 54 x 29	150	112	22	\$1756	\$2108
DERL4824CG	24 x 48 x 29	150	105	19	\$1558	\$1868
DERL4224CG	24 x 42 x 29	150	97	17	\$1367	\$1639

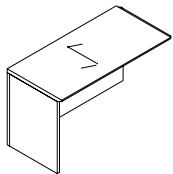

Flush Return - LEFT 24" Deep

Return has **no pedestal**. For use with right handed single pedestal desks, credenzas, desk shells, credenza shells, "D" islands or "P" islands.

### Required Specifications

Veneer Finish  
Laminate Finish

### Optional Specifications

Grommet

**RETURNS**

**MODEL# DIMENSIONS FREIGHT CLASS WT/LBS. CUBIC FT. VENEER/LAMINATE ALL VENEER**

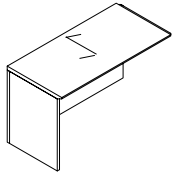

**Flush Return - LEFT  
22" Deep**

	<b>D x W x H</b>						
DERL7222CG	22 x 72 x 29	150	130	27	<b>\$2227</b>	<b>\$2672</b>	
DERL6622CG	22 x 66 x 29	150	122	24	<b>\$1865</b>	<b>\$2238</b>	
DERL6022CG	22 x 60 x 29	150	115	22	<b>\$1701</b>	<b>\$2039</b>	
DERL5422CG	22 x 54 x 29	150	105	20	<b>\$1633</b>	<b>\$1958</b>	
DERL4822CG	22 x 48 x 29	150	100	18	<b>\$1367</b>	<b>\$1639</b>	
DERL4222CG	22 x 42 x 29	150	90	16	<b>\$1194</b>	<b>\$1434</b>	

Return has **no pedestal**. For use with right handed single pedestal desks, credenzas, desk shells, credenza shells, "D" islands or "P" islands.

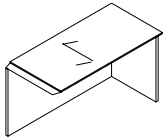

**Flush Return - RIGHT  
24" Deep**

DERR7224CG	24 x 72 x 29	150	135	29	<b>\$2336</b>	<b>\$2803</b>	
DERR6624CG	24 x 66 x 29	150	127	27	<b>\$2137</b>	<b>\$2566</b>	
DERR6024CG	24 x 60 x 29	150	120	24	<b>\$1945</b>	<b>\$2335</b>	
DERR5424CG	24 x 54 x 29	150	112	22	<b>\$1756</b>	<b>\$2108</b>	
DERR4824CG	24 x 48 x 29	150	105	19	<b>\$1558</b>	<b>\$1868</b>	
DERR4224CG	24 x 42 x 29	150	97	17	<b>\$1367</b>	<b>\$1639</b>	

Return has **no pedestal**. For use with left handed single pedestal desks, credenzas, desk shells, credenza shells, "D" islands or "P" islands.

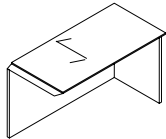

**Flush Return - RIGHT  
22" Deep**

DERR7222CG	22 x 72 x 29	150	130	27	<b>\$2227</b>	<b>\$2672</b>	
DERR6622CG	22 x 66 x 29	150	122	24	<b>\$1865</b>	<b>\$2238</b>	
DERR6022CG	22 x 60 x 29	150	115	22	<b>\$1701</b>	<b>\$2039</b>	
DERR5422CG	22 x 54 x 29	150	105	20	<b>\$1529</b>	<b>\$1835</b>	
DERR4822CG	22 x 48 x 29	150	100	18	<b>\$1359</b>	<b>\$1632</b>	
DERR4222CG	22 x 42 x 29	150	90	16	<b>\$1188</b>	<b>\$1424</b>	

Return has **no pedestal**. For use with left handed single pedestal desks, credenzas, desk shells, credenza shells, "D" islands or "P" islands.

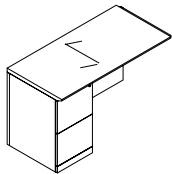

**Flush Return - LEFT\*  
24" Deep**

DERL7224ECG	24 x 72 x 29	100	250	29	<b>\$4123</b>	<b>\$4946</b>	
DERL6624ECG	24 x 66 x 29	100	236	27	<b>\$3964</b>	<b>\$4758</b>	
DERL6024ECG	24 x 60 x 29	100	227	24	<b>\$3608</b>	<b>\$4329</b>	
DERL5424ECG	24 x 54 x 29	100	205	22	<b>\$3479</b>	<b>\$4174</b>	
DERL4824ECG	24 x 48 x 29	100	185	19	<b>\$3088</b>	<b>\$3705</b>	
DERL4224ECG	24 x 42 x 29	92.5	178	17	<b>\$2979</b>	<b>\$3574</b>	

Return has **file/file** pedestal on the **left**. Pedestal locks. For use with right handed single pedestal desks, credenzas, desk shells, credenza shells, "D" islands or "P" islands.

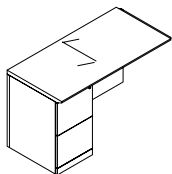

**Flush Return - LEFT\*  
22" Deep**

DERL7222ECG	22 x 72 x 29	100	240	27	<b>\$3964</b>	<b>\$4758</b>	
DERL6622ECG	22 x 66 x 29	100	231	24	<b>\$3498</b>	<b>\$4200</b>	
DERL6022ECG	22 x 60 x 29	92.5	222	22	<b>\$3185</b>	<b>\$3822</b>	
DERL5422ECG	22 x 54 x 29	92.5	200	20	<b>\$3068</b>	<b>\$3682</b>	
DERL4822ECG	22 x 48 x 29	92.5	180	18	<b>\$2727</b>	<b>\$3272</b>	
DERL4222ECG	22 x 42 x 29	92.5	173	16	<b>\$2624</b>	<b>\$3148</b>	

Return has **file/file** pedestal on the **left**. Pedestal locks. For use with right handed single pedestal desks, credenzas, desk shells, credenza shells, "D" islands or "P" islands.

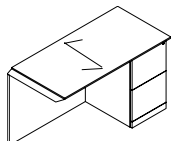

**Flush Return - RIGHT\*  
24" Deep**

DERR7224ECG	24 x 72 x 29	100	250	29	<b>\$4123</b>	<b>\$4946</b>	
DERR6624ECG	24 x 66 x 29	100	236	27	<b>\$3964</b>	<b>\$4758</b>	
DERR6024ECG	24 x 60 x 29	100	227	24	<b>\$3608</b>	<b>\$4329</b>	
DERR5424ECG	24 x 54 x 29	100	205	22	<b>\$3479</b>	<b>\$4174</b>	
DERR4824ECG	24 x 48 x 29	100	185	19	<b>\$3088</b>	<b>\$3705</b>	
DERR4224ECG	24 x 42 x 29	92.5	178	17	<b>\$2979</b>	<b>\$3574</b>	

Return has **file/file** pedestal on the **right**. Pedestal locks. For use with right handed single pedestal desks, credenzas, desk shells, credenza shells, "D" islands or "P" islands.

**Required Specifications**

Veneer Finish  
Laminate Finish  
Handle Style\*

**Optional Specifications**

Grommet

RETURNS

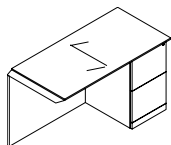

**Flush Return - RIGHT**  
**22" Deep**

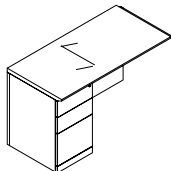

**Flush Return - LEFT**  
**24" Deep**

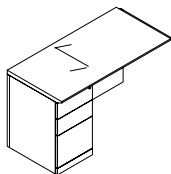

**Flush Return - LEFT**  
**22" Deep**

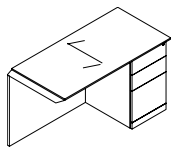

**Flush Return - RIGHT**  
**24" Deep**

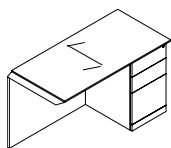

**Flush Return - RIGHT**  
**22" Deep**

MODEL# DIMENSIONS FREIGHT CLASS WT/LBS. CUBIC FT. VENEER/LAMINATE ALL VENEER

D x W x H

DERR7222ECG	22 x 72 x 29	100	240	27	<b>\$3964</b>	<b>\$4758</b>
DERR6622ECG	22 x 66 x 29	100	231	24	<b>\$3498</b>	<b>\$4200</b>
DERR6022ECG	22 x 60 x 29	92.5	222	22	<b>\$3185</b>	<b>\$3822</b>
DERR5422ECG	22 x 54 x 29	92.5	200	20	<b>\$3068</b>	<b>\$3682</b>
DERR4822ECG	22 x 48 x 29	92.5	180	18	<b>\$2727</b>	<b>\$3272</b>
DERR4222ECG	22 x 42 x 29	92.5	173	16	<b>\$2624</b>	<b>\$3148</b>

Return has **file/file** pedestal on the **right**. Pedestal locks. For use with right handed single pedestal desks, credenzas, desk shells, credenza shells, "D" islands or "P" islands.

DERL7224DCG	24 x 72 x 29	100	250	29	<b>\$4123</b>	<b>\$4946</b>
DERL6624DCG	24 x 66 x 29	100	236	27	<b>\$3964</b>	<b>\$4758</b>
DERL6024DCG	24 x 60 x 29	100	227	24	<b>\$3608</b>	<b>\$4329</b>
DERL5424DCG	24 x 54 x 29	100	205	22	<b>\$3479</b>	<b>\$4174</b>
DERL4824DCG	24 x 48 x 29	100	185	19	<b>\$3088</b>	<b>\$3705</b>
DERL4224DCG	24 x 42 x 29	92.5	178	17	<b>\$2979</b>	<b>\$3574</b>

Return has **box/box/file** pedestal on the **left**. Pedestal locks. For use with right handed single pedestal desks, credenzas, desk shells, credenza shells, "D" islands or "P" islands.

DERL7222DCG	22 x 72 x 29	100	240	27	<b>\$3964</b>	<b>\$4758</b>
DERL6622DCG	22 x 66 x 29	100	231	24	<b>\$3498</b>	<b>\$4200</b>
DERL6022DCG	22 x 60 x 29	92.5	222	22	<b>\$3185</b>	<b>\$3822</b>
DERL5422DCG	22 x 54 x 29	92.5	200	20	<b>\$3068</b>	<b>\$3682</b>
DERL4822DCG	22 x 48 x 29	150	180	18	<b>\$2727</b>	<b>\$3272</b>
DERL4222DCG	22 x 42 x 29	92.5	173	16	<b>\$2624</b>	<b>\$3148</b>

Return has **box/box/file** pedestal on the **left**. Pedestal locks. For use with right handed single pedestal desks, credenzas, desk shells, credenza shells, "D" islands or "P" islands.

DERR7224DCG	24 x 72 x 29	100	250	29	<b>\$4123</b>	<b>\$4946</b>
DERR6624DCG	24 x 66 x 29	100	236	27	<b>\$3964</b>	<b>\$4758</b>
DERR6024DCG	24 x 60 x 29	100	227	24	<b>\$3608</b>	<b>\$4329</b>
DERR5424DCG	24 x 54 x 29	100	205	22	<b>\$3479</b>	<b>\$4174</b>
DERR4824DCG	24 x 48 x 29	100	185	19	<b>\$3088</b>	<b>\$3705</b>
DERR4224DCG	24 x 42 x 29	92.5	178	17	<b>\$2979</b>	<b>\$3574</b>

Return has **box/box/file** pedestal on the **right**. Pedestal locks. For use with right handed single pedestal desks, credenzas, desk shells, credenza shells, "D" islands or "P" islands.

DERR7222DCG	22 x 72 x 29	100	240	27	<b>\$3964</b>	<b>\$4758</b>
DERR6622DCG	22 x 66 x 29	100	231	24	<b>\$3498</b>	<b>\$4200</b>
DERR6022DCG	22 x 60 x 29	92.5	222	22	<b>\$3185</b>	<b>\$3822</b>
DERR5422DCG	22 x 54 x 29	92.5	200	20	<b>\$3068</b>	<b>\$3682</b>
DERR4822DCG	22 x 48 x 29	92.5	180	18	<b>\$2727</b>	<b>\$3272</b>
DERR4222DCG	22 x 42 x 29	92.5	173	16	<b>\$2624</b>	<b>\$3148</b>

Return has **box/box/file** pedestal on the **right**. Pedestal locks. For use with right handed single pedestal desks, credenzas, desk shells, credenza shells, "D" islands or "P" islands.

**Required Specifications**

Veneer Finish  
Laminate Finish  
Handle Style

**Optional Specifications**

Grommet

**BRIDGES - EXECUTIVE**

MODEL#

DIMENSIONS

FREIGHT CLASS

WT/LBS.

CUBIC FT.

VENEER/LAMINATE

ALL VENEER

D x W x H

- An Executive Bridge is used to connect a Desk to a Credenza.
- Not to be used with Corner Components or Piano Desks,
- Three Modesty Panel options - Full Modesty, 8" Modesty and No Modesty (Flush Bridge Top).
- Modesty panel flush with end panels of Desk and Credenza.
- Includes GM1 grommet in the top center position.
- Both connecting sides of executive bridges feature a reverse profile edge

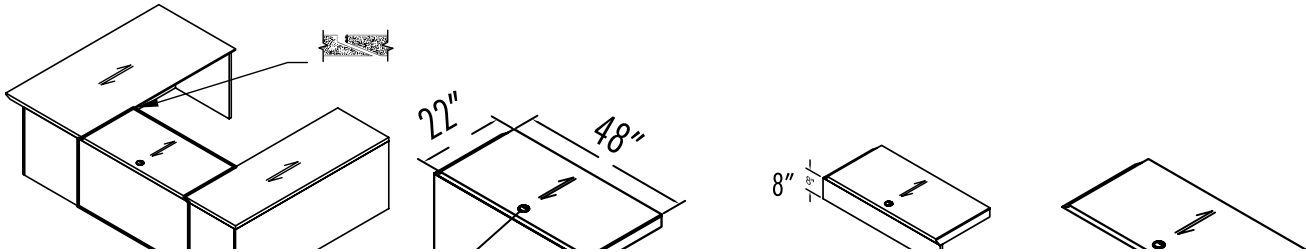

**BRIDGES - LINKING**

- A Linking Bridge is used to connect Corner Components to a Single Pedestal Desk, Single Pedestal Credenza, Desk Shell or Credenza Shell.
- Two Modesty Panel options - Full Modesty and 8" Modesty.
- Includes GM1 grommet in the top center position.
- Hand of Linking Bridge is determined by location of half end panel from user side.
- Linking Bridges are handed **left and right** (Handedness is determined by connecting side with the self edge). The opposite connecting side features a reverse profile edge.

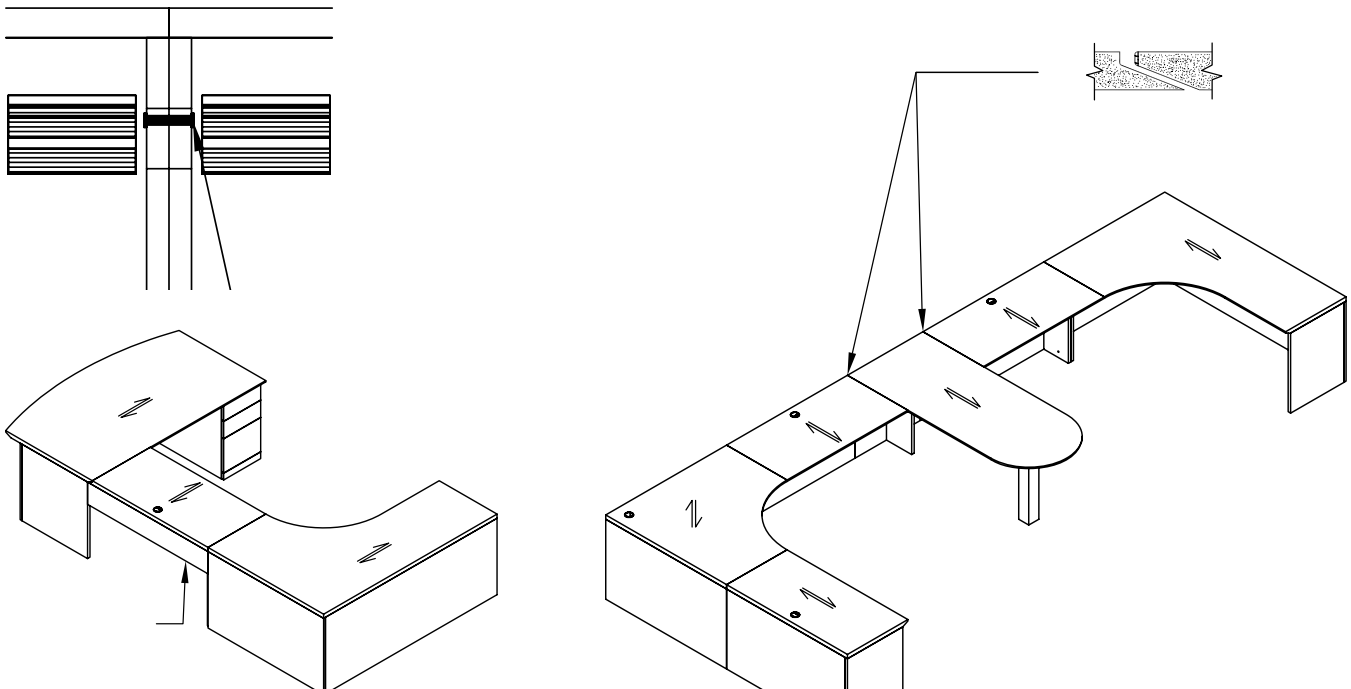

BRIDGES - FLUSH

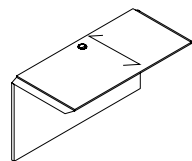

Flush Bridge

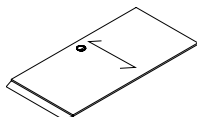

Flush Bridge Top

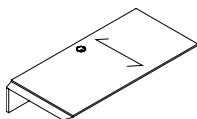

Flush Bridge Top, 8" Modesty Panel

MODEL#	DIMENSIONS D x W x H	FREIGHT CLASS	WT/LBS.	CUBIC FT.	VENEER/LAMINATE	ALL VENEER
DBT6024CG	24 x 60 x 29	70	144	10	\$1670	\$2007
DBT5424CG	24 x 54 x 29	70	129	9	\$1509	\$1808
DBT4824CG	24 x 48 x 29	70	120	8	\$1338	\$1606
DBT4224CG	24 x 42 x 29	85	105	7	\$1172	\$1404
DBT6022CG	22 x 60 x 29	70	138	9	\$1369	\$1642
DBT5422CG	22 x 54 x 29	70	124	8	\$1355	\$1624
DBT4822CG	22 x 48 x 29	85	115	7	\$1202	\$1445
DBT4222CG	22 x 42 x 29	85	101	6	\$1055	\$1268
DBT6020CG	20 x 60 x 29	70	131	8	\$1369	\$1642
DBT5420CG	20 x 54 x 29	85	118	8	\$1235	\$1481
DBT4820CG	20 x 48 x 29	85	110	7	\$1097	\$1316
DBT4220CG	20 x 42 x 29	85	96	6	\$942	\$1127

Top surface, back panel and hardware to create a "U" configuration with a single pedestal desk or credenza. **Cannot be used with corners.** Grommet in worksurface. Shipped RTA (ready to assemble).

- If linking to bookcase or open storage, add **/S** to end of model number

DBT5424TCG	24 x 54 x --	70	129	9	N/A	\$1129
DBT4824TCG	24 x 48 x --	70	120	8	N/A	\$1004
DBT4224TCG	24 x 42 x --	70	105	7	N/A	\$879
DBT5422TCG	22 x 54 x --	70	124	8	N/A	\$907
DBT4822TCG	22 x 48 x --	70	115	7	N/A	\$807
DBT4222TCG	22 x 42 x --	70	101	6	N/A	\$707
DBT5420TCG	20 x 54 x --	70	118	8	N/A	\$829
DBT4820TCG	20 x 48 x --	70	110	7	N/A	\$735
DBT4220TCG	20 x 42 x --	70	96	6	N/A	\$632

Top surface only to create a "U" configuration with a single pedestal desk or credenza. **Cannot be used with corners.** Grommet in worksurface. Shipped RTA (ready to assemble).

- If linking to bookcase or open storage, add **/S** to end of model number

DBT6024Q8CG	24 x 60 x --	70	144	10	\$1502	\$1803
DBT5424Q8CG	24 x 54 x --	70	129	9	\$1355	\$1624
DBT4824Q8CG	24 x 48 x --	70	120	8	\$1203	\$1446
DBT4224Q8CG	24 x 42 x --	70	105	7	\$1053	\$1267
DBT6022Q8CG	22 x 60 x --	70	138	9	\$1355	\$1624
DBT5422Q8CG	22 x 54 x --	70	124	8	\$1219	\$1463
DBT4822Q8CG	22 x 48 x --	70	115	7	\$1082	\$1296
DBT4222Q8CG	22 x 42 x --	70	101	6	\$950	\$1141
DBT6020Q8CG	20 x 60 x --	70	131	8	\$1235	\$1481
DBT5420Q8CG	20 x 54 x --	70	118	8	\$1108	\$1331
DBT4820Q8CG	20 x 48 x --	70	110	7	\$987	\$1185
DBT4220Q8CG	20 x 42 x --	70	96	6	\$846	\$1015

Top surface with 8" modesty panel for utility access. Create a "U" configuration with a single pedestal desk or credenza. **Cannot be used with corners.** Grommet in worksurface. Shipped RTA (ready to assemble).

- If linking to bookcase or open storage, add **/S** to end of model number

Required Specifications

Veneer finish  
Laminate finish

Optional Specifications

Additional grommet

**BRIDGES - LINKING**

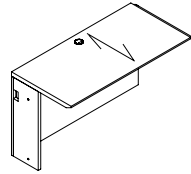

**Linking Bridge - LEFT**

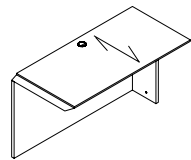

**Linking Bridge - RIGHT**

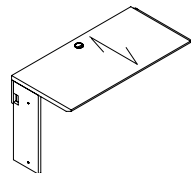

**Linking Bridge, 8" Modesty Panel - LEFT**

MODEL#	DIMENSIONS	FREIGHT CLASS	WT/LBS.	CUBIC FT.	VENEER/LAMINATE	ALL VENEER
--------	------------	---------------	---------	-----------	-----------------	------------

**D x W x H**

DBT6024NLLCG	24 x 60 x 29	125	145	24	<b>\$1658</b>	<b>\$1987</b>
DBT5424NLLCG	24 x 54 x 29	150	131	22	<b>\$1493</b>	<b>\$1791</b>
DBT4824NLLCG	24 x 48 x 29	125	116	19	<b>\$1327</b>	<b>\$1593</b>
DBT4224NLLCG	24 x 42 x 29	125	102	17	<b>\$1075</b>	<b>\$1290</b>
DBT3624NLLCG	24 x 36 x 29	150	87	15	<b>\$978</b>	<b>\$1174</b>
DBT3024NLLCG	24 x 30 x 29	125	73	12	<b>\$954</b>	<b>\$1144</b>

DBT6022NLLCG	22 x 60 x 29	150	131	22	<b>\$1578</b>	<b>\$1894</b>
DBT5422NLLCG	22 x 54 x 29	150	118	20	<b>\$1423</b>	<b>\$1709</b>
DBT4822NLLCG	22 x 48 x 29	125	110	18	<b>\$1263</b>	<b>\$1514</b>
DBT4222NLLCG	22 x 42 x 29	150	95	16	<b>\$1026</b>	<b>\$1230</b>
DBT3622NLLCG	22 x 36 x 29	125	80	13	<b>\$929</b>	<b>\$1116</b>
DBT3022NLLCG	22 x 30 x 29	150	65	11	<b>\$908</b>	<b>\$1092</b>

Top surface, back panel and hardware. **Left side** connects to a 5-Sided Corner, Extended Corner or Connectable Table. Right side connects to a single pedestal desk or credenza, "D" island, Boat shaped island, "P" island and Delta island with a "T" base. Grommet in worksurface.

DBT6024NLRCG	24 x 60 x 29	125	145	24	<b>\$1658</b>	<b>\$1987</b>
DBT5424NLRCG	24 x 54 x 29	150	131	22	<b>\$1493</b>	<b>\$1791</b>
DBT4824NLRCG	24 x 48 x 29	125	116	19	<b>\$1327</b>	<b>\$1593</b>
DBT4224NLRCG	24 x 42 x 29	125	102	17	<b>\$1075</b>	<b>\$1290</b>
DBT3624NLRCG	24 x 36 x 29	150	87	15	<b>\$978</b>	<b>\$1174</b>
DBT3024NLRCG	24 x 30 x 29	125	73	12	<b>\$954</b>	<b>\$1144</b>

DBT6022NLRCG	22 x 60 x 29	150	131	22	<b>\$1578</b>	<b>\$1894</b>
DBT5422NLRCG	22 x 54 x 29	150	118	20	<b>\$1423</b>	<b>\$1709</b>
DBT4822NLRCG	22 x 48 x 29	125	110	18	<b>\$1263</b>	<b>\$1514</b>
DBT4222NLRCG	22 x 42 x 29	150	95	16	<b>\$1026</b>	<b>\$1230</b>
DBT3622NLRCG	22 x 36 x 29	125	80	13	<b>\$929</b>	<b>\$1116</b>
DBT3022NLRCG	22 x 30 x 29	150	65	11	<b>\$908</b>	<b>\$1092</b>

Top surface, back panel and hardware. **Right side** connects to a 5-Sided Corner, Extended Corner or Connectable Table. Left side connects to a single pedestal desk or credenza, "D" island, Boat shaped island, "P" island and Delta island with a "T" base. Grommet in worksurface.

DBT6024NLLQ8CG	24 x 60 x 29	125	145	24	<b>\$1824</b>	<b>\$2188</b>
DBT5424NLLQ8CG	24 x 54 x 29	150	131	22	<b>\$1645</b>	<b>\$1975</b>
DBT4824NLLQ8CG	24 x 48 x 29	125	116	19	<b>\$1462</b>	<b>\$1755</b>
DBT4224NLLQ8CG	24 x 42 x 29	125	102	17	<b>\$1315</b>	<b>\$1575</b>
DBT3624NLLQ8CG	24 x 36 x 29	150	87	15	<b>\$1075</b>	<b>\$1290</b>
DBT3024NLLQ8CG	24 x 30 x 29	125	73	12	<b>\$1052</b>	<b>\$1263</b>

DBT6022NLLQ8CG	22 x 60 x 29	150	131	22	<b>\$1738</b>	<b>\$2085</b>
DBT5422NLLQ8CG	22 x 54 x 29	150	118	20	<b>\$1565</b>	<b>\$1879</b>
DBT4822NLLQ8CG	22 x 48 x 29	125	110	18	<b>\$1391</b>	<b>\$1667</b>
DBT4222NLLQ8CG	22 x 42 x 29	150	95	16	<b>\$1125</b>	<b>\$1348</b>
DBT3622NLLQ8CG	22 x 36 x 29	125	80	13	<b>\$1023</b>	<b>\$1229</b>
DBT3022NLLQ8CG	22 x 30 x 29	150	65	11	<b>\$1000</b>	<b>\$1199</b>

Top surface with 8" modesty panel for utility access and hardware. **Left side** connects to a 5-Sided Corner, Extended Corner or Connectable Table. Right side connects to a single pedestal desk or credenza, "D" island, Boat shaped island, "P" island and Delta island with a "T" base. Grommet in worksurface. Shipped RTA (ready to assemble).

**Required Specifications**

Veneer finish  
Laminate finish

**Optional Specifications**

Additional grommet

## BRIDGES - LINKING

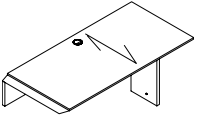

**Linking Bridge, 8" Modesty Panel - RIGHT**

MODEL#	DIMENSIONS	FREIGHT CLASS	WT/LBS.	CUBIC FT.	VENEER/LAMINATE	ALL VENEER
D x W x H						
DBT6024NLRQ8CG	24 x 60 x 29	125	145	24	<b>\$1824</b>	<b>\$2188</b>
DBT5424NLRQ8CG	24 x 54 x 29	150	131	22	<b>\$1645</b>	<b>\$1975</b>
DBT4824NLRQ8CG	24 x 48 x 29	125	116	19	<b>\$1462</b>	<b>\$1755</b>
DBT4224NLRQ8CG	24 x 42 x 29	125	102	17	<b>\$1315</b>	<b>\$1575</b>
DBT3624NLRQ8CG	24 x 36 x 29	150	87	15	<b>\$1075</b>	<b>\$1290</b>
DBT3024NLRQ8CG	24 x 30 x 29	125	73	12	<b>\$1052</b>	<b>\$1263</b>
DBT6022NLRQ8CG	22 x 60 x 29	150	131	22	<b>\$1738</b>	<b>\$2085</b>
DBT5422NLRQ8CG	22 x 54 x 29	150	118	20	<b>\$1565</b>	<b>\$1879</b>
DBT4822NLRQ8CG	22 x 48 x 29	125	110	18	<b>\$1391</b>	<b>\$1667</b>
DBT4222NLRQ8CG	22 x 42 x 29	150	95	16	<b>\$1125</b>	<b>\$1348</b>
DBT3622NLRQ8CG	22 x 36 x 29	125	80	13	<b>\$1023</b>	<b>\$1229</b>
DBT3022NLRQ8CG	22 x 30 x 29	150	65	11	<b>\$1000</b>	<b>\$1199</b>

Top surface with 8" modesty panel for utility access and hardware. **Right side** connects to a 5-Sided Corner, Extended Corner or Connectable Table. Right side connects to a single pedestal desk or credenza, "D" island, Boat shaped island, "P" island and Delta island with a "T" base. Grommet in worksurface. Shipped RTA (ready to assemble).

## CREDENZAS

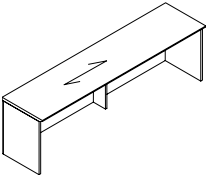

sizes 96" and larger

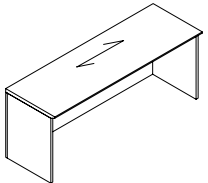

sizes less than 96"

**Credenza Shell\***

MODEL#	DIMENSIONS	FREIGHT CLASS	WT/LBS.	CUBIC FT.	VENEER/LAMINATE	ALL VENEER
DC12024	24 x 120 x 29	100	387	48	<b>\$4169</b>	<b>\$5003</b>
DC11424	24 x 114 x 29	125	367	46	<b>\$3960</b>	<b>\$4754</b>
DC10824	24 x 108 x 29	125	348	44	<b>\$3754</b>	<b>\$4502</b>
DC10224	24 x 102 x 29	100	329	41	<b>\$3545</b>	<b>\$4253</b>
DC9624	24 x 96 x 29	125	309	39	<b>\$3335</b>	<b>\$4001</b>
DC9024	24 x 90 x 29	100	290	36	<b>\$3128</b>	<b>\$3754</b>
DC8424	24 x 84 x 29	125	271	34	<b>\$2920</b>	<b>\$3505</b>
DC7824	24 x 78 x 29	100	251	31	<b>\$2711</b>	<b>\$3252</b>
DC7224	24 x 72 x 29	100	232	29	<b>\$2502</b>	<b>\$3002</b>
DC6624	24 x 66 x 29	125	213	27	<b>\$2408</b>	<b>\$2892</b>
DC6024	24 x 60 x 29	100	193	24	<b>\$2189</b>	<b>\$2627</b>
DC5424	24 x 54 x 29	125	174	22	<b>\$2076</b>	<b>\$2493</b>
DC4824	24 x 48 x 29	100	155	19	<b>\$1961</b>	<b>\$2353</b>
DC4224	24 x 42 x 29	125	135	17	<b>\$1661</b>	<b>\$1993</b>
DC12022	22 x 120 x 29	100	358	44	<b>\$3822</b>	<b>\$4585</b>
DC11422	22 x 114 x 29	100	340	42	<b>\$3630</b>	<b>\$4355</b>
DC10822	22 x 108 x 29	100	323	40	<b>\$3438</b>	<b>\$4128</b>
DC10222	22 x 102 x 29	100	305	38	<b>\$3245</b>	<b>\$3898</b>
DC9622	22 x 96 x 29	100	287	35	<b>\$3061</b>	<b>\$3671</b>
DC9022	22 x 90 x 29	100	269	33	<b>\$2868</b>	<b>\$3442</b>
DC8422	22 x 84 x 29	100	251	31	<b>\$2678</b>	<b>\$3216</b>
DC7822	22 x 78 x 29	100	233	29	<b>\$2484</b>	<b>\$2983</b>
DC7222	22 x 72 x 29	125	215	27	<b>\$2296</b>	<b>\$2754</b>
DC6622	22 x 66 x 29	100	197	24	<b>\$2213</b>	<b>\$2656</b>
DC6022	22 x 60 x 29	100	179	22	<b>\$2009</b>	<b>\$2408</b>
DC5422	22 x 54 x 29	100	161	20	<b>\$1903</b>	<b>\$2284</b>
DC4822	22 x 48 x 29	125	143	18	<b>\$1802</b>	<b>\$2162</b>
DC4222	22 x 42 x 29	125	125	16	<b>\$1522</b>	<b>\$1829</b>

Standard with **no pedestals**. Flush full modesty panel. 96" w and larger includes a center support leg. If using storage component shells underneath to support the worksurface, **no more than 72" may be left unsupported**.

### Required Specifications

Veneer finish  
Laminate finish

### Optional Specifications

Additional grommet

### Accessories

Modular Storage\*

CREDENZAS

MODEL# DIMENSIONS FREIGHT CLASS WT/LBS. CUBIC FT. VENEER/LAMINATE ALL VENEER

D x W x H

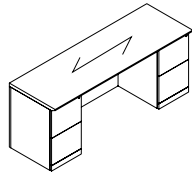

Kneespace Credenza

DCK8424EE	24 x 84 x 29	92.5	348	34	\$6178	\$7413
DCK7824EE	24 x 78 x 29	92.5	319	31	\$5740	\$6888
DCK7224EE	24 x 72 x 29	100	280	29	\$5301	\$6360
DCK6624EE	24 x 66 x 29	100	261	27	\$5220	\$6265
DCK6024EE	24 x 60 x 29	100	238	24	\$4856	\$5826
DCK8422EE	22 x 84 x 29	92.5	320	34	\$5663	\$6796
DCK7822EE	22 x 78 x 29	92.5	298	31	\$5262	\$6313
DCK7222EE	22 x 72 x 29	92.5	280	29	\$4857	\$5827
DCK6622EE	22 x 66 x 29	92.5	257	27	\$4784	\$5742
DCK6022EE	22 x 60 x 29	92.5	233	24	\$4449	\$5339

Standard with full to floor **file/file** pedestals on **left** and **right**. **Center is open** Pedestals lock.

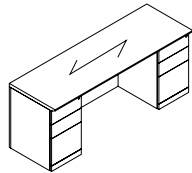

Kneespace Credenza

DCK8424DD	24 x 84 x 29	92.5	348	34	\$6178	\$7413
DCK7824DD	24 x 78 x 29	92.5	319	31	\$5740	\$6888
DCK7224DD	24 x 72 x 29	100	280	29	\$5301	\$6360
DCK6624DD	24 x 66 x 29	100	261	27	\$5220	\$6265
DCK6024DD	24 x 60 x 29	100	238	24	\$4856	\$5826
DCK8422DD	22 x 84 x 29	92.5	320	34	\$5663	\$6796
DCK7822DD	22 x 78 x 29	92.5	298	31	\$5262	\$6313
DCK7222DD	22 x 72 x 29	92.5	280	29	\$4857	\$5827
DCK6622DD	22 x 66 x 29	92.5	257	27	\$4784	\$5742
DCK6022DD	22 x 60 x 29	92.5	233	24	\$4449	\$5339

Standard with full to floor **box/box/file** pedestals on **left** and **right**. **Center is open** Pedestals lock. One pencil tray.

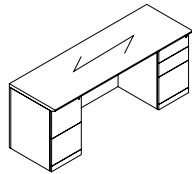

Kneespace Credenza

DCK8424ED	24 x 84 x 29	92.5	348	34	\$6178	\$7413
DCK7824ED	24 x 78 x 29	92.5	319	31	\$5740	\$6888
DCK7224ED	24 x 72 x 29	100	280	29	\$5301	\$6360
DCK6624ED	24 x 66 x 29	100	261	27	\$5220	\$6265
DCK6024ED	24 x 60 x 29	100	238	24	\$4856	\$5826
DCK8422ED	22 x 84 x 29	92.5	320	34	\$5663	\$6796
DCK7822ED	22 x 78 x 29	92.5	298	31	\$5262	\$6313
DCK7222ED	22 x 72 x 29	92.5	280	29	\$4857	\$5827
DCK6622ED	22 x 66 x 29	92.5	257	27	\$4784	\$5742
DCK6022ED	22 x 60 x 29	92.5	233	24	\$4449	\$5339

Standard with full to floor **file/file** pedestal on **left** and **box/box/file** pedestal on **right**. **Center is open** Pedestals lock. One pencil tray.

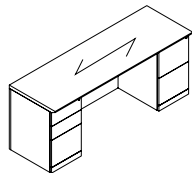

Kneespace Credenza

DCK8424DE	24 x 84 x 29	92.5	348	34	\$6178	\$7413
DCK7824DE	24 x 78 x 29	92.5	319	31	\$5740	\$6888
DCK7224DE	24 x 72 x 29	100	280	29	\$5301	\$6360
DCK6624DE	24 x 66 x 29	100	261	27	\$5220	\$6265
DCK6024DE	24 x 60 x 29	100	238	24	\$4856	\$5826
DCK8422DE	22 x 84 x 29	92.5	320	34	\$5663	\$6796
DCK7822DE	22 x 78 x 29	92.5	298	31	\$5262	\$6313
DCK7222DE	22 x 72 x 29	92.5	280	29	\$4857	\$5827
DCK6622DE	22 x 66 x 29	92.5	257	27	\$4784	\$5742
DCK6022DE	22 x 60 x 29	92.5	233	24	\$4449	\$5339

Standard with full to floor **box/box/file** pedestal on **left** and **file/file** pedestal on **right**. **Center is open** Pedestals lock. One pencil tray.

**Required Specifications**

- Veneer Finish
- Laminate Finish
- Handle style

**Optional Specifications**

- Grommet



CREDENZAS

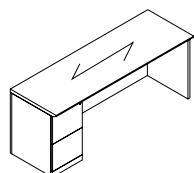

Single Pedestal Credenza - LEFT

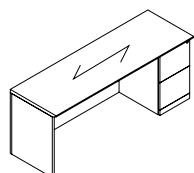

Single Pedestal Credenza - RIGHT

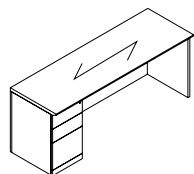

Single Pedestal Credenza - LEFT

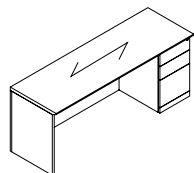

Single Pedestal Credenza - RIGHT

MODEL#	DIMENSIONS D x W x H	FREIGHT CLASS	WT/LBS.	CUBIC FT.	VENEER/LAMINATE	ALL VENEER
DCL8424E	24 x 84 x 29	100	315	34	\$4673	\$5608
DCL7824E	24 x 78 x 29	100	292	31	\$4340	\$5205
DCL7224E	24 x 72 x 29	100	270	29	\$4007	\$4807
DCL6624E	24 x 66 x 29	100	247	27	\$3857	\$4629
DCL6024E	24 x 60 x 29	100	225	24	\$3507	\$4207
DCL8422E	22 x 84 x 29	100	286	34	\$4284	\$5140
DCL7822E	22 x 78 x 29	100	265	31	\$3980	\$4777
DCL7222E	22 x 72 x 29	100	250	29	\$3676	\$4407
DCL6622E	22 x 66 x 29	100	229	27	\$3537	\$4245
DCL6022E	22 x 60 x 29	100	208	24	\$3216	\$3857

Standard with full to floor **file/file** pedestal on **left**. Pedestal locks.

DCR8424E	24 x 84 x 29	100	315	34	\$4673	\$5608
DCR7824E	24 x 78 x 29	100	292	31	\$4340	\$5205
DCR7224E	24 x 72 x 29	100	270	29	\$4007	\$4807
DCR6624E	24 x 66 x 29	100	247	27	\$3857	\$4629
DCR6024E	24 x 60 x 29	100	225	24	\$3507	\$4207
DCR8422E	22 x 84 x 29	100	286	34	\$4284	\$5140
DCR7822E	22 x 78 x 29	100	265	31	\$3980	\$4777
DCR7222E	22 x 72 x 29	100	250	29	\$3676	\$4407
DCR6622E	22 x 66 x 29	100	229	27	\$3537	\$4245
DCR6022E	22 x 60 x 29	100	208	24	\$3216	\$3857

Standard with full to floor **file/file** pedestal on **right**. Pedestal locks.

DCL8424D	24 x 84 x 29	100	315	34	\$4673	\$5608
DCL7824D	24 x 78 x 29	100	292	31	\$4340	\$5205
DCL7224D	24 x 72 x 29	100	270	29	\$4007	\$4807
DCL6624D	24 x 66 x 29	100	247	27	\$3857	\$4629
DCL6024D	24 x 60 x 29	100	225	24	\$3507	\$4207
DCL8422D	22 x 84 x 29	100	286	34	\$4284	\$5140
DCL7822D	22 x 78 x 29	100	265	31	\$3980	\$4777
DCL7222D	22 x 72 x 29	100	250	29	\$3676	\$4407
DCL6622D	22 x 66 x 29	100	229	27	\$3537	\$4245
DCL6022D	22 x 60 x 29	100	208	24	\$3216	\$3857

Standard with full to floor **box/box/file** pedestal on **left**. Pedestal locks.

DCR8424D	24 x 84 x 29	100	315	34	\$4673	\$5608
DCR7824D	24 x 78 x 29	100	292	31	\$4340	\$5205
DCR7224D	24 x 72 x 29	100	270	29	\$4007	\$4807
DCR6624D	24 x 66 x 29	100	247	27	\$3857	\$4629
DCR6024D	24 x 60 x 29	100	225	24	\$3507	\$4207
DCR8422D	22 x 84 x 29	100	286	34	\$4284	\$5140
DCR7822D	22 x 78 x 29	100	265	31	\$3980	\$4777
DCR7222D	22 x 72 x 29	100	250	29	\$3676	\$4407
DCR6622D	22 x 66 x 29	100	229	27	\$3537	\$4245
DCR6022D	22 x 60 x 29	100	208	24	\$3216	\$3857

Standard with full to floor **box/box/file** pedestal on **right**. Pedestal locks.

**Required Specifications**

Veneer Finish  
Laminate Finish  
Handle style

**Optional Specifications**

Grommet

CREENZAS

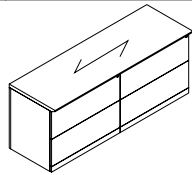

Lateral File Credenza

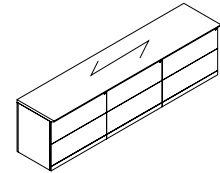

Lateral File Credenza

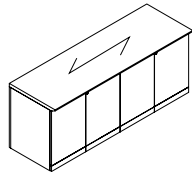

Storage Cabinet Credenza

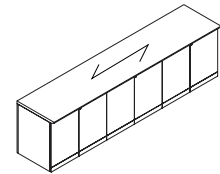

Storage Cabinet Credenza

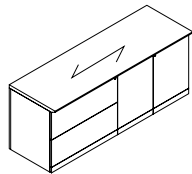

Lateral File/Storage Cabinet Credenza

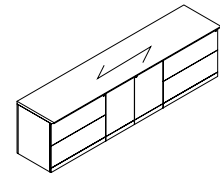

Lateral File/Storage Cabinet Credenza

MODEL#	DIMENSIONS D x W x H	FREIGHT CLASS	WT/LBS.	CUBIC FT.	VENEER/LAMINATE	ALL VENEER
DC7224FF	24 x 72 x 29	92.5	328	29	\$6445	\$7738
DC7222FF	22 x 72 x 29	92.5	300	27	\$5912	\$7092
DC6024NN	24 x 60 x 29	92.5	273	24	\$5911	\$7091
DC6022NN	22 x 60 x 29	100	218	22	\$5422	\$6508

Two 2-drawer lateral files side-by-side. Locking drawers. Anti-lock tilt suspension. **Not for stacking materials on lateral file drawer bottom.**

- "FF" models use two 36" wide lateral files, "NN" models use 30" wide.

DC10824FFF	24 x 108 x 29	92.5	457	44	\$11339	\$13606
DC10822FFF	22 x 108 x 29	92.5	435	40	\$10393	\$12472
DC9024NNN	24 x 90 x 29	92.5	381	36	\$9452	\$11341
DC9022NNN	22 x 90 x 29	92.5	372	33	\$8666	\$10400

Three 2-drawer lateral files side-by-side. Locking drawers. Anti-lock tilt suspension. **Not for stacking materials on lateral file drawer bottom.**

- "FFF" models use two 36" wide lateral files, "NNN" models use 30" wide.

DC7224GG	24 x 72 x 29	92.5	300	29	\$4785	\$5744
DC7222GG	22 x 72 x 29	92.5	277	27	\$4387	\$5264
DC6024MM	24 x 60 x 29	92.5	254	24	\$4387	\$5264
DC6022MM	22 x 60 x 29	92.5	232	22	\$4023	\$4828

Two 2-door storage cabinets side-by-side. Locking doors. Self-closing hinged doors cover one adjustable shelf.

- "GG" models use two 36" wide storage cabinets, "MM" models use 30" wide.

DC10824GGG	24 x 108 x 29	100	392	44	\$9041	\$10849
DC10822GGG	22 x 108 x 29	100	348	40	\$8287	\$9944
DC9024MMM	24 x 90 x 29	100	326	36	\$7535	\$9042
DC9022MMM	22 x 90 x 29	100	302	33	\$6910	\$8291

Three 2-door storage cabinets side-by-side. Locking doors. Self-closing hinged doors cover one adjustable shelf.

- "GGG" models use two 36" wide storage cabinets, "MMM" models use 30" wide.

DCF7224	24 x 72 x 29	92.5	305	29	\$5044	\$6053
DCF7222	22 x 72 x 29	92.5	285	27	\$4624	\$5550
DCF6024	24 x 60 x 29	92.5	254	24	\$4204	\$5044
DCF6022	22 x 60 x 29	92.5	233	22	\$3853	\$4622

One 2-drawer lateral file and one storage cabinet. Locking door/drawers. Storage cabinet includes one adjustable shelf. Anti-lock tilt suspension. **Not for stacking materials on lateral file drawer bottom.**

DC10824FGF	24 x 108 x 29	92.5	392	44	\$10576	\$12692
DC10822FGF	22 x 108 x 29	92.5	348	40	\$9691	\$11631
DC9024NMN	24 x 90 x 29	92.5	326	36	\$8813	\$10576
DC9022NMN	22 x 90 x 29	92.5	302	33	\$8080	\$9696

One 2-drawer lateral file and one storage cabinet. Locking door/drawers. Storage cabinet includes one adjustable shelf. Anti-lock tilt suspension. **Not for stacking materials on lateral file drawer bottom.**

- "FGF" models use two 36" wide lateral files and one 36" wide storage cabinet, "NMN" models use 30" wide.

**Required Specifications**

- Veneer Finish
- Laminate Finish
- Handle style

CREDENZAS

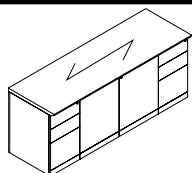

Vertical File/Storage Cabinet Credenza

MODEL#	DIMENSIONS D x W x H	FREIGHT CLASS	WT./LBS.	CUBIC FT.	VENEER/LAMINATE	ALL VENEER
DCD7224D	24 x 72 x 29	92.5	319	29	\$5912	\$7092
DCD7222D	22 x 72 x 29	92.5	298	24	\$5422	\$6508
DCD6024D	24 x 60 x 29	92.5	266	24	\$5422	\$6508
DCD6022D	22 x 60 x 29	92.5	246	20	\$4969	\$5965

Two box/box/file vertical files and one storage cabinet. Locking door/drawers. Storage cabinet includes one adjustable shelf. One pencil tray.

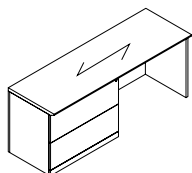

Kneespace Lateral File Credenza - LEFT\*

DCL8424F	24 x 84 x 29	100	305	34	\$5429	\$6515
DCL7824F	24 x 78 x 29	100	285	31	\$5042	\$6052
DCL7224F	24 x 72 x 29	100	261	29	\$4653	\$5584
DCL6624F	24 x 66 x 29	100	239	27	\$4480	\$5375
DCL6024F	24 x 60 x 29	100	218	24	\$4070	\$4884
DCL8422F	22 x 84 x 29	100	266	31	\$4982	\$5976
DCL7822F	22 x 78 x 29	100	245	29	\$4622	\$5548
DCL7222F	22 x 72 x 29	100	230	27	\$4270	\$5124
DCL6622F	22 x 66 x 29	100	209	24	\$4109	\$4932
DCL6022F	22 x 60 x 29	100	188	22	\$3732	\$4477

One 2-drawer lateral file on the **left**. Locking drawers. Anti-lock tilt suspension. **Not for stacking materials on lateral file drawer bottom.**

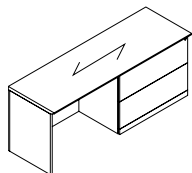

Kneespace Lateral File Credenza - RIGHT\*

DCR8424F	24 x 84 x 29	100	305	34	\$5429	\$6515
DCR7824F	24 x 78 x 29	100	285	31	\$5042	\$6052
DCR7224F	24 x 72 x 29	100	261	29	\$4653	\$5584
DCR6624F	24 x 66 x 29	100	239	27	\$4480	\$5375
DCR6024F	24 x 60 x 29	100	218	24	\$4070	\$4884
DCR8422F	22 x 84 x 29	100	266	31	\$4982	\$5976
DCR7822F	22 x 78 x 29	100	245	29	\$4622	\$5548
DCR7222F	22 x 72 x 29	100	230	27	\$4270	\$5124
DCR6622F	22 x 66 x 29	100	209	24	\$4109	\$4932
DCR6022F	22 x 60 x 29	100	188	22	\$3732	\$4477

One 2-drawer lateral file on the **right**. Locking drawers. Anti-lock tilt suspension. **Not for stacking materials on lateral file drawer bottom.**

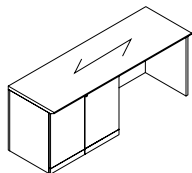

Kneespace Storage Cabinet \* Credenza - LEFT

DCL8424G	24 x 84 x 29	100	338	34	\$4872	\$5848
DCL7824G	24 x 78 x 29	92.5	314	31	\$4527	\$5433
DCL7224G	24 x 72 x 29	92.5	290	29	\$4178	\$5014
DCL6624G	24 x 66 x 29	100	266	27	\$4022	\$4826
DCL6024G	24 x 60 x 29	92.5	242	24	\$3659	\$4391
DCL8422G	22 x 84 x 29	100	266	31	\$4474	\$5370
DCL7822G	22 x 78 x 29	100	245	29	\$4153	\$4985
DCL7222G	22 x 72 x 29	100	230	27	\$3832	\$4597
DCL6622G	22 x 66 x 29	92.5	209	24	\$3687	\$4424
DCL6022G	22 x 60 x 29	92.5	188	22	\$3357	\$4026

One storage cabinet on **left**. Locking doors. Storage cabinet has one adjustable shelf.

Required Specifications

Veneer Finish  
Laminate Finish  
Handle style

Optional Specifications

Grommet\*

CRENZAS

MODEL# DIMENSIONS FREIGHT CLASS WT/LBS. CUBIC FT. VENEER/LAMINATE ALL VENEER

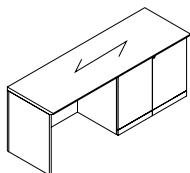

**Kneespace Storage Cabinet Credenza - RIGHT**

	D x W x H						
DCR8424G	24 x 84 x 29	100	338	34	\$4872	\$5848	
DCR7824G	24 x 78 x 29	92.5	314	31	\$4527	\$5433	
DCR7224G	24 x 72 x 29	92.5	290	29	\$4178	\$5014	
DCR6624G	24 x 66 x 29	100	266	27	\$4022	\$4826	
DCR6024G	24 x 60 x 29	92.5	242	24	\$3659	\$4391	
DCR8422G	22 x 84 x 29	100	266	31	\$4474	\$5370	
DCR7822G	22 x 78 x 29	100	245	29	\$4153	\$4985	
DCR7222G	22 x 72 x 29	100	230	27	\$3832	\$4597	
DCR6622G	22 x 66 x 29	92.5	209	24	\$3687	\$4424	
DCR6022G	22 x 60 x 29	92.5	188	22	\$3357	\$4026	

One storage cabinet on **right**. Locking doors. Storage cabinet has one adjustable shelf.

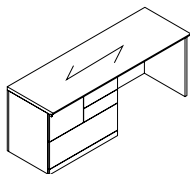

**Mixed Storage Credenza - LEFT**

DCL8424Z	24 x 84 x 29	100	338	34	\$5929	\$7116	
DCL7824Z	24 x 78 x 29	92.5	314	31	\$5506	\$6606	
DCL7224Z	24 x 72 x 29	92.5	290	29	\$5084	\$6099	
DCL6624Z	24 x 66 x 29	100	266	27	\$4893	\$5872	
DCL6024Z	24 x 60 x 29	92.5	242	24	\$4447	\$5335	
DCL8422Z	22 x 84 x 29	92.5	309	31	\$5434	\$6523	
DCL7822Z	22 x 78 x 29	100	287	29	\$5047	\$6057	
DCL7222Z	22 x 72 x 29	92.5	270	27	\$4661	\$5592	
DCL6622Z	22 x 66 x 29	92.5	248	24	\$4486	\$5382	
DCL6022Z	22 x 60 x 29	92.5	225	22	\$4077	\$4893	

Standard with two box drawers, one file drawer, and one 36"W lateral file drawer on the **left**. File drawer and lateral file drawer lock. Front-to-back and side-to-side filing. **Not for stacking materials on lateral file drawer bottom.**

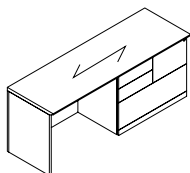

**Mixed Storage Credenza - RIGHT**

DCR8424Z	24 x 84 x 29	100	338	34	\$5929	\$7116	
DCR7824Z	24 x 78 x 29	92.5	314	31	\$5506	\$6606	
DCR7224Z	24 x 72 x 29	92.5	290	29	\$5084	\$6099	
DCR6624Z	24 x 66 x 29	100	266	27	\$4893	\$5872	
DCR6024Z	24 x 60 x 29	92.5	242	24	\$4447	\$5335	
DCR8422Z	22 x 84 x 29	92.5	309	31	\$5434	\$6523	
DCR7822Z	22 x 78 x 29	100	287	29	\$5048	\$6058	
DCR7222Z	22 x 72 x 29	92.5	270	27	\$4661	\$5592	
DCR6622Z	22 x 66 x 29	92.5	248	24	\$4486	\$5382	
DCR6022Z	22 x 60 x 29	92.5	225	22	\$4077	\$4893	

Standard with two box drawers, one file drawer, and one 36"W lateral file drawer on the **right**. File drawer and lateral file drawer lock. Front-to-back and side-to-side filing. **Not for stacking materials on lateral file drawer bottom.**

**Required Specifications**

Veneer Finish  
Laminate Finish  
Handle style

**Optional Specifications**

Grommet

# D DUFFERIN

**CORNERS**      **MODEL#**      **DIMENSIONS**      **FREIGHT CLASS**      **WT./LBS.**      **CUBIC FT.**      **VENEER/LAMINATE**      **ALL VENEER**

**D x W x H**

- A Corner Desk is used to connect to a Linking Bridge and Linking Credenza, or Connectable Table
- Cable management tray is included.
- Full Modesty Panel option.
- 5-Sided Corners include a GM1 grommet in the top center position. Grommets are available as an option on Extended Corners.
- Hand of Linking Credenza is determined by location of full end panel from user side.
- Hand of Extended Corner is determined by location of long narrow end from user side.
- Connecting sides feature a self edge.

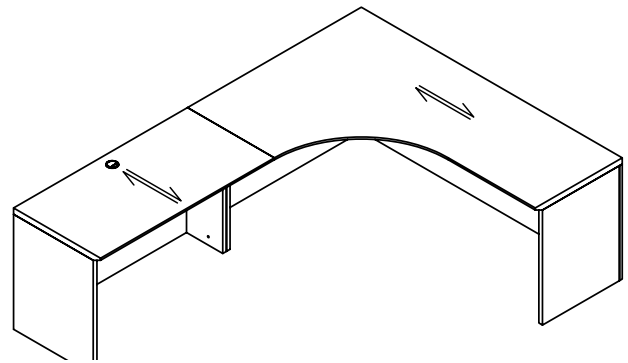
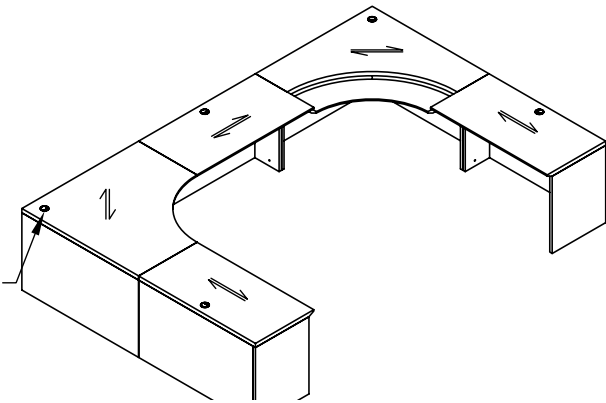
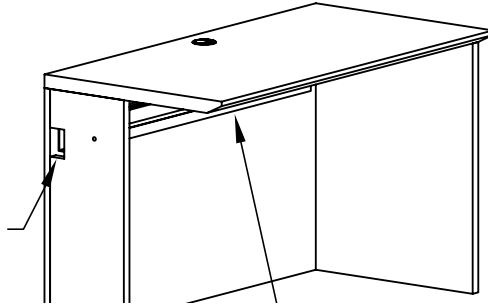
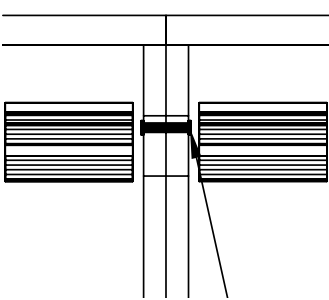

**5-SIDED CORNERS**      **MODEL#**      **DIMENSIONS**      **FREIGHT CLASS**      **WT./LBS.**      **CUBIC FT.**      **VENEER/LAMINATE**      **ALL VENEER**

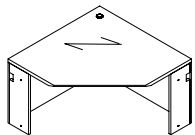

**5-Sided Corner**

DE484824	48 x 48 x 29	150	201	39	<b>\$2832</b>	<b>\$3398</b>
DE424224	42 x 42 x 29	150	155	30	<b>\$2172</b>	<b>\$2604</b>
DE363624	36 x 36 x 29	125	135	22	<b>\$2064</b>	<b>\$2477</b>

Connects to **24"D** connectables, returns, extended corners, storage/lateral file credenzas, credenzas and bridges. Includes grommet and installed horizontal wire management. Narrow end panels on left and right.

- *Not freestanding*

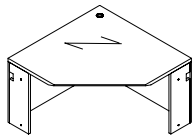

**5-Sided Corner**

DE484822	48 x 48 x 29	150	196	39	<b>\$2832</b>	<b>\$3398</b>
DE424222	42 x 42 x 29	150	150	30	<b>\$2172</b>	<b>\$2604</b>
DE363622	36 x 36 x 29	150	130	22	<b>\$2064</b>	<b>\$2477</b>

Connects to **22"D** connectables, returns, extended corners, storage/lateral file credenzas, credenzas and bridges. Includes grommet and installed horizontal wire management. Narrow end panels on left and right.

- *Not freestanding*

**Required Specifications**

Veneer Finish  
Laminate Finish

**Optional Specifications**

Additional grommet

**LEFT EXTENDED CORNERS**

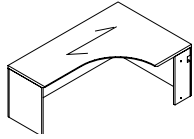

**Left Extended Corner**

MODEL#	DIMENSIONS	FREIGHT CLASS	WT/LBS.	CUBIC FT.	VENEER/LAMINATE	ALL VENEER
<b>D x W x H</b>						
DEKL964824	24-48 x 96 x 29	150	387	77	<b>\$4714</b>	<b>\$5654</b>
DEKL904824	24-48 x 90 x 29	150	363	73	<b>\$4384</b>	<b>\$5260</b>
DEKL844824	24-48 x 84 x 29	150	338	68	<b>\$4378</b>	<b>\$5255</b>
DEKL784824	24-48 x 78 x 29	150	314	63	<b>\$4308</b>	<b>\$5169</b>
DEKL724824	24-48 x 72 x 29	150	290	58	<b>\$4039</b>	<b>\$4847</b>
DEKL664824	24-48 x 66 x 29	150	266	52	<b>\$3820</b>	<b>\$4583</b>
DEKL604824	24-48 x 60 x 29	150	242	48	<b>\$3539</b>	<b>\$4246</b>

Extended worksurface on **left. Full end panel on left, narrow end panel on right.** Connects to Linking Bridges, Extended Corners and Connectable Tables.

**RIGHT EXTENDED CORNERS**

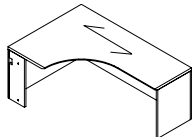

**Right Extended Corner**

MODEL#	DIMENSIONS	FREIGHT CLASS	WT/LBS.	CUBIC FT.	VENEER/LAMINATE	ALL VENEER
DEKR489624	24-48 x 96 x 29	150	387	77	<b>\$4714</b>	<b>\$5654</b>
DEKR489024	24-48 x 90 x 29	150	363	73	<b>\$4384</b>	<b>\$5260</b>
DEKR488424	24-48 x 84 x 29	150	338	68	<b>\$4378</b>	<b>\$5255</b>
DEKR487824	24-48 x 78 x 29	150	314	63	<b>\$4308</b>	<b>\$5169</b>
DEKR487224	24-48 x 72 x 29	150	290	58	<b>\$4039</b>	<b>\$4847</b>
DEKR486624	24-48 x 66 x 29	150	266	52	<b>\$3820</b>	<b>\$4583</b>
DEKR486024	24-48 x 60 x 29	150	242	48	<b>\$3539</b>	<b>\$4246</b>

Extended worksurface on **right. Full end panel on right, narrow end panel on left.** Connects to Linking Bridges, Extended Corners and Connectable Tables.

**FREESTANDING TABLES**

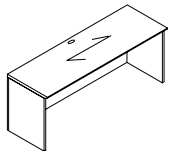

**24" Deep Freestanding Table**

MODEL#	DIMENSIONS	FREIGHT CLASS	WT/LBS.	CUBIC FT.	VENEER/LAMINATE	ALL VENEER
DVT9624	24 x 96 x 29	150	213	39	<b>\$2810</b>	<b>\$3371</b>
DVT9024	24 x 90 x 29	150	199	36	<b>\$2633</b>	<b>\$3160</b>
DVT8424	24 x 84 x 29	150	186	34	<b>\$2459</b>	<b>\$2951</b>
DVT7824	24 x 78 x 29	150	173	31	<b>\$2284</b>	<b>\$2741</b>
DVT7224	24 x 72 x 29	150	160	29	<b>\$2108</b>	<b>\$2528</b>
DVT6624	24 x 66 x 29	150	146	27	<b>\$1982</b>	<b>\$2379</b>
DVT6024	24 x 60 x 29	150	133	24	<b>\$1856</b>	<b>\$2227</b>
DVT5424	24 x 54 x 29	150	128	22	<b>\$1755</b>	<b>\$2105</b>
DVT4824	24 x 48 x 29	125	120	19	<b>\$1649</b>	<b>\$1980</b>
DVT4224	24 x 42 x 29	125	104	17	<b>\$1397</b>	<b>\$1678</b>
DVT3624	24 x 36 x 29	150	88	15	<b>\$1353</b>	<b>\$1623</b>
DVT3024	24 x 30 x 29	125	82	12	<b>\$1327</b>	<b>\$1593</b>
DVT2424	24 x 24 x 29	125	65	10	<b>\$1115</b>	<b>\$1338</b>

Two full end panels. **Cannot be connected on left or right side.**

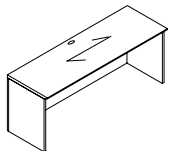

**22" Deep Freestanding Table**

DVT9622	22 x 96 x 29	150	193	35	<b>\$2677</b>	<b>\$3214</b>
DVT9022	22 x 90 x 29	150	181	33	<b>\$2507</b>	<b>\$3011</b>
DVT8422	22 x 84 x 29	150	169	31	<b>\$2345</b>	<b>\$2813</b>
DVT7822	22 x 78 x 29	150	157	29	<b>\$2174</b>	<b>\$2609</b>
DVT7222	22 x 72 x 29	150	145	27	<b>\$2009</b>	<b>\$2408</b>
DVT6622	22 x 66 x 29	150	138	24	<b>\$1887</b>	<b>\$2263</b>
DVT6022	22 x 60 x 29	150	130	22	<b>\$1768</b>	<b>\$2123</b>
DVT5422	22 x 54 x 29	125	123	20	<b>\$1668</b>	<b>\$2006</b>
DVT4822	22 x 48 x 29	125	115	18	<b>\$1573</b>	<b>\$1890</b>
DVT4222	22 x 42 x 29	125	100	16	<b>\$1331</b>	<b>\$1598</b>
DVT3622	22 x 36 x 29	125	85	13	<b>\$1290</b>	<b>\$1546</b>
DVT3022	22 x 30 x 29	125	80	11	<b>\$1263</b>	<b>\$1514</b>
DVT2422	22 x 24 x 29	125	64	9	<b>\$1061</b>	<b>\$1274</b>

Two full end panels. **Cannot be connected on left or right side.**

**Required Specifications**

Veneer Finish  
Laminate Finish

**Optional Specifications**

Grommet

CONNECTABLE TABLES

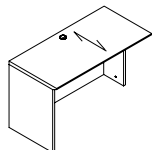

24" Deep Connectable Table - LEFT

MODEL#	DIMENSIONS D x W x H	FREIGHT CLASS	WT./LBS.	CUBIC FT.	VENEER/LAMINATE	ALL VENEER
DVL9624CG	24 x 96 x 29	150	200	39	\$3109	\$3731
DVL9024CG	24 x 90 x 29	150	187	36	\$2911	\$3493
DVL8424CG	24 x 84 x 29	150	174	34	\$2719	\$3263
DVL7824CG	24 x 78 x 29	150	162	31	\$2522	\$3024
DVL7224CG	24 x 72 x 29	150	149	29	\$2330	\$2796
DVL6624CG	24 x 66 x 29	150	141	27	\$2185	\$2623
DVL6024CG	24 x 60 x 29	150	132	24	\$2043	\$2453
DVL5424CG	24 x 54 x 29	150	121	22	\$1928	\$2309
DVL4824CG	24 x 48 x 29	125	115	19	\$1810	\$2173
DVL4224CG	24 x 42 x 29	150	99	17	\$1529	\$1835
DVL3624CG	24 x 36 x 29	150	83	15	\$1473	\$1770
DVL3024CG	24 x 30 x 29	125	77	12	\$1447	\$1737
DVL2424CG	24 x 24 x 29	125	61	10	\$1216	\$1458

**Full end panel on left.** Right narrow end panel connects to 24"D center/right connectable table; 24"D extended corners, 24"D 5-sided corners; Grommet in worksurface.

- To remove cross grain veneer pattern on top, **delete suffix "CG"** from the model number. Available as a special - no upcharge.

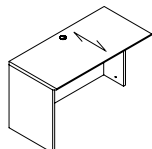

22" Deep Connectable Table - LEFT

DVL9622CG	22 x 96 x 29	150	187	39	\$2958	\$3549
DVL9022CG	22 x 90 x 29	150	175	36	\$2776	\$3332
DVL8422CG	22 x 84 x 29	150	163	34	\$2591	\$3109
DVL7822CG	22 x 78 x 29	150	152	31	\$2403	\$2882
DVL7222CG	22 x 72 x 29	150	140	29	\$2219	\$2662
DVL6622CG	22 x 66 x 29	150	133	27	\$2085	\$2501
DVL6022CG	22 x 60 x 29	150	125	24	\$1947	\$2338
DVL5422CG	22 x 54 x 29	150	113	22	\$1840	\$2207
DVL4822CG	22 x 48 x 29	125	110	19	\$1729	\$2074
DVL4222CG	22 x 42 x 29	150	95	17	\$1460	\$1749
DVL3622CG	22 x 36 x 29	125	80	15	\$1403	\$1685
DVL3022CG	22 x 30 x 29	125	75	12	\$1379	\$1658
DVL2422CG	22 x 24 x 29	125	60	10	\$1160	\$1392

**Full end panel on left.** Right narrow end panel connects to 22"D center/right connectable table; 22"D 5-sided corners; Grommet in worksurface.

- To remove cross grain veneer pattern on top, **delete suffix "CG"** from the model number. Available as a special - no upcharge.

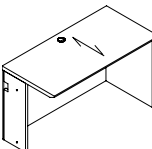

24" Deep Connectable Table - RIGHT

DVR9624CG	24 x 96 x 29	150	200	39	\$3109	\$3731
DVR9024CG	24 x 90 x 29	150	187	36	\$2911	\$3493
DVR8424CG	24 x 84 x 29	150	174	34	\$2719	\$3263
DVR7824CG	24 x 78 x 29	150	162	31	\$2522	\$3024
DVR7224CG	24 x 72 x 29	150	149	29	\$2330	\$2796
DVR6624CG	24 x 66 x 29	150	141	27	\$2185	\$2623
DVR6024CG	24 x 60 x 29	150	132	24	\$2040	\$2449
DVR5424CG	24 x 54 x 29	150	121	22	\$1928	\$2309
DVR4824CG	24 x 48 x 29	125	115	19	\$1812	\$2174
DVR4224CG	24 x 42 x 29	150	99	17	\$1529	\$1835
DVR3624CG	24 x 36 x 29	150	83	15	\$1473	\$1770
DVR3024CG	24 x 30 x 29	125	77	12	\$1447	\$1737
DVR2424CG	24 x 24 x 29	125	61	10	\$1216	\$1458

**Full end panel on right.** Left narrow end panel connects to 24"D center/left connectable table; 24"D extended corners, 24"D 5-sided corners; Grommet in worksurface.

- To remove cross grain veneer pattern on top, **delete suffix "CG"** from the model number. Available as a special - no upcharge.

**Required Specifications**

Veneer Finish  
Laminate Finish

**Optional Specifications**

Additional grommet

CONNECTABLE TABLES

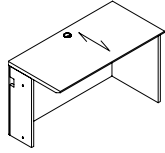

22" Deep Connectable Table - RIGHT

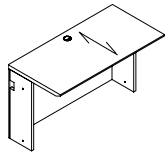

24" Deep Connectable Table

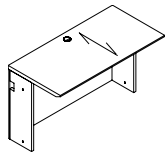

22" Deep Connectable Table

MODEL#	DIMENSIONS	FREIGHT CLASS	WT/LBS.	CUBIC FT.	veneer/LAMINATE	ALL VENEER
D x W x H						
DVR9622CG	22 x 96 x 29	150	187	39	\$2958	\$3549
DVR9022CG	22 x 90 x 29	150	175	36	\$2776	\$3332
DVR8422CG	22 x 84 x 29	150	163	34	\$2591	\$3109
DVR7822CG	22 x 78 x 29	150	152	31	\$2403	\$2882
DVR7222CG	22 x 72 x 29	150	140	29	\$2219	\$2662
DVR6622CG	22 x 66 x 29	150	133	27	\$2085	\$2501
DVR6022CG	22 x 60 x 29	150	125	24	\$1947	\$2338
DVR5422CG	22 x 54 x 29	150	113	22	\$1840	\$2207
DVR4822CG	22 x 48 x 29	125	110	19	\$1729	\$2074
DVR4222CG	22 x 42 x 29	150	95	17	\$1460	\$1749
DVR3622CG	22 x 36 x 29	125	80	15	\$1403	\$1685
DVR3022CG	22 x 30 x 29	125	75	12	\$1379	\$1658
DVR2422CG	22 x 24 x 29	125	60	10	\$1160	\$1392

**Full end panel on right.** Left narrow end panel connects to 22"D center/left connectable table; 22"D 5-sided corners; Grommet in worksurface.

- To remove cross grain veneer pattern on top, delete suffix "CG" from the model number. Available as a special - no upcharge.

DV9624CG	24 x 96 x 29	150	197	39	\$3035	\$3640
DV9024CG	24 x 90 x 29	150	185	36	\$2848	\$3418
DV8424CG	24 x 84 x 29	150	173	34	\$2658	\$3190
DV7824CG	24 x 78 x 29	150	160	31	\$2468	\$2961
DV7224CG	24 x 72 x 29	150	145	29	\$2276	\$2730
DV6624CG	24 x 66 x 29	150	136	27	\$2303	\$2765
DV6024CG	24 x 60 x 29	150	123	24	\$1987	\$2384
DV5424CG	24 x 54 x 29	150	119	22	\$1870	\$2246
DV4824CG	24 x 48 x 29	150	107	19	\$1756	\$2108
DV4224CG	24 x 42 x 29	150	91	17	\$1473	\$1770
DV3624CG	24 x 36 x 29	150	76	15	\$1421	\$1704
DV3024CG	24 x 30 x 29	150	70	12	\$1392	\$1668
DV2424CG	24 x 24 x 29	150	53	10	\$1169	\$1402

**Narrow end panels on left and right** connects to 24"D connectable table; 24"D extended corners, 24"D 5-sided corners; Grommet in worksurface.

- To remove cross grain veneer pattern on top, delete suffix "CG" from the model number. Available as a special - no upcharge.

DV9622CG	22 x 96 x 29	150	181	35	\$2891	\$3468
DV9022CG	22 x 90 x 29	150	169	33	\$2714	\$3256
DV8422CG	22 x 84 x 29	150	157	31	\$2528	\$3035
DV7822CG	22 x 78 x 29	150	145	29	\$2350	\$2820
DV7222CG	22 x 72 x 29	150	133	27	\$2164	\$2598
DV6622CG	22 x 66 x 29	150	126	24	\$2030	\$2435
DV6022CG	22 x 60 x 29	150	118	22	\$1898	\$2279
DV5422CG	22 x 54 x 29	150	111	20	\$1782	\$2137
DV4822CG	22 x 48 x 29	150	103	18	\$1671	\$2008
DV4222CG	22 x 42 x 29	150	88	16	\$1399	\$1680
DV3622CG	22 x 36 x 29	150	73	13	\$1352	\$1622
DV3022CG	22 x 30 x 29	125	68	11	\$1325	\$1589
DV2422CG	22 x 24 x 29	150	52	9	\$1111	\$1333

**Narrow end panels on left and right** connects to 22"D connectable table; 22"D extended corners, 22"D 5-sided corners; Grommet in worksurface.

- To remove cross grain veneer pattern on top, delete suffix "CG" from the model number. Available as a special - no upcharge.

**Required Specifications**

Veneer Finish  
Laminate Finish

**Optional Specifications**

Additional grommet



# DUFFERIN

## "D" ISLANDS

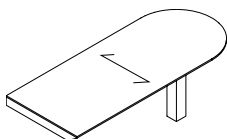

"D" Island with Monopost

MODEL#	DIMENSIONS D x W x H	FREIGHT CLASS	WT./LBS.	CUBIC FT.	VENEER/LAMINATE	ALL VENEER
DRD8436CG	36 x 84 x 29	250	135	51	N/A	<b>\$2865</b>
DRD7236CG	36 x 72 x 29	250	121	44	N/A	<b>\$2453</b>
DRD7230CG	30 x 72 x 29	250	99	36	N/A	<b>\$2296</b>
DRD6636CG	36 x 66 x 29	250	99	40	N/A	<b>\$2296</b>
DRD6030CG	30 x 60 x 29	250	83	30	N/A	<b>\$2137</b>

Attaches to edge of worksurfaces with Dufferin knife (molding) edge. Attaching hardware included. Shipped RTA (ready to assemble).

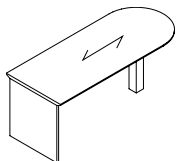

"D" Island - Full End Panel\* (T-Base) & Monopost

DDD8436	36 x 84 x 29	125	343	51	<b>\$4547</b>	<b>\$5458</b>
DDD7236	36 x 72 x 29	125	294	44	<b>\$3897</b>	<b>\$4674</b>
DDD7230	30 x 72 x 29	125	264	36	<b>\$3622</b>	<b>\$4345</b>
DDD6636	36 x 66 x 29	125	245	40	<b>\$3622</b>	<b>\$4345</b>
DDD6030	30 x 60 x 29	125	225	30	<b>\$3482</b>	<b>\$4176</b>

Connects to Linking Bridges or Executive Returns. Attaching hardware included. **Not freestanding.**

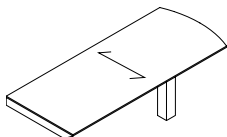

"D" Island with Monopost, Bow End

DRDBE8436CG	36 x 84 x 29	250	135	51	N/A	<b>\$2865</b>
DRDBE7236CG	36 x 72 x 29	250	121	44	N/A	<b>\$2453</b>
DRDBE7230CG	30 x 72 x 29	250	99	36	N/A	<b>\$2296</b>
DRDBE6636CG	36 x 66 x 29	250	99	40	N/A	<b>\$2296</b>
DRDBE6030CG	30 x 60 x 29	250	83	30	N/A	<b>\$2137</b>

Attaches to edge of worksurfaces with Dufferin knife (molding) edge. Attaching hardware included. Shipped RTA (ready to assemble).

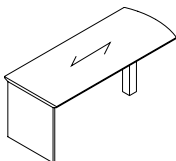

"D" Island - Full End Panel, Bow End (T-Base) & Monopost

DRDBE8436	36 x 84 x 29	125	343	51	<b>\$4546</b>	<b>\$5455</b>
DRDBE7236	36 x 72 x 29	125	294	44	<b>\$3897</b>	<b>\$4674</b>
DRDBE7230	30 x 72 x 29	125	264	36	<b>\$3621</b>	<b>\$4344</b>
DRDBE6636	36 x 66 x 29	125	245	40	<b>\$3621</b>	<b>\$4344</b>
DRDBE6030	30 x 60 x 29	125	225	30	<b>\$3479</b>	<b>\$4174</b>

Connects to Linking Bridges or Executive Returns. Attaching hardware included. **Not freestanding.**

## BOAT SHAPED ISLANDS

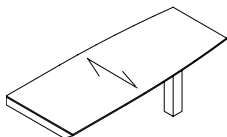

Boat Shaped Island with Monopost

MODEL#	DIMENSIONS	FREIGHT CLASS	WT./LBS.	CUBIC FT.	VENEER/LAMINATE	ALL VENEER
DRDBS8442CG	42 x 84 x 29	250	179	59	N/A	<b>\$3335</b>
DRDBS8436CG	36 x 84 x 29	250	155	51	N/A	<b>\$2865</b>
DRDBS7236CG	36 x 72 x 29	250	141	44	N/A	<b>\$2453</b>
DRDBS7230CG	30 x 72 x 29	250	119	36	N/A	<b>\$2296</b>
DRDBS6636CG	36 x 66 x 29	250	119	40	N/A	<b>\$2296</b>
DRDBS6030CG	30 x 60 x 29	250	103	30	N/A	<b>\$2137</b>

Attaches to edge of worksurfaces with Dufferin knife (molding) edge. Attaching hardware included. Shipped RTA (ready to assemble).

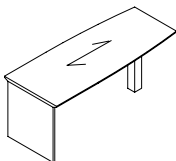

Boat Shaped Island - Full End Panel\* (T-Base) & Monopost

DRDBS8442	42 x 84 x 29	125	414	59	<b>\$5382</b>	<b>\$6460</b>
DRDBS8436	36 x 84 x 29	125	343	51	<b>\$4546</b>	<b>\$5455</b>
DRDBS7236	36 x 72 x 29	125	314	44	<b>\$3897</b>	<b>\$4674</b>
DRDBS7230	30 x 72 x 29	125	284	36	<b>\$3621</b>	<b>\$4344</b>
DRDBS6636	36 x 66 x 29	125	265	40	<b>\$3621</b>	<b>\$4344</b>
DRDBS6030	30 x 60 x 29	100	245	30	<b>\$3479</b>	<b>\$4174</b>

Connects to Linking Bridges or Executive Returns. Attaching hardware included. **Not freestanding.**

### Required Specifications

Veneer finish  
Laminate finish\*  
Monopost finish

### Optional Specifications

Grommet  
Modesty panel  
Monopost (Base) upgrade

**"P" ISLANDS**

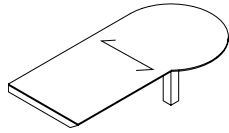

**"P" Island - LEFT with Monopost**

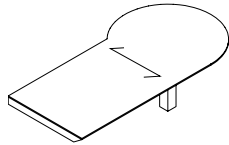

**"P" Island - RIGHT with Monopost**

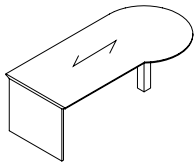

**"P" Island - LEFT with Monopost (T-Base) & Monopost\***

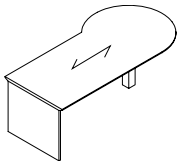

**"P" Island - RIGHT with Monopost (T-Base) & Monopost\***

MODEL#	DIMENSIONS D x W x H	FREIGHT CLASS	WT/LBS.	CUBIC FT.	LIST PRICE
DRPL9642CG	42 x 96 x 29	250	239	68	N/A <b>\$4408</b>
DRPL8442CG	42 x 84 x 29	250	209	59	N/A <b>\$3855</b>
DRPL7242CG	42 x 72 x 29	250	143	51	N/A <b>\$3309</b>

Attaches to edge of worksurfaces with Dufferin knife (molding) edge. Attaching hardware included. Shipped RTA (ready to assemble).

DRPR9642CG	42 x 96 x 29	250	239	68	N/A <b>\$4408</b>
DRPR8442CG	42 x 84 x 29	250	209	59	N/A <b>\$3855</b>
DRPR7242CG	42 x 72 x 29	250	143	51	N/A <b>\$3309</b>

Attaches to edge of worksurfaces with Dufferin knife (molding) edge. Attaching hardware included. Shipped RTA (ready to assemble).

DTPL9642	42 x 96 x 29	125	440	68	<b>\$4163</b> <b>\$4993</b>
DTPL8442	42 x 84 x 29	125	385	59	<b>\$3641</b> <b>\$4371</b>
DTPL7242	42 x 72 x 29	125	319	51	<b>\$3319</b> <b>\$3982</b>

Connects to Linking Bridges or Executive Returns. Attaching hardware included. **Not freestanding.**

DTPR9642	42 x 96 x 29	125	440	68	<b>\$4163</b> <b>\$4993</b>
DTPR8442	42 x 84 x 29	125	385	59	<b>\$3641</b> <b>\$4371</b>
DTPR7242	42 x 72 x 29	125	319	51	<b>\$3319</b> <b>\$3982</b>

Connects to Linking Bridges or Executive Returns. Attaching hardware included. **Not freestanding.**

**Required Specifications**

Veneer finish  
Laminate finish\*  
Monopost finish

**Optional Specifications**

Grommet  
Modesty panel  
Monopost (Base) upgrade

# D DUFFERIN

PIANO DESKS      MODEL#      DIMENSIONS      FREIGHT CLASS      WT/LBS.      CUBIC FT.      VENEER/LAMINATE      ALL VENEER

D x W x H

- Can be ordered as a shell or with pedestals.
- Components include a GM1 grommet in the top center position.
- Hand of Rectangular Desk is determined by location of pedestal from user side.
- Hand of "D" Top is determined by outward orientation of curved end from user projection.
- Hand of "P" Top is determined by outward orientation of conference end from user projection.
- Connectable Tables and Bridges - To remove cross grain veneer pattern on top, delete suffix "CG" from the model number. Available as a special - no upcharge.

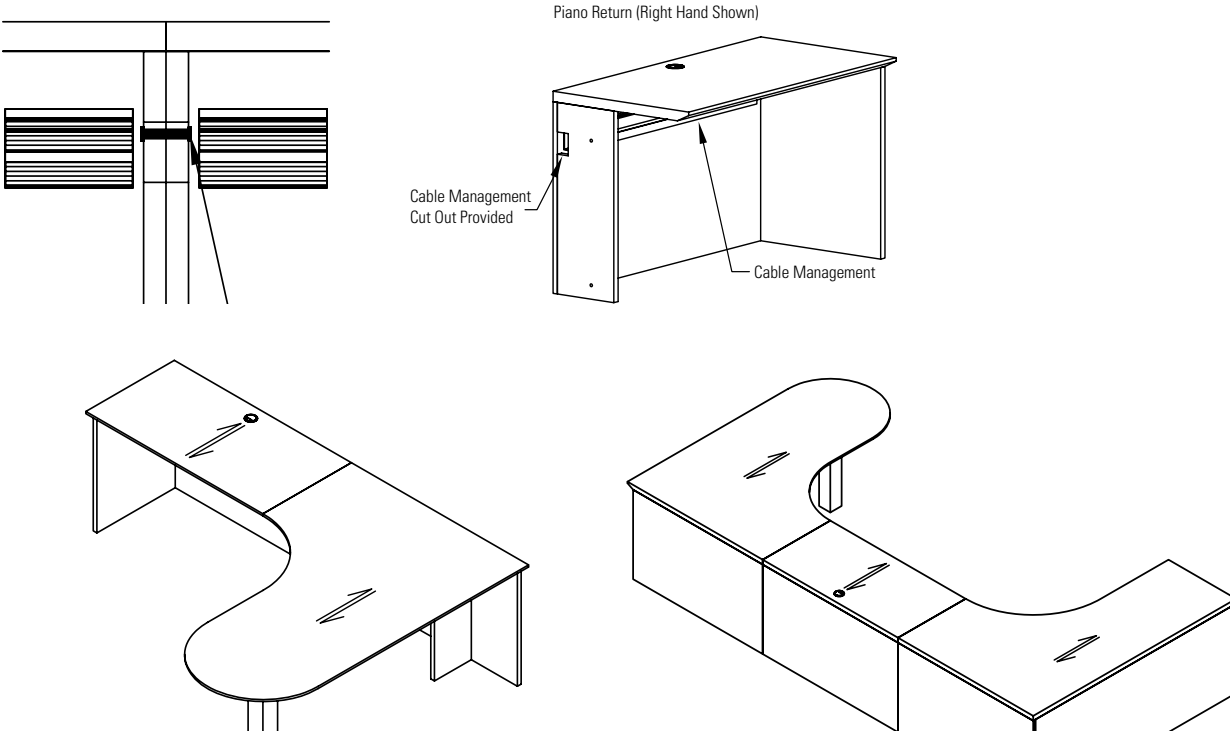

"D" ISLANDS (PIANO DESKS)      MODEL#      DIMENSIONS      FREIGHT CLASS      WT/LBS.      CUBIC FT.      VENEER/LAMINATE      ALL VENEER

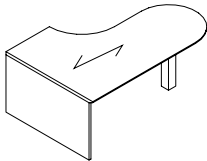

"D" Island LEFT - Full End Panel & Monopost, Piano Desk

DTDPL96304824	48 x 96 x 29	125	464	77	<b>\$4317</b>	<b>\$5179</b>
DTDPL84304824	48 x 84 x 29	150	406	68	<b>\$3843</b>	<b>\$4613</b>
DTDPL72304824	48 x 72 x 29	125	348	58	<b>\$3366</b>	<b>\$4039</b>

Extended island worksurface on the **left**. Narrow end panel on right connects to **24"D** returns or bridges for Piano Desks **Only** (see above). **Not freestanding**. Includes installed horizontal wire management.

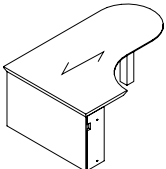

"D" Island RIGHT - Full End Panel & Monopost, Piano Desk

DTDPR96304824	48 x 96 x 29	125	464	77	<b>\$4317</b>	<b>\$5179</b>
DTDPR84304824	48 x 84 x 29	150	406	68	<b>\$3843</b>	<b>\$4613</b>
DTDPR72304824	48 x 72 x 29	125	348	58	<b>\$3366</b>	<b>\$4039</b>

Extended island worksurface on the **right**. Narrow end panel on left connects to **24"D** returns or bridges for Piano Desks **Only** (see above). **Not freestanding**. Includes installed horizontal wire management.

**Required Specifications**

Veneer finish  
Laminate finish  
Monopost finish

**Optional Specifications**

Grommet  
Modesty panel  
Monopost (Base) upgrade

**BOAT SHAPED ISLANDS (PIANO DESKS)**

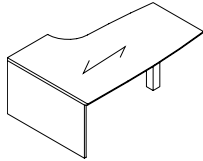

**Boat Shaped Island LEFT - Full End Panel & Monopost, Piano Desk**

MODEL#	DIMENSIONS	FREIGHT CLASS	WT/LBS.	CUBIC FT.	VENEER/LAMINATE	ALL VENEER
<b>D x W x H</b>						
DTBPL96304824	48 x 96 x 29	125	522	87	<b>\$5131</b>	<b>\$6157</b>
DTBPL84304824	48 x 84 x 29	125	457	76	<b>\$5131</b>	<b>\$6157</b>
DTBPL72304824	48 x 72 x 29	125	392	65	<b>\$4480</b>	<b>\$5375</b>

Extended island worksurface on the **left**. Narrow end panel on right connects to **24"D** returns or bridges **for Piano Desks Only** (see pg. 35). **Not freestanding**. Includes installed horizontal wire management.

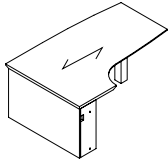

**Boat Shaped Island RIGHT - Full End Panel & Monopost, Piano Desk**

DTBPR96304824	48 x 96 x 29	125	522	87	<b>\$5131</b>	<b>\$6157</b>
DTBPR84304824	48 x 84 x 29	125	457	76	<b>\$5131</b>	<b>\$6157</b>
DTBPR72304824	48 x 72 x 29	125	392	65	<b>\$4477</b>	<b>\$5374</b>

Extended island worksurface on the **right**. Narrow end panel on left connects to **24"D** returns or bridges **for Piano Desks Only** (see pg. 35). **Not freestanding**. Includes installed horizontal wire management.

**"P" ISLANDS (PIANO DESKS)**

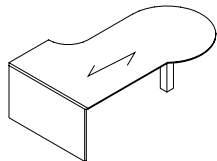

**"P" Shaped Island LEFT - Full End Panel & Monopost, Piano Desk**

MODEL#	DIMENSIONS	FREIGHT CLASS	WT/LBS.	CUBIC FT.	VENEER/LAMINATE	ALL VENEER
DTPPL96424824	60 x 96 x 29	150	580	97	<b>\$4924</b>	<b>\$5911</b>
DTPPL84424824	60 x 84 x 29	150	508	85	<b>\$4405</b>	<b>\$5285</b>
DTPPL72424824	60 x 72 x 29	150	435	73	<b>\$4084</b>	<b>\$4901</b>

Extended island worksurface on the **left**. Narrow end panel on right connects to **24"D** returns or bridges **for Piano Desks Only** (see pg. 35). **Not freestanding**. Includes installed horizontal wire management.

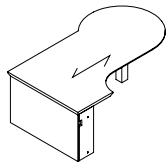

**Boat Shaped Island RIGHT - Full End Panel & Monopost, Piano Desk**

DTPPR96424824	60 x 96 x 29	150	580	97	<b>\$4921</b>	<b>\$5905</b>
DTPPR84424824	60 x 84 x 29	150	508	85	<b>\$4405</b>	<b>\$5285</b>
DTPPR72424824	60 x 72 x 29	150	435	73	<b>\$4084</b>	<b>\$4901</b>

Extended island worksurface on the **right**. Narrow end panel on left connects to **24"D** returns or bridges **for Piano Desks Only** (see pg. 35). **Not freestanding**. Includes installed horizontal wire management.

**DELTA ISLANDS (PIANO DESKS)**

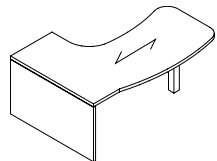

**Delta Island LEFT - Full End Panel & Monopost, Piano Desk**

MODEL#	DIMENSIONS	FREIGHT CLASS	WT/LBS.	CUBIC FT.	VENEER/LAMINATE	ALL VENEER
DBTHPL96304824	54 x 96 x 29	125	531	87	<b>\$4669</b>	<b>\$5603</b>
DBTHPL84304824	54 x 84 x 29	125	464	76	<b>\$4151</b>	<b>\$4982</b>
DBTHPL72304824	54 x 72 x 29	125	398	65	<b>\$3831</b>	<b>\$4595</b>

Extended island worksurface on the **left**. Narrow end panel on right connects to **24"D** returns or bridges **for Piano Desks Only** (see pg. 35). **Not freestanding**. Includes installed horizontal wire management.

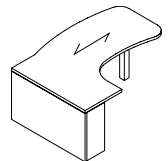

**Delta Island RIGHT - Full End Panel & Monopost, Piano Desk**

DBTHPR96304824	54 x 96 x 29	125	531	87	<b>\$4669</b>	<b>\$5603</b>
DBTHPR84304824	54 x 84 x 29	125	464	76	<b>\$4151</b>	<b>\$4982</b>
DBTHPR72304824	54 x 72 x 29	125	398	65	<b>\$3831</b>	<b>\$4595</b>

Extended island worksurface on the **right**. Narrow end panel on left connects to **24"D** returns or bridges **for Piano Desks Only** (see pg. 35). **Not freestanding**. Includes installed horizontal wire management.

**Required Specifications**

Veneer finish  
Laminate finish  
Monopost finish

**Optional Specifications**

Grommet  
Modesty panel  
Monopost (Base) upgrade

CONNECTABLE TABLES - LEFT (FOR PIANO DESKS)

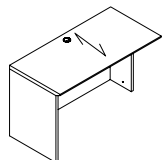

24" Deep Connectable Table - LEFT  
For Piano Desk

MODEL#	DIMENSIONS D x W x H	FREIGHT CLASS	WT/LBS.	CUBIC FT.	veneER/LAMINATE	ALL veneER
DVEL9624CG	24 x 96 x 29	150	200	39	\$3226	\$3872
DVEL9024CG	24 x 90 x 29	150	187	36	\$3027	\$3634
DVEL8424CG	24 x 84 x 29	150	174	34	\$2822	\$3386
DVEL7824CG	24 x 78 x 29	150	162	31	\$2624	\$3148
DVEL7224CG	24 x 72 x 29	150	149	29	\$2425	\$2910
DVEL6624CG	24 x 66 x 29	150	141	27	\$2268	\$2723
DVEL6024CG	24 x 60 x 29	150	132	24	\$2126	\$2550
DVEL5424CG	24 x 54 x 29	150	121	22	\$2001	\$2402
DVEL4824CG	24 x 48 x 29	125	115	19	\$1885	\$2262
DVEL4224CG	24 x 42 x 29	150	99	17	\$1586	\$1901
DVEL3624CG	24 x 36 x 29	150	83	15	\$1538	\$1843
DVEL3024CG	24 x 30 x 29	125	77	12	\$1645	\$1975
DVEL2424CG	24 x 24 x 29	125	61	10	\$1263	\$1514

**Full end panel on left.** Right narrow end panel connects to 24"D right connectable table, "D" islands, Boat shaped islands, "P" islands or Delta islands with "T" bases **for Piano Desks Only**. Grommet in worksurface. Shipped RTA (ready to assemble).

- To remove cross grain veneer pattern on top, **delete suffix "CG"** from the model number. Available as a special - no upcharge.

CONNECTABLE TABLES - RIGHT (FOR PIANO DESKS)

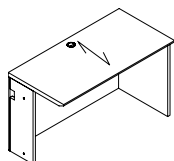

24" Deep Connectable Table - RIGHT  
For Piano Desk

MODEL#	DIMENSIONS	FREIGHT CLASS	WT/LBS.	CUBIC FT.	veneER/LAMINATE	ALL veneER
DVER9624CG	24 x 96 x 29	150	200	39	\$3226	\$3872
DVER9024CG	24 x 90 x 29	150	187	36	\$3027	\$3634
DVER8424CG	24 x 84 x 29	150	174	34	\$2822	\$3386
DVER7824CG	24 x 78 x 29	150	162	31	\$2624	\$3148
DVER7224CG	24 x 72 x 29	150	149	29	\$2425	\$2910
DVER6624CG	24 x 66 x 29	150	141	27	\$2268	\$2723
DVER6024CG	24 x 60 x 29	150	132	24	\$2126	\$2550
DVER5424CG	24 x 54 x 29	150	121	22	\$2001	\$2402
DVER4824CG	24 x 48 x 29	125	115	19	\$1885	\$2262
DVER4224CG	24 x 42 x 29	150	99	17	\$1586	\$1901
DVER3624CG	24 x 36 x 29	150	83	15	\$1538	\$1843
DVER3024CG	24 x 30 x 29	125	77	12	\$1522	\$1829
DVER2424CG	24 x 24 x 29	125	61	10	\$1263	\$1514

**Full end panel on right.** Left narrow end panel connects to 24"D left connectable table, "D" islands, Boat shaped islands, "P" islands or Delta islands with "T" bases **for Piano Desks Only**. Grommet in worksurface. Shipped RTA (ready to assemble).

- To remove cross grain veneer pattern on top, **delete suffix "CG"** from the model number. Available as a special - no upcharge.

BRIDGES (FOR PIANO DESKS)

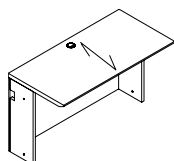

Flush Bridge

MODEL#	DIMENSIONS	FREIGHT CLASS	WT/LBS.	CUBIC FT.	veneER/LAMINATE	ALL veneER
DBTN4824CG	24 x 48 x 29	125	116	19	\$1617	\$1941
DBTN4224CG	24 x 42 x 29	92.5	102	17	\$1359	\$1632
DBTN3624CG	24 x 36 x 29	150	87	15	\$1302	\$1564
DBTN3024CG	24 x 30 x 29	125	73	12	\$1276	\$1533
DBTN2424CG	24 x 24 x 29	150	58	10	\$1073	\$1287
DBTN1824CG	24 x 18 x 29	150	43	8	\$805	\$966
DBTN1224CG	24 x 12 x 29	150	29	5	\$537	\$647

**Full end panel on both sides** connects to 24"D worksurfaces, "D" islands, Boat shaped islands, "P" islands or Delta islands with "T" bases **for Piano Desks Only**. Grommet in worksurface. Shipped RTA (ready to assemble).

- To remove cross grain veneer pattern on top, **delete suffix "CG"** from the model number. Available as a special - no upcharge.

**Required Specifications**

Veneer finish  
Laminate finish

**Optional Specifications**

Additional grommet

**TABLE DESK**

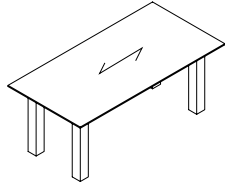
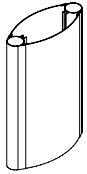

**Table Desk\*\***

MODEL#	DIMENSIONS	FREIGHT CLASS	WT/LBS.	CUBIC FT.	VENEER/LAMINATE	ALL VENEER
<b>D x W x H</b>						
DTB8442	42 x 84 x 29	150	272	59	N/A	<b>\$7689</b>
DTB7842	42 x 78 x 29	150	253	55	N/A	<b>\$7141</b>
DTB7236	36 x 72 x 29	150	205	44	N/A	<b>\$5651</b>
DTB7230	30 x 72 x 29	150	192	36	N/A	<b>\$5544</b>
DTB6636	36 x 66 x 29	150	192	40	N/A	<b>\$5544</b>
DTB6630	30 x 66 x 29	150	188	33	N/A	<b>\$5436</b>
DTB6030	30 x 60 x 29	150	171	30	N/A	<b>\$5180</b>

Four 4" square metal legs. Includes centered pencil drawer.

**MONOPOST (BASE) UPGRADES**



**Elliptical Base Upgrade**

MODEL#	DIMENSIONS	FREIGHT CLASS	WT/LBS.	CUBIC FT.	VENEER/LAMINATE	ALL VENEER
TE18	5 x 18 x 28	70	30	2	N/A	<b>\$1291</b>

To replace one standard monopost on Islands ONLY. Must specify at time of order. **Cannot be retrofitted in the field.**

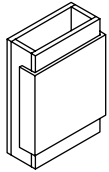

**Rectangular Base Upgrade**

TPML18	8 x 18 x 28	70	36	2	N/A	<b>\$1229</b>
--------	-------------	----	----	---	-----	---------------

To replace one standard monopost on Islands ONLY. Must specify at time of order. **Cannot be retrofitted in the field. Not sold individually - to be ordered as an upgrade option only.**

**Required Specifications**

Veneer Finish  
Laminate Finish  
Metal finish\*

**Optional Specifications**

Lock\*\*  
Veneer top\*\*

# D DUFFERIN

## MODESTY PANEL OPTIONS

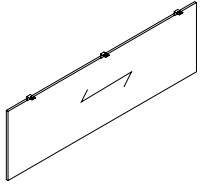

**Veneer Modesty Panel Upgrade\***

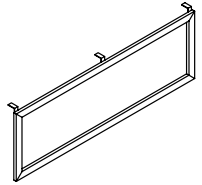

**Glass Modesty Panel Upgrade**

MODEL#	DIMENSIONS D x W x H	FREIGHT CLASS	WT/LBS.	CUBIC FT.	LIST PRICE
CMP72W	0.75 x 67 x 18	--	20	1	<b>\$1622</b>
CMP66W	0.75 x 61 x 18	--	18	1	<b>\$1570</b>
CMP60W	0.75 x 55 x 18	--	16	1	<b>\$1546</b>
CMP54W	0.75 x 49 x 18	--	14	1	<b>\$1520</b>
CMP48W	0.75 x 43 x 18	--	13	1	<b>\$1496</b>

Straight modesty panel. Attaches to underside of worksurface. **Can not be retrofitted in the field *Not sold individually - to be ordered as an upgrade option only.***

- CMP72W - Specify on "P" Top Islands or 96" x 48" Islands for Piano Desks.
- CMP66W - Specify on 84" x 36" "D" Top Islands.
- CMP60W - Specify on 84" x 42" "P" Top Islands or 84" x 48" Islands for Piano Desks.
- CMP54W - Specify on 72" x 30" "D" Top Islands.
- CMP48W - Specify on 66" x 36" , 60" x 30" "D" Top Islands, 72" x 42" "P" Top Islands or 72" x 48" Islands for Piano Desks.

CMP72G	0.75 x 67 x 18	--	20	1	<b>\$2485</b>
CMP66G	0.75 x 61 x 18	--	18	1	<b>\$2351</b>
CMP60G	0.75 x 55 x 18	--	16	1	<b>\$2149</b>
CMP54G	0.75 x 49 x 18	--	14	1	<b>\$2001</b>
CMP48G	0.75 x 43 x 18	--	13	1	<b>\$1911</b>

Straight modesty panel. Translucent, screened glass. Aluminum box frame construction in Tungsten Only. Attaches to underside of worksurface. **Can not be retrofitted in the field. *Not sold individually - to be ordered as an upgrade option only.***

- CMP72G - Specify on "P" Top Islands or 96" x 48" Islands for Piano Desks.
- CMP66G - Specify on 84" x 36" "D" Top Islands.
- CMP60G - Specify on 84" x 42" "P" Top Islands or 84" x 48" Islands for Piano Desks.
- CMP54G - Specify on 72" x 30" "D" Top Islands.
- CMP48G - Specify on 66" x 36" , 60" x 30" "D" Top Islands, 72" x 42" "P" Top Islands or 72" x 48" Islands for Piano Desks.
- Tungsten finish on the aluminum box frame closely resembles the existing Tungsten finish.

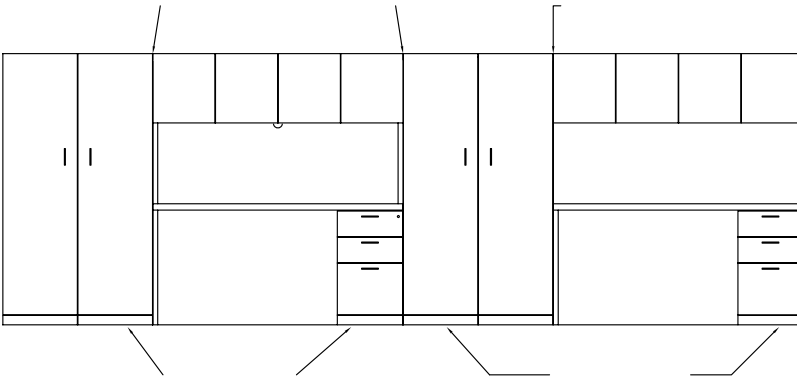

### Required Specifications

Veneer finish

**STORAGE SHELLS      MODEL#      DIMENSIONS      FREIGHT CLASS      WT/LBS.      CUBIC FT.      VENEER/LAMINATE      ALL VENEER**

**D x W x H**

- When using Storage Shells, laminate gables will show.
- Credenza shell cannot be completely filled up with storage shells to create a full storage credenza.
- Handle style must be specified.

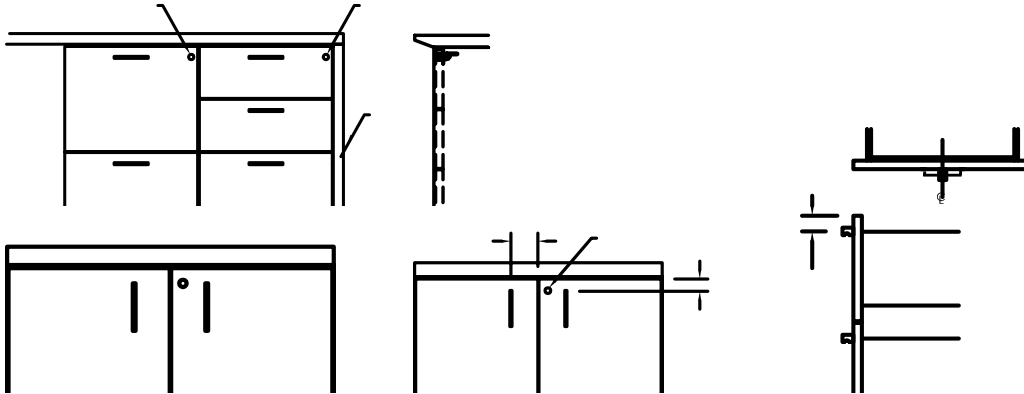

**STORAGE SHELLS      MODEL#      DIMENSIONS      FREIGHT CLASS      WT/LBS.      CUBIC FT.      VENEER/LAMINATE      ALL VENEER**

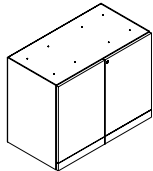

**Storage Shell**

DWG	19.1 x 36.75 x 28	92.5	115	11	<b>\$1582</b>	<b>\$1896</b>
DWM	19.1 x 31.625 x 28	92.5	96	9	<b>\$1399</b>	<b>\$1680</b>

For use **under a freestanding worksurface (22", 24", 30" or 36"D)**. Top drilled to attach to worksurface. One adjustable shelf. **Standard with lock.**

- **Unfinished top and back**

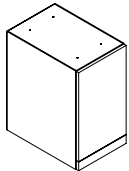

**Storage Shell - LEFT**

DWWIL	23 x 15.6 x 28	100	53	6	<b>\$1406</b>	<b>\$1687</b>
DWIL	19.1 x 15.6 x 28	100	45	5	<b>\$1162</b>	<b>\$1393</b>

For use **under a freestanding worksurface (22", 24", 30" or 36"D)**. Top drilled to attach to worksurface. One adjustable shelf. Handle is on the **right**, door opens to the **left**.

- For 22" or 24"D worksurface, order **DWIL**. For 30" or 36"D worksurface, order **DWWIL**.

- **Unfinished top and back**

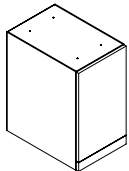

**Storage Shell - RIGHT**

DWWIR	23 x 15.6 x 28	100	53	6	<b>\$1406</b>	<b>\$1687</b>
DWIR	19.1 x 15.6 x 28	100	45	5	<b>\$1162</b>	<b>\$1393</b>

For use **under a freestanding worksurface (22", 24", 30" or 36"D)**. Top drilled to attach to worksurface. One adjustable shelf. Handle is on the **left**, door opens to the **right**.

- For 22" or 24"D worksurface, order **DWIR**. For 30" or 36"D worksurface, order **DWWIR**.

- **Unfinished top and back**

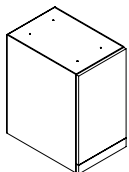

**Storage Shell - LEFT  
Eight Storage Slot Shelves**

DWWIL8S	23 x 15.6 x 28	125	45	6	<b>\$1922</b>	<b>\$2306</b>
DWIL8S	19.1 x 15.6 x 28	125	37	5	<b>\$1670</b>	<b>\$2007</b>

For use **under a freestanding worksurface (22", 24", 30" or 36"D)**. Top drilled to attach to worksurface. Eight adjustable storage slot shelves. Handle is on the **right**, door opens to the **left**.

- For 22" or 24"D worksurface, order **DWIL8S**. For 30" or 36"D worksurface, order **DWWIL8S**.

- **Unfinished top and back**

**Required Specifications**

Veneer Finish (doors)  
Laminate Finish (body)  
Handle Style

**Optional Specifications**

Lock



STORAGE SHELLS

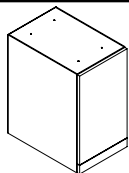

Storage Shell - RIGHT  
Eight Storage Slot Shelves

MODEL#	DIMENSIONS D x W x H	FREIGHT CLASS	WT./LBS.	CUBIC FT.	VENEER/LAMINATE	ALL VENEER
DWWIR8S	23 x 15.6 x 28	125	45	6	\$1922	\$2306
DWIR8S	19.1 x 15.6 x 28	125	37	5	\$1670	\$2007

For use **under a freestanding worksurface (22", 24", 30" or 36"D)**. Top drilled to attach to worksurface. Eight adjustable storage slot shelves. Handle is on the **left**, door opens to the **right**.

- For 22" or 24"D worksurface, order **DWIR8S**. For 30" or 36"D worksurface, order **DWWIR8S**.
- **Unfinished top and back**

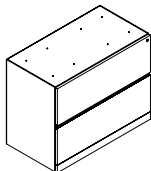

File/File Shell - Lateral

DWF	19.1 x 36.75 x 28	92.5	115	11	\$2264	\$2719
DWN	19.1 x 31.625 x 28	92.5	96	9	\$1983	\$2380

For use **under a freestanding worksurface (22", 24", 30" or 36"D)**. Top drilled to attach to worksurface. **Two lateral file drawers**. Lock secures all drawers. Side-to-side file bars included.

- **Unfinished top and back**

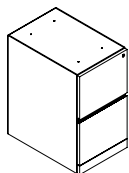

File/File Shell - Vertical\*

LETTER						
DWWE	23 x 15.6 x 28	85	72	6	\$1745	\$2096
DWE	19.1 x 15.6 x 28	85	70	5	\$1521	\$1825
LEGAL						
DWWLE	23 x 18.5 x 28	85	85	7	\$2098	\$2518
DWLE	19.1 x 18.5 x 28	85	83	6	\$1825	\$2189

For use **under a freestanding worksurface (22", 24", 30" or 36"D)**. Top drilled to attach to worksurface. **Two file drawers**. Lock secures all drawers.

- For 22" or 24"D worksurface, order **DWE or DWLE**. For 30" or 36"D worksurface, order **DWWE or DWWLE**.
- **Unfinished top and back**

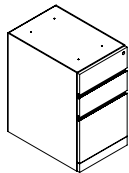

Box/Box/File Shell - Vertical\*

LETTER						
DWWD	23 x 15.6 x 28	85	72	6	\$1745	\$2096
DWD	19.1 x 15.6 x 28	85	70	5	\$1521	\$1825
LEGAL						
DWWLD	23 x 18.5 x 28	85	85	7	\$2098	\$2518
DWLD	19.1 x 18.5 x 28	85	83	6	\$1825	\$2189

For use **under a freestanding worksurface (22", 24", 30" or 36"D)**. Top drilled to attach to worksurface. **Two box and one file drawers**. One pencil tray. Lock secures all drawers.

- For 22" or 24"D worksurface, order **DWD or DWLD**. For 30" or 36"D worksurface, order **DWWD or DWWLD**.
- **Unfinished top and back**

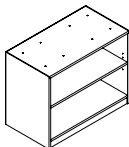

Open Shelving Shell

DWOB36	19.1 x 36.75 x 28	100	92	11	\$1196	\$1435
DWOB30	19.1 x 31.625 x 28	100	77	9	\$1059	\$1271

For use **under a freestanding worksurface (22", 24", 30" or 36"D)**. Top drilled to attach to worksurface. One adjustable veneer shelf.

- **Unfinished top and back**

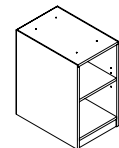

Open Shelving Shell

DWWQ	23 x 15.6 x 28	125	45	6	\$1238	\$1484
DWQ	19.1 x 15.6 x 28	125	37	5	\$1023	\$1229

For use **under a freestanding worksurface (22", 24", 30" or 36"D)**. Top drilled to attach to worksurface. One adjustable veneer shelf.

- For 22" or 24"D worksurface, order **DWQ**. For 30" or 36"D worksurface, order **DWWQ**.
- **Unfinished top and back**

**Required Specifications**

Veneer Finish (doors, drawer fronts, open shelves)  
Laminate Finish (body)  
Handle Style

**Optional Specifications**

Additional Lock\*

**STORAGE SHELLS**

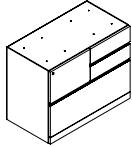

**Mixed Storage Shell - LEFT**

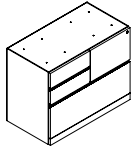

**Mixed Storage Shell - RIGHT**

**MODEL# DIMENSIONS FREIGHT CLASS WT/LBS. CUBIC FT. VENEER/LAMINATE ALL VENEER**

	D x W x H					
DWZL	19.1 x 36.75 x 28	92.5	115	11	\$2629	\$3156

For use **under a freestanding worksurface (22", 24", 30" or 36"D)**. Top drilled to attach to worksurface. One file drawer on **left**, two box drawers on **right** and one lateral file drawer on bottom. File drawer and lateral file drawer lock. One pencil tray. **Not for stacking materials on lateral file drawer bottom.**

- **Unfinished top and back**

DWZR	19.1 x 36.75 x 28	92.5	115	11	\$2629	\$3156
------	-------------------	------	-----	----	--------	--------

For use **under a freestanding worksurface (22", 24", 30" or 36"D)**. Top drilled to attach to worksurface. One file drawer on **right**, two box drawers on **left** and one lateral file drawer on bottom. File drawer and lateral file drawer lock. One pencil tray. **Not for stacking materials on lateral file drawer bottom.**

- **Unfinished top and back**

**STORAGE MODULES - (FREESTANDING)**

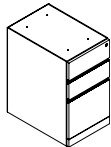

**Box/Box/File Freestanding Pedestal**

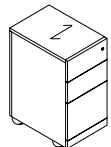

**Box/Box/File Module, Mobile**

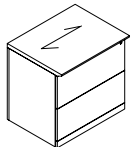

**File/File Module, Lateral**

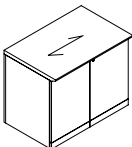

**Storage Cabinet w/Doors**

**MODEL# DIMENSIONS FREIGHT CLASS WT/LBS. CUBIC FT. VENEER/LAMINATE ALL VENEER**

DWDB	19.8 x 15.5 x 28	85	70	5	\$1648	\$1979
DWWDB	23.8 x 15.5 x 28	300	75	6	\$1898	\$2279

**Two box and one file drawer.** One pencil tray. Lock secures all drawers. Finished back.

DWDM	19.8 x 15.5 x 28	85	70	5	\$1774	\$2128
DWWDM	23.8 x 15.5 x 28	300	75	6	\$2038	\$2447

**Two box and one file drawer.** One pencil tray. Lock secures all drawers. Casters.

DF3624	24 x 36 x 29	85	184	15	\$3153	\$3783
DN3024	24 x 30 x 29	85	153	12	\$2761	\$3314
DF3622	22 x 36 x 29	85	170	13	\$2890	\$3467
DN3022	22 x 30 x 29	85	142	11	\$2532	\$3039

**Two lateral file drawers.** Lock secures all drawers. Side-to-side file bars included.

DBD3624	24 x 36 x 29	92.5	152	15	\$1972	\$2365
DBD3024	24 x 30 x 29	92.5	127	12	\$1725	\$2068
DBD3622	22 x 36 x 29	92.5	140	13	\$1806	\$2165
DBD3022	22 x 30 x 29	92.5	117	11	\$1582	\$1896

Includes one adjustable shelf. Standard with lock.

**Required Specifications**

- Veneer Finish (doors, drawer fronts, open shelves)
- Laminate Finish (top/body)
- Handle Style

STORAGE MODULES - FREESTANDING

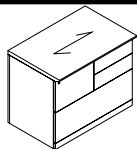

Mixed Storage Cabinet - LEFT

MODEL#	DIMENSIONS D x W x H	FREIGHT CLASS	WT/LBS.	CUBIC FT.	VENEER/LAMINATE	ALL VENEER
DZL3624	24 x 36 x 29	85	184	15	\$3138	\$3764
DZL3622	22 x 36 x 29	85	170	13	\$2876	\$3453

One file drawer on the **left**, two box drawers on the **right** and one lateral file drawer on the bottom. File drawer and lateral file drawer lock. One pencil tray. Not for stacking materials on lateral file drawer bottom.

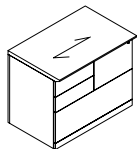

Mixed Storage Cabinet - RIGHT

DZR3624	24 x 36 x 29	85	184	15	\$3138	\$3764
DZR3622	22 x 36 x 29	85	170	13	\$2876	\$3453

One file drawer on the **right**, two box drawers on the **left** and one lateral file drawer on the bottom. File drawer and lateral file drawer lock. One pencil tray. Not for stacking materials on lateral file drawer bottom.

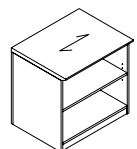

Open Storage Cabinet

DOB3624	24 x 36 x 29	100	123	15	\$1521	\$1825
DOB3024	24 x 30 x 29	100	103	12	\$1333	\$1599
DOB3622	22 x 36 x 29	100	115	13	\$1397	\$1678
DOB3022	22 x 30 x 29	100	96	11	\$1223	\$1467

One fixed and **one** adjustable veneer shelf. Shelves are 3/4" thick.

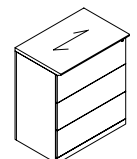

Three File Module

DF36243	24 x 36 x 42	92.5	231	21	\$3809	\$4573
DN30243	24 x 30 x 42	92.5	193	18	\$3341	\$4010
DF36223	22 x 36 x 42	92.5	212	19	\$3527	\$4231
DN30223	22 x 30 x 42	92.5	176	16	\$3095	\$3712

**Three lateral file drawers.** Lock secures all drawers.

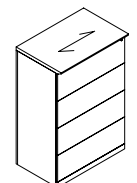

Four File Module

DF36244	24 x 36 x 54	92.5	297	27	\$5041	\$6049
DN30244	24 x 30 x 54	92.5	248	23	\$4304	\$5165
DF36224	22 x 36 x 54	92.5	270	25	\$4297	\$5156
DN30224	22 x 30 x 54	92.5	225	21	\$3765	\$4520

**Four lateral file drawers.** Lock secures all drawers.

STORAGE MODULES - 48" HIGH (FREESTANDING)

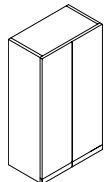

Storage Cabinet w/Doors\*

MODEL#	DIMENSIONS	FREIGHT CLASS	WT/LBS.	CUBIC FT.	VENEER/LAMINATE	ALL VENEER
D1D22H48	22 x 36 x 48	150	107	22	\$3040	\$3647
D1D22W30H48	22 x 30 x 48	150	90	19	\$2969	\$3563
D1D22W24H48	22 x 24 x 48	150	72	15	\$2911	\$3493
D1D20H48	20 x 36 x 48	150	97	20	\$2766	\$3317
D1D20W30H48	20 x 30 x 48	150	81	17	\$2706	\$3245
D1D20W24H48	20 x 24 x 48	150	63	13	\$2647	\$3175

Includes four adjustable shelves.

**Required Specifications**

Veneer finish  
Laminate finish (body)  
Handle Style

**Optional Specifications**

Lock\*  
Veneer Top\*

STORAGE MODULES - 48" HIGH (FREESTANDING)

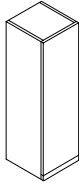

Storage Cabinet w/Door - LEFT\*

MODEL#	DIMENSIONS D x W x H	FREIGHT CLASS	WT/LBS.	CUBIC FT.	veneer/LAMINATE	ALL VENEER
D1D22W18H48L	22 x 18 x 48	150	60	11	<b>\$1919</b>	<b>\$2304</b>
D1D22W16H48L	22 x 16 x 48	150	54	10	<b>\$1707</b>	<b>\$2050</b>
D1D20W18H48L	20 x 18 x 48	125	60	10	<b>\$1747</b>	<b>\$2099</b>
D1D20W16H48L	20 x 16 x 48	125	54	9	<b>\$1549</b>	<b>\$1859</b>

Includes three adjustable shelves. Handle is on the **right**, door opens to the **left**.

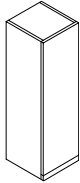

Storage Cabinet w/Door - RIGHT\*

D1D22W18H48R	22 x 18 x 48	150	60	11	<b>\$1919</b>	<b>\$2304</b>
D1D22W16H48R	22 x 16 x 48	150	54	10	<b>\$1707</b>	<b>\$2050</b>
D1D20W18H48R	20 x 18 x 48	125	60	10	<b>\$1747</b>	<b>\$2099</b>
D1D20W16H48R	20 x 16 x 48	125	54	9	<b>\$1549</b>	<b>\$1859</b>

Includes three adjustable shelves. Handle is on the **left**, door opens to the **right**.

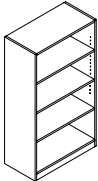

Open Storage Cabinet

D7D22W36H48	22 x 36 x 48	150	118	22	<b>\$2398</b>	<b>\$2878</b>
D7D22W30H48	22 x 30 x 48	150	98	19	<b>\$1782</b>	<b>\$2137</b>
D7D22W24H48	22 x 24 x 48	150	78	15	<b>\$1421</b>	<b>\$1704</b>
D7D22W18H48	22 x 18 x 48	150	59	11	<b>\$1194</b>	<b>\$1434</b>
D7D20W36H48	20 x 36 x 48	150	108	20	<b>\$2180</b>	<b>\$2616</b>
D7D20W30H48	20 x 30 x 48	150	90	17	<b>\$1617</b>	<b>\$1941</b>
D7D20W24H48	20 x 24 x 48	100	72	13	<b>\$1584</b>	<b>\$1898</b>
D7D20W18H48	20 x 18 x 48	150	54	10	<b>\$1140</b>	<b>\$1368</b>

One fixed and **three** adjustable veneer shelves. Shelves are 3/4" thick.

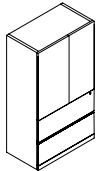

Two File Module w/Doors\*

D13D22H48	22 x 36 x 48	150	117	23	<b>\$3239</b>	<b>\$3885</b>
D13D22W30H48	22 x 30 x 48	150	101	19	<b>\$2932</b>	<b>\$3517</b>
D13H48	20 x 36 x 48	150	107	23	<b>\$3102</b>	<b>\$3725</b>
D13W30H48	20 x 30 x 48	150	91	19	<b>\$3793</b>	<b>\$4550</b>

Two lateral file drawers on bottom. Includes two adjustable shelves. Lower lock secures two file drawers. **Not for stacking materials on lateral file drawer bottom.**

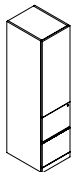

Two File Module w/Door - LEFT\*

D17D22H48L	22 x 16 x 48	125	97	13	<b>\$2404</b>	<b>\$2885</b>
D17D20H48L	20 x 16 x 48	125	88	13	<b>\$2193</b>	<b>\$2631</b>

Two file drawers on bottom. Includes two adjustable shelves. Lower lock secures two file drawers. Handle is on the right, door opens to the left.

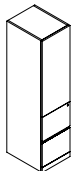

Two File Module w/Door - RIGHT\*

D17D22H48R	22 x 16 x 48	125	97	13	<b>\$2404</b>	<b>\$2885</b>
D17D20H48R	20 x 16 x 48	125	88	13	<b>\$2193</b>	<b>\$2631</b>

Two file drawers on bottom. Includes two adjustable shelves. Lower lock secures two file drawers. Handle is on the left, door opens to the right.

**Required Specifications**

Veneer finish (doors, drawer fronts)  
Laminate finish (top/body)  
Handle Style\*

**Optional Specifications**

Lock\*  
Veneer top

**STORAGE MODULES - 48" HIGH (FREESTANDING)    MODEL#    DIMENSIONS    FREIGHT CLASS    WT/LBS.    CUBIC FT.    VENEER/LAMINATE    ALL VENEER**

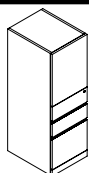

**Box/Box/File Module w/Door - LEFT**

	D x W x H					
D18D22H48L	22 x 16 x 48	125	64	9	<b>\$2404</b>	<b>\$2885</b>
D18D20H48L	20 x 16 x 48	125	59	9	<b>\$2193</b>	<b>\$2631</b>

Two box drawers and one file drawer on bottom. Includes two adjustable shelves. Lower lock secures all drawers. Handle is on the **right**, door opens to the **left**.

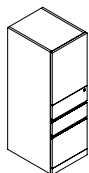

**Box/Box/File Module w/Door - RIGHT**

D18D22H48R	22 x 16 x 48	125	64	9	<b>\$2404</b>	<b>\$2885</b>
D18D20H48R	20 x 16 x 48	125	59	9	<b>\$2193</b>	<b>\$2631</b>

Two box drawers and one file drawer on bottom. Includes two adjustable shelves. Lower lock secures all drawers. Handle is on the **left**, door opens to the **right**.

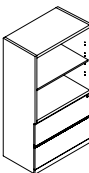

**Two File Module w/Open Shelf**

D12D22H48	22 x 36 x 48	150	117	23	<b>\$3041</b>	<b>\$3650</b>
D12D22W30H48	22 x 30 x 48	150	101	19	<b>\$2629</b>	<b>\$3156</b>
D12H48	20 x 36 x 48	150	107	23	<b>\$2919</b>	<b>\$3503</b>
D12W30H48	20 x 30 x 48	150	91	19	<b>\$3561</b>	<b>\$4272</b>

Two open veneer shelves and two lateral file drawers on bottom. Includes one adjustable shelf. Lock secures all drawers. **Not for stacking materials on lateral file drawer bottom.**

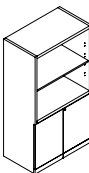

**Storage Module w/Open Shelf**

D22D22H48	22 x 36 x 48	150	117	23	<b>\$2745</b>	<b>\$3292</b>
D22D22W30H48	22 x 30 x 48	150	101	19	<b>\$1879</b>	<b>\$2253</b>
D22D20H48	20 x 36 x 48	150	107	23	<b>\$2160</b>	<b>\$2591</b>
D22D20W30H48	20 x 30 x 48	150	91	19	<b>\$1795</b>	<b>\$2154</b>

Two open veneer shelves and storage cabinet on bottom. Includes one adjustable shelf in upper compartment and one adjustable shelf in storage cabinet. Lock secures storage cabinet.

**WARDROBE CABINETS - 48" HIGH    MODEL#    DIMENSIONS    FREIGHT CLASS    WT/LBS.    CUBIC FT.    VENEER/LAMINATE    ALL VENEER**

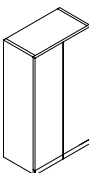

**Wardrobe Cabinet\***

D2D22H48	22 x 36 x 48	150	107	22	<b>\$2485</b>	<b>\$2986</b>
D2D22W30H48	22 x 30 x 48	150	107	19	<b>\$2433</b>	<b>\$2919</b>
D2D22W24H48	22 x 24 x 48	150	85	15	<b>\$2911</b>	<b>\$3493</b>
D2H48	20 x 36 x 48	150	102	20	<b>\$2261</b>	<b>\$2714</b>
D2W30H48	20 x 30 x 48	150	89	17	<b>\$2213</b>	<b>\$2656</b>
D2W24H48	20 x 24 x 48	150	72	13	<b>\$2164</b>	<b>\$2598</b>

Includes full length hanging rod and fixed hat shelf.

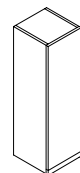

**Wardrobe Cabinet - LEFT\***

D2D22W24H48L	22 x 24 x 48	150	80	15	<b>\$2384</b>	<b>\$2864</b>
D2D22W18H48L	22 x 18 x 48	150	60	11	<b>\$1919</b>	<b>\$2304</b>
D2D22W12H48L	22 x 12 x 48	150	40	7	<b>\$1832</b>	<b>\$2199</b>
D2D20W24H48L	20 x 24 x 48	150	72	13	<b>\$2164</b>	<b>\$2598</b>
D2D20W18H48L	20 x 18 x 48	150	54	10	<b>\$1747</b>	<b>\$2099</b>
D2D20W12H48L	20 x 12 x 48	125	36	7	<b>\$2032</b>	<b>\$2437</b>

Includes full length hanging rod and fixed hat shelf. Handle is on the **right**, door opens to the **left**.

**Required Specifications**

Veneer Finish (doors, drawer fronts)  
Laminate Finish (top/body)  
Handle Style

**Optional Specifications**

Lock\*  
Veneer Top

**WARDROBE CABINETS - 48" HIGH**

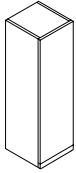

**Wardrobe Cabinet - RIGHT\***

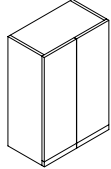

**Wardrobe Cabinet/Shelving Combo\***

MODEL#	DIMENSIONS	FREIGHT CLASS	WT/LBS.	CUBIC FT.	veneer/LAMINATE	ALL VENEER
<b>D x W x H</b>						
D2D22W24H48R	22 x 24 x 48	150	80	15	<b>\$2384</b>	<b>\$2864</b>
D2D22W18H48R	22 x 18 x 48	150	60	11	<b>\$1919</b>	<b>\$2304</b>
D2D22W12H48R	22 x 12 x 48	150	40	7	<b>\$1832</b>	<b>\$2199</b>
D2D20W24H48R	20 x 24 x 48	150	72	13	<b>\$2164</b>	<b>\$2598</b>
D2D20W18H48R	20 x 18 x 48	150	54	10	<b>\$1747</b>	<b>\$2099</b>
D2D20W12H48R	20 x 12 x 48	125	36	7	<b>\$2032</b>	<b>\$2437</b>

Includes full length hanging rod and fixed hat shelf. Handle is on the **left**, door opens to the **right**.

D25D22H48	22 x 36 x 48	150	117	23	<b>\$2646</b>	<b>\$3174</b>
D25D22W30H48	22 x 30 x 48	150	101	19	<b>\$2596</b>	<b>\$3115</b>
D25D20H48	20 x 36 x 48	150	107	23	<b>\$2534</b>	<b>\$3041</b>
D25D20W30H48	20 x 30 x 48	60	91	19	<b>\$2485</b>	<b>\$2986</b>

Wardrobe compartment on **left** includes hanging rod and fixed hat shelf. Storage compartment on **right** includes three adjustable shelves.

**STORAGE MODULES - 54" HIGH (FREESTANDING)**

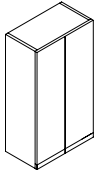

**Storage Cabinet w/Doors\***

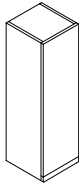

**Storage Cabinet w/Door - LEFT\***

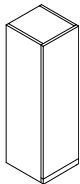

**Storage Cabinet w/Door - RIGHT\***

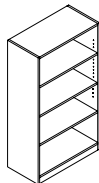

**Open Storage Cabinet**

MODEL#	DIMENSIONS	FREIGHT CLASS	WT/LBS.	CUBIC FT.	veneer/LAMINATE	ALL VENEER
D1D22H54	22 x 36 x 54	150	120	22	<b>\$2692</b>	<b>\$3231</b>
D1D22W30H54	22 x 30 x 54	150	102	19	<b>\$2678</b>	<b>\$3216</b>
D1D22W24H54	22 x 24 x 54	150	81	17	<b>\$3272</b>	<b>\$3929</b>
D1D20H54	20 x 36 x 54	150	110	20	<b>\$2543</b>	<b>\$3049</b>
D1D20W30H54	20 x 30 x 54	150	92	17	<b>\$2485</b>	<b>\$2986</b>
D1D20W24H54	20 x 24 x 54	150	71	13	<b>\$2440</b>	<b>\$2925</b>

Includes four adjustable shelves.

D1D22W18H54L	22 x 18 x 54	150	68	12	<b>\$2164</b>	<b>\$2598</b>
D1D22W16H54L	22 x 16 x 54	150	61	11	<b>\$1919</b>	<b>\$2304</b>
D1D20W18H54L	20 x 18 x 54	125	68	11	<b>\$1961</b>	<b>\$2353</b>
D1D20W16H54L	20 x 16 x 54	125	61	10	<b>\$1747</b>	<b>\$2099</b>

Includes three adjustable shelves. Handle is on the **right**, door opens to the **left**.

D1D22W18H54R	22 x 18 x 54	150	68	12	<b>\$2164</b>	<b>\$2598</b>
D1D22W16H54R	22 x 16 x 54	150	61	11	<b>\$1919</b>	<b>\$2304</b>
D1D20W18H54R	20 x 18 x 54	125	68	11	<b>\$1961</b>	<b>\$2353</b>
D1D20W16H54R	20 x 16 x 54	125	61	10	<b>\$1747</b>	<b>\$2099</b>

Includes three adjustable shelves. Handle is on the **left**, door opens to the **right**.

D7D22W36H54	22 x 36 x 54	150	132	25	<b>\$2700</b>	<b>\$3239</b>
D7D22W30H54	22 x 30 x 54	150	110	21	<b>\$2001</b>	<b>\$2402</b>
D7D22W24H54	22 x 24 x 54	150	88	17	<b>\$1606</b>	<b>\$1928</b>
D7D22W18H54	22 x 18 x 54	150	67	12	<b>\$1254</b>	<b>\$1509</b>
D7D20W36H54	20 x 36 x 54	150	122	23	<b>\$2453</b>	<b>\$2944</b>
D7D20W30H54	20 x 30 x 54	150	102	19	<b>\$1824</b>	<b>\$2188</b>
D7D20W24H54	20 x 24 x 54	150	81	15	<b>\$1455</b>	<b>\$1744</b>
D7D20W18H54	20 x 18 x 54	150	61	11	<b>\$1180</b>	<b>\$1417</b>

One fixed and **three** adjustable veneer shelves. Shelves are ¾" thick.

**Required Specifications**

Veneer Finish (doors)  
Laminate Finish (top/body)  
Handle Style\*

**Optional Specifications**

Lock\*  
Veneer Top

STORAGE MODULES - 54" HIGH (FREESTANDING)

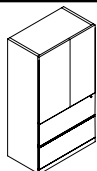

Two File Module w/Doors

MODEL#	DIMENSIONS D x W x H	FREIGHT CLASS	WT/LBS.	CUBIC FT.	VENEER/LAMINATE	ALL VENEER
D13D22H54	22 x 36 x 54	150	130	24	\$4449	\$5339
D13D22W30H54	22 x 30 x 54	150	112	20	\$3293	\$3954
D13H54	20 x 36 x 54	125	120	19	\$3493	\$4193
D13W30H54	20 x 30 x 54	150	102	21	\$3159	\$3788

Two lateral file drawers on bottom. Includes two adjustable shelves. Lower lock secures two file drawers. Front-to-back and side-to-side filing. **Not for stacking materials on lateral file drawer bottom.**



Two File Module w/Door - LEFT

D17D22H54L	22 x 16 x 54	100	110	13	\$2714	\$3256
D17D20H54L	20 x 16 x 54	125	99	13	\$2468	\$2961

Two file drawers on bottom. Includes two adjustable shelves. Lower lock secures two file drawers. Handle is on the right, door opens to the left.



Two File Module w/Door - RIGHT

D17D22H54R	22 x 16 x 54	100	110	13	\$2714	\$3256
D17D20H54R	20 x 16 x 54	125	99	13	\$2468	\$2961

Two file drawers on bottom. Includes two adjustable shelves. Lower lock secures two file drawers. Handle is on the left, door opens to the right.

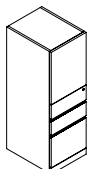

Box/Box/File Module w/Door - LEFT

D18D22H54L	22 x 16 x 54	125	71	10	\$2714	\$3256
D18D20H54L	20 x 16 x 54	125	66	10	\$2468	\$2961

Two box drawers and one file drawer on bottom. Includes two adjustable shelves. Lower lock secures all drawers. Handle is on the **right**, door opens to the **left**.

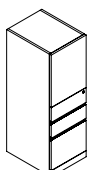

Box/Box/File Module w/Door - RIGHT

D18D22H54R	22 x 16 x 54	125	71	10	\$2714	\$3256
D18D20H54R	20 x 16 x 54	125	66	10	\$2468	\$2961

Two box drawers and one file drawer on bottom. Includes two adjustable shelves. Lower lock secures all drawers. Handle is on the **left**, door opens to the **right**.

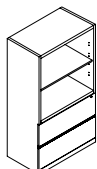

Two File Module w/Open Shelf

D12D22H54	22 x 36 x 54	150	130	24	\$3641	\$4371
D12D22W30H54	22 x 30 x 54	150	112	20	\$2958	\$3549
D12H54	20 x 36 x 54	125	120	19	\$3641	\$4371
D12W30H54	20 x 30 x 54	150	102	21	\$2835	\$3405

Two open veneer shelves and two lateral file drawers on bottom. Includes one adjustable shelf. Lock secures all drawers. Front-to-back and side-to-side filing. **Not for stacking materials on lateral file drawer bottom.**

**Required Specifications**

Veneer Finish (doors, drawer fronts, open shelves)  
Laminate Finish (top/body)  
Handle Style

**Optional Specifications**

Additional Lock (storage compartments)  
Veneer Top

**STORAGE MODULES - 54" HIGH (FREESTANDING)**

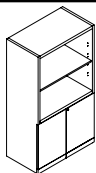

**Storage Module w/Open Shelf**

MODEL#	DIMENSIONS	FREIGHT CLASS	WT/LBS.	CUBIC FT.	veneer/LAMINATE	ALL VENEER
<b>D x W x H</b>						
D22D22H54	22 x 36 x 54	150	130	24	<b>\$2528</b>	<b>\$3035</b>
D22D22W30H54	22 x 30 x 54	150	112	20	<b>\$2110</b>	<b>\$2533</b>
D22D20H54	20 x 36 x 54	150	120	24	<b>\$2425</b>	<b>\$2910</b>
D22D20W30H54	20 x 30 x 54	150	102	20	<b>\$2021</b>	<b>\$2427</b>

Two open veneer shelves and storage cabinet on bottom. Includes one adjustable shelf in upper compartment and one adjustable shelf in storage cabinet. Lock secures storage cabinet.

**WARDROBE CABINETS - 54" HIGH**

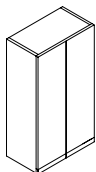

**Wardrobe Cabinet\***

MODEL#	DIMENSIONS	FREIGHT CLASS	WT/LBS.	CUBIC FT.	veneer/LAMINATE	ALL VENEER
D2D22H54	22 x 36 x 54	150	120	25	<b>\$2692</b>	<b>\$3231</b>
D2D22W30H54	22 x 30 x 54	150	120	21	<b>\$2678</b>	<b>\$3216</b>
D2D22W24H54	22 x 24 x 54	150	95	17	<b>\$3272</b>	<b>\$3929</b>
D2H54	20 x 36 x 54	150	119	23	<b>\$2543</b>	<b>\$3049</b>
D2W30H54	20 x 30 x 54	150	101	19	<b>\$2485</b>	<b>\$2986</b>
D2W24H54	20 x 24 x 54	150	81	15	<b>\$2440</b>	<b>\$2925</b>

Includes full length hanging rod and fixed hat shelf.

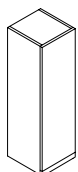

**Wardrobe Cabinet - LEFT\***

D2D22W24H54L	22 x 24 x 54	150	90	17	<b>\$2678</b>	<b>\$3216</b>
D2D22W18H54L	22 x 18 x 54	150	68	12	<b>\$2160</b>	<b>\$2591</b>
D2D22W12H54L	22 x 12 x 54	150	45	8	<b>\$2056</b>	<b>\$2468</b>
D2D20W24H54L	20 x 24 x 54	150	81	15	<b>\$2974</b>	<b>\$3571</b>
D2D20W18H54L	20 x 18 x 54	150	61	11	<b>\$1961</b>	<b>\$2353</b>
D2D20W12H54L	20 x 12 x 54	150	41	8	<b>\$2286</b>	<b>\$2743</b>

Includes full length hanging rod and fixed hat shelf. Handle is on the **right**, door opens to the **left**.

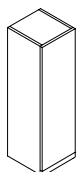

**Wardrobe Cabinet - RIGHT\***

D2D22W24H54R	22 x 24 x 54	150	90	17	<b>\$2678</b>	<b>\$3216</b>
D2D22W18H54R	22 x 18 x 54	150	68	12	<b>\$2160</b>	<b>\$2591</b>
D2D22W12H54R	22 x 12 x 54	150	45	8	<b>\$2056</b>	<b>\$2468</b>
D2D20W24H54R	20 x 24 x 54	150	81	15	<b>\$2974</b>	<b>\$3571</b>
D2D20W18H54R	20 x 18 x 54	150	61	11	<b>\$1961</b>	<b>\$2353</b>
D2D20W12H54R	20 x 12 x 54	150	41	8	<b>\$2286</b>	<b>\$2743</b>

Includes full length hanging rod and fixed hat shelf. Handle is on the **left**, door opens to the **right**.

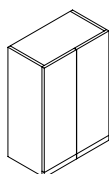

**Wardrobe Cabinet/Shelving Combo\***

D25D22H54	22 x 36 x 54	150	130	24	<b>\$2972</b>	<b>\$3566</b>
D25D22W30H54	22 x 30 x 54	150	112	20	<b>\$2919</b>	<b>\$3503</b>
D25D20H54	20 x 36 x 54	150	120	24	<b>\$2848</b>	<b>\$3418</b>
D25D20W30H54	20 x 30 x 54	150	102	20	<b>\$2802</b>	<b>\$3361</b>

Wardrobe compartment on **left** includes hanging rod and fixed hat shelf. Storage compartment on **right** includes three adjustable shelves.

**STORAGE MODULES - 66" HIGH (FREESTANDING)**

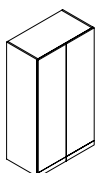

**Storage Cabinet w/Doors**

MODEL#	DIMENSIONS	FREIGHT CLASS	WT/LBS.	CUBIC FT.	veneer/LAMINATE	ALL VENEER
D1D22	22 x 36 x 66	100	259	30	<b>\$3328</b>	<b>\$3992</b>
D1D22W30	22 x 30 x 66	100	259	25	<b>\$2914</b>	<b>\$3496</b>
D1D22W24	22 x 24 x 66	125	173	22	<b>\$2501</b>	<b>\$3001</b>
D1	20 x 36 x 66	100	245	28	<b>\$3173</b>	<b>\$3805</b>
D1W30	20 x 30 x 66	100	202	23	<b>\$2646</b>	<b>\$3174</b>
D1W24	20 x 24 x 66	125	163	18	<b>\$2111</b>	<b>\$2534</b>

Includes four adjustable shelves.

**Required Specifications**

Veneer Finish (doors, drawer fronts, open shelves)  
Laminate Finish (top/body)  
Handle Style

**Optional Specifications**

Lock\*  
Veneer Top



STORAGE MODULES - 66" HIGH (FREESTANDING)

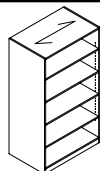

Open Storage Cabinet

MODEL#	DIMENSIONS D x W x H	FREIGHT CLASS	WT/LBS.	CUBIC FT.	VENEER/LAMINATE	ALL VENEER
D7D24	24 x 36 x 66	100	281	33	\$3062	\$3676
D7D24W30	24 x 30 x 66	100	234	28	\$2678	\$3216
D7	20 x 36 x 66	100	234	28	\$2538	\$3046
D7W30	20 x 30 x 66	100	193	23	\$2227	\$2672

Includes one fixed and **four** adjustable veneer shelves. Shelves are 3/4" thick.

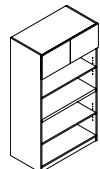

Open Storage Cabinet w/Doors

D9D22	22 x 36 x 66	92.5	308	30	\$2865	\$3436
D9D22W30	22 x 30 x 66	92.5	257	25	\$2506	\$3009
D9	20 x 36 x 66	92.5	294	28	\$2726	\$3271
D9W30	20 x 30 x 66	92.5	243	23	\$2276	\$2730

Storage compartment with fixed shelf. One fixed and **two** adjustable veneer shelves. Fixed shelf is at 29" high. Shelves are 3/4" thick.

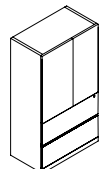

Two File Module w/Doors

D13D22	22 x 36 x 66	92.5	313	30	\$4118	\$4942
D13D22W30	22 x 30 x 66	92.5	261	25	\$3608	\$4329
D13	20 x 36 x 66	92.5	299	28	\$3923	\$4708
D13W30	20 x 30 x 66	92.5	247	23	\$3271	\$3925

Two lateral file drawers on bottom. Includes **two** adjustable shelves. Lower lock secures two file drawers. Front-to-back and side-to-side filing. **Not for stacking materials on lateral file drawer bottom.**



Two File Module w/Door - LEFT

D17D22L	22 x 16 x 66	125	91	13	\$2865	\$3436
D17D20L	20 x 16 x 66	125	83	12	\$2602	\$3123

Two file drawers on bottom. Includes two adjustable shelves. Lower lock secures two file drawers. Handle is on the **right**, door opens to the **left**.



Two File Module w/Door - RIGHT

D17D22R	22 x 16 x 66	125	91	13	\$2865	\$3436
D17D20R	20 x 16 x 66	125	83	12	\$2602	\$3123

Two file drawers on bottom. Includes two adjustable shelves. Lower lock secures two file drawers. Handle is on the **left**, door opens to the **right**.

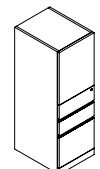

Box/Box/File Module w/Door - LEFT

D18D22L	22 x 16 x 66	125	91	13	\$2865	\$3436
D18D20L	20 x 16 x 66	125	83	12	\$2602	\$3123

Two box drawers and one file drawer on bottom. Includes two adjustable shelves. Lower lock secures all drawers. Handle is on the **right**, door opens to the **left**.

**Required Specifications**

Veneer Finish (doors, drawer fronts, open shelves)  
Laminate Finish (top/body)  
Handle Style

**Optional Specifications**

Additional Lock (storage compartments)  
Veneer Top

**PERSONAL TOWERS - 66" HIGH (FREESTANDING) MODEL# DIMENSIONS FREIGHT CLASS WT/LBS. CUBIC FT. VENEER/LAMINATE ALL VENEER**

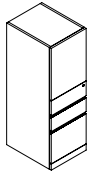

**Box/Box/File Module w/Door - RIGHT**

	D x W x H						
D18D22R	22 x 16 x 66	125	91	13	<b>\$2865</b>	<b>\$3436</b>	
D18D20R	20 x 16 x 66	125	83	12	<b>\$2602</b>	<b>\$3123</b>	

Two box drawers and one file drawer on bottom. Includes two adjustable shelves. Lower lock secures all drawers. Handle is on the left, door opens to the right.

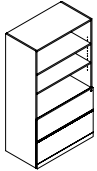

**Two File Module w/Open Shelves**

D12D22	22 x 36 x 66	92.5	303	30	<b>\$3615</b>	<b>\$4342</b>	
D12D22W30	22 x 30 x 66	92.5	253	25	<b>\$3166</b>	<b>\$3801</b>	
D12	20 x 36 x 66	92.5	289	28	<b>\$3442</b>	<b>\$4129</b>	
D12W30	20 x 30 x 66	92.5	239	23	<b>\$2871</b>	<b>\$3448</b>	

Three open veneer shelves and two lateral file drawers on bottom. Includes two adjustable shelves. Lock secures all drawers. Front-to-back and side-to-side filing. **Not for stacking materials on lateral file drawer bottom.**

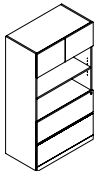

**Two File Module w/Doors and Open Shelves**

D10D22	22 x 36 x 66	92.5	308	30	<b>\$4001</b>	<b>\$4803</b>	
D10D22W30	22 x 30 x 66	92.5	257	25	<b>\$3505</b>	<b>\$4204</b>	
D10	20 x 36 x 66	92.5	294	28	<b>\$3808</b>	<b>\$4572</b>	
D10W30	20 x 30 x 66	92.5	243	23	<b>\$3177</b>	<b>\$3811</b>	

Storage compartment with fixed shelf. Two open veneer shelves and two lateral file drawers on bottom. Includes one adjustable shelf. Lock secures all drawers. Front-to-back and side-to-side filing. **Not for stacking materials on lateral file drawer bottom.**

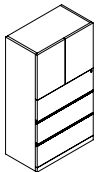

**Three File Module w/Doors**

D14D22	22 x 36 x 66	100	286	30	<b>\$4429</b>	<b>\$5316</b>	
D14D22W30	22 x 30 x 66	100	238	25	<b>\$3879</b>	<b>\$4655</b>	
D14	20 x 36 x 66	100	272	28	<b>\$4220</b>	<b>\$5063</b>	
D14W30	20 x 30 x 66	100	224	23	<b>\$3514</b>	<b>\$4219</b>	

Three lateral file drawers on bottom. Includes one adjustable shelf. Lock secures all drawers. Front-to-back and side-to-side filing. **Not for stacking materials on lateral file drawer bottom.**

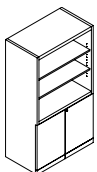

**Storage Module w/Open Shelves**

D22D22	22 x 36 x 66	100	275	30	<b>\$3035</b>	<b>\$3640</b>	
D22D22W30	22 x 30 x 66	100	243	25	<b>\$2655</b>	<b>\$3186</b>	
D22	20 x 36 x 66	100	278	28	<b>\$2892</b>	<b>\$3469</b>	
D22W30	20 x 30 x 66	100	229	23	<b>\$2406</b>	<b>\$2890</b>	

Three open veneer shelves and storage cabinet on bottom. Includes two adjustable shelves in upper compartment and one adjustable shelf in storage cabinet. Lock secures storage cabinet.

**WARDROBE CABINETS - 66" HIGH (FREESTANDING) MODEL# DIMENSIONS FREIGHT CLASS WT/LBS. CUBIC FT. VENEER/LAMINATE ALL VENEER**

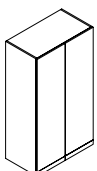

**Wardrobe Cabinet\***

D2D22	22 x 36 x 66	100	259	30	<b>\$2892</b>	<b>\$3469</b>	
D2D22W30	22 x 30 x 66	100	216	30	<b>\$2528</b>	<b>\$3035</b>	
D2D22W24	22 x 24 x 66	100	198	22	<b>\$2166</b>	<b>\$2600</b>	
D2	20 x 36 x 66	100	245	28	<b>\$2753</b>	<b>\$3306</b>	
D2W30	20 x 30 x 66	100	202	23	<b>\$2293</b>	<b>\$2752</b>	
D2W24	20 x 24 x 66	125	163	18	<b>\$1835</b>	<b>\$2203</b>	

Includes full length hanging rod and fixed hat shelf.

**Required Specifications**

Veneer Finish (doors, drawer fronts)  
Laminate Finish (top/body)  
Handle Style

**Optional Specifications**

Additional Lock (storage compartments)  
Lock\*  
Veneer Top

**WARDROBE CABINETS - 66" HIGH (FREESTANDING) MODEL# DIMENSIONS FREIGHT CLASS WT/LBS. CUBIC FT. VENEER/LAMINATE ALL VENEER**

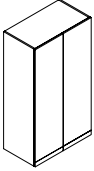

**Wardrobe Cabinet/Shelving Combo\***

	D x W x H					
D25D22	22 x 36 x 66	100	292	30	<b>\$3734</b>	<b>\$4480</b>
D25D22W30	22 x 30 x 66	100	243	25	<b>\$3267</b>	<b>\$3921</b>
D25D22W24	22 x 24 x 66	100	195	22	<b>\$2799</b>	<b>\$3359</b>
D25	20 x 36 x 66	100	278	28	<b>\$3553</b>	<b>\$4265</b>
D25W30	20 x 30 x 66	100	229	23	<b>\$2964</b>	<b>\$3557</b>
D25W24	20 x 24 x 66	100	185	18	<b>\$2371</b>	<b>\$2846</b>

Wardrobe compartment on **left** includes hanging rod and fixed hat shelf. Storage compartment on **right** includes three adjustable shelves.

**PERSONAL TOWERS - 66" HIGH (FREESTANDING) MODEL# DIMENSIONS FREIGHT CLASS WT/LBS. CUBIC FT. VENEER/LAMINATE ALL VENEER**

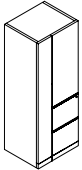

**Personal Tower - LEFT**

D29D22W24L	22 x 24 x 66	125	141	20	<b>\$3887</b>	<b>\$4667</b>
D29W24L	20 x 24 x 66	125	128	18	<b>\$3684</b>	<b>\$4421</b>

**Two file** drawers on bottom. Wardrobe compartment on **left** includes hanging rod. Storage compartment on **right** includes one adjustable shelf. Lower lock secures all drawers.

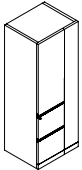

**Personal Tower - RIGHT**

D29D22W24R	22 x 24 x 66	125	141	20	<b>\$3887</b>	<b>\$4667</b>
D29W24R	20 x 24 x 66	125	128	18	<b>\$3684</b>	<b>\$4421</b>

**Two file** drawers on bottom. Wardrobe compartment on **right** includes hanging rod. Storage compartment on **left** includes one adjustable shelf. Lower lock secures all drawers.

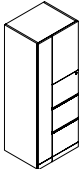

**Personal Tower - LEFT**

D27D22W24L	22 x 24 x 66	125	141	20	<b>\$4422</b>	<b>\$5308</b>
D27W24L	20 x 24 x 66	125	128	18	<b>\$4211</b>	<b>\$5053</b>

**Three file** drawers on bottom. Wardrobe compartment on **left** includes hanging rod. Storage compartment on **right** includes one adjustable shelf. Lower lock secures all drawers.

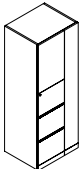

**Personal Tower - RIGHT**

D27D22W24R	22 x 24 x 66	125	141	20	<b>\$4422</b>	<b>\$5308</b>
D27W24R	20 x 24 x 66	125	128	18	<b>\$4211</b>	<b>\$5053</b>

**Three file** drawers on bottom. Wardrobe compartment on **right** includes hanging rod. Storage compartment on **left** includes one adjustable shelf. Lower lock secures all drawers.

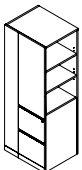

**Personal Tower w/Open Bookcase - LEFT**

D30D22W24L	22 x 24 x 66	125	141	20	<b>\$3887</b>	<b>\$4667</b>
D30W24L	20 x 24 x 66	125	128	18	<b>\$3684</b>	<b>\$4421</b>

**Two file drawers** on bottom. Wardrobe compartment on **left** includes hanging rod. Storage compartment on **right** includes one adjustable shelf. Open bookcase on **right** includes two adjustable shelves. Lower lock secures all drawers.

**Required Specifications**

Veneer Finish (doors, drawer fronts)  
Laminate Finish (top/body)  
Handle Style

**Optional Specifications**

Additional Lock (storage compartments)  
Lock\*  
Veneer Top

**PERSONAL TOWERS - 66" HIGH (FREESTANDING)**

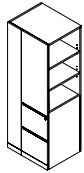

**Personal Tower w/Open Bookcase - RIGHT**

MODEL#	DIMENSIONS D x W x H	FREIGHT CLASS	WT/LBS.	CUBIC FT.	veneer/LAMINATE	ALL VENEER
D30D22W24R	22 x 24 x 66	125	141	20	<b>\$3887</b>	<b>\$4667</b>
D30W24R	20 x 24 x 66	125	128	18	<b>\$3684</b>	<b>\$4421</b>

**Two file drawers** on bottom. Wardrobe compartment on **right** includes hanging rod. Storage compartment on **left** includes one adjustable shelf. Open bookcase on **left** includes two adjustable shelves. Lower lock secures all drawers.

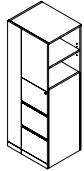

**Personal Tower w/Open Bookcase - LEFT**

D26D22W24L	22 x 24 x 66	125	141	20	<b>\$5356</b>	<b>\$6427</b>
D26W24L	20 x 24 x 66	125	128	18	<b>\$5102</b>	<b>\$6122</b>

**Three file drawers** on bottom. Wardrobe compartment on **left** includes hanging rod. Storage compartment on **right** includes one adjustable shelf. Open bookcase on **right** includes one adjustable shelf. Lower lock secures all drawers.

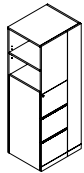

**Personal Tower w/Open Bookcase - RIGHT**

D26D22W24R	22 x 24 x 66	125	141	20	<b>\$5356</b>	<b>\$6427</b>
D26W24R	20 x 24 x 66	125	128	18	<b>\$5102</b>	<b>\$6122</b>

**Three file drawers** on bottom. Wardrobe compartment on **right** includes hanging rod. Storage compartment on **left** includes one adjustable shelf. Open bookcase on **left** includes one adjustable shelf. Lower lock secures all drawers.

**STORAGE MODULES - 72" HIGH (FREESTANDING)**

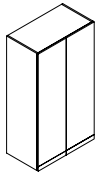

**Storage Cabinet w/Doors**

MODEL#	DIMENSIONS	FREIGHT CLASS	WT/LBS.	CUBIC FT.	veneer/LAMINATE	ALL VENEER
D1D22H72	22 x 36 x 72	100	283	33	<b>\$3633</b>	<b>\$4359</b>
D1D22W30H72	22 x 30 x 72	100	283	28	<b>\$3177</b>	<b>\$3811</b>
D1D22W24H72	22 x 24 x 72	125	255	24	<b>\$2724</b>	<b>\$3269</b>
D1H72	20 x 36 x 72	100	269	30	<b>\$3461</b>	<b>\$4152</b>
D1W30H72	20 x 30 x 72	100	233	25	<b>\$2882</b>	<b>\$3459</b>
D1W24H72	20 x 24 x 72	125	179	20	<b>\$2307</b>	<b>\$2769</b>

Includes four adjustable shelves.

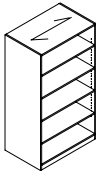

**Open Storage Cabinet**

D7D24H72	24 x 36 x 72	100	306	36	<b>\$3341</b>	<b>\$4010</b>
D7D24W30H72	24 x 30 x 72	100	255	30	<b>\$2923</b>	<b>\$3509</b>
D7H72	20 x 36 x 72	100	257	30	<b>\$2770</b>	<b>\$3326</b>
D7W30H72	20 x 30 x 72	100	223	25	<b>\$2308</b>	<b>\$2771</b>

Includes one fixed and **four** adjustable veneer shelves. Shelves are 3/4" thick.

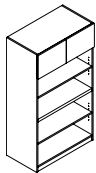

**Open Storage Cabinet w/Doors**

D9D22H72	22 x 36 x 72	92.5	336	33	<b>\$3123</b>	<b>\$3749</b>
D9D22W30H72	22 x 30 x 72	92.5	294	28	<b>\$2732</b>	<b>\$3281</b>
D9H72	20 x 36 x 72	92.5	322	30	<b>\$2972</b>	<b>\$3566</b>
D9W30H72	20 x 30 x 72	92.5	280	25	<b>\$2480</b>	<b>\$2974</b>

Storage compartment with fixed shelf. One fixed and **two** adjustable veneer shelves. Fixed shelf is at 29" high. Shelves are 3/4" thick.

**Required Specifications**

Veneer Finish (doors, drawer fronts, open shelves)  
Laminate Finish (top/body)  
Handle Style

**Optional Specifications**

Additional Lock (storage compartments)  
Veneer Top

STORAGE MODULES - 72" HIGH (FREESTANDING)

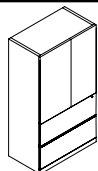

Two File Module w/Doors

MODEL#	DIMENSIONS D x W x H	FREIGHT CLASS	WT/LBS.	CUBIC FT.	VENEER/LAMINATE	ALL VENEER
D13D22H72	22 x 36 x 72	92.5	341	33	<b>\$4496</b>	<b>\$5396</b>
D13D22W30H72	22 x 30 x 72	125	299	28	<b>\$3932</b>	<b>\$4717</b>
D13H72	20 x 36 x 72	92.5	327	30	<b>\$4281</b>	<b>\$5136</b>
D13W30H72	20 x 30 x 72	92.5	285	25	<b>\$3566</b>	<b>\$4281</b>

Two lateral file drawers on bottom. Includes **two** adjustable shelves. Lower lock secures two file drawers. Front-to-back and side-to-side filing. **Not for stacking materials on lateral file drawer bottom.**



Two File Module w/Door - LEFT

D17D22H72L	22 x 16 x 72	125	99	15	<b>\$3129</b>	<b>\$3756</b>
D17D20H72L	20 x 16 x 72	125	90	13	<b>\$2844</b>	<b>\$3412</b>

Two file drawers on bottom. Includes two adjustable shelves. Lower lock secures two file drawers. Handle is on the **right**, door opens to the **left**.



Two File Module w/Door - RIGHT

D17D22H72R	22 x 16 x 72	125	99	15	<b>\$3129</b>	<b>\$3756</b>
D17D20H72R	20 x 16 x 72	125	90	13	<b>\$2844</b>	<b>\$3412</b>

Two file drawers on bottom. Includes two adjustable shelves. Lower lock secures two file drawers. Handle is on the **left**, door opens to the **right**.

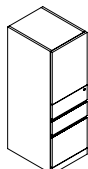

Box/Box/File Module w/Door - LEFT

D18D22H72L	22 x 16 x 72	125	99	15	<b>\$3129</b>	<b>\$3756</b>
D18D20H72L	20 x 16 x 72	125	90	13	<b>\$2844</b>	<b>\$3412</b>

Two box drawers and one file drawer on bottom. Includes two adjustable shelves. Lower lock secures all drawers. Handle is on the **right**, door opens to the **left**.

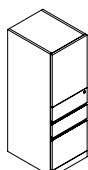

Box/Box/File Module w/Door - RIGHT

D18D22H72R	22 x 16 x 72	125	99	15	<b>\$3129</b>	<b>\$3756</b>
D18D20H72R	20 x 16 x 72	125	90	13	<b>\$2844</b>	<b>\$3412</b>

Two box drawers and one file drawer on bottom. Includes two adjustable shelves. Lower lock secures all drawers. Handle is on the **left**, door opens to the **right**.

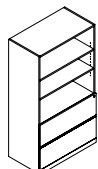

Two File Module w/Open Shelves

D12D22H72	22 x 36 x 72	92.5	331	33	<b>\$3947</b>	<b>\$4736</b>
D12D22W30H72	22 x 30 x 72	92.5	289	28	<b>\$3453</b>	<b>\$4143</b>
D12H72	20 x 36 x 72	92.5	317	30	<b>\$3757</b>	<b>\$4508</b>
D12W30H72	20 x 30 x 72	92.5	275	25	<b>\$3288</b>	<b>\$3945</b>

Three open veneer shelves and two lateral file drawers on bottom. Includes two adjustable shelves. Lock secures all drawers. Front-to-back and side-to-side filing. **Not for stacking materials on lateral file drawer bottom.**

**Required Specifications**

Veneer Finish (doors, drawer fronts, open shelves)  
Laminate Finish (top/body)  
Handle Style

**Optional Specifications**

Additional Lock (storage compartments)  
Lock (Wardrobe Cabinets)  
Veneer Top

STORAGE MODULES - 72" HIGH (FREESTANDING)

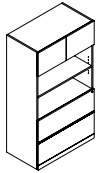

Two File Module w/Doors and Open Shelves

MODEL#	DIMENSIONS	FREIGHT CLASS	WT./LBS.	CUBIC FT.	VENEER/LAMINATE	ALL VENEER
<b>D x W x H</b>						
D10D22H72	22 x 36 x 72	92.5	336	33	\$4365	\$5238
D10D22W30H72	22 x 30 x 72	92.5	294	28	\$3820	\$4583
D10H72	20 x 36 x 72	92.5	322	30	\$4154	\$4986
D10W30H72	20 x 30 x 72	92.5	280	25	\$3463	\$4155

Storage compartment with fixed shelf. Two open veneer shelves and two lateral file drawers on bottom. Includes one adjustable shelf. Lock secures all drawers. Front-to-back and side-to-side filing. **Not for stacking materials on lateral file drawer bottom.**

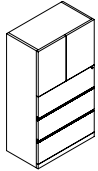

Three File Module w/Doors

D14D22H72	22 x 36 x 72	100	312	33	\$4832	\$5797
D14D22W30H72	22 x 30 x 72	100	273	28	\$4228	\$5075
D14H72	20 x 36 x 72	100	298	30	\$4600	\$5522
D14W30H72	20 x 30 x 72	92.5	259	25	\$3835	\$4601

Three lateral file drawers on bottom. Includes one adjustable shelf. Lock secures all drawers. Front-to-back and side-to-side filing. **Not for stacking materials on lateral file drawer bottom.**

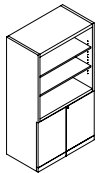

Storage Module w/Open Shelves

D22D22H72	22 x 36 x 72	100	300	33	\$3313	\$3974
D22D22W30H72	22 x 30 x 72	100	279	28	\$2899	\$3479
D22H72	20 x 36 x 72	100	305	30	\$3149	\$3780
D22W30H72	20 x 30 x 72	100	265	25	\$2627	\$3153

Three open veneer shelves and storage cabinet on bottom. Includes two adjustable shelves in upper compartment and one adjustable shelf in storage cabinet. Lock secures storage cabinet.

WARDROBE CABINETS - 72" HIGH (FREESTANDING)

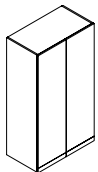

Wardrobe Cabinet

MODEL#	DIMENSIONS	FREIGHT CLASS	WT./LBS.	CUBIC FT.	VENEER/LAMINATE	ALL VENEER
D2D22H72	22 x 36 x 72	100	283	33	\$3149	\$3780
D2D22W30H72	22 x 30 x 72	100	247	33	\$2756	\$3309
D2D22W24H72	22 x 24 x 72	125	216	24	\$2341	\$2809
D2H72	20 x 36 x 72	100	269	30	\$3001	\$3603
D2W30H72	20 x 30 x 72	100	233	25	\$2501	\$3001
D2W24H72	20 x 24 x 72	125	179	20	\$2001	\$2402

Includes full length hanging rod and fixed hat shelf.

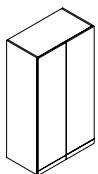

Wardrobe Cabinet/ Shelving Combo

D25D22H72	22 x 36 x 72	100	319	33	\$4074	\$4888
D25D22W30H72	22 x 30 x 72	100	279	28	\$3562	\$4274
D25D22W24H72	22 x 24 x 72	100	213	24	\$3054	\$3663
D25H72	20 x 36 x 72	92.5	305	30	\$4744	\$5691
D25W30H72	20 x 30 x 72	92.5	265	25	\$3236	\$3881
D25W24H72	20 x 24 x 72	100	203	20	\$2588	\$3104

Wardrobe compartment on **left** includes hanging rod and fixed hat shelf. Storage compartment on **right** includes three adjustable shelves.

PERSONAL TOWERS - 72" HIGH (FREESTANDING)

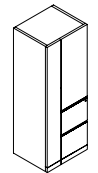

Personal Tower - LEFT

MODEL#	DIMENSIONS	FREIGHT CLASS	WT./LBS.	CUBIC FT.	VENEER/LAMINATE	ALL VENEER
D29D22W24H72L	22 x 24 x 72	125	154	22	\$4287	\$5142
D29W24H72L	20 x 24 x 72	125	140	20	\$4960	\$5951

**Two file** drawers on bottom. Wardrobe compartment on **left** includes hanging rod. Storage compartment on **right** includes one adjustable shelf. Lower lock secures all drawers.

**Required Specifications**

Veneer Finish (doors, drawer fronts, open shelves)  
Laminate Finish (top/body)  
Handle Style

**Optional Specifications**

Additional Lock (storage compartments)  
Veneer Top

PERSONAL TOWERS - 72" HIGH (FREESTANDING)    MODEL#    DIMENSIONS    FREIGHT CLASS    WT/LBS.    CUBIC FT.    VENEER/LAMINATE    ALL VENEER

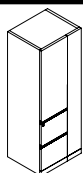

Personal Tower - RIGHT

	D x W x H						
D29D22W24H72R	22 x 24 x 72	125	154	22	<b>\$4287</b>	<b>\$5142</b>	
D29W24H72R	20 x 24 x 72	125	140	20	<b>\$4059</b>	<b>\$4871</b>	

**Two file** drawers on bottom. Wardrobe compartment on **right** includes hanging rod. Storage compartment on **left** includes one adjustable shelf. Lower lock secures all drawers.

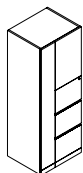

Personal Tower - LEFT

D27D22W24H72L	22 x 24 x 72	125	154	22	<b>\$4822</b>	<b>\$5788</b>	
D27W24H72L	20 x 24 x 72	125	140	20	<b>\$4595</b>	<b>\$5514</b>	

**Three file** drawers on bottom. Wardrobe compartment on **left** includes hanging rod. Storage compartment on **right** includes one adjustable shelf. Lower lock secures all drawers.

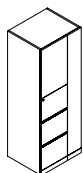

Personal Tower - RIGHT

D27D22W24H72R	22 x 24 x 72	125	154	22	<b>\$4822</b>	<b>\$5788</b>	
D27W24H72R	20 x 24 x 72	125	140	20	<b>\$4595</b>	<b>\$5514</b>	

**Three file** drawers on bottom. Wardrobe compartment on **right** includes hanging rod. Storage compartment on **left** includes one adjustable shelf. Lower lock secures all drawers.

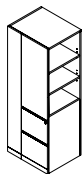

Personal Tower w/Open Bookcase - LEFT

D30D22W24H72L	22 x 24 x 72	125	154	22	<b>\$4287</b>	<b>\$5142</b>	
D30W24H72L	20 x 24 x 72	125	140	20	<b>\$4059</b>	<b>\$4871</b>	

**Two file drawers** on bottom. Wardrobe compartment on **left** includes hanging rod. Storage compartment on **right** includes one adjustable shelf. Open bookcase on **right** includes two adjustable shelves. Lower lock secures all drawers.

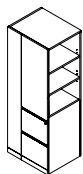

Personal Tower w/Open Bookcase - RIGHT

D30D22W24H72R	22 x 24 x 72	125	154	22	<b>\$4287</b>	<b>\$5142</b>	
D30W24H72R	20 x 24 x 72	125	140	20	<b>\$4059</b>	<b>\$4871</b>	

**Two file drawers** on bottom. Wardrobe compartment on **right** includes hanging rod. Storage compartment on **left** includes one adjustable shelf. Open bookcase on **left** includes two adjustable shelves. Lower lock secures all drawers.

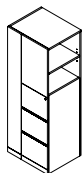

Personal Tower w/Open Bookcase - LEFT

D26D22W24H72L	22 x 24 x 72	125	154	22	<b>\$4778</b>	<b>\$5733</b>	
D26W24H72L	20 x 24 x 72	125	140	20	<b>\$5562</b>	<b>\$6675</b>	

**Three file drawers** on bottom. Wardrobe compartment on **left** includes hanging rod. Storage compartment on **right** includes one adjustable shelf. Open bookcase on **right** includes one adjustable shelf. Lower lock secures all drawers.

**Required Specifications**

Veneer Finish (doors, drawer fronts, open shelves)  
Laminate Finish (top/body)  
Handle Style

**Optional Specifications**

Additional Lock (storage compartments)  
Veneer Top

PERSONAL TOWERS - 72" HIGH (FREESTANDING)

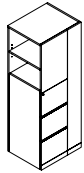

Personal Tower w/Open Bookcase - RIGHT

MODEL#	DIMENSIONS	FREIGHT CLASS	WT/LBS.	CUBIC FT.	ENEER/LAMINATE	ALL VENEER
<b>D x W x H</b>						
D26D22W24H72R	22 x 24 x 72	125	154	22	<b>\$4778</b>	<b>\$5733</b>
D26W24H72R	20 x 24 x 72	125	140	20	<b>\$5562</b>	<b>\$6675</b>

**Three file drawers** on bottom. Wardrobe compartment on **right** includes hanging rod. Storage compartment on **left** includes one adjustable shelf. Open bookcase on **left** includes one adjustable shelf. Lower lock secures all drawers.

STORAGE MODULES - 84" HIGH (FREESTANDING)

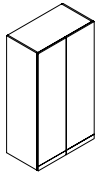

Storage Cabinet w/Doors

MODEL#	DIMENSIONS	FREIGHT CLASS	WT/LBS.	CUBIC FT.	ENEER/LAMINATE	ALL VENEER
D1D22H84	22 x 36 x 84	125	304	42	<b>\$4197</b>	<b>\$5036</b>
D1D22W30H84	22 x 30 x 84	100	304	35	<b>\$3669</b>	<b>\$4404</b>
D1D22W24H84	22 x 24 x 84	92.5	320	28	<b>\$3142</b>	<b>\$3770</b>
D1H84	20 x 36 x 84	100	297	35	<b>\$3999</b>	<b>\$4796</b>
D1W30H84	20 x 30 x 84	100	257	29	<b>\$3328</b>	<b>\$3992</b>
D1W24H84	20 x 24 x 84	100	198	23	<b>\$2666</b>	<b>\$3197</b>

Includes four adjustable shelves. Standard with lock.

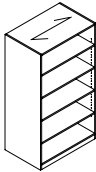

Open Storage Cabinet

D7D24H84	24 x 36 x 84	125	331	43	<b>\$3897</b>	<b>\$4674</b>
D7D24W30H84	24 x 30 x 84	125	280	36	<b>\$3410</b>	<b>\$4095</b>
D7H84	20 x 36 x 84	100	282	35	<b>\$3405</b>	<b>\$4084</b>
D7W30H84	20 x 30 x 84	100	248	29	<b>\$2835</b>	<b>\$3405</b>

Includes one fixed and **four** adjustable veneer shelves. Shelves are 3/4" thick.

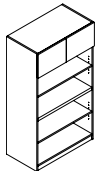

Open Storage Cabinet w/Doors

D9D22H84	22 x 36 x 84	92.5	364	36	<b>\$3641</b>	<b>\$4371</b>
D9D22W30H84	22 x 30 x 84	92.5	330	31	<b>\$3192</b>	<b>\$3831</b>
D9H84	20 x 36 x 84	92.5	348	33	<b>\$3464</b>	<b>\$4156</b>
D9W30H84	20 x 30 x 84	92.5	317	28	<b>\$2891</b>	<b>\$3468</b>

Storage compartment with fixed shelf. One fixed and **two** adjustable veneer shelves. Fixed shelf is at 29" high. Shelves are 3/4" thick.

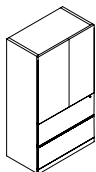

Two File Module w/Doors

D13D22H84	22 x 36 x 84	92.5	364	36	<b>\$5195</b>	<b>\$6234</b>
D13D22W30H84	22 x 30 x 84	92.5	330	31	<b>\$4546</b>	<b>\$5455</b>
D13H84	20 x 36 x 84	92.5	365	35	<b>\$4943</b>	<b>\$5931</b>
D13W30H84	20 x 30 x 84	92.5	305	29	<b>\$4513</b>	<b>\$5412</b>

Two lateral file drawers on bottom. Includes **two** adjustable shelves. Lower lock secures two file drawers. Front-to-back and side-to-side filing. **Not for stacking materials on lateral file drawer bottom.**

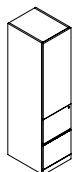

Two File Module w/Door - LEFT

D17D22H84L	22 x 16 x 84	125	116	17	<b>\$3754</b>	<b>\$4502</b>
D17D20H84L	20 x 16 x 84	125	105	15	<b>\$3410</b>	<b>\$4095</b>

Two file drawers on bottom. Includes two adjustable shelves. Lower lock secures two file drawers. Handle is on the **right**, door opens to the **left**.

**Required Specifications**

Veneer Finish (doors, drawer fronts, open shelves)  
Laminate Finish (top/body)  
Handle Style

**Optional Specifications**

Additional Lock (storage compartments)  
Veneer Top



STORAGE MODULES - 84" HIGH (FREESTANDING) MODEL# DIMENSIONS FREIGHT CLASS WT/LBS. CUBIC FT. VENEER/LAMINATE ALL VENEER



	D x W x H					
D17D22H84R	22 x 16 x 84	125	116	17	<b>\$3754</b>	<b>\$4502</b>
D17D20H84R	20 x 16 x 84	125	105	15	<b>\$3410</b>	<b>\$4095</b>

Two File Module w/Door - RIGHT

Two file drawers on bottom. Includes two adjustable shelves. Lower lock secures two file drawers. Handle is on the **left**, door opens to the **right**.

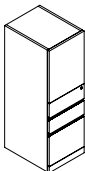

D18D22H84L	22 x 16 x 84	125	116	17	<b>\$3754</b>	<b>\$4502</b>
D18D20H84L	20 x 16 x 84	125	105	15	<b>\$3410</b>	<b>\$4095</b>

Box/Box/File Module w/Door - LEFT

Two box drawers and one file drawer on bottom. Includes two adjustable shelves. Lower lock secures all drawers. Handle is on the **right**, door opens to the **left**.

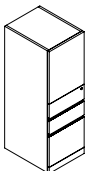

D18D22H84R	22 x 16 x 84	125	116	17	<b>\$3754</b>	<b>\$4502</b>
D18D20H84R	20 x 16 x 84	125	105	15	<b>\$3410</b>	<b>\$4095</b>

Box/Box/File Module w/Door - RIGHT

Two box drawers and one file drawer on bottom. Includes two adjustable shelves. Lower lock secures all drawers. Handle is on the **left**, door opens to the **right**.

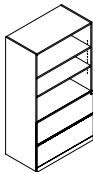

D12D22H84	22 x 36 x 84	92.5	364	36	<b>\$4561</b>	<b>\$5472</b>
D12D22W30H84	22 x 30 x 84	92.5	330	31	<b>\$3992</b>	<b>\$4791</b>
D12H84	20 x 36 x 84	92.5	348	33	<b>\$4389</b>	<b>\$5265</b>
D12W30H84	20 x 30 x 84	92.5	317	28	<b>\$3801</b>	<b>\$4561</b>

Two File Module w/Open Shelves

Three open veneer shelves and two lateral file drawers on bottom. Includes two adjustable shelves. Lock secures all drawers. Front-to-back and side-to-side filing. **Not for stacking materials on lateral file drawer bottom.**

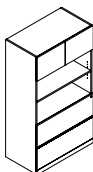

D10D22H84	22 x 36 x 84	92.5	364	36	<b>\$5045</b>	<b>\$6055</b>
D10D22W30H84	22 x 30 x 84	92.5	330	31	<b>\$4418</b>	<b>\$5301</b>
D10H84	20 x 36 x 84	92.5	348	33	<b>\$4805</b>	<b>\$5766</b>
D10W30H84	20 x 30 x 84	92.5	317	28	<b>\$4007</b>	<b>\$4807</b>

Two File Module w/Doors and Open Shelves

Storage compartment with fixed shelf. Two open veneer shelves and two lateral file drawers on bottom. Includes one adjustable shelf. Lock secures all drawers. Front-to-back and side-to-side filing. **Not for stacking materials on lateral file drawer bottom.**

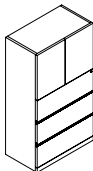

D14D22H84	22 x 36 x 84	100	340	42	<b>\$5605</b>	<b>\$6728</b>
D14D22W30H84	22 x 30 x 84	100	308	35	<b>\$4888</b>	<b>\$5867</b>
D14H84	20 x 36 x 84	100	330	35	<b>\$5319</b>	<b>\$6384</b>
D14W30H84	20 x 30 x 84	92.5	298	29	<b>\$4436</b>	<b>\$5321</b>

Three File Module w/Doors

Three lateral file drawers on bottom. Includes one adjustable shelf. Lock secures all drawers. Front-to-back and side-to-side filing. **Not for stacking materials on lateral file drawer bottom.**

**Required Specifications**

Veneer Finish (doors, drawer fronts, open shelves)  
Laminate Finish (top/body)  
Handle Style

**Optional Specifications**

Additional Lock (storage compartments)  
Veneer Top

**STORAGE MODULES - 84" HIGH (FREESTANDING)**

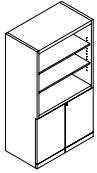

**Storage Module w/Open Shelves**

MODEL#	DIMENSIONS	FREIGHT CLASS	WT/LBS.	CUBIC FT.	veneer/LAMINATE	ALL VENEER
<b>D x W x H</b>						
D22D22H84	22 x 36 x 84	125	325	42	<b>\$3827</b>	<b>\$4592</b>
D22D22W30H84	22 x 30 x 84	100	304	35	<b>\$3347</b>	<b>\$4019</b>
D22H84	20 x 36 x 84	100	327	33	<b>\$3641</b>	<b>\$4371</b>
D22W30H84	20 x 30 x 84	92.5	301	28	<b>\$3041</b>	<b>\$3650</b>

Three open veneer shelves and storage cabinet on bottom. Includes two adjustable shelves in upper compartment and one adjustable shelf in storage cabinet. Lock secures storage cabinet.

**WARDROBE CABINETS - 84" HIGH (FREESTANDING)**

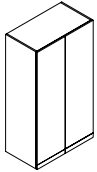

**Wardrobe Cabinet**

MODEL#	DIMENSIONS	FREIGHT CLASS	WT/LBS.	CUBIC FT.	veneer/LAMINATE	ALL VENEER
D2D22H84	22 x 36 x 84	125	307	42	<b>\$3641</b>	<b>\$4371</b>
D2D22W30H84	22 x 30 x 84	125	260	42	<b>\$3192</b>	<b>\$3831</b>
D2D22W24H84	22 x 24 x 84	100	242	28	<b>\$2732</b>	<b>\$3281</b>
D2H84	20 x 36 x 84	100	297	35	<b>\$3464</b>	<b>\$4156</b>
D2W30H84	20 x 30 x 84	100	257	29	<b>\$2891</b>	<b>\$3468</b>
D2W24H84	20 x 24 x 84	100	198	23	<b>\$2315</b>	<b>\$2777</b>

Includes full length hanging rod and fixed hat shelf.

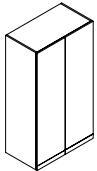

**Wardrobe Cabinet/Shelving Combo**

D25D22H84	22 x 36 x 84	100	348	42	<b>\$4712</b>	<b>\$5652</b>
D25D22W30H84	22 x 30 x 84	100	307	35	<b>\$4114</b>	<b>\$4938</b>
D25D22W24H84	22 x 24 x 84	100	254	28	<b>\$3527</b>	<b>\$4231</b>
D25H84	20 x 36 x 84	100	330	35	<b>\$4484</b>	<b>\$5381</b>
D25W30H84	20 x 30 x 84	92.5	300	29	<b>\$3738</b>	<b>\$4486</b>
D25W24H84	20 x 24 x 84	92.5	235	23	<b>\$2995</b>	<b>\$3591</b>

Wardrobe compartment on **left** includes hanging rod and fixed hat shelf. Storage compartment on **right** includes three adjustable shelves.

**PERSONAL TOWERS - 84" HIGH (FREESTANDING)**

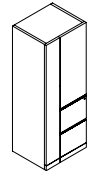

**Personal Tower - LEFT**

MODEL#	DIMENSIONS	FREIGHT CLASS	WT/LBS.	CUBIC FT.	veneer/LAMINATE	ALL VENEER
D29D22W24H84L	22 x 24 x 84	125	167	24	<b>\$5086</b>	<b>\$6101</b>
D29W24H84L	20 x 24 x 84	125	152	22	<b>\$4818</b>	<b>\$5782</b>

**Two file** drawers on bottom. Wardrobe compartment on **left** includes hanging rod. Storage compartment on **right** includes one adjustable shelf. Lower lock secures all drawers.

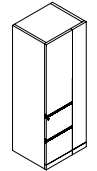

**Personal Tower - RIGHT**

D29D22W24H84R	22 x 24 x 84	125	167	24	<b>\$5086</b>	<b>\$6101</b>
D29W24H84R	20 x 24 x 84	125	152	22	<b>\$4818</b>	<b>\$5782</b>

**Two file** drawers on bottom. Wardrobe compartment on **right** includes hanging rod. Storage compartment on **left** includes one adjustable shelf. Lower lock secures all drawers.

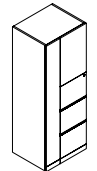

**Personal Tower - LEFT**

D27D22W24H84L	22 x 24 x 84	125	167	24	<b>\$6815</b>	<b>\$8180</b>
D27W24H84L	20 x 24 x 84	125	152	22	<b>\$6488</b>	<b>\$7786</b>

**Three file** drawers on bottom. Wardrobe compartment on **left** includes hanging rod. Storage compartment on **right** includes one adjustable shelf. Lower lock secures all drawers.

**Required Specifications**

Veneer Finish (doors, drawer fronts, open shelves)  
Laminate Finish (top/body)  
Handle Style

**Optional Specifications**

Additional Lock (storage compartments)  
Veneer Top

PERSONAL TOWERS - 84" HIGH (FREESTANDING)

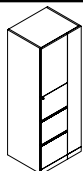

Personal Tower - RIGHT

MODEL#	DIMENSIONS D x W x H	FREIGHT CLASS	WT/LBS.	CUBIC FT.	veneer/LAMINATE	ALL VENEER
D27D22W24H84R	22 x 24 x 84	125	167	24	<b>\$6815</b>	<b>\$8180</b>
D27W24H84R	20 x 24 x 84	125	152	22	<b>\$6488</b>	<b>\$7786</b>

**Three file drawers** on bottom. Wardrobe compartment on **right** includes hanging rod. Storage compartment on **left** includes one adjustable shelf. Lower lock secures all drawers.

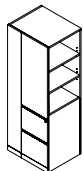

Personal Tower w/Open Bookcase - LEFT

D30D22W24H84L	22 x 24 x 84	125	167	24	<b>\$5086</b>	<b>\$6101</b>
D30W24H84L	20 x 24 x 84	125	152	22	<b>\$4818</b>	<b>\$5782</b>

**Two file drawers** on bottom. Wardrobe compartment on **left** includes hanging rod. Storage compartment on **right** includes one adjustable shelf. Open bookcase on **right** includes two adjustable shelves. Lower lock secures all drawers.

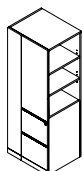

Personal Tower w/Open Bookcase - RIGHT

D30D22W24H84R	22 x 24 x 84	125	167	24	<b>\$5086</b>	<b>\$6101</b>
D30W24H84R	20 x 24 x 84	125	152	22	<b>\$4818</b>	<b>\$5782</b>

**Two file drawers** on bottom. Wardrobe compartment on **right** includes hanging rod. Storage compartment on **left** includes one adjustable shelf. Open bookcase on **left** includes two adjustable shelves. Lower lock secures all drawers.

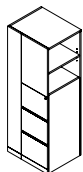

Personal Tower w/Open Bookcase - LEFT

D26D22W24H84L	22 x 24 x 84	125	167	24	<b>\$6815</b>	<b>\$8180</b>
D26W24H84L	20 x 24 x 84	125	152	22	<b>\$6488</b>	<b>\$7786</b>

**Three file drawers** on bottom. Wardrobe compartment on **left** includes hanging rod. Storage compartment on **right** includes one adjustable shelf. Open bookcase on **right** includes one adjustable shelf. Lower lock secures all drawers.

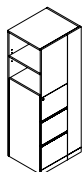

Personal Tower w/Open Bookcase - RIGHT

D26D22W24H84R	22 x 24 x 84	125	167	24	<b>\$6815</b>	<b>\$8180</b>
D26W24H84R	20 x 24 x 84	125	152	22	<b>\$6488</b>	<b>\$7786</b>

**Three file drawers** on bottom. Wardrobe compartment on **right** includes hanging rod. Storage compartment on **left** includes one adjustable shelf. Open bookcase on **left** includes one adjustable shelf. Lower lock secures all drawers.

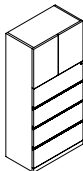

Four File Module w/Doors

D6W30H84	20 x 30 x 84	85	351	29	<b>\$5405</b>	<b>\$6484</b>
----------	--------------	----	-----	----	---------------	---------------

Four lateral file drawers on bottom. Includes one adjustable shelf. Lock secures all drawers. Front-to-back and side-to-side filing. **Not for stacking materials on lateral file drawer bottom.**

**Required Specifications**

Veneer Finish (doors, drawer fronts, open shelves)  
Laminate Finish (top/body)  
Handle Style

**Optional Specifications**

Additional Lock (storage compartments)  
Veneer Top

TOPS FOR STORAGE MODELS

MODEL#	DIMENSIONS	FREIGHT CLASS	WT./LBS.	CUBIC FT.	VENEER/LAMINATE	ALL VENEER
	<b>D x W x H</b>					
D12024T	24 x 120 x 1	60	115	2	N/A	<b>\$2303</b>
D11824T	24 x 118 x 1	60	109	2	N/A	<b>\$2268</b>
D11624T	24 x 116 x 1	60	107	2	N/A	<b>\$2235</b>
D11424T	24 x 114 x 1	60	105	2	N/A	<b>\$2206</b>
D11224T	24 x 112 x 1	60	103	2	N/A	<b>\$2152</b>
D11024T	24 x 110 x 1	60	102	2	N/A	<b>\$2110</b>
D10824T	24 x 108 x 1	60	100	2	N/A	<b>\$2071</b>
D10624T	24 x 106 x 1	60	98	2	N/A	<b>\$2034</b>
D10424T	24 x 104 x 1	60	96	2	N/A	<b>\$1994</b>
D10224T	24 x 102 x 1	60	94	2	N/A	<b>\$1961</b>
D10024T	24 x 100 x 1	60	92	2	N/A	<b>\$1919</b>
D9824T	24 x 98 x 1	60	90	2	N/A	<b>\$1879</b>
D9624T	24 x 96 x 1	60	88	2	N/A	<b>\$1843</b>
D9424T	24 x 94 x 1	60	86	2	N/A	<b>\$1803</b>
D9224T	24 x 92 x 1	60	85	2	N/A	<b>\$1768</b>
D9024T	24 x 90 x 1	60	83	2	N/A	<b>\$1729</b>
D8824T	24 x 88 x 1	60	81	2	N/A	<b>\$1693</b>
D8624T	24 x 86 x 1	60	80	2	N/A	<b>\$1652</b>
D8424T	24 x 84 x 1	60	78	2	N/A	<b>\$1611</b>
D8224T	24 x 82 x 1	60	75	2	N/A	<b>\$1575</b>
D8024T	24 x 80 x 1	60	74	2	N/A	<b>\$1538</b>
D7824T	24 x 78 x 1	60	72	2	N/A	<b>\$1516</b>
D7624T	24 x 76 x 1	60	70	2	N/A	<b>\$1462</b>
D7424T	24 x 74 x 1	60	69	2	N/A	<b>\$1425</b>
D7224T	24 x 72 x 1	60	66	2	N/A	<b>\$1386</b>
D7024T	24 x 70 x 1	60	64	2	N/A	<b>\$1345</b>
D6824T	24 x 68 x 1	60	62	2	N/A	<b>\$1313</b>
D6624T	24 x 66 x 1	60	61	2	N/A	<b>\$1270</b>
D6424T	24 x 64 x 1	60	59	1	N/A	<b>\$1228</b>
D6224T	24 x 62 x 1	60	57	1	N/A	<b>\$1194</b>
D6024T	24 x 60 x 1	60	55	1	N/A	<b>\$1152</b>
D5824T	24 x 58 x 1	60	54	1	N/A	<b>\$1111</b>
D5624T	24 x 56 x 1	60	52	1	N/A	<b>\$1077</b>
D5424T	24 x 54 x 1	60	50	1	N/A	<b>\$1038</b>
D5224T	24 x 52 x 1	60	48	1	N/A	<b>\$1001</b>
D5024T	24 x 50 x 1	60	46	1	N/A	<b>\$961</b>
D4824T	24 x 48 x 1	60	44	1	N/A	<b>\$921</b>
D4224T	24 x 42 x 1	60	39	1	N/A	<b>\$894</b>
D4024T	24 x 40 x 1	60	37	1	N/A	<b>\$853</b>
D3824T	24 x 38 x 1	60	35	1	N/A	<b>\$811</b>
D3624T	24 x 36 x 1	60	33	1	N/A	<b>\$763</b>
D3424T	24 x 34 x 1	60	31	1	N/A	<b>\$714</b>
D3224T	24 x 32 x 1	65	29	1	N/A	<b>\$675</b>
D3024T	24 x 30 x 1	65	28	1	N/A	<b>\$578</b>
D2424T	24 x 24 x 1	65	23	1	N/A	<b>\$578</b>
D1824T	24 x 18 x 1	70	17	1	N/A	<b>\$420</b>
D1624T	24 x 16 x 1	70	15	1	N/A	<b>\$407</b>
D1224T	24 x 12 x 1	92.5	11	1	N/A	<b>\$305</b>

**EXAMPLE:**

(1) D9024T  
Veneer Top

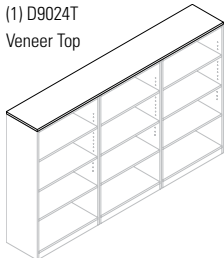

(3) D7D22W30H48 - Open Storage Cabinet

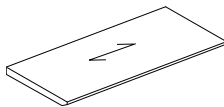

**Tops - 24" Deep**

For use with 22" deep units. Tops are 1" thick.

• **This is an OPTION for Storage Modules, Wardrobe Cabinets and Personal Towers.**  
**Specify a Veneer Top from the listing above (either a single model or straight run).**

**Required Specifications**

Veneer finish

TOPS FOR STORAGE MODELS

MODEL#	DIMENSIONS	FREIGHT CLASS	WT./LBS.	CUBIC FT.	VENEER/LAMINATE	ALL VENEER
D x W x H						
D12022T	22 x 120 x 1	60	101	2	N/A	\$2110
D11822T	22 x 118 x 1	60	100	2	N/A	\$2076
D11622T	22 x 116 x 1	60	97	2	N/A	\$2040
D11422T	22 x 114 x 1	60	96	2	N/A	\$2009
D11222T	22 x 112 x 1	60	95	2	N/A	\$1975
D11022T	22 x 110 x 1	60	92	2	N/A	\$1933
D10822T	22 x 108 x 1	60	91	2	N/A	\$1898
D10622T	22 x 106 x 1	60	89	2	N/A	\$1865
D10422T	22 x 104 x 1	60	87	2	N/A	\$1832
D10222T	22 x 102 x 1	60	86	2	N/A	\$1795
D10022T	22 x 100 x 1	60	84	2	N/A	\$1762
D9822T	22 x 98 x 1	60	83	2	N/A	\$1720
D9622T	22 x 96 x 1	60	81	2	N/A	\$1687
D9422T	22 x 94 x 1	60	79	2	N/A	\$1652
D9222T	22 x 92 x 1	60	77	2	N/A	\$1617
D9022T	22 x 90 x 1	60	76	2	N/A	\$1617
D8822T	22 x 88 x 1	60	74	2	N/A	\$1549
D8622T	22 x 86 x 1	60	73	2	N/A	\$1516
D8422T	22 x 84 x 1	60	71	2	N/A	\$1481
D8222T	22 x 82 x 1	60	69	2	N/A	\$1447
D8022T	22 x 80 x 1	60	67	2	N/A	\$1407
D7822T	22 x 78 x 1	60	66	2	N/A	\$1371
D7622T	22 x 76 x 1	60	65	2	N/A	\$1338
D7422T	22 x 74 x 1	60	63	2	N/A	\$1302
D7222T	22 x 72 x 1	60	61	2	N/A	\$1302
D7022T	22 x 70 x 1	65	59	2	N/A	\$1237
D6822T	22 x 68 x 1	65	57	2	N/A	\$1201
D6622T	22 x 66 x 1	65	55	2	N/A	\$1169
D6422T	22 x 64 x 1	65	54	1	N/A	\$1126
D6222T	22 x 62 x 1	60	52	1	N/A	\$1094
D6022T	22 x 60 x 1	60	50	1	N/A	\$1056
D5822T	22 x 58 x 1	60	49	1	N/A	\$1022
D5622T	22 x 56 x 1	60	47	1	N/A	\$990
D5422T	22 x 54 x 1	60	46	1	N/A	\$955
D5222T	22 x 52 x 1	60	44	1	N/A	\$921
D5022T	22 x 50 x 1	60	42	1	N/A	\$879
D4822T	22 x 48 x 1	60	40	1	N/A	\$846
D4222T	22 x 42 x 1	60	36	1	N/A	\$819
D4022T	22 x 40 x 1	60	34	1	N/A	\$777
D3822T	22 x 38 x 1	60	32	1	N/A	\$742
D3622T	22 x 36 x 1	60	30	1	N/A	\$703
D3422T	22 x 34 x 1	65	28	1	N/A	\$660
D3222T	22 x 32 x 1	65	27	1	N/A	\$621
D3022T	22 x 30 x 1	65	25	1	N/A	\$578
D2422T	22 x 24 x 1	70	20	1	N/A	\$557
D1822T	22 x 18 x 1	70	15	1	N/A	\$420
D1622T	22 x 16 x 1	85	14	1	N/A	\$372
D1222T	22 x 12 x 1	92.5	10	1	N/A	\$279

EXAMPLE:

(1) D9022T  
Veneer Top

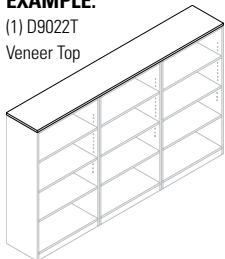

(3) D7D20W30H48 - Open Storage Cabinet

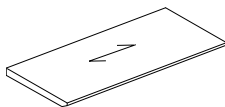

Tops - 22" Deep

For use with 20" deep units. Tops are 1" thick.

- **This is an OPTION for Storage Modules, Wardrobe Cabinets and Personal Towers.**  
**Specify a Veneer Top from the listing above (either a single model or straight run).**

FLOATING SHELF

MODEL#	DIMENSIONS	FREIGHT CLASS	WT./LBS.	CUBIC FT.	LIST PRICE
CBYF096D12H8	12 x 96 x 8	125	78	10	\$2688
CBYF064D12H8	12 x 64 x 8	125	50	8	\$1758
CBYF032D12H8	12 x 32 x 8	100	35	4	\$1593

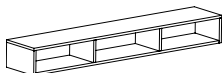

Wall Mounted Open Storage\*

To be used as a stand alone unit.

Required Specifications

Veneer finish

OVERHEAD STORAGE

sizes 48" and larger

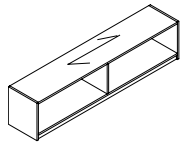

sizes less than 48"

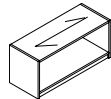

Open Front Overhead Storage

MODEL#	DIMENSIONS D x W x H	FREIGHT CLASS	WT./LBS.	CUBIC FT.	veneer/LAMINATE	ALL VENEER
DCSF072	14.5 x 72 x 16.5	125	100	10	\$1627	\$1954
DCSF066	14.5 x 66 x 16.5	125	83	9	\$1494	\$1792
DCSF060	14.5 x 60 x 16.5	100	75	8	\$1357	\$1627
DCSF054	14.5 x 54 x 16.5	100	68	7	\$1223	\$1467
DCSF048	14.5 x 48 x 16.5	100	60	7	\$1088	\$1305
DCSF042	14.5 x 42 x 16.5	100	55	6	\$1005	\$1204
DCSF036	14.5 x 36 x 16.5	100	50	5	\$995	\$1192
DCSF030	14.5 x 30 x 16.5	100	45	4	\$972	\$1169

Includes pre-mounted "J" brackets for wall mount applications.

- **NOTE:** Care should be taken to mount the units. Units should be mounted to wall studs using correct fasteners. Failure to do so may result in collapse of the unit and subsequent personal injury. **Mounting hardware not included.** Mounting hardware used should be based on wall material. Consult an installation professional for proper wall mounting.

sizes 48" and larger

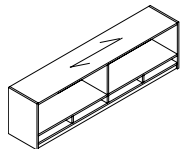

sizes less than 48"

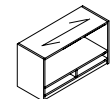

Open Front Overhead Storage - Pigeon-Hole Storage

DCSFOP72	14.5 x 72 x 19.5	125	100	12	\$1954	\$2345
DCSFOP66	14.5 x 66 x 19.5	125	83	11	\$1791	\$2150
DCSFOP60	14.5 x 60 x 19.5	125	75	10	\$1627	\$1954
DCSFOP54	14.5 x 54 x 19.5	125	68	9	\$1469	\$1763
DCSFOP48	14.5 x 48 x 19.5	125	60	8	\$1301	\$1562
DCSFOP42	14.5 x 42 x 19.5	125	55	7	\$1223	\$1467
DCSFOP36	14.5 x 36 x 19.5	125	50	6	\$1185	\$1422
DCSFOP30	14.5 x 30 x 19.5	125	45	5	\$1171	\$1403

Includes pre-mounted "J" brackets for wall mount applications. Horizontal pigeon-hole storage on bottom of overhead.

- **NOTE:** Care should be taken to mount the units. Units should be mounted to wall studs using correct fasteners. Failure to do so may result in collapse of the unit and subsequent personal injury. **Mounting hardware not included.** Mounting hardware used should be based on wall material. Consult an installation professional for proper wall mounting.

sizes 48" and larger

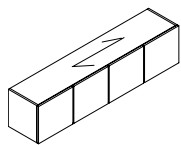

sizes less than 48"

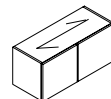

Closed Front Overhead Storage with Hinge Doors\*

DSF72	14.5 x 72 x 16.5	92.5	100	10	\$2105	\$2525
DSF66	14.5 x 66 x 16.5	100	83	9	\$1933	\$2320
DSF60	14.5 x 60 x 16.5	100	75	8	\$1756	\$2108
DSF54	14.5 x 54 x 16.5	100	68	7	\$1575	\$1891
DSF48	14.5 x 48 x 16.5	60	60	7	\$1549	\$1859
DSF42	14.5 x 42 x 16.5	100	55	6	\$1291	\$1548
DSF36	14.5 x 36 x 16.5	92.5	50	5	\$1263	\$1514
DSF30	14.5 x 30 x 16.5	92.5	45	4	\$1241	\$1491

Includes pre-mounted "J" brackets for wall mount applications.

- **NOTE:** Care should be taken to mount the units. Units should be mounted to wall studs using correct fasteners. Failure to do so may result in collapse of the unit and subsequent personal injury. **Mounting hardware not included.** Mounting hardware used should be based on wall material. Consult an installation professional for proper wall mounting.

sizes 48" and larger

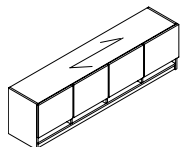

sizes less than 48"

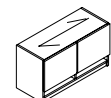

Closed Front Overhead Storage with Hinge Doors & Pigeon-Hole Storage\*

DSFP72	14.5 x 72 x 19.5	100	100	12	\$2528	\$3035
DSFP66	14.5 x 66 x 19.5	125	83	11	\$2315	\$2777
DSFP60	14.5 x 60 x 19.5	125	75	10	\$2110	\$2533
DSFP54	14.5 x 54 x 19.5	125	68	9	\$1898	\$2279
DSFP48	14.5 x 48 x 19.5	125	60	8	\$1681	\$2015
DSFP42	14.5 x 42 x 19.5	125	55	7	\$1606	\$1928
DSFP36	14.5 x 36 x 19.5	100	50	6	\$1516	\$1819
DSFP30	14.5 x 30 x 19.5	100	45	5	\$1495	\$1793

Includes pre-mounted "J" brackets for wall mount applications. Horizontal pigeon-hole storage on bottom of overhead.

- **NOTE:** Care should be taken to mount the units. Units should be mounted to wall studs using correct fasteners. Failure to do so may result in collapse of the unit and subsequent personal injury. **Mounting hardware not included.** Mounting hardware used should be based on wall material. Consult an installation professional for proper wall mounting.

Required Specifications

Veneer Finish  
Laminate Finish (top/body)

Optional Specifications

Lock\*  
Handle style\*

OVERHEAD STORAGE

sizes 48" and larger

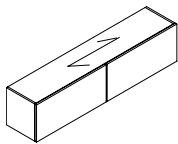

sizes less than 48"

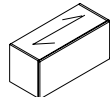

Closed Front Overhead Storage - with Flipper Doors

sizes 48" and larger

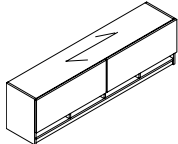

sizes less than 48"

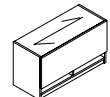

Closed Front Overhead Storage with Flipper Doors & Pigeon-Hole Storage

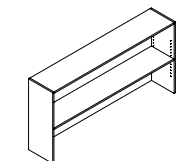

Open Hutch with Closed Back

MODEL#	DIMENSIONS	FREIGHT CLASS	WT/LBS.	CUBIC FT.	VENEER/LAMINATE	ALL VENEER
	<b>D x W x H</b>					
DSFF72	14.5 x 72 x 16.5	92.5	100	10	\$2282	\$2738
DSFF66	14.5 x 66 x 16.5	100	83	9	\$2089	\$2507
DSFF60	14.5 x 60 x 16.5	100	75	8	\$1898	\$2279
DSFF54	14.5 x 54 x 16.5	100	68	7	\$1714	\$2057
DSFF48	14.5 x 48 x 16.5	100	60	7	\$1522	\$1829
DSFF42	14.5 x 42 x 16.5	100	55	6	\$1414	\$1694
DSFF36	14.5 x 36 x 16.5	92.5	50	5	\$1386	\$1664
DSFF30	14.5 x 30 x 16.5	92.5	45	4	\$1367	\$1639

Includes pre-mounted "J" brackets for wall mount applications. Horizontal pigeon-hole storage on bottom of overhead.

- **NOTE:** Care should be taken to mount the units. Units should be mounted to wall studs using correct fasteners. Failure to do so may result in collapse of the unit and subsequent personal injury. **Mounting hardware not included.** Mounting hardware used should be based on wall material. Consult an installation professional for proper wall mounting.

DSFFP72	14.5 x 72 x 19.5	100	100	12	\$2992	\$3590
DSFFP66	14.5 x 66 x 19.5	125	83	11	\$2506	\$3009
DSFFP60	14.5 x 60 x 19.5	125	75	10	\$2282	\$2738
DSFFP54	14.5 x 54 x 19.5	125	68	9	\$2051	\$2458
DSFFP48	14.5 x 48 x 19.5	125	60	8	\$1824	\$2188
DSFFP42	14.5 x 42 x 19.5	125	55	7	\$1693	\$2032
DSFFP36	14.5 x 36 x 19.5	100	50	6	\$1660	\$1991
DSFFP30	14.5 x 30 x 19.5	100	45	5	\$1633	\$1958

Includes pre-mounted "J" brackets for wall mount applications. Horizontal pigeon-hole storage on bottom of overhead.

- **NOTE:** Care should be taken to mount the units. Units should be mounted to wall studs using correct fasteners. Failure to do so may result in collapse of the unit and subsequent personal injury. **Mounting hardware not included.** Mounting hardware used should be based on wall material. Consult an installation professional for proper wall mounting.

D72CL36	16 x 72 x 36	125	155	23	\$1817	\$2180
D66CL36	16 x 66 x 36	125	140	21	\$1685	\$2020
D60CL36	16 x 60 x 36	125	130	19	\$1495	\$1793
D48CL36	16 x 48 x 36	125	110	15	\$1423	\$1709
D42CL36	16 x 42 x 36	125	95	13	\$1291	\$1548
D36CL36	16 x 36 x 36	125	80	11	\$1214	\$1455
D30CL36	16 x 30 x 36	125	67	9	\$1008	\$1214

One adjustable shelf. Closed back. All hutches shipped pre-assembled.

- **A Tackboard cannot be used with this hutch.**

CLOSED HUTCHES

sizes 120"-108"w

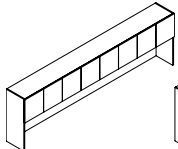

sizes 102"-84"w

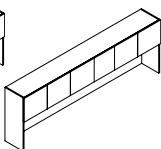

sizes 78"-60"w

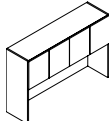

sizes 36"-30"w

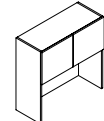

Closed Hutch w/Veneer Doors 36" High\*

MODEL#	DIMENSIONS	FREIGHT CLASS	WT/LBS.	CUBIC FT.	VENEER/LAMINATE	ALL VENEER
D120SH36	16 x 120 x 36	125	295	38	\$4910	\$5893
D114SH36	16 x 114 x 36	125	281	36	\$4663	\$5596
D108SH36	16 x 108 x 36	125	268	34	\$4419	\$5302
D102SH36	16 x 102 x 36	125	254	32	\$4174	\$5009
D96SH36	16 x 96 x 36	100	241	30	\$3930	\$4715
D90SH36	16 x 90 x 36	100	227	28	\$3682	\$4419
D84SH36	16 x 84 x 36	100	214	26	\$3436	\$4124
D78SH36	16 x 78 x 36	100	200	24	\$3192	\$3831
D72SH36	16 x 72 x 36	125	187	23	\$2947	\$3537
D66SH36	16 x 66 x 36	100	173	21	\$2840	\$3406
D60SH36	16 x 60 x 36	100	160	19	\$2701	\$3241
D36SH36	16 x 36 x 36	100	94	11	\$1844	\$2214
D30SH36	16 x 30 x 36	100	78	9	\$1613	\$1935

One fixed shelf. Closed back features one grommet. All hutches shipped pre-assembled.

- Models 120"w- 108"w have three fixed shelf dividers.
- Models 84"w- 102"w have two fixed shelf dividers.
- Models 60"w - 78"w have one fixed shelf divider.
- *Clearance from worksurface to valance is 19.5".*

Required Specifications

Veneer Finish  
Laminate Finish (top/body)

Optional Specifications

Lock (models with doors)  
Handle Style (models with doors)

Accessories

Tackboard\*  
Tasklight\*

**CLOSED HUTCHES**

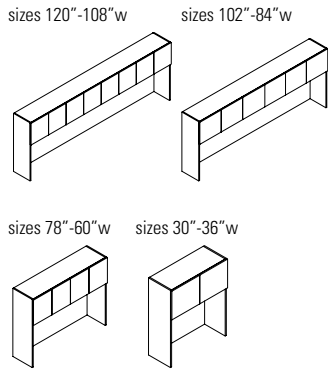

**Closed Hutch w/Veneer Doors 42" H**

MODEL#	DIMENSIONS	FREIGHT CLASS	WT./LBS.	CUBIC FT.	veneER/LAMINATE	ALL veneER
	<b>D x W x H</b>					
D120SH42	16 x 120 x 42	125	341	44	<b>\$5727</b>	<b>\$6871</b>
D114SH42	16 x 114 x 42	125	324	42	<b>\$5437</b>	<b>\$6526</b>
D108SH42	16 x 108 x 42	125	307	39	<b>\$5414</b>	<b>\$6497</b>
D102SH42	16 x 102 x 42	125	290	37	<b>\$4867</b>	<b>\$5841</b>
D96SH42	16 x 96 x 42	125	273	35	<b>\$4582</b>	<b>\$5498</b>
D90SH42	16 x 90 x 42	125	256	33	<b>\$4295</b>	<b>\$5154</b>
D84SH42	16 x 84 x 42	125	239	31	<b>\$4211</b>	<b>\$5053</b>
D78SH42	16 x 78 x 42	125	222	38	<b>\$3725</b>	<b>\$4469</b>
D72SH42	16 x 72 x 42	125	205	26	<b>\$3436</b>	<b>\$4124</b>
D66SH42	16 x 66 x 42	125	188	24	<b>\$3310</b>	<b>\$3973</b>
D60SH42	16 x 60 x 42	125	171	22	<b>\$3149</b>	<b>\$3780</b>
D36SH42	16 x 36 x 42	125	102	13	<b>\$2151</b>	<b>\$2579</b>
D30SH42	16 x 30 x 42	125	85	11	<b>\$1883</b>	<b>\$2259</b>

One fixed shelf. Closed back features one grommet. All hutches shipped pre-assembled.

- Models 120" w- 108" w have three fixed shelf dividers.
- Models 84" w- 102" w have two fixed shelf dividers.
- Models 60" w - 78" w have one fixed shelf divider.
- Clearance from worksurface to valance is 19.5".

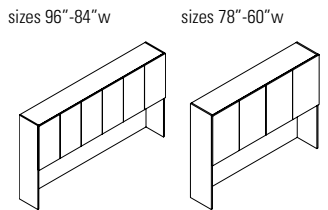

**Closed Hutch w/Veneer Doors 54" H**

D962SH54	15 x 96 x 54	125	351	45	<b>\$5885</b>	<b>\$7062</b>
D902SH54	15 x 90 x 54	125	329	42	<b>\$5522</b>	<b>\$6625</b>
D842SH54	15 x 84 x 54	125	307	39	<b>\$5153</b>	<b>\$6180</b>
D782SH54	15 x 78 x 54	125	285	37	<b>\$4784</b>	<b>\$5742</b>
D722SH54	15 x 72 x 54	300	263	34	<b>\$4418</b>	<b>\$5301</b>
D662SH54	15 x 66 x 54	125	241	31	<b>\$4253</b>	<b>\$5104</b>
D602SH54	15 x 60 x 54	125	219	28	<b>\$4051</b>	<b>\$4860</b>

One fixed shelf and one adjustable shelf (per compartment). Closed back features one grommet. All hutches shipped pre-assembled.

- Clearance from worksurface to valance is 25.5".

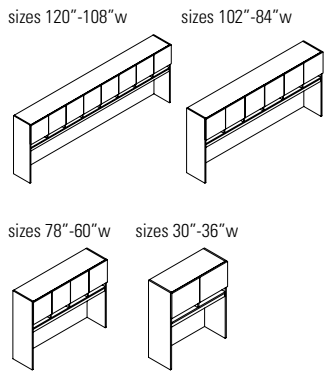

**Closed Hutch w/Veneer Doors Pigeon-Hole Storage, 42" High**

D120SHP42	15 x 120 x 42	125	341	44	<b>\$6871</b>	<b>\$8246</b>
D114SHP42	15 x 114 x 42	125	324	42	<b>\$6527</b>	<b>\$7834</b>
D108SHP42	15 x 108 x 42	125	307	39	<b>\$6187</b>	<b>\$7421</b>
D102SHP42	15 x 102 x 42	125	290	37	<b>\$5841</b>	<b>\$7009</b>
D96SHP42	15 x 96 x 42	125	273	35	<b>\$5498</b>	<b>\$6597</b>
D90SHP42	15 x 90 x 42	125	256	33	<b>\$5154</b>	<b>\$6187</b>
D84SHP42	15 x 84 x 42	125	239	31	<b>\$4811</b>	<b>\$5772</b>
D78SHP42	15 x 78 x 42	125	222	38	<b>\$4468</b>	<b>\$5360</b>
D72SHP42	15 x 72 x 42	125	205	26	<b>\$4318</b>	<b>\$5180</b>
D66SHP42	15 x 66 x 42	125	188	24	<b>\$4169</b>	<b>\$5003</b>
D60SHP42	15 x 60 x 42	125	171	22	<b>\$3973</b>	<b>\$4767</b>
D36SHP42	15 x 36 x 42	125	102	13	<b>\$2579</b>	<b>\$3096</b>
D30SHP42	15 x 30 x 42	125	85	11	<b>\$2259</b>	<b>\$2712</b>

One fixed shelf. Closed back features one grommet. Horizontal pigeon-hole storage top mounted to hutch. All hutches shipped pre-assembled.

- Models 120" w- 108" w have three fixed shelf dividers.
- Models 84" w- 102" w have two fixed shelf dividers.
- Models 60" w - 78" w have one fixed shelf divider.
- Clearance from worksurface to valance is 21.5".

**Required Specifications**

Veneer Finish (doors)  
Laminate Finish (top/body)

**Optional Specifications**

Lock  
Handle Style

**Accessories**

Tackboard  
Tasklight



CLOSED HUTCHES

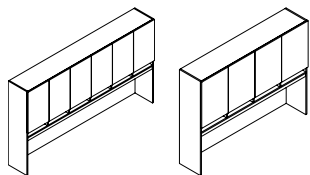

**Closed Hutch w/Veneer Doors**  
**Pigeon-Hole Storage, 54"H\***

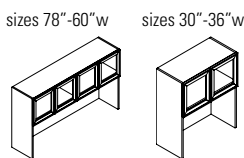
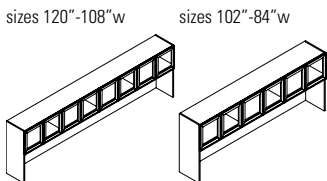

**Closed Hutch w/Glass Doors 36"H\*\***

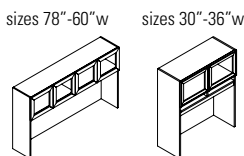
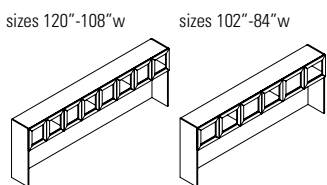

**Closed Hutch w/Glass Doors 42"H\*\***

MODEL#	DIMENSIONS	FREIGHT CLASS	WT./LBS.	CUBIC FT.	VENEER/LAMINATE	ALL VENEER
	<b>D x W x H</b>					
D962SHP54	15 x 96 x 54	125	351	45	<b>\$7067</b>	<b>\$8481</b>
D902SHP54	15 x 90 x 54	125	329	42	<b>\$6622</b>	<b>\$7945</b>
D842SHP54	15 x 84 x 54	125	307	39	<b>\$6178</b>	<b>\$7413</b>
D782SHP54	15 x 78 x 54	125	285	37	<b>\$5740</b>	<b>\$6888</b>
D722SHP54	15 x 72 x 54	125	263	34	<b>\$5301</b>	<b>\$6360</b>
D662SHP54	15 x 66 x 54	125	241	31	<b>\$5102</b>	<b>\$6122</b>
D602SHP54	15 x 60 x 54	125	219	28	<b>\$4858</b>	<b>\$5829</b>

One fixed shelf and one adjustable shelf (per compartment). Closed back features one grommet. Horizontal pigeon-hole storage top mounted to hutch. All hutches shipped pre-assembled.

- Clearance from worksurface to valance is 21.5".

D120SH36G	15 x 120 x 36	125	295	38	<b>\$7344</b>	<b>\$8811</b>
D114SH36G	15 x 114 x 36	125	281	36	<b>\$7049</b>	<b>\$8459</b>
D108SH36G	15 x 108 x 36	125	268	34	<b>\$6762</b>	<b>\$8114</b>
D102SH36G	15 x 102 x 36	125	254	32	<b>\$6071</b>	<b>\$7285</b>
D96SH36G	15 x 96 x 36	85	241	30	<b>\$5791</b>	<b>\$6949</b>
D90SH36G	15 x 90 x 36	100	227	28	<b>\$5504</b>	<b>\$6605</b>
D84SH36G	15 x 84 x 36	100	214	26	<b>\$5223</b>	<b>\$6267</b>
D78SH36G	15 x 78 x 36	85	200	24	<b>\$4949</b>	<b>\$5939</b>
D72SH36G	15 x 72 x 36	100	187	23	<b>\$4300</b>	<b>\$5159</b>
D66SH36G	15 x 66 x 36	100	173	21	<b>\$4114</b>	<b>\$4938</b>
D60SH36G	15 x 60 x 36	100	160	19	<b>\$3931</b>	<b>\$4716</b>
D36SH36G	15 x 36 x 36	100	94	11	<b>\$2500</b>	<b>\$2999</b>
D30SH36G	15 x 30 x 36	100	78	9	<b>\$2235</b>	<b>\$2679</b>

One fixed shelf. Closed back features one grommet. Aluminum frame available in Tungsten finish only. All hutches shipped pre-assembled. Translucent, screened glass.

- Models 120"w- 108"w have three fixed shelf dividers.
- Models 84"w- 102"w have two fixed shelf dividers.
- Models 60"w - 78"w have one fixed shelf divider.
- Clearance from worksurface to valance is 19.5".
- Locks are not available on hutches with Glass Doors.

D120SH42G	15 x 120 x 42	125	341	44	<b>\$7720</b>	<b>\$9265</b>
D114SH42G	15 x 114 x 42	125	324	42	<b>\$7405</b>	<b>\$8886</b>
D108SH42G	15 x 108 x 42	125	307	39	<b>\$7098</b>	<b>\$8517</b>
D102SH42G	15 x 102 x 42	125	290	37	<b>\$6398</b>	<b>\$7680</b>
D96SH42G	15 x 96 x 42	125	273	35	<b>\$6098</b>	<b>\$7317</b>
D90SH42G	15 x 90 x 42	125	256	33	<b>\$5872</b>	<b>\$7047</b>
D84SH42G	15 x 84 x 42	125	239	31	<b>\$5483</b>	<b>\$6580</b>
D78SH42G	15 x 78 x 42	150	222	38	<b>\$5181</b>	<b>\$6217</b>
D72SH42G	15 x 72 x 42	125	205	26	<b>\$4472</b>	<b>\$5364</b>
D66SH42G	15 x 66 x 42	125	188	24	<b>\$4314</b>	<b>\$5177</b>
D60SH42G	15 x 60 x 42	125	171	22	<b>\$4163</b>	<b>\$4993</b>
D36SH42G	15 x 36 x 42	125	102	13	<b>\$3250</b>	<b>\$3900</b>
D30SH42G	15 x 30 x 42	125	85	11	<b>\$2363</b>	<b>\$2840</b>

One fixed shelf. Closed back features one grommet. Aluminum frame available in Tungsten finish only. All hutches shipped pre-assembled. Translucent, screened glass.

- Models 120"w- 108"w have three fixed shelf dividers.
- Models 84"w- 102"w have two fixed shelf dividers.
- Models 60"w - 78"w have one fixed shelf divider.
- Clearance from worksurface to valance is 25.5".
- Locks are not available on hutches with Glass Doors.

**Required Specifications**

Veneer finish\*  
Laminate finish (body)\*\*  
Handle Style

**Optional Specifications**

Lock\*  
Veneer top\*

**Accessories**

Tackboard  
Tasklight

**CLOSED HUTCHES**

sizes 96"-84"w

sizes 78"-60"w

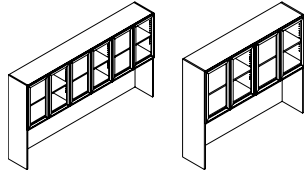

**Closed Hutch w/Glass Doors 54"H**

MODEL#	DIMENSIONS	FREIGHT CLASS	WT./LBS.	CUBIC FT.	veneer/LAMINATE	ALL VENEER
<b>D x W x H</b>						
D962SH54G	15 x 96 x 54	125	351	45	<b>\$7788</b>	<b>\$9345</b>
D902SH54G	15 x 90 x 54	125	329	42	<b>\$7227</b>	<b>\$8674</b>
D842SH54G	15 x 84 x 54	125	307	39	<b>\$6714</b>	<b>\$8058</b>
D782SH54G	15 x 78 x 54	125	285	37	<b>\$6173</b>	<b>\$7409</b>
D722SH54G	15 x 72 x 54	125	263	34	<b>\$5640</b>	<b>\$6767</b>
D662SH54G	15 x 66 x 54	125	241	31	<b>\$5443</b>	<b>\$6532</b>
D602SH54G	15 x 60 x 54	125	219	28	<b>\$5202</b>	<b>\$6243</b>

One fixed shelf and one adjustable shelf (per compartment). Closed back features one grommet. Aluminum frame available in Tungsten finish only. All hutches shipped pre-assembled. Translucent, screened glass.

- Clearance from worksurface to valance is 25.5".
- Locks are not available on hutches with Glass Doors.

sizes 120"-108"w

sizes 102"-84"w

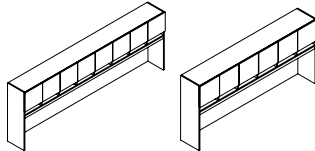

sizes 78"-60"w

sizes 30"-36"w

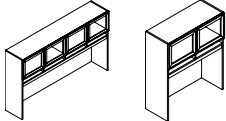

**Closed Hutch w/Glass Doors Pigeon-Hole Storage, 42"H**

D120SHP42G	15 x 120 x 42	125	341	44	<b>\$8799</b>	<b>\$10560</b>
D114SHP42G	15 x 114 x 42	125	324	42	<b>\$8419</b>	<b>\$10101</b>
D108SHP42G	15 x 108 x 42	125	307	39	<b>\$8068</b>	<b>\$9683</b>
D102SHP42G	15 x 102 x 42	125	290	37	<b>\$7322</b>	<b>\$8787</b>
D96SHP42G	15 x 96 x 42	125	273	35	<b>\$6982</b>	<b>\$8379</b>
D90SHP42G	15 x 90 x 42	125	256	33	<b>\$6960</b>	<b>\$8353</b>
D84SHP42G	15 x 84 x 42	125	239	31	<b>\$6236</b>	<b>\$7480</b>
D78SHP42G	15 x 78 x 42	150	222	38	<b>\$5879</b>	<b>\$7054</b>
D72SHP42G	15 x 72 x 42	125	205	26	<b>\$5128</b>	<b>\$6152</b>
D66SHP42G	15 x 66 x 42	125	188	24	<b>\$4963</b>	<b>\$5956</b>
D60SHP42G	15 x 60 x 42	125	171	22	<b>\$4723</b>	<b>\$5668</b>
D36SHP42G	15 x 36 x 42	125	102	13	<b>\$3068</b>	<b>\$3682</b>
D30SHP42G	15 x 30 x 42	125	85	11	<b>\$2739</b>	<b>\$3288</b>

One fixed shelf. Closed back features one grommet. Aluminum frame available in Tungsten finish only. Horizontal pigeon-hole storage top mounted to hutch. All hutches shipped pre-assembled. Translucent, screened glass.

- Models 120"w- 108"w have three fixed shelf dividers.
- Models 84"w- 102"w have two fixed shelf dividers.
- Models 60"w - 78"w have one fixed shelf divider.
- Clearance from worksurface to valance is 21.5".
- Locks are not available on hutches with Glass Doors.

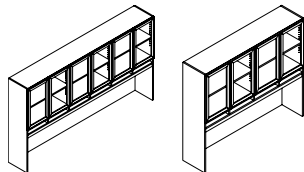

**Closed Hutch w/Glass Doors Pigeon-Hole Storage, 54"H**

D962SHP54G	15 x 96 x 54	125	351	45	<b>\$8950</b>	<b>\$10742</b>
D902SHP54G	15 x 90 x 54	125	329	42	<b>\$8342</b>	<b>\$10010</b>
D842SHP54G	15 x 84 x 54	125	307	39	<b>\$7732</b>	<b>\$9280</b>
D782SHP54G	15 x 78 x 54	125	285	37	<b>\$7125</b>	<b>\$8549</b>
D722SHP54G	15 x 72 x 54	125	263	34	<b>\$6516</b>	<b>\$7819</b>
D662SHP54G	15 x 66 x 54	125	241	31	<b>\$6283</b>	<b>\$7538</b>
D602SHP54G	15 x 60 x 54	125	219	28	<b>\$6002</b>	<b>\$7204</b>

One fixed shelf and one adjustable shelf (per compartment). Closed back features one grommet. Aluminum frame available in Tungsten finish only. Horizontal pigeon-hole storage top mounted to hutch. All hutches shipped pre-assembled. Translucent, screened glass.

- Clearance from worksurface to valance is 21.5".
- Locks are not available on hutches with Glass Doors.

**Required Specifications**  
Laminate Finish (body)

**Accessories**  
Tackboard  
Task Light

CLOSED HUTCHES

MODEL# DIMENSIONS FREIGHT CLASS WT/LBS. CUBIC FT. GR. 1-3 GR. 4-5

D x W x H

**TACKBOARD** Notes: Tackboards can be upholstered in all of the following fabrics:

**Grade 1:** Hudson, Jenny, Quilt, Terrace, Urban, Waterfall

**Grade 2:** Couture, Imprint, Lola, Match, Replay, Silhouette

**Grade 3:** Anchorage, Merge

WALL MOUNTED TACKBOARDS FOR OVERHEAD STORAGE

GR. 1-3 GR. 4-5

TS120	1 x 120 x 20	70	26	2	<b>\$1522</b>	<b>\$1902</b>
TS114	1 x 114 x 20	70	25	2	<b>\$1449</b>	<b>\$1814</b>
TS108	1 x 108 x 20	70	23	2	<b>\$1370</b>	<b>\$1713</b>
TS102	1 x 102 x 20	85	19	2	<b>\$1298</b>	<b>\$1623</b>
TS96	1 x 96 x 20	70	17	1	<b>\$1214</b>	<b>\$1520</b>
TS90	1 x 90 x 20	70	15	1	<b>\$1141</b>	<b>\$1428</b>
TS84	1 x 84 x 20	70	14	1	<b>\$1069</b>	<b>\$1335</b>
TS78	1 x 78 x 20	70	13	1	<b>\$990</b>	<b>\$1238</b>
TS72	1 x 72 x 20	70	12	1	<b>\$557</b>	<b>\$698</b>
TS66	1 x 66 x 20	85	11	1	<b>\$512</b>	<b>\$644</b>
TS60	1 x 60 x 20	85	10	1	<b>\$471</b>	<b>\$592</b>
TS54	1 x 54 x 20	85	10	1	<b>\$427</b>	<b>\$537</b>
TS48	1 x 48 x 20	85	10	1	<b>\$382</b>	<b>\$479</b>
TS42	1 x 42 x 20	85	10	1	<b>\$338</b>	<b>\$425</b>
TS36	1 x 36 x 20	100	8	1	<b>\$302</b>	<b>\$383</b>
TS30	1 x 30 x 20	150	5	1	<b>\$251</b>	<b>\$316</b>

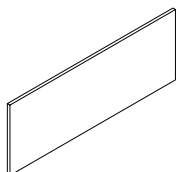

Tackboard

For use on **16.5"H** overhead storage (**DCSFO\_**, **DSF\_**, **DSFF\_**) at a finished height of **66"**. See Tackboard Notes above for exact fabric availability. List Price shown applies for all fabric grades.

- **NOTE:** Care should be taken to mount the units. Units should be mounted to wall studs using correct fasteners. Failure to do so may result in collapse of the unit and subsequent personal injury. **Mounting hardware not included.** Mounting hardware used should be based on wall material. Consult an installation professional for proper wall mounting.

TS120H26	1 x 120 x 26	70	34	2	<b>\$1979</b>	<b>\$2474</b>
TS114H26	1 x 114 x 26	70	32	2	<b>\$1880</b>	<b>\$2351</b>
TS108H26	1 x 108 x 26	70	30	2	<b>\$1782</b>	<b>\$2229</b>
TS102H26	1 x 102 x 26	85	24	2	<b>\$1678</b>	<b>\$2098</b>
TS96H26	1 x 96 x 26	92.5	22	2	<b>\$1587</b>	<b>\$1986</b>
TS90H26	1 x 90 x 26	92.5	20	2	<b>\$1488</b>	<b>\$1859</b>
TS84H26	1 x 84 x 26	100	18	2	<b>\$1383</b>	<b>\$1729</b>
TS78H26	1 x 78 x 26	100	17	2	<b>\$1286</b>	<b>\$1609</b>
TS72H26	1 x 72 x 26	70	16	1	<b>\$714</b>	<b>\$897</b>
TS66H26	1 x 66 x 26	85	14	1	<b>\$658</b>	<b>\$825</b>
TS60H26	1 x 60 x 26	85	13	1	<b>\$601</b>	<b>\$755</b>
TS54H26	1 x 54 x 26	85	13	1	<b>\$552</b>	<b>\$692</b>
TS48H26	1 x 48 x 26	85	13	1	<b>\$488</b>	<b>\$613</b>
TS42H26	1 x 42 x 26	85	13	1	<b>\$433</b>	<b>\$538</b>
TS36H26	1 x 36 x 26	100	8	1	<b>\$378</b>	<b>\$475</b>
TS30H26	1 x 30 x 26	150	5	1	<b>\$317</b>	<b>\$401</b>

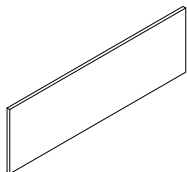

Tackboard

For use on **16.5"H** overhead storage (**DCSFO\_**, **DSF\_**, **DSFF\_**) at a finished height of **72"**. See Tackboard Notes above for exact fabric availability. List Price shown applies for all fabric grades.

- **NOTE:** Care should be taken to mount the units. Units should be mounted to wall studs using correct fasteners. Failure to do so may result in collapse of the unit and subsequent personal injury. **Mounting hardware not included.** Mounting hardware used should be based on wall material. Consult an installation professional for proper wall mounting.

**Required Specifications**

Fabric

TACKBOARDS FOR OVERHEAD STORAGE & HUTCHES MODEL# DIMENSIONS FREIGHT CLASS WT/LBS. CUBIC FT. GR. 1-3 GR. 4-5

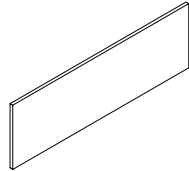

Tackboard

	D x W x H						
TSP120H23	1 x 120 x 23	70	34	2	\$1718	\$2148	
TSP114H23	1 x 114 x 23	70	32	2	\$1632	\$2039	
TSP108H23	1 x 108 x 23	70	30	2	\$1600	\$1920	
TSP102H23	1 x 102 x 23	85	24	2	\$1525	\$1831	
TSP96H23	1 x 96 x 23	92.5	20	2	\$1377	\$1720	
TSP90H23	1 x 90 x 23	92.5	20	1	\$1286	\$1609	
TSP84H23	1 x 84 x 23	70	18	1	\$1201	\$1501	
TSP78H23	1 x 78 x 23	70	17	1	\$983	\$1195	
TSP72H23	1 x 72 x 23	70	16	1	\$913	\$1147	
TSP66H23	1 x 66 x 23	85	14	1	\$830	\$1041	
TSP60H23	1 x 60 x 23	85	13	1	\$601	\$755	
TSP54H23	1 x 54 x 23	85	13	1	\$762	\$955	
TSP48H23	1 x 48 x 23	85	13	1	\$602	\$613	
TSP42H23	1 x 42 x 23	85	13	1	\$530	\$538	
TSP36H23	1 x 36 x 23	100	8	1	\$458	\$474	
TSP30H23	1 x 30 x 23	150	5	1	\$379	\$403	

For use on 19.5"H overhead storage (DCSFOP\_, DSFP\_, DSFFP\_) with Pigeon-Hole Storage at a finished height of 72". See Tackboard Notes above for exact fabric availability. List Price shown applies for all fabric grades.

- **NOTE:** Care should be taken to mount the units. Units should be mounted to wall studs using correct fasteners. Failure to do so may result in collapse of the unit and subsequent personal injury. **Mounting hardware not included.** Mounting hardware used should be based on wall material. Consult an installation professional for proper wall mounting.

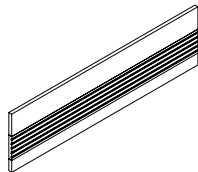

Tackboard - Accessory Rail

TSA120	1 x 120 x 20	85	26	2	\$2679	\$3349
TSA114	1 x 114 x 20	85	25	2	\$2549	\$3187
TSA108	1 x 108 x 20	92.5	23	2	\$2412	\$3014
TSA102	1 x 102 x 20	100	19	2	\$2287	\$2859
TSA96	1 x 96 x 20	70	15	1	\$2143	\$2679
TSA90	1 x 90 x 20	70	15	1	\$2011	\$2514
TSA84	1 x 84 x 20	85	14	1	\$1874	\$2345
TSA78	1 x 78 x 20	85	13	1	\$1743	\$2180
TSA72	1 x 72 x 20	85	12	1	\$1606	\$2008
TSA66	1 x 66 x 20	92.5	11	1	\$1474	\$1844
TSA60	1 x 60 x 20	92.5	10	1	\$1338	\$1674
TSA54	1 x 54 x 20	92.5	10	1	\$1207	\$1511
TSA48	1 x 48 x 20	92.5	10	1	\$1076	\$1346
TSA42	1 x 42 x 20	92.5	10	1	\$938	\$1173
TSA36	1 x 36 x 20	125	6	1	\$801	\$1004
TSA30	1 x 30 x 20	150	4	1	\$624	\$780

For use on 16.5"H overhead storage (DCSFO\_, DSF\_, DSFF\_) at a finished height of 66". See Tackboard Notes above for exact fabric availability. List Price shown applies for all fabric grades.

- **Must Specify Black (E) or Tungsten (K) Accessory Rail finish.**
- **NOTE:** Care should be taken to mount the units. Units should be mounted to wall studs using correct fasteners. Failure to do so may result in collapse of the unit and subsequent personal injury. **Mounting hardware not included.** Mounting hardware used should be based on wall material. Consult an installation professional for proper wall mounting.

Required Specifications

- Fabric
- Accessory Rail Finish

## WALL MOUNTED TACKBOARDS FOR OVERHEAD STORAGE MODEL#

### DIMENSIONS

### FREIGHT CLASS

### WT/LBS.

### CUBIC FT.

### GR. 1-3

### GR. 4-5

#### D x W x H

TSA120H26	1 x 120 x 26	85	26	2	\$3217	\$4021
TSA114H26	1 x 114 x 26	85	25	2	\$3053	\$3816
TSA108H26	1 x 108 x 26	92.5	23	2	\$2903	\$3628
TSA102H26	1 x 102 x 26	100	19	2	\$2738	\$3424
TSA96H26	1 x 96 x 26	70	15	1	\$2424	\$3031
TSA90H26	1 x 90 x 26	70	15	1	\$2418	\$3024
TSA84H26	1 x 84 x 26	85	14	1	\$2228	\$2785
TSA78H26	1 x 78 x 26	85	13	1	\$2090	\$2615
TSA72H26	1 x 72 x 26	85	12	1	\$1901	\$2378
TSA66H26	1 x 66 x 26	92.5	11	1	\$1777	\$2220
TSA60H26	1 x 60 x 26	92.5	10	1	\$1606	\$2008
TSA54H26	1 x 54 x 26	92.5	10	1	\$1449	\$1814
TSA48H26	1 x 48 x 26	92.5	10	1	\$1292	\$1615
TSA42H26	1 x 42 x 26	92.5	10	1	\$1136	\$1418
TSA36H26	1 x 36 x 26	125	6	1	\$965	\$1207
TSA30H26	1 x 30 x 26	150	4	1	\$807	\$1010

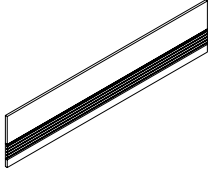

Tackboard - Accessory Rail

For use on **16.5"H** overhead storage (**DCSF0\_**, **DSF\_**, **DSFF\_**) at a finished height of **72"**. See *Tackboard Notes* above for exact fabric availability. List Price shown applies for all fabric grades.

• **Must Specify Black (E) or Tungsten (K) Accessory Rail finish.**

• **NOTE:** Care should be taken to mount the units. Units should be mounted to wall studs using correct fasteners. Failure to do so may result in collapse of the unit and subsequent personal injury. **Mounting hardware not included.** Mounting hardware used should be based on wall material. Consult an installation professional for proper wall mounting.

TSPA120H23	1 x 120 x 23	70	34	2	\$2929	\$3661
TSPA114H23	1 x 114 x 23	70	32	2	\$2771	\$3468
TSPA108H23	1 x 108 x 23	70	30	2	\$2614	\$3269
TSPA102H23	1 x 102 x 23	85	24	2	\$2490	\$3112
TSPA96H23	1 x 96 x 23	92.5	20	2	\$2332	\$2918
TSPA90H23	1 x 90 x 23	70	20	2	\$2189	\$2737
TSPA84H23	1 x 84 x 23	100	18	2	\$2038	\$2548
TSPA78H23	1 x 78 x 23	100	17	2	\$1895	\$2370
TSPA72H23	1 x 72 x 23	70	16	1	\$1749	\$2188
TSPA66H23	1 x 66 x 23	85	14	1	\$1606	\$2008
TSPA60H23	1 x 60 x 23	85	13	1	\$1456	\$1821
TSPA54H23	1 x 54 x 23	85	13	1	\$1286	\$1609
TSPA48H23	1 x 48 x 23	85	13	1	\$1166	\$1460
TSPA42H23	1 x 42 x 23	85	13	1	\$1023	\$1280
TSPA36H23	1 x 36 x 23	100	6	1	\$879	\$1098
TSPA30H23	1 x 30 x 23	150	4	1	\$729	\$913

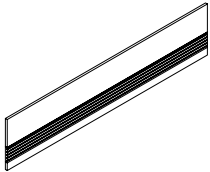

Tackboard - Accessory Rail

For use on **19.5"H** overhead storage (**DCSF0P\_**, **DSFP\_**, **DSFFP\_**) with Pigeon-Hole Storage at a finished height of **72"**. See *Tackboard Notes* above for exact fabric availability. List Price shown applies for all fabric grades.

• **Must Specify Black (E) or Tungsten (K) Accessory Rail finish.**

• **NOTE:** Care should be taken to mount the units. Units should be mounted to wall studs using correct fasteners. Failure to do so may result in collapse of the unit and subsequent personal injury. **Mounting hardware not included.** Mounting hardware used should be based on wall material. Consult an installation professional for proper wall mounting.

#### Required Specifications

Fabric

Accessory Rail Finish

**WALL MOUNTED TACKBOARDS FOR OVERHEAD STORAGE MODEL# DIMENSIONS FREIGHT CLASS WT/LBS. CUBIC FT. GR. 1-3 GR. 4-5**

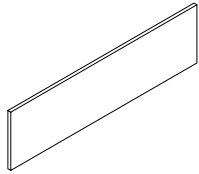

**Tackboard**

	D x W x H						
DTS120	1 x 118 x 20	70	26	2	\$904	\$1133	
DTS114	1 x 112 x 20	70	25	2	\$858	\$1075	
DTS108	1 x 106 x 20	70	23	2	\$816	\$1024	
DTS102	1 x 100 x 20	85	19	2	\$773	\$969	
DTS96	1 x 94 x 20	70	15	1	\$728	\$913	
DTS90	1 x 88 x 20	70	15	1	\$689	\$867	
DTS84	1 x 82 x 20	70	14	1	\$647	\$811	
DTS78	1 x 76 x 20	70	13	1	\$601	\$755	
DTS72	1 x 70 x 20	70	12	1	\$557	\$698	
DTS66	1 x 64 x 20	85	11	1	\$512	\$644	
DTS60	1 x 58 x 20	85	10	1	\$471	\$592	
DTS36	1 x 34 x 20	100	6	1	\$302	\$383	
DTS30	1 x 28 x 20	150	4	1	\$251	\$316	

For use on **36" H** hutches (**D\_SH36, D\_SH36G, D\_SH36DGD, D\_SH36GDG**). **Factory installed**, with velcro tape. Please specify hutch to be installed on. *See Tackboard Notes above for exact fabric availability.* List Price shown applies for all fabric grades.

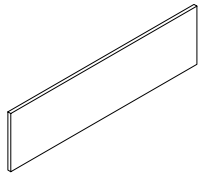

**Tackboard**

DTS120H26	1 x 118 x 26	70	34	2	\$1169	\$1463
DTS114H26	1 x 112 x 26	70	32	2	\$1111	\$1392
DTS108H26	1 x 106 x 26	70	30	2	\$1053	\$1319
DTS102H26	1 x 100 x 26	85	24	2	\$998	\$1253
DTS96H26	1 x 94 x 26	92.5	20	2	\$943	\$1182
DTS90H26	1 x 88 x 26	92.5	20	2	\$883	\$1108
DTS84H26	1 x 82 x 26	100	18	2	\$828	\$1039
DTS78H26	1 x 76 x 26	100	17	2	\$773	\$969
DTS72H26	1 x 70 x 26	70	16	1	\$714	\$897
DTS66H26	1 x 64 x 26	85	14	1	\$658	\$825
DTS60H26	1 x 58 x 26	85	13	1	\$601	\$755
DTS36H26	1 x 34 x 26	100	8	1	\$378	\$475
DTS30H26	1 x 28 x 26	150	5	1	\$317	\$401

For use on **42" H and 54" H** hutches (**D\_SH42/54, D\_SH42/54G, D\_SH42/54DGD, D\_SH42/54GDG**). **Factory installed**, with velcro tape. Please specify hutch to be installed on. *See Tackboard Notes above for exact fabric availability.* List Price shown applies for all fabric grades.

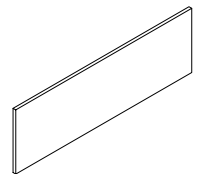

**Tackboard**

DTSP120H23	1 x 118 x 23	70	34	2	\$1169	\$1463
DTSP114H23	1 x 112 x 23	70	32	2	\$1111	\$1392
DTSP108H23	1 x 106 x 23	70	30	2	\$1053	\$1319
DTSP102H23	1 x 100 x 23	85	24	2	\$998	\$1253
DTSP96H23	1 x 94 x 23	92.5	20	2	\$943	\$1182
DTSP90H23	1 x 88 x 23	92.5	20	1	\$883	\$1108
DTSP84H23	1 x 82 x 23	70	18	1	\$828	\$1039
DTSP78H23	1 x 76 x 23	70	17	1	\$773	\$969
DTSP72H23	1 x 70 x 23	70	16	1	\$714	\$897
DTSP66H23	1 x 64 x 23	85	14	1	\$658	\$825
DTSP60H23	1 x 58 x 23	85	13	1	\$601	\$755
DTSP54H23	1 x 52 x 23	85	13	1	\$552	\$692
DTSP48H23	1 x 46 x 23	85	13	1	\$488	\$613
DTSP42H23	1 x 40 x 23	85	13	1	\$433	\$545
DTSP36H23	1 x 34 x 23	100	8	1	\$378	\$475
DTSP30H23	1 x 28 x 23	150	5	1	\$317	\$401

For use on **42" H and 54" H** hutches (**D\_SHP42/54, D\_SHP42/54G, D\_SHP42/54DGD, D\_SHP42/54GDG**) with Pigeon-Hole Storage. **Factory installed**, with velcro tape. Please specify hutch to be installed on. *See Tackboard Notes above for exact fabric availability.* List Price shown applies for all fabric grades.

**Required Specifications**

Fabric

TACKBOARDS FOR HUTCHES

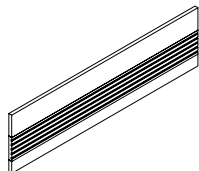

Tackboard - Accessory Rail

MODEL#	DIMENSIONS	FREIGHT CLASS	WT/LBS.	CUBIC FT.	GR. 1-3	GR. 4-5
D x W x H						
DTSA120	1 x 118 x 20	85	26	2	\$1575	\$1974
DTSA114	1 x 112 x 20	85	25	2	\$1501	\$1881
DTSA108	1 x 106 x 20	92.5	23	2	\$1418	\$1776
DTSA102	1 x 100 x 20	100	19	2	\$1344	\$1683
DTSA96	1 x 94 x 20	70	15	1	\$1263	\$1581
DTSA90	1 x 88 x 20	70	15	1	\$1193	\$1496
DTSA84	1 x 82 x 20	85	14	1	\$1111	\$1392
DTSA78	1 x 76 x 20	85	13	1	\$1037	\$1299
DTSA72	1 x 70 x 20	85	12	1	\$960	\$1202
DTSA66	1 x 64 x 20	92.5	11	1	\$878	\$1101
DTSA60	1 x 58 x 20	92.5	10	1	\$803	\$1008
DTSA54	1 x 52 x 20	92.5	10	1	\$728	\$913
DTSA48	1 x 46 x 20	92.5	10	1	\$652	\$817
DTSA42	1 x 40 x 20	92.5	10	1	\$577	\$725
DTSA36	1 x 34 x 20	125	6	1	\$495	\$623
DTSA30	1 x 28 x 20	150	4	1	\$417	\$526

For use on 36" H hutches (D\_SH36, D\_SH36G, D\_SH36DGD, D\_SH36GDG). Factory installed, with velcro tape. Please specify hutch to be installed on. See Tackboard Notes above for exact fabric availability. List Price shown applies for all fabric grades.

- Must Specify Black (E) or Tungsten (K) Accessory Rail finish.

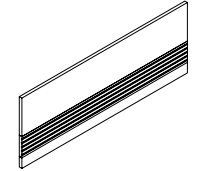

Tackboard - Accessory Rail

DTSA120H26	1 x 118 x 26	85	26	2	\$1884	\$2359
DTSA114H26	1 x 112 x 26	85	25	2	\$1791	\$2244
DTSA108H26	1 x 106 x 26	92.5	23	2	\$1702	\$2133
DTSA102H26	1 x 100 x 26	100	19	2	\$1609	\$2014
DTSA96H26	1 x 94 x 26	70	15	1	\$1513	\$1895
DTSA90H26	1 x 88 x 26	70	15	1	\$1425	\$1784
DTSA78H26	1 x 76 x 26	85	13	1	\$1238	\$1551
DTSA72H26	1 x 70 x 26	85	12	1	\$1124	\$1409
DTSA66H26	1 x 64 x 26	92.5	11	1	\$1053	\$1319
DTSA60H26	1 x 58 x 26	92.5	10	1	\$960	\$1202
DTSA54H26	1 x 52 x 26	92.5	10	1	\$867	\$1086
DTSA48H26	1 x 46 x 26	92.5	10	1	\$777	\$975
DTSA42H26	1 x 40 x 26	92.5	10	1	\$684	\$857
DTSA36H26	1 x 34 x 26	125	6	1	\$588	\$737
DTSA30H26	1 x 28 x 26	150	4	1	\$501	\$630

For use on 42" H and 54" H hutches (D\_SH42/54, D\_SH42/54G, D\_SH42/54DGD, D\_SH42/54GDG). Factory installed, with velcro tape. Please specify hutch to be installed on. See Tackboard Notes above for exact fabric availability. List Price shown applies for all fabric grades.

- Must Specify Black (E) or Tungsten (K) Accessory Rail finish.

Required Specifications

- Fabric
- Accessory Rail finish

TACKBOARDS FOR HUTCHES

MODEL#	DIMENSIONS	FREIGHT CLASS	WT./LBS.	CUBIC FT.	GR. 1-3	GR. 4-5
<b>D x W x H</b>						
DTSPA120H23	1 x 118 x 23	70	34	2	<b>\$1960</b>	<b>\$2452</b>
DTSPA114H23	1 x 112 x 23	70	32	2	<b>\$1866</b>	<b>\$2337</b>
DTSPA108H23	1 x 106 x 23	70	30	2	<b>\$1764</b>	<b>\$2207</b>
DTSPA102H23	1 x 100 x 23	85	24	2	<b>\$1685</b>	<b>\$2111</b>
DTSPA96H23	1 x 94 x 23	92.5	20	2	<b>\$1575</b>	<b>\$1974</b>
DTSPA90H23	1 x 88 x 23	92.5	20	2	<b>\$1483</b>	<b>\$1860</b>
DTSPA84H23	1 x 82 x 23	100	18	2	<b>\$1382</b>	<b>\$1732</b>
DTSPA78H23	1 x 76 x 23	100	17	2	<b>\$1289</b>	<b>\$1615</b>
DTSPA72H23	1 x 70 x 23	70	16	1	<b>\$1193</b>	<b>\$1496</b>
DTSPA66H23	1 x 64 x 23	85	14	1	<b>\$1094</b>	<b>\$1372</b>
DTSPA60H23	1 x 58 x 23	85	13	1	<b>\$998</b>	<b>\$1253</b>
DTSPA54H23	1 x 52 x 23	85	13	1	<b>\$904</b>	<b>\$1133</b>
DTSPA48H23	1 x 46 x 23	85	13	1	<b>\$803</b>	<b>\$1008</b>
DTSPA42H23	1 x 40 x 23	85	13	1	<b>\$709</b>	<b>\$890</b>
DTSPA36H23	1 x 34 x 23	100	8	1	<b>\$613</b>	<b>\$772</b>
DTSPA30H23	1 x 28 x 23	150	5	1	<b>\$521</b>	<b>\$655</b>

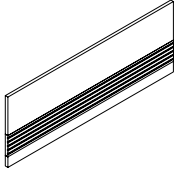

Tackboard - Accessory Rail\*

For use on **42"H and 54"H** hutches (**D\_SHP42/54, D\_SHP42/54G, D\_SHP42/54DGD, D\_SHP42/54GDG**) with Pigeon-Hole Storage. **Factory installed**, with velcro tape. Please specify hutch to be installed on. See *Tackboard Notes above* for exact fabric availability. List Price shown applies for all fabric grades.

- **Must Specify Black (E) or Tungsten (K) Accessory Rail finish.**

HUTCH ACCESSORIES

MODEL#	DIMENSIONS	FREIGHT CLASS	WT./LBS.	CUBIC FT.	veneer/LAMINATE	ALL VENEER
DCPH131226	12 x 13 x 26	100	16	2	<b>\$575</b>	<b>\$688</b>
DCPH131223	12 x 13 x 23	125	15	2	<b>\$488</b>	<b>\$586</b>
DCPH131219	12 x 13 x 19	125	12	2	<b>\$368</b>	<b>\$443</b>

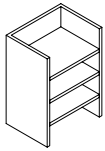

Vertical Pigeon-Hole Storage, Letter\*\*

Used in conjunction with overhead storage units and hutches that incorporate horizontal pigeon-hole storage. Not freestanding. Shipped RTA (ready to assemble).

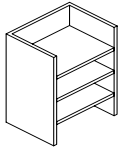

Vertical Pigeon-Hole Storage, Legal\*\*

DCPH161226	12 x 16 x 26	125	20	3	<b>\$707</b>	<b>\$850</b>
DCPH161223	12 x 16 x 23	125	18	3	<b>\$599</b>	<b>\$719</b>
DCPH161219	12 x 16 x 19	125	15	2	<b>\$455</b>	<b>\$543</b>

Used in conjunction with overhead storage units and hutches that incorporate horizontal pigeon-hole storage. Not freestanding. Shipped RTA (ready to assemble).

**Required Specifications**

- Fabric\*
- Accessory Rail finish\*
- Veneer finish\*\*
- Laminate finish\*\*



ACCESSORY RAIL/PANEL ORGANIZERS

MODEL# DIMENSIONS FREIGHT CLASS WT/LBS. CUBIC FT. LIST PRICE

Available Finishes:

		D x W x H	
BLK	Black	SIL	Silver
CHR	Charcoal	TPE	Taupe
DWT	Designer White	TUN	Tungsten
NEV	Nevada		

MODEL# DIMENSIONS FREIGHT CLASS WT/LBS. CUBIC FT. LIST PRICE

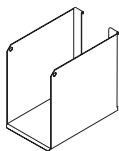

**Binder Bin**

BABB01	10.25 x 4 x 9	100	2	.21	<b>\$70</b>
--------	---------------	-----	---	-----	-------------

Load bar/accessory rail mounted metal binder bin.

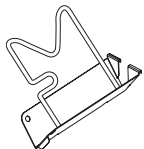

**Flip Sorter**

BAFS01	9.25 x 2.75 x 9.25	70	.06	.14	<b>\$54</b>
--------	--------------------	----	-----	-----	-------------

Load bar/accessory rail mounted metal flip sorter. Comes with chrome wire.

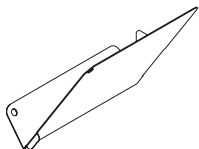

**Slant Sorter**

BASS01L (Left)	10.25 x 5 x 9.5	70	1	.28	<b>\$44</b>
BASS01R (Right)	10.25 x 5 x 9.5	70	1	.28	<b>\$44</b>

Load bar/accessory rail mounted metal slant sorter.

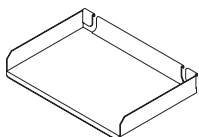

**Letter Tray**

BALTO1	9.25 x 13.5 x 2	70	.50	.15	<b>\$58</b>
--------	-----------------	----	-----	-----	-------------

Load bar/accessory rail mounted metal letter tray.

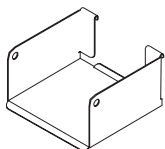

**Media Bin**

BAMB01	5.25 x 5.75 x 3	70	.08	.05	<b>\$58</b>
--------	-----------------	----	-----	-----	-------------

Load bar/accessory rail mounted metal media bin.

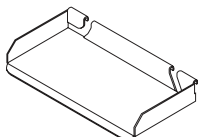

**Utility Tray**

BAUT01	3.75 x 5.75 x 3	70	.05	.02	<b>\$38</b>
--------	-----------------	----	-----	-----	-------------

Load bar/accessory rail mounted metal utility tray.

**Required Specifications**

Metal finish

ACCESSORY RAIL/PANEL ORGANIZERS

MODEL# DIMENSIONS FREIGHT CLASS WT/LBS. CUBIC FT. LIST PRICE

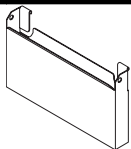

Mail Box\*

D x W x H	
BAPP01	2.75 x 16 x 9

Load bar/accessory rail mounted metal mail box.



Telephone Holder\*

BATH01	10 x 9 x 2
--------	------------

Load bar/accessory rail mounted metal telephone holder.

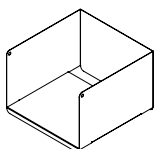

Elevated Shelf Binder Bin\*

BRTESBBIN	12 x 12 x 8
-----------	-------------

Load bar/accessory rail mounted elevated shelf binder bin.

BOOKCASES

MODEL# DIMENSIONS FREIGHT CLASS WT/LBS. CUBIC FT. VENEER/LAMINATE ALL VENEER

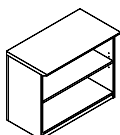

Bookcase - 29" High\*\*

DB23615	15 x 36 x 29	92.5	90	9	\$1267	\$1518
DB23015	15 x 30 x 29	92.5	90	8	\$1107	\$1329

Includes **one adjustable** veneer shelf. Shelf is 3/4" thick.

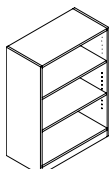

Bookcase - 48" High\*\*

DB43615	15 x 36 x 48	100	140	15	\$1581	\$1895
DB43015	15 x 30 x 48	92.5	140	13	\$1384	\$1660

Includes **two adjustable** veneer shelves. Shelf is 3/4" thick.

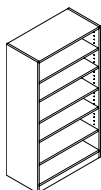

Bookcase - 66" High\*\*

DB53615	15 x 36 x 66	100	188	21	\$1917	\$2301
DB53015	15 x 30 x 66	92.5	188	17	\$1678	\$2012

Includes **five adjustable** veneer shelves. Shelf is 3/4" thick.

Required Specifications

- Metal finish\*
- Veneer finish (shelves)\*\*
- Laminate finish (top/body)\*\*

BOOKCASES

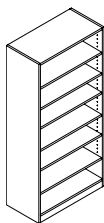

Bookcase - 72" High

MODEL#	DIMENSIONS D x W x H	FREIGHT CLASS	WT/LBS.	CUBIC FT.	VENEER/LAMINATE	ALL VENEER
DB63615	15 x 36 x 72	100	210	23	\$2078	\$2495
DB63015	15 x 30 x 72	92.5	210	19	\$1820	\$2184

Includes **six adjustable** veneer shelves. Shelf is 3/4" thick.

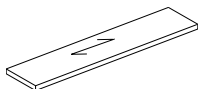

Tops 15" Deep

DT3617D	17 x 36 x 1	65	27	1	N/A	\$622
DT3017D	17 x 30 x 1	65	23	1	N/A	\$517

For use with 15" deep bookcases. Tops are 1" thick.

END SHELVES

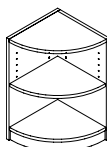

End Shelf - 29" High

MODEL#	DIMENSIONS	FREIGHT CLASS	WT/LBS.	CUBIC FT.	VENEER/LAMINATE	ALL VENEER
DB2R1515	15 x 15 x 29	100	37	4	\$998	\$1197

For use at end of **worksurfaces or storage modules**. Includes one adjustable veneer shelf. Shipped RTA (ready to assemble).

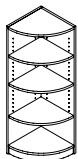

End Shelf - 48" High

DB4R1515	15 x 15 x 48	100	59	6	\$1242	\$1492
----------	--------------	-----	----	---	--------	--------

For use at end of **storage modules or wardrobe cabinets**. Includes **three adjustable** veneer shelves. Shipped RTA (ready to assemble).

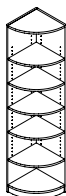

End Shelf - 66" High

DB5R1515	15 x 15 x 66	100	81	9	\$1511	\$1812
----------	--------------	-----	----	---	--------	--------

For use at end of **storage modules, wardrobe cabinets or personal towers**. Includes **five adjustable** veneer shelves. Shipped RTA (ready to assemble).

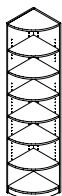

End Shelf - 72" High

DB6R1515	15 x 15 x 72	100	83	9	\$1641	\$1968
----------	--------------	-----	----	---	--------	--------

For use at end of **storage modules, wardrobe cabinets or personal towers**. Includes **six adjustable** veneer shelves. Shipped RTA (ready to assemble).

Required Specifications

- Veneer finish (shelves)
- Laminate finish (top/body)

END SHELVES

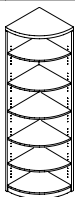

End Shelf - 66" High

MODEL#	DIMENSIONS D x W x H	FREIGHT CLASS	WT/LBS.	CUBIC FT.	veneer/LAMINATE	ALL VENEER
DB7R2424	24 x 24 x 66	100	187	22	<b>\$2754</b>	<b>\$3307</b>
DB7R2222	22 x 22 x 66	100	157	18	<b>\$2398</b>	<b>\$2878</b>
DB7R2020	20 x 20 x 66	100	130	15	<b>\$2287</b>	<b>\$2746</b>

For use at end of **storage modules, wardrobe cabinets or personal towers**. Includes **five adjustable** veneer shelves. Shipped RTA (ready to assemble).

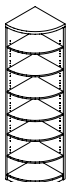

End Shelf - 72" High

DB7R2424H72	24 x 24 x 72	125	204	28	<b>\$3007</b>	<b>\$3608</b>
DB7R2222H72	22 x 22 x 72	100	171	20	<b>\$2620</b>	<b>\$3141</b>
DB7R2020H72	20 x 20 x 72	100	142	17	<b>\$2495</b>	<b>\$2995</b>

For use at end of **storage modules, wardrobe cabinets or personal towers**. Includes **six adjustable** veneer shelves. Shipped RTA (ready to assemble).



End Shelf - 84" High

DB7R2424H84	24 x 24 x 84	100	234	28	<b>\$3507</b>	<b>\$4207</b>
DB7R2222H84	22 x 22 x 84	100	189	20	<b>\$3214</b>	<b>\$3855</b>
DB7R2020H84	20 x 20 x 84	100	163	19	<b>\$3062</b>	<b>\$3676</b>

For use at end of **storage modules, wardrobe cabinets or personal towers**. Includes **seven adjustable** veneer shelves. Shipped RTA (ready to assemble).

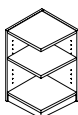

End Shelf - 29" High - Square

DB2S1515	15 x 15 x 29	100	37	4	<b>\$1050</b>	<b>\$1262</b>
----------	--------------	-----	----	---	---------------	---------------

For use at end of **worksurfaces or storage modules**. Includes **one adjustable** veneer shelf. Shipped RTA (ready to assemble).

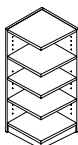

End Shelf - 48" High - Square

DB4S1515	15 x 15 x 48	100	59	6	<b>\$1313</b>	<b>\$1571</b>
----------	--------------	-----	----	---	---------------	---------------

For use at end of **storage modules or wardrobe cabinets**. Includes **three adjustable** veneer shelves. Shipped RTA (ready to assemble).

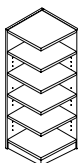

End Shelf - 66" High - Square

DB5S1515	15 x 15 x 66	100	81	9	<b>\$1591</b>	<b>\$1910</b>
----------	--------------	-----	----	---	---------------	---------------

For use at end of **storage modules, wardrobe cabinets or personal towers**. Includes **five adjustable** veneer shelves. Shipped RTA (ready to assemble).

**Required Specifications**

- Veneer finish (shelves)
- Laminate finish (top/body)

# D DUFFERIN

## END SHELVES

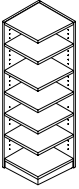

**End Shelf - 72" High - Square**

MODEL#	DIMENSIONS D x W x H	FREIGHT CLASS	WT./LBS.	CUBIC FT.	VENEER/LAMINATE	ALL VENEER
DB6S1515	15 x 15 x 72	100	83	9	\$1729	\$2074

For use at end of **storage modules, wardrobe cabinets or personal towers**. Includes **six adjustable** veneer shelves. Shipped RTA (ready to assemble).

## RECEPTION DESKS

- To add storage use storage shells. See pages 40-42.
- Includes GM1 grommet.
- Transaction tops to be specified separately, handed by square edge from user side.
- Decorative Front Panels should be specified separately. Size chosen should be 12" less than desk dimensions. Available in Reverse Diamond, Vertical Rib, Vertical Grain and Horizontal Grain Patterns.

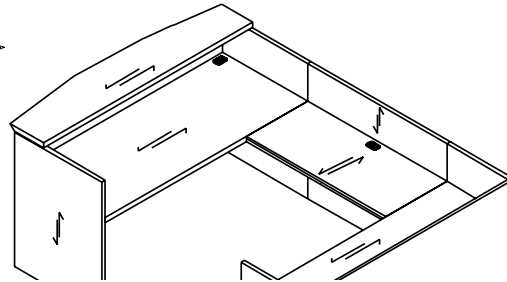
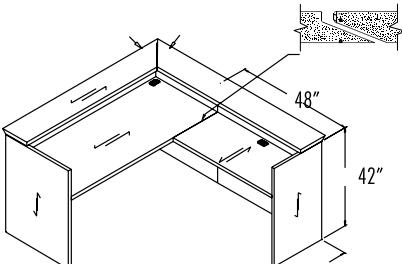

### OPTION DETAILS

Decorative Front Panel (Reverse Diamond Pattern)  
DGFDP5430F

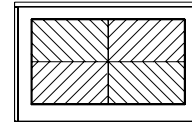

Decorative Front Panel (Vertical Rib Pattern)  
DGFDP5430RIB

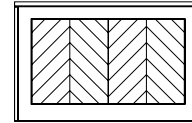

MODEL#	DIMENSIONS	FREIGHT CLASS	WT./LBS.	CUBIC FT.	VENEER/LAMINATE	ALL VENEER
DGC10836	36 x 108 x 42	150	533	95	\$6462	\$7753
DGC10236	36 x 102 x 42	150	503	89	\$6101	\$7322
DGC9636	36 x 96 x 42	150	473	84	\$5744	\$6892
DGC9036	36 x 90 x 42	150	444	79	\$5385	\$6463
DGC8436	36 x 84 x 42	150	414	74	\$5025	\$6028
DGC7236	36 x 72 x 42	150	355	63	\$4308	\$5169
DGC7230	30 x 72 x 42	150	315	53	\$4168	\$5001
DGC6630	30 x 66 x 42	125	295	48	\$3756	\$4506
DGC6030	30 x 60 x 42	125	275	44	\$4064	\$4875

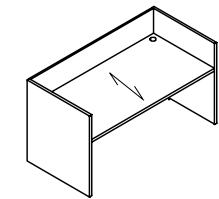

**Gallery/Reception Desk Shell\***

No pedestals. Two grommets in worksurface. For use with modular storage components.

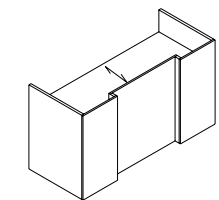

**Gallery/Reception Desk Shell  
Breakfront Style**

DGIC10836	36 x 108 x 42	150	533	95	\$7938	\$9526
DGIC10236	36 x 102 x 42	150	503	89	\$7498	\$8997
DGIC9636	36 x 96 x 42	150	473	84	\$7058	\$8469
DGIC9036	36 x 90 x 42	150	444	79	\$6617	\$7940
DGIC8436	36 x 84 x 42	150	414	74	\$6176	\$7412
DGIC7236	36 x 72 x 42	150	355	63	\$5295	\$6354
DGIC7230	30 x 72 x 42	150	315	53	\$5122	\$6145
DGIC6630	30 x 66 x 42	125	295	48	\$4993	\$5993
DGIC6030	30 x 60 x 42	125	275	44	\$4712	\$5652

No pedestals. Two grommets in worksurface. For use with modular storage components.

### Required Specifications

Veneer Finish  
Laminate Finish

### Optional Specifications

Additional Grommet (Reception Desks)  
Decorative Panel\*

### Accessories

Storage Shells (Reception Desks)

RECEPTION DESKS

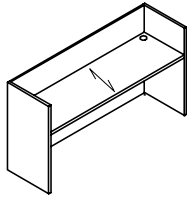

Gallery/Reception Credenza Shell\*

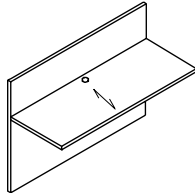

Bridge

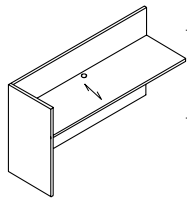

Reception Return - LEFT

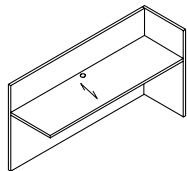

Reception Return - RIGHT

MODEL#	DIMENSIONS	FREIGHT CLASS	WT/LBS.	CUBIC FT.	VENEER/LAMINATE	ALL VENEER
	<b>D x W x H</b>					
DGC10824	24 x 108 x 42	150	353	63	\$5064	\$6077
DGC10224	24 x 102 x 42	150	333	60	\$4784	\$5742
DGC9624	24 x 96 x 42	150	314	56	\$4501	\$5403
DGC9024	24 x 90 x 42	150	294	53	\$4220	\$5063
DGC8424	24 x 84 x 42	150	274	49	\$3937	\$4727
DGC7224	24 x 72 x 42	150	235	42	\$3379	\$4053
DGC6624	24 x 66 x 42	150	216	39	\$3175	\$3809
DGC6024	24 x 60 x 42	150	196	35	\$2973	\$3569

**No pedestals.** Two grommets in worksurface. For use with modular storage components.

DGBT5624CG	24 x 56 x 42	150	178	32	\$2833	\$3403
DGBT5424CG	24 x 54 x 42	150	169	29	\$2833	\$3403
DGBT5024CG	24 x 50 x 42	150	151	27	\$2518	\$3020
DGBT4824CG	24 x 48 x 42	150	142	26	\$2518	\$3020
DGBT4424CG	24 x 44 x 42	150	134	23	\$2204	\$2643
DGBT4224CG	24 x 42 x 42	150	127	22	\$2204	\$2643
DGBT3824CG	24 x 38 x 42	150	119	20	\$1985	\$2382
DGBT3624CG	24 x 36 x 42	150	112	19	\$1985	\$2382

Attaches between **Gallery Desk and Gallery Credenza Only**. One grommet in center of worksurface. Shipped RTA (ready to assemble).

- To remove cross-grain veneer pattern on top, **delete "CG"** from model number. Available as a special - no upcharge.

DGRL7224	24 x 72 x 42	125	273	42	\$4253	\$5104
DGRL6624	24 x 66 x 42	125	250	39	\$3899	\$4679
DGRL6024	24 x 60 x 42	125	228	35	\$3547	\$4254
DGRL5424	24 x 54 x 42	125	205	32	\$3192	\$3831
DGRL4824	24 x 48 x 42	125	182	28	\$2840	\$3406
DGRL4224	24 x 42 x 42	125	159	25	\$2482	\$2979
DGRL3624	24 x 36 x 42	125	137	21	\$2235	\$2679

**No pedestal.** One grommet in center of worksurface. For use with modular storage components.

DGRR7224	24 x 72 x 42	125	273	42	\$4253	\$5104
DGRR6624	24 x 66 x 42	125	250	39	\$3899	\$4679
DGRR6024	24 x 60 x 42	125	228	35	\$3547	\$4254
DGRR5424	24 x 54 x 42	125	205	32	\$3192	\$3831
DGRR4824	24 x 48 x 42	125	182	28	\$2840	\$3406
DGRR4224	24 x 42 x 42	125	159	25	\$2482	\$2979
DGRR3624	24 x 36 x 42	125	137	21	\$2235	\$2679

**No pedestal.** One grommet in center of worksurface. For use with modular storage components.

**Required Specifications**

Veneer Finish  
Laminate Finish

**Optional Specifications**

Additional grommet\*  
Decorative panel\*

**Accessories**

Storage shells\*

TRANSACTION TOPS

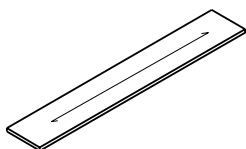

Transaction Counter Top

MODEL#	DIMENSIONS D x W x H	FREIGHT CLASS	WT./LBS.	CUBIC FT.	VENEER/LAMINATE	ALL VENEER
DGTT10810	10 x 108 x 1.50	100	78	8	N/A	<b>\$1198</b>
DGTT10210	10 x 102 x 1.50	92.5	72	7	N/A	<b>\$1133</b>
DGTT9610	10 x 96 x 1.50	100	66	7	N/A	<b>\$1067</b>
DGTT9010	10 x 90 x 1.50	92.5	60	6	N/A	<b>\$1000</b>
DGTT8410	10 x 84 x 1.50	100	54	6	N/A	<b>\$933</b>
DGTT7210	10 x 72 x 1.50	100	48	5	N/A	<b>\$801</b>
DGTT6610	10 x 66 x 1.50	100	42	5	N/A	<b>\$732</b>
DGTT6010	10 x 60 x 1.50	100	36	4	N/A	<b>\$668</b>

**Rectangular top** for main reception desk. Counter sits on top of Gallery panels. Does not overhang. **Factory installed - specify Gallery to be used on.** Size must match dimension of desk front or combined desk side and return length. Hardware included.

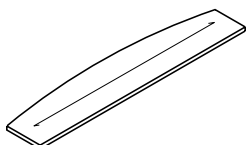

Bow Front Transaction Counter Top

DGTTM1081013	10-13 x 108 x 1.50	125	78	10	N/A	<b>\$2395</b>
DGTTM1021013	10-13 x 102 x 1.50	100	72	9	N/A	<b>\$2658</b>
DGTTM961013	10-13 x 96 x 1.50	125	66	9	N/A	<b>\$2129</b>
DGTTM901013	10-13 x 90 x 1.50	125	60	8	N/A	<b>\$1996</b>
DGTTM841013	10-13 x 84 x 1.50	125	54	8	N/A	<b>\$1864</b>
DGTTM721013	10-13 x 72 x 1.50	125	48	7	N/A	<b>\$1598</b>
DGTTM661013	10-13 x 66 x 1.50	125	42	6	N/A	<b>\$1466</b>
DGTTM601013	10-13 x 60 x 1.50	125	36	5	N/A	<b>\$1331</b>

**Bow top** for main reception desk. Counter sits on top of Gallery panels. Bow front overhangs 3". **Factory installed - specify Gallery to be used on.** Size must match dimension of desk front or combined desk side and return length. Hardware included.

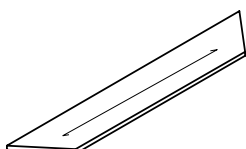

Trapezoid Transaction Counter Top

DGTTA10810	10 x 108 x 1.50	100	78	8	N/A	<b>\$1360</b>
DGTTA10210	10 x 102 x 1.50	92.5	72	7	N/A	<b>\$1293</b>
DGTTA9610	10 x 96 x 1.50	100	66	7	N/A	<b>\$1227</b>
DGTTA9010	10 x 90 x 1.50	92.5	60	6	N/A	<b>\$1160</b>
DGTTA8410	10 x 84 x 1.50	100	54	6	N/A	<b>\$1096</b>
DGTTA7210	10 x 72 x 1.50	100	48	5	N/A	<b>\$961</b>
DGTTA6610	10 x 66 x 1.50	100	42	5	N/A	<b>\$897</b>
DGTTA6010	10 x 60 x 1.50	100	36	4	N/A	<b>\$828</b>

**Trapezoid top** for main reception desk. 45° mitered ends on left and right. For use with left and right 45° mitered return transaction counters. Counter sits on top of Gallery panels. Does not overhang. **Factory installed - specify Gallery to be used on.** Width must match dimension of desk front. Hardware included.

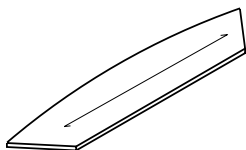

Bow Front Trapezoid Transaction Counter Top

DGTTMA1081013	10-13 x 108 x 1.50	125	78	10	N/A	<b>\$2552</b>
DGTTMA1021013	10-13 x 102 x 1.50	100	72	9	N/A	<b>\$2420</b>
DGTTMA961013	10-13 x 96 x 1.50	125	66	9	N/A	<b>\$2288</b>
DGTTMA901013	10-13 x 90 x 1.50	125	60	8	N/A	<b>\$2155</b>
DGTTMA841013	10-13 x 84 x 1.50	125	54	8	N/A	<b>\$2026</b>
DGTTMA721013	10-13 x 72 x 1.50	125	48	7	N/A	<b>\$1757</b>
DGTTMA661013	10-13 x 66 x 1.50	125	42	6	N/A	<b>\$1623</b>
DGTTMA601013	10-13 x 60 x 1.50	125	36	5	N/A	<b>\$1493</b>

**Trapezoid bow top** for main reception desk. 45° mitered ends on left and right. For use with left and right 45° mitered return transaction counters. Counter sits on top of Gallery panels. Bow front overhangs 3". **Factory installed - specify Gallery to be used on.** Width must match dimension of desk front. Hardware included.

**Required Specifications**  
Veneer Finish

TRANSACTION TOPS

MODEL# DIMENSIONS FREIGHT CLASS WT/LBS. CUBIC FT. VENEER/LAMINATE ALL VENEER

D x W x H

DGTTAL12010	10 x 120 x 1.50	92.5	84	8	N/A	<b>\$1437</b>
DGTTAL11410	10 x 114 x 1.50	92.5	81	8	N/A	<b>\$1366</b>
DGTTAL10810	10 x 108 x 1.50	100	78	8	N/A	<b>\$1305</b>
DGTTAL10210	10 x 102 x 1.50	92.5	72	7	N/A	<b>\$1240</b>
DGTTAL9610	10 x 96 x 1.50	100	66	7	N/A	<b>\$1174</b>
DGTTAL9010	10 x 90 x 1.50	92.5	60	6	N/A	<b>\$1106</b>
DGTTAL8410	10 x 84 x 1.50	100	54	6	N/A	<b>\$1042</b>
DGTTAL7210	10 x 72 x 1.50	100	48	5	N/A	<b>\$907</b>
DGTTAL6610	10 x 66 x 1.50	100	42	5	N/A	<b>\$843</b>
DGTTAL6010	10 x 60 x 1.50	100	36	4	N/A	<b>\$776</b>
DGTTAL3610	10 x 36 x 1.50	100	24	3	N/A	<b>\$466</b>
DGTTAL3010	10 x 30 x 1.50	92.5	20	2	N/A	<b>\$391</b>
DGTTAL2410	10 x 24 x 1.50	100	16	2	N/A	<b>\$343</b>

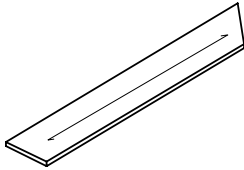

Transaction Counter Top - LEFT

**Rectangular top** for main reception desk with 45° mitered end on **left**. For use with rectangular or bow front transaction counters with miters at both ends. Width must match dimension of Gallery Desk end and Return width. Counter sits on top of Gallery panels. Does not overhang. **Factory installed - specify Gallery to be used on.** Hardware included.

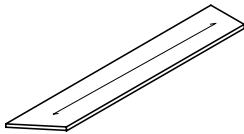

Transaction Counter Top - RIGHT

DGTTAR12010	10 x 120 x 1.50	92.5	84	8	N/A	<b>\$1437</b>
DGTTAR11410	10 x 114 x 1.50	92.5	81	8	N/A	<b>\$1366</b>
DGTTAR10810	10 x 108 x 1.50	100	78	8	N/A	<b>\$1305</b>
DGTTAR10210	10 x 102 x 1.50	92.5	72	7	N/A	<b>\$1240</b>
DGTTAR9610	10 x 96 x 1.50	100	66	7	N/A	<b>\$1174</b>
DGTTAR9010	10 x 90 x 1.50	92.5	60	6	N/A	<b>\$1106</b>
DGTTAR8410	10 x 84 x 1.50	100	54	6	N/A	<b>\$1042</b>
DGTTAR7210	10 x 72 x 1.50	100	48	5	N/A	<b>\$907</b>
DGTTAR6610	10 x 66 x 1.50	100	42	5	N/A	<b>\$843</b>
DGTTAR6010	10 x 60 x 1.50	100	36	4	N/A	<b>\$776</b>
DGTTAR3610	10 x 36 x 1.50	100	24	3	N/A	<b>\$466</b>
DGTTAR3010	10 x 30 x 1.50	92.5	20	2	N/A	<b>\$391</b>
DGTTAR2410	10 x 24 x 1.50	100	16	2	N/A	<b>\$343</b>

**Rectangular top** for main reception desk with 45° mitered end on **right**. For use with rectangular or bow front transaction counters with miters at both ends. Width must match dimension of Gallery Desk end and Return width. Counter sits on top of Gallery panels. Does not overhang. **Factory installed - specify Gallery to be used on.** Hardware included.

**Required Specifications**

Veneer Finish



RECEPTION DESKS

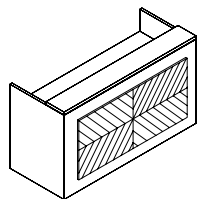

**Decorative Front Panel  
Reverse Diamond Pattern**

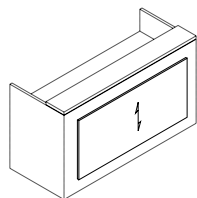

**Decorative Front Panel  
Vertical Grain Pattern**

MODEL#	DIMENSIONS D x W x H	FREIGHT CLASS	WT/LBS.	CUBIC FT.	VENEER/LAMINATE	ALL VENEER
DGFDP9630F	1 x 96 x 30	92.5	81	8	N/A	<b>\$2384</b>
DGFDP9030F	1 x 90 x 30	100	78	8	N/A	<b>\$2231</b>
DGFDP8430F	1 x 84 x 30	92.5	72	7	N/A	<b>\$2086</b>
DGFDP7230F	1 x 72 x 30	100	66	7	N/A	<b>\$1787</b>
DGFDP6030F	1 x 60 x 30	92.5	60	6	N/A	<b>\$1493</b>
DGFDP5430F	1 x 54 x 30	100	54	6	N/A	<b>\$1341</b>
DGFDP4830F	1 x 48 x 30	100	48	5	N/A	<b>\$1194</b>

Raised decorative front panel for a reception desk. Size should be 12" less than desk dimensions. **Factory installed.** Hardware included.

DGFDP9630V	1 x 96 x 30	92.5	81	8	N/A	<b>\$2075</b>
DGFDP9030V	1 x 90 x 30	100	78	8	N/A	<b>\$1942</b>
DGFDP8430V	1 x 84 x 30	92.5	72	7	N/A	<b>\$1817</b>
DGFDP7230V	1 x 72 x 30	100	66	7	N/A	<b>\$1555</b>
DGFDP6030V	1 x 60 x 30	92.5	60	6	N/A	<b>\$1296</b>
DGFDP5430V	1 x 54 x 30	100	54	6	N/A	<b>\$1172</b>
DGFDP4830V	1 x 48 x 30	100	48	5	N/A	<b>\$1037</b>

Raised decorative front panel for a reception desk. Size should be 12" less than desk dimensions. **Factory installed.** Hardware included.

**Required Specifications**

Veneer finish

# THIS FORM IS TO BE USED FOR NON-STANDARD CUT-OUT SIZES

Dufferin and Lufton tables up to 120" (Corby up to 84").

Model # \_\_\_\_\_ (please use one page for each model #)

Please check all that apply. Note: Base positions will vary based on style chosen. Outer cut-outs are approximately 18"-20" in from each end.

## CUT-OUT POSITION(S)

- Position 1 - near left base - use option code **CCUTL**
- Position 2 - center of table - use option code **CCUTC**
- Position 3 - near right base - use option code **CCUTR**
- Custom position(s) - indicate on diagram below w/dimensions to **center point** of cut-outs - use option code **CCUS**

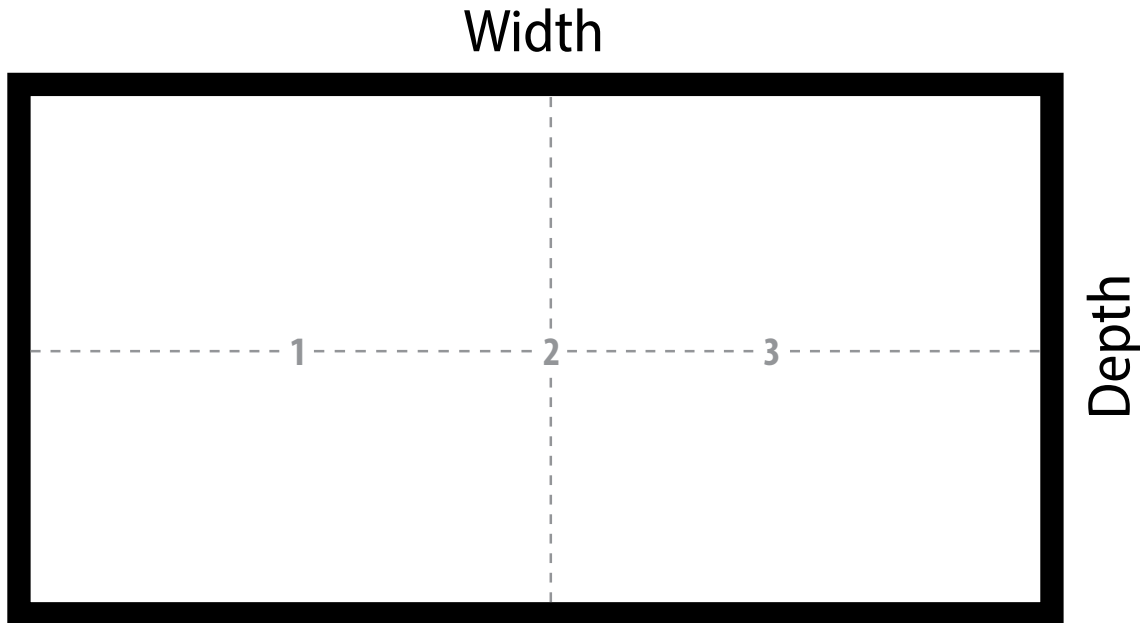

## CUT-OUT CRITERIA

All cut-outs require a minimum 8mm radius at each corner.

Cut-outs **must be centered** on the depth of each table due to wire management runners below the worksurface.

### Indicate cut-out size:

\_\_\_\_\_ " X dimension of cut-out runs the width of the table.

\_\_\_\_\_ " Y dimension of cut-out runs the depth of the table.

Y dimension not to exceed 14"

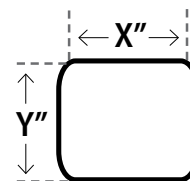

Dealer PO# \_\_\_\_\_

Internal use only

Global order# \_\_\_\_\_

Global trailer/load #: L \_\_\_\_\_ ID #: \_\_\_\_\_

# THIS FORM IS TO BE USED FOR NON-STANDARD CUT-OUT SIZES

Dufferin and Lufton tables 144" - 240".

Model # \_\_\_\_\_ (please use one page for each model #)

Please check all that apply. Note: Base positions will vary based on style chosen. Outer cutouts are approximately 18"-20" in from each end

## CUT-OUT POSITION(S)

- Position 1 - near left base - use option code **CCUTL**
- Position 2 - center of table - use option code **CCUTC**
- Position 3 - near right base - use option code **CCUTR**
- Custom position(s) - indicate on diagram below w/dimensions to **center point** of cut-outs - use option code **CCUS**

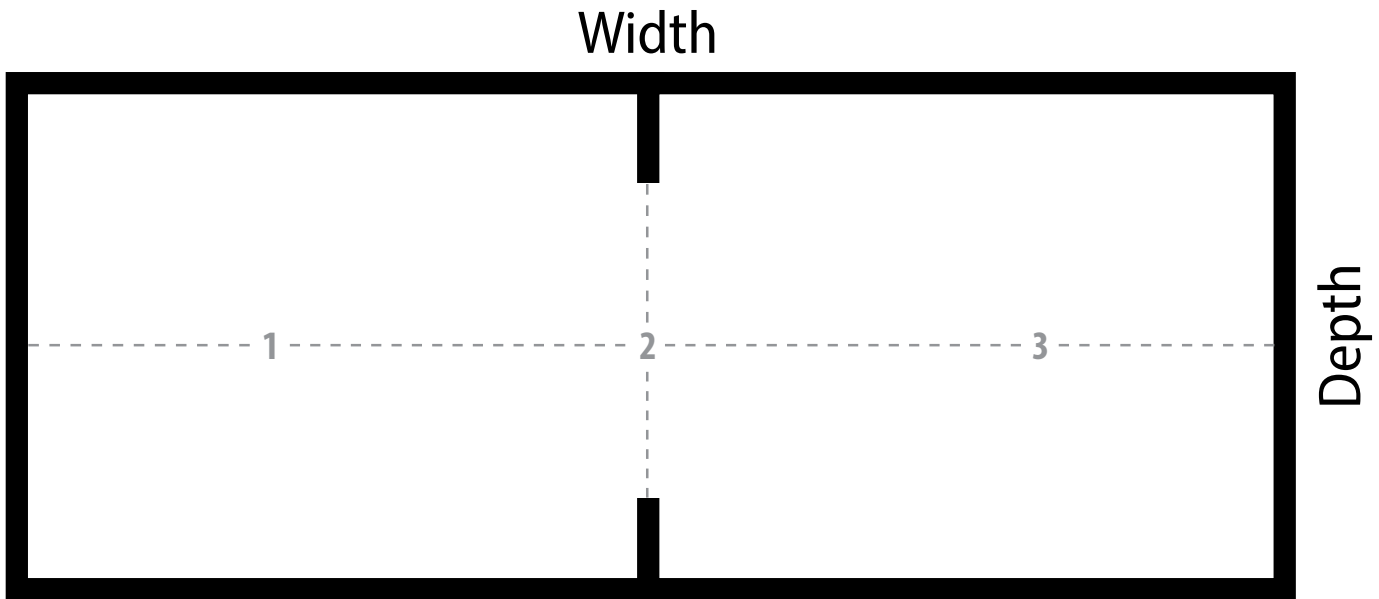

## CUT-OUT CRITERIA

All cut-outs require a minimum 8mm radius at each corner.

Cut-outs **must be centered** on the depth of each table due to wire management runners below the worksurface.

### Indicate cut-out size:

\_\_\_\_\_ " X dimension of cut-out runs the width of the table.

\_\_\_\_\_ " Y dimension of cut-out runs the depth of the table.  
Y dimension not to exceed 14"

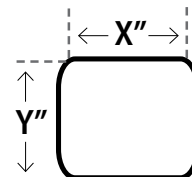

Dealer PO# \_\_\_\_\_

Internal use only

Global order# \_\_\_\_\_

Global trailer/load #: L \_\_\_\_\_ ID #: \_\_\_\_\_