



Introducing the Corby Collection of wood veneer and laminate desks, tables and storage elements. Christopher Wright has reflected on the mid-century modern vernacular to design a unique series of workplace furnishings that reward a new generation of pioneers and nation builders.

Corby is suited for any office environment, private office, boardrooms, open desking and collaborative areas. Its timeless design is expressed in subtle details - flared legs that elevate storage off the floor, tapered aprons on the bottom of storage pieces which reflect the knife edge detail of the worksurface. Standard height and counter height tables combined with tiered storage pieces offer a reprieve from formal boardrooms and deliver a more casual style for meeting areas.

Corby is a fresh take on desking, blending the warmth and comfort of residential-style furniture with the features and long lasting quality you'd expect from Global.

Features and Benefits

- Tapered solid wood legs in two heights
- Modesty panel in two heights
- Drawers are standard vinyl-wrapped construction with black drawer sides and bottom.
- 75 lb box - 150 lb. file drawer weight capacity with full height sides with pencil tray included in box drawer
- Lateral file drawers can accommodate legal or letter documents
- Premium full extension progressive ball bearing slides on file drawers
- Box drawers mounted on 3/4 extension premium ball bearing slides.
- Power / data accessories are available to be factory installed
- Designed by Christopher Wright



Overlapping worksurface with knife edge



Pedestal with optional cushion (shown with low base)

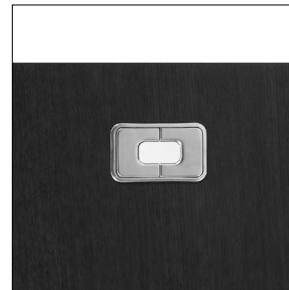

Rectangular grommet in tungsten

GENERAL INFORMATION

- Corby detailing is new century modern with a knife edge on table tops.
- Solid walnut, cherry, oak and maple edging on 1-3/8" tops (veneer).
- 3mm matching PVC edge on laminate surfaces.
- Tapered, solid wood legs are used to support the peninsula, work, collaboration and occasional tables.
- Pedestal, credenza and bookcase bottoms include 1 3/8" thick painted, beveled profile and tapered solid wood legs (4"H or 11 1/2"H).
- Productivity Solutions by Global offers multiple desktop power options that can be retrofitted into grommets, or clamp mounting on the edge of worksurfaces. Under mount options provide a clean way to power accessories in storage cabinets.
- For environmental certifications, please visit globalfurnituregroup.com.

WORKSURFACES

- Standard with 1 3/8" top thickness
- Veneer surfaces constructed from grade "A" veneers
- When laminate is specified, all surfaces constructed using high pressure laminate.
- Peninsula tables, freestanding work tables, collaboration tables and coffee tables feature a contemporary 2" overhang knife edge on all sides. All other surfaces feature a self-edge veneer.

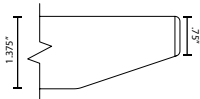

CONSTRUCTION

- "Number one select, architectural grade A" oak, American black walnut, American black cherry, and hard maple. Wood worksurface moulded edges are solid oak, walnut, cherry or maple (except where square self-edges exist, i.e. credenza and computer worksurface back edges that are most commonly against walls).
- Stack-on unit back panels are a solid thermally fused laminate color.
- When veneer is specified, tapered, solid wood legs (walnut, cherry, oak and maple) are used to support the Peninsula, Work, Collaboration and Occasional Tables.
- When laminate is specified, tapered, solid poplar legs are used to support the Peninsula, Work, Collaboration and Occasional Tables.
- Pedestal, Credenza and Bookcase bottoms include 1 3/8" thick painted, beveled profile and tapered solid wood legs.

FINISHES

- Conversion varnish (similar to catalyzed lacquer, but tougher), 25 degree sheen. Finishes are not buffed or rubbed.
- Global Corby Wood Veneer Desking products are veneered and finished on the back sides (360° finishing)
- Touch up kits available, includes a touch up marker and fill crayon. Order **VTOUCHUPKIT, \$164** list. Specify finish when ordering.
- Global standard finish, on oak and walnut, is open pore and on cherry and maple is semi-closed pore. If a full finish is required for walnut, cherry, anigre and maple tops, Add the suffix "2" to the finish code and Add 5% to the base pricing for each product.

CUSTOM FINISH IS AVAILABLE.

PEDESTALS, STORAGE CABINETS, CRENZAS AND BOOKCASES

- All units are elevated 4" (xxLB = Low Base), or 11.5" (xxHB = High Base) off the floor by tapered, solid wood legs.

HANDLES

- All box and lateral drawers have one vertical handle PL89 (chrome finish) installed. Doors are equipped with touch latch mechanism with no handles.
- Handles can be purchased separately and installed in the field - no template is provided.



STACK-ON BOOKCASES AND STORAGE CABINETS

- Stack-on units are designed to be placed and installed on top of the credenzas with low and high base

LOCKS

- Front locking is standard on the Pedestals with box/file and file drawers, credenzas with box/lateral and lateral drawers. Box/box drawer units are non-locking. Optional locking on doors is available. Specify **LO, add \$134**.

DRAWER SUSPENSIONS

- Pedestal drawer suspensions are metal ball-bearing type. Both box and file drawers are full extension.

HANGING FILE RAILS

- Pre-installed on file drawer perimeters. The back rail in a lateral file drawer is designed for both legal and letter size filing. Legal filing can be achieved either as side-to-side or front-to-back. Letter filing can be achieved as front-to-back filing only.

DRAWER CONSTRUCTION

- Drawers are standard vinyl-wrapped construction with black drawer sides and bottom

DRAWER FRONTS

- The drawer front is an applied element to a four sided drawer. Drawer fronts are veneered on all surfaces. Drawer fronts can be removed or replaced in the field.

LEVELING GLIDES

- Levelers have a 1" range of adjustment

HARDWARE

- All necessary hardware for attaching furniture is included in the shipment

1. SPECIFY MODEL NUMBER

2. SPECIFY FINISH

VENEER FINISHES - Top, Chassis, Doors and Fronts:

Code	Finish	Veneer Type	Cut
AMW	Almond Cherry	Cherry	Flat Sliced
ACW	Amber Cherry	Cherry	Flat Sliced
BTW	Biscotti	White Oak	Rift
CAW	Cocoa Walnut	Walnut	Flat Sliced
CRW	Coral	White Oak	Rift
DCW	Dark Cherry	Cherry	Flat Sliced
DWW	Dark Walnut	Walnut	Flat Sliced
EWV	Espresso Walnut	Walnut	Flat Sliced
EW	Evening Oak	White Oak	Rift
GRW	Grey on Oak	White Oak	Rift
HAW	Hazelnut	Maple	Flat Sliced
JAW	Java	White Oak	Rift
LTW	Latte Walnut	Walnut	Flat Sliced
MHW	Mahogany on Walnut	Walnut	Flat Sliced
MTW	Milestone	White Oak	Rift
MPW	Natural Maple	Maple	Flat Sliced
NLW	Natural Walnut	Walnut	Flat Sliced
RCW	Red Cherry	Cherry	Flat Sliced
VNW	Vintage Cherry	Cherry	Flat Sliced
ULW	Umber Walnut	Walnut	Flat Sliced
WLW	Walnut	Walnut	Flat Sliced
WCW	Warm Cherry	Cherry	Flat Sliced
WMW	White Maple	Maple	Flat Sliced

LAMINATE FINISHES - Top, Chassis, Doors and Fronts:

ACJ	Absolute Acajou	NBL	Noce Biondo
ASN	Asian Night	NGL	Noce Grigio
BLK	Black	NEL	Noce Leggero
BZD	Blizzard	NML	Noce Medio
CMB	Clear Maple	SBY	Sheer Beauty
CGY	Custom Grey	SDT	Stonedust
DES	Dark Espresso	SOG	Storm Grey
DWT	Designer White	WHE	Walnut Heights
FAS	Fashionista	WCR	Winter Cherry
FCL	First Class		

LAMINATE FINISHES - Back Panel*, Painted Legs and Base**:

BLK	Black	BZD	Blizzard
CGY	Custom Grey	DWT	Designer White
SOG	Storm Grey	STG	String
MSM	Moss	SDT	Stonedust
SEM	Sienna	SPM	Spice
SRM	Surf		

*Back panel only when unit is specified in veneer.

**Back panel, painted legs + base when unit is specified in laminate.

3. SPECIFY OPTIONS

Grommets

- Standard grommet on all components is GM5C. Grommet is included with products where shown in line drawings in price book.
- Optional grommets may be ordered along the centerline of Peninsula, Work and Collaboration tables. Order as GM5CTL, GM5CTC, GM5CTR. **Add \$96.**
- Grommet hole dimensions are 3.4" x 1.85". GM5C metal chrome grommet is available exclusively on Corby. Order as G5CTL, G5CTC, G5CTR. **Add \$96.**
- Components that come standard with grommet may be ordered without a grommet. Order as **RSG - Add \$53.**

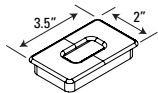

OPTIONAL GM5C GROMMET SPECIFICATION



Work and Collaboration Table
From 32" to 42" deep tops

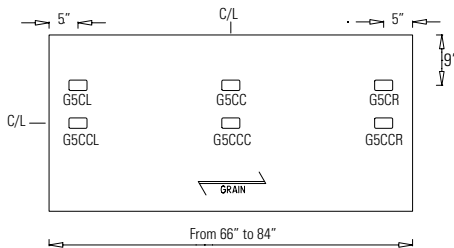

Peninsula Table
For 32" deep tops

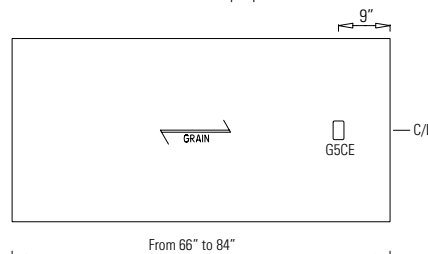

Executive Returns

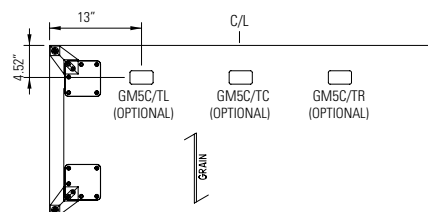

Executive Bridges

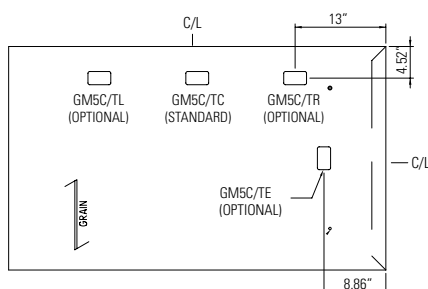

Cushions

- Cushions are standard in Global Grade 2 seating textiles. Please refer to the website for the current offering: www.globalfurnituregroup.com

Wood Back Panel

- For units that come with a laminate back panel (all stack-on and freestanding bookcases), an option is available for veneer back panel. Specify **WBP. Add \$687.**

Custom Cut-out

- Optional custom sized cut-out available in standard locations - **CCUTL** (left), **CCUTC** (center) and **CCUTR** (right) for all CBYRTxxxx and CBYRTCxxxx tables. Submit appropriate form (beginning on page 402) with order. **Add \$300** for each cut-out.

POWER BLOCKS

OPTIONAL GM5C
CUT-OUT SPECIFICATION



Work and Collaboration Table
From 32" to 42" deep tops

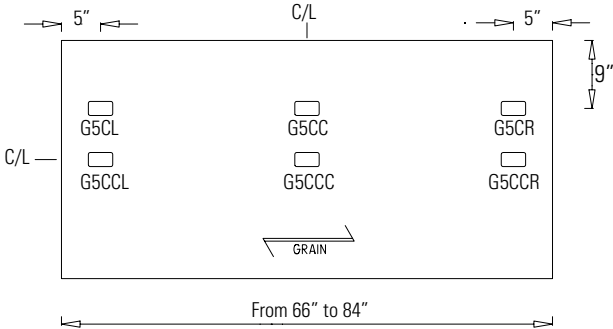

Peninsula Table
For 32" deep tops

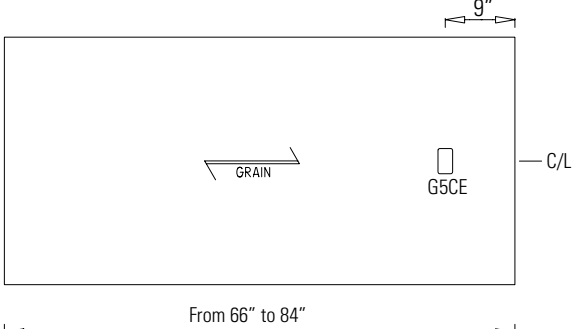

CREDENZA WIRE MANAGEMENT CUTOUT

- Option C275

Cut-out Specification

- Available on all 27.5"H credenzas, above open positions only (not available on door or drawer positions).
- Use in conjunction with CBYRxxxx Peninsula Tops that have G5CE grommet specified to provide a means of wire management from the surface, thru the credenza top and out the credenza back.
- When specified, the C275 includes a 5.90" w x 3.90" d cut-out in the credenza top and a standard GM5C grommet in the back, upper section of the open cavity.
- Order as **C275L**, **C275C**, **C275R**. Add **\$402** list.

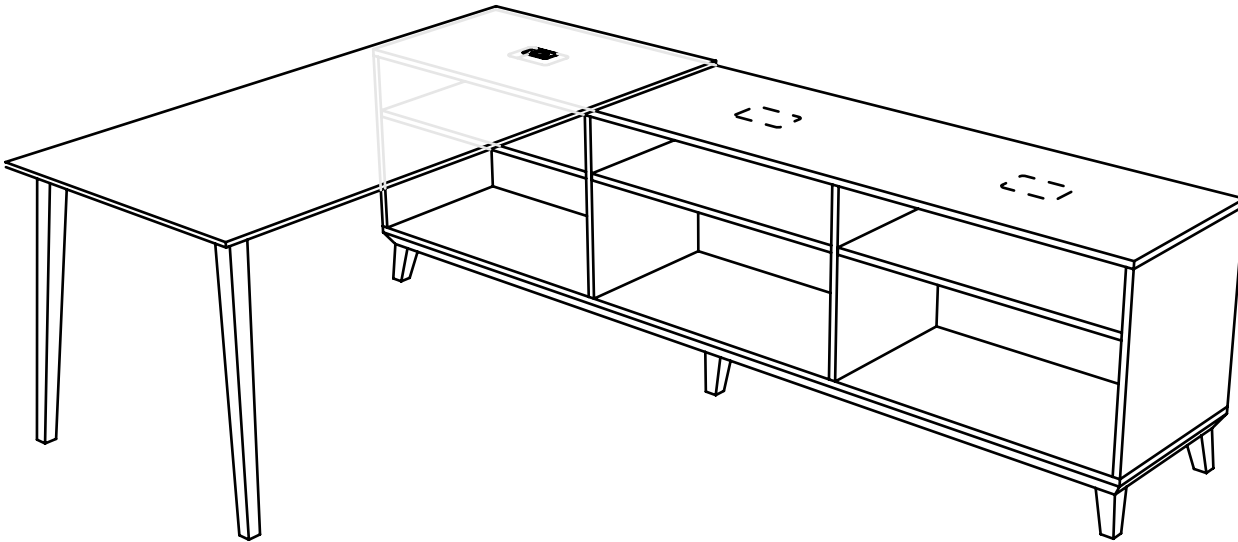
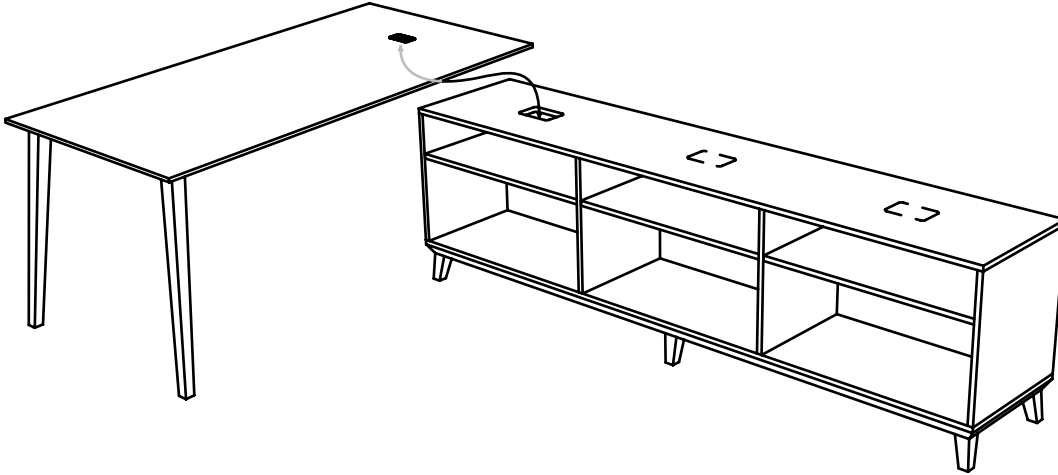

MODESTY PANEL OPTIONS

- Wood Modesty Panels are available in 15" and 22" height.
- To be used on Work Tables and on the Peninsula Table with and without the Riser Box.
- Recommended position for installation is 6" inset.

PENINSULA TABLE WITH HIGH BASE PEDESTAL**MODESTY SIZES:**

CBYCMPW44H15 - 44" x 15" x 0.75"

CBYCMPW50H15 - 50" x 15" x 0.75"

CBYCMPW56H15 - 56" x 15" x 0.75"

CBYCMPW62H15 - 62" x 15" x 0.75"

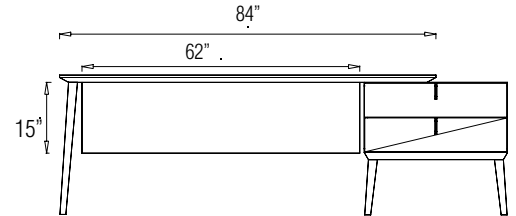
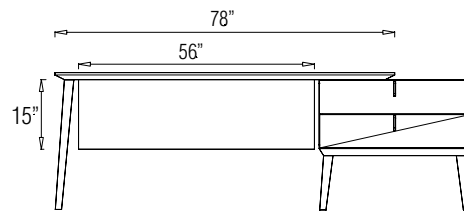
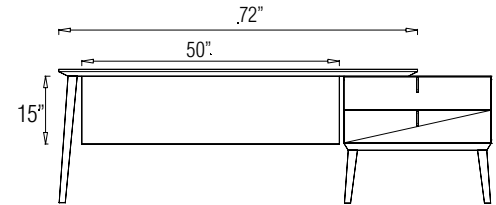
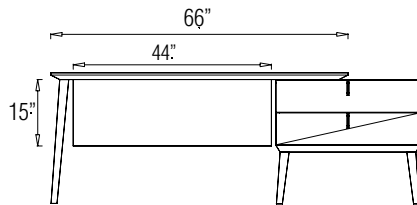
**PENINSULA TABLE WITH LOW BASE PEDESTAL****MODESTY SIZES:**

CBYCMPW44H22 - 44" x 22" x 0.75"

CBYCMPW50H22 - 50" x 22" x 0.75"

CBYCMPW56H22 - 56" x 22" x 0.75"

CBYCMPW62H22 - 62" x 22" x 0.75"

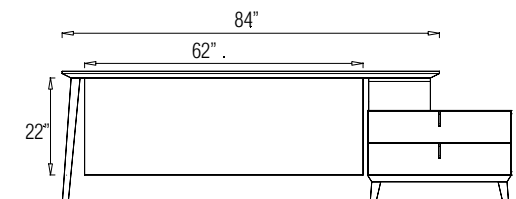
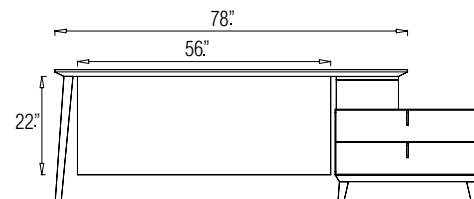
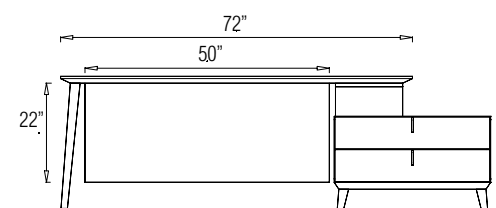
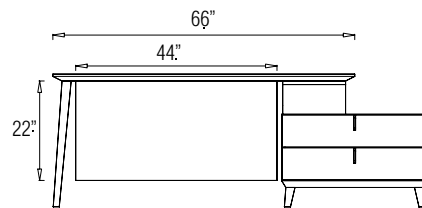
**PENINSULA TABLE WITH HIGH BASE CREDENZA****MODESTY SIZES:**

CBYCMPW38H15 - 38" x 15" x 0.75"

CBYCMPW44H15 - 44" x 15" x 0.75"

CBYCMPW50H15 - 50" x 15" x 0.75"

CBYCMPW56H15 - 56" x 15" x 0.75"

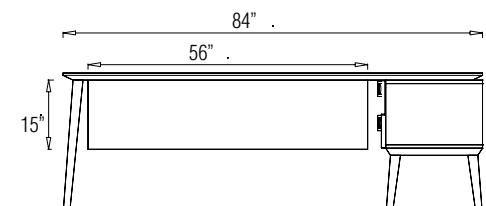
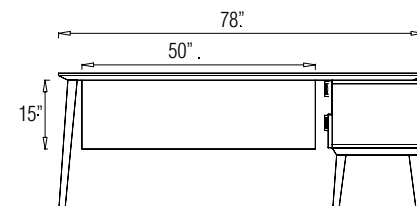
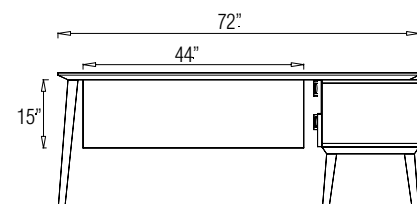
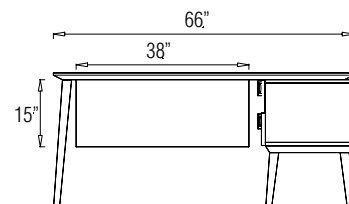

**MODESTY PANEL OPTIONS
PENINSULA TABLE WITH
LOW BASE CREDENZA**

MODESTY SIZES:

- CBYCMWP38H22 - 38" x 22" x 0.75"
- CBYCMWP44H22 - 44" x 22" x 0.75"
- CBYCMWP50H22 - 50" x 22" x 0.75"
- CBYCMWP56H22 - 56" x 22" x 0.75"

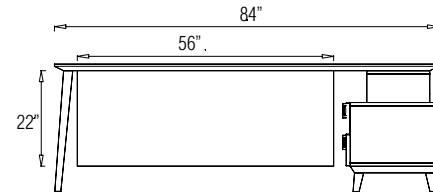
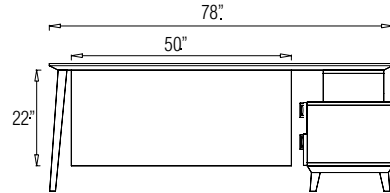
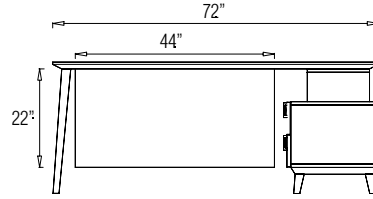
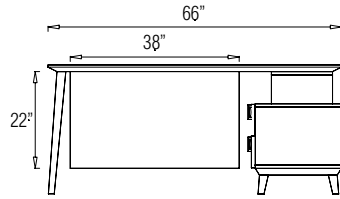

**FREESTANDING WORK TABLES
& COLLABORATION TABLES**

MODESTY SIZES:

- CBYCMWP56H15 - 56" x 15" x 0.75"
- CBYCMWP62H15 - 62" x 15" x 0.75"
- CBYCMWP68H15 - 68" x 15" x 0.75"
- CBYCMWP74H15 - 74" x 15" x 0.75"

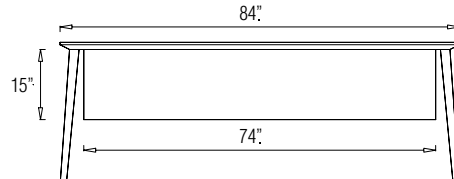
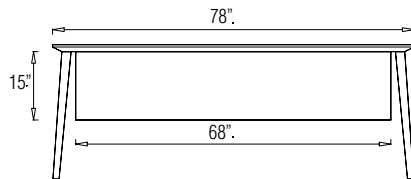
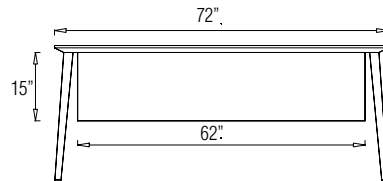
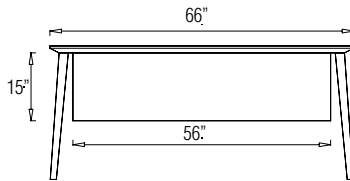

RISER BOX

- Riser Box is to be used as a spacer between the peninsula table and 20"H pedestals and credenzas
- CBYSPBOX2814 to be used with 32"D peninsula tables and executive bridges
- CBYSPBOX2014 to be used with 24"D executive bridges

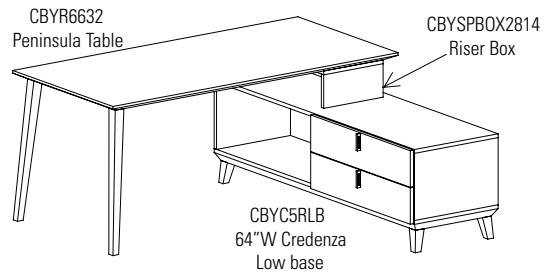
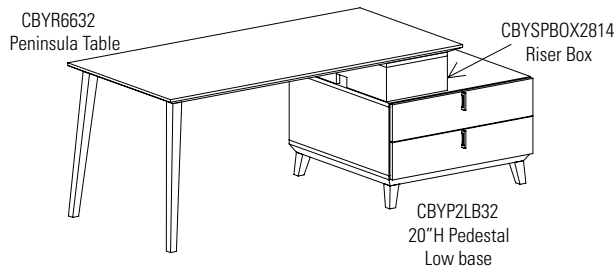

- On Peninsula Table, the Riser Box can be installed as below:

Riser Box opening is on the outside.

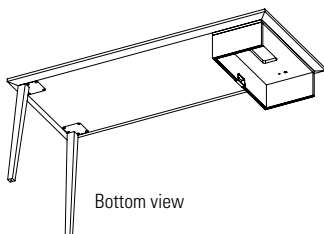

Riser Box opening is on the inside.

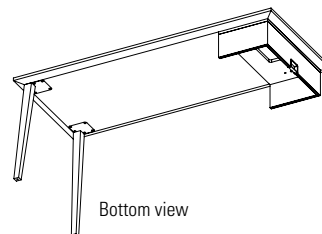

HEIGHT GRID - FLOOR UNITS, LOW BASE

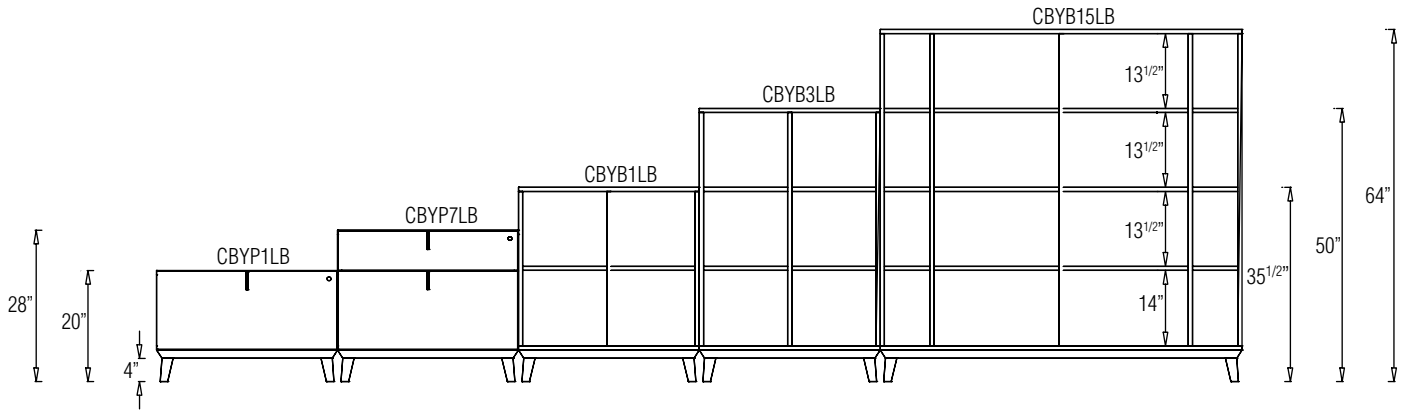

HEIGHT GRID - FLOOR UNITS, HIGH BASE

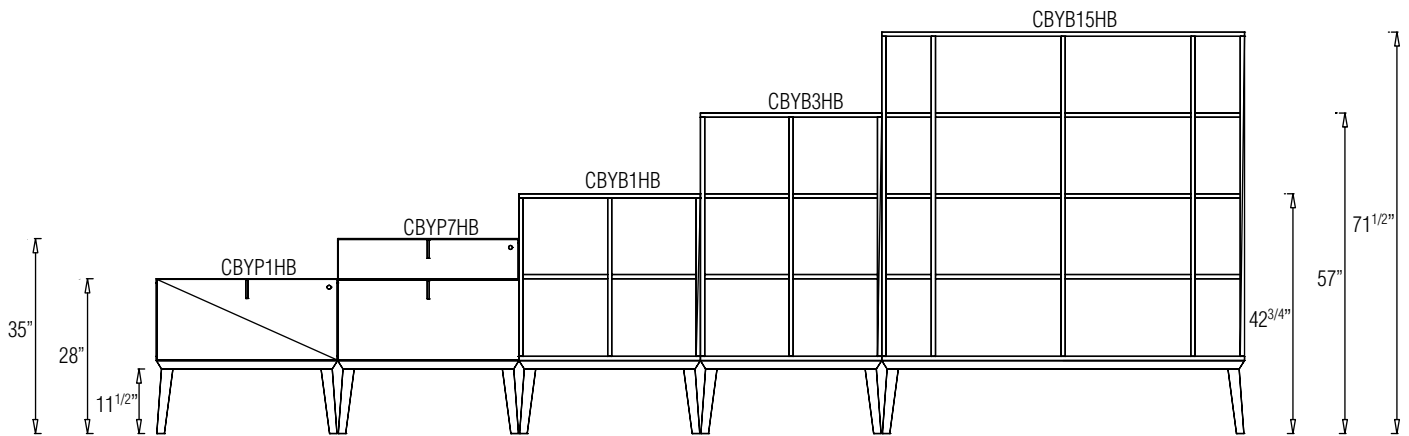

HEIGHT GRID - STACK-ON UNITS

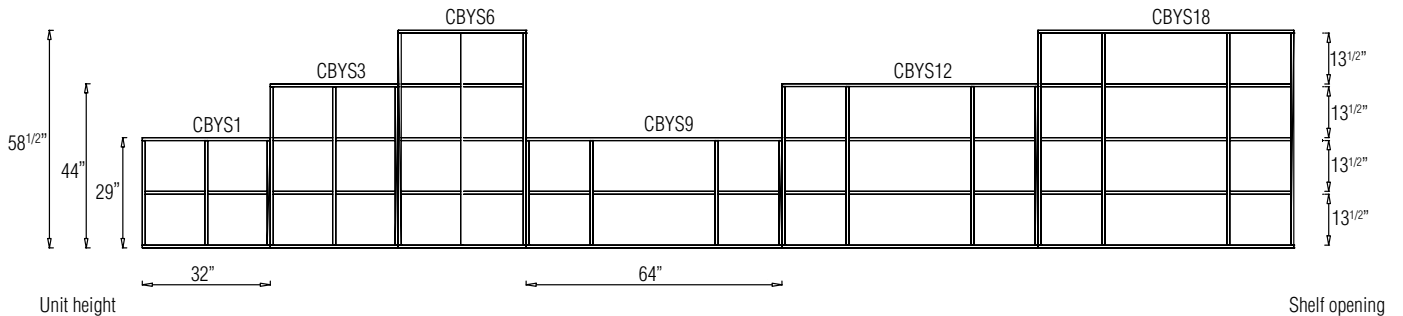

TABLES

D x W x H

- All tables are shipped Knock Down (KD). Please see assembly instructions included with product.
- Available modesty panels are 15" and 22" height
- Peninsula table has metal inserts installed for quick assembly to the pedestal or pedestal with riser box

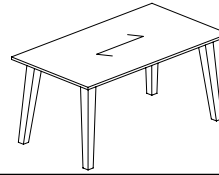

Note - Arrow indicates grain direction

TABLES + RETURNS

MODEL# **DIMENSIONS** **FREIGHT CLASS** **WT/LBS.** **CUBIC FT.** **LAMINATE** **VENEER**

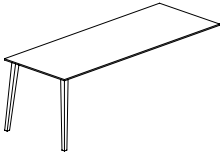

Peninsula Table

CBYR8432	32 x 84 x 29	100	119	12	\$2948	\$3685
CBYR7832	32 x 78 x 29	92.5	112	12	\$2801	\$3503
CBYR7232	32 x 72 x 29	100	105	11	\$2669	\$3338
CBYR6632	32 x 66 x 29	100	98	10	\$2532	\$3167

Table with two legs. Connects to 27.5"H storage. Must be supported by 32"D storage on one side (sold separately).



Round Table

CBY42H29	42 x 42 x 29	300	89	38	\$4185	\$5233
CBY36H29	36 x 36 x 29	300	77	31	\$3947	\$4935
CBY30H29	30 x 30 x 29	300	65	22	\$3657	\$4574

Round table with four legs.

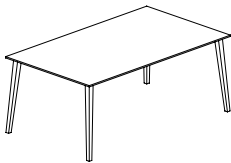

Freestanding Work Table*

CBYRT8442	42 x 84 x 29	65	170	15	\$4569	\$5712
CBYRT7842	42 x 78 x 29	92.5	161	14	\$4378	\$5472
CBYRT7242	42 x 72 x 29	65	152	13	\$4204	\$5257
CBYRT6642	42 x 66 x 29	70	142	13	\$4028	\$5036
CBYRT8432	32 x 84 x 29	65	139	12	\$3970	\$4965
CBYRT7832	32 x 78 x 29	92.5	132	12	\$3825	\$4784
CBYRT7232	32 x 72 x 29	65	125	11	\$3690	\$4614
CBYRT6632	32 x 66 x 29	65	118	10	\$3558	\$4448

Freestanding work table with four legs.

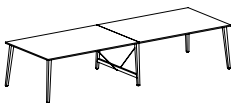

Conference Tables*

CBYRT16848	48 x 168 x 29	85	400	30	\$22193	\$27742
CBYRT14448	48 x 144 x 29	85	356	28	\$20510	\$25638
CBYRT12048	48 x 120 x 29	92.5	284	24	\$18826	\$23533
CBYRT9648	48 x 96 x 29	92.5	240	21	\$17141	\$21428
CBYRT16842	42 x 168 x 29	85	360	27	\$20721	\$25901
CBYRT14442	42 x 144 x 29	85	324	25	\$19246	\$24059
CBYRT12042	42 x 120 x 29	85	260	21	\$17774	\$22218
CBYRT9642	42 x 96 x 29	92.5	219	19	\$16300	\$20376
CBYRT16832	32 x 168 x 29	85	296	21	\$18404	\$23006
CBYRT14432	32 x 144 x 29	85	268	19	\$17141	\$21428
CBYRT12032	32 x 120 x 29	85	212	17	\$16089	\$20112
CBYRT9632	32 x 96 x 29	85	183	15	\$14827	\$18533

Freestanding conference table with six legs. 96" tables shipped in 4 cartons.

- 120", 144" and 168" tables are in two sections. Shipped in 5 cartons.

Required Specifications

Finish

Optional Specifications

Grommet
Custom cut-out*

MODESTY PANELS

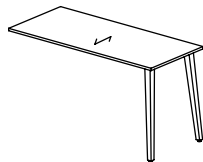
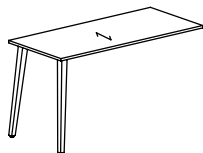
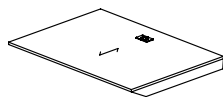
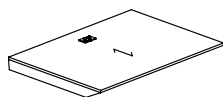
**Executive Return****Executive Bridge**

MODEL#	DIMENSIONS	FREIGHT CLASS	WT./LBS.	CUBIC FT.	LAMINATE	VENEER
--------	------------	---------------	----------	-----------	----------	--------

D x W x H

Left:

CBYERL6024CG	24 x 60 x 29	70	56	3.30	\$2170	\$2714
CBYERL5424CG	24 x 54 x 29	70	50	3	\$2062	\$2578
CBYERL4824CG	24 x 48 x 29	70	45	2.60	\$1952	\$2442
CBYERL4224CG	24 x 42 x 29	70	39	2.30	\$1844	\$2306
CBYERL3624CG	24 x 36 x 29	70	34	2	\$1736	\$2172

Right:

CBYERR6024CG	24 x 60 x 29	70	56	3.30	\$2170	\$2714
CBYERR5424CG	24 x 54 x 29	70	50	3	\$2062	\$2578
CBYERR4824CG	24 x 48 x 29	70	45	2.60	\$1952	\$2442
CBYERR4224CG	24 x 42 x 29	70	39	2.30	\$1844	\$2306
CBYERR3624CG	24 x 36 x 29	70	34	2	\$1736	\$2172

Executive return with two legs. Coped edge on opposite side to connect to a freestanding work table, creating an "L" workstation. CBYERRxxxxCG has legs on right side. CBYERLxxxxCG has legs on left side.

Left:

CBY6024TLCG	24 x 60 x 29	70	56	3.30	\$1545	\$1933
CBY5424TLCG	24 x 54 x 29	70	50	3	\$1395	\$1744
CBY4824TLCG	24 x 48 x 29	70	45	2.60	\$1240	\$1553
CBY4224TLCG	24 x 42 x 29	70	39	2.30	\$1087	\$1359
CBY3624TLCG	24 x 36 x 29	70	34	2	\$931	\$1165

CBY6032TLCG	32 x 60 x 29	70	75	4.20	\$2062	\$2578
CBY5432TLCG	32 x 54 x 29	70	68	3.80	\$1861	\$2327
CBY4832TLCG	32 x 48 x 29	70	60	3.40	\$1653	\$2068
CBY4232TLCG	32 x 42 x 29	70	53	3	\$1447	\$1810
CBY3632TLCG	32 x 36 x 29	70	45	1	\$1240	\$1553

Right:

CBY6024TRCG	24 x 60 x 29	70	56	3.30	\$1545	\$1933
CBY5424TRCG	24 x 54 x 29	70	50	3	\$1395	\$1744
CBY4824TRCG	24 x 48 x 29	70	45	2.60	\$1240	\$1553
CBY4224TRCG	24 x 42 x 29	70	39	2.30	\$1087	\$1359
CBY3624TRCG	24 x 36 x 29	70	34	2	\$931	\$1165

CBY6032TRCG	32 x 60 x 29	70	75	4.20	\$2062	\$2578
CBY5432TRCG	32 x 54 x 29	70	68	3.80	\$1861	\$2327
CBY4832TRCG	32 x 48 x 29	70	60	3.40	\$1653	\$2068
CBY4232TRCG	32 x 42 x 29	70	53	3	\$1447	\$1810
CBY3632TRCG	32 x 36 x 29	70	45	1	\$1240	\$1553

Executive return with coped edge on one side to connect to a freestanding work table, overlapping a 27.5" h or 20" h storage piece (using "Riser Box", sold separately) on the opposite side. Standard with grommet.

- Available in 32" d to match cavity opening on credenzas and storage, or 24" d for a narrower workspace
- CBYxxxxTLCG units have a coped edge on the **left, forming a right return**
- CBYxxxxTRCG units have a coped edge on the **right, forming a left return**

Required Specifications

Finish

Optional SpecificationsAdditional grommet
Custom cut-out*

COLLABORATION TABLE

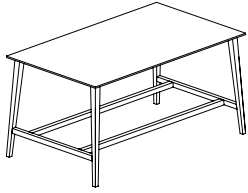

Freestanding Collaboration Table*

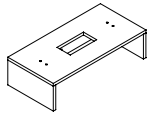

Riser Box

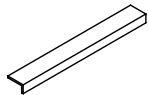

Footrest Cover

MODEL#	DIMENSIONS D x W x H	FREIGHT CLASS	WT/LBS.	CUBIC FT.	LIST PRICE	
CBYRTC8442	42 x 84 x 36	250	230	79	\$5593	\$6993
CBYRTC7842	42 x 78 x 36	250	211	73	\$5406	\$6759
CBYRTC7242	42 x 72 x 36	250	192	68	\$5230	\$6539
CBYRTC6642	42 x 66 x 36	250	172	62	\$5053	\$6318
CBYRTC8432	32 x 84 x 36	250	189	61	\$4993	\$6243
CBYRTC7832	32 x 78 x 36	250	172	56	\$4845	\$6059
CBYRTC7232	32 x 72 x 36	250	155	52	\$4715	\$5895
CBYRTC6632	32 x 66 x 36	250	138	48	\$4583	\$5730

Freestanding collaboration table with four legs and foot rests. Long footrests are steel and available in Brushed Chrome (**BCH**) or Black (**BLK**). Short footrests are wood and stained to match the veneer surface. Footrest covers are available as an option - please see page 14. Ships assembled.

CBYSPBOX2814	14 x 28 x 7.5	150	14	3	\$220	\$277
CBYSPBOX2014	14 x 20 x 7.5	250	2	1	\$405	\$508

Riser box for 20"H storage to support peninsula table. For wire pass through grommets, both top and back are included.

- CBYSPBOX2814 for use with 32"D peninsula tables and executive bridges.
- CBYSPBOX2014 for use with 24"D executive bridges

FRC8442	--	70	--	--	\$1141	
FRC7842	--	70	--	--	\$1077	
FRC7242	--	70	--	--	\$1015	
FRC6642	--	70	--	--	\$952	
FRC8432	--	70	--	--	\$1015	
FRC7832	--	70	--	--	\$952	
FRC7232	--	70	--	--	\$889	
FRC6632	--	70	--	--	\$825	

Factory installed.

MODESTY PANELS

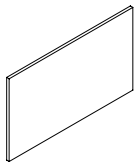

Hanging Wood Modesty Panel

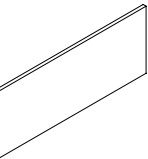

Hanging Wood Modesty Panel

MODEL#	DIMENSIONS	FREIGHT CLASS	WT/LBS.	CUBIC FT.	LAMINATE	VEENER
CBYCMPW62H22	.75 x 62 x 22	100	28	3	\$836	\$1047
CBYCMPW56H22	.75 x 56 x 22	100	26	3	\$779	\$976
CBYCMPW50H22	.75 x 50 x 22	100	24	3	\$735	\$920
CBYCMPW44H22	.75 x 44 x 22	92.5	22	2	\$675	\$845
CBYCMPW38H22	.75 x 38 x 22	92.5	20	2	\$619	\$775

22" hanging wood modesty panel.

CBYCMPW74H15	.75 x 74 x 15	100	24	3	\$860	\$1077
CBYCMPW68H15	.75 x 68 x 15	125	23	3	\$811	\$1015
CBYCMPW62H15	.75 x 62 x 15	92.5	21	2	\$811	\$1015
CBYCMPW56H15	.75 x 56 x 15	92.5	20	2	\$755	\$945
CBYCMPW50H15	.75 x 50 x 15	100	18	2	\$709	\$889
CBYCMPW44H15	.75 x 44 x 15	100	17	2	\$648	\$812
CBYCMPW38H15	.75 x 38 x 15	125	15	2	\$593	\$742

15" hanging wood modesty panel.

Required Specifications

Veneer finish
Long footrest finish*

Optional Specifications

Additional grommet
Custom cut-out*

COLLABORATION MEDIA TABLES

D x W x H

COLLABORATION MEDIA TABLE (CBYxx32) AND WALL MOUNT MEDIA STORAGE (CBYFO-GM)

32" Wide, Wall Mount Media Storage

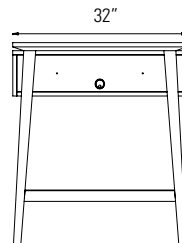
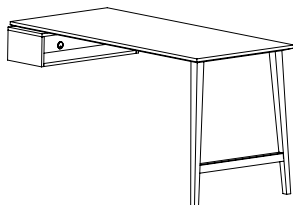

64" Wide, Wall Mount Media Storage

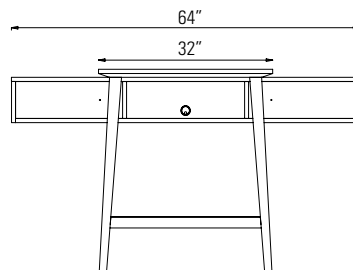
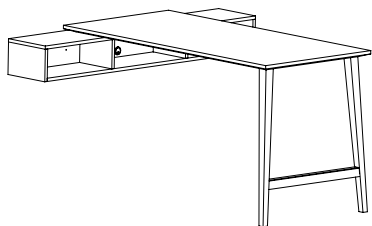

96" Wide, Wall Mount Media Storage

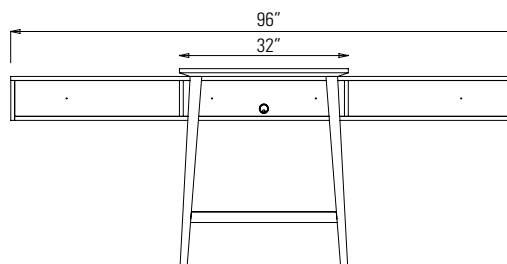
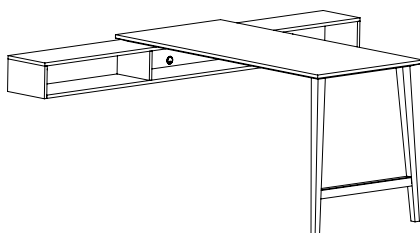

COLLABORATION MEDIA TABLES

MODEL#

DIMENSIONS

FREIGHT CLASS

WT./LBS.

CUBIC FT.

LAMINATE

VENEER

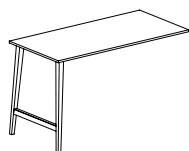

Collaboration Media Table

CBYRC8432	32 x 84 x 36	250	140	57	\$4122	\$5154
CBYRC7832	32 x 78 x 36	250	124	52	\$3969	\$4963
CBYRC7232	32 x 72 x 36	250	117	49	\$3831	\$4791
CBYRC6632	32 x 66 x 36	250	110	45	\$3690	\$4614

Table with two legs. To be used with Wall Mount Media Storage (CBYFOxxD12H8-GM).

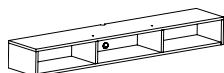

Wall Mounted Media Storage

CBYFO96D12H8-GM	12 x 96 x 8	125	78	10	\$2227	\$2785
CBYFO64D12H8-GM	12 x 64 x 8	125	50	8	\$1485	\$1858
CBYFO32D12H8-GM	12 x 32 x 8	100	35	4	\$1358	\$1699

To be used with Collaboration Media Table (CBYxx32). GM grommet on the back panel is included. For wire pass through, scoop cutouts on both top and bottom are included. Pre-drilled insert holes on top panel.

Required Specifications

Veneer finish

OCCASIONAL TABLES

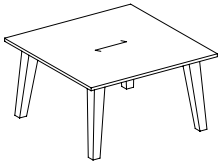

Square Occasional Table

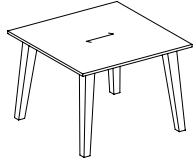

Square Occasional Table

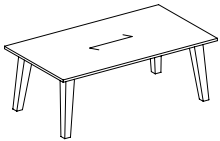

Rectangular Occasional Table

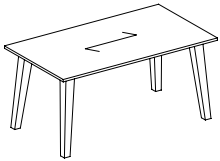

Rectangular Occasional Table



Round Occasional Table

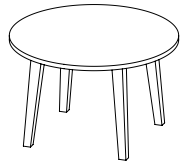

Round Occasional Table

MODEL#	DIMENSIONS D x W x H	FREIGHT CLASS	WT/LBS.	CUBIC FT.	LAMINATE	veneer
CBYCT3636H13	36 x 36 x 13	125	73	8	\$2388	\$2986
CBYCT3030H13	30 x 30 x 13	125	59	6	\$2107	\$2637
CBYCT2424H13	24 x 24 x 13	125	47	5	\$1876	\$2347

13"H square occasional table.

CBYCT3636H17	36 x 36 x 17	150	78	9	\$2680	\$3351
CBYCT3030H17	30 x 30 x 17	150	64	7	\$2400	\$3001
CBYCT2424H17	24 x 24 x 17	125	52	6	\$2170	\$2714

17"H square occasional table.

CBYCT4820H13	48 x 20 x 13	125	61	7	\$2154	\$2693
CBYCT4220H13	42 x 20 x 13	125	57	6	\$2055	\$2570
CBYCT3620H13	36 x 20 x 13	125	52	6	\$1978	\$2473

13"H rectangular occasional table.

CBYCT4820H17	48 x 20 x 17	125	66	8	\$2448	\$3061
CBYCT4220H17	42 x 20 x 17	125	62	7	\$2345	\$2933
CBYCT3620H17	36 x 20 x 17	125	57	7	\$2272	\$2841

17"H rectangular occasional table.

CBY36H13	36 x 36 x 13	150	73	16	\$3316	\$4147
CBY30H13	30 x 30 x 13	150	59	12	\$2723	\$3405
CBY24H13	24 x 24 x 13	150	47	8	\$2481	\$3102

13"H round occasional table.

CBY36H17	36 x 36 x 17	250	78	20	\$3578	\$4475
CBY30H17	30 x 30 x 17	150	64	14	\$3027	\$3784
CBY24H17	24 x 24 x 17	150	52	10	\$2785	\$3483

17"H round occasional table.

Required Specifications

Veneer finish

32"W FREESTANDING PEDESTALS + STORAGE

D x W x H

- All pedestals and storage units are shipped assembled
- Freestanding Pedestals and Storage may be used as stand alone units or as the Peninsula Table Support (20" and 27.5" height units).
- To support the Peninsula Table with 20"H Pedestal, the Riser Box is required (see Tables / Accessories section).
- Pedestal and Storage units are available in two base heights: 4" (xxLB = Low Base) or 11.5" (xxHB = High Base)
- All drawer fronts have one vertical handle (PL89) installed.
- Front locking is standard on the Pedestals with box/file and file drawers.
- Optional locking on doors (Storage units) is available (see Accessories section).
- Optional Cushions (32" x 14") for Pedestal tops are available (see Accessories section).

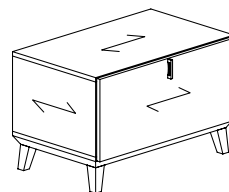
**Note** - Arrow indicates grain direction

32"W PEDESTALS - LOW BASE

MODEL#	DIMENSIONS	FREIGHT CLASS	WT/LBS.	CUBIC FT.	LAMINATE	veneer
--------	------------	---------------	---------	-----------	----------	--------

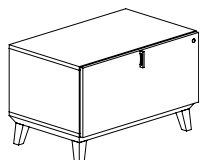
**Pedestal**

CBYP1LB	20 x 32 x 20	92.5	106	9	\$2374	\$2970
---------	--------------	------	-----	---	--------	--------

20"H freestanding pedestal with front locking lateral drawer. Low base.

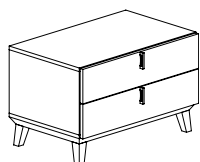
**Pedestal**

CBYP2LB	20 x 32 x 20	92.5	105	9	\$2360	\$2951
---------	--------------	------	-----	---	--------	--------

20"H freestanding pedestal with two box drawers. Low base.

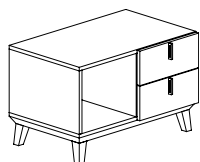
**Pedestal**

CBYP3LB	20 x 32 x 20	92.5	105	9	\$2508	\$3137
---------	--------------	------	-----	---	--------	--------

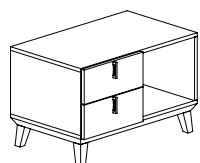
20"H freestanding pedestal with open cabinet on **left**, two box drawers on **right**. Low base.**Pedestal**

CBYP4LB	20 x 32 x 20	92.5	105	9	\$2508	\$3137
---------	--------------	------	-----	---	--------	--------

20"H freestanding pedestal with open cabinet on **right**, two box drawers on **left**. Low base.**Required Specifications**

Veneer finish

32"W PEDESTALS - LOW BASE

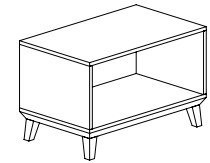

Pedestal

MODEL#	DIMENSIONS D x W x H	FREIGHT CLASS	WT./LBS.	CUBIC FT.	LAMINATE	veneer
CBYP5LB	20 x 32 x 20	100	86	9	\$2055	\$2570

20"H freestanding pedestal with open cabinet. Low base.

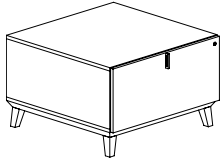

Pedestal

CBYP1LB32	32 x 32 x 20	100	136	14	\$2522	\$3154
-----------	--------------	-----	-----	----	--------	--------

20"H freestanding pedestal with front locking lateral drawer. Can be used to support peninsula table in conjunction with optional riser box ("CBYSPBOX2814"). Low base.

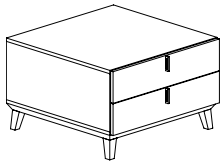

Pedestal

CBYP2LB32	32 x 32 x 20	100	135	14	\$2508	\$3137
-----------	--------------	-----	-----	----	--------	--------

20"H freestanding pedestal with two box drawers. Can be used to support peninsula table in conjunction with optional riser box ("CBYSPBOX2814"). Low base.

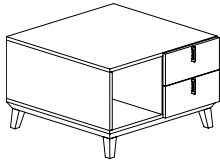

Pedestal

CBYP3LB32	32 x 32 x 20	100	135	14	\$2653	\$3318
-----------	--------------	-----	-----	----	--------	--------

20"H freestanding pedestal with open cabinet on **left**, two box drawers on **right**. Can be used to support peninsula table in conjunction with optional riser box ("CBYSPBOX2814"). Low base.

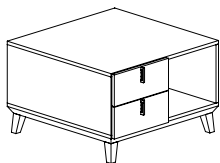

Pedestal

CBYP4LB32	32 x 32 x 20	100	135	14	\$2653	\$3318
-----------	--------------	-----	-----	----	--------	--------

20"H freestanding pedestal with open cabinet on **right**, two box drawers on **left**. Can be used to support peninsula table in conjunction with optional riser box ("CBYSPBOX2814"). Low base.

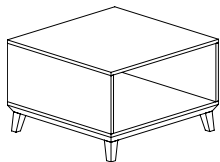

Pedestal

CBYP5LB32	32 x 32 x 20	100	135	14	\$2198	\$2750
-----------	--------------	-----	-----	----	--------	--------

20"H freestanding pedestal with open cabinet. Can be used to support peninsula table in conjunction with optional riser box ("CBYSPBOX2814"). Low base.

Required Specifications
Veneer finish

Optional Specifications

32"W PEDESTALS - LOW BASE

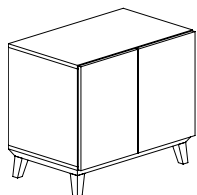

Pedestal*

MODEL#	DIMENSIONS	FREIGHT CLASS	WT/LBS.	CUBIC FT.	LAMINATE	VENEER
--------	------------	---------------	---------	-----------	----------	--------

	D x W x H					
CBYP6LB	20 x 32 x 27.5	100	117	12	\$2492	\$3117

27.5"H freestanding storage cabinet with two doors, one adjustable shelf. Low base.

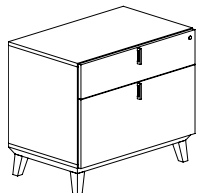

Pedestal

CBYP7LB	20 x 32 x 27.5	92.5	124	12	\$3180	\$3976
---------	----------------	------	-----	----	--------	--------

27.5"H freestanding pedestal with front locking lateral and box drawer. Low base.

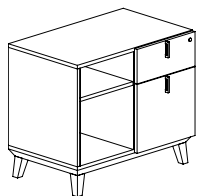

Pedestal

CBYP8LB	20 x 32 x 27.5	92.5	124	12	\$3324	\$4156
---------	----------------	------	-----	----	--------	--------

27.5"H freestanding pedestal with open fixed shelf on **left**, front locking box file drawer on **right**. Low base.

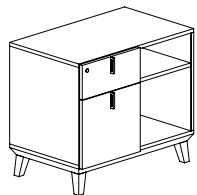

Pedestal

CBYP9LB	20 x 32 x 27.5	92.5	124	12	\$3324	\$4156
---------	----------------	------	-----	----	--------	--------

27.5"H freestanding pedestal with open fixed shelf on **right**, front locking box file drawer on **left**. Low base.

32"W PEDESTALS - HIGH BASE

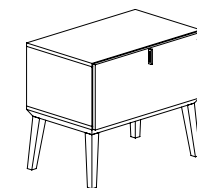

Pedestal

MODEL#	DIMENSIONS	FREIGHT CLASS	WT/LBS.	CUBIC FT.	LAMINATE	VENEER
--------	------------	---------------	---------	-----------	----------	--------

CBYP1HB	20 x 32 x 27.5	100	111	12	\$2669	\$3338
---------	----------------	-----	-----	----	--------	--------

27.5"H freestanding pedestal with front locking lateral drawer. High base.

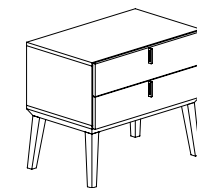

Pedestal

CBYP2HB	20 x 32 x 27.5	100	111	12	\$2653	\$3318
---------	----------------	-----	-----	----	--------	--------

27.5"H freestanding pedestal with two box drawers. High base.

Required Specifications

Veneer finish

Optional SpecificationsLock*
Handles*

32"W PEDESTALS - HIGH BASE

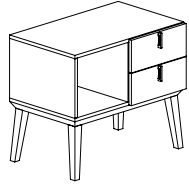

Pedestal

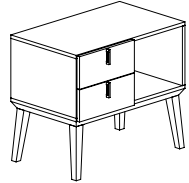

Pedestal

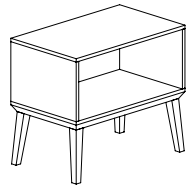

Pedestal

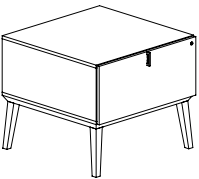

Pedestal

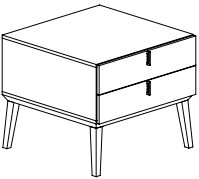

Pedestal

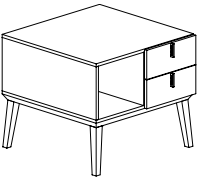

Pedestal

MODEL#	DIMENSIONS D x W x H	FREIGHT CLASS	WT/LBS.	CUBIC FT.	LAMINATE	veneer
CBYP3HB	20 x 32 x 27.5	100	111	12	\$2508	\$3137

27.5"H freestanding pedestal with open cabinet on **left**, two box drawers on **right**. High base.

CBYP4HB	20 x 32 x 27.5	100	110	12	\$2508	\$3137
---------	----------------	-----	-----	----	---------------	---------------

27.5"H freestanding pedestal with open cabinet on **right**, two box drawers on **left**. High base.

CBYP5HB	20 x 32 x 27.5	125	91	12	\$2055	\$2570
---------	----------------	-----	----	----	---------------	---------------

27.5"H freestanding pedestal with open cabinet. High base.

CBYP1HB32	32 x 32 x 27.5	125	141	18	\$2814	\$3520
-----------	----------------	-----	-----	----	---------------	---------------

27.5"H freestanding pedestal with front locking lateral drawer. Can be used to support peninsula table. High base.

CBYP2HB32	32 x 32 x 27.5	125	140	18	\$2731	\$3503
-----------	----------------	-----	-----	----	---------------	---------------

27.5"H freestanding pedestal with two box drawers. Can be used to support peninsula table. High base.

CBYP3HB32	32 x 32 x 27.5	125	140	18	\$2653	\$3318
-----------	----------------	-----	-----	----	---------------	---------------

27.5"H freestanding pedestal with open cabinet on **left**, two box drawers on **right**. Can be used to support peninsula table. High base.

Required Specifications
Veneer finish

Optional Specifications

64"W AND 96"W FREESTANDING CREDENZAS

D x W x H

- All Credenzas are shipped assembled.
- Freestanding Credenzas may be used as stand alone units or as the Peninsula Table Support (20" and 27.5" Height units)
- To support the Peninsula Table with 20"H Credenza, the Riser Box is required (see Tables or Accessories section).
- Credenza units are available in two base heights: 4" (xxLB = Low Base), or 11.5" (xxHB = High Base).
- All drawer fronts have vertical handle (PL89) installed where indicated.
- Front locking is standard on the Credenzas with box/lateral and lateral drawers.
- Optional locking on doors (Storage units) is available (see Accessories section).
- Optional Cushions (32" x 14") for Credenza tops are available (see Accessories section).

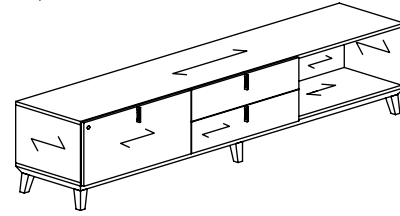

Note - Arrow indicates grain direction

64"W FREESTANDING CREDENZAS - LOW BASE

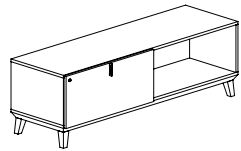

Credenza

MODEL#	DIMENSIONS	FREIGHT CLASS	WT/LBS.	CUBIC FT.	LAMINATE	VENEER
CBYC1LLB	20 x 64 x 20	125	161	17	\$4204	\$5257

Freestanding credenza with front locking lateral drawer on **left**, open on **right**. Low base.

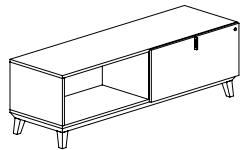

Credenza

CBYC1RLB	20 x 64 x 20	125	161	17	\$4204	\$5257
----------	--------------	-----	-----	----	--------	--------

Freestanding credenza with front locking lateral drawer on **right**, open on **left**. Low base.

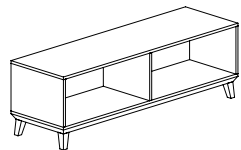

Credenza

CBYC2LB	20 x 64 x 20	100	141	17	\$3588	\$4487
---------	--------------	-----	-----	----	--------	--------

Freestanding credenza, open on left and right. Low base.

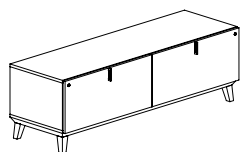

Credenza

CBYC3LB	20 x 64 x 20	92.5	180	17	\$4673	\$5844
---------	--------------	------	-----	----	--------	--------

Freestanding credenza, two front locking lateral drawers. Low base.

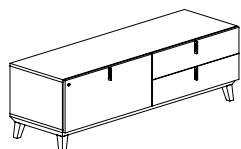

Credenza

CBYC4LLB	20 x 64 x 20	92.5	179	17	\$4660	\$5826
----------	--------------	------	-----	----	--------	--------

Freestanding credenza, front locking lateral drawer on **left**, two box drawers **right**. Low base.

Required Specifications

Veneer finish

Optional Specifications

64"W FREESTANDING CREDENZAS - LOW BASE

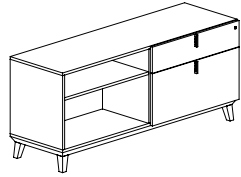

Credenza**

MODEL#	DIMENSIONS D x W x H	FREIGHT CLASS	WT/LBS.	CUBIC FT.	LAMINATE	VENEER
CBYC8RLB	20 x 64 x 27.5	100	194	23	\$5010	\$6263

Freestanding credenza, front locking lateral drawer with box drawer on **right**, open with fixed shelf on **left**. Low base.

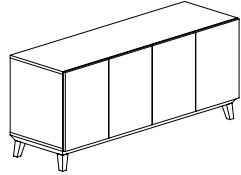

Credenza*

CBYC9LB	20 x 64 x 27.5	100	189	23	\$4982	\$6230
---------	----------------	-----	-----	----	---------------	---------------

Freestanding storage credenza, four doors with two adjustable shelves. Low base.

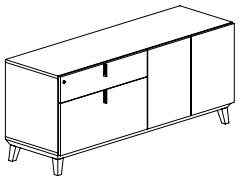

Credenza*

CBYC10LLB	20 x 64 x 27.5	100	206	23	\$5299	\$6626
-----------	----------------	-----	-----	----	---------------	---------------

Freestanding credenza, front locking lateral drawer with box drawer on **left**, two doors with adjustable shelf on **right**. Low base.

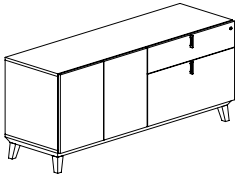

Credenza*

CBYC10RLB	20 x 64 x 27.5	100	206	23	\$5299	\$6626
-----------	----------------	-----	-----	----	---------------	---------------

Freestanding credenza, front locking lateral drawer with box drawer on **right**, two doors with adjustable shelf on **left**. Low base.

64"W FREESTANDING CREDENZAS - HIGH BASE

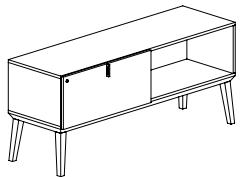

Credenza**

MODEL#	DIMENSIONS	FREIGHT CLASS	WT/LBS.	CUBIC FT.	LAMINATE	VENEER
CBYC1LHB	20 x 64 x 27.5	125	166	23	\$4498	\$5624

Freestanding credenza with front locking lateral drawer on **left**, open on **right**. High base.

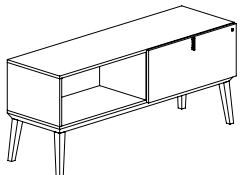

Credenza**

CBYC1RHB	20 x 64 x 27.5	125	166	23	\$4498	\$5624
----------	----------------	-----	-----	----	---------------	---------------

Freestanding credenza with front locking lateral drawer on **right**, open on **left**. High base.

Required Specifications

Veneer finish

Optional Specifications

Lock*
Handles*
Wire management (C275)**

64"W FREESTANDING CREDENZAS - HIGH BASE

MODEL#	DIMENSIONS	FREIGHT CLASS	WT/LBS.	CUBIC FT.	LAMINATE	VENEER
	D x W x H					
CBYC2HB	20 x 64 x 27.5	125	146	23	\$3882	\$4854
CBYC3HB	20 x 64 x 27.5	100	185	23	\$4819	\$6026
CBYC4LHB	20 x 64 x 27.5	100	184	23	\$4807	\$6010
CBYC4RHB	20 x 64 x 27.5	100	184	23	\$4807	\$6010
CBYC5LHB	20 x 64 x 27.5	125	165	23	\$4498	\$5624
CBYC5RHB	20 x 64 x 27.5	125	165	23	\$4498	\$5624

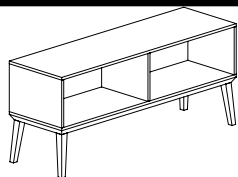

Credenza*

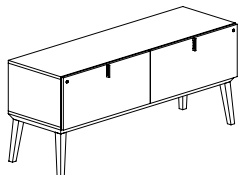
Freestanding credenza open on **left** and **right**. High base.

Credenza

Freestanding credenza, two front locking lateral drawers. High base.

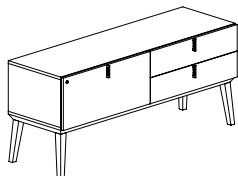

Credenza

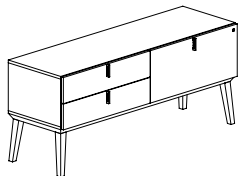
Freestanding credenza, front locking lateral drawer on **left**, two box drawers on **right**. High base.

Credenza

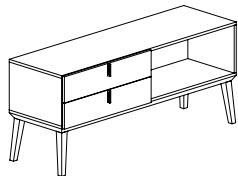
Freestanding credenza, front locking lateral drawer on **right**, two box drawers on **left**. High base.

Credenza*

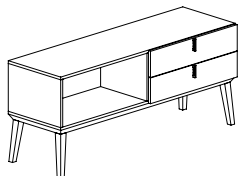
Freestanding credenza, two box drawers on **left**, open on **right**. High base.

Credenza*

Freestanding credenza, two box drawers on **right**, open on **left**. High base.**Required Specifications**Veneer finish
Laminate finish**Optional Specifications**Lock*
Handles*

64"W FREESTANDING CREDENZAS - HIGH BASE

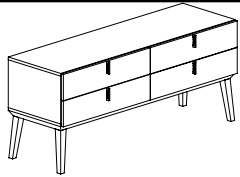

Credenza

MODEL#	DIMENSIONS D x W x H	FREIGHT CLASS	WT/LBS.	CUBIC FT.	LAMINATE	veneer
CBYC6HB	20 x 64 x 27.5	100	184	23	\$4791	\$5990

Freestanding credenza with four box drawers. High base.

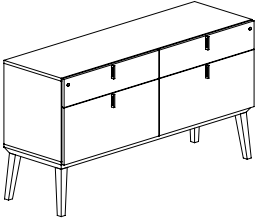

Credenza

CBYC7HB	20 x 64 x 35	125	218	29	\$5933	\$7418
---------	--------------	-----	-----	----	---------------	---------------

Freestanding credenza, front locking lateral drawer with box drawer on **left** and **right**. High base.

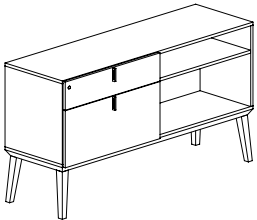

Credenza

CBYC8LHB	20 x 64 x 35	125	199	29	\$5299	\$6626
----------	--------------	-----	-----	----	---------------	---------------

Freestanding credenza, front locking lateral with box drawer on **left**, open with fixed shelf on **right**. High base.

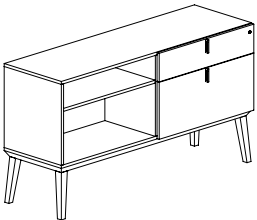

Credenza

CBYC8RHB	20 x 64 x 35	125	199	29	\$5299	\$6626
----------	--------------	-----	-----	----	---------------	---------------

Freestanding credenza, front locking lateral with box drawer on **right**, open with fixed shelf on **left**. High base.

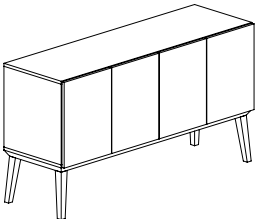

Credenza*

CBYC9HB	20 x 64 x 35	125	194	29	\$5270	\$6588
---------	--------------	-----	-----	----	---------------	---------------

Freestanding storage credenza, four doors with two adjustable shelves. High base.

Required Specifications

Veneer finish
Laminate finish

Optional Specifications

Lock*
Handles*

64"W FREESTANDING CREDENZAS - HIGH BASE

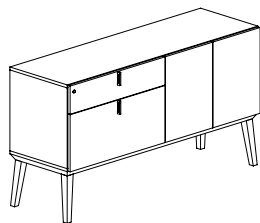

Credenza*

MODEL#	DIMENSIONS	FREIGHT CLASS	WT/LBS.	CUBIC FT.	LAMINATE	VENEER
--------	------------	---------------	---------	-----------	----------	--------

D x W x H						
CBYC10LHB	20 x 64 x 35	125	211	29	\$5593	\$6993

Freestanding credenza, front locking lateral with box drawer on **left**, two doors with adjustable shelf on **right**. High base.

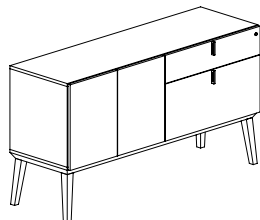

Credenza*

CBYC10RHB	20 x 64 x 35	125	211	29	\$5593	\$6993
-----------	--------------	-----	-----	----	--------	--------

Freestanding credenza, front locking lateral with box drawer on **right**, two doors with adjustable shelf on **left**. High base.

96"W FREESTANDING CREDENZAS - LOW BASE

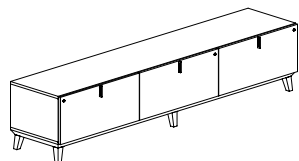

Credenza

MODEL#	DIMENSIONS	FREIGHT CLASS	WT/LBS.	CUBIC FT.	LAMINATE	VENEER
--------	------------	---------------	---------	-----------	----------	--------

CBYC11LB	20 x 96 x 20	92.5	259	25	\$6973	\$8717
----------	--------------	------	-----	----	--------	--------

Freestanding credenza, three front locking lateral drawers. Low base.

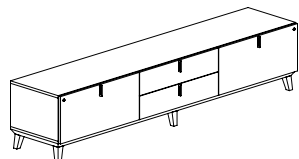

Credenza

CBYC12LB	20 x 96 x 20	92.5	258	25	\$6958	\$8699
----------	--------------	------	-----	----	--------	--------

Freestanding credenza, front locking lateral drawer on **left**, two box drawers **center**, and front locking lateral drawer on **right**. Low base.

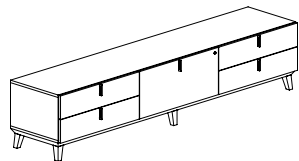

Credenza

CBYC13LB	20 x 96 x 20	92.5	258	25	\$6941	\$8678
----------	--------------	------	-----	----	--------	--------

Freestanding credenza, two box drawers on **left**, front locking lateral drawer **center**, and two box drawers on **right**. Low base.

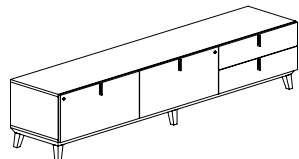

Credenza

CBYC14LB	20 x 96 x 20	92.5	258	25	\$6958	\$8699
----------	--------------	------	-----	----	--------	--------

Freestanding credenza, front locking lateral drawers **left** and **center**, and two box drawers on **right**. Low base.

Required Specifications

Veneer finish
Laminate finish

Optional Specifications

Lock*
Handles*

96"W FREESTANDING CREDENZAS - LOW BASE

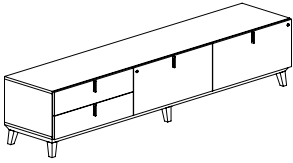

Credenza

MODEL#	DIMENSIONS D x W x H	FREIGHT CLASS	WT/LBS.	CUBIC FT.	LAMINATE	VENEER
CBYC15LB	20 x 96 x 20	92.5	258	25	\$6958	\$8699

Freestanding credenza, two box drawers on **left**, front locking lateral drawer **center** and **right**. Low base.

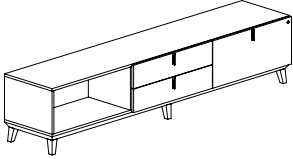

Credenza

CBYC16LB	20 x 96 x 20	100	239	25	\$6488	\$8112
----------	--------------	-----	-----	----	---------------	---------------

Freestanding credenza, open on **left**, two box drawers **center**, and front locking lateral drawer on **right**. Low base.

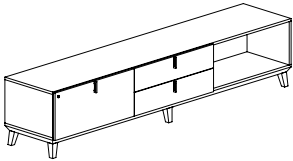

Credenza

CBYC17LB	20 x 96 x 20	100	239	25	\$6488	\$8112
----------	--------------	-----	-----	----	---------------	---------------

Freestanding credenza, front locking lateral drawer on **left**, two box drawers **center**, and open on **right**. Low base.

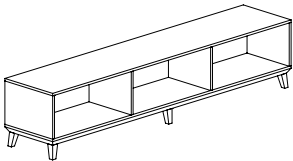

Credenza

CBYC18LB	20 x 96 x 20	100	201	25	\$5564	\$6956
----------	--------------	-----	-----	----	---------------	---------------

Freestanding credenza, open **left**, **center** and **right**. Low base.

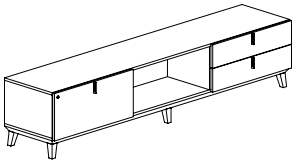

Credenza

CBYC19LB	20 x 96 x 20	100	239	25	\$6488	\$8112
----------	--------------	-----	-----	----	---------------	---------------

Freestanding credenza, front locking lateral drawer on **left**, open **center**, and two box drawers on **right**. Low base.

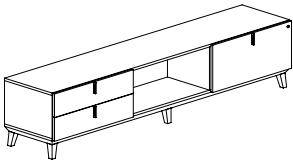

Credenza

CBYC20LB	20 x 96 x 20	100	239	25	\$6488	\$8112
----------	--------------	-----	-----	----	---------------	---------------

Freestanding credenza, two box drawers on **left**, open **center**, and front locking lateral drawer on **right**. Low base.

Required Specifications

- Veneer finish
- Laminate finish

96"W FREESTANDING CRENZAS - LOW BASE

MODEL#	DIMENSIONS	FREIGHT CLASS	WT/LBS.	CUBIC FT.	LAMINATE	VENEER
	D x W x H					
CBYC21LB	20 x 96 x 20	100	225	25	\$6149	\$7688
CBYC22LB	20 x 96 x 20	100	217	25	\$6002	\$7504
CBYC23LB	20 x 96 x 20	92.5	256	25	\$6926	\$8659
CBYC24LB	20 x 96 x 27.5	100	304	34	\$7659	\$9576
CBYC25LB	20 x 96 x 27.5	100	284	34	\$6958	\$8699
CBYC26LB	20 x 96 x 27.5	100	296	34	\$7103	\$8881

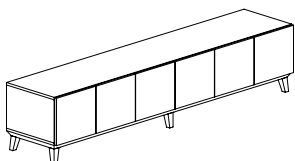

Credenza*

Freestanding storage credenza with six doors. Low base.

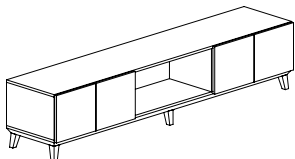

Credenza*

Freestanding storage credenza with two doors on **left**, open **center**, and two doors on **right**. Low base.

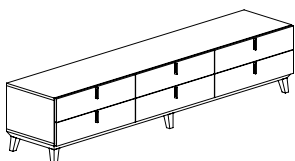

Credenza

Freestanding credenza with six box drawers. Low base.

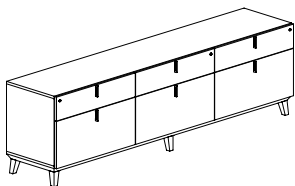

Credenza

Freestanding credenza, front locking lateral drawer with box drawer **left**, **center** and **right**. Low base.

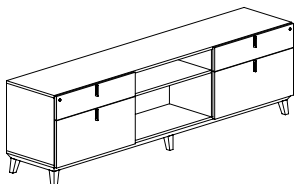

Credenza**

Freestanding credenza, front locking lateral drawer with box drawer on **left**, open with fixed shelf **center**, and front locking lateral drawer with box drawer on **right**. Low base.

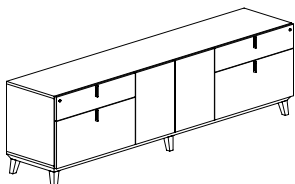

Credenza*

Freestanding credenza, front locking lateral drawer with box drawer on **left**, two door storage with adjustable shelf **center**, and front locking lateral drawer with box drawer on **right**. Low base.

Required Specifications

Veneer finish
Laminate finish

Optional Specifications

Lock
Handles
Wire management (C275)*

96"W FREESTANDING CREDENZAS - LOW BASE

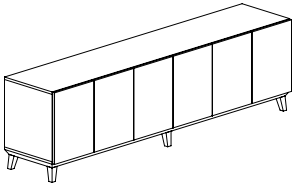

Credenza

MODEL#	DIMENSIONS D x W x H	FREIGHT CLASS	WT/LBS.	CUBIC FT.	LAMINATE	veneer
CBYC27LB	20 x 96 x 27.5	100	281	34	\$6589	\$8237

Freestanding storage credenza, six doors with three adjustable shelves. Low base.

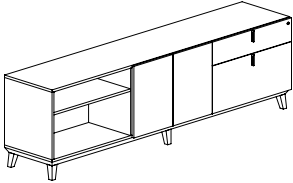

Credenza*

CBYC28LB	20 x 96 x 27.5	100	277	34	\$6401	\$8003
----------	----------------	-----	-----	----	--------	--------

Freestanding credenza, open with fixed shelf on **left**, two door storage with adjustable shelf **center**, and front locking lateral drawer with box drawer on **right**. Low base.

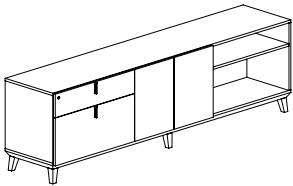

Credenza*

CBYC29LB	20 x 96 x 27.5	100	277	34	\$6401	\$8003
----------	----------------	-----	-----	----	--------	--------

Freestanding credenza, front locking lateral drawer with box drawer on **left**, two door storage with adjustable shelf **center**, and open with fixed shelf on **right**. Low base.

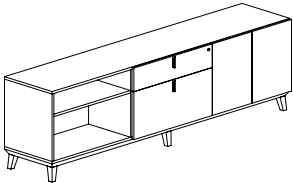

Credenza*

CBYC30LB	20 x 96 x 27.5	100	277	34	\$6401	\$8003
----------	----------------	-----	-----	----	--------	--------

Freestanding credenza, open with fixed shelf on **left**, front locking lateral drawer with box drawer **center**, and two door storage with adjustable shelf on **right**. Low base.

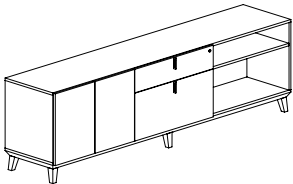

Credenza*

CBYC31LB	20 x 96 x 27.5	100	277	34	\$6401	\$8003
----------	----------------	-----	-----	----	--------	--------

Freestanding credenza, two door storage with adjustable shelf on **left**, front locking lateral drawer with box drawer **center**, and open with fixed shelf on **right**. Low base.

Required Specifications

Veneer finish
Laminate finish

Optional Specifications

Lock
Handles
Wire management (C275)*

96"W FREESTANDING CREDENZAS - LOW BASE

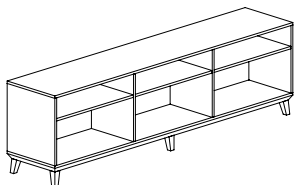

Credenza*

MODEL#	DIMENSIONS	FREIGHT CLASS	WT/LBS.	CUBIC FT.	LAMINATE	VENEER
--------	------------	---------------	---------	-----------	----------	--------

D x W x H						
CBYC32LB	20 x 96 x 27.5	125	277	34	\$6149	\$7688

Freestanding credenza, open with fixed shelf **left, center** and **right**. Low base.

96"W FREESTANDING CREDENZAS - HIGH BASE

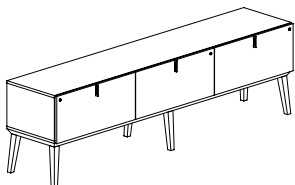

Credenza

MODEL#	DIMENSIONS	FREIGHT CLASS	WT/LBS.	CUBIC FT.	LAMINATE	VENEER
--------	------------	---------------	---------	-----------	----------	--------

CBYC11HB	20 x 96 x 27.5	125	264	34	\$7266	\$9084
----------	----------------	-----	-----	----	--------	--------

Freestanding credenza, three front locking lateral drawers. High base.

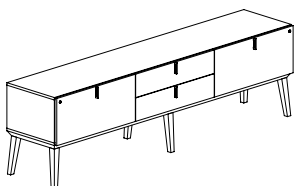

Credenza

CBYC12HB	20 x 96 x 27.5	125	263	34	\$7250	\$9064
----------	----------------	-----	-----	----	--------	--------

Freestanding credenza, front locking lateral drawer on **left**, two box drawers **center**, and front locking lateral drawer on **right**. High base.

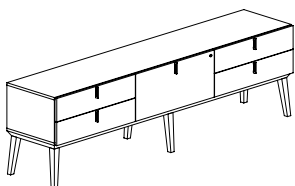

Credenza

CBYC13HB	20 x 96 x 27.5	125	263	34	\$7235	\$9046
----------	----------------	-----	-----	----	--------	--------

Freestanding credenza, two box drawers on **left**, front locking lateral drawer **center**, and two box drawers on **right**. High base.

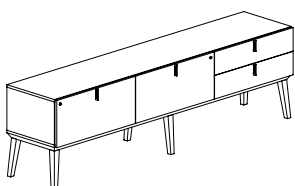

Credenza

CBYC14HB	20 x 96 x 27.5	125	263	34	\$7250	\$9064
----------	----------------	-----	-----	----	--------	--------

Freestanding credenza, front locking lateral drawer on **left** and **center**, two box drawers on **right**. High base.

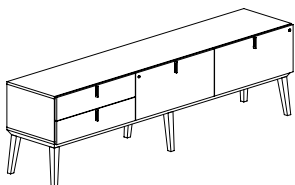

Credenza

CBYC15HB	20 x 96 x 27.5	125	263	34	\$7250	\$9064
----------	----------------	-----	-----	----	--------	--------

Freestanding credenza, two box drawers on **left** and front locking lateral drawer **center** and **right**. High base.

Required Specifications

Veneer finish
Laminate finish

Optional Specifications

Wire management (C275)*

96"W FREESTANDING CREDENZAS - HIGH BASE

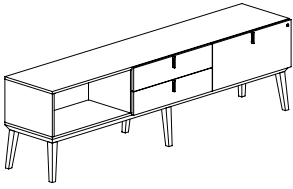

Credenza*

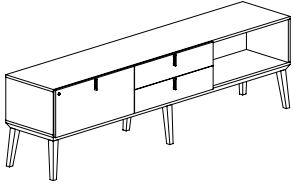

Credenza*

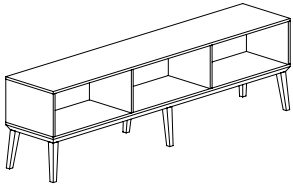

Credenza*

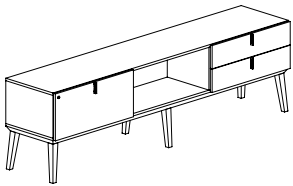

Credenza*

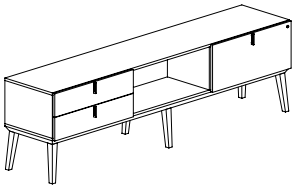

Credenza*

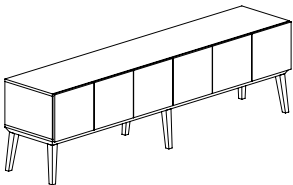

Credenza**

MODEL#	DIMENSIONS D x W x H	FREIGHT CLASS	WT/LBS.	CUBIC FT.	LAMINATE	veneer
CBYC16HB	20 x 96 x 27.5	125	244	34	\$6781	\$8478
Freestanding credenza, open on left , two box drawers center , and front locking lateral drawer on right . High base.						
CBYC17HB	20 x 96 x 27.5	125	244	34	\$6781	\$8478
Freestanding credenza, front locking lateral drawer on left , two box drawers center , and open on right . High base.						
CBYC18HB	20 x 96 x 27.5	125	206	34	\$5855	\$7321
Freestanding credenza, open left , center and right . High base.						
CBYC19HB	20 x 96 x 27.5	125	244	34	\$6781	\$8478
Freestanding credenza, front locking lateral drawer on left , open center , and two box drawers on right . High base.						
CBYC20HB	20 x 96 x 27.5	125	244	34	\$6781	\$8478
Freestanding credenza, two box drawers on left , open center , and front locking lateral drawer on right . High base.						
CBYC21HB	20 x 96 x 27.5	125	230	34	\$6443	\$8054
Freestanding storage credenza, six doors. High base.						

Required Specifications

Veneer finish
Laminate finish

Optional Specifications

Wire management (C275)*
Lock**
Handles**

96"W FREESTANDING CREDENZAS - HIGH BASE

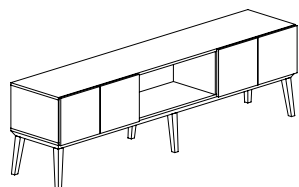

Credenza**

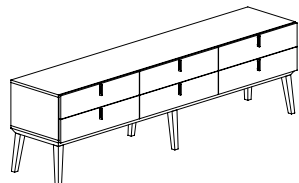

Credenza

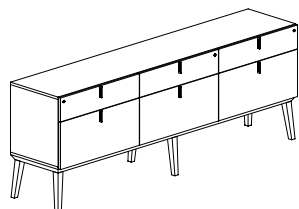

Credenza

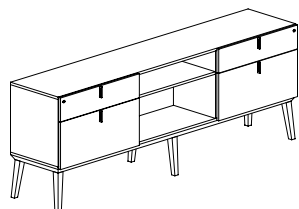

Credenza

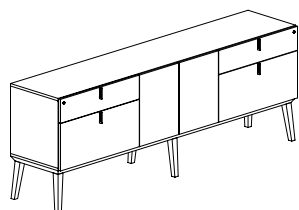

Credenza*

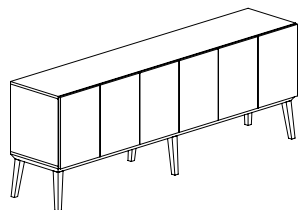

Credenza*

MODEL# DIMENSIONS FREIGHT CLASS WT/LBS. CUBIC FT. LAMINATE VENEER

D x W x H

MODEL#	DIMENSIONS	FREIGHT CLASS	WT/LBS.	CUBIC FT.	LAMINATE	VENEER
CBYC22HB	20 x 96 x 27.5	125	222	34	\$6295	\$7870
CBYC23HB	20 x 96 x 27.5	125	261	34	\$7220	\$9026
CBYC24HB	20 x 96 x 35	125	309	43	\$7951	\$9940
CBYC25HB	20 x 96 x 35	125	289	43	\$7250	\$9064
CBYC26HB	20 x 96 x 35	125	301	43	\$7395	\$9246
CBYC27HB	20 x 96 x 35	125	286	43	\$6882	\$8604

Freestanding storage credenza with two doors on **left**, open **center**, and two doors on **right**. High base.

Freestanding credenza with six box drawers. High base.

Freestanding credenza, front locking lateral drawer with box drawer **left**, **center** and **right**. High base.

Freestanding credenza, front locking lateral drawer with box drawer on **left**, open with fixed shelf **center**, and front locking lateral drawer with box drawer on **right**. High base.

Freestanding credenza, front locking lateral drawer with box drawer on **left**, two door storage with adjustable shelf **center**, and front locking lateral drawer with box drawer on **right**. High base.

Freestanding storage credenza, six doors with three adjustable shelves. High base.

Required Specifications

Veneer finish
Laminate finish

Optional Specifications

Lock*
Handles*
Wire management (C275)**

96"W FREESTANDING CRENZAS - HIGH BASE

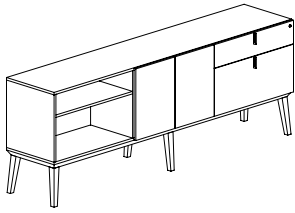

Credenza*

MODEL#	DIMENSIONS D x W x H	FREIGHT CLASS	WT/LBS.	CUBIC FT.	LAMINATE	veneer
CBYC28HB	20 x 96 x 35	125	282	43	\$6694	\$8370

Freestanding credenza, open with fixed shelf on **left**, two door storage with adjustable shelf **center**, and front locking lateral drawer with box drawer on **right**. High base.

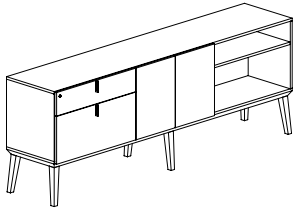

Credenza*

CBYC29HB	20 x 96 x 35	125	282	43	\$6694	\$8370
----------	--------------	-----	-----	----	---------------	---------------

Freestanding credenza, front locking lateral drawer with box drawer on **left**, two door storage with adjustable shelf **center**, and open with fixed shelf on **right**. High base.

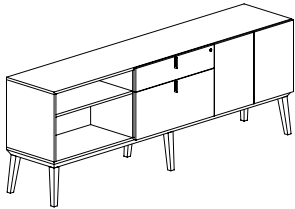

Credenza*

CBYC30HB	20 x 96 x 35	125	282	43	\$6694	\$8370
----------	--------------	-----	-----	----	---------------	---------------

Freestanding credenza, open with fixed shelf on **left**, front locking lateral drawer with box drawer **center**, and two door storage with adjustable shelf on **right**. High base.

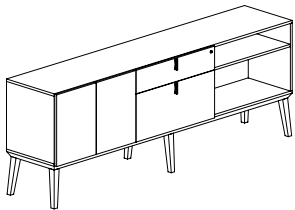

Credenza*

CBYC31HB	20 x 96 x 35	125	282	43	\$6694	\$8370
----------	--------------	-----	-----	----	---------------	---------------

Freestanding credenza, two door storage with adjustable shelf on **left**, front locking lateral drawer with box drawer **center**, and open with fixed shelf on **right**. High base.

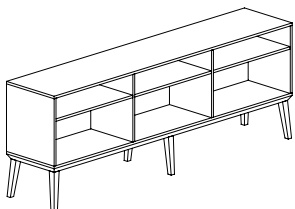

Credenza

CBYC32HB	20 x 96 x 35	150	250	43	\$6442	\$8054
----------	--------------	-----	-----	----	---------------	---------------

Freestanding credenza, open with fixed shelf **left, center** and **right**. High base.

Required Specifications

Veneer finish
Laminate finish

Optional Specifications

Veneer back panel

32"W AND 64"W STACK-ON BOOKCASES AND STORAGE CABINETS

D x W x H

- All Stack-on Bookcases and Storage Cabinets are shipped assembled.
- Stack-on units are designed to be placed and installed on top of the Credenzas with Low or High Base.
- Stack on Units are available in three heights 29.5", 44" and 58.5". For the overall height, please see page A.7.
- Back Panels of the Stack-on units are made of LP solid color laminate.
- Optional locking on doors (Storage units) is available (see Accessories section)

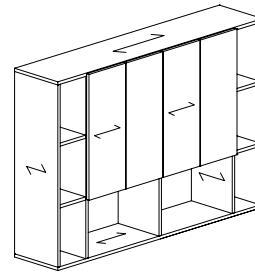

Note - Arrow indicates grain direction

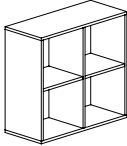
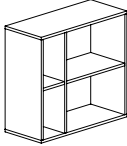
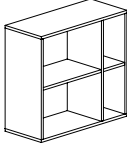
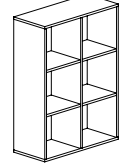
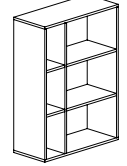
32"W STACK-ON BOOKCASES	MODEL#	DIMENSIONS D x W x H	FREIGHT CLASS	WT/LBS.	CUBIC FT.	LAMINATE	veneer
	CBYS1	14.5 x 32 x 29.5	125	69	9	\$1978	\$2473
Stack-on Bookcase	Two-high stack-on bookcase with symmetrical 16" wide openings, fixed shelves. LP laminate back.						
	CBYS2L	14.5 x 32 x 29.5	125	69	9	\$1978	\$2473
Stack-on Bookcase	Two-high stack-on bookcase with asymmetrical openings - 8" left / 24" right , fixed shelves. LP laminate back.						
	CBYS2R	14.5 x 32 x 29.5	125	69	9	\$1978	\$2473
Stack-on Bookcase	Two-high stack-on bookcase with asymmetrical openings - 24" left / 8" right , fixed shelves. LP laminate back.						
	CBYS3	14.5 x 32 x 44	125	95	14	\$2709	\$3387
Stack-on Bookcase	Three-high stack-on bookcase with symmetrical 16" wide openings, fixed shelves. LP laminate back.						
	CBYS4L	14.5 x 32 x 44	125	95	14	\$2709	\$3387
Stack-on Bookcase	Three-high stack-on bookcase with asymmetrical openings - 8" left / 24" right , fixed shelves. LP laminate back.						

Required Specifications

Veneer finish
Laminate finish

Optional Specifications

Veneer back panel

32"W STACK-ON BOOKCASES

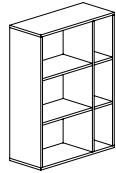

Stack-on Bookcase

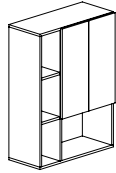

Stack-on Bookcase*

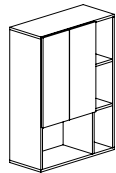

Stack-on Bookcase*

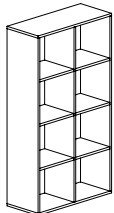

Stack-on Bookcase

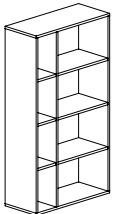

Stack-on Bookcase

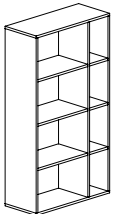

Stack-on Bookcase

MODEL#	DIMENSIONS D x W x H	FREIGHT CLASS	WT./LBS.	CUBIC FT.	LAMINATE	veneer
CBYS4R	14.5 x 32 x 44	125	95	14	\$2709	\$3387

Three-high stack-on bookcase with asymmetrical openings - **24" left / 8" right**, fixed shelves. LP laminate back.

CBYS5L	14.5 x 32 x 44	125	106	14	\$3208	\$4013
--------	----------------	-----	-----	----	---------------	---------------

Three-high stack-on bookcase with asymmetrical openings - **8" left / 24" right**, fixed shelves, two door storage upper right with one adjustable shelf. LP laminate back.

CBYS5R	14.5 x 32 x 44	125	106	14	\$3208	\$4013
--------	----------------	-----	-----	----	---------------	---------------

Three-high stack-on bookcase with asymmetrical openings - **24" left / 8" right**, fixed shelves, two door storage upper left with one adjustable shelf. LP laminate back.

CBYS6	14.5 x 32 x 58.5	125	111	18	\$3588	\$4487
-------	------------------	-----	-----	----	---------------	---------------

Four-high stack-on bookcase with symmetrical 16" wide openings, fixed shelves. LP laminate back.

CBYS7L	14.5 x 32 x 58.5	125	111	18	\$3588	\$4487
--------	------------------	-----	-----	----	---------------	---------------

Four-high stack-on bookcase with asymmetrical openings - **8" left / 24" right**, fixed shelves. LP laminate back.

CBYS7R	14.5 x 32 x 58.5	125	111	18	\$3588	\$4487
--------	------------------	-----	-----	----	---------------	---------------

Four-high stack-on bookcase with asymmetrical openings - **24" left / 8" right**, fixed shelves. LP laminate back.

Required Specifications

Veneer finish
Laminate finish

Optional Specifications

Lock*
Handles*
Veneer back panel

32"W STACK-ON BOOKCASES

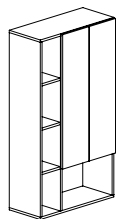

Stack-on Bookcase*

MODEL#	DIMENSIONS	FREIGHT CLASS	WT/LBS.	CUBIC FT.	LAMINATE	ENEER
--------	------------	---------------	---------	-----------	----------	-------

D x W x H

CBYS8L	14.5 x 32 x 58.5	125	129	18	\$4350	\$5441
--------	------------------	-----	-----	----	--------	--------

Four-high stack-on bookcase with asymmetrical openings - **8" left / 24" right**, fixed shelves. two door storage upper right with two adjustable shelves. LP laminate back.

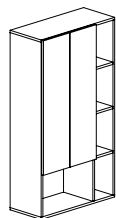

Stack-on Bookcase*

CBYS8R	14.5 x 32 x 58.5	125	129	18	\$4350	\$5441
--------	------------------	-----	-----	----	--------	--------

Four-high stack-on bookcase with asymmetrical openings - **24" left / 8" right**, fixed shelves. two door storage upper left with two adjustable shelves. LP laminate back.

64"W STACK-ON BOOKCASES

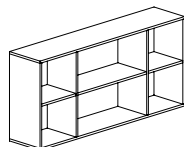

Stack-on Bookcase

MODEL#	DIMENSIONS	FREIGHT CLASS	WT/LBS.	CUBIC FT.	LAMINATE	ENEER
--------	------------	---------------	---------	-----------	----------	-------

CBYS9	14.5 x 64 x 29.5	125	119	18	\$3442	\$4304
-------	------------------	-----	-----	----	--------	--------

Two-high stack-on bookcase, 32" open fixed shelf center, 16" open fixed shelves on either side. LP laminate back.

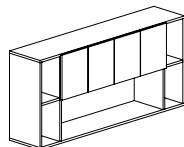

Stack-on Bookcase*

CBYS10	14.5 x 64 x 29.5	125	134	18	\$4071	\$5091
--------	------------------	-----	-----	----	--------	--------

Two-high stack-on bookcase, four door storage upper center, 48" open fixed shelf lower center, and 8" open fixed shelves on either side. LP laminate back.

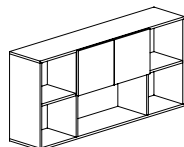

Stack-on Bookcase*

CBYS11	14.5 x 64 x 29.5	125	127	18	\$3825	\$4784
--------	------------------	-----	-----	----	--------	--------

Two-high stack-on bookcase, two door storage upper center, 32" open fixed shelves center, and 16" open fixed shelves on either side. LP laminate back.

Required Specifications

Veneer finish
Laminate finish

Optional Specifications

Lock*
Handles*
Veneer back panel

64"W STACK-ON BOOKCASES

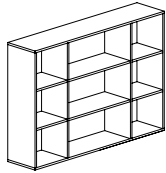

Stack-on Bookcase

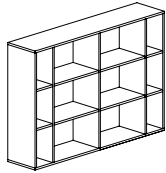

Stack-on Bookcase

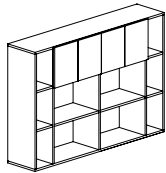

Stack-on Bookcase*

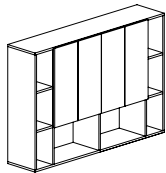

Stack-on Bookcase*

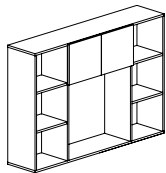

Stack-on Bookcase*

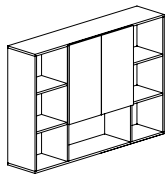

Stack-on Bookcase*

MODEL#	DIMENSIONS	FREIGHT CLASS	WT/LBS.	CUBIC FT.	LAMINATE	veneer
--------	------------	---------------	---------	-----------	----------	--------

	D x W x H					
CBYS12	14.5 x 64 x 44	125	164	27	\$4837	\$6047

Three-high stack-on bookcase, 32" open fixed shelves center, 16" open fixed shelves on either side. LP laminate back.

CBYS13	14.5 x 64 x 44	125	174	27	\$5100	\$6376
--------	----------------	-----	-----	----	---------------	---------------

Three-high stack-on bookcase, two 24" open fixed shelves center, 8" open fixed shelves on either side. LP laminate back.

CBYS14	14.5 x 64 x 44	125	186	27	\$5802	\$7253
--------	----------------	-----	-----	----	---------------	---------------

Three-high stack-on bookcase, four door storage upper center, two 24" open fixed shelves lower center, 8" open fixed shelves on either side. LP laminate back.

CBYS15	14.5 x 64 x 44	125	198	27	\$6163	\$7706
--------	----------------	-----	-----	----	---------------	---------------

Three-high stack-on bookcase, four door storage upper center, two 24" open fixed shelves lower center, 8" open fixed shelves on either side. LP laminate back.

CBYS16	14.5 x 64 x 44	125	172	27	\$5214	\$6520
--------	----------------	-----	-----	----	---------------	---------------

Three-high stack-on bookcase, two door storage upper center, 32" open shelf lower center, 16" open fixed shelves on either side. LP laminate back.

CBYS17	14.5 x 64 x 44	125	172	27	\$5461	\$6829
--------	----------------	-----	-----	----	---------------	---------------

Three-high stack-on bookcase, two door storage upper center with adjustable shelf, 32" open fixed shelf lower center, 16" open fixed shelves on either side. LP laminate back.

Required Specifications

Veneer finish
Laminate finish

Optional Specifications

Lock*
Handles*
Veneer back panel

64"W STACK-ON BOOKCASES

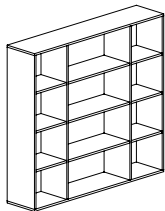
**Stack-on Bookcase**

MODEL#	DIMENSIONS D x W x H	FREIGHT CLASS	WT/LBS.	CUBIC FT.	LAMINATE	VENEER
CBYS18	14.5 x 64 x 58.5	150	208	35	\$6224	\$7782

Four-high stack-on bookcase, 32" open fixed shelves center, 16" open fixed shelves on either side. LP laminate back.

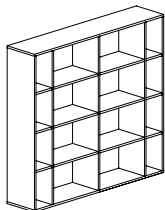
**Stack-on Bookcase**

CBYS19	14.5 x 64 x 58.5	125	222	35	\$6665	\$8332
--------	------------------	-----	-----	----	---------------	---------------

Four-high stack-on bookcase, two 24" open fixed shelves center, 8" open fixed shelves on either side. LP laminate back.

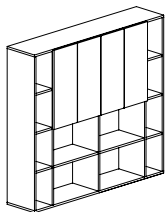
**Stack-on Bookcase***

CBYS20	14.5 x 64 x 58.5	125	245	35	\$7659	\$9576
--------	------------------	-----	-----	----	---------------	---------------

Four-high stack-on bookcase, four door storage upper center, with adjustable shelves, two 24" open fixed shelves lower center, 8" open fixed shelves on either side. LP laminate back.

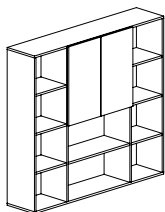
**Stack-on Bookcase***

CBYS21	14.5 x 64 x 58.5	125	224	35	\$6720	\$8401
--------	------------------	-----	-----	----	---------------	---------------

Four-high stack-on bookcase, two door storage upper center, with adjustable shelf, 32" open fixed shelf lower center, 16" open fixed shelves on either side. LP laminate back.

Required Specifications

Veneer finish
Laminate finish

Optional Specifications

Lock*
Handles*
Veneer back panel

32"W AND 64"W FREESTANDING BOOKCASES AND STORAGE CABINETS

D x W x H

- All Bookcases and Storage cabinets are shipped assembled.
- Bookcases and Storage cabinets are available in two base heights: 4" (xxLB = Low Base) or 11.5" (xxHB = High Base)
- Back Panels of the Bookcases and storage cabinets are made of LP solid color laminate.
- Optional locking on doors (Storage units) is available (see Accessories section).

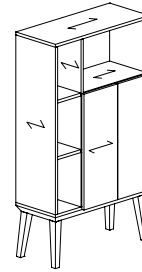

Note - Arrow indicates grain direction

32"W FREESTANDING BOOKCASES - LOW BASE

MODEL#	DIMENSIONS	FREIGHT CLASS	WT/LBS.	CUBIC FT.	LAMINATE	veneer
--------	------------	---------------	---------	-----------	----------	--------

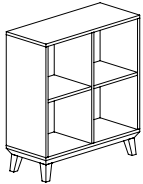

Freestanding Bookcase

CBYB1LB	14.5 x 32 x 35.5	100	101	11	\$2563	\$3205
---------	------------------	-----	-----	----	---------------	---------------

Freestanding two-high bookcase with symmetrical 16" wide openings, fixed shelves. Low base. LP Laminate back.

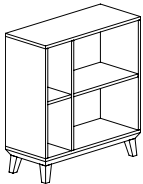

Freestanding Bookcase

CBYB2LLB	14.5 x 32 x 35.5	100	101	11	\$2563	\$3205
----------	------------------	-----	-----	----	---------------	---------------

Freestanding two-high bookcase with asymmetrical openings - **8" left / 24" right**, fixed shelves. Low base. LP laminate back.

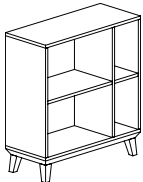

Freestanding Bookcase

CBYB2RLB	14.5 x 32 x 35.5	100	101	11	\$2563	\$3205
----------	------------------	-----	-----	----	---------------	---------------

Freestanding two-high bookcase with asymmetrical openings - **24" left / 8" right**, fixed shelves. Low base. LP laminate back.

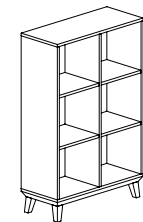

Freestanding Bookcase

CBYB3LB	14.5 x 32 x 50	125	119	15	\$3297	\$4122
---------	----------------	-----	-----	----	---------------	---------------

Freestanding three-high bookcase with symmetrical 16" wide openings, fixed shelves. Low base. LP Laminate back.

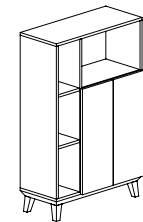

Freestanding Bookcase*

CBYB4LLB	14.5 x 32 x 50	100	138	15	\$3796	\$4746
----------	----------------	-----	-----	----	---------------	---------------

Freestanding three-high bookcase with asymmetrical openings - **8" left / 24" right**, fixed shelves, two door storage lower right with one adjustable shelf. Low base. LP Laminate back.

Required Specifications

Veneer finish
Laminate finish

Optional Specifications

Lock*
Handles*
Veneer back panel

32"W FREESTANDING BOOKCASES - LOW BASE

MODEL#

DIMENSIONS

FREIGHT CLASS

WT/LBS.

CUBIC FT.

LAMINATE

VENEER

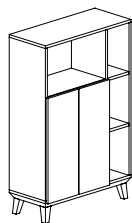

Freestanding Bookcase*

	D x W x H						
CBYB4RLB	14.5 x 32 x 50	100	138	15	\$3796	\$4746	

Freestanding three-high bookcase with asymmetrical openings - **24" left / 8" right**, fixed shelves, two door storage lower left with one adjustable shelf. Low base. LP Laminate back.

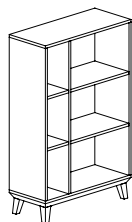

Freestanding Bookcase

CBYB5LLB	14.5 x 32 x 50	100	126	15	\$3297	\$4122	
----------	----------------	-----	-----	----	---------------	---------------	--

Freestanding three-high bookcase with asymmetrical openings - **8" left / 24" right**, fixed shelves. Low base. LP Laminate back.

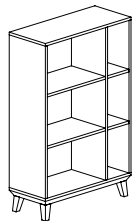

Freestanding Bookcase

CBYB5RLB	14.5 x 32 x 50	100	126	15	\$3297	\$4122	
----------	----------------	-----	-----	----	---------------	---------------	--

Freestanding three-high bookcase with asymmetrical openings - **24" left / 8" right**, fixed shelves. Low base. LP Laminate back.

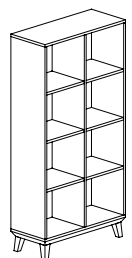

Freestanding Bookcase

CBYB6LB	14.5 x 32 x 64	125	152	20	\$4175	\$5219	
---------	----------------	-----	-----	----	---------------	---------------	--

Freestanding four-high bookcase with symmetrical 16" wide openings, fixed shelves. Low base. LP Laminate back.

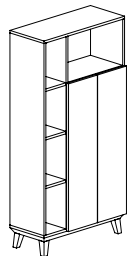

Freestanding Bookcase*

CBYB7LLB	14.5 x 32 x 64	100	169	20	\$4937	\$6173	
----------	----------------	-----	-----	----	---------------	---------------	--

Freestanding four-high bookcase with asymmetrical openings - **8" left / 24" right**, fixed shelves, two door storage lower right with two adjustable shelves. Low base. LP Laminate back.

Required Specifications

Veneer finish
Laminate finish

Optional Specifications

Lock*
Handles*
Veneer back panel

32"W FREESTANDING BOOKCASES - LOW BASE

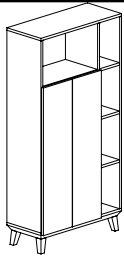

Freestanding Bookcase*

MODEL#	DIMENSIONS D x W x H	FREIGHT CLASS	WT/LBS.	CUBIC FT.	LAMINATE	ENEER
CBYB7RLB	14.5 x 32 x 64	100	169	20	\$4937	\$6173

Freestanding four-high bookcase with asymmetrical openings - **24" left / 8" right**, fixed shelves, two door storage lower left with two adjustable shelves. Low base. LP Laminate back.

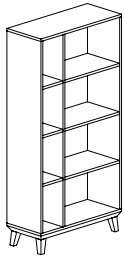

Freestanding Bookcase

CBYB8LLB	14.5 x 32 x 64	125	152	20	\$4175	\$5219
----------	----------------	-----	-----	----	--------	--------

Freestanding four-high bookcase with asymmetrical openings - **8" left / 24" right**, fixed shelves. Low base. LP Laminate back.

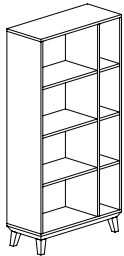

Freestanding Bookcase

CBYB8RLB	14.5 x 32 x 64	125	152	20	\$4175	\$5219
----------	----------------	-----	-----	----	--------	--------

Freestanding four-high bookcase with asymmetrical openings - **24" left / 8" right**, fixed shelves. Low base. LP Laminate back.

32"W FREESTANDING BOOKCASES - HIGH BASE

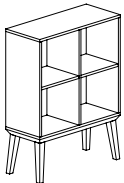

Freestanding Bookcase

MODEL#	DIMENSIONS	FREIGHT CLASS	WT/LBS.	CUBIC FT.	LAMINATE	ENEER
CBYB1HB	14.5 x 32 x 42.75	100	106	13	\$2856	\$3571

Freestanding two-high bookcase with symmetrical 16" wide openings, fixed shelves. High base. LP Laminate back.

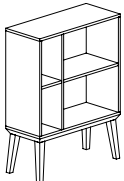

Freestanding Bookcase

CBYB2LHB	14.5 x 32 x 42.75	100	106	13	\$2856	\$3571
----------	-------------------	-----	-----	----	--------	--------

Freestanding two-high bookcase with asymmetrical openings - **8" left / 24" right**, fixed shelves. High base. LP laminate back.

Required Specifications

Veneer finish
Laminate finish

Optional Specifications

Lock*
Handles*
Veneer back panel

32"W FREESTANDING BOOKCASES - HIGH BASE

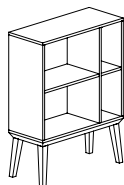

Freestanding Bookcase

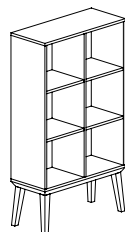

Freestanding Bookcase

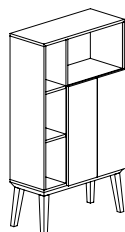

Freestanding Bookcase*

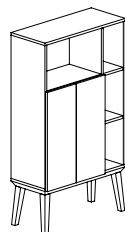

Freestanding Bookcase*

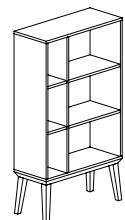

Freestanding Bookcase

MODEL#	DIMENSIONS	FREIGHT CLASS	WT/LBS.	CUBIC FT.	LAMINATE	VENEER
--------	------------	---------------	---------	-----------	----------	--------

D x W x H

CBYB2RHB	14.5 x 32 x 42.75	100	106	13	\$2856	\$3571
----------	-------------------	-----	-----	----	--------	--------

Freestanding two-high bookcase with asymmetrical openings - **24" left / 8" right**, fixed shelves. High base. LP laminate back.

CBYB3HB	14.5 x 32 x 57	125	119	18	\$3588	\$4487
---------	----------------	-----	-----	----	--------	--------

Freestanding three-high bookcase with symmetrical 16" wide openings, fixed shelves. High base. LP Laminate back.

CBYB4LHB	14.5 x 32 x 57	125	143	18	\$4088	\$5111
----------	----------------	-----	-----	----	--------	--------

Freestanding three-high bookcase with asymmetrical openings - **8" left / 24" right**, fixed shelves, two door storage lower right with one adjustable shelf. High base. LP Laminate back.

CBYB4RHB	14.5 x 32 x 57	125	143	18	\$4088	\$5111
----------	----------------	-----	-----	----	--------	--------

Freestanding three-high bookcase with asymmetrical openings - **24" left / 8" right**, fixed shelves, two door storage lower right with one adjustable shelf. High base. LP Laminate back.

CBYB5LHB	14.5 x 32 x 57	125	131	18	\$3588	\$4487
----------	----------------	-----	-----	----	--------	--------

Freestanding three-high bookcase with asymmetrical openings - **8" left / 24" right**, fixed shelves. High base. LP Laminate back.

Required Specifications

Veneer finish
Laminate finish

Optional Specifications

Lock*
Handles*
Veneer back panel

32"W FREESTANDING BOOKCASES - HIGH BASE

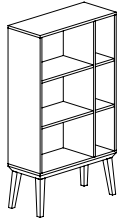

Freestanding Bookcase

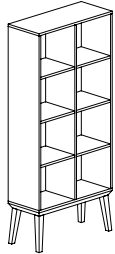

Freestanding Bookcase

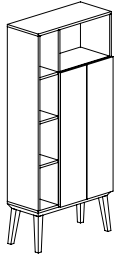

Freestanding Bookcase*

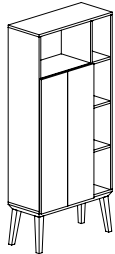

Freestanding Bookcase*

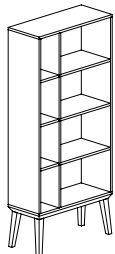

Freestanding Bookcase

MODEL#	DIMENSIONS	FREIGHT CLASS	WT/LBS.	CUBIC FT.	LAMINATE	VENEER
--------	------------	---------------	---------	-----------	----------	--------

	D x W x H					
CBYB5RHB	14.5 x 32 x 57	125	131	18	\$3588	\$4487

Freestanding three-high bookcase with asymmetrical openings - **24" left / 8" right**, fixed shelves. High base. LP Laminate back.

CBYB6HB	14.5 x 32 x 71.5	125	157	22	\$4467	\$5585
---------	------------------	-----	-----	----	---------------	---------------

Freestanding four-high bookcase with symmetrical 16" wide openings, fixed shelves. High base. LP Laminate back.

CBYB7LHB	14.5 x 32 x 71.5	125	174	22	\$5230	\$6539
----------	------------------	-----	-----	----	---------------	---------------

Freestanding four-high bookcase with asymmetrical openings - **8" left / 24" right**, fixed shelves, two door storage lower right with two adjustable shelves. High base. LP Laminate back.

CBYB7RHB	14.5 x 32 x 71.5	125	174	22	\$5230	\$6539
----------	------------------	-----	-----	----	---------------	---------------

Freestanding four-high bookcase with asymmetrical openings - **24" left / 8" right**, fixed shelves, two door storage lower left with two adjustable shelves. High base. LP Laminate back.

CBYB8LHB	14.5 x 32 x 71.5	125	157	22	\$4467	\$5585
----------	------------------	-----	-----	----	---------------	---------------

Freestanding four-high bookcase with asymmetrical openings - **8" left / 24" right**, fixed shelves. High base. LP Laminate back.

Required Specifications

- Veneer finish
- Laminate finish

Optional Specifications

- Lock*
- Handles*
- Veneer back panel

32"W FREESTANDING BOOKCASES - HIGH BASE

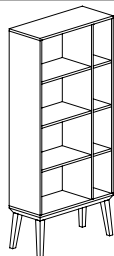

Freestanding Bookcase

MODEL#

DIMENSIONS

FREIGHT CLASS

WT/LBS.

CUBIC FT.

LAMINATE

VENEER

D x W x H

CBYB8RHB

14.5 x 32 x 71.5

125

157

22

\$4467

\$5585

Freestanding four-high bookcase with asymmetrical openings - **24" left / 8" right**, fixed shelves. High base. LP Laminate back.

64"W FREESTANDING BOOKCASES - LOW BASE

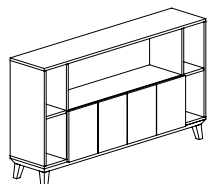

Freestanding Bookcase*

MODEL#

DIMENSIONS

FREIGHT CLASS

WT/LBS.

CUBIC FT.

LAMINATE

VENEER

CBYB9LB

14.5 x 64 x 35.5

100

177

21

\$4660

\$5826

Freestanding two-high bookcase with four door storage lower center, 48" open fixed upper shelf and 8" open fixed shelves on either side. Low base. LP Laminate back.

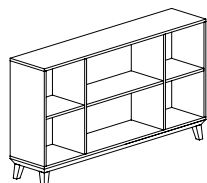

Freestanding Bookcase

CBYB10LB

14.5 x 64 x 35.5

125

162

21

\$4028

\$5036

Freestanding two-high bookcase, 32" open fixed shelf center, and 16" open fixed shelves on either side. Low base. LP Laminate back.

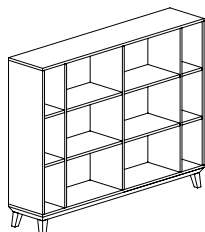

Freestanding Bookcase

CBYB11LB

14.5 x 64 x 50

125

217

30

\$4290

\$5364

Freestanding three-high bookcase, two 24" open fixed shelves center, and 8" open fixed shelves on either side. Low base. LP Laminate back.

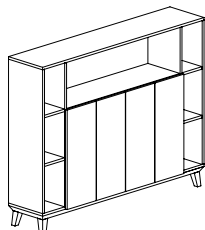

Freestanding Bookcase*

CBYB12LB

14.5 x 64 x 50

125

237

30

\$6750

\$8439

Freestanding three-high bookcase, four door storage lower center with adjustable shelves, 48" open fixed shelf upper, and 8" open fixed shelves on either side. Low base. LP Laminate back.

Required Specifications

Veneer finish
Laminate finish

Optional Specifications

Lock*
Handles*
Veneer back panel

64"W FREESTANDING BOOKCASES - LOW BASE

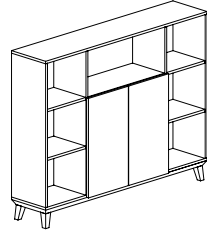

Freestanding Bookcase*

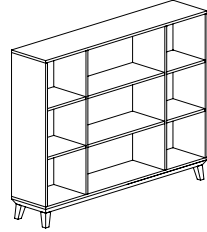

Freestanding Bookcase

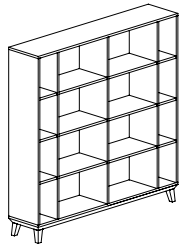

Freestanding Bookcase

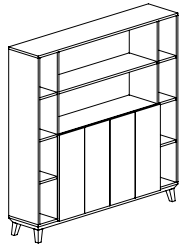

Freestanding Bookcase*

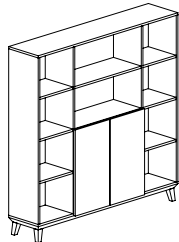

Freestanding Bookcase*

MODEL#	DIMENSIONS	FREIGHT CLASS	WT/LBS.	CUBIC FT.	LAMINATE	veneer
--------	------------	---------------	---------	-----------	----------	--------

CBYB13LB	14.5 x 64 x 50	125	223	30	\$6049	\$7562
----------	----------------	-----	-----	----	---------------	---------------

Freestanding three-high bookcase, two door storage lower center with adjustable shelves, 32" open fixed shelf upper, and 8" open fixed shelves on either side. Low base. LP Laminate back.

CBYB14LB	14.5 x 64 x 50	125	207	30	\$5416	\$6772
----------	----------------	-----	-----	----	---------------	---------------

Freestanding three-high bookcase, 32" open fixed shelves center, and 16" open fixed shelves on either side. Low base. LP Laminate back.

CBYB15LB	14.5 x 64 x 64	125	265	38	\$7250	\$9064
----------	----------------	-----	-----	----	---------------	---------------

Freestanding four-high bookcase, two 24" open fixed shelves center, and 8" open fixed shelves on either side. Low base. LP Laminate back.

CBYB16LB	14.5 x 64 x 64	125	281	38	\$8244	\$10307
----------	----------------	-----	-----	----	---------------	----------------

Freestanding four-high bookcase, four door storage lower center with adjustable shelves, 48" open fixed upper shelves, and 8" open fixed shelves on either side. Low base. LP Laminate back.

CBYB17LB	14.5 x 64 x 64	125	267	38	\$7304	\$9133
----------	----------------	-----	-----	----	---------------	---------------

Freestanding four-high bookcase, two door storage lower center with adjustable shelves, 32" open fixed upper shelves, and 8" open fixed shelves on either side. Low base. LP Laminate back.

Required Specifications

Veneer finish
Laminate finish

Optional Specifications

Lock*
Handles*
Veneer back panel

64"W FREESTANDING BOOKCASES - LOW BASE

MODEL#	DIMENSIONS	FREIGHT CLASS	WT/LBS.	CUBIC FT.	LAMINATE	VENEER
--------	------------	---------------	---------	-----------	----------	--------

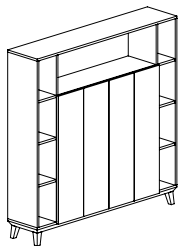

Freestanding Bookcase*

	D x W x H					
CBYB18LB	14.5 x 64 x 64	125	295	38	\$8391	\$10490

Freestanding four-high bookcase, four door storage lower center with adjustable shelves, 48" open fixed upper shelf, and 8" open fixed shelves on either side. Low base. LP Laminate back.

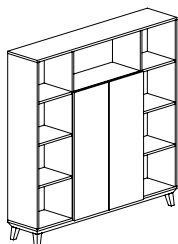

Freestanding Bookcase*

CBYB19LB	14.5 x 64 x 64	125	275	38	\$7453	\$9317
----------	----------------	-----	-----	----	--------	--------

Freestanding four-high bookcase, four door storage lower center with adjustable shelves, 32" open fixed upper shelf, and 16" open fixed shelves on either side. Low base. LP Laminate back.

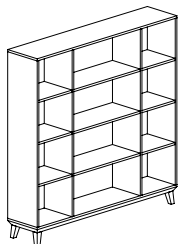

Freestanding Bookcase

CBYB20LB	14.5 x 64 x 64	125	251	38	\$6812	\$8516
----------	----------------	-----	-----	----	--------	--------

Freestanding four-high bookcase, 32" open fixed shelves center, and 16" open fixed shelves on either side. Low base. LP Laminate back.

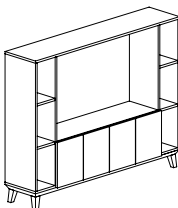

Freestanding Media Cabinet*

CBYTV1LB	14.5 x 64 x 50	125	222	30	\$6387	\$7984
----------	----------------	-----	-----	----	--------	--------

Freestanding media cabinet, 48" wide two high opening can accommodate up to a 50" monitor, four door storage lower center, 8" open fixed shelf center on either side. Monitor mount is optional. Please see accessories. Low base. LP Laminate back.

64"W FREESTANDING BOOKCASES - HIGH BASE

MODEL#	DIMENSIONS	FREIGHT CLASS	WT/LBS.	CUBIC FT.	LAMINATE	VENEER
--------	------------	---------------	---------	-----------	----------	--------

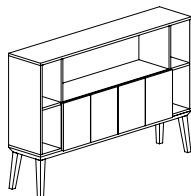

Freestanding Bookcase*

CBYB9HB	14.5 x 64 x 42.75	125	182	26	\$4953	\$6192
---------	-------------------	-----	-----	----	--------	--------

Freestanding two-high bookcase with four door storage lower center, 48" open fixed upper shelf and 8" open fixed shelves on either side. High base. LP Laminate back.

Required Specifications

Veneer finish
Laminate finish

Optional Specifications

Lock*
Handles*
Veneer back panel

64"W FREESTANDING BOOKCASES - HIGH BASE



Freestanding Bookcase

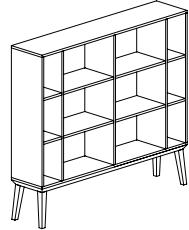

Freestanding Bookcase

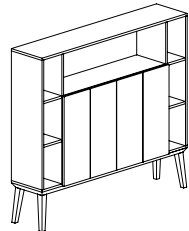

Freestanding Bookcase*

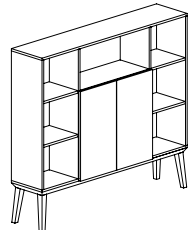

Freestanding Bookcase*

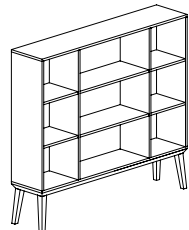

Freestanding Bookcase

MODEL#	DIMENSIONS	FREIGHT CLASS	WT/LBS.	CUBIC FT.	LAMINATE	VENEER
--------	------------	---------------	---------	-----------	----------	--------

D x W x H

CBYB10HB	14.5 x 64 x 42.75	125	167	26	\$4321	\$5403
----------	-------------------	-----	-----	----	---------------	---------------

Freestanding two-high bookcase, 32" open fixed shelf center, and 16" open fixed shelves on either side. High base. LP Laminate back.

CBYB11HB	14.5 x 64 x 57	125	222	34	\$4583	\$5730
----------	----------------	-----	-----	----	---------------	---------------

Freestanding three-high bookcase, two 24" open fixed shelves center, and 8" open fixed shelves on either side. High base. LP Laminate back.

CBYB12HB	14.5 x 64 x 57	125	242	34	\$7043	\$8806
----------	----------------	-----	-----	----	---------------	---------------

Freestanding three-high bookcase, four door storage lower center with adjustable shelves, 48" open fixed shelf upper, and 8" open fixed shelves on either side. High base. LP Laminate back.

CBYB13HB	14.5 x 64 x 57	125	228	34	\$6340	\$7927
----------	----------------	-----	-----	----	---------------	---------------

Freestanding three-high bookcase, two door storage lower center with adjustable shelves, 32" open fixed shelf upper, and 8" open fixed shelves on either side. High base. LP Laminate back.

CBYB14HB	14.5 x 64 x 57	125	212	34	\$5710	\$7139
----------	----------------	-----	-----	----	---------------	---------------

Freestanding three-high bookcase, 32" open fixed shelves center, and 16" open fixed shelves on either side. High base. LP Laminate back.

Required Specifications

Veneer finish
Laminate finish

Optional Specifications

Lock*
Handles*
Veneer back panel

64"W FREESTANDING BOOKCASES - HIGH BASE

MODEL#

DIMENSIONS

FREIGHT CLASS

WT/LBS.

CUBIC FT.

LAMINATE

VENEER

D x W x H

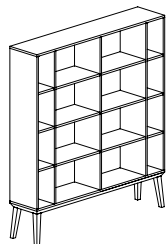

Freestanding Bookcase

MODEL#	DIMENSIONS	FREIGHT CLASS	WT/LBS.	CUBIC FT.	LAMINATE	VENEER
CBYB15HB	14.5 x 64 x 71.5	125	270	43	\$7543	\$9431

Freestanding four-high bookcase, two 24" open fixed shelves center, and 8" open fixed shelves on either side. High base. LP Laminate back.

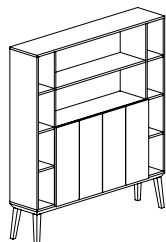

Freestanding Bookcase*

CBYB16HB	14.5 x 64 x 71.5	125	286	43	\$8539	\$10675
----------	------------------	-----	-----	----	--------	---------

Freestanding four-high bookcase, four door storage lower center with adjustable shelves, 48" open fixed upper shelves, and 8" open fixed shelves on either side. High base. LP Laminate back.

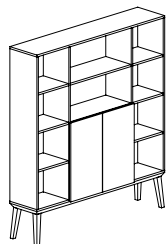

Freestanding Bookcase*

CBYB17HB	14.5 x 64 x 71.5	125	272	43	\$7599	\$9500
----------	------------------	-----	-----	----	--------	--------

Freestanding four-high bookcase, two door storage lower center with adjustable shelves, 32" open fixed upper shelves, and 8" open fixed shelves on either side. High base. LP Laminate back.

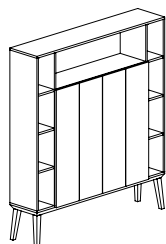

Freestanding Bookcase*

CBYB18HB	14.5 x 64 x 71.5	125	300	43	\$8684	\$10857
----------	------------------	-----	-----	----	--------	---------

Freestanding four-high bookcase, four door storage lower center with adjustable shelves, 48" open fixed upper shelf, and 8" open fixed shelves on either side. High base. LP Laminate back.

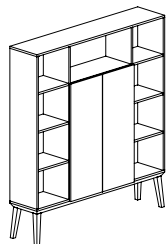

Freestanding Bookcase*

CBYB19HB	14.5 x 64 x 71.5	125	280	43	\$7746	\$9684
----------	------------------	-----	-----	----	--------	--------

Freestanding four-high bookcase, four door storage lower center with adjustable shelves, 32" open fixed upper shelf, and 16" open fixed shelves on either side. High base. LP Laminate back.

Required Specifications

Veneer finish
Laminate finish

Optional Specifications

Lock*
Handles*
Veneer back panel

64"W FREESTANDING BOOKCASES - HIGH BASE

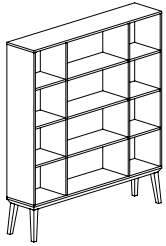

Freestanding Bookcase

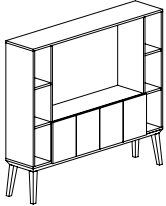

Freestanding Media Cabinet*

MODEL#	DIMENSIONS	FREIGHT CLASS	WT/LBS.	CUBIC FT.	LAMINATE	VENEER
--------	------------	---------------	---------	-----------	----------	--------

	D x W x H					
CBYB20HB	14.5 x 64 x 71.5	150	256	43	\$7103	\$8881

Freestanding four-high bookcase, 32" open fixed shelves center, and 16" open fixed shelves on either side. High base. LP Laminate back.

CBYTV1HB	14.5 x 64 x 57	125	227	34	\$6680	\$8349
----------	----------------	-----	-----	----	--------	--------

Freestanding media cabinet, 48" wide two high opening can accommodate up to a 50" monitor, four door storage lower center, 8" open fixed shelf center on either side. Monitor mount is optional. Please see accessories. High base. LP Laminate back.

ROOM DIVIDING BOOKCASES - LOW BASE

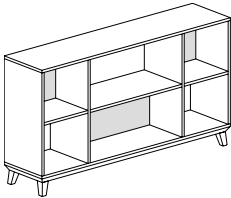

Freestanding Bookcase

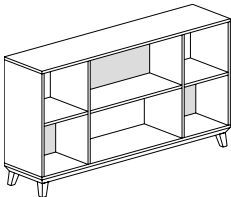

Freestanding Bookcase

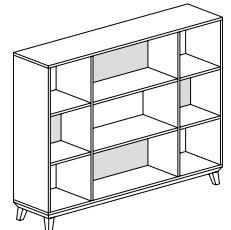

Freestanding Bookcase

MODEL#	DIMENSIONS	FREIGHT CLASS	WT/LBS.	CUBIC FT.	LAMINATE	VENEER
--------	------------	---------------	---------	-----------	----------	--------

CBYB28LB	15 x 64 x 35	125	162	21	\$5765	\$7209
----------	--------------	-----	-----	----	--------	--------

Shaded areas indicate closed cavities.

Freestanding two-high bookcase for use in open plan areas as space division. Low base. LP laminate back.

- Two 24" fixed shelves in center. Top cavity is open as a pass-through, bottom cavity is closed.
- 8" fixed shelves on either side. Top cavity is closed, bottom is open as a pass-through.

CBYB29LB	15 x 64 x 35	125	162	21	\$5765	\$7209
----------	--------------	-----	-----	----	--------	--------

Shaded areas indicate closed cavities.

Freestanding two-high bookcase for use in open plan areas as space division. Low base. LP laminate back.

- Two 24" fixed shelves in center. Top cavity is closed, bottom cavity is open as a pass-through.
- 8" fixed shelves on either side. Top cavity is open as a pass-through, bottom is closed.

CBYB26LB	15 x 64 x 49	125	217	30	\$6644	\$8307
----------	--------------	-----	-----	----	--------	--------

Shaded areas indicate closed cavities.

Freestanding three-high bookcase for use in open plan areas as space division. Low base. LP laminate back.

- Three 24" fixed shelves in center. Top and bottom cavities are closed, middle is open as a pass-through.
- Three 8" fixed shelves on either side. Top and bottom cavities are open as a pass-through, middle is closed.

Required Specifications

Veneer finish
Laminate finish

Optional Specifications

Lock*
Handles*
Veneer back panel

ROOM DIVIDING BOOKCASES - LOW BASE

MODEL#	DIMENSIONS	FREIGHT CLASS	WT/LBS.	CUBIC FT.	LAMINATE	VENEER
--------	------------	---------------	---------	-----------	----------	--------

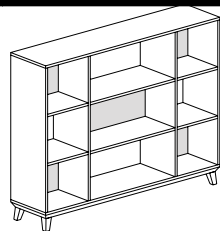

Freestanding Bookcase

	D x W x H					
CBYB27LB	15 x 64 x 49	125	217	30	\$6644	\$8307

Shaded areas indicate closed cavities.

Freestanding three-high bookcase for use in open plan areas as space division. Low base. LP laminate back.

- Three 24" fixed shelves in center. Top and bottom cavities are open as a pass-through, middle is closed.
- Three 8" fixed shelves on either side. Top and bottom cavities are closed, middle is open as a pass-through.

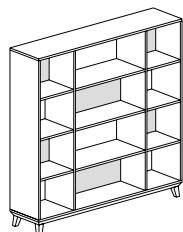

Freestanding Bookcase

CBYB22LB	15 x 64 x 64	125	265	38	\$8376	\$10471
----------	--------------	-----	-----	----	--------	---------

Shaded areas indicate closed cavities.

Freestanding four-high bookcase for use in open plan areas as space division. Low base. LP laminate back.

- Four 24" fixed shelves in center. Cavities alternate from top to bottom: open/closed/open/closed.
- Four 8" fixed shelves on either side. Cavities alternate from top to bottom: closed/open/closed/open.

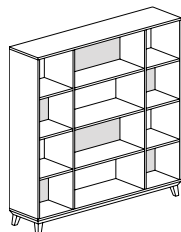

Freestanding Bookcase

CBYB23LB	15 x 64 x 64	125	265	38	\$8376	\$10471
----------	--------------	-----	-----	----	--------	---------

Shaded areas indicate closed cavities.

Freestanding four-high bookcase for use in open plan areas as space division. Low base. LP laminate back.

- Four 24" fixed shelves in center. Cavities alternate from top to bottom: closed/open/closed/open.
- Four 8" fixed shelves on either side. Cavities alternate from top to bottom: open/closed/open/closed.

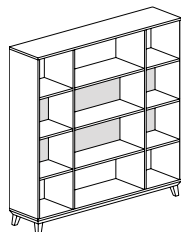

Freestanding Bookcase

CBYB24LB	15 x 64 x 64	125	265	38	\$8376	\$10471
----------	--------------	-----	-----	----	--------	---------

Shaded areas indicate closed cavities.

Freestanding four-high bookcase for use in open plan areas as space division. Low base. LP laminate back.

- Four 24" fixed shelves in center. Top and bottom cavities are open as a pass-through. Two middle cavities are closed.
- Four 8" fixed shelves on either side. Top and bottom cavities are closed. Two middle cavities are open as a pass-through.

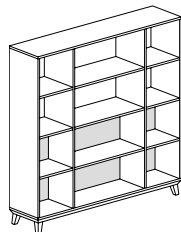

Freestanding Bookcase

CBYB25LB	15 x 64 x 64	125	265	38	\$8376	\$10471
----------	--------------	-----	-----	----	--------	---------

Shaded areas indicate closed cavities.

Freestanding four-high bookcase for use in open plan areas as space division. Low base. LP laminate back.

- Four 24" fixed shelves in center. Top two cavities are open as a pass-through. Bottom two cavities are closed.
- Four 8" fixed shelves on either side. Top two cavities are open as a pass-through. Bottom two cavities are closed.

Required Specifications

Veneer finish
Laminate finish

Optional Specifications

Veneer back panel

ROOM DIVIDING BOOKCASES - HIGH BASE

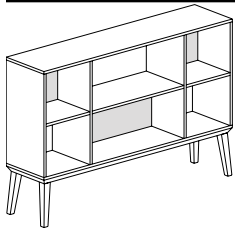

Freestanding Bookcase

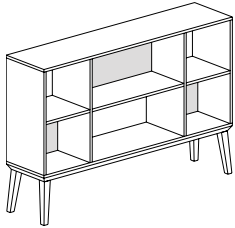

Freestanding Bookcase

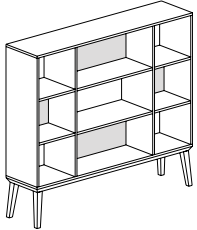

Freestanding Bookcase

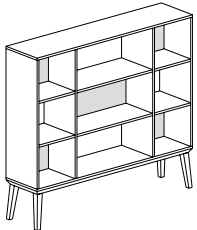

Freestanding Bookcase

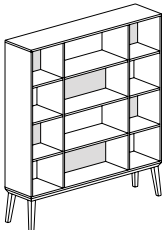

Freestanding Bookcase

MODEL#	DIMENSIONS D x W x H	FREIGHT CLASS	WT/LBS.	CUBIC FT.	LAMINATE	veneer
CBYB28HB	15 x 64 x 43	125	167	26	\$6049	\$7562

Shaded areas indicate closed cavities.

Freestanding two-high bookcase for use in open plan areas as space division. High base. LP laminate back.

- Two 24" fixed shelves in center. Top cavity is open as a pass-through, bottom cavity is closed.
- 8" fixed shelves on either side. Top cavity is closed, bottom is open as a pass-through.

CBYB29HB	15 x 64 x 43	125	167	26	\$6049	\$7562
----------	--------------	-----	-----	----	---------------	---------------

Shaded areas indicate closed cavities.

Freestanding two-high bookcase for use in open plan areas as space division. High base. LP laminate back.

- Two 24" fixed shelves in center. Top cavity is closed, bottom cavity is open as a pass-through.
- 8" fixed shelves on either side. Top cavity is open as a pass-through, bottom is closed.

CBYB26HB	15 x 64 x 57	125	222	34	\$6923	\$8656
----------	--------------	-----	-----	----	---------------	---------------

Shaded areas indicate closed cavities.

Freestanding three-high bookcase for use in open plan areas as space division. High base. LP laminate back.

- Three 24" fixed shelves in center. Top and bottom cavities are closed, middle is open as a pass-through.
- Three 8" fixed shelves on either side. Top and bottom cavities are open as a pass-through, middle is closed.

CBYB27HB	15 x 64 x 57	125	222	34	\$6923	\$8656
----------	--------------	-----	-----	----	---------------	---------------

Shaded areas indicate closed cavities.

Freestanding three-high bookcase for use in open plan areas as space division. High base. LP laminate back.

- Three 24" fixed shelves in center. Top and bottom cavities are open as a pass-through, middle is closed.
- Three 8" fixed shelves on either side. Top and bottom cavities are closed, middle is open as a pass-through.

CBYB22HB	15 x 64 x 72	125	270	43	\$8713	\$10894
----------	--------------	-----	-----	----	---------------	----------------

Shaded areas indicate closed cavities.

Freestanding four-high bookcase for use in open plan areas as space division. High base. LP laminate back.

- Four 24" fixed shelves in center. Cavities alternate from top to bottom: open/closed/open/closed.
- Four 8" fixed shelves on either side. Cavities alternate from top to bottom: closed/open/closed/open.

Required Specifications

Veneer finish
Laminate finish

Optional Specifications

Veneer back panel

ROOM DIVIDING BOOKCASES - HIGH BASE

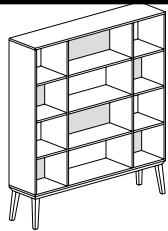

Freestanding Bookcase

MODEL#	DIMENSIONS D x W x H	FREIGHT CLASS	WT/LBS.	CUBIC FT.	LAMINATE	VENEER
CBYB23HB	15 x 64 x 72	125	270	43	\$8713	\$10894

Shaded areas indicate closed cavities.

Freestanding four-high bookcase for use in open plan areas as space division. High base. LP laminate back.

- Four 24" fixed shelves in center. Cavities alternate from top to bottom: closed/open/closed/open.
- Four 8" fixed shelves on either side. Cavities alternate from top to bottom: open/closed/open/closed.

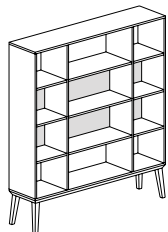

Freestanding Bookcase

CBYB24HB	15 x 64 x 72	125	270	43	\$8713	\$10894
----------	--------------	-----	-----	----	--------	---------

Shaded areas indicate closed cavities.

Freestanding four-high bookcase for use in open plan areas as space division. High base. LP laminate back.

- Four 24" fixed shelves in center. Top and bottom cavities are open as a pass-through. Two middle cavities are closed.
- Four 8" fixed shelves on either side. Top and bottom cavities are closed. Two middle cavities are open as a pass-through.

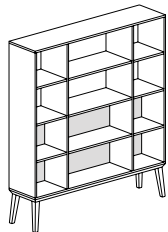

Freestanding Bookcase

CBYB25HB	15 x 64 x 72	125	270	43	\$8713	\$10894
----------	--------------	-----	-----	----	--------	---------

Shaded areas indicate closed cavities.

Freestanding four-high bookcase for use in open plan areas as space division. High base. LP laminate back.

- Four 24" fixed shelves in center. Top two cavities are open as a pass-through. Bottom two cavities are closed.
- Four 8" fixed shelves on either side. Top two cavities are open as a pass-through. Bottom two cavities are closed.

FLOATING SHELF

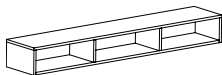

Wall Mounted Open Storage

MODEL#	DIMENSIONS	FREIGHT CLASS	WT/LBS.	CUBIC FT.	LAMINATE	VENEER
CBYF096D12H8	12 x 96 x 8	125	78	10	\$2150	\$2688
CBYF064D12H8	12 x 64 x 8	125	50	8	\$1404	\$1758
CBYF032D12H8	12 x 32 x 8	100	35	4	\$1272	\$1593

To be used as a stand alone unit.

Required Specifications

Veneer finish
Laminate finish

Optional Specifications

Veneer back panel

ACCESSORIES

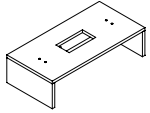

Riser Box*

MODEL#	DIMENSIONS D x W x H	FREIGHT CLASS	WT./LBS.	CUBIC FT.	LAMINATE	VENEER
CBYSPBOX2814	14 x 28 x 7.5	150	14	3	\$220	\$277
CBYSPBOX2014	14 x 20 x 7.5	250	2	1	\$405	\$508

Riser box for 20"H storage to support peninsula table. For wire pass through grommets, both top and back are included.

- CBYSPBOX2814 for use with 32"D peninsula tables and executive bridges.
- CBYSPBOX2014 for use with 24"D executive bridges

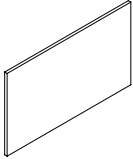

Hanging Wood Modesty Panel*

CBYCMPW62H22	.75 x 62 x 22	100	28	3	\$836	\$1047
CBYCMPW56H22	.75 x 56 x 22	100	26	3	\$779	\$976
CBYCMPW50H22	.75 x 50 x 22	100	24	3	\$735	\$920
CBYCMPW44H22	.75 x 44 x 22	92.5	22	2	\$675	\$845
CBYCMPW38H22	.75 x 38 x 22	92.5	20	2	\$619	\$775

22" hanging wood modesty panel.

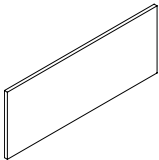

Hanging Wood Modesty Panel*

CBYCMPW74H15	.75 x 74 x 15	100	24	3	\$860	\$1077
CBYCMPW68H15	.75 x 68 x 15	125	23	3	\$811	\$1015
CBYCMPW62H15	.75 x 62 x 15	92.5	21	2	\$811	\$1015
CBYCMPW56H15	.75 x 56 x 15	92.5	20	2	\$755	\$945
CBYCMPW50H15	.75 x 50 x 15	100	18	2	\$709	\$889
CBYCMPW44H15	.75 x 44 x 15	100	17	2	\$648	\$812
CBYCMPW38H15	.75 x 38 x 15	125	15	2	\$593	\$742

15" hanging wood modesty panel.

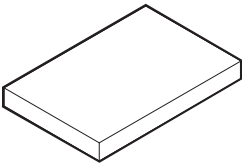

Cushion**

CU3020	20 x 30 x 2.5	150	6	1.30	1	\$232	7	\$501
	2				\$275	8	\$594	
	3				\$304	9	\$666	
	4				\$350	10	\$744	
	5				\$412	11	\$907	
	6				\$444	12	\$1085	

Cushion attaches with Velcro strips. For use on cabinets of coordinating size..

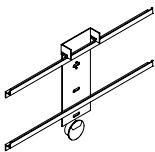

Flat Screen Monitor Mount

FVMED	2 x 28 x 17	70	14	.70	\$735
-------	-------------	----	----	-----	--------------

Flat screen monitor mount up to 50". To be used on CBYTV1LB and CBYTV1HB media cabinets. GM1K (tungsten) grommet on the back panel is included.

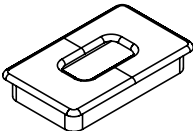

Grommet

GM5C	2 x 3.5 x --	70	--	--	\$107
------	--------------	----	----	----	--------------

Rectangular grommet in metal, tungsten finish.

Required Specifications

- Finish
- Fabric (cushion)**

POWER/DATA



Single Sided Recessed Power Block

MODEL#	DIMENSIONS	FREIGHT CLASS	WT/LBS.	CUBIC FT.	LIST PRICE
--------	------------	---------------	---------	-----------	------------

D x W x H					
-----------	--	--	--	--	--

PRTMCS401B	4.22 x 10.78 x 4.86	100	4.3	0.51	\$456
PRTMCS401T	4.22 x 10.78 x 4.86	100	4.3	0.51	\$456
PRTMCS401W	4.22 x 10.78 x 4.86	100	4.3	0.51	\$456

Single-sided recessed power block with **one regular duplex and one telecom knockout on top; one power duplex on bottom**. 10' power cord with straight plug. Specify telecom options separately, see page 56. Available in Black (**B**), Tungsten (**T**) or Designer White (**W**) as indicated by the last letter of model number. Duplexes always Grey. Corresponding cut-out options are **R1, R2** or **R3**. Units are not approved for daisy chaining. UL listed: UL 1363.



Single Sided Recessed Power Block - USB-A + USB-C

PRTMCS421B	4.22 x 10.78 x 4.86	100	4.3	0.51	\$599
PRTMCS421T	4.22 x 10.78 x 4.86	100	4.3	0.51	\$599
PRTMCS421W	4.22 x 10.78 x 4.86	100	4.3	0.51	\$599

Single-sided recessed power block with **one power/USB-A/USB-C duplex and one telecom knockout on top; one power duplex on bottom**. USB-A port charges max 2.4 amps at 5V and USB-C port charges max 3 amps at 5V. 10' power cord with straight plug. Specify telecom options separately, see page 56. Available in Black (**B**), Tungsten (**T**) or Designer White (**W**) as indicated by the last letter of model number. Duplexes always Grey (duplex with USB ports is glossy finish). Corresponding cut-out options are **R1, R2** or **R3**. Units are not approved for daisy chaining. UL listed: UL 1363.



Double Sided Recessed Power Block

PRTMCD602B	6.22 x 10.78 x 4.86	92.5	5.9	0.51	\$521
PRTMCD602T	6.22 x 10.78 x 4.86	92.5	5.9	0.51	\$521
PRTMCD602W	6.22 x 10.78 x 4.86	92.5	5.9	0.51	\$521

Double-sided recessed power block with **two regular power duplexes and two telecom knockouts on top; one power duplex on bottom**. 10' power cord with straight plug. Specify telecom options separately, see page 56. Available in Black (**B**), Tungsten (**T**) or Designer White (**W**) as indicated by last letter of model number. Duplexes always Grey. Corresponding cut-out options are **T1, T2** or **T3**. Units are not approved for daisy chaining. UL listed: UL 1363.



Double Sided Recessed Power Block - USB-A + USB-C

PRTMCD622B	6.22 x 10.78 x 4.86	92.5	6.1	0.51	\$656
PRTMCD622T	6.22 x 10.78 x 4.86	92.5	6.1	0.51	\$656
PRTMCD622W	6.22 x 10.78 x 4.86	92.5	6.1	0.51	\$656

Double-sided recessed power block with **one regular power duplex, one power/USB-A/USB-C duplex and two telecom knockouts on top; one power duplex on bottom**. USB-A port charges max 2.4 amps at 5V and USB-C port charges max 3 amps at 5V. 10' power cord with straight plug. Specify telecom options separately, see page 56. Available in Black (**B**), Tungsten (**T**) or Designer White (**W**) as indicated by last letter of model number. Duplexes always Grey (duplex with USB ports is glossy finish). Corresponding cut-out options are **T1, T2** or **T3**. Units are not approved for daisy chaining. UL listed: UL 1363.



Double Sided Recessed Power Block - USB-A + USB-C

PRTMCD642B	6.22 x 10.78 x 4.86	85	6.3	0.51	\$790
PRTMCD642T	6.22 x 10.78 x 4.86	85	6.3	0.51	\$790
PRTMCD642W	6.22 x 10.78 x 4.86	85	6.3	0.51	\$790

Double-sided recessed power block with **two power/USB-A/USB-C duplexes and two telecom knockouts on top; one power duplex on bottom**. USB-A port charges max 2.4 amps at 5V and USB-C port charges max 3 amps at 5V. 10' power cord with straight plug. Specify telecom options separately, see page 56. Available in Black (**B**), Tungsten (**T**) or Designer White (**W**) as indicated by last letter of model number. Duplexes always Grey (duplex with USB ports is glossy finish). Corresponding cut-out options are **T1, T2** or **T3**. Units are not approved for daisy chaining. UL listed: UL 1363.

Required Specifications

Finish

POWER / DATA

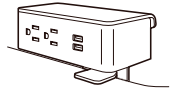

Edge Mounted 2 Power/USB

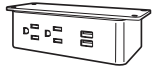

Under Mounted 2 Power/USB*

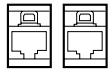

Telecom Plate - 2 x 6



Telecom Plate - 3 x 6

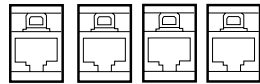

Telecom Plate - 4 x 6



Telecom Plate - 3TSV

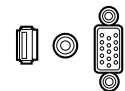

Telecom Plate - 3SVH

MODEL#	DIMENSIONS D x W x H	FREIGHT CLASS	WT/LBS.	CUBIC FT.	LIST PRICE
PS305057	5.5 x 3.2 x 3	60	3.01	0.05	\$386
PS305002	5.5 x 3.2 x 3	60	3.01	0.05	\$386

Edge mounted power module with two power outlets and two 2.1 amp USB ports. Edge clamp accommodates worksurfaces 0.5" to 1.5" thick; fastened with thumb screws. 6' cord.

PS305057 - White module with Silver bracket. PS305002 - Black module with Silver bracket

PS305157	5.5 x 2.8 x 1.8	60	3.2	0.05	\$335
PS305102	5.5 x 2.8 x 1.8	60	3.2	0.05	\$335

Under mount power module with two power outlets and two 2.1 amp USB ports. Mountable under most worksurfaces. Installation template provided. 6' cord.

PS305157 - White module with Silver bracket. PS305102 - Black module with Silver bracket.

PTEL01	- x - x -	70	0.01	0.05	\$164
--------	-----------	----	------	------	--------------

Includes 2 x RJ45 cat 6 data. Black telecom plate. To be hardwired by data contractor.

PTEL02	- x - x -	70	0.01	0.05	\$222
--------	-----------	----	------	------	--------------

Includes 2 x RJ45 cat 6 data and 1 RJ11 cat phone. Black telecom plate. To be hardwired by data contractor.

PTEL03	- x - x -	70	0.01	0.05	\$340
--------	-----------	----	------	------	--------------

Includes 4 x RJ45 cat 6 data. Black telecom plate. To be hardwired by data contractor.

PTEL04	- x - x -	70	0.01	0.05	\$290
--------	-----------	----	------	------	--------------

Includes 1 x RJ45 cat 6 data, mini stereo and 15 pin HD VGA. Black telecom plate. To be hardwired by data contractor.

PTEL05	- x - x -	70	0.01	0.05	\$401
--------	-----------	----	------	------	--------------

Includes mini stereo, 15 pin HD VGA and HDMI. Black telecom plate.

Required Specifications

Finish*

ACCESSORIES

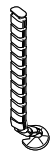
**Cable Snake**

MODEL#	DIMENSIONS	FREIGHT CLASS	WT/LBS.	CUBIC FT.	LIST PRICE
BRTCS	D x W x H 2 x 8 x 30	70	3	.19	\$152

Flexible cable management trough. Two pathways within the snake, one for data/communication and one for routing power cables. Translucent White finish only.

**Cable Snake**

PCSN01	-- x -- x --	92.5	2.10	.20	\$135
--------	--------------	------	------	-----	--------------

Flexible cable management. Provides access to power/data from floor to underside of worksurface where it attaches. Two pathways within Cable Snake. Length under desk is 31.25". Silver (**SIL**) plastic only.

**Cable Snake Extension**

PCSN01E	- x - x -	92.5	2.1	0.2	\$108
---------	-----------	------	-----	-----	--------------

Extension kit to use with cable snake PCSN01. Additional 8 links extend cable snake up to 49" in length. Ideal for height adjustable tables. Silver plastic only.

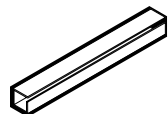
**Wire Management Track - Single**

C2M72	2 x 72 x 2	70	0.10	0.10	\$83
C2M60	2 x 60 x 2	70	0.10	0.10	\$69
C2M48	2 x 48 x 2	70	0.10	0.10	\$57
C2M36	2 x 36 x 2	70	0.10	0.10	\$42
C2M24	2 x 24 x 2	70	0.10	0.10	\$31
C2M12	2 x 12 x 2	70	0.10	0.10	\$17

To conceal and organize wires and cords. Attaches to Modesty Panel with double sided tape. Plastic.

• **Available in Black Plastic Only.**

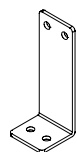
**L Bracket**

BAR526	--	70	.25	.10	\$131
--------	----	----	-----	-----	--------------

Set of two. For securing the stack-on units to the credenza.

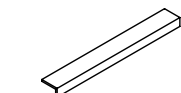
**Foot Rest Cover**

FRC8442	--	70	--	.10	\$1141
FRC7842	--	70	--	.10	\$1077
FRC7242	--	70	--	.10	\$1015
FRC6642	--	70	--	.10	\$952
FRC8432	--	70	--	.10	\$1015
FRC7832	--	70	--	.10	\$952
FRC7232	--	70	--	.10	\$889
FRC6632	--	70	--	.10	\$825

Factory installed.

ACCESSORIES



Handle

MODEL#	DIMENSIONS	FREIGHT CLASS	WT/LBS.	CUBIC FT.	LIST PRICE
--------	------------	---------------	---------	-----------	------------

D x W x H

PL89	--	70	--	--	\$35
------	----	----	----	----	-------------

Chrome finish.

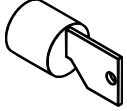

Lock Assembly

LO/C	--	70	--	--	\$106
------	----	----	----	----	--------------

Tungsten.

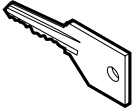

Extra Key

LOCK	--	70	--	--	\$43
------	----	----	----	----	-------------

Specify key #. Key range 401 - 420.

dufferin



global