

Seating

Effective January 1, 2023 USA

Updated June 4, 2024



PRICE LIST seating



think global

THE GLOBAL EDGE

ERGONOMICS IN THE TOTAL OFFICE

- One stop shopping for a full range of office furniture.
- Seating, desks, tables, files, modular furniture, panels and accessories.
- Ergonomics, competitive pricing and built-in value.

STRENGTH AND STABILITY

- Established in 1966.
- One of North America's largest office furniture manufacturers.
- Manufacturing and showrooms worldwide.

QUICK SHIP - INSTOCK

- Thousands of products available in a 2 day quickship program.
- Hundreds of products in stock for immediate delivery.

STRONG LOCAL REPRESENTATION

- Service and expert advice where you are, when you need it!

MANUFACTURING CAPABILITY

- Vertical integration ensures "start to finish" control.
- Ongoing research and investment in new, innovative production technology.

QUALITY ASSURANCE

- Quality Assurance Program is qualified by C.G.S.B. ISO9001 standards.
- On-site furniture testing facility.
- Product and components are tested to meet or exceed ANSI/BIFMA standards.

ENVIRONMENTAL COMMITMENT

- Continuous development of "earth friendly" programs.
- One of the first molded foam manufacturers to create ozone friendly, CFC and HFC-free process.
- Seat and back pans are made from recyclable plastics and wood waste, enabling little waste and cost effective products.

SYMBOL IDENTIFICATION

Each seating product with an RTA code identifies the assembly requirements.

RTA 00 FULLY ASSEMBLED

RTA 1 SIMPLE ASSEMBLY (No Tools Required)

Parts to Install:

- Casters
- Base
- Pneumatic Cylinder/Cover can

RTA 2 MODEST ASSEMBLY (Tools Supplied, if necessary)

Parts to Install:

- Casters
- Base
- Pneumatic Cylinder/Cover can
- Back

RTA 4 MODERATE ASSEMBLY (Tools Supplied)

Parts to Install:

- Casters
- Base
- Pneumatic Cylinder/Cover can
- Back
- Armrest

RTA 8 FULL ASSEMBLY (Tools Supplied)

Parts to Install:

- Casters
- Base
- Pneumatic Cylinder/Cover can
- Back
- Armrest
- Mechanism



Global's Certified Products are in compliance with the stringent emission guidelines set by the GREENGUARD Environmental Institute and include all Upholstered Seating. To obtain a GREENGUARD or GREENGUARD Gold Certificate for any product, please go to the Environmental Commitment section on our website www.globalfurnituregroup.com and click on "GREENGUARD".



level™ certification, based on the ANSI/BIFMA e3-2012 furniture sustainability standard, sets furniture manufacturers on a path toward greater sustainability over time. Based on environmental and social criteria set forth in the standard, a product's entire supply chain is assessed.

Certification assessment includes an evaluation of specific corporate policies and guidelines and an assessment of associated company manufacturing facilities. Products must meet quantifiable milestones of environmental and social performance at every step of development.

The quantitative assessment addresses four categories: material use, energy and atmosphere impacts, human and ecosystem health and social responsibility.

Manufacturers earn points in each of the four categories. The level™ brand and its numeric rating of 1, 2 or 3 indicate what threshold of certification a product has achieved. level™ 3 is the highest rating.



All products with this designation are suitable for FedEx and UPS shipment throughout the United States.

TABLE OF CONTENTS

A		K
Academic Task435	Enterprise33	Kate339
Arno25	Erin177	
Arturo26	F	L
Aspen27	Factor37	Layne183
Auburn29	File Buddy179	Lite185
	Flap180	Loover60
B		Luray64
Bakhita135	G	Lux340
Ballara270	G139	
Beach138	G2041	M
Beam Seating139	Global Accord42	Malaga67
Braden282	Goal46	Malaga TS415
Bridges II Collaborative Seating285	Graham48	Marche190
	Granada49	Mayne192
C	Granada Deluxe54	Mirage68
Calidon293	Granada Deluxe TS415	ML342
Camino299	Graphic58	ML Park342
Caprice149		Moda Four-Legged193
Chap151	I	Moda Stacking194
Citi304	Industrial Seating437	
Citi Square309	Industrial Wipe Down442	N
Comet153	Islands182	Noetic69
Concorde30		Novello74
	J	
D	Jeo336	
Diplomat32		
Drift318		
Duet157		
Duet tables174		

TABLE OF CONTENTS

O

ObusForme Comfort + XL78

P

Popcorn196

Prairie345

Prefer84

R

Rebound201

River346

River Personal Harbor362

River+364

Robust421

Roma86

Roma Nester206

S

Sas208

Saxon422

Sidero210

Sirena396

Solar90

Solo92

Sonic214

Sora94

Spritz96

Spritz multi-purpose230

Spyker233

Stream234

Supra101

Supra X103

Synopsis106

T

Tamiri109

Traditional111

Triumph115

Truform116

Twilight246

Tye119

V

Venture400

Vion122

Vion guest249

Vitrola403

W

Weev130

Willow254

Wind405

Wind Linear407

Z

Zoma268

REFERENCES/PROGRAMS

Seating by Category Types 4-11

Suggested Applications by Series 12-13

Ergonomic Features and Benefits 15

Mechanism Adjustments 16

How to Order Seating 17

Act Performance Symbols 18

Fast5 19

Heavy Duty/24 Hour 414

How to select armrests 426

Arm selections 427

Caster selections 430

Cylinder chart 432

Duet + Popcorn glide selections 433

Specialty seating 439

Textiles + Finishes 448





COM Authorization Form 455

Terms/Conditions/Warranty 458

SEATING BY CATEGORY TYPE



















Task

 Arno.....25	 Luray64	 Stream.....98
 Aspen27	 Malaga67	 Supra101
 Duet.....135	 Noetic.....69	 Supra X103
 Enterprise33	 Novello74	 Synopsis106
 Factor37	 ObusForme Comfort + XL78	 Tamiri109
 G139	 Popcorn196	 Triumph115
 G2041	 Prefer84	 Truform116
 Goal46	 Roma86	 Tye119
 Graham48	 Solar90	 Vion122
 Granada49	 Solo92	 Weev130
 Granada Deluxe54	 Sonic214	
 Graphic58	 Sora94	
 Loover60	 Spritz96	

SEATING BY CATEGORY TYPE

Conference/Management

























 Arno25	 Kate.....339	 Solar90
 Arturo26	 Luray64	 Solo92
 Diplomat32	 Mirage68	 Supra101
 Enterprise33	 Roma86	 Synopsis106
 Global Accord42		 Tamiri109
 Graphic58		 Traditional111
 Jeo336		

SEATING BY CATEGORY TYPE

Executive















 Arno25	 Enterprise.....33	
 Arturo26	 Global Accord42	 Synopsis.....106
 Auburn29	 Luray64	 Tamiri109
 Concorde30	 Mirage68	 Traditional111
 Diplomat.....32		

Height Adjustable Stools





 Aspen27	 Loover60	 Spritz96
 Duet.....157	 Malaga67	 Stream.....98
 Factor37	 Noetic.....69	 Supra X.....103
 G1 Ergo Select39	 Novello74	 Synopsis106
 Global Accord42	 ObusForme Comfort + XL78	 Truform116
 Goal46	 Prefer84	 Tye119
 Granada49	 Roma86	 Vion122
 Granada Deluxe54	 Solar90	 Weev130
 Graphic58		



Stacking







 Bakhita135	 Popcorn196	 Spyker233
 Comet153	 Rebound201	 Stream234
 Duet157	 Sas208	 Vion guest249
 Flap180	 Sidero210	 Willow254
 Moda194	 Sonic214	 Zoma268

Guest (Metal)

 Arno25	 Jeo336	 Sidero210
 Caprice149	 Kate339	 Sonic214
 Comet153	 Lite185	 Stream234
 Diplomat156	 Marche190	 Twilight246
 Drift318	 Popcorn196	 Vion guest249
 Enterprise33	 Rebound201	 Willow254
 Erin177	 Sas208	

SEATING BY CATEGORY TYPE















Guest (Wood)

 Beach138	 Drift.....318	 Layne183
 Chap151	 Islands182	 Mayne192















Nesting

 Roma Nester206	 Spritz Nester230
--	--

Tandem/Beam/Pedestal

 Duet (Beam)144	 Roma (Pedestal).....86	 Synopsis (Pedestal).....106
 Duet (Pedestal).....157	 Sidero (Beam)146	 Vion (Beam)147
 Global Accord (Pedestal).....42	 Sonic (Beam)146	 Vion (Pedestal).....122
 Luray (Pedestal).....64	 Sonic (Pedestal).....214	Beam Seating139
 Novello (Pedestal).....74	 Spritz (Pedestal).....230	
 Popcorn (Beam)145	 Stream (Pedestal).....234	

Stools

 Diplomat156	 ML.....342	 Sonic214
 Duet157	 Popcorn196	 Stream234
 Drift.....318	 Rebound.....201	 Twilight246
 File Buddy179	 Sas208	 Vion guest249
 Marche190	 Sidero210	 Willow.....254



LOUNGE SEATING

Ballara.....270	Kate.....339	Sirena.....396
Braden.....282	Lux.....340	Venture.....400
Bridges II Collaborative Seating...285	ML.....342	Vitrola.....403
Camino.....299	ML Park.....344	Wind.....405
Citi.....304	Prairie.....345	
Drift.....318	River.....346	
Jeo.....336	River+.....364	

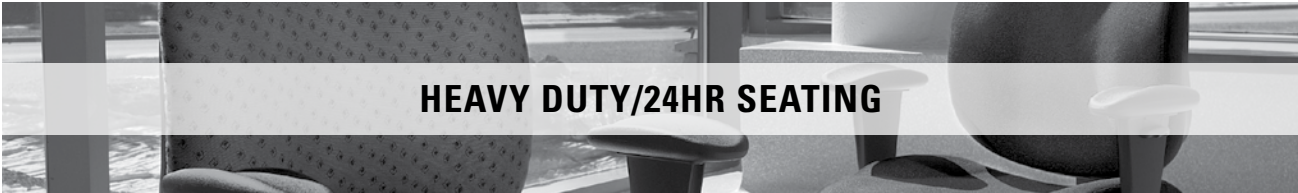

HEAVY DUTY/24HR SEATING

Concorde Executive 24HR.....418	Malaga TS.....415	Saxon.....422
G1 Ergo Select TS.....419	ObusForme Comfort TS.....416	Truform TS.....417
Granada TS.....414	Robust.....421	Vion TS.....423
Granada Deluxe TS.....415		

SEATING BY CATEGORY TYPE



EDUCATION

Classroom

Academic Task435	Popcorn196	Spritz Nester230
Duet157	Rebound201	Supra X103
Duet tables174	Roma Nester206	Vion122
Graphic58	Sidero210	Willow.....254
Novello74	Sonic214	

Work + Task

Factor37	Noetic.....69	Sora94
G139	Novello74	Spritz96
Granada49	ObusForme Comfort + XL78	Supra X103
Graphic58	Prefer84	Truform116
Loover60	Roma86	Vion122

SEATING BY CATEGORY TYPE

Guest

Caprice149	Rebound201	Vion guest249
Duet157	Roma Nester206	Willow.....254
Graphic58	Sidero210	Zoma268
Islands182	Sonic214	

Lecture Hall

Duet (Beam)144	Sidero (Beam)146	Vion (Beam)147
Popcorn (Beam)145	Sonic (Beam)146	

Lab Seating + Stools

Caprice149	Novello74	Spritz96
Duet157	Sidero210	Supra X103
Graphic58	Sonic214	Vion122

Cafeteria

Bakhita135	Popcorn196	Spyker233
Duet157	Rebound201	Willow.....254
Sas208	Sonic214	

SEATING BY CATEGORY TYPE



EDUCATION

Lounge

Ballara.....270	Citi Square309	Sirena.....396
Citi.....304	River.....346	Wind Linear.....407
Drift.....318	River+364	

Stacking & Nesting

Bakhita135	Roma Nester206	Spritz Nester230
Duet157	Sas208	Spyker233
Popcorn196	Sidero210	Stream234
Rebound.....201	Sonic214	Zoma268

SUGGESTED APPLICATIONS BY SERIES

SERIES	SUGGESTED APPLICATION	ACADEMIC SEATING	CAFETERIA SEATING	CONFERENCE ROOM SEATING	ERGONOMIC AND TASK	EXECUTIVE TASK SEATING	HEAVY DUTY SEATING	HOSPITALITY SEATING	GUEST SEATING	LOUNGE/RECEPTION SEATING	MANAGEMENT SEATING	MEETING ROOM SEATING	MULTI PURPOSE SEATING	PUBLIC SEATING	STACKING SEATING	STOODLS	TABLET SEATING	TECHNICAL SEATING	WOOD GUEST SEATING
ARNO			•						•		•	•							
ARTURO			•								•								
ASPEN				•	•						•	•							
AUBURN			•								•								
BAKHITA	•	•											•		•				
BALLARA								•		•							•		
BEACH								•	•	•			•	•					•
BEAM SEATING	•	•						•	•										
BRADEN										•									
BRIDGES II COLLAB. SEATING								•	•	•			•						
CAMINO								•	•	•									
CAPRICE		•							•				•			•			
CHAP								•	•	•									•
CITI & CITI SQUARE								•	•				•				•		
COMET		•							•	•		•	•						
CONCORDE					•	•													
DIPLOMAT			•						•	•	•					•			•
DUET	•	•	•	•					•		•	•	•	•	•	•	•		
ENTERPRISE			•	•					•		•	•							
FACTOR			•	•							•						•		
FILE BUDDY													•				•		
G1 ERGO SELECT			•	•	•						•							•	
G20			•	•	•						•	•							
GLOBAL ACCORD			•								•	•		•					
GOAL	•			•															•
GRAHAM				•															
GRANADA & GRANADA DELUXE	•			•		•			•								•		•
GRAPHIC			•								•						•		
ISLANDS								•	•	•									•
JEO									•	•			•						
KATE			•						•										
LAYNE								•	•										•
LITE	•	•						•	•	•			•						
LOOVER			•	•					•		•								
LURAY			•	•						•				•					
LUX									•	•									
MALAGA	•			•		•			•								•		
MARCHE								•	•			•				•			

SUGGESTED APPLICATIONS BY SERIES

SERIES	SUGGESTED APPLICATION	ACADEMIC SEATING	CAFETERIA SEATING	CONFERENCE ROOM SEATING	ERGONOMIC AND TASK	EXECUTIVE TASK SEATING	HEAVY DUTY SEATING	HOSPITALITY SEATING	GUEST SEATING	LOUNGE/RECEPTION SEATING	MANAGEMENT SEATING	MEETING ROOM SEATING	MULTI PURPOSE SEATING	PUBLIC SEATING	STACKING SEATING	STOODLS	TABLET SEATING	TECHNICAL SEATING	WOOD GUEST SEATING
MAYNE								•	•										•
MIRAGE																			
ML			•					•	•	•						•			
ML PARK			•					•	•	•						•			
MODA			•						•						•				
NOVELLO	•			•	•			•			•	•	•			•			
OBUSFORME COMFORT				•	•					•									
POPCORN			•	•					•	•	•	•	•						
PRAIRIE									•										
RIVER								•	•	•			•						
ROBUST							•			•									
ROMA			•	•	•						•	•	•			•			
ROMA NESTER												•	•						
SAS			•					•	•					•	•				•
SAXON							•												
SIDERO			•					•	•			•		•	•				
SIRENA								•	•								•		
SOLAR				•	•			•											
SOLO				•					•		•								
SONIC			•		•				•	•	•	•	•	•	•	•	•		
SPRITZ	•	•		•					•	•	•	•	•	•	•				
SPYKER			•									•		•					
STREAM	•	•		•				•	•	•	•	•	•	•	•	•	•		
SUPRA				•				•		•									
SUPRA X	•			•													•		
SYNOPSIS				•	•			•		•	•					•			
TAMIRI				•				•		•									
TRADITIONAL								•	•	•									
TRIUMPH					•					•									
TRUFORM				•		•				•									
TWILIGHT			•					•			•	•							•
TYE				•	•				•		•								•
VENTURE								•	•				•						
VION				•	•	•	•	•	•	•			•	•	•				
VITROLA								•		•			•						
WEEV				•	•					•									•
WIND & WIND LINEAR									•										
ZOMA			•					•	•		•	•	•		•				

ERGONOMIC FEATURES & BENEFITS

EACH GLOBAL CHAIR IS BUILT WITH FEATURES THAT ARE ERGONOMICALLY DESIGNED TO PROMOTE GOOD POSTURE AND PROVIDE MAXIMUM COMFORT. WHILE FULLY SUPPORTING YOUR BODY, THESE FEATURES SHOULD ALSO ALLOW YOU TO ADJUST YOUR CHAIR TO FIT YOU.



A TENSION ADJUSTMENT

Increase or decrease to match body weight. Allows you to rock comfortably, without heavy pushing, reducing muscle fatigue.



B CHAIR TILT LOCK

Lock the tilt movement in position(s) to accommodate your working posture. Allows you to lock your chair in a comfortable and supportive position. (Can be either single position or infinite style).



C SEAT HEIGHT

Raise or lower to allow your feet to rest flat on the floor. Avoids pressure under your thighs, easing blood flow.



D BACK HEIGHT

Raise or lower to position lumbar support in your lumbar area. Reduces likelihood of back pain.



E SEAT DEPTH

Change the depth of the seat to accommodate the length of your thighs. Keeps your back in contact with the backrest while avoiding pressure behind your knees.



F FORWARD SEAT ANGLE

Allows chair to tilt forward changing the angle of your thighs in relation to the floor. Helps reduce disc pressure during forward leaning tasks.



G BACK ANGLE

Adjust to change the angle of your torso in relation to your thighs. Helps reduce disc pressure and relaxes your back muscles.



H ARM HEIGHT

Raise or lower to support your forearms. Reduces muscular effort in neck and shoulders, minimizing risk of pain.



J KNEE-TILT MOVEMENT

Chair tilt pivot point is toward the front of the seat. Stability is maintained as the user reclines, keeping their feet on the floor and maintaining the same torso to thigh angle.



L SYNCHRO-TILT MOVEMENT

The seat pivots at the center point, while the backrest reclines at a faster rate than the seat, increasing the angle between the user's torso and thighs. Enhances comfort and encourages dynamic body movement.



M WATERFALL SEAT EDGE

Reduces pressure at the back of the knee, contributing to good blood flow.



N CONTOURED CUSHION

Supports the body effectively, allowing you to sit longer without discomfort.



P VIBRATING SEAT & BACK

Soothing effect contributes to your relaxation during work breaks.



Q WIDTH ADJUSTABLE ARMS

Allows outward movement of armrests to match shoulder breadth. Ensures armrests properly support forearms, reducing muscular efforts in neck and shoulders.



R ARM ROTATION

Rotate armcaps to support your forearms in various positions. Reduces muscular effort in neck and shoulders minimizing risk of pain.

Top View



S CENTER TILT

Chair tilts at the center point of the seat allowing you to recline while maintaining the same torso to thigh angle. When your feet are well supported, blood flow is enhanced.



U SOFT DESCENT PNEUMATIC LIFT

Gently and gradually lowering the seat helps you easily select proper seat height without causing a jerking motion.



V LUMBAR DEPTH ADJUSTMENT

Increase or decrease curvature of the back to match the profile of your lower back. Enhances comfort and support in the lower lumbar area.

MAXIMIZING YOUR ERGONOMIC SEATING

- Always select a chair that is designed for the type of work you perform and make certain the chair is comfortable for the length of time spent using it.
- Ensure that the seat and back cushions are contoured to fit your body, which will help eliminate pressure points.
- An ergonomically designed chair should allow changing positions easily.
- As you work, reposition yourself throughout the day to reduce strain and stress on specific muscle groups. If you change job functions, adjust your chair to fit the new task.
- Proper ergonomic seating should help eliminate many of the work related injuries that result from poor posture and poorly designed chairs.

TASK (-6)



ADJUSTMENTS

- (2) Pneumatic seat height
- (8) Manual seat depth
- Back height **
- Swivel

POSTURE TASK (-7)

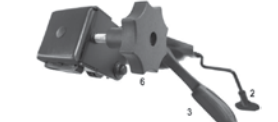

ADJUSTMENTS

- (2) Pneumatic seat height
- (3) Back angle
- (6) Back height **
- Seat depth *
- Swivel

TILTER (-4)

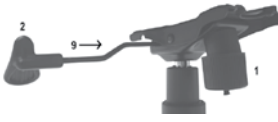

ADJUSTMENTS

- (2) Pneumatic seat height
- (9) Chair tilt lock *
- Center-tilt action
- Swivel

KNEE-TILTER (-2)



ADJUSTMENTS

- (1) Tilt tension
- (2) Pneumatic seat height
- (9) Chair tilt-lock *
- Back height **
- Knee-tilt action
- Swivel
- Optional sliding seat depth adjustment (MD)

MULTI-TILTER (-3)



ADJUSTMENTS

- (1) Tilt tension
- (2) Pneumatic seat height
- (3) Back angle adjustment
- (9) Infinite position seat tilt lock
- (7) Forward tilt lock *
- (8) Sliding seat depth adjustment (MD)
- Back height **
- Center-tilt action
- Swivel

SYNCHRO-TILTER (-0, -8)



ADJUSTMENTS

- (1) Tilt tension
- (2) Pneumatic seat height
- (3) Back angle adjustment
- (8) Sliding seat depth adjustment (MD)
- (9) Chair tilt lock Synchro-tilt action
- Anti-kickback *
- Back height **
- Swivel

POSTURE-TILTER *



ADJUSTMENTS

- (1) Tilt tension
- (2) Pneumatic seat height
- (8) Sliding seat depth adjustment (MD)
- (9) Infinite position seat tilt lock
- Back height **
- Swivel

OPERATOR (-5)



ADJUSTMENTS

- (2) Pneumatic seat height
- (3) Back angle *(Free Float/lock)
- (4) Seat angle *(Free Float/lock)
- (4) Seat angle / Back angle
- Back height **
- Free floating seat and back *
- With single lever operator mechanism, seat and back angle are controlled using lever 4 *
- Swivel

NOTES

- * Selected models only.
- ** RATCHET back height adjustment on selected models.
- *** Mechanisms shown are generic depictions and may differ from one chair to another.

HOW TO ORDER SEATING



5451-3

MODEL NUMBER

+



MD

MECHANISM OPTION

+



BK

FRAME FINISH

+



AX27

FABRIC CODE

FABRIC CHAIR EXAMPLE

If there are any options for the chair they would be inserted between the Model Number with Arm Style and Frame Finish. For example (see above):

5451-3 BK AX27

This would be the **Truform Medium Back Multi-Tilter** with standard Height Adjustable Arms and Multi-Tilter. Black Frame **BK** and Oxygen fabric in Axis, Noir **AX27**, complete the chair.

CHAIR SAFETY TIPS

Common sense guidelines to ensure that your Global chair will provide many years of comfort and service in a safe and productive environment:

- Always read and follow assembly instructions. Make sure that all of the pieces of your Global chair are installed in the proper order to ensure structural integrity.
- Ensure that chair casters are fully inserted into the base of the unit.
- Inspect your chair for loose or worn parts at least once a year.
- Always keep the base of your chair completely on the floor.
- Most Global chairs are equipped with casters for use on carpeted surfaces. Other flooring surfaces may require different casters.
- Speak to your Global Sales Representative or refer to the Casters Section of this Price Book for appropriate custom selections.
- Many Global office chairs are equipped with tilt tension controls on the seating mechanism. The tension control compensates for different body weights and postures. Always ensure that the control is properly adjusted for a smooth and controlled tilt motion. Your Global Sales Representative can demonstrate the proper use of all the adjustments on your office chair.
- Do not stand on your Global chair or sit on the arms of your chair.
- Do not put electrical appliances on chairs. Even fire retardant fabrics can be damaged when exposed to direct heat or flame.
- Choose the right chair for your work environment. Global offers a full line of Intensive Use, Multi-Shift and Specialized chairs for environments with demanding health or safety requirements. Your Global Sales Representative is trained to help you make the right choice for your workplace.

THE ASSOCIATION FOR CONTRACT TEXTILES (ACT) HAS DEVELOPED THE FOLLOWING PERFORMANCE GUIDELINES TO MAKE FABRIC SPECIFICATION EASIER. THE FIVE SYMBOLS GIVE ARCHITECTS, DESIGNERS AND END USERS A VAST AMOUNT OF PERFORMANCE INFORMATION IN A SUCCINCT, VISUAL WAY. THIS CHART LISTS THE REQUIRED TESTS THAT CORRESPOND TO SPECIFIC END USES. AN EXPLANATION OF THE SYMBOL ALSO APPEARS.

FIRE RETARDANCY



Flammability testing determines a fabric's performance and resistance to burning.

APPLICATION

Upholstery
Panels and upholstered walls

PASSES

California bulletin 117, section E.
ASTM E 84-03 Class A or Class 1 (unadhered method).

COLOR FASTNESS TO WET & DRY CROCKING



Color fastness to wet & dry crocking refers to the rubbing off of color from the fabric onto clothing, hands or other materials and can occur under wet or dry conditions.

APPLICATION

Upholstery
Panels and upholstered walls

PASSES

AATCC 8-2001 Dry crocking. Class 4 minimum.
Wet crocking, Class 3 minimum.
AATCC 8-2001 E 84 (unadhered method).

COLOR FASTNESS TO LIGHT



Color fastness to light is the degree to which fabric will retain its color when exposed to light.

APPLICATION

Upholstery
Panels and upholstered walls

PASSES

AATCC option 2-2003 or AATCC - option 3-2003.
Class 4 minimum of 40 hours.
AATCC option 2-2003 or AATCC - option 3-2003.
Class 4 minimum of 40 hours.

PHYSICAL PROPERTIES



Three physical property tests include: 1 - Brush pill test to determine a fabric's pilling (the formation of fuzzy galls of fiber on the surface of a fabric). 2 - Breaking/tensile strength is the ability of a fabric to withstand tension without breaking or tearing. 3 - Seam slippage is the pulling apart of fabrics at the seams.

APPLICATION

Upholstery
Panels and upholstered walls

PASSES

Brush pill ASTM D3511-02, 3 minimum.
Breaking strength ASTM D5034-95 (2001) 50 lbs. minimum in warp & weft.
Seam slippage ASTM D4034 25 lbs. minimum in warp & weft.
Breaking strength ASTM D5034-95 (2001) (grab test).
35 lbs. minimum in warp & weft.

ABRASION



Abrasion is the ability of a fabric to withstand damage from wear and rubbing. There is a general contract specification as well as a heavy duty specification.

APPLICATION

General contract upholstery
Heavy duty upholstery

PASSES

ASTM D4157-02 (#10 cotton duck) 15,000 double rubs, Wyzenbeek method.
ASTM D4966-98 (12 KPA pressure) 20,000 double rubs, Martindale method.
ASTM D4157-02 (#10 cotton duck) 30,000 double rubs, Wyzenbeek method.
ASTM D4966-98 (12 KPA pressure) 40,000 double rubs, Martindale method.

fast5

Global's fast5 quick ship program offers many of our bestselling models upholstered in your choice of our most popular textiles.

- 20+ Series, 150+ Models, 200+ Textiles to customize your order
- No special order forms required

Global's fast production and shipping make it simple to order and ideal for tight deadlines!

Color it your way

GRADE 1

Carrera 100% Polyester	
CE84 Zest	CE85 Savannah
CE86 Slate	CE87 Rainforest
CE88 Aspen	CE89 Dune
CE90 Flannel	CE91 Azure
CE92 Chili	CE93 Jute
CE95 Ink	CE96 Sangria
CE97 Java	CE98 Charcoal

Fusion 90% Virgin Polyester / 10% Post-Consumer Recycled Polyester

FU71 Tangerine	FU72 Fresh
FU73 Moss	FU74 Tomato
FU75 Aqua	FU76 Sandstone
FU77 Granite	FU78 Poppy
FU79 Cadet	FU80 Oasis
FU81 Graphite	FU82 Viola
FU83 Cobalt	FU84 Flax
FU85 Carbon	

Illusion 100% Virgin Polyester

II01 Cappuccino	II02 Paprika
II03 Tropic	II04 Wicker
II05 Hemp	II06 Cayenne
II07 Maui	II08 Dusk
II09 Smoke	II10 Currant
II11 Fiji	II12 Ozone
II13 Ebony	

Jenny 100% Polyester

JN01 Midnite	JN02 Ebony
JN03 Slate	JN07 Vermilion
JN08 Admiral	JN11 Charcoal
JN25 Silver Lining	JN26 Oatmeal
JN27 Sunflower	JN28 Cascade
JN29 Harvest	JN30 Melon
JN31 Berry	JN32 Green Grass
JN33 Roast	

Quilt 100% Polyester

QL10 Black	QL11 Charcoal Grey
QL14 Navy	QL16 Wine
QL19 Silver	QL20 Feather
QL21 Dune	QL22 Meadow
QL23 Cadet	QL24 Geranium
QL25 Daisy	QL26 Quest
QL27 Punch	QL28 Tangerine
QL29 Cocoa	

Trak 100% Recycled Polyester

TK40 Taupe	TK41 Mustard
TK42 Latte	TK43 Cement
TK44 Silver	TK45 Copper
TK46 Teal	TK47 Apple
TK48 Steel	TK49 Merlot
TK50 Midnight Sky	TK51 Mocha
TK52 Carbon	

Urban 62% Recycled Polyester / 32% Polyester

UR10 Red Rose	UR11 Ocean Blue
UR12 Blue Bayou	UR13 Green Grass
UR14 Sandcastle	UR15 Beach Day
UR16 Boardwalk	UR17 Earth
UR18 Brown Ridge	UR19 White Sand
UR20 Granite Rock	UR21 Gravel Road
UR22 Black Coal	

Wavelength 100% Virgin Polyester

WV01 Lime	WV02 Mint
WV03 Stone	WV04 Flame
WV05 Mykonos	WV06 Savannah
WV07 Mesa	WV08 Plasma
WV09 Cancun	WV10 Quartz
WV11 Moonrock	WV12 Rubine
WV13 Corfu	WV14 Bluejey
WV14 Panther	

GRADE 2

Atlante Flee 100% Vinyl Face / 100% Polyester Backing	
A01F Illusion	A02F Bright White
A03F White Crush	A04F Ivory
A05F Ice	A06F Bleached Sand
A07F Taupe Fawn	A08F Warm Smoke
A09F Autumn Rain	A10F Cookie
A11F Sierra Brick	A12F Gibraltar
A13F Chateau Grey	A14F Garden Green
A15F Oasis Green	A16F Ink Black
A17F Purple Impulse	A18F Italian Rose
A19F Mountain Sky	A20F Old Navy
A21F Galaxy	A22F Red Truffle
A23F Chocolate Sundae	A24F Province Blue
A25F Eclipse	

Elevate 80% Post-Consumer Recycled Polyester / 20% Rayon

EL51 Halo	EL52 Dove
EL53 Safari	EL54 Sunglow
EL55 Margarita	EL56 Fiji
EL57 Mist	EL58 Blaze
EL59 Wasabi	EL60 Mystic
EL61 Mica	EL62 Cherry
EL63 Scuba	EL64 Lapis
EL65 Onyx	

Etch 80% Post-Consumer Recycled Polyester / 20% Rayon

ET81 Drift	ET82 Citron
ET83 Calypso	ET84 Mandarin
ET85 Crisp	ET86 Iris
ET87 Nickel	ET88 Paprika
ET89 Nutmeg	ET90 Marine
ET91 Magnet	ET92 Infrared
ET93 Espresso	ET94 Indigo
ET95 Anthracite	

Imprint 100% Post-Consumer Polyester

IM70 Almond	IM71 Cork
IM72 Sand	IM73 Currie
IM74 Candy Apple	IM75 Ocean
IM76 Navy	IM77 Green Tea
IM78 Celery	IM79 Oregano
IM80 Walnut	IM81 Paprika
IM82 Graphite	IM83 Slate
IM84 Licorice	

Luxhide 100% Vinyl Face / Bonded Leather Backing

BL20 Black	BL22 Parchment
BL23 Saddle	BL24 Dark Brown
BL26 Burgundy	BL27 Charcoal
BL28 White	
BL34 Light Grey	

Release 100% Vinyl Face

RL11 White	RL12 Chalk
RL13 Stone	RL14 Taupe
RL15 Orange	RL16 Country
RL17 Tuscan	RL18 Cottage
RL19 Yellow	RL21 Red Barn
RL22 Brave Red	RL23 Gypsy Red
RL24 Cajun	RL25 Vineyard
RL26 Olive	RL27 Bonsai
RL28 Summer's Dream	RL29 Calico
RL31 Green	RL32 Blue
RL33 Black	RL34 Cool Grey
RL35 Thunder Grey	RL36 Navy
RL37 Dark Chocolate	RL38 Espresso





















GRADE 10

Prescott Leather	
PC02 Zinc	PC04 Papyrus
PC05 Soul White	PC10 Caffè Latte
PC14 Avana	PC18 Swamp
PC41 Antique	PC54 Antipol
PC57 Chestnut	PC79 Oceania
PC80 Indigo	PC81 Deep
PC86 Santorini	PC96 Turtledove
PC97 Smoke	PD02 Grayshadow
PD03 Black Ink	

Textiles are subject to change, please confirm current selection.

TERMS AND CONDITIONS

- All product series have MAXIMUM order quantities which can be fulfilled within the fast5 program. These are noted with each series' Specs + Options. For greater quantities, please contact CustomerCare for lead time and terms.
- Orders that exceed maximum unit quantities will receive standard lead times.
- Orders must clearly note "fast5" and be submitted as a separate purchase order. Global cannot mix fast5 and standard delivery or InStock products on the same purchase order.
- Purchase orders containing products from fast5 and fast10 programs will automatically receive fast10 lead time and shipping. Purchase order should be noted "fast10".
- Certain models, noted on the series' Specs + Options, are multi-packed and must be ordered in quantities accordingly. Package unit quantities cannot be changed.
- Program is limited to exact models, model options and textiles within series listed.
- Program is limited to exact textile pattern colorways listed in the fast5 program. Use the Textile Search Tool to confirm desired textile is approved for use on the selected series.
- Orders must be clean with correct model numbers, options, textiles, correct pricing, etc. to apply.
- Orders cannot be changed or canceled after order acknowledgment.
- Current Global list pricing applies at the time of order. fast5 orders may be shipped FedEx, UPS or via alternate carriers. Global reserves the right to ship "best way".
- fast5 products will be manufactured to your orders' specifications in 5 business days or less and ship immediately thereafter.
- Orders will ship to the dealer or commercial end-user directly. Delivery charges may apply for special handling, services, etc. Please consult your Territory Manager or CustomerCare Representative.
- Dealer must be in good standing and account within terms for order(s) to be processed without delay.
- fast5 program is available in the 48 contiguous United States.

Series	Model Numbers	Series	Model Numbers	Series	Model Numbers	
Aspen 	(maximum 20) 2851-3 2853-3	Luray 	(maximum 20) 6461 6462	Sonic 	Plastic (maximum 100) 6508 6508MB 6513 6513MB 6558 6558CS 6573 6573MB 6577 6577MB	
	Comet 		(maximum 50) 2171WS 2172WS		Popcorn 	Plastic (maximum 100) 6710 6711 Upholstered (maximum 50) 6712 6713 6715
Duet 	Plastic (maximum 100) 6620 6621 Upholstered (maximum 50) 6622 6627 6623 6628 6624	Prefer 	(maximum 20) 8458 8459	Sora 	(maximum 20) 6941 6942	
	Factor 		(maximum 50) 5540 5541 5540NA 5541NA		Rebound 	Plastic (maximum 100) R5NPPG R5APPG R5NPPC R5APPC Upholstered (maximum 50) R5NPUG R5APUG R5NPUC R5APUC
G1 Ergo Select 	(maximum 50) 7331 7332	Roma 	(maximum 50) 1890 1903 1896 1906 1897 1907 1901 1908 1902	Synopsis 	(maximum 50) 5080-0 5081-3 5080-3 5090-4 5081-0 5091-4	
	Global Accord 		(maximum 50) 2670-2 2676-2 2670-4 2676-4 2671-2 2677-2 2671-4 2677-4 2672-6 2678-6		Nester (maximum 50) 1898 1900 1899	Sidero 
Goal 	(maximum 50) 2235-6 2237-5 2236-6 2237-6 2237-3 2239-6	Solar 	(maximum 50) 8456 8457 8456NA 8457NA 8456S 8457S 8456SNA 8457SNA	Triumph 	(maximum 20) 3650-3 3651-3 3650-8 3651-8	
	Granada 		(maximum 50) 3212 3254 3278		Solo 	(maximum 50) 5228
Loover 	(maximum 50) 2661-0 2662-0 2661-3 2662-3 2661-4 2662-4 2661-8 2662-8				Upholstered (maximum 50) 6331-0 6332-0 6331-3 6332-3 6331-4 6332-4 6331-8 6332-8	
					Guest (maximum 50) 6324 6325 6324C 6325C	

fast10

Global's fast10 quick ship program offers many of our bestselling models upholstered in your choice of our most popular textiles.

- 5 Series, 25+ Models, 200+ Textiles to customize your order
- No special order forms required

Global's fast production and shipping make it simple to order and ideal for tight deadlines!

Color it your way

GRADE 1

Carrera 100% Polyester	
CE84 Zest	CE85 Savannah
CE86 Slate	CE87 Rainforest
CE88 Aspen	CE89 Dune
CE90 Flannel	CE91 Azure
CE92 Chili	CE93 Jute
CE95 Ink	CE96 Sangria
CE97 Java	CE98 Charcoal

Fusion 90% Virgin Polyester / 10% Post-Consumer Recycled Polyester

FU71 Tangerine	FU72 Fresh
FU73 Moss	FU74 Tomato
FU75 Aqua	FU76 Sandstone
FU77 Granite	FU78 Poppy
FU79 Cadet	FU80 Oasis
FU81 Graphite	FU82 Viola
FU83 Cobalt	FU84 Flax
FU85 Carbon	

Illusion 100% Virgin Polyester

I101 Cappuccino	I102 Paprika
I103 Tropic	I104 Wicker
I105 Hemp	I106 Cayenne
I107 Maui	I108 Dusk
I109 Smoke	I110 Currant
I111 Fiji	I112 Ozone
I113 Ebony	

Jenny 100% Polyester

JN01 Midnite	JN02 Ebony
JN03 Slate	JN07 Vermilion
JN08 Admiral	JN11 Charcoal
JN25 Silver Lining	JN26 Oatmeal
JN27 Sunflower	JN28 Cascade
JN29 Harvest	JN30 Melon
JN31 Berry	JN32 Green Grass
JN33 Roast	

Quilt 100% Polyester

QL10 Black	QL11 Charcoal Grey
QL14 Navy	QL16 Wine
QL19 Silver	QL20 Feather
QL21 Dune	QL22 Meadow
QL23 Cadet	QL24 Geranium
QL25 Daisy	QL26 Quest
QL27 Punch	QL28 Tangerine
QL29 Cocoa	

Trak 100% Recycled Polyester

TK40 Taupe	TK41 Mustard
TK42 Latte	TK43 Cement
TK44 Silver	TK45 Copper
TK46 Teal	TK47 Apple
TK48 Steel	TK49 Merlot
TK50 Midnight Sky	TK51 Mocha
TK52 Carbon	

Urban 62% Recycled Polyester / 32% Polyester

UR10 Red Rose	UR11 Ocean Blue
UR12 Blue Bayou	UR13 Green Grass
UR14 Sandcastle	UR15 Beach Day
UR16 Boardwalk	UR17 Earth
UR18 Brown Ridge	UR19 White Sand
UR20 Granite Rock	UR21 Gravel Road
UR22 Black Coal	

Wavelength 100% Virgin Polyester

WV01 Lime	WV02 Mint
WV03 Stone	WV04 Flame
WV05 Mykonos	WV06 Savannah
WV07 Mesa	WV08 Plasma
WV09 Cancun	WV10 Quartz
WV11 Moonrock	WV12 Rubine
WV13 Corfu	WV14 Bluejay
WV14 Panther	

GRADE 2

Allante Free 100% Vinyl Face / 100% Polyester Backing

A01F Illusion	A02F Bright White
A03F White Crush	A04F Ivory
A05F Ice	A06F Bleached Sand
A07F Taupe Fawn	A08F Warm Smoke
A09F Autumn Rain	A10F Cookie
A11F Sierra Brick	A12F Gibraltar
A13F Chateau Grey	A14F Garden Green
A15F Oasis Green	A16F Ink Black
A17F Purple Impulse	A18F Italian Rose
A19F Mountain Sky	A20F Old Navy
A21F Galaxy	A22F Red Truffle
A23F Chocolate Sundae	A24F Province Blue
A25F Eclipse	

Elevate 80% Post-Consumer Recycled Polyester/ 20% Rayon

EL51 Halo	EL52 Dove
EL53 Safari	EL54 Sunglow
EL55 Margarita	EL56 Fiji
EL57 Mist	EL58 Blaze
EL59 Wasabi	EL60 Mystic
EL61 Mica	EL62 Cherry
EL63 Scuba	EL64 Lapis
EL65 Onyx	

Etch 80% Post-Consumer Recycled Polyester/ 20% Rayon

ET81 Drift	ET82 Citron
ET83 Calypso	ET84 Mandarin
ET85 Crisp	ET86 Iris
ET87 Nickel	ET88 Paprika
ET89 Nutmeg	ET90 Marine
ET91 Magnet	ET92 Infrared
ET93 Espresso	ET94 Indigo
ET95 Anthracite	

Imprint 100% Post-Consumer Polyester

IM70 Almond	IM71 Cork
IM72 Sand	IM73 Currie
IM74 Candy Apple	IM75 Ocean
IM76 Navy	IM77 Green Tea
IM78 Celery	IM79 Oregano
IM80 Walnut	IM81 Paprika
IM82 Graphite	IM83 Slate
IM84 Licorice	

Luxhide 100% Vinyl Face / Bonded Leather Backing

BL20 Black	BL22 Parchment
BL23 Saddle	BL24 Dark Brown
BL26 Burgundy	BL27 Charcoal
BL28 White	
BL34 Light Grey	

Release 100% Vinyl Face

RL11 White	RL12 Chalk
RL13 Stone	RL14 Taupe
RL15 Orange	RL16 Country
RL17 Tuscan	RL18 Cottage
RL19 Yellow	RL21 Red Barn
RL22 Brave Red	RL23 Gypsy Red
RL24 Cajun	RL25 Vineyard
RL26 Olive	RL27 Bonsai
RL28 Summer's Dream	RL29 Calico
RL31 Green	RL32 Blue
RL33 Black	RL34 Cool Grey
RL35 Thunder Grey	RL36 Navy
RL37 Dark Chocolate	RL38 Espresso

GRADE 10

Prescott Leather	
PC02 Zinc	PC04 Papyrus
PC05 Soul White	PC10 Caffè Latte
PC14 Avana	PC18 Swamp
PC41 Antique	PC54 Antipol
PC57 Chestnut	PC79 Oceania
PC80 Indigo	PC81 Deep
PC86 Santorini	PC86 Turtledove
PC97 Smoke	PD02 Grayshadow
PD03 Black Ink	

Textiles are subject to change, please confirm current selection.

TERMS AND CONDITIONS

- All models have MAXIMUM quantity of 10 pieces, noted on each sheet, which can be fulfilled within the fast10 program. These are noted next to each series' Specs + Options. For greater quantities, please contact CustomerCare for lead times and terms.
- Orders that exceed maximum unit quantities will receive standard lead times.
- Orders must clearly note "fast10" and be submitted as a separate purchase order. Global cannot mix "fast10" and standard delivery or InStock products on the same purchase order.
- Purchase orders containing products from fast5 and fast10 programs will automatically receive fast10 lead time and shipping. Purchase order should be noted "fast10".
- Program is limited to exact models, model options and textiles within series listed.
- Program is limited to exact textile pattern colorways listed in the fast10 program. Use the Textile Search Tool to confirm desired textile is approved for use on the selected series.
- Orders must be clean with correct model numbers, options, textiles, correct pricing, etc. to apply.
- Orders cannot be changed or canceled after order acknowledgment.
- Current Global list pricing applies at the time of order.
- fast10 models are not available for FEDEX or UPS shipping. Global reserves the right to ship "best way".
- fast10 products will be manufactured to your orders' specifications in 10 business days or less and be consolidated for shipping immediately thereafter.
- Orders will ship to the dealer or commercial end-user directly. Delivery charges may apply for special handling, services, etc. Please consult your Territory Manager or CustomerCare Representative.
- Dealer must be in good standing and account within terms for order(s) to be processed without delay.
- fast10 Program is available in the 48 contiguous United States.

Series	Model Numbers	Series	Model Numbers	Series	Model Numbers
Citi 	(maximum 10)	Wind 	(maximum 10)	Drift 	(maximum 10)
	7864		3361		8016
	7875		3362		8021
	7876		3363		8022
	7877				8023
	7879				8024
	7885		8026		
			8030		
			8032		
			8033		
			8034		
			8035		
			8036		
<hr/> Citi Square		<hr/> sirena			
	(maximum 10)		(maximum 10)		
	S7875		3371		
	S7876				
	S7877				
	S7877				
	S7911				

work + task

Arno	25	G1 Ergo Select	39	Luray	64
Arturo	26	G20	41	Malaga	67
Aspen	27	Global Accord	42	Mirage	68
Auburn	29	Goal	46	Noetic.....	69
Concorde	30	Graham	48	Novello	74
Diplomat	32	Granada	49	ObusForme Comfort + XL	78
Enterprise	33	Granada Deluxe	54	Prefer	84
Factor	37	Graphic	58		
		Loover	60		

work + task

Roma	86	Synopsis	106
Solar	90	Tamiri	109
Solo	92	Traditional	111
Sora	94	Triumph	115
Spritz	96	Truform	116
Stream.....	98	Tye	119
Supra	101	Vion	122
Supra X	103	Weev	130

ARNO™



model 4003



HB Tilter

COM Yardage: 2.50
Freight Class: 250
Product Weight (lbs.): 39
Cubic Feet Per Carton: 11.50

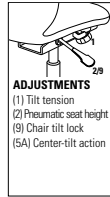

Ergonomic Features:
A, B, C, N, S



HB Conference Chair

COM Yardage: 2.50
Freight Class: 250
Product Weight (lbs.): 39
Cubic Feet Per Carton: 11.50



Armchair w/ Sled Base

COM Yardage: 2.50
Freight Class: 250
Product Weight (lbs.): 33
Cubic Feet Per Carton: 13

Ergonomic Features:
N

STANDARD FEATURES

- Perforated leather inserts in the seat and back surfaces.
- Standard Black (BK) molded flared loop arms and a five-legged injection molded base with C65 casters.
- Model 4003-SC features a self centering cylinder which swivels and automatically returns to the starting seat location. Standard with a flat 5 star base in Black (BK) with C7 glides.
- Standard in Luxhide. Not available in fabric. Starting at grade 5 pricing.
- Check textile availability prior to specifying upholstery material.

OPTIONAL FEATURES

- Please refer to the "Casters Selection" section of the price book for caster options. Optional casters may be priced higher than the standard casters for your chair and the difference will be charged. Lower priced optional casters will not be credited.
- An optional abrasion resistant outer back fabric (polyester) is available. Resistant to impact damage. Available in Black only. Add \$23.
- For hard surface flooring casters, please specify C10R. Add \$118.
- For fully assembled in box, please specify SU. Add \$76.

	1	2	3	4	5	6	7	8	9	10	11	12
4003	-	-	-	-	540	614	-	987	1124	1346	1678	2077

OVERALL DIMENSIONS			SEAT DIMENSIONS			BACK DIMENSIONS	
W	D	H	W	D	H	W	H
25	29	42	20.5	19	16-20	21	24



	1	2	3	4	5	6	7	8	9	10	11	12
4003-SC	-	-	-	-	614	687	-	1068	1207	1433	1773	2182

OVERALL DIMENSIONS			SEAT DIMENSIONS			BACK DIMENSIONS	
W	D	H	W	D	H	W	H
25	29	44	20.5	18	18.5	21	24



	1	2	3	4	5	6	7	8	9	10	11	12
4004	-	-	-	-	540	614	-	987	1124	1346	1678	2077

OVERALL DIMENSIONS			SEAT DIMENSIONS			BACK DIMENSIONS	
W	D	H	W	D	H	W	H
24.5	26.5	36	20	19	18	20.5	19



ARTURO™



model 3991







model 3992

STANDARD FEATURES

- Stitched seat and back design, padded headrest (model 3991) and upholstered open arms.
- All models are standard with a five prong, injection molded, fiberglass reinforced nylon Black spider base with (C65) dual wheel carpet casters.
- Base and frame are available in Black only.
- Standard in Luxhide. Not available in fabric. Starting at grade 5 pricing.
- Check textile availability prior to specifying upholstery material.

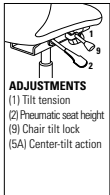
OPTIONAL FEATURES

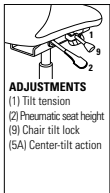
- There are no arm options for this series.
- An optional abrasion resistant outer back fabric (polyester) is available. Resistant to impact damage. Available in Black only. Specify (BKB). Add \$23.
- For hard surface flooring casters, specify (C65R). Add \$73.
- Please refer to the "Casters Selection" section of the price book for caster options. Optional casters may be priced higher than the standard casters for your chair and the difference will be charged. Lower priced optional casters will not be credited.
- For fully assembled in box, specify (SU). Add \$76.

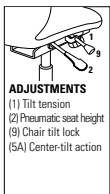
DESCRIPTION	FEATURES	MODEL#	STANDARD TEXTILE GRADES												
			1	2	3	4	5	6	7	8	9	10	11	12	
 <p>Extended HB Tilter COM Yardage: 4 Freight Class: 250 Product Weight (lbs.): 54 Cubic Feet Per Carton: 14</p>	 <p>ADJUSTMENTS (1) Tilt tension (2) Pneumatic seat height (9) Chair tilt lock (5A) Center-tilt action</p>	3991	-	-	-	-	1539	1652	1863	2250	2463	2820	3354	3993	
		OVERALL DIMENSIONS			SEAT DIMENSIONS			BACK DIMENSIONS							
		W	D	H	W	D	H	W	H						
		26	30.5	50	21	20	16.5-20.5	21.5	30.5						
			RTA 1			FedEx			UPS						
 <p>HB Tilter COM Yardage: 3.50 Freight Class: 250 Product Weight (lbs.): 52 Cubic Feet Per Carton: 13.25</p>	 <p>ADJUSTMENTS (1) Tilt tension (2) Pneumatic seat height (9) Chair tilt lock (5A) Center-tilt action</p>	3992	-	-	-	-	1424	1524	1709	2044	2234	2544	3014	3574	
		OVERALL DIMENSIONS			SEAT DIMENSIONS			BACK DIMENSIONS							
		W	D	H	W	D	H	W	H						
		26	30	43	20.5	19.5	16.5-20.5	20.5	25						
			RTA 1			FedEx			UPS						
 <p>LB Tilter COM Yardage: 3.50 Freight Class: 250 Product Weight (lbs.): 44 Cubic Feet Per Carton: 11.50</p>	 <p>ADJUSTMENTS (1) Tilt tension (2) Pneumatic seat height (9) Chair tilt lock (5A) Center-tilt action</p>	3993	-	-	-	-	1370	1472	1657	1994	2184	2498	2962	3520	
		OVERALL DIMENSIONS			SEAT DIMENSIONS			BACK DIMENSIONS							
		W	D	H	W	D	H	W	H						
		26	29.5	37	20.5	19.5	16.5-20.5	20.5	18						
			RTA 1			FedEx			UPS						

ASPEN™



model 2850-3



model 2851-3



Lumbar Support

Back height can be adjusted to enable a user to reposition the contact zone of lumbar support.

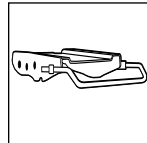

Multi-Depth Mechanism

Standard on Multi - Tilter. Allows seat to move forward and backward over a 2" range with 5 locking positions to provide a more shallow or deeper seat.



model 2852-3

STANDARD FEATURES

- Aspen features a slender design and sensitive profile with a superior level of comfort.
- Extended back models are standard with a height adjustable headrest.
- All models offer 2.25" back/lumbar height adjustment via a concealed ratchet system.
- All models are standard with height and width adjustable arms (**AS**) that feature a sliding armcap providing extra support for all users.
- Models feature braille on the underside of all paddles.
- Model **2852-6SC** features a self centering cylinder which swivels and automatically returns to the starting seat location. This model is standard with a flat 5 star base in Black (**BK**) with **C7** glides.
- Base and arm detail is standard in Black.
- All models are shipped partially KD.
- **C82** dual wheel carpet casters are standard.
- Multi-depth mechanism is standard on multi-tilter models. Allows seat to move forward and backward over a 2" range with 5 locking positions to provide a shallower or deeper seat.
- Check textile availability prior to specifying upholstery material.

OPTIONAL FEATURES

- Polished Aluminum base is available. Specify (**ALU**). Add \$167.
- Coordinating Chrome finished arms are available at no upcharge. Specify (**AC**).
- Please refer to "Arm Selection" section of the price book for additional arm options.
- Please refer to "Cylinder Selection" section of the price book for additional cylinder options.
- For hard surface flooring casters, specify **C9R**. Add \$98
- For fully assembled in box, specify **SU**. Add \$76.



DESCRIPTION FEATURES MODEL# STANDARD FABRIC GRADES



Extended Back Multi - Tilter

COM Yardage: 2.50
Freight Class: 150
Product Weight (lbs.): 66
Cubic Feet Per Carton: 14.75

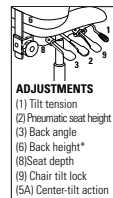

ADJUSTMENTS

- (1) Tilt tension
- (2) Pneumatic seat height
- (3) Back angle
- (6) Back height*
- (8) Seat depth
- (9) Chair tilt lock
- (5A) Center-tilt action

Ergonomic Features:

A, B, C, D, E, F, G, H, M, N, Q, S, V

MODEL#	1	2	3	4	5	6	7	8	9	10	11	12
2850-3	1530	1620	1690	1794	1942	1994	2123	2369	2490	2717	3028	3415

OVERALL DIMENSIONS			SEAT DIMENSIONS			BACK DIMENSIONS	
W	D	H	W	D	H	W	H
25	24	45	19.5	19.5-21	16.5-20.5	18.5	26.5-29

RTA 2



HB Multi - Tilter

COM Yardage: 2.25
Freight Class: 150
Product Weight (lbs.): 64
Cubic Feet Per Carton: 14.75

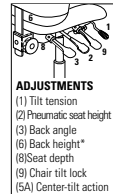

ADJUSTMENTS

- (1) Tilt tension
- (2) Pneumatic seat height
- (3) Back angle
- (6) Back height*
- (8) Seat depth
- (9) Chair tilt lock
- (5A) Center-tilt action

Ergonomic Features:

A, B, C, D, E, F, G, H, M, N, Q, S, V

MODEL#	1	2	3	4	5	6	7	8	9	10	11	12
2851-3	1367	1446	1512	1605	1738	1784	1901	2123	2229	2436	2714	3063

OVERALL DIMENSIONS			SEAT DIMENSIONS			BACK DIMENSIONS	
W	D	H	W	D	H	W	H
25	24	41	19.5	18-19.5	16.5-20.5	19.5	22.5

RTA 2



MB Multi - Tilter

COM Yardage: 2
Freight Class: 150
Product Weight (lbs.): 62
Cubic Feet Per Carton: 13

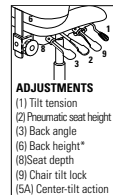

ADJUSTMENTS

- (1) Tilt tension
- (2) Pneumatic seat height
- (3) Back angle
- (6) Back height*
- (8) Seat depth
- (9) Chair tilt lock
- (5A) Center-tilt action

Ergonomic Features:

A, B, C, D, E, F, G, H, M, N, Q, S, V

MODEL#	1	2	3	4	5	6	7	8	9	10	11	12
2852-3	1327	1400	1456	1540	1659	1699	1803	2000	2094	2277	2526	2836

OVERALL DIMENSIONS			SEAT DIMENSIONS			BACK DIMENSIONS	
W	D	H	W	D	H	W	H
25	24	37	19.5	18.5-21	16.5-20.5	18.5	18.5-21

RTA 2



DESCRIPTION	FEATURES	MODEL#	STANDARD FABRIC GRADES												
			1	2	3	4	5	6	7	8	9	10	11	12	
 <p>MB Conference Chair COM Yardage: 2 Freight Class: 250 Product Weight (lbs.): 44 Cubic Feet Per Carton: 13</p>	Ergonomic Features: A, B, D, H, M, N, Q, S	2852-6SC	1219	1292	1348	1432	1551	1591	1695	1892	1986	2169	2418	2728	
		OVERALL DIMENSIONS			SEAT DIMENSIONS			BACK DIMENSIONS							
		W	D	H	W	D	H	W	H						
			25	24	37	19.5	18.5	18.5	18.5	18.5-21					
			RTA 2												

AUBURN



model 3767



Wood-capped base



Polished Aluminum



Optional Base
Polished Aluminum (ALU) finish is available on arm frame and base at an upcharge. Add \$334.



Optional Base
Wood-capped steel base with C1 casters is available at an upcharge (B4M). Add \$468

STANDARD FEATURES

- This transitional style judge's chair offers a scrolled urethane arm for durability and comfort.
- Arm frame is made from Black cast aluminum for exceptional strength and quality
- Standard with soft, durable, self-skinned urethane (SSU) armcaps that are warm to the touch
- Five prong, injection molded, fiberglass reinforced nylon Black spider base with **C10** dual wheel carpet casters.
- Standard in Luxhide. Not available in fabric. Starting at grade 5 pricing.
- Check textile availability prior to specifying upholstery material.

OPTIONAL FEATURES

- Oval style wood-capped steel base (**B4M**) with (**C1**) casters is available. Genuine maple faced veneers and solids are used. Available in Absolute (AAM), Black (BKM), Cherry (ACM), Espresso Cafe (ECM), English Oak (EOM), Fruitwood (TFM), Gray (HGM), Honey (AHM), Mahogany (TMM), Maple (AVM), Medium Walnut (MWM), Natural Walnut (NLW), Night (ASM), Noce Biondo (NBM), Noce Grigio (NGM), Noce Leggero (NEM), Noce Medio (NMM), Shaker Cherry (SKM), Walnut (TWM), WC Cream (WTM), White (WHM) and Winter Cherry (WCM). Please specify. Add \$468.
- Polished Aluminum base is available. A **B2** aluminum base with black scuff tips and **C10** casters. Add \$167.
- For hard flooring surface casters with wood-capped base, please specify **C9R**. Add \$18.
- For hard surface flooring please specify **C10R** casters. Add \$66.
- Please refer to the "Casters Selection" section of the price book for caster options. Optional casters may be priced higher than the standard casters for your chair and the difference will be charged. Lower priced optional casters will not be credited.

DESCRIPTION	FEATURES	MODEL#	STANDARD TEXTILE GRADES											
			1	2	3	4	5	6	7	8	9	10	11	12
<p>ADJUSTMENTS (1) Tilt tension (2) Pneumatic seat height (3) Chair tilt lock (5A) Center-tilt action</p>	<p>ADJUSTMENTS (1) Tilt tension (2) Pneumatic seat height (3) Chair tilt lock (5A) Center-tilt action</p>	3767	-	-	-	1745	1828	-	2246	2397	2647	3021	3469	
		OVERALL DIMENSIONS			SEAT DIMENSIONS			BACK DIMENSIONS						
		W	D	H	W	D	H	W	H					
28	28	46.5	21.5	18	16.5-20.5	21.5	27.5							
<p>HB Tilter COM Yardage: 3 Freight Class: 250 Product Weight (lbs.): 63 Cubic Feet Per Carton: 22.25</p>		<p>Ergonomic Features: A, B, C, M, N, S</p>		<p>RTA 00</p>										

CONCORDE™



model 2400-18



model 2400-18



Push Button
Location within reach increases your adjustment. Promotes good posture as you move to various positions.



model 2409



Polished Aluminum Base
Concorde Presidential models are standard with a polished aluminum base.

STANDARD FEATURES

- All adjustments are made with easy-use button controls that are conveniently located in full view.
- Compound curved molded foam seat and back cushions.
- Standard with Allen-bolted width adjustable arms (Allen key included). Arms adjust 1.25" wider on each side for a total of 2.5" extra width.
- Push button controlled tilt lock and push button controlled seat height.
- Seat cushions are easily removed without tools for ease of cleaning.
- Five prong, injection molded, fiberglass reinforced nylon Black base with (C10) dual wheel carpet casters.
- Upholstery options: leather. Not available in vinyl.
- Model 2424 is rated for multi-shift use for persons up to 350 pounds.
- For 24 hour application, Global's limited lifetime warranty is applicable only on fabrics that are rated for 100,000 double rubs.
- Concorde is fully assembled in box, as standard.
- Check textile availability prior to specifying upholstery material.

OPTIONAL FEATURES

- There are no arm options for this series.
- Optional aluminum base is available. Add. \$167.
- For hard surface flooring casters, please specify (C10R). Add \$66.
- For additional caster options, please refer to the Arm and Caster section. Optional casters may be priced higher than the standard casters for your chair and the difference will be charged. Lower priced optional casters will not be credited.



CONCORDE PRESIDENTIAL (MODEL #2409)



STANDARD FEATURES

- Only available in Leather.
- Has a larger headrest, wider back and closed upholstered arms.
- Features decorative stitching, standard in a heavy gauge off-white stitch detail to show contrast with leather upholstery.
- Features perforated leather inserts in the seat and back cushions.
- Standard with (C25) dual wheel carpet casters.
- Standard with a Black arm button trim
- Standard with a Polished Aluminum base.

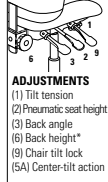
OPTIONAL FEATURES

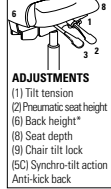
- Normal gauge color coordinated thread can be used upon request. Specify "matching thread" on order. No upcharge.
- Non-perforated leather inserts in the seat and back cushions are optional. Specify (NR).
- Optional with a Black base at no additional charge. Specify (BK).

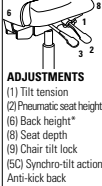
DESCRIPTION	FEATURES	MODEL#	STANDARD TEXTILE GRADES												
			1	2	3	4	5	6	7	8	9	10	11	12	
 <p>HB Multi - Tilter Concorde Executive COM Yardage: 2.50 Freight Class: 250 Product Weight (lbs.): 76 Cubic Feet Per Carton: 23.50</p>	 <p>ADJUSTMENTS (1) Tilt tension (2) Pneumatic seat height (3) Back angle (6) Back height* (9) Chair tilt lock (5A) Center-tilt action</p>	<p>Ergonomic Features: A, B, C, D, G, M, N, Q, S, T</p>	2400-18	-	4273	4346	4456	4608	4664	4798	5047	5169	5404	5730	6129
			OVERALL DIMENSIONS			SEAT DIMENSIONS			BACK DIMENSIONS						
			W	D	H	W	D	H	W	H					
	26	28	48	21	19.5	17.5-21.5	21	31							
 <p>HB Synchro - Tilter Deluxe Concorde Presidential COM Yardage: 23.50 Freight Class: 250 Product Weight (lbs.): 78 Cubic Feet Per Carton: 23.50</p>	 <p>ADJUSTMENTS (1) Tilt tension (2) Pneumatic seat height (6) Back height* (8) Seat depth (9) Chair tilt lock (5C) Synchro-tilt action Anti-kick back</p>	<p>Ergonomic Features: A, B, C, D, E, L, M, N, Q, T</p>	2409	-	-	-	-	-	-	-	-	-	7009	7539	8094
			OVERALL DIMENSIONS			SEAT DIMENSIONS			BACK DIMENSIONS						
			W	D	H	W	D	H	W	H					
	28.5	27	50	21	18-20	18-22	21	28-31							

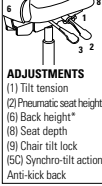
DESCRIPTION	FEATURES	MODEL#	STANDARD TEXTILE GRADES											
			1	2	3	4	5	6	7	8	9	10	11	12
 <p>HB Synchro - Tilter Concorde Executive 24HR COM Yardage: 2.50 Freight Class: 250 Product Weight (lbs.): 78 Cubic Feet Per Carton: 23.50</p>	 <p>ADJUSTMENTS (1) Tilt tension (2) Pneumatic seat height (6) Back height* (8) Seat depth (9) Chair tilt lock (5C) Synchro-tilt action Anti-kick back</p>	2424	-	3199	3273	3381	3536	3592	3724	3975	4095	4331	4653	5053
			OVERALL DIMENSIONS			SEAT DIMENSIONS			BACK DIMENSIONS					
			W	D	H	W	D	H	W	H				
			28.5	27	50	21	17.5-19	18-22	21	28-31				
			RTA 00											
 <p>HB Synchro - Tilter Concorde Executive 24HR COM Yardage: 2.50 Freight Class: 250 Product Weight (lbs.): 78 Cubic Feet Per Carton: 23.50</p>	 <p>ADJUSTMENTS (1) Tilt tension (2) Pneumatic seat height (6) Back height* (8) Seat depth (9) Chair tilt lock (5C) Synchro-tilt action Anti-kick back</p>	2424-18	-	3251	3330	3436	3586	3645	3781	4028	4153	4388	4711	5110
			OVERALL DIMENSIONS			SEAT DIMENSIONS			BACK DIMENSIONS					
			W	D	H	W	D	H	W	H				
			28.5	27	50	21	17.5-19	18-22	21	28-31				
			RTA 00											

DIPLOMAT



model 2106



model 2107

Also see Diplomat Guest Chairs



For Diplomat guest chairs, please see 156.

STANDARD FEATURES



- A contoured seat and back are accented by wood arms and base (on tilter models), providing comfort and classic styling.
- Series includes tilters, guest chairs and bar stool. See page 163 for additional series
- C1 casters are standard on tilter models.
- When upholstered in Leather, models will be in all Leather.
- Check textile availability prior to specifying upholstery material.

OPTIONAL FEATURES

- Wood-capped base and arms are available in Absolute (AAM), Black (BKM), Cherry (ACM), Espresso Cafe (ECM), English Oak (EOM), Fruitwood (TFM), Gray (HGM), Honey (AHM), Mahogany (TMM), Maple (AVM), Medium

Walnut (MWM), Night (ASM), Shaker Cherry (SKM), Walnut (TWM), WC Cream (WTM), White (WHM) and Winter Cherry (WCM). Please Specify. Genuine maple faced veneers and solids are used.

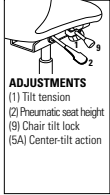
- Please refer to the "Casters Selection" section of the price book for caster options. Optional casters may be priced higher than the standard casters for your chair and the difference will be charged. Lower priced optional casters will not be credited.
- For fully assembled in box, specify **SU**. Add \$76.

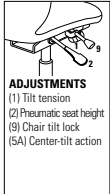
DESCRIPTION	FEATURES	MODEL#	STANDARD TEXTILE GRADES												
			1	2	3	4	5	6	7	8	9	10	11	12	
 <p>HB Tilter COM Yardage: 11.75 Freight Class: 250 Product Weight (lbs.): 40 Cubic Feet Per Carton: 11.75</p>	 <p>ADJUSTMENTS (1) Tilt tension (2) Pneumatic seat height (9) Chair tilt lock (5A) Center-tilt action</p>	2106	1163	1236	1292	1376	1495	1535	1639	1836	1930	2113	2362	2672	
		OVERALL DIMENSIONS			SEAT DIMENSIONS			BACK DIMENSIONS							
		W	D	H	W	D	H	W	H						
		24.5	27	43.5	21	18.5	17.5-21.5	21	27.5						
			RTA 1	FedEx	ups										
 <p>MB Tilter COM Yardage: 1.75 Freight Class: 250 Product Weight (lbs.): 39 Cubic Feet Per Carton: 11.50</p>	 <p>ADJUSTMENTS (1) Tilt tension (2) Pneumatic seat height (9) Chair tilt lock (5A) Center-tilt action</p>	2107	1132	1197	1246	1317	1422	1459	1548	1721	1805	1964	2181	2453	
		OVERALL DIMENSIONS			SEAT DIMENSIONS			BACK DIMENSIONS							
		W	D	H	W	D	H	W	H						
		24.5	26.5	37	19	20	17-21	22	19						
			RTA 1	FedEx	ups										

ENTERPRISE®



model 4560



model 4565

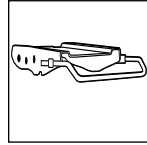

Multi-Depth Mechanism
Seat depth option is available on multi-tilter models. (see notes for more details)



model 4571-3

STANDARD FEATURES

- Gently sculpted seat and back provide lateral and lumbar support.
- Fixed height, impact and scuff resistant curved arms are standard on models 4560, 4561 and 4565. All other models are standard with adjustable height T-arms with teardrop shaped urethane armcaps (TD).
- All models (except armchair) are standard with a five prong, injection molded, fiberglass reinforced nylon Black base with dual wheel carpet casters (C65).
- Arms are available in Black (BK) only.
- Vari-Width (WA) width adjustable arm extensions are standard when chair is ordered with adjustable arms. Allows the arms to move away from the seat by 2" on each side to allow space if desired for broader hip widths.
- Model 4561-SC features a self centering cylinder which swivels and automatically returns to the starting seat location. This model is standard with a flat 5 star base in Black (BK) with C7 glides.
- Check textile availability prior to specifying upholstery material.

OPTIONAL FEATURES

- An optional abrasion resistant outer back fabric (polyester) is available. Resistant to impact damage. Available in Black only (BKB). Add \$23.
- Available with back edge vinyl bumper guard option (VBG). Add \$26.
- Multi-Depth Mechanism a seat depth option available on multi-tilter models 4570-3 and 4571-3. Allows seat to move forward and backward over a 2" range with 5 locking positions to provide a more shallow or deeper seat. Specify "MD". Add \$129.
- For hard surface flooring casters, specify C65R. Add \$73.
- For additional arm/caster options, please refer to the Arm and Caster section. Optional casters may be priced higher than the standard casters for your chair and the difference will be charged. Lower priced optional casters will not be credited.
- For fully assembled in box, specify SU. Add \$76.

DESCRIPTION FEATURES MODEL# STANDARD TEXTILE GRADES



HB Tilter w/ Fixed Height Loop Arms
COM Yardage: 2
Freight Class: 250
Product Weight (lbs.): 39
Cubic Feet Per Carton: 11.50

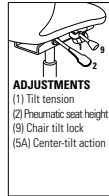

ADJUSTMENTS
(1) Tilt tension
(2) Pneumatic seat height
(9) Chair tilt lock
(5A) Center-tilt action

Ergonomic Features:
A, B, C, M, N, S

MODEL#	1	2	3	4	5	6	7	8	9	10	11	12
4560	694	768	823	909	1031	1079	1182	1387	1483	1672	1926	2248

OVERALL DIMENSIONS			SEAT DIMENSIONS			BACK DIMENSIONS	
W	D	H	W	D	H	W	H
24.5	27	45	20.5	18.5	17-22	20	26

RTA 1



HB Knee - Tilter w/ Fixed Height Loop Arms
COM Yardage: 2
Freight Class: 250
Product Weight (lbs.): 41
Cubic Feet Per Carton: 13.25

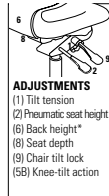

ADJUSTMENTS
(1) Tilt tension
(2) Pneumatic seat height
(6) Back height*
(8) Seat depth
(9) Chair tilt lock
(5B) Knee-tilt action

Ergonomic Features:
A, B, C, J, M, N

MODEL#	1	2	3	4	5	6	7	8	9	10	11	12
4560-2	953	1028	1086	1172	1297	1341	1448	1657	1757	1951	2211	2534

OVERALL DIMENSIONS			SEAT DIMENSIONS			BACK DIMENSIONS	
W	D	H	W	D	H	W	H
24.5	27	45	21	19.5	17-21	21	25

RTA 1



LB Tilter w/ Fixed Height Loop Arms
COM Yardage: 1.75
Freight Class: 250
Product Weight (lbs.): 36
Cubic Feet Per Carton: 9.75

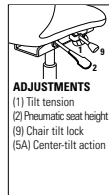

ADJUSTMENTS
(1) Tilt tension
(2) Pneumatic seat height
(9) Chair tilt lock
(5A) Center-tilt action

Ergonomic Features:
A, B, C, M, N, S

MODEL#	1	2	3	4	5	6	7	8	9	10	11	12
4561	663	728	780	850	959	998	1093	1268	1355	1519	1743	2022

OVERALL DIMENSIONS			SEAT DIMENSIONS			BACK DIMENSIONS	
W	D	H	W	D	H	W	H
24.5	26.5	39	20.5	18.5	17-22	20	21

RTA 1



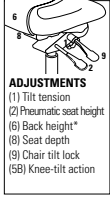



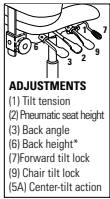

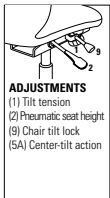

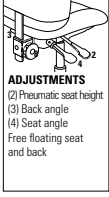

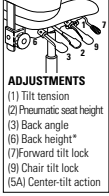
DESCRIPTION	FEATURES	MODEL#	STANDARD TEXTILE GRADES											
			1	2	3	4	5	6	7	8	9	10	11	12
 MB Conference Chair w/ Fixed Height Loop Arms COM Yardage: 1.75 Freight Class: 250 Product Weight (lbs.): 36 Cubic Feet Per Carton: 9.75		4561-SC	725	792	844	914	1029	1067	1161	1344	1430	1598	1826	2109
	OVERALL DIMENSIONS			SEAT DIMENSIONS			BACK DIMENSIONS							
	W	D	H	W	D	H	W	H						
24.5	26.5	37	21	19.5	18	21	19							
			RTA 1											



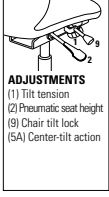

DESCRIPTION	FEATURES	MODEL#	STANDARD TEXTILE GRADES											
			1	2	3	4	5	6	7	8	9	10	11	12
 LB Knee - Tilter w/ Fixed Height Loop Arms COM Yardage: 1.75 Freight Class: 250 Product Weight (lbs.): 39 Cubic Feet Per Carton: 11.50	 ADJUSTMENTS (1) Tilt tension (2) Pneumatic seat height (6) Back height* (8) Seat depth (9) Chair tilt lock (5B) Knee-tilt action	4561-2	912	981	1031	1109	1219	1256	1353	1531	1618	1785	2014	2296
		OVERALL DIMENSIONS			SEAT DIMENSIONS			BACK DIMENSIONS						
		W	D	H	W	D	H	W	H					
25	26.5	39	12	19.5	17-21	21	19							
			RTA 1											
			Ergonomic Features: A, B, C, J, M, N											

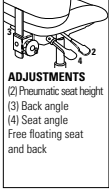
DESCRIPTION	FEATURES	MODEL#	STANDARD TEXTILE GRADES											
			1	2	3	4	5	6	7	8	9	10	11	12
 Armchair w/ Fixed Height Loop Arms COM Yardage: 1.75 Freight Class: 250 Product Weight (lbs.): 33 Cubic Feet Per Carton: 10	Ergonomic Features: M, N	4565	663	728	780	850	959	998	1093	1268	1355	1519	1743	2022
		OVERALL DIMENSIONS			SEAT DIMENSIONS			BACK DIMENSIONS						
		W	D	H	W	D	H	W	H					
24.5	26.5	37	19.5	18-19.5	16.5-20.5	18	22.5							
			RTA 2											

DESCRIPTION	FEATURES	MODEL#	STANDARD TEXTILE GRADES											
			1	2	3	4	5	6	7	8	9	10	11	12
 HB Multi - Tilter w/ Adjustable (TD) Arms COM Yardage: 2 Freight Class: 150 Product Weight (lbs.): 54 Cubic Feet Per Carton: 11	 ADJUSTMENTS (1) Tilt tension (2) Pneumatic seat height (3) Back angle (6) Back height* (7) Forward tilt lock (9) Chair tilt lock (5A) Center-tilt action	4570-3	1269	1342	1399	1485	1606	1655	1757	1962	2059	2248	2502	2823
		OVERALL DIMENSIONS			SEAT DIMENSIONS			BACK DIMENSIONS						
		W	D	H	W	D	H	W	H					
26.5	26.5	47	22	19	17-21	21.5	26-28							
			RTA 2											
			FedEx UPS											

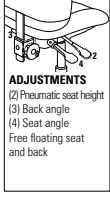
DESCRIPTION	FEATURES	MODEL#	STANDARD TEXTILE GRADES											
			1	2	3	4	5	6	7	8	9	10	11	12
 HB Tilter w/ Adjustable (TD) Arms COM Yardage: 2 Freight Class: 150 Product Weight (lbs.): 47 Cubic Feet Per Carton: 11.50	 ADJUSTMENTS (1) Tilt tension (2) Pneumatic seat height (9) Chair tilt lock (5A) Center-tilt action	4570-4	1133	1209	1266	1356	1472	1519	1624	1828	1926	2112	2689	1133
		OVERALL DIMENSIONS			SEAT DIMENSIONS			BACK DIMENSIONS						
		W	D	H	W	D	H	W	H					
26.5	27	47.5	22	19	17-21	21.5	26-28							
			RTA 2											
			FedEx UPS											

DESCRIPTION	FEATURES	MODEL#	STANDARD TEXTILE GRADES																														
			1	2	3	4	5	6	7	8	9	10	11	12																			
 <p>HB Operator w/ Adjustable (TD) Arms COM Yardage: 2 Freight Class: 150 Product Weight (lbs.): 46 Cubic Feet Per Carton: 11</p>	 <p>ADJUSTMENTS (2) Pneumatic seat height (3) Back angle (4) Seat angle Free floating seat and back</p>	<p>Ergonomic Features: C, D, F, G, H, M, N, Q</p>	<table border="1"> <tr> <td>4570-5</td><td>1251</td><td>1325</td><td>1381</td><td>1466</td><td>1588</td><td>1636</td><td>1739</td><td>1943</td><td>2043</td><td>2229</td><td>2487</td><td>2801</td> </tr> </table>												4570-5	1251	1325	1381	1466	1588	1636	1739	1943	2043	2229	2487	2801						
			4570-5	1251	1325	1381	1466	1588	1636	1739	1943	2043	2229	2487	2801																		
			<table border="1"> <tr> <th colspan="3">OVERALL DIMENSIONS</th> <th colspan="3">SEAT DIMENSIONS</th> <th colspan="3">BACK DIMENSIONS</th> </tr> <tr> <th>W</th><th>D</th><th>H</th> <th>W</th><th>D</th><th>H</th> <th>W</th><th>H</th> </tr> <tr> <td>26.5</td><td>26.5</td><td>47</td> <td>22</td><td>19.5</td><td>17-21</td> <td>21.5</td><td>26-28</td> </tr> </table>			OVERALL DIMENSIONS			SEAT DIMENSIONS			BACK DIMENSIONS			W	D	H	W	D	H	W	H	26.5	26.5	47	22	19.5	17-21	21.5	26-28	<p>RTA 2</p>		
			OVERALL DIMENSIONS			SEAT DIMENSIONS			BACK DIMENSIONS																								
W	D	H	W	D	H	W	H																										
26.5	26.5	47	22	19.5	17-21	21.5	26-28																										
 <p>MB Multi-Tiler w/ Adjustable (TD) Arms COM Yardage: 1.75 Freight Class: 150 Product Weight (lbs.): 52 Cubic Feet Per Carton: 9.50</p>	 <p>ADJUSTMENTS (1) Tilt tension (2) Pneumatic seat height (3) Back angle (6) Back height* (7) Forward tilt lock (9) Chair tilt lock (5A) Center-tilt action</p>	<p>Ergonomic Features: A, B, C, D, F, G, H, M, N, Q, S</p>	<table border="1"> <tr> <td>4571-3</td><td>1142</td><td>1207</td><td>1257</td><td>1328</td><td>1437</td><td>1475</td><td>1570</td><td>1746</td><td>1832</td><td>1998</td><td>2219</td><td>2500</td> </tr> </table>												4571-3	1142	1207	1257	1328	1437	1475	1570	1746	1832	1998	2219	2500						
			4571-3	1142	1207	1257	1328	1437	1475	1570	1746	1832	1998	2219	2500																		
			<table border="1"> <tr> <th colspan="3">OVERALL DIMENSIONS</th> <th colspan="3">SEAT DIMENSIONS</th> <th colspan="3">BACK DIMENSIONS</th> </tr> <tr> <th>W</th><th>D</th><th>H</th> <th>W</th><th>D</th><th>H</th> <th>W</th><th>H</th> </tr> <tr> <td>26.5</td><td>26</td><td>41</td> <td>22</td><td>19</td><td>17-21</td> <td>21.5</td><td>20.5-22.5</td> </tr> </table>			OVERALL DIMENSIONS			SEAT DIMENSIONS			BACK DIMENSIONS			W	D	H	W	D	H	W	H	26.5	26	41	22	19	17-21	21.5	20.5-22.5	<p>RTA 2  </p>		
			OVERALL DIMENSIONS			SEAT DIMENSIONS			BACK DIMENSIONS																								
W	D	H	W	D	H	W	H																										
26.5	26	41	22	19	17-21	21.5	20.5-22.5																										
 <p>MB Tilter w/ Adjustable (TD) Arms COM Yardage: 1.75 Freight Class: 150 Product Weight (lbs.): 46 Cubic Feet Per Carton: 11.50</p>	 <p>ADJUSTMENTS (1) Tilt tension (2) Pneumatic seat height (9) Chair tilt lock (5A) Center-tilt action</p>	<p>Ergonomic Features: A, B, C, H, M, N, Q, S</p>	<table border="1"> <tr> <td>4571-4</td><td>1025</td><td>1090</td><td>1140</td><td>1213</td><td>1320</td><td>1361</td><td>1451</td><td>1629</td><td>1717</td><td>1881</td><td>2104</td><td>2383</td> </tr> </table>												4571-4	1025	1090	1140	1213	1320	1361	1451	1629	1717	1881	2104	2383						
			4571-4	1025	1090	1140	1213	1320	1361	1451	1629	1717	1881	2104	2383																		
			<table border="1"> <tr> <th colspan="3">OVERALL DIMENSIONS</th> <th colspan="3">SEAT DIMENSIONS</th> <th colspan="3">BACK DIMENSIONS</th> </tr> <tr> <th>W</th><th>D</th><th>H</th> <th>W</th><th>D</th><th>H</th> <th>W</th><th>H</th> </tr> <tr> <td>26.5</td><td>26</td><td>41.5</td> <td>22</td><td>19</td><td>17-21</td> <td>21.5</td><td>20.5-22.5</td> </tr> </table>			OVERALL DIMENSIONS			SEAT DIMENSIONS			BACK DIMENSIONS			W	D	H	W	D	H	W	H	26.5	26	41.5	22	19	17-21	21.5	20.5-22.5	<p>RTA 2  </p>		
			OVERALL DIMENSIONS			SEAT DIMENSIONS			BACK DIMENSIONS																								
W	D	H	W	D	H	W	H																										
26.5	26	41.5	22	19	17-21	21.5	20.5-22.5																										
 <p>LB Operator w/ Adjustable (TD) Arms COM Yardage: 1.75 Freight Class: 150 Product Weight (lbs.): 43 Cubic Feet Per Carton: 8.25</p>	 <p>ADJUSTMENTS (2) Pneumatic seat height (3) Back angle (4) Seat angle Free floating seat and back</p>	<p>Ergonomic Features: C, D, F, G, H, M, N, Q</p>	<table border="1"> <tr> <td>4573-5</td><td>1113</td><td>1179</td><td>1227</td><td>1302</td><td>1410</td><td>1449</td><td>1541</td><td>1720</td><td>1805</td><td>1969</td><td>2193</td><td>2471</td> </tr> </table>												4573-5	1113	1179	1227	1302	1410	1449	1541	1720	1805	1969	2193	2471						
			4573-5	1113	1179	1227	1302	1410	1449	1541	1720	1805	1969	2193	2471																		
			<table border="1"> <tr> <th colspan="3">OVERALL DIMENSIONS</th> <th colspan="3">SEAT DIMENSIONS</th> <th colspan="3">BACK DIMENSIONS</th> </tr> <tr> <th>W</th><th>D</th><th>H</th> <th>W</th><th>D</th><th>H</th> <th>W</th><th>H</th> </tr> <tr> <td>26.5</td><td>25</td><td>38</td> <td>22</td><td>19.5</td><td>17-21</td> <td>19</td><td>18.5-20.5</td> </tr> </table>			OVERALL DIMENSIONS			SEAT DIMENSIONS			BACK DIMENSIONS			W	D	H	W	D	H	W	H	26.5	25	38	22	19.5	17-21	19	18.5-20.5	<p>RTA 2  </p>		
			OVERALL DIMENSIONS			SEAT DIMENSIONS			BACK DIMENSIONS																								
W	D	H	W	D	H	W	H																										
26.5	25	38	22	19.5	17-21	19	18.5-20.5																										

DESCRIPTION	FEATURES	MODEL#	STANDARD TEXTILE GRADES											
			1	2	3	4	5	6	7	8	9	10	11	12
 <p>LB Operator Armless COM Yardage: 1.75 Freight Class: 150 Product Weight (lbs.): 36 Cubic Feet Per Carton: 7</p>	 <p>ADJUSTMENTS (2) Pneumatic seat height (3) Back angle (4) Seat angle Free floating seat and back</p>	4577-5	923	988	1038	1110	1218	1258	1349	1529	1614	1779	2001	2282
			OVERALL DIMENSIONS W D H			SEAT DIMENSIONS W D H			BACK DIMENSIONS W H					
			26.5	25.5	40.5	22	19.5	17-21	19	18.5-20.5				
	Ergonomic Features: C, D, F, G, H, M, N													

FACTOR



model 5540



model 5541

STANDARD MODEL MECHANISM:

Task Basic Swivel mechanism (-6)

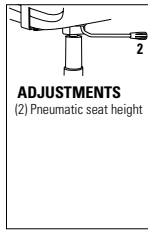

ADJUSTMENTS
(2) Pneumatic seat height

Ergonomic features:
C

MECHANISM OPTIONS:

Tilter mechanism (-4)

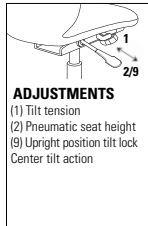

ADJUSTMENTS
(1) Tilt tension
(2) Pneumatic seat height
(9) Upright position tilt lock
Center tilt action

Ergonomic features:
A, B, C, S

Weight sensing

Synchro-tilter mechanism (-8)

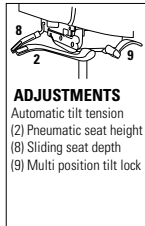

ADJUSTMENTS
Automatic tilt tension
(2) Pneumatic seat height
(8) Sliding seat depth
(9) Multi position tilt lock

Ergonomic features:
A, B, C, E, L

STANDARD FEATURES

- Factor, a value seating series with a full spectrum of mesh colors. Enhanced in July 2023 with an improved softer sit, a better ride supporting a wider range of users, and a redesigned lumbar pad for optimal support.
- Adjustable lumbar support is standard on all models. Height adjustable and split down the middle to flex independently side-to-side.
- Standard with (-6) Task Basic Swivel mechanism.
- (U1) Standard with fixed, forward swept arms. Self-skinned urethane (SSU) armcaps will match the selected frame color (Black or Shadow); Cloud frame comes with coordinating Fog armcaps.
- Standard with five prong, injection molded, fiberglass reinforced nylon Black base with (C82) dual wheel carpet casters. Base will match frame color selection; casters coordinate with base color.
- Upholstery options: fabric, vinyl or leather.
- Check textile availability prior to specifying upholstery material.
- Standard Ergonomic features: C, D, M, N, U (see Ergonomic Features & Benefits page).

OPTIONAL FEATURES

- Weight Sensing Synchro-Tilter control mechanism (-8) includes side activated sliding seat depth adjustment.
- Optional Tilter mechanism (-4) is also available.
- (U2) Optional height adjustable arms are available. Ergonomic Feature: H
- (U3) Optional height adjustable arms with sliding armcaps are available. Ergonomic Feature: H,Q
- For additional arms/caster options, please refer to the Arm and Caster section. Optional casters may be priced higher than the standard casters for your chair and the difference will be charged. Lower priced optional casters will not be credited.
- For fully assembled in box, please specify (SU). Add \$76.

Please add option codes in the following order:

- Model number**
5540 High back with arms.
5540NA High back, no arms.
5541 Medium back with arms.
5541NA Medium back, no arms.
5546 Medium task stool with arms (Task Basic Swivel mechanism only).
5546NA Medium task stool, no arms (Task Basic Swivel mechanism only).
- Mesh back** (colors shown on website)
(P-1) Snow (P-8) Mocha
(P-2) Sand (P-9) Eggplant
(P-3) Pewter (Q-1) Buzz Blue
(P-4) Silver Grey (Q-2) Poppy
(P-5) Charcoal (Q-3) Pumpkin
(P-6) Black (Q-4) Lime
- Textile**
Specify textile code for seat.
- Frame color**
(BK) Black. (Standard).
(SH) Shadow. Add \$49 for armless models. Add \$64 for models with arms.
(IC) Cloud. Add \$49 for armless models. Add \$64 for models with arms.
- Arms**
(A-U1) Fixed height arms. (Standard).
(A-U2) Height adjustable arms. Add \$23.
(A-U3) Height adjustable arms w/sliding armcaps. Add \$56.
- Base**
(B7) Nylon base. (Color matches frame).
(A7) Polished Aluminum base. Add \$167.
- Mechanism**
(-4) Tilter mechanism. Add \$23.
(-6) Task Basic Swivel mechanism (standard). No upcharge.
(-8) Weight sensing synchro-tilter mechanism w/ standard seat slider. Add \$118.
- Casters**
(C82) Carpet Casters (Standard).
(C82R) Rubber Hard Floor Casters. Add \$94

EXAMPLE FACTOR ORDER CODE:





5541	-P-5	-FU75	-8	-SH	A-U3	-B7	-C82R
------	------	-------	----	-----	------	-----	-------

Model # Mesh Back Textile Mechanism Frame Color Arms Base Casters

DESCRIPTION	FEATURES	MODEL#	STANDARD TEXTILE GRADES											
			1	2	3	4	5	6	7	8	9	10	11	12
 <p>High Back COM Yardage: 1 Freight Class: 250 Product Weight (lbs.): 37 (armless 31) Cubic Feet Per Carton: 10.5</p>		5540	715	764	779	819	873	900	949	1030	1090	1159	1295	1444
	With arms													
			OVERALL DIMENSIONS			SEAT DIMENSIONS			BACK DIMENSIONS					
			W	D	H	W	D	H	W	H				
			26.5	24	41.5	20	17.5	16-20	18.5	23				



1 per carton

DESCRIPTION	FEATURES	MODEL#	STANDARD TEXTILE GRADES												
			1	2	3	4	5	6	7	8	9	10	11	12	
 High Back COM Yardage: 1 Freight Class: 250 Product Weight (lbs.): 37 (armless 31) Cubic Feet Per Carton: 10.5			1	2	3	4	5	6	7	8	9	10	11	12	
	5540NA	667	711	731	771	832	852	906	988	1049	1118	1260	1417		
	OVERALL DIMENSIONS	W	D	H	SEAT DIMENSIONS	W	D	H	BACK DIMENSIONS		W	H			
	20	24	41.5	20	17.5	16-20	18.5	23							
		RTA 1	FedEx	ups	1 per carton										
 Medium Back COM Yardage: 1 Freight Class: 250 Product Weight (lbs.): 36 (armless 30) Cubic Feet Per Carton: 10.5			1	2	3	4	5	6	7	8	9	10	11	12	
	5541	674	710	738	778	832	853	900	982	1043	1104	1246	1389		
	OVERALL DIMENSIONS	W	D	H	SEAT DIMENSIONS	W	D	H	BACK DIMENSIONS		W	H			
	26.5	24	39	20	17.5	16-20	18.5	20							
		RTA 1	FedEx	ups	1 per carton										
 Medium Back COM Yardage: 1 Freight Class: 250 Product Weight (lbs.): 36 (armless 30) Cubic Feet Per Carton: 10.5			1	2	3	4	5	6	7	8	9	10	11	12	
	5541NA	626	662	690	730	784	811	860	941	1001	1070	1212	1361		
	OVERALL DIMENSIONS	W	D	H	SEAT DIMENSIONS	W	D	H	BACK DIMENSIONS		W	H			
	20	24	39	20	17.5	16-20	18.5	20							
		RTA 1	FedEx	ups	1 per carton										
 Stool COM Yardage: 1 Freight Class: 250 Product Weight (lbs.): 40 (armless 34) Cubic Feet Per Carton: 10.5			1	2	3	4	5	6	7	8	9	10	11	12	
	5546	831	867	895	935	989	1016	1065	1146	1206	1275	1417	1566		
	OVERALL DIMENSIONS	W	D	H	SEAT DIMENSIONS	W	D	H	BACK DIMENSIONS		W	H			
	26.5	23.5	49	20	17.5	23.75-33.75	18.5	20.5							
		RTA 1	FedEx	ups	1 per carton										
 Stool COM Yardage: 1 Freight Class: 250 Product Weight (lbs.): 40 (armless 34) Cubic Feet Per Carton: 10.5			1	2	3	4	5	6	7	8	9	10	11	12	
	5546NA	782	826	852	886	954	975	1021	1103	1171	1238	1382	1537		
	OVERALL DIMENSIONS	W	D	H	SEAT DIMENSIONS	W	D	H	BACK DIMENSIONS		W	H			
	20	23.5	49	20	17.5	23.75-33.75	18.5	20.5							
		RTA 1	FedEx	ups	1 per carton										

G1 ERGO SELECT™



model 7331



model 7333

MECHANISM OPTIONS:

Synchro-tilter mechanism (-0)

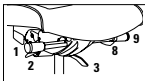

ADJUSTMENTS
 (1) Tilt tension
 (2) Pneumatic seat height/lumbar height
 (3) Back angle adjustment
 (8) Sliding seat depth
 (9) Multi position tilt lock
 Synchro tilt action
 Anti kick back

Ergonomic features:
 A, B, C, D, E, G, H, L, M, N, Q, R, U

Multi-tilter mechanism (-3)

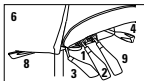

ADJUSTMENTS
 (1) Tilt tension
 (2) Pneumatic seat height
 (3) Back angle
 (4) Seat angle
 (6) Back/lumbar height
 (8) Sliding seat depth
 (9) Infinite position tilt lock
 Center tilt action

Ergonomic features:
 A, B, C, D, E, F, G, H, M, N, Q, R, S, U

Weight sensing synchro-tilter mechanism (-8)

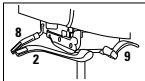

ADJUSTMENTS
 Weight sensing auto tension adjustment
 (2) Pneumatic seat height back/lumbar height
 (8) Sliding seat depth
 (9) Multi position tilt lock

Ergonomic features:
 A, B, C, D, E, H, L, M, N, Q, R, U

Posture task mechanism (-7)

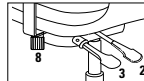

ADJUSTMENTS
 (2) Pneumatic seat height
 (3) Back angle
 Back/lumbar height
 (8) Manual seat depth
 20" diameter Chrome footrest

Ergonomic features:
 C, D, G, H, M, N, Q, R, U, V

STANDARD FEATURES

- G1 Ergo Select was designed to provide exceptional support and comfort throughout the work day.
- Available in three back heights and three seat sizes, varying in depth and width, to fit a person's body type and movements while at work.
- Adjustable lumbar support standard on all models.
- Stitch detail on edges of seat and back is discrete, using matched thread as standard.
- Choice of three mechanisms; synchro-tilter, multi-tilter and weight sensing synchro-tilter. Stool model available with posture task mechanism only.
- Standard with Global's high quality Soft Descent™ pneumatic lift which slowly and gently lowers the seat height of the chair making it easy to obtain the exact seat height you desire.
- Standard with height and width adjustable (G5) arms with sliding armcaps. Armcaps also articulate inwards and outwards to aim toward the keyboard or mouse area.
- G1 Ergo Select is fully compliant with latest BIFMA G1, GSA, and CGSB specifications.
- Five prong, injection molded, fiberglass reinforced nylon Black base with (C82) dual wheel carpet casters.
- Upholstery options: fabric, vinyl or leather.
- Check textile availability prior to specifying upholstery material.

OPTIONAL FEATURES

- Upholstery is available with exaggerated top stitch detail (heavier thread). Fourteen coordinating or contrasting colors may be selected. Please specify.
- Optional Ergo Select arms are height (4") and width adjustable with sliding armcaps. Armcaps also articulate inwards (25°) and outwards (25°) to aim toward the keyboard or mouse area.
- For additional arms/caster options, please refer to the Arm and Caster section (page 430). Optional casters may be priced higher than the standard casters for your chair and the difference will be charged. Lower priced optional casters will not be credited.





Please add option codes in the following order:

- Model number**
7331 Medium back with arms
7332 High back with arms
7333 Extended high back with arms
7336 Medium task stool with arms (posture task mechanism only)
7336NA Medium task stool, armless (posture task mechanism only)
- Textile**
 Specify textile codes for back and seat
- Mechanism (No Upcharge)**
(-0) Synchro-tilter mechanism
(-3) Multi-tilter mechanism
(-8) Weight sensing synchro-tilter mechanism
(-7) Posture task mechanism (models 7336 / 7336NA only)
- Seat Size**
(P) Petite seat
(STAN) Standard seat
(GS) Generous seat
- Arms**
(G5) G5 arms **Standard**
(H1) Ergo Select arms **Add \$90**
(H2) Ergo Select arms w/wide armcaps **Add \$125**
- Base**
(B7) Black nylon B7B base **Standard**
(A7) Polished aluminum B7A base.... **Add \$167**
- Cylinder**
 Please refer to "Cylinder Selection" section of the price book for cylinder options.
- Casters**
(C82) Dual wheel carpet casters..... **Standard**
(C82R) Dual wheel hard floor casters **Add \$94**
- Stitch detail**
(MS) Color matched stitching
 Decorative top stitch **No upcharge**
(XP) Black **(XB)** Beige
(XG) Copen **(XA)** Graphite
(XK) Mahogany **(XJ)** Natural
(XH) Navy #3 **(XD)** New Grey
(XF) Nickel **(XN)** Off-White
(XL) Rubytone **(XI)** Scarlett
(XC) Smoke **(XE)** Taupe
 (colors shown on website)

EXAMPLE G1 ERGO SELECT ORDER CODE:

7332	-WA53	-WA53	-8	-STAN	-H1	-B7	-4L	-C82	-MS
Model #	Back fabric	Seat fabric	Mechanism	Seat size	Arms	Base	Cylinder	Casters	Stitch detail

G1 Ergo Select dimensional information: based on measurements with multi-tilter mechanism				
	Distance between arms	Standard arm height	Seat depth range	Standard seat height
Petite seat (P) Soft Descent 4" lift & (H1) arms	15.25" - 20.75" = 5.5" adjustment	7.3" - 11.4"	15.75" - 18.75"	16.5" - 20.5"
Standard seat (STAN) Soft Descent 4" lift & (H1) arms	16" - 21.5" = 5.5" adjustment		16.5" - 19.5"	
Generous seat (GS) Soft Descent 4" lift & (H1) arms	17.25" - 22.75" = 5.5" adjustment		17.25" - 19.5"	

DESCRIPTION	FEATURES	MODEL#	STANDARD TEXTILE GRADES											
			1	2	3	4	5	6	7	8	9	10	11	12
 <p>Medium Back COM Yardage: 1.65 Freight Class: 125 Product Weight (lbs.): 66 Cubic Feet Per Carton: 10.50</p>	<p>See series notes for mechanism options.</p> <p>* Standard seat</p>	7331	1296	1356	1400	1468	1563	1610	1697	1836	1942	2062	2307	2567
			OVERALL DIMENSIONS			SEAT DIMENSIONS*			BACK DIMENSIONS					
			W	D	H	W	D	H	W	H				
			24	21.5	41	19.75	16.5-19.5	16.5-20.5	19	22				
						RTA 1	FedEx		ups	1 per carton				
 <p>High Back COM Yardage: 1.75 Freight Class: 125 Product Weight (lbs.): 68 Cubic Feet Per Carton: 10.50</p>	<p>See series notes for mechanism options.</p> <p>* Standard seat</p>	7332	1368	1432	1478	1552	1654	1703	1795	1944	2060	2184	2447	2727
			OVERALL DIMENSIONS			SEAT DIMENSIONS*			BACK DIMENSIONS					
			W	D	H	W	D	H	W	H				
			24.5	23	44.5	19.75	16.5-19.5	16.5-20.5	19	24.5				
						RTA 1	FedEx		ups	1 per carton				
 <p>Extended High Back COM Yardage: 2 Freight Class: 125 Product Weight (lbs.): 70 Cubic Feet Per Carton: 11</p>	<p>See series notes for mechanism options.</p> <p>* Standard seat</p>	7333	1437	1510	1565	1649	1768	1823	1930	2100	2232	2378	2679	3001
			OVERALL DIMENSIONS			SEAT DIMENSIONS*			BACK DIMENSIONS					
			W	D	H	W	D	H	W	H				
			26	24	50	19.75	16.5-19.5	16.5-20.5	19	27				
						RTA 1	FedEx		ups	1 per carton				
 <p>Medium Back Stool COM Yardage: 1.65 Freight Class: 150 Product Weight (lbs.): 59 Cubic Feet Per Carton: 10.50</p>	<p>See series notes for mechanism options.</p> <p>* Standard seat</p>	7336	1401	1462	1506	1575	1670	1716	1804	1943	2048	2170	2416	2677
			7336NA Armless	1296	1359	1402	1473	1570	1615	1704	1844	1953	2073	2321
		OVERALL DIMENSIONS			SEAT DIMENSIONS*			BACK DIMENSIONS						
		W	D	H	W	D	H	W	H					
		24	22.5	46	18.5	16.5	22-30	19	22					
			RTA 1	FedEx		ups	1 per carton							

G G20

G20



model 6007



Lumbar Support

Automatic lumbar tension mechanism naturally adjusts to your posture while in upright or reclined position. The lumbar is also height adjustable.



Optional Fixed "C" Arm

WORK & TASK

STANDARD FEATURES

- The striped mesh back is composed of an alternating vertical rows of clear elastomeric yarns and polyester yarns. This provides a very responsive back support.
- The inside of the mesh back is Black while the outside of the mesh is Silver to coordinate with the Polished Aluminum trim. Only available in a Black mesh back with Black arms and frame.
- Synchronized mechanism allows the back to smoothly tilt, while the seat gently reclines and slides to the rear. The seat does not lift up and keeps feet planted on floor. Four tilt positions, locks and infinite free float.
- Height adjustable self-skinned urethane (SSU) arms with sliding and pivoting armcaps.
- Independent lumbar adjustment on back (2.5" of height adjustment range on each side).
- Adjustable tilt tension knob located beside the seat. Simply rotate the knob for user preference.
- Side activated sliding seat depth adjustment (**MD**) is standard and provides 2" of adjustment.
- Base and frame are standard in Polished Aluminum with dual wheel carpet casters (**C82**).
- Check textile availability prior to specifying upholstery material.

OPTIONAL FEATURES

- An optional black nylon base (**B7B**) is available. No upcharge.
- Optional fixed aluminum "C" arms with SSU armcaps (**DF**) are available. No upcharge.
- Please refer to "Cylinder Selection" section of the price book for additional cylinder options.
- For hard surface flooring casters, please specify (**C9R**). Add \$98
- For fully assembled in box, specify **SU**. Add \$76.

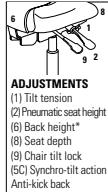
DESCRIPTION	FEATURES	MODEL#	STANDARD TEXTILE GRADES																				
			1	2	3	4	5	6	7	8	9	10	11	12									
 <p>Synchro - Tilter COM Yardage: 1 Freight Class: 150 Product Weight (lbs.): 53 Cubic Feet Per Carton: 11</p>	 <p>ADJUSTMENTS (1) Tilt tension (2) Pneumatic seat height (6) Back height* (8) Seat depth (9) Chair tilt lock (5C) Synchro-tilt action Anti-kick back</p>	6007	1767	1805	1834	1875	1934	1954	2005	2104	2153	2243	2369	2522									
		<p>OVERALL DIMENSIONS</p> <table border="1"> <thead> <tr> <th>W</th> <th>D</th> <th>H</th> </tr> </thead> <tbody> <tr> <td>25.5</td> <td>23</td> <td>41.5</td> </tr> </tbody> </table>			W	D	H	25.5	23	41.5	<p>SEAT DIMENSIONS</p> <table border="1"> <thead> <tr> <th>W</th> <th>D</th> <th>H</th> </tr> </thead> <tbody> <tr> <td>19.5</td> <td>16</td> <td>17.75-22.75</td> </tr> </tbody> </table>			W	D	H	19.5	16	17.75-22.75	<p>BACK DIMENSIONS</p> <table border="1"> <thead> <tr> <th>W</th> <th>H</th> </tr> </thead> <tbody> <tr> <td>19</td> <td>22</td> </tr> </tbody> </table>		W	H
W	D	H																					
25.5	23	41.5																					
W	D	H																					
19.5	16	17.75-22.75																					
W	H																						
19	22																						
		RTA 4	FedEx		ups																		

Ergonomic Features:
A, B, C, D, E, H, L, M, N, Q, R, U

GLOBAL ACCORD™



model 2670-2



model 2670-2



Polished Aluminum Base
Arched aluminum spider base on all models add a distinctive look to the Global Accord series.



model 2671-4



model 2676-2



model 2670-4PB



STANDARD FEATURES

- Global Accord offers an elegant and refined design that features a sling back style that molds to and evenly supports the back and spine.
- Cast aluminum with a mirror finish accent the arms and base.
- Soft touch self-skinned urethane armcaps are available in Black Only.
- All models are standard with a five prong, polished cast aluminum spider base with dual wheel carpet casters (**C1**).
- Pedestal base models are offered on (-4) Tilter mechanisms only. These models provide fixed location seating for use in auditoriums, classrooms, jury boxes, public venues and more. The base must be mounted to the floor (mounting hardware not included). See Pedestal Base Installation Guide for details.
- Mesh back models are available featuring a breathable mesh sling style back in 24 brilliant Vue colors: Sandy Beach (VU10), Desert Sand (VU11), Orange Sunset (VU12), Chocolate Fountain (VU13), Arctic Blue (VU14), Quarry Grey (VU15), Tidal Wave (VU16), Ivy Moss (VU17), Red Rose (VU18), Coal Black (VU19), White (VU20), Lime (VU21), Chartreuse (VU23), Pool Blue (VU26), Sky (VU28), Primary Blue (VU32), Tangerine (VU34), Paprika (VU37), Grain (VU40), Yellow (VU43), Silver Grey (VU55), Silver (VU63), Hot Pink (VU65) and Red Mittens (VU70). Please specify
- Check textile availability prior to specifying upholstery material.

OPTIONAL FEATURES

- There are no arm options for the Accord series.
- Optional (**B5**) black plastic base with aluminum arms combination. No upcharge.
- For hard surface flooring casters, please specify (**C5R**). Add \$72
- Please refer to the "Casters Selection" section of the price book for caster options. Optional casters may be priced higher than the standard casters for your chair and the difference will be charged. Lower priced optional casters will not be credited.
- Pedestal Base models have Black bases with 2" height adjustable cylinders. Please specify: (**SCC**) Swivel, auto return to max height. No upcharge. (**SN**) Non-swivel, auto return to max height. Add \$21. (**SC**) Swivel, self-centering and return to max height. Add \$33.
- For Memory Foam, specify (**MF**) and add \$117.
- For fully assembled in box, specify **SU**. Add \$76.

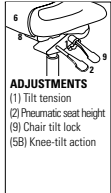

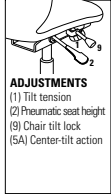
DESCRIPTION	FEATURES	MODEL#	STANDARD TEXTILE GRADES													
			1	2	3	4	5	6	7	8	9	10	11	12		
 <p>HB Knee - Tilter COM Yardage: 2 Freight Class: 150 Product Weight (lbs.): 56 Cubic Feet Per Carton: 13</p>	 <p>ADJUSTMENTS (1) Tilt tension (2) Pneumatic seat height (9) Chair tilt lock (5B) Knee-tilt action</p>	2670-2	1587	1657	1712	1793	1924	1973	2075	2278	2376	2565	2820	3139		
			OVERALL DIMENSIONS			SEAT DIMENSIONS			BACK DIMENSIONS							
			W	D	H	W	D	H	W	H						
			25	25	44	20	19	18-22	18.5	23						
 <p>HB Tilter COM Yardage: 2 Freight Class: 150 Product Weight (lbs.): 43 Cubic Feet Per Carton: 10.75</p>	 <p>ADJUSTMENTS (1) Tilt tension (2) Pneumatic seat height (9) Chair tilt lock (5A) Center-tilt action</p>	2670-4	1304	1377	1430	1510	1625	1690	1794	1947	2096	2217	2540	2858		
			OVERALL DIMENSIONS			SEAT DIMENSIONS			BACK DIMENSIONS							
			W	D	H	W	D	H	W	H						
			25	25	42.5	20	19	17-21	18.5	23						

DESCRIPTION FEATURES MODEL# STANDARD TEXTILE GRADES



MB Knee - Tilter
COM Yardage: 1.75
Freight Class: 150
Product Weight (lbs.): 50
Cubic Feet Per Carton: 10.75

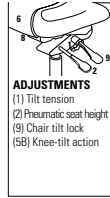

ADJUSTMENTS
(1) Tilt tension
(2) Pneumatic seat height
(9) Chair tilt lock
(5B) Knee-tilt action

Ergonomic Features:
A, B, C, J, M, N, U

MODEL#	1	2	3	4	5	6	7	8	9	10	11	12
2671-2	1546	1616	1671	1750	1863	1879	1973	2187	2236	2458	2624	2903
OVERALL DIMENSIONS			SEAT DIMENSIONS			BACK DIMENSIONS						
W	D	H	W	D	H	W	H					
25	25	38.5	20	19	18-22	18.5	18					

RTA 1



MB Tilter
COM Yardage: 1.75
Freight Class: 250
Product Weight (lbs.): 40
Cubic Feet Per Carton: 10.75

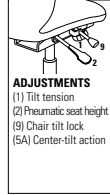

ADJUSTMENTS
(1) Tilt tension
(2) Pneumatic seat height
(9) Chair tilt lock
(5A) Center-tilt action

Ergonomic Features:
A, B, C, M, N, S, U

MODEL#	1	2	3	4	5	6	7	8	9	10	11	12
2671-4	1264	1334	1391	1470	1585	1599	1695	1907	1955	2177	2343	2624
OVERALL DIMENSIONS			SEAT DIMENSIONS			BACK DIMENSIONS						
W	D	H	W	D	H	W	H					
25	25	37	20	19	17-21	18.5	18					

RTA 1



MB Stool
COM Yardage: 1.75
Freight Class: 150
Product Weight (lbs.): 48
Cubic Feet Per Carton: 10.75

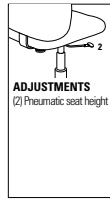

ADJUSTMENTS
(2) Pneumatic seat height

Ergonomic Features:
C, M, N, U

MODEL#	1	2	3	4	5	6	7	8	9	10	11	12
2672-6	1552	1617	1662	1737	1838	1871	1961	2130	2211	2368	2582	2848
OVERALL DIMENSIONS			SEAT DIMENSIONS			BACK DIMENSIONS						
W	D	H	W	D	H	W	H					
25	26	46.5	20	19	22.75-32.75	18.5	18					

RTA 1



Mesh HB Knee - Tilter
COM Yardage: 1
Freight Class: 150
Product Weight (lbs.): 56
Cubic Feet Per Carton: 13

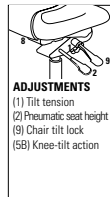

ADJUSTMENTS
(1) Tilt tension
(2) Pneumatic seat height
(9) Chair tilt lock
(5B) Knee-tilt action

Ergonomic Features:
A, B, C, J, M, N, U

MODEL#	1	2	3	4	5	6	7	8	9	10	11	12
2676-2	1718	1756	1784	1824	1885	1905	1956	2055	2104	2193	2318	2473
OVERALL DIMENSIONS			SEAT DIMENSIONS			BACK DIMENSIONS						
W	D	H	W	D	H	W	H					
25	25	44	20	19	18-22	18.5	23					

RTA 1



Mesh HB Tilter
COM Yardage: 1
Freight Class: 150
Product Weight (lbs.): 43
Cubic Feet Per Carton: 10.75

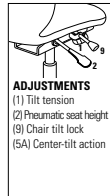











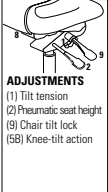



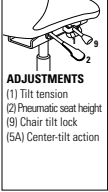

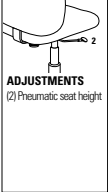

ADJUSTMENTS
(1) Tilt tension
(2) Pneumatic seat height
(9) Chair tilt lock
(5A) Center-tilt action

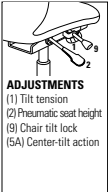

Ergonomic Features:
A, B, C, M, N, S, U

MODEL#	1	2	3	4	5	6	7	8	9	10	11	12
2676-4	1436	1474	1503	1543	1603	1623	1674	1773	1822	1912	2038	2191
OVERALL DIMENSIONS			SEAT DIMENSIONS			BACK DIMENSIONS						
W	D	H	W	D	H	W	H					
25	25	42.5	20	19	17-21	18.5	23					

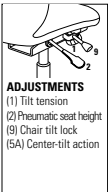
RTA 1

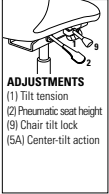

DESCRIPTION	FEATURES	MODEL#	STANDARD TEXTILE GRADES																											
			1	2	3	4	5	6	7	8	9	10	11	12																
 <p>Mesh MB Knee - Tilter COM Yardage: 1 Freight Class: 150 Product Weight (lbs.): 50 Cubic Feet Per Carton: 10.75</p>	 <p>ADJUSTMENTS (1) Tilt tension (2) Pneumatic seat height (9) Chair tilt lock (5B) Knee-tilt action</p>	<p>Ergonomic Features: A, B, C, J, M, N, U</p>	<table border="1"> <tr> <td>2677-2</td> <td>1663</td> <td>1700</td> <td>1728</td> <td>1769</td> <td>1828</td> <td>1849</td> <td>1900</td> <td>1999</td> <td>2048</td> <td>2138</td> <td>2263</td> <td>2417</td> </tr> </table>												2677-2	1663	1700	1728	1769	1828	1849	1900	1999	2048	2138	2263	2417			
			2677-2	1663	1700	1728	1769	1828	1849	1900	1999	2048	2138	2263	2417															
			<p>OVERALL DIMENSIONS</p> <table border="1"> <tr> <th>W</th> <th>D</th> <th>H</th> </tr> <tr> <td>25</td> <td>25</td> <td>38.5</td> </tr> </table>			W	D	H	25	25	38.5	<p>SEAT DIMENSIONS</p> <table border="1"> <tr> <th>W</th> <th>D</th> <th>H</th> </tr> <tr> <td>20</td> <td>19</td> <td>18-22</td> </tr> </table>			W	D	H	20	19	18-22	<p>BACK DIMENSIONS</p> <table border="1"> <tr> <th>W</th> <th>H</th> </tr> <tr> <td>18.5</td> <td>18</td> </tr> </table>						W	H	18.5	18
			W	D	H																									
25	25	38.5																												
W	D	H																												
20	19	18-22																												
W	H																													
18.5	18																													
<p>RTA 1</p>																														
 <p>Mesh MB Tilter COM Yardage: 1 Freight Class: 250 Product Weight (lbs.): 40 Cubic Feet Per Carton: 10.75</p>	 <p>ADJUSTMENTS (1) Tilt tension (2) Pneumatic seat height (9) Chair tilt lock (5A) Center-tilt action</p>	<p>Ergonomic Features: A, B, C, M, N, S, U</p>	<table border="1"> <tr> <td>2677-4</td> <td>1380</td> <td>1418</td> <td>1446</td> <td>1486</td> <td>1547</td> <td>1567</td> <td>1618</td> <td>1717</td> <td>1766</td> <td>1855</td> <td>1980</td> <td>2135</td> </tr> </table>												2677-4	1380	1418	1446	1486	1547	1567	1618	1717	1766	1855	1980	2135			
			2677-4	1380	1418	1446	1486	1547	1567	1618	1717	1766	1855	1980	2135															
			<p>OVERALL DIMENSIONS</p> <table border="1"> <tr> <th>W</th> <th>D</th> <th>H</th> </tr> <tr> <td>25</td> <td>25</td> <td>37</td> </tr> </table>			W	D	H	25	25	37	<p>SEAT DIMENSIONS</p> <table border="1"> <tr> <th>W</th> <th>D</th> <th>H</th> </tr> <tr> <td>20</td> <td>19</td> <td>17-21</td> </tr> </table>			W	D	H	20	19	17-21	<p>BACK DIMENSIONS</p> <table border="1"> <tr> <th>W</th> <th>H</th> </tr> <tr> <td>18.5</td> <td>18</td> </tr> </table>						W	H	18.5	18
			W	D	H																									
25	25	37																												
W	D	H																												
20	19	17-21																												
W	H																													
18.5	18																													
<p>RTA 1</p>																														
 <p>Mesh MB Stool COM Yardage: 1 Freight Class: 150 Product Weight (lbs.): 48 Cubic Feet Per Carton: 10.75</p>	 <p>ADJUSTMENTS (2) Pneumatic seat height</p>	<p>Ergonomic Features: C, M, N, U</p>	<table border="1"> <tr> <td>2678-6</td> <td>1651</td> <td>1689</td> <td>1717</td> <td>1757</td> <td>1816</td> <td>1838</td> <td>1889</td> <td>1988</td> <td>2037</td> <td>2126</td> <td>2251</td> <td>2406</td> </tr> </table>												2678-6	1651	1689	1717	1757	1816	1838	1889	1988	2037	2126	2251	2406			
			2678-6	1651	1689	1717	1757	1816	1838	1889	1988	2037	2126	2251	2406															
			<p>OVERALL DIMENSIONS</p> <table border="1"> <tr> <th>W</th> <th>D</th> <th>H</th> </tr> <tr> <td>25</td> <td>26</td> <td>47</td> </tr> </table>			W	D	H	25	26	47	<p>SEAT DIMENSIONS</p> <table border="1"> <tr> <th>W</th> <th>D</th> <th>H</th> </tr> <tr> <td>20</td> <td>19</td> <td>23.5-33.5</td> </tr> </table>			W	D	H	20	19	23.5-33.5	<p>BACK DIMENSIONS</p> <table border="1"> <tr> <th>W</th> <th>H</th> </tr> <tr> <td>18.5</td> <td>18</td> </tr> </table>						W	H	18.5	18
			W	D	H																									
25	26	47																												
W	D	H																												
20	19	23.5-33.5																												
W	H																													
18.5	18																													
<p>RTA 1</p>																														
 <p>HB Tilter with Pedestal Base COM Yardage: 2 Freight Class: 150 Product Weight (lbs.): 47 Cubic Feet Per Carton: 10.75</p>	 <p>ADJUSTMENTS (1) Tilt tension (2) Pneumatic seat height (9) Chair tilt lock (5A) Center-tilt action</p>	<p>Ergonomic Features: A, B, C, M, N, S, U</p>	<table border="1"> <tr> <td>2670-4PB</td> <td>1536</td> <td>1611</td> <td>1668</td> <td>1755</td> <td>1877</td> <td>1934</td> <td>2044</td> <td>2221</td> <td>2358</td> <td>2507</td> <td>2818</td> <td>3149</td> </tr> </table>												2670-4PB	1536	1611	1668	1755	1877	1934	2044	2221	2358	2507	2818	3149			
			2670-4PB	1536	1611	1668	1755	1877	1934	2044	2221	2358	2507	2818	3149															
			<p>OVERALL DIMENSIONS</p> <table border="1"> <tr> <th>W</th> <th>D</th> <th>H</th> </tr> <tr> <td>25</td> <td>25</td> <td>41</td> </tr> </table>			W	D	H	25	25	41	<p>SEAT DIMENSIONS</p> <table border="1"> <tr> <th>W</th> <th>D</th> <th>H</th> </tr> <tr> <td>20</td> <td>19</td> <td>16.5-18.5</td> </tr> </table>			W	D	H	20	19	16.5-18.5	<p>BACK DIMENSIONS</p> <table border="1"> <tr> <th>W</th> <th>H</th> </tr> <tr> <td>18.5</td> <td>23</td> </tr> </table>						W	H	18.5	23
			W	D	H																									
25	25	41																												
W	D	H																												
20	19	16.5-18.5																												
W	H																													
18.5	23																													
<p>RTA 1</p>																														
 <p>MB Tilter with Pedestal Base COM Yardage: 1.75 Freight Class: 150 Product Weight (lbs.): 44 Cubic Feet Per Carton: 10.75</p>	 <p>ADJUSTMENTS (1) Tilt tension (2) Pneumatic seat height (9) Chair tilt lock (5A) Center-tilt action</p>	<p>Ergonomic Features: A, B, C, M, N, S, U</p>	<table border="1"> <tr> <td>2671-4PB</td> <td>1495</td> <td>1559</td> <td>1619</td> <td>1709</td> <td>1837</td> <td>1898</td> <td>1942</td> <td>2095</td> <td>2215</td> <td>2347</td> <td>2619</td> <td>2907</td> </tr> </table>												2671-4PB	1495	1559	1619	1709	1837	1898	1942	2095	2215	2347	2619	2907			
			2671-4PB	1495	1559	1619	1709	1837	1898	1942	2095	2215	2347	2619	2907															
			<p>OVERALL DIMENSIONS</p> <table border="1"> <tr> <th>W</th> <th>D</th> <th>H</th> </tr> <tr> <td>25</td> <td>25</td> <td>36</td> </tr> </table>			W	D	H	25	25	36	<p>SEAT DIMENSIONS</p> <table border="1"> <tr> <th>W</th> <th>D</th> <th>H</th> </tr> <tr> <td>20</td> <td>19</td> <td>16.5-18.5</td> </tr> </table>			W	D	H	20	19	16.5-18.5	<p>BACK DIMENSIONS</p> <table border="1"> <tr> <th>W</th> <th>H</th> </tr> <tr> <td>18.5</td> <td>18</td> </tr> </table>						W	H	18.5	18
			W	D	H																									
25	25	36																												
W	D	H																												
20	19	16.5-18.5																												
W	H																													
18.5	18																													
<p>RTA 1</p>																														

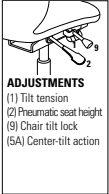
DESCRIPTION	FEATURES	MODEL#	STANDARD TEXTILE GRADES											
			1	2	3	4	5	6	7	8	9	10	11	12
 <p>Mesh HB Tilter with Pedestal Base COM Yardage: 1 Freight Class: 150 Product Weight (lbs.): 47 Cubic Feet Per Carton: 10.75</p>	 <p>ADJUSTMENTS (1) Tilt tension (2) Pneumatic seat height (9) Chair tilt lock (5A) Center-tilt action</p>	2676-4PB	1667	1707	1736	1777	1839	1868	1923	2010	2079	2153	2309	2473
			OVERALL DIMENSIONS			SEAT DIMENSIONS			BACK DIMENSIONS					
			W	D	H	W	D	H	W	H				
			25	25	41	20	19	16.5-18.5	18.5	23				
			Ergonomic Features: A, B, C, M, N, S, U			RTA 1			FedEx			ups		
 <p>Mesh MB Tilter with Pedestal Base COM Yardage: 1 Freight Class: 150 Product Weight (lbs.): 44 Cubic Feet Per Carton: 10.75</p>	 <p>ADJUSTMENTS (1) Tilt tension (2) Pneumatic seat height (9) Chair tilt lock (5A) Center-tilt action</p>	2677-4PB	1611	1649	1678	1721	1782	1810	1866	1954	2023	2096	2253	2417
			OVERALL DIMENSIONS			SEAT DIMENSIONS			BACK DIMENSIONS					
			W	D	H	W	D	H	W	H				
			25	25	36	20	19	16-18.5	18.5	18				
			Ergonomic Features: A, B, C, M, N, S, U			RTA 1			FedEx			ups		

GOAL™



model 2237-3



model 2239-6



Vari-Width Adapter Plate (WA)

Available when chair is ordered with adjustable height arms.

STANDARD FEATURES

- Designed with substantial upholstery and cushioning treatment.
- Standard with adjustable height T-arms with curved urethane armcaps (3N) in Black only.
- All models are standard with a five-legged, injection molded "spider" base and C65 casters
- Base and frame available in Black (BK) only.
- Vari-Width Adapter Plate (WA) allows each arm to move outward an additional 2". Add \$87. Also height adjustable.
- Check textile availability prior to specifying upholstery material.

- Available with back edge vinyl bumper guard option (VBG). Add \$26.
- Please refer to the "Casters Selection" section of the price book for caster options. Optional casters may be priced higher than the standard casters for your chair and the difference will be charged. Lower priced optional casters will not be credited.
- For hard surface flooring casters, specify C65R. Add \$73.
- For fully assembled in box, please specify SU. Add \$76.

OPTIONAL FEATURES

- Please refer to "Arms Selection" section of the price book for arm options.
- An optional abrasion resistant outer back fabric (polyester) is available. Resistant to impact damage. Available in Black only (BKB). Add \$23.

DESCRIPTION	FEATURES	MODEL#	STANDARD TEXTILE GRADES											
			1	2	3	4	5	6	7	8	9	10	11	12



LB Multi - Tilter
COM Yardage: 1.50
Freight Class: 150
Product Weight (lbs.): 53
Cubic Feet Per Carton: 9.25

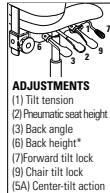

ADJUSTMENTS
(1) Tilt tension
(2) Pneumatic seat height
(3) Back angle
(6) Back height*
(7) Forward tilt lock
(9) Chair tilt lock
(SA) Center-tilt action

Ergonomic Features:
A, B, C, D, F, G, H, N, S

2237-3	766	822	866	930	1021	1055	1133	1288	1359	1499	1690	1932
--------	-----	-----	-----	-----	------	------	------	------	------	------	------	------

OVERALL DIMENSIONS			SEAT DIMENSIONS			BACK DIMENSIONS	
W	D	H	W	D	H	W	H
25	22.5	36	20	17	16.5-20.5	18.5	18-21

RTA 2



LB Tilter
COM Yardage: 1.50
Freight Class: 150
Product Weight (lbs.): 43
Cubic Feet Per Carton: 9.75

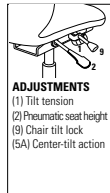

ADJUSTMENTS
(1) Tilt tension
(2) Pneumatic seat height
(9) Chair tilt lock
(SA) Center-tilt action

Ergonomic Features:
A, B, C, H, N, S

2237-4	663	721	765	827	918	950	1031	1185	1256	1396	1588	1826
--------	-----	-----	-----	-----	-----	-----	------	------	------	------	------	------

OVERALL DIMENSIONS			SEAT DIMENSIONS			BACK DIMENSIONS	
W	D	H	W	D	H	W	H
25	25	36.5	20	17	15.5-20.5	18.5	19

RTA 2



LB Operator w/ Arms
COM Yardage: 1.50
Freight Class: 125
Product Weight (lbs.): 44
Cubic Feet Per Carton: 6.25

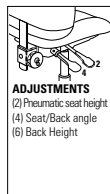

ADJUSTMENTS
(2) Pneumatic seat height
(4) Seat/Back angle
(6) Back Height









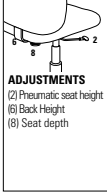

Ergonomic Features:
C, D, F, G, H, N

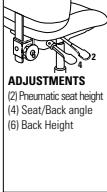
2237-5	603	663	705	770	858	892	971	1125	1196	1336	1528	1769
--------	-----	-----	-----	-----	-----	-----	-----	------	------	------	------	------

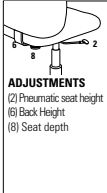
OVERALL DIMENSIONS			SEAT DIMENSIONS			BACK DIMENSIONS	
W	D	H	W	D	H	W	H
25	22.5	36	20	17	15.5-20.5	18.5	18-21

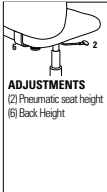
RTA 2

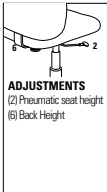

DESCRIPTION	FEATURES	MODEL#	STANDARD TEXTILE GRADES													
			1	2	3	4	5	6	7	8	9	10	11	12		
 <p>LB Task w/ Arms COM Yardage: 1.50 Freight Class: 125 Product Weight (lbs.): 36 Cubic Feet Per Carton: 5.75</p>	 <p>ADJUSTMENTS (2) Pneumatic seat height (6) Back Height (8) Seat depth</p>	2237-6	503	564	607	670	761	790	872	1025	1096	1237	1431	1673		
			OVERALL DIMENSIONS			SEAT DIMENSIONS			BACK DIMENSIONS							
			W	D	H	W	D	H	W	H						
			25	24.5	39	20	17-18.5	15.5-20.5	18.5	20.5-22						
<p>Ergonomic Features: C, D, E, H, N</p>																
		 <p>LB Operator Armless COM Yardage: 1.50 Freight Class: 125 Product Weight (lbs.): 30 Cubic Feet Per Carton: 4.90</p>	 <p>ADJUSTMENTS (2) Pneumatic seat height (4) Seat/Back angle (6) Back Height</p>	2239-5	503	564	607	670	761	790	872	1025	1096	1237	1431	1673
					OVERALL DIMENSIONS			SEAT DIMENSIONS			BACK DIMENSIONS					
					W	D	H	W	D	H	W	H				
20.5	22.5				36	20	17	15.5-20.5	18.5	18-21						
<p>Ergonomic Features: C, D, F, G, H, N</p>																
		 <p>LB Task Armless COM Yardage: 1.50 Freight Class: 125 Product Weight (lbs.): 30 Cubic Feet Per Carton: 4.90</p>	 <p>ADJUSTMENTS (2) Pneumatic seat height (6) Back Height (8) Seat depth</p>	2239-6	388	448	490	552	644	677	756	910	979	1122	1313	1554
					OVERALL DIMENSIONS			SEAT DIMENSIONS			BACK DIMENSIONS					
					W	D	H	W	D	H	W	H				
20.5	24.5				39	20	17-18.5	15.5-20.5	18.5	20.5-22						
<p>Ergonomic Features: C, D, E, N</p>																
		 <p>Height Adjustable Task Chair w/ Arms COM Yardage: 1.50 Freight Class: 125 Product Weight (lbs.): 44 Cubic Feet Per Carton: 6.75</p>	 <p>ADJUSTMENTS (2) Pneumatic seat height (6) Back Height</p>	2235-6	653	713	757	820	911	945	1022	1176	1249	1390	1581	1823
					OVERALL DIMENSIONS			SEAT DIMENSIONS			BACK DIMENSIONS					
					W	D	H	W	D	H	W	H				
25	24.5				48	20	17	23.5-33.5	18.5	20.5-22						
<p>Ergonomic Features: C, D, H, N</p>																
		 <p>Height Adjustable Task Chair Armless COM Yardage: 1.50 Freight Class: 150 Product Weight (lbs.): 36 Cubic Feet Per Carton: 6.75</p>	 <p>ADJUSTMENTS (2) Pneumatic seat height (6) Back Height</p>	2236-6	575	635	677	742	830	864	943	1097	1166	1308	1500	1743
					OVERALL DIMENSIONS			SEAT DIMENSIONS			BACK DIMENSIONS					
					W	D	H	W	D	H	W	H				
20.5	24.5				48	20	17	23.5-33.5	18.5	20.5-22						
<p>Ergonomic Features: C, D, H, N</p>																

GRAHAM™



model 3144 (3N)

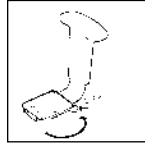

Vari-Width Adapter Plate (WA)
Available when chair is ordered with adjustable height arms.

STANDARD FEATURES

- Features a multi-curved backrest with an impact resistant outer back shell.
- Standard with adjustable height T-arms with curved urethane armcaps (**3N**) in Black Only.
- All models are standard with a five-legged, injection molded "spider" base and **C10** casters
- Base and frame available in Black (**BK**) Only.
- Check textile availability prior to specifying upholstery material.
- Vari-Width Adapter Plate (**WA**) allows each arm to move outward an additional 2". Specify "**WA**". Add \$87 also height adjustable.

OPTIONAL FEATURES

- Please refer to "Arms Selection" section of the price book for arm options.
- An optional abrasion resistant outer back fabric (polyester) is available. Resistant to impact damage. Available in Black only (**BKB**). Add \$23.
- Please refer to the "Casters Selection" section of the price book for caster options. Optional casters may be priced higher than the standard casters for your chair and the difference will be charged. Lower priced optional casters will not be credited.
- For hard surface flooring casters, specify **C10R**. Add \$66.
- For fully assembled in box, please specify **SU**. Add \$76.

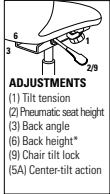
DESCRIPTION	FEATURES	MODEL#	STANDARD TEXTILE GRADES											
			1	2	3	4	5	6	7	8	9	10	11	12
 <p>LB Ergo - Tilter COM Yardage: 1.50 Freight Class: 150 Product Weight (lbs.): 50 Cubic Feet Per Carton: 9.25</p>	 <p>ADJUSTMENTS (1) Tilt tension (2) Pneumatic seat height (3) Back angle (6) Back height* (9) Chair tilt lock (5A) Center-tilt action</p>	<p>3144</p>	765	818	863	927	1017	1052	1132	1286	1356	1496	1689	1929
			OVERALL DIMENSIONS			SEAT DIMENSIONS			BACK DIMENSIONS					
			W	D	H	W	D	H	W	H				
25	26	37.5	20	19.5	17-21	19.5	17.5-20							
		RTA 2												

Ergonomic Features:
A, B, C, D, G, H, M, N, S

GRANADA®



model 3212 (3N)



model 3212 (3N)

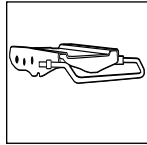

Multi-Depth Mechanism
Seat depth option is available on multi-tilter models. (see notes for more details)



model 3217



model 3217

STANDARD FEATURES

- Features a sculpted back with pronounced lumbar support.
- Standard with adjustable height T-arms with curved urethane armcaps (3N) in Black Only.(except for model 3262 which has a fixed height version of this same arm style.)
- Standard when chair is ordered with adjustable height arms (AA, O, OJ, SB, TD, UB, ZH, ZT, 3M, 3N, 4J, 4M, 4T, 6L, 9B and 9S). Allows each arm to move outward an additional 2" (for a total of 4" extra seat width) and locks with the use of an easy to maneuver lever.
- All models (except armchair and side chair styles) are standard with a five-legged, injection molded base.
- Base and frame are available in Black (BK) Only.
- All models are shipped partially KD.
- Height Adjustable Stools are equipped with a 20" diameter, height adjustable chrome foot ring.
- C65 casters are standard except for heavy duty models.
- Check textile availability prior to specifying upholstery material.
- Granada heavy duty models can be found under the Heavy Duty section.
- Upholstery options: fabric or vinyl only.

- When upholstered in vinyl, models may feature stitch detail across the seat and/ or back cushions and additional wrinkling may occur around seat perimeter and outside back will be attached with decorative screws.

OPTIONAL FEATURES

- Available with back edge vinyl bumper guard option (VBG). Add \$26.
- Please refer to "Arms Selection" section of the price book for arm options.
- An optional abrasion resistant outer back fabric (polyester) is available. Resistant to impact damage. Available in Black only (BKB). Add \$23
- For hard surface flooring please specify C10R. Add \$118.
- Please refer to the "Casters Selection" section of the price book for caster options. Optional casters may be priced higher than the standard casters for your chair and the difference will be charged. Lower priced optional casters will not be credited.
- For fully assembled in box, specify SU. Add \$76.

DESCRIPTION FEATURES MODEL# STANDARD TEXTILE GRADES



LB Multi - Tilter Plain Back Ratchet Back
COM Yardage: 1.50
Freight Class: 150
Product Weight (lbs.): 52
Cubic Feet Per Carton: 9.25

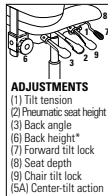

Ergonomic Features:
A, B, C, D, E, F, G, M, N, S

MODEL#	1	2	3	4	5	6	7	8	9	10	11	12
3121	1401	1459	1500	1561	1649	1682	1759	1907	1978	2115	2302	2533

OVERALL DIMENSIONS			SEAT DIMENSIONS			BACK DIMENSIONS	
W	D	H	W	D	H	W	H
26	24.5	40	20.5	16.5	17-21	19	17.5-20.5



HB Multi - Tilter Plain Back Ratchet Back
COM Yardage: 1.75
Freight Class: 150
Product Weight (lbs.): 55
Cubic Feet Per Carton: 9.25

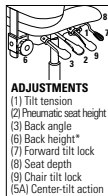

Ergonomic Features:
A, B, C, D, E, F, G, H, M, N, Q, S

MODEL#	1	2	3	4	5	6	7	8	9	10	11	12
3123	1546	1625	1683	1780	1908	1932	2034	2288	2336	2593	2780	3098

OVERALL DIMENSIONS			SEAT DIMENSIONS			BACK DIMENSIONS	
W	D	H	W	D	H	W	H
26	24.5	43	20.5	17-19.5	17-21	19	22-25



LB Multi - Tilter Detailed/Styled Back
COM Yardage: 1.50
Freight Class: 150
Product Weight (lbs.): 52
Cubic Feet Per Carton: 9.25

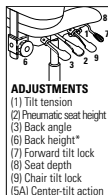









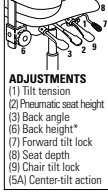



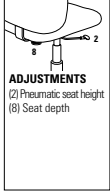





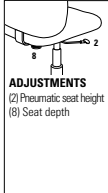



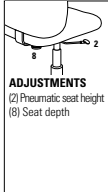

Ergonomic Features:
A, B, C, D, E, F, G, M, N, S





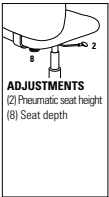

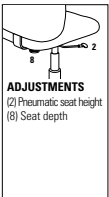

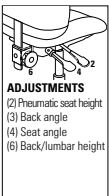

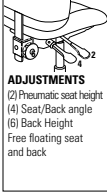



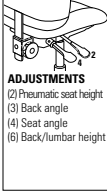

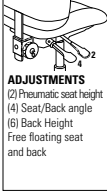

MODEL#	1	2	3	4	5	6	7	8	9	10	11	12
3202	1157	1218	1259	1324	1413	1447	1526	1679	1750	1891	2082	2325



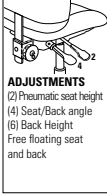

OVERALL DIMENSIONS			SEAT DIMENSIONS			BACK DIMENSIONS	
W	D	H	W	D	H	W	H
26	22.5	40	19	16.5	18-22	18.5	21

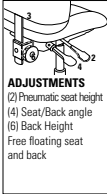

DESCRIPTION	FEATURES	MODEL#	STANDARD TEXTILE GRADES													
			1	2	3	4	5	6	7	8	9	10	11	12		
 <p>LB Multi - Tilter Plain Back COM Yardage: 1.50 Freight Class: 125 Product Weight (lbs.): 58 Cubic Feet Per Carton: 9.25</p>	 <p>ADJUSTMENTS (1) Tilt tension (2) Pneumatic seat height (3) Back angle (6) Back height* (7) Forward tilt lock (8) Seat depth (9) Chair tilt lock (5A) Center-tilt action</p>	3212	1025	1085	1125	1192	1283	1317	1393	1548	1618	1758	1949	2191		
		OVERALL DIMENSIONS			SEAT DIMENSIONS			BACK DIMENSIONS								
		W	D	H	W	D	H	W		H						
		26	24	40	19	16.5	18-22	18.5		21						
<p>Ergonomic Features: A, B, C, D, E, F, G, H, M, N, Q, S</p>	<p>RTA 2</p>  															
		 <p>HB Multi - Tilter Plain Back COM Yardage: 1.75 Freight Class: 150 Product Weight (lbs.): 57 Cubic Feet Per Carton: 10.50</p>	 <p>ADJUSTMENTS (1) Tilt tension (2) Pneumatic seat height (3) Back angle (6) Back height* (7) Forward tilt lock (8) Seat depth (9) Chair tilt lock (5A) Center-tilt action</p>	3217	1153	1219	1268	1346	1449	1488	1581	1758	1844	2011	2233	2511
				OVERALL DIMENSIONS			SEAT DIMENSIONS			BACK DIMENSIONS						
				W	D	H	W	D	H	W		H				
26	24.5			43	19	17.5	18-22	18.5		26						
<p>Ergonomic Features: A, B, C, D, E, F, G, H, M, N, Q, S</p>	<p>RTA 2</p>  															
		 <p>Side Chair Plain Back COM Yardage: 1.50 Freight Class: 300 Product Weight (lbs.): 32 Cubic Feet Per Carton: 17.25</p>	 <p>ADJUSTMENTS (1) Tilt tension (2) Pneumatic seat height (8) Seat depth</p>	3253	826	887	930	994	1084	1119	1197	1351	1424	1561	1755	1994
				OVERALL DIMENSIONS			SEAT DIMENSIONS			BACK DIMENSIONS						
				W	D	H	W	D	H	W		H				
20.5	23.5			37.5	19	16.5	19	18.5		21						
<p>Ergonomic Features: M, N</p>	<p>RTA 2</p>  															
		 <p>LB Task Armless/Plain Back COM Yardage: 1.50 Freight Class: 250 Product Weight (lbs.): 32 Cubic Feet Per Carton: 9.25</p>	 <p>ADJUSTMENTS (2) Pneumatic seat height (8) Seat depth</p>	3254	663	717	763	825	918	949	1030	1184	1254	1395	1586	1826
				OVERALL DIMENSIONS			SEAT DIMENSIONS			BACK DIMENSIONS						
				W	D	H	W	D	H	W		H				
21	24			38	19	16.5	17-22	18.5		21						
<p>Ergonomic Features: C, E, M, N</p>	<p>RTA 2</p>  															
		 <p>LB Task w/Arm/Plain Back COM Yardage: 1.50 Freight Class: 150 Product Weight (lbs.): 40 Cubic Feet Per Carton: 9.25</p>	 <p>ADJUSTMENTS (2) Pneumatic seat height (8) Seat depth</p>	3255	835	891	934	997	1090	1122	1201	1357	1426	1567	1758	1998
				OVERALL DIMENSIONS			SEAT DIMENSIONS			BACK DIMENSIONS						
				W	D	H	W	D	H	W		H				
26	24			38	19	16.5	17-22	18.5		21						
<p>Ergonomic Features: C, E, H, M, N, Q</p>	<p>RTA 2</p>  															

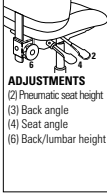
DESCRIPTION	FEATURES	MODEL#	STANDARD TEXTILE GRADES											
			1	2	3	4	5	6	7	8	9	10	11	12
 Armchair Detailed/Styled Back COM Yardage: 1.50 Freight Class: 250 Product Weight (lbs.): 40 Cubic Feet Per Carton: 17	Ergonomic Features: M, N	RTA 2 FedEx ups	1085	1141	1187	1250	1339	1371	1452	1607	1676	1818	2010	2251
			OVERALL DIMENSIONS			SEAT DIMENSIONS			BACK DIMENSIONS					
			W	D	H	W	D	H	W	H				
			26	23.5	37.5	19	16.5	19	18.5	21				
 Side Chair Detailed/Styled Back COM Yardage: 1.50 Freight Class: 300 Product Weight (lbs.): 32 Cubic Feet Per Carton: 17.25	Ergonomic Features: M, N	RTA 2 FedEx ups	880	938	980	1045	1135	1167	1248	1402	1471	1613	1805	2046
			OVERALL DIMENSIONS			SEAT DIMENSIONS			BACK DIMENSIONS					
			W	D	H	W	D	H	W	H				
			20.5	23.5	37.5	19	16.5	19	18.5	21				
 LB Task Armless/Detailed/Styled Back COM Yardage: 1.50 Freight Class: 250 Product Weight (lbs.): 32 Cubic Feet Per Carton: 9.25	 ADJUSTMENTS (2) Pneumatic seat height (8) Seat depth	RTA 2 FedEx ups	701	761	805	866	957	991	1070	1223	1294	1434	1629	1869
			OVERALL DIMENSIONS			SEAT DIMENSIONS			BACK DIMENSIONS					
			W	D	H	W	D	H	W	H				
			21	23.5	39	19	16.5	17-22	18.5	21				
 LB Task w/Arm/Detailed/Styled Back COM Yardage: 1.50 Freight Class: 150 Product Weight (lbs.): 40 Cubic Feet Per Carton: 9.25	 ADJUSTMENTS (2) Pneumatic seat height (8) Seat depth	RTA 2 FedEx	880	938	980	1045	1135	1167	1248	1402	1471	1613	1805	2046
			OVERALL DIMENSIONS			SEAT DIMENSIONS			BACK DIMENSIONS					
			W	D	H	W	D	H	W	H				
			26	23.5	39	19	16.5	17-22	18.5	21				
 LB Operator w/Arm/Plain Back COM Yardage: 1.50 Freight Class: 150 Product Weight (lbs.): 46 Cubic Feet Per Carton: 9.25	 ADJUSTMENTS (2) Pneumatic seat height (3) Back angle (4) Seat angle (6) Back/Lumbar height	RTA 2 FedEx ups	994	1055	1096	1161	1252	1286	1363	1517	1588	1727	1919	2160
			OVERALL DIMENSIONS			SEAT DIMENSIONS			BACK DIMENSIONS					
			W	D	H	W	D	H	W	H				
			26	22.5	39	19	16.5	17-22	18.5	21				

DESCRIPTION	FEATURES	MODEL#	STANDARD TEXTILE GRADES													
			1	2	3	4	5	6	7	8	9	10	11	12		
 <p>Height Adjustable Stool Armless/Detailed/Styled Back COM Yardage: 1.50 Freight Class: 150 Product Weight (lbs.): 43 Cubic Feet Per Carton: 9.25</p>	 <p>ADJUSTMENTS (2) Pneumatic seat height (4) Seat/Back angle (6) Back Height Free floating seat and back</p>	3277	1446	1506	1548	1611	1702	1738	1815	1968	2039	2180	2374	2612		
			OVERALL DIMENSIONS			SEAT DIMENSIONS			BACK DIMENSIONS							
			W	D	H	W	D	H	W	H						
			21	22.5	48	19	16.5	24-34	18.5	21						
			RTA 2													
 <p>Height Adjustable Stool Armless/Plain Back COM Yardage: 1.50 Freight Class: 150 Product Weight (lbs.): 43 Cubic Feet Per Carton: 9.25</p>	 <p>ADJUSTMENTS (2) Pneumatic seat height (3) Back angle (4) Seat angle (6) Back/lumbar height</p>	3278	1389	1449	1491	1554	1644	1678	1757	1911	1982	2122	2313	2559		
			OVERALL DIMENSIONS			SEAT DIMENSIONS			BACK DIMENSIONS							
			W	D	H	W	D	H	W	H						
			21	23.5	48	19	16.5	24-34	18.5	21						
			RTA 2													
 <p>LB Operator Armless Detailed/Styled Back COM Yardage: 1.50 Freight Class: 150 Product Weight (lbs.): 40 Cubic Feet Per Carton: 9.25</p>	 <p>ADJUSTMENTS (2) Pneumatic seat height (4) Seat/Back angle (6) Back Height Free floating seat and back</p>	3284	862	923	964	1027	1120	1154	1231	1387	1455	1596	1787	2030		
			OVERALL DIMENSIONS			SEAT DIMENSIONS			BACK DIMENSIONS							
			W	D	H	W	D	H	W	H						
			21	22.5	39	20.5	16.5	17-22	19	21						
			RTA 2													
 <p>LB Operator w/Arms/Detailed/Styled Back COM Yardage: 1.50 Freight Class: 150 Product Weight (lbs.): 46 Cubic Feet Per Carton: 9.25</p>	 <p>ADJUSTMENTS (2) Pneumatic seat height (4) Seat/Back angle (6) Back Height Free floating seat and back</p>	3285	1036	1096	1136	1201	1292	1326	1404	1558	1630	1771	1964	2206		
			OVERALL DIMENSIONS			SEAT DIMENSIONS			BACK DIMENSIONS							
			W	D	H	W	D	H	W	H						
			26	22.5	39	19	16.5	17-22	18.5	21						
			RTA 2													
 <p>Height Adjustable Stool w/Arms/Detailed/Styled Back COM Yardage: 1.50 Freight Class: 150 Product Weight (lbs.): 51 Cubic Feet Per Carton: 9.25</p>	 <p>ADJUSTMENTS (2) Pneumatic seat height (4) Seat/Back angle (6) Back Height Free floating seat and back</p>	3287	1646	1707	1748	1814	1905	1939	2015	2171	2239	2380	2571	2816		
			OVERALL DIMENSIONS			SEAT DIMENSIONS			BACK DIMENSIONS							
			W	D	H	W	D	H	W	H						
			26	22.5	48	19	16.5	24-34	18.5	21						
			RTA 2													

DESCRIPTION	FEATURES	MODEL#	STANDARD TEXTILE GRADES											
			1	2	3	4	5	6	7	8	9	10	11	12
 <p>Height Adjustable Stool w/Arms/Plain Back COM Yardage: 1.50 Freight Class: 150 Product Weight (lbs.): 51 Cubic Feet Per Carton: 9.25</p>	 <p>ADJUSTMENTS (1) Pneumatic seat height (2) Back angle (3) Seat angle (4) Back/lumbar height</p>	3288	1595	1655	1699	1760	1850	1884	1964	2117	2188	2330	2523	2761
			OVERALL DIMENSIONS			SEAT DIMENSIONS			BACK DIMENSIONS					
			W	D	H	W	D	H	W	H				
			26	23.5	48	19	16.5	24-34	18.5	21				
	Ergonomic Features: C, D, F, G, H, M, N, Q													

GRANADA® DELUXE



model 1170-3









model 1171-3



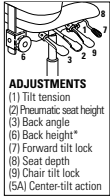



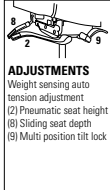

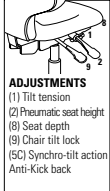
STANDARD FEATURES

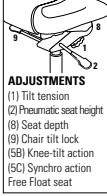

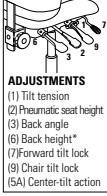

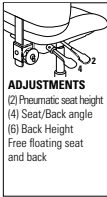

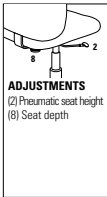

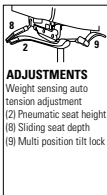

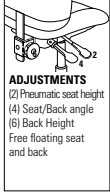



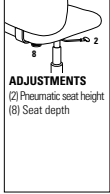

- Granada Deluxe offers dramatic seating comfort with a more contoured seat.
- Standard with height and width adjustable height T-arms with teardrop shaped urethane armcaps (3B).
- All models except the armchair and sidechair are standard with a five legged, injection molded reinforced nylon spider base with C65 casters.
- Base and frames are standard in Black (BK).
- Side activated sliding seat depth adjustment (MD) is standard on multi-tilters.
- Granada heavy duty models can be found under the Heavy Duty section.
- Upholstery options: fabric or vinyl only. When upholstered in vinyl, models may feature stitch detail across the seat and/or back cushions and additional wrinkling may occur around seat perimeter and outside back will be attached with decorative screws
- Check textile availability prior to specifying upholstery material.







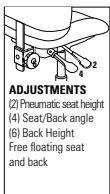



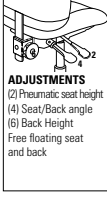



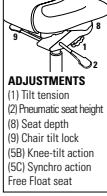



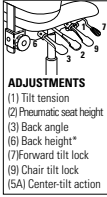

OPTIONAL FEATURES

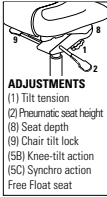
- Seat depth is optional on model 1171-2. Please specify (MD). Add \$113
- An optional abrasion resistant outer back fabric (polyester) is available. Resistant to impact damage. Available in Black only (BKB), add \$23.
- Available with back edge vinyl bumper guard option (VBG). Add \$26.
- Polished Aluminum base with black scuff tips. Specify "B2". Add \$167
- For hard surface flooring casters, specify C65R. Add \$73.
- For fully assembled in box, please specify SU. Add \$76.
- Please refer to "Arms Selection" section of the price book for arm options.
- Please refer to "Cylinder Selection" section of the price book for additional cylinder options.

DESCRIPTION	FEATURES	MODEL#	STANDARD TEXTILE GRADES											
			1	2	3	4	5	6	7	8	9	10	11	12
 <p>HB Multi - Tilter COM Yardage: 2 Freight Class: 125 Product Weight (lbs.): 65 Cubic Feet Per Carton: 9.25</p>	 <p>ADJUSTMENTS (1) Tilt tension (2) Pneumatic seat height (3) Back angle (6) Back height* (7) Forward tilt lock (8) Seat depth (9) Chair tilt lock (SA) Center-tilt action</p>	1170-3	1223	1292	1341	1419	1528	1565	1659	1842	1928	2097	2325	2607
		OVERALL DIMENSIONS			SEAT DIMENSIONS			BACK DIMENSIONS						
		W	D	H	W	D	H	W	H					
	26	23.5	45	21	18-20.5	16-20	20	23-28.25						
				RTA 2										
 <p>HB Weight Sensing Synchro - Tilter COM Yardage: 2 Freight Class: 125 Product Weight (lbs.): 61 Cubic Feet Per Carton: 9.25</p>	 <p>ADJUSTMENTS Weight sensing auto tension adjustment (2) Pneumatic seat height (8) Sliding seat depth (9) Multi position tilt lock</p>	1170-8	1223	1290	1340	1419	1527	1564	1658	1842	1927	2096	2324	2607
		OVERALL DIMENSIONS			SEAT DIMENSIONS			BACK DIMENSIONS						
		W	D	H	W	D	H	W	H					
	26	23.5	44	21	18-20.5	16.5-20.5	20	23-28.2						
				RTA 2										
 <p>HB Synchro - Tilter w/Back Angle Adjustment COM Yardage: 1.75 Freight Class: 125 Product Weight (lbs.): 60 Cubic Feet Per Carton: 9.25</p>	 <p>ADJUSTMENTS (1) Tilt tension (2) Pneumatic seat height (8) Seat depth (9) Chair tilt lock (5C) Synchro-tilt action Anti-Kick back</p>	1171-0	1098	1156	1200	1263	1360	1392	1472	1628	1703	1847	2042	2286
		OVERALL DIMENSIONS			SEAT DIMENSIONS			BACK DIMENSIONS						
		W	D	H	W	D	H	W	H					
	26	23.5	43	21	18-20.5	17.25-21.25	20	20-25.2						
				RTA 2										

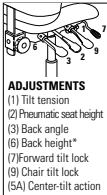
DESCRIPTION	FEATURES	MODEL#	STANDARD TEXTILE GRADES											
			1	2	3	4	5	6	7	8	9	10	11	12
 <p>MB Synchro Knee - Tilter COM Yardage: 1.75 Freight Class: 125 Product Weight (lbs.): 61 Cubic Feet Per Carton: 9.25</p>	 <p>ADJUSTMENTS (1) Tilt tension (2) Pneumatic seat height (8) Seat depth (9) Chair tilt lock (5B) Knee-tilt action (5C) Synchro action Free Float seat</p>	1171-2	1248	1304	1350	1415	1508	1541	1621	1778	1851	1997	2192	2435
			OVERALL DIMENSIONS			SEAT DIMENSIONS			BACK DIMENSIONS					
			W	D	H	W	D	H	W	H				
			26	23.5	42.5	21	18-20.5	16-20	20	23-28.51				
			Ergonomic Features: A, B, C, D, G, J, H, L, M, N, Q			RTA 2			FedEx			ups		
 <p>MB Multi - Tilter COM Yardage: 1.75 Freight Class: 125 Product Weight (lbs.): 61 Cubic Feet Per Carton: 9.25</p>	 <p>ADJUSTMENTS (1) Tilt tension (2) Pneumatic seat height (3) Back angle (6) Back height* (7) Forward tilt lock (9) Chair tilt lock (5A) Center-tilt action</p>	1171-3	1098	1159	1202	1266	1361	1393	1474	1630	1704	1849	2046	2288
			OVERALL DIMENSIONS			SEAT DIMENSIONS			BACK DIMENSIONS					
			W	D	H	W	D	H	W	H				
			26	23.5	42	21	18-20.5	16-20	20	23-28.25				
			Ergonomic Features: A, B, C, D, E, F, G, H, M, N, Q, S, U			RTA 2			FedEx			ups		
 <p>MB Operator COM Yardage: 1.75 Freight Class: 150 Product Weight (lbs.): 54 Cubic Feet Per Carton: 9.25</p>	 <p>ADJUSTMENTS (2) Pneumatic seat height (4) Seat/Back angle (6) Back Height Free floating seat and back</p>	1171-5	1059	1120	1163	1227	1322	1354	1435	1591	1664	1810	2007	2249
			OVERALL DIMENSIONS			SEAT DIMENSIONS			BACK DIMENSIONS					
			W	D	H	W	D	H	W	H				
			26	23.5	39	21	18	16.5-20.5	20	19-24.25				
			Ergonomic Features: C, D, F, G, H, M, N, Q, S, U			RTA 2			FedEx			ups		
 <p>MB Task COM Yardage: 1.75 Freight Class: 150 Product Weight (lbs.): 49 Cubic Feet Per Carton: 9.25</p>	 <p>ADJUSTMENTS (2) Pneumatic seat height (8) Seat depth</p>	1171-6	893	953	997	1061	1156	1188	1269	1426	1498	1644	1841	2083
			OVERALL DIMENSIONS			SEAT DIMENSIONS			BACK DIMENSIONS					
			W	D	H	W	D	H	W	H				
			26	23.5	38	21	17-18	16-21	20	19				
			Ergonomic Features: C, E, H, M, N, U, Q			RTA 2			FedEx			ups		
 <p>MB Weight Sensing Synchro - Tilter COM Yardage: 1.75 Freight Class: 125 Product Weight (lbs.): 61 Cubic Feet Per Carton: 9.25</p>	 <p>ADJUSTMENTS Weight sensing auto tension adjustment (2) Pneumatic seat height (8) Sliding seat depth (9) Multi position tilt lock</p>	1171-8	1098	1156	1200	1263	1360	1392	1472	1628	1703	1847	2042	2286
			OVERALL DIMENSIONS			SEAT DIMENSIONS			BACK DIMENSIONS					
			W	D	H	W	D	H	W	H				
			26	23.5	41	21	18-20.5	16.25-20.25	20	20 - 25.2				
			Ergonomic Features: A, B, C, D, E, H, L, M, N, Q			RTA 2								

DESCRIPTION	FEATURES	MODEL#	STANDARD TEXTILE GRADES												
			1	2	3	4	5	6	7	8	9	10	11	12	
 <p>MB Operator Armless COM Yardage: 1.75 Freight Class: 150 Product Weight (lbs.): 49 Cubic Feet Per Carton: 9.25</p>	 <p>ADJUSTMENTS (2) Pneumatic seat height (4) Seat/Back angle (6) Back Height Free floating seat and back</p>	<p>Ergonomic Features: C, D, E, F, G, M, N, Q, S, U</p>	1172-5	875	931	977	1042	1134	1165	1250	1403	1479	1622	1817	2065
			OVERALL DIMENSIONS			SEAT DIMENSIONS			BACK DIMENSIONS						
			W	D	H	W	D	H	W	H					
	21	23.5	39	21	18	16.5-20.5	20	19-24.25							
				RTA 2											
 <p>MB Task Armless COM Yardage: 1.75 Freight Class: 150 Product Weight (lbs.): 21. Cubic Feet Per Carton: 9.25</p>	 <p>ADJUSTMENTS (2) Pneumatic seat height (8) Seat depth</p>	<p>Ergonomic Features: C, E, H, M, N, U Q</p>	1172-6	711	769	813	878	970	1004	1086	1241	1315	1460	1654	1899
			OVERALL DIMENSIONS			SEAT DIMENSIONS			BACK DIMENSIONS						
			W	D	H	W	D	H	W	H					
	21	23.5	38	21	17-18	16-21	20	19							
				RTA 2											
 <p>Side Chair COM Yardage: 1.75 Freight Class: 250 Product Weight (lbs.): 35 Cubic Feet Per Carton: 10</p>		<p>Ergonomic Features: M, N</p>	1174	634	687	736	802	893	926	1008	1162	1236	1381	1576	1821
			OVERALL DIMENSIONS			SEAT DIMENSIONS			BACK DIMENSIONS						
			W	D	H	W	D	H	W	H					
	21	24	38	21	18	18	20	20.5							
				RTA 2											
 <p>Armchair COM Yardage: 1.75 Freight Class: 150 Product Weight (lbs.): 40 Cubic Feet Per Carton: 10</p>		<p>Ergonomic Features: M, N</p>	1175	848	906	950	1013	1107	1140	1223	1379	1451	1597	1791	2036
			OVERALL DIMENSIONS			SEAT DIMENSIONS			BACK DIMENSIONS						
			W	D	H	W	D	H	W	H					
	24.5	24	38	21	18	18	20	20.5							
				RTA 2											
 <p>Height Adjustable Stool Operator Armless COM Yardage: 1.75 Freight Class: 150 Product Weight (lbs.): 52 Cubic Feet Per Carton: 9.25</p>	 <p>ADJUSTMENTS (2) Pneumatic seat height (4) Seat/Back angle (6) Back Height Free floating seat and back</p>	<p>Ergonomic Features: C, D, F, G, H, M, N, S, U</p>	1177-5	1101	1157	1201	1266	1361	1394	1475	1631	1705	1848	2044	2289
			OVERALL DIMENSIONS			SEAT DIMENSIONS			BACK DIMENSIONS						
			W	D	H	W	D	H	W	H					
	21	23.5	48	20	18	23.5-33.5	20	19-24.25							
				RTA 2											

DESCRIPTION	FEATURES	MODEL#	STANDARD TEXTILE GRADES													
			1	2	3	4	5	6	7	8	9	10	11	12		
 <p>Height Adjustable Stool Operator w/Arm COM Yardage: 1.75 Freight Class: 125 Product Weight (lbs.): 57 Cubic Feet Per Carton: 9.25</p>	 <p>ADJUSTMENTS (2) Pneumatic seat height (4) Seat/Back angle (6) Back Height Free floating seat and back</p>	1178-5	1285	1341	1389	1452	1545	1578	1658	1815	1888	2034	2229	2473		
			OVERALL DIMENSIONS			SEAT DIMENSIONS			BACK DIMENSIONS							
			W	D	H	W	D	H	W	H						
			26	23.5	48	21	18	23.5-33.5	20	19-24.25						
			Ergonomic Features: C, D, F, G, H, M, N, S, U			  										
 <p>HB Synchro Knee - Tilter w/ Schukra Lumbar COM Yardage: 2 Freight Class: 125 Product Weight (lbs.): 63 Cubic Feet Per Carton: 9.25</p>	 <p>ADJUSTMENTS (1) Tilt tension (2) Pneumatic seat height (8) Seat depth (9) Chair tilt lock (5B) Knee-tilt action (5C) Synchro action Free Float seat</p>	1190-2	1669	1744	1804	1891	2015	2058	2170	2374	2474	2667	2926	3251		
			OVERALL DIMENSIONS			SEAT DIMENSIONS			BACK DIMENSIONS							
			W	D	H	W	D	H	W	H						
			26	23.5	45.5	21	18-20.5	16.5-20.5	20	23-28.25						
			Ergonomic Features: A, B, C, D, E, G, H, J, M, N, Q, R, V			  										
 <p>HB Multi - Tilter COM Yardage: 2 Freight Class: 125 Product Weight (lbs.): 65 Cubic Feet Per Carton: 9.25</p>	 <p>ADJUSTMENTS (1) Tilt tension (2) Pneumatic seat height (3) Back angle (6) Back height* (7) Forward tilt lock (9) Chair tilt lock (5A) Center-tilt action</p>	1190-3	1509	1585	1644	1732	1856	1902	2011	2215	2314	2508	2767	3092		
			OVERALL DIMENSIONS			SEAT DIMENSIONS			BACK DIMENSIONS							
			W	D	H	W	D	H	W	H						
			26	23.5	45	21	18-20.5	16-20	20	23-28.25						
			Ergonomic Features: A, B, C, D, E, F, G, H, M, N, Q, S, U			  										
 <p>MB Synchro Knee - Tilter w/ Schukra Lumbar COM Yardage: 1.75 Freight Class: 125 Product Weight (lbs.): 61 Cubic Feet Per Carton: 9.25</p>	 <p>ADJUSTMENTS (1) Tilt tension (2) Pneumatic seat height (8) Seat depth (9) Chair tilt lock (5B) Knee-tilt action (5C) Synchro action Free Float seat</p>	1191-2	1533	1602	1653	1729	1840	1877	1974	2152	2239	2407	2635	2919		
			OVERALL DIMENSIONS			SEAT DIMENSIONS			BACK DIMENSIONS							
			W	D	H	W	D	H	W	H						
			26	23.5	42.5	21	18-20.5	16-20	20	23-28.51						
			Ergonomic Features: A, B, C, D, E, G, H, J, M, N, Q, R, V			  										
 <p>MB Multi - Tilter COM Yardage: 1.75 Freight Class: 125 Product Weight (lbs.): 61 Cubic Feet Per Carton: 9.25</p>	 <p>ADJUSTMENTS (1) Tilt tension (2) Pneumatic seat height (3) Back angle (6) Back height* (7) Forward tilt lock (9) Chair tilt lock (5A) Center-tilt action</p>	1191-2	1533	1602	1653	1729	1840	1877	1974	2152	2239	2407	2635	2919		
			OVERALL DIMENSIONS			SEAT DIMENSIONS			BACK DIMENSIONS							
			W	D	H	W	D	H	W	H						
			26	23.5	42	21	18-20.5	16-20	20	23-28.25						
			Ergonomic Features: A, B, C, D, E, F, G, H, M, N, Q, S, U			  										

GRAPHIC™



model 2739



model 2738MB



Optional Base
An optional five-legged, arched steel base in Tungsten finish is available. Specify (TTU). Add \$83.











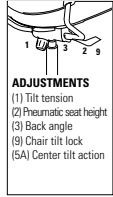





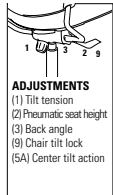

STANDARD FEATURES

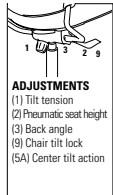



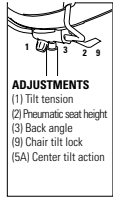





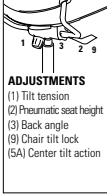



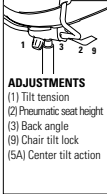

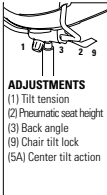
- European detailing and a clean slim profile.
- Features a generous compound curved back and seat.
- Three distinctive back styles: upholstered back, perforated Black nylon back and breathable Black mesh back.
- Posture back chairs with arms are standard with height adjustable, forward swept arms and sliding armcaps (G4).
- Vari-Width (WA) width adjustable arm extensions are standard when chair is ordered with adjustable arms. Allows the arms to move away from the seat by 2" on each side to allow space if desired for broader hip widths.
- Check textile availability prior to specifying upholstery material.

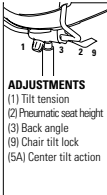
- Posture mechanism offers exceptional back support, two position tilt lock adjustment and tilt tension control.
- Five prong, injection molded, fiberglass reinforced nylon Black spider base with dual wheel carpet casters (C1).

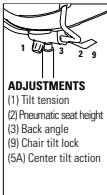
OPTIONAL FEATURES

- For hard surface flooring please specify C9R. Add \$73.
- A steel base with Tungsten finish is available. Specify (TTU). Add \$90.
- Please refer to "Arms and Casters" section of the price book for arm and caster options.
- For fully assembled in box, specify SU. Add \$76.

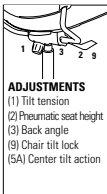
DESCRIPTION	FEATURES	MODEL#	STANDARD TEXTILE GRADES											
			1	2	3	4	5	6	7	8	9	10	11	12
 <p>Medium Posture Nylon Back Armless COM Yardage: 1 Freight Class: 250 Product Weight (lbs.): 34 Cubic Feet Per Carton: 9.75</p> <p>Ergonomic Features: A, C, G, M, N</p>	 <p>ADJUSTMENTS (1) Tilt tension (2) Pneumatic seat height (3) Back angle (9) Chair tilt lock (5A) Center tilt action</p>	2736	735	775	804	843	904	924	976	1076	1123	1216	1337	1494
		OVERALL DIMENSIONS			SEAT DIMENSIONS			BACK DIMENSIONS						
		W	D	H	W	D	H	W		H				
		20	24	36	20	19	16.5-20.5	19		19				
			  											
 <p>Medium Posture Mesh Back Armless COM Yardage: 1 Freight Class: 250 Product Weight (lbs.): 34 Cubic Feet Per Carton: 9.75</p> <p>Ergonomic Features: A, C, G, M, N</p>	 <p>ADJUSTMENTS (1) Tilt tension (2) Pneumatic seat height (3) Back angle (9) Chair tilt lock (5A) Center tilt action</p>	2736MB	815	858	884	925	986	1008	1057	1157	1203	1296	1418	1575
		OVERALL DIMENSIONS			SEAT DIMENSIONS			BACK DIMENSIONS						
		W	D	H	W	D	H	W		H				
		20	24	36	20	19	16.5-20.5	19		19				
			  											
 <p>Medium Posture Back - Fully Upholstered Armless COM Yardage: 1.25 Freight Class: 250 Product Weight (lbs.): 34 Cubic Feet Per Carton: 9.75</p> <p>Ergonomic Features: A, C, G, M, N</p>	 <p>ADJUSTMENTS (1) Tilt tension (2) Pneumatic seat height (3) Back angle (9) Chair tilt lock (5A) Center tilt action</p>	2737	815	862	898	948	1023	1050	1112	1237	1297	1409	1567	1759
		OVERALL DIMENSIONS			SEAT DIMENSIONS			BACK DIMENSIONS						
		W	D	H	W	D	H	W		H				
		20	24	36	20	19	16.5-20.5	19		19				
			  											
 <p>Medium Posture Nylon Back w/Arms COM Yardage: 1 Freight Class: 150 Product Weight (lbs.): 45 Cubic Feet Per Carton: 9.75</p> <p>Ergonomic Features: A, C, G, H, M, N, Q</p>	 <p>ADJUSTMENTS (1) Tilt tension (2) Pneumatic seat height (3) Back angle (9) Chair tilt lock (5A) Center tilt action</p>	2738	815	855	882	923	983	1002	1056	1156	1202	1294	1417	1574
		OVERALL DIMENSIONS			SEAT DIMENSIONS			BACK DIMENSIONS						
		W	D	H	W	D	H	W		H				
		25	24	36	20	19	16.5-20.5	19		19				
			  											

DESCRIPTION	FEATURES	MODEL#	STANDARD TEXTILE GRADES											
			1	2	3	4	5	6	7	8	9	10	11	12
 <p>Medium Posture Mesh Back w/Arms COM Yardage: 1 Freight Class: 150 Product Weight (lbs.): 45 Cubic Feet Per Carton: 9.75</p>	 <p>ADJUSTMENTS (1) Tilt tension (2) Pneumatic seat height (3) Back angle (9) Chair tilt lock (5A) Center tilt action</p>	2738MB	899	942	968	1009	1068	1092	1140	1240	1288	1380	1502	1658
			OVERALL DIMENSIONS			SEAT DIMENSIONS			BACK DIMENSIONS					
			W	D	H	W	D	H	W	H				
			25	24	36	20	19	16.5-20.5	19	19				
			RTA 1											
 <p>Medium Posture Back - Fully Upholstered w/Arms COM Yardage: 1.25 Freight Class: 150 Product Weight (lbs.): 45 Cubic Feet Per Carton: 9.75</p>	 <p>ADJUSTMENTS (1) Tilt tension (2) Pneumatic seat height (3) Back angle (9) Chair tilt lock (5A) Center tilt action</p>	2739	899	946	982	1032	1107	1134	1196	1321	1381	1493	1651	1843
			OVERALL DIMENSIONS			SEAT DIMENSIONS			BACK DIMENSIONS					
			W	D	H	W	D	H	W	H				
			25	24	36	20	19	16.5-20.5	19	19				
			RTA 1											
 <p>Medium Posture Stool Nylon Back w/Arms COM Yardage: 1 Freight Class: 150 Product Weight (lbs.): 50 Cubic Feet Per Carton: 9.75</p>	 <p>ADJUSTMENTS (1) Tilt tension (2) Pneumatic seat height (3) Back angle (9) Chair tilt lock (5A) Center tilt action</p>	2748	1028	1068	1098	1142	1203	1226	1282	1383	1433	1531	1660	1821
			OVERALL DIMENSIONS			SEAT DIMENSIONS			BACK DIMENSIONS					
			W	D	H	W	D	H	W	H				
			25	24	46	20	19	23-33	19	19				
			RTA 1											
 <p>Medium Posture Stool Mesh Back w/Arms COM Yardage: 1 Freight Class: 150 Product Weight (lbs.): 51 Cubic Feet Per Carton: 9.75</p>	 <p>ADJUSTMENTS (1) Tilt tension (2) Pneumatic seat height (3) Back angle (9) Chair tilt lock (5A) Center tilt action</p>	2748MB	1114	1154	1184	1228	1289	1311	1367	1468	1518	1616	1746	1907
			OVERALL DIMENSIONS			SEAT DIMENSIONS			BACK DIMENSIONS					
			W	D	H	W	D	H	W	H				
			25	24	46	20	19	23-33	19	19				
			RTA 1											
 <p>Medium Posture Stool - Fully Upholstered w/Arms COM Yardage: 1.25 Freight Class: 150 Product Weight (lbs.): 52 Cubic Feet Per Carton: 9.75</p>	 <p>ADJUSTMENTS (1) Tilt tension (2) Pneumatic seat height (3) Back angle (9) Chair tilt lock (5A) Center tilt action</p>	2749	1110	1158	1197	1252	1328	1356	1425	1553	1615	1736	1897	2101
			OVERALL DIMENSIONS			SEAT DIMENSIONS			BACK DIMENSIONS					
			W	D	H	W	D	H	W	H				
			25	24	46	20	19	23-33	19	19				
			RTA 1											

LOOVER



model 2660-8



model 2660-3



Memory Foam
Available, use code "MF" and Add \$117.



model 2661-8



model 2662-3

STANDARD FEATURES

- Global's first chair to feature a weight sensing synchro-tilter mechanism that requires no tilt tension adjustment.
- A live lumber support is incorporated into the back design which is height adjustable via a concealed ratchet system, offering a 2.25" height adjustment.
- Standard with Global's high quality Soft Descent™ pneumatic lift which slowly and gently lowers the seat height of the chair making it easy to obtain the exact seat height you desire.
- Side activated sliding seat depth adjustment, **(MD)** is standard on for Mutil-Tilters, Synchro-Tilters, and Weight Sensing Synchro-Tilter. Provides 2"-3" of seat depth adjustment.
- Height and width **(WA)** adjustable **G5** lockable arms. Armcaps are soft to the touch Self Skinned Urethane, depth adjustable (slide forward and backward) movements can be locked to avoid unintentional movement). Armcaps also articulate inwards and outwards 30° to aim toward the keyboard or mouse arena.
- Vari-Width **(WA)** Width Adjustable Arm Extensions are standard, allowing the arms to move away from the seat by 2" on each side to allow space if desired for broader hip widths.
- Five prong, injection molded, fiberglass reinforced, Nylon medium rise base **B7B** with **C1** dual wheel carpet casters.

- Check textile availability prior to specifying upholstery material.
- Mesh backs are available in 24 brilliant Vue colors: Sandy Beach (VU10), Desert Sand (VU11), Orange Sunset (VU12), Chocolate Fountain (VU13), Arctic Blue (VU14), Quarry Grey (VU15), Tidal Wave (VU16), Ivy Moss (VU17), Red Rose (VU18), Coal Black (VU19), White (VU20), Lime (VU21), Chartreuse (VU23), Pool Blue (VU26), Sky (VU28), Primary Blue (VU32), Tangerine (VU34), Paprika (VU37), Grain (VU40), Yellow (VU43), Silver Grey (VU55), Silver (VU63), Hot Pink (VU65) and Red Mittens (VU70). Please specify

OPTIONAL FEATURES

- Petite models are available at no upcharge. Please specify P. Seat is overall 1 inch smaller in depth and 1.5 inch smaller in width. Model numbers are listed below.
- Seat available in memory foam **(MF)**. Add \$117.
- Optional Polished Aluminum base **(B7A)** Please specify **(ALU)** base. Add \$167.
- For hard surface flooring casters, please specify **C9R**. Add \$72.
- Please refer to "Arms Selection" section of the price book for arm options. Please refer to "Cylinder Selection" section of the price book for additional cylinder options.
- For fully assembled in box, specify **SU**. Add \$76.

DESCRIPTION FEATURES MODEL# STANDARD TEXTILE GRADES



Extended HB Synchro - Tilter w/Back Angle Adjustment
COM Yardage: 1
Freight Class: 125
Product Weight (lbs.): 68
Cubic Feet Per Carton: 11

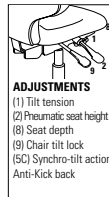

ADJUSTMENTS
(1) Tilt tension
(2) Pneumatic seat height
(8) Seat depth
(9) Chair tilt lock
(5C) Synchro-tilt action
Anti-Kick back

Ergonomic Features:
A, B, C, D, E, G, H, L, M, N, Q, R, U

	1	2	3	4	5	6	7	8	9	10	11	12
2660-0	\$1213	\$1253	\$1282	\$1323	\$1382	\$1400	\$1455	\$1554	\$1601	\$1694	\$1816	\$1972
2660P-0 Small Seat												

OVERALL DIMENSIONS			SEAT DIMENSIONS			BACK DIMENSIONS	
W	D	H	W	D	H	W	H
25.5	25	45.5	19	19-22	16.25-20.25	19.5	26.5-29

RTA 2 FedEx ups



Extended HB Multi Tilter
COM Yardage: 1
Freight Class: 125
Product Weight (lbs.): 68
Cubic Feet Per Carton: 11

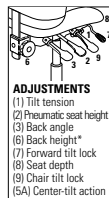

ADJUSTMENTS
(1) Tilt tension
(2) Pneumatic seat height
(3) Back angle
(6) Back height*
(7) Forward tilt lock
(8) Seat depth
(9) Chair tilt lock
(5A) Center-tilt action

Ergonomic Features:
A, B, C, D, E, F, G, H, M, N, Q, R, S, U

	1	2	3	4	5	6	7	8	9	10	11	12
2660-3	\$1213	\$1253	\$1282	\$1323	\$1382	\$1400	\$1455	\$1554	\$1601	\$1694	\$1816	\$1972
2660P-3 Small Seat												

OVERALL DIMENSIONS			SEAT DIMENSIONS			BACK DIMENSIONS	
W	D	H	W	D	H	W	H
25.5	25	45.5	20	19-22	16-20	19.5	26.5-29

RTA 2 FedEx ups



Extended HB Tilter
COM Yardage: 1
Freight Class: 150
Product Weight (lbs.): 62
Cubic Feet Per Carton: 11

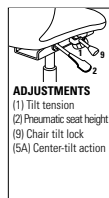









ADJUSTMENTS
(1) Tilt tension
(2) Pneumatic seat height
(9) Chair tilt lock
(5A) Center-tilt action

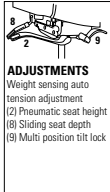

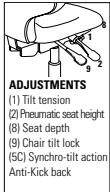

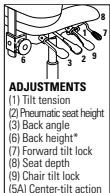

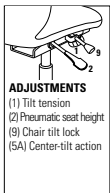

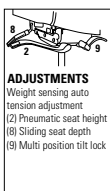

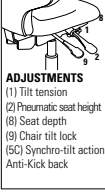



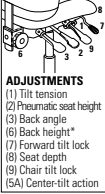



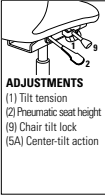

Ergonomic Features:
A, B, C, D, H, M, N, Q, R, S, U

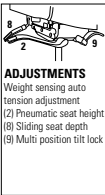

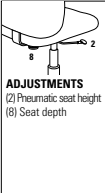

	1	2	3	4	5	6	7	8	9	10	11	12
2660-4	\$1060	\$1098	\$1127	\$1168	\$1228	\$1246	\$1301	\$1397	\$1447	\$1539	\$1662	\$1816
2660P-4 Small Seat												

OVERALL DIMENSIONS			SEAT DIMENSIONS			BACK DIMENSIONS	
W	D	H	W	D	H	W	H
25.5	25	45.5	20	19-20	16-21	19.5	26.5-29

RTA 2 FedEx ups

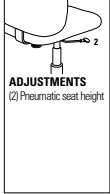
DESCRIPTION	FEATURES	MODEL#	STANDARD TEXTILE GRADES											
			1	2	3	4	5	6	7	8	9	10	11	12
 <p>Extended HB Weight Sensing Synchro - Tilter COM Yardage: 1 Freight Class: 125 Product Weight (lbs.): 66 Cubic Feet Per Carton: 11</p>	 <p>ADJUSTMENTS Weight sensing auto tension adjustment (2) Pneumatic seat height (8) Sliding seat depth (9) Multi position tilt lock</p>	<p>Ergonomic Features: A, B, C, D, E, H, L, M, N, Q, R, U</p>	<p>2660-8 \$1213 \$1253 \$1282 \$1323 \$1382 \$1400 \$1455 \$1554 \$1601 \$1694 \$1816 \$1972 2660P-8 Small Seat</p>											
			OVERALL DIMENSIONS			SEAT DIMENSIONS			BACK DIMENSIONS					
			W	D	H	W	D	H	W		H			
			25.5	25	45.5	20	19-22	16-21	19.5		26.5-27.5			
			<p>RTA 2 FedEx UPS</p>											
 <p>HB Synchro - Tilter w/Back Angle Adjustment COM Yardage: 1 Freight Class: 125 Product Weight (lbs.): 66 Cubic Feet Per Carton: 10.5</p>	 <p>ADJUSTMENTS (1) Tilt tension (2) Pneumatic seat height (8) Seat depth (9) Chair tilt lock (5C) Synchro-tilt action Anti-Kick back</p>	<p>Ergonomic Features: A, B, C, D, E, G, H, L, M, N, Q, R, U</p>	<p>2661-0 \$1132 \$1169 \$1199 \$1240 \$1300 \$1318 \$1373 \$1469 \$1519 \$1611 \$1734 \$1888 2661P-0 Small Seat</p>											
			OVERALL DIMENSIONS			SEAT DIMENSIONS			BACK DIMENSIONS					
			W	D	H	W	D	H	W		H			
			25.5	24	42.5	20	19-22	16.25-20.25	19.5		19.5-27.5			
			<p>RTA 2 FedEx UPS</p>											
 <p>HB Multi - Tilter COM Yardage: 1 Freight Class: 125 Product Weight (lbs.): 68 Cubic Feet Per Carton: 10.5</p>	 <p>ADJUSTMENTS (1) Tilt tension (2) Pneumatic seat height (3) Back angle (6) Back height* (7) Forward tilt lock (8) Seat depth (9) Chair tilt lock (5A) Center-tilt action</p>	<p>Ergonomic Features: A, B, C, D, E, F, G, H, M, N, Q, R, S, U</p>	<p>2661-3 \$1132 \$1169 \$1199 \$1240 \$1300 \$1318 \$1373 \$1469 \$1519 \$1611 \$1734 \$1888 2661P-3 Small Seat</p>											
			OVERALL DIMENSIONS			SEAT DIMENSIONS			BACK DIMENSIONS					
			W	D	H	W	D	H	W		H			
			25.5	25	42.5	20	19-22	16-20	19.5		25-27.5			
			<p>RTA 2 FedEx UPS</p>											
 <p>HB Tilter COM Yardage: 1 Freight Class: 150 Product Weight (lbs.): 62 Cubic Feet Per Carton: 10.5</p>	 <p>ADJUSTMENTS (1) Tilt tension (2) Pneumatic seat height (9) Chair tilt lock (5A) Center-tilt action</p>	<p>Ergonomic Features: A, B, C, D, H, M, N, Q, R, S, U</p>	<p>2661-4 \$995 \$1033 \$1062 \$1103 \$1163 \$1181 \$1236 \$1334 \$1382 \$1474 \$1597 \$1751 2661P-4 Small Seat</p>											
			OVERALL DIMENSIONS			SEAT DIMENSIONS			BACK DIMENSIONS					
			W	D	H	W	D	H	W		H			
			25.5	25	42.5	20	19-20	16-21	19.5		25-27.5			
			<p>RTA 2 FedEx UPS</p>											
 <p>HB Weight Sensing Synchro - Tilter COM Yardage: 1 Freight Class: 125 Product Weight (lbs.): 66 Cubic Feet Per Carton: 10.5</p>	 <p>ADJUSTMENTS Weight sensing auto tension adjustment (2) Pneumatic seat height (8) Sliding seat depth (9) Multi position tilt lock</p>	<p>Ergonomic Features: A, B, C, D, E, H, L, M, N, Q, R, U</p>	<p>2661-8 \$1132 \$1170 \$1199 \$1240 \$1300 \$1318 \$1373 \$1469 \$1519 \$1611 \$1734 \$1888 2661P-8 Small Seat</p>											
			OVERALL DIMENSIONS			SEAT DIMENSIONS			BACK DIMENSIONS					
			W	D	H	W	D	H	W		H			
			25.5	24	42.5	20	19-20	16-21	19.5		25-27.5			
			<p>RTA 2 FedEx UPS</p>											

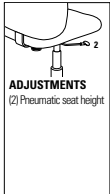
DESCRIPTION	FEATURES	MODEL#	STANDARD TEXTILE GRADES											
			1	2	3	4	5	6	7	8	9	10	11	12
 <p>MB Synchro - Tilter w/Back Angle Adjustment COM Yardage: 1 Freight Class: 125 Product Weight (lbs.): 64 Cubic Feet Per Carton: 10.5</p>	 <p>ADJUSTMENTS (1) Tilt tension (2) Pneumatic seat height (8) Seat depth (9) Chair tilt lock (5C) Synchro-tilt action Anti-Kick back</p>	<p>2662-0 \$1083 \$1121 \$1150 \$1191 \$1251 \$1270 \$1324 \$1422 \$1471 \$1562 \$1686 \$1839 2662P-0 Small Seat</p>	OVERALL DIMENSIONS			SEAT DIMENSIONS			BACK DIMENSIONS					
			W	D	H	W	D	H	W	H				
			25.5	24	39.5	20	19-22	16.25-20.25	19.5	22-24.5				
<p>Ergonomic Features: A, B, C, D, E, G, H, L, M, N, Q, R, U</p>			  											
 <p>MB Multi Tilter COM Yardage: 1 Freight Class: 125 Product Weight (lbs.): 66 Cubic Feet Per Carton: 10.5</p>	 <p>ADJUSTMENTS (1) Tilt tension (2) Pneumatic seat height (3) Back angle (6) Back height* (7) Forward tilt lock (8) Seat depth (9) Chair tilt lock (5A) Center-tilt action</p>	<p>2662-3 \$1083 \$1121 \$1150 \$1191 \$1251 \$1270 \$1324 \$1422 \$1471 \$1562 \$1686 \$1839 2662P-3 Small Seat</p>	OVERALL DIMENSIONS			SEAT DIMENSIONS			BACK DIMENSIONS					
			W	D	H	W	D	H	W	H				
			25.5	25	39.5	20	19-22	16-20	19.5	22-24.5				
<p>Ergonomic Features: A, B, C, D, E, F, G, H, M, N, Q, R, S, U</p>			  											
 <p>MB Tilter COM Yardage: 1 Freight Class: 150 Product Weight (lbs.): 60 Cubic Feet Per Carton: 10.5</p>	 <p>ADJUSTMENTS (1) Tilt tension (2) Pneumatic seat height (9) Chair tilt lock (5A) Center-tilt action</p>	<p>2662-4 \$963 \$1001 \$1030 \$1071 \$1131 \$1149 \$1204 \$1302 \$1350 \$1442 \$1565 \$1719 2662P-4 Small Seat</p>	OVERALL DIMENSIONS			SEAT DIMENSIONS			BACK DIMENSIONS					
			W	D	H	W	D	H	W	H				
			25.5	25	39.5	20	19-20	16-21	19.5	22-24.5				
<p>Ergonomic Features: A, B, C, D, H, M, N, Q, R, S, U</p>			  											
 <p>MB Weight Sensing Synchro - Tilter COM Yardage: 1 Freight Class: 125 Product Weight (lbs.): 64 Cubic Feet Per Carton: 10.5</p>	 <p>ADJUSTMENTS Weight sensing auto tension adjustment (2) Pneumatic seat height (8) Sliding seat depth (9) Multi position tilt lock</p>	<p>2662-8 \$1083 \$1121 \$1149 \$1189 \$1250 \$1270 \$1322 \$1420 \$1470 \$1559 \$1683 \$1838 2662P-8 Small Seat</p>	OVERALL DIMENSIONS			SEAT DIMENSIONS			BACK DIMENSIONS					
			W	D	H	W	D	H	W	H				
			25.5	24	39.5	20	19-22	16-21	19.5	22-24.5				
<p>Ergonomic Features: A, B, C, D, E, H, L, M, N, Q, R, U</p>			  											
 <p>MB Task COM Yardage: 1 Freight Class: 150 Product Weight (lbs.): 45 Cubic Feet Per Carton: 10.5</p>	 <p>ADJUSTMENTS (2) Pneumatic seat height (8) Seat depth</p>	<p>2662-6 \$1023 \$1061 \$1090 \$1131 \$1191 \$1209 \$1264 \$1360 \$1410 \$1502 \$1625 \$1779 2662P-6 Small Seat</p>	OVERALL DIMENSIONS			SEAT DIMENSIONS			BACK DIMENSIONS					
			W	D	H	W	D	H	W	H				
			25.5	25	39.5	20	19-20	16.5-21.5	19.5	21				
<p>Ergonomic Features: C, E, H, M, N, Q, R, U</p>			  											

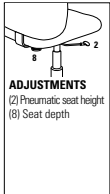
DESCRIPTION	FEATURES	MODEL#	STANDARD TEXTILE GRADES																																																												
			1	2	3	4	5	6	7	8	9	10	11	12																																																	
 <p>MB Height Adjustable Stool - Task COM Yardage: 1 Freight Class: 150 Product Weight (lbs.): 50 Cubic Feet Per Carton: 10.5</p>	 <p>ADJUSTMENTS (2) Pneumatic seat height</p>	Ergonomic Features: C, E, H, M, N, Q, R, U	<table border="1"> <tr> <th colspan="12">STANDARD TEXTILE GRADES</th> </tr> <tr> <td>1</td><td>2</td><td>3</td><td>4</td><td>5</td><td>6</td><td>7</td><td>8</td><td>9</td><td>10</td><td>11</td><td>12</td> </tr> <tr> <td>2663-6</td><td>\$1406</td><td>\$1444</td><td>\$1473</td><td>\$1514</td><td>\$1574</td><td>\$1593</td><td>\$1647</td><td>\$1745</td><td>\$1793</td><td>\$1885</td><td>\$2009</td><td>\$2162</td> </tr> <tr> <td colspan="12">2663P-6 Small Seat</td> </tr> </table>												STANDARD TEXTILE GRADES												1	2	3	4	5	6	7	8	9	10	11	12	2663-6	\$1406	\$1444	\$1473	\$1514	\$1574	\$1593	\$1647	\$1745	\$1793	\$1885	\$2009	\$2162	2663P-6 Small Seat											
			STANDARD TEXTILE GRADES																																																												
			1	2	3	4	5	6	7	8	9	10	11	12																																																	
			2663-6	\$1406	\$1444	\$1473	\$1514	\$1574	\$1593	\$1647	\$1745	\$1793	\$1885	\$2009	\$2162																																																
2663P-6 Small Seat																																																															
<table border="1"> <thead> <tr> <th colspan="3">OVERALL DIMENSIONS</th> <th colspan="3">SEAT DIMENSIONS</th> <th colspan="2">BACK DIMENSIONS</th> </tr> <tr> <th>W</th> <th>D</th> <th>H</th> <th>W</th> <th>D</th> <th>H</th> <th>W</th> <th>H</th> </tr> </thead> <tbody> <tr> <td>25.5</td> <td>25</td> <td>50</td> <td>20</td> <td>19-20</td> <td>24-34</td> <td>19.5</td> <td>21</td> </tr> </tbody> </table>			OVERALL DIMENSIONS			SEAT DIMENSIONS			BACK DIMENSIONS		W	D	H	W	D	H	W	H	25.5	25	50	20	19-20	24-34	19.5	21	<table border="1"> <tr> <td>RTA 2</td> <td>FedEx</td> <td>ups</td> </tr> </table>			RTA 2	FedEx	ups																															
OVERALL DIMENSIONS			SEAT DIMENSIONS			BACK DIMENSIONS																																																									
W	D	H	W	D	H	W	H																																																								
25.5	25	50	20	19-20	24-34	19.5	21																																																								
RTA 2	FedEx	ups																																																													
 <p>MB Height Adjustable Stool - Task COM Yardage: 1 Freight Class: 150 Product Weight (lbs.): 44 Cubic Feet Per Carton: 10.5</p>	 <p>ADJUSTMENTS (2) Pneumatic seat height</p>	Ergonomic Features: C, E, M, N, U	<table border="1"> <tr> <th colspan="12">STANDARD TEXTILE GRADES</th> </tr> <tr> <td>1</td><td>2</td><td>3</td><td>4</td><td>5</td><td>6</td><td>7</td><td>8</td><td>9</td><td>10</td><td>11</td><td>12</td> </tr> <tr> <td>2664-6</td><td>\$1278</td><td>\$1316</td><td>\$1345</td><td>\$1386</td><td>\$1446</td><td>\$1464</td><td>\$1519</td><td>\$1615</td><td>\$1665</td><td>\$1757</td><td>\$1880</td><td>\$2034</td> </tr> <tr> <td colspan="12">2664P-6 Small Seat</td> </tr> </table>												STANDARD TEXTILE GRADES												1	2	3	4	5	6	7	8	9	10	11	12	2664-6	\$1278	\$1316	\$1345	\$1386	\$1446	\$1464	\$1519	\$1615	\$1665	\$1757	\$1880	\$2034	2664P-6 Small Seat											
			STANDARD TEXTILE GRADES																																																												
			1	2	3	4	5	6	7	8	9	10	11	12																																																	
			2664-6	\$1278	\$1316	\$1345	\$1386	\$1446	\$1464	\$1519	\$1615	\$1665	\$1757	\$1880	\$2034																																																
2664P-6 Small Seat																																																															
<table border="1"> <thead> <tr> <th colspan="3">OVERALL DIMENSIONS</th> <th colspan="3">SEAT DIMENSIONS</th> <th colspan="2">BACK DIMENSIONS</th> </tr> <tr> <th>W</th> <th>D</th> <th>H</th> <th>W</th> <th>D</th> <th>H</th> <th>W</th> <th>H</th> </tr> </thead> <tbody> <tr> <td>20</td> <td>25</td> <td>50</td> <td>20</td> <td>19-20</td> <td>24-34</td> <td>19.5</td> <td>21</td> </tr> </tbody> </table>			OVERALL DIMENSIONS			SEAT DIMENSIONS			BACK DIMENSIONS		W	D	H	W	D	H	W	H	20	25	50	20	19-20	24-34	19.5	21	<table border="1"> <tr> <td>RTA 2</td> <td>FedEx</td> <td>ups</td> </tr> </table>			RTA 2	FedEx	ups																															
OVERALL DIMENSIONS			SEAT DIMENSIONS			BACK DIMENSIONS																																																									
W	D	H	W	D	H	W	H																																																								
20	25	50	20	19-20	24-34	19.5	21																																																								
RTA 2	FedEx	ups																																																													
 <p>MB Task COM Yardage: 1 Freight Class: 250 Product Weight (lbs.): 39 Cubic Feet Per Carton: 10.5</p>	 <p>ADJUSTMENTS (2) Pneumatic seat height (8) Seat depth</p>	Ergonomic Features: C, E, M, N, U	<table border="1"> <tr> <th colspan="12">STANDARD TEXTILE GRADES</th> </tr> <tr> <td>1</td><td>2</td><td>3</td><td>4</td><td>5</td><td>6</td><td>7</td><td>8</td><td>9</td><td>10</td><td>11</td><td>12</td> </tr> <tr> <td>2665-6</td><td>\$890</td><td>\$928</td><td>\$957</td><td>\$998</td><td>\$1058</td><td>\$1076</td><td>\$1131</td><td>\$1229</td><td>\$1277</td><td>\$1369</td><td>\$1492</td><td>\$1646</td> </tr> <tr> <td colspan="12">2665P-6 Small Seat</td> </tr> </table>												STANDARD TEXTILE GRADES												1	2	3	4	5	6	7	8	9	10	11	12	2665-6	\$890	\$928	\$957	\$998	\$1058	\$1076	\$1131	\$1229	\$1277	\$1369	\$1492	\$1646	2665P-6 Small Seat											
			STANDARD TEXTILE GRADES																																																												
			1	2	3	4	5	6	7	8	9	10	11	12																																																	
			2665-6	\$890	\$928	\$957	\$998	\$1058	\$1076	\$1131	\$1229	\$1277	\$1369	\$1492	\$1646																																																
2665P-6 Small Seat																																																															
<table border="1"> <thead> <tr> <th colspan="3">OVERALL DIMENSIONS</th> <th colspan="3">SEAT DIMENSIONS</th> <th colspan="2">BACK DIMENSIONS</th> </tr> <tr> <th>W</th> <th>D</th> <th>H</th> <th>W</th> <th>D</th> <th>H</th> <th>W</th> <th>H</th> </tr> </thead> <tbody> <tr> <td>20</td> <td>25</td> <td>39.5</td> <td>20</td> <td>19-20</td> <td>16.5-21.5</td> <td>19.5</td> <td>16.5</td> </tr> </tbody> </table>			OVERALL DIMENSIONS			SEAT DIMENSIONS			BACK DIMENSIONS		W	D	H	W	D	H	W	H	20	25	39.5	20	19-20	16.5-21.5	19.5	16.5	<table border="1"> <tr> <td>RTA 2</td> <td>FedEx</td> <td>ups</td> </tr> </table>			RTA 2	FedEx	ups																															
OVERALL DIMENSIONS			SEAT DIMENSIONS			BACK DIMENSIONS																																																									
W	D	H	W	D	H	W	H																																																								
20	25	39.5	20	19-20	16.5-21.5	19.5	16.5																																																								
RTA 2	FedEx	ups																																																													

LURAY



Luray is offered in three back heights.



Standard Black Nylon Base/Arms with Self Skinned Urethane Armcaps

Optional Aluminum Base/Arms with Self Skinned Urethane Armcaps

Optional Aluminum Base/Arms with Wood Armcaps



Model 6460PB

MECHANISMS OPTIONS

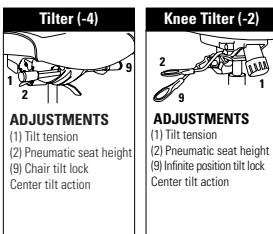

Ergonomic Features:
A, B, C, M, N, S, U

Ergonomic Features:
A, B, C, J, M, N, U

STANDARD FEATURES

- Luray is designed for boardrooms, meeting rooms and executive offices.
- Luray offers a choice of finishes to match any environment: from durable nylon components to sophisticated polished aluminum and elegant wood trim.
- Three back heights are available, featuring horizontal sewing details.
- Stitch detail on edges of seat and back is discrete, using matched thread as standard.
- Choice of two mechanisms; tilter and knee-tilter.
- Standard with Global's high quality Soft Descent™ pneumatic lift which slowly and gently lowers the seat height of the chair making it easy to obtain the exact seat height you desire.
- Fixed loop arm design comes standard in Black fiberglass reinforced nylon with a self-skinned urethane (SSU) armcap; which is soft, durable and warm to the touch. The armcap overhangs the front and side of the arm so that chair to table contact is cushioned by the pliable edge.
- Five prong, injection molded, fiberglass reinforced, nylon medium rise base (B7B) with (C1) dual wheel carpet casters.
- Check textile availability prior to specifying upholstery material.
- Pedestal base models are offered on (-4) Tilter mechanisms only. These models provide fixed location seating for use in auditoriums, classrooms, jury boxes, public venues and more. The base must be mounted to the floor (mounting hardware not included). See Pedestal Base Installation Guide for details.

OPTIONAL FEATURES

- Upholstery is available with exaggerated top stitch detail (heavier thread). Fourteen coordinating or contrasting colors may be selected. Please specify.
- For Additional caster options, please refer to the Arm and Caster section of the Price Book. Optional casters may be priced higher than the standard casters for your chair and the difference will be charged. Lower priced optional casters will not be credited.
- Please refer to "Cylinder Selection" section of the price book for additional cylinder options.
- For Memory Foam, specify (MF) and add \$117.
- Pedestal Base models have black bases with 2" height adjust cylinders. Specify (SCC) swivel, auto return to max height (no upcharge); (SN) non-swivel, auto return to max height (Add \$21); or (SC) swivel, self-centering and return to max height (Add \$33).

OPTION CODES

Please Add option codes in the following order:



- Model number**
6460 Extended high back
6461 High back
6462 Medium back



- Fabric**
Specify fabric code.
- Mechanism**
(-4) Tilter mechanism **No Upcharge**
(-2) Knee-tilt mechanism **Add \$152**
- Arms**
(SS) Black nylon arms w/SSU armcaps **No Upcharge**
(AN) Aluminum arms w/SSU armcaps **Add \$225**
Aluminum arms w/Wood armcaps **Add \$225**
Specify finish from the following:
(AB) Absolute (AAM)
(B2) Black (BKM)
(AE) Cherry (ACM)
(EO) English Oak (EOM)
(EC) Espresso Café (ECM)
(HG) Gray (HGM)
(AH) Honey (AHM)
(TM) Mahogany (TMM)
(AV) Maple (AVM)
(MW) Medium walnut (MWM)
(NT) Natural Walnut (NLW)
(AT) Night (ASM)
(BI) Noce Biondo (NBM)
(GI) Noce Grigio (NGM)
(EI) Noce Leggero (NEM)
(MI) Noce Medio (NMM)
(SK) Shaker Cherry (SKM)
(TF) Fruitwood (TFM)
(W4) Walnut (TWM)
(WR) WC Cream (WTM)
(WH) White (WHM)
(WC) Winter Cherry (WCM)
(colors shown on website)
- Base**
(B7) Black nylon base.
(A7) Polished aluminum **Add \$167**
- Casters**
(C1) Dual wheel carpet casters.
(C9R) Dual wheel hard floor casters **Add \$73**
- Stitch detail**
(MS) Color matched stitching
Decorative top stitch **No Upcharge**
(XP) Black (XB) Beige
(XG) Copen (XA) Graphite
(XK) Mahogany (XJ) Natural
(XH) Navy (XD) New Grey
(XF) Nickel (XN) Off White
(XL) Rubytone (XI) Scarlet
(XC) Smoke (XE) Taupe
(colors shown on website)
- Seat foam**
(SF) Standard foam
(MF) Memory foam **Add \$117**
- Chair assembly**
(SU) Assembled in Box **Add \$76**
- Cylinder (for Pedestal Base)**
(SCC) Swivel, auto return turn to max height
(SN) Non-swivel, auto return turn to max height **Add \$21**
(SC) Swivel, self-centering and return to max height **Add \$33**

EXAMPLE OF ORDER CODE:

6460	WA50	4	AH	A7	C1	MS	SF	SU
Model Number	Fabric	Mechanism	Arms	Base	Casters	Stitch Detail	Seat Foam	Chair Assembly

DESCRIPTION	FEATURES	MODEL#	STANDARD TEXTILE GRADES											
			1	2	3	4	5	6	7	8	9	10	11	12
 <p>Extended High Back COM Yardage: 2.25 Freight Class: 250 Product Weight (lbs.): 46 Cubic Feet Per Carton: 14.75</p>		6460	1287	1376	1444	1546	1690	1758	1889	2097	2257	2438	2805	3197
			OVERALL DIMENSIONS			SEAT DIMENSIONS			BACK DIMENSIONS					
			W	D	H	W	D	H	W	H				
			25	26.5	46	20	19	16.5-21.5	20	27.5				
			RTA 1											

DESCRIPTION	FEATURES	MODEL#	STANDARD TEXTILE GRADES											
			1	2	3	4	5	6	7	8	9	10	11	12
 <p>High Back COM Yardage: 2 Freight Class: 44 Product Weight (lbs.): 44 Cubic Feet Per Carton: 13.75</p>		6461	1249	1327	1387	1477	1606	1666	1783	1970	2112	2270	2597	2946
			OVERALL DIMENSIONS			SEAT DIMENSIONS			BACK DIMENSIONS					
			W	D	H	W	D	H	W	H				
			25	26.5	42.5	20	19	16.5-21.5	20	24				
			RTA 1											
			 											

DESCRIPTION	FEATURES	MODEL#	STANDARD TEXTILE GRADES											
			1	2	3	4	5	6	7	8	9	10	11	12
 <p>Medium Back COM Yardage: 1.75 Freight Class: 250 Product Weight (lbs.): 40 Cubic Feet Per Carton: 13.75</p>		6462	1211	1283	1335	1416	1527	1579	1682	1844	1967	2107	2393	2699
			OVERALL DIMENSIONS			SEAT DIMENSIONS			BACK DIMENSIONS					
			W	D	H	W	D	H	W	H				
			25	26.5	39.5	20	19	16.5-21.5	20	21				
			RTA 1											
			 											

DESCRIPTION	FEATURES	MODEL#	STANDARD TEXTILE GRADES											
			1	2	3	4	5	6	7	8	9	10	11	12
 <p>Extended High Back with Pedestal Base COM Yardage: 2.25 Freight Class: 250 Product Weight (lbs.): 47 Cubic Feet Per Carton: 14.75</p>		6460PB	1517	1603	1665	1762	1898	1964	2087	2284	2437	2605	2954	3324
			OVERALL DIMENSIONS			SEAT DIMENSIONS			BACK DIMENSIONS					
			W	D	H	W	D	H	W	H				
			25	26.5	44	20	19	16.5-21.5	20	27.5				
			RTA 1											

DESCRIPTION	FEATURES	MODEL#	STANDARD TEXTILE GRADES											
			1	2	3	4	5	6	7	8	9	10	11	12
 <p>High Back with Pedestal Base COM Yardage: 2 Freight Class: 45 Product Weight (lbs.): 45 Cubic Feet Per Carton: 13.75</p>		6461PB	1480	1554	1610	1695	1817	1875	1984	2158	2293	2444	2752	3080
			OVERALL DIMENSIONS			SEAT DIMENSIONS			BACK DIMENSIONS					
			W	D	H	W	D	H	W	H				
			25	26.5	41	20	19	16.5-21.5	20	24				
			RTA 1											

DESCRIPTION	FEATURES	MODEL#	STANDARD TEXTILE GRADES											
			1	2	3	4	5	6	7	8	9	10	11	12
 <p>Medium Back with Pedestal Base COM Yardage: 1.75 Freight Class: 250 Product Weight (lbs.): 40 Cubic Feet Per Carton: 13.75</p>		6462PB	1441	1506	1556	1628	1735	1785	1882	2032	2152	2281	2551	2838
			OVERALL DIMENSIONS			SEAT DIMENSIONS			BACK DIMENSIONS					
			W	D	H	W	D	H	W	H				
			25	26.5	37	20	19	16.5-21.5	20	21				
			RTA 1		FedEx		UPS							

MALAGA®



model 3140-3 (TD)



model 3140-3 (TD/PSB)



model 3141-3



model 3141-3

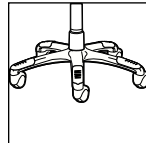

Optional Base
Polished Aluminum base with black scuff tips. Specify "B2". Add \$167.



STANDARD FEATURES

- A contoured molded foam seat, built-in lumbar support and an upholstered outer back shell is standard on all models.
- Standard with adjustable height T-arms with teardrop shaped (TD) self-skinned urethane (SSU) armcaps.
- All models are standard with a five prong, injection molded, fiberglass reinforced nylon Black spider base with dual wheel carpet casters (C10).
- Base and frame are available in Black (BK) Only.
- Side activated sliding seat depth adjustment (MD) is standard on multi-tilters.
- All models (except high back) are shipped partially KD.
- Check textile availability prior to specifying upholstery material.

- Optional abrasion resistant outer back fabric (polyester) is available. Resistant to impact damage. Available in Black only (BK). Add \$23.
- Optional Polished Aluminum base with black scuff tips. Specify "B2". Add \$167
- Please refer to the "Casters Selection" section of the price book for caster options. Optional casters may be priced higher than the standard casters for your chair and the difference will be charged. Lower priced optional casters will not be credited.
- Please refer to "Cylinder Selection" section of the price book for additional cylinder options.
- For hard surface flooring please specify C10R. Add \$66.
- For fully assembled in box, specify SU. Add \$76.

OPTIONAL FEATURES

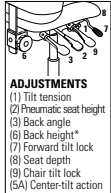
- To order a Malaga arm kit as a separate stand-alone item without a chair, use model number 3200 with the appropriate letter from the Arm Chart Price List for the arm style of your choice. Please refer to "Arms Selection" section of the price book.
- Available with an impact resistant polypropylene back shroud in Black Only. Specify (PSB). No upcharge.

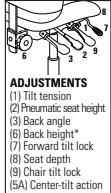
DESCRIPTION	FEATURES	MODEL#	STANDARD TEXTILE GRADES											
			1	2	3	4	5	6	7	8	9	10	11	12
 <p>HB Multi - Tilter COM Yardage: 1.75 Freight Class: 150 Product Weight (lbs.): 54 Cubic Feet Per Carton: 9.25</p>	 <p>ADJUSTMENTS (1) Tilt tension (2) Pneumatic seat height (3) Back angle (6) Back height* (7) Forward tilt lock (8) Seat depth (9) Chair tilt lock (5A) Center-tilt action</p>	3140-3	\$1446	\$1512	\$1563	\$1635	\$1743	\$1782	\$1877	\$2052	\$2138	\$2304	\$2528	\$2806
		OVERALL DIMENSIONS			SEAT DIMENSIONS			BACK DIMENSIONS						
		W	D	H	W	D	H	W	H					
26	25	41	20	18	16.5-20.5	18.5	22.5-25							
 <p>LB Multi - Tilter COM Yardage: 1.5 Freight Class: 150 Product Weight (lbs.): 52 Cubic Feet Per Carton: 9.25</p>	 <p>ADJUSTMENTS (1) Tilt tension (2) Pneumatic seat height (3) Back angle (6) Back height* (7) Forward tilt lock (8) Seat depth (9) Chair tilt lock (5A) Center-tilt action</p>	3141-3	\$1320	\$1374	\$1420	\$1485	\$1575	\$1609	\$1687	\$1842	\$1911	\$2053	\$2244	\$2486
		OVERALL DIMENSIONS			SEAT DIMENSIONS			BACK DIMENSIONS						
		W	D	H	W	D	H	W	H					
26	24	37	20	18	16.5-20.5	18.5	19-21.5							

MIRAGE™



model 2790-4



model 2791-4



Standard with a polished aluminum loop arm with SSU armcap.

STANDARD FEATURES

- Ideal for management seating and meeting rooms, Mirage offers both function and style.
- There are no arm options for this series.
- Base and frame are standard in polished aluminum only.
- **C10** carpet casters are standard.
- Check textile availability prior to specifying upholstery material.

OPTIONAL FEATURES

- For hard surface flooring casters, specify **C10R** and Add \$66.
- For fully assembled in box, please specify **SU**. Add \$76..

DESCRIPTION

FEATURES

MODEL#

STANDARD TEXTILE GRADES



HB Tilter

COM Yardage: 2
 Freight Class: 250
 Product Weight (lbs.): 0
 Cubic Feet Per Carton: 20.25

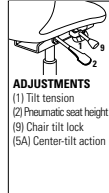

Ergonomic Features:
 A, B, C, M, N, S

	1	2	3	4	5	6	7	8	9	10	11	12
2790-4	\$1247	\$1320	\$1375	\$1460	\$1579	\$1618	\$1723	\$1920	\$2014	\$2197	\$2444	\$2754

OVERALL DIMENSIONS			SEAT DIMENSIONS			BACK DIMENSIONS	
W	D	H	W	D	H	W	H
0	0	0	20.5	19	16-20	20.5	24.5

RTA 00



MB Tilter

COM Yardage: 1.75
 Freight Class: 250
 Product Weight (lbs.): 50
 Cubic Feet Per Carton: 15.75

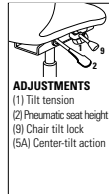

Ergonomic Features:
 A, B, C, M, N, S

	1	2	3	4	5	6	7	8	9	10	11	12
2791-4	\$1212	\$1277	\$1326	\$1397	\$1502	\$1536	\$1628	\$1801	\$1883	\$2044	\$2261	\$2533

OVERALL DIMENSIONS			SEAT DIMENSIONS			BACK DIMENSIONS	
W	D	H	W	D	H	W	H
0	0	0	19	19	16-20	19.5	17

RTA 00

NOETIC™



Model 6074
Mesh Back Chair, Weight Sensing Synchro-tilter



Model 6075
Upholstered Back Chair, Weight Sensing Synchro-tilter

MECHANISM OPTIONS:

Multi-tilter mechanism

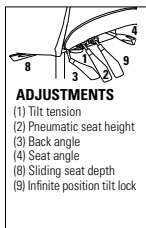

- ADJUSTMENTS**
- (1) Tilt tension
 - (2) Pneumatic seat height
 - (3) Back angle
 - (4) Seat angle
 - (8) Sliding seat depth
 - (9) Infinite position tilt lock

Ergonomic features:
A, B, C, E, F, G, M, N, S

Task basic swivel mechanism

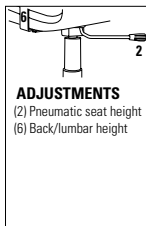

- ADJUSTMENTS**
- (2) Pneumatic seat height
 - (6) Back/lumbar height

Ergonomic features:
C, M, N

Weight sensing synchro-tilter mechanism

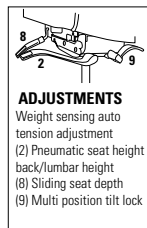

- ADJUSTMENTS**
- Weight sensing auto tension adjustment
- (2) Pneumatic seat height back/lumbar height
 - (8) Sliding seat depth
 - (9) Multi position tilt lock

Ergonomic features:
B, C, E, L, M, N

Stitch detail on coated textile and leather upholstered seats



STANDARD FEATURES

- Noetic is a thoughtful ergonomic task chair designed to inspire each individual's best work.
- Task chairs are available with three different mechanisms: task basic swivel, multi-tilter and weight-sensing synchro-tilter. Height adjustable stools are available with task basic swivel mechanism only.
- Chairs are available in three frame colors: Black, Shadow and Fog (see upcharges).
- Mesh back models are available with either Digital Mesh (6 colors) or Dimension Mesh (10 colors).
- Upholstered back models have a front textile (select from available approved textiles). The outer back is Dimension Mesh which coordinates with the selected frame color (BLK frame - DBK mesh; SHW frame - DGM mesh; FOG frame - DST mesh).
- Task chairs with multi-tilter and weight sensing synchro-tilter mechanisms are standard with a 2.5" adjustable sliding seat depth.
- Arm and armless models are available. For arms, choose between color matched P-style fixed arms or adjustable height arms with either (2D) arms with front/back sliding armcap or (4D) arms with front/back/side sliding and rotating armcaps. Black and Shadow frames receive color matching arms and armcaps. Fog frame height adjustable arms match the frame with Shadow armcap, height control button and accent trim.
- An adjustable lumbar support is available on mesh back models, see upcharge. Lumbar adjusts up/down and coordinates with frame finish (Black with BLK; Shadow with SHW and FOG).
- All models are available with a color matching nylon five prong base or chrome base (with upcharge).
- Casters are available for carpet (type C82) or hard surface flooring (type C82R, see upcharge) and coordinate with base finish. Black or Shadow bases have Black casters. Fog bases have Fog casters. Aluminum bases receive Black casters.
- Upholstery options: fabric, coated textile or leather. Coated textiles and leather seats will include perimeter stitch detail.
- To calculate pricing for mesh back models, start with the model base price and add the appropriate seat textile grade upcharge.
- For upholstered back models, two textiles (inside back and seat textiles) may be selected. For pricing, start with the model base price shown and add the appropriate grade upcharges for the inside back textile and the seat textile. The Blended Textile Matrix does not apply to this series.
- Weight capacity is 300 lbs.





OPTIONAL FEATURES





Please add option codes in the following order:





- **Model number**
Specify model number
- **Mesh Finish** (mesh back models)
(D50) Digital Mesh Red
(D51) Digital Mesh Blue
(D52) Digital Mesh Navy
(D53) Digital Mesh Shadow
(D54) Digital Mesh Fog
(D55) Digital Mesh Black
(DBK) Dimension Mesh Black
(DST) Dimension Mesh Fog
(DCL) Dimension Mesh Chalk
(DGM) Dimension Mesh Shadow
(DCH) Dimension Mesh Charcoal
(DSD) Dimension Mesh Sand
(DCO) Dimension Mesh Cobalt
(DPB) Dimension Mesh Pool Blue
(DCT) Dimension Mesh Citrus
(DBE) Dimension Mesh Berry
- **Inside back textile** (upholstered back models, outer back mesh matches frame finish). Specify textile code. See model grade upcharges.
- **Seat textile**
Specify textile code. See model grade upcharges.
- **Frame finish**
(BLK) Black
(SHW) Shadow. Add \$76
(FOG) Fog. Add \$76
- **Arm Type** (armed models only, see notes for color matching)
(FP) Fixed P Arm. No charge.
(2D) Height adjustable with depth sliding armcap No charge.
(4D) Height adjustable with width, depth and rotating sliding armcap. No charge.
- **Base type**
(B7) Nylon base (color matches frame).
(A7) Polished aluminum base. Add \$167
- **Caster type**
(82) 2.5" casters for carpet
(8R) 2.5" casters for most hard surfaces
- **Lumbar** (mesh back models)
(NAL) No lumbar
(ADL) Adjustable lumbar. Add \$38
- **Moisture Barrier** (seat)
(NB) No moisture barrier
(MB) Moisture barrier. Add \$101

EXAMPLE NOETIC ORDER CODE:

6074	DBK	FU75	BLK	2D	B7	C82	ADL	NB
Model	Mesh Finish	Textile	Frame Finish	Arm Type	Base Type	Caster Type	Lumbar	Moisture Barrier

DESCRIPTION	MODEL#/ FEATURES	STANDARD TEXTILE GRADES											
		1/COM	2	3	4	5	6	7	8	9	10	11	12
 <p>Mesh Back Chair, Multi-tilter COM Yardage: Seat: 0.75 Freight Class: 150 Product Weight (lbs.): 60 Cubic Feet Per Carton: 10.5</p>	6070	Base Price:	\$945										
		Seat upcharge:	+0	\$24	\$43	\$71	\$110	\$126	\$160	\$213	\$253	\$297	\$387
	OVERALL DIMENSIONS			SEAT DIMENSIONS			BACK DIMENSIONS						
	W D H			W D H			W H						
	26 24 41.5			20 17.5 17.5 - 21.5			16 22						
			RTA 00	1 per carton									
 <p>Armless Mesh Back Chair, Multi-tilter COM Yardage: Seat: 0.75 Freight Class: 150 Product Weight (lbs.): 55 Cubic Feet Per Carton: 10.5</p>	6070NA	Base Price:	\$817										
		Seat upcharge:	+0	\$24	\$43	\$71	\$110	\$126	\$160	\$213	\$253	\$297	\$387
	OVERALL DIMENSIONS			SEAT DIMENSIONS			BACK DIMENSIONS						
	W D H			W D H			W H						
	20 24 41.5			20 17.5 17.5 - 21.5			16 22						
			RTA 00	1 per carton									
 <p>Upholstered Back Chair, Multi-tilter COM Yardage: Back: .75 ; Seat: .75 Freight Class: 150 Product Weight (lbs.): 60 Cubic Feet Per Carton: 10.5</p>	6071	Base Price:	\$1132										
		Back upcharge:	+0	\$24	\$43	\$71	\$110	\$126	\$160	\$213	\$253	\$297	\$387
	Seat upcharge:	+0	\$24	\$43	\$71	\$110	\$126	\$160	\$213	\$253	\$297	\$387	\$483
	OVERALL DIMENSIONS			SEAT DIMENSIONS			BACK DIMENSIONS						
	W D H			W D H			W H						
26 24 41.5			20 18.5 17.5 - 21.5			16 21							
			RTA 00	1 per carton									
 <p>Armless Upholstered Back Chair, Multi-tilter COM Yardage: Back: .75 ; Seat: .75 Freight Class: 150 Product Weight (lbs.): 55 Cubic Feet Per Carton: 10.5</p>	6071NA	Base Price:	\$997										
		Back upcharge:	+0	\$24	\$43	\$71	\$110	\$126	\$160	\$213	\$253	\$297	\$387
	Seat upcharge:	+0	\$24	\$43	\$71	\$110	\$126	\$160	\$213	\$253	\$297	\$387	\$483
	OVERALL DIMENSIONS			SEAT DIMENSIONS			BACK DIMENSIONS						
	W D H			W D H			W H						
20 24 41.5			20 17 17.5 - 21			16 21							
			RTA 00	1 per carton									
 <p>Mesh Back Chair, Task Basic Swivel COM Yardage: Seat: 0.75 Freight Class: 150 Product Weight (lbs.): 44 Cubic Feet Per Carton: 10.5</p>	6072	Base Price:	\$861										
		Seat upcharge:	+0	\$24	\$43	\$71	\$110	\$126	\$160	\$213	\$253	\$297	\$387
	OVERALL DIMENSIONS			SEAT DIMENSIONS			BACK DIMENSIONS						
	W D H			W D H			W H						
	26 24 41.25			20 17 16.25 - 20.25			16 21						
			RTA 00	1 per carton									

DESCRIPTION	MODEL#/ FEATURES	STANDARD TEXTILE GRADES											
		1/COM	2	3	4	5	6	7	8	9	10	11	12
 <p>Armless Mesh Back Chair, Task Basic Swivel COM Yardage: Seat: 0.75 Freight Class: 250 Product Weight (lbs.): 39.5 Cubic Feet Per Carton: 10.5</p>	<p>6072NA Base Price: \$741 Seat upcharge: +0</p>												
		OVERALL DIMENSIONS			SEAT DIMENSIONS			BACK DIMENSIONS					
		W	D	H	W	D	H	W	H				
		20	24	41.25	20	17	16.25 - 20.25	16	21				
		RTA 00 1 per carton											
 <p>Upholstered Back Chair, Task Basic Swivel COM Yardage: Back: .75 ; Seat: .75 Freight Class: 150 Product Weight (lbs.): 44 Cubic Feet Per Carton: 10.5</p>	<p>6073 Base Price: \$1041 Back upcharge: +0 Seat upcharge: +0</p>												
		OVERALL DIMENSIONS			SEAT DIMENSIONS			BACK DIMENSIONS					
		W	D	H	W	D	H	W	H				
		26	24	41.25	20	17	16.25 - 20.25	16	21				
		RTA 00 1 per carton											
 <p>Armless Upholstered Back Chair, Task Basic Swivel COM Yardage: Back: .75 ; Seat: .75 Freight Class: 250 Product Weight (lbs.): 39.5 Cubic Feet Per Carton: 10.5</p>	<p>6073NA Base Price: \$928 Back upcharge: +0 Seat upcharge: +0</p>												
		OVERALL DIMENSIONS			SEAT DIMENSIONS			BACK DIMENSIONS					
		W	D	H	W	D	H	W	H				
		20	24	41.25	20	17	16.25 - 20.25	16	21				
		RTA 00 1 per carton											
 <p>Mesh Back Chair, Weight Sensing Synchro-tilter COM Yardage: Seat: 0.75 Freight Class: 150 Product Weight (lbs.): 45.5 Cubic Feet Per Carton: 10.5</p>	<p>6074 Base Price: \$916 Seat upcharge: +0</p>												
		OVERALL DIMENSIONS			SEAT DIMENSIONS			BACK DIMENSIONS					
		W	D	H	W	D	H	W	H				
		26	24	40	20	17.5	17 - 21	16	21				
		RTA 00 1 per carton											
 <p>Armless Mesh Back Chair, Weight Sensing Synchro-tilter COM Yardage: Seat: 0.75 Freight Class: 150 Product Weight (lbs.): 54 Cubic Feet Per Carton: 10.5</p>	<p>6074NA Base Price: \$798 Seat upcharge: +0</p>												
		OVERALL DIMENSIONS			SEAT DIMENSIONS			BACK DIMENSIONS					
		W	D	H	W	D	H	W	H				
		20	24	40	20	17.5	17 - 21	16	21				
		RTA 00 1 per carton											

DESCRIPTION	MODEL#/ FEATURES	STANDARD TEXTILE GRADES											
		1/COM	2	3	4	5	6	7	8	9	10	11	12
 <p>Upholstered Back Chair, Weight Sensing Synchro-tilter COM Yardage: Back: .75 ; Seat: .75 Freight Class: 150 Product Weight (lbs.): 44.5 Cubic Feet Per Carton: 10.5</p>	6075	Base Price:	\$1096										
	Back upcharge:	+0	\$24	\$43	\$71	\$110	\$126	\$160	\$213	\$253	\$297	\$387	\$483
	Seat upcharge:	+0	\$24	\$43	\$71	\$110	\$126	\$160	\$213	\$253	\$297	\$387	\$483
	OVERALL DIMENSIONS			SEAT DIMENSIONS			BACK DIMENSIONS						
	W D H			W D H			W H						
	26 24 40			20 17.5 17 - 21			16 21						
			RTA 00	1 per carton									
 <p>Armless Upholstered Back Chair, Weight Sensing Synchro-tilter COM Yardage: Back: .75 ; Seat: .75 Freight Class: 150 Product Weight (lbs.): 54 Cubic Feet Per Carton: 10.5</p>	6075NA	Base Price:	\$984										
	Back upcharge:	+0	\$24	\$43	\$71	\$110	\$126	\$160	\$213	\$253	\$297	\$387	\$483
	Seat upcharge:	+0	\$24	\$43	\$71	\$110	\$126	\$160	\$213	\$253	\$297	\$387	\$483
	OVERALL DIMENSIONS			SEAT DIMENSIONS			BACK DIMENSIONS						
	W D H			W D H			W H						
	20 24 40			20 17.5 17 - 21			16 21						
			RTA 00	1 per carton									
 <p>Mesh Back Height Adjustable Stool COM Yardage: Seat: 0.75 Freight Class: 150 Product Weight (lbs.): 49 Cubic Feet Per Carton: 10.5</p>	6076	Base Price:	\$1041										
	Seat upcharge:	+0	\$24	\$43	\$71	\$110	\$126	\$160	\$213	\$253	\$297	\$387	\$483
	OVERALL DIMENSIONS			SEAT DIMENSIONS			BACK DIMENSIONS						
	W D H			W D H			W H						
	26 24 51			20 17.5 25 - 35			16 21						
				RTA 00	1 per carton								
 <p>Armless Mesh Back Height Adjustable stool COM Yardage: Seat: 0.75 Freight Class: 150 Product Weight (lbs.): 45 Cubic Feet Per Carton: 10.5</p>	6076NA	Base Price:	\$897										
	Seat upcharge:	+0	\$24	\$43	\$71	\$110	\$126	\$160	\$213	\$253	\$297	\$387	\$483
	OVERALL DIMENSIONS			SEAT DIMENSIONS			BACK DIMENSIONS						
	W D H			W D H			W H						
	20 24 51			20 17.5 25 - 35			16 21						
				RTA 00	1 per carton								
 <p>Upholstered Back Height Adjustable Stool COM Yardage: Back: .75 ; Seat: .75 Freight Class: 150 Product Weight (lbs.): 49.5 Cubic Feet Per Carton: 10.5</p>	6077	Base Price:	\$1221										
	Back upcharge:	+0	\$24	\$43	\$71	\$110	\$126	\$160	\$213	\$253	\$297	\$387	\$483
	Seat upcharge:	+0	\$24	\$43	\$71	\$110	\$126	\$160	\$213	\$253	\$297	\$387	\$483
	OVERALL DIMENSIONS			SEAT DIMENSIONS			BACK DIMENSIONS						
	W D H			W D H			W H						
	26 24 51			20 17 25 - 35			16 21						
			RTA 00	1 per carton									

DESCRIPTION	MODEL#/ FEATURES	STANDARD TEXTILE GRADES											
		1/COM	2	3	4	5	6	7	8	9	10	11	12
 <p>Armless Upholstered Back Height Adjustable Stool COM Yardage: Back: .75 ; Seat: .75 Freight Class: 150 Product Weight (lbs.): 46 Cubic Feet Per Carton: 10.5</p>	6077NA	Base Price:	\$1078										
	Back upcharge:	+0	\$24	\$43	\$71	\$110	\$126	\$160	\$213	\$253	\$297	\$387	\$483
	Seat upcharge:	+0	\$24	\$43	\$71	\$110	\$126	\$160	\$213	\$253	\$297	\$387	\$483
	OVERALL DIMENSIONS			SEAT DIMENSIONS			BACK DIMENSIONS						
		W	D	H	W	D	H	W	H				
	20	24	51	20	17	25 - 35	16	21					
							RTA 00	1 per carton					

NOVELLO



Novello is offered in three frame finishes: Black, Fog and Ivory Cloud.



Model 6400PB

STANDARD MECHANISMS

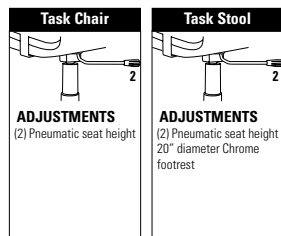

Ergonomic Features:
C, M

Ergonomic Features:
C, M

STANDARD FEATURES

- A revolutionary new task chair that can go anywhere - it requires no adjustments and provides exceptional comfort for any size user.
- Novello features a special polymer shell that flexes, allowing the seat to glide smoothly on a concealed track system. It is strong and durable, with clean lines and offers effective support.
- Chairs are molded with one-piece flexible shells; available in Black (BK), Fog (FG) or Cloud (IC). Black is the base list price.
- Chairs with Black shells are standard with five prong, injection molded, fiberglass reinforced nylon Black base (B5) with (C82) dual wheel carpet casters.
- Chairs with Fog or Cloud shells are standard with a five prong, polished cast aluminum base with Black accents (BA) and black (C82) dual wheel carpet casters.
- Fog and Cloud chairs and Black models with an aluminum base come with a chrome gas cylinder.
- All models with arms are standard with Black armcaps.
- Standard with Global's high quality Soft Descent™ pneumatic lift which slowly and gently lowers the seat height of the chair making it easy to obtain the exact seat height you desire.
- Check textile availability prior to specifying upholstery material.
- Pedestal base models are offered on with Tilter mechanisms only. These models provide fixed location seating for use in auditoriums, classrooms, jury boxes, public venues and more. The base must be mounted to the floor (mounting hardware not included). See Pedestal Base Installation Guide for details.

OPTIONAL FEATURES

- There are no arm options for this series.
- For Additional caster options, please refer to the Arm and Caster section.
- Optional casters may be priced higher than the standard casters for your chair and the difference will be charged. Lower priced optional casters will not be credited.
- Please refer to "Cylinder Selection" section of the price book for additional cylinder options.
- Pedestal Base models have black bases with 2" height adjust cylinders. Specify (SCC) swivel, auto return to max height (no upcharge); (SN) non-swivel, auto return to max height (Add \$21; or (SC) swivel, self-centering and return to max height (Add \$33).











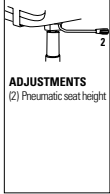



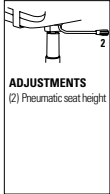

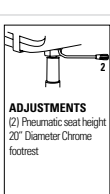

OPTION CODES



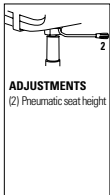



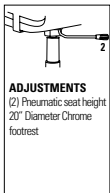

















Please Add option codes in the following order:



- **Model Number**
6400 Chair with arms
6401 Chair, armless
6402 Chair with arms, fully upholstered
6403 Chair, armless, fully upholstered
6410 Stool with arms
6411 Stool, armless
6412 Stool with arms, fully upholstered
6413 Stool, armless, fully upholstered
- **Fabric**
Specify fabric code
- **Shell/arm color**
(BK) Black shell **No Upcharge**
(FG) Fog shell **Add \$34**
(IC) Cloud shell **Add \$34**
- **Armcaps (No Upcharge)**
(BP) Black self-skinned urethane.
(FP) Fog self-skinned urethane.
(CP) Cloud self-skinned urethane.
- **Base**
(BB5) Black nylon base..... **No Upcharge**
(FB5) Fog nylon base..... **Add \$47**
(CB5) Cloud nylon base **Add \$47**
(BBA) Polished aluminum w/Black accent **Add \$76**
(FBA) Polished aluminum w/Fog accent **Add \$76**
(CBA) Polished aluminum w/Cloud accent..... **Add \$76**
- **Adjustable Footring (stool models)**
(R3) Black footring..... **No Upcharge**
- **Casters**
(C82) Black dual wheel carpet casters **No Upcharge**
(C82R) Black dual wheel hard floor casters **Add \$98**
(C82F) Fog dual wheel carpet casters **No Upcharge**
(C82FR) Fog dual wheel hard floor casters..... **Add \$98**
- **Seat foam**
(SF) Standard foam..... **No Upcharge**
(PF) Extra plush cushion **No Upcharge**
- **Chair Assembly**
(SU) Assembled in Box **\$76**
- **Cylinder (for Pedestal Base)**
(SCC) Swivel, auto return turn to max height
(SN) Non-swivel, auto return turn to max height. **Add \$21**
(SC) Swivel, self-centering and return to max height. **Add \$33**

EXAMPLE OF ORDER CODE:

6400BK	WA50	EG	BK	AL	R3	C9R	SU
Model Number	Fabric	Shell/Arms	Armcaps	Base	Footring	Casters	Chair Assembly

DESCRIPTION	FEATURES	MODEL#	STANDARD TEXTILE GRADES													
			1	2	3	4	5	6	7	8	9	10	11	12		
 <p>Task Chair w/Arms COM Yardage: 0.75 Freight Class: 150 Product Weight (lbs.): 40 Cubic Feet Per Carton: 8.25</p>	 <p>ADJUSTMENTS (2) Pneumatic seat height</p> <p>Upholstered seat/ Polypropylene back</p> <p>Ergonomic Features: C, M</p>	6400	1004	1038	1062	1096	1146	1163	1209	1291	1331	1408	1511	1642		
			OVERALL DIMENSIONS			SEAT DIMENSIONS			BACK DIMENSIONS							
			W	D	H	W	D	H	W	H						
			25	22	36	18.5	18	16.5-21.5	20.5	18.5						
			RTA 2													
 <p>Armless Task Chair COM Yardage: 0.75 Freight Class: 150 Product Weight (lbs.): 35 Cubic Feet Per Carton: 6.75</p>	 <p>ADJUSTMENTS (2) Pneumatic seat height</p> <p>Upholstered seat/ Polypropylene back</p> <p>Ergonomic Features: C, M</p>	6401	909	943	965	998	1046	1068	1114	1182	1236	1296	1417	1549		
			OVERALL DIMENSIONS			SEAT DIMENSIONS			BACK DIMENSIONS							
			W	D	H	W	D	H	W	H						
			21.5	22	36	18.5	18	16.5-21.5	20.5	18.5						
			RTA 2													
 <p>Task Chair w/Arms COM Yardage: 0.75 Freight Class: 150 Product Weight (lbs.): 40 Cubic Feet Per Carton: 8.25</p>	 <p>ADJUSTMENTS (2) Pneumatic seat height</p> <p>Upholstered seat & back</p> <p>Ergonomic Features: C, M</p>	6402	1085	1118	1141	1174	1222	1244	1290	1358	1412	1472	1593	1725		
			OVERALL DIMENSIONS			SEAT DIMENSIONS			BACK DIMENSIONS							
			W	D	H	W	D	H	W	H						
			25	22	36	18.5	17.5	16.5-21.5	20.5	18.5						
			RTA 2													
 <p>Armless Task Chair COM Yardage: 0.75 Freight Class: 150 Product Weight (lbs.): 37 Cubic Feet Per Carton: 6.75</p>	 <p>ADJUSTMENTS (2) Pneumatic seat height</p> <p>Upholstered seat & back</p> <p>Ergonomic Features: C, M</p>	6403	998	1033	1056	1088	1136	1158	1204	1272	1326	1386	1508	1639		
			OVERALL DIMENSIONS			SEAT DIMENSIONS			BACK DIMENSIONS							
			W	D	H	W	D	H	W	H						
			21.5	22	36	18.5	17.5	16.5-21.5	20.5	18.5						
			RTA 2													
 <p>Task Stool w/Arms COM Yardage: 0.75 Freight Class: 150 Product Weight (lbs.): 44 Cubic Feet Per Carton: 8.25</p>	 <p>ADJUSTMENTS (2) Pneumatic seat height 20" Diameter Chrome footrest</p> <p>Upholstered seat/ Polypropylene back</p> <p>Ergonomic Features: C, M</p>	6410	1153	1188	1211	1243	1291	1313	1359	1427	1481	1541	1663	1794		
			OVERALL DIMENSIONS			SEAT DIMENSIONS			BACK DIMENSIONS							
			W	D	H	W	D	H	W	H						
			25	22	46	18.5	18	24-34	20.5	18.5						
			RTA 2													

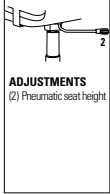
DESCRIPTION	FEATURES	MODEL#	STANDARD TEXTILE GRADES													
			1	2	3	4	5	6	7	8	9	10	11	12		
 <p>Armless Task Stool COM Yardage: 0.75 Freight Class: 150 Product Weight (lbs.): 39 Cubic Feet Per Carton: 8.25</p>	 <p>ADJUSTMENTS (2) Pneumatic seat height 20" Diameter Chrome footrest</p>	<p>6411</p>	1056	1090	1112	1145	1193	1215	1261	1329	1383	1443	1564	1696		
			OVERALL DIMENSIONS			SEAT DIMENSIONS			BACK DIMENSIONS							
			W	D	H	W	D	H	W	H						
			25	21.5	46	18.5	17.5	24-34	20.5	18.5						
			  													
 <p>Task Stool w/Arms COM Yardage: 0.75 Freight Class: 150 Product Weight (lbs.): 46 Cubic Feet Per Carton: 8.25</p>	 <p>ADJUSTMENTS (2) Pneumatic seat height 20" Diameter Chrome footrest</p>	<p>6412</p>	1234	1268	1292	1326	1376	1393	1439	1521	1558	1637	1741	1872		
			OVERALL DIMENSIONS			SEAT DIMENSIONS			BACK DIMENSIONS							
			W	D	H	W	D	H	W	H						
			25	22	46	18.5	18	24-34	20.5	18.5						
			  													
 <p>Armless Task Stool COM Yardage: 0.75 Freight Class: 150 Product Weight (lbs.): 39 Cubic Feet Per Carton: 8.25</p>	 <p>ADJUSTMENTS (2) Pneumatic seat height 20" Diameter Chrome footrest</p>	<p>6413</p>	1138	1172	1194	1227	1275	1297	1343	1411	1465	1525	1646	1778		
			OVERALL DIMENSIONS			SEAT DIMENSIONS			BACK DIMENSIONS							
			W	D	H	W	D	H	W	H						
			25	21.5	46	18.5	18	24-34	20.5	18.5						
			  													
 <p>Task Chair w/Arms and Pedestal Base COM Yardage: 0.75 Freight Class: 150 Product Weight (lbs.): 42 Cubic Feet Per Carton: 8.25</p>	 <p>ADJUSTMENTS (2) Pneumatic seat height</p>	<p>6400PB</p>	1236	1263	1284	1312	1355	1374	1413	1472	1518	1570	1677	1788		
			OVERALL DIMENSIONS			SEAT DIMENSIONS			BACK DIMENSIONS							
			W	D	H	W	D	H	W	H						
			25	22	34	18.5	18	16.5-21.5	20.5	18.5						
			  													
 <p>Armless Task Chair with Pedestal Base COM Yardage: 0.75 Freight Class: 150 Product Weight (lbs.): 39 Cubic Feet Per Carton: 6.75</p>	 <p>ADJUSTMENTS (2) Pneumatic seat height</p>	<p>6401PB</p>	1139	1165	1186	1214	1257	1276	1314	1374	1420	1472	1577	1690		
			OVERALL DIMENSIONS			SEAT DIMENSIONS			BACK DIMENSIONS							
			W	D	H	W	D	H	W	H						
			21.5	22	34	18.5	18	16.5-21.5	20.5	18.5						
			  													

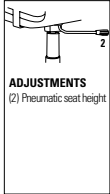
DESCRIPTION	FEATURES	MODEL#	STANDARD TEXTILE GRADES											
			1	2	3	4	5	6	7	8	9	10	11	12
 <p>Task Chair w/Arms with Pedestal Base COM Yardage: 0.75 Freight Class: 150 Product Weight (lbs.): 44 Cubic Feet Per Carton: 8.25</p>	 <p>ADJUSTMENTS (2) Pneumatic seat height</p> <p>Upholstered seat & back</p> <p>Ergonomic Features: C, M</p>	6402PB	1317	1343	1364	1392	1435	1454	1492	1552	1598	1650	1755	1868
			OVERALL DIMENSIONS			SEAT DIMENSIONS			BACK DIMENSIONS					
			W	D	H	W	D	H	W	H				
			25	22	34	18.5	17.5	16.5-21.5	20.5	18.5				
			RTA 2	FedEx		ups								
 <p>Armless Task Chair COM Yardage: 0.75 Freight Class: 125 Product Weight (lbs.): 41 Cubic Feet Per Carton: 6.75</p>	 <p>ADJUSTMENTS (2) Pneumatic seat height</p> <p>Upholstered seat & back</p> <p>Ergonomic Features: C, M</p>	6403PB	1230	1256	1277	1306	1348	1368	1407	1466	1512	1564	1671	1783
			OVERALL DIMENSIONS			SEAT DIMENSIONS			BACK DIMENSIONS					
			W	D	H	W	D	H	W	H				
			21.5	22	34	18.5	17.5	16.5-21.5	20.5	18.5				
			RTA 2	FedEx		ups								

OBUSFORME® COMFORT



model 1240-3



model 1241-3



Memory Foam
Available, use code "MF" and Add \$117.



model 1261-3



STANDARD FEATURES

- ObusForme Comfort is recommended by chiropractors worldwide.
- Features a new elastomeric back support system that provides impressive, comfortable support with no pressure points along the spine.
- Height, width and depth adjustable (**G3**) arms with self-skinned urethane (SSU) arm pads. Armcaps articulate inwards 30°
- Five prong, injection molded, fiberglass reinforced nylon Black spider base with dual wheel carpet casters (**C65**).
- Standard seat foam is a dual cushion with a soft top layer and a firmly supportive lower layer.
- Side activated sliding seat depth adjustment (**MD**) is standard on multi-tilters.
- Schukra™ depth adjustable lumbar support for personalized back support and comfort is standard on select models.
- Vari-Width (**WA**) width adjustable arm extensions
- are standard when chair is ordered with adjustable arms. Allows the arms to move away from the seat by 2" on each side to allow space if desired for broader hip widths.
- All models are shipped partially KD.
- Check textile availability prior to specifying upholstery material.

- "P" petite seat models have a seat that is 0.75 shallower and 1.5" narrower than the standard seat.
- Petite seats have the same list prices as standard models.

OPTIONAL FEATURES

- Optional Memory Foam (**MF**) seats are available. This slow release foam molds to your contour and evenly distributes body weight. Please specify. Add \$117.
- An optional Polished Aluminum base with scuff resistant tips is available. Please specify (**ALU**). Add \$167
- Please refer to the "Casters Selection" section of the price book for caster options. Optional casters may be priced higher than the standard casters for your chair and the difference will be charged. Lower priced optional casters will not be credited.
- Please refer to "Cylinder Selection" section of the price book for additional cylinder options.
- Please specify **C65R** for hard surface flooring. Add \$73
- For fully assembled in box, please **SU**. Add \$76.

DESCRIPTION FEATURES MODEL# STANDARD TEXTILE GRADES



HB Knee - Tilter
COM Yardage: 2.25
Freight Class: 125
Product Weight (lbs.): 67
Cubic Feet Per Carton: 11

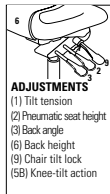

Ergonomic Features:
A, B, C, D, E, G, H, J, M, N, Q, R, U

MODEL#	1	2	3	4	5	6	7	8	9	10	11	12
1240-2	\$1447	\$1539	\$1609	\$1713	\$1863	\$1918	\$2049	\$2299	\$2417	\$2648	\$2964	\$3355

1240P-2 Petite seat

OVERALL DIMENSIONS			SEAT DIMENSIONS			BACK DIMENSIONS	
W	D	H	W	D	H	W	H
26	25	48.5	21	17.5-20	16.5-20.5	19	27.5



HB Multi - Tilter
COM Yardage: 2.25
Freight Class: 125
Product Weight (lbs.): 69
Cubic Feet Per Carton: 11

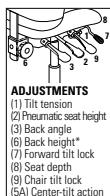

Ergonomic Features:
A, B, C, D, E, F, G, H, M, N, Q, R, S, U

MODEL#	1	2	3	4	5	6	7	8	9	10	11	12
1240-3	\$1236	\$1328	\$1398	\$1502	\$1652	\$1707	\$1838	\$2088	\$2206	\$2437	\$2753	\$3144

1240P-3 Petite seat

OVERALL DIMENSIONS			SEAT DIMENSIONS			BACK DIMENSIONS	
W	D	H	W	D	H	W	H
26	25	48	21	17.5-20	16-20	19	27



MB Knee - Tilter
COM Yardage: 2
Freight Class: 125
Product Weight (lbs.): 67
Cubic Feet Per Carton: 10.5

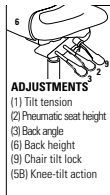









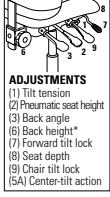





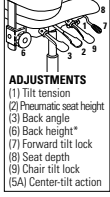

Ergonomic Features:
A, B, C, D, E, G, H, J, M, N, Q, R, U

MODEL#	1	2	3	4	5	6	7	8	9	10	11	12
1241-2	\$1386	\$1465	\$1530	\$1622	\$1755	\$1803	\$1918	\$2140	\$2247	\$2451	\$2730	\$3080

OVERALL DIMENSIONS			SEAT DIMENSIONS			BACK DIMENSIONS	
W	D	H	W	D	H	W	H
26	25	44.5	21	17.5-20	16.5-20.5	19.5	22-27.5

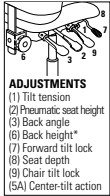

DESCRIPTION	FEATURES	MODEL#	STANDARD TEXTILE GRADES													
			1	2	3	4	5	6	7	8	9	10	11	12		
 <p>MB Multi -Tilter COM Yardage: 2 Freight Class: 125 Product Weight (lbs.): 67 Cubic Feet Per Carton: 10.5</p>	 <p>ADJUSTMENTS (1) Tilt tension (2) Pneumatic seat height (3) Back angle (6) Back height* (7) Forward tilt lock (8) Seat depth (9) Chair tilt lock (5A) Center-tilt action</p>	1241-3	\$1174	\$1253	\$1318	\$1410	\$1543	\$1591	\$1706	\$1928	\$2035	\$2239	\$2518	\$2868		
			OVERALL DIMENSIONS			SEAT DIMENSIONS			BACK DIMENSIONS							
			W	D	H	W	D	H	W	H						
			26	25	44	21	17.5-20	16-20	19.5	22						
<p>Ergonomic Features: A, B, C, D, E, F, G, H, M, N, Q, R, S, U</p>		RTA 2	 													
 <p>Armchair - Sled Base COM Yardage: 1.75 Freight Class: 250 Product Weight (lbs.): 35 Cubic Feet Per Carton: 10</p>		1246	\$756	\$825	\$876	\$952	\$1061	\$1098	\$1194	\$1373	\$1462	\$1630	\$1858	\$2142		
			OVERALL DIMENSIONS			SEAT DIMENSIONS			BACK DIMENSIONS							
			W	D	H	W	D	H	W	H						
			21	24	38	21	18	18	20	20.5						
<p>Ergonomic Features: M, N</p>		RTA 2	 													
 <p>Armchair - Sled Base COM Yardage: 1.75 Freight Class: 250 Product Weight (lbs.): 40 Cubic Feet Per Carton: 13</p>		1247	\$995	\$1064	\$1115	\$1192	\$1300	\$1338	\$1433	\$1614	\$1701	\$1870	\$2098	\$2379		
			OVERALL DIMENSIONS			SEAT DIMENSIONS			BACK DIMENSIONS							
			W	D	H	W	D	H	W	H						
			26.5	24	38	21	18	18	20	20.5						
<p>Ergonomic Features: M, N</p>		RTA 2	 													
 <p>HB Multi -Tilter w/Schukra COM Yardage: 2.25 Freight Class: 125 Product Weight (lbs.): 69 Cubic Feet Per Carton: 11</p>	 <p>ADJUSTMENTS (1) Tilt tension (2) Pneumatic seat height (3) Back angle (6) Back height* (7) Forward tilt lock (8) Seat depth (9) Chair tilt lock (5A) Center-tilt action</p>	1260-3	\$1399	\$1491	\$1561	\$1665	\$1815	\$1870	\$2001	\$2251	\$2369	\$2600	\$2916	\$3307		
			OVERALL DIMENSIONS			SEAT DIMENSIONS			BACK DIMENSIONS							
			W	D	H	W	D	H	W	H						
			26	25	48	21	17.5-20	16-20	19.5	27-32.25						
<p>Ergonomic Features: A, B, C, D, E, F, G, H, M, N, Q, R, S, U, V</p>		RTA 2	 													
 <p>MB Multi -Tilter w/Schukra COM Yardage: 2 Freight Class: 125 Product Weight (lbs.): 67 Cubic Feet Per Carton: 10.5</p>	 <p>ADJUSTMENTS (1) Tilt tension (2) Pneumatic seat height (3) Back angle (6) Back height* (7) Forward tilt lock (8) Seat depth (9) Chair tilt lock (5A) Center-tilt action</p>	1261-3	\$1339	\$1422	\$1484	\$1577	\$1710	\$1756	\$1873	\$2094	\$2201	\$2408	\$2686	\$3035		
			OVERALL DIMENSIONS			SEAT DIMENSIONS			BACK DIMENSIONS							
			W	D	H	W	D	H	W	H						
			26	25	44	21	17.5-20	16-20	19.5	22						
<p>Ergonomic Features: A, B, C, D, E, F, G, H, M, N, Q</p>		RTA 2	 													

OBUSFORME® COMFORT XL



model 1251-0

model 1252-8



Memory Foam
Available, use code "MF" and Add \$117





STANDARD FEATURES





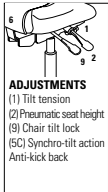

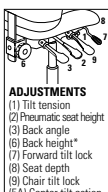

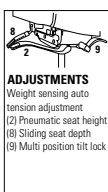
- ObusForme Comfort XL is the newest Addition to the ObusForme family and is recommended by chiropractors worldwide.
- All models provided Additional height and/or seat depth, design to meet the requirements of the large occupant chair.
- Features a elastomeric back support system that provides impressive comfortable support with no pressure points along the spine, with a compound curved back and seat.
- Standard seat foam is extra thick dual cushion with a soft top layer and a firmly supportive lower layer.
- Standard with height and width adjustable forward swept arms with "sliding armcaps" (G3).
- Standard with Global's high quality Soft Descent™ Pneumatic lift which slowly and gently lowers the seat height of the chair making it easy to obtain exactly the right seat height you desire.
- Vari - Width Adapter Plate (WA) is standard. Allows each arm to move outward an Additional 2" (for a total of 4" extra seat width) and locks with the use of an easy to maneuver lever.
- Check textile availability prior to specifying upholstery material.

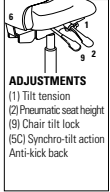

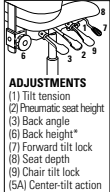

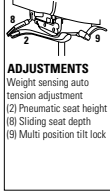

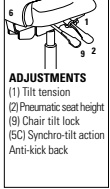

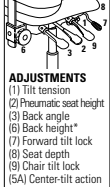
- Sliding seat depth is standard on all models.
- Vertical back height ratchet adjustment of 5 1/4", standard on all models.
- Standard five-legged, injection moulded, fiberglass reinforced nylon black spider base.
- C65 dual wheel carpet casters are standard.
- All models are rated for 400lbs.
- All models ship fully assembled in the box.

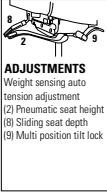

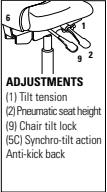

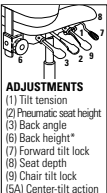

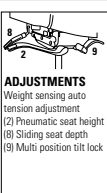

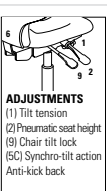
OPTIONAL FEATURES

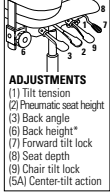
- Please specify C65R for hard surface flooring. Add \$73.

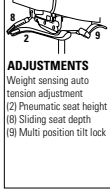
DESCRIPTION	FEATURES	MODEL#	STANDARD TEXTILE GRADES																								
			1	2	3	4	5	6	7	8	9	10	11	12													
 <p>Extended Back Synchro - Tilter w/ Back Angle Adj. COM Yardage: 2.75 Freight Class: 250 Product Weight (lbs.): 69 Cubic Feet Per Carton: 24.25</p>	 <p>ADJUSTMENTS (1) Tilt tension (2) Pneumatic seat height (9) Chair tilt lock (5C) Synchro-tilt action Anti-kick back</p>	<p>Extra Tall/Wide Back. Wide/Deep Seat.</p> <p>Ergonomic Features: A, B, C, D, E, G, H, L, M, N, Q, R, U</p>	<table border="1"> <tr> <td>1251-0</td><td>1892</td><td>1992</td><td>2067</td><td>2182</td><td>2345</td><td>2402</td><td>2544</td><td>2815</td><td>2945</td><td>3195</td><td>3539</td><td>3965</td> </tr> </table>												1251-0	1892	1992	2067	2182	2345	2402	2544	2815	2945	3195	3539	3965
			1251-0	1892	1992	2067	2182	2345	2402	2544	2815	2945	3195	3539	3965												
			OVERALL DIMENSIONS			SEAT DIMENSIONS			BACK DIMENSIONS																		
			W	D	H	W	D	H	W	H																	
28	26	53	23.5	19-21.5	17-21	22	31-36.25																				
			RTA 00																								
 <p>Extended Back Multi - Tilter COM Yardage: 2.75 Freight Class: 250 Product Weight (lbs.): 71 Cubic Feet Per Carton: 24.25</p>	 <p>ADJUSTMENTS (1) Tilt tension (2) Pneumatic seat height (3) Back angle (6) Back height* (7) Forward tilt lock (8) Seat depth (9) Chair tilt lock (5A) Center-tilt action</p>	<p>Extra Tall/Wide Back. Wide/Deep Seat.</p> <p>Ergonomic Features: A, B, C, D, E, F, G, H, M, N, Q, R, S, U</p>	<table border="1"> <tr> <td>1251-3</td><td>1892</td><td>1992</td><td>2067</td><td>2182</td><td>2345</td><td>2402</td><td>2544</td><td>2815</td><td>2945</td><td>3195</td><td>3539</td><td>3965</td> </tr> </table>												1251-3	1892	1992	2067	2182	2345	2402	2544	2815	2945	3195	3539	3965
			1251-3	1892	1992	2067	2182	2345	2402	2544	2815	2945	3195	3539	3965												
			OVERALL DIMENSIONS			SEAT DIMENSIONS			BACK DIMENSIONS																		
			W	D	H	W	D	H	W	H																	
28	26	53	23.5	19-21.5	17-21	22	31-36.25																				
			RTA 00																								
 <p>Extended Back Weight Sensing Synchro - Tilter COM Yardage: 2.75 Freight Class: 250 Product Weight (lbs.): 66 Cubic Feet Per Carton: 24.25</p>	 <p>ADJUSTMENTS Weight sensing auto tension adjustment (2) Pneumatic seat height (8) Sliding seat depth (9) Multi position tilt lock</p>	<p>Extra Tall/Wide Back. Wide/Deep Seat.</p> <p>Ergonomic Features: A, B, C, D, E, H, L, M, N, Q, R, U</p>	<table border="1"> <tr> <td>1251-8</td><td>1892</td><td>1992</td><td>2067</td><td>2182</td><td>2345</td><td>2402</td><td>2544</td><td>2815</td><td>2945</td><td>3195</td><td>3539</td><td>3965</td> </tr> </table>												1251-8	1892	1992	2067	2182	2345	2402	2544	2815	2945	3195	3539	3965
			1251-8	1892	1992	2067	2182	2345	2402	2544	2815	2945	3195	3539	3965												
			OVERALL DIMENSIONS			SEAT DIMENSIONS			BACK DIMENSIONS																		
			W	D	H	W	D	H	W	H																	
28	26	53	23.5	19-21.5	17-21	22	31-36.25																				
			RTA 00																								

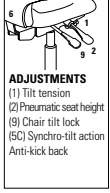
DESCRIPTION	FEATURES	MODEL#	STANDARD TEXTILE GRADES													
			1	2	3	4	5	6	7	8	9	10	11	12		
 <p>High Back Synchro - Tilter w/ Back Angle Adj. COM Yardage: 2.50 Freight Class: 250 Product Weight (lbs.): 65 Cubic Feet Per Carton: 22.25</p>	 <p>ADJUSTMENTS (1) Tilt tension (2) Pneumatic seat height (9) Chair tilt lock (5C) Synchro-tilt action Anti-kick back</p>	<p>High/Wide Back. Wide/Deep Seat.</p> <p>Ergonomic Features: A, B, C, D, E, G, H, L, M, N, Q, R, U</p>	1252-0	1808	1898	1968	2072	2220	2272	2401	2647	2768	2995	3306	3693	
			OVERALL DIMENSIONS			SEAT DIMENSIONS			BACK DIMENSIONS							
			W	D	H	W	D	H	W	H						
			28	26	48.5	23.5	19-21.5	17-21	22	26.5-31.75						
			RTA 00													
 <p>High Back Multi - Tilter COM Yardage: 2.50 Freight Class: 250 Product Weight (lbs.): 67 Cubic Feet Per Carton: 22.25</p>	 <p>ADJUSTMENTS (1) Tilt tension (2) Pneumatic seat height (3) Back angle (6) Back height* (7) Forward tilt lock (8) Seat depth (9) Chair tilt lock (5A) Center-tilt action</p>	<p>High/Wide Back. Wide/Deep Seat.</p> <p>Ergonomic Features: A, B, C, D, E, F, G, H, M, N, Q, R, S, U</p>	1252-3	1808	1898	1968	2072	2220	2272	2401	2647	2768	2995	3306	3693	
			OVERALL DIMENSIONS			SEAT DIMENSIONS			BACK DIMENSIONS							
			W	D	H	W	D	H	W	H						
			28	26	48.5	23.5	19-21.5	17-21	22	26.5-31.75						
			RTA 00													
 <p>High Back Weight Sensing Synchro - Tilter COM Yardage: 2.50 Freight Class: 250 Product Weight (lbs.): 62 Cubic Feet Per Carton: 22.25</p>	 <p>ADJUSTMENTS Weight sensing auto tension adjustment (2) Pneumatic seat height (8) Sliding seat depth (9) Multi-position tilt lock</p>	<p>High/Wide Back. Wide/Deep Seat.</p> <p>Ergonomic Features: A, B, C, D, E, H, L, M, N, Q, R, U</p>	1252-8	1808	1898	1968	2072	2220	2272	2401	2647	2768	2995	3306	3693	
			OVERALL DIMENSIONS			SEAT DIMENSIONS			BACK DIMENSIONS							
			W	D	H	W	D	H	W	H						
			28	26	48.5	23.5	19-21.5	17-21	22	26.5-31.75						
			RTA 00													
 <p>Mid Back Synchro - Tilter w/ Back Angle Adj. COM Yardage: 1.75 Freight Class: 150 Product Weight (lbs.): 46 Cubic Feet Per Carton: 10.50</p>	 <p>ADJUSTMENTS (1) Tilt tension (2) Pneumatic seat height (9) Chair tilt lock (5C) Synchro-tilt action Anti-kick back</p>	<p>Mid/Wide Back Wide/Deep Seat.</p> <p>Ergonomic Features: A, B, C, D, E, G, H, L, M, N, Q, R, U</p>	1253-0	1726	1816	1886	1990	2138	2190	2319	2565	2686	2913	3224	3611	
			OVERALL DIMENSIONS			SEAT DIMENSIONS			BACK DIMENSIONS							
			W	D	H	W	D	H	W	H						
			28	26	44.5	23.5	19-21.5	17-21	22	22-27.25						
			RTA 00													
 <p>Mid Back Multi - Tilter COM Yardage: 1.75 Freight Class: 150 Product Weight (lbs.): 41 Cubic Feet Per Carton: 10.50</p>	 <p>ADJUSTMENTS (1) Tilt tension (2) Pneumatic seat height (3) Back angle (6) Back height* (7) Forward tilt lock (8) Seat depth (9) Chair tilt lock (5A) Center-tilt action</p>	<p>Mid/Wide Back. Wide/Deep Seat.</p> <p>Ergonomic Features: A, B, C, D, E, F, G, H, M, N, Q, R, S, U</p>	1253-3	1726	1816	1886	1990	2138	2190	2319	2565	2686	2913	3224	3611	
			OVERALL DIMENSIONS			SEAT DIMENSIONS			BACK DIMENSIONS							
			W	D	H	W	D	H	W	H						
			28	26	44.5	23.5	19-21.5	17-21	22	22-27.25						
			RTA 00													

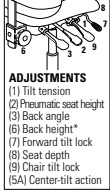
DESCRIPTION	FEATURES	MODEL#	STANDARD TEXTILE GRADES											
			1	2	3	4	5	6	7	8	9	10	11	12
 <p>Mid Back Weight Sensing Synchro - Tilter COM Yardage: 1.75 Freight Class: 150 Product Weight (lbs.): 35 Cubic Feet Per Carton: 10</p>	 <p>ADJUSTMENTS Weight sensing auto tension adjustment (2) Pneumatic seat height (8) Sliding seat depth (9) Multi position tilt lock</p>	1253-8	1726	1816	1886	1990	2138	2190	2319	2565	2686	2913	3224	3611
			OVERALL DIMENSIONS			SEAT DIMENSIONS			BACK DIMENSIONS					
			W	D	H	W	D	H	W	H				
	28	26	44.5	23.5	19-21.5	17-21	22	22-27.25						
							RTA 00							
 <p>Extended Back Synchro - Tilter w/ Back Angle Adj. COM Yardage: 1.75 Freight Class: 250 Product Weight (lbs.): 40 Cubic Feet Per Carton: 10</p>	 <p>ADJUSTMENTS (1) Tilt tension (2) Pneumatic seat height (9) Chair tilt lock (5C) Synchro-tilt action Anti-kick back</p>	1254-0	1808	1908	1983	2100	2261	2318	2461	2731	2861	3111	3455	3881
			OVERALL DIMENSIONS			SEAT DIMENSIONS			BACK DIMENSIONS					
			W	D	H	W	D	H	W	H				
	28	24.5	53	23.5	17-19.5	17-21	22	31-36.25						
							RTA 00							
 <p>Extended Back Multi - Tilter COM Yardage: 1.75 Freight Class: 250 Product Weight (lbs.): 49 Cubic Feet Per Carton: 10.50</p>	 <p>ADJUSTMENTS (1) Tilt tension (2) Pneumatic seat height (3) Back angle (6) Back height* (7) Forward tilt lock (8) Seat depth (9) Chair tilt lock (5A) Center-tilt action</p>	1254-3	1808	1908	1983	2100	2261	2318	2461	2731	2861	3111	3455	3881
			OVERALL DIMENSIONS			SEAT DIMENSIONS			BACK DIMENSIONS					
			W	D	H	W	D	H	W	H				
	28	24.5	53	23.5	17-19.5	17-21	22	31-36.25						
							RTA 00							
 <p>Extended Back Weight Sensing Synchro - Tilter COM Yardage: 1.75 Freight Class: 250 Product Weight (lbs.): 54 Cubic Feet Per Carton: 10.50</p>	 <p>ADJUSTMENTS Weight sensing auto tension adjustment (2) Pneumatic seat height (8) Sliding seat depth (9) Multi position tilt lock</p>	1254-8	1808	1908	1983	2100	2261	2318	2461	2731	2861	3111	3455	3881
			OVERALL DIMENSIONS			SEAT DIMENSIONS			BACK DIMENSIONS					
			W	D	H	W	D	H	W	H				
	28	24.5	53	23.5	17-19.5	17-21	22	31-36.25						
							RTA 00							
 <p>High Back Synchro - Tilter w/ Back Angle Adj. COM Yardage: 2.25 Freight Class: 250 Product Weight (lbs.): 67 Cubic Feet Per Carton: 11</p>	 <p>ADJUSTMENTS (1) Tilt tension (2) Pneumatic seat height (9) Chair tilt lock (5C) Synchro-tilt action Anti-kick back</p>	1255-0	1726	1816	1886	1990	2138	2190	2319	2565	2686	2913	3224	3611
			OVERALL DIMENSIONS			SEAT DIMENSIONS			BACK DIMENSIONS					
			W	D	H	W	D	H	W	H				
	28	24.5	48	23.5	17-19.5	17-21	22	26.5-31.75						
							RTA 00							

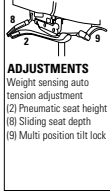
DESCRIPTION	FEATURES	MODEL#	STANDARD TEXTILE GRADES														
			1	2	3	4	5	6	7	8	9	10	11	12			
 <p>High Back Multi - Tilter COM Yardage: 2.25 Freight Class: 250 Product Weight (lbs.): 69 Cubic Feet Per Carton: 11</p>	 <p>ADJUSTMENTS (1) Tilt tension (2) Pneumatic seat height (3) Back angle (6) Back height* (7) Forward tilt lock (8) Seat depth (9) Chair tilt lock (5A) Center-tilt action</p>	1255-3	1726	1816	1886	1990	2138	2190	2319	2565	2686	2913	3224	3611			
			OVERALL DIMENSIONS			SEAT DIMENSIONS			BACK DIMENSIONS								
			W	D	H	W	D	H	W		H						
			28	24.5	48.5	23.5	17-19.5	17-21	22		26.5-31.75						
<p>High/Wide Back. Standard Seat.</p> <p>Ergonomic Features: A, B, C, D, E, F, G, H, M, N, Q, R, S, U</p>	<p>High/Wide Back. Standard Seat.</p> <p>Ergonomic Features: A, B, C, D, E, F, G, H, M, N, Q, R, S, U</p>	<p>RTA 00</p>															
			 <p>High Back Weight Sensing Synchro - Tilter COM Yardage: 2 Freight Class: 250 Product Weight (lbs.): 67 Cubic Feet Per Carton: 10.50</p>	 <p>ADJUSTMENTS Weight sensing auto tension adjustment (2) Pneumatic seat height (8) Sliding seat depth (9) Multi position tilt lock</p>	1255-8	1726	1816	1886	1990	2138	2190	2319	2565	2686	2913	3224	3611
						OVERALL DIMENSIONS			SEAT DIMENSIONS			BACK DIMENSIONS					
						W	D	H	W	D	H	W		H			
28	24.5	48.5				23.5	17-19.5	17-21	22		26.5-31.75						
<p>High/Wide Back. Standard Seat.</p> <p>Ergonomic Features: A, B, C, D, E, H, L, M, N, Q, R, U</p>	<p>High/Wide Back. Standard Seat.</p> <p>Ergonomic Features: A, B, C, D, E, H, L, M, N, Q, R, U</p>	<p>RTA 00</p>															
			 <p>Mid Back Synchro - Tilter w/ Back Angle Adj. COM Yardage: 2 Freight Class: 150 Product Weight (lbs.): 67 Cubic Feet Per Carton: 10.50</p>	 <p>ADJUSTMENTS (1) Tilt tension (2) Pneumatic seat height (9) Chair tilt lock (5C) Synchro-tilt action Anti-kick back</p>	1256-0	1645	1735	1805	1909	2057	2109	2238	2484	2605	2832	3143	3530
						OVERALL DIMENSIONS			SEAT DIMENSIONS			BACK DIMENSIONS					
						W	D	H	W	D	H	W		H			
28	24.5	44.5				23.5	17-19.5	17-21	22		22-27.25						
<p>Mid/Wide Back. Standard Seat.</p> <p>Ergonomic Features: A, B, C, D, E, G, H, L, M, N, Q, R, U</p>	<p>Mid/Wide Back. Standard Seat.</p> <p>Ergonomic Features: A, B, C, D, E, G, H, L, M, N, Q, R, U</p>	<p>RTA 00</p>															
			 <p>Mid Back Multi - Tilter COM Yardage: 2 Freight Class: 150 Product Weight (lbs.): 67 Cubic Feet Per Carton: 10.50</p>	 <p>ADJUSTMENTS (1) Tilt tension (2) Pneumatic seat height (3) Back angle (6) Back height* (7) Forward tilt lock (8) Seat depth (9) Chair tilt lock (5A) Center-tilt action</p>	1256-3	1645	1735	1805	1909	2057	2109	2238	2484	2605	2832	3143	3530
						OVERALL DIMENSIONS			SEAT DIMENSIONS			BACK DIMENSIONS					
						W	D	H	W	D	H	W		H			
28	24.5	44.5				23.5	17-19.5	17-21	22		22-27.25						
<p>Mid/Wide Back. Standard Seat.</p> <p>Ergonomic Features: A, B, C, D, E, F, G, H, M, N, Q</p>	<p>Mid/Wide Back. Standard Seat.</p> <p>Ergonomic Features: A, B, C, D, E, F, G, H, M, N, Q</p>	<p>RTA 00</p>															
			 <p>Mid Back Weight Sensing Synchro - Tilter COM Yardage: 2 Freight Class: 150 Product Weight (lbs.): 67 Cubic Feet Per Carton: 10.50</p>	 <p>ADJUSTMENTS Weight sensing auto tension adjustment (2) Pneumatic seat height (8) Sliding seat depth (9) Multi position tilt lock</p>	1256-8	1645	1735	1805	1909	2057	2109	2238	2484	2605	2832	3143	3530
						OVERALL DIMENSIONS			SEAT DIMENSIONS			BACK DIMENSIONS					
						W	D	H	W	D	H	W		H			
28	24.5	44.5				23.5	17-19.5	17-21	22		22-27.25						
<p>Mid/Wide Back. Standard Seat.</p> <p>Ergonomic Features: A, B, C, D, E, H, L, M, N, Q, R, U</p>	<p>Mid/Wide Back. Standard Seat.</p> <p>Ergonomic Features: A, B, C, D, E, H, L, M, N, Q, R, U</p>	<p>RTA 00</p>															

PREFER



model 8458NA



model 8459



STANDARD FEATURES

- A sleek and comfortable all-purpose chair beautifully suited for conference, collaboration and training environments. Designed by Norbert Geelen.
- Swivel tilt function with no visible levers or mechanism.
- Standard with Asphalt or Alabaster frame and base, armless or with fixed arms.
- Integrated seat height adjustment lever is intuitive and easy to utilize.
- Dual wheel carpet casters are standard. Black (C82) casters standard on Asphalt models. Fog Grey (C82F) casters standard on Alabaster models.
- Check textile availability prior to specifying upholstery material.

OPTIONAL FEATURES

- Dimension Mesh is available in Black (DBK), Charcoal (DCH), Citrus (DCT), Pool Blue (DPB), Sand (DSD), Fog (DST), Chalk (DCL), Shadow (DGM), Cobalt (DCO) and Berry (DBE).
- Polished Aluminum (ALU) base available for Asphalt and Alabaster frames. Add \$171.
- Polished Aluminum (AL) arms available for Asphalt and Alabaster fixed arm models. Add \$171.
- For Alabaster base on the Asphalt frame, please specify (ABR). For Asphalt base on the Alabaster frame, please specify (ABT). Add \$76.
- Optional low black glides (G) are available at no upcharge.
- For hard floor surface casters, please specify (C82R) for Black and (C82FR) for Fog. Add \$94.
- For fully assembled in the box, specify (SU). Add \$76.

DESCRIPTION

FEATURES

MODEL#

STANDARD TEXTILE GRADES



Multi-task chair- Asphalt Base/Frame

COM Yardage: 1
Freight Class: 250
Product Weight (lbs.): 29
Cubic Feet Per Carton: 9

Ergonomic Features:
C, M

	1	2	3	4	5	6	7	8	9	10	11	12
8458	1234	1268	1294	1330	1382	1408	1456	1531	1590	1657	1790	1933

OVERALL DIMENSIONS

W D H

25.5 25 36

SEAT DIMENSIONS

W D H

20 20 17.5-22

BACK DIMENSIONS

W H

21 20



Multi-task chair, armless- Asphalt Base/Frame

COM Yardage: 0.75
Freight Class: 250
Product Weight (lbs.): 29
Cubic Feet Per Carton: 9

Ergonomic Features:
C, M

	1	2	3	4	5	6	7	8	9	10	11	12
8458NA	1080	1114	1137	1173	1225	1248	1295	1369	1427	1491	1620	1760

OVERALL DIMENSIONS

W D H

22 25 36

SEAT DIMENSIONS

W D H

20 20 17.5-22

BACK DIMENSIONS

W H

21 20



Height Adjustable Stool- Asphalt Base/Frame

COM Yardage: 0.75
Freight Class: 250
Product Weight (lbs.): 36
Cubic Feet Per Carton: 9

Ergonomic Features:
C, M

	1	2	3	4	5	6	7	8	9	10	11	12
8458S	1420	1446	1466	1493	1533	1550	1587	1644	1687	1737	1837	1945

OVERALL DIMENSIONS

W D H

25.5 25 42

SEAT DIMENSIONS

W D H

20 20 23-31

BACK DIMENSIONS

W H

21 20



Height Adjustable Stool, armless- Asphalt Base/Frame

COM Yardage: 0.75
Freight Class: 250
Product Weight (lbs.): 36
Cubic Feet Per Carton: 9

Ergonomic Features:
C, M

	1	2	3	4	5	6	7	8	9	10	11	12
8458NAS	1294	1327	1352	1388	1441	1466	1514	1590	1649	1712	1847	1991

OVERALL DIMENSIONS

W D H

25.5 25 42

SEAT DIMENSIONS

W D H





20 20 23-31

BACK DIMENSIONS

W H

21 20



DESCRIPTION	FEATURES	MODEL#	STANDARD TEXTILE GRADES											
			1	2	3	4	5	6	7	8	9	10	11	12
 <p>Multi-task chair- Alabaster Base/Frame COM Yardage: 0.75 Freight Class: 250 Product Weight (lbs.): 29 Cubic Feet Per Carton: 9</p>	Ergonomic Features: C, M	8459	1294	1327	1352	1388	1441	1466	1514	1590	1649	1712	1847	1991
			OVERALL DIMENSIONS			SEAT DIMENSIONS			BACK DIMENSIONS					
			W	D	H	W	D	H	W	H				
			25.5	25	36	20	20	17.5-22	21	20				
			RTA 1		FedEx		UPS							
 <p>Multi-task chair, armless- Alabaster Base/Frame COM Yardage: 0.75 Freight Class: 250 Product Weight (lbs.): 29 Cubic Feet Per Carton: 9</p>	Ergonomic Features: C, M	8459NA	1185	1219	1243	1281	1333	1359	1408	1484	1543	1610	1746	1890
			OVERALL DIMENSIONS			SEAT DIMENSIONS			BACK DIMENSIONS					
			W	D	H	W	D	H	W	H				
			22	25	36	20	20	17.5-22	21	20				
			RTA 1		FedEx		UPS							
 <p>Height Adjustable Stool- Alabaster Base/Frame COM Yardage: 0.75 Freight Class: 250 Product Weight (lbs.): 36 Cubic Feet Per Carton: 9</p>	Ergonomic Features: C, M	8459S	1480	1514	1540	1576	1628	1654	1702	1777	1836	1902	2036	2179
			OVERALL DIMENSIONS			SEAT DIMENSIONS			BACK DIMENSIONS					
			W	D	H	W	D	H	W	H				
			25.5	25	42	20	20	23-31	21	20				
			RTA 1											
 <p>Height Adjustable Stool, armless- Alabaster Base/Frame COM Yardage: 0.75 Freight Class: 250 Product Weight (lbs.): 36 Cubic Feet Per Carton: 9</p>	Ergonomic Features: C, M	8459NAS	1360	1395	1420	1456	1508	1534	1582	1657	1717	1783	1917	2060
			OVERALL DIMENSIONS			SEAT DIMENSIONS			BACK DIMENSIONS					
			W	D	H	W	D	H	W	H				
			25.5	25	42	20	20	23-31	21	20				
			RTA 1											

ROMA®



model 1906



model 1908



Optional Arms

A height adjustable arm is optionally available for task seating. Please specify (RA). Add \$79.

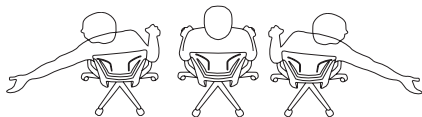





The Polypropylene Medium Back and the Upholstered Medium Back feature a flexible back construction that provides support, proper spinal alignment and comfort when moving or reaching in a seated position.

STANDARD FEATURES





- Flexible, elegant and affordable, Roma offers a family of seating with simple clean lines.
- Roma features an exclusive chair control mechanism which allows the chair back and arms to recline together while the chair seat moves just enough to ensure comfort.
- The series includes nesting chairs, task seating and height adjustable stools, with and without arms.
- For Nesting chairs see page 206.
- Four back versions are available: mesh, upholstered, flexible polypropylene or honeycomb polypropylene.
- Flexible polypropylene back chair features a built in lumbar support designed to move as you move and is available exclusively in black.
- The task chair upholstered back features a removable cover for on-site replacement and cleaning.
- Fixed arms are durable fiberglass reinforced nylon, fixed height. Standard with soft, durable, self-skinned urethane (SSU) armcaps that are warm to the touch.
- Standard with Global's high quality Soft Descent™ pneumatic lift which slowly and gently lowers the seat height of the chair making it easy to obtain the exact seat height you desire.
- Task chairs and stools are standard with a five prong, injection molded, fiberglass reinforced nylon Black spider base with dual wheel carpet casters (C1).
- All models upholstered in leather have two-piece seats with a radius towards the rear of the seat.
- Check textile availability prior to specifying upholstery material.















OPTIONAL FEATURES













- Breathable mesh back is available in six colors: Autumn Orange (AO), Spring Green (SG) Winter Grey (WG), Midnight Black (MB), Summer Blue (SB), Fall Burgundy (FB).
- An optional polished aluminum base is available at an upcharge. Specify (ALU). Add \$167.
- Please refer to "Cylinder Selection" section of the price book for additional cylinder options.
- Optional height adjustable arms are available, on task models. Please specify (RA). Add \$86.
- For hard surface flooring casters, please specify C9R. Add \$72.
- For fully assembled in box, please specify SU. Add \$76.

DESCRIPTION	FEATURES	MODEL#	STANDARD TEXTILE GRADES											
			1	2	3	4	5	6	7	8	9	10	11	12
 <p>Mesh MB - Armless Height Adjustable Stool COM Yardage: 1 Freight Class: 150 Product Weight (lbs): 43 Cubic Feet Per Carton: 9.25</p>		1871	1104	1144	1171	1214	1272	1291	1345	1443	1492	1583	1707	1860
		OVERALL DIMENSIONS W D H			SEAT DIMENSIONS W D H			BACK DIMENSIONS W H						
			19.5	23.5	48	19.5	18	24.5-34.5	18.5	19				
														

Ergonomic Features:
B, C, M, N

DESCRIPTION	FEATURES	MODEL#	STANDARD TEXTILE GRADES													
			1	2	3	4	5	6	7	8	9	10	11	12		
 <p>Polypropylene MB - Armless Height Adjustable Stool COM Yardage: 1 Freight Class: 150 Product Weight (lbs.): 43 Cubic Feet Per Carton: 9.25</p>	Ergonomic Features: B, C, M, N	1872	1104	1144	1171	1214	1272	1291	1345	1443	1492	1583	1707	1860		
			OVERALL DIMENSIONS W D H			SEAT DIMENSIONS W D H			BACK DIMENSIONS W H							
			19.5	23.5	48	19.5	18	24.5-34.5	18.5	19						
			RTA 2													
 <p>Honeycomb MB - Armless Height Adjustable Stool COM Yardage: 1 Freight Class: 150 Product Weight (lbs.): 43 Cubic Feet Per Carton: 9.25</p>	Ergonomic Features: B, C, M, N	1874	1147	1185	1213	1255	1314	1333	1385	1484	1534	1624	1749	1902		
			OVERALL DIMENSIONS W D H			SEAT DIMENSIONS W D H			BACK DIMENSIONS W H							
			19.5	23.5	48	19.5	18	24.5-34.5	18.5	19						
			RTA 2 FedEx ups													
 <p>Mesh MB - Height Adjustable Stool COM Yardage: 1 Freight Class: 150 Product Weight (lbs.): 50 Cubic Feet Per Carton: 9.25</p>	Ergonomic Features: B, C, M, N	1876	1174	1211	1239	1281	1339	1360	1412	1510	1560	1650	1774	1928		
			OVERALL DIMENSIONS W D H			SEAT DIMENSIONS W D H			BACK DIMENSIONS W H							
			25.5	23.5	48	19.5	18	24.5-34.5	18.5	19						
			RTA 2 FedEx ups													
 <p>Polypropylene MB - Height Adjustable Stool COM Yardage: 1 Freight Class: 150 Product Weight (lbs.): 50 Cubic Feet Per Carton: 9.25</p>	Ergonomic Features: B, C, M, N	1877	1174	1214	1241	1284	1342	1361	1415	1513	1562	1653	1777	1930		
			OVERALL DIMENSIONS W D H			SEAT DIMENSIONS W D H			BACK DIMENSIONS W H							
			25.5	23.5	48	19.5	18	24.5-34.5	18.5	19						
			RTA 2 FedEx ups													
 <p>Honeycomb MB - Height Adjustable Stool COM Yardage: 1 Freight Class: 150 Product Weight (lbs.): 50 Cubic Feet Per Carton: 9.25</p>	Ergonomic Features: B, C, M, N	1879	1217	1255	1283	1325	1384	1403	1458	1554	1604	1694	1819	1973		
			OVERALL DIMENSIONS W D H			SEAT DIMENSIONS W D H			BACK DIMENSIONS W H							
			25.5	23.5	48	19.5	18	24.5-34.5	18.5	19						
			RTA 2 FedEx ups													

DESCRIPTION	FEATURES	MODEL#	STANDARD TEXTILE GRADES												
			1	2	3	4	5	6	7	8	9	10	11	12	
 <p>Honeycomb MB - Armless COM Yardage: 1 Freight Class: 150 Product Weight (lbs.): 38 Cubic Feet Per Carton: 9.25</p>	<p>Ergonomic Features: B, C, M, N</p>	<p>RTA 2</p>  	1896	891	929	958	999	1059	1078	1132	1230	1278	1370	1494	1647
			<p>OVERALL DIMENSIONS</p> <p>W D H</p>			<p>SEAT DIMENSIONS</p> <p>W D H</p>			<p>BACK DIMENSIONS</p> <p>W H</p>						
			<p>19.5 23.5 38</p>			<p>19.5 18 15-19</p>			<p>18.5 19</p>						
			<hr/>												
 <p>Honeycomb MB - w/Arms COM Yardage: 1 Freight Class: 150 Product Weight (lbs.): 45 Cubic Feet Per Carton: 9.25</p>	<p>Ergonomic Features: B, C, M, N</p>	<p>RTA 2</p>  	1897	952	990	1019	1060	1120	1138	1193	1291	1339	1431	1554	1708
			<p>OVERALL DIMENSIONS</p> <p>W D H</p>			<p>SEAT DIMENSIONS</p> <p>W D H</p>			<p>BACK DIMENSIONS</p> <p>W H</p>						
			<p>25.5 23.5 38</p>			<p>19.5 18 15-19</p>			<p>18.5 19</p>						
			<hr/>												
 <p>Mesh MB - Armless COM Yardage: 1 Freight Class: 150 Product Weight (lbs.): 38 Cubic Feet Per Carton: 9.25</p>	<p>Ergonomic Features: B, C, M, N</p>	<p>RTA 2</p>  	1901	891	931	961	1005	1066	1089	1144	1246	1296	1394	1524	1684
			<p>OVERALL DIMENSIONS</p> <p>W D H</p>			<p>SEAT DIMENSIONS</p> <p>W D H</p>			<p>BACK DIMENSIONS</p> <p>W H</p>						
			<p>19.5 23.5 36.25</p>			<p>19.5 18 15-19</p>			<p>18.5 19</p>						
			<hr/>												
 <p>Polypropylene MB - Armless COM Yardage: 1 Freight Class: 150 Product Weight (lbs.): 36.25 Cubic Feet Per Carton: 9.25</p>	<p>Ergonomic Features: B, C, M, N</p>	<p>RTA 2</p>  	1902	891	931	961	1005	1066	1089	1144	1246	1296	1394	1524	1684
			<p>OVERALL DIMENSIONS</p> <p>W D H</p>			<p>SEAT DIMENSIONS</p> <p>W D H</p>			<p>BACK DIMENSIONS</p> <p>W H</p>						
			<p>19.5 23.5 36.25</p>			<p>19.5 18 15-19</p>			<p>18.5 19</p>						
			<hr/>												
 <p>Upholstered MB - Armless COM Yardage: 1.75 Freight Class: 150 Product Weight (lbs.): 38 Cubic Feet Per Carton: 9.25</p>	<p>Ergonomic Features: B, C, M, N</p>	<p>RTA 2</p>  	1903	960	1029	1079	1157	1265	1302	1398	1579	1665	1835	2062	2344
			<p>OVERALL DIMENSIONS</p> <p>W D H</p>			<p>SEAT DIMENSIONS</p> <p>W D H</p>			<p>BACK DIMENSIONS</p> <p>W H</p>						
			<p>19.5 23.5 36.25</p>			<p>19.5 18 15-19</p>			<p>18.5 19</p>						
			<hr/>												

DESCRIPTION	FEATURES	MODEL#	STANDARD TEXTILE GRADES														
			1	2	3	4	5	6	7	8	9	10	11	12			
 <p>Mesh MB - w/Arms COM Yardage: 1 Freight Class: 150 Product Weight (lbs.): 45 Cubic Feet Per Carton: 9.25</p>	<p>Ergonomic Features: B, C, M, N</p>	<p>RTA 2  </p>	1906	952	990	1021	1062	1127	1149	1202	1303	1355	1453	1581	1745		
			OVERALL DIMENSIONS			SEAT DIMENSIONS			BACK DIMENSIONS								
			W	D	H	W	D	H	W	H							
			25.5	23.5	36.25	19.5	18	15-19	18.5	19							
 <p>Polypropylene MB - w/Arms COM Yardage: 1 Freight Class: 150 Product Weight (lbs.): 45 Cubic Feet Per Carton: 9.25</p>	<p>Ergonomic Features: B, C, M, N</p>	<p>RTA 2  </p>	1907	952	992	1022	1066	1127	1150	1205	1306	1357	1454	1584	1745		
			OVERALL DIMENSIONS			SEAT DIMENSIONS			BACK DIMENSIONS								
			W	D	H	W	D	H	W	H							
			25.5	23.5	36.25	19.5	18	15-19	18.5	19							
 <p>Upholstered MB - w/Arms COM Yardage: 1.75 Freight Class: 150 Product Weight (lbs.): 45 Cubic Feet Per Carton: 9.25</p>	<p>Ergonomic Features: B, C, M, N</p>	<p>RTA 2  </p>	1908	1023	1088	1137	1208	1313	1350	1439	1612	1696	1855	2072	2344		
			OVERALL DIMENSIONS			SEAT DIMENSIONS			BACK DIMENSIONS								
			W	D	H	W	D	H	W	H							
			25.5	23.5	36.25	19.5	18	16.5-20.5	18.5	19							
 <p>Upholstered Back Pad COM Yardage: 1 Freight Class: 70 Product Weight (lbs.): 1.5 Cubic Feet Per Carton: 1.1</p>																	
				1909	193	233	263	308	371	391	447	548	600	696	826	989	
	OVERALL DIMENSIONS			SEAT DIMENSIONS			BACK DIMENSIONS										
	W	D	H	W	D	H	W	H									
	20.5	19	0.38	21	18	18	20	20.5									
		<p>RTA 00  </p>															

SOLAR



model 8456



model 8457



model 8456NA















model 8457NA





STANDARD FEATURES

- A sophisticated and versatile seating solution for conference and collaborative environments. Designed by Paul Brooks.
- One piece molded frame is extremely light (chair weighs 24 lbs.) and exceeds BIFMA standard for commercial applications.
- Cascading forward seat surface and reverse edge profile provide better leg clearance and comfort.
- Integrated seat height adjustment lever is intuitive and easy to utilize.
- The under seat structure maintains the seamless and fluid aesthetic that defines Solar.
- All bases are standard with Black (C1) dual wheel carpet casters.
- Check textile availability prior to specifying upholstery material.

OPTIONAL FEATURES

- Mesh is available in Midnight (MDN), Storm (STM), and Dove (DVE).
- Polished Aluminum (ALU) base is available. Add \$167.
- Alabaster (ABR) base can be ordered on an Asphalt frame, please specify. Add \$76
- Asphalt (APT) base can be ordered on an Alabaster frame, please specify. Add \$70.
- Optional hard surface Black Glide (C7) is available. No upcharge.
- For hard floor surface casters please specify C9R, please add \$72.

DESCRIPTION	FEATURES	MODEL#	STANDARD TEXTILE GRADES														
			1	2	3	4	5	6	7	8	9	10	11	12			
 <p>MB Mesh Tilter - Asphalt Base/Frame COM Yardage: N/A Freight Class: 250 Product Weight (lbs.): 27 Cubic Feet Per Carton: 9.5</p>	Ergonomic Features: C, M	8456	1088	-	-	-	-	-	-	-	-	-	-	-	-		
		OVERALL DIMENSIONS			SEAT DIMENSIONS			BACK DIMENSIONS									
		W	D	H	W	D	H	W	H								
			23.25	25	36	19.25	18	17-21	19	19							
			  														
 <p>MB Mesh Tilter - Alabaster Base/Frame COM Yardage: N/A Freight Class: 250 Product Weight (lbs.): 27 Cubic Feet Per Carton: 9.5</p>	Ergonomic Features: C, M	8457	1193	-	-	-	-	-	-	-	-	-	-	-	-		
		OVERALL DIMENSIONS			SEAT DIMENSIONS			BACK DIMENSIONS									
		W	D	H	W	D	H	W	H								
			23.25	25	36	19.25	18	17-21	19	19							
			  														
 <p>MB Mesh Stool - Asphalt Base/Frame COM Yardage: N/A Freight Class: 250 Product Weight (lbs.): 31 Cubic Feet Per Carton: 9.5</p>	Ergonomic Features: C, M	8456S	1387	-	-	-	-	-	-	-	-	-	-	-	-		
		OVERALL DIMENSIONS			SEAT DIMENSIONS			BACK DIMENSIONS									
		W	D	H	W	D	H	W	H								
			23.25	25	42	19.25	18	22.5-30.5	19	19							
			  														

DESCRIPTION	FEATURES	MODEL#	STANDARD TEXTILE GRADES											
			1	2	3	4	5	6	7	8	9	10	11	12
 <p>MB Mesh Stool - Alabaster Base/Frame COM Yardage: N/A Freight Class: 250 Product Weight (lbs.): 31 Cubic Feet Per Carton: 9.5</p>	Ergonomic Features: C, M	8457S	1492	-	-	-	-	-	-	-	-	-	-	
		OVERALL DIMENSIONS			SEAT DIMENSIONS			BACK DIMENSIONS						
		W	D	H	W	D	H	W	H					
		23.25	25	42	19.25	18	22.5-30.5	19	19					
			RTA 1	FedEx		UPS								
 <p>MB Mesh Tilter - Asphalt Base/Frame COM Yardage: N/A Freight Class: 250 Product Weight (lbs.): 25 Cubic Feet Per Carton: 9.5</p>	Ergonomic Features: C, M	8456NA	1044	-	-	-	-	-	-	-	-	-	-	
		OVERALL DIMENSIONS			SEAT DIMENSIONS			BACK DIMENSIONS						
		W	D	H	W	D	H	W	H					
		23.25	25	36	19.25	18	17-21	19	19					
			RTA 1	FedEx		UPS								
 <p>MB Mesh Tilter - Alabaster Base/Frame COM Yardage: N/A Freight Class: 250 Product Weight (lbs.): 25 Cubic Feet Per Carton: 9.5</p>	Ergonomic Features: C, M	8457NA	1150	-	-	-	-	-	-	-	-	-	-	
		OVERALL DIMENSIONS			SEAT DIMENSIONS			BACK DIMENSIONS						
		W	D	H	W	D	H	W	H					
		23.25	25	36	19.25	18	17-21	19	19					
			RTA 1	FedEx		UPS								
 <p>MB Mesh Stool - Asphalt Base/Frame COM Yardage: N/A Freight Class: 250 Product Weight (lbs.): 29 Cubic Feet Per Carton: 9.5</p>	Ergonomic Features: C, M	8456SNA	1343	-	-	-	-	-	-	-	-	-	-	
		OVERALL DIMENSIONS			SEAT DIMENSIONS			BACK DIMENSIONS						
		W	D	H	W	D	H	W	H					
		23.25	25	42	19.25	18	22.5-30.5	19	19					
			RTA 1	FedEx		UPS								
 <p>MB Mesh Stool - Alabaster Base/Frame COM Yardage: N/A Freight Class: 250 Product Weight (lbs.): 31 Cubic Feet Per Carton: 9</p>	Ergonomic Features: C, M	8457SNA	1448	-	-	-	-	-	-	-	-	-	-	
		OVERALL DIMENSIONS			SEAT DIMENSIONS			BACK DIMENSIONS						
		W	D	H	W	D	H	W	H					
		23.25	25	42	19.25	18	22.5-30.5	19	19					
			RTA 1	FedEx		UPS								

SOLO®



model 5228



model 5226

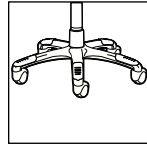



Optional Base
Polished Aluminum base with black scuff tips. Specify "B2". Add \$167.



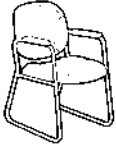

STANDARD FEATURES

- Contoured seat and back, waterfall seat edge and SSU armcaps provide extended comfort.
- All models (except armchairs and side chairs) are standard with a five prong, injection molded base with dual wheel carpet casters (**C65**).
- Seat frame and arm frame are standard in Black.
- Ganging clamp 5233 used for models 5225 and 5226 sled base models. Can be used for Supra models 5332 and 5332L.
- Ganging Clamp 2755 For model 5226. Zinc plated.
- Specifications and pricing is for 1 chair.
- Armchair models are standard with Black glides.
- Check textile availability prior to specifying upholstery material.
- An optional abrasion resistant outer back fabric (polyester) is available. Resistant to impact damage. Available in Black only. Add \$23.
- Vinyl Bumper Guard available with back edge vinyl bumper guard option (**VBG**). Add \$26.
- Non-marking (**NM**) glides are available at no charge to replace Black glides. Please Specify.
- Polished Aluminum base with black scuff tips. Specify "**B2**". Add \$167.
- Please refer to the "Casters Selection" section of the price book for caster options. Optional casters may be priced higher than the standard casters for your chair and the difference will be charged. Lower priced optional casters will not be credited.
- For hard surface flooring casters, specify **C65R**, add \$73.
- For fully assembled in box, specify **SU**. Add \$76

OPTIONAL FEATURES

- Chrome upper finish with Black base available on models 5227 and 5228 Add 10% of opening published grade price.
- Model 5225 and 5226 frame finishes are standard in Black (**TBL**), Shadow (**TSH**), and Tungsten (**TTU**). Chrome (**CHM**) is also available. Add \$40.

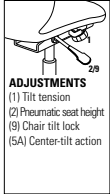
DESCRIPTION	FEATURES	MODEL#	STANDARD TEXTILE GRADES													
			1	2	3	4	5	6	7	8	9	10	11	12		
 <p>Armchair COM Yardage: 1.25 Freight Class: 250 Product Weight (lbs.): 25 Cubic Feet Per Carton: 10.13 (2 per carton)</p> <p>Ergonomic Features: M, N</p>	<p>RTA 00</p> <p>FedEx</p> <p>UPS</p>	5225	427	474	513	567	642	669	739	862	923	1041	1201	1399		
		OVERALL DIMENSIONS			SEAT DIMENSIONS			BACK DIMENSIONS								
		W	D	H	W	D	H	W	H							
		24	25	34	20	18	18	20	18							
 <p>Side Chair COM Yardage: 1.25 Freight Class: 250 Product Weight (lbs.): 21 Cubic Feet Per Carton: 8.75 (2 per carton)</p> <p>Ergonomic Features: M, N</p>	<p>RTA 00</p>	5226	395	445	482	537	611	640	707	831	891	1011	1170	1399		
		OVERALL DIMENSIONS			SEAT DIMENSIONS			BACK DIMENSIONS								
		W	D	H	W	D	H	W	H							
		22	25.5	34	20	18	18	20	18							
 <p>Ganging Clamp COM Yardage: N/A Freight Class: 70 Product Weight (lbs.): 0.3 Cubic Feet Per Carton: 0.1</p> <p>Ergonomic Features: M, N</p>	<p>RTA 00</p> <p>FedEx</p> <p>UPS</p>	2755	35	-	-	-	-	-	-	-	-	-	-	-		
		OVERALL DIMENSIONS			SEAT DIMENSIONS			BACK DIMENSIONS								
		W	D	H	W	D	H	W	H							
		0	00	0	-	-	-	-	-							

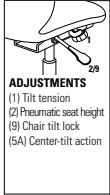
DESCRIPTION	FEATURES	MODEL#	STANDARD TEXTILE GRADES													
			1	2	3	4	5	6	7	8	9	10	11	12		
 <p>Ganging Clamps - Set of 2 COM Yardage: N/A Freight Class: 70 Product Weight: .20 Cubic Feet Per Carton: .04</p>		5233	33	-	-	-	-	-	-	-	-	-	-	-	-	
 <p>HB Tilter COM Yardage: 1.5 Freight Class: 250 Product Weight (lbs.): 34 Cubic Feet Per Carton: 10.13 (2 per carton)</p>	 <p>ADJUSTMENTS (1) Tilt tension (2) Pneumatic seat height (9) Chair tilt lock (5A) Center-tilt action</p>		5227	629	687	731	793	885	918	997	1154	1222	1363	1554	1795	
 <p>LB Tilter COM Yardage: 1.25 Freight Class: 250 Product Weight (lbs.): 32 Cubic Feet Per Carton: 10.13 (2 per carton)</p>	 <p>ADJUSTMENTS (1) Tilt tension (2) Pneumatic seat height (9) Chair tilt lock (5A) Center-tilt action</p>		5228	565	612	649	703	779	807	874	999	1059	1178	1338	1536	

SORA™



model 6941



model 6942

MECHANISM:

Weight sensing
synchro-tilter mechanism (-8)

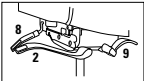

ADJUSTMENTS

Weight sensing auto
tension adjustment
(2) Pneumatic seat height
back/lumbar height
(8) Sliding seat depth
(9) Multi position tilt lock

Ergonomic features:

B, C, D, E, H, L, M, N, Q, R, U, V

STANDARD FEATURES

- Designed in three seat sizes and two back sizes to accommodate many body shapes.
- The upper back shape encourages free lateral movement.
- Features a weight sensing synchro-tilter mechanism (-8) that requires no tilt tension adjustment.
- Side activated sliding seat depth adjustment (**MD**).
- 4.4" adjustable lumbar area for personalized comfort and support is standard.
- Standard with Global's high quality Soft Descent™ 4" travel pneumatic lift which slowly and gently lowers the seat height of the chair making it easy to obtain the exact seat height you desire.
- 4.5" travel height adjustable arms.
- Five prong, injection molded, fiberglass reinforced nylon base with dual wheel casters.
- Sora is fully compliant with the latest BIFMA G1, GSA, and CGSB specifications.
- Frame is only available in Black.
- Check textile availability prior to specifying upholstery material.

OPTIONAL FEATURES

- Height (**E2**), height and width adjustable (**E3**), and fully ergonomic arms (**E4**) are available.
- Fully ergonomic arms (**E4**) are height and width (1.4" travel) adjustable arms with sliding armcaps. Sliding armcaps travel 1" in width and 2" in depth, and articulate 20° inwards and 10° outwards to aim toward the keyboard or mouse area.
- Mesh backs are available in 24 brilliant Vue colors.

Please add option codes in the following order:

- **Model number**
6941 High back
6942 Medium back
- **Fabric**
Specify fabric code
- **Mechanism**
(-8) Weight sensing synchro-tilt
- **Arms**
(E2) Height adjustable arms..... **No upcharge**
(E3) Height and width adjustable arms..... **Add \$96**
(E4) Fully ergonomic arms..... **Add \$214**
- **Base**
(B7) Black nylon base..... **No upcharge**
(A7) Polished aluminum base..... **Add \$167**
- **Casters**
(C82) Dual wheel carpet casters..... **No upcharge**
(C82R) Dual wheel hard floor casters..... **Add \$94**
- **Mesh** (colors shown on website)



(VU10) Sandy Beach	(VU23) Chartreuse
(VU11) Desert Sand	(VU26) Pool Blue
(VU12) Orange Sunset	(VU28) Sky
(VU13) Chocolate Fountain	(VU32) Primary Blue
(VU14) Arctic Blue	(VU34) Tangerine
(VU15) Quarry Grey	(VU37) Paprika
(VU16) Tidal Wave	(VU40) Grain
(VU17) Ivy Moss	(VU43) Yellow
(VU18) Red Rose	(VU55) Silver Grey
(VU19) Coal Black	(VU63) Silver
(VU20) White	(VU65) Hot Pink
(VU21) Lime	(VU70) Red Mittens
- **Seat Size**
(P) Petite seat, 17" wide
(STAN) Standard seat, 18.5" wide
(GS) Generous seat, 19.5" wide
- **Cylinder (No Upcharge)**
(4L) Standard (4")
(5L) High (5")
(4S) Short (4"). Seat height: 14.8" - 18.7"
Seat height range achieved using (C1) casters.

EXAMPLE SORA ORDER CODE

6942	-HD08	-8	-E4	-A7	-C82	-VU32	-STAN	-4L
Model #	Fabric	Mechanism	Arm	Base	Casters	Mesh	Seat	Cylinder

Sora recommended dimensional information: based on measurements with weight sensing synchro-tilter mechanism				
	Distance between arms (pivot not included)	Standard arm height	Seat depth range	Standard seat height
Petite seat (P) Soft Descent 4" lift & (E4) arm	14.7" - 17.5" = 2.8" adjustment	7" - 11.5"	15.5" - 18.5"	16.1" - 20.1"
Standard seat (STAN) Soft Descent 4" lift & (E4) arm	16.2" - 19" = 2.8" adjustment		16.5" - 19.5"	
Generous seat (GS) Soft Descent 4" lift & (E4) arm	17.2" - 20" = 2.8" adjustment		17.5" - 19.75"	

Measurements shown are measured to the requirements of BIFMA G1-2013 / CGSB 44.232-2008.

DESCRIPTION	FEATURES	MODEL#	STANDARD TEXTILE GRADES												
			1	2	3	4	5	6	7	8	9	10	11	12	
 <p>HB Weight Sensing Synchro-Tilter COM Yardage: 1 Freight Class: 250 Product Weight (lbs.): 60 Cubic Feet Per Carton: 20.5</p>		6941	1373	1411	1440	1480	1540	1569	1619	1706	1769	1841	1992	2149	
			OVERALL DIMENSIONS			SEAT DIMENSIONS			BACK DIMENSIONS						
			W	D	H	W	D	H	W	H					
			25	24	42.5	18.5	16.5-19.5	16.1-20.1	18.5	26					
					RTA 1	1 per carton									
 <p>MB Weight Sensing Synchro-Tilter COM Yardage: 1 Freight Class: 250 Product Weight (lbs.): 58 Cubic Feet Per Carton: 20.5</p>		6942	1319	1357	1386	1426	1486	1515	1567	1653	1716	1790	1939	2098	
			OVERALL DIMENSIONS			SEAT DIMENSIONS			BACK DIMENSIONS						
			W	D	H	W	D	H	W	H					
			25	24	40.5	18.5	16.5-19.5	16.1-20.1	18.5	24					
					RTA 1	1 per carton									

SPRITZ™



Spritz is offered in with or without an optional lumbar support

MECHANISMS OPTIONS

<p>Tilter (-4)</p>	<p>Weight Sensing (-8)</p>
<p>ADJUSTMENTS (1) Tilt tension (2) Pneumatic seat height (9) Upright position tilt lock Center tilt action</p>	<p>ADJUSTMENTS Weight sensing auto tension adjustment (2) Pneumatic seat height (8) Sliding seat depth (9) Multi position tilt lock</p>

Ergonomic Features:
A, B, C, D, H, M, N, Q, S, U

Ergonomic Features:
A, B, C, E, H, L, M, N, Q, U

SPRITZ NESTING/MULTI-PURPOSE CHAIRS



For Spritz Nesting/Multi-Purpose chairs, please refer to Multi-Purpose section of price book.

STANDARD FEATURES

- An exceptionally comfortable chair series featuring a sophisticated, translucent mesh and models for all applications.
- Side activated sliding seat depth adjustment (**MD**) is standard on weight sensing synchro tilter control mechanism.
- Standard with height adjustable, forward swept arms and sliding armcaps (**G4**).
- Standard with Global's high quality Soft Descent™ pneumatic lift which slowly and gently lowers the seat height of the chair making it easy to obtain the exact seat height you desire.
- Five prong, injection molded, fiberglass reinforced nylon Black base with **C10** dual wheel carpet casters.
- Check textile availability prior to specifying upholstery material.
- Models can be ordered in Leather using appropriate grade.

OPTIONAL FEATURES

- For additional caster options, please refer to the Arm and Caster section.
- Optional casters may be priced higher than the standard casters for your chair and the difference will be charged. Lower priced optional casters will not be credited.

OPTION CODES

Please add option codes in the following order:

- **Model number**
6761 Task Chair
- Add **(-4)** to model number if ordering Tilter mechanism
Add **(-8)** to model number if ordering Weight Sensing Synchro-Tilter mechanism
- **Fabric**
Specify fabric code for seat.
- **Arms**
(G4) Black nylon arms w/SSU armcaps **Standard**
- **Lumbar Pad Option**
(LSP) Lumbar Pad..... **Add \$40**
- **Base**
(BK) Black nylon base..... **Standard**
- **Casters**
(C10) Dual wheel carpet casters **Standard**
(C10R) Dual wheel hard floor casters..... **Add \$66**
- **Mesh Back**
(U1) Black
(U2) Burgundy
(U3) Blue
(U4) Green
(colors shown on website)
- **Vari-Width**
(WA) Width adjustable arm extensions **Add \$87**
- **Chair Assembly**
(-SU) Assembled in Box..... **Add \$76**





EXAMPLE OF ORDER CODE:

6761-4	WA50	G4	LSP	SD	C10	U2	WA	SU
Model Number	Fabric	Arms	Lumbar Pad	Base	Casters	Mesh Back	Vari-Width	Chair Assembly

DESCRIPTION	FEATURES	MODEL#	STANDARD TEXTILE GRADES													
			1	2	3	4	5	6	7	8	9	10	11	12		
<p>Tilter COM Yardage: 1 Freight Class: 150 Product Weight (lbs.): 48 Cubic Feet Per Carton: 10.5</p>	<p>ADJUSTMENTS (1) Tilt tension (2) Pneumatic seat height (9) Upright position tilt lock Center tilt action</p>	6761-4	974	1011	1040	1081	1141	1170	1222	1307	1371	1445	1595	1754		
		<p>OVERALL DIMENSIONS</p> <p>W D H</p>			<p>SEAT DIMENSIONS</p> <p>W D H</p>			<p>BACK DIMENSIONS</p> <p>W H</p>								
			26	24	38.5	19.5	19	16-20	17.5	20						

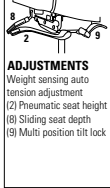
RTA 2



DESCRIPTION	FEATURES	MODEL#	STANDARD TEXTILE GRADES																										
			1	2	3	4	5	6	7	8	9	10	11	12															
 <p>Weight Sensing Sychro-Tilter COM Yardage: 1 Freight Class: 150 Product Weight (lbs.): 54 Cubic Feet Per Carton: 10.5</p>	 <p>ADJUSTMENTS (1) Weight-sensing auto tension adjustment (2) Pneumatic seat height (8) Sliding seat depth (9) Multi position tilt lock</p>	6761-8	1114	1151	1180	1221	1281	1310	1362	1448	1512	1586	1737	1895															
		<table border="1"> <thead> <tr> <th colspan="3">OVERALL DIMENSIONS</th> <th colspan="3">SEAT DIMENSIONS</th> <th colspan="2">BACK DIMENSIONS</th> </tr> <tr> <th>W</th> <th>D</th> <th>H</th> <th>W</th> <th>D</th> <th>H</th> <th>W</th> <th>H</th> </tr> </thead> <tbody> <tr> <td>26</td> <td>24</td> <td>38.5</td> <td>19.5</td> <td>19-21.5</td> <td>16-20</td> <td>17.5</td> <td>20</td> </tr> </tbody> </table>			OVERALL DIMENSIONS			SEAT DIMENSIONS			BACK DIMENSIONS		W	D	H	W	D	H	W	H	26	24	38.5	19.5	19-21.5	16-20	17.5	20	  
OVERALL DIMENSIONS			SEAT DIMENSIONS			BACK DIMENSIONS																							
W	D	H	W	D	H	W	H																						
26	24	38.5	19.5	19-21.5	16-20	17.5	20																						

STREAM



model 2073APP



model 2074AUU

MECHANISMS OPTIONS

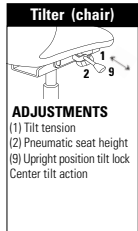

Ergonomic Features:
A, B, C, M, N, S.

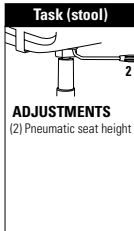

Ergonomic Features:
C, M, N

STANDARD FEATURES

- Our popular Stream series now features 5-star base task chairs and heights adjustable stools.
- Task chairs are available with tilter mechanism only.
- Height adjustable stools are available with simple swivel mechanism only.
- Task chairs and height adjustable stools have a five-prong base with dual wheel casters.
- Units available with or without arms. Arms match seat/back finish.
- Perforated Polypropylene seats and backs are available in 14 colors.
- Check textile availability prior to specifying upholstery material.

OPTIONAL FEATURES

- Base is Black nylon, no upcharge, or Polished Aluminum, add **\$167**.
- Choose (82) carpet casters, no upcharge, or (8R) hard floor casters, add **\$77**.

Please add option codes in the following order:

- **Model number**
2073 Task chair
2074 Height adjustable stool
- **Textile**
 Specify textile code for back (UU models only).
 Specify textile code for seat (PU, UU models only).
- **Seat/back finish** (no upcharge)
(BZB) Buzz Blue **(FRO)** Frost
(CCT) Cactus **(INK)** Ink
(CRO) Carrot **(LAB)** Latte
(IVC) Cloud **(BLK)** Night
(DJN) Dijon **(SND)** Sand
(EGP) Eggplant **(SAR)** Scarlet
(FOG) Fog **(SHW)** Shadow
- **Frame finish**
(BK) Black. No upcharge.
(TN) Tungsten. No upcharge.
(CM) Chrome. Add \$48.
- **Base**
(B7) Black nylon base. No upcharge.
(A7) Polished Aluminum base. Add \$167.
- **Casters**
(82) 82 dual wheel carpet casters. No upcharge.
(8R) 8R dual wheel hard floor casters. Add **\$89**



Stream Multi-Purpose Chairs











For Stream multi-purpose chairs, please see page 234.

EXAMPLE STREAM TASK ORDER CODE:

2073APP	-	-	-IVC	-CM	-A7	-82
Model #	Back Textile	Seat Textile	Seat/back finish	Frame finish	Base	Caster

DESCRIPTION	FEATURES	MODEL#	STANDARD TEXTILE GRADES												
			1	2	3	4	5	6	7	8	9	10	11	12	
 Tilter Chair w/Arms COM Yardage: N/A Freight Class: 250 Product Weight (lbs.):34 Cubic Feet Per Carton: 15.5		2073APP	872	Polypropylene seat & back											
				OVERALL DIMENSIONS			SEAT DIMENSIONS			BACK DIMENSIONS					
				W	D	H	W	D	H	W	H				
				24	23.5	33.5	18	18	15.5	16	16.5				
		RTA 00		1 per carton											
 2073APU		2073APU	1056	1083	1103	1134	1176	1196	1235	1297	1345	1397	1507	1621	
				Upholstered seat											
				OVERALL DIMENSIONS			SEAT DIMENSIONS			BACK DIMENSIONS					
				W	D	H	W	D	H	W	H				
			24	23.5	33.5	18	18	17.5	16	16					
		RTA 00		1 per carton											
 2073AUU		2073AUU	1171	1198	1218	1247	1290	1311	1349	1410	1457	1510	1619	1734	
				Upholstered seat & back											
				OVERALL DIMENSIONS			SEAT DIMENSIONS			BACK DIMENSIONS					
				W	D	H	W	D	H	W	H				
			24	23.5	33.5	18	18	17.5	16	16					
		RTA 00		1 per carton											

DESCRIPTION	FEATURES	MODEL#	STANDARD TEXTILE GRADES												
			1	2	3	4	5	6	7	8	9	10	11	12	
 <p>Armless Tilter Chair COM Yardage: N/A Freight Class: 300 Product Weight (lbs.): 30 Cubic Feet Per Carton:</p>		2073NPP	779 Polypropylene seat & back												
			OVERALL DIMENSIONS			SEAT DIMENSIONS			BACK DIMENSIONS						
			W	D	H	W	D	H	W	H					
			20.5	23.5	33.5	18	18	15.5	16	16.5					
			RTA 00	1 per carton											
  <p>Armless Tilter Chair COM Yardage: 0.75 Freight Class: 250 Product Weight: 33 Cubic Feet Per Carton: 15.5</p>		2073NPU	963 990 1010 1039 1082 1102 1141 1201 1249 1300 1410 1525 Upholstered seat												
			2073NUU	1077 1104 1124 1153 1195 1216 1254 1314 1362 1413 1521 1635 Upholstered seat & back											
				OVERALL DIMENSIONS			SEAT DIMENSIONS			BACK DIMENSIONS					
				W	D	H	W	D	H	W	H				
				20.5	23.5	33.5	18	18	16	16	16				
		RTA 00	1 per carton												
 <p>Height Adjustable Stool w/Arms COM Yardage: N/A Freight Class: 300 Product Weight (lbs.): 37 Cubic Feet Per Carton: 19.5</p>		2074APP	984 Polypropylene seat & back												
				OVERALL DIMENSIONS			SEAT DIMENSIONS			BACK DIMENSIONS					
				W	D	H	W	D	H	W	H				
				24	23.5	43	18	18	22	16	16.5				
			RTA 00	1 per carton											
  <p>Height Adjustable Stool w/Arms COM Yardage: 0.75 Freight Class: 250 Product Weight: 40 Cubic Feet Per Carton: 19.5</p>		2074APU	1166 1196 1216 1249 1293 1313 1353 1419 1469 1523 1637 1759 Upholstered seat												
			2074AUU	1281 1308 1330 1361 1406 1426 1466 1529 1578 1635 1747 1867 Upholstered seat & back											
				OVERALL DIMENSIONS			SEAT DIMENSIONS			BACK DIMENSIONS					
				W	D	H	W	D	H	W	H				
				24	23.5	43	18	18	22.5	16	16				
		RTA 00	1 per carton												
 <p>Armless Height Adjustable Stool COM Yardage: N/A Freight Class: 300 Product Weight (lbs.): 33 Cubic Feet Per Carton: 19.5</p>		2074NPP	870 Polypropylene seat & back												
				OVERALL DIMENSIONS			SEAT DIMENSIONS			BACK DIMENSIONS					
				W	D	H	W	D	H	W	H				
				20.5	23.5	43	18	18	22	16	16.5				
			RTA 00	1 per carton											

DESCRIPTION	FEATURES	MODEL#	STANDARD TEXTILE GRADES											
			1	2	3	4	5	6	7	8	9	10	11	12
 2074NPU	 2074NUU	2074NPU Upholstered seat	1052	1079	1100	1131	1176	1195	1235	1298	1346	1400	1513	1629
		2074NUU Upholstered seat & back	1168	1197	1217	1247	1292	1312	1351	1413	1462	1515	1624	1743
			OVERALL DIMENSIONS			SEAT DIMENSIONS			BACK DIMENSIONS					
			W	D	H	W	D	H	W	D	H			
Armless Height Adjustable Stool COM Yardage: 0.75 Freight Class: 300 Product Weight: 38 Cubic Feet Per Carton: 19.5			20.5	23.5	43	18	18	22.5	16	16				
			RTA 00			1 per carton								

SUPRA™



model 5330-4 (UB)



model 5332 (TUN)



Impact Resistant Back
All models are standard with an impact resistant back cover, in Black Only.



Optional Base
Arched aluminum base available as an option on models that are standard with a black arched base. Specify "TB5". Add \$167.







model 5332

STANDARD FEATURES

- Contoured cushions support the user in a comfortable, contemporary style.
- Stylish arm/frame design sweeps from under the seat through the back and culminates in a hoop at the rear of the seat.
- Tilters are standard with a Tungsten (TUB) finish and Black nylon base. Armchairs are standard with a Tungsten finish (TTU).
- Molded self-skinned urethane waterfall armrests are available in Black (BK) Only.
- The impact resistant outer back shell adds a decorative look and protects from damage. Available in Black (BK) Only.
- Five prong base models: dual wheel carpet casters
- (C65) are standard.
- Model 5331-4SC features a self centering cylinder which swivels and automatically returns to the starting seat location. This model is standard with a flat 5 star base in Black (BK) with C7 glides.
- Check textile availability prior to specifying upholstery material.

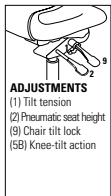
OPTIONAL FEATURES

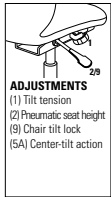
- Models 5332 and 5332L can be joined together using ganging clamp model 5233.
- Optional steel cushioned glides (B) are available on models 5332 and 5332L. Specify. Add \$34.
- Optional frame finishes include: Please Specify a Tungsten finish with Tungsten base (TUT)* on Tilter models. Add \$*90. (* Equipped with a 3" cylinder instead of the standard 4" cylinder to maintain seat height range.)
- Arm frames are available in Black finish with Black nylon base, please specify (TBB). No upcharge.
- Armchair optional frame finishes include: (TBL) Black and (TTU) Tungsten. For a Chrome (CHM) finish on armchairs, add \$127.
- Please refer to the "Casters Selection" section of the price book for caster options. Optional casters may be priced higher than the standard casters for your chair and the difference will be charged. Lower priced optional casters will not be credited.
- For hard surface flooring casters, please specify C65R casters. Add \$73.
- For fully assembled in box, please specify SU. Add \$76.

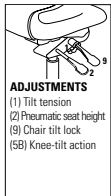
DESCRIPTION	FEATURES	MODEL#	STANDARD TEXTILE GRADES																														
			1	2	3	4	5	6	7	8	9	10	11	12																			
 <p>HB Knee - Tilter COM Yardage: 1.5 Freight Class: 250 Product Weight (lbs.): 41 Cubic Feet Per Carton: 13.25</p>	 <p>ADJUSTMENTS (1) Tilt tension (2) Pneumatic seat height (9) Chair tilt lock (5B) Knee-tilt action</p>	<p>Ergonomic Features: A, B, C, J, M, N</p>	<table border="1"> <tr> <td>5330-2</td><td>956</td><td>1016</td><td>1058</td><td>1123</td><td>1212</td><td>1245</td><td>1325</td><td>1478</td><td>1550</td><td>1690</td><td>1881</td><td>2122</td> </tr> </table>												5330-2	956	1016	1058	1123	1212	1245	1325	1478	1550	1690	1881	2122						
			5330-2	956	1016	1058	1123	1212	1245	1325	1478	1550	1690	1881	2122																		
			<table border="1"> <tr> <th colspan="3">OVERALL DIMENSIONS</th> <th colspan="3">SEAT DIMENSIONS</th> <th colspan="3">BACK DIMENSIONS</th> </tr> <tr> <th>W</th><th>D</th><th>H</th> <th>W</th><th>D</th><th>H</th> <th>W</th><th>H</th> </tr> <tr> <td>26</td><td>27</td><td>42.5</td> <td>21</td><td>18.5</td><td>17.5-21.5</td> <td>20</td><td>24</td> </tr> </table>			OVERALL DIMENSIONS			SEAT DIMENSIONS			BACK DIMENSIONS			W	D	H	W	D	H	W	H	26	27	42.5	21	18.5	17.5-21.5	20	24	<p>RTA 2 FedEx UPS</p>		
			OVERALL DIMENSIONS			SEAT DIMENSIONS			BACK DIMENSIONS																								
W	D	H	W	D	H	W	H																										
26	27	42.5	21	18.5	17.5-21.5	20	24																										
 <p>HB Tilter COM Yardage: 1.5 Freight Class: 250 Product Weight (lbs.): 40 Cubic Feet Per Carton: 12</p>	 <p>ADJUSTMENTS (1) Tilt tension (2) Pneumatic seat height (9) Chair tilt lock (5A) Center-tilt action</p>	<p>Ergonomic Features: A, B, C, M, N, S</p>	<table border="1"> <tr> <td>5330-4</td><td>725</td><td>783</td><td>825</td><td>890</td><td>980</td><td>1014</td><td>1093</td><td>1247</td><td>1319</td><td>1460</td><td>1650</td><td>1891</td> </tr> </table>												5330-4	725	783	825	890	980	1014	1093	1247	1319	1460	1650	1891						
			5330-4	725	783	825	890	980	1014	1093	1247	1319	1460	1650	1891																		
			<table border="1"> <tr> <th colspan="3">OVERALL DIMENSIONS</th> <th colspan="3">SEAT DIMENSIONS</th> <th colspan="3">BACK DIMENSIONS</th> </tr> <tr> <th>W</th><th>D</th><th>H</th> <th>W</th><th>D</th><th>H</th> <th>W</th><th>H</th> </tr> <tr> <td>26</td><td>27</td><td>42</td> <td>21</td><td>18.5</td><td>16.5-20.5</td> <td>20</td><td>24</td> </tr> </table>			OVERALL DIMENSIONS			SEAT DIMENSIONS			BACK DIMENSIONS			W	D	H	W	D	H	W	H	26	27	42	21	18.5	16.5-20.5	20	24	<p>RTA 2 FedEx UPS</p>		
			OVERALL DIMENSIONS			SEAT DIMENSIONS			BACK DIMENSIONS																								
W	D	H	W	D	H	W	H																										
26	27	42	21	18.5	16.5-20.5	20	24																										
 <p>MB Knee - Tilter COM Yardage: 1.25 Freight Class: 250 Product Weight (lbs.): 39 Cubic Feet Per Carton: 13.25</p>	 <p>ADJUSTMENTS (1) Tilt tension (2) Pneumatic seat height (9) Chair tilt lock (5B) Knee-tilt action</p>	<p>Ergonomic Features: A, B, C, J, M, N</p>	<table border="1"> <tr> <td>5331-2</td><td>906</td><td>954</td><td>993</td><td>1044</td><td>1121</td><td>1148</td><td>1218</td><td>1340</td><td>1401</td><td>1520</td><td>1680</td><td>1878</td> </tr> </table>												5331-2	906	954	993	1044	1121	1148	1218	1340	1401	1520	1680	1878						
			5331-2	906	954	993	1044	1121	1148	1218	1340	1401	1520	1680	1878																		
			<table border="1"> <tr> <th colspan="3">OVERALL DIMENSIONS</th> <th colspan="3">SEAT DIMENSIONS</th> <th colspan="3">BACK DIMENSIONS</th> </tr> <tr> <th>W</th><th>D</th><th>H</th> <th>W</th><th>D</th><th>H</th> <th>W</th><th>H</th> </tr> <tr> <td>26</td><td>26</td><td>39.5</td> <td>21</td><td>18.5</td><td>17.5-21.5</td> <td>20</td><td>19.5</td> </tr> </table>			OVERALL DIMENSIONS			SEAT DIMENSIONS			BACK DIMENSIONS			W	D	H	W	D	H	W	H	26	26	39.5	21	18.5	17.5-21.5	20	19.5	<p>RTA 2 FedEx UPS</p>		
			OVERALL DIMENSIONS			SEAT DIMENSIONS			BACK DIMENSIONS																								
W	D	H	W	D	H	W	H																										
26	26	39.5	21	18.5	17.5-21.5	20	19.5																										

DESCRIPTION FEATURES MODEL# STANDARD TEXTILE GRADES



5331-4



5331L-4

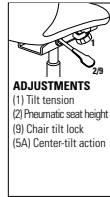

MB Tilter

COM Yardage: 1.25
 Freight Class: 250
 Product Weight (lbs.): 37
 Cubic Feet Per Carton: 12

Ergonomic Features:
 A, B, C, M, N, S

RTA 2



MODEL#	1	2	3	4	5	6	7	8	9	10	11	12
5331-4	678	725	766	815	892	921	987	1114	1173	1292	1452	1650

OVERALL DIMENSIONS			SEAT DIMENSIONS			BACK DIMENSIONS	
W	D	H	W	D	H	W	H
26	26	39	21	18.5	16.5-20.5	20	19.5



5331-4SC



5331L-4SC

MB Conference Chair

COM Yardage: 1.25
 Freight Class: 250
 Product Weight (lbs.): 37
 Cubic Feet Per Carton: 11.5

Ergonomic Features:
 A, B, C, M, N, S

RTA 2



MODEL#	1	2	3	4	5	6	7	8	9	10	11	12
5331-4SC	753	805	841	895	975	999	1068	1197	1260	1382	1542	1747

OVERALL DIMENSIONS			SEAT DIMENSIONS			BACK DIMENSIONS	
W	D	H	W	D	H	W	H
26	26	37	21	18.5	18	20	19.5



5332



5332L

Armchair

COM Yardage: 1.25
 Freight Class: 300
 Product Weight (lbs.): 28
 Cubic Feet Per Carton: 17

Ergonomic Features:
 M, N

RTA 00

MODEL#	1	2	3	4	5	6	7	8	9	10	11	12
5332	565	612	649	703	779	807	874	999	1059	1178	1338	1536

OVERALL DIMENSIONS			SEAT DIMENSIONS			BACK DIMENSIONS	
W	D	H	W	D	H	W	H
25	25.5	36	21	18.5	17.5	20	19.5



5332C



5332LC

Armchair Casters

COM Yardage: 1.25
 Freight Class: 300
 Product Weight (lbs.): 28
 Cubic Feet Per Carton: 17

Ergonomic Features:
 M, N

RTA 00

MODEL#	1	2	3	4	5	6	7	8	9	10	11	12
5332C	744	792	831	886	962	990	1059	1188	1250	1369	1531	1738

OVERALL DIMENSIONS			SEAT DIMENSIONS			BACK DIMENSIONS	
W	D	H	W	D	H	W	H
25	25.5	38	21	18.5	17.5	20	19.5



5335



5335L

Armchair Sled base

COM Yardage: 1.25
 Freight Class: 300
 Product Weight (lbs.): 33
 Cubic Feet Per Carton: 17.5

Ergonomic Features:
 M, N

RTA 00

MODEL#	1	2	3	4	5	6	7	8	9	10	11	12
5335	678	725	766	815	892	921	987	1114	1173	1292	1452	1650

OVERALL DIMENSIONS			SEAT DIMENSIONS			BACK DIMENSIONS	
W	D	H	W	D	H	W	H
25	28	38	21	18.5	18.5	20	19.5

SUPRA X™



Impact Resistant Back
All models are standard with an impact resistant back cover, in Black Only.

model 5336-5



Additional stitch detail for leather upholstery

model 5337-6

STANDARD FEATURES

- Ergonomic office seating with height adjustable lumbar support.
- Control knobs on the outside of the back allow the adjustment of the lumbar support.
- An impact resistant outer back shell adds a distinctive look to this series and protects against damage.
- Height and depth adjustable lumbar support.
- Standard with adjustable height forward swept arms with kidney shaped urethane armcaps (SC).
- Base and frame are standard in Black (BK).
- All models are standard with a five-legged, injection molded "spider" base.
- C65 casters are standard.
- Check textile availability prior to specifying upholstery material.

OPTIONAL FEATURES

- Please refer to "Arms Selection" section of the price book for arm options.
- Please refer to "Cylinder Selection" section of the price book for additional cylinder options.
- Please refer to the "Casters Selection" section of the price book for caster options. Optional casters may be priced higher than the standard casters for your chair and the difference will be charged. Lower priced optional casters will not be credited.
- For hard surface flooring casters, please specify C65R casters. Add \$73
- Vari-Width Adapter Plate (WA) is standard when chair is ordered with adjustable height arms. Allows each arm to move outward an additional 2" (for a total of 4" extra seat width) and locks with the use of an easy to maneuver lever (WA).
- For fully assembled in box, please SU. Add \$76.

DESCRIPTION FEATURES MODEL# STANDARD TEXTILE GRADES



HB Multi - Tilter
COM Yardage: 1.5
Freight Class: 150
Product Weight (lbs.): 58
Cubic Feet Per Carton: 10.5

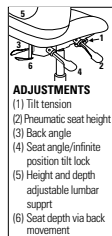

Ergonomic Features:
A, B, C, E, G, H, M, N, S

MODEL#	1	2	3	4	5	6	7	8	9	10	11	12
5333-3	1087	1147	1191	1255	1349	1381	1463	1619	1691	1838	2032	2275

OVERALL DIMENSIONS			SEAT DIMENSIONS			BACK DIMENSIONS	
W	D	H	W	D	H	W	H
26	26.5	41	20	19-20	16-20	18	23.5

RTA 2 FedEx UPS



HB Tilter
COM Yardage: 1.5
Freight Class: 150
Product Weight (lbs.): 55
Cubic Feet Per Carton: 10.5

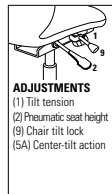

Ergonomic Features:
A, B, C, E, H, M, N, S

MODEL#	1	2	3	4	5	6	7	8	9	10	11	12
5333-4	1014	1074	1119	1183	1276	1307	1391	1546	1619	1763	1959	2204

OVERALL DIMENSIONS			SEAT DIMENSIONS			BACK DIMENSIONS	
W	D	H	W	D	H	W	H
26	25.5	41.5	21	18-19	16-20	18	23

RTA 2 FedEx UPS



MB Synchro - Tilter
COM Yardage: 1.25
Freight Class: 150
Product Weight (lbs.): 57
Cubic Feet Per Carton: 10.5

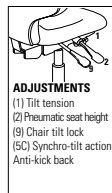









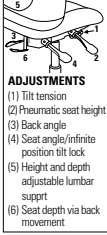







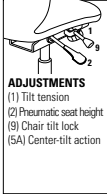







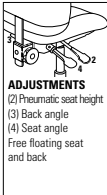







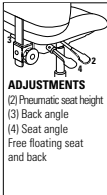







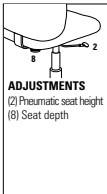

Ergonomic Features:
A, B, C, H, L, M, N, Q

MODEL#	1	2	3	4	5	6	7	8	9	10	11	12
5336-1	1269	1323	1358	1414	1491	1517	1586	1714	1776	1899	2056	2263

OVERALL DIMENSIONS			SEAT DIMENSIONS			BACK DIMENSIONS	
W	D	H	W	D	H	W	H
26	26.5	37.5	20	19-20	16-20	18	16.5

RTA 2 FedEx UPS

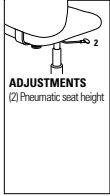
DESCRIPTION	FEATURES	MODEL#	STANDARD TEXTILE GRADES																								
			1	2	3	4	5	6	7	8	9	10	11	12													
 <p>MB Multi - Tilter COM Yardage: 1.25 Freight Class: 150 Product Weight (lbs.): 55 Cubic Feet Per Carton: 10.5</p>	 <p>ADJUSTMENTS (1) Tilt tension (2) Pneumatic seat height (3) Back angle (4) Seat angle/infinite position tilt lock (5) Height and depth adjustable lumbar support (6) Seat depth via back movement</p>	<p>Ergonomic Features: A, B, C, E, G, H, M, N, Q, S</p>	<table border="1"> <tr> <td>5336-3</td> <td>924</td> <td>969</td> <td>999</td> <td>1049</td> <td>1118</td> <td>1149</td> <td>1211</td> <td>1310</td> <td>1387</td> <td>1471</td> <td>1646</td> <td>1833</td> </tr> </table>												5336-3	924	969	999	1049	1118	1149	1211	1310	1387	1471	1646	1833
			5336-3	924	969	999	1049	1118	1149	1211	1310	1387	1471	1646	1833												
			OVERALL DIMENSIONS			SEAT DIMENSIONS			BACK DIMENSIONS																		
			W	D	H	W	D	H	W	H																	
26	26.5	37.5	20	17-18.5	17-21	18	20																				
			<table border="0"> <tr> <td>RTA 2</td> <td></td> <td></td> </tr> </table>												RTA 2												
RTA 2																											
 <p>MB Tilter COM Yardage: 1.25 Freight Class: 150 Product Weight (lbs.): 53 Cubic Feet Per Carton: 10.5</p>	 <p>ADJUSTMENTS (1) Tilt tension (2) Pneumatic seat height (9) Chair tilt lock (5A) Center-tilt action</p>	<p>Ergonomic Features: A, B, C, E, H, M, N, Q, S</p>	<table border="1"> <tr> <td>5336-4</td> <td>924</td> <td>971</td> <td>1007</td> <td>1061</td> <td>1136</td> <td>1171</td> <td>1240</td> <td>1349</td> <td>1432</td> <td>1527</td> <td>1719</td> <td>1926</td> </tr> </table>												5336-4	924	971	1007	1061	1136	1171	1240	1349	1432	1527	1719	1926
			5336-4	924	971	1007	1061	1136	1171	1240	1349	1432	1527	1719	1926												
			OVERALL DIMENSIONS			SEAT DIMENSIONS			BACK DIMENSIONS																		
			W	D	H	W	D	H	W	H																	
26	25.5	37.5	21	18-19	16-20	19	19																				
			<table border="0"> <tr> <td>RTA 2</td> <td></td> <td></td> </tr> </table>												RTA 2												
RTA 2																											
 <p>MB Operator COM Yardage: 1.25 Freight Class: 150 Product Weight (lbs.): 49 Cubic Feet Per Carton: 9.25</p>	 <p>ADJUSTMENTS (2) Pneumatic seat height (3) Back angle (4) Seat angle Free floating seat and back</p>	<p>Ergonomic Features: C, E, F, G, H, M, N, Q, S</p>	<table border="1"> <tr> <td>5336-5</td> <td>893</td> <td>938</td> <td>971</td> <td>1022</td> <td>1094</td> <td>1129</td> <td>1194</td> <td>1297</td> <td>1378</td> <td>1466</td> <td>1649</td> <td>1846</td> </tr> </table>												5336-5	893	938	971	1022	1094	1129	1194	1297	1378	1466	1649	1846
			5336-5	893	938	971	1022	1094	1129	1194	1297	1378	1466	1649	1846												
			OVERALL DIMENSIONS			SEAT DIMENSIONS			BACK DIMENSIONS																		
			W	D	H	W	D	H	W	H																	
26	27.5	37.5	20	17-18.5	16.5-21.5	18	20																				
			<table border="0"> <tr> <td>RTA 2</td> <td></td> <td></td> </tr> </table>												RTA 2												
RTA 2																											
 <p>MB Operator Armless COM Yardage: 1.25 Freight Class: 150 Product Weight (lbs.): 43 Cubic Feet Per Carton: 9.25</p>	 <p>ADJUSTMENTS (2) Pneumatic seat height (3) Back angle (4) Seat angle Free floating seat and back</p>	<p>Ergonomic Features: C, E, F, G, M, N, Q, S</p>	<table border="1"> <tr> <td>5337-5</td> <td>740</td> <td>785</td> <td>819</td> <td>869</td> <td>942</td> <td>977</td> <td>1043</td> <td>1148</td> <td>1228</td> <td>1318</td> <td>1503</td> <td>1701</td> </tr> </table>												5337-5	740	785	819	869	942	977	1043	1148	1228	1318	1503	1701
			5337-5	740	785	819	869	942	977	1043	1148	1228	1318	1503	1701												
			OVERALL DIMENSIONS			SEAT DIMENSIONS			BACK DIMENSIONS																		
			W	D	H	W	D	H	W	H																	
20	27.5	37.5	20	17-18.5	16.5-21.5	18	20																				
			<table border="0"> <tr> <td>RTA 2</td> <td></td> <td></td> </tr> </table>												RTA 2												
RTA 2																											
 <p>MB Task Armless COM Yardage: 1.25 Freight Class: 150 Product Weight (lbs.): 30 Cubic Feet Per Carton: 6.75</p>	 <p>ADJUSTMENTS (2) Pneumatic seat height (8) Seat depth</p>	<p>Ergonomic Features: C, E, M, N, Q</p>	<table border="1"> <tr> <td>5337-6</td> <td>600</td> <td>647</td> <td>684</td> <td>738</td> <td>814</td> <td>850</td> <td>918</td> <td>1030</td> <td>1115</td> <td>1210</td> <td>1405</td> <td>1614</td> </tr> </table>												5337-6	600	647	684	738	814	850	918	1030	1115	1210	1405	1614
			5337-6	600	647	684	738	814	850	918	1030	1115	1210	1405	1614												
			OVERALL DIMENSIONS			SEAT DIMENSIONS			BACK DIMENSIONS																		
			W	D	H	W	D	H	W	H																	
20	25	38.5	20	17-18.5	16.5-21.5	18	20																				
			<table border="0"> <tr> <td>RTA 2</td> <td></td> <td></td> </tr> </table>												RTA 2												
RTA 2																											

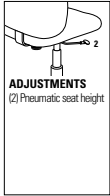
DESCRIPTION	FEATURES	MODEL#	STANDARD TEXTILE GRADES													
			1	2	3	4	5	6	7	8	9	10	11	12		
 <p>Height Adjustable Chair Task COM Yardage: 1.25 Freight Class: 125 Product Weight (lbs.): 42 Cubic Feet Per Carton: 6.75</p>	 <p>ADJUSTMENTS (2) Pneumatic seat height</p>	5338-6	1234	1283	1320	1374	1452	1488	1557	1670	1756	1851	2049	2258		
			OVERALL DIMENSIONS			SEAT DIMENSIONS			BACK DIMENSIONS							
			W	D	H	W	D	H	W	H						
			26	25	46.5	20	18.5-19.5	23.5-33.5	18	19						
			RTA 2	FedEx	ups											
 <p>Height Adjustable Chair Task Armless COM Yardage: 1.25 Freight Class: 150 Product Weight (lbs.): 36 Cubic Feet Per Carton: 6.75</p>	 <p>ADJUSTMENTS (2) Pneumatic seat height</p>	5339-6	1077	1126	1163	1219	1297	1333	1405	1518	1605	1702	1902	2113		
			OVERALL DIMENSIONS			SEAT DIMENSIONS			BACK DIMENSIONS							
			W	D	H	W	D	H	W	H						
			20	25	46.5	20	18.5-19.5	23.5-33.5	18	19						
			RTA 2	FedEx	ups											

SYNOPSIS®



model 5080-3



model 5091-4



model 5090-4PB







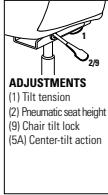

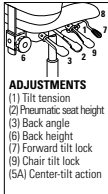
STANDARD FEATURES

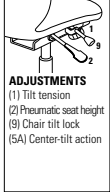

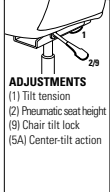

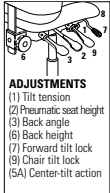
- A compound curved back adds a distinct look while maximizing comfort.
- Fixed height, impact and scuff resistant curved arms are standard on models 5090-4, 5091-4 and 5092
- Tilter, Synchro-Tilter, and Multi-Tilter models (starting with 5080) are standard with adjustable height T arms with teardrop shaped urethane armcaps (3B).
- Ratchet style back height and pneumatic seat height adjustments is standard on Synchro-Tilter and Multi-Tilter models.
- Vari-Width (WA), Width adjustable arm extensions are standard with adjustable height T arms.
- Synchro-Tilter and Multi-Tilters feature a black impact resistant outer back shell. Height adjustable stools have a plastic back panel. All other models feature a fully upholstered outer back.
- Sliding seat depth is available on Synchro-Tilters and Multi-Tilters. Seat depth can be adjusted with a lever on the side of the chair.
- All models (except armchair) are standard with a five-legged, injection molded base.
- Base and arms are available in Black (BK) Only.
- C65 casters are standard.
- Pedestal base models are offered on 5090 and 5091 (-4) Tilter mechanisms only. These models provide fixed location seating for use in auditoriums, classrooms, jury boxes, public venues and more. The base must be mounted to the floor (mounting hardware not included). See Pedestal Base Installation Guide for details.
- Check textile availability prior to specifying upholstery material.

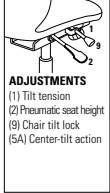
OPTIONAL FEATURES

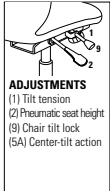
- Polished Aluminum base with black scuff tips. Specify "B2". Add \$167. Available on select models: 5080-0, 5080-4, 5081-0, 5081-4, 5090-4, and 5091-4.
- Please refer to "Arms Selection" section of the price book for arm options.
- Please refer to "Cylinder Selection" section of the price book for additional cylinder options.
- For hard surface flooring casters, specify C65R, add \$73.
- Please refer to the "Casters Selection" section of the price book for caster options. Optional casters may be priced higher than the standard casters for your chair and the difference will be charged. Lower priced optional casters will not be credited.
- For fully assembled in box, specify SU. Add \$76
- Pedestal Base models have black bases with 2" height adjust cylinders. Specify (SCC) swivel, auto return to max height (no upcharge); (SN) non-swivel, auto return to max height (Add \$21); or (SC) swivel, self-centering and return to max height (Add \$33).

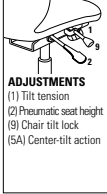
DESCRIPTION	FEATURES	MODEL#	STANDARD TEXTILE GRADES																								
			1	2	3	4	5	6	7	8	9	10	11	12													
 <p>HB Synchro - Tilter w/Back Angle Adjustment COM Yardage: 2 Freight Class: 150 Product Weight (lbs.): 65 Cubic Feet Per Carton: 14.25</p>	 <p>ADJUSTMENTS (1) Tilt tension (2) Pneumatic seat height (9) Chair tilt lock (5A) Center-tilt action</p>	<p>Ergonomic Features: A, B, C, E, H, L, M, N, R</p>	<table border="1"> <tr> <td>5080-0</td> <td>1203</td> <td>1336</td> <td>1392</td> <td>1476</td> <td>1596</td> <td>1638</td> <td>1740</td> <td>1937</td> <td>2032</td> <td>2214</td> <td>2462</td> <td>2773</td> </tr> </table>												5080-0	1203	1336	1392	1476	1596	1638	1740	1937	2032	2214	2462	2773
			5080-0	1203	1336	1392	1476	1596	1638	1740	1937	2032	2214	2462	2773												
			<p>OVERALL DIMENSIONS</p> <table border="1"> <tr> <th>W</th> <th>D</th> <th>H</th> </tr> <tr> <td>24</td> <td>25</td> <td>46</td> </tr> </table>			W	D	H	24	25	46	<p>SEAT DIMENSIONS</p> <table border="1"> <tr> <th>W</th> <th>D</th> <th>H</th> </tr> <tr> <td>19.5</td> <td>18-20.5</td> <td>17-21</td> </tr> </table>			W	D	H	19.5	18-20.5	17-21	<p>BACK DIMENSIONS</p> <table border="1"> <tr> <th>W</th> <th>H</th> </tr> <tr> <td>19</td> <td>26-28.5</td> </tr> </table>			W	H	19	26-28.5
W	D	H																									
24	25	46																									
W	D	H																									
19.5	18-20.5	17-21																									
W	H																										
19	26-28.5																										
<p>RTA 1</p>																											
 <p>HB Multi - Tilter COM Yardage: 2 Freight Class: 150 Product Weight (lbs.): 67 Cubic Feet Per Carton: 14.25</p>	 <p>ADJUSTMENTS (1) Tilt tension (2) Pneumatic seat height (3) Back angle (6) Back height (7) Forward tilt lock (9) Chair tilt lock (5A) Center-tilt action</p>	<p>Ergonomic Features: A, B, C, D, E, F, G, H, M, N, O, S</p>	<table border="1"> <tr> <td>5080-3</td> <td>1203</td> <td>1335</td> <td>1391</td> <td>1476</td> <td>1596</td> <td>1635</td> <td>1740</td> <td>1937</td> <td>2030</td> <td>2214</td> <td>2462</td> <td>2772</td> </tr> </table>												5080-3	1203	1335	1391	1476	1596	1635	1740	1937	2030	2214	2462	2772
			5080-3	1203	1335	1391	1476	1596	1635	1740	1937	2030	2214	2462	2772												
			<p>OVERALL DIMENSIONS</p> <table border="1"> <tr> <th>W</th> <th>D</th> <th>H</th> </tr> <tr> <td>24</td> <td>25</td> <td>46</td> </tr> </table>			W	D	H	24	25	46	<p>SEAT DIMENSIONS</p> <table border="1"> <tr> <th>W</th> <th>D</th> <th>H</th> </tr> <tr> <td>19.5</td> <td>18-20.5</td> <td>17-21</td> </tr> </table>			W	D	H	19.5	18-20.5	17-21	<p>BACK DIMENSIONS</p> <table border="1"> <tr> <th>W</th> <th>H</th> </tr> <tr> <td>19</td> <td>26-28.5</td> </tr> </table>			W	H	19	26-28.5
W	D	H																									
24	25	46																									
W	D	H																									
19.5	18-20.5	17-21																									
W	H																										
19	26-28.5																										
<p>RTA 1</p>																											

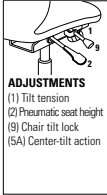
DESCRIPTION	FEATURES	MODEL#	STANDARD TEXTILE GRADES														
			1	2	3	4	5	6	7	8	9	10	11	12			
 <p>HB Tilter COM Yardage: 2 Freight Class: 150 Product Weight (lbs.): 45 Cubic Feet Per Carton: 9.75</p>	 <p>ADJUSTMENTS (1) Tilt tension (2) Pneumatic seat height (9) Chair tilt lock (5A) Center-tilt action</p>	<p>Ergonomic Features: A, B, C, M, N, S</p>	5080-4	1031	1104	1160	1244	1363	1403	1507	1704	1798	1981	2230	2540		
			OVERALL DIMENSIONS			SEAT DIMENSIONS			BACK DIMENSIONS								
			W	D	H	W	D	H	W	H							
			24.5	26.5	43.5	19.5	18-19.5	16.5-20.5	19	25.5							
			RTA 2	FedEx		UPS											
 <p>MB Synchro - Tilter w/Back Angle Adjustment COM Yardage: 1.75 Freight Class: 150 Product Weight (lbs.): 62 Cubic Feet Per Carton: 14.25</p>	 <p>ADJUSTMENTS (1) Tilt tension (2) Pneumatic seat height (9) Chair tilt lock (5A) Center-tilt action</p>	<p>Ergonomic Features: A, B, C, E, H, L, M, N, R</p>	5081-0	1088	1207	1257	1329	1432	1470	1560	1731	1815	1974	2192	2464		
			OVERALL DIMENSIONS			SEAT DIMENSIONS			BACK DIMENSIONS								
			W	D	H	W	D	H	W	H							
			24	25	42	19.5	18-20.5	17-21	19	22-24.5							
			RTA 1														
 <p>MB Multi - Tilter COM Yardage: 1.75 Freight Class: 150 Product Weight (lbs.): 64 Cubic Feet Per Carton: 14.25</p>	 <p>ADJUSTMENTS (1) Tilt tension (2) Pneumatic seat height (3) Back angle (6) Back height (7) Forward tilt lock (9) Chair tilt lock (5A) Center-tilt action</p>	<p>Ergonomic Features: A, B, C, D, E, F, G, H, M, N, Q, S</p>	5081-3	1088	1207	1257	1329	1432	1470	1560	1731	1815	1974	2192	2464		
			OVERALL DIMENSIONS			SEAT DIMENSIONS			BACK DIMENSIONS								
			W	D	H	W	D	H	W	H							
			24	25	42	19.5	18-20.5	17-21	19	22-24.5							
			RTA 1														
 <p>MB Tilter COM Yardage: 1.75 Freight Class: 150 Product Weight (lbs.): 45 Cubic Feet Per Carton: 9.75</p>	 <p>ADJUSTMENTS (1) Tilt tension (2) Pneumatic seat height (9) Chair tilt lock (5A) Center-tilt action</p>	<p>Ergonomic Features: A, B, C, M, N, S</p>	5081-4	906	976	1030	1110	1221	1273	1374	1538	1662	1801	2087	2391		
			OVERALL DIMENSIONS			SEAT DIMENSIONS			BACK DIMENSIONS								
			W	D	H	W	D	H	W	H							
			24.5	26.5	43.5	19.5	18-19.5	16.5-20.5	19	25.5							
			RTA 2	FedEx		UPS											
 <p>HB Tilter w/ Fixed Arm COM Yardage: 2 Freight Class: 250 Product Weight (lbs.): 41 Cubic Feet Per Carton: 11.5</p>	 <p>ADJUSTMENTS (1) Tilt tension (2) Pneumatic seat height (9) Chair tilt lock (5A) Center-tilt action</p>	<p>Ergonomic Features: A, B, C, M, N, S</p>	5090-4	752	860	916	1000	1120	1160	1262	1460	1554	1741	1986	2297		
			OVERALL DIMENSIONS			SEAT DIMENSIONS			BACK DIMENSIONS								
			W	D	H	W	D	H	W	H							
			24.5	26.5	43.5	19.5	19.5	16.5-20.5	19	25.5							
			RTA 1	FedEx		UPS											

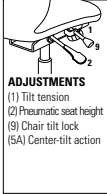
DESCRIPTION	FEATURES	MODEL#	STANDARD TEXTILE GRADES											
			1	2	3	4	5	6	7	8	9	10	11	12
 <p>MB Tilter w/ Fixed Arm COM Yardage: 1.75 Freight Class: 250 Product Weight (lbs.): 38 Cubic Feet Per Carton: 11.5</p>	 <p>ADJUSTMENTS (1) Tilt tension (2) Pneumatic seat height (9) Chair tilt lock (5A) Center-tilt action</p>	5091-4	705	805	852	924	1027	1065	1156	1328	1410	1571	1788	2059
			OVERALL DIMENSIONS			SEAT DIMENSIONS			BACK DIMENSIONS					
			W	D	H	W	D	H	W	H				
			24.5	26.5	39.5	19.5	19.5	16.5-20.5	19	21.5				
			RTA 1	FedEx		UPS								
 <p>Armchair COM Yardage: 1.75 Freight Class: 250 Product Weight (lbs.): 40 Cubic Feet Per Carton: 17</p>	<p>Ergonomic Features: A, B, C, M, N, S</p>	5092	715	815	863	934	1039	1079	1166	1338	1423	1581	1800	2069
			OVERALL DIMENSIONS			SEAT DIMENSIONS			BACK DIMENSIONS					
			W	D	H	W	D	H	W	H				
			25	26	37	19.5	19	16.5	19	27				
			RTA 00											
 <p>HB Tilter with Pedestal Base COM Yardage: 2 Freight Class: 250 Product Weight (lbs.): 44 Cubic Feet Per Carton: 11.5</p>	 <p>ADJUSTMENTS (1) Tilt tension (2) Pneumatic seat height (9) Chair tilt lock (5A) Center-tilt action</p>	5090-4PB	983	1052	1107	1187	1299	1352	1455	1620	1745	1886	2175	2484
			OVERALL DIMENSIONS			SEAT DIMENSIONS			BACK DIMENSIONS					
			W	D	H	W	D	H	W	H				
			24.5	26.5	39.5	19.5	19.5	16.5-20.5	19	25.5				
			RTA 1	FedEx		UPS								
 <p>MB Tilter with Pedestal Base COM Yardage: 1.75 Freight Class: 250 Product Weight (lbs.): 41 Cubic Feet Per Carton: 11.5</p>	 <p>ADJUSTMENTS (1) Tilt tension (2) Pneumatic seat height (9) Chair tilt lock (5A) Center-tilt action</p>	5091-4PB	937	1000	1044	1116	1215	1260	1352	1497	1607	1730	1984	2254
			OVERALL DIMENSIONS			SEAT DIMENSIONS			BACK DIMENSIONS					
			W	D	H	W	D	H	W	H				
			24.5	26.5	37.5	19.5	19.5	16.5-20.5	19	21.5				
			RTA 1	FedEx		UPS								

TAMIRI®



model 4520-3 (TD)

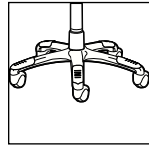

Optional Base











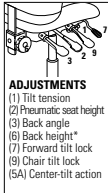

Polished aluminum base with black scuff tips (B2) is available at an upcharge. Add \$167.

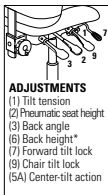



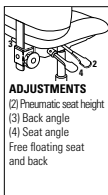

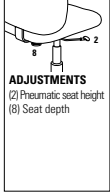

STANDARD FEATURES

- Perforated, breathable leather panels in the seat and back provide long-term comfort through better ventilation.
- Fixed height, impact and scuff resistant curved arms with perforated leather pads are standard on managerial, executive and armchair models.
- All other models are standard with adjustable height T-arms with teardrop shaped urethane armcaps (TD).
- Models 4522, 4526 and 4527 are standard with upholstered armcaps. All polypropylene arms are available at no charge. Please specify "PA" when ordering.
- All models (except armchair) are standard with a five-legged, injection molded "spider" base.
- Base and arms are available in Black (BK) Only.
- C10 casters are standard.
- Upholstery options: vinyl or leather. Not available in fabric.
- Standard in Luxhide. Not available in fabric. Starting at grade 5 pricing.
- Vari-Width (WA) Width Adjustable Arm Extensions are standard.

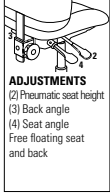
OPTIONAL FEATURES

- Available with back edge vinyl bumper guard option (VBG). Add \$26.
- Polished Aluminum base with black scuff tips. Specify "B2". Add \$167.
- Please refer to "Arms Selection" section of the price book for arm options.
- For hard surface flooring casters Please Specify C10R, Add \$65.
- Please refer to the "Casters Selection" section of the price book for caster options. Optional casters may be priced higher than the standard casters for your chair and the difference will be charged. Lower priced optional casters will not be credited.
- For fully assembled in box, please specify SU. Add \$76.

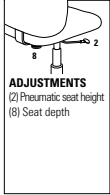
DESCRIPTION	FEATURES	MODEL#	STANDARD FABRIC GRADES													
			1	2	3	4	5	6	7	8	9	10	11	12		
 <p>HB Multi - Tilter w/Adj. Teardrop Arms COM Yardage: 2.25 Freight Class: 150 Product Weight (lbs.): 56 Cubic Feet Per Carton: 11</p> <p>Ergonomic Features: A, B, C, D, F, G, H, M, N, Q, S</p>	 <p>ADJUSTMENTS (1) Tilt tension (2) Pneumatic seat height (3) Back angle (6) Back height* (7) Forward tilt lock (9) Chair tilt lock (5A) Center-tilt action</p>	4520-3	-	-	-	-	1276	1337	-	1676	1798	1999	2298	2657		
		OVERALL DIMENSIONS			SEAT DIMENSIONS			BACK DIMENSIONS								
		W	D	H	W	D	H	W	H							
		25.5	26.5	47.5	22	19.5	17-21	21	26-28							
									  							
 <p>MB Multi - Tilter w/Adj. Teardrop Arms COM Yardage: 2 Freight Class: 150 Product Weight (lbs.): 53 Cubic Feet Per Carton: 9.5</p> <p>Ergonomic Features: A, B, C, D, F, G, H, M, N, Q, S</p>	 <p>ADJUSTMENTS (1) Tilt tension (2) Pneumatic seat height (3) Back angle (6) Back height* (7) Forward tilt lock (9) Chair tilt lock (5A) Center-tilt action</p>	4521-3	-	-	-	-	1155	1215	-	1512	1621	1796	2066	2383		
		OVERALL DIMENSIONS			SEAT DIMENSIONS			BACK DIMENSIONS								
		W	D	H	W	D	H	W	H							
		25	26	41	22	19	17-21	21	20.5-22.5							
									  							
 <p>LB Operator w/Adj. Teardrop Arms COM Yardage: 1.75 Freight Class: 150 Product Weight (lbs.): 46 Cubic Feet Per Carton: 7.5</p> <p>Ergonomic Features: C, D, F, G, H, M, N, Q</p>	 <p>ADJUSTMENTS (2) Pneumatic seat height (3) Back angle (4) Seat angle Free floating seat and back</p>	4528-5	-	-	-	-	1069	1119	-	1382	1476	1631	1868	2147		
		OVERALL DIMENSIONS			SEAT DIMENSIONS			BACK DIMENSIONS								
		W	D	H	W	D	H	W	H							
		25	39	39	22	19.5	17-22	19	19-21							
									  							

DESCRIPTION	FEATURES	MODEL#	STANDARD FABRIC GRADES													
			1	2	3	4	5	6	7	8	9	10	11	12		
 <p>LB Task w/Adj. Teardrop Arms COM Yardage: 1.75 Freight Class: 150 Product Weight (lbs.): 41 Cubic Feet Per Carton: 7</p>	 <p>ADJUSTMENTS (2) Pneumatic seat height (8) Seat depth</p>	<p>4528-6</p>	-	-	-	-	832	881	-	1141	1237	1393	1631	1909		
			OVERALL DIMENSIONS			SEAT DIMENSIONS			BACK DIMENSIONS							
			W	D	H	W	D	H	W	H						
			26.5	25	41	22	17-18.5	16.5-21.5	19	21						
			<p>Ergonomic Features: C, E, H, M, N, Q</p>													
			<p>RTA 2</p>													
 <p>LB Operator Armless COM Yardage: 1.75 Freight Class: 150 Product Weight (lbs.): 41 Cubic Feet Per Carton: 7</p>	 <p>ADJUSTMENTS (2) Pneumatic seat height (3) Back angle (4) Seat angle Free floating seat and back</p>	<p>4529-5</p>	-	-	-	-	871	921	-	1184	1279	1432	1670	1948		
			OVERALL DIMENSIONS			SEAT DIMENSIONS			BACK DIMENSIONS							
			W	D	H	W	D	H	W	H						
			26.5	25	41	22	19.5	17-22	19	19-21						
			<p>Ergonomic Features: C, D, F, G, M, N</p>													
			<p>RTA 2  </p>													
 <p>LB Task Armless COM Yardage: 1.75 Freight Class: 150 Product Weight (lbs.): 34 Cubic Feet Per Carton: 7</p>	 <p>ADJUSTMENTS (2) Pneumatic seat height (8) Seat depth</p>	<p>4529-6</p>	-	-	-	-	675	724	-	988	1082	1236	1471	1752		
			OVERALL DIMENSIONS			SEAT DIMENSIONS			BACK DIMENSIONS							
			W	D	H	W	D	H	W	H						
			22.5	25	41	22	17-18.5	16.5-21.5	19	21						
			<p>Ergonomic Features: C, E, M, N</p>													
			<p>RTA 2  </p>													

TRADITIONAL™



model 3720



model 3722



Standard Feature
Attractive brass-colored nail head trim is standard on all models



model 3747



STANDARD FEATURES







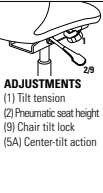

- Tilter chairs are standard with a traditional style wood capped steel base.
- All models are Tufted design with brass-colored nail head trim and vinyl bumper guards. Pneumatic seat height adjustment and tilt tension control.
- **C1** casters are standard.
- All models ship fully assembled in the box.
- Check textile availability prior to specifying upholstery material.

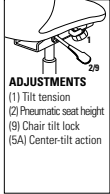

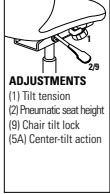

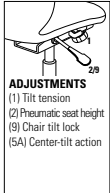

- Please refer to the “Casters Selection” section of the price book for caster options. Optional casters may be priced higher than the standard casters for your chair and the difference will be charged. Lower priced optional casters will not be credited.
- For hard surface flooring casters. Specify **C9R**, Add \$72.

OPTIONAL FEATURES

- Wood base, arms and frames are available in Absolute (**AAM**), Black (**BKM**), Cherry (**ACM**), Espresso Cafe (**ECM**), English Oak (**EOM**), Fruitwood (**TFM**), Gray (**HGM**), Honey (**AHM**), Mahogany (**TMM**), Maple (**AVM**), Medium Walnut (**MWM**), Natural Walnut (**NLW**), Night (**ASM**), Noce Biondo (**NBM**), Noce Grigio (**NGM**), Noce Leggero (**NEM**), Noce Medio (**NMM**), Shaker Cherry (**SKM**), Walnut (**TWM**), WC Cream (**WTM**), White (**WHM**) and Winter Cherry (**WCM**). Please Specify. Genuine maple faced veneers and solids are used.
- Tilter models can be ordered with an optional Black nylon base upon request, at no upcharge.

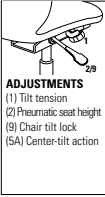
DESCRIPTION	FEATURES	MODEL#	STANDARD FABRIC GRADES												
			1	2	3	4	5	6	7	8	9	10	11	12	
 <p>HB Tilter Queen Anne Style COM Yardage: 4.75 Freight Class: 250 Product Weight (lbs.): 64 Cubic Feet Per Carton: 22.25</p>	 <p>ADJUSTMENTS (1) Tilt tension (2) Pneumatic seat height (9) Chair tilt lock (SA) Center-tilt action</p>	3720	1650	1822	1959	--	2450	2557	--	3288	3518	3968	4574	5332	
		OVERALL DIMENSIONS			SEAT DIMENSIONS			BACK DIMENSIONS							
		W	D	H	W	D	H	W	H						
		29	30	44.5	19.5	19.5	19-23	19	26						
 <p>ArmChair Banker's Style COM Yardage: 2 Freight Class: 250 Product Weight (lbs.): 31 Cubic Feet Per Carton: 11.25</p>	<p>*Fabrics Limited, See notes</p> <p>Ergonomic Features: A, C, M, N, S</p>	3722	829	905	--	--	1165	1215	--	1524	1621	1807	2066	2381	
		OVERALL DIMENSIONS			SEAT DIMENSIONS			BACK DIMENSIONS							
		W	D	H	W	D	H	W	H						
		25	22.5	31	25	18	19.5	23	11						
		3722C with casters	883	958	--	--	1225	1268	--	1577	1676	1862	2119	2440	
		OVERALL DIMENSIONS	SEAT DIMENSIONS			BACK DIMENSIONS									
		W	D	H	W	D	H	W	H						
		25	22.5	31	25	18	19.5	23	11						
			RTA 00	FedEx	ups										

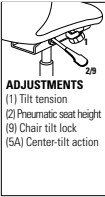
DESCRIPTION	FEATURES	MODEL#	STANDARD FABRIC GRADES												
 <p>HB Tilter Martha Washington Style COM Yardage: 3 Freight Class: 250 Product Weight (lbs.): 52 Cubic Feet Per Carton: 20.25</p>	 <p>ADJUSTMENTS (1) Tilt tension (2) Pneumatic seat height (9) Chair tilt lock (5A) Center-tilt action</p>	3730	1	2	3	4	5	6	7	8	9	10	11	12	
			1595	1703	--	--	2101	2170	--	2631	2777	3058	3440	3920	
		OVERALL DIMENSIONS			SEAT DIMENSIONS			BACK DIMENSIONS							
		W	D	H	W	D	H	W	H						
	0	0	0	18	18	17.5-21.5	19	23							
				RTA 00											
*Fabrics Limited, See notes															
Ergonomic Features: A, C, M, N, S															
 <p>LB Tilter Martha Washington Style COM Yardage: 2.75 Freight Class: 250 Product Weight (lbs.): 46 Cubic Feet Per Carton: 15.75</p>	 <p>ADJUSTMENTS (1) Tilt tension (2) Pneumatic seat height (9) Chair tilt lock (5A) Center-tilt action</p>	3731	1	2	3	4	5	6	7	8	9	10	11	12	
			1479	1579	--	--	1945	2002	--	2427	2562	2821	3173	3612	
		OVERALL DIMENSIONS			SEAT DIMENSIONS			BACK DIMENSIONS							
		W	D	H	W	D	H	W	H						
	25.5	26	36	18	18	17.5-21.5	19	18							
				RTA 00											
*Fabrics Limited, See notes															
Ergonomic Features: A, C, M, N, S															
 <p>LB Armchair Martha Washington Style COM Yardage: 2.75 Freight Class: 300 Product Weight (lbs.): 28 Cubic Feet Per Carton: 15.75</p>	 <p>ADJUSTMENTS (1) Tilt tension (2) Pneumatic seat height (9) Chair tilt lock (5A) Center-tilt action</p>	3732	1	2	3	4	5	6	7	8	9	10	11	12	
			1227	1329	--	--	1693	1751	--	2176	2310	2569	2922	3359	
		OVERALL DIMENSIONS			SEAT DIMENSIONS			BACK DIMENSIONS							
		W	D	H	W	D	H	W	H						
	25.5	24.5	34	20	18	19	19	18							
				RTA 00											
*Fabrics Limited, See notes															
Ergonomic Features: M, N															
 <p>HB Armchair Martha Washington Style COM Yardage: 3 Freight Class: 300 Product Weight (lbs.): 32 Cubic Feet Per Carton: 20.25</p>	 <p>ADJUSTMENTS (1) Tilt tension (2) Pneumatic seat height (9) Chair tilt lock (5A) Center-tilt action</p>	3735	1	2	3	4	5	6	7	8	9	10	11	12	
			1343	1449	--	--	1847	1914	--	2376	2525	2806	3189	3669	
		OVERALL DIMENSIONS			SEAT DIMENSIONS			BACK DIMENSIONS							
		W	D	H	W	D	H	W	H						
	25	27.5	39.5	20	18	19	19	22.5							
				RTA 00											
*Fabrics Limited, See notes															
Ergonomic Features: M, N															
 <p>LB Tilter Martha Washington Style COM Yardage: 2.75 Freight Class: 250 Product Weight (lbs.): 47 Cubic Feet Per Carton: 15.75</p>	 <p>ADJUSTMENTS (1) Tilt tension (2) Pneumatic seat height (9) Chair tilt lock (5A) Center-tilt action</p>	3741	1	2	3	4	5	6	7	8	9	10	11	12	
			1500	1600	--	--	1964	2023	--	2448	2583	2842	3194	3633	
		OVERALL DIMENSIONS			SEAT DIMENSIONS			BACK DIMENSIONS							
		W	D	H	W	D	H	W	H						
	0	0	0	20	18	17.5-21.5	19	18							
				RTA 00											
*Fabrics Limited, See notes															
Ergonomic Features: A, C, M, N, S															

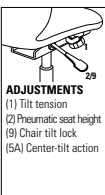
DESCRIPTION	FEATURES	MODEL#	STANDARD FABRIC GRADES											
			1	2	3	4	5	6	7	8	9	10	11	12
 LB Armchair Martha Washington Style COM Yardage: 2.75 Freight Class: 300 Product Weight (lbs.): 28 Cubic Feet Per Carton: 15.75	*Fabrics Limited, See notes Ergonomic Features: M, N	3742	1248	1351	--	--	1714	1773	--	2198	2331	2591	2942	3380
			OVERALL DIMENSIONS			SEAT DIMENSIONS			BACK DIMENSIONS					
			W	D	H	W	D	H	W	H				
			25	34.5	34.5	20	18	19	19	18				
 HB Armchair Martha Washington Style COM Yardage: 3 Freight Class: 300 Product Weight (lbs.): 26 Cubic Feet Per Carton: 20.25	*Fabrics Limited, See notes Ergonomic Features: M, N	3745	1366	1474	--	--	1873	1942	--	2404	2548	2831	3212	3693
			OVERALL DIMENSIONS			SEAT DIMENSIONS			BACK DIMENSIONS					
			W	D	H	W	D	H	W	H				
			25	27.5	39.5	20	18	19	19	22.5				
 MB Tilter Martha Washington Style COM Yardage: 3 Freight Class: 300 Product Weight (lbs.): 40 Cubic Feet Per Carton: 20.25	 ADJUSTMENTS (1) Tilt tension (2) Pneumatic seat height (9) Chair tilt lock (5A) Center-tilt action	3746	1479	1587	--	--	1985	2050	--	2517	2661	2941	3326	3806
			OVERALL DIMENSIONS			SEAT DIMENSIONS			BACK DIMENSIONS					
			W	D	H	W	D	H	W	H				
			26.5	29	38	20	18	17-21	20	24				
 MB Tilter Martha Washington Style COM Yardage: 3 Freight Class: 250 Product Weight (lbs.): 48 Cubic Feet Per Carton: 20.25	 ADJUSTMENTS (1) Tilt tension (2) Pneumatic seat height (9) Chair tilt lock (5A) Center-tilt action	3747	1453	1561	--	--	1959	2028	--	2491	2635	2918	3301	3779
			OVERALL DIMENSIONS			SEAT DIMENSIONS			BACK DIMENSIONS					
			W	D	H	W	D	H	W	H				
			0	0	0	20	18	17-21	20	24				
 HB Tilter Judge's Style COM Yardage: 5 Freight Class: 250 Product Weight (lbs.): 63 Cubic Feet Per Carton: 28.25	 ADJUSTMENTS (1) Tilt tension (2) Pneumatic seat height (9) Chair tilt lock (5A) Center-tilt action	3760	1836	2018	--	--	2679	2786	--	3560	3804	4272	4916	5709
			OVERALL DIMENSIONS			SEAT DIMENSIONS			BACK DIMENSIONS					
			W	D	H	W	D	H	W	H				
			29	32	48	20.5	18.5	18-22	20.5	26				

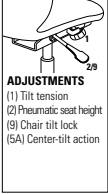
DESCRIPTION	FEATURES	MODEL#		STANDARD FABRIC GRADES																																	
		1	2	3	4	5	6	7	8	9	10	11	12																								
 <p>HB Tilter Judge's Style COM Yardage: 4.75 Freight Class: 250 Product Weight (lbs.): 70 Cubic Feet Per Carton: 28.25</p>	 <p>ADJUSTMENTS (1) Tilt tension (2) Pneumatic seat height (9) Chair tilt lock (5A) Center-tilt action</p>	3766																																			
		<table border="1"> <thead> <tr> <th colspan="3">OVERALL DIMENSIONS</th> <th colspan="3">SEAT DIMENSIONS</th> <th colspan="2">BACK DIMENSIONS</th> </tr> <tr> <th>W</th> <th>D</th> <th>H</th> <th>W</th> <th>D</th> <th>H</th> <th>W</th> <th>H</th> </tr> </thead> <tbody> <tr> <td>29</td> <td>32</td> <td>48</td> <td>20.5</td> <td>18.5</td> <td>18-22</td> <td>20.5</td> <td>26</td> </tr> </tbody> </table>												OVERALL DIMENSIONS			SEAT DIMENSIONS			BACK DIMENSIONS		W	D	H	W	D	H	W	H	29	32	48	20.5	18.5	18-22	20.5	26
		OVERALL DIMENSIONS			SEAT DIMENSIONS			BACK DIMENSIONS																													
W	D	H	W	D	H	W	H																														
29	32	48	20.5	18.5	18-22	20.5	26																														
*Fabrics Limited, See notes Ergonomic Features: A, C, M, N, S		RTA 00																																			

TRIUMPH™



model 3650-3

model 3651-3

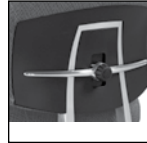

Lumbar Support







Adjusted in and out by turning the knob and vertically by moving up and down the slider.

STANDARD FEATURES

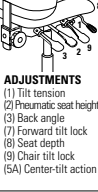
- Contemporary seating series featuring exceptional comfort, support and adjustment.
- Standard with adjustable height, forward swept arms with "sliding armcaps" (G1).
- Outer back knob can be adjusted in and out for lumbar support and vertically for optimal positioning.
- Frame is standard with a polished aluminum arched base and accentuated with polished aluminum back trim.
- Side activated sliding seat depth adjustment (MD), is standard on both control mechanisms. Provides 2" of seat depth adjustment.
- C1 casters are standard.

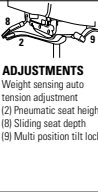
OPTIONAL FEATURES

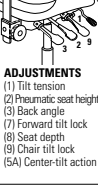
- For hard surface flooring please specify C9R. Add \$73.
- Check textile availability prior to specifying upholstery material.
- Please refer to the "Casters Selection" section of the price book for caster options.
- Please refer to "Cylinder Selection" section of the price book for additional cylinder options.
- For fully assembled in box, please specify SU. Add \$76.

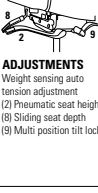
DESCRIPTION	FEATURES	MODEL#	STANDARD FABRIC GRADES											
			1	2	3	4	5	6	7	8	9	10	11	12
 <p>HB Multi-Tilter COM Yardage: 2 Freight Class: 250 Product Weight (lbs.): 66 Cubic Feet Per Carton: 23.5</p>	 <p>ADJUSTMENTS (1) Tilt tension (2) Pneumatic seat height (3) Back angle (7) Forward tilt lock (8) Seat depth (9) Chair tilt lock (5A) Center-tilt action</p>	<p>3650-3</p>	1641	1799	1855	1944	2068	2113	2219	2426	2526	2719	2980	3306
			OVERALL DIMENSIONS			SEAT DIMENSIONS			BACK DIMENSIONS					
			W	D	H	W	D	H	W	H				
	26	25	46.5	21	18-20.5	17-21	20	27						
									RTA 00					
 <p>HB Weight Sensing Synchro - Tilter COM Yardage: 2 Freight Class: 250 Product Weight (lbs.): 66 Cubic Feet Per Carton: 23.5</p>	 <p>ADJUSTMENTS Weight sensing auto tension adjustment (2) Pneumatic seat height (8) Sliding seat depth (9) Multi position tilt lock</p>	<p>3650-8</p>	1641	1799	1855	1944	2068	2113	2219	2426	2526	2719	2980	3306
			OVERALL DIMENSIONS			SEAT DIMENSIONS			BACK DIMENSIONS					
			W	D	H	W	D	H	W	H				
	26	25	46.5	21	18-20.5	17-21	20	27						
									RTA 00					
 <p>MB Multi - Tilter COM Yardage: 1.75 Freight Class: 250 Product Weight (lbs.): 64 Cubic Feet Per Carton: 20.5</p>	 <p>ADJUSTMENTS (1) Tilt tension (2) Pneumatic seat height (3) Back angle (7) Forward tilt lock (8) Seat depth (9) Chair tilt lock (5A) Center-tilt action</p>	<p>3651-3</p>	1608	1765	1823	1912	2036	2080	2188	2394	2493	2687	2947	3274
			OVERALL DIMENSIONS			SEAT DIMENSIONS			BACK DIMENSIONS					
			W	D	H	W	D	H	W	H				
	26	25	39.5	21	18-20.5	17-21	20	21						
									RTA 00					
 <p>MB Weight Sensing Synchro - Tilter COM Yardage: 1.75 Freight Class: 250 Product Weight (lbs.): 64 Cubic Feet Per Carton: 20.5</p>	 <p>ADJUSTMENTS Weight sensing auto tension adjustment (2) Pneumatic seat height (8) Sliding seat depth (9) Multi position tilt lock</p>	<p>3651-8</p>	1608	1765	1823	1912	2036	2080	2188	2394	2493	2687	2947	3274
			OVERALL DIMENSIONS			SEAT DIMENSIONS			BACK DIMENSIONS					
			W	D	H	W	D	H	W	H				
	26	25	39.5	21	18-20.5	17-21	20	21						
									RTA 00					

TRUFORM™



model 5450-3



model 5451-3

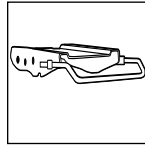

Multi-Depth Mechanism
Seat depth option is available on multi-tilter models. (see notes for more details)

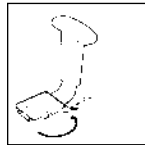





Vari-Width (WA)
Width Adjustable Arm Extensions is standard when order with adjustable height arms.





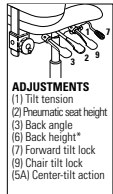

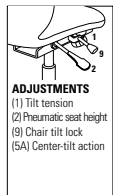

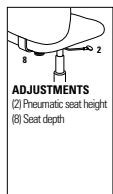















STANDARD FEATURES



- A range of models available, all featuring gently curved, streamlined seat and back cushions
- Standard with adjustable height **SC** arms.
- All models are standard with a high rise, injection molded base, standard in black.
- All models are shipped partially **KD**.
- **C1** casters are standard.
- Check textile availability prior to specifying upholstery material.

OPTIONAL FEATURES

- Seat depth is standard on models 5450-3, 5450-8, 5451-0, 5451-3.
- An optional polished aluminum base is available, specify **ALU**. Add **\$167**.
- Please refer to "Arms Selection" section of the price book for arm options.
- Please refer to "Cylinder Selection" section of the price book for additional cylinder options.
- Please refer to the "Casters Selection" section of the price book for caster options. Optional casters may be priced higher than the standard casters for your chair and the difference will be charged. Lower priced optional casters will not be credited.
- For hard surface flooring please specify **C9R** and Add \$72.
- For fully assembled in box, please specify **SU**. Add \$76.

DESCRIPTION	FEATURES	MODEL#	STANDARD FABRIC GRADES													
			1	2	3	4	5	6	7	8	9	10	11	12		
 HB Multi - Tilter COM Yardage: 2 Freight Class: 125 Product Weight (lbs.): 63 Cubic Feet Per Carton: 10.5	 ADJUSTMENTS (1) Tilt tension (2) Pneumatic seat height (3) Back angle (6) Back height* (7) Forward tilt lock (9) Chair tilt lock (5A) Center-tilt action	5450-3	965	1041	1095	1181	1302	1346	1450	1650	1747	1936	2188	2504		
		OVERALL DIMENSIONS			SEAT DIMENSIONS			BACK DIMENSIONS								
		W	D	H	W	D	H	W	H							
	26	25	42	20	18-20.5	16.5-20.5	20	23.5-26								
				RTA 2	FedEx	UPS										
 HB Tilter COM Yardage: 2 Freight Class: 150 Product Weight (lbs.): 50 Cubic Feet Per Carton: 10.5	 ADJUSTMENTS (1) Tilt tension (2) Pneumatic seat height (9) Chair tilt lock (5A) Center-tilt action	5450-4	858	932	990	1076	1197	1240	1343	1544	1640	1828	2082	2397		
		OVERALL DIMENSIONS			SEAT DIMENSIONS			BACK DIMENSIONS								
		W	D	H	W	D	H	W	H							
	26	25	42	20	18-20.5	16.5-20.5	20	23-26								
				RTA 2	FedEx	UPS										
 HB Task COM Yardage: 2 Freight Class: 250 Product Weight (lbs.): 44 Cubic Feet Per Carton: 10.5	 ADJUSTMENTS (2) Pneumatic seat height (8) Seat depth	5450-6	790	864	922	1008	1129	1172	1276	1476	1572	1760	2014	2329		
		OVERALL DIMENSIONS			SEAT DIMENSIONS			BACK DIMENSIONS								
		W	D	H	W	D	H	W	H							
	26	25	41.5	20	18-20.5	16-20	20	23.5-26								
				RTA 2	FedEx	UPS										

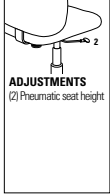
DESCRIPTION	FEATURES	MODEL#	STANDARD FABRIC GRADES													
			1	2	3	4	5	6	7	8	9	10	11	12		
 <p>HB Weight Sensing Synchro - Tilter COM Yardage: 2 Freight Class: 125 Product Weight (lbs.): 64 Cubic Feet Per Carton: 10.5</p>	 <p>ADJUSTMENTS (1) Weight sensing auto tension adjustment (2) Pneumatic seat height (8) Sliding seat depth (9) Multi position tilt lock</p>	5450-8	965	1038	1094	1179	1298	1337	1442	1639	1734	1916	2164	2474		
			OVERALL DIMENSIONS			SEAT DIMENSIONS			BACK DIMENSIONS							
			W	D	H	W	D	H	W	H						
			26	25	41.5	20	18-20.5	16.5-20.5	20	23.5-26						
<p>Ergonomic Features: A, B, C, E, H, M, N, Q</p>	  															
		 <p>MB Synchro - Tilter w/Back Angle Adjustment COM Yardage: 1.75 Freight Class: 125 Product Weight (lbs.): 63 Cubic Feet Per Carton: 10.5</p>	 <p>ADJUSTMENTS (1) Tilt tension (2) Pneumatic seat height (6) Back height (9) Chair tilt lock (5C) Synchro-tilt action Anti-kick back</p>	5451-0	925	992	1044	1118	1221	1260	1352	1528	1611	1777	1997	2272
					OVERALL DIMENSIONS			SEAT DIMENSIONS			BACK DIMENSIONS					
					W	D	H	W	D	H	W	H				
26	25				38.5	20	18-20.5	17-21	20	23.5-26						
<p>Ergonomic Features: A, B, C, J, M, N</p>	  															
		 <p>MB Multi - Tilter COM Yardage: 1.75 Freight Class: 150 Product Weight (lbs.): 60 Cubic Feet Per Carton: 10.5</p>	 <p>ADJUSTMENTS (1) Tilt tension (2) Pneumatic seat height (3) Back angle (6) Back height* (7) Forward tilt lock (9) Chair tilt lock (5A) Center-tilt action</p>	5451-3	925	992	1044	1118	1221	1260	1352	1528	1611	1777	1997	2272
					OVERALL DIMENSIONS			SEAT DIMENSIONS			BACK DIMENSIONS					
					W	D	H	W	D	H	W	H				
26	25				38.5	20	18-20.5	16.5-20.5	20	20-22.5						
<p>Ergonomic Features: A, B, C, D, F, G, H, M, N, Q, S</p>	  															
		 <p>MB Tilter COM Yardage: 1.75 Freight Class: 150 Product Weight (lbs.): 48 Cubic Feet Per Carton: 10.5</p>	 <p>ADJUSTMENTS (1) Tilt tension (2) Pneumatic seat height (9) Chair tilt lock (5A) Center-tilt action</p>	5451-4	819	886	934	1008	1114	1154	1245	1419	1504	1668	1890	2165
					OVERALL DIMENSIONS			SEAT DIMENSIONS			BACK DIMENSIONS					
					W	D	H	W	D	H	W	H				
26	25				38.5	20	18-20.5	16.5-20.5	20	20-22.5						
<p>Ergonomic Features: A, B, C, J, M, N</p>	  															
		 <p>MB Operator COM Yardage: 1.75 Freight Class: 150 Product Weight (lbs.): 45 Cubic Feet Per Carton: 10.5</p>	 <p>ADJUSTMENTS (2) Pneumatic seat height (3) Back angle (4) Seat angle Free floating seat and back</p>	5451-5	920	987	1035	1107	1216	1255	1346	1522	1606	1770	1992	2266
					OVERALL DIMENSIONS			SEAT DIMENSIONS			BACK DIMENSIONS					
					W	D	H	W	D	H	W	H				
26	25				38.5	20	18-20.5	16.5-20.5	20	20-22.5						
<p>Ergonomic Features: A, B, C, J, M, N</p>	  															

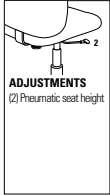
DESCRIPTION	FEATURES	MODEL#	STANDARD FABRIC GRADES													
			1	2	3	4	5	6	7	8	9	10	11	12		
 <p>MB Height Adjustable Stool Armless COM Yardage: 1.75 Freight Class: 250 Product Weight (lbs.): 38 Cubic Feet Per Carton: 10.5</p>	 <p>ADJUSTMENTS (2) Pneumatic seat height</p> <p>Ergonomic Features: A, B, C, J, M, N</p>	5457-6	1099	1166	1218	1292	1395	1433	1527	1702	1785	1951	2172	2446		
			OVERALL DIMENSIONS			SEAT DIMENSIONS			BACK DIMENSIONS							
			W	D	H	W	D	H	W	H						
			20	25	47	20	17.5-19	22-30	20	20						
			RTA 2	FedEx	ups											
 <p>MB Height Adjustable Stool COM Yardage: 1.75 Freight Class: 150 Product Weight (lbs.): 44 Cubic Feet Per Carton: 10.5</p>	 <p>ADJUSTMENTS (2) Pneumatic seat height</p> <p>Ergonomic Features: A, B, C, J, M, N</p>	5458-6	1284	1349	1399	1471	1578	1617	1710	1884	1967	2132	2355	2630		
			OVERALL DIMENSIONS			SEAT DIMENSIONS			BACK DIMENSIONS							
			W	D	H	W	D	H	W	H						
			26	25	47	20	17.5-19	22-30	20	20						
			RTA 2	FedEx	ups											

TYE™



model 1950-4 (3N)



model 1951-4 (3N)

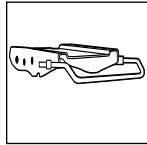

Multi-Depth Mechanism
Seat depth option is available on multi-tilter models. (see notes for more details)



model 1953

STANDARD FEATURES

- Contemporary mesh fabric and upholstered panels are used on chair backs.
- Standard with adjustable height T-arms with curved urethane armcaps (3N) in Black Only, (except model 1953 which has a fixed height version of this same arm style). All models (except armchair) are standard with a five-legged, injection molded "spider" base.
- C65 casters are standard.
- Where fabric is approved for use only on seat, Luxhide Bonded Leather is recommended for the back textile selection.
- Seat depth and pneumatic seat height adjustments. Tilt tension adjustment with tilt lock.
- Mesh available in Black only.
- Check textile availability prior to specifying upholstery material.

OPTIONAL FEATURES

- Cantilever frame on armchair (model 1953) is available in Black (TBL) or Tungsten (TTU). No upcharge. For Chrome (CHM) finish, add 10% of opening published grade price.. Please refer to "Arms Selection" section of the price book for arm options.
- Please refer to the "Casters Selection" section of the price book for caster options. Optional casters may be priced higher than the standard casters for your chair and the difference will be charged. Lower priced optional casters will not be credited.
- For hard surface flooring, specify C65R. Add \$73.
- For fully assembled in box, specify SU. Add \$76.

DESCRIPTION FEATURES MODEL# STANDARD TEXTILE GRADES



HB Synchro - Tilter
COM Yardage: 1.5
Freight Class: 150
Product Weight (lbs.): 56
Cubic Feet Per Carton: 11

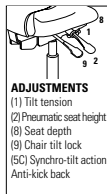

ADJUSTMENTS
(1) Tilt tension
(2) Pneumatic seat height
(8) Seat depth
(9) Chair tilt lock
(5C) Synchro-tilt action
Anti-kick back

Ergonomic Features:
A, B, C, E, H, L, M, N

MODEL#	1	2	3	4	5	6	7	8	9	10	11	12
1950-1	1056	1116	1158	1223	1312	1346	1427	1578	1650	1791	1981	2224

OVERALL DIMENSIONS			SEAT DIMENSIONS			BACK DIMENSIONS	
W	D	H	W	D	H	W	H
25	26	45	21	19-20.5	17.5-21.5	19.5	27

RTA 2 FedEx UPS



HB Multi - Tilter
COM Yardage: 1.5
Freight Class: 150
Product Weight (lbs.): 55
Cubic Feet Per Carton: 11

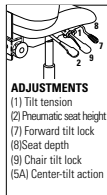

ADJUSTMENTS
(1) Tilt tension
(2) Pneumatic seat height
(7) Forward tilt lock
(8) Seat depth
(9) Chair tilt lock
(5A) Center-tilt action

Ergonomic Features:
A, B, C, E, F, H, M, N, S

MODEL#	1	2	3	4	5	6	7	8	9	10	11	12
1950-3	1036	1092	1135	1200	1290	1325	1403	1557	1629	1770	1961	2204

OVERALL DIMENSIONS			SEAT DIMENSIONS			BACK DIMENSIONS	
W	D	H	W	D	H	W	H
25	26	45	21	19-20.5	17.5-21.5	19.5	27

RTA 2 FedEx UPS



HB Tilter
COM Yardage: 1.5
Freight Class: 150
Product Weight (lbs.): 52
Cubic Feet Per Carton: 11

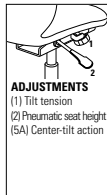







ADJUSTMENTS
(1) Tilt tension
(2) Pneumatic seat height
(5A) Center-tilt action

Ergonomic Features:
A, C, E, H, M, N

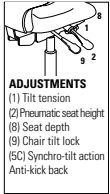
MODEL#	1	2	3	4	5	6	7	8	9	10	11	12
1950-4	881	935	980	1048	1135	1166	1250	1402	1472	1613	1805	2047

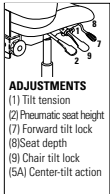
OVERALL DIMENSIONS			SEAT DIMENSIONS			BACK DIMENSIONS	
W	D	H	W	D	H	W	H
25	26	45.5	21	19-20.5	16.5-20.5	19.5	27

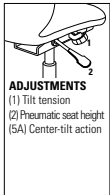
RTA 2 FedEx UPS

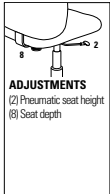
DESCRIPTION	FEATURES	MODEL#	STANDARD TEXTILE GRADES																																				
			1	2	3	4	5	6	7	8	9	10	11	12																									
 <p>MB Synchro - Tilter COM Yardage: 1.25 Freight Class: 150 Product Weight (lbs.): 54 Cubic Feet Per Carton: 10.5</p>	 <p>ADJUSTMENTS (1) Tilt tension (2) Pneumatic seat height (8) Seat depth (9) Chair tilt lock (5C) Synchro-tilt action Anti-kick back</p>	<p>Ergonomic Features: A, B, C, E, H, L, M, N</p>	<table border="1"> <thead> <tr> <th colspan="3">OVERALL DIMENSIONS</th> <th colspan="3">SEAT DIMENSIONS</th> <th colspan="3">BACK DIMENSIONS</th> </tr> <tr> <th>W</th> <th>D</th> <th>H</th> <th>W</th> <th>D</th> <th>H</th> <th>W</th> <th>H</th> </tr> </thead> <tbody> <tr> <td>25</td> <td>26</td> <td>40.5</td> <td>21</td> <td>19-20.5</td> <td>17-21</td> <td>19.5</td> <td>23</td> </tr> </tbody> </table>												OVERALL DIMENSIONS			SEAT DIMENSIONS			BACK DIMENSIONS			W	D	H	W	D	H	W	H	25	26	40.5	21	19-20.5	17-21	19.5	23
			OVERALL DIMENSIONS			SEAT DIMENSIONS			BACK DIMENSIONS																														
			W	D	H	W	D	H	W	H																													
			25	26	40.5	21	19-20.5	17-21	19.5	23																													
<p>RTA 2 FedEx ups</p>																																							
 <p>MB Multi - Tilter COM Yardage: 1.25 Freight Class: 150 Product Weight (lbs.): 53 Cubic Feet Per Carton: 10.5</p>	 <p>ADJUSTMENTS (1) Tilt tension (2) Pneumatic seat height (7) Forward tilt lock (8) Seat depth (9) Chair tilt lock (5A) Center-tilt action</p>	<p>Ergonomic Features: A, B, C, E, F, H, M, N, S</p>	<table border="1"> <thead> <tr> <th colspan="3">OVERALL DIMENSIONS</th> <th colspan="3">SEAT DIMENSIONS</th> <th colspan="3">BACK DIMENSIONS</th> </tr> <tr> <th>W</th> <th>D</th> <th>H</th> <th>W</th> <th>D</th> <th>H</th> <th>W</th> <th>H</th> </tr> </thead> <tbody> <tr> <td>25</td> <td>26</td> <td>40.5</td> <td>21</td> <td>19-20.5</td> <td>17-21</td> <td>19.5</td> <td>23</td> </tr> </tbody> </table>												OVERALL DIMENSIONS			SEAT DIMENSIONS			BACK DIMENSIONS			W	D	H	W	D	H	W	H	25	26	40.5	21	19-20.5	17-21	19.5	23
			OVERALL DIMENSIONS			SEAT DIMENSIONS			BACK DIMENSIONS																														
			W	D	H	W	D	H	W	H																													
			25	26	40.5	21	19-20.5	17-21	19.5	23																													
<p>RTA 2 FedEx ups</p>																																							
 <p>MB Tilter COM Yardage: 1.25 Freight Class: 150 Product Weight (lbs.): 50 Cubic Feet Per Carton: 10.5</p>	 <p>ADJUSTMENTS (1) Tilt tension (2) Pneumatic seat height (5A) Center-tilt action</p>	<p>Ergonomic Features: A, C, E, H, M, N</p>	<table border="1"> <thead> <tr> <th colspan="3">OVERALL DIMENSIONS</th> <th colspan="3">SEAT DIMENSIONS</th> <th colspan="3">BACK DIMENSIONS</th> </tr> <tr> <th>W</th> <th>D</th> <th>H</th> <th>W</th> <th>D</th> <th>H</th> <th>W</th> <th>H</th> </tr> </thead> <tbody> <tr> <td>25</td> <td>26</td> <td>41</td> <td>21</td> <td>19-20.5</td> <td>17-21</td> <td>19.5</td> <td>23</td> </tr> </tbody> </table>												OVERALL DIMENSIONS			SEAT DIMENSIONS			BACK DIMENSIONS			W	D	H	W	D	H	W	H	25	26	41	21	19-20.5	17-21	19.5	23
			OVERALL DIMENSIONS			SEAT DIMENSIONS			BACK DIMENSIONS																														
			W	D	H	W	D	H	W	H																													
			25	26	41	21	19-20.5	17-21	19.5	23																													
<p>RTA 2 FedEx ups</p>																																							
 <p>LB Task w/Arms COM Yardage: 1 Freight Class: 150 Product Weight (lbs.): 43 Cubic Feet Per Carton: 9.25</p>	 <p>ADJUSTMENTS (2) Pneumatic seat height (8) Seat depth</p>	<p>Ergonomic Features: C, E, H, M, N</p>	<table border="1"> <thead> <tr> <th colspan="3">OVERALL DIMENSIONS</th> <th colspan="3">SEAT DIMENSIONS</th> <th colspan="3">BACK DIMENSIONS</th> </tr> <tr> <th>W</th> <th>D</th> <th>H</th> <th>W</th> <th>D</th> <th>H</th> <th>W</th> <th>H</th> </tr> </thead> <tbody> <tr> <td>25</td> <td>26</td> <td>35</td> <td>21</td> <td>19-20.5</td> <td>17-20</td> <td>19.5</td> <td>16</td> </tr> </tbody> </table>												OVERALL DIMENSIONS			SEAT DIMENSIONS			BACK DIMENSIONS			W	D	H	W	D	H	W	H	25	26	35	21	19-20.5	17-20	19.5	16
			OVERALL DIMENSIONS			SEAT DIMENSIONS			BACK DIMENSIONS																														
			W	D	H	W	D	H	W	H																													
			25	26	35	21	19-20.5	17-20	19.5	16																													
<p>RTA 2 FedEx ups</p>																																							

DESCRIPTION FEATURES MODEL# STANDARD TEXTILE GRADES



Armchair

COM Yardage: 1
 Freight Class: 250
 Product Weight (lbs.): 36
 Cubic Feet Per Carton: 10.25

Ergonomic Features:
 M, N

MODEL#	1	2	3	4	5	6	7	8	9	10	11	12
1953	653	697	720	767	825	850	905	1004	1051	1147	1274	1432

OVERALL DIMENSIONS			SEAT DIMENSIONS			BACK DIMENSIONS	
W	D	H	W	D	H	W	H
27	23	35	21	18.5	18	19.5	18



LB Task Armless

COM Yardage: 1
 Freight Class: 150
 Product Weight (lbs.): 37
 Cubic Feet Per Carton: 9.25

Ergonomic Features:
 C, E, M, N

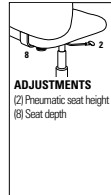

MODEL#	1	2	3	4	5	6	7	8	9	10	11	12
1954-6	626	672	709	764	839	864	931	1057	1120	1236	1398	1596

OVERALL DIMENSIONS			SEAT DIMENSIONS			BACK DIMENSIONS	
W	D	H	W	D	H	W	H
25	26	35	21	19-20.5	17-22	19.5	16



LB Task Height Adjustable Chair

COM Yardage: 1
 Freight Class: 150
 Product Weight (lbs.): 47
 Cubic Feet Per Carton: 9.25

Ergonomic Features:
 C, E, M, N

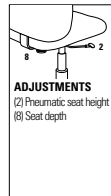

MODEL#	1	2	3	4	5	6	7	8	9	10	11	12
1922-6	874	912	943	988	1049	1070	1127	1228	1278	1375	1504	1667

OVERALL DIMENSIONS			SEAT DIMENSIONS			BACK DIMENSIONS	
W	D	H	W	D	H	W	H
25	26	44.5	21	19-20.5	24-34	19.5	16



LB Task Height Adjustable Chair Armless

COM Yardage: 1
 Freight Class: 150
 Product Weight (lbs.): 40
 Cubic Feet Per Carton: 9.25

Ergonomic Features:
 C, E, G, M

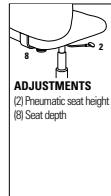

MODEL#	1	2	3	4	5	6	7	8	9	10	11	12
1924-6	769	807	835	876	934	956	1007	1106	1155	1245	1371	1524

OVERALL DIMENSIONS			SEAT DIMENSIONS			BACK DIMENSIONS	
W	D	H	W	D	H	W	H
25	26	44.5	21	19-20.5	24-34	19.5	16



VION



model 6321-8



model 6331-8



Optional Live Lumbar Support Pad (LS)

Lumbar Pad is spring loaded, providing pressure sensitive depth adjustment and 3 inches of height adjustment.



model 6322-4 (C)



model 6321-4PB



Vion Guest Chair please see 249

VION FINISHES - TASK SEATING				
Back Frame	Base	Specify Code	Arm Option	Specify Code
Black	Black	BLK no upcharge	Adj. "T" arm (Black) Adj. "T" arm, fixed armcap (Black) Adj. "T" arm (Black , Chrome accent)	AS AF AC
Black	Polished Aluminum	BAU Add \$167	Adj. "T" arm, fixed armcap (Black , Chrome accent) Fixed "C" arm (Black) Fixed "C" arm (Polished Aluminum)	A C CA - Add \$202
Shadow	Shadow	SHW Add \$76	Adj. "T" arm (Shadow) Adj. "T" arm, fixed armcap (Shadow) Adj. "T" arm (Shadow , Chrome accent)	SHA SHF SHR
Shadow	Polished Aluminum	SAU Add \$241	Adj. "T" arm, fixed armcap (Shadow , Chrome accent) Fixed "C" arm (Shadow) Fixed "C" arm (Polished Aluminum)	SHD SHC CA - Add \$202
Fog	Fog	FOG Add \$76	Adj. "T" arm (Fog) Adj. "T" arm, fixed armcap (Fog) Adj. "T" arm (Fog , Chrome accent)	FA FF FC
Fog	Polished Aluminum	FAU Add \$241	Adj. "T" arm, fixed armcap (Fog , Chrome accent) Fixed "C" arm (Fog) Fixed "C" arm (Polished Aluminum)	CF CC CA - Add \$202

* All arms have Black SSU Armcaps.

STANDARD FEATURES

- Vion is a comprehensive seating series offering a family of models to address multiple applications: task, management, conference, guest, pedestal base, heavy duty 24/7 and stools.
- Vion Care Compliant models, with "GC" model code prefix, are available for select models (GC6322-0, GC6322-4, GC6331-0, GC6331-4). These models have standard high density, ultracell foam and polyurethane seat underside with sealed connections. Optional sealed seat seams and moisture barrier are available on these models only.
- Vion Heavy Duty models can be found in the Heavy Duty section of the price book (423).
- Series offers mid and high back models with either a mesh or upholstered back.
- Five different control mechanism options to suit all price points and ergonomic requirements.
- All models are standard with height and width adjustable arms (**AS**) that feature a front to back sliding armcap.
- Standard with Global's high quality Soft Descent™ pneumatic lift which slowly and gently lowers the seat height of the chair, making it easy to obtain the desired position.
- Side activated sliding seat depth adjustment (**MD**) is standard on multi-tilter, synchro tilter with back angle adjustment and weight sensing synchro tilter control mechanisms.
- Standard with Black five prong, injection molded, fiberglass reinforced nylon Governor base (**B7**) with dual wheel carpet casters (**C1**).
- Mesh back models are available in 10 standard Vion colors: Aqua (**MS75**), Black (**MS69**), Black Cherry (**MS76**), Blue (**MS72**), Dust (**MS77**), Ivory (**MS78**), Natural (**MS74**), Paprika (**MS79**), Rope (**MS73**) and Stone (**MS71**).
- Upholstered back models feature black fabric Jenny (**JN02**) on the back side as standard.
- Check textile availability prior to specifying upholstery material.
- Pedestal base models are offered on (-4) Tilter and (-6) Task (basic swivel) mechanisms only. These models provide fixed location seating for use in auditoriums, classrooms, jury boxes, public venues and more. The base must be mounted to the floor (mounting hardware not included). See Pedestal Base Installation Guide for details.

OPTIONAL FEATURES

- Vion back frames, arms and bases are available in three colors: Black, Shadow and Fog. See Vion finishes chart for options and upcharges. Armcaps are always Black.
- Mesh back models are also available in 10 Dimension Mesh colors: Black (**DBK**), Fog (**DST**), Chalk (**DCL**), Shadow (**DGM**), Charcoal (**DCH**), Sand (**DSD**), Cobalt (**DCO**), Pool Blue (**DPB**), Citrus (**DCT**) and Berry (**DBE**). Add \$27.
- Upholstered back models offer a Matching Outer (**MO**) upholstery option. Due to the Additional material needed, these models are listed separately and are priced differently than the standard upholstered back models.
- Optional lumbar pad can be added at the time of order. Please specify (**LS**) and add \$40 Lumbar pad can also be ordered after sale as a kit, specify model 6339 at \$43 list. The lumbar pad is adjustable up to 3".
- Seat available in memory foam. Please specify (**MF**) and add \$117.
- Petite seat models (2" shorter and 2" narrower than the standard size seat) are available. Specify (**ST**) for standard foam or (**P**) for petite seat, no upcharge.
- A moisture barrier is available for the seat cushion on GC Vion models only. Specify (**NB**) for no moisture barrier, no upcharge, or (**MB**) for Moisture Barrier. Add \$117.
- Sealed seams are available on the seat of GC Vion models when specified with approved coated textile. Contact Customer Care for availability. Specify (**NS**) for no sealed seams, no upcharge, or (**SE**) for sealed seat seams. Add \$26.
- For hard surface flooring casters, please specify (**C9R**). Add \$72.
- Two featured "T" arm options that include height and width adjusting arms, one with sliding arm caps (**AS**) and one without sliding arm caps (**AF**). Also, available is a stylish fixed urethane arm (**C**) for conference/management environments.
- For additional arm/caster options, please refer to the Arm and Caster section (425). Optional casters may be priced higher than the standard casters for your chair and the difference will be charged. Lower priced optional casters will not be credited.
- Please refer to "Cylinder Selection" section of the price book for additional cylinder options.
- For fully assembled in box, please specify **SU**. Add \$76.
- Pedestal Base models have black bases with 2" height adjust cylinders. Specify (**SCC**) swivel, auto return to max height (no upcharge); (**SN**) non-swivel, auto return to max height (Add \$21); or (**SC**) swivel, self-centering and return to max height (Add \$33).

DESCRIPTION



HB Synchro - Tilter w/Back Angle Adjustment
COM Yardage: 1
Freight Class: 150
Product Weight (lbs.): 60
Cubic Feet Per Carton: 10.5

FEATURES

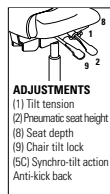

Mesh Back

Ergonomic Features:
A, B, C, E, G, H, L, M, N, Q, U









MODEL#

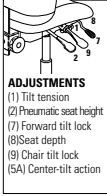

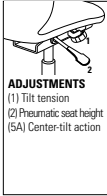

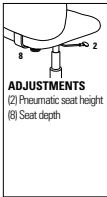

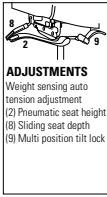

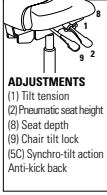
STANDARD TEXTILE GRADES

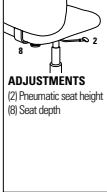

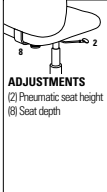

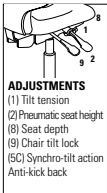

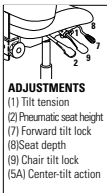

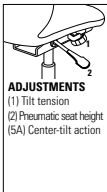
	1	2	3	4	5	6	7	8	9	10	11	12
6321-0	998	1035	1063	1104	1162	1184	1235	1334	1383	1473	1598	1751

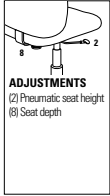

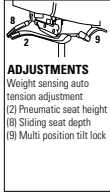

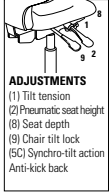

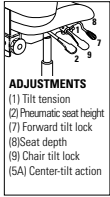

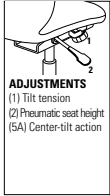

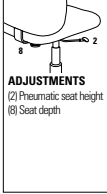
OVERALL DIMENSIONS			SEAT DIMENSIONS			BACK DIMENSIONS	
W	D	H	W	D	H	W	H
25.5	24	41.5	20	17-20	17.5-22.5	18.5	23

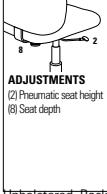

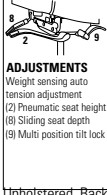

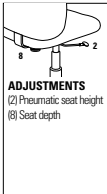

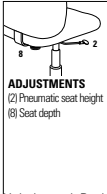



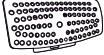

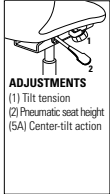

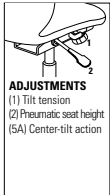

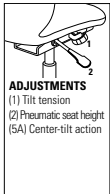

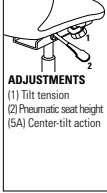

DESCRIPTION	FEATURES	MODEL#	STANDARD TEXTILE GRADES														
			1	2	3	4	5	6	7	8	9	10	11	12			
 <p>HB Multi - Tilter COM Yardage: 1 Freight Class: 150 Product Weight (lbs.): 62 Cubic Feet Per Carton: 10.5</p>	 <p>ADJUSTMENTS (1) Tilt tension (2) Pneumatic seat height (7) Forward tilt lock (8) Seat depth (9) Chair tilt lock (5A) Center-tilt action</p>	6321-3	998	1035	1063	1104	1162	1184	1235	1334	1383	1473	1598	1751			
			OVERALL DIMENSIONS			SEAT DIMENSIONS			BACK DIMENSIONS								
			W	D	H	W	D	H	W	H							
			25.5	24	41	20	17-20	17.25-22.25	18.5	23							
<p>Mesh Back</p> <p>Ergonomic Features: A, B, C, E, F, G, H, M, N, Q, U, S</p> <p>RTA 2 FedEx ups</p>			1	2	3	4	5	6	7	8	9	10	11	12			
			 <p>HB Tilter COM Yardage: 1 Freight Class: 150 Product Weight (lbs.): 54 Cubic Feet Per Carton: 10.5</p>	 <p>ADJUSTMENTS (1) Tilt tension (2) Pneumatic seat height (5A) Center-tilt action</p>	6321-4	893	930	959	1000	1058	1080	1131	1230	1279	1369	1493	1647
						OVERALL DIMENSIONS			SEAT DIMENSIONS			BACK DIMENSIONS					
						W	D	H	W	D	H	W	H				
25.5	24	39.25				20	17.5	16-21	18.5	23							
<p>Mesh Back</p> <p>Ergonomic Features: A, B, C, E, H, M, N, Q, S, U</p> <p>RTA 2 FedEx ups</p>			1	2	3	4	5	6	7	8	9	10	11	12			
			 <p>HB Task COM Yardage: 1 Freight Class: 150 Product Weight (lbs.): 49 Cubic Feet Per Carton: 10.5</p>	 <p>ADJUSTMENTS (2) Pneumatic seat height (8) Seat depth</p>	6321-6	856	893	922	962	1021	1042	1094	1193	1241	1331	1456	1609
						OVERALL DIMENSIONS			SEAT DIMENSIONS			BACK DIMENSIONS					
						W	D	H	W	D	H	W	H				
25.5	24	39.25				20	17.5	17-22	18.5	23							
<p>Mesh Back</p> <p>Ergonomic Features: C, E, M, N, U</p> <p>RTA 2 FedEx ups</p>			1	2	3	4	5	6	7	8	9	10	11	12			
			 <p>HB Weight Sensing Synchro - Tilter COM Yardage: 1 Freight Class: 150 Product Weight (lbs.): 57 Cubic Feet Per Carton: 10.5</p>	 <p>ADJUSTMENTS Weight sensing auto tension adjustment (2) Pneumatic seat height (8) Sliding seat depth (9) Multi position tilt lock</p>	6321-8	998	1035	1063	1104	1162	1184	1235	1334	1383	1473	1598	1751
						OVERALL DIMENSIONS			SEAT DIMENSIONS			BACK DIMENSIONS					
						W	D	H	W	D	H	W	H				
25.5	24	40				20	17-20	16.5-21.5	18.5	23							
<p>Mesh Back</p> <p>Ergonomic Features: A, B, C, E, H, L, M, N, Q, U</p> <p>RTA 2 FedEx ups</p>			1	2	3	4	5	6	7	8	9	10	11	12			
			 <p>MB Synchro - Tilter w/Back Angle Adjustment COM Yardage: 1 Freight Class: 150 Product Weight (lbs.): 58 Cubic Feet Per Carton: 10.5</p>	 <p>ADJUSTMENTS (1) Tilt tension (2) Pneumatic seat height (8) Seat depth (9) Chair tilt lock (5C) Synchro-tilt action Anti-kick back</p>	6322-0	945	981	1010	1051	1109	1131	1182	1281	1330	1420	1545	1698
						OVERALL DIMENSIONS			SEAT DIMENSIONS			BACK DIMENSIONS					
						W	D	H	W	D	H	W	H				
25.5	24	39.5				20	17-20	17.5-22.5	18.5	21							
<p>Mesh Back</p> <p>Ergonomic Features: A, B, C, E, G, H, L, M, N, Q, U</p> <p>RTA 2 FedEx ups</p>			1	2	3	4	5	6	7	8	9	10	11	12			
				G6322-0	-	\$1332	1358	1396	1447	1471	\$1518	\$1594	\$1650	1716	1847	1988	
					OVERALL DIMENSIONS			SEAT DIMENSIONS			BACK DIMENSIONS						
					W	D	H	W	D	H	W	H					
25.5	24	39.5			20	17-20	17.5-22.5	18.5	21								

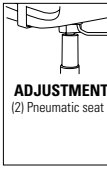
DESCRIPTION	FEATURES	MODEL#	STANDARD TEXTILE GRADES																																																		
			1	2	3	4	5	6	7	8	9	10	11	12																																							
 <p>MB Height Adjustable Stool - Task Armless COM Yardage: 1 Freight Class: 150 Product Weight (lbs.): 50 Cubic Feet Per Carton: 10.5</p>	 <p>ADJUSTMENTS (2) Pneumatic seat height (8) Seat depth</p>	<p>Mesh Back</p> <p>Ergonomic Features: C, E, M, N, U</p>	<table border="1"> <tr> <td>6327-6</td> <td>856</td> <td>894</td> <td>923</td> <td>963</td> <td>1023</td> <td>1044</td> <td>1095</td> <td>1195</td> <td>1243</td> <td>1332</td> <td>1458</td> <td>1612</td> </tr> </table>												6327-6	856	894	923	963	1023	1044	1095	1195	1243	1332	1458	1612																										
			6327-6	856	894	923	963	1023	1044	1095	1195	1243	1332	1458	1612																																						
			<table border="1"> <tr> <th colspan="3">OVERALL DIMENSIONS</th> <th colspan="3">SEAT DIMENSIONS</th> <th colspan="3">BACK DIMENSIONS</th> </tr> <tr> <th>W</th> <th>D</th> <th>H</th> <th>W</th> <th>D</th> <th>H</th> <th>W</th> <th colspan="2">H</th> </tr> <tr> <td>20</td> <td>24</td> <td>48</td> <td>20</td> <td>17.5</td> <td>23.5-33.5</td> <td>18.5</td> <td colspan="2">21</td> </tr> </table>			OVERALL DIMENSIONS			SEAT DIMENSIONS			BACK DIMENSIONS			W	D	H	W	D	H	W	H		20	24	48	20	17.5	23.5-33.5	18.5	21		<p>RTA 2</p> <p>FedEx</p> <p>ups</p>																				
			OVERALL DIMENSIONS			SEAT DIMENSIONS			BACK DIMENSIONS																																												
W	D	H	W	D	H	W	H																																														
20	24	48	20	17.5	23.5-33.5	18.5	21																																														
 <p>MB Height Adjustable Stool - Task COM Yardage: 1 Freight Class: 150 Product Weight (lbs.): 44 Cubic Feet Per Carton: 10.5</p>	 <p>ADJUSTMENTS (2) Pneumatic seat height (8) Seat depth</p>	<p>Mesh Back</p> <p>Ergonomic Features: C, E, H, M, N, Q, U</p>	<table border="1"> <tr> <td>6328-6</td> <td>966</td> <td>1004</td> <td>1033</td> <td>1073</td> <td>1133</td> <td>1153</td> <td>1204</td> <td>1303</td> <td>1352</td> <td>1442</td> <td>1568</td> <td>1720</td> </tr> </table>												6328-6	966	1004	1033	1073	1133	1153	1204	1303	1352	1442	1568	1720																										
			6328-6	966	1004	1033	1073	1133	1153	1204	1303	1352	1442	1568	1720																																						
			<table border="1"> <tr> <th colspan="3">OVERALL DIMENSIONS</th> <th colspan="3">SEAT DIMENSIONS</th> <th colspan="3">BACK DIMENSIONS</th> </tr> <tr> <th>W</th> <th>D</th> <th>H</th> <th>W</th> <th>D</th> <th>H</th> <th>W</th> <th colspan="2">H</th> </tr> <tr> <td>20</td> <td>24</td> <td>48</td> <td>20</td> <td>17.5</td> <td>23.5-33.5</td> <td>18.5</td> <td colspan="2">21</td> </tr> </table>			OVERALL DIMENSIONS			SEAT DIMENSIONS			BACK DIMENSIONS			W	D	H	W	D	H	W	H		20	24	48	20	17.5	23.5-33.5	18.5	21		<p>RTA 2</p> <p>FedEx</p> <p>ups</p>																				
			OVERALL DIMENSIONS			SEAT DIMENSIONS			BACK DIMENSIONS																																												
W	D	H	W	D	H	W	H																																														
20	24	48	20	17.5	23.5-33.5	18.5	21																																														
 <p>HB Synchro - Tilter w/Back Angle Adjustment COM Yardage: 1.25 Freight Class: 150 Product Weight (lbs.): 61 Cubic Feet Per Carton: 10.50</p>	 <p>ADJUSTMENTS (1) Tilt tension (2) Pneumatic seat height (8) Seat depth (9) Chair tilt lock (5C) Synchro-tilt action Anti-kick back</p>	<p>Upholstered Back</p> <p>Ergonomic Features: A, B, C, E, G, H, L, M, N, Q, U</p>	<table border="1"> <tr> <td>6331-0</td> <td>1131</td> <td>1179</td> <td>1211</td> <td>1263</td> <td>1338</td> <td>1367</td> <td>1428</td> <td>1554</td> <td>1612</td> <td>1725</td> <td>1882</td> <td>2074</td> </tr> <tr> <td>6331-0MO</td> <td>1192</td> <td>1262</td> <td>1320</td> <td>1401</td> <td>1520</td> <td>1563</td> <td>1666</td> <td>1863</td> <td>1957</td> <td>2140</td> <td>2389</td> <td>2698</td> </tr> <tr> <td>GC6331-0</td> <td>-</td> <td>\$1388</td> <td>\$1421</td> <td>\$1466</td> <td>\$1531</td> <td>\$1562</td> <td>\$1621</td> <td>\$1715</td> <td>\$1786</td> <td>\$1867</td> <td>\$2032</td> <td>\$2208</td> </tr> </table>												6331-0	1131	1179	1211	1263	1338	1367	1428	1554	1612	1725	1882	2074	6331-0MO	1192	1262	1320	1401	1520	1563	1666	1863	1957	2140	2389	2698	GC6331-0	-	\$1388	\$1421	\$1466	\$1531	\$1562	\$1621	\$1715	\$1786	\$1867	\$2032	\$2208
			6331-0	1131	1179	1211	1263	1338	1367	1428	1554	1612	1725	1882	2074																																						
			6331-0MO	1192	1262	1320	1401	1520	1563	1666	1863	1957	2140	2389	2698																																						
			GC6331-0	-	\$1388	\$1421	\$1466	\$1531	\$1562	\$1621	\$1715	\$1786	\$1867	\$2032	\$2208																																						
<table border="1"> <tr> <th colspan="3">OVERALL DIMENSIONS</th> <th colspan="3">SEAT DIMENSIONS</th> <th colspan="3">BACK DIMENSIONS</th> </tr> <tr> <th>W</th> <th>D</th> <th>H</th> <th>W</th> <th>D</th> <th>H</th> <th>W</th> <th colspan="2">H</th> </tr> <tr> <td>25.5</td> <td>24</td> <td>41.5</td> <td>20</td> <td>17-20</td> <td>17.5-22.5</td> <td>18.5</td> <td colspan="2">23</td> </tr> </table>			OVERALL DIMENSIONS			SEAT DIMENSIONS			BACK DIMENSIONS			W	D	H	W	D	H	W	H		25.5	24	41.5	20	17-20	17.5-22.5	18.5	23		<p>RTA 2</p> <p>FedEx</p> <p>ups</p>																							
OVERALL DIMENSIONS			SEAT DIMENSIONS			BACK DIMENSIONS																																															
W	D	H	W	D	H	W	H																																														
25.5	24	41.5	20	17-20	17.5-22.5	18.5	23																																														
 <p>HB Multi - Tilter COM Yardage: 1.25 Freight Class: 125 Product Weight (lbs.): 63 Cubic Feet Per Carton: 10.5</p>	 <p>ADJUSTMENTS (1) Tilt tension (2) Pneumatic seat height (7) Forward tilt lock (8) Seat depth (9) Chair tilt lock (5A) Center-tilt action</p>	<p>Upholstered back</p> <p>Ergonomic Features: A, B, C, E, F, G, H, M, N, Q, U, S</p>	<table border="1"> <tr> <td>6331-3</td> <td>1131</td> <td>1179</td> <td>1211</td> <td>1263</td> <td>1338</td> <td>1367</td> <td>1428</td> <td>1554</td> <td>1612</td> <td>1725</td> <td>1882</td> <td>2074</td> </tr> <tr> <td>6331-3MO</td> <td>1192</td> <td>1262</td> <td>1320</td> <td>1401</td> <td>1520</td> <td>1563</td> <td>1666</td> <td>1863</td> <td>1957</td> <td>2140</td> <td>2389</td> <td>2698</td> </tr> </table>												6331-3	1131	1179	1211	1263	1338	1367	1428	1554	1612	1725	1882	2074	6331-3MO	1192	1262	1320	1401	1520	1563	1666	1863	1957	2140	2389	2698													
			6331-3	1131	1179	1211	1263	1338	1367	1428	1554	1612	1725	1882	2074																																						
			6331-3MO	1192	1262	1320	1401	1520	1563	1666	1863	1957	2140	2389	2698																																						
			<table border="1"> <tr> <th colspan="3">OVERALL DIMENSIONS</th> <th colspan="3">SEAT DIMENSIONS</th> <th colspan="3">BACK DIMENSIONS</th> </tr> <tr> <th>W</th> <th>D</th> <th>H</th> <th>W</th> <th>D</th> <th>H</th> <th>W</th> <th colspan="2">H</th> </tr> <tr> <td>25.5</td> <td>24</td> <td>41</td> <td>20</td> <td>17-20</td> <td>17.25-22.25</td> <td>18.5</td> <td colspan="2">23</td> </tr> </table>			OVERALL DIMENSIONS			SEAT DIMENSIONS			BACK DIMENSIONS			W	D	H	W	D	H	W	H		25.5	24	41	20	17-20	17.25-22.25	18.5	23		<p>RTA 2</p> <p>FedEx</p> <p>ups</p>																				
OVERALL DIMENSIONS			SEAT DIMENSIONS			BACK DIMENSIONS																																															
W	D	H	W	D	H	W	H																																														
25.5	24	41	20	17-20	17.25-22.25	18.5	23																																														
 <p>HB Tilter COM Yardage: 1.25 Freight Class: 150 Product Weight (lbs.): 55 Cubic Feet Per Carton: 10.5</p>	 <p>ADJUSTMENTS (1) Tilt tension (2) Pneumatic seat height (5A) Center-tilt action</p>	<p>Upholstered back</p> <p>Ergonomic Features: A, B, C, E, H, M, N, Q, S, U</p>	<table border="1"> <tr> <td>6331-4</td> <td>1011</td> <td>1059</td> <td>1095</td> <td>1146</td> <td>1220</td> <td>1247</td> <td>1308</td> <td>1434</td> <td>1493</td> <td>1607</td> <td>1763</td> <td>1954</td> </tr> <tr> <td>6331-4MO</td> <td>1072</td> <td>1145</td> <td>1200</td> <td>1284</td> <td>1400</td> <td>1444</td> <td>1547</td> <td>1744</td> <td>1839</td> <td>2021</td> <td>2269</td> <td>2581</td> </tr> <tr> <td>GC6331-4</td> <td>-</td> <td>\$1213</td> <td>\$1247</td> <td>\$1293</td> <td>\$1360</td> <td>\$1392</td> <td>\$1452</td> <td>\$1548</td> <td>\$1624</td> <td>\$1706</td> <td>\$1876</td> <td>\$2058</td> </tr> </table>												6331-4	1011	1059	1095	1146	1220	1247	1308	1434	1493	1607	1763	1954	6331-4MO	1072	1145	1200	1284	1400	1444	1547	1744	1839	2021	2269	2581	GC6331-4	-	\$1213	\$1247	\$1293	\$1360	\$1392	\$1452	\$1548	\$1624	\$1706	\$1876	\$2058
			6331-4	1011	1059	1095	1146	1220	1247	1308	1434	1493	1607	1763	1954																																						
			6331-4MO	1072	1145	1200	1284	1400	1444	1547	1744	1839	2021	2269	2581																																						
			GC6331-4	-	\$1213	\$1247	\$1293	\$1360	\$1392	\$1452	\$1548	\$1624	\$1706	\$1876	\$2058																																						
<table border="1"> <tr> <th colspan="3">OVERALL DIMENSIONS</th> <th colspan="3">SEAT DIMENSIONS</th> <th colspan="3">BACK DIMENSIONS</th> </tr> <tr> <th>W</th> <th>D</th> <th>H</th> <th>W</th> <th>D</th> <th>H</th> <th>W</th> <th colspan="2">H</th> </tr> <tr> <td>25.5</td> <td>24</td> <td>39.25</td> <td>20</td> <td>17.5</td> <td>16-21</td> <td>18.5</td> <td colspan="2">23</td> </tr> </table>			OVERALL DIMENSIONS			SEAT DIMENSIONS			BACK DIMENSIONS			W	D	H	W	D	H	W	H		25.5	24	39.25	20	17.5	16-21	18.5	23		<p>RTA 2</p> <p>FedEx</p> <p>ups</p>																							
OVERALL DIMENSIONS			SEAT DIMENSIONS			BACK DIMENSIONS																																															
W	D	H	W	D	H	W	H																																														
25.5	24	39.25	20	17.5	16-21	18.5	23																																														

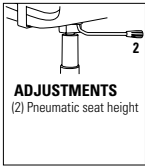
DESCRIPTION	FEATURES	MODEL#	STANDARD TEXTILE GRADES																																					
			1	2	3	4	5	6	7	8	9	10	11	12																										
 <p>HB Task COM Yardage: 1.25 Freight Class: 150 Product Weight (lbs.): 49 Cubic Feet Per Carton: 10.5</p>	 <p>ADJUSTMENTS (2) Pneumatic seat height (8) Seat depth</p>	<p>Upholstered Back</p> <p>Ergonomic Features: C, E, M, N</p>	<table border="1"> <tr> <td>6331-6</td> <td>982</td> <td>1029</td> <td>1062</td> <td>1114</td> <td>1189</td> <td>1216</td> <td>1279</td> <td>1404</td> <td>1463</td> <td>1576</td> <td>1733</td> <td>1925</td> </tr> <tr> <td>6331-6MO</td> <td>1042</td> <td>1114</td> <td>1170</td> <td>1254</td> <td>1373</td> <td>1414</td> <td>1517</td> <td>1714</td> <td>1808</td> <td>1991</td> <td>2239</td> <td>2549</td> </tr> </table>												6331-6	982	1029	1062	1114	1189	1216	1279	1404	1463	1576	1733	1925	6331-6MO	1042	1114	1170	1254	1373	1414	1517	1714	1808	1991	2239	2549
			6331-6	982	1029	1062	1114	1189	1216	1279	1404	1463	1576	1733	1925																									
			6331-6MO	1042	1114	1170	1254	1373	1414	1517	1714	1808	1991	2239	2549																									
			OVERALL DIMENSIONS			SEAT DIMENSIONS			BACK DIMENSIONS																															
W	D	H	W	D	H	W	H																																	
25.5	24	39.25	20	17.5	17-22	18.5	23																																	
			<p>RTA 2 FedEx UPS</p>																																					
 <p>HB Weight Sensing Synchro - Tilter COM Yardage: 1.25 Freight Class: 150 Product Weight (lbs.): 58 Cubic Feet Per Carton: 10.5</p>	 <p>ADJUSTMENTS Weight sensing auto tension adjustment (2) Pneumatic seat height (8) Sliding seat depth (9) Multi position tilt lock</p>	<p>Upholstered Back</p> <p>Ergonomic Features: A, B, C, E, H, L, M, N, Q, U</p>	<table border="1"> <tr> <td>6331-8</td> <td>1131</td> <td>1179</td> <td>1211</td> <td>1263</td> <td>1338</td> <td>1367</td> <td>1428</td> <td>1554</td> <td>1612</td> <td>1725</td> <td>1882</td> <td>2074</td> </tr> <tr> <td>6331-8MO</td> <td>1192</td> <td>1262</td> <td>1320</td> <td>1401</td> <td>1520</td> <td>1563</td> <td>1666</td> <td>1863</td> <td>1957</td> <td>2140</td> <td>2389</td> <td>2698</td> </tr> </table>												6331-8	1131	1179	1211	1263	1338	1367	1428	1554	1612	1725	1882	2074	6331-8MO	1192	1262	1320	1401	1520	1563	1666	1863	1957	2140	2389	2698
			6331-8	1131	1179	1211	1263	1338	1367	1428	1554	1612	1725	1882	2074																									
			6331-8MO	1192	1262	1320	1401	1520	1563	1666	1863	1957	2140	2389	2698																									
			OVERALL DIMENSIONS			SEAT DIMENSIONS			BACK DIMENSIONS																															
W	D	H	W	D	H	W	H																																	
25.5	24	40	20	17-20	16.5-21.5	18.5	23																																	
			<p>RTA 2 FedEx UPS</p>																																					
 <p>MB Synchro - Tilter w/Back Angle Adjustment COM Yardage: 1.25 Freight Class: 150 Product Weight (lbs.): 59 Cubic Feet Per Carton: 10.5</p>	 <p>ADJUSTMENTS (1) Tilt tension (2) Pneumatic seat height (8) Seat depth (9) Chair tilt lock (5C) Synchro-tilt action Anti-kick back</p>	<p>Upholstered Back</p> <p>Ergonomic Features: A, B, C, E, G, H, L, M, N, Q, U</p>	<table border="1"> <tr> <td>6332-0</td> <td>1079</td> <td>1127</td> <td>1159</td> <td>1211</td> <td>1286</td> <td>1314</td> <td>1376</td> <td>1502</td> <td>1560</td> <td>1673</td> <td>1830</td> <td>2022</td> </tr> <tr> <td>6332-0MO</td> <td>1138</td> <td>1214</td> <td>1278</td> <td>1370</td> <td>1495</td> <td>1555</td> <td>1672</td> <td>1858</td> <td>2000</td> <td>2160</td> <td>2487</td> <td>2835</td> </tr> </table>												6332-0	1079	1127	1159	1211	1286	1314	1376	1502	1560	1673	1830	2022	6332-0MO	1138	1214	1278	1370	1495	1555	1672	1858	2000	2160	2487	2835
			6332-0	1079	1127	1159	1211	1286	1314	1376	1502	1560	1673	1830	2022																									
			6332-0MO	1138	1214	1278	1370	1495	1555	1672	1858	2000	2160	2487	2835																									
			OVERALL DIMENSIONS			SEAT DIMENSIONS			BACK DIMENSIONS																															
W	D	H	W	D	H	W	H																																	
25.5	24	39.5	20	17-20	17.5-22.5	18.5	21																																	
			<p>RTA 2 FedEx UPS</p>																																					
 <p>MB Multi - Tilter COM Yardage: 1.25 Freight Class: 150 Product Weight (lbs.): 61 Cubic Feet Per Carton: 10.5</p>	 <p>ADJUSTMENTS (1) Tilt tension (2) Pneumatic seat height (7) Forward tilt lock (8) Seat depth (9) Chair tilt lock (5A) Center-tilt action</p>	<p>Upholstered Back</p> <p>Ergonomic Features: A, B, C, E, F, G, H, M, N, Q, U, S</p>	<table border="1"> <tr> <td>6332-3</td> <td>1079</td> <td>1127</td> <td>1159</td> <td>1211</td> <td>1286</td> <td>1314</td> <td>1376</td> <td>1502</td> <td>1560</td> <td>1673</td> <td>1830</td> <td>2022</td> </tr> <tr> <td>6332-3MO</td> <td>1138</td> <td>1214</td> <td>1278</td> <td>1370</td> <td>1495</td> <td>1555</td> <td>1672</td> <td>1858</td> <td>2000</td> <td>2160</td> <td>2487</td> <td>2835</td> </tr> </table>												6332-3	1079	1127	1159	1211	1286	1314	1376	1502	1560	1673	1830	2022	6332-3MO	1138	1214	1278	1370	1495	1555	1672	1858	2000	2160	2487	2835
			6332-3	1079	1127	1159	1211	1286	1314	1376	1502	1560	1673	1830	2022																									
			6332-3MO	1138	1214	1278	1370	1495	1555	1672	1858	2000	2160	2487	2835																									
			OVERALL DIMENSIONS			SEAT DIMENSIONS			BACK DIMENSIONS																															
W	D	H	W	D	H	W	H																																	
25.5	24	39	20	17-20	17.25-22.25	18.5	21																																	
			<p>RTA 2 FedEx UPS</p>																																					
 <p>MB Tilter COM Yardage: 1.25 Freight Class: 150 Product Weight (lbs.): 53 Cubic Feet Per Carton: 10.5</p>	 <p>ADJUSTMENTS (1) Tilt tension (2) Pneumatic seat height (5A) Center-tilt action</p>	<p>Upholstered Back</p> <p>Ergonomic Features: A, B, C, E, H, M, N, Q, S, U</p>	<table border="1"> <tr> <td>6332-4</td> <td>966</td> <td>1013</td> <td>1049</td> <td>1099</td> <td>1174</td> <td>1201</td> <td>1262</td> <td>1388</td> <td>1447</td> <td>1560</td> <td>1717</td> <td>1909</td> </tr> <tr> <td>6332-4MO</td> <td>1028</td> <td>1101</td> <td>1156</td> <td>1240</td> <td>1356</td> <td>1400</td> <td>1503</td> <td>1700</td> <td>1795</td> <td>1977</td> <td>2225</td> <td>2537</td> </tr> </table>												6332-4	966	1013	1049	1099	1174	1201	1262	1388	1447	1560	1717	1909	6332-4MO	1028	1101	1156	1240	1356	1400	1503	1700	1795	1977	2225	2537
			6332-4	966	1013	1049	1099	1174	1201	1262	1388	1447	1560	1717	1909																									
			6332-4MO	1028	1101	1156	1240	1356	1400	1503	1700	1795	1977	2225	2537																									
			OVERALL DIMENSIONS			SEAT DIMENSIONS			BACK DIMENSIONS																															
W	D	H	W	D	H	W	H																																	
25.5	24	37.5	20	17.5	16-21	18.5	21																																	
			<p>RTA 2 FedEx UPS</p>																																					

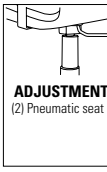
DESCRIPTION	FEATURES	MODEL#	STANDARD TEXTILE GRADES													
			1	2	3	4	5	6	7	8	9	10	11	12		
 <p>MB Task COM Yardage: 1.25 Freight Class: 150 Product Weight (lbs.): 48 Cubic Feet Per Carton: 10.5</p>	 <p>ADJUSTMENTS (2) Pneumatic seat height (8) Seat depth</p>	6332-6	939	987	1022	1072	1147	1175	1236	1362	1421	1533	1691	1882		
		6332-6MO	999	1071	1127	1208	1327	1371	1473	1670	1765	1947	2194	2506		
		OVERALL DIMENSIONS	W	D	H	SEAT DIMENSIONS			BACK DIMENSIONS							
		25.5	24	37.5	20	17.5	17-22	18.5	21							
<p>Upholstered Back</p> <p>Ergonomic Features: C, E, M, N, Q, U</p>																
		 <p>MB Task - Armless COM Yardage: 1.25 Freight Class: 150 Product Weight (lbs.): 42 Cubic Feet Per Carton: 10.5</p>	 <p>ADJUSTMENTS (2) Pneumatic seat height (8) Seat depth</p>	6333-6	893	940	973	1025	1100	1128	1189	1315	1374	1486	1644	1836
				6333-6MO	963	1036	1091	1176	1294	1335	1437	1634	1729	1912	2162	2469
				OVERALL DIMENSIONS	W	D	H	SEAT DIMENSIONS			BACK DIMENSIONS					
20	24			37.5	20	17.5	17-22	18.5	21							
<p>Upholstered Back</p> <p>Ergonomic Features: C, E, M, N, U</p>																
		 <p>MB Weight Sensing Synchro - Tilter COM Yardage: 1.25 Freight Class: 150 Product Weight (lbs.): 56 Cubic Feet Per Carton: 10.5</p>	 <p>ADJUSTMENTS Weight sensing auto tension adjustment (2) Pneumatic seat height (8) Sliding seat depth (9) Multi position tilt lock</p>	6332-8	1079	1127	1159	1211	1286	1314	1376	1502	1560	1673	1830	2022
				6332-8MO	1138	1214	1278	1370	1495	1555	1672	1858	2000	2160	2487	2835
				OVERALL DIMENSIONS	W	D	H	SEAT DIMENSIONS			BACK DIMENSIONS					
25.5	24			38	20	17-20	16.5-21.5	18.5	21							
<p>Upholstered Back</p> <p>Ergonomic Features: A, B, C, E, H, L, M, N, Q, U</p>																
		 <p>MB Height Adjustable Stool - Task Armless COM Yardage: 1.25 Freight Class: 150 Product Weight (lbs.): 45 Cubic Feet Per Carton: 10.5</p>	 <p>ADJUSTMENTS (2) Pneumatic seat height (8) Seat depth</p>	6337-6	966	1014	1050	1101	1175	1202	1265	1389	1448	1562	1718	1910
				6337-6MO	1033	1105	1160	1245	1361	1404	1507	1704	1799	1981	2228	2540
				OVERALL DIMENSIONS	W	D	H	SEAT DIMENSIONS			BACK DIMENSIONS					
20	24			48	20	17.5	23.5-33.5	18.5	21							
<p>Upholstered Back</p> <p>Ergonomic Features: C, E, M, N, U</p>																
		 <p>MB Height Adjustable Stool - Task COM Yardage: 1.25 Freight Class: 150 Product Weight (lbs.): 51 Cubic Feet Per Carton: 10.5</p>	 <p>ADJUSTMENTS (2) Pneumatic seat height (8) Seat depth</p>	6338-6	1085	1133	1168	1220	1293	1321	1382	1508	1567	1679	1837	2028
				6338-6MO	1150	1223	1278	1362	1478	1522	1624	1821	1916	2098	2347	2656
				OVERALL DIMENSIONS	W	D	H	SEAT DIMENSIONS			BACK DIMENSIONS					
20	24			48	20	17.5	23.5-33.5	18.5	21							
<p>Upholstered Back</p> <p>Ergonomic Features: C, E, H, M, N, Q, U</p>																

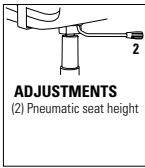
DESCRIPTION	FEATURES	MODEL#	STANDARD TEXTILE GRADES													
			1	2	3	4	5	6	7	8	9	10	11	12		
 <p>Lumbar Pad Kit COM Yardage: N/A Freight Class: 70 Product Weight (lbs.): 1.5 Cubic Feet Per Carton: 0.5</p>		6339	43	-	-	-	-	-	-	-	-	-	-	-	-	
			OVERALL DIMENSIONS			SEAT DIMENSIONS			BACK DIMENSIONS							
			W	D	H	W	D	H	W	H						
			10.25	3.5	5.25											
			RTA 00	FedEx		ups										
 <p>HB Tilter with Pedestal Base COM Yardage: 1 Freight Class: 150 Product Weight (lbs.): 55 Cubic Feet Per Carton: 10.5</p>	 <p>ADJUSTMENTS (1) Tilt tension (2) Pneumatic seat height (5A) Center-tilt action</p>	6321-4PB	1124	1159	1185	1224	1279	1304	1356	1433	1495	1562	1702	1851		
			OVERALL DIMENSIONS			SEAT DIMENSIONS			BACK DIMENSIONS							
			W	D	H	W	D	H	W	H						
			25.5	24	41	20	17.5	16-21	18.5	23						
			RTA 2	FedEx		ups										
 <p>MB Tilter with Pedestal Base COM Yardage: 1 Freight Class: 150 Product Weight (lbs.): 52 Cubic Feet Per Carton: 10.5</p>	 <p>ADJUSTMENTS (1) Tilt tension (2) Pneumatic seat height (5A) Center-tilt action</p>	6322-4PB	1072													
			OVERALL DIMENSIONS			SEAT DIMENSIONS			BACK DIMENSIONS							
			W	D	H	W	D	H	W	H						
			25.5	24	37.5	20	17.5	16-21	18.5	21						
			RTA 2	FedEx		ups										
 <p>HB Tilter with Pedestal Base COM Yardage: 1.9 Freight Class: 150 Product Weight (lbs.): 56 Cubic Feet Per Carton: 10.5</p>	 <p>ADJUSTMENTS (1) Tilt tension (2) Pneumatic seat height (5A) Center-tilt action</p>	6331-4PB	1242	1312	1367	1448	1563	1617	1723	1887	2017	2157	2453	2764		
			OVERALL DIMENSIONS			SEAT DIMENSIONS			BACK DIMENSIONS							
			W	D	H	W	D	H	W	H						
			25.5	24	39.25	20	17.5	16-21	18.5	23						
			RTA 2	FedEx		ups										

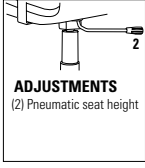
DESCRIPTION	FEATURES	MODEL#	STANDARD TEXTILE GRADES														
			1	2	3	4	5	6	7	8	9	10	11	12			
 <p>MB Tilter with Pedestal Base COM Yardage: 1.25 Freight Class: 150 Product Weight (lbs.): 54 Cubic Feet Per Carton: 10.5</p>	 <p>ADJUSTMENTS (1) Tilt tension (2) Pneumatic seat height (5A) Center-tilt action</p> <p>Upholstered Back</p> <p>Ergonomic Features: A, B, C, E, H, M, N, O, S, U</p>	<p>6332-4PB</p>	1197	1246	1284	1339	1413	1451	1519	1631	1719	1813	2010	2219			
			OVERALL DIMENSIONS			SEAT DIMENSIONS			BACK DIMENSIONS								
			W	D	H	W	D	H	W	H							
			25.5	24	39	20	17.5	16-21	18.5	21							
			<p>RTA 2   1 per carton</p>														
 <p>mesh back</p> <p>Armless Task with Pedestal Base COM Yardage: 1 Freight Class: 150 Product Weight (lbs.): 33 Cubic Feet Per Carton: 15.75</p>	 <p>ADJUSTMENTS (2) Pneumatic seat height</p> <p>Ergonomic features: M, N</p>	<p>6364-6PB</p>	\$1130	\$1168	\$1196	\$1237	\$1297	\$1326	\$1378	\$1463	\$1528	\$1601	\$1751	\$1910			
			OVERALL DIMENSIONS			SEAT DIMENSIONS			BACK DIMENSIONS								
			W	D	H	W	D	H	W	H							
			23.5	29	35.5	19	18	16-21	19	17							
			<p>RTA 00 1 per carton</p>														
 <p>mesh back</p> <p>Armless Task w/Tablet and Pedestal Base COM Yardage: 1 Freight Class: 150 Product Weight (lbs.): 33 Cubic Feet Per Carton: 17.75</p>	 <p>ADJUSTMENTS (2) Pneumatic seat height</p> <p>Ergonomic features: M, N</p> <p>Specify (L) left or (R) right tablet. (Example: 6364-6L or 6364-6R).</p>	<p>6364-6LPB 6364-6RPB</p>	1453	1490	1518	1559	1618	1648	1699	1786	1850	1924	2073	2233			
			OVERALL DIMENSIONS			SEAT DIMENSIONS			BACK DIMENSIONS								
			W	D	H	W	D	H	W	H							
			23.5	29	35.5	19	18	16-21	19	17							
			<p>RTA 00 1 per carton</p>														
 <p>upholstered back</p> <p>Armless Task with Pedestal Base COM Yardage: 1.25 Freight Class: 150 Product Weight (lbs.): 33 Cubic Feet Per Carton: 15.75</p>	 <p>ADJUSTMENTS (2) Pneumatic seat height</p> <p>Ergonomic features: M, N</p>	<p>6374-6PB</p>	\$1130	\$1177	\$1213	\$1263	\$1337	\$1372	\$1439	\$1545	\$1626	\$1717	\$1905	\$2104			
			OVERALL DIMENSIONS			SEAT DIMENSIONS			BACK DIMENSIONS								
			W	D	H	W	D	H	W	H							
			23.5	29	35.5	19	18	16-21	19	17							
			<p>RTA 00 1 per carton</p>														
 <p>upholstered back</p> <p>Armless Task w/Tablet and Pedestal Base COM Yardage: 1.25 Freight Class: 250 Product Weight (lbs.): 44 Cubic Feet Per Carton: 11.75</p>	 <p>ADJUSTMENTS (2) Pneumatic seat height</p> <p>Ergonomic features: M, N</p> <p>Specify (L) left or (R) right tablet. (Example: 6374-6L or 6374-6R, 6374-6MOL or 6374-6MOR).</p>	<p>6374-6LPB 6374-6RPB</p>	1453	1499	1533	1585	1659	1694	1761	1867	1949	2040	2228	2427			
			OVERALL DIMENSIONS			SEAT DIMENSIONS			BACK DIMENSIONS								
			W	D	H	W	D	H	W	H							
			23.5	29	35.5	19	18	16-21	19	17							
			<p>RTA 00 1 per carton</p>														

WEEV



model 2220-3



model 2221-4

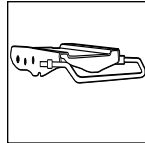

Multi-Depth Mechanism
Seat depth is standard on Multi-tilter and Synchro-Tilter models. (see notes for more details)



Stitch detail on Leather upholstered seat



Vari-Width (WA)
Width Adjustable Arm Extensions is standard when order with adjustable height arms.





STANDARD FEATURES





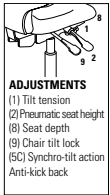

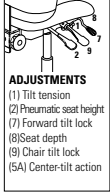

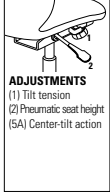

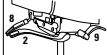
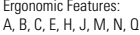



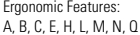

- A beautiful, breathable mesh, functional task seating series, at affordable pricing.
- Weev series includes six mechanisms, a Synchro-Tilter with Back Angle, Weight Sensing Synchro-Tilter, Multi-Tilter, Tilter, and Task.
- The Black mesh for the back of the chair is woven to breathe and give as the user leans into it removing pressure points along the spine.
- The lumbar support built into the design of the back is flexible and reshapes itself to match and support the user's body profile.
- Side activated sliding seat depth adjustment (**MD**), is standard on Multi-Tilters and Synchro-Tilters providing 2" of seat depth adjustment.
- Height and width (**WA**) adjustable GL arms. Armcaps are soft to the touch Self-Skinned Urethane. Armcaps are depth adjustable (slide forward and backward) to suit user preference.
- Vari-Width (**WA**) Width Adjustable Arm Extensions are standard, allowing the arms to move away from the seat by 2" on each side to allow space for broader hip widths. Five legged, injection molded, fiberglass reinforced, nylon base **B7B** is standard.
- **C1** dual wheel carpet casters are standard.

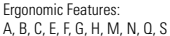



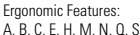

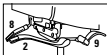
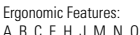
- Models upholstered in leather have a straight seam across the seat.
- Check textile availability prior to specifying upholstery material.

OPTIONAL FEATURES

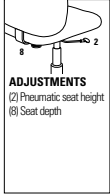
- Please refer to the "Arm Selection" section of the price book for arm options.
- Please refer to "Cylinder Selection" section of the price book for additional cylinder options.
- For optional polished Aluminum base (**B7A**) Please specify **ALU** base. Add \$167.
- For hard surface flooring casters, specify **C9R**. Add \$73.
- Please refer to the "Casters Selection" section of the price book for caster options. Optional casters may be priced higher than the standard casters for your chair and the difference will be charged. Lower priced optional casters will not be credited.
- For fully assembled in box, specify **SU**. Add \$76.

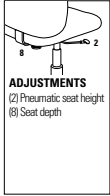
DESCRIPTION	FEATURES	MODEL#	STANDARD TEXTILE GRADES													
			1	2	3	4	5	6	7	8	9	10	11	12		
 <p>HB Synchro - Tilter w/Back Angle Adjustment COM Yardage: 1 Freight Class: 125 Product Weight (lbs.): 68 Cubic Feet Per Carton: 10.5</p>	 <p>ADJUSTMENTS (1) Tilt tension (2) Pneumatic seat height (8) Seat depth (9) Chair tilt lock (5C) Synchro-tilt action Anti-kick back</p>	<p>2220-0</p>	925	963	992	1033	1094	1112	1164	1262	1312	1402	1528	1680		
			OVERALL DIMENSIONS			SEAT DIMENSIONS			BACK DIMENSIONS							
			W	D	H	W	D	H	W	H						
			25	24	42	19	18-20.5	16-20	19	27						
			RTA 2			FedEx			ups							
 <p>HB Multi - Tilter COM Yardage: 1 Freight Class: 125 Product Weight (lbs.): 70 Cubic Feet Per Carton: 10.5</p>	 <p>ADJUSTMENTS (1) Tilt tension (2) Pneumatic seat height (7) Forward tilt lock (8) Seat depth (9) Chair tilt lock (5A) Center-tilt action</p>	<p>2220-3</p>	925	963	992	1033	1094	1112	1164	1262	1312	1402	1528	1680		
			OVERALL DIMENSIONS			SEAT DIMENSIONS			BACK DIMENSIONS							
			W	D	H	W	D	H	W	H						
			25	24	42	19	18-20.5	16-20	19	27						
			RTA 2			FedEx			ups							
 <p>HB Tilter COM Yardage: 1 Freight Class: 150 Product Weight (lbs.): 59 Cubic Feet Per Carton: 10.5</p>	 <p>ADJUSTMENTS (1) Tilt tension (2) Pneumatic seat height (5A) Center-tilt action</p>	<p>2220-4</p>	793	831	860	903	961	980	1034	1132	1181	1272	1396	1549		
			OVERALL DIMENSIONS			SEAT DIMENSIONS			BACK DIMENSIONS							
			W	D	H	W	D	H	W	H						
			25	24	42.5	19	18-20.5	16-20	19	27						
			RTA 2			FedEx			ups							

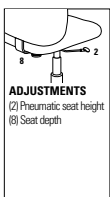
DESCRIPTION	FEATURES	MODEL#	STANDARD TEXTILE GRADES														
			1	2	3	4	5	6	7	8	9	10	11	12			
 <p>HB Weight Sensing Synchro - Tilter COM Yardage: 1 Freight Class: 125 Product Weight (lbs.): 70 Cubic Feet Per Carton: 10.5</p>	 <p>ADJUSTMENTS Weight sensing auto tension adjustment (2) Pneumatic seat height (8) Sliding seat depth (9) Multi position tilt lock</p>	2220-8	925	963	992	1033	1094	1112	1164	1262	1312	1402	1528	1680			
			OVERALL DIMENSIONS			SEAT DIMENSIONS			BACK DIMENSIONS								
			W	D	H	W	D	H	W	H							
			25	24	42	19	18-20.5	16-20	19	27							
																	
			 <p>MB Synchro - Tilter w/Back Angle Adjustment COM Yardage: 1 Freight Class: 125 Product Weight (lbs.): 66 Cubic Feet Per Carton: 10.5</p>	 <p>ADJUSTMENTS (1) Tilt tension (2) Pneumatic seat height (8) Seat depth (9) Chair tilt lock (5C) Synchro-tilt action Anti-knock back</p>	2221-0	895	931	960	1001	1060	1081	1133	1231	1280	1371	1495	1649
						OVERALL DIMENSIONS			SEAT DIMENSIONS			BACK DIMENSIONS					
						W	D	H	W	D	H	W	H				
25	24	39				19	18-20.5	16-20	19	24							
																	
			 <p>MB Multi - Tilter COM Yardage: 1 Freight Class: 125 Product Weight (lbs.): 68 Cubic Feet Per Carton: 10.5</p>	 <p>ADJUSTMENTS (1) Tilt tension (2) Pneumatic seat height (7) Forward tilt lock (8) Seat depth (9) Chair tilt lock (5A) Center-tilt action</p>	2221-3	895	931	960	1001	1060	1081	1133	1231	1280	1371	1495	1649
						OVERALL DIMENSIONS			SEAT DIMENSIONS			BACK DIMENSIONS					
						W	D	H	W	D	H	W	H				
25	24	39				19	18-20.5	16-20	19	24							
																	
			 <p>MB Tilter COM Yardage: 1 Freight Class: 150 Product Weight (lbs.): 57 Cubic Feet Per Carton: 10.5</p>	 <p>ADJUSTMENTS (1) Tilt tension (2) Pneumatic seat height (5A) Center-tilt action</p>	2221-4	765	803	830	872	930	951	1003	1101	1151	1240	1365	1519
						OVERALL DIMENSIONS			SEAT DIMENSIONS			BACK DIMENSIONS					
						W	D	H	W	D	H	W	H				
25	24	39.5				19	18-20.5	16-20	19	24							
																	
			 <p>MB Weight Sensing Synchro - Tilter COM Yardage: 1 Freight Class: 125 Product Weight (lbs.): 68 Cubic Feet Per Carton: 10.5</p>	 <p>ADJUSTMENTS Weight sensing auto tension adjustment (2) Pneumatic seat height (8) Sliding seat depth (9) Multi position tilt lock</p>	2221-8	895	931	960	1001	1060	1081	1133	1231	1280	1371	1495	1649
						OVERALL DIMENSIONS			SEAT DIMENSIONS			BACK DIMENSIONS					
						W	D	H	W	D	H	W	H				
25	24	39				19	18-20.5	16-20	19	24							
																	

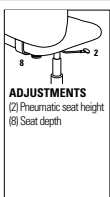
DESCRIPTION	FEATURES	MODEL#	STANDARD TEXTILE GRADES											
			1	2	3	4	5	6	7	8	9	10	11	12
 <p>MB Task COM Yardage: 1 Freight Class: 150 Product Weight (lbs.): 48 Cubic Feet Per Carton: 10.5</p>	 <p>ADJUSTMENTS (2) Pneumatic seat height (8) Seat depth</p> <p>Ergonomic Features: C, E, H, M, N, Q</p>	2221-6	765	803	830	872	930	951	1003	1101	1151	1240	1365	1519
			OVERALL DIMENSIONS			SEAT DIMENSIONS			BACK DIMENSIONS					
			W	D	H	W	D	H	W	H				
			25	24	41	19	17.5-18.5	16.5-20.5	19	24				
			RTA 2	FedEx	ups									
 <p>MB Task Armless COM Yardage: 1 Freight Class: 150 Product Weight (lbs.): 42 Cubic Feet Per Carton: 10.5</p>	 <p>ADJUSTMENTS (2) Pneumatic seat height (8) Seat depth</p> <p>Ergonomic Features: C, E, M, N</p>	2222-6	640	680	709	748	809	827	881	979	1027	1117	1242	1396
			OVERALL DIMENSIONS			SEAT DIMENSIONS			BACK DIMENSIONS					
			W	D	H	W	D	H	W	H				
			25	24	41	19	17.5-18.5	16.5-20.5	19	24				
			RTA 2	FedEx	ups									
 <p>MB Height Adjustable Stool Task COM Yardage: 1 Freight Class: 150 Product Weight (lbs.): 51 Cubic Feet Per Carton: 10.5</p>	 <p>ADJUSTMENTS (2) Pneumatic seat height (8) Seat depth</p> <p>Ergonomic Features: C, E, H, M, N, Q</p>	2223-6	1193	1230	1258	1299	1360	1378	1431	1529	1578	1669	1793	1947
			OVERALL DIMENSIONS			SEAT DIMENSIONS			BACK DIMENSIONS					
			W	D	H	W	D	H	W	H				
			20.5	24.5	48	19	17.5-18.5	24-34	19	24				
			RTA 2	FedEx	ups									
 <p>MB Height Adjustable Stool Task Armless COM Yardage: 1 Freight Class: 150 Product Weight (lbs.): 45 Cubic Feet Per Carton: 10.5</p>	 <p>ADJUSTMENTS (2) Pneumatic seat height (8) Seat depth</p> <p>Ergonomic Features: C, E, M, N</p>	2224-6	1064	1102	1131	1172	1232	1251	1303	1401	1450	1541	1667	1819
			OVERALL DIMENSIONS			SEAT DIMENSIONS			BACK DIMENSIONS					
			W	D	H	W	D	H	W	H				
			19	24	50.5	19	17.5-18.5	24-34	19	24				
			RTA 2											

multi-purpose

Bakhita	135	Islands	182	Sas	208
Beach	138	Layne	183	Sidero	210
Beam Seating	139	Lite	185	Sonic	214
Caprice	149	Marche	190	Spritz	230
Chap	151	Mayne	192	Spyker	233
Comet	153	Moda Four-Legged	193	Stream	234
Diplomat	156	Moda Stacking	194	Twilight	246
Duet	157	Popcorn	196	Vion guest	249
Erin	177	Rebound	201	Willow	254
File Buddy	179	Roma Nester	206	Zoma	268

BAKHITA



model 6750



model 6753









model 6754









model 6785

STANDARD FEATURES

- A comfortable, high-quality, lightweight, stacking chair that is incredibly strong and durable.
- Bakhita is an all polymer chair intended for use indoors or outdoors. Products must be stored inside during extreme and inclement weather. See Global's Outdoor Furniture warranty for additional information.
- Weather resistant, UV and stain resistant, with a modern design.
- Standard height models (6750, 6751) are suitable for use in MRI rooms.
- Chairs are simultaneously molded with two different materials. Inside is a structural fiberglass frame for strength. Outside is a durable polypropylene light fast compound.
- Armchairs and Armless Chairs are finished with a smooth surface. Bar Stools and Counter Stools are finished with a slightly textured surface.
- Upholstered seats will only fit on a frame made for this purpose, it is not possible to add an upholstered seat onto an existing all plastic chair in the field.
- Upholstered seats are fixed and non-removable.
- Chair legs are equipped with translucent non-marking glides as standard. Suitable for outdoor environments, carpet and hard surface flooring.
- Check textile availability prior to specifying upholstery material.
- All Bakhita products (except upholstered models) are only available through Global's InStock program. Contact CustomerCare for lead times and quotation for quantities beyond InStock inventory.
- For outdoor use Global recommends marine grade vinyls or Sunbrella fabrics with UV resistance.
- Chairs are available in 3 plastic colors: Alloy (ALY), Char (CHA), and Milk (MLK).
- Tables are available in standard or bar height and are suitable for outdoor use.
- Tables are available with a Silver base and Milk (MLK) top only.
- Table tops are constructed from technopolymer compounds with high structural, heat and abrasion resistance. Tops are UV, shock and stain resistant.

DESCRIPTION	FEATURES	MODEL#	STANDARD TEXTILE GRADES													
			1	2	3	4	5	6	7	8	9	10	11	12		
 <p>Armchair Poly Seat & Back COM Yardage: N/A Freight Class: 150 Product Weight (lbs.): 14.25 Cubic Feet Per Carton: 3.38(4 per carton)</p>	<p>Stacks 8 high on floor. Stacks 10 high on dolly.</p>	6750	294													
					<p>OVERALL DIMENSIONS W D H</p>			<p>SEAT DIMENSIONS W D H</p>			<p>BACK DIMENSIONS W H</p>					
					22.5	21	31.5	16	16	17.25	17	14.5				
					<p>RTA 00</p>		<p>FedEx </p>		<p>4 per carton (pricing and specifications are for one chair)</p>							
 <p>Armless Chair Poly Seat & Back COM Yardage: N/A Freight Class: 150 Product Weight (lbs.): 13 Cubic Feet Per Carton: 2.88(4 per carton)</p>	<p>Stacks 8 high on floor. Stacks 12 high on dolly</p>	6751	261													
					<p>OVERALL DIMENSIONS W D H</p>			<p>SEAT DIMENSIONS W D H</p>			<p>BACK DIMENSIONS W H</p>					
					18	21	31.5	16	16	17.25	17	14.5				
					<p>RTA 00</p>		<p>FedEx </p>		<p>4 per carton (pricing and specifications are for one chair)</p>							
 <p>Armchair Uph Seat & Poly Back COM Yardage: 0.75 Freight Class: 250 Product Weight (lbs.): 16 Cubic Feet Per Carton: 4.5 (3 per carton)</p>	<p>Stacks 8 high on floor. Stacks 10 high on dolly</p>	6752	529	555	574	602	642	659	697	754	801	848	952	1059		
					<p>OVERALL DIMENSIONS W D H</p>			<p>SEAT DIMENSIONS W D H</p>			<p>BACK DIMENSIONS W H</p>					
					22.5	21	31.5	16	16	18	17	14.5				
					<p>RTA 00</p>		<p>FedEx </p>		<p>3 per carton (pricing and specifications are for one chair)</p>							

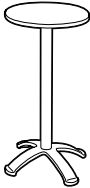
DESCRIPTION	FEATURES	MODEL#	STANDARD TEXTILE GRADES											
			1	2	3	4	5	6	7	8	9	10	11	12
 <p>Armless Chair Uph Seat & Poly Back COM Yardage: 0.75 Freight Class: 250 Product Weight (lbs.): 14.67 Cubic Feet Per Carton: 3.83(3 per carton)</p>	Stacks 8 high on floor. Stacks 12 high on dolly	6753	\$484	\$510	\$529	\$557	\$597	\$614	\$652	\$709	\$756	\$803	\$907	\$1014
			OVERALL DIMENSIONS			SEAT DIMENSIONS			BACK DIMENSIONS					
			W	D	H	W	D	H	W	H				
			18	21	31.5	16	16	18	17	14.5				
			RTA 00			FedEx			ups			3 per carton (pricing and specifications are for one chair)		
 <p>Armless Bar Stool Poly Seat & Back COM Yardage: 0.75 Freight Class: 250 Product Weight (lbs.): 14.67 Cubic Feet Per Carton: 3.19 (4 per carton)</p>	Stacks 4 high on floor.	6754	1	2	3	4	5	6	7	8	9	10	11	12
			OVERALL DIMENSIONS			SEAT DIMENSIONS			BACK DIMENSIONS					
			W	D	H	W	D	H	W	H				
			19.25	18.75	40.5	14	15	30	17	10.5				
RTA 00			FedEx			ups			4 per carton (pricing and specifications are for one chair)					
 <p>Armless Bar Stool Uph Seat & Poly Back COM Yardage: 0.75 Freight Class: 250 Product Weight (lbs.): 14.67 Cubic Feet Per Carton: 4.25 (3 per carton)</p>	Stacks 4 high on floor.	6755	1	2	3	4	5	6	7	8	9	10	11	12
			OVERALL DIMENSIONS			SEAT DIMENSIONS			BACK DIMENSIONS					
			W	D	H	W	D	H	W	H				
			19	18	40	14	15	30.75	17	10.5				
RTA 00			FedEx			ups			3 per carton (pricing and specifications are for one chair)					
 <p>Chair Dolly COM Yardage: N/A Freight Class: 250 Product Weight (lbs.): 11 Cubic Feet Per Carton: 2.9</p>		6783	1	2	3	4	5	6	7	8	9	10	11	12
			OVERALL DIMENSIONS			SEAT DIMENSIONS			BACK DIMENSIONS					
			W	D	H	W	D	H	W	H				
			19.75	23.25	9.75	-	-	-	-	-				
RTA 00			FedEx			ups			1 per carton					

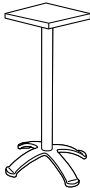
DESCRIPTION	FEATURES	MODEL#	STANDARD TEXTILE GRADES											
			1	2	3	4	5	6	7	8	9	10	11	12
 <p>Round Table - Café Height COM Yardage: N/A Freight Class: 100 Product Weight (lbs.): 40 Cubic Feet Per Carton: 4.49 (3 cartons per one model)</p>		6780	568											
 <p>Round Table - Bar Height COM Yardage: N/A Freight Class: 100 Product Weight (lbs.): 41 Cubic Feet Per Carton: 4.49 (3 cartons per one model)</p>		6781	581											
 <p>Square Table - Café Height COM Yardage: N/A Freight Class: 100 Product Weight (lbs.): 42.5 Cubic Feet Per Carton: 4.49 (3 cartons per one model)</p>		6785	621											
 <p>Square Table - Bar Height COM Yardage: N/A Freight Class: 100 Product Weight (lbs.): 43.5 Cubic Feet Per Carton: 4.49 (3 cartons per one model)</p>		6786	634											

BEACH™



model 4077









model 4078

STANDARD FEATURES

- Elegant wood seating with a choice of an upholstered or vertical wood slat back.
- Frame construction is beech hardwood.
- Furniture legs are equipped with white non marking polypropylene glides as standard. Suitable for both carpet and hard surface flooring.
- All cushions are fixed and non-removable.
- Cushions are highly resilient foam and seats are equipped with a synthetic rubberized webbing suspension system for extra comfort.

OPTIONAL FEATURES

- Frame available in Absolute (AAM), Black (BKM), Cherry (ACM), Espresso Cafe (ECM), English Oak (EOM), Fruitwood (TFM), Gray (HGM), Honey (AHM), Mahogany (TMM), Maple (AVM), Medium Walnut (MWM), Natural Walnut (NLW), Night (ASM), NoceBiondo (NBM), Noce Grigio (NGM), Noce Leggero (NEM), Noce Medio (NMM), Shaker Cherry (SKM), Walnut (TWM), WC Cream (WTM), White (WHM) and Winter Cherry (WCM). Please Specify.
- Check textile availability prior to specifying upholstery material.

DESCRIPTION	FEATURES	MODEL#	STANDARD TEXTILE GRADES												
			1	2	3	4	5	6	7	8	9	10	11	12	
 <p>Armchair w/Upholstered back. COM Yardage: 1.50 Freight Class: 300 Product Weight (lbs.): 20 Cubic Feet Per Carton: 11.75</p>	Does not stack.	4077	\$894	\$932	\$961	\$1001	\$1061	\$1090	\$1142	\$1228	\$1291	\$1365	\$1514	\$1673	
		OVERALL DIMENSIONS W D H			SEAT DIMENSIONS W D H			BACK DIMENSIONS W H							
		22	23	33.5	19.5	18.5	18.75	19.5	15.5						
		  													
 <p>Armchair w/Vertical Wood Slat back. COM Yardage: 1.00 Freight Class: 300 Product Weight (lbs.): 20 Cubic Feet Per Carton: 11.75</p>	Does not stack.	4078	\$939	\$977	\$1008	\$1052	\$1113	\$1143	\$1198	\$1286	\$1354	\$1432	\$1586	\$1754	
		OVERALL DIMENSIONS W D H			SEAT DIMENSIONS W D H			BACK DIMENSIONS W H							
		22	23	33.5	19.5	18.5	18.75	19.5	15.5						
															

BEAM SEATING



*see sample layout SON507 for models included above.

STANDARD FEATURES

- The universal beam units and tables listed are shown here, along with beam seating upper components from several seating lines.
- Beams are standard in Black. The “T” shaped legs are available in Chrome only with Black anti scuff tips and trim.
- Corner beam creates 90° turn in beam seating. Only table units can be attached.
- Beams and legs are shipped fully assembled.
- Upper seating units include mounting brackets and all necessary hardware for attachment to beam.
- Upper seating units and/or tables can be placed in any order along the beam.
- Power monument has two AC outlets, dual 2.1 amp USB ports.
- **Specifications and pricing are for 1 chair.**

OPTIONAL FEATURES

- Check textile availability prior to specifying upholstery material.
- Optional universal aluminum arm with soft pad available for mounting on beam in multiple positions, model 6500A8. \$161 list.
- Sonic seating units are available in mesh back, Black only.
- Vion seating units available in 10 mesh colors: Black (MS69), Stone (MS71), Blue (MS72), Rope (MS73), Natural (MS74), Aqua (MS75), Black Cherry (MS76), Dust (MS77), Ivory (MS78) and Paprika (MS79). Please specify. No upcharge.

OPTIONAL FEATURES (continued)

- Vion is available with a Black (BLK) Back Frame as standard or an optional Fog (FOG) Back Frame, please add \$76.
- Duet, Popcorn and Sonic seating units are available in 14 designer colors. Choose from Buzz Blue (BZB), Cactus (CCT), Carrot (CRO), Cloud (IVC), Dijon (DJN), Eggplant (EGP), Fog (FOG), Frost (FRO), Ink (INK), Latte (LAB), Night (BLK), Sand (SND), Scarlet (SAR), and Shadow (SHW).
- Duet arms will match the specified polypropylene color.
- Sidero, Sonic and Vion arm models are standard in Black only.
- Sonic is available in the following frame finishes: Chrome (CHM), Black (TBL), Buzz Blue (TBZ), Cactus (TCC), Carrot (TCR), Dijon (TDJ), Designer White (TDW), Eggplant (TEG), Fog (TFO), Frost (TFR), Ink (TIN), Cloud (TIV), Kalua (TKA), Latte (TLA), Mocha (TMO), Nevada (TNE), Toast (TOA), Shadow (TSH), Sand (TSN), Scarlet (TSR) and Tungsten (TTU). Please specify
- Duet and Popcorn are standard in a Chrome (CH) frame finish. Sidero and Vion are standard in Black (BK) frame finish.
- Beam seating laminate table tops are available in Absolute Acajou (ACJ), Asian Night (ASN), Avant Cherry (AWC), Avant Honey (AWH), Blizzard (BZD), Brushed Cobalt (BRC), Clear Maple (CMB), Custom Grey (CGY), Dark Espresso (DES), Designer White (DWT), Fashionista (FAS), First Class (FCL), Noce Biondo (NBL), Noce Grigio (NGL), Noce Leggero (NEL), Noce Medio (NML), Sheer Beauty (SBY), Stone Dust (SDT), Walnut Heights (WHE), Winter Cherry (WCR), White Chocolate (WHC). Please specify. No upcharge.

SAMPLE LAYOUTS

VON501 - Shown



Approximate dimensions: 74”W x 24”D

Kit Layout	Description	Total (Grd. 1)
VON501	Vion armless seat units with Beam components: 6340 (3 seats), 6500S3 (1 beam)	\$3,380
DUT501	Duet armless seat units with Beam components: 6691 (3 seats), 6500S3 (1 beam)	\$1,799
POP501	Popcorn armless seat units with Beam components: 6717 (3 seats), 6500S3 (1 beam)	\$1,925
SID501	Sidero armless seat units with Beam components: 6931 (3 seats), 6500S3 (1 beam)	\$2,867
SON501	Sonic armless seat units with Beam components: 6501 (3 seats), 6500S3 (1 beam)	\$2,186

*See next pages for individual model description, dimensions and starting list price.

SON502 - Shown



Approximate dimensions: 100”W x 24”D

Kit Layout	Description	Total (Grd. 1)
SON502	Sonic arm seat units with Beam components: 6506 (4 seats), 6500S4 (1 beam)	\$3,721
DUT502	Duet arm seat units with Beam components: 6690 (4 seats), 6500S4 (1 beam)	\$2,901
POP502	Popcorn armless seat units with Universal arms and Beam components: 6717 (4 seats), 6500S4 (1 beam), and 6500A8 (5 arms)	\$3,426
SID502	Sidero arm seat units with Beam components: 6930 (4 seats), 6500S4 (1 beam)	\$4,124
VON502	Vion arm seat units with Beam components: 6342 (4 seats), 6500S4 (1 beam)	\$4,313

*See next pages for individual model description, dimensions and starting list price.

SAMPLE LAYOUTS

DUT503 - Shown



Approximate dimensions: 100"W x 24"D

Kit Layout	Description	Total (Grd. 1)
DUT503	Duet armless seat units with Beam components: 6691 (3 seats), 6500S4 (1 beam), 6507 (1 table)	\$2,478
POP503	Popcorn armless seat units with Beam components: 6717 (3 seats), 6500S4 (1 beam), 6507 (1 table)	\$2,604
SID503	Sidero armless seat units with Beam components: 6931 (3 seats), 6500S4 (1 beam), 6507 (1 table)	\$3,546
SON503	Sonic armless seat units with Beam components: 6501 (3 seats), 6500S4 (1 beam), 6507 (1 table)	\$2,865
VON503	Vion armless seat units with Beam components: 6340 (3 seats), 6500S4 (1 beam), 6507 (1 table)	\$4,059

*See next pages for individual model description, dimensions and starting list price.

POP504 - Shown



Approximate dimensions: 122"W x 24"D

Kit Layout	Description	Total (Grd. 1)
POP504	Popcorn seat units with Universal arms and Beam components: 6717 (4 seats), 6500A8 (6 arms), 6500S3 (1 beam), 6500A2 (1 beam), 6507 (1 table), 6591B (1 Module)	\$4,756
DUT504	Duet arm seat units with Beam components: 6690 (4 seats), 6500S3 (1 beam), 6500A2 (1 beam), 6507 (1 table), 6591B (1 Module)	\$4,070
SID504	Sidero arm seat units with Beam components: 6930 (4 seats), 6500S3 (1 beam), 6500A2 (1 beam), 6507 (1 table), 6591B (1 Module)	\$5,290
SON504	Sonic arm seat units with Beam components: 6504 (4 seats), 6500S3 (1 beam), 6500A2 (1 beam), 6507 (1 table), 6591B (1 Module)	\$4,450
VON504	Vion arm seat units with Beam components: 6342 (4 seats), 6500S3 (1 beam), 6500A2 (1 beam), 6507 (1 table), 6591B (1 Module)	\$5,482

*See next pages for individual model description, dimensions and starting list price.

SID505 - Shown



Approximate dimensions: 147"W x 24"D

Kit Layout	Description	Total (Grd. 1)
SID505	Sidero armless seat units with Beam components: 6931 (4 seats), 6500S3 (1 beam), 6500A3 (1 beam), 6507 (2 table)	\$4,926
DUT505	Duet armless seat units with Beam components: 6691 (4 seats), 6500S3 (1 beam), 6500A3 (1 beam), 6507 (2 table)	\$3,502
POP505	Popcorn armless seat units with Beam components: 6717 (4 seats), 6500S3 (1 beam), 6500A3 (1 beam), 6507 (2 table)	\$3,670
SON505	Sonic armless seat units with Beam components: 6501 (4 seats), 6500S3 (1 beam), 6500A3 (1 beam), 6507 (2 table)	\$4,018
VON505	Vion armless seat units with Beam components: 6340 (4 seats), 6500S3 (1 beam), 6500A3 (1 beam), 6507 (2 table)	\$5,650

*See next pages for individual model description, dimensions and starting list price.

VON506 - Shown



Approximate dimensions: 103"W x 103"D

Kit Layout	Description	Total (Grd. 1)
VON506	Vion arm seat units with Beam components: 6342 (6 seats), 6500S3 (2 beams), 6507-T2 (1 table), 6500A9 (1 Connector)	\$7,142
DUT504	Duet arm seat units with Beam components: 6690 (6 seats), 6500S3 (2 beams), 6507-T2 (1 table), 6500A9 (1 Connector)	\$5,024
POP505	Popcorn armless seat units with Universal arms and Beam components: 6717 (6 seats), 6500A8 (8 arms), 6500S3 (2 beams), 6507-T2 (1 table), 6500A9 (1 Connector)	\$5,892
SID504	Sidero arm seat units with Beam components: 6930 (6 seats), 6500S3 (2 beams), 6507-T2 (1 table), 6500A9 (1 Connector)	\$6,854
SON504	Sonic arm seat units with Beam components: 6504 (6 seats), 6500S3 (2 beams), 6507-T2 (1 table), 6500A9 (1 Connector)	\$5,594

*See next pages for individual model description, dimensions and starting list price.

SAMPLE LAYOUTS

SON507 - Shown



Approximate dimensions: 103"W x 103"D

Kit Layout	Description	Total (Grd. 1)
SON507	Sonic arm seat units with Beam components: 6506 (6 seats), 6500S3 (2 beams), 6507-T2 (1 table), 6500A9 (1 connector)	\$6,254
DUT507	Duet arm seat units with Beam components: 6690 (6 seats), 6500S3 (2 beams), 6507-T2 (1 table), 6500A9 (1 connector)	\$5,024
POP507	Popcorn armless seat units with Universal arms and Beam components: 6717 (6 seats), 6500S3 (2 beams), 6507-T2 (1 table), 6500A9 (1 connector) and 6500A8 (8 arms)	\$5,892
SID507	Sidero arm seat units with Beam components: 6930 (6 seats), 6500S3 (2 beams), 6507-T2 (1 table), 6500A9 (1 connector)	\$6,854
VON507	Vion arm seat units with Beam components: 6342 (6 seats), 6500S3 (2 beams), 6507-T2 (1 table), 6500A9 (1 connector)	\$7,142

*See next pages for individual model description, dimensions and starting list price.

DUT508 - Shown



Approximate dimensions: 131"W x 78"D

Kit Layout	Description	Total (Grd. 1)
DUT508	Duet armless seat units with Beam components: 6691 (7 seats), 6500S3 (1 Beam), 6500S2 (2 Beams), 6507-T2 (2 Tables), 6500A9 (2 Connector), 6591B (2 Modules)	\$7,257
POP508	Popcorn armless seat units with Beam components: 6717 (7 seats), 6500S3 (1 Beam), 6500S2 (2 Beams), 6507-T2 (2 Tables), 6500A9 (2 Connector), 6591B (2 Modules)	\$7,551
SID508	Sidero armless seat units with Beam components: 6931 (7 seats), 6500S3 (1 Beam), 6500S2 (2 Beams), 6507-T2 (2 Tables), 6500A9 (2 Connector), 6591B (2 Modules)	\$9,749
SON508	Sonic armless seat units with Beam components: 6501 (7 seats), 6500S3 (1 Beam), 6500S2 (2 Beams), 6507-T2 (2 Tables), 6500A9 (2 Connector), 6591B (2 Modules)	\$8,160
VON507	Vion armless seat units with Beam components: 6340 (7 seats), 6500S3 (1 Beam), 6500S2 (2 Beams), 6507-T2 (2 Tables), 6500A9 (2 Connector), 6591B (2 Modules)	\$10,946

*See next pages for individual model description, dimensions and starting list price.

DESCRIPTION	FEATURES	MODEL#	STANDARD TEXTILE GRADES											
			1	2	3	4	5	6	7	8	9	10	11	12

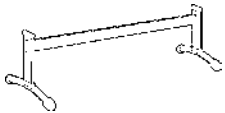

Beam - Accommodates 2 Seats
COM Yardage: N/A
Freight Class: 250
Product Weight (lbs.): 37
Cubic Feet Per Carton: 11 (1 per carton)

Freestanding

6500S2	\$748	-	-	-	-	-	-	-	-	-	-	-	-
---------------	-------	---	---	---	---	---	---	---	---	---	---	---	---

OVERALL DIMENSIONS			SEAT DIMENSIONS			BACK DIMENSIONS	
W	D	H	W	D	H	W	H

49.5	24	16	-	-	-	-	-
------	----	----	---	---	---	---	---

RTA 00

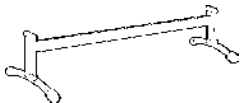

Beam - Accommodates 3 Seats
COM Yardage: N/A
Freight Class: 250
Product Weight (lbs.): 43
Cubic Feet Per Carton: 16 (1 per carton)





Freestanding



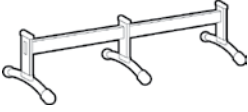

6500S3	\$863	-	-	-	-	-	-	-	-	-	-	-
---------------	-------	---	---	---	---	---	---	---	---	---	---	---













OVERALL DIMENSIONS			SEAT DIMENSIONS			BACK DIMENSIONS	
W	D	H	W	D	H	W	H

















74	24	16	-	-	-	-	-
----	----	----	---	---	---	---	---

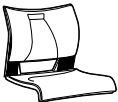









RTA 00









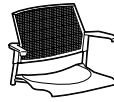

DESCRIPTION	FEATURES	MODEL#	STANDARD TEXTILE GRADES												
			1	2	3	4	5	6	7	8	9	10	11	12	
 <p>Beam - Accommodates 4 Seats COM Yardage: N/A Freight Class: 250 Product Weight (lbs.): 58 Cubic Feet Per Carton: 22 (1 per carton)</p>	Freestanding	6500S4	\$1205	-	-	-	-	-	-	-	-	-	-	-	
		OVERALL DIMENSIONS			SEAT DIMENSIONS			BACK DIMENSIONS							
		W	D	H	W	D	H	W	H						
		100	24	16	-	-	-	-	-						
			RTA 00												
 <p>Beam Extender - Accommodates 2 Seats COM Yardage: N/A Freight Class: 85 Product Weight (lbs.): 36 Cubic Feet Per Carton: 10.5 (1 per carton)</p>	Not Freestanding. Includes hardware.	6500A2	\$571	-	-	-	-	-	-	-	-	-	-	-	
		OVERALL DIMENSIONS			SEAT DIMENSIONS			BACK DIMENSIONS							
		W	D	H	W	D	H	W	H						
		47.5	24	16	-	-	-	-	-						
			RTA 00												
 <p>Beam Extender - Accommodates 3 Seats COM Yardage: N/A Freight Class: 85 Product Weight (lbs.): 43 Cubic Feet Per Carton: 16 (1 per carton)</p>	Not Freestanding. Includes hardware.	6500A3	\$717	-	-	-	-	-	-	-	-	-	-	-	
		OVERALL DIMENSIONS			SEAT DIMENSIONS			BACK DIMENSIONS							
		W	D	H	W	D	H	W	H						
		72	24	16	-	-	-	-	-						
			RTA 00												
 <p>Beam Extender - Accommodates 4 Seats COM Yardage: N/A Freight Class: 85 Product Weight (lbs.): 58 Cubic Feet Per Carton: 21.75 (1 per carton)</p>	Not Freestanding. Includes hardware.	6500A4	\$1074	-	-	-	-	-	-	-	-	-	-	-	
		OVERALL DIMENSIONS			SEAT DIMENSIONS			BACK DIMENSIONS							
		W	D	H	W	D	H	W	H						
		98	24	16	-	-	-	-	-						
			RTA 00												
 <p>Universal Aluminum Arm w/Pad COM Yardage: N/A Freight Class: 85 Product Weight (lbs.): 3.5 Cubic Feet Per Carton: 0.5 (1 per carton)</p>	Includes hardware.	6500A8	\$161	-	-	-	-	-	-	-	-	-	-	-	
		OVERALL DIMENSIONS			SEAT DIMENSIONS			BACK DIMENSIONS							
		W	D	H	W	D	H	W	H						
		2.5	10	14	-	-	-	-	-						
			RTA 00												



DESCRIPTION	FEATURES	MODEL#	STANDARD TEXTILE GRADES											
			1	2	3	4	5	6	7	8	9	10	11	12
 <p>Corner Connector Beam COM Yardage: N/A Freight Class: 85 Product Weight (lbs.): 9 Cubic Feet Per Carton: 0.07 (1 per carton)</p>	Not Freestanding. Includes hardware.	6500A9	\$313	-	-	-	-	-	-	-	-	-	-	-
		OVERALL DIMENSIONS			SEAT DIMENSIONS			BACK DIMENSIONS						
		W	D	H	W	D	H	W	H					
		1.75	24	3.25	-	-	-	-	-					
			RTA 00											
 <p>Bolt Down Kit COM Yardage: N/A Freight Class: 85 Product Weight (lbs.): 8 Cubic Feet Per Carton: 0.6 (1 per carton)</p>	Set of 4 brackets. Includes hardware.	6500BD	\$148	-	-	-	-	-	-	-	-	-	-	
		OVERALL DIMENSIONS			SEAT DIMENSIONS			BACK DIMENSIONS						
		W	D	H	W	D	H	W	H					
		17.75	17.75	1	-	-	-	-	-					
			RTA 00	FedEx										
 <p>Power Module COM Yardage: N/A Freight Class: 85 Product Weight (lbs.): 3.2 Cubic Feet Per Carton: 0.5 (1 per carton)</p>	Under mount, 10 ft. cord. Black only.	6591B	\$603	-	-	-	-	-	-	-	-	-	-	
		OVERALL DIMENSIONS			SEAT DIMENSIONS			BACK DIMENSIONS						
		W	D	H	W	D	H	W	H					
		21	21	1	-	-	-	-	-					
			RTA 00	FedEx										
 <p>End Table Top COM Yardage: N/A Freight Class: 85 Product Weight (lbs.): 8 Cubic Feet Per Carton: 0.6 (1 per carton)</p>	Includes hardware. Use on beams.	6507	\$337	-	-	-	-	-	-	-	-	-	-	
		OVERALL DIMENSIONS			SEAT DIMENSIONS			BACK DIMENSIONS						
		W	D	H	W	D	H	W	H					
		17.75	17.75	1	-	-	-	-	-					
			RTA 00	FedEx										
 <p>Square Corner Table Top COM Yardage: N/A Freight Class: 85 Product Weight (lbs.): 14 Cubic Feet Per Carton: 1.9 (1 per carton)</p>	Includes hardware. Use on beams.	6507-T1	400	-	-	-	-	-	-	-	-	-	-	
		OVERALL DIMENSIONS			SEAT DIMENSIONS			BACK DIMENSIONS						
		W	D	H	W	D	H	W	H					
		21	21	1	-	-	-	-	-					
			RTA 00											

DESCRIPTION	FEATURES	MODEL#	STANDARD TEXTILE GRADES											
			1	2	3	4	5	6	7	8	9	10	11	12
 <p>Radius Corner Table Top COM Yardage: N/A Freight Class: 85 Product Weight (lbs.): 14 Cubic Feet Per Carton: 1.9 (1 per carton)</p>	Includes hardware. Use on beams.	6507-T2	\$441	-	-	-	-	-	-	-	-	-	-	
			OVERALL DIMENSIONS			SEAT DIMENSIONS			BACK DIMENSIONS					
			W	D	H	W	D	H	W	H				
			21	21	1	-	-	-	-	-				
			RTA 00											
 <p>Coffee Table COM Yardage: N/A Freight Class: 85 Product Weight (lbs.): 52 Cubic Feet Per Carton: 12.25 (1 per carton)</p>		6507-CT	\$975	-	-	-	-	-	-	-	-	-	-	
			OVERALL DIMENSIONS			SEAT DIMENSIONS			BACK DIMENSIONS					
			W	D	H	W	D	H	W	H				
			24	42	17.5	-	-	-	-	-				
			RTA 00  											
 <p>Seat Unit w/Arms COM Yardage: N/A Freight Class: 250 Product Weight (lbs.): 19 Cubic Feet Per Carton: 4.88 (2 per carton)</p>	Duet Use with beams.	6690	\$424	-	-	-	-	-	-	-	-	-	-	
			OVERALL DIMENSIONS			SEAT DIMENSIONS			BACK DIMENSIONS					
			W	D	H	W	D	H	W	H				
			25.5	21	18	18	17.5	-	18	16				
			RTA 00  											
 <p>Armless Seat Unit COM Yardage: N/A Freight Class: 150 Product Weight (lbs.): 18 Cubic Feet Per Carton: 3.25 (2 per carton)</p>	Duet Use with beams.	6691	\$312	-	-	-	-	-	-	-	-	-	-	
			OVERALL DIMENSIONS			SEAT DIMENSIONS			BACK DIMENSIONS					
			W	D	H	W	D	H	W	H				
			18	21	18	18	17.5	-	18	16				
			RTA 00  											
 <p>Seat Unit w/Arms COM Yardage: 0.75 Freight Class: 250 Product Weight (lbs.): 19 Cubic Feet Per Carton: 4.88 (2 per carton)</p>	Duet Upholstered Seat. Use with beams.	6692	\$519	\$557	\$586	\$627	\$687	\$705	\$760	\$856	\$906	\$998	\$1121	\$1275
			OVERALL DIMENSIONS			SEAT DIMENSIONS			BACK DIMENSIONS					
			W	D	H	W	D	H	W	H				
			25.5	21	18	18	17.5	-	18	16				
			RTA 00  											

DESCRIPTION	FEATURES	MODEL#	STANDARD TEXTILE GRADES											
			1	2	3	4	5	6	7	8	9	10	11	12
 Armless Seat Unit COM Yardage: 0.75 Freight Class: 150 Product Weight (lbs.): 19 Cubic Feet Per Carton: 3.25 (2 per carton)	Duet Upholstered Seat. Use with beams.	6693	\$403	\$441	\$469	\$511	\$570	\$589	\$642	\$740	\$790	\$880	\$1005	\$1158
			OVERALL DIMENSIONS			SEAT DIMENSIONS			BACK DIMENSIONS					
			W	D	H	W	D	H	W	H				
			18	21	18	18	17.5	-	18	16				
														
 Seat Unit w/Arms COM Yardage: 0.75 Freight Class: 150 Product Weight (lbs.): 20 Cubic Feet Per Carton: 4.88 (2 per carton)	Duet Upholstered Seat and Back. Use with beams.	6697	\$550	\$588	\$616	\$658	\$717	\$736	\$789	\$887	\$937	\$1027	\$1152	\$1305
			OVERALL DIMENSIONS			SEAT DIMENSIONS			BACK DIMENSIONS					
			W	D	H	W	D	H	W	H				
			25.5	21	18	18	17.5	-	18	16				
														
 Armless Seat Unit COM Yardage: 0.75 Freight Class: 150 Product Weight (lbs.): 19 Cubic Feet Per Carton: 3.25 (2 per carton)	Duet Upholstered Seat and Back. Use with beams.	6698	\$449	\$487	\$516	\$557	\$617	\$635	\$690	\$788	\$836	\$928	\$1051	\$1205
			OVERALL DIMENSIONS			SEAT DIMENSIONS			BACK DIMENSIONS					
			W	D	H	W	D	H	W	H				
			18	21	18	18	17.5	-	18	16				
														
 Armless Seat Unit COM Yardage: N/A Freight Class: 150 Product Weight (lbs.): 17 Cubic Feet Per Carton: 6.5 (2 per carton)	Popcorn Polypropylene Seat and Back. use with beam	6717	354	-	-	-	-	-	-	-	-	-	-	-
			OVERALL DIMENSIONS			SEAT DIMENSIONS			BACK DIMENSIONS					
			W	D	H	W	D	H	W	H				
			20	21	18	18	18	-	19.5	16				
														
 Armless Seat Unit COM Yardage: 0.75 Freight Class: 150 Product Weight (lbs.): 18 Cubic Feet Per Carton: 6.5 (2 per carton)	Popcorn Upholstered Seat and Polypropylene Back. Use with beam.	6719	462	496	518	551	599	621	667	735	789	849	970	1102
			OVERALL DIMENSIONS			SEAT DIMENSIONS			BACK DIMENSIONS					
			W	D	H	W	D	H	W	H				
			20	21	18	18	18	-	19.5	16				
														

DESCRIPTION	FEATURES	MODEL#	STANDARD TEXTILE GRADES												
			1	2	3	4	5	6	7	8	9	10	11	12	
 <p>Seat Unit w/Arms COM Yardage: 1.25 Freight Class: 300 Product Weight (lbs.): 20 Cubic Feet Per Carton: 9.75</p>	<p>Sidero Upholstered Seat and Back. Use with beam.</p>	6930	729	779	818	875	954	992	1065	1181	1271	1370	1575	1790	
		OVERALL DIMENSIONS			SEAT DIMENSIONS			BACK DIMENSIONS							
		W	D	H	W	D	H	W	H						
		25.5	23.5	19	19.5	18	-	19	15.5						
			RTA 00												
 <p>Armless Seat Unit COM Yardage: 1.25 Freight Class: 300 Product Weight (lbs.): 18 Cubic Feet Per Carton: 9.75</p>	<p>Sidero Upholstered Seat and Back. Use with beam.</p>	6931	668	718	757	814	893	931	1004	1120	1210	1309	1514	1729	
		OVERALL DIMENSIONS			SEAT DIMENSIONS			BACK DIMENSIONS							
		W	D	H	W	D	H	W	H						
		21	23.5	19	19.5	18	-	19	15.5						
			RTA 00												
 <p>Armless Seat Unit COM Yardage: N/A Freight Class: 250 Product Weight (lbs.): 12 Cubic Feet Per Carton: 3.25 (2 per carton)</p>	<p>Sonic Polypropylene Seat and Back. Use with Beam.</p>	6501	\$441	-	-	-	-	-	-	-	-	-	-	-	
		OVERALL DIMENSIONS			SEAT DIMENSIONS			BACK DIMENSIONS							
		W	D	H	W	D	H	W	H						
		20	21.5	17	17	16	-	17	15						
			RTA 00  												
 <p>Armless Seat Unit COM Yardage: 0.75 Freight Class: 250 Product Weight (lbs.): 12 Cubic Feet Per Carton: 3.25 (2 per carton)</p>	<p>Sonic Upholstered Seat and Polypropylene Back. Use with Beam.</p>	6502	\$497	\$528	\$547	\$581	\$629	\$643	\$685	\$762	\$800	\$871	\$969	\$1093	
		OVERALL DIMENSIONS			SEAT DIMENSIONS			BACK DIMENSIONS							
		W	D	H	W	D	H	W	H						
		20	22	17	17	16	-	17	15						
			RTA 00  												
 <p>Armless Seat Unit COM Yardage: 0.75 Freight Class: 150 Product Weight (lbs.): 13 Cubic Feet Per Carton: 3.25 (2 per carton)</p>	<p>Sonic Upholstered Seat and Back. Use with Beam.</p>	6503	\$550	\$579	\$600	\$634	\$680	\$697	\$736	\$815	\$853	\$924	\$1024	\$1144	
		OVERALL DIMENSIONS			SEAT DIMENSIONS			BACK DIMENSIONS							
		W	D	H	W	D	H	W	H						
		20	22	17	17	16	-	17	15						
			RTA 00  												

DESCRIPTION	FEATURES	MODEL#	STANDARD TEXTILE GRADES											
			1	2	3	4	5	6	7	8	9	10	11	12
 6504	 6504MB (Mesh Back)	Sonic Polypropylene Seat. Use with Beam.	\$519	-	-	-	-	-	-	-	-	-	-	
			\$562	-	-	-	-	-	-	-	-	-	-	-
Seat Unit w/Arms COM Yardage: N/A Freight Class: 150 Product Weight (lbs.): 13 Cubic Feet Per Carton: 3.25 (2 per carton)			OVERALL DIMENSIONS W D H			SEAT DIMENSIONS W D H			BACK DIMENSIONS W H					
			23	21.5	17	17	16	-	17	15				
														
 6505	 6505MB (Mesh Back)	Sonic Upholstered Seat. Use with Beam.	\$576	\$603	\$626	\$659	\$706	\$721	\$763	\$839	\$877	\$949	\$1048	\$1170
			\$719	\$753	\$775	\$808	\$856	\$878	\$924	\$992	\$1046	\$1106	\$1227	\$1359
Seat Unit w/Arms COM Yardage: 0.75 Freight Class: 22. Product Weight (lbs.): 13 Cubic Feet Per Carton: 3.25 (2 per carton)			OVERALL DIMENSIONS W D H			SEAT DIMENSIONS W D H			BACK DIMENSIONS W H					
			23	22	17	17	16	-	17	15				
														
 6506		Sonic Upholstered Seat and Back Use with Beam.	\$629	\$660	\$681	\$715	\$761	\$777	\$817	\$895	\$934	\$1005	\$1105	\$1225
Seat Unit w/Arms COM Yardage: 0.75 Freight Class: 150 Product Weight (lbs.): 14 Cubic Feet Per Carton: 3.25 (2 per carton)			OVERALL DIMENSIONS W D H			SEAT DIMENSIONS W D H			BACK DIMENSIONS W H					
			23	22	17	17	16	-	17	15				
														
 6340		Vion Upholstered Seat and Mesh Back. Use with beam.	\$839	\$882	\$911	\$957	\$1021	\$1051	\$1108	\$1201	\$1273	\$1351	\$1516	\$1692
Armless Seat Unit COM Yardage: 1 Freight Class: 250 Product Weight (lbs.): 20 Cubic Feet Per Carton: 7.25			OVERALL DIMENSIONS W D H			SEAT DIMENSIONS W D H			BACK DIMENSIONS W H					
			21	23.5	20.5	17.5	18	-	19	17				
														
 6341		Vion Upholstered Seat and Back. Use with beam.	\$978	\$1027	\$1066	\$1123	\$1203	\$1240	\$1314	\$1430	\$1520	\$1619	\$1821	\$2039
Armless Seat Unit COM Yardage: 1 Freight Class: 250 Product Weight (lbs.): 20 Cubic Feet Per Carton: 7.25			OVERALL DIMENSIONS W D H			SEAT DIMENSIONS W D H			BACK DIMENSIONS W H					
			21	23.5	20.5	17.5	18	-	19	17				
														

DESCRIPTION	FEATURES	MODEL#	STANDARD TEXTILE GRADES											
			1	2	3	4	5	6	7	8	9	10	11	12
 <p>Seat Unit w/Arms COM Yardage: 1 Freight Class: 250 Product Weight (lbs.): 21 Cubic Feet Per Carton: 9.75</p>	<p>Vion Upholstered Seat and Mesh Back. Use with beam.</p>	<p>6342</p>	\$777	\$817	\$849	\$894	\$957	\$986	\$1046	\$1138	\$1208	\$1288	\$1452	\$1627
			<p>OVERALL DIMENSIONS</p>			<p>SEAT DIMENSIONS</p>			<p>BACK DIMENSIONS</p>					
			W	D	H	W	D	H	W	H				
			25.5	23.5	20.5	17.5	18	-	19	17				
			<p>RTA 00</p>											
 <p>Seat Unit w/Arms COM Yardage: 1 Freight Class: 250 Product Weight (lbs.): 21 Cubic Feet Per Carton: 9.75</p>	<p>Vion Upholstered Seat and Back. Use with beam.</p>	<p>6343</p>	\$899	\$948	\$987	\$1043	\$1123	\$1159	\$1233	\$1348	\$1437	\$1537	\$1742	\$1959
			<p>OVERALL DIMENSIONS</p>			<p>SEAT DIMENSIONS</p>			<p>BACK DIMENSIONS</p>					
			W	D	H	W	D	H	W	H				
			25.5	23.5	20.5	17.5	18	-	19	17				
			<p>RTA 00</p>											

CAPRICE™



model 3365 (TUN)



model 3365C (TUN)

STANDARD FEATURES

- Modern light scale guest seating.
- Durable molded armcaps in Black Only.
- Frame is standard in a Tungsten colored finish (TUN).
- Standard with Black "bullet style" glides.
- Non-castered models can be joined together using ganging clamp model 6522.
- **C1** dual wheel carpet casters are standard on models 3365C.
- Does not stack.
- Check textile availability prior to specifying upholstery material.



OPTIONAL FEATURES

- Optional steel cushioned glides (**B**) are available. Add \$31. Please specify.
- For hard surface flooring casters, specify **C9R**. Add \$72.

Frame finish

- (TBL) Black
 - (TCC) Cactus
 - (TDJ) Dijon
 - (TEG) Eggplant
 - (TFR) Frost
 - (TIV) Cloud
 - (TLA) Latte
 - (TNE) Nevada
 - (TSN) Sand
 - (TTU) Tungsten
 - (ACO) Antique Copper. Add **\$346**
 - (BCH) Brushed Chrome. Add **\$227**
 - (CHM) Chrome. **Upcharge varies.**
 - (SBR) Satin Brass. Add **\$346**
- Please Specify.

- (TBZ) Buzz Blue
 - (TCR) Carrot
 - (TDW) Designer White
 - (TFO) Fog
 - (TIN) Ink
 - (TKA) Kalua
 - (TOA) Toast
 - (TSH) Shadow
 - (TSR) Scarlet
- A Chrome (**CHM**) finish is also available. Add \$81 for side chairs. Add \$135 for counter and bar stools.

DESCRIPTION	FEATURES	MODEL#	STANDARD TEXTILE GRADES													
			1	2	3	4	5	6	7	8	9	10	11	12		
 <p>Armchair 4 Legged COM Yardage: 1.25 Freight Class: 300 Product Weight (lbs.): 22 Cubic Feet Per Carton: 14.5</p>	Does not stack.	3365	\$890	\$937	\$977	\$1030	\$1104	\$1133	\$1202	\$1328	\$1391	\$1506	\$1666	\$1864		
		OVERALL DIMENSIONS			SEAT DIMENSIONS			BACK DIMENSIONS								
		W	D	H	W	D	H	W	H							
		25	24	31.5	19.5	19.5	18.5	18	13							
			RTA 00													
 <p>Armchair 4 Legged w/casters COM Yardage: 1.25 Freight Class: 300 Product Weight (lbs.): 23 Cubic Feet Per Carton: 14.5</p>	Does not stack.	3365C	\$1035	\$1083	\$1121	\$1177	\$1250	\$1280	\$1349	\$1478	\$1540	\$1660	\$1822	\$2026		
		OVERALL DIMENSIONS			SEAT DIMENSIONS			BACK DIMENSIONS								
		W	D	H	W	D	H	W	H							
		25	23.5	32.5	19.5	18.5	18	18	14.5							
			RTA 00													
 <p>Barstool - 4 Legged COM Yardage: 1.25 Freight Class: 300 Product Weight (lbs.): 32 Cubic Feet Per Carton: 20</p>	Does not stack.	3369	\$1125	\$1173	\$1211	\$1267	\$1343	\$1371	\$1439	\$1568	\$1629	\$1750	\$1911	\$2116		
		OVERALL DIMENSIONS			SEAT DIMENSIONS			BACK DIMENSIONS								
		W	D	H	W	D	H	W	H							
		25	26.5	45.5	19.5	19.5	30.5	18	13							
			RTA 00													

CHAP™



Wood Back Armchair model 1010



Upholstered Back Armchair model 1015



Upholstered Round Back Armchair model 1004



Wood Round Back Armchair model 1005



Underseat panel (USP)





STANDARD FEATURES

- Chap offers mid-century modern styling in a finely crafted beechwood armchair series.
- Straight and round back models have upholstered seats with upholstered or open wood frame backs.
- Straight back models are available with exposed wood or upholstered front seat rails
- For reorders of discontinued models 1002 and 1003, use models 1004 and 1005 with 18" reduced seat depth.
- Custom stain matching is not available on models 1004 and 1005.
- Chairs are standard with a black liner under seat cushion. An underseat panel (USP) is available which conceals seat structure. It is covered with a coated textile and secured with tamperproof fasteners.
- For graded pricing, select model base price. Add graded textile upcharges for seat or for upholstered back models, both seat and back.
- The Blended Textile matrix does not apply to this series.
- Upholstery options include fabric, coated textiles and leather.
- Chap series is covered under Global's Limited Lifetime warranty, for single shift use.
- For multi-shift environments, and coverage under Globalcare's 24/7 warranty, Ultracell foam - 24/7 warranty (UC) must be selected.
- Textiles with a minimum of 100,000 double rubs must be specified to meet Global's 24/7 warranty coverage. For healthcare textiles, visit the website at globalfurnituregroup.com.
- Does not stack.
- Custom stain matching is not available on round back models.

Please add option codes in the following order:

- **Model number**
Specify model number
- **Back textile**
Specify textile code
- **Seat textile**
Specify textile code
- **Frame finish** (Round back models)
1004 and 1005 available in select finishes (*).
(AAM) Absolute*
(BKM) Black*
(ACM) Cherry*
(EOM) English Oak
(ECM) Espresso Cafe*
(TFM) Fruitwood
(HGM) Gray
(AHM) Honey
(TMM) Mahogany*
(AVM) Maple
(MWM) Medium Walnut*
(NLW) Natural Walnut
(ASM) Night*
(NBM) Noce Biondo
(NGM) Noce Grigio
(NEM) Noce Leggero
(NMM) Noce Medio*
(SKM) Shaker Cherry*
(TWM) Walnut*
(WTM) WC Cream*
(WHM) White*
(WCM) Winter Cherry
- **Glides**
(XG) No Glide for Carpeted Surfaces.
(NM) White Non-marking Nylon Glide for most floor surfaces.
(SG) Steel Cushioned Glide for carpeted surfaces. Add \$34
(FG) Felt Glide for most hard floor surfaces. Add \$34
(RG) Rubber Non-slip Glide for most hard floor surfaces. Add \$34
- **Sealed Seams** (on approved coated textiles)
(NS) No sealed seams
(SSS) Sealed seat seams. Add \$63
- **Moisture barrier** (seat only, not available with sealed seams)
(NB) No moisture barrier. No upcharge
(MB) Moisture barrier. Add \$107.
- **Seat foam**
(SF) Standard foam
(UC) Ultracell foam - 24/7 warranty
- **Seat underside**
(USL) Under seat liner
(USP) Under seat panel. Add \$79

DESCRIPTION	FEATURES	MODEL#												STANDARD TEXTILE GRADES												
		1/COM	2	3	4	5	6	7	8	9	10	11	12	1	2	3	4	5	6	7	8	9	10	11	12	
 <p>Wood Back Armchair w/ Upholstered Seat Front COM Yardage: 1 Freight Class: 250 Product Weight (lbs.): 33 Cubic Feet Per Carton: 15.75</p>	<p>Does not stack. Active weight 350 lbs. Ergonomic Features M, N</p>	1010	\$1307	\$1339	\$1364	\$1401	\$1453	\$1475	\$1520	\$1591	\$1644	\$1702	\$1823	\$1950												
		OVERALL DIMENSIONS				SEAT DIMENSIONS				BACK DIMENSIONS																
		W	D	H	W	D	H	W	D	H	W	H														
		25.5	25	31	21	20	18	20.5	13.5																	
		RTA 00																								

DESCRIPTION	FEATURES	MODEL#	STANDARD TEXTILE GRADES																																			
			1/COM	2	3	4	5	6	7	8	9	10	11	12																								
 <p>Upholstered Back Armchair w/ Upholstered Seat Front COM Yardage: Back: .75; Seat: .75 Freight Class: 250 Product Weight (lbs.): 33 Cubic Feet Per Carton: 15.75</p>	<p>1011</p> <p>Base Price: \$1315 Seat upcharge: +0 Back upcharge: +0</p> <p>Does not stack. Active weight 350 lbs. Ergonomic Features M, N</p>																																					
		<table border="1"> <thead> <tr> <th colspan="3">OVERALL DIMENSIONS</th> <th colspan="3">SEAT DIMENSIONS</th> <th colspan="3">BACK DIMENSIONS</th> </tr> <tr> <th>W</th> <th>D</th> <th>H</th> <th>W</th> <th>D</th> <th>H</th> <th>W</th> <th>H</th> </tr> </thead> <tbody> <tr> <td>25.5</td> <td>25</td> <td>31.5</td> <td>21</td> <td>20</td> <td>18</td> <td>20.5</td> <td>13.5</td> </tr> </tbody> </table>												OVERALL DIMENSIONS			SEAT DIMENSIONS			BACK DIMENSIONS			W	D	H	W	D	H	W	H	25.5	25	31.5	21	20	18	20.5	13.5
		OVERALL DIMENSIONS			SEAT DIMENSIONS			BACK DIMENSIONS																														
		W	D	H	W	D	H	W	H																													
25.5	25	31.5	21	20	18	20.5	13.5																															
<p>RTA 00</p>																																						
 <p>Wood Back Armchair w/ Wood Front Rail COM Yardage: 1 Freight Class: 250 Product Weight (lbs.): 33 Cubic Feet Per Carton: 15.75</p>	<p>1014</p> <p>Does not stack. Active weight 350 lbs. Ergonomic Features M, N</p>																																					
		<table border="1"> <thead> <tr> <th colspan="3">OVERALL DIMENSIONS</th> <th colspan="3">SEAT DIMENSIONS</th> <th colspan="3">BACK DIMENSIONS</th> </tr> <tr> <th>W</th> <th>D</th> <th>H</th> <th>W</th> <th>D</th> <th>H</th> <th>W</th> <th>H</th> </tr> </thead> <tbody> <tr> <td>25.5</td> <td>25</td> <td>31</td> <td>21</td> <td>20</td> <td>18</td> <td>20.5</td> <td>13.5</td> </tr> </tbody> </table>												OVERALL DIMENSIONS			SEAT DIMENSIONS			BACK DIMENSIONS			W	D	H	W	D	H	W	H	25.5	25	31	21	20	18	20.5	13.5
		OVERALL DIMENSIONS			SEAT DIMENSIONS			BACK DIMENSIONS																														
		W	D	H	W	D	H	W	H																													
25.5	25	31	21	20	18	20.5	13.5																															
<p>RTA 00</p>																																						
 <p>Upholstered Back Armchair w/ Wood Front Rail COM Yardage: Back: .75; Seat: .75 Freight Class: 250 Product Weight (lbs.): 33 Cubic Feet Per Carton: 15.75</p>	<p>1015</p> <p>Base Price: \$1315 Seat upcharge: +0 Back upcharge: +0</p> <p>Does not stack. Active weight 350 lbs. Ergonomic Features M, N</p>																																					
		<table border="1"> <thead> <tr> <th colspan="3">OVERALL DIMENSIONS</th> <th colspan="3">SEAT DIMENSIONS</th> <th colspan="3">BACK DIMENSIONS</th> </tr> <tr> <th>W</th> <th>D</th> <th>H</th> <th>W</th> <th>D</th> <th>H</th> <th>W</th> <th>H</th> </tr> </thead> <tbody> <tr> <td>25.5</td> <td>25</td> <td>31.5</td> <td>21</td> <td>20</td> <td>18</td> <td>20.5</td> <td>13.5</td> </tr> </tbody> </table>												OVERALL DIMENSIONS			SEAT DIMENSIONS			BACK DIMENSIONS			W	D	H	W	D	H	W	H	25.5	25	31.5	21	20	18	20.5	13.5
		OVERALL DIMENSIONS			SEAT DIMENSIONS			BACK DIMENSIONS																														
		W	D	H	W	D	H	W	H																													
25.5	25	31.5	21	20	18	20.5	13.5																															
<p>RTA 00</p>																																						
 <p>Upholstered Roundback Armchair w/ Upholstered Seat Front COM Yardage: Back: .75 ; Seat: .75 Freight Class: 300 Product Weight (lbs.): 26 Cubic Feet Per Carton: 13.25</p>	<p>1004</p> <p>Base Price: \$1488 Seat upcharge: +0 Back upcharge: +0</p> <p>Does not stack. Active weight 350 lbs. Ergonomic Features M, N</p>																																					
		<table border="1"> <thead> <tr> <th colspan="3">OVERALL DIMENSIONS</th> <th colspan="3">SEAT DIMENSIONS</th> <th colspan="3">BACK DIMENSIONS</th> </tr> <tr> <th>W</th> <th>D</th> <th>H</th> <th>W</th> <th>D</th> <th>H</th> <th>W</th> <th>H</th> </tr> </thead> <tbody> <tr> <td>24.5</td> <td>22.5</td> <td>30</td> <td>22</td> <td>18</td> <td>18</td> <td>20</td> <td>12.5</td> </tr> </tbody> </table>												OVERALL DIMENSIONS			SEAT DIMENSIONS			BACK DIMENSIONS			W	D	H	W	D	H	W	H	24.5	22.5	30	22	18	18	20	12.5
		OVERALL DIMENSIONS			SEAT DIMENSIONS			BACK DIMENSIONS																														
		W	D	H	W	D	H	W	H																													
24.5	22.5	30	22	18	18	20	12.5																															
<p>RTA 00</p>																																						
 <p>Round Wood Back Armchair w/ Upholstered Seat Front COM Yardage: 1 Freight Class: 300 Product Weight (lbs.): 25 Cubic Feet Per Carton: 13.25</p>	<p>1005</p> <p>Does not stack. Active weight 350 lbs. Ergonomic Features M, N</p>																																					
		<table border="1"> <thead> <tr> <th colspan="3">OVERALL DIMENSIONS</th> <th colspan="3">SEAT DIMENSIONS</th> <th colspan="3">BACK DIMENSIONS</th> </tr> <tr> <th>W</th> <th>D</th> <th>H</th> <th>W</th> <th>D</th> <th>H</th> <th>W</th> <th>H</th> </tr> </thead> <tbody> <tr> <td>24.5</td> <td>22.5</td> <td>30</td> <td>22</td> <td>18</td> <td>18</td> <td>20</td> <td>12.5</td> </tr> </tbody> </table>												OVERALL DIMENSIONS			SEAT DIMENSIONS			BACK DIMENSIONS			W	D	H	W	D	H	W	H	24.5	22.5	30	22	18	18	20	12.5
		OVERALL DIMENSIONS			SEAT DIMENSIONS			BACK DIMENSIONS																														
		W	D	H	W	D	H	W	H																													
24.5	22.5	30	22	18	18	20	12.5																															
<p>RTA 00</p>																																						

COMET™



model 2171 (BK)



model 2172 (TUN)



model 2174 (TUN)



model 2183 (BK)













STANDARD FEATURES







- Reinforced models incorporate welded corner gussets for additional strength and support.
- Heavy Duty models 2173 and 2174 use Ultracell seat foam for lasting comfort.
- Models 2171 and 2172 stack 5 high on floor or 8 high on dolly 2125WS for easy storage.
- **WS** models have a wall saver frame design.
- Models with corner gussets are not recommended for stacking due to their heavy duty design.
- Stacked chairs may leave frame impressions in chair(s) below.
- Two ganging plates are packed at no charge with each table to attach to two chairs only. Order separately for additional chair-to-chair ganging.
- All Specifications and Pricing are for 1 chair.



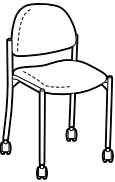

OPTIONAL FEATURES

- Optional steel cushioned glides (**B**) are available on models 2171, 2172, 2173, 2174, 2183, and 2184. Add \$34. Please specify.
- **Frame finish**
 - (**TBL**) Black
 - (**TCC**) Cactus
 - (**TDJ**) Dijon
 - (**TEG**) Eggplant
 - (**TFR**) Frost
 - (**TIV**) Cloud
 - (**TLA**) Latte
 - (**TOA**) Toast
 - (**TSH**) Shadow
 - (**TSR**) Scarlet
- Check textile availability prior to specifying upholstery material.

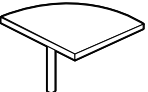
- (**TBZ**) Buzz Blue
- (**TCR**) Carrot
- (**TDW**) Designer White
- (**TFO**) Fog
- (**TIN**) Ink
- (**TKA**) Kalua
- (**TMO**) Mocha
- (**TNE**) Nevada
- (**TSN**) Sand
- (**TTU**) Tungsten

DESCRIPTION	FEATURES	MODEL#	STANDARD TEXTILE GRADES											
			1	2	3	4	5	6	7	8	9	10	11	12
 <p>2171</p> <p>Nesting Chair COM Yardage: 1 Freight Class: 250 Product Weight (lbs.): 15.33 Cubic Feet Per Carton: 3.92 (3 per carton)</p>	<p>Stacks 5 high on floor. Stacks 8 high on dolly. Ergonomic Features: M, N</p>		1	2	3	4	5	6	7	8	9	10	11	12
		2171	\$358	\$396	\$427	\$468	\$529	\$555	\$603	\$705	\$755	\$852	\$977	\$1138
		2171WS	\$412	\$455	\$482	\$527	\$590	\$609	\$666	\$767	\$817	\$915	\$1045	\$1208
			OVERALL DIMENSIONS			SEAT DIMENSIONS			BACK DIMENSIONS					
			W	D	H	W	D	H	W	H				
			0	0	0	18	17	18.5	17.5	15				
														
 <p>2171C</p> <p>Reinforced Armchair w/casters COM Yardage: 1 Freight Class: 250 Product Weight (lbs.): 46 Cubic Feet Per Carton: 11.75 (1 per carton)</p>	<p>Does not stack.</p> <p>Ergonomic Features: M, N</p>		1	2	3	4	5	6	7	8	9	10	11	12
		2171C	\$537	\$575	\$603	\$643	\$702	\$724	\$774	\$872	\$915	\$1008	\$1127	\$1281
		2171WS	\$327	\$370	\$397	\$442	\$502	\$525	\$582	\$684	\$732	\$830	\$960	\$1120
			OVERALL DIMENSIONS			SEAT DIMENSIONS			BACK DIMENSIONS					
			W	D	H	W	D	H	W	H				
			23	22	32.5	18	17.5	18.5	17	14				
														
 <p>2172</p> <p>Armless Stacking Chair COM Yardage: 1 Freight Class: 250 Product Weight (lbs.): 14.33 Cubic Feet Per Carton: 3.83 (3 per carton)</p>	<p>Stacks 5 high on floor. Ergonomic Features: M, N</p>		1	2	3	4	5	6	7	8	9	10	11	12
		2172	\$270	\$308	\$339	\$383	\$441	\$465	\$516	\$618	\$666	\$760	\$889	\$1049
		2172WS	\$327	\$370	\$397	\$442	\$502	\$525	\$582	\$684	\$732	\$830	\$960	\$1120
			OVERALL DIMENSIONS			SEAT DIMENSIONS			BACK DIMENSIONS					
			W	D	H	W	D	H	W	H				
			0	0	0	18	17.5	18.5	17.5	14				
														

DESCRIPTION	FEATURES	MODEL#	STANDARD TEXTILE GRADES												
			1	2	3	4	5	6	7	8	9	10	11	12	
 <p>Reinforced Armless Chair w/casters COM Yardage: 1 Freight Class: 250 Product Weight (lbs.): 14.33 Cubic Feet Per Carton: 4.5 (3 per carton)</p>	<p>Does not stack. Ergonomic Features: M, N</p>	2172C	\$442	\$479	\$506	\$548	\$602	\$625	\$676	\$774	\$820	\$909	\$1031	\$1182	
			OVERALL DIMENSIONS			SEAT DIMENSIONS			BACK DIMENSIONS						
			W	D	H	W	D	H	W	H					
			19	22	32.5	17.5	17.5	14	17	15					
			RTA 00			FedEx			ups						
  <p>2173 2173WS</p> <p>Reinforced Armchair COM Yardage: 1 Freight Class: 250 Product Weight (lbs.): 15.33 Cubic Feet Per Carton: 3.92 (3 per carton)</p>	<p>Does not stack. Ergonomic Features: M, N</p>	2173	\$498	\$538	\$567	\$608	\$670	\$695	\$746	\$849	\$899	\$992	\$1118	\$1279	
			2173WS	\$560	\$600	\$630	\$674	\$735	\$758	\$813	\$915	\$965	\$1062	\$1192	\$1353
				OVERALL DIMENSIONS			SEAT DIMENSIONS			BACK DIMENSIONS					
				W	D	H	W	D	H	W	H				
				23	22	32	18	17.5	18.5	17.5	14				
RTA 00				FedEx			ups								
  <p>2174 2174WS</p> <p>Reinforced Armless Chair COM Yardage: 1 Freight Class: 250 Product Weight (lbs.): 14.33 Cubic Feet Per Carton: 3.83 (3 per carton)</p>	<p>Does not stack. Ergonomic Features: M, N</p>	2174	\$407	\$447	\$476	\$520	\$576	\$602	\$655	\$758	\$803	\$900	\$1027	\$1184	
			2174WS	\$467	\$507	\$537	\$582	\$642	\$665	\$722	\$824	\$872	\$970	\$1100	\$1260
				OVERALL DIMENSIONS			SEAT DIMENSIONS			BACK DIMENSIONS					
				W	D	H	W	D	H	W	H				
				20	22	32	18	17	18.5	17.5	13.5				
RTA 00				FedEx			ups								
 <p>Ganging Plate COM Yardage: N/A Freight Class: 70 Product Weight (lbs.): 2.1 Cubic Feet Per Carton: 0.1</p>		2176	\$86	-	-	-	-	-	-	-	-	-	-		
			OVERALL DIMENSIONS			SEAT DIMENSIONS			BACK DIMENSIONS						
			W	D	H	W	D	H	W	H					
			13.25	4.75	00.06	-	-	-	-	-					
			RTA 00			FedEx			ups						
 <p>Corner Table Radius COM Yardage: N/A Freight Class: 70 Product Weight (lbs.): 23 Cubic Feet Per Carton: 1.3</p>		2178 Radius	\$326	-	-	-	-	-	-	-	-	-			
			OVERALL DIMENSIONS			SEAT DIMENSIONS			BACK DIMENSIONS						
			W	D	H	W	D	H	W	H					
			18	18	17.5	-	-	-	-	-					
			RTA 8			FedEx			ups						

DESCRIPTION	FEATURES	MODEL#	STANDARD TEXTILE GRADES													
			1	2	3	4	5	6	7	8	9	10	11	12		
 <p>Corner Table Crescent COM Yardage: N/A Freight Class: 85 Product Weight (lbs.): 43 Cubic Feet Per Carton: 3.5</p>		2179 Crescent	\$455	-	-	-	-	-	-	-	-	-	-	-	-	
			OVERALL DIMENSIONS			SEAT DIMENSIONS			BACK DIMENSIONS							
			W	D	H	W	D	H	W	H						
			0	0	0	-	-	-	-	-						
			RTA 8			FedEx			ups							
 <p>Ganging Clamp COM Yardage: N/A Freight Class: 70 Product Weight (lbs.): 0.2 Cubic Feet Per Carton: 0.04</p>		2180	\$35	-	-	-	-	-	-	-	-	-	-	-		
			OVERALL DIMENSIONS			SEAT DIMENSIONS			BACK DIMENSIONS							
			W	D	H	W	D	H	W	H						
			00.87	7.75	1.5	-	-	-	-	-						
			RTA 00			FedEx			ups							
 <p>Reinforced Armchair Square Back COM Yardage: 1 Freight Class: 250 Product Weight (lbs.): 15.33 Cubic Feet Per Carton: 4.17 (3 per carton)</p>	Does not stack. Ergonomic Features: M, N	2183	\$428	\$468	\$495	\$538	\$599	\$625	\$674	\$779	\$828	\$922	\$1048	\$1209		
			OVERALL DIMENSIONS			SEAT DIMENSIONS			BACK DIMENSIONS							
			W	D	H	W	D	H	W	H						
			23	20	32	18	17.5	18.5	18	13.5						
			RTA 00			FedEx			ups							
 <p>Reinforced Armless Chair Square Back COM Yardage: 1 Freight Class: 250 Product Weight (lbs.): 14.33 Cubic Feet Per Carton: 4.17 (3 per carton)</p>	Does not stack. Ergonomic Features: M, N	2184	\$337	\$375	\$404	\$447	\$508	\$530	\$585	\$684	\$732	\$827	\$954	\$1113		
			OVERALL DIMENSIONS			SEAT DIMENSIONS			BACK DIMENSIONS							
			W	D	H	W	D	H	W	H						
			19.5	20	32	18	17.5	18.5	18	13.5						
			RTA 00			FedEx			ups							

DIPLOMAT











model 2105

STANDARD FEATURES

- A contoured seat and back are accented by wood arms providing comfort and classic styling.
- For complementary task chairs see page 42.
- Models 2105 and 2108 can be joined together using model 6526 ganging clamp.
- Does not stack.
- When upholstered in Leather, models will be in all Leather.
- Check textile availability prior to specifying upholstery material.

OPTIONAL FEATURES

- Frames are standard in a Black (**TBL**), Tungsten (**TTU**), or (**TSH**) Shadow frame finish at no upcharge and Chrome (**CHM**) frame finish, please add \$64.
- Wood capped arms are available in Absolute (**AAM**), Black (**BKM**), Cherry (**ACM**), Espresso Cafe (**ECM**), English Oak (**EOM**), Fruitwood (**TFM**), Gray (**HGM**), Honey (**AHM**), Mahogany (**TMM**), Maple (**AVM**), Medium Walnut (**MWM**), Natural Walnut (**NLW**), Night (**ASM**), Noce Biondo (**NBM**), Noce Grigio (**NGM**), Noce Leggero (**NEM**), Noce Medio (**NMM**), Shaker Cherry (**SKM**), Walnut (**TWM**), WC Cream (**WTM**), White (**WHM**) and Winter Cherry (**WCM**). Please Specify. Genuine maple faced veneers and solids are used.
- Optional steel cushioned glides (**B**) on model 2105. Add \$31. Please specify.

DESCRIPTION	FEATURES	MODEL#	STANDARD TEXTILE GRADES													
			1	2	3	4	5	6	7	8	9	10	11	12		
 <p>Armchair Wood caps arms COM Yardage: 1.25 Freight Class: 250 Product Weight (lbs.): 25 Cubic Feet Per Carton: 11.75</p>	<p>Does not stack.</p> <p>Ergonomic Features: M, N</p>	<p>2105</p>	\$756	\$803	\$839	\$889	\$964	\$991	\$1053	\$1178	\$1238	\$1350	\$1508	\$1700		
			OVERALL DIMENSIONS			SEAT DIMENSIONS			BACK DIMENSIONS							
			W	D	H	W	D	H	W	H						
			24	22	34.5	20.5	17	18.5	20.5	16						
			  													
 <p>Armless Side Chair COM Yardage: 1.25 Freight Class: 300 Product Weight (lbs.): 22 Cubic Feet Per Carton: 11.75</p>	<p>Does not stack.</p> <p>Ergonomic Features: M, N</p>	<p>2108</p>	\$536	\$583	\$620	\$676	\$752	\$781	\$850	\$979	\$1042	\$1161	\$1323	\$1527		
			OVERALL DIMENSIONS			SEAT DIMENSIONS			BACK DIMENSIONS							
			W	D	H	W	D	H	W	H						
			21.5	22	34.5	20.5	17	18.5	20.5	16						
																
 <p>Armless Barstool COM Yardage: 1.25 Freight Class: 250 Product Weight (lbs.): 30 Cubic Feet Per Carton: 14.75</p>	<p>Does not stack.</p> <p>Ergonomic Features: M, N</p>	<p>2109</p>	\$773	\$820	\$859	\$913	\$991	\$1018	\$1088	\$1217	\$1278	\$1398	\$1560	\$1763		
			OVERALL DIMENSIONS			SEAT DIMENSIONS			BACK DIMENSIONS							
			W	D	H	W	D	H	W	H						
			21	23.5	44.5	20	17	28	20.5	17.5						
																

DUET™



model 6620



model 6621G



model 6627



model 6621TR



model 6632



model 6720PB



model 6720



model 6692 (2 units) on 6500S2 (Beam)

STANDARD FEATURES

- Unique high density seating that is both comfortable and durable.
- Tablet arms are extremely rugged and meets ANSI-BIFMA testing requirements. Tablet hinges up to allow ease of egress. Tablet slides forward and back to accommodate any body size comfortably. Tablet models do not stack.
- Standard tablet (**D8**) size is 18"D x 14 1/2"W and is made of black polymer. Tablets are attached at the left or right (as seated). Tablet arms are not available on stools. Tablet models do not stack.
- All sled-base models have a wall saver frame design with rear legs contacting the wall first leaving clearance between the seat back and wall.
- Armless "G" models feature a patented interlocking feature that allows chairs to be ganged together in rows.
- Model 6626 ganging clamp set is available for use on all armchairs and standard armless models. These brackets snap on the front and rear of the sled base allowing these models to connect together in rows. In Black finish only.
- Clear polycarbonate glides (**CG**) are standard and suitable for carpet, rubber or concrete flooring.
- Weight capacity for this series is 300 lbs.
- Dual wheel carpet casters (**C1**) are standard on task chairs.
- Duet beam seating consists of upper seat units (models 6690, 6691, 6692, 6693, 6697 and 6698) including mounting brackets and all hardware necessary for attachment to beam.
- For all beam components, tables and a complete list of available upper seat units, see Beam Seating series.
- **Specifications and pricing are for 1 chair.**
- Pedestal base models provide fixed location seating for use in auditoriums, classrooms, jury boxes, public venues and more. The base must be mounted to the floor (mounting hardware not included). See Pedestal Base Installation Guide for details.
- Check textile availability prior to specifying upholstery material.









OPTIONAL FEATURES





- Polypropylene seats, backs and coordinating arms are available in 14 designer colors. Choose from Buzz Blue (**BZB**), Cactus (**CCT**), Carrot (**CRO**), Cloud (**IVC**), Dijon (**DJN**), Eggplant (**EGP**), Fog (**FOG**), Frost (**FRO**), Ink (**INK**), Latte (**LAB**), Night (**BLK**), Sand (**SND**), Scarlet (**SAR**), and Shadow (**SHW**).
- An optional 18.5"D x 18.5"W high pressure laminate writing tablet is available. The core is hardwood veneer plywood with radiused edge finished in clear lacquer. This writing tablet is offered in the following finishes: Black (**BLK**), Clear Maple (**CMB**), Designer White (**DWT**) and Noce Grigio (**NGL**). Please specify. Add \$64.
- Chairs will have additional stitch details when upholstered in vinyl.
- A selection of glide options is available. Glide must be chosen to best suit flooring type and site conditions.
- Chrome frame is optionally available without glides (**WS**) and is suitable for rubberized and carpeted floors, please specify. No upcharge
- Glides with felt pads (**FG**) are available for vinyl sheet, cork or laminate flooring, please specify. Add \$34
- Glides with rubber pads (**RG**) are available for vinyl, hardwood, laminate, stone or ceramic flooring, please specify. Add \$34.
- Glides with stainless steel pads (**SG**) are available for carpet or rubber flooring, please specify. Add \$34.
- For task base models, hard surface flooring casters are available. Specify (**C9R**). Add \$72.
- Pedestal base models have black base with 2" height adjustable cylinders. Specify (**SCC**) swivel, auto return to max height (no upcharge); (**SN**) non-swivel, auto return to max height (Add \$21); or, (**SC**) swivel, self-centering and return to max height (add \$33).





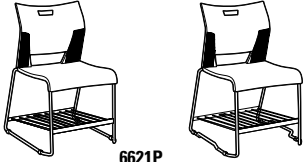

	Duet Chairs Stacking Capability		Duet Stools Stacking Capability	
	Stacking on floor	Stacking on dolly #6624	Stacking on floor	Stacking on dolly
Armless				
Polypropylene seat & back	up to 12 high	up to 40* high	up to 12 high	N/A
Polypropylene back & upholstered seat	up to 5 high	up to 12 high	up to 5 high	N/A
Upholstered seat & back	up to 5 high	up to 12 high	up to 5 high	N/A
With Arms				
Polypropylene seat & back	up to 5 high	up to 24 high	up to 5 high	N/A
Polypropylene back & upholstered seat	up to 5 high	up to 12 high	up to 5 high	N/A
Upholstered seat & back	up to 5 high	up to 12 high	up to 5 high	N/A





* THROUGH 80" DOORWAY, STACKS 36 HIGH





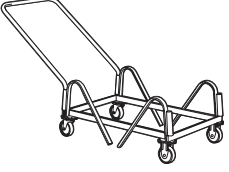

MULTI-PURPOSE





DESCRIPTION	FEATURES	MODEL#	STANDARD TEXTILE GRADES													
			1	2	3	4	5	6	7	8	9	10	11	12		
 <p>ArmChair COM Yardage: N/A Freight Class: 150 Product Weight (lbs.): 19 Cubic Feet Per Carton: 4.63 (4 per carton)</p>	Stacks 5 high on floor. Stacks 24 high on dolly.	6620	\$368	-	-	-	-	-	-	-	-	-	-	-		
			OVERALL DIMENSIONS			SEAT DIMENSIONS			BACK DIMENSIONS							
			W	D	H	W	D	H	W	H						
			25.5	22.75	33.25	18	17.5	16.5	18	16						
			RTA 00													
 <p>Armchair w/Back pack rack COM Yardage: N/A Freight Class: 300 Product Weight (lbs.): 25.5 Cubic Feet Per Carton: 13.25 (1 per carton)</p>	Does not stack.	6620P	\$542	-	-	-	-	-	-	-	-	-	-			
			OVERALL DIMENSIONS			SEAT DIMENSIONS			BACK DIMENSIONS							
			W	D	H	W	D	H	W	H						
			25.5	22.75	33.25	18	17.5	16.5	18	16						
			RTA 00													
 <p>Armchair w/Tablet COM Yardage: N/A Freight Class: 150 Product Weight (lbs.): 33 Cubic Feet Per Carton: 8 (2 per carton)</p>	Does not stack.	6620TR 6620TL	\$763	-	-	-	-	-	-	-	-	-	-			
			OVERALL DIMENSIONS			SEAT DIMENSIONS			BACK DIMENSIONS							
			W	D	H	W	D	H	W	H						
			26.25	27.75	33.25	18	17.5	16.5	18	16						
			RTA 00													
 <p>Armchair w/Tablet and Back pack rack COM Yardage: N/A Freight Class: 250 Product Weight (lbs.): 34 Cubic Feet Per Carton: 16.25 (1 per carton)</p>	Does not stack.	6620TRP 6620TLP	\$957	-	-	-	-	-	-	-	-	-	-			
			OVERALL DIMENSIONS			SEAT DIMENSIONS			BACK DIMENSIONS							
			W	D	H	W	D	H	W	H						
			26.25	27.75	33.25	18	17.5	16.5	18	16						
			RTA 00													
  <p>6621 6621G</p> <p>Armless Chair COM Yardage: N/A Freight Class: 150 Product Weight (lbs.): 20.5 Cubic Feet Per Carton: 3.5/4 per carton)</p>	Stacks 12 high on floor. Stacks 40 high on dolly.	6621 6621G Ganging	\$261	-	-	-	-	-	-	-	-	-	-			
			OVERALL DIMENSIONS			SEAT DIMENSIONS			BACK DIMENSIONS							
			W	D	H	W	D	H	W	H						
			20.75	22.75	33.25	18	17.5	17	18	16						
			RTA 00													
			 													





DESCRIPTION	FEATURES	MODEL#	STANDARD TEXTILE GRADES													
			1	2	3	4	5	6	7	8	9	10	11	12		
 <p>6621P 6621GP</p> <p>Armless Chair w/Back pack rack COM Yardage: N/A Freight Class: 250 Product Weight (lbs.): 25 Cubic Feet Per Carton: 11.25 (1 per carton)</p>	Does not stack.	6621P \$435 6621GP \$447 Ganging														
			OVERALL DIMENSIONS W D H			SEAT DIMENSIONS W D H			BACK DIMENSIONS W H							
			20.75	22.75	33.25	18	17.5	16.5	18	16						
			RTA 00 FedEx ups													
 <p>6621TR 6621TL</p> <p>Armless Chair w/Tablet COM Yardage: N/A Freight Class: 150 Product Weight (lbs.): 32 Cubic Feet Per Carton: 8 (2 per carton)</p>	Does not stack.	6621TR \$654 6621TL														
			OVERALL DIMENSIONS W D H			SEAT DIMENSIONS W D H			BACK DIMENSIONS W H							
			24.5	27.75	33.25	18	17.5	16.5	18	16						
			RTA 00													
 <p>6621TRP 6621TLP</p> <p>Armless Chair w/Tablet and Back pack rack COM Yardage: N/A Freight Class: 300 Product Weight (lbs.): 27 Cubic Feet Per Carton: 16.25 (1 per carton)</p>	Does not stack.	6621TRP \$850 6621TLP														
			OVERALL DIMENSIONS W D H			SEAT DIMENSIONS W D H			BACK DIMENSIONS W H							
			24.5	27.75	33.25	18	17.5	16.5	18	16						
			RTA 00													
 <p>6622</p> <p>Armchair COM Yardage: 0.75 Freight Class: 150 Product Weight (lbs.): 25 Cubic Feet Per Carton: 5.56 (4 per carton)</p>	Upholstered Seat. Stacks 5 high on floor. Stacks 12 high on dolly.	6622 \$476 \$514 \$543 \$584 \$643 \$663 \$715 \$815 \$863 \$953 \$1078 \$1232														
			OVERALL DIMENSIONS W D H			SEAT DIMENSIONS W D H			BACK DIMENSIONS W H							
			25.5	23	33.25	18	17.5	17	18	16						
			RTA 00													
 <p>6622P</p> <p>Armchair w/Back pack rack COM Yardage: 0.75 Freight Class: 250 Product Weight (lbs.): 29 Cubic Feet Per Carton: 13.25 (1 per carton)</p>	Upholstered Seat. Does not stack.	6622P \$656 \$696 \$725 \$770 \$831 \$852 \$909 \$1010 \$1060 \$1158 \$1288 \$1448														
			OVERALL DIMENSIONS W D H			SEAT DIMENSIONS W D H			BACK DIMENSIONS W H							
			25.5	23	33.25	18	17.5	17	18	16						
			RTA 00													











DESCRIPTION	FEATURES	MODEL#	STANDARD TEXTILE GRADES											
			1	2	3	4	5	6	7	8	9	10	11	12
 <p>Armchair w/Tablet COM Yardage: 1 Freight Class: 250 Product Weight (lbs.): 27 Cubic Feet Per Carton: 16 (2 per carton)</p>	<p>Upholstered Seat. Does not stack. Must specify (L) Left or (R) Right Tablet.</p>	6622TR 6622TL	\$868	\$908	\$941	\$987	\$1053	\$1076	\$1134	\$1245	\$1299	\$1401	\$1541	\$1717
		OVERALL DIMENSIONS W D H	SEAT DIMENSIONS W D H	BACK DIMENSIONS W H	26.25	27.75	33.25	18	17.5	17	18	15.5		
		<p>RTA 00</p>												
 <p>Armchair w/Tablet and Back pack rack COM Yardage: 1 Freight Class: 250 Product Weight (lbs.): 37 Cubic Feet Per Carton: 16.25 (1 per carton)</p>	<p>Upholstered Seat. Does not stack.</p>	6622TRP 6622TLP	\$1062	\$1105	\$1136	\$1182	\$1247	\$1271	\$1329	\$1439	\$1494	\$1596	\$1736	\$1911
		OVERALL DIMENSIONS W D H	SEAT DIMENSIONS W D H	BACK DIMENSIONS W H	26.25	27.75	33.25	18	17.5	17	18	15.5		
		<p>RTA 00</p>												
  <p>6623 6623G</p> <p>Armless Chair COM Yardage: 0.75 Freight Class: 150 Product Weight (lbs.): 21 Cubic Feet Per Carton: 4.63 (4 per carton)</p>	<p>Upholstered Seat. Stacks 5 high on floor. Stacks 12 high on dolly.</p>	6623	\$362	\$400	\$429	\$470	\$529	\$549	\$601	\$701	\$749	\$839	\$964	\$1118
		6623G Ganging	\$389	\$427	\$456	\$497	\$556	\$576	\$628	\$728	\$776	\$866	\$991	\$1145
		OVERALL DIMENSIONS W D H	SEAT DIMENSIONS W D H	BACK DIMENSIONS W H	20.5	23	33.25	18	17.5	17	18	16		
<p>RTA 00</p>														
  <p>6623P 6623GP</p> <p>Armless Chair w/Back pack rack COM Yardage: 0.75 Freight Class: 250 Product Weight (lbs.): 28 Cubic Feet Per Carton: 11.25 (1 per carton)</p>	<p>Upholstered Seat. Does not stack.</p>	6623P	\$539	\$579	\$609	\$652	\$714	\$737	\$792	\$893	\$943	\$1041	\$1169	\$1332
		6623GP Ganging	\$565	\$605	\$635	\$678	\$740	\$763	\$818	\$919	\$969	\$1067	\$1195	\$1358
		OVERALL DIMENSIONS W D H	SEAT DIMENSIONS W D H	BACK DIMENSIONS W H	20.5	23	33.25	18	17.5	17	18	16		
<p>RTA 00</p>														
 <p>6623TR 6623TL</p> <p>Armless Chair w/Tablet COM Yardage: 1 Freight Class: 250 Product Weight (lbs.): 29 Cubic Feet Per Carton: 16 (2 per carton)</p>	<p>Upholstered Seat. Does not stack.</p>	6623TR 6623TL	\$759	\$803	\$833	\$879	\$944	\$967	\$1026	\$1136	\$1190	\$1292	\$1432	\$1608
		OVERALL DIMENSIONS W D H	SEAT DIMENSIONS W D H	BACK DIMENSIONS W H	24.5	27.75	33.25	18	17.5	17	18	15.5		
		<p>RTA 00</p>												



















DESCRIPTION	FEATURES	MODEL#	STANDARD TEXTILE GRADES												
			1	2	3	4	5	6	7	8	9	10	11	12	
 <p>Dolly COM Yardage: N/A Freight Class: 150 Product Weight (lbs.): 40 Cubic Feet Per Carton: 9.5 (1 per carton)</p>		6624	\$772	-	-	-	-	-	-	-	-	-	-	-	-
			OVERALL DIMENSIONS			SEAT DIMENSIONS			BACK DIMENSIONS						
			W	D	H	W	D	H	W	H					
			22.5	51	38.25	-	-	-	-	-					
			RTA 1		FedEx		UPS								
 <p>Ganging Clamp Set - 2 Clamps COM Yardage: N/A Freight Class: 70 Product Weight (lbs.): 0.3 Cubic Feet Per Carton: 0.01 (1 set per carton)</p>		6626	\$30	-	-	-	-	-	-	-	-	-	-	-	
			OVERALL DIMENSIONS			SEAT DIMENSIONS			BACK DIMENSIONS						
			W	D	H	W	D	H	W	H					
			1	6.5	00.75	-	-	-	-	-					
			RTA 00		FedEx		UPS								
 <p>Armchair COM Yardage: 0.75 Freight Class: 150 Product Weight (lbs.): 27 Cubic Feet Per Carton: 5.56 (4 per carton)</p>	Upholstered Seat and Back. Stacks 5 high on floor. Stacks 12 high on dolly.	6627	\$525	\$592	\$623	\$663	\$729	\$747	\$802	\$906	\$955	\$1051	\$1182	\$1347	
			OVERALL DIMENSIONS			SEAT DIMENSIONS			BACK DIMENSIONS						
			W	D	H	W	D	H	W	H					
			25.5	23	33.25	18	17.5	17	18	16					
			RTA 00												
 <p>Armchair w/Back pack rack COM Yardage: 0.75 Freight Class: 250 Product Weight (lbs.): 31 Cubic Feet Per Carton: 13.25 (1 per carton)</p>	Upholstered Seat and Back. Does not stack.	6627P	\$706	\$746	\$776	\$820	\$881	\$904	\$960	\$1061	\$1111	\$1208	\$1338	\$1499	
			OVERALL DIMENSIONS			SEAT DIMENSIONS			BACK DIMENSIONS						
			W	D	H	W	D	H	W	H					
			25.5	23	33.25	18	17.5	17	18	16					
			RTA 00												
 <p>Armchair w/Tablet COM Yardage: 1 Freight Class: 250 Product Weight (lbs.): 32 Cubic Feet Per Carton: 16 (2 per carton)</p>	Upholstered Seat and Back. Does not stack.	6627TR 6627TL	\$912	\$955	\$985	\$1031	\$1097	\$1120	\$1178	\$1289	\$1343	\$1445	\$1585	\$1761	
			OVERALL DIMENSIONS			SEAT DIMENSIONS			BACK DIMENSIONS						
			W	D	H	W	D	H	W	H					
			26.25	27.75	33.25	18	17	17	18	15.5					
			RTA 00												



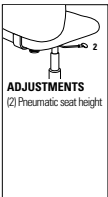



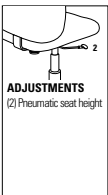

DESCRIPTION	FEATURES	MODEL#	STANDARD TEXTILE GRADES												
			1	2	3	4	5	6	7	8	9	10	11	12	
 <p>Armchair w/Tablet and Back pack rack COM Yardage: 1 Freight Class: 250 Product Weight (lbs.): 39 Cubic Feet Per Carton: 16.25 (1 per carton)</p>	Upholstered Seat and Back. Does not stack.	6627TRP 6627TLP	\$1107	\$1150	\$1180	\$1226	\$1291	\$1315	\$1373	\$1484	\$1538	\$1641	\$1780	\$1956	
			OVERALL DIMENSIONS			SEAT DIMENSIONS			BACK DIMENSIONS						
		W	D	H	W	D	H	W	H						
		26.25	27.75	33.25	18	17	17	18	15.5						
			RTA 00												
  <p>6628 6628G</p> <p>Armless Chair COM Yardage: 0.75 Freight Class: 150 Product Weight (lbs.): 23 Cubic Feet Per Carton: 4.63 (4 per carton)</p>	Upholstered Seat and Back. Stacks 5 high on floor. Stacks 12 high on dolly.	6628	\$425	\$489	\$517	\$558	\$623	\$643	\$697	\$801	\$852	\$947	\$1077	\$1240	
			6628G Ganging	\$441	\$504	\$531	\$573	\$638	\$660	\$714	\$818	\$868	\$964	\$1093	\$1255
		OVERALL DIMENSIONS			SEAT DIMENSIONS			BACK DIMENSIONS							
		W	D	H	W	D	H	W	H						
20.5	23	33.25	18	17	17	18	15.5								
			RTA 00												
  <p>6628P 6628GP</p> <p>Armless Chair w/Back pack rack COM Yardage: 0.75 Freight Class: 250 Product Weight (lbs.): 30 Cubic Feet Per Carton: 11.25 (1 per carton)</p>	Upholstered Seat and Back. Does not stack.	6628P	\$609	\$649	\$679	\$724	\$784	\$807	\$863	\$964	\$1016	\$1112	\$1241	\$1402	
			6628GP Ganging	\$626	\$666	\$696	\$740	\$801	\$823	\$879	\$980	\$1030	\$1128	\$1258	\$1419
		OVERALL DIMENSIONS			SEAT DIMENSIONS			BACK DIMENSIONS							
		W	D	H	W	D	H	W	H						
20.5	23	33.25	18	17	17	18	15.5								
			RTA 00												
 <p>Armless Chair w/Tablet COM Yardage: 1 Freight Class: 250 Product Weight (lbs.): 31 Cubic Feet Per Carton: 16 (2 per carton)</p>	Upholstered Seat and Back. Does not stack.	6628TR 6628TL	\$799	\$843	\$873	\$919	\$985	\$1011	\$1066	\$1180	\$1233	\$1335	\$1474	\$1651	
			OVERALL DIMENSIONS			SEAT DIMENSIONS			BACK DIMENSIONS						
		W	D	H	W	D	H	W	H						
		24.5	27.75	33.25	18	17	17	18	15.5						
			RTA 00												
 <p>Armless Chair w/Tablet and Back pack rack COM Yardage: 1 Freight Class: 250 Product Weight (lbs.): 38 Cubic Feet Per Carton: 16.25 (1 per carton)</p>	Upholstered Seat and Back. Does not stack.	6628TRP 6628TLP	\$999	\$1042	\$1072	\$1118	\$1185	\$1208	\$1265	\$1377	\$1431	\$1533	\$1673	\$1849	
			OVERALL DIMENSIONS			SEAT DIMENSIONS			BACK DIMENSIONS						
		W	D	H	W	D	H	W	H						
		24.5	27.75	33.25	18	17	17	18	15.5						
			RTA 00												



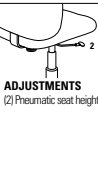

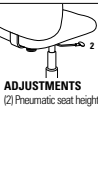

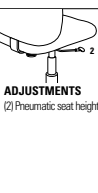

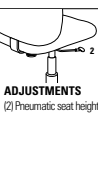

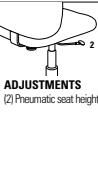

DESCRIPTION	FEATURES	MODEL#	STANDARD TEXTILE GRADES											
			1	2	3	4	5	6	7	8	9	10	11	12
 <p>Barstool with Arms COM Yardage: N/A Freight Class: 250 Product Weight (lbs.): 30 Cubic Feet Per Carton: 10.75 (2 per carton)</p>	Stacks 5 high on floor.	6630	\$641	-	-	-	-	-	-	-	-	-	-	-
			OVERALL DIMENSIONS			SEAT DIMENSIONS			BACK DIMENSIONS					
			W	D	H	W	D	H	W	H				
			25.5	23.5	45	18	17.5	29.5	18	16				
RTA 00														
 <p>Armless Barstool COM Yardage: N/A Freight Class: 250 Product Weight (lbs.): 29</p>	Stacks 8 high on floor.	6631	\$477	-	-	-	-	-	-	-	-	-	-	
			OVERALL DIMENSIONS			SEAT DIMENSIONS			BACK DIMENSIONS					
			W	D	H	W	D	H	W	H				
			20.75	23.5	45	18	17.5	29.5	18	16				
RTA 00														
 <p>Barstool with Arms COM Yardage: 0.75 Freight Class: 250 Product Weight (lbs.): 31 Cubic Feet Per Carton: 10.75 (2 per carton)</p>	Upholstered Seat Stacks 5 high on floor	6632	\$739	\$776	\$806	\$847	\$908	\$925	\$981	\$1080	\$1126	\$1218	\$1341	\$1495
			OVERALL DIMENSIONS			SEAT DIMENSIONS			BACK DIMENSIONS					
			W	D	H	W	D	H	W	H				
			25.5	23.5	45	18	17.5	30	18	15.5				
RTA 00														
 <p>Armless Barstool COM Yardage: 0.75 Freight Class: 250 Product Weight (lbs.): 30 Cubic Feet Per Carton: 17.5 (2 per carton)</p>	Upholstered Seat. Stacks 5 high on floor.	6633	\$571	\$609	\$638	\$679	\$739	\$758	\$812	\$910	\$958	\$1050	\$1174	\$1327
			OVERALL DIMENSIONS			SEAT DIMENSIONS			BACK DIMENSIONS					
			W	D	H	W	D	H	W	H				
			20.75	23.5	45	18	17.5	30	18	15.5				
RTA 00														
 <p>Barstool with Arms COM Yardage: 0.75 Freight Class: 250 Product Weight (lbs.): 31.5 Cubic Feet Per Carton: 10.75 (2 per carton)</p>	Upholstered Seat and Back. Stacks 3 high on floor.	6637	\$781	\$818	\$847	\$889	\$949	\$967	\$1022	\$1120	\$1168	\$1260	\$1383	\$1537
			OVERALL DIMENSIONS			SEAT DIMENSIONS			BACK DIMENSIONS					
			W	D	H	W	D	H	W	H				
			25.5	23.5	45	18	17.5	30	18	15.5				
RTA 00														







DESCRIPTION	FEATURES	MODEL#	STANDARD TEXTILE GRADES											
			1	2	3	4	5	6	7	8	9	10	11	12
 <p>Armless Barstool COM Yardage: 0.75 Freight Class: 250 Product Weight (lbs.): 30.5 Cubic Feet Per Carton: 8.75 (2 per carton)</p>	Upholstered Seat and Back. Stacks 3 high on floor.	6638	\$670	\$708	\$737	\$777	\$838	\$856	\$911	\$1009	\$1057	\$1147	\$1270	\$1426
			OVERALL DIMENSIONS			SEAT DIMENSIONS			BACK DIMENSIONS					
			W	D	H	W	D	H	W	H				
			20.75	23.5	45	18	17.5	30	18	15.5				
			RTA 00											
 <p>Counter Stool with Arms COM Yardage: N/A Freight Class: 250 Product Weight (lbs.): 25 Cubic Feet Per Carton: 10.75 (2 per carton)</p>	Stacks 5 high on floor.	6660	\$641	-	-	-	-	-	-	-	-	-	-	-
			OVERALL DIMENSIONS			SEAT DIMENSIONS			BACK DIMENSIONS					
			W	D	H	W	D	H	W	H				
			25.5	23.5	39.5	18	17.5	24	18	16				
			RTA 00											
 <p>Armless Counter Stool COM Yardage: N/A Freight Class: 250 Product Weight (lbs.): 24 Cubic Feet Per Carton: 8.75 (2 per carton)</p>	Stacks 5 high on floor.	6661	\$477	-	-	-	-	-	-	-	-	-	-	
			OVERALL DIMENSIONS			SEAT DIMENSIONS			BACK DIMENSIONS					
			W	D	H	W	D	H	W	H				
			20.75	23.5	39.5	18	17.5	24	18	16				
			RTA 00											
 <p>Counter Stool w/Arms COM Yardage: 0.75 Freight Class: 250 Product Weight (lbs.): 26 Cubic Feet Per Carton: 10.75 (2 per carton)</p>	Upholstered Seat. Stacks 5 high on floor.	6662	\$739	\$776	\$805	\$847	\$908	\$925	\$981	\$1080	\$1126	\$1218	\$1341	\$1495
			OVERALL DIMENSIONS			SEAT DIMENSIONS			BACK DIMENSIONS					
			W	D	H	W	D	H	W	H				
			20.75	23.5	39.5	18	17.5	24	18	16				
			RTA 00											
 <p>Armless Counter Stool COM Yardage: 0.75 Freight Class: 250 Product Weight (lbs.): 25 Cubic Feet Per Carton: 8.75 (2 per carton)</p>	Upholstered Seat. Stacks 5 high on floor.	6663	\$571	\$609	\$638	\$679	\$739	\$758	\$812	\$910	\$958	\$1050	\$1174	\$1327
			OVERALL DIMENSIONS			SEAT DIMENSIONS			BACK DIMENSIONS					
			W	D	H	W	D	H	W	H				
			20.75	23.5	39.5	18	17.5	24	18	16				
			RTA 00											

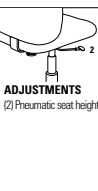

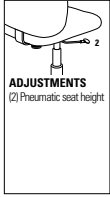

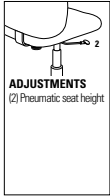

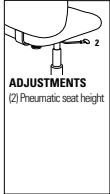
DESCRIPTION	FEATURES	MODEL#	STANDARD TEXTILE GRADES											
			1	2	3	4	5	6	7	8	9	10	11	12
 <p>Counter Stool w/Arms COM Yardage: 0.75 Freight Class: 250 Product Weight (lbs.): 26.5 Cubic Feet Per Carton: 10.75 (2 per carton)</p>	Upholstered Seat and Back. Stacks 3 high on floor.	6667	\$781	\$818	\$847	\$889	\$949	\$967	\$1022	\$1120	\$1168	\$1260	\$1383	\$1537
			OVERALL DIMENSIONS			SEAT DIMENSIONS			BACK DIMENSIONS					
			W	D	H	W	D	H	W	H				
			25.5	23.5	39.5	18	17.5	24	18	16				
			RTA 00											
 <p>Armless Counter Stool COM Yardage: 0.75 Freight Class: 250 Product Weight (lbs.): 25.5 Cubic Feet Per Carton: 8.75 (2 per carton)</p>	Upholstered Seat and Back. Stacks 3 high on floor.	6668	\$670	\$708	\$737	\$777	\$838	\$856	\$911	\$1009	\$1057	\$1147	\$1270	\$1426
			OVERALL DIMENSIONS			SEAT DIMENSIONS			BACK DIMENSIONS					
			W	D	H	W	D	H	W	H				
			20.75	23.5	39.5	18	17.5	24	18	16				
			RTA 00											
 <p>Seat Unit w/Arms COM Yardage: N/A Freight Class: 250 Product Weight (lbs.): 19 Cubic Feet Per Carton: 4.88 (2 per carton)</p>	Use with beams.	6690	\$424	-	-	-	-	-	-	-	-	-	-	-
			OVERALL DIMENSIONS			SEAT DIMENSIONS			BACK DIMENSIONS					
			W	D	H	W	D	H	W	H				
			25.5	21	18	18	17.5	-	18	16				
			RTA 00  											
 <p>Armless Seat Unit COM Yardage: N/A Freight Class: 150 Product Weight (lbs.): 18 Cubic Feet Per Carton: 3.25 (2 per carton)</p>	Use with beams.	6691	\$312	-	-	-	-	-	-	-	-	-	-	-
			OVERALL DIMENSIONS			SEAT DIMENSIONS			BACK DIMENSIONS					
			W	D	H	W	D	H	W	H				
			18	21	18	18	17.5	-	18	16				
			RTA 00  											
 <p>Seat Unit w/Arms COM Yardage: 0.75 Freight Class: 250 Product Weight (lbs.): 19 Cubic Feet Per Carton: 4.88 (2 per carton)</p>	Upholstered Seat. Use with beams.	6692	\$519	\$557	\$586	\$627	\$687	\$705	\$760	\$856	\$906	\$998	\$1121	\$1275
			OVERALL DIMENSIONS			SEAT DIMENSIONS			BACK DIMENSIONS					
			W	D	H	W	D	H	W	H				
			25.5	21	18	18	17.5	-	18	15.5				
			RTA 00  											

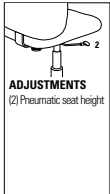

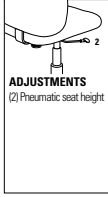

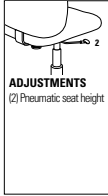

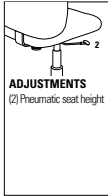
DESCRIPTION	FEATURES	MODEL#	STANDARD TEXTILE GRADES											
			1	2	3	4	5	6	7	8	9	10	11	12
 Armless Seat Unit COM Yardage: 0.75 Freight Class: 150 Product Weight (lbs.): 19 Cubic Feet Per Carton: 3.25 (2 per carton)	Upholstered Seat. Use with beams.	6693	\$403	\$441	\$469	\$511	\$570	\$589	\$642	\$740	\$790	\$880	\$1005	\$1158
			OVERALL DIMENSIONS W D H			SEAT DIMENSIONS W D H			BACK DIMENSIONS W H					
			18	21	18	18	17.5	-	18	15.5				
			  											
 Seat Unit w/Arms COM Yardage: 0.75 Freight Class: 150 Product Weight (lbs.): 20 Cubic Feet Per Carton: 4.88 (2 per carton)	Upholstered Seat and Back. Use with beams.	6697	\$550	\$588	\$616	\$658	\$717	\$736	\$789	\$887	\$937	\$1027	\$1152	\$1305
			OVERALL DIMENSIONS W D H			SEAT DIMENSIONS W D H			BACK DIMENSIONS W H					
			25.5	21	18	18	17	-	18	15.5				
			  											
 Armless Seat Unit COM Yardage: 0.75 Freight Class: 150 Product Weight (lbs.): 19 Cubic Feet Per Carton: 3.25 (2 per carton)	Upholstered Seat and Back. Use with beams.	6698	\$449	\$487	\$516	\$557	\$617	\$635	\$690	\$788	\$836	\$928	\$1051	\$1205
			OVERALL DIMENSIONS W D H			SEAT DIMENSIONS W D H			BACK DIMENSIONS W H					
			18	21	18	18	17	-	18	15.5				
			  											
 Task w/Arms COM Yardage: N/A Freight Class: 250 Product Weight (lbs.): 32 Cubic Feet Per Carton: 9.75	 ADJUSTMENTS (2) Pneumatic seat height	Polypropylene Seat and Back Ergonomic Features: C, M	6720	\$610	-	-	-	-	-	-	-	-	-	-
				OVERALL DIMENSIONS W D H			SEAT DIMENSIONS W D H			BACK DIMENSIONS W H				
				25.5	21.5	32.5	18	17.5	14-19	18	16			
				  										
 Task w/Arms and Tablet COM Yardage: N/A Freight Class: 250 Product Weight (lbs.): 40 Cubic Feet Per Carton: 15.75	 ADJUSTMENTS (2) Pneumatic seat height	Polypropylene Seat and Back Specify (L) left or (R) right tablet. Ergonomic Features: C, M	6720TR 6720TL	\$1050	-	-	-	-	-	-	-	-	-	-
				OVERALL DIMENSIONS W D H			SEAT DIMENSIONS W D H			BACK DIMENSIONS W H				
				26.5	25.5	33.25	18	17.5	14-19	18	16			
														

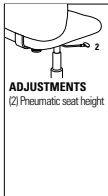
DESCRIPTION	FEATURES	MODEL#	STANDARD TEXTILE GRADES												
			1	2	3	4	5	6	7	8	9	10	11	12	
 <p>Task Armless COM Yardage: N/A Freight Class: 250 Product Weight (lbs.): 31 Cubic Feet Per Carton: 9.75</p>	 <p>ADJUSTMENTS (2) Pneumatic seat height</p> <p>Polypropylene Seat and Back</p> <p>Ergonomic Features: C, M</p>	6721	\$468	-	-	-	-	-	-	-	-	-	-	-	
		OVERALL DIMENSIONS			SEAT DIMENSIONS			BACK DIMENSIONS							
		W	D	H	W	D	H	W	H						
		18	21.5	32.5	18	17.5	14-19	18	16						
			RTA 1	FedEx		ups									
 <p>Task Armless w/Tablet COM Yardage: N/A Freight Class: 250 Product Weight (lbs.): 39 Cubic Feet Per Carton: 15.75</p>	 <p>ADJUSTMENTS (2) Pneumatic seat height</p> <p>Polypropylene Seat and Back Specify (L) left or (R) right tablet.</p> <p>Ergonomic Features: C, M</p>	6721TR 6721TL	\$891	-	-	-	-	-	-	-	-	-	-		
		OVERALL DIMENSIONS			SEAT DIMENSIONS			BACK DIMENSIONS							
		W	D	H	W	D	H	W	H						
		23.5	25.5	33.25	18	17.5	14-19	18	16						
			RTA 1												
 <p>Task w/Arms COM Yardage: 0.75 Freight Class: 250 Product Weight (lbs.): 33 Cubic Feet Per Carton: 9.75</p>	 <p>ADJUSTMENTS (2) Pneumatic seat height</p> <p>Upholstered Seat</p> <p>Ergonomic Features: C, M</p>	6722	\$671	\$709	\$738	\$779	\$838	\$858	\$910	\$1010	\$1058	\$1148	\$1273	\$1427	
		OVERALL DIMENSIONS			SEAT DIMENSIONS			BACK DIMENSIONS							
		W	D	H	W	D	H	W	H						
		25.5	21.5	32.5	18	17.5	14.5-19.5	18	15.5						
			RTA 1												
 <p>Task w/Arms and Tablet COM Yardage: 0.75 Freight Class: 250 Product Weight (lbs.): 41 Cubic Feet Per Carton: 15.75</p>	 <p>ADJUSTMENTS (2) Pneumatic seat height</p> <p>Upholstered Seat Specify (L) left or (R) right tablet.</p> <p>Ergonomic Features: C, M</p>	6722TR 6722TL	\$1095	\$1121	\$1140	\$1169	\$1209	\$1228	\$1264	\$1323	\$1371	\$1418	\$1522	\$1631	
		OVERALL DIMENSIONS			SEAT DIMENSIONS			BACK DIMENSIONS							
		W	D	H	W	D	H	W	H						
		26.5	25.5	33.25	18	17.5	14.5-19.5	18	15.5						
			RTA 1												
 <p>Task Armless COM Yardage: 0.75 Freight Class: 250 Product Weight (lbs.): 32 Cubic Feet Per Carton: 9.75</p>	 <p>ADJUSTMENTS (2) Pneumatic seat height</p> <p>Upholstered Seat</p> <p>Ergonomic Features: C, M</p>	6723	\$549	\$586	\$615	\$656	\$714	\$735	\$786	\$885	\$935	\$1024	\$1149	\$1302	
		OVERALL DIMENSIONS			SEAT DIMENSIONS			BACK DIMENSIONS							
		W	D	H	W	D	H	W	H						
		18	21.5	32.5	18	17	14.5-19.5	18	15.5						
			RTA 1	FedEx		ups									

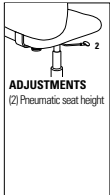
DESCRIPTION	FEATURES	MODEL#	STANDARD TEXTILE GRADES																													
			1	2	3	4	5	6	7	8	9	10	11	12																		
 <p>Height Adjustable Stool w/Arms COM Yardage: N/A Freight Class: 250 Product Weight (lbs.): 38 Cubic Feet Per Carton: 9.75</p>	 <p>ADJUSTMENTS (2) Pneumatic seat height</p>	<p>Polypropylene Seat and Back</p> <p>Ergonomic Features: C, M</p>	<table border="1"> <tr> <td>6730</td> <td>\$812</td> <td>-</td> <td>-</td> <td>-</td> <td>-</td> <td>-</td> <td>-</td> <td>-</td> <td>-</td> <td>-</td> <td>-</td> <td>-</td> <td>-</td> <td>-</td> <td>-</td> </tr> </table>												6730	\$812	-	-	-	-	-	-	-	-	-	-	-	-	-	-		
			6730	\$812	-	-	-	-	-	-	-	-	-	-	-	-	-	-														
			<table border="1"> <tr> <th colspan="3">OVERALL DIMENSIONS</th> <th colspan="3">SEAT DIMENSIONS</th> <th colspan="2">BACK DIMENSIONS</th> </tr> <tr> <th>W</th> <th>D</th> <th>H</th> <th>W</th> <th>D</th> <th>H</th> <th>W</th> <th>H</th> </tr> <tr> <td>25.5</td> <td>21.5</td> <td>41</td> <td>18</td> <td>17.5</td> <td>21-31</td> <td>18</td> <td>16</td> </tr> </table>			OVERALL DIMENSIONS			SEAT DIMENSIONS			BACK DIMENSIONS		W	D	H	W	D	H	W	H	25.5	21.5	41	18	17.5	21-31	18	16	<p>RTA 1 </p>		
			OVERALL DIMENSIONS			SEAT DIMENSIONS			BACK DIMENSIONS																							
W	D	H	W	D	H	W	H																									
25.5	21.5	41	18	17.5	21-31	18	16																									
 <p>Height Adjustable Stool - Armless COM Yardage: N/A Freight Class: 250 Product Weight (lbs.): 37 Cubic Feet Per Carton: 9.75</p>	 <p>ADJUSTMENTS (2) Pneumatic seat height</p>	<p>Polypropylene Seat and Back</p> <p>Ergonomic Features: C, M</p>	<table border="1"> <tr> <td>6731</td> <td>\$718</td> <td>-</td> <td>-</td> <td>-</td> <td>-</td> <td>-</td> <td>-</td> <td>-</td> <td>-</td> <td>-</td> <td>-</td> <td>-</td> <td>-</td> <td>-</td> <td>-</td> </tr> </table>												6731	\$718	-	-	-	-	-	-	-	-	-	-	-	-	-	-		
			6731	\$718	-	-	-	-	-	-	-	-	-	-	-	-	-	-														
			<table border="1"> <tr> <th colspan="3">OVERALL DIMENSIONS</th> <th colspan="3">SEAT DIMENSIONS</th> <th colspan="2">BACK DIMENSIONS</th> </tr> <tr> <th>W</th> <th>D</th> <th>H</th> <th>W</th> <th>D</th> <th>H</th> <th>W</th> <th>H</th> </tr> <tr> <td>18</td> <td>21.5</td> <td>41</td> <td>18</td> <td>17.5</td> <td>21.5-31.5</td> <td>18</td> <td>15.5</td> </tr> </table>			OVERALL DIMENSIONS			SEAT DIMENSIONS			BACK DIMENSIONS		W	D	H	W	D	H	W	H	18	21.5	41	18	17.5	21.5-31.5	18	15.5	<p>RTA 1  </p>		
			OVERALL DIMENSIONS			SEAT DIMENSIONS			BACK DIMENSIONS																							
W	D	H	W	D	H	W	H																									
18	21.5	41	18	17.5	21.5-31.5	18	15.5																									
 <p>Height Adjustable Stool w/Arms COM Yardage: 0.75 Freight Class: 150 Product Weight (lbs.): 39 Cubic Feet Per Carton: 9.75</p>	 <p>ADJUSTMENTS (2) Pneumatic seat height</p>	<p>Upholstered Seat</p> <p>Ergonomic Features: C, M</p>	<table border="1"> <tr> <td>6732</td> <td>\$903</td> <td>\$943</td> <td>\$972</td> <td>\$1013</td> <td>\$1071</td> <td>\$1092</td> <td>\$1144</td> <td>\$1244</td> <td>\$1291</td> <td>\$1382</td> <td>\$1506</td> <td>\$1659</td> </tr> </table>												6732	\$903	\$943	\$972	\$1013	\$1071	\$1092	\$1144	\$1244	\$1291	\$1382	\$1506	\$1659					
			6732	\$903	\$943	\$972	\$1013	\$1071	\$1092	\$1144	\$1244	\$1291	\$1382	\$1506	\$1659																	
			<table border="1"> <tr> <th colspan="3">OVERALL DIMENSIONS</th> <th colspan="3">SEAT DIMENSIONS</th> <th colspan="2">BACK DIMENSIONS</th> </tr> <tr> <th>W</th> <th>D</th> <th>H</th> <th>W</th> <th>D</th> <th>H</th> <th>W</th> <th>H</th> </tr> <tr> <td>25.5</td> <td>21.5</td> <td>41</td> <td>18</td> <td>17.5</td> <td>21.5-31.5</td> <td>18</td> <td>15.5</td> </tr> </table>			OVERALL DIMENSIONS			SEAT DIMENSIONS			BACK DIMENSIONS		W	D	H	W	D	H	W	H	25.5	21.5	41	18	17.5	21.5-31.5	18	15.5	<p>RTA 1</p>		
			OVERALL DIMENSIONS			SEAT DIMENSIONS			BACK DIMENSIONS																							
W	D	H	W	D	H	W	H																									
25.5	21.5	41	18	17.5	21.5-31.5	18	15.5																									
 <p>Height Adjustable Stool - Armless COM Yardage: 0.75 Freight Class: 250 Product Weight (lbs.): 38 Cubic Feet Per Carton: 9.75</p>	 <p>ADJUSTMENTS (2) Pneumatic seat height</p>	<p>Upholstered Seat</p> <p>Ergonomic Features: C, M</p>	<table border="1"> <tr> <td>6733</td> <td>\$812</td> <td>\$850</td> <td>\$879</td> <td>\$920</td> <td>\$979</td> <td>\$999</td> <td>\$1051</td> <td>\$1151</td> <td>\$1199</td> <td>\$1289</td> <td>\$1414</td> <td>\$1567</td> </tr> </table>												6733	\$812	\$850	\$879	\$920	\$979	\$999	\$1051	\$1151	\$1199	\$1289	\$1414	\$1567					
			6733	\$812	\$850	\$879	\$920	\$979	\$999	\$1051	\$1151	\$1199	\$1289	\$1414	\$1567																	
			<table border="1"> <tr> <th colspan="3">OVERALL DIMENSIONS</th> <th colspan="3">SEAT DIMENSIONS</th> <th colspan="2">BACK DIMENSIONS</th> </tr> <tr> <th>W</th> <th>D</th> <th>H</th> <th>W</th> <th>D</th> <th>H</th> <th>W</th> <th>H</th> </tr> <tr> <td>18</td> <td>21.5</td> <td>41</td> <td>18</td> <td>17.5</td> <td>21.5-31.5</td> <td>18</td> <td>15.5</td> </tr> </table>			OVERALL DIMENSIONS			SEAT DIMENSIONS			BACK DIMENSIONS		W	D	H	W	D	H	W	H	18	21.5	41	18	17.5	21.5-31.5	18	15.5	<p>RTA 1  </p>		
			OVERALL DIMENSIONS			SEAT DIMENSIONS			BACK DIMENSIONS																							
W	D	H	W	D	H	W	H																									
18	21.5	41	18	17.5	21.5-31.5	18	15.5																									
 <p>Height Adjustable Stool w/Arms COM Yardage: 0.75 Freight Class: 150 Product Weight (lbs.): 40 Cubic Feet Per Carton: 9.75</p>	 <p>ADJUSTMENTS (2) Pneumatic seat height</p>	<p>Upholstered Seat and Back</p> <p>Ergonomic Features: C, M</p>	<table border="1"> <tr> <td>6737</td> <td>\$997</td> <td>\$1035</td> <td>\$1064</td> <td>\$1105</td> <td>\$1164</td> <td>\$1184</td> <td>\$1236</td> <td>\$1336</td> <td>\$1384</td> <td>\$1474</td> <td>\$1599</td> <td>\$1753</td> </tr> </table>												6737	\$997	\$1035	\$1064	\$1105	\$1164	\$1184	\$1236	\$1336	\$1384	\$1474	\$1599	\$1753					
			6737	\$997	\$1035	\$1064	\$1105	\$1164	\$1184	\$1236	\$1336	\$1384	\$1474	\$1599	\$1753																	
			<table border="1"> <tr> <th colspan="3">OVERALL DIMENSIONS</th> <th colspan="3">SEAT DIMENSIONS</th> <th colspan="2">BACK DIMENSIONS</th> </tr> <tr> <th>W</th> <th>D</th> <th>H</th> <th>W</th> <th>D</th> <th>H</th> <th>W</th> <th>H</th> </tr> <tr> <td>25.5</td> <td>21.5</td> <td>41</td> <td>18</td> <td>17</td> <td>21.5-31.5</td> <td>18</td> <td>15.5</td> </tr> </table>			OVERALL DIMENSIONS			SEAT DIMENSIONS			BACK DIMENSIONS		W	D	H	W	D	H	W	H	25.5	21.5	41	18	17	21.5-31.5	18	15.5	<p>RTA 1</p>		
			OVERALL DIMENSIONS			SEAT DIMENSIONS			BACK DIMENSIONS																							
W	D	H	W	D	H	W	H																									
25.5	21.5	41	18	17	21.5-31.5	18	15.5																									

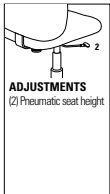
DESCRIPTION	FEATURES	MODEL#	STANDARD TEXTILE GRADES												
			1	2	3	4	5	6	7	8	9	10	11	12	
 <p>Height Adjustable Stool - Armless COM Yardage: 0.75 Freight Class: 150 Product Weight (lbs.): 39 Cubic Feet Per Carton: 9.75</p>	 <p>ADJUSTMENTS (2) Pneumatic seat height</p>	6738	\$903	\$941	\$970	\$1011	\$1070	\$1090	\$1142	\$1242	\$1290	\$1380	\$1505	\$1659	
		OVERALL DIMENSIONS			SEAT DIMENSIONS			BACK DIMENSIONS							
		W	D	H	W	D	H	W	H						
	18	21.5	41	18	17	21.5-31.5	18	16.5							
				RTA 1											
 <p>Task w/Arms and Pedestal Base COM Yardage: N/A Freight Class: 250 Product Weight (lbs.): 37 Cubic Feet Per Carton: 10.75</p>	 <p>ADJUSTMENTS (2) Pneumatic seat height</p>	6720PB	\$850	-	-	-	-	-	-	-	-	-	-	-	
		OVERALL DIMENSIONS			SEAT DIMENSIONS			BACK DIMENSIONS							
		W	D	H	W	D	H	W	H						
	25.5	21.5	33	18	17.5	14-19	18	16							
				RTA 1											
 <p>Task w/Arms, Tablet and Pedestal Base COM Yardage: N/A Freight Class: 150 Product Weight (lbs.): 45 Cubic Feet Per Carton: 10.75</p>	 <p>ADJUSTMENTS (2) Pneumatic seat height</p>	6720TRPB 6720TLPB	\$1292	-	-	-	-	-	-	-	-	-	-	-	
		OVERALL DIMENSIONS			SEAT DIMENSIONS			BACK DIMENSIONS							
		W	D	H	W	D	H	W	H						
	26.5	25.5	33	18	17.5	14-19	18	16							
				RTA 1											
 <p>Task Armless w/ Pedestal Base COM Yardage: N/A Freight Class: 250 Product Weight (lbs.): 37 Cubic Feet Per Carton: 10.75</p>	 <p>ADJUSTMENTS (2) Pneumatic seat height</p>	6721PB	\$710	-	-	-	-	-	-	-	-	-	-		
		OVERALL DIMENSIONS			SEAT DIMENSIONS			BACK DIMENSIONS							
		W	D	H	W	D	H	W	H						
	18	21.5	33	18	17.5	14-19	18	16							
				RTA 1 FedEx											

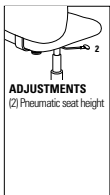
DESCRIPTION	FEATURES	MODEL#	STANDARD TEXTILE GRADES																																							
			1	2	3	4	5	6	7	8	9	10	11	12																												
 <p>Task Armless w/Tablet and Pedestal Base COM Yardage: N/A Freight Class: 150 Product Weight (lbs.): 43 Cubic Feet Per Carton: 10.75</p>	 <p>ADJUSTMENTS (2) Pneumatic seat height</p>	<p>Polypropylene Seat and Back Specify (L) left or (R) right tablet.</p> <p>Ergonomic Features: C, M</p>	<table border="1"> <tr> <td>6721TRPB</td> <td>\$1132</td> <td>-</td> <td>-</td> <td>-</td> <td>-</td> <td>-</td> <td>-</td> <td>-</td> <td>-</td> <td>-</td> <td>-</td> <td>-</td> <td>-</td> </tr> <tr> <td>6721TLPB</td> <td></td> <td></td> <td></td> <td></td> <td></td> <td></td> <td></td> <td></td> <td></td> <td></td> <td></td> <td></td> <td></td> </tr> </table>												6721TRPB	\$1132	-	-	-	-	-	-	-	-	-	-	-	-	6721TLPB													
			6721TRPB	\$1132	-	-	-	-	-	-	-	-	-	-	-	-																										
			6721TLPB																																							
			<table border="1"> <tr> <th colspan="3">OVERALL DIMENSIONS</th> <th colspan="3">SEAT DIMENSIONS</th> <th colspan="2">BACK DIMENSIONS</th> </tr> <tr> <th>W</th> <th>D</th> <th>H</th> <th>W</th> <th>D</th> <th>H</th> <th>W</th> <th>H</th> </tr> <tr> <td>23.5</td> <td>25.5</td> <td>33</td> <td>18</td> <td>17.5</td> <td>14-19</td> <td>18</td> <td>16</td> </tr> </table>			OVERALL DIMENSIONS			SEAT DIMENSIONS			BACK DIMENSIONS		W	D	H	W	D	H	W	H	23.5	25.5	33	18	17.5	14-19	18	16	<p>RTA 1</p>												
OVERALL DIMENSIONS			SEAT DIMENSIONS			BACK DIMENSIONS																																				
W	D	H	W	D	H	W	H																																			
23.5	25.5	33	18	17.5	14-19	18	16																																			
 <p>Task w/Arms and Pedestal Base COM Yardage: 0.75 Freight Class: 250 Product Weight (lbs.): 40 Cubic Feet Per Carton: 10.75</p>	 <p>ADJUSTMENTS (2) Pneumatic seat height</p>	<p>Upholstered Seat</p> <p>Ergonomic Features: C, M</p>	<table border="1"> <tr> <td>6722PB</td> <td>\$912</td> <td>\$938</td> <td>\$958</td> <td>\$987</td> <td>\$1029</td> <td>\$1047</td> <td>\$1086</td> <td>\$1145</td> <td>\$1190</td> <td>\$1240</td> <td>\$1344</td> <td>\$1457</td> </tr> </table>												6722PB	\$912	\$938	\$958	\$987	\$1029	\$1047	\$1086	\$1145	\$1190	\$1240	\$1344	\$1457															
			6722PB	\$912	\$938	\$958	\$987	\$1029	\$1047	\$1086	\$1145	\$1190	\$1240	\$1344	\$1457																											
			<table border="1"> <tr> <th colspan="3">OVERALL DIMENSIONS</th> <th colspan="3">SEAT DIMENSIONS</th> <th colspan="2">BACK DIMENSIONS</th> </tr> <tr> <th>W</th> <th>D</th> <th>H</th> <th>W</th> <th>D</th> <th>H</th> <th>W</th> <th>H</th> </tr> <tr> <td>25.5</td> <td>21.5</td> <td>32.5</td> <td>18</td> <td>17.5</td> <td>14.5-19.5</td> <td>18</td> <td>15.5</td> </tr> </table>			OVERALL DIMENSIONS			SEAT DIMENSIONS			BACK DIMENSIONS		W	D	H	W	D	H	W	H	25.5	21.5	32.5	18	17.5	14.5-19.5	18	15.5	<p>RTA 1</p>												
			OVERALL DIMENSIONS			SEAT DIMENSIONS			BACK DIMENSIONS																																	
W	D	H	W	D	H	W	H																																			
25.5	21.5	32.5	18	17.5	14.5-19.5	18	15.5																																			
 <p>Task w/Arms, Tablet and Pedestal Base COM Yardage: 0.75 Freight Class: 150 Product Weight (lbs.): 45 Cubic Feet Per Carton: 10.75</p>	 <p>ADJUSTMENTS (2) Pneumatic seat height</p>	<p>Upholstered Seat Specify (L) left or (R) right tablet.</p> <p>Ergonomic Features: C, M</p>	<table border="1"> <tr> <td>6722TRPB</td> <td>\$1336</td> <td>\$1362</td> <td>\$1382</td> <td>\$1411</td> <td>\$1453</td> <td>\$1471</td> <td>\$1508</td> <td>\$1569</td> <td>\$1614</td> <td>\$1664</td> <td>\$1768</td> <td>\$1880</td> </tr> <tr> <td>6722TLPB</td> <td></td> <td></td> <td></td> <td></td> <td></td> <td></td> <td></td> <td></td> <td></td> <td></td> <td></td> <td></td> </tr> </table>												6722TRPB	\$1336	\$1362	\$1382	\$1411	\$1453	\$1471	\$1508	\$1569	\$1614	\$1664	\$1768	\$1880	6722TLPB														
			6722TRPB	\$1336	\$1362	\$1382	\$1411	\$1453	\$1471	\$1508	\$1569	\$1614	\$1664	\$1768	\$1880																											
			6722TLPB																																							
			<table border="1"> <tr> <th colspan="3">OVERALL DIMENSIONS</th> <th colspan="3">SEAT DIMENSIONS</th> <th colspan="2">BACK DIMENSIONS</th> </tr> <tr> <th>W</th> <th>D</th> <th>H</th> <th>W</th> <th>D</th> <th>H</th> <th>W</th> <th>H</th> </tr> <tr> <td>26.5</td> <td>25.5</td> <td>32.5</td> <td>18</td> <td>17.5</td> <td>14.5-19.5</td> <td>18</td> <td>15.5</td> </tr> </table>			OVERALL DIMENSIONS			SEAT DIMENSIONS			BACK DIMENSIONS		W	D	H	W	D	H	W	H	26.5	25.5	32.5	18	17.5	14.5-19.5	18	15.5	<p>RTA 1</p>												
OVERALL DIMENSIONS			SEAT DIMENSIONS			BACK DIMENSIONS																																				
W	D	H	W	D	H	W	H																																			
26.5	25.5	32.5	18	17.5	14.5-19.5	18	15.5																																			
 <p>Task Armless w/Pedestal Base COM Yardage: 0.75 Freight Class: 250 Product Weight (lbs.): 38 Cubic Feet Per Carton: 10.75</p>	 <p>ADJUSTMENTS (2) Pneumatic seat height</p>	<p>Upholstered Seat</p> <p>Ergonomic Features: C, M</p>	<table border="1"> <tr> <td>6723PB</td> <td>\$774</td> <td>\$800</td> <td>\$819</td> <td>\$847</td> <td>\$887</td> <td>\$904</td> <td>\$942</td> <td>\$999</td> <td>\$1043</td> <td>\$1092</td> <td>\$1196</td> <td>\$1302</td> </tr> </table>												6723PB	\$774	\$800	\$819	\$847	\$887	\$904	\$942	\$999	\$1043	\$1092	\$1196	\$1302															
			6723PB	\$774	\$800	\$819	\$847	\$887	\$904	\$942	\$999	\$1043	\$1092	\$1196	\$1302																											
			<table border="1"> <tr> <th colspan="3">OVERALL DIMENSIONS</th> <th colspan="3">SEAT DIMENSIONS</th> <th colspan="2">BACK DIMENSIONS</th> </tr> <tr> <th>W</th> <th>D</th> <th>H</th> <th>W</th> <th>D</th> <th>H</th> <th>W</th> <th>H</th> </tr> <tr> <td>18</td> <td>21.5</td> <td>32.5</td> <td>18</td> <td>17</td> <td>14.5-19.5</td> <td>18</td> <td>15.5</td> </tr> </table>			OVERALL DIMENSIONS			SEAT DIMENSIONS			BACK DIMENSIONS		W	D	H	W	D	H	W	H	18	21.5	32.5	18	17	14.5-19.5	18	15.5	<p>RTA 1</p>												
			OVERALL DIMENSIONS			SEAT DIMENSIONS			BACK DIMENSIONS																																	
W	D	H	W	D	H	W	H																																			
18	21.5	32.5	18	17	14.5-19.5	18	15.5																																			

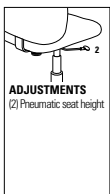
DESCRIPTION	FEATURES	MODEL#	STANDARD TEXTILE GRADES											
			1	2	3	4	5	6	7	8	9	10	11	12
 <p>Task w/Arms, Tablet and Pedestal Base COM Yardage: 0.75 Freight Class: 150 Product Weight (lbs.): 45 Cubic Feet Per Carton: 10.75</p>	 <p>ADJUSTMENTS (2) Pneumatic seat height</p>	<p>Upholstered Seat Specify (L) left or (R) right tablet.</p> <p>Ergonomic Features: C, M</p>	<p>6723TRPB \$1193 \$1219 \$1238 \$1266 \$1306 \$1322 \$1360 \$1417 \$1459 \$1509 \$1609 \$1717</p> <p>6723TLPB</p>											
			<p>OVERALL DIMENSIONS</p> <p>W D H</p>			<p>SEAT DIMENSIONS</p> <p>W D H</p>			<p>BACK DIMENSIONS</p> <p>W H</p>					
			23.5	25.5	32.5	18	17	14.5-19.5	18	15.5				
			<p>RTA 1</p>											
 <p>Task w/Arms and Pedestal Base COM Yardage: 0.75 Freight Class: 250 Product Weight (lbs.): 40 Cubic Feet Per Carton: 10.75</p>	 <p>ADJUSTMENTS (2) Pneumatic seat height</p>	<p>Upholstered Seat and Back</p> <p>Ergonomic Features: C, M</p>	<p>6727PB \$1007 \$1038 \$1057 \$1090 \$1133 \$1153 \$1193 \$1259 \$1306 \$1361 \$1474 \$1593</p>											
			<p>OVERALL DIMENSIONS</p> <p>W D H</p>			<p>SEAT DIMENSIONS</p> <p>W D H</p>			<p>BACK DIMENSIONS</p> <p>W H</p>					
			25.5	21.5	32.5	18	17	14.5-19.5	18	16				
			<p>RTA 1</p>											
 <p>Task w/Arms, Tablet and Pedestal Base COM Yardage: 0.75 Freight Class: 150 Product Weight (lbs.): 46 Cubic Feet Per Carton: 10.75</p>	 <p>ADJUSTMENTS (2) Pneumatic seat height</p>	<p>Upholstered Seat and Back Specify (L) left or (R) right tablet.</p> <p>Ergonomic Features: C, M</p>	<p>6727TRPB \$1469 \$1500 \$1519 \$1552 \$1595 \$1616 \$1655 \$1721 \$1770 \$1824 \$1937 \$2058</p> <p>6727TLPB</p>											
			<p>OVERALL DIMENSIONS</p> <p>W D H</p>			<p>SEAT DIMENSIONS</p> <p>W D H</p>			<p>BACK DIMENSIONS</p> <p>W H</p>					
			26.5	25.5	32.25	18	17	14.5-19.5	18	16				
			<p>RTA 1</p>											
 <p>Task Armless w/Tablet and Pedestal Base COM Yardage: 0.75 Freight Class: 250 Product Weight (lbs.): 40 Cubic Feet Per Carton: 10.75</p>	 <p>ADJUSTMENTS (2) Pneumatic seat height</p>	<p>Upholstered Seat and Back</p> <p>Ergonomic Features: C, M</p>	<p>6728PB \$866 \$895 \$915 \$945 \$990 \$1010 \$1049 \$1111 \$1159 \$1213 \$1322 \$1441</p>											
			<p>OVERALL DIMENSIONS</p> <p>W D H</p>			<p>SEAT DIMENSIONS</p> <p>W D H</p>			<p>BACK DIMENSIONS</p> <p>W H</p>					
			18	21.5	32.5	18	17	14.5-19.5	18	15.5				
			<p>RTA 1</p>											

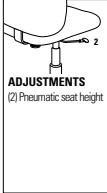
DESCRIPTION	FEATURES	MODEL#	STANDARD TEXTILE GRADES																															
			1	2	3	4	5	6	7	8	9	10	11	12																				
 <p>Task Armless w/Tablet and Pedestal Base COM Yardage: 0.75 Freight Class: 150 Product Weight (lbs.): 46 Cubic Feet Per Carton: 10.75</p>	 <p>ADJUSTMENTS (2) Pneumatic seat height</p>	6728TRPB 6728TLPB	\$1318	\$1345	\$1366	\$1397	\$1442	\$1462	\$1500	\$1563	\$1611	\$1665	\$1774	\$1893																				
		<table border="1"> <thead> <tr> <th colspan="3">OVERALL DIMENSIONS</th> <th colspan="3">SEAT DIMENSIONS</th> <th colspan="2">BACK DIMENSIONS</th> </tr> <tr> <th>W</th> <th>D</th> <th>H</th> <th>W</th> <th>D</th> <th>H</th> <th>W</th> <th>H</th> </tr> </thead> <tbody> <tr> <td>23.5</td> <td>25.5</td> <td>32.25</td> <td>18</td> <td>17</td> <td>14.5-19.5</td> <td>18</td> <td>15.5</td> </tr> </tbody> </table>	OVERALL DIMENSIONS			SEAT DIMENSIONS			BACK DIMENSIONS		W	D	H	W	D	H	W	H	23.5	25.5	32.25	18	17	14.5-19.5	18	15.5								
OVERALL DIMENSIONS			SEAT DIMENSIONS			BACK DIMENSIONS																												
W	D	H	W	D	H	W	H																											
23.5	25.5	32.25	18	17	14.5-19.5	18	15.5																											
	Upholstered Seat and Back Specify (L) left or (R) right tablet. Ergonomic Features: C, M	RTA 1																																



Duet tables are multi-purpose stacking tables that offer optimum space utilization and flexibility. Their personality and simple design make them ideal for use in any learning or training environment at post-secondary and adult levels. Temporarily and easily convert auditoriums and other spaces into examination and seminar spaces. They can be partnered with stacking chairs such as Duet or Popcorn in matching or complementary colors (stacking chairs can be found in the Multi-Purpose section of the Seating price list).

The one-piece molded top and modesty are gently contoured providing an eased edge with an elegant waterfall transition from top to modesty.

Tops are available in a wide array of colors in 0.5" thick polypropylene. Polypropylene material offers strength and ease of cleaning with a slightly textured surface to offer scratch resistance.



Features and Benefits

- One-piece molded top and modesty are 0.5" thick polypropylene.
- Tables are rated 250 lbs. capacity.
- Surface includes factory installed metal inserts for solid and secure connection to the sled frame.
- 0.5" diameter solid steel rod sled frame.
- Bumpers on the underside for protection when stacking.
- Model with ADA width compliant frame is available.
- Shipped fully assembled.



One-piece top and modesty.



Stacks 5 high on floor or 20 high on dolly.

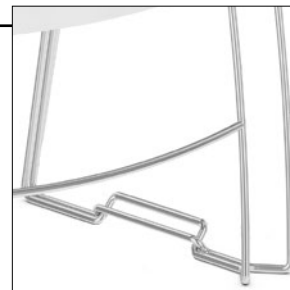

Ganging frame to keep tables evenly aligned.

GENERAL INFORMATION

- Duet tables are multi-purpose stacking tables ideal for auditoriums, seminars or any learning or training environment.
- Lightweight and easy to handle whether stacking for storage or setting up a room.
- Made of durable materials to withstand more demanding environments.
- Shipped fully assembled. Packaged 4 per carton.
- Global products are in compliance with stringent emission guidelines set out by the Greenguard Environmental Institute under the standards for low emitting products and materials. www.greenguard.org.
- Covered by Global's Lifetime Warranty.
- **Level 2 Certified.**

WORKSURFACES

26" W x 18" D x 9.75" H

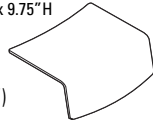

- Top and modesty are a one-piece injection molded design in 0.5" thick polypropylene.
- Available in a wide array of colors (see right column "FINISHES") to complement any space or to define sections by color.
- One-piece molded top and modesty are contoured providing an eased user edge, with an elegant waterfall transition from top to modesty.

CONSTRUCTION

- Surface includes molded in threaded inserts to provide a secure metal-to-metal connection to the sled frame.
- Bumpers are included on the underside of top and inside modesty to protect surfaces when stacking.

FRAME

- 0.5" diameter solid steel rod sled frame.
- Available in a durable Chrome finish.
- Model with ganging frame keeps tables evenly positioned and aligned. No tools or fasteners required for ganging; the frames simply interlock.
- Model with ADA compliant frame is also available. The frame is 33" wide and the polypropylene top/modesty remain a constant size.
- Tables are standard without glides and are suitable for carpet, rubber or cork flooring.
- Glide options are available (see right column "GLIDES"). Glides must be chosen to best suit flooring type and site conditions. Upcharges apply.

DOLLY

- For space saving storage and transport.
- Constructed from 1.5" x 0.5" steel tubing with heavy duty casters (two locking) and a removable handle.
- Dolly can stack up to 20 tables.
- Stacking height on dolly is up to 68".

Required specifications

Top finish*

Optional specifications

Glide option*

FINISHES

BZB	Buzz Blue	FRO	Frost
CCT	Cactus	INK	Ink
CRO	Carrot	LAB	Latte
IVC	Cloud	BLK	Night
DJN	Dijon	SND	Sand
EGP	Eggplant	SAR	Scarlet
FOG	Fog	SHW	Shadow

GLIDES

CG	Clear polycarbonate (for carpet, rubber or concrete flooring). Height added to table: 0.18". Add \$18/set.
SG	Glides with stainless steel pads (for carpet or rubber flooring). Height added to table: 0.17". Add \$34/set.
FG	Glides with felt pads (for vinyl, cork or laminate flooring). Height added to table: 0.24". Add \$34/set.
RG	Glides with rubber pads (for vinyl, hardwood, laminate, stone or ceramic flooring). Height added to table: 0.16". Add \$34/set.

SPECIFICATIONS

- Specifications marked with an * are applicable to only those products which have the* symbol beside the product name.

EXAMPLE DUET TABLE ORDER CODE:

Duet stacking table, polypropylene surface in Shadow, clear polycarbonate glides

DTS1828P	-SHW	-CG
Model #	Surface finish	Glides

STACKING TABLES **MODEL#** **DIMENSIONS** **FREIGHT CLASS** **WT./LBS.** **CUBIC FT.** **LIST PRICE**

D x W x H

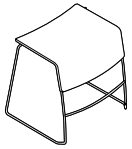

Stacking Table*

DTS1828P	25 x 29 x 28	150	26	17.75	\$516
----------	--------------	-----	----	-------	--------------

One-piece polypropylene top and modesty with Chrome frame. Shipped fully assembled, 4 per carton.

- Price shown is per table. It is recommended to order in multiples of 4.
- Please be sure to select the appropriate glide (see previous page) for the flooring surface, as scratches could occur.
- Worksurface is 18"D x 28"W

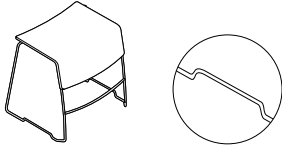

Stacking Table, Ganging Frame*

DTS1828PG	25 x 30.75 x 28	150	26	17.75	\$550
-----------	-----------------	-----	----	-------	--------------

One-piece polypropylene top and modesty with Chrome ganging frame.

Shipped fully assembled, 4 per carton.

- Price shown is per table. It is recommended to order in multiples of 4.
- Please be sure to select the appropriate glide (see previous page) for the flooring surface, as scratches could occur.
- Worksurface is 18"D x 28"W

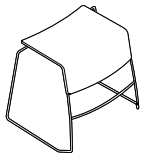

Stacking Table, 32" Wide*

DTA1832P	25 x 33 x 28	150	26	17.75	\$583
----------	--------------	-----	----	-------	--------------

ADA (American with Disabilities Act) compliant. 33" wide. One-piece polypropylene top and modesty with Chrome frame.

Underside clearance is 27.1"H (extra height if glides are selected). Stacks up to 5 high on floor only; dolly does not accommodate.

Shipped fully assembled, 4 per carton.

- Price shown is per table. It is recommended to order in multiples of 4.
- Please be sure to select the appropriate glide (see previous page) for the flooring surface, as scratches could occur.
- Worksurface is 18"D x 32"W

DOLLY



Dolly

DTD20	29.5 x 63 x 38.5	250	50	21	\$749
-------	------------------	-----	----	----	--------------

For use with tables DTS1828P and DTS1828PG. Can stack up to 20 tables. Black only. Removable handle for storage.

Shipped fully assembled in 1 carton.

ERIN



model GC36531
Armless Guest Chair,
Metal Legs



model GC36532
Guest Armchair,
Wood Legs

STANDARD FEATURES

- Erin offers a streamlined silhouette brimming with mid-century modern style.
- A rounded arch gently curves around and under the seat to give extra support to a user's upper back and sides, while creating an open clean-out space at the back of the cushion.
- The series is available to specify with two textiles, one for the seat cushion and one for the back, arms and front rail (see model image).
- For pricing, start with the base price and add both back/arms graded textile upcharge and the seat graded textile upcharge.
- Tapered legs add style and elegance.
- Legs are available in wood or metal painted/plated finishes (noted).
- The seat underside is sealed with a non-porous material to support housekeeping and infection control protocols.
- Additional improved cleaning options include sealed seams (back and/or seat) and moisture barrier (seat). Upcharges apply.
- Assembled with tamper-resistant fasteners for greater security.
- For added comfort, the seat cushions are standard with high density Ultracell foam.
- Glides are self-leveling. Choose from standard non-marking glides, rubber non-slip glides or felt glides (upcharges apply).
- The Globalcare warranty (for healthcare and 24/7 environments) applies for all Erin GC models when performance textiles are selected. Visit the website at globalfurnituregroup.com/healthcare.
- Global's standard lifetime warranty applies when approved standard Global textiles are selected.
- For alternate textile applications, contact Global specials. The Blended Textile matrix does not apply to this series.
- Shipped fully assembled.

SUGGESTED APPLICATIONS

- Dining/Cafeteria
- Guest seating
- Lobbies
- Lounge/Waiting
- Patient rooms
- Resident rooms





OPTIONAL FEATURES

Please add option codes in the following order:

- **Model number**
GC36530 Guest armless chair, wood legs
GC36531 Guest armless chair, metal legs
GC36532 Guest armchair, wood legs
GC36533 Guest armchair, metal legs
- **Back/Arm Textile**
Specify textile code. See model grade upcharges.
- **Seat Textile**
Specify textile code. See model grade upcharges.
- **Wood leg finish** (models GC36530 and GC36532)
(AAM) Absolute **(MWM)** Medium Walnut
(BKM) Black **(NLW)** Natural Walnut
(CJM) Charcoal Java **(ASM)** Night
(ACM) Cherry **(NBM)** Noce Biondo
(EMM) Empire Mahogany **(NGM)** Noce Grigio
(EOM) English Oak **(NEM)** Noce Leggero
(ECM) Espresso Cafe **(NMM)** Noce Medio
(TFM) Fruitwood **(SBM)** Sandy Beach
(HGM) Grey **(SKM)** Shaker Cherry
(HOM) Harvest Oak **(SOM)** Silver Oak
(AHM) Honey **(TWM)** Walnut
(JOM) Jet Onyx **(WTM)** WC Cream
(LHM) Light Honey **(WHM)** White
(TMM) Mahogany **(WCM)** Winter Cherry
(AVM) Maple
- **Metal leg finish** (models GC36531 and GC36533)
(CHM) Chrome **(TTU)** Tungsten
(TBL) Black **(TKA)** Kalua
(TLA) Latte **(TMO)** Mocha
(TSH) Shadow **(TOA)** Toast
- **Glides**
(NM) Non-marking glide. No upcharge
(RG) Rubber, non-slip glide. Add \$60.
(FG) Felt glide. Add \$60.
- **Sealed Back Seams** (Contact Customer Care for approved textiles)
(NBS) No sealed back seams
(SBS) Sealed back seams. Upcharges vary, see model.
- **Sealed Seat Seams** (Contact Customer Care for approved textiles)
(NSS) No sealed seat seams
(SSS) Sealed seat seams. Add \$20.
- **Moisture Barrier** (Not available with Sealed Seams)
(NB) No moisture barrier.
(MB) Moisture barrier (seat only). Add \$110.

EXAMPLE ERIN ORDER CODE:

GC36530	CE90	CE90	AAM	NM	NBS	NSS	NB
Model #	Seat/Arm textile	Seat textile	Leg finish	Glide	Sealed Back Seams	Sealed Seat Seams	Moisture Barrier

DESCRIPTION	MODEL#/ FEATURES	STANDARD TEXTILE GRADES											
		1/COM	2	3	4	5	6	7	8	9	10	11	12
 <p>Armless Guest Chair, Wood Legs COM Yardage: Back/Arm: 1.75; Seat: 1 Freight Class: 250 Product Weight (lbs.): 32.5 Cubic Feet Per Carton: 13.25</p>	GC36530 Base Price:	\$1892											
	Back/Arm upcharge:	+0	+\$56	+\$100	+\$165	+\$256	+\$294	+\$373	+\$497	+\$590	+\$692	+\$903	+\$1126
	Seat upcharge:	+0	+\$32	+\$57	+\$94	+\$146	+\$168	+\$213	+\$284	+\$337	+\$395	+\$516	+\$643
	OVERALL DIMENSIONS			SEAT DIMENSIONS			BACK DIMENSIONS						
	W D H			W D H			W H						
	24 22.25 34			19 18 19			15 15.5						
Active weight 350 lbs. Add \$49 for (SBS), \$20 for (SSS)													
 <p>Armless Guest Chair, Metal Legs COM Yardage: Back/Arm: 1.75; Seat: 1 Freight Class: 250 Product Weight (lbs.): 34.5 Cubic Feet Per Carton: 13.25</p>	GC36531 Base Price:	\$1801											
	Back/Arm upcharge:	+0	+\$56	+\$100	+\$165	+\$256	+\$294	+\$373	+\$497	+\$590	+\$692	+\$903	+\$1126
	Seat upcharge:	+0	+\$32	+\$57	+\$94	+\$146	+\$168	+\$213	+\$284	+\$337	+\$395	+\$516	+\$643
	OVERALL DIMENSIONS			SEAT DIMENSIONS			BACK DIMENSIONS						
	W D H			W D H			W H						
	24 22.25 34			19 18 19			15 15.5						
Active weight 350 lbs. Add \$49 for (SBS), \$20 for (SSS)													
 <p>Guest Armchair, Wood Legs COM Yardage: Back/Arm: 1.75; Seat: 1 Freight Class: 250 Product Weight (lbs.): 33 Cubic Feet Per Carton: 13.25</p>	GC36532 Base Price:	\$1892											
	Back/Arm upcharge:	+0	+\$56	+\$100	+\$165	+\$256	+\$294	+\$373	+\$497	+\$590	+\$692	+\$903	+\$1126
	Seat upcharge:	+0	+\$32	+\$57	+\$94	+\$146	+\$168	+\$213	+\$284	+\$337	+\$395	+\$516	+\$643
	OVERALL DIMENSIONS			SEAT DIMENSIONS			BACK DIMENSIONS						
	W D H			W D H			W H						
	24 22 34.25			19 18.5 18.5			17 15.75						
Active weight 350 lbs. Add \$52 for (SBS), \$20 for (SSS)													
 <p>Guest Armchair, Metal Legs COM Yardage: Back/Arm: 1.75; Seat: 1 Freight Class: 250 Product Weight (lbs.): 35 Cubic Feet Per Carton: 13.25</p>	GC36533 Base Price:	\$1801											
	Back/Arm upcharge:	+0	+\$56	+\$100	+\$165	+\$256	+\$294	+\$373	+\$497	+\$590	+\$692	+\$903	+\$1126
	Seat upcharge:	+0	+\$32	+\$57	+\$94	+\$146	+\$168	+\$213	+\$284	+\$337	+\$395	+\$516	+\$643
	OVERALL DIMENSIONS			SEAT DIMENSIONS			BACK DIMENSIONS						
	W D H			W D H			W H						
	24 22 34.25			19 18.5 18.5			17 15.75						
Active weight 350 lbs. Add \$52 for (SBS), \$20 for (SSS)													

FILE BUDDY™



model 1105



model 1110 Shown with 25-400 Vertical File

STANDARD FEATURES

- Standard with C65 casters.
- Shipped R.T.A. (Ready to assemble).
- Pneumatic. Black, five-legged, injection molded base.
- 14" diameter seat.
- Check textile availability prior to specifying upholstery material.

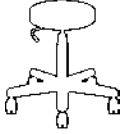
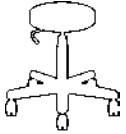
DESCRIPTION	FEATURES	MODEL#	STANDARD TEXTILE GRADES											
			1	2	3	4	5	6	7	8	9	10	11	12
 <p>Swivel Stool 5" Pneumatic, 20" Base COM Yardage: 0.75 Freight Class: 150 Product Weight (lbs.): 14 Cubic Feet Per Carton: 2.9</p>		1105	\$418	\$447	\$468	\$502	\$546	\$570	\$602	\$680	\$714	\$784	\$881	\$1001
	<p>OVERALL DIMENSIONS</p> <p>W D H</p>	<p>SEAT DIMENSIONS</p> <p>W D H</p>	<p>BACK DIMENSIONS</p> <p>W H</p>	14	14	18.5	14	-	16.5-21.5	-	-			
	<p>RTA 1</p>	<p>FedEx</p>	<p>UPS</p>											
 <p>Swivel Stool 10" Pneumatic, 22" Base COM Yardage: 0.75 Freight Class: 150 Product Weight (lbs.): 14 Cubic Feet Per Carton: 2.9</p>		1110	\$490	\$515	\$538	\$574	\$616	\$640	\$672	\$749	\$784	\$854	\$952	\$1073
	<p>OVERALL DIMENSIONS</p> <p>W D H</p>	<p>SEAT DIMENSIONS</p> <p>W D H</p>	<p>BACK DIMENSIONS</p> <p>W H</p>	14	14	18.5	14	-	22.5-32.5	-	-			
	<p>RTA 1</p>	<p>FedEx</p>	<p>UPS</p>											

FLAP™



Folding Chair
model 6775

STANDARD FEATURES

- A modern design, high quality, lightweight, all polymer folding chair intended for use indoors or outdoors. Products must be stored inside during extreme and inclement weather. See Global's Outdoor Furniture warranty for additional information.
- Weather resistant, UV resistant, stain resistant, 100% non-ferrous, and recyclable design that is 1:10 bleach solution cleanable.
- Chair legs are equipped with clear non-marking glides as standard. Suitable for outdoor environments, carpet and hard surface flooring
- Chairs are stocked in 2 colors:
Alloy (**ALY**)
Milk (**MLK**)
- No upholstery options available
- Rated to 275 lbs.
- Single chair folds flat to 2.2" (55 mm).
- Flap achieves its strength and durability using glass filled polymer. Evidence of this material may be visible on the surface and is often more evident in darker colors.
- All Flap products are only available through Global's InStock program. Contact CustomerCare for lead times and quotation for quantities beyond InStock inventory.
- The Flap Wall Hook (6776), sold individually, supports up to two folded Flap chairs. This Milk (**MLK**) colored plastic hook mounts on walls or inside closets and wardrobe cabinets providing easy access to extra seating. Two chairs on Wall Hook measure 7.3" (185 mm) deep off wall. Mounting hardware not included. Recommended mounting into stud.
- Flap Ganging Brackets (6778) are sold 12 to a

box. These translucent, frosted plastic brackets attach across two adjacent chairs, just above or below the seat to provide temporary ganging for organized events.

- The Flap Dolly (6777), ordered separately, supports up to 24 chairs folded and stacked flat. Includes strap to secure chairs for storage and transport.



Please add option codes in the following order

- **Model number**
6775 Folding Chair
6776 Wall Hook
6777 Dolly
6778 Ganging Brackets
- **Chair Color**
(ALY) Alloy
(MLK) Milk

EXAMPLE OF FLAP ORDER CODE:

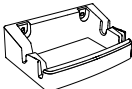
6775	ALY
Model Number	Finish

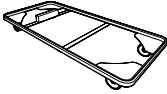
DESCRIPTION	FEATURES	MODEL#	STANDARD TEXTILE GRADES																
			1	2	3	4	5	6	7	8	9	10	11	12					
 <p>Folding Chair COM Yardage: N/A Freight Class: 100 Product Weight (lbs.): 13.5 Cubic Feet Per Carton: 1.6</p>	<p>Shipped 2 per box. Ordered as each.</p>	6775	214																
			OVERALL DIMENSIONS			SEAT DIMENSIONS			BACK DIMENSIONS										
			W	D	H	W	D	H	W	H									
			19	21.5	33.5	16	16.5	18.5	18.5	16									
			RTA 00	FedEx		2 per carton (pricing and specifications are for one chair)													
 <p>Flap Wall Hook COM Yardage: N/A Freight Class: 70 Product Weight (lbs.): 0.75 Cubic Feet Per Carton: 0.2</p>		6776	48																
			OVERALL DIMENSIONS			SEAT DIMENSIONS			BACK DIMENSIONS										
			W	D	H	W	D	H	W	H									
			9	6	2.75														
			RTA 00	FedEx		ups		1 per carton											

DESCRIPTION	FEATURES	MODEL#	STANDARD TEXTILE GRADES											
			1	2	3	4	5	6	7	8	9	10	11	12
 <p>Dolly for Flap Folding Chairs COM Yardage: N/A Freight Class: 150 Product Weight (lbs.): 23 Cubic Feet Per Carton: 4.5</p>	Holds up to 24 Flap folded chairs. Includes tether strap.	6777	614											
		OVERALL DIMENSIONS W D H			SEAT DIMENSIONS W D H			BACK DIMENSIONS W H						
		20.75	44	5.25										
		RTA 00 FedEx ups 1 per carton												
 <p>Flap Ganging Bracket (box of 12) COM Yardage: N/A Freight Class: 70 Product Weight (lbs.): 0.29 Cubic Feet Per Carton: 0.03</p>		6778	188											
		OVERALL DIMENSIONS W D H			SEAT DIMENSIONS W D H			BACK DIMENSIONS W H						
		0	0	0										
		RTA 00 FedEx ups 12 per carton (pricing and specifications are for box of 12)												

ISLANDS™



model 4075



model 4076





Leather upholstered seat and back additional stitch detail shown.

STANDARD FEATURES

- Islands offers wood guest seating with contemporary styling.
- Offered in two styles; Upholstered back pad or Horizontal wood slat.
- Check textile availability prior to specifying upholstery material.
- When upholstered in Leather, there are additional stitching details with a seam across the middle of the back and two seams on the seat.
- Does not stack.

OPTIONAL FEATURES

- Frame available in Absolute (AAM), Black (BKM), Cherry (ACM), Espresso Cafe (ECM), English Oak (EOM), Fruitwood (TFM), Gray (HGM), Honey (AHM), Mahogany (TMM), Maple (AVM), Medium Walnut (MWM), Natural Walnut (NLW), Night (ASM), Noce Biondo (NBM), Noce Grigio (NGM), Noce Leggero (NEM), Noce Medio (NMM), Shaker Cherry (SKM), Walnut (TWM), WC Cream (WTM), White (WHM) and Winter Cherry (WCM). Please Specify. Genuine maple faced veneers and solids are used.

DESCRIPTION	FEATURES	MODEL#	STANDARD TEXTILE GRADES													
			1	2	3	4	5	6	7	8	9	10	11	12		
 <p>4075</p> <p>Armchair Upholstered back. COM Yardage: 1.5 Freight Class: 300 Product Weight (lbs.): 25 Cubic Feet Per Carton: 13.25</p>	<p>Does not stack.</p> <p>Ergonomic Features: M, N</p>	4075	\$963	\$1019	\$1062	\$1122	\$1211	\$1253	\$1332	\$1459	\$1557	\$1667	\$1892	\$2131		
		OVERALL DIMENSIONS			SEAT DIMENSIONS			BACK DIMENSIONS								
		W	D	H	W	D	H	W	H							
		24.5	23.5	32	20.5	18	18.5	19	13							
 <p>4076</p> <p>Armchair Horizontal wood slat back. COM Yardage: 1 Freight Class: 300 Product Weight (lbs.): 25 Cubic Feet Per Carton: 13.25</p>	<p>Does not stack.</p> <p>Ergonomic Features: M, N</p>	4076	\$1021	\$1059	\$1088	\$1128	\$1188	\$1217	\$1269	\$1355	\$1418	\$1492	\$1641	\$1800		
		OVERALL DIMENSIONS			SEAT DIMENSIONS			BACK DIMENSIONS								
		W	D	H	W	D	H	W	H							
		24.5	23.5	32	20.5	18	18.5	19	13							
			RTA 00													
			RTA 00	FedEx		UPS										

LAYNE™



model 8520T







model 8525T

STANDARD FEATURES

- Layne offers classic styling and value in a finely crafted wood framed side chair series.
- Frame construction is beechwood.
- Legs are equipped with White non-marking polypropylene glides. Suitable for both carpet and hard surface flooring.
- Offered in four back styles; Fully Upholstered, Picture Frame or Vertical Wood Slat.
- Check textile availability prior to specifying upholstery material.
- Does not stack.

OPTIONAL FEATURES

- Wood frames are available in Absolute (AAM), Black (BKM), Cherry (ACM), Espresso Cafe (ECM), English Oak (EOM), Fruitwood (TFM), Gray (HGM), Honey (AHM), Mahogany (TMM), Maple (AVM), Medium Walnut (MWM), Natural Walnut (NLW), Night (ASM), Noce Biondo (NBM), Noce Grigio (NGM), Noce Leggero (NEM), Noce Medio (NMM), Shaker Cherry (SKM), Walnut (TWM), WC Cream (WTM), White (WHM) and Winter Cherry (WCM). Please Specify.

DESCRIPTION	FEATURES	MODEL#	STANDARD TEXTILE GRADES												
			1	2	3	4	5	6	7	8	9	10	11	12	
 <p>Armless Upholstered Side Chair COM Yardage: 1 Freight Class: 300 Product Weight (lbs.): 21 Cubic Feet Per Carton: 13.25</p>	<p>Does not stack.</p> <p>Ergonomic Features: M, N</p>	<p>8520T</p>	\$863	\$909	\$942	\$991	\$1064	\$1088	\$1152	\$1268	\$1325	\$1434	\$1583	\$1769	
			OVERALL DIMENSIONS			SEAT DIMENSIONS			BACK DIMENSIONS						
			W	D	H	W	D	H	W	H					
			22.75	24	33	20	18.25	18	17.5	14					
			<p>RTA 00</p>												
 <p>Fully Upholstered Armchair COM Yardage: 2.25 Freight Class: 300 Product Weight (lbs.): 22 Cubic Feet Per Carton: 13.25</p>	<p>Does not stack</p> <p>Ergonomic Features: M, N</p>	<p>8521T</p>	\$930	\$1019	\$1089	\$1194	\$1343	\$1413	\$1547	\$1762	\$1928	\$2111	\$2490	\$2894	
			OVERALL DIMENSIONS			SEAT DIMENSIONS			BACK DIMENSIONS						
			W	D	H	W	D	H	W	H					
			22.75	24	33	20	18.25	18	17.5	14					
			<p>RTA 00</p>												
 <p>Picture Frame Armchair COM Yardage: 1.25 Freight Class: 300 Product Weight (lbs.): 22 Cubic Feet Per Carton: 13.25</p>	<p>Does not stack</p> <p>Ergonomic Features: M, N</p>	<p>8522T</p>	\$1052	\$1089	\$1116	\$1156	\$1211	\$1232	\$1284	\$1374	\$1421	\$1508	\$1628	\$1775	
			OVERALL DIMENSIONS			SEAT DIMENSIONS			BACK DIMENSIONS						
			W	D	H	W	D	H	W	H					
			22.75	24	33	20	18.25	18	17.5	14					
			<p>RTA 00</p>												
 <p>Upholstered Armchair COM Yardage: 1 Freight Class: 300 Product Weight (lbs.): 22 Cubic Feet Per Carton: 13.25</p>	<p>Does not stack</p> <p>Ergonomic Features: M, N</p>	<p>8525T</p>	\$982	\$1029	\$1062	\$1115	\$1190	\$1217	\$1279	\$1404	\$1464	\$1576	\$1734	\$1926	
			OVERALL DIMENSIONS			SEAT DIMENSIONS			BACK DIMENSIONS						
			W	D	H	W	D	H	W	H					
			22.75	24	33	20	18.25	18	17.5	14					
			<p>RTA 00</p>												

DESCRIPTION	FEATURES	MODEL#	STANDARD TEXTILE GRADES												
			1	2	3	4	5	6	7	8	9	10	11	12	
 <p>Vertical Wood Slat Armchair COM Yardage: 1 Freight Class: 300 Product Weight (lbs.): 22 Cubic Feet Per Carton: 13.25</p>	<p>Does not stack.</p> <p>Ergonomic Features: M, N</p>	8526T	\$1020	\$1055	\$1081	\$1122	\$1177	\$1203	\$1255	\$1335	\$1396	\$1467	\$1609	\$1761	
		OVERALL DIMENSIONS			SEAT DIMENSIONS			BACK DIMENSIONS							
		W	D	H	W	D	H	W	H						
			22.75	24	33	20	18.25	18	17.5	14					
			RTA 00												

LITE



model 5940



model 5944



Closed Loop Arms.



model 5945



model 5951C



STANDARD FEATURES















- Lite is a modern series inspired by classic designs.
- Arms are standard in cantilevered or closed loop. Both are made from fiberglass reinforced nylon, available in Black only.
- Frame is heavy duty, equipped with Sytex™ high-strength polyester webbing suspension system for extra comfort.
- Cantilever frame models are 1" diameter 12 gauge tubular steel.
- Four legged frames are 1" diameter 12 gauge tubular steel front legs and 7/8" diameter 14 gauge tubular steel rear legs, depending on the model.
- Glides are non-marking polypropylene (NM) suitable for both carpet and hard surface flooring.
- All models are rated for active user load of 300 lbs. per seat.
- Dual wheel carpet casters (C82) are standard on caster models.
- Check textile availability prior to specifying upholstery material.







OPTIONAL FEATURES





- Mesh models are available in any of the 24 standard Vue Mesh colors. Seat and back will be the same color mesh. Specify color: Sandy Beach (VU10), Dessert Sand (VU11), Orange Sunset (VU12), Chocolate Fountain (VU13), Artic Blue (VU14), Quarry Grey (VU15), Tidal Wave (VU16), Ivy Moss (VU17), Red Rose (VU18), Black (VU19), White (VU20), Lime (VU21), Chartreuse (VU23), Pool Blue (VU26), Sky (VU28), Ice (VU30), Primary Blue (VU32), Tangerine (VU34), Paprika (VU37), Grain (VU40), Yellow (VU43), Silver Grey (VU55), Silver (VU63), Hot Pink (VU65) and Red Mittens (VU70)
 - A selection of glide options is available for four-legged chairs (models 5940, 5941, 5942, 5950, 5951 and 5952). Glides must be chosen to best suit flooring type and site conditions.
 - Glides with felt pads (FG) are available for vinyl sheet, cork or laminate flooring, please specify. Add \$60.
 - Glides with rubber pads (RG) are available for vinyl, hardwood, laminate, stone or ceramic flooring, please specify. Add \$60.
 - For hard floor surface flooring casters please specify C9R, add \$98.
 - **Frame finish**



(TBL) Black	(TBZ) Buzz Blue
(TCC) Cactus	(TCR) Carrot
(TDJ) Dijon	(TDW) Designer White
(TEG) Eggplant	(TFO) Fog
(TFR) Frost	(TIN) Ink
(TIV) Cloud	(TKA) Kalua
(TLA) Latte	(TMO) Mocha
(TOA) Toast	(TNE) Nevada
(TSH) Shadow	(TSN) Sand
(TSR) Scarlet	(TTU) Tungsten
 - (CHM) Chrome. Add \$100
 - (ACO) Antique Copper. Add \$226 for four-legged frame. Add \$335 for cantilever frame.
 - (BCH) Brushed Chrome. Add \$107 for four-legged frame. Add \$227 for cantilever frame.
 - (SBR) Satin Brass. Add \$226 for four-legged frame. Add \$335 for cantilever frame.
- Please Specify.

DESCRIPTION	FEATURES	MODEL#	STANDARD TEXTILE GRADES														
			1	2	3	4	5	6	7	8	9	10	11	12			
 Four-legged Frame Armless COM Yardage: N/A Freight Class: 150 Product Weight (lbs.): 26 Cubic Feet Per Carton: 12.5	Does not stack.	5940	\$801														
					OVERALL DIMENSIONS			SEAT DIMENSIONS			BACK DIMENSIONS						
					W	D	H	W	D	H	W	H					
					21.75	24.75	34.25	20	17	19	16	19					
			RTA 00														
 Four-legged Frame Armless w/Casters COM Yardage: N/A Freight Class: 150 Product Weight (lbs.): 26 Cubic Feet Per Carton: 12.5	Does not stack.	5940C	\$926														
					OVERALL DIMENSIONS			SEAT DIMENSIONS			BACK DIMENSIONS						
					W	D	H	W	D	H	W	H					
					21.75	24.75	34.25	20	17	19	16	19					
			RTA 00														

DESCRIPTION	FEATURES	MODEL#	STANDARD TEXTILE GRADES												
			1	2	3	4	5	6	7	8	9	10	11	12	
 <p>Four-legged Frame w/Cantilever Arms COM Yardage: N/A Freight Class: 150 Product Weight (lbs.): 29 Cubic Feet Per Carton: 13.75</p>	Does not stack.	5941	\$921												
		OVERALL DIMENSIONS			SEAT DIMENSIONS			BACK DIMENSIONS							
		W	D	H	W	D	H	W	H						
		24	25.5	34.25	20	17	19	16	19						
		  													
 <p>Four-legged Frame w/Cantilever Arms & Casters COM Yardage: N/A Freight Class: 150 Product Weight (lbs.): 29 Cubic Feet Per Carton: 13.75</p>	Does not stack.	5941C	\$1046												
		OVERALL DIMENSIONS			SEAT DIMENSIONS			BACK DIMENSIONS							
		W	D	H	W	D	H	W	H						
		24	25.5	34.25	20	17	19	16	19						
		  													
 <p>Four-legged Frame w/ Loop Arms COM Yardage: N/A Freight Class: 150 Product Weight (lbs.): 29 Cubic Feet Per Carton: 13.75</p>	Does not stack.	5942	\$921												
		OVERALL DIMENSIONS			SEAT DIMENSIONS			BACK DIMENSIONS							
		W	D	H	W	D	H	W	H						
		23.75	25.5	34.25	20	17	19	16	19						
		  													
 <p>Four-legged Frame w/ Loop Arms & Casters COM Yardage: N/A Freight Class: 150 Product Weight (lbs.): 29 Cubic Feet Per Carton: 13.75</p>	Does not stack.	5942C	\$1046												
		OVERALL DIMENSIONS			SEAT DIMENSIONS			BACK DIMENSIONS							
		W	D	H	W	D	H	W	H						
		23.75	25.5	34.25	20	17	19	16	19						
															

DESCRIPTION	FEATURES	MODEL#	STANDARD TEXTILE GRADES												
			1	2	3	4	5	6	7	8	9	10	11	12	
 Cantilever Frame Armless COM Yardage: N/A Freight Class: 150 Product Weight (lbs.): 27 Cubic Feet Per Carton: 12.5	Does not stack.	5943	\$868												
		OVERALL DIMENSIONS			SEAT DIMENSIONS			BACK DIMENSIONS							
		W	D	H	W	D	H	W	H						
		21.75	23.5	34.25	20	17	19	16	19						
			RTA 00												
 Cantilever Frame w/Cantilever Arms COM Yardage: N/A Freight Class: 150 Product Weight (lbs.): 35 Cubic Feet Per Carton: 13.75	Does not stack.	5944	\$987												
		OVERALL DIMENSIONS			SEAT DIMENSIONS			BACK DIMENSIONS							
		W	D	H	W	D	H	W	H						
		24	23.5	34.25	20	17	19	16	19						
			RTA 00												
 Cantilever Frame w/Loop Arms COM Yardage: N/A Freight Class: 150 Product Weight (lbs.): 35 Cubic Feet Per Carton: 13.75	Does not stack.	5945	\$987												
		OVERALL DIMENSIONS			SEAT DIMENSIONS			BACK DIMENSIONS							
		W	D	H	W	D	H	W	H						
		23.75	23.5	34.25	20	17	19	16	19						
			RTA 00  												
 Upholstered Four-legged Frame Armless COM Yardage: 1.50 Freight Class: 150 Product Weight (lbs.): 26 Cubic Feet Per Carton: 12.5	Does not stack.	5950	\$663	\$726	\$769	\$837	\$932	\$978	\$1066	\$1205	\$1310	\$1430	\$1677	\$1937	
		OVERALL DIMENSIONS			SEAT DIMENSIONS			BACK DIMENSIONS							
		W	D	H	W	D	H	W	H						
		21.75	24.75	34.25	20	17	19	16	19						
			RTA 00												
 Upholstered Four-legged Frame Armless w/Casters COM Yardage: 1.50 Freight Class: 150 Product Weight (lbs.): 26 Cubic Feet Per Carton: 12.5	Does not stack.	5950C	\$789	\$852	\$895	\$963	\$1058	\$1104	\$1192	\$1331	\$1436	\$1556	\$1803	1362	
		OVERALL DIMENSIONS			SEAT DIMENSIONS			BACK DIMENSIONS							
		W	D	H	W	D	H	W	H						
		21.75	24.75	34.25	20	17	19	16	19						
			RTA 00												

DESCRIPTION	FEATURES	MODEL#	STANDARD TEXTILE GRADES											
			1	2	3	4	5	6	7	8	9	10	11	12
 <p>Upholstered Four-legged Frame w/Cantilever Arms COM Yardage: 1.50 Freight Class: 150 Product Weight (lbs.): 29 Cubic Feet Per Carton: 13.75</p>	Does not stack.	5951	\$779	\$842	\$885	\$953	\$1048	\$1094	\$1182	\$1321	\$1426	\$1546	\$1793	1357
		OVERALL DIMENSIONS			SEAT DIMENSIONS			BACK DIMENSIONS						
		W	D	H	W	D	H	W	H					
		24	25.5	34.25	20	17	19	16	19					
			RTA 00											
 <p>Upholstered Four-legged Frame w/Cantilever Arms & Casters COM Yardage: 1.50 Freight Class: 150 Product Weight (lbs.): 29 Cubic Feet Per Carton: 13.75</p>	Does not stack.	5951C	\$907	\$970	\$1013	\$1081	\$1176	\$1222	\$1310	\$1449	\$1554	\$1674	\$1921	1439
		OVERALL DIMENSIONS			SEAT DIMENSIONS			BACK DIMENSIONS						
		W	D	H	W	D	H	W	H					
		24	25.5	34.25	20	17	19	16	19					
			RTA 00											
 <p>Upholstered Four-legged Frame w/Loop Arms COM Yardage: 1.50 Freight Class: 150 Product Weight (lbs.): 29 Cubic Feet Per Carton: 13.75</p>	Does not stack.	5952	\$779	\$842	\$885	\$953	\$1048	\$1094	\$1182	\$1321	\$1426	\$1546	\$1793	1357
		OVERALL DIMENSIONS			SEAT DIMENSIONS			BACK DIMENSIONS						
		W	D	H	W	D	H	W	H					
		23.75	25.5	34.25	20	17	19	16	19					
			RTA 00											
 <p>Upholstered Four-legged Frame w/Loop Arms & Casters COM Yardage: 1.50 Freight Class: 150 Product Weight (lbs.): 29 Cubic Feet Per Carton: 13.75</p>	Does not stack.	5952C	\$907	\$970	\$1013	\$1081	\$1176	\$1222	\$1310	\$1449	\$1554	\$1674	\$1921	1439
		OVERALL DIMENSIONS			SEAT DIMENSIONS			BACK DIMENSIONS						
		W	D	H	W	D	H	W	H					
		23.75	25.5	34.25	20	17	19	16	19					
			RTA 00											
 <p>Upholstered Cantilever Frame Armless COM Yardage: 1.50 Freight Class: 150 Product Weight (lbs.): 27 Cubic Feet Per Carton: 12.5</p>	Does not stack.	5953	\$726	\$789	\$832	\$900	\$995	\$1041	\$1129	\$1268	\$1373	\$1493	\$1740	1323
		OVERALL DIMENSIONS			SEAT DIMENSIONS			BACK DIMENSIONS						
		W	D	H	W	D	H	W	H					
		21.75	23.5	34.25	20	17	19	16	19					
			RTA 00											

DESCRIPTION	FEATURES	MODEL#	STANDARD TEXTILE GRADES											
			1	2	3	4	5	6	7	8	9	10	11	12
 <p>Upholstered Cantilever Frame w/Cantilever Arms COM Yardage: 1.50 Freight Class: 150 Product Weight (lbs.): 35 Cubic Feet Per Carton: 13.75</p>	Does not stack.	5954	\$847	\$910	\$953	\$1021	\$1116	\$1162	\$1250	\$1389	\$1494	\$1614	\$1861	\$2121
		OVERALL DIMENSIONS			SEAT DIMENSIONS			BACK DIMENSIONS						
		W	D	H	W	D	H	W	H					
		24	23.5	34.25	20	17	19	16	19					
			RTA 00											
 <p>Upholstered Cantilever Frame w/Loop Arms COM Yardage: 1.50 Freight Class: 150 Product Weight (lbs.): 35 Cubic Feet Per Carton: 13.75</p>	Does not stack.	5955	\$847	\$910	\$953	\$1021	\$1116	\$1162	\$1250	\$1389	\$1494	\$1614	\$1861	1400
		OVERALL DIMENSIONS			SEAT DIMENSIONS			BACK DIMENSIONS						
		W	D	H	W	D	H	W	H					
		23.75	23.5	34.25	20	17	19	16	19					
			RTA 00											

MARCHE™



STANDARD FEATURES

- A contemporary wood seating series.
- Legs are standard in Black with Black non-marking glides.
- Does not stack.
- Check textile availability prior to specifying upholstery material.









OPTIONAL FEATURES





- Wood backs are available in Absolute (AAM), Black (BKM), Cherry (ACM), English Oak (EOM), Espresso Cafe (ECM), Fruitwood (TFM), Gray (HGM), Honey (AHM), Mahogany (TMM), Maple (AVM), Medium Walnut (MWM), Night (ASM),

Noce Biondo (NBM), Noce Grigio (NGM), Noce Leggero (NEM), Noce Medio (NMM), Shaker Cherry (SKM), Walnut (TWM), WC Cream (WTM), White (WHM) and Winter Cherry (WCM). Please Specify.

- Optional finishes are available at an upcharge. For models 8621, 8622 or 8624 add \$94 for Chrome (CHM) or Brushed Chrome (BCH), Add \$65 for Tungsten (TTU).

For models 8621S, 8622S or 8624S add \$125 for Chrome (CHM) or Brushed Chrome (BCH), Add \$89 for Tungsten (TTU).

DESCRIPTION	FEATURES	MODEL#	STANDARD TEXTILE GRADES											
			1	2	3	4	5	6	7	8	9	10	11	12
 <p>Side Chair Open wood back COM Yardage: 1 Freight Class: 250 Product Weight (lbs.): 27 Cubic Feet Per Carton: 11.25</p>	Does not stack.	8621	\$1182	\$1219	\$1249	\$1292	\$1353	\$1381	\$1437	\$1526	\$1594	\$1670	\$1826	\$1992
			OVERALL DIMENSIONS			SEAT DIMENSIONS			BACK DIMENSIONS					
			W	D	H	W	D	H	W	H				
			20	21	31.5	19	16.5	19	20	13.5				
														
 <p>Side Chair Closed Upholstered Wood back COM Yardage: 2.25 Freight Class: 250 Product Weight (lbs.): 27 Cubic Feet Per Carton: 11.25</p>	Does not stack.	8622	\$1193	\$1295	\$1328	\$1378	\$1449	\$1475	\$1536	\$1655	\$1709	\$1819	\$1968	\$2154
			OVERALL DIMENSIONS			SEAT DIMENSIONS			BACK DIMENSIONS					
			W	D	H	W	D	H	W	H				
			20	21	31.5	19	16.5	19	20	13.5				
														
 <p>Side Chair Closed Wood Back COM Yardage: 1 Freight Class: 250 Product Weight (lbs.): 27 Cubic Feet Per Carton: 11.25</p>	Does not stack.	8624	\$1182	\$1219	\$1249	\$1292	\$1353	\$1381	\$1437	\$1526	\$1594	\$1670	\$1826	\$1992
			OVERALL DIMENSIONS			SEAT DIMENSIONS			BACK DIMENSIONS					
			W	D	H	W	D	H	W	H				
			20	21	31.5	19	16.5	19	20	13.5				
														
 <p>Counter Stool Open Wood Back COM Yardage: 1 Freight Class: 300 Product Weight (lbs.): 32 Cubic Feet Per Carton: 13</p>	Does not stack.	8621S26	\$1458	\$1492	\$1514	\$1547	\$1595	\$1617	\$1663	\$1731	\$1785	\$1845	\$1966	\$2098
			OVERALL DIMENSIONS			SEAT DIMENSIONS			BACK DIMENSIONS					
			W	D	H	W	D	H	W	H				
			20	21	38.5	19	16.5	26	20	13.5				
														

DESCRIPTION	FEATURES	MODEL#	STANDARD TEXTILE GRADES											
			1	2	3	4	5	6	7	8	9	10	11	12
 Counter Stool Closed Upholstered Wood Back COM Yardage: 2.25 Freight Class: 250 Product Weight (lbs.): 32 Cubic Feet Per Carton: 13	Does not stack.	8622S26	\$1517	\$1600	\$1662	\$1758	\$1893	\$1959	\$2081	\$2277	\$2428	\$2596	\$2941	\$3312
			OVERALL DIMENSIONS			SEAT DIMENSIONS			BACK DIMENSIONS					
			W	D	H	W	D	H	W	H				
			20	21	38.5	19	16.5	26	20	13.5				
RTA 00														
 Counter Stool Closed Wood Back COM Yardage: 1 Freight Class: 250 Product Weight (lbs.): 32 Cubic Feet Per Carton: 13	Does not stack.	8624S26	\$1458	\$1492	\$1514	\$1547	\$1595	\$1617	\$1663	\$1731	\$1785	\$1845	\$1966	\$2098
			OVERALL DIMENSIONS			SEAT DIMENSIONS			BACK DIMENSIONS					
			W	D	H	W	D	H	W	H				
			20	21	38.5	19	16.5	26	20	13.5				
RTA 00														
 Barstool Open Wood Back COM Yardage: 1 Freight Class: 250 Product Weight (lbs.): 38 Cubic Feet Per Carton: 14	Does not stack.	8621S30	\$1536	\$1641	\$1659	\$1691	\$1733	\$1745	\$1782	\$1854	\$1889	\$1953	\$2043	\$2153
			OVERALL DIMENSIONS			SEAT DIMENSIONS			BACK DIMENSIONS					
			W	D	H	W	D	H	W	H				
			20	21	42.5	19	16.5	30	20	13.5				
RTA 00														
 Barstool Closed Upholstered Wood Back COM Yardage: 2.25 Freight Class: 250 Product Weight (lbs.): 38 Cubic Feet Per Carton: 14	Does not stack.	8622S30	\$1595	\$1678	\$1740	\$1836	\$1971	\$2036	\$2158	\$2355	\$2506	\$2674	\$3019	\$3388
			OVERALL DIMENSIONS			SEAT DIMENSIONS			BACK DIMENSIONS					
			W	D	H	W	D	H	W	H				
			20	21	42.5	19	16.5	30	20	13.5				
RTA 00														
 Barstool Closed Wood Back COM Yardage: 1 Freight Class: 250 Product Weight (lbs.): 38 Cubic Feet Per Carton: 14	Does not stack.	8624S30	\$1536	\$1641	\$1659	\$1691	\$1733	\$1745	\$1782	\$1854	\$1889	\$1953	\$2043	\$2153
			OVERALL DIMENSIONS			SEAT DIMENSIONS			BACK DIMENSIONS					
			W	D	H	W	D	H	W	H				
			20	21	42.5	19	16.5	30	20	13.5				
RTA 00														

MAYNE™



model 8335T





model 8336T

STANDARD FEATURES

- Mayne offers classic styling and value in a finely crafted wood framed side chair.
- Frame construction is beechwood.
- Legs are equipped with White non-marking polypropylene glides Suitable for both carpet and hard surface flooring.
- Offered in two back styles; Upholstered back or Vertical wood slat.
- Check textile availability prior to specifying upholstery material.
- Does not stack.

OPTIONAL FEATURES

- Wood frames available in Absolute (AAM), Black (BKM), Cherry (ACM), Espresso Cafe (ECM), English Oak (EOM), Fruitwood (TFM), Gray (HGM), Honey (AHM), Mahogany (TMM), Maple (AVM), Medium Walnut (MWM), Natural Walnut (NLW), Night (ASM), Noce Biondo (NBM), Noce Grigio (NGM), Noce Leggero (NEM), Noce Medio (NMM), Shaker Cherry (SKM), Walnut (TWM), WC Cream (WTM), White (WHM) and Winter Cherry (WCM). Please Specify..

DESCRIPTION	FEATURES	MODEL #	STANDARD TEXTILE GRADES													
			1	2	3	4	5	6	7	8	9	10	11	12		
 <p>Upholstered Armchair COM Yardage: 1 Freight Class: 250 Product Weight (lbs.): 27 Cubic Feet Per Carton: 13.25</p>	<p>Does not stack.</p> <p>Ergonomic Features: M, N</p>	<p>8335T</p> <p>RTA 00</p>	\$1042	\$1087	\$1121	\$1170	\$1241	\$1266	\$1329	\$1446	\$1503	\$1612	\$1761	\$1946		
			<p>OVERALL DIMENSIONS</p> <p>W D H</p>			<p>SEAT DIMENSIONS</p> <p>W D H</p>			<p>BACK DIMENSIONS</p> <p>W H</p>							
			23	24.5	33	20	18.25	18	17.5	14						
 <p>Vertical Wood Slat Armchair COM Yardage: 1 Freight Class: 300 Product Weight (lbs.): 25 Cubic Feet Per Carton: 13.25</p>	<p>Does not stack.</p> <p>Ergonomic Features: M, N</p>	<p>8336T</p> <p>RTA 00</p>	\$1079	\$1114	\$1140	\$1179	\$1234	\$1259	\$1311	\$1388	\$1450	\$1516	\$1656	\$1804		
			<p>OVERALL DIMENSIONS</p> <p>W D H</p>			<p>SEAT DIMENSIONS</p> <p>W D H</p>			<p>BACK DIMENSIONS</p> <p>W H</p>							
			23	24.5	33	20	18.25	18	17.5	14						

MODA™



model 6960



model 6961

Also see Moda Stacking Chairs



For Moda stacking chairs, please see page 194.

STANDARD FEATURES

- Moda is an upscale, classic looking multi-purpose product, ideal for conference rooms, training, break out and collaboration areas as well as light-use tasking.
- Chairs are molded with a one-piece shell. Available in Night (**BLK**), Cloud (**IVC**) or Shadow (**SHW**).
- Chair frame consists of a Polished Aluminum chassis on four steel legs in a durable Chrome finish.
- Standard with nylon glides (**N1**), suitable for carpet, rubber or concrete flooring.
- Check textile availability prior to specifying upholstery material.
- Four legged chairs do not stack.

OPTIONAL FEATURES

- All models are available with optional armcaps in Black self-skinned urethane (SSU), or in Black, White or Clear Grey finish hard plastic.
- Model 6961 armcaps can also be upholstered in the matching fabric, vinyl or leather.
- Glides with felt pads (**FG**) are available for vinyl sheet, cork or laminate flooring, please specify. Add \$37.
- Glides with felt pads (**RG**) are available for vinyl sheet, hardwood, laminate, stone or ceramic flooring, please specify. Add \$37.
- Adjustable swivel glides (**SWG**) are available for uneven floors, please specify. No upcharge



OPTION CODES

Please add option codes in the following order:

- **Model number**
6960 Armchair
6961 Armchair w/upholstered seat
- **Textile**
Specify textile code for seat (model 6961 only).
- **Shell color** (no upcharge)
(**BLK**) Night
(**IVC**) Cloud
(**SHW**) Shadow
- **Frame finish**
(**CHM**) Chrome. No upcharge.
(**TBL**) Black. Add \$87.
(**TTU**) Tungsten. Add \$87.
(**BT**) Butternut woodgrain. Add \$178.
(**EB**) Ebony woodgrain. Add \$178.
(**WU**) Walnut woodgrain. Add \$178.
- **Armcaps**
(**NC**) No armcaps.
(**SS**) Black SSU. Add \$66.
(**GC**) Clear Grey hard plastic. Add \$37.
(**H3**) Black hard plastic. Add \$37.
(**H4**) White hard plastic. Add \$37.
Armcaps (to match woodgrain frame finish only)
(**BT**) Butternut woodgrain. Add \$123.
(**EB**) Ebony woodgrain. Add \$123.
(**WU**) Walnut woodgrain. Add \$123.
Armcaps (upholstered model 6961 only)
(**UP**) Matching upholstery. Add \$73.
- **Glide style** (no upcharge)
(**FX**) Fixed glide (STD)
(**SWG**) Adjustable swivel
- **Glide type**
(**N1**) Standard nylon. No upcharge.
(**FG**) Felt. Add \$37.
(**RG**) Rubber. Add \$37.

EXAMPLE MODA ORDER CODE:

6960	-HD05	-IVC	-CHM	-NC	-FX	-N1
Model #	Textile	Shell	Frame	Armcaps	Glide style	Glide type

DESCRIPTION	FEATURES	MODEL #	STANDARD TEXTILE GRADES												
			1	2	3	4	5	6	7	8	9	10	11	12	
 <p>Four-Legged Armchair COM Yardage: N/A Freight Class: 300 Product Weight (lbs.): 16 Cubic Feet Per Carton: 14.5</p>	Polypropylene seat & back.	6960	\$773												
				OVERALL DIMENSIONS W D H			SEAT DIMENSIONS W D H			BACK DIMENSIONS W H					
				25	25	31	20.5	18	15.5	20	16				
				RTA 1	1 per carton										
 <p>Four-Legged Armchair COM Yardage: 0.75 Freight Class: 300 Product Weight (lbs.): 17 Cubic Feet Per Carton: 14.5</p>	Upholstered seat/polypropylene back.	6961	\$912	\$948	\$975	\$1015	\$1070	\$1097	\$1149	\$1231	\$1294	\$1365	\$1509	\$1663	
				OVERALL DIMENSIONS W D H			SEAT DIMENSIONS W D H			BACK DIMENSIONS W H					
				25	25	31	20.5	18	16	20	15.5				
				RTA 1	1 per carton										

MODA



model 6962



model 6963

Also see Moda Stacking Chairs



For Moda four-legged chairs, please see page 193.

STANDARD FEATURES

- Moda is an upscale, classic looking multi-purpose product, ideal for conference rooms, training, break out and collaboration areas as well as light-use tasking.
- Chairs are molded with a one-piece shell. Available in Night (BLK), Cloud (IVC) or Shadow (SHW).
- Chair frame consists of 0.5" diameter solid steel rod available exclusively in a durable Chrome finish. No crossbar to interfere with feet or leg positions.
- Chairs can be ganged together using ganging clamp set 6970.
- Standard with shell-matching nylon glides (N1), suitable for carpet, rubber or concrete flooring.
- Check textile availability prior to specifying upholstery material.

OPTIONAL FEATURES



- All models are available with optional armcaps in Black self-skinned urethane (SSU), or in Black, White or Clear Grey finish hard plastic.
- Model 6963 armcaps can also be upholstered in the matching fabric, vinyl or leather.
- Glides with felt pads (FG) are available for vinyl sheet, cork or laminate flooring, please specify. Add \$37.
- Glides with felt pads (RG) are available for vinyl sheet, hardwood, laminate, stone or ceramic flooring, please specify. Add \$37.



Please add option codes in the following order:

- **Model number**
6962 Armchair
6963 Armchair w/upholstered seat
- **Textile**
Specify textile code for seat (model 6963 only).
- **Shell color** (no upcharge)
(BLK) Night
(IVC) Cloud
(SHW) Shadow
- **Armcaps**
(NC) No armcaps.
(SS) Black SSU. Add \$66.
(GC) Clear Grey hard plastic. Add \$88
(H3) Black hard plastic. Add \$37.
(H4) White hard plastic. Add \$37.
(UP) Matching upholstery (upholstered model 6963 only). Add \$73.
- **Glides**
(N1) Standard nylon. No upcharge.
(FG) Felt. Add \$37.
(RG) Rubber. Add \$37.

EXAMPLE MODA ORDER CODE:

6963	-HD05	-IVC	-NC	-N1
Model #	Textile	Shell	Armcaps	Glides

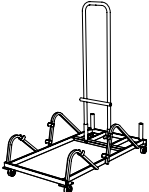
DESCRIPTION	FEATURES	MODEL #	STANDARD TEXTILE GRADES														
			1	2	3	4	5	6	7	8	9	10	11	12			
 <p>Armchair COM Yardage: N/A Freight Class: 300 Product Weight (lbs.): 16 Cubic Feet Per Carton: 15.75</p>	Polypropylene seat & back. Stacks 5 high on floor Stacks 14 high on dolly	6962	\$690														
				OVERALL DIMENSIONS		SEAT DIMENSIONS			BACK DIMENSIONS								
			W	D	H	W	D	H	W	H							
			25	25	31	20.5	18	17	20	15							
		RTA 1		2 per carton													
 <p>Armchair COM Yardage: 0.75 Freight Class: 300 Product Weight (lbs.): 17 Cubic Feet Per Carton: 15.75</p>	Upholstered seat/polypropylene back. Stacks 4 high on floor Stacks 8 high on dolly.	6963	\$829	\$865	\$892	\$932	\$988	\$1014	\$1065	\$1147	\$1210	\$1281	\$1423	\$1578			
				OVERALL DIMENSIONS		SEAT DIMENSIONS			BACK DIMENSIONS								
			W	D	H	W	D	H	W	H							
			25	25	31	20.5	18	17.5	20	15							
		RTA 1		2 per carton													

DESCRIPTION	FEATURES	MODEL #	STANDARD TEXTILE GRADES												
			1	2	3	4	5	6	7	8	9	10	11	12	
 <p>Medium Density Dolly COM Yardage: N/A Freight Class: 150 Product Weight (lbs.): 43 Cubic Feet Per Carton: 13.25</p>	For use w/ sled base chairs only	6969	\$1031												
		OVERALL DIMENSIONS			SEAT DIMENSIONS			BACK DIMENSIONS							
		W	D	H	W	D	H	W	H						
		25	63	36.75	-	-	-	-	-						
		RTA 00			FedEx			ups			1 per carton				
 <p>Ganging Clamp COM Yardage: N/A Freight Class: 70 Product Weight (lbs.): 0.13 Cubic Feet Per Carton: 0.3</p>	Two per chair recommended. Packed 2 per bag For use w/ sled base chairs only	6970	\$60												
		OVERALL DIMENSIONS			SEAT DIMENSIONS			BACK DIMENSIONS							
		W	D	H	W	D	H	W	H						
		3.0	1.5	0.75	-	-	-	-	-						
		RTA 00			FedEx			ups			25 per carton				

POPCORN



model 6711



model 6712



model 6711TR



Hand Hold Feature



	Chair Stacking Capability		Stool Stacking Capability
	Stacks on floor	Stacks on dolly	Stacks on floor
Armless			
Polypropylene seat	up to 10 high	up to 34 high	up to 8 high
Upholstered seat	up to 8 high	up to 15 high	up to 8 high
With Arms			
Polypropylene seat	up to 10 high	up to 34 high	up to 8 high
Upholstered seat	up to 8 high	up to 15 high	up to 8 high

















STANDARD FEATURES



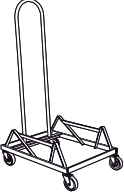



- Popcorn a high quality stacking chair that is ideal for multi-purpose stack applications within corporate, government and healthcare facilities.
- Chair frame is constructed of 1/2" diameter solid chrome steel rod available exclusively in a durable chrome finish. There is no crossbar to interfere with feet or leg positions. Chrome frame without glides is standard and suitable for cork, rubberized and carpeted floors.
- Wall saver frame design; the base touches the wall before the upper back to protect the wall from damage.
- Upper back features a cut out hand hold to assist in stacking and transportation.
- Seat and back is a one piece polypropylene shell for strength and ease of cleaning and disinfecting.
- Chairs can be ganged together using ganging clamp set (6626), providing a 2" space between armchair models and 5" space between armless models.
- Upholstered models are equipped with a smooth black shroud underneath the seat to help prevent frame imprints on the lower chair while stacked.
- Task chairs are available with a tablet. Tablet arms are extremely rugged and meets ANSI-BIFMA testing requirements. Tablet hinges up to allow ease of egress. Tablet slides forward and back to accommodate any body size comfortably. Tablet models do not stack.
- Standard tablet (D8) size is 18"D x 14.5"W and is made of Black polymer. Tablets are attached at the left or right (as seated) of the task chair.
- Popcorn beam seating consists of upper seat units (6717, 6719) including mounting brackets and all hardware necessary for attachment to beam.
- For all beam components, tables and a complete list of available upper seat units, see Beam Seating series.
- **Specifications and pricing are for 1 chair.**



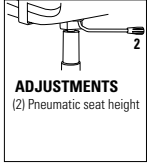

OPTIONAL FEATURES

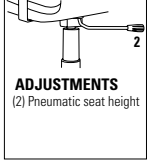

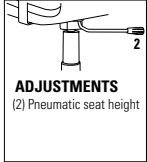

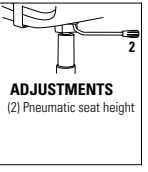
- Polypropylene shell and coordinating arms are available in 14 designer colors. Choose from Buzz Blue (BZB), Cactus (CCT), Carrot (CRO), Cloud (IVC), Dijon (DJN), Eggplant (EGP), Fog (FOG), Frost (FRO), Ink (INK), Latte (LAB), Night (BLK), Sand (SND), Scarlet (SAR), and Shadow (SHW).
- An optional 18.5"D x 18.5"W high pressure laminate writing tablet is available. The core is hardwood veneer plywood with radiused edge finished in clear lacquer. This writing tablet is offered in the following finishes: Black (BLK), Clear Maple (CMB), Designer White (DWT) and Noce Grigio (NGL). Please specify. Add \$64.
- Check textile availability prior to specifying upholstery material.
- Chairs will have additional stitch details when upholstered in vinyl.
- For hard surface flooring casters on Task chairs, please specify (C9R). Add \$72.
- A selection of glide options is available. Glides must be chosen to best suit flooring type and site conditions.
- Clear polycarbonate glides (CG) are available for carpet, rubber or concrete flooring, please specify. Add \$18
- Glides with felt pads (FG) are available for vinyl sheet, cork or laminate flooring, please specify. Add \$34.
- Glides with rubber pads (RG) are available for vinyl, hardwood, laminate, stone or ceramic flooring, please specify. Add \$34.
- Glides with stainless steel pads (SG) are available for carpet or rubber flooring, specify. Add \$34.

DESCRIPTION	FEATURES	MODEL#	STANDARD TEXTILE GRADES													
			1	2	3	4	5	6	7	8	9	10	11	12		
 <p>Armchair COM Yardage: N/A Freight Class: 150 Product Weight (lbs.): 23.5 Cubic Feet Per Carton: 4.44 (4 per carton)</p>	<p>Polypropylene Seat and Back. Stacks 10 high on floor. Stacks 34 high on dolly</p>	6710	\$347													
			OVERALL DIMENSIONS			SEAT DIMENSIONS			BACK DIMENSIONS							
			W	D	H	W	D	H	W	H						
			24.5	23.5	32.5	18	18	16.5	19.5	16						
			RTA 00													
 <p>Armless Chair COM Yardage: N/A Freight Class: 150 Product Weight (lbs.): 17.25 Cubic Feet Per Carton: 14.75 (4 per carton)</p>	<p>Polypropylene Seat and Back. Stacks 10 high on floor. Stacks 34 high on dolly</p>	6711	\$228													
			OVERALL DIMENSIONS			SEAT DIMENSIONS			BACK DIMENSIONS							
			W	D	H	W	D	H	W	H						
			20	23.5	32.5	18	18	16.5	19.5	16						
			RTA 00													

DESCRIPTION	FEATURES	MODEL#	STANDARD TEXTILE GRADES													
			1	2	3	4	5	6	7	8	9	10	11	12		
 <p>Armchair COM Yardage: 0.75 Freight Class: 150 Product Weight (lbs.): 24.5 Cubic Feet Per Carton: 4.81 (4 per carton)</p>	Upholstered seat and Polypropylene Back Stacks 8 high on floor. Stacks 15 high on dolly	6712	\$454	\$487	\$506	\$538	\$582	\$599	\$637	\$712	\$744	\$812	\$905	1021		
			OVERALL DIMENSIONS			SEAT DIMENSIONS			BACK DIMENSIONS							
			W	D	H	W	D	H	W	H						
			24.5	23.5	32.5	18	18	17	19.5	15.5						
			  													
 <p>Armless Chair COM Yardage: 0.75 Freight Class: 250 Product Weight (lbs.): 16 Cubic Feet Per Carton: 9 (4 per carton)</p>	Upholstered seat and Polypropylene Back Stacks 8 high on floor. Stacks 15 high on dolly	6713	\$336	\$367	\$386	\$419	\$462	\$479	\$518	\$591	\$625	\$696	\$788	902		
			OVERALL DIMENSIONS			SEAT DIMENSIONS			BACK DIMENSIONS							
			W	D	H	W	D	H	W	H						
			20	23.5	32.5	18	18	17	19.5	15.5						
																
 <p>Medium Density Dolly COM Yardage: N/A Freight Class: 250 Product Weight (lbs.): 29 Cubic Feet Per Carton: 9</p>	For upholstered models Can stack chairs up to 15 high Fits through standard 80" door frame	6714	\$772	-	-	-	-	-	-	-	-	-	-	-		
			OVERALL DIMENSIONS			SEAT DIMENSIONS			BACK DIMENSIONS							
			W	D	H	W	D	H	W	H						
			23	31	18.5	-	-	-	-	-						
			  													
 <p>High Density Dolly COM Yardage: N/A Freight Class: 125 Product Weight (lbs.): 30 Cubic Feet Per Carton: 5.5</p>	For polypropylene models Can stack chairs up to 34 high Fits through standard 80" door frame	6715	\$772	-	-	-	-	-	-	-	-	-	-	-		
			OVERALL DIMENSIONS			SEAT DIMENSIONS			BACK DIMENSIONS							
			W	D	H	W	D	H	W	H						
			21.37	31.75	51.75	-	-	-	-	-						
			  													
 <p>Armless Seat Unit COM Yardage: N/A Freight Class: 150 Product Weight (lbs.): 17 Cubic Feet Per Carton: 6.5 (2 per carton)</p>	Polypropylene Seat and Back. Use with beam.	6717	\$354	-	-	-	-	-	-	-	-	-	-	-		
			OVERALL DIMENSIONS			SEAT DIMENSIONS			BACK DIMENSIONS							
			W	D	H	W	D	H	W	H						
			20	21	18	18	18	-	19.5	16						
																

DESCRIPTION	FEATURES	MODEL#	STANDARD TEXTILE GRADES													
			1	2	3	4	5	6	7	8	9	10	11	12		
 <p>Armless Seat Unit COM Yardage: 0.75 Freight Class: 150 Product Weight (lbs.): 18 Cubic Feet Per Carton: 6.5 (2 per carton)</p>	<p>Popcorn Upholstered Seat and Polypropylene Back. Use with beam.</p>	<p>6719</p>	\$462	\$496	\$518	\$551	\$599	\$621	\$667	\$735	\$789	\$849	\$970	\$1102		
			OVERALL DIMENSIONS			SEAT DIMENSIONS			BACK DIMENSIONS							
			W	D	H	W	D	H	W	H						
			20	21	18	18	18	-	19.5	16						
			RTA 00													
 <p>Ganging Clamp Set - 2 Clamps COM Yardage: N/A Freight Class: 70 Product Weight (lbs.): 0.3 Cubic Feet Per Carton: 0.01 (1 set per carton)</p>		<p>6626</p>	\$30	-	-	-	-	-	-	-	-	-	-	-		
			OVERALL DIMENSIONS			SEAT DIMENSIONS			BACK DIMENSIONS							
			W	D	H	W	D	H	W	H						
			1	6.5	00.75	-	-	-	-	-						
			RTA 00													
 <p>Armless Task COM Yardage: N/A Freight Class: 250 Product Weight (lbs.): 31 Cubic Feet Per Carton: 14.25</p>	 <p>ADJUSTMENTS (2) Pneumatic seat height</p>	<p>6741</p>	List price													
			\$504													
			OVERALL DIMENSIONS			SEAT DIMENSIONS			BACK DIMENSIONS							
			W	D	H	W	D	H	W	H						
20	23	30.5	18	18	15.5	19.5	16									
			RTA 00 1 per carton													
 <p>Armless Task w/ Tablet COM Yardage: N/A Freight Class: 250 Product Weight (lbs.): 40 Cubic Feet Per Carton: 15.75</p>	 <p>ADJUSTMENTS (2) Pneumatic seat height</p>	<p>6741TR 6741TL</p>	List price													
			\$842													
			OVERALL DIMENSIONS			SEAT DIMENSIONS			BACK DIMENSIONS							
			W	D	H	W	D	H	W	H						
24.75	26	30.5	18	18	15.5	19.5	16									
			RTA 00 1 per carton													
 <p>Armless Task COM Yardage: 0.75 Freight Class: 250 Product Weight (lbs.): 33 Cubic Feet Per Carton: 14.25</p>	 <p>ADJUSTMENTS (2) Pneumatic seat height</p>	<p>6743</p>	\$617	\$650	\$670	\$706	\$754	\$774	\$819	\$890	\$941	\$1003	\$1125	\$1257		
			OVERALL DIMENSIONS			SEAT DIMENSIONS			BACK DIMENSIONS							
			W	D	H	W	D	H	W	H						
			20	23	30.5	18	18	16	19.5	16						
			RTA 00 1 per carton													

DESCRIPTION	FEATURES	MODEL#	STANDARD TEXTILE GRADES													
			1	2	3	4	5	6	7	8	9	10	11	12		
 <p>Armless Task w/ Tablet COM Yardage: 0.75 Freight Class: 250 Product Weight (lbs.): 42 Cubic Feet Per Carton: 15.75</p>	 <p>ADJUSTMENTS (2) Pneumatic seat height</p>	<p>Upholstered seat/polypropylene back. Ergonomic features: C Specify (L) left or (R) right tablet.</p>	6743TR	955	984	1004	1035	1081	1101	1141	1207	1254	1312	1423	1545	
			OVERALL DIMENSIONS			SEAT DIMENSIONS			BACK DIMENSIONS							
			W	D	H	W	D	H	W	H						
			24.75	26	30.5	18	18	16	19.5	16						
												<p>RTA 00 1 per carton</p>				
 <p>Barstool w/ Arms COM Yardage: N/A Freight Class: 250 Product Weight (lbs.): 29 Cubic Feet Per Carton: 21.50 (2 per carton)</p>	<p>Polypropylene Seat and Back. Stacks 8 high on floor.</p>	<p>RTA 00</p>	6710BS	\$561												
			OVERALL DIMENSIONS			SEAT DIMENSIONS			BACK DIMENSIONS							
			W	D	H	W	D	H	W	H						
			24.5	25.5	44.5	18	18	29	19.5	16						
 <p>Counter stool w/ Arms COM Yardage: N/A Freight Class: 250 Product Weight (lbs.): 24 Cubic Feet Per Carton: 21.50 (2 per carton)</p>	<p>Polypropylene Seat and Back. Stacks 8 high on floor.</p>	<p>RTA 00</p>	6710CS	\$561												
			OVERALL DIMENSIONS			SEAT DIMENSIONS			BACK DIMENSIONS							
			W	D	H	W	D	H	W	H						
			24.5	25.5	40.5	18	18	24	19.5	16						
 <p>Armless Barstool COM Yardage: N/A Freight Class: 250 Product Weight (lbs.): 27 Cubic Feet Per Carton: 17.50 (2 per carton)</p>	<p>Polypropylene Seat and Back. Stacks 8 high on floor.</p>	<p>RTA 00</p>	6711BS	\$405												
			OVERALL DIMENSIONS			SEAT DIMENSIONS			BACK DIMENSIONS							
			W	D	H	W	D	H	W	H						
			20	25.5	44.5	18	18	29	19.5	16						
 <p>Armless Counter Stool COM Yardage: N/A Freight Class: 250 Product Weight (lbs.): 22 Cubic Feet Per Carton: 17.50 (2 per carton)</p>	<p>Polypropylene Seat and Back. Stacks 8 high on floor.</p>	<p>RTA 00</p>	6711CS	\$405												
			OVERALL DIMENSIONS			SEAT DIMENSIONS			BACK DIMENSIONS							
			W	D	H	W	D	H	W	H						
			20	25.5	40.5	18	18	24	19.5	16						

DESCRIPTION	FEATURES	MODEL#	STANDARD TEXTILE GRADES											
			1	2	3	4	5	6	7	8	9	10	11	12
 <p>Barstool w/Arms COM Yardage: 0.75 Freight Class: 150 Product Weight (lbs.): 24.5 Cubic Feet Per Carton: 4.81 (2 per carton)</p>	<p>Upholstered seat and Polypropylene Back Stacks 8 high on floor.</p>	6712BS	\$674	\$707	\$728	\$762	\$809	\$832	\$878	\$947	\$998	\$1060	\$1181	\$1312
			OVERALL DIMENSIONS			SEAT DIMENSIONS			BACK DIMENSIONS					
			W	D	H	W	D	H	W	H				
			24.5	25.5	44.5	18	18	29.5	19.5	16				
			RTA 00											
 <p>Counter Stool w/Arms COM Yardage: 0.75 Freight Class: 150 Product Weight (lbs.): 24.5 Cubic Feet Per Carton: 4.81 (2 per carton)</p>	<p>Upholstered seat and Polypropylene Back Stacks 8 high on floor.</p>	6712CS	\$674	\$708	\$730	\$763	\$811	\$833	\$879	\$947	\$1001	\$1061	\$1182	\$1314
			OVERALL DIMENSIONS			SEAT DIMENSIONS			BACK DIMENSIONS					
			W	D	H	W	D	H	W	H				
			24.5	25.5	18	18	18	24.5	19.5	16				
			RTA 00											
 <p>Armless Barstool COM Yardage: 0.75 Freight Class: 250 Product Weight (lbs.): 29 Cubic Feet Per Carton: 9 (2 per carton)</p>	<p>Upholstered seat and Polypropylene Back Stacks 8 high on floor.</p>	6713BS	\$551	\$584	\$605	\$639	\$686	\$709	\$755	\$824	\$875	\$937	\$1058	\$1189
			OVERALL DIMENSIONS			SEAT DIMENSIONS			BACK DIMENSIONS					
			W	D	H	W	D	H	W	H				
			20	25.5	18	18	18	29.5	19.5	16				
			RTA 00											
 <p>Armless Counter Stool COM Yardage: 0.75 Freight Class: 250 Product Weight (lbs.): 29 Cubic Feet Per Carton: 9 (2 per carton)</p>	<p>Upholstered seat and Polypropylene Back Stacks 8 high on floor.</p>	6713CS	\$551	\$584	\$605	\$639	\$686	\$709	\$755	\$824	\$875	\$937	\$1058	\$1189
			OVERALL DIMENSIONS			SEAT DIMENSIONS			BACK DIMENSIONS					
			W	D	H	W	D	H	W	H				
			20	25.5	18	18	18	24.5	19.5	16				
			RTA 00											

REBOUND™



Model R5APUG
Armchair, Upholstered Seat



Model R5CSAPUG
Counter Stool, Arms, Upholstered Seat

	Chair Stacking Capability		Stools Stacking Capability
	stacks on floor	stacks on dolly (RDOL)	stacks on floor only
Four-Leg (Glide/Caster) + Sled Base Models			
Polypropylene	up to 5 high	up to 10 high	up to 5 high
Upholstered seat	up to 5 high	up to 10 high	up to 5 high

EXAMPLE REBOUND ORDER CODE:

R5APUG	CCT	BL20	CHM	NM
Model #	Back, seat and arm Textile	Seat Textile	Frame Finish	Glide Type





STANDARD FEATURES





- Designed by Alessandro Piretti, the Rebound series has a flexible back designed for ultimate comfort in multi-purpose seating. The series includes: four-leg and sled base chairs and four leg counter and bar stools.
- Features a cleanable, easy to wipe down, all polypropylene shell design in a wide variety of finishes.
- Models available with all polypropylene back/seat or polypropylene back/upholstered seat.
- Models available with or without arms. Arms match selected shell finish.
- Four leg and sled base models have tubular steel bases available in a wide variety of painted and metallic finishes.
- Chairs with four legs are available with glides (G suffix models) and casters (C suffix models). Select from a variety of glide types to best suit the flooring type and site conditions. See upcharges.
- Sled base chairs are available with either Black or White nylon glides.
- Four leg (glide and caster) chairs and sled base chairs are stackable up to 5 high on floor and 10 high on dolly (RDOL). Models with upholstered seats stack 5 high on floor and 10 high on the dolly. Counter and Bar stools stack up to 5 high on floor.
- All models are equipped with a color coordinated under seat shroud.
- Due to the flex back design, it is recommended the chair be positioned away from wall for use.
- Upholstery seat options: fabric, coated materials (such as vinyl) or leather
- The series is designed for use across a range of facilities and is covered under Global's limited lifetime warranty for single-shift use. Specify from approved textiles.
- Active weight capacity is 300 lbs. for four leg seating with casters, 400 lbs. for seating on glides.





OPTIONAL FEATURES



Please add option codes in the following order:

- **Model number**
R5_ _ _ (G or C) Four-legged chair, glides or casters
R6_ _ _ Sled Base
R5BS_ _ _ Bar stool
R5CS_ _ _ Counter stool
RDOL Stacking Dolly
- **Back seat and arm finish**
(BZB) Buzz Blue (CCT) Cactus
(CRO) Carrot (IVC) Cloud
(DJN) Dijon (EGP) Eggplant
(FOG) Fog (FRO) Frost
(INK) Ink (LAB) Latte
(BLK) Night (SND) Sand
(SAR) Scarlet (SHW) Shadow
- **Seat textile** (PU models)
Specify textile
- **Frame finish**
Painted Finishes:
Black (TBL) Buzz Blue (TBZ)
Cactus (TCC) Carrot (TCR)
Cloud (TIV) Designer White (TDW)
Dijon (TDJ) Eggplant (TEG)
Fog (TFO) Frost (TFR)
Ink (TIN) Kalua (TKA)
Latte (TLA) Mocha (TMO)
Nevada (TNE) Sand (TSN)
Scarlet (TSR) Shadow (TSH)
Toast (TOA) Tungsten (TTU)
- **Metallics:** Chair Counter/Bar
(CHM) Chrome Add \$39 \$71
(BCH) Brushed Chrome Add \$139 \$231
(SBR) Satin Brass Add \$206 \$338
(ACO) Antique Copper Add \$206 \$338
- **Glide type** (chairs and stools with four legs)
(BG) Black nylon glide for most floor surfaces.
(NM) White nylon Glide non-marking glide for most floor surfaces
(FG) Felt glide for most hard floor surfaces. Add \$34.
(RG) Rubber non-slip glide for most hard floor surfaces. Add \$34.
(SG) Steel cushioned glide for carpeted surfaces. Add \$34
- **Glide type** (sled base models)
(GL) Black nylon glide for most floor surfaces.
(NM) White nylon glide for most floor surfaces.
- **Caster type** (caster chair models)
(DC) 2" Caster for Carpeted Surfaces
(RC) 2" Caster for Most Hard Floor Surfaces. Add \$50.

DESCRIPTION		MODEL#/ FEATURES		STANDARD TEXTILE GRADES												
	<p>R5APPG Glides</p> <p>R5APPC Casters</p>	1/COM	2	3	4	5	6	7	8	9	10	11	12			
		559														
		615														
		OVERALL DIMENSIONS			SEAT DIMENSIONS			BACK DIMENSIONS								
<p>W D H</p> <p>26.25 20.5 32.75</p>			<p>W D H</p> <p>19.25 17.75 17.5</p>			<p>W H</p> <p>18.5 15.25</p>										
<p>Armchair, Polypropylene Seat COM Yardage: N/A Freight Class: 300 Product Weight (lbs.): 13.5 Cubic Feet Per Carton: 7.63</p>		<p>Active weight with casters 300 lbs. Active weight with glides 400 lbs. Stacks 5 high on floor. Stacks 10 high on dolly.</p>														
		<p>RTA 00 2 per carton (pricing and specifications are for one seat unit)</p>														
	<p>R5APUG Glides</p> <p>R5APUC Casters</p>	1/COM	2	3	4	5	6	7	8	9	10	11	12			
		724	748	767	795	834	850	884	937	977	1021	1111	1207			
		780	804	823	851	890	906	940	993	1033	1077	1167	1263			
		OVERALL DIMENSIONS			SEAT DIMENSIONS			BACK DIMENSIONS								
<p>W D H</p> <p>26.25 20.5 32.75</p>			<p>W D H</p> <p>19.25 17.75 18.5</p>			<p>W H</p> <p>18.5 15.25</p>										
<p>Armchair, Upholstered Seat COM Yardage: 0.75 Freight Class: 300 Product Weight (lbs.): 14.5 Cubic Feet Per Carton: 7.63</p>		<p>Active weight with casters 300 lbs. Active weight with glides 400 lbs. Stacks 5 high on floor. Stacks 10 high on dolly.</p>														
		<p>RTA 00 2 per carton (pricing and specifications are for one seat unit)</p>														
	<p>R5NPPG Glides</p> <p>R5NPPC Casters</p>	1/COM	2	3	4	5	6	7	8	9	10	11	12			
		448														
		504														
		OVERALL DIMENSIONS			SEAT DIMENSIONS			BACK DIMENSIONS								
<p>W D H</p> <p>22 20.5 32.75</p>			<p>W D H</p> <p>19.25 17.75 17.5</p>			<p>W H</p> <p>18.5 15.25</p>										
<p>Armless Chair, Polypropylene Seat COM Yardage: N/A Freight Class: 300 Product Weight (lbs.): 12.25 Cubic Feet Per Carton: 6.38</p>		<p>Active weight with casters 300 lbs. Active weight with glides 400 lbs. Stacks 5 high on floor. Stacks 10 high on dolly.</p>														
		<p>RTA 00 2 per carton (pricing and specifications are for one seat unit)</p>														
	<p>R5NPUG Glides</p> <p>R5NPUC Casters</p>	1/COM	2	3	4	5	6	7	8	9	10	11	12			
		613	637	656	684	723	739	773	826	866	910	1000	1096			
		669	693	712	740	779	795	829	882	922	966	1056	1152			
		OVERALL DIMENSIONS			SEAT DIMENSIONS			BACK DIMENSIONS								
<p>W D H</p> <p>22 20.5 32.75</p>			<p>W D H</p> <p>19.25 17.75 18.5</p>			<p>W H</p> <p>18.5 14.25</p>										
<p>Armless Chair, Upholstered Seat COM Yardage: 0.75 Freight Class: 300 Product Weight (lbs.): 12.25 Cubic Feet Per Carton: 6.38</p>		<p>Active weight with casters 300 lbs. Active weight with glides 400 lbs. Stacks 5 high on floor. Stacks 10 high on dolly.</p>														
		<p>RTA 00 2 per carton (pricing and specifications are for one seat unit)</p>														
	<p>R6APP</p>	1/COM	2	3	4	5	6	7	8	9	10	11	12			
		591														
		OVERALL DIMENSIONS			SEAT DIMENSIONS			BACK DIMENSIONS								
		<p>W D H</p> <p>26.25 21.5 32.75</p>			<p>W D H</p> <p>19.25 17.75 17.5</p>			<p>W H</p> <p>18.5 15.25</p>								
<p>Armchair, Polypropylene Seat, Sled Base COM Yardage: N/A Freight Class: 300 Product Weight (lbs.): 13.75 Cubic Feet Per Carton: 7.63</p>		<p>Active weight 400 lbs. Stacks 5 high on floor. Stacks 10 high on dolly.</p>														
		<p>RTA 00 2 per carton (pricing and specifications are for one seat unit)</p>														

DESCRIPTION	MODEL#/ FEATURES	STANDARD TEXTILE GRADES											
		1/COM	2	3	4	5	6	7	8	9	10	11	12
 <p>Armchair, Upholstered Seat, Sled Base COM Yardage: 0.75 Freight Class: 300 Product Weight (lbs.): 14.75 Cubic Feet Per Carton: 7.63</p>	<p>R6APU</p> <p>Active weight 400 lbs. Stacks 5 high on floor. Stacks 10 high on dolly.</p>	755	779	798	826	865	881	915	968	1008	1052	1142	1238
		OVERALL DIMENSIONS			SEAT DIMENSIONS			BACK DIMENSIONS					
		W	D	H	W	D	H	W	H				
		26.25	21.5	32.75	19.25	17.75	18.5	18.5	14.25				
		<p>RTA 00 2 per carton (pricing and specifications are for one seat unit)</p>											
 <p>Armless Chair, Polypropylene Seat, Sled Base COM Yardage: N/A Freight Class: 300 Product Weight (lbs.): 12.25 Cubic Feet Per Carton: 6.38</p>	<p>R6NPP</p> <p>Active weight 400 lbs. Stacks 5 high on floor. Stacks 10 high on dolly.</p>	480											
		OVERALL DIMENSIONS			SEAT DIMENSIONS			BACK DIMENSIONS					
		W	D	H	W	D	H	W	H				
		22	21.5	32.75	19.25	17.75	17.5	18.5	15.25				
		<p>RTA 00 2 per carton (pricing and specifications are for one seat unit)</p>											
 <p>Armless Chair, Upholstered Seat, Sled Base COM Yardage: 0.75 Freight Class: 250 Product Weight (lbs.): 13.25 Cubic Feet Per Carton: 6.38</p>	<p>R6NPU</p> <p>Active weight 400 lbs. Stacks 5 high on floor. Stacks 10 high on dolly.</p>	644	668	687	715	754	770	804	857	897	941	1031	1127
		OVERALL DIMENSIONS			SEAT DIMENSIONS			BACK DIMENSIONS					
		W	D	H	W	D	H	W	H				
		22	21.5	32.75	19.25	17.75	18.5	18.5	14.25				
		<p>RTA 00 2 per carton (pricing and specifications are for one seat unit)</p>											
 <p>Counter Stool, Arms, Polypropylene Seat COM Yardage: N/A Freight Class: 300 Product Weight (lbs.): 16 Cubic Feet Per Carton: 8.88</p>	<p>R5CSAPP</p> <p>Polypropylene seat & back. Active weight 400 lbs. Stacks 5 high on floor.</p>	658											
		OVERALL DIMENSIONS			SEAT DIMENSIONS			BACK DIMENSIONS					
		W	D	H	W	D	H	W	H				
		26.25	21.75	38.25	19.25	17.75	23.75	18.5	15.25				
		<p>RTA 00 2 per carton (pricing and specifications are for one seat unit)</p>											
 <p>Counter Stool, Arms, Upholstered Seat COM Yardage: 0.75 Freight Class: 300 Product Weight (lbs.): 17 Cubic Feet Per Carton: 8.88</p>	<p>R5CSAPU</p> <p>Active weight 400 lbs. Stacks 5 high on floor.</p>	822	846	865	893	932	948	982	1035	1075	1119	1209	1305
		OVERALL DIMENSIONS			SEAT DIMENSIONS			BACK DIMENSIONS					
		W	D	H	W	D	H	W	H				
		26.25	21.75	38.25	19.25	17.75	23.75	18.5	15.25				
		<p>RTA 00 2 per carton (pricing and specifications are for one seat unit)</p>											

DESCRIPTION	MODEL#/ FEATURES	STANDARD TEXTILE GRADES											
		1/COM	2	3	4	5	6	7	8	9	10	11	12
 <p>Armless Counter Stool, Polypropylene Seat COM Yardage: N/A Freight Class: 300 Product Weight (lbs.): 14.5 Cubic Feet Per Carton: 8.88</p>	<p>R5CSNPP Polypropylene seat & back. Active weight 400 lbs. Stacks 5 high on floor.</p>	547											
		OVERALL DIMENSIONS			SEAT DIMENSIONS			BACK DIMENSIONS					
		W	D	H	W	D	H	W	H				
		22	21.75	38.25	19.25	17.75	23.75	18.5	15.25				
		<p>RTA 00 2 per carton (pricing and specifications are for one seat unit)</p>											
 <p>Armless Counter Stool, Upholstered Seat COM Yardage: 0.75 Freight Class: 300 Product Weight (lbs.): 15.5 Cubic Feet Per Carton: 8.88</p>	<p>R5CSNPU Active weight 400 lbs. Stacks 5 high on floor.</p>	712 736 755 783 822 838 872 925 965 1009 1099 1195											
		OVERALL DIMENSIONS			SEAT DIMENSIONS			BACK DIMENSIONS					
		W	D	H	W	D	H	W	H				
		22	21.75	38.25	19.25	17.75	24.75	18.5	14.25				
		<p>RTA 00 2 per carton (pricing and specifications are for one seat unit)</p>											
 <p>Bar Stool, Arms, Polypropylene Seat COM Yardage: N/A Freight Class: 300 Product Weight (lbs.): 16.75 Cubic Feet Per Carton: 9.75</p>	<p>R5BSAPP Polypropylene seat & back. Active weight 400 lbs. Stacks 5 high on floor.</p>	671											
		OVERALL DIMENSIONS			SEAT DIMENSIONS			BACK DIMENSIONS					
		W	D	H	W	D	H	W	H				
		26.25	21.75	43.25	19.25	17.75	28.75	18.5	15.25				
		<p>RTA 00 2 per carton (pricing and specifications are for one seat unit)</p>											
 <p>Bar Stool, Arms, Upholstered Seat COM Yardage: 0.75 Freight Class: 300 Product Weight (lbs.): 17.75 Cubic Feet Per Carton: 9.75</p>	<p>R5BSAPU Active weight 400 lbs. Stacks 5 high on floor.</p>	836 860 879 907 946 962 996 1049 1089 1133 1223 1319											
		OVERALL DIMENSIONS			SEAT DIMENSIONS			BACK DIMENSIONS					
		W	D	H	W	D	H	W	H				
		26.25	21.75	43.25	19.25	17.75	29.75	18.5	14.25				
		<p>RTA 00 2 per carton (pricing and specifications are for one seat unit)</p>											
 <p>Armless Bar Stool, Polypropylene Seat COM Yardage: N/A Freight Class: 300 Product Weight (lbs.): 14.5 Cubic Feet Per Carton: 8.25</p>	<p>R5BSNPP Polypropylene seat & back. Active weight 400 lbs. Stacks 5 high on floor.</p>	560											
		OVERALL DIMENSIONS			SEAT DIMENSIONS			BACK DIMENSIONS					
		W	D	H	W	D	H	W	H				
		26.25	21.75	43.25	19.25	17.75	28.75	18.5	15.25				
		<p>RTA 00 2 per carton (pricing and specifications are for one seat unit)</p>											

DESCRIPTION	MODEL#/ FEATURES	STANDARD TEXTILE GRADES												
		1/COM	2	3	4	5	6	7	8	9	10	11	12	
 <p>Armless Bar Stool, Upholstered Seat COM Yardage: 0.75 Freight Class: 300 Product Weight (lbs.): 15.5 Cubic Feet Per Carton: 8.25</p>	<p>R5BSNPU</p> <p>Active weight 400 lbs. Stacks 5 high on floor.</p>	725	749	768	796	835	851	885	938	978	1022	1112	1208	
		OVERALL DIMENSIONS W D H			SEAT DIMENSIONS W D H			BACK DIMENSIONS W H						
		26.25	21.75	43.25	19.25	17.75	29.75	18.5	14.25					
		<p>RTA 00 2 per carton (pricing and specifications are for one seat unit)</p>												
 <p>Stacking Dolly COM Yardage: N/A Freight Class: 150 Product Weight (lbs.): 18 Cubic Feet Per Carton: 4.4</p>	<p>RDOL</p>	426												
		OVERALL DIMENSIONS W D H												
		23.75	21.25	12.25										
		<p>RTA 00</p>												

MULTI-PURPOSE

ROMA® NESTER R

ROMA® NESTER



model 1898



model 1899

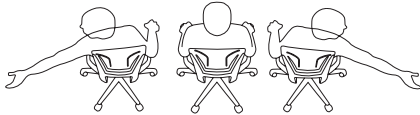

(Models 1890 and 1900)

The Polypropylene Medium Back and the Upholstered Medium Back feature a flexible back construction that provides support, proper spinal alignment and comfort when moving or reaching in a seated position.

STANDARD FEATURES



- Flexible, elegant and affordable, Roma offers a family of seating with simple clean lines.
- Please see Work + Task section for additional Roma models.
- Four back versions are available. Choose from Mesh, Flexible Polypropylene or Honeycomb Polypropylene back.
- Models upholstered in leather have a curved seam across the seat.
- Flexible polypropylene back chair features a built in lumbar support designed to move as you move and is available exclusively in black.
- The horizontal nesting chairs are easy to store. Simply flip the seat upward and then roll into nesting position, like a shopping cart.
- When nesting horizontal nesting chairs, each additional chair adds 8" to depth.
- Arms are durable fiberglass reinforced Nylon, fixed height. Armcaps are durable Polyurethane (SSU), soft and warm to the touch.
- C1 casters are standard.



OPTIONAL FEATURES

- Breathable mesh back is available in six colors. Choose from Autumn Orange (AO), Spring Green (SG) Winter Grey (WG), Midnight Black (MB), Summer Blue (SB), Fall Burgundy (FB).
- Nesting chairs are standard in Black (TBL), Tungsten (TTU) or Shadow (TSH). Optional Chrome (CHM) frame is available. Add \$44.
- Check textile availability prior to specifying upholstery material.



Stitch detail on Leather upholstered seat

DESCRIPTION	FEATURES	MODEL#	STANDARD TEXTILE GRADES													
			1	2	3	4	5	6	7	8	9	10	11	12		
 <p>Honeycomb MB - Armless Flip Seat Nesting Chair COM Yardage: 1 Freight Class: 250 Product Weight (lbs.): 29 Cubic Feet Per Carton: 13.75</p>	<p>Nesting chair.</p> <p>Ergonomic Features: M, N</p>	1888	\$722	\$759	\$788	\$828	\$889	\$908	\$961	\$1059	\$1108	\$1198	\$1320	\$1477		
		OVERALL DIMENSIONS			SEAT DIMENSIONS			BACK DIMENSIONS								
		W	D	H	W	D	H	W	H							
		24.5	23.5	36	19.5	17	18	18.5	18							
 <p>Mesh MB - Armless Flip Seat Nesting Chair COM Yardage: 1 Freight Class: 250 Product Weight (lbs.): 29 Cubic Feet Per Carton: 13.75</p>	<p>Nesting chair.</p> <p>Ergonomic Features: M, N</p>	1889	\$712	\$750	\$779	\$820	\$880	\$898	\$953	\$1051	\$1099	\$1191	\$1314	\$1468		
		OVERALL DIMENSIONS			SEAT DIMENSIONS			BACK DIMENSIONS								
		W	D	H	W	D	H	W	H							
		24.5	23.5	36	19.5	17	18	18.5	18							
 <p>Polypropylene MB - Armless Flip Seat Nesting Chair COM Yardage: 1 Freight Class: 250 Product Weight (lbs.): 29 Cubic Feet Per Carton: 13.75</p>	<p>Nesting chair.</p> <p>Ergonomic Features: M, N</p>	1890	\$712	\$750	\$779	\$820	\$880	\$898	\$953	\$1051	\$1099	\$1191	\$1314	\$1468		
		OVERALL DIMENSIONS			SEAT DIMENSIONS			BACK DIMENSIONS								
		W	D	H	W	D	H	W	H							
		24.5	23.5	36	19.5	17	18	18.5	18							

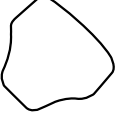
DESCRIPTION	FEATURES	MODEL#	STANDARD TEXTILE GRADES													
			1	2	3	4	5	6	7	8	9	10	11	12		
 <p>Honeycomb MB - Flip Seat Nesting Armchair COM Yardage: 1 Freight Class: 250 Product Weight (lbs.): 30 Cubic Feet Per Carton: 13.75</p>	<p>Nesting chair.</p> <p>Ergonomic Features: M, N</p>	<p>1898</p> <p>RTA 00</p>	\$785	\$823	\$851	\$892	\$953	\$971	\$1024	\$1122	\$1171	\$1262	\$1387	\$1540		
			OVERALL DIMENSIONS			SEAT DIMENSIONS			BACK DIMENSIONS							
			W	D	H	W	D	H	W	H						
			24.5	23.5	36	19.5	17	18	18.5	18						
 <p>Mesh MB - Flip Seat Nesting Armchair COM Yardage: 1 Freight Class: 250 Product Weight (lbs.): 30 Cubic Feet Per Carton: 13.75</p>	<p>Nesting chair.</p> <p>Ergonomic Features: M, N</p>	<p>1899</p> <p>RTA 00</p>	\$773	\$811	\$840	\$881	\$941	\$959	\$1014	\$1110	\$1160	\$1252	\$1375	\$1529		
			OVERALL DIMENSIONS			SEAT DIMENSIONS			BACK DIMENSIONS							
			W	D	H	W	D	H	W	H						
			24.5	23.5	36	19.5	17	18	18.5	18						
 <p>Polypropylene MB - Flip Seat Nesting Armchair COM Yardage: 1 Freight Class: 250 Product Weight (lbs.): 30 Cubic Feet Per Carton: 13.75</p>	<p>Nesting chair.</p> <p>Ergonomic Features: M, N</p>	<p>1900</p> <p>RTA 00</p>	\$773	\$811	\$840	\$881	\$941	\$959	\$1014	\$1110	\$1160	\$1252	\$1375	\$1529		
			OVERALL DIMENSIONS			SEAT DIMENSIONS			BACK DIMENSIONS							
			W	D	H	W	D	H	W	H						
			24.5	23.5	36	19.5	17	18	18.5	18						
 <p>Upholstered Back Pad COM Yardage: 1 Freight Class: 70 Product Weight (lbs.): 1.5 Cubic Feet Per Carton: 1.1</p>		<p>1909</p> <p>RTA 00</p>	\$193	\$233	\$263	\$308	\$371	\$391	\$447	\$548	\$600	\$696	\$826	\$989		
			OVERALL DIMENSIONS			SEAT DIMENSIONS			BACK DIMENSIONS							
			W	D	H	W	D	H	W	H						
			20.5	19	0.38	21	18	18	20	20.5						

SAS™



Mid Back Side Chair
model 8647



Low Back Counter Stool
model 8648LBNS24



Mid Back Counter Stool
model 8648PS24



Mid Back Bar Stool
model 8648PS30

STANDARD FEATURES

- The Sas side chair and stools have a single, molded plywood shell of wood veneer.
- Available with two seat options: unupholstered seat and upholstered seat (**P**).
- Available in three heights: side chair, counter stool and bar stool.
- Sas side chair in mid back height only. Counter and bar height stools available with mid or low backs.
- Dimensions shown are for unupholstered models.
- Unupholstered side chairs can be stacked up to 4 high on the floor and up to 10 high on the available dolly. Unupholstered stools can be stacked up to 4 high on the floor only. Upholstered models cannot be stacked.
- Check textile availability prior to specifying upholstery material.

OPTIONAL FEATURES

Tubular frame is available in the following finishes:

- **Frame finish**
(**TBL**) Black
(**TDW**) Designer White
(**TTU**) Tungsten
(**CHM**) Chrome. **Add \$118**
- **Shell**
(**AAM**) Absolute
(**BKM**) Black
(**ACM**) Cherry
(**EOM**) English Oak
(**ECM**) Espresso Cafe
(**TFM**) Fruitwood
(**HGM**) Gray
(**AHM**) Honey
(**TMM**) Mahogany
(**AVM**) Maple
(**MWM**) Medium Walnut
(**ASM**) Night
(**NBM**) Noce Biondo
(**NGM**) Noce Grigio
(**NEM**) Noce Leggero
(**NMM**) Noce Medio
(**SKM**) Shaker Cherry
(**TWM**) Walnut
(**WTM**) WC Cream
(**WHM**) White. **Add \$108**
(**WCM**) Winter Cherry
Please Specify.

EXAMPLE SAS ORDER CODE:

8647P	-HD05	-TBL	-AAM
-------	-------	------	------

Model # Textile Frame Color Shell

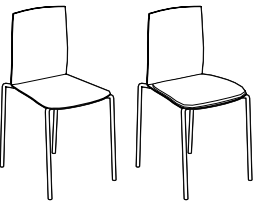
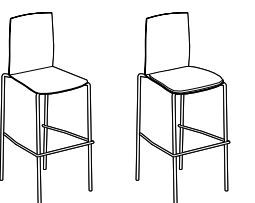
DESCRIPTION	FEATURES	MODEL#	STANDARD TEXTILE GRADES											
			1	2	3	4	5	6	7	8	9	10	11	12
 <p>Mid Back Side Chair COM Yardage: 0.75 Freight Class: 250 Product Weight (lbs.): 12 Cubic Feet Per Carton: 12</p>	<p>Stacks 4 high on floor. Stacks 10 high on dolly. Upholstered models do not stack.</p>	8647	\$593	-	-	-	-	-	-	-	-	-	-	-
		8647P	\$765	\$794	\$813	\$843	\$884	\$904	\$942	\$1002	\$1048	\$1100	\$1208	\$1321
		Upholstered Seat												
			OVERALL DIMENSIONS			SEAT DIMENSIONS			BACK DIMENSIONS					
			W	D	H	W	D	H	W		H			
			18.75	21	33	16	15.5	18	16		15			
			RTA 00		FedEx		ups		2 per carton					
 <p>Mid Back Counter Stool, 24" COM Yardage: 0.75 Freight Class: 400 Product Weight (lbs.): 16 Cubic Feet Per Carton: 14.5</p>	<p>Stacks 4 high on floor only. Upholstered models do not stack.</p>	8648S24	\$816	-	-	-	-	-	-	-	-	-	-	
		8648PS24	\$1005	\$1031	\$1051	\$1078	\$1118	\$1135	\$1172	\$1229	\$1272	\$1322	\$1422	\$1529
		Upholstered Seat												
			OVERALL DIMENSIONS			SEAT DIMENSIONS			BACK DIMENSIONS					
			W	D	H	W	D	H	W		H			
			19.5	22	39	16	15.5	24	16		15			
			RTA 00		1 per carton									

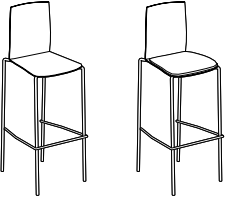
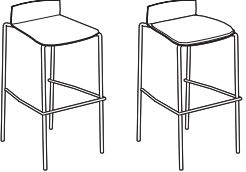
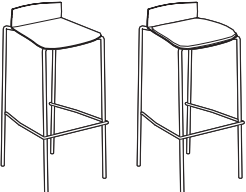
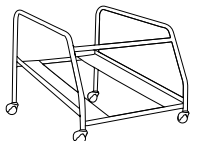
DESCRIPTION	FEATURES	MODEL#	STANDARD TEXTILE GRADES											
			1	2	3	4	5	6	7	8	9	10	11	12
 <p>Mid Back Bar Stool, 30" COM Yardage: 0.75 Freight Class: 400 Product Weight (lbs.): 16 Cubic Feet Per Carton: 14.5</p>	Stacks 4 high on floor only. Upholstered models do not stack.	8648S30	\$816	-	-	-	-	-	-	-	-	-	-	
		8648PS30	\$1005	\$1031	\$1051	\$1078	\$1118	\$1135	\$1172	\$1229	\$1272	\$1322	\$1422	\$1529
		OVERALL DIMENSIONS			SEAT DIMENSIONS			BACK DIMENSIONS						
		W	D	H	W	D	H	W	H					
19.5	22	45	16	15.5	30	16	15							
			RTA 00	1 per carton										
 <p>Low Back Counter Stool, 24" COM Yardage: 0.75 Freight Class: 400 Product Weight (lbs.): 16 Cubic Feet Per Carton: 8.25</p>	Stacks 4 high on floor only. Upholstered models do not stack.	8648LBNS24	\$875	-	-	-	-	-	-	-	-	-	-	
		8648LBPS24	\$1005	\$1031	\$1051	\$1078	\$1118	\$1135	\$1172	\$1229	\$1272	\$1322	\$1422	\$1529
		OVERALL DIMENSIONS			SEAT DIMENSIONS			BACK DIMENSIONS						
		W	D	H	W	D	H	W	H					
19.5	22	26.25	16	15.5	24	16	2.25							
			RTA 00	1 per carton										
 <p>Low Back Bar Stool, 30" COM Yardage: 0.75 Freight Class: 400 Product Weight (lbs.): 22 Cubic Feet Per Carton: 17</p>	Stacks 4 high on floor only. Upholstered models do not stack.	8648LBNS30	\$875	-	-	-	-	-	-	-	-	-	-	
		8648LBPS30	\$1005	\$1031	\$1051	\$1078	\$1118	\$1135	\$1172	\$1229	\$1272	\$1322	\$1422	\$1529
		OVERALL DIMENSIONS			SEAT DIMENSIONS			BACK DIMENSIONS						
		W	D	H	W	D	H	W	H					
19.5	22	32.25	16	15.5	30	16	2.25							
			RTA 00	1 per carton										
 <p>Dolly COM Yardage: N/A Freight Class: 250 Product Weight (lbs.): 19 Cubic Feet Per Carton: 10.75</p>		8649	\$545	-	-	-	-	-	-	-	-	-	-	
		OVERALL DIMENSIONS			SEAT DIMENSIONS			BACK DIMENSIONS						
		W	D	H	W	D	H	W	H					
		25.75	28.5	22	-	-	-	-	-					
			RTA 00	FedEx		ups	1 per carton							

MULTI-PURPOSE

SIDERO



model 6901 (BLK)



model 6900 (BLK) Stacked



model 6900TL



model 6900C



model 6905



model 6903

Models Types	Sidero Chairs Stacking Capability	
	Stacking on floor	Stacking on dolly
Arm Chairs without Casters	up to 5 high	up to 8 high
Arm Chairs with Casters	up to 3 high	N/A
Armless Chairs without Casters	up to 5 high	up to 8 high
Armless Chairs with Casters	up to 3 high	N/A
Preschool Armless Models	up to 4 high	N/A

STANDARD FEATURES







- Sidero seating has a sculptured appearance, featuring wide curved arms and a round tubular steel frame, with wall safe construction.
- Sidero series includes side chairs (arms and armless), available with casters or with a sled base, counter stools and bar stools.
- Arms are 2 1/8 inches wide and full length, offering support to help stabilize users as they sit in or exit chairs.
- The gently curved arms are made from incredibly strong fiberglass reinforced nylon.
- The back of the chair is compound curved to provide comfort and support in multiple seating positions. No visible back attachment hardware. Backs are attached using concealed hardware only.
- The outer back is upholstered in the same material selection as the rest of the chair.
- Chairs are "Wall Safe." Rear legs hit the baseboard first leaving clearance between the back of the chair and the wall, saving both the chair and the wall from damage.
- Legs flair out to the rear to provide additional stability.
- The rugged steel frame is made from round welded steel tubing 7/8" dia.
- Armchairs (four legged and sled base) can be joined together using ganging clamp model 5233. Armless chairs (four legged and sled base) can be joined together using ganging clamp model 6526.
- Equipped with a polypropylene seat shroud that helps stabilize chairs when stacked and avoid frame imprints on upholstered seats.
- Four legged models can be stacked. Stools and sled base models do not stack. Please note when stacking painted frame chairs, paint may scratch.
- Standard glide is a durable Black Polypropylene foot.
- Four Legged chairs with casters are standard with (C82) dual wheel carpet casters.
- Sidero beam seating consists of upper seat units (6930, 6931) including mounting brackets and all hardware necessary for attachment to beam.
- For all beam components, tables and a complete list of available upper seat units, see Beam Seating series.

- Tablet arms are extremely rugged and meet ANSI-BIFMA testing requirements. Tablet hinges up to allow ease of egress. Tablet slides forward and back to accommodate any body size comfortably. Tablet models do not stack.
- Standard tablet (DB) size is 18"D x 14.5"W and is made of Black polymer. Tablets are attached at the left or right (as seated) Tablet arms are not available on stools. Specify (L) left or (R) right tablet. (Example: 6900TL or 6900TR).

- Check textile availability prior to specifying upholstery material.

OPTIONAL FEATURES

- Frame finish**
 - (TBL) Black
 - (TFO) Fog
 - (TIV) Cloud
 - (TLA) Latte
 - (TNE) Nevada
 - (TSH) Shadow
 - (TTU) Tungsten
 - (CHM) Chrome. Add \$44. Please Specify.
 - (TDW) Designer White
 - (TFR) Frost
 - (TKA) Kalua
 - (TMO) Mocha
 - (TOA) Toast
 - (TSN) Sand
- An optional 18.5"D x 18.5"W high pressure laminate writing tablet is available. The core is hardwood veneer plywood with radiused edge finished in clear lacquer. This writing tablet is offered in the following finishes: Black (BLK), Clear Maple (CMB), Designer White (DWT) and Noce Grigio (NGL). Please specify. Add \$64.
- Glides with felt pads (FG) are available for vinyl sheet, cork or laminate flooring, please specify. Add \$60.
- Glides with rubber pads (RG) are available for vinyl, hardwood, laminate, stone or ceramic flooring, please specify. Add \$60.
- For chairs used on hard surface floors PLEASE SPECIFY Opaque (off White) Non-Marking Glides (NM). No upcharge.
- Steel cushioned self-leveling glide is optionally available. Please specify (B), add \$34
- For hard surface flooring please Specify (C9R), with rubber covered wheels. Add \$98.
- An optional abrasion-resistant outer back fabric (polyester) is available. Resistant to impact damage. Available in Black only. Add \$23.
- Optional 1 inch additional seat foam. Please specify (3F). Add \$43.

DESCRIPTION	FEATURES	MODEL#	STANDARD TEXTILE GRADES												
			1	2	3	4	5	6	7	8	9	10	11	12	
 <p>Armchair COM Yardage: 1.25 Freight Class: 250 Product Weight (lbs.): 29 Cubic Feet Per Carton: 13.5</p>	<p>Stacks 5 high on floor. Stacks 8 high on dolly. Tablet models do not stack.</p> <p>Available with tablet: Specify (L) left or (R) right tablet.</p>	<p>RTA 00</p>  	6900	\$588	\$634	\$668	\$718	\$795	\$821	\$885	\$1010	\$1069	\$1182	\$1337	\$1531
			6900T	\$923	\$969	\$1002	\$1053	\$1128	\$1161	\$1228	\$1331	\$1414	\$1505	\$1690	\$1887
 <p>Armchair w/ Casters COM Yardage: 1.25 Freight Class: 250 Product Weight (lbs.): 29 Cubic Feet Per Carton: 13.5</p>	<p>Stacks 3 high on floor. Tablet models do not stack.</p> <p>Available with tablet: Specify (L) left or (R) right tablet.</p>	<p>RTA 00</p>  	6900C	\$670	\$716	\$753	\$803	\$878	\$905	\$969	\$1092	\$1152	\$1264	\$1422	\$1614
			6900CT	\$984	\$1028	\$1058	\$1108	\$1177	\$1208	\$1271	\$1371	\$1446	\$1529	\$1705	\$1891

DESCRIPTION

FEATURES

MODEL#

STANDARD TEXTILE GRADES



Side Chair
COM Yardage: 1.25
Freight Class: 250
Product Weight (lbs.): 26
Cubic Feet Per Carton: 11.25

Stacks 5 high on floor.
Stacks 8 high on dolly.
Tablet models do not stack.

Available with tablet:
Specify (L) left or (R) right tablet.

MODEL#	1	2	3	4	5	6	7	8	9	10	11	12
6901	\$531	\$577	\$611	\$663	\$738	\$765	\$830	\$953	\$1012	\$1125	\$1282	\$1474
6901T	\$854	\$899	\$932	\$981	\$1052	\$1087	\$1148	\$1250	\$1330	\$1417	\$1596	\$1788

OVERALL DIMENSIONS			SEAT DIMENSIONS			BACK DIMENSIONS	
W	D	H	W	D	H	W	H
21	24	33	19.5	18	17.5	19	15.5



Side Chair w/ Casters
COM Yardage: 1.25
Freight Class: 250
Product Weight (lbs.): 26
Cubic Feet Per Carton: 11.25

Stacks 3 high on floor.
Tablet models do not stack.

Available with tablet:
Specify (L) left or (R) right tablet.

MODEL#	1	2	3	4	5	6	7	8	9	10	11	12
6901C	\$637	\$684	\$721	\$772	\$846	\$874	\$940	\$1060	\$1120	\$1233	\$1390	\$1582
6901CT	\$974	\$1019	\$1052	\$1101	\$1173	\$1206	\$1269	\$1371	\$1449	\$1537	\$1716	\$1908

OVERALL DIMENSIONS			SEAT DIMENSIONS			BACK DIMENSIONS	
W	D	H	W	D	H	W	H
21	24	33	19.5	18	17.5	19	15.5



Armchair - Sled Base
COM Yardage: 1.25
Freight Class: 250
Product Weight (lbs.): 32
Cubic Feet Per Carton: 13.5

Does not stack.

MODEL#	1	2	3	4	5	6	7	8	9	10	11	12
6902	\$735	\$782	\$819	\$870	\$944	\$970	\$1034	\$1158	\$1218	\$1331	\$1487	\$1680

OVERALL DIMENSIONS			SEAT DIMENSIONS			BACK DIMENSIONS	
W	D	H	W	D	H	W	H
25.5	24	33	19.5	18	17.5	19	15.5



Side Chair - Sled Base
COM Yardage: 1.25
Freight Class: 250
Product Weight (lbs.): 29
Cubic Feet Per Carton: 11.25

Does not stack.

MODEL#	1	2	3	4	5	6	7	8	9	10	11	12
6903	\$682	\$729	\$766	\$815	\$890	\$917	\$981	\$1104	\$1164	\$1276	\$1434	\$1627

OVERALL DIMENSIONS			SEAT DIMENSIONS			BACK DIMENSIONS	
W	D	H	W	D	H	W	H
21	24	33	19.5	18	17.5	19	15.5

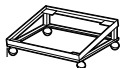









Dolly
COM Yardage: N/A
Freight Class: 150
Product Weight (lbs.): 16
Cubic Feet Per Carton: 3.8

MODEL#	1	2	3	4	5	6	7	8	9	10	11	12
2125WS	\$452	-	-	-	-	-	-	-	-	-	-	-

OVERALL DIMENSIONS			SEAT DIMENSIONS			BACK DIMENSIONS	
W	D	H	W	D	H	W	H
23.25	24.75	12.25	-	-	-	-	-



DESCRIPTION	FEATURES	MODEL#	STANDARD TEXTILE GRADES												
			1	2	3	4	5	6	7	8	9	10	11	12	
 <p>Counter Stool w/Arms COM Yardage: 1.25 Freight Class: 300 Product Weight (lbs.): 32 Cubic Feet Per Carton: 17.5</p>	Does not stack.	6904	\$795	\$843	\$881	\$930	\$1004	\$1032	\$1098	\$1221	\$1278	\$1393	\$1548	\$1743	
		OVERALL DIMENSIONS			SEAT DIMENSIONS			BACK DIMENSIONS							
		W	D	H	W	D	H	W	H						
		25.5	24	40.5	19.5	18	24.5	19	15.5						
		RTA 00													
 <p>Armless Counter Stool COM Yardage: 1.25 Freight Class: 300 Product Weight (lbs.): 28 Cubic Feet Per Carton: 14.5</p>	Does not stack.	6905	\$733	\$779	\$816	\$865	\$941	\$967	\$1030	\$1155	\$1215	\$1327	\$1484	\$1677	
		OVERALL DIMENSIONS			SEAT DIMENSIONS			BACK DIMENSIONS							
		W	D	H	W	D	H	W	H						
		21	24	40.5	19.5	18	24.5	19	15.5						
		RTA 00													
 <p>Barstool w/Arms COM Yardage: 1.25 Freight Class: 300 Product Weight (lbs.): 34 Cubic Feet Per Carton: 20</p>	Does not stack.	6906	\$831	\$879	\$917	\$966	\$1040	\$1068	\$1134	\$1257	\$1314	\$1429	\$1584	\$1779	
		OVERALL DIMENSIONS			SEAT DIMENSIONS			BACK DIMENSIONS							
		W	D	H	W	D	H	W	H						
		25.5	24	44.5	19.5	18	28.5	19	15.5						
		RTA 00													
 <p>Armless Barstool COM Yardage: 1.25 Freight Class: 300 Product Weight (lbs.): 30 Cubic Feet Per Carton: 15.75</p>	Does not stack.	6907	\$750	\$796	\$833	\$883	\$958	\$985	\$1049	\$1172	\$1232	\$1344	\$1502	\$1695	
		OVERALL DIMENSIONS			SEAT DIMENSIONS			BACK DIMENSIONS							
		W	D	H	W	D	H	W	H						
		21	24	44.5	19.5	18	28.5	19	15.5						
		RTA 00													

DESCRIPTION	FEATURES	MODEL#	STANDARD TEXTILE GRADES													
			1	2	3	4	5	6	7	8	9	10	11	12		
 <p>Armless Chair - 13" High Seat COM Yardage: 1 Freight Class: 250 Product Weight (lbs.): 15 Cubic Feet Per Carton: 4.1</p>	Stack up to 4 high on floor. For Preschool to Grade 2.	6909	\$476	\$516	\$543	\$586	\$644	\$663	\$717	\$815	\$864	\$955	\$1079	\$1232		
			OVERALL DIMENSIONS W D H			SEAT DIMENSIONS W D H			BACK DIMENSIONS W H							
			15.5	15.5	24	14	10	13	13.5	11						
																
 <p>Seat Unit w/Arms COM Yardage: 1.25 Freight Class: 300 Product Weight (lbs.): 20 Cubic Feet Per Carton: 9.75</p>	Upholstered Seat and Back. Use with beam.	6930	\$729	\$779	\$818	\$875	\$954	\$992	\$1065	\$1181	\$1271	\$1370	\$1575	\$1790		
			OVERALL DIMENSIONS W D H			SEAT DIMENSIONS W D H			BACK DIMENSIONS W H							
			25.5	23.5	19	19.5	18	-	19	15.5						
																
 <p>Armless Seat Unit COM Yardage: 1.25 Freight Class: 300 Product Weight (lbs.): 18 Cubic Feet Per Carton: 9.75</p>	Upholstered Seat and Back. Use with beam.	6931	\$668	\$718	\$757	\$814	\$893	\$931	\$1004	\$1120	\$1210	\$1309	\$1514	\$1729		
			OVERALL DIMENSIONS W D H			SEAT DIMENSIONS W D H			BACK DIMENSIONS W H							
			21	23.5	19	19.5	18	-	19	15.5						
																

SONIC™



model 6514MB



model 6515



model 6511TR



model 6524TR

STANDARD FEATURES

- Sonic multi-purpose series includes: four-leg, sled base, 5 star base task, and fixed pedestal base and beam seating in addition to bar, counter and height adjustable stools.
- Four-legged/freestanding models are standard with a straight leg or with a "WS" wall saver frame and durable polypropylene glides.
- WS models have a wall saver frame design; the base touches the wall before the upper back to protect the wall from damage.
- Four-legged/freestanding chairs are available with painted or chrome legs.
- Models are available with or without arms. Arms available in Black only.
- Freestanding models are stackable up to 5 high on floor and 10 high on dolly 6517WS. **Caster models do not stack.**
- Tablet arms are available on all seated height base types (not available on stools).
- Tablet arms are extremely rugged and meet ANSI-BIFMA testing requirements. Tablet hinges up to allow ease of egress. Tablet slides forward and back to accommodate any body size comfortably. Tablet models do not stack.
- Standard tablet (**DB**) size is 18"d x 14 1/2"w and is made of black polymer. Tablets are attached at the left or right (as seated). Please specify.
- Sonic beam seating consists of upper seat units (models 6501, 6502, 6503, 6504, 6505, and 6506) including mounting brackets and all hardware necessary for attachment to beam
- For all beam components, tables and a complete list of available upper seat units, see Beam Seating series.
- Task chairs and height adjustable stools have a five star, reinforced, black nylon base.
- All Sonic models with casters have black, dual-wheel casters. Select caster based on flooring type.
- Pedestal base models provide fixed location seating for use in auditoriums, classrooms, jury boxes, public venues and more. The base must be mounted to the floor (mounting hardware not included). See Pedestal Base Installation Guide for details.
- Upholstery inserts are simple to replace for ease of on-site long term maintenance.
- Mesh back (MB) models are available in Black mesh only.
- **Specifications and pricing are for 1 chair.**
- Check textile availability prior to specifying upholstery material.

OPTIONAL FEATURES

- Polypropylene seats, backs and coordinating arms are available in 14 designer colors. Choose from Buzz Blue (**BZB**), Cactus (**CCT**), Carrot (**CRO**), Cloud (**IVC**), Dijon (**DJN**), Eggplant (**EGP**), Fog (**FOG**), Frost (**FRO**), Ink (**INK**), Latte (**LAB**), Night (**BLK**), Sand (**SND**), Scarlet (**SAR**), and Shadow (**SHW**).
- An optional 18.5"D x 18.5"W high pressure laminate writing tablet is available. The core is hardwood veneer plywood with radiused edge finished in clear lacquer. This writing tablet is offered in the following finishes: Black (**BLK**), Clear Maple (**CMB**), Designer White (**DWT**) and Noce Grigio (**NGL**). Please specify. Add \$64.
- Frame finishes are available in Chrome (**CHM**), Black (**TBL**), Buzz Blue (**TBZ**), Cactus (**TCC**), Carrot (**TCR**), Dijon (**TDJ**), Designer White (**TDW**), Eggplant (**TEG**), Fog (**TFO**), Frost (**TFR**), Ink (**TIN**), Cloud (**TIV**), Kalua (**TKA**), Latte (**TLA**), Mocha (**TMO**), Nevada (**TNE**), Toast (**TOA**), Shadow (**TSH**), Sand (**TSN**), Scarlet (**TSR**) and Tungsten (**TTU**). Please specify
- For four-legged chairs with casters, specify (**C1**) 2" carpet casters, no upcharge, (**C9R**) 2-1/2" hard surface flooring casters, add \$58, (**C15**) 2" manual locking casters, add \$95 or (**C14R**) 2" auto-locking, rubber caster, add \$253.
- For five-star base models, specify (**C65**) 2" carpet casters or (**C65R**) 2" hard surface flooring casters.
- For sled base models, select (**GLD**) black, non-marking glides or (**NM**) opaque, offwhite, non-marking glides for hard surfaces.
- For four-legged chairs without casters, optional steel cushioned glides (**B**) are available. Please specify and add \$34. Glides with felt pads (**FG**) are available for vinyl sheet, cork or laminate flooring, please specify. Add \$60. Glides with rubber pads (**RG**) are available for vinyl, hardwood, laminate, stone or ceramic flooring, please specify. Add \$60.
- Pedestal base models have black metal base with 2" height adjust cylinders. Specify (**SCC**) swivel, auto return to max height (no upcharge); (**SN**) non-swivel, auto return to max height (Add \$21); or, (**SC**) swivel, self-centering and return to max height (add \$33).

DESCRIPTION

FEATURES

MODEL#

STANDARD TEXTILE GRADES

	1	2	3	4	5	6	7	8	9	10	11	12
--	---	---	---	---	---	---	---	---	---	----	----	----

6500BR	\$236	-	-	-	-	-	-	-	-	-	-	-
--------	-------	---	---	---	---	---	---	---	---	---	---	---

OVERALL DIMENSIONS

SEAT DIMENSIONS

BACK DIMENSIONS

W	D	H	W	D	H	W	H
19.25	14.75	6	-	-	-	-	-

























Book Rack





COM Yardage: N/A
 Freight Class: 250
 Product Weight (lbs.): 5
 Cubic Feet Per Carton: 1.40 (1 per carton)

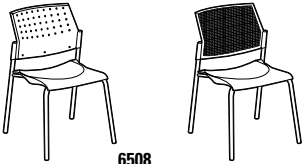
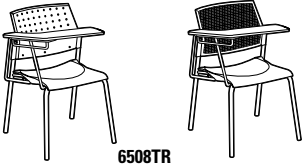

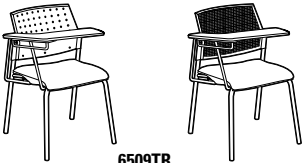



Use with Tablet models.



DESCRIPTION	FEATURES	MODEL#	STANDARD TEXTILE GRADES											
			1	2	3	4	5	6	7	8	9	10	11	12
 Armless Seat Unit COM Yardage: N/A Freight Class: 250 Product Weight (lbs.): 12 Cubic Feet Per Carton: 3.25 (2 per carton)	Polypropylene Seat and Back. Use with Beam.	6501	\$441	-	-	-	-	-	-	-	-	-	-	
		OVERALL DIMENSIONS			SEAT DIMENSIONS			BACK DIMENSIONS						
		W	D	H	W	D	H	W	H					
		20	21.5	17	17	16	-	17	15					
		  												
 Armless Seat Unit COM Yardage: 0.75 Freight Class: 250 Product Weight (lbs.): 12 Cubic Feet Per Carton: 3.25 (2 per carton)	Upholstered Seat and Polypropylene Back. Use with Beam.	6502	\$497	\$528	\$547	\$581	\$629	\$643	\$685	\$762	\$800	\$871	\$969	\$1093
		OVERALL DIMENSIONS			SEAT DIMENSIONS			BACK DIMENSIONS						
		W	D	H	W	D	H	W	H					
		20	22	17	17	16	-	17	15					
		  												
 Armless Seat Unit COM Yardage: 0.75 Freight Class: 150 Product Weight (lbs.): 13 Cubic Feet Per Carton: 3.25 (2 per carton)	Upholstered Seat and Back. Use with Beam.	6503	\$550	\$579	\$600	\$634	\$680	\$697	\$736	\$815	\$853	\$924	\$1024	\$1144
		OVERALL DIMENSIONS			SEAT DIMENSIONS			BACK DIMENSIONS						
		W	D	H	W	D	H	W	H					
		20	22	17	17	15.5	-	17	15					
		  												
 Seat Unit w/Arms COM Yardage: N/A Freight Class: 150 Product Weight (lbs.): 13 Cubic Feet Per Carton: 3.25 (2 per carton)	Polypropylene Seat and Back. Use with Beam.	6504	\$519	-	-	-	-	-	-	-	-	-	-	
		OVERALL DIMENSIONS			SEAT DIMENSIONS			BACK DIMENSIONS						
		W	D	H	W	D	H	W	H					
		23	21.5	17	17	16	-	17	15					
		  												
 Seat Unit w/Arms COM Yardage: 0.75 Freight Class: 22 Product Weight (lbs.): 13 Cubic Feet Per Carton: 3.25 (2 per carton)	Upholstered Seat and Polypropylene Back. Use with Beam.	6505	\$576	\$603	\$626	\$659	\$706	\$721	\$763	\$839	\$877	\$949	\$1048	\$1170
		OVERALL DIMENSIONS			SEAT DIMENSIONS			BACK DIMENSIONS						
		W	D	H	W	D	H	W	H					
		23	22	17	17	16	-	17	15					
		  												

DESCRIPTION	FEATURES	MODEL#	STANDARD TEXTILE GRADES												
			1	2	3	4	5	6	7	8	9	10	11	12	
 <p>Seat Unit w/Arms COM Yardage: 0.75 Freight Class: 150 Product Weight (lbs.): 14 Cubic Feet Per Carton: 3.25 (2 per carton)</p>	Upholstered Seat and Back Use with Beam.	6506	\$629	\$660	\$681	\$715	\$761	\$777	\$817	\$895	\$934	\$1005	\$1105	\$1225	
			OVERALL DIMENSIONS			SEAT DIMENSIONS			BACK DIMENSIONS						
			W	D	H	W	D	H	W	H					
			23	22	17	17	16	-	17	15					
			RTA 00	FedEx		ups									
 <p>Armless Chair COM Yardage: N/A Freight Class: 250 Product Weight (lbs.): 10 Cubic Feet Per Carton: 13.5 (2 per carton)</p>	Polypropylene Seat. Stacks 5 high on floor. Stacks 10 high on dolly.	6508	\$331	-	-	-	-	-	-	-	-	-	-	-	
			6508WS	\$363	-	-	-	-	-	-	-	-	-	-	-
			6508MB	\$396	-	-	-	-	-	-	-	-	-	-	-
			6508WSMB	\$427	-	-	-	-	-	-	-	-	-	-	-
OVERALL DIMENSIONS			SEAT DIMENSIONS			BACK DIMENSIONS									
W	D	H	W	D	H	W	H								
21.5	21.5	33	17	16	18	17	15								
			RTA 00	FedEx		ups									
 <p>Armless Chair w/Tablet COM Yardage: N/A Freight Class: 250 Product Weight (lbs.): 26 Cubic Feet Per Carton: 14.25 (1 per carton)</p>	Polypropylene Seat. Does not stack. Must specify (L) Left or (R) Right Tablet (Example: 6508TL or 6508TR)	6508TR	\$660	-	-	-	-	-	-	-	-	-	-		
			6508TWS	\$695	-	-	-	-	-	-	-	-	-	-	
			6508TMB	\$722	-	-	-	-	-	-	-	-	-	-	
			6508TWSMB	\$754	-	-	-	-	-	-	-	-	-	-	
OVERALL DIMENSIONS			SEAT DIMENSIONS			BACK DIMENSIONS									
W	D	H	W	D	H	W	H								
24.75	26.5	32.5	17	16	18	17	15								
			RTA 00	FedEx		ups									
 <p>Armless Chair COM Yardage: 0.75 Freight Class: 300 Product Weight (lbs.): 10 Cubic Feet Per Carton: 13.5 (2 per carton)</p>	Upholstered Seat. Stacks 5 high on floor. Stacks 10 high on dolly.	6509	\$382	\$413	\$432	\$468	\$511	\$529	\$569	\$647	\$681	\$753	\$846	\$969	
			6509MB	\$445	\$476	\$495	\$531	\$574	\$592	\$632	\$710	\$744	\$816	\$917	\$1039
			6509WS	\$445	\$472	\$493	\$529	\$573	\$588	\$629	\$705	\$740	\$811	\$907	\$1030
			6509WSMB	\$482	\$515	\$534	\$568	\$615	\$629	\$671	\$748	\$786	\$858	\$957	\$1078
OVERALL DIMENSIONS			SEAT DIMENSIONS			BACK DIMENSIONS									
W	D	H	W	D	H	W	H								
21.5	22	33	17	16	18.5	17	15								
			RTA 00	FedEx		ups									
 <p>Armless Chair w/Tablet COM Yardage: 0.75 Freight Class: 250 Product Weight (lbs.): 28 Cubic Feet Per Carton: 14.25 (1 per carton)</p>	Upholstered Seat. Does not stack. Must specify (L) Left or (R) Right Tablet (Example: 6509TL or 6509TR)	6509TR	\$706	\$740	\$764	\$798	\$848	\$865	\$911	\$993	\$1033	\$1110	\$1213	\$1344	
			6509TWS	\$739	\$773	\$797	\$831	\$881	\$898	\$944	\$1026	\$1066	\$1143	\$1246	\$1377
			6509TMB	\$765	\$799	\$823	\$857	\$907	\$924	\$970	\$1052	\$1092	\$1169	\$1272	\$1403
			6509TWSMB	\$799	\$833	\$857	\$891	\$941	\$958	\$1004	\$1086	\$1126	\$1203	\$1306	\$1437
OVERALL DIMENSIONS			SEAT DIMENSIONS			BACK DIMENSIONS									
W	D	H	W	D	H	W	H								
24.75	26.5	32.5	17	16	18.5	17	15								
			RTA 00	FedEx		ups									

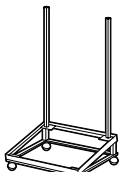
DESCRIPTION	FEATURES	MODEL#	STANDARD TEXTILE GRADES												
			1	2	3	4	5	6	7	8	9	10	11	12	
 <p>6511</p> <p>Armless Chair COM Yardage: 0.75 Freight Class: 300 Product Weight (lbs.): 11 Cubic Feet Per Carton: 13.5 (2 per carton)</p>	<p>Upholstered Seat and Back. Stacks 5 high on floor. Stacks 10 high on dolly.</p>	<p>6511</p>	\$428	\$459	\$482	\$514	\$558	\$575	\$614	\$691	\$725	\$800	\$894	\$1014	
			6511WS	\$459	\$492	\$513	\$545	\$589	\$606	\$645	\$723	\$758	\$827	\$925	\$1046
			OVERALL DIMENSIONS			SEAT DIMENSIONS			BACK DIMENSIONS						
			W	D	H	W	D	H	W	H					
21.5	21.5	32	17	16	18.5	17	15								
			RTA 00		FedEx		ups								
 <p>6511TR</p> <p>Armless Chair w/Tablet COM Yardage: 0.75 Freight Class: 250 Product Weight (lbs.): 28 Cubic Feet Per Carton: 14.25 (1 per carton)</p>	<p>Upholstered Seat & Back. Does not stack. Must specify (L) Left or (R) Right Tablet (Example: 6511TL or 6511TR)</p>	<p>6511T</p>	\$760	\$794	\$818	\$852	\$902	\$919	\$965	\$1047	\$1087	\$1164	\$1267	\$1398	
			6511TWS	\$794	\$828	\$852	\$886	\$936	\$953	\$999	\$1081	\$1121	\$1198	\$1301	\$1432
			OVERALL DIMENSIONS			SEAT DIMENSIONS			BACK DIMENSIONS						
			W	D	H	W	D	H	W	H					
24.75	26.5	32.5	17	16	18.5	17	15								
			RTA 00		FedEx		ups								
 <p>6513</p> <p>Armchair COM Yardage: N/A Freight Class: 250 Product Weight (lbs.): 11 Cubic Feet Per Carton: 13.5 (2 per carton)</p>	<p>Polypropylene Seat. Stacks 5 high on floor. Stacks 10 high on dolly.</p>	<p>6513</p>	\$403	-	-	-	-	-	-	-	-	-	-	-	
			6513WS	\$445	-	-	-	-	-	-	-	-	-	-	-
			6513MB	\$466	-	-	-	-	-	-	-	-	-	-	-
			6513WSMB	\$508	-	-	-	-	-	-	-	-	-	-	-
OVERALL DIMENSIONS			SEAT DIMENSIONS			BACK DIMENSIONS									
W	D	H	W	D	H	W	H								
23	21.5	33	17	16	18	17	15								
			RTA 00		FedEx		ups								
 <p>6513TR</p> <p>Armchair w/Tablet COM Yardage: N/A Freight Class: 250 Product Weight (lbs.): 27 Cubic Feet Per Carton: 14.25 (1 per carton)</p>	<p>Polypropylene Seat. Does not stack. Must specify (L) Left or (R) Right Tablet (Example: 6513TL or 6513TR)</p>	<p>6513T</p>	\$738	-	-	-	-	-	-	-	-	-	-	-	
			6513TWS	\$774	-	-	-	-	-	-	-	-	-	-	-
			6513TMB	\$749	-	-	-	-	-	-	-	-	-	-	-
			6513TWSMB	\$781	-	-	-	-	-	-	-	-	-	-	-
OVERALL DIMENSIONS			SEAT DIMENSIONS			BACK DIMENSIONS									
W	D	H	W	D	H	W	H								
25	26.5	32.5	17	16	18	17	15								
			RTA 00		FedEx		ups								
 <p>6514</p> <p>Armchair COM Yardage: 0.75 Freight Class: 300 Product Weight (lbs.): 11 Cubic Feet Per Carton: 13.5 (2 per carton)</p>	<p>Upholstered Seat. Stacks 5 high on floor. Stacks 10 high on dolly.</p>	<p>6514</p>	\$451	\$480	\$501	\$535	\$580	\$594	\$636	\$713	\$747	\$818	\$914	\$1036	
			6514WS	\$483	\$512	\$533	\$567	\$611	\$626	\$667	\$743	\$779	\$850	\$946	\$1068
			6514MB	\$518	\$552	\$572	\$606	\$653	\$668	\$711	\$785	\$823	\$894	\$993	\$1115
			6514WSMB	\$560	\$576	\$596	\$629	\$678	\$692	\$732	\$813	\$849	\$920	\$1017	\$1142
OVERALL DIMENSIONS			SEAT DIMENSIONS			BACK DIMENSIONS									
W	D	H	W	D	H	W	H								
23	22	33	17	16	18.5	17	15								
			RTA 00		FedEx		ups								

DESCRIPTION	FEATURES	MODEL#	STANDARD TEXTILE GRADES												
			1	2	3	4	5	6	7	8	9	10	11	12	
 6514TR	 6514TRMB (Mesh back)	Upholstered Seat. Does not stack. Must specify (L) Left or (R) Right Tablet (Example: 6514TL or 6514TR)	6514T	\$788	\$822	\$846	\$880	\$930	\$947	\$993	\$1075	\$1115	\$1192	\$1295	\$1426
			6514TWS	\$820	\$854	\$878	\$912	\$962	\$979	\$1025	\$1107	\$1147	\$1224	\$1327	\$1458
COM Yardage: 0.75 Freight Class: 250 Product Weight (lbs.): 29 Cubic Feet Per Carton: 14.25 (1 per carton)			OVERALL DIMENSIONS: W 25, D 26.5, H 32.5 SEAT DIMENSIONS: W 17, D 16, H 18.5 BACK DIMENSIONS: W 17, H 15												
			RTA 00 FedEx ups												
 6515	Upholstered Seat and Back. Stacks 5 high on floor. Stacks 10 high on dolly.	6515	\$494	\$523	\$544	\$580	\$622	\$640	\$680	\$757	\$790	\$862	\$957	\$1080	
		6515WS	\$529	\$558	\$579	\$615	\$658	\$674	\$713	\$791	\$825	\$896	\$991	\$1115	
COM Yardage: 0.75 Freight Class: 300 Product Weight (lbs.): 11.50 Cubic Feet Per Carton: 5.88 (2 per carton)			OVERALL DIMENSIONS: W 23, D 22, H 34 SEAT DIMENSIONS: W 17, D 15.5, H 18.5 BACK DIMENSIONS: W 17, H 15												
			RTA 00 FedEx ups												
 6515TR	Upholstered Seat & Back. Does not stack. Must specify (L) Left or (R) Right Tablet (Example: 6515TL or 6515TR)	6515T	\$788	\$865	\$889	\$923	\$973	\$990	\$1036	\$1118	\$1158	\$1235	\$1338	\$1469	
		6515TWS	\$864	\$898	\$922	\$956	\$1006	\$1023	\$1069	\$1151	\$1191	\$1268	\$1371	\$1502	
COM Yardage: 0.75 Freight Class: 250 Product Weight (lbs.): 30 Cubic Feet Per Carton: 14.25 (1 per carton)			OVERALL DIMENSIONS: W 25, D 26.5, H 32.5 SEAT DIMENSIONS: W 17, D 16, H 18 BACK DIMENSIONS: W 17, H 15												
			RTA 00												
	Accommodates 10 chairs.	6517WS	\$574	-	-	-	-	-	-	-	-	-	-	-	
		OVERALL DIMENSIONS: W 23.25, D 24.75, H 12.25 SEAT DIMENSIONS: W -, D -, H - BACK DIMENSIONS: W -, H -													
COM Yardage: N/A Freight Class: 150 Product Weight (lbs.): 20 Cubic Feet Per Carton: 4 (0.5 per carton)			RTA 1 FedEx ups												
 6518	 6518MB (Mesh Back)	6518	\$397	-	-	-	-	-	-	-	-	-	-	-	
		6518WS	\$432	-	-	-	-	-	-	-	-	-	-	-	-
COM Yardage: N/A Freight Class: 250 Product Weight (lbs.): 14 Cubic Feet Per Carton: 11.75 (2 per carton)			OVERALL DIMENSIONS: W 22, D 21, H 32.5 SEAT DIMENSIONS: W 17, D 16, H 17 BACK DIMENSIONS: W 17, H 15												
			RTA 00 FedEx ups												

DESCRIPTION FEATURES MODEL# STANDARD TEXTILE GRADES

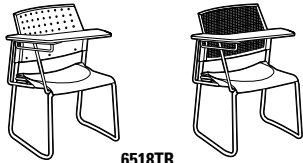

6518TR 6518TRMB (Mesh back)

Armless Chair w/Tablet and Sled Base
 COM Yardage: N/A
 Freight Class: 300
 Product Weight (lbs.): 26
 Cubic Feet Per Carton: 14.25 (1 per carton)

Polypropylene Seat. Does not stack.
Must specify (L) Left or (R) Right Tablet
 (Example: 6518TL or 6518TR)

	1	2	3	4	5	6	7	8	9	10	11	12
6518T	\$734	-	-	-	-	-	-	-	-	-	-	-
6518TWS	\$768	-	-	-	-	-	-	-	-	-	-	-
6518TMB	\$788	-	-	-	-	-	-	-	-	-	-	-
6518TWSMB	\$821	-	-	-	-	-	-	-	-	-	-	-

OVERALL DIMENSIONS			SEAT DIMENSIONS			BACK DIMENSIONS		
W	D	H	W	D	H	W	H	
24.75	26.5	32.5	17	16	18	17	15	

RTA 00

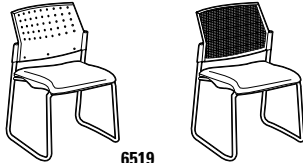

6519 6519MB (Mesh Back)

Armless Chair w/Sled Base
 COM Yardage: 0.75
 Freight Class: 250
 Product Weight (lbs.): 14
 Cubic Feet Per Carton: 5.88 (2 per carton)

Upholstered Seat.
 Stacks 5 high on floor.
 Stacks 10 high on dolly.

	1	2	3	4	5	6	7	8	9	10	11	12
6519	\$447	\$476	\$497	\$531	\$575	\$590	\$631	\$707	\$742	\$813	\$909	\$1032
6519WS	\$489	\$523	\$545	\$577	\$624	\$641	\$682	\$758	\$796	\$865	\$966	\$1086
6519MB	\$510	\$543	\$564	\$596	\$643	\$658	\$703	\$776	\$815	\$886	\$986	\$1106
6519WSMB	\$555	\$588	\$609	\$642	\$687	\$702	\$744	\$820	\$859	\$931	\$1030	\$1151

OVERALL DIMENSIONS			SEAT DIMENSIONS			BACK DIMENSIONS		
W	D	H	W	D	H	W	H	
22	21	33	17	16	17	17	15	

RTA 00

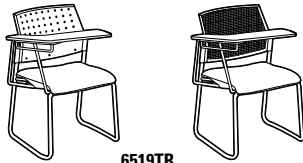

6519TR 6519TRMB (Mesh back)

Armless Chair w/Tablet and Sled Base
 COM Yardage: 0.75
 Freight Class: 300
 Product Weight (lbs.): 28
 Cubic Feet Per Carton: 14.25 (1 per carton)

Upholstered Seat. Does not stack.
Must specify (L) Left or (R) Right Tablet
 (Example: 6519TL or 6519TR)

	1	2	3	4	5	6	7	8	9	10	11	12
6519T	\$777	\$811	\$835	\$869	\$919	\$936	\$982	\$1064	\$1104	\$1181	\$1284	\$1415
6519TWS	\$805	\$839	\$863	\$897	\$947	\$964	\$1010	\$1092	\$1132	\$1209	\$1312	\$1443
6519TMB	\$836	\$870	\$894	\$928	\$978	\$995	\$1041	\$1123	\$1163	\$1240	\$1343	\$1474
6519TWSMB	\$926	\$960	\$1010	\$1027	\$1073	\$1155	\$1195	\$1272	\$1375	\$1506	\$1375	\$1474

OVERALL DIMENSIONS			SEAT DIMENSIONS			BACK DIMENSIONS		
W	D	H	W	D	H	W	H	
24.5	26.5	32.5	17	16	18	17	15	

RTA 00



6521

Armless Chair w/Sled Base
 COM Yardage: 0.75
 Freight Class: 250
 Product Weight (lbs.): 15
 Cubic Feet Per Carton: 13.5 (2 per carton)

Upholstered Seat and Back.
 Stacks 5 high on floor.
 Stacks 10 high on dolly.

	1	2	3	4	5	6	7	8	9	10	11	12
6521	\$488	\$519	\$540	\$575	\$618	\$634	\$674	\$750	\$784	\$855	\$952	\$1074
6521WS	\$525	\$556	\$575	\$608	\$651	\$668	\$707	\$781	\$815	\$885	\$977	\$1092

OVERALL DIMENSIONS			SEAT DIMENSIONS			BACK DIMENSIONS		
W	D	H	W	D	H	W	H	
22	21	33	17	16	18.5	17	15	

RTA 00



6521TR

Armless Chair w/Tablet and Sled Base
 COM Yardage: 0.75
 Freight Class: 300
 Product Weight (lbs.): 29
 Cubic Feet Per Carton: 14.25 (1 per carton)









Upholstered Seat & Back. Does not stack.
Must specify (L) Left or (R) Right Tablet
 (Example: 6521TL or 6521TR)

	1	2	3	4	5	6	7	8	9	10	11	12
6521T	\$779	\$813	\$837	\$871	\$921	\$938	\$984	\$1066	\$1106	\$1183	\$1286	\$1417
6521TWS	\$809	\$843	\$867	\$901	\$951	\$968	\$1014	\$1096	\$1136	\$1213	\$1316	\$1447

OVERALL DIMENSIONS			SEAT DIMENSIONS			BACK DIMENSIONS		
W	D	H	W	D	H	W	H	
24.75	26.5	32.5	17	16	18.5	17	15	

RTA 00



MULTI-PURPOSE

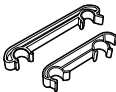

DESCRIPTION	FEATURES	MODEL#	STANDARD TEXTILE GRADES														
			1	2	3	4	5	6	7	8	9	10	11	12			
 6523	 6523MB (Mesh Back)		6523	\$462	-	-	-	-	-	-	-	-	-	-	-	-	
			6523WS	\$508	-	-	-	-	-	-	-	-	-	-	-	-	-
Armchair w/Sled Base COM Yardage: N/A Freight Class: 250 Product Weight (lbs.): 15 Cubic Feet Per Carton: 13.5 (2 per carton)			Polypropylene Seat. Stacks 5 high on floor. Stacks 10 high on dolly.			RTA 00 FedEx UPS											
 6523TR	 6523TRMB (Mesh back)		6523T	\$809	-	-	-	-	-	-	-	-	-	-	-	-	
			6523TWS	\$844	-	-	-	-	-	-	-	-	-	-	-	-	-
Armchair w/Tablet and Sled Base COM Yardage: N/A Freight Class: 300 Product Weight (lbs.): 27 Cubic Feet Per Carton: 14.25 (1 per carton)			Polypropylene Seat. Does not stack. Must specify (L) Left or (R) Right Tablet (Example: 6523TL or 6523TR)			RTA 00 FedEx UPS											
 6524	 6524MB (Mesh Back)		6524	\$508	\$539	\$558	\$592	\$637	\$655	\$693	\$772	\$807	\$877	\$972	\$1094		
			6524WS	\$571	\$602	\$623	\$657	\$704	\$718	\$758	\$837	\$876	\$946	\$1046	\$1165		
Armchair w/Sled Base COM Yardage: 0.75 Freight Class: 250 Product Weight (lbs.): 15 Cubic Feet Per Carton: 13.5 (2 per carton)			Upholstered Seat. Stacks 5 high on floor. Stacks 10 high on dolly.			RTA 00 FedEx UPS											
 6524TR	 6524TRMB (Mesh back)		6524T	\$849	\$883	\$907	\$941	\$991	\$1008	\$1054	\$1136	\$1176	\$1253	\$1356	\$1487		
			6524TWS	\$881	\$915	\$939	\$973	\$1023	\$1040	\$1086	\$1168	\$1208	\$1285	\$1388	\$1519		
Armchair w/Tablet and Sled Base COM Yardage: 0.75 Freight Class: 300 Product Weight (lbs.): 29 Cubic Feet Per Carton: 13.5 (1 per carton)			Upholstered Seat. Does not stack. Must specify (L) Left or (R) Right Tablet (Example: 6524TL or 6524TR)			RTA 00 FedEx UPS											
 6525			6525	\$555	\$588	\$609	\$642	\$685	\$701	\$742	\$818	\$852	\$924	\$1019	\$1141		
			6525WS	\$610	\$641	\$662	\$696	\$743	\$757	\$797	\$877	\$915	\$986	\$1086	\$1204		
Armchair COM Yardage: 0.75 Freight Class: 250 Product Weight (lbs.): 16 Cubic Feet Per Carton: 13.5 (2 per carton)			Upholstered Seat and Back. Stacks 5 high on floor. Stacks 10 high on dolly.			RTA 00 FedEx UPS											

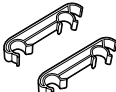



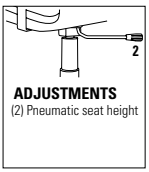



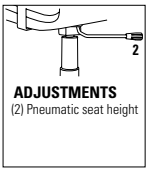

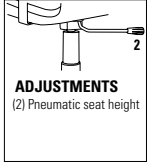
DESCRIPTION	FEATURES	MODEL#	STANDARD TEXTILE GRADES											
			1	2	3	4	5	6	7	8	9	10	11	12
 <p>6525TR</p> <p>Armchair w/Tablet and Sled Base COM Yardage: 0.75 Freight Class: 300 Product Weight (lbs.): 30 Cubic Feet Per Carton: 14.25 (1 per carton)</p>	<p>Upholstered Seat & Back. Does not stack. Must specify (L) Left or (R) Right Tablet (Example: 6525TL or 6525TR)</p>	6525T	\$888	\$922	\$946	\$980	\$1030	\$1047	\$1093	\$1175	\$1215	\$1292	\$1395	\$1526
		6525TWS	\$921	\$955	\$979	\$1013	\$1063	\$1080	\$1126	\$1208	\$1248	\$1325	\$1428	\$1559
			OVERALL DIMENSIONS			SEAT DIMENSIONS			BACK DIMENSIONS					
			W	D	H	W	D	H	W	H				
			25	26.5	32.5	17	16	18.5	17	15				
			RTA 00	FedEx		ups								









DESCRIPTION	FEATURES	MODEL#	STANDARD TEXTILE GRADES											
			1	2	3	4	5	6	7	8	9	10	11	12
 <p>6522</p> <p>Ganging Brackets COM Yardage: N/A Freight Class: 70 Product Weight (lbs.): 0.2 Cubic Feet Per Carton: 1 (25 per carton)</p>	<p>For four legged models only.</p>	6522	\$35	-	-	-	-	-	-	-	-	-	-	-
					OVERALL DIMENSIONS			SEAT DIMENSIONS			BACK DIMENSIONS			
			W	D	H	W	D	H	W	H				
			0.87	7.75	1.5	-	-	-	-	-				
			RTA 00	FedEx		ups								



DESCRIPTION	FEATURES	MODEL#	STANDARD TEXTILE GRADES											
			1	2	3	4	5	6	7	8	9	10	11	12
 <p>6526</p> <p>Ganging Brackets COM Yardage: N/A Freight Class: 70 Product Weight (lbs.): 0.25 Cubic Feet Per Carton: 1 (25 per carton)</p>	<p>Sled base models only.</p>	6526	\$26	-	-	-	-	-	-	-	-	-	-	-
					OVERALL DIMENSIONS			SEAT DIMENSIONS			BACK DIMENSIONS			
			W	D	H	W	D	H	W	H				
			0.75	5.75	1.25	-	-	-	-	-				
			RTA 00	FedEx		ups								

DESCRIPTION	FEATURES	MODEL#	STANDARD TEXTILE GRADES												
			1	2	3	4	5	6	7	8	9	10	11	12	
 <p>6537</p> <p>Armless LB Task COM Yardage: N/A Freight Class: 250 Product Weight (lbs.): 21.5 Cubic Feet Per Carton: 6.5</p>	 <p>6537MB</p> <p>Armless LB Task COM Yardage: 0.75 Freight Class: 250 Product Weight (lbs.): 22.5 Cubic Feet Per Carton: 6.5</p>	 <p>ADJUSTMENTS (2) Pneumatic seat height</p>	6537	\$536											
			6537T	\$945											
			6537MB	\$603											
			6537MBT	\$1016											
			OVERALL DIMENSIONS			SEAT DIMENSIONS			BACK DIMENSIONS						
			W	D	H	W	D	H	W	H					
			20.5	20.5	32.5	17	16	15.5-19.5	17	15					
			24	26	33	17	16	15.5-19.5	17	15					
			RTA 1	FedEx		ups		1 per carton							

DESCRIPTION	FEATURES	MODEL#	STANDARD TEXTILE GRADES												
			1	2	3	4	5	6	7	8	9	10	11	12	
 <p>6538</p> <p>Armless LB Task COM Yardage: 0.75 Freight Class: 250 Product Weight (lbs.): 22.5 Cubic Feet Per Carton: 6.5</p>	 <p>6538MB</p> <p>Armless LB Task COM Yardage: 0.75 Freight Class: 250 Product Weight (lbs.): 22.5 Cubic Feet Per Carton: 6.5</p>	 <p>ADJUSTMENTS (2) Pneumatic seat height</p>	6538	\$580	\$611	\$630	\$664	\$709	\$727	\$765	\$844	\$879	\$949	\$1043	\$1165
			6538T	\$978	\$1012	\$1038	\$1074	\$1126	\$1150	\$1197	\$1273	\$1332	\$1395	\$1529	\$1672
			6538MB	\$652	\$685	\$704	\$738	\$785	\$800	\$841	\$918	\$957	\$1028	\$1128	\$1248
			6538MBT	\$1060	\$1096	\$1121	\$1158	\$1210	\$1237	\$1285	\$1363	\$1422	\$1488	\$1623	\$1768
			OVERALL DIMENSIONS			SEAT DIMENSIONS			BACK DIMENSIONS						
			W	D	H	W	D	H	W	H					
			20.5	20.5	32.5	17	16	16-20	17	14.5					
			24	26	33	17	16	16-20	17	14.5					
			RTA 1	FedEx		ups		1 per carton							



DESCRIPTION	FEATURES	MODEL#	STANDARD TEXTILE GRADES													
			1	2	3	4	5	6	7	8	9	10	11	12		
 <p>Armless LB Task COM Yardage: 6.5 Freight Class: 250 Product Weight (lbs.): 23.5 Cubic Feet Per Carton: 6.5</p>	 <p>ADJUSTMENTS (2) Pneumatic seat height</p> <p>Upholstered seat & back. Ergonomic features: C</p> <p>Available with tablet: Specify (L) left or (R) right tablet. (Example: 6539TL or 6539TR).</p>															
		6539	\$624	\$655	\$676	\$711	\$753	\$770	\$811	\$888	\$921	\$992	\$1088	\$1210		
		6539T	\$1019	\$1053	\$1075	\$1112	\$1165	\$1190	\$1235	\$1309	\$1368	\$1432	\$1564	\$1704		
		OVERALL DIMENSIONS	W D H			SEAT DIMENSIONS			W D H			BACK DIMENSIONS			W H	
			20.5 24	20.5 26	33 33		17 17	15.5 16	16-20 16-20		17 17	15 14.5				
		RTA 1	  1 per carton													
 <p>6558</p>	 <p>6558MB (Mesh Back)</p>															
		6558	\$517	-	-	-	-	-	-	-	-	-	-	-	-	
		6558MB	\$603	-	-	-	-	-	-	-	-	-	-	-		
		OVERALL DIMENSIONS	W D H			SEAT DIMENSIONS			W D H			BACK DIMENSIONS			W H	
			22	23	42		17	16	28		17	15				
		RTA 00														
 <p>6558CS</p>	 <p>6558CSMB (Mesh Back)</p>															
		6558CS	\$517	-	-	-	-	-	-	-	-	-	-	-	-	
		6558CSMB	\$603	-	-	-	-	-	-	-	-	-	-	-		
		OVERALL DIMENSIONS	W D H			SEAT DIMENSIONS			W D H			BACK DIMENSIONS			W H	
			22.5	22	38		17	16	24		17	15				
		RTA 00														
 <p>6559</p>	 <p>6559MB (Mesh Back)</p>															
		6559	\$561	\$592	\$614	\$647	\$690	\$708	\$746	\$824	\$857	\$930	\$1024	\$1146		
		6559MB	\$628	\$661	\$682	\$715	\$761	\$778	\$817	\$894	\$933	\$1005	\$1105	\$1224		
		OVERALL DIMENSIONS	W D H			SEAT DIMENSIONS			W D H			BACK DIMENSIONS			W H	
			22	23	42		17	16	28.5		17	15				
		RTA 00														
 <p>6559CS</p>	 <p>6559CSMB (Mesh Back)</p>															
		6559CS	\$561	\$592	\$614	\$647	\$690	\$708	\$746	\$824	\$857	\$930	\$1024	\$1146		
		6559CSMB	\$628	\$661	\$682	\$715	\$761	\$778	\$817	\$894	\$933	\$1005	\$1105	\$1224		
		OVERALL DIMENSIONS	W D H			SEAT DIMENSIONS			W D H			BACK DIMENSIONS			W H	
			22.5	22	38		17	16	24.5		17	15				
		RTA 00														

DESCRIPTION	FEATURES	MODEL#	STANDARD TEXTILE GRADES											
			1	2	3	4	5	6	7	8	9	10	11	12
 <p>Armless Bar Stool COM Yardage: 0.75 Freight Class: 300 Product Weight (lbs.): 18 Cubic Feet Per Carton: 14.75 (1 per carton)</p>	<p>Upholstered Seat and back. Stacks 5 high on floor. Stacks 10 high on dolly.</p>	<p>6561</p>	\$610	\$641	\$662	\$696	\$742	\$755	\$795	\$873	\$907	\$978	\$1074	\$1197
			OVERALL DIMENSIONS			SEAT DIMENSIONS			BACK DIMENSIONS					
			W	D	H	W	D	H	W	H				
			22	23	42.5	17	16	28.5	17	15				
			<p>RTA 00</p>											
 <p>Armless Counter Stool COM Yardage: 0.75 Freight Class: 300 Product Weight (lbs.): 27 Cubic Feet Per Carton: 14.75 (2 per carton)</p>	<p>Upholstered Seat and back. Stacks 5 high on floor.</p>	<p>6561CS</p>	\$610	\$639	\$662	\$694	\$740	\$755	\$794	\$872	\$907	\$978	\$1074	\$1197
			OVERALL DIMENSIONS			SEAT DIMENSIONS			BACK DIMENSIONS					
			W	D	H	W	D	H	W	H				
			22.5	22	38	17	16	24.5	17	15				
			<p>RTA 00</p>											
 <p>6563</p>	 <p>6563MB (Mesh Back)</p>	<p>6563</p>	\$587	-	-	-	-	-	-	-	-	-	-	-
			OVERALL DIMENSIONS			SEAT DIMENSIONS			BACK DIMENSIONS					
			W	D	H	W	D	H	W	H				
			23	23	42	17	16	28	17	15				
			<p>RTA 00</p>											
 <p>6563CS</p>	 <p>6563CSMB (Mesh Back)</p>	<p>6563CS</p>	\$587	-	-	-	-	-	-	-	-	-	-	
			OVERALL DIMENSIONS			SEAT DIMENSIONS			BACK DIMENSIONS					
			W	D	H	W	D	H	W	H				
			22.5	23	38	17	16	24	17	15				
			<p>RTA 00</p>											
 <p>6564</p>	 <p>6564MB (Mesh Back)</p>	<p>6564</p>	\$626	\$659	\$679	\$712	\$754	\$772	\$812	\$889	\$925	\$993	\$1090	\$1211
			OVERALL DIMENSIONS			SEAT DIMENSIONS			BACK DIMENSIONS					
			W	D	H	W	D	H	W	H				
			23	23	42.5	17	16	28.5	17	15				
			<p>RTA 00</p>											



DESCRIPTION	FEATURES	MODEL#	STANDARD TEXTILE GRADES														
			1	2	3	4	5	6	7	8	9	10	11	12			
 6564CS	 6564CSMB (Mesh Back)		\$626	\$659	\$679	\$712	\$754	\$772	\$812	\$889	\$925	\$993	\$1090	\$1211			
			\$726	\$759	\$782	\$814	\$859	\$876	\$919	\$993	\$1031	\$1103	\$1203	\$1322			
Counter Stool w/Arms COM Yardage: 0.75 Freight Class: 300 Product Weight (lbs.): 25 Cubic Feet Per Carton: 14.75 (2 per carton)			Upholstered Seat. Stacks 5 high on floor.			OVERALL DIMENSIONS W D H						SEAT DIMENSIONS W D H			BACK DIMENSIONS W H		
			22.5 23 38			17 16 24.5			17 15			RTA 00					

 6565		\$668	\$702	\$722	\$755	\$798	\$816	\$855	\$933	\$972	\$1040	\$1135	\$1255				
Bar Stool w/Arms COM Yardage: 0.75 Freight Class: 300 Product Weight (lbs.): 19 Cubic Feet Per Carton: 14.75 (1 per carton)			Upholstered seat and back. Stacks 5 high on floor.			OVERALL DIMENSIONS W D H						SEAT DIMENSIONS W D H			BACK DIMENSIONS W H		
			23 23 42.5			17 16 28.5			17 15			RTA 00					







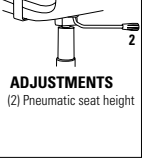

 6565CS		\$668	\$702	\$722	\$755	\$798	\$816	\$855	\$933	\$972	\$1040	\$1135	\$1255				
Counter Stool w/Arms COM Yardage: 0.75 Freight Class: 300 Product Weight (lbs.): 27 Cubic Feet Per Carton: 14.75 (2 per carton)			Upholstered Seat. Stacks 5 high on floor.			OVERALL DIMENSIONS W D H						SEAT DIMENSIONS W D H			BACK DIMENSIONS W H		
			22.5 23 38			17 16 24.5			17 15			RTA 00					

		List price															
 6567	 6567MB		\$603	\$1001	\$674	\$1087											
			\$674	\$1087													
LB Task w/Arms COM Yardage: N/A Freight Class: 250 Product Weight (lbs.): 23 Cubic Feet Per Carton: 6.5			Polypropylene seat. Ergonomic features: C			OVERALL DIMENSIONS W D H						SEAT DIMENSIONS W D H			BACK DIMENSIONS W H		
Available with tablet: Specify (L) left or (R) right tablet. (Example: 6577L or 6567TR).			23 20.5 32.5			17 16 15.5-20.5			17 15			RTA 1					















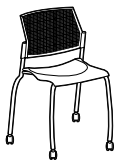

FedEx UPS 1 per carton

 6568	 6568MB		\$646	\$675	\$696	\$732	\$775	\$791	\$831	\$909	\$942	\$1015	\$1109	\$1231			
			\$710	\$739	\$760	\$794	\$842	\$857	\$896	\$976	\$1014	\$1083	\$1185	\$1304			
LB Task w/Arms COM Yardage: N/A Freight Class: 250 Product Weight (lbs.): 24 Cubic Feet Per Carton: 6.5			Upholstered seat. Ergonomic features: C			OVERALL DIMENSIONS W D H						SEAT DIMENSIONS W D H			BACK DIMENSIONS W H		
Available with tablet: Specify (L) left or (R) right tablet. (Example: 6568TL or 6568TR).			23 20.5 32.5			17 16 16-21			17 14.5			RTA 1					

FedEx UPS 1 per carton

DESCRIPTION	FEATURES	MODEL#	STANDARD TEXTILE GRADES											
			1	2	3	4	5	6	7	8	9	10	11	12
 <p>LB Task w/Arms COM Yardage: N/A Freight Class: 250 Product Weight (lbs.): 25 Cubic Feet Per Carton: 6.5</p>	 <p>ADJUSTMENTS (2) Pneumatic seat height</p> <p>Upholstered seat & back. Ergonomic features: C</p> <p>Available with tablet: Specify (L) left or (R) right tablet. (Example: 6569TL or 6569TR).</p>		1	2	3	4	5	6	7	8	9	10	11	12
		6569	\$691	\$722	\$741	\$777	\$821	\$837	\$877	\$955	\$988	\$1060	\$1154	\$1277
		6569T	\$1076	\$1110	\$1134	\$1169	\$1221	\$1244	\$1289	\$1363	\$1420	\$1481	\$1610	\$1749
		OVERALL DIMENSIONS	SEAT DIMENSIONS			BACK DIMENSIONS								
	W	D	H	W	D	H	W	H						
	23	20.5	33	17	15.5	16-21	17	15						
				RTA 1	FedEx	ups	1 per carton							
 <p>6573</p>	 <p>6573MB (Mesh Back)</p>		1	2	3	4	5	6	7	8	9	10	11	12
		6573	\$485	-	-	-	-	-	-	-	-	-	-	-
		6573MB	\$550	-	-	-	-	-	-	-	-	-	-	-
		OVERALL DIMENSIONS	SEAT DIMENSIONS			BACK DIMENSIONS								
	W	D	H	W	D	H	W	H						
	23	21	32	17	16	17.5	17	14.5						
				RTA 00	FedEx	ups								
 <p>6573TR</p>	 <p>6573TRMB (Mesh Back)</p>		1	2	3	4	5	6	7	8	9	10	11	12
		6573T	\$823	-	-	-	-	-	-	-	-	-	-	-
		6573TMB	\$881	-	-	-	-	-	-	-	-	-	-	-
		OVERALL DIMENSIONS	SEAT DIMENSIONS			BACK DIMENSIONS								
	W	D	H	W	D	H	W	H						
	25	26.5	32.5	17	16	18	17	15						
				RTA 00	FedEx	ups								
 <p>6574</p>	 <p>6574MB (Mesh Back)</p>		1	2	3	4	5	6	7	8	9	10	11	12
		6574	\$532	\$561	\$584	\$618	\$660	\$678	\$718	\$792	\$828	\$901	\$998	\$1118
		6574MB	\$597	\$630	\$651	\$684	\$730	\$747	\$786	\$863	\$904	\$974	\$1074	\$1195
		OVERALL DIMENSIONS	SEAT DIMENSIONS			BACK DIMENSIONS								
	W	D	H	W	D	H	W	H						
	23	21.5	33	17	16	18	17	14						
				RTA 00	FedEx	ups								
 <p>6574TR</p>	 <p>6574TRMB (Mesh Back)</p>		1	2	3	4	5	6	7	8	9	10	11	12
		6574T	\$868	\$902	\$926	\$960	\$1010	\$1027	\$1073	\$1155	\$1195	\$1272	\$1375	\$1506
		6574TMB	\$930	\$964	\$988	\$1022	\$1072	\$1089	\$1135	\$1217	\$1257	\$1334	\$1437	\$1568
		OVERALL DIMENSIONS	SEAT DIMENSIONS			BACK DIMENSIONS								
	W	D	H	W	D	H	W	H						
	25	26.5	32.5	17	16	18	17	15						
				RTA 00	FedEx	ups								

MULTI-PURPOSE

DESCRIPTION	FEATURES	MODEL#	STANDARD TEXTILE GRADES											
			1	2	3	4	5	6	7	8	9	10	11	12
 <p>Armchair w/Casters COM Yardage: 0.75 Freight Class: 250 Product Weight (lbs.): 15 Cubic Feet Per Carton: 13.5 (2 per carton)</p>	Upholstered Seat and Back. Does not stack.	6575	\$556	\$589	\$610	\$643	\$686	\$702	\$743	\$819	\$853	\$925	\$1020	\$1142
			OVERALL DIMENSIONS			SEAT DIMENSIONS			BACK DIMENSIONS					
			W	D	H	W	D	H	W	H				
			23	21.5	32.5	17	15.5	18	17	14.5				
			RTA 00											
 <p>6575TR</p> <p>Armchair w/Tablet and Casters COM Yardage: 0.75 Freight Class: 300 Product Weight (lbs.): 30 Cubic Feet Per Carton: 14.25 (1 per carton)</p>	Upholstered Seat & Back. Does not stack. Must specify (L) Left or (R) Right Tablet (Example: 6575TL or 6575TR)	6575T	\$902	\$936	\$960	\$994	\$1044	\$1061	\$1107	\$1189	\$1229	\$1306	\$1409	\$1540
			OVERALL DIMENSIONS			SEAT DIMENSIONS			BACK DIMENSIONS					
			W	D	H	W	D	H	W	H				
			25	26.5	32.5	17	16	18.5	17	15				
			RTA 00											
 <p>6577</p> <p>Armless Chair w/Casters COM Yardage: N/A Freight Class: 300 Product Weight (lbs.): 12 Cubic Feet Per Carton: 13.5 (2 per carton)</p>	Polypropylene Seat. Does not stack.	6577	\$422	-	-	-	-	-	-	-	-	-	-	-
			OVERALL DIMENSIONS			SEAT DIMENSIONS			BACK DIMENSIONS					
			W	D	H	W	D	H	W	H				
			21	21	33	17	16	17.5	17	14.5				
			RTA 00  											
 <p>6577MB (Mesh Back)</p> <p>Armless Chair w/Casters COM Yardage: N/A Freight Class: 300 Product Weight (lbs.): 12 Cubic Feet Per Carton: 13.5 (2 per carton)</p>	Polypropylene Seat. Does not stack.	6577MB Mesh Back	\$482	-	-	-	-	-	-	-	-	-	-	-
			OVERALL DIMENSIONS			SEAT DIMENSIONS			BACK DIMENSIONS					
			W	D	H	W	D	H	W	H				
			21	21	33	17	16	17.5	17	14.5				
			RTA 00  											
 <p>6577T</p> <p>Armless Chair w/Tablet and Casters COM Yardage: N/A Freight Class: 300 Product Weight (lbs.): 27 Cubic Feet Per Carton: 14.25 (1 per carton)</p>	Polypropylene Seat. Does not stack. Must specify (L) Left or (R) Right Tablet (Example: 6577TL or 6577TR)	6577T	\$750	-	-	-	-	-	-	-	-	-	-	-
			OVERALL DIMENSIONS			SEAT DIMENSIONS			BACK DIMENSIONS					
			W	D	H	W	D	H	W	H				
			24.75	26.5	32.5	17	16	18	17	15				
			RTA 00  											
 <p>6577TMB (Mesh Back)</p> <p>Armless Chair w/Tablet and Casters COM Yardage: N/A Freight Class: 300 Product Weight (lbs.): 27 Cubic Feet Per Carton: 14.25 (1 per carton)</p>	Polypropylene Seat. Does not stack. Must specify (L) Left or (R) Right Tablet (Example: 6577TL or 6577TR)	6577TMB Mesh Back	\$809	-	-	-	-	-	-	-	-	-	-	-
			OVERALL DIMENSIONS			SEAT DIMENSIONS			BACK DIMENSIONS					
			W	D	H	W	D	H	W	H				
			24.75	26.5	32.5	17	16	18	17	15				
			RTA 00  											
 <p>6578</p> <p>Armless Chair w/Casters COM Yardage: 0.75 Freight Class: 300 Product Weight (lbs.): 13 Cubic Feet Per Carton: 13.5 (2 per carton)</p>	Upholstered Seat. Does not stack.	6578	\$466	\$499	\$518	\$553	\$596	\$614	\$653	\$729	\$765	\$838	\$932	\$1052
			OVERALL DIMENSIONS			SEAT DIMENSIONS			BACK DIMENSIONS					
			W	D	H	W	D	H	W	H				
			21	21.5	33	17	16	18	17	14				
			RTA 00  											

DESCRIPTION FEATURES MODEL# STANDARD TEXTILE GRADES

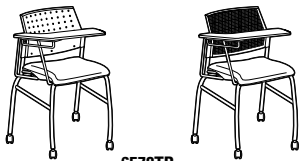

6578TR

6578TRMB (Mesh Back)

Armless Chair w/Tablet and Casters
 COM Yardage: 0.75
 Freight Class: 300
 Product Weight (lbs.): 28
 Cubic Feet Per Carton: 14.25 (1 per carton)

Upholstered Seat. Does not stack.
Must specify (L) Left or (R) Right Tablet
(Example: 6578TL or 6578TR)

MODEL#	1	2	3	4	5	6	7	8	9	10	11	12
--------	---	---	---	---	---	---	---	---	---	----	----	----

6578T	\$795	\$829	\$853	\$887	\$937	\$954	\$1000	\$1082	\$1122	\$1199	\$1302	\$1433
--------------	-------	-------	-------	-------	-------	-------	--------	--------	--------	--------	--------	--------

6578TMB Mesh Back	\$849	\$883	\$907	\$941	\$991	\$1008	\$1054	\$1136	\$1176	\$1253	\$1356	\$1487
-----------------------------	-------	-------	-------	-------	-------	--------	--------	--------	--------	--------	--------	--------

OVERALL DIMENSIONS			SEAT DIMENSIONS			BACK DIMENSIONS		
W	D	H	W	D	H	W	H	

24.75	26.5	32.5	17	16	18.5	17	15	
-------	------	------	----	----	------	----	----	--



Armless chair w/Casters
 COM Yardage: 0.75
 Freight Class: 250
 Product Weight (lbs.): 13
 Cubic Feet Per Carton: 13.5 (2 per carton)

Upholstered Seat and Back.
 Does not stack.

MODEL#	1	2	3	4	5	6	7	8	9	10	11	12
--------	---	---	---	---	---	---	---	---	---	----	----	----

6579	\$510	\$541	\$560	\$594	\$640	\$656	\$695	\$773	\$807	\$879	\$974	\$1095
-------------	-------	-------	-------	-------	-------	-------	-------	-------	-------	-------	-------	--------

OVERALL DIMENSIONS			SEAT DIMENSIONS			BACK DIMENSIONS		
W	D	H	W	D	H	W	H	

21	21.5	32.5	17	15.5	18	17	14.5	
----	------	------	----	------	----	----	------	--



6579TR

Armless Chair w/Tablet and Casters
 COM Yardage: 0.75
 Freight Class: 300
 Product Weight (lbs.): 18
 Cubic Feet Per Carton: 11.75 (1 per carton)

Upholstered Seat & Back. Does not stack.
Must specify (L) Left or (R) Right Tablet
(Example: 6579TL or 6579TR)

MODEL#	1	2	3	4	5	6	7	8	9	10	11	12
--------	---	---	---	---	---	---	---	---	---	----	----	----

6579T	\$849	\$883	\$907	\$941	\$991	\$1008	\$1054	\$1136	\$1176	\$1253	\$1356	\$1487
--------------	-------	-------	-------	-------	-------	--------	--------	--------	--------	--------	--------	--------

OVERALL DIMENSIONS			SEAT DIMENSIONS			BACK DIMENSIONS		
W	D	H	W	D	H	W	H	

23.5	21.5	33	17	16	18.5	17	15	
------	------	----	----	----	------	----	----	--



LB Task Height Adjustable Chair
 COM Yardage: 0.75
 Freight Class: 250
 Product Weight (lbs.): 28
 Cubic Feet Per Carton: 8.25 (1 per carton)

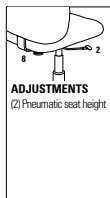

Upholstered Seat and Back.
 Ergonomic Features:
 C, M

MODEL#	1	2	3	4	5	6	7	8	9	10	11	12
--------	---	---	---	---	---	---	---	---	---	----	----	----

6586	\$944	\$975	\$998	\$1031	\$1074	\$1094	\$1133	\$1210	\$1249	\$1320	\$1419	\$1540
-------------	-------	-------	-------	--------	--------	--------	--------	--------	--------	--------	--------	--------

OVERALL DIMENSIONS			SEAT DIMENSIONS			BACK DIMENSIONS		
W	D	H	W	D	H	W	H	

24	21.5	21.5	17	16	22-32	17	14.5	
----	------	------	----	----	-------	----	------	--



LB Task Height Adjustable Chair
 COM Yardage: N/A
 Freight Class: 250
 Product Weight (lbs.): 26
 Cubic Feet Per Carton: 8.25 (1 per carton)

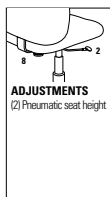

Polypropylene Seat.
 Ergonomic Features:
 C, M



MODEL#	1	2	3	4	5	6	7	8	9	10	11	12
--------	---	---	---	---	---	---	---	---	---	----	----	----





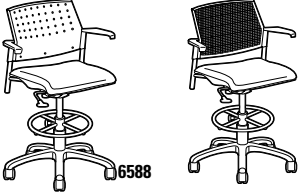
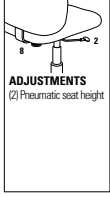
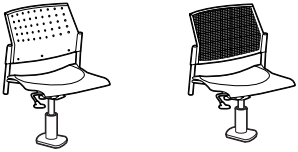
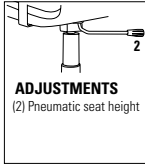

6587	\$792	-	-	-	-	-	-	-	-	-	-	-
-------------	-------	---	---	---	---	---	---	---	---	---	---	---

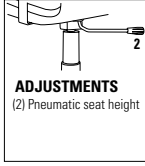
OVERALL DIMENSIONS			SEAT DIMENSIONS			BACK DIMENSIONS		
W	D	H	W	D	H	W	H	

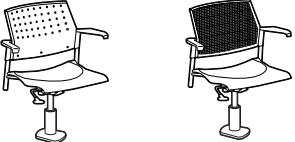
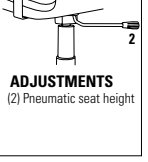
24.0	21.5	42.5	17	16	22-32	17	14.5	
------	------	------	----	----	-------	----	------	--

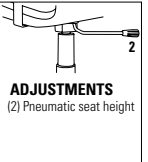

DESCRIPTION	FEATURES	MODEL#	STANDARD TEXTILE GRADES											
			1	2	3	4	5	6	7	8	9	10	11	12
 <p>LB Task Height Adjustable Chair COM Yardage: 0.75 Freight Class: 250 Product Weight (lbs.): 28 Cubic Feet Per Carton: 8.25 (1 per carton)</p>	 <p>ADJUSTMENTS (2) Pneumatic seat height</p> <p>Upholstered Seat. Ergonomic Features: C, M</p>	6588	\$894	\$925	\$946	\$977	\$1026	\$1041	\$1081	\$1158	\$1198	\$1268	\$1369	\$1488
		6588MB	\$874	\$905	\$928	\$961	\$1006	\$1022	\$1063	\$1141	\$1179	\$1250	\$1350	\$1472
			OVERALL DIMENSIONS			SEAT DIMENSIONS			BACK DIMENSIONS					
			W	D	H	W	D	H	W	H				
			24	21.5	42.5	17	16	22-32	17	14.5				
			RTA 1	FedEx		UPS								
 <p>Armless LB Task with Pedestal Base COM Yardage: N/A Freight Class: 250 Product Weight (lbs.): 28 Cubic Feet Per Carton: 9.75</p>	 <p>ADJUSTMENTS (2) Pneumatic seat height</p> <p>Polypropylene seat. Ergonomic features: C</p> <p>Available with tablet: Specify (L) left or (R) right tablet. (Example: 6537TL or 6537TR).</p>	6537PB	\$778											
		6537MBPB	\$1186	\$1186										
			6537MBPB	\$844										
			6537MBTLPB	\$1258										
			6537MBTRPB	\$1258										
			OVERALL DIMENSIONS			SEAT DIMENSIONS			BACK DIMENSIONS					
			W	D	H	W	D	H	W	H				
			20.5	20.5	31	17	16	15.5-19.5	17	15				
			24	26	31	17	16	15.5-19.5	17	15				
			RTA 1	1 per carton										
 <p>Armless LB Task with Pedestal Base COM Yardage: 6.5 Freight Class: 250 Product Weight (lbs.): 23.5 Cubic Feet Per Carton: 6.5</p>	 <p>ADJUSTMENTS (2) Pneumatic seat height</p> <p>Upholstered seat & back. Ergonomic features: C</p> <p>Available with tablet: Specify (L) left or (R) right tablet. (Example: 6539TL or 6539TR).</p>	6539PB	\$866	\$899	\$919	\$955	\$1004	\$1026	\$1071	\$1142	\$1197	\$1255	\$1379	\$1511
		6539TLPB	\$1261	\$1294	\$1315	\$1351	\$1403	\$1425	\$1469	\$1542	\$1597	\$1658	\$1785	\$1920
			6539TRPB											
			OVERALL DIMENSIONS			SEAT DIMENSIONS			BACK DIMENSIONS					
			W	D	H	W	D	H	W	H				
			24	20.5	31	17	15.5	16-20	17	15				
			24	26	31	17	16	16-20	17	14.5				
			RTA 1	1 per carton										

DESCRIPTION	FEATURES	MODEL#	STANDARD TEXTILE GRADES											
			1	2	3	4	5	6	7	8	9	10	11	12
 <p>6567PB 6567MBPB</p> <p>LB Task w/Arms, plastic seat & back COM Yardage: N/A Freight Class: 250 Product Weight (lbs.): 28 Cubic Feet Per Carton: 9.75</p>	 <p>ADJUSTMENTS (2) Pneumatic seat height</p> <p>Polypropylene seat. Ergonomic features: C</p> <p>Available with tablet: Specify (L) left or (R) right tablet. (Example: 6537TL or 6537TR).</p>	<p>6567PB \$844 6567TLPB \$1242 6567TRPB \$1242</p> <p>6567MBPB 917 6567MBTLPB 1295 6567MBTRPB 1295</p>	<p>OVERALL DIMENSIONS</p> <p>W D H</p>			<p>SEAT DIMENSIONS</p> <p>W D H</p>			<p>BACK DIMENSIONS</p> <p>W H</p>					
		<p>20.5 20.5 31 24 26 31</p>	<p>17 16 15.5-19.5 17 16 15.5-19.5</p>	<p>17 15 17 15</p>	<p>RTA 1   1 per carton</p>									
 <p>Task w/Arms upholstered seat & back COM Yardage: 6.5 Freight Class: 250 Product Weight (lbs.): 23.5 Cubic Feet Per Carton: 6.5</p>	 <p>ADJUSTMENTS (2) Pneumatic seat height</p> <p>Upholstered seat & back. Ergonomic features: C</p> <p>Available with tablet: Specify (L) left or (R) right tablet. (Example: 6539TL or 6539TR).</p>	<p>6569PB \$931 \$962 \$981 \$1017 \$1069 \$1091 \$1136 \$1207 \$1259 \$1319 \$1442 \$1574</p> <p>6569TLPB \$1318 \$1351 \$1372 \$1407 \$1456 \$1478 \$1524 \$1595 \$1650 \$1711 \$1834 \$1970 6569TRPB</p>	<p>OVERALL DIMENSIONS</p> <p>W D H</p>			<p>SEAT DIMENSIONS</p> <p>W D H</p>			<p>BACK DIMENSIONS</p> <p>W H</p>					
		<p>24 20.5 31 24 26 31</p>	<p>17 15.5 16-20 17 16 16-20</p>	<p>17 15 17 14.5</p>	<p>RTA 1   1 per carton</p>									

MULTI-PURPOSE

SPRITZ™



Model 6762-6



Model 6766



Model 6768-6



Model 6762-6PB

NESTING FEATURES



Articulating back on nesting chairs and height adjustable stools.

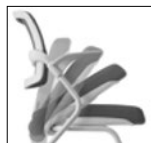

Flip up seat on nesting chairs.

MECHANISMS OPTIONS

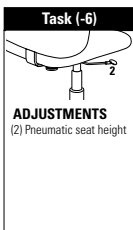

Ergonomic Features:
C, G, M, N, U

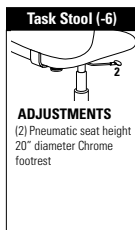

Ergonomic Features:
C, G, M, N, U

STANDARD FEATURES

- An exceptionally comfortable chair series featuring a sophisticated, translucent mesh and models for all applications.
- Features an auto-adjusting comfort back.
- Spring loaded back reacts to body pressure and articulates 12°.
- Multi-purpose models standard with Global's high quality Soft Descent™ pneumatic lift which slowly and gently lowers the seat height of the chair making it easy to obtain the exact seat height you desire.
- Five prong, injection molded, fiberglass reinforced nylon Black base with **C10** dual wheel carpet casters.
- Nesting chairs have a flip up seat allowing chairs to stack horizontally.
- When nesting horizontal nesting chairs, each additional chair adds 10" to depth.
- Nesting chairs are standard with four Black nylon glides, **C1** carpet casters or with two casters at front, two glides at rear.
- Chairs are "Wall Safe". Rear legs hit the baseboard first leaving clearance between the back of the chair and the wall, saving both the chair and the wall from damage.
- Check textile availability prior to specifying upholstery material.
- Models can be ordered in Leather using appropriate grade.
- Pedestal base models are offered with (-6) Task mechanisms only. These models provide fixed location seating for use in auditoriums, classrooms, jury boxes, public venues and more. The base must be mounted to the floor (mounting hardware not included). See Pedestal Base Installation Guide for details.

OPTIONAL FEATURES

- For additional caster options, please refer to the Arm and Caster section.
- Optional casters may be priced higher than the standard casters for your chair and the difference will be charged. Lower priced optional casters will not be credited.
- Pedestal base models have black base with 2" height adjust cylinders. Specify (**SCC**) swivel, auto return to max height (no upcharge); (**SN**) non-swivel, auto return to max height (Add \$21); or, (**SC**) swivel, self-centering and return to max height (add \$33).

OPTION CODES

Please add option codes in the following order:

- **Model number**
6762-6 Task Chair w/Arms
6763-6 Task Chair without Arms
6764 Nesting Chair on Glides
6765 Nesting Chair w/arms on Glides
6767-6 Height Adjustable Stool without Arms
6768-6 Height Adjustable Stool w/Arms
- Add **(-C)** to model number if ordering with casters. Add **(-FC)** to model number if ordering Front casters/rear glides.
- **Fabric**
Specify fabric code for seat.
- **Frame**
(TBL) Black frame finish..... **Standard**
(TSH) Shadow frame finish..... **Standard**
(TTU) Tungsten frame finish..... **Standard**
(CHM) Chrome frame finish..... **Add \$64**
- **Base** (task models/ height adjustable stools only)
(B-BK) Black nylon base..... **Standard**
- **Casters** (task models /height adjustable stools only)
(C10) Dual wheel carpet casters **Standard**
(C10R) Dual wheel hard floor casters..... **Add \$66**
- **Casters** (nesting models only)
(C1) Dual wheel carpet casters **Standard**
(C9R) Dual wheel hard floor casters..... **Add \$73**
- **Mesh Back**
(U1) Black
(U2) Burgundy
(U3) Blue
(U4) Green
(colors shown on website)
- **Chair Assembly**
(task models /height adjustable stools only)
(-SU) Assembled in Box..... **Add \$76**
- **Cylinder (for Pedestal Base models)**
(SCC) Swivel, auto return to max height.
(SN) Non-swivel, auto return to center and return to max height. **Add \$21**
(SC) Swivel, self-centering and return to max height. **Add \$33.**

SPRITZ WORK & TASK CHAIRS









For Spritz Task chairs, please refer to Work + Task section of pricebook.





EXAMPLE OF ORDER CODE: (Task models/Height Adjustable Stool Models)

6762-6	WA50	TBL	B-BK	C10	U2	SU
Model Number	Fabric	Frame	Base	Casters	Mesh	Chair Assembly

EXAMPLE OF ORDER CODE: (Nesting Models)

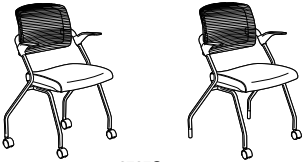
6764C	WA50	TTU	C9R	U2
Model Number	Fabric	Frame	Casters	Mesh

DESCRIPTION	FEATURES	MODEL#	STANDARD TEXTILE GRADES											
			1	2	3	4	5	6	7	8	9	10	11	12
 <p>Task Chair w/Arms COM Yardage: 00.75 Freight Class: 250 Product Weight (lbs.): 29 Cubic Feet Per Carton: 9.75</p>		6762-6	786	819	839	873	918	941	983	1049	1100	1157	1274	1401
			OVERALL DIMENSIONS			SEAT DIMENSIONS			BACK DIMENSIONS					
			W	D	H	W	D	H	W	H				
			23.5	20.5	31	18	16.5	15.5	17	16.5				
			RTA 00		FedEx		ups							
 <p>Task Chair without Arms COM Yardage: 00.75 Freight Class: 250 Product Weight (lbs.): 28 Cubic Feet Per Carton: 9.75</p>		6763-6	752	783	804	838	882	905	948	1014	1066	1123	1240	1367
			OVERALL DIMENSIONS			SEAT DIMENSIONS			BACK DIMENSIONS					
			W	D	H	W	D	H	W	H				
			20.5	20.5	31	18	16.5	15.5	17	16.5				
			RTA 00											
 <p>Armless Flip Seat Nesting Chair w/Glides COM Yardage: 00.75 Freight Class: 300 Product Weight (lbs.): 22 Cubic Feet Per Carton: 11.25</p>		6764	653	684	705	737	782	806	849	913	966	1022	1138	1266
			OVERALL DIMENSIONS			SEAT DIMENSIONS			BACK DIMENSIONS					
			W	D	H	W	D	H	W	H				
			20.5	23	33	18	17	17	17	16				
			RTA 00		FedEx		ups							
 <p>6764C</p>		6764C	653	684	705	737	782	806	849	913	966	1022	1138	1266
			OVERALL DIMENSIONS			SEAT DIMENSIONS			BACK DIMENSIONS					
			W	D	H	W	D	H	W	H				
			20.5	23	33	18	17	17	17	16				
			RTA 00		FedEx		ups							
 <p>6764FC</p>		6764FC	653	684	705	737	782	806	849	913	966	1022	1138	1266
			OVERALL DIMENSIONS			SEAT DIMENSIONS			BACK DIMENSIONS					
			W	D	H	W	D	H	W	H				
			20.5	23	33	18	17	17	17	16				
			RTA 00		FedEx		ups							
 <p>Flip Seat Nesting Chair w/Arms & Glides COM Yardage: 0.75 Freight Class: 300 Product Weight (lbs.): 23 Cubic Feet Per Carton: 11.75</p>		6765	695	726	747	781	825	850	892	957	1009	1066	1185	1311
			OVERALL DIMENSIONS			SEAT DIMENSIONS			BACK DIMENSIONS					
			W	D	H	W	D	H	W	H				
			23.75	23	33	18.5	17	17	17	16				
			RTA 00		FedEx		ups							

DESCRIPTION	FEATURES	MODEL#	STANDARD TEXTILE GRADES											
			1	2	3	4	5	6	7	8	9	10	11	12
 <p>6765C 6765FC</p> <p>Flip Seat Nesting Chair w/Arms & Casters COM Yardage: 00.75 Freight Class: 300 Product Weight (lbs.): 23 Cubic Feet Per Carton: 11.75</p>	<p>C= Casters all 4 legs FC=Casters on front legs only Seat Flips up for nesting Ergonomic Features: G, M, N</p>	6765C	695	726	747	781	825	850	892	957	1009	1066	1185	1311
		6765FC	695	726	747	781	825	850	892	957	1009	1066	1185	1311
			OVERALL DIMENSIONS			SEAT DIMENSIONS			BACK DIMENSIONS					
			W	D	H	W	D	H	W	H				
			23.75	23	33	18.5	17	17	17	16				
			RTA 00	FedEx		ups								
 <p>6767-6</p> <p>Armless Height Adjustable Stool COM Yardage: 00.75 Freight Class: 250 Product Weight (lbs.): 28 Cubic Feet Per Carton: 9.75</p>		6767-6	863	892	913	943	988	1009	1048	1113	1160	1216	1327	1447
				OVERALL DIMENSIONS			SEAT DIMENSIONS			BACK DIMENSIONS				
			W	D	H	W	D	H	W	H				
			20.5	20.5	42.5	18	16.5	22	17	16.5				
			RTA 00	FedEx		ups								
 <p>6768-6</p> <p>Height Adjustable Stool w/Arms COM Yardage: 00.75 Freight Class: 250 Product Weight (lbs.): 31 Cubic Feet Per Carton: 9.75</p>		6768-6	899	930	951	982	1025	1046	1084	1151	1198	1253	1365	1484
				OVERALL DIMENSIONS			SEAT DIMENSIONS			BACK DIMENSIONS				
			W	D	H	W	D	H	W	H				
			23.5	20.5	42.5	18	16.5	22	17	16.5				
			RTA 00	FedEx		ups								
 <p>6762-6PB</p> <p>Task Chair w/Arms and Pedestal Base COM Yardage: 0.75 Freight Class: 250 Product Weight (lbs.): 29 Cubic Feet Per Carton: 9.75</p>		6762-6PB	1018	1047	1068	1101	1145	1166	1206	1273	1325	1380	1495	1618
				OVERALL DIMENSIONS			SEAT DIMENSIONS			BACK DIMENSIONS				
			W	D	H	W	D	H	W	H				
			23.5	20.5	34	18	16.5	15.5	17	16.5				
			RTA 00	FedEx		ups								
 <p>6763-6PB</p> <p>Task Chair without Arms w/Pedestal Base COM Yardage: 0.75 Freight Class: 250 Product Weight (lbs.): 28 Cubic Feet Per Carton: 9.75</p>		6763-6PB	983	1014	1035	1067	1112	1135	1176	1241	1291	1349	1464	1587
				OVERALL DIMENSIONS			SEAT DIMENSIONS			BACK DIMENSIONS				
			W	D	H	W	D	H	W	H				
			20.5	20.5	34	18	16.5	15.5	17	16.5				
			RTA 00	FedEx		ups								

SPYKER™



Armless Chair
model 6791



Armchair
model 6790

	Chair Stacking Capability	
	Stacks on floor	Stacks on dolly
Armless		
6791	up to 10 high	up to 12 high (use 6783)
With Arms		
6790	up to 7 high	up to 7 high (use 6783)

STANDARD FEATURES

- A comfortable, high quality, lightweight, all polymer stacking chair intended for use indoors or outdoors. Products must be stored inside during extreme and inclement weather. See Global's Outdoor Furniture warranty for additional information.
- Perforations in the chair's seat and back provide ventilation and wet weather drainage.
- Weather resistant, UV resistant and stain resistant with a modern design.
- Chair legs are equipped with translucent non-marking glides as standard. Suitable for outdoor environments, carpet and hard surface flooring.
- All Spyker products are only available through Global's InStock program. Contact CustomerCare for lead times and quotation for quantities beyond InStock inventory.

- Chairs are stocked in 3 plastic finishes:
Alloy (**ALY**)
Char (**CHA**)
Milk (**MLK**)
- No upholstery options available.
- Rated to 300 lbs.
- Spyker achieves its strength and durability using glass filler polymer. Evidence of this material may be visible on the surface and is often more evident in darker colors.

EXAMPLE OF SPYKER ORDER CODE:

6791	ALY
Model Number	Finish

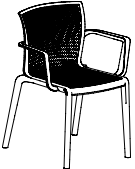
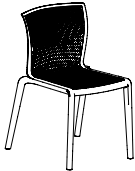
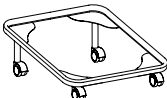
DESCRIPTION	FEATURES	MODEL#	STANDARD TEXTILE GRADES													
			1	2	3	4	5	6	7	8	9	10	11	12		
 Arm Chair COM Yardage: N/A Freight Class: 92.5 Product Weight (lbs.): 9 Cubic Feet Per Carton: 16.24 (4 per carton)	Stacks 7 high on floor. Stacks 7 high on dolly.	6790	261													
		OVERALL DIMENSIONS			SEAT DIMENSIONS			BACK DIMENSIONS								
		W	D	H	W	D	H	W	H							
		23.23	20.86	31.29	17	17.75	17.71	17	15							
			RTA 00	FedEx			ups			4 per carton (pricing and specifications are for one chair)						
 Armless Chair COM Yardage: N/A Freight Class: 92.5 Product Weight (lbs.): 8.2 Cubic Feet Per Carton: 14.08 (4 per carton)	Stacks 10 high on floor. Stacks 12 high on dolly.	6791	234													
		OVERALL DIMENSIONS			SEAT DIMENSIONS			BACK DIMENSIONS								
		W	D	H	W	D	H	W	H							
		17.91	20.86	31.29	17	17.75	17.71	17	15							
			RTA 00	4 per carton (pricing and specifications are for one chair)												
 Dolly for Spyker and Bakhita Chairs COM Yardage: N/A Freight Class: 250 Product Weight (lbs.): 11 Cubic Feet Per Carton: 2.9		6783	347													
		OVERALL DIMENSIONS			SEAT DIMENSIONS			BACK DIMENSIONS								
		W	D	H	W	D	H	W	H							
		19.75	23.25	9.75												
			RTA 00	FedEx			ups			1 per carton						

STREAM



model 2075APP
Stacking, 4-Leg Arm Chair



model 2076NPU
Stacking, Sled Base Chair, Armless



model 2075APPT
4-Leg Chair, w/Tablet



model 2075CSAPP
Stacking Bar Stool, w/Arms



model 2073APP
Tiltler Chair w/Arms



model 2073NPPPB
Armless Tiltler with Pedestal Base

	Stream Chairs Stacking Capability		Stream Stools Stacking Capability
	Chair Stacking Capability		Stool Stacking Capability
	Stacks on floor	Stacks on dolly 2085	Stacks on floor only
Four-Leg (Glide/Caster) + Sled Base Models			
Polypropylene seat	up to 5 high	up to 15 high	up to 5 high
Poly back & Upholstered seat	up to 5 high	up to 10 high	up to 5 high
Upholstered seat & back	up to 5 high	up to 10 high	up to 5 high

STANDARD FEATURES

- Stream multi-purpose product family includes: four-leg, sled base, 5 star base and pedestal base chairs in addition to bar, counter and height adjustable stools.
- Seats and backs are made of perforated polypropylene, with or without arms. Choose from 14 finishes, arm color matches seat/back finish.
- Four-leg and sled base chairs and stools are stackable. See stacking chart for details. Bases are available in 20 painted or four metallic finishes (see upcharges).
- Four-leg chair models are available with glides or casters, see upcharge. Chairs stack with glides and casters.
- A selection of glide options is available. Glides must be chosen to best suit flooring type and site conditions. For more information, please refer to the glide section.
- Bullet-shaped glides may be specified in any plastic color. A natural, non-marking bullet-shaped glide is available where colored glides may be a concern. Bullet-shaped glides are not recommended for LVT flooring.
- Glides are included on sled base chairs. Select black or opaque, non-marking glide finish.
- Upholstered models are equipped with a color matching shroud beneath the seat.
- Tablet models are available on all but pedestal base chairs and backpack racks are available on four-leg models only.
- Chairs with tablet or backpack racks do not stack.
- Tablet arms are extremely rugged and meet ANSI-BIFMA testing requirements. Tablets hinge up to allow ease of egress and slide forward and back to comfortably fit most users.
- Standard tablet size is 18"D x 14.5"W and is made of Black polymer (D8). Tablets are specified left (LT) or right (RT) as seated.
- Five-star base chairs have a swivel tilt mechanism.
- Height adjustable stools have a simple swivel mechanism.
- Five-star and height-adjustable stool bases are Black nylon or Polished Aluminum (see upcharge). Dual wheel casters are available for carpet or hard floor casters. See upcharge.
- Pedestal base are available for fixed location seating. The base must be mounted to the floor (mounting hardware not included). See installation guide for details. Models are available with simple swivel or tilt mechanisms.
- Check textile availability prior to specifying upholstery material.

OPTIONAL FEATURES

- Pedestal base models have black metal bases with 2" height adjust cylinders.
- An optional 18.5"D x 18.5"W high pressure laminate writing tablet is available. The core is hardwood veneer plywood with radiused edge finished in clear lacquer. This writing tablet is offered in the following finishes: Black (BLK), Clear Maple (CMB), Designer White (DWT) and Noce Grigio (NGL). Please specify. Add \$64.

Add options codes in the following order:







- Model number**
Enter Model number.
- Textile** (UU and PU models)
Specify textile code for back (UU models only).
Specify textile code for seat (PU, UU models only).









- Seat/back finish** (no upcharge)
(BZB) Buzz Blue (CCT) Cactus
(CRO) Carrot (IVC) Cloud
(DJN) Dijon (EGP) Eggplant
(FOG) Fog (FRO) Frost
(INK) Ink (LAB) Latte
(BLK) Night (SND) Sand
(SAR) Scarlet (SHW) Shadow
- Frame Type** (four-leg base models)
(FG) Glides
(FC) Casters. Add \$110
- Glide Type** (four-leg base)
(BG) Bullet Glide for Some Hard Floor and Carpeted Surfaces.
(FG) Felt Glide for Most Hard Floor Surfaces. Add \$34.
(RG) Rubber Non-slip Glide for Most Hard Floor Surfaces. Add \$34.
(SG) Steel Cushioned Glide for Carpeted Surfaces. Add \$34.
- Bullet glide finish** (four-legged chair and stool models)
(BZB) Buzz Blue (CCT) Cactus
(CRO) Carrot (IVC) Cloud
(DJN) Dijon (EGP) Eggplant
(FOG) Fog (FRO) Frost
(INK) Ink (LAB) Latte
(BLK) Night (SND) Sand
(SAR) Scarlet (SHW) Shadow
(NAT) Natural non-marking
- Glide Type** (sled base models)
(GL) Black glides.
(NM) Opaque non-marking glides.
- Frame Finish** (Four-legged/sled base models only)
(TBL) Black (TBZ) Buzz Blue
(TCC) Cactus (TCR) Carrot
(TDJ) Dijon (TDW) Designer White
(TEG) Eggplant (TFO) Fog
(TFR) Frost (TIN) Ink
(TIV) Cloud (TKA) Kalua
(TLA) Latte (TMO) Mocha
(TOA) Toast (TNE) Nevada
(TSH) Shadow (TSN) Sand
(TSR) Scarlet (TTU) Tungsten
Metallic Finishes: Chairs Stools
(ACO) Antique Copper. Add \$319 Add \$415
(BCH) Brushed Chrome Add \$174 Add \$259
(CHM) Chrome. Add \$48 Add \$92
(SBR) Satin Brass. Add \$319 Add \$415
- Caster type** (four-leg with FC caster selection)
(DC) C107 carpet.
(RC) C107R hard floor. Add \$23.
- Base (five star base models)**
(B7) Black nylon base. No upcharge.
(A7) Polished Aluminum base. Add \$154.
- Caster type (Five star base)**
(82) 82 dual wheel carpet casters. No upcharge.
(8R) 8R dual wheel hard floor casters. Add \$89.
- Tablet** ("T" models)
(LT) Left
(RT) Right
- Tablet option** ("T" models)
(D8) Black polymer. Black polymer 18"Dx14.5"W. No upcharge.
Laminate finish (18.5"D x 18.5"W). Add \$64
(BLK) Black laminate. Add \$64.
(CMB) Clear Maple laminate. Add \$64.
(DWT) Designer White laminate. Add \$64.
(NGL) Noce Grigio laminate. Add \$64.
- Cylinder Type** (pedestal base models)
(SCC) swivel, auto return to max height (no upcharge)
(SC) swivel, self-centering and return to max height (add \$30).
(SN) non-swivel, auto return to max height (Add \$19).







EXAMPLE STREAM ORDER CODE:









2075NPP	-	-	-IVC	-FG	-BLK	-CHM	-	-	-
Model #	Back textile	Seat textile	Seat/back finish	Glides/Casters	Glide color	Frame finish	Caster type	Tablet	Tablet finish









DESCRIPTION	FEATURES	MODEL#	STANDARD TEXTILE GRADES													
			1	2	3	4	5	6	7	8	9	10	11	12		
 <p>Armchair COM Yardage: N/A Freight Class: 250 Product Weight (lbs.): 15.5 Cubic Feet Per Carton: 14</p>	<p>Glides + Casters Stacks 5 high on floor. Stacks 15 high on dolly.</p>	<p>2075APP 495 Polypropylene seat & back</p>														
			OVERALL DIMENSIONS			SEAT DIMENSIONS			BACK DIMENSIONS							
			W	D	H	W	D	H	W	H						
			24	25	33.25	18	18	17	16	16.5						
			<p>RTA 00 4 per carton (pricing and specifications are for one seat unit)</p>													
 <p>2075APU</p>	 <p>2075AUU</p>	<p>2075APU 678 Upholstered seat</p>														
			<p>2075AUU 792 817 837 863 904 921 958 1015 1058 1108 1208 1317 Upholstered seat & back</p>													
			OVERALL DIMENSIONS			SEAT DIMENSIONS			BACK DIMENSIONS							
			W	D	H	W	D	H	W	H						
			24	25	33.25	17.5	18	17.5	16	16						
<p>RTA 00 4 per carton (pricing and specifications are for one seat unit)</p>																
 <p>Armless Chair COM Yardage: N/A Freight Class: 250 Product Weight: 12.25 Cubic Feet Per Carton: 13</p>	<p>Glides + Casters Stacks 5 high on floor. Stacks 15 high on dolly.</p>	<p>2075NPP 385 Polypropylene seat & back</p>														
			OVERALL DIMENSIONS			SEAT DIMENSIONS			BACK DIMENSIONS							
			W	D	H	W	D	H	W	H						
			20.5	25	33.25	18	18	18	16	16.5						
			<p>RTA 00 4 per carton (pricing and specifications are for one seat unit)</p>													
 <p>2075NPU</p>	 <p>2075NUU</p>	<p>2075NPU 576 Upholstered seat</p>														
			<p>2075NUU 686 712 731 756 794 813 846 902 945 991 1089 1192 Upholstered seat & back</p>													
			OVERALL DIMENSIONS			SEAT DIMENSIONS			BACK DIMENSIONS							
			W	D	H	W	D	H	W	H						
			20.5	25	33.25	18	18	17.5	16	16						
<p>RTA 00 4 per carton (pricing and specifications are for one seat unit)</p>																
 <p>Armchair w/ Tablet COM Yardage: N/A Freight Class: 300 Product Weight: 26 Cubic Feet Per Carton: 14.75</p>	<p>Specify (L) left or (R) right tablet (Example: 2075APPTL or 2075APPTR) Does not stack.</p>	<p>2075APPT 812 Polypropylene seat & back</p>														
			OVERALL DIMENSIONS			SEAT DIMENSIONS			BACK DIMENSIONS							
			W	D	H	W	D	H	W	H						
			26.5	27.25	33.25	18	18	17	16	16.5						
			<p>RTA 00 1 per carton</p>													

DESCRIPTION	FEATURES	MODEL#	STANDARD TEXTILE GRADES												
			1	2	3	4	5	6	7	8	9	10	11	12	
  2075NPUT 2075NUUT Armless Chair w/Tablet COM Yardage: 0.75 Freight Class: 250 Product Weight: 31 Cubic Feet Per Carton: 14.75	Specify (L) left or (R) right tablet Does not stack.	2075NPUT	885	912	933	964	1009	1029	1069	1132	1181	1236	1348	1467	
		Upholstered seat													
			2075NUUT	999	1026	1047	1078	1122	1142	1182	1244	1293	1346	1456	1575
			Upholstered seat & back												
			OVERALL DIMENSIONS			SEAT DIMENSIONS			BACK DIMENSIONS						
			W	D	H	W	D	H	W	H					
			26.5	27.25	33.25	18	18	17.5	16	16					
			RTA 00		1 per carton										
 2075NPPT Armless Chair w/Tablet COM Yardage: N/A Freight Class: 300 Product Weight: 26 Cubic Feet Per Carton: 14.75	Specify (L) left or (R) right tablet Does not stack.	2075NPPT	702												
		Polypropylene seat & back													
			OVERALL DIMENSIONS			SEAT DIMENSIONS			BACK DIMENSIONS						
			W	D	H	W	D	H	W	H					
			25	27.25	33.25	18	18	17	16.5	16					
			RTA 00		1 per carton										
  2075NPUT 2075NUUT Armless Chair w/Tablet COM Yardage: 0.75 Freight Class: 300 Product Weight: 29 Cubic Feet Per Carton: 14.75	Specify (L) left or (R) right tablet Does not stack.	2075NPUT	885	912	933	964	1009	1029	1069	1132	1181	1236	1348	1467	
		Upholstered seat													
			2075NUUT	999	1026	1047	1078	1122	1142	1182	1244	1293	1346	1456	1575
			Upholstered seat & back												
			OVERALL DIMENSIONS			SEAT DIMENSIONS			BACK DIMENSIONS						
			W	D	H	W	D	H	W	H					
			25	27.25	33.25	18	18	17.5	16	16.5					
			RTA 00		1 per carton										
 2075BRAPP Armchair w/Backpack Rack COM Yardage: N/A Freight Class: 300 Product Weight: 24 Cubic Feet Per Carton: 14	Does not stack.	2075BRAPP	645												
		Polypropylene seat & back													
			OVERALL DIMENSIONS			SEAT DIMENSIONS			BACK DIMENSIONS						
			W	D	H	W	D	H	W	H					
			24	25	33.25	18	18	17	16	16.5					
			RTA 00		1 per carton										
  2075BRAPU 2075BRAUU Armchair w/Backpack Rack COM Yardage: 0.75 Freight Class: 300 Product Weight: 27 Cubic Feet Per Carton: 14	Does not stack.	2075BRAPU	828	855	875	904	946	966	1005	1065	1111	1163	1271	1385	
		Upholstered seat													
			2075BRAUU	943	969	990	1018	1061	1081	1118	1179	1225	1277	1384	1496
			Upholstered seat & back												
			OVERALL DIMENSIONS			SEAT DIMENSIONS			BACK DIMENSIONS						
			W	D	H	W	D	H	W	H					
			24	25	33.25	18	18	17.5	16	16					
			RTA 00		1 per carton										





DESCRIPTION	FEATURES	MODEL#	STANDARD TEXTILE GRADES														
			1	2	3	4	5	6	7	8	9	10	11	12			
 <p>Armless Chair w/Backpack Rack COM Yardage: N/A Freight Class: 300 Product Weight: 20 Cubic Feet Per Carton: 13</p>	Does not stack.	2075BRNPP 543 Polypropylene seat & back															
			OVERALL DIMENSIONS			SEAT DIMENSIONS			BACK DIMENSIONS								
			W	D	H	W	D	H	W	H							
			20.5	25	33.25	18	18	18	16	16.5							
  <p>2075BRNPU 2075BRNUU</p> <p>Armless Chair w/Backpack Rack COM Yardage: 0.75 Freight Class: 300 Product Weight: 23 Cubic Feet Per Carton: 13</p>	Does not stack.	2075BRNPU 726 753 773 801 843 863 900 959 1004 1055 1158 1270 Upholstered seat															
			2075BRNUU 842 868 888 916 957 977 1013 1074 1118 1169 1273 1385 Upholstered seat & back														
			OVERALL DIMENSIONS			SEAT DIMENSIONS			BACK DIMENSIONS								
			W	D	H	W	D	H	W	H							
20.5	25	33.25	18	18	17.5	16	16										
		RTA 00		1 per carton													
 <p>Armchair w/Backpack Rack and Tablet COM Yardage: N/A Freight Class: 23 Product Weight: 29 Cubic Feet Per Carton: 13.5</p>	Specify (L) left or (R) right tablet Does not stack.	2075BRAPPT 963 Polypropylene seat & back															
			OVERALL DIMENSIONS			SEAT DIMENSIONS			BACK DIMENSIONS								
			W	D	H	W	D	H	W	H							
			26.5	27.25	33.25	18	18	17	16	16.5							
  <p>2075BRAPUT 2075BRAUT</p> <p>Armchair w/Backpack Rack and Tablet COM Yardage: 0.75 Freight Class: 250 Product Weight: 35 Cubic Feet Per Carton: 14.75</p>	Specify (L) left or (R) right tablet Does not stack.	2075BRAPUT 1144 1171 1192 1223 1268 1288 1328 1391 1439 1493 1606 1726 Upholstered seat															
			2075BRAUT 1260 1287 1308 1339 1383 1403 1443 1505 1554 1607 1717 1836 Upholstered seat & back														
			OVERALL DIMENSIONS			SEAT DIMENSIONS			BACK DIMENSIONS								
			W	D	H	W	D	H	W	H							
26.5	27.25	33.25	18	18	17.5	16	16										
		RTA 00		1 per carton													
 <p>Armless Chair w/Backpack Rack and Tablet COM Yardage: N/A Freight Class: 250 Product Weight: 30 Cubic Feet Per Carton: 14.75</p>	Specify (L) left or (R) right tablet Does not stack.	2075BRNPPT 853 Polypropylene seat & back															
			OVERALL DIMENSIONS			SEAT DIMENSIONS			BACK DIMENSIONS								
			W	D	H	W	D	H	W	H							
			27.25	27.25	33.25	18	18	17	16	16.5							



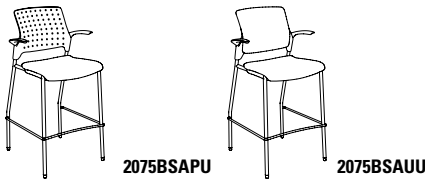

DESCRIPTION	FEATURES	MODEL#	STANDARD TEXTILE GRADES											
			1	2	3	4	5	6	7	8	9	10	11	12
 2075BRNPUT  2075BRNUUT	<p>Armless Chair w/Backpack Rack and Tablet COM Yardage: 0.75 Freight Class: 250 Product Weight: 32 Cubic Feet Per Carton: 14.75</p> <p>Specify (L) left or (R) right tablet Does not stack.</p>	<p>2075BRNPUT \$1035 \$1062 \$1083 \$1113 \$1155 \$1177 \$1215 \$1277 \$1324 \$1377 \$1487 \$1602 Upholstered seat</p> <p>2075BRNUUT 1151 1178 1198 1229 1270 1291 1330 1390 1438 1492 1600 1715 Upholstered seat & back</p>	OVERALL DIMENSIONS			SEAT DIMENSIONS			BACK DIMENSIONS					
		<p>W D H</p> <p>25 27.25 33.25</p> <p>18 18 17.5</p> <p>16 16</p>												
		RTA 00	1 per carton											
 2076APP	<p>Armchair w/Sled Base COM Yardage: N/A Freight Class: 250 Product Weight: 14 Cubic Feet Per Carton: 14</p> <p>Stacks 5 high on floor. Stacks 15 high on dolly.</p>	<p>2076APP \$556 Polypropylene seat & back</p>	OVERALL DIMENSIONS			SEAT DIMENSIONS			BACK DIMENSIONS					
		<p>W D H</p> <p>25.5 24 33.25</p> <p>18 18 17</p> <p>16 16.5</p>												
		RTA 00	4 per carton (pricing and specifications are for one seat unit)											
 2076APU  2076AAU	<p>Armchair w/Sled Base COM Yardage: 0.75 Freight Class: 250 Product Weight: 19.5 Cubic Feet Per Carton: 14</p> <p>Stacks 5 high on floor. Stacks 10 high on dolly.</p>	<p>2076APU 738 764 783 811 850 868 905 962 1005 1055 1155 1264 Upholstered seat</p> <p>2076AAU 854 881 900 928 968 986 1022 1079 1126 1173 1276 1384 Upholstered seat & back</p>	OVERALL DIMENSIONS			SEAT DIMENSIONS			BACK DIMENSIONS					
		<p>W D H</p> <p>24 25 33.25</p> <p>18 18 17.5</p> <p>16 16</p>												
		RTA 00	4 per carton (pricing and specifications are for one seat unit)											
 2076NPP	<p>Armless Chair w/Sled Base COM Yardage: N/A Freight Class: 250 Product Weight: 12 Cubic Feet Per Carton: 13</p> <p>Stacks 5 high on floor. Stacks 15 high on dolly.</p>	<p>2076NPP 445 Polypropylene seat & back</p>	OVERALL DIMENSIONS			SEAT DIMENSIONS			BACK DIMENSIONS					
		<p>W D H</p> <p>20.5 25 33.25</p> <p>18 18 18</p> <p>16 16.5</p>												
		RTA 00	4 per carton (pricing and specifications are for one seat unit)											
 2076NPU  2076NUU	<p>Armless Chair w/Sled Base COM Yardage: 0.75 Freight Class: 150 Product Weight: 15 Cubic Feet Per Carton: 13</p> <p>Stacks 5 high on floor. Stacks 10 high on dolly.</p>	<p>2076NPU 629 654 672 698 735 754 788 843 885 932 1027 1132 Upholstered seat</p> <p>2076NUU 745 770 789 815 852 871 905 961 1003 1050 1148 1252 Upholstered seat & back</p>	OVERALL DIMENSIONS			SEAT DIMENSIONS			BACK DIMENSIONS					
		<p>W D H</p> <p>20.5 25 33.25</p> <p>18 18 17.5</p> <p>16 16</p>												
		RTA 00	4 per carton (pricing and specifications are for one seat unit)											



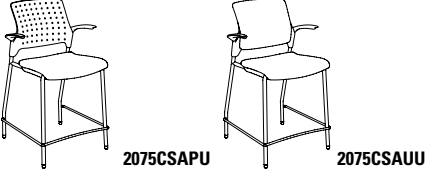

DESCRIPTION	FEATURES	MODEL#	STANDARD TEXTILE GRADES														
			1	2	3	4	5	6	7	8	9	10	11	12			
 <p>Armchair w/Sled Base and Tablet COM Yardage: N/A Freight Class: 300 Product Weight: 27 Cubic Feet Per Carton: 14.75</p>	<p>Specify (L) left or (R) right tablet</p> <p>Does not stack.</p>	<p>2076APPT 872 Polypropylene seat & back</p>															
			OVERALL DIMENSIONS			SEAT DIMENSIONS			BACK DIMENSIONS								
			W	D	H	W	D	H	W	H							
			26.5	27.25	33.25	18	18	17	16	16.5							
			<p>RTA 00 1 per carton</p>														
 <p>2076APUT</p>  <p>2076AUUT</p> <p>Armchair w/Sled Base and Tablet COM Yardage: 0.75 Freight Class: 250 Product Weight: 32 Cubic Feet Per Carton: 14.75</p>	<p>Specify (L) left or (R) right tablet</p> <p>Does not stack.</p>	<p>2076APUT 1056 1085 1105 1136 1182 1202 1243 1309 1358 1413 1527 1649 Upholstered seat</p> <p>2076AUUT 1171 1201 1221 1254 1297 1317 1357 1423 1472 1526 1639 1760 Upholstered seat & back</p>															
			OVERALL DIMENSIONS			SEAT DIMENSIONS			BACK DIMENSIONS								
			W	D	H	W	D	H	W	H							
			26.5	27.25	33.25	18	18	17.5	16	16							
			<p>RTA 00 1 per carton</p>														
 <p>Armless Chair w/Sled Base and Tablet COM Yardage: N/A Freight Class: 300 Product Weight: 27 Cubic Feet Per Carton: 14.75</p>	<p>Specify (L) left or (R) right tablet</p> <p>Does not stack</p>	<p>2076NPPT 765 Polypropylene seat & back</p>															
			OVERALL DIMENSIONS			SEAT DIMENSIONS			BACK DIMENSIONS								
			W	D	H	W	D	H	W	H							
			26.5	27.25	33.25	18	18	17	16	16.5							
			<p>RTA 00 1 per carton</p>														
 <p>2076NPUT</p>  <p>2076NUUT</p> <p>Armless Chair w/Sled Base and Tablet COM Yardage: 0.75 Freight Class: 250 Product Weight: 30 Cubic Feet Per Carton: 14.75</p>	<p>Specify (L) left or (R) right tablet</p> <p>Does not stack</p>	<p>2076NPUT 945 974 994 1025 1070 1090 1130 1193 1241 1296 1409 1528 Upholstered seat</p> <p>2076NUUT 1061 1088 1109 1140 1184 1204 1243 1306 1354 1408 1517 1637 Upholstered seat & back</p>															
			OVERALL DIMENSIONS			SEAT DIMENSIONS			BACK DIMENSIONS								
			W	D	H	W	D	H	W	H							
			25	27.25	33.25	18	18	17.5	16	16							
			<p>RTA 00 1 per carton</p>														
 <p>Bar Stool w/Arms COM Yardage: N/A Freight Class: 250 Product Weight: 25 Cubic Feet Per Carton: 10.75</p>	<p>Stacks 5 high on floor.</p>	<p>2075BSAPP 701 Polypropylene seat & back</p>															
			OVERALL DIMENSIONS			SEAT DIMENSIONS			BACK DIMENSIONS								
			W	D	H	W	D	H	W	H							
			24	24.75	45	18	18	29	16	16.5							
			<p>RTA 00 2 per carton (pricing and specifications are for one seat unit)</p>														

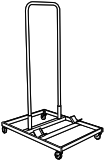

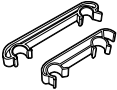

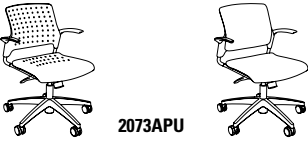
MULTI-PURPOSE

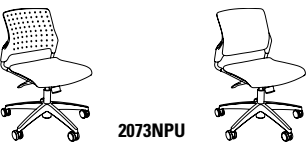

STREAM S

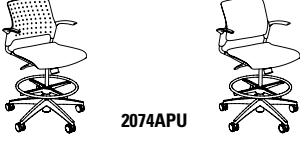

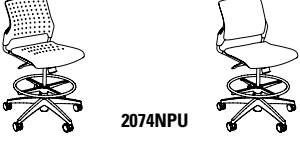
DESCRIPTION	FEATURES	MODEL#	STANDARD TEXTILE GRADES											
			1	2	3	4	5	6	7	8	9	10	11	12
 <p>2075BSAPU 2075BSAAU</p> <p>Bar Stool w/Arms COM Yardage: 0.75 Freight Class: 250 Product Weight: 28 Cubic Feet Per Carton: 21.5</p>	Stacks 5 high on floor.	2075BSAPU	883	909	929	958	998	1018	1055	1116	1161	1212	1317	1429
		Upholstered seat												
		2075BSAAU	998	1024	1044	1072	1113	1133	1170	1231	1275	1327	1432	1543
		Upholstered seat & back												
		OVERALL DIMENSIONS	SEAT DIMENSIONS			BACK DIMENSIONS								
		W D H	W	D	H	W	D	H	W	H				
		24 24.75 45	18	18	29.5	16	16							
		RTA 00	2 per carton (pricing and specifications are for one seat unit)											
 <p>2075BSNPP</p> <p>Armless Bar Stool COM Yardage: N/A Freight Class: 250 Product Weight: 21 Cubic Feet Per Carton: 17.75</p>	Stacks 5 high on floor.	2075BSNPP	592											
		Polypropylene seat & back												
		OVERALL DIMENSIONS	SEAT DIMENSIONS			BACK DIMENSIONS								
		W D H	W	D	H	W	D	H	W	H				
		22 24.75 45	18	18	29	16	16.5							
		RTA 00	2 per carton (pricing and specifications are for one seat unit)											
 <p>2075BSNPU 2075BSNUU</p> <p>Armless Bar Stool COM Yardage: 0.75 Freight Class: 250 Product Weight: 24 Cubic Feet Per Carton: 17.75</p>	Stacks 5 high on floor.	2075BSNPU	774	800	819	847	886	904	941	998	1041	1091	1192	1300
		Upholstered seat												
		2075BSNUU	889	916	935	963	1003	1021	1057	1115	1161	1208	1312	1419
		Upholstered seat & back												
		OVERALL DIMENSIONS	SEAT DIMENSIONS			BACK DIMENSIONS								
		W D H	W	D	H	W	D	H	W	H				
		22 24.75 45	18	18	29.5	16	16							
		RTA 00	2 per carton (pricing and specifications are for one seat unit)											
 <p>2075CSAPP</p> <p>Counter Stool w/Arms COM Yardage: N/A Freight Class: 250 Product Weight: 24 Cubic Feet Per Carton: 21.5</p>	Stacks 5 high on floor.	2075CSAPP	701											
		Polypropylene seat & back												
		OVERALL DIMENSIONS	SEAT DIMENSIONS			BACK DIMENSIONS								
		W D H	W	D	H	W	D	H	W	H				
		24 24.75 40	18	18	24	16	16.5							
		RTA 00	2 per carton (pricing and specifications are for one seat unit)											
 <p>2075CSAPU 2075CSAAU</p> <p>Counter Stool w/Arms COM Yardage: 0.75 Freight Class: 250 Product Weight: 27 Cubic Feet Per Carton: 21.5</p>	Stacks 5 high on floor.	2075CSAPU	883	912	932	963	1008	1029	1069	1133	1184	1238	1351	1472
		Upholstered seat												
		2075CSAAU	998	1025	1046	1077	1122	1142	1182	1245	1294	1349	1462	1581
		Upholstered seat & back												
		OVERALL DIMENSIONS	SEAT DIMENSIONS			BACK DIMENSIONS								
		W D H	W	D	H	W	D	H	W	H				
		24 24.75 40	18	18	24.5	16	16							
		RTA 00	2 per carton (pricing and specifications are for one seat unit)											

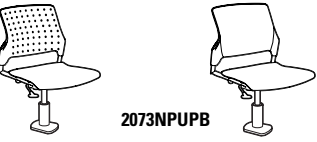
DESCRIPTION	FEATURES	MODEL#	STANDARD TEXTILE GRADES														
			1	2	3	4	5	6	7	8	9	10	11	12			
 <p>Armless Counter Stool COM Yardage: N/A Freight Class: 250 Product Weight: 20 Cubic Feet Per Carton: 19</p>	Stacks 5 high on floor.	2075CSNPP 592 Polypropylene seat & back															
			OVERALL DIMENSIONS			SEAT DIMENSIONS			BACK DIMENSIONS								
			W	D	H	W	D	H	W	H							
			22	24.75	40	18	18	24	16	16.5							
			RTA 00	2 per carton (pricing and specifications are for one seat unit)													
  <p>Armless Counter Stool COM Yardage: 0.75 Freight Class: 250 Product Weight: 23 Cubic Feet Per Carton: 19</p>	Stacks 5 high on floor.	2075CSNPU 774 801 822 852 897 917 956 1017 1067 1120 1229 1347 Upholstered seat 2075CSNUU 889 916 937 967 1009 1031 1069 1131 1179 1232 1341 1456 Upholstered seat & back															
			OVERALL DIMENSIONS			SEAT DIMENSIONS			BACK DIMENSIONS								
			W	D	H	W	D	H	W	H							
			22	24.75	40	18	18	24.5	16	16							
			RTA 00	2 per carton (pricing and specifications are for one seat unit)													
 <p>Dolly COM Yardage: N/A Freight Class: 125 Product Weight: 41 Cubic Feet Per Carton: 6.75</p>	Accommodates 10-15 chairs depending on model.	2085 790															
			OVERALL DIMENSIONS			SEAT DIMENSIONS			BACK DIMENSIONS								
			W	D	H	W	D	H	W	H							
			24	33.5	53												
			RTA 00	FedEx 2 per carton													
 <p>Ganging Clamps - Set of 2 COM Yardage: N/A Freight Class: 70 Product Weight: .20 Cubic Feet Per Carton: .04</p>	For use with armchair models. Chair clearance 0.25"	5233 \$33															
			OVERALL DIMENSIONS			SEAT DIMENSIONS			BACK DIMENSIONS								
			W	D	H	W	D	H	W	H							
			.87	0.75	1												
			RTA 00	Pricing is for the set, specifications are for one clamp													
 <p>Ganging Brackets - Set of 2 COM Yardage: N/A Freight Class: 70 Product Weight: 0.01 Cubic Feet Per Carton: 0.02</p>	For use with armless models. Chair clearance 0.25"	6526 \$26															
			OVERALL DIMENSIONS			SEAT DIMENSIONS			BACK DIMENSIONS								
			W	D	H	W	D	H	W	H							
			0.75	5.75	1.25												
			RTA 00	Pricing is for the set, specifications are for one clamp													

DESCRIPTION	FEATURES	MODEL#	STANDARD TEXTILE GRADES															
			1	2	3	4	5	6	7	8	9	10	11	12				
 <p>Tilter Chair w/Arms COM Yardage: N/A Freight Class: 250 Product Weight (lbs.): 34 Cubic Feet Per Carton: 15.5</p>		2073APP	\$872													Polypropylene seat & back		
			OVERALL DIMENSIONS			SEAT DIMENSIONS			BACK DIMENSIONS									
			W	D	H	W	D	H	W	H								
			24	23.5	33.5	18	18	15.5-20.5	16	16.5								
			RTA 00	1 per carton														
 <p>Tilter Chair w/Arms COM Yardage: .75 Freight Class: 250 Product Weight: 39 Cubic Feet Per Carton: 15.5</p>		2073APU	\$1056	\$1083	\$1103	\$1134	\$1176	\$1196	\$1235	\$1297	\$1345	\$1397	\$1507	\$1621	Upholstered seat			
			2073AUU	\$1171	\$1198	\$1218	\$1247	\$1290	\$1311	\$1349	\$1410	\$1457	\$1510	\$1619	\$1734	Upholstered seat & back		
		OVERALL DIMENSIONS			SEAT DIMENSIONS			BACK DIMENSIONS										
		W	D	H	W	D	H	W	H									
24	23.5	33.5	18	18	16-21	16	16											
			RTA 00	1 per carton														
 <p>Armless Tilter Chair COM Yardage: N/A Freight Class: 300 Product Weight (lbs.): 30 Cubic Feet Per Carton:</p>		2073NPP	\$779												Polypropylene seat & back			
			OVERALL DIMENSIONS			SEAT DIMENSIONS			BACK DIMENSIONS									
			W	D	H	W	D	H	W	H								
			20.5	23.5	33.5	18	18	15.5-20.5	16	16.5								
			RTA 00	1 per carton														
 <p>Armless Tilter Chair COM Yardage: 0.75 Freight Class: 250 Product Weight: 33 Cubic Feet Per Carton: 15.5</p>		2073NPU	\$963	\$990	\$1010	\$1039	\$1082	\$1102	\$1141	\$1201	\$1249	\$1300	\$1410	\$1525	Upholstered seat			
			2073NUU	\$1077	\$1104	\$1124	\$1153	\$1195	\$1216	\$1254	\$1314	\$1362	\$1413	\$1521	\$1635	Upholstered seat & back		
		OVERALL DIMENSIONS			SEAT DIMENSIONS			BACK DIMENSIONS										
		W	D	H	W	D	H	W	H									
20.5	23.5	33.5	18	18	16-21	16	16											
			RTA 00	1 per carton														
 <p>Height Adjustable Stool w/Arms COM Yardage: N/A Freight Class: 300 Product Weight (lbs.): 37 Cubic Feet Per Carton: 19.5</p>		2074APP	\$984												Polypropylene seat & back			
			OVERALL DIMENSIONS			SEAT DIMENSIONS			BACK DIMENSIONS									
			W	D	H	W	D	H	W	H								
			24	23.5	43	18	18	22-32	16	16.5								
			RTA 00	1 per carton														

DESCRIPTION	FEATURES	MODEL#	STANDARD TEXTILE GRADES											
			1	2	3	4	5	6	7	8	9	10	11	12
 <p>2074APU 2074AAU</p> <p>Height Adjustable Stool w/Arms COM Yardage: 0.75 Freight Class: 250 Product Weight: 40 Cubic Feet Per Carton: 19.5</p>		2074APU	\$1166	\$1196	\$1216	\$1249	\$1293	\$1313	\$1353	\$1419	\$1469	\$1523	\$1637	\$1759
			2074AAU	\$1281	\$1308	\$1330	\$1361	\$1406	\$1426	\$1466	\$1529	\$1578	\$1635	\$1747
			OVERALL DIMENSIONS			SEAT DIMENSIONS			BACK DIMENSIONS					
			W	D	H	W	D	H	W	H	W	H		
			24	23.5	43	18	18	22.5-32.5	16	16				
			RTA 00	1 per carton										
 <p>2074NPP</p> <p>Armless Height Adjustable Stool COM Yardage: N/A Freight Class: 300 Product Weight (lbs.): 33 Cubic Feet Per Carton: 19.5</p>		2074NPP	\$870	Polypropylene seat & back										
				OVERALL DIMENSIONS			SEAT DIMENSIONS			BACK DIMENSIONS				
			W	D	H	W	D	H	W	H	W	H		
			20.5	23.5	43	18	18	22-32	16	16.5				
			RTA 00	1 per carton										
 <p>2074NPU 2074NUU</p> <p>Armless Height Adjustable Stool COM Yardage: 0.75 Freight Class: 300 Product Weight: 38 Cubic Feet Per Carton: 19.5</p>		2074NPU	\$1052	\$1079	\$1100	\$1131	\$1176	\$1195	\$1235	\$1298	\$1346	\$1400	\$1513	\$1629
			2074NUU	\$1168	\$1197	\$1217	\$1247	\$1292	\$1312	\$1351	\$1413	\$1462	\$1515	\$1624
			OVERALL DIMENSIONS			SEAT DIMENSIONS			BACK DIMENSIONS					
			W	D	H	W	D	H	W	H	W	H		
			20.5	23.5	43	18	18	22.5-32.5	16	16				
			RTA 00	1 per carton										
 <p>2073NPPPB</p> <p>Armless Tilter with Pedestal Base COM Yardage: N/A Freight Class: 250 Product Weight (lbs.): 30 Cubic Feet Per Carton: 10.25</p>		2073NPPPB	1009	Polypropylene seat & back										
				OVERALL DIMENSIONS			SEAT DIMENSIONS			BACK DIMENSIONS				
			W	D	H	W	D	H	W	H	W	H		
			20.5	23.5	33.5	18	18	16.5	16	16				
			RTA 00	1 per carton										
 <p>2073NPUPB 2073NUUPB</p> <p>Armless Tilter with Pedestal Base COM Yardage: 0.75 Freight Class: 250 Product Weight: 33 Cubic Feet Per Carton: 10.25</p>		2073NPUPB	1193	1220	1240	1269	1311	1331	1370	1430	1476	1528	1636	1750
			2073NUUPB	1193	1218	1237	1262	1300	1193	1353	1408	1451	1497	1596
			OVERALL DIMENSIONS			SEAT DIMENSIONS			BACK DIMENSIONS					
			W	D	H	W	D	H	W	H	W	H		
			20.5	23.5	33.5	18	18	16.5	16	16				
			RTA 00	1 per carton										

DESCRIPTION	FEATURES	MODEL#	STANDARD TEXTILE GRADES														
			1	2	3	4	5	6	7	8	9	10	11	12			
 <p>Tilter Chair w/Arms and Pedestal Base COM Yardage: N/A Freight Class: 250 Product Weight (lbs.): 34 Cubic Feet Per Carton: 10.25</p>		2073APPPB	1103 Polypropylene seat & back														
			OVERALL DIMENSIONS	SEAT DIMENSIONS			BACK DIMENSIONS										
				W	D	H	W	D	H	W	H						
				20.5	23.5	33.5	18	18	16.5	16	16						
			RTA 00	1 per carton													
  <p>2073APUPB 2073AUUPB</p> <p>Tilter Chair w/Arms and Pedestal Base COM Yardage: 0.75 Freight Class: 250 Product Weight: 37 Cubic Feet Per Carton: 10.25</p>		2073APUPB	1286	1313	1333	1362	1405	1425	1464	1524	1571	1623	1731	1847			
				Upholstered seat													
			2073AUUPB	1401	1428	1448	1477	1519	1401	1578	1638	1686	1737	1845	1959		
				Upholstered seat & back													
			RTA 00	1 per carton													
 <p>Armless Task Chair w/Pedestal Base COM Yardage: N/A Freight Class: 250 Product Weight (lbs.): 30 Cubic Feet Per Carton: 10.25</p>		2074NPPPB	1100 Polypropylene seat & back														
				OVERALL DIMENSIONS	SEAT DIMENSIONS			BACK DIMENSIONS									
				W	D	H	W	D	H	W	H						
				20.5	23.5	33.5	18	18	16.5	16	16						
			RTA 00	1 per carton													
  <p>2074NPUPB 2074NUUPB</p> <p>Armless Task Chair w/Pedestal Base COM Yardage: 0.75 Freight Class: 250 Product Weight: 33 Cubic Feet Per Carton: 10.25</p>		2074NPUPB	1282	1311	1331	1361	1405	1425	1464	1525	1574	1626	1736	1853			
				Upholstered seat													
			2074NUUPB	1399	1428	1448	1478	1522	1399	1579	1641	1689	1742	1851	1966		
				Upholstered seat & back													
			RTA 00	1 per carton													
 <p>Task Chair w/Pedestal Base COM Yardage: N/A Freight Class: 250 Product Weight (lbs.): 34 Cubic Feet Per Carton: 10.25</p>		2074APPPB	1214 Polypropylene seat & back														
				OVERALL DIMENSIONS	SEAT DIMENSIONS			BACK DIMENSIONS									
				W	D	H	W	D	H	W	H						
				20.5	23.5	33.5	18	18	16.5	16	16						
			RTA 00	1 per carton													

DESCRIPTION	FEATURES	MODEL#	STANDARD TEXTILE GRADES													
			1	2	3	4	5	6	7	8	9	10	11	12		
 2074APUPB	 2074AUUPB															
		2074APUPB	1397	1424	1445	1476	1521	1541	1581	1644	1693	1748	1860	1979	Upholstered seat	
		2074AUUPB	1511	1538	1559	1590	1635	1511	1694	1757	1805	1859	1972	2088	Upholstered seat & back	
			OVERALL DIMENSIONS			SEAT DIMENSIONS			BACK DIMENSIONS							
			W	D	H	W	D	H	W	H						
			20.5	23.5	33.5	18	18	16.5	16	16						
Task Chair w/Pedestal Base COM Yardage: 0.75 Freight Class: 250 Product Weight: 37 Cubic Feet Per Carton: 10.25			RTA 00			1 per carton										

TWILIGHT™



model 2194 (BK)





model 2198C (TUN)

STANDARD FEATURES

- Twilight series armchairs and barstools feature a flared back design.
- Chairs can stack 5 high on floor and 8 high on dolly 2125WS. Stools do not stack.
- Comet series tables and connecting brackets are compatible with Twilight models.
- Arm and Armless models can be joined together using ganging clamp model 2180.
- All Twilight models have welded corner gussets for additional strength & support.
- **Specifications and pricing are for 1 chair.**
- Check textile availability prior to specifying upholstery material.

OPTIONAL FEATURES

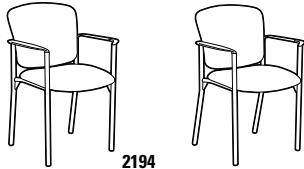
- Frames available in Black (TBL) or Tungsten (TTU).
- Optional steel cushioned glides (B) are available on all models. Add \$31. Please specify.
- Models featuring a wood veneer back are available in Absolute (AAM), Black (BKM), Cherry (ACM), Espresso Cafe (ECM), English Oak (EOM), Fruitwood (TFM), Gray (HGM), Honey (AHM), Mahogany (TMM), Maple (AVM), Medium Walnut (MWM), Night (ASM), Noce Biondo (NBM), Noce Grigio (NGM), Noce Leggero (NEM), Noce Medio (NMM), Shaker Cherry (SKM), Walnut (TWM), WC Cream (WTM), White (WHM) and Winter Cherry (WCM). Please Specify. Genuine maple faced veneers and solids are used.
- Models featuring wood veneer backs can incorporate a custom logo. Please contact Customer Service for further details.

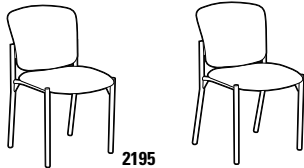
DESCRIPTION	FEATURES	MODEL#	STANDARD TEXTILE GRADES											
			1	2	3	4	5	6	7	8	9	10	11	12
 <p>2194 2194WS</p> <p>Armchair Upholstered Back COM Yardage: 1.25 Freight Class: 250 Product Weight (lbs.): 21 Cubic Feet Per Carton: 6.25 (2 per carton)</p>	<p>Stacks 5 high on floor. Stacks 8 high on dolly. Ergonomic Features: M, N</p>	2194	\$646	\$694	\$730	\$776	\$851	\$889	\$958	\$1051	\$1148	\$1223	\$1422	\$1622
		2194WS	\$671	\$718	\$758	\$811	\$889	\$916	\$986	\$1115	\$1176	\$1296	\$1458	\$1662
			OVERALL DIMENSIONS			SEAT DIMENSIONS			BACK DIMENSIONS					
			W	D	H	W	D	H	W	H				
			23.5	22	35	18	16	18	18	16				
			RTA 00											
 <p>2194C</p> <p>Armchair w/Casters Upholstered Back COM Yardage: 1.25 Freight Class: 250 Product Weight (lbs.): 21 Cubic Feet Per Carton: 6.25 (2 per carton)</p>	<p>Stacks 5 high on floor. Stacks 8 high on dolly. Ergonomic Features: M, N</p>	2194C	\$758	\$805	\$842	\$888	\$964	\$991	\$1052	\$1173	\$1233	\$1342	\$1497	\$1687
					OVERALL DIMENSIONS			SEAT DIMENSIONS			BACK DIMENSIONS			
			W	D	H	W	D	H	W	H				
			23.5	22	35	18	16	18	18	18.5				
			RTA 00											
 <p>2195 2195WS</p> <p>Armless Chair Upholstered Back COM Yardage: 1.25 Freight Class: 250 Product Weight (lbs.): 18 Cubic Feet Per Carton: 6.25 (2 per carton)</p>	<p>Stacks 5 high on floor. Stacks 8 high on dolly. Ergonomic Features: M, N</p>	2195	\$560	\$605	\$639	\$690	\$765	\$801	\$869	\$963	\$1055	\$1130	\$1333	\$1532
		2195WS	\$583	\$631	\$670	\$725	\$801	\$829	\$898	\$1026	\$1088	\$1209	\$1370	\$1574
			OVERALL DIMENSIONS			SEAT DIMENSIONS			BACK DIMENSIONS					
			W	D	H	W	D	H	W	H				
			20	22	35	18	16	18.5	18	16				
			RTA 00											

DESCRIPTION FEATURES MODEL# STANDARD TEXTILE GRADES



Armless Chair w/Casters Upholstered Back
 COM Yardage: 1.25
 Freight Class: 250
 Product Weight (lbs.): 18
 Cubic Feet Per Carton: 6.25 (2 per carton)

Stacks 5 high on floor.
 Stacks 8 high on dolly.
 Ergonomic Features:
 M, N

MODEL#	1	2	3	4	5	6	7	8	9	10	11	12
2195C	\$671	\$716	\$751	\$803	\$877	\$904	\$965	\$1086	\$1146	\$1256	\$1410	\$1599

OVERALL DIMENSIONS			SEAT DIMENSIONS			BACK DIMENSIONS	
W	D	H	W	D	H	W	H
20	22	35	18	16	18	18.5	16

RTA 00



2198



\$691WS

Armchair Wood Veneer Back
 COM Yardage: 0.75
 Freight Class: 250
 Product Weight (lbs.): 20
 Cubic Feet Per Carton: 6.25 (2 per carton)

Stacks 5 high on floor.
 Stacks 8 high on dolly.
 Ergonomic Features:
 M, N

MODEL#	1	2	3	4	5	6	7	8	9	10	11	12
2198	\$691	\$717	\$739	\$771	\$814	\$838	\$877	\$934	\$988	\$1035	\$1155	\$1276

2198WS Wall Saver	\$710	\$743	\$766	\$798	\$842	\$860	\$903	\$976	\$1015	\$1087	\$1186	\$1304
-----------------------------	-------	-------	-------	-------	-------	-------	-------	-------	--------	--------	--------	--------

OVERALL DIMENSIONS			SEAT DIMENSIONS			BACK DIMENSIONS	
W	D	H	W	D	H	W	H
23.5	22	35	18	17.5	18	18.5	16.5

RTA 00



Armchair w/Casters Wood Veneer Back
 COM Yardage: 0.75
 Freight Class: 250
 Product Weight (lbs.): 20
 Cubic Feet Per Carton: 6.25 (2 per carton)

Stacks 5 high on floor.
 Stacks 8 high on dolly.
 Ergonomic Features:
 M, N

MODEL#	1	2	3	4	5	6	7	8	9	10	11	12
2198C	\$717	\$750	\$771	\$803	\$843	\$859	\$899	\$971	\$1004	\$1071	\$1162	\$1277

OVERALL DIMENSIONS			SEAT DIMENSIONS			BACK DIMENSIONS	
W	D	H	W	D	H	W	H
23.5	22	35	18	16	18	18.5	16

RTA 00



2199



2199WS

Armless Chair Wood Veneer Back
 COM Yardage: 0.75
 Freight Class: 250
 Product Weight (lbs.): 18
 Cubic Feet Per Carton: 6.25 (2 per carton)

Stacks 5 high on floor.
 Stacks 8 high on dolly.
 Ergonomic Features:
 M, N

MODEL#	1	2	3	4	5	6	7	8	9	10	11	12
2199	\$597	\$623	\$644	\$672	\$715	\$741	\$782	\$838	\$892	\$940	\$1060	\$1182

2199WS Wall Saver	\$618	\$649	\$672	\$705	\$748	\$768	\$807	\$884	\$923	\$994	\$1093	\$1214
-----------------------------	-------	-------	-------	-------	-------	-------	-------	-------	-------	-------	--------	--------

OVERALL DIMENSIONS			SEAT DIMENSIONS			BACK DIMENSIONS	
W	D	H	W	D	H	W	H
20	22	35	18	17.5	18	18.5	16.5

RTA 00



Armless Chair w/Casters Wood Veneer Back
 COM Yardage: 0.75
 Freight Class: 250
 Product Weight (lbs.): 18
 Cubic Feet Per Carton: 6.25 (2 per carton)



Stacks 5 high on floor.
 Stacks 8 high on dolly.
 Ergonomic Features:
 M, N

MODEL#	1	2	3	4	5	6	7	8	9	10	11	12
2199C	\$634	\$667	\$682	\$714	\$760	\$774	\$813	\$887	\$920	\$987	\$1078	\$1192

OVERALL DIMENSIONS			SEAT DIMENSIONS			BACK DIMENSIONS	
W	D	H	W	D	H	W	H
20	22	35	18	17.5	18	18.5	16

RTA 00

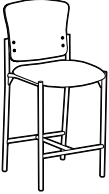

DESCRIPTION	FEATURES	MODEL#	STANDARD TEXTILE GRADES											
			1	2	3	4	5	6	7	8	9	10	11	12
 <p>Barstool w/Arms Wood Veneer Back COM Yardage: 0.75 Freight Class: 300 Product Weight (lbs.): 27 Cubic Feet Per Carton: 14.75 (1 per carton)</p>	<p>Does not stack.</p> <p>Ergonomic Features: M, N</p>	2188	\$994	\$1028	\$1050	\$1082	\$1131	\$1144	\$1187	\$1263	\$1302	\$1372	\$1473	\$1592
			OVERALL DIMENSIONS			SEAT DIMENSIONS			BACK DIMENSIONS					
			W	D	H	W	D	H	W	H				
			23	22	45	18	16	29	18.5	16				
			RTA 00											
 <p>Armless Barstool Wood Veneer Back COM Yardage: 0.75 Freight Class: 300 Product Weight (lbs.): 25 Cubic Feet Per Carton: 14.75 (1 per carton)</p>	<p>Does not stack.</p> <p>Ergonomic Features: M, N</p>	2189	\$899	\$934	\$955	\$988	\$1034	\$1051	\$1092	\$1168	\$1206	\$1277	\$1376	\$1499
			OVERALL DIMENSIONS			SEAT DIMENSIONS			BACK DIMENSIONS					
			W	D	H	W	D	H	W	H				
			20	22	45	18	16	29	18.5	16				
			RTA 00											
 <p>Barstool w/Arms Upholstered Back COM Yardage: 1.25 Freight Class: 300 Product Weight (lbs.): 28 Cubic Feet Per Carton: 14.75 (1 per carton)</p>	<p>Does not stack.</p> <p>Ergonomic Features: M, N</p>	2196	\$954	\$1004	\$1041	\$1097	\$1173	\$1202	\$1269	\$1399	\$1460	\$1580	\$1743	\$1949
			OVERALL DIMENSIONS			SEAT DIMENSIONS			BACK DIMENSIONS					
			W	D	H	W	D	H	W	H				
			23	22	45	18	16	29	18.5	16				
			RTA 00											
 <p>Armless Barstool w/ Upholstered Back COM Yardage: 1.25 Freight Class: 300 Product Weight (lbs.): 22 Cubic Feet Per Carton: 14.75 (1 per carton)</p>	<p>Does not stack.</p> <p>Ergonomic Features: M, N</p>	2197	\$860	\$910	\$947	\$1000	\$1078	\$1105	\$1174	\$1303	\$1366	\$1486	\$1647	\$1851
			OVERALL DIMENSIONS			SEAT DIMENSIONS			BACK DIMENSIONS					
			W	D	H	W	D	H	W	H				
			20	22	45	18	16	29	18.5	16				
			RTA 00											

VION



VION FINISHES - GUEST SEATING				
Back Frame	Specify Code	Frame	Specify Code	Arm Option
Black	BLK	Black	TBL	Fiber Glass Reinforced Nylon (Black)
Shadow	SHW Add \$76	Fog	TFO	
		Shadow	TSH	
Fog	FOG Add \$76	Tungsten	TTU	
		Chrome	CHM - Add \$40	

STANDARD FEATURES

- Vion is a comprehensive seating series offering a family of models to Address multiple applications: task, management, conference, guest, heavy duty 24-7, and height adjustable stools.
- Series offers models with either a mesh or upholstered back.
- Vion guest chairs offer a wall saver frame design, which is constructed from 7/8" diameter steel tubing.
- Vion guest chairs can stack 4 high on the floor.
- Arm design is gently curved and made from strong fiberglass reinforced black nylon.
- Guest chairs are standard with durable polypropylene glides.
- Dual wheel carpet casters (C82) are standard on guest models with casters.
- Mesh back models are available in 10 standard colors: Aqua (MS75), Black (MS69), Black Cherry (MS76), Blue (MS72), Dust (MS77), Ivory (MS78), Natural (MS74), Paprika (MS79), Rope (MS73) and Stone (MS71).
- Upholstered back models feature Black fabric (Jenny JN02) on the back side as standard.
- Check textile availability prior to specifying upholstery material.
- Vion beam seating consists of upper seat units (6340-6343) including mounting brackets and all hardware necessary for attachment to beam.
- For all beam components, tables and a complete list of available upper seat units, see Beam seating section.

OPTIONAL FEATURES

- Please refer to the chart for optional back frame and base frame finishes.
- Mesh back models are also available in 10 Dimension Mesh colors: Black (DBK), Fog (DST), Chalk (DCL), Shadow (DGM), Charcoal (DCH), Sand (DSD), Cobalt (DCO), Pool Blue (DPB), Citrus (DCT) and Berry (DBE). Add \$27
- Upholstered back models offer a Matching Outer (MO) upholstery option. Due to the additional material needed, these models are listed separately and are priced differently than the standard upholstered back models.
- Seat available in memory foam. Please specify (MF). Add \$117.
- Opaque off-white non-marking glides for hard surface flooring are optional for guest chairs, please specify (NM). No upcharge.
- Felt glides (FG) and rubber glides (RG) are available on guest chairs, please specify and add \$60.
- Steel cushioned self-leveling glides (B) are available on guest chairs (adds 0.5" to seat height), please specify and add \$34.
- Dolly available for stacking guest chairs up to 8 high. Specify model 2125WS, \$452 List.
- Please refer to chart for optional Arms, Back, Base and Frame finishes.

DESCRIPTION FEATURES MODEL# STANDARD TEXTILE GRADES



mesh back

Stacks 4 high on floor.
Stacks 8 high on dolly.
Ergonomic Features: M, N





Armless Side Chair















COM Yardage: 1
Freight Class: 250
Product Weight (lbs.): 24
Cubic Feet Per Carton: 11.75





MODEL#	1	2	3	4	5	6	7	8	9	10	11	12
6324	626	663	691	732	790	812	863	962	1011	1101	1226	1380





OVERALL DIMENSIONS			SEAT DIMENSIONS			BACK DIMENSIONS	
W	D	H	W	D	H	W	H
20	24	34.5	19	17.5	17.5	19	17



DESCRIPTION	FEATURES	MODEL#	STANDARD TEXTILE GRADES											
			1	2	3	4	5	6	7	8	9	10	11	12
 <p>mesh back</p> <p>Armless Side Chair w/Casters COM Yardage: 1 Freight Class: 250 Product Weight (lbs.): 24 Cubic Feet Per Carton: 11.75</p>	<p>Does not stack.</p> <p>Ergonomic Features: M, N</p>	6324C	699	736	765	806	864	885	936	1036	1085	1175	1299	1453
			OVERALL DIMENSIONS			SEAT DIMENSIONS			BACK DIMENSIONS					
			W	D	H	W	D	H	W	H				
			20	24	34.5	19	17.5	17.5	19	17				
			RTA 00	FedEx		ups								
 <p>mesh back</p> <p>Side Chair COM Yardage: 1 Freight Class: 300 Product Weight (lbs.): 26 Cubic Feet Per Carton: 13.75</p>	<p>Stacks 4 high on floor. Stacks 8 high on dolly.</p> <p>Ergonomic Features: M, N</p>	6325	671	709	737	778	836	858	909	1008	1057	1147	1273	1425
			OVERALL DIMENSIONS			SEAT DIMENSIONS			BACK DIMENSIONS					
			W	D	H	W	D	H	W	H				
			25.5	24	34.5	19	17.5	17.5	19	17				
			RTA 00	FedEx		ups								
 <p>mesh back</p> <p>Side Chair w/Casters COM Yardage: 1 Freight Class: 300 Product Weight (lbs.): 26 Cubic Feet Per Carton: 13.75</p>	<p>Does not stack.</p> <p>Ergonomic Features: M, N</p>	6325C	742	780	809	850	909	929	980	1081	1129	1219	1344	1497
			OVERALL DIMENSIONS			SEAT DIMENSIONS			BACK DIMENSIONS					
			W	D	H	W	D	H	W	H				
			25.5	24	34.5	19	17.5	17.5	19	17				
			RTA 00	FedEx		ups								
 <p>upholstered back</p> <p>Armless Side Chair COM Yardage: 1.25 Freight Class: 250 Product Weight (lbs.): 25 Cubic Feet Per Carton: 11.75 Cubic Feet Per Carton: 11.75</p>	<p>Stacks 4 high on floor. Stacks 8 high on dolly.</p> <p>Ergonomic Features: M, N</p>	6334	685	733	770	824	901	938	1008	1120	1207	1302	1500	1710
			OVERALL DIMENSIONS			SEAT DIMENSIONS			BACK DIMENSIONS					
			W	D	H	W	D	H	W	H				
			20	24	34.5	19	17.5	17.5	19	17				
			RTA 00	FedEx		ups								
 <p>upholstered back</p> <p>Armless Side Chair w/Casters COM Yardage: 1.25 Freight Class: 250 Product Weight (lbs.): 25 Cubic Feet Per Carton: 11.75</p>	<p>Does not stack.</p> <p>Ergonomic Features: M, N</p>	6334MO	822	894	950	1034	1150	1193	1296	1493	1587	1770	2019	2327
			OVERALL DIMENSIONS			SEAT DIMENSIONS			BACK DIMENSIONS					
			W	D	H	W	D	H	W	H				
			20	24	34.5	19	17.5	17.5	19	17				
			RTA 00	FedEx		ups								

DESCRIPTION	FEATURES	MODEL#	STANDARD TEXTILE GRADES											
			1	2	3	4	5	6	7	8	9	10	11	12
 upholstered back	Stacks 4 high on floor. Stacks 8 high on dolly. Ergonomic Features: M, N	6335 6335MO	731	779	816	870	946	983	1052	1162	1247	1344	1538	1747
			787	860	915	1000	1115	1159	1261	1459	1554	1737	1986	2296
			OVERALL DIMENSIONS W D H			SEAT DIMENSIONS W D H			BACK DIMENSIONS W H					
			25.5	24	34.5	19	17.5	17.5	19	17				
			  											
 upholstered back	Does not stack. Ergonomic Features: M, N	6335C 6335CMO	810	856	889	940	1014	1048	1114	1219	1301	1390	1576	1774
			864	936	992	1076	1195	1236	1338	1535	1630	1813	2063	2371
			OVERALL DIMENSIONS W D H			SEAT DIMENSIONS W D H			BACK DIMENSIONS W H					
			25.5	24	34.5	19	18	17.5	19	17				
			  											
	Upholstered seat/mesh back. Use with beam.	6340	\$839	\$882	\$911	\$957	\$1021	\$1051	\$1108	\$1201	\$1273	\$1351	\$1516	\$1692
			OVERALL DIMENSIONS W D H			SEAT DIMENSIONS W D H			BACK DIMENSIONS W H					
			21	23.5	20.5	17.5	18	-	19	17				
														
	Upholstered seat and back. Use with beam.	6341	978	1027	1066	1123	1203	1240	1314	1430	1520	1619	1821	2039
			OVERALL DIMENSIONS W D H			SEAT DIMENSIONS W D H			BACK DIMENSIONS W H					
			21	23.5	20.5	17.5	18	-	19	17				
														
	Upholstered seat/mesh back. Use with beam.	6342	777	817	849	894	957	986	1046	1138	1208	1288	1452	1627
			OVERALL DIMENSIONS W D H			SEAT DIMENSIONS W D H			BACK DIMENSIONS W H					
			25.5	23.5	20.5	17.5	18	-	19	17				
														

DESCRIPTION	FEATURES	MODEL#	STANDARD TEXTILE GRADES											
			1	2	3	4	5	6	7	8	9	10	11	12
 <p>Seat Unit w/Arms COM Yardage: 1 Freight Class: 250 Product Weight (lbs.): 27 Cubic Feet Per Carton: 9.75</p>	<p>Upholstered seat and back. Use with beam.</p>	6343	899	948	987	1043	1123	1159	1233	1348	1437	1537	1742	1959
			OVERALL DIMENSIONS			SEAT DIMENSIONS			BACK DIMENSIONS					
			W	D	H	W	D	H	W	H				
			25.5	23.5	20.5	17.5	18	-	19	17				
			RTA 00											
 <p>Bar Height Stool w/Arms COM Yardage: 1.00 Freight Class: 300 Product Weight (lbs.): 35 Cubic Feet Per Carton: 20</p>	<p>Mesh Back. Does not stack.</p> <p>Ergonomic Features: M, N</p>	6350	871	911	941	988	1051	1080	1138	1232	1302	1382	1546	1721
			OVERALL DIMENSIONS			SEAT DIMENSIONS			BACK DIMENSIONS					
			W	D	H	W	D	H	W	H				
			25.5	25	44.5	19	17.5	28.5	18	16				
			RTA 00											
 <p>Armless Bar Height Stool COM Yardage: 1.00 Freight Class: 250 Product Weight (lbs.): 33 Cubic Feet Per Carton: 15.75</p>	<p>Mesh Back. Does not stack.</p> <p>Ergonomic Features: M, N</p>	6351	829	869	901	946	1009	1038	1098	1190	1260	1340	1504	1679
			OVERALL DIMENSIONS			SEAT DIMENSIONS			BACK DIMENSIONS					
			W	D	H	W	D	H	W	H				
			21	25	44.5	19	17.5	28.5	18	16				
			RTA 00											
 <p>Counter Height Stool w/Arms COM Yardage: 1.00 Freight Class: 300 Product Weight (lbs.): 25 Cubic Feet Per Carton: 18.5</p>	<p>Mesh Back. Does not stack.</p> <p>Ergonomic Features: M, N</p>	6352	871	911	941	988	1051	1080	1138	1232	1302	1382	1546	1721
			OVERALL DIMENSIONS			SEAT DIMENSIONS			BACK DIMENSIONS					
			W	D	H	W	D	H	W	H				
			25.5	24.5	40.5	19	17.5	24.5	18	16				
			RTA 00											
 <p>Armless Counter Height Stool COM Yardage: 1.00 Freight Class: 250 Product Weight (lbs.): 31 Cubic Feet Per Carton: 14.50</p>	<p>Mesh Back. Does not stack.</p> <p>Ergonomic Features: M, N</p>	6353	829	869	901	946	1009	1038	1098	1190	1260	1340	1504	1679
			OVERALL DIMENSIONS			SEAT DIMENSIONS			BACK DIMENSIONS					
			W	D	H	W	D	H	W	H				
			21	24.5	40.5	19	17.5	24.5	18	16				
			RTA 00											

DESCRIPTION	FEATURES	MODEL#	STANDARD TEXTILE GRADES															
			1	2	3	4	5	6	7	8	9	10	11	12				
 <p>Bar Height Stool w/Arms COM Yardage: 1.25 Freight Class: 300 Product Weight (lbs.): 35</p>	Upholstered Back Does not stack. Ergonomic Features:	6360	949	998	1037	1093	1174	1209	1283	1398	1487	1589	1792	2009				
		6360MO	1004	1082	1144	1232	1361	1421	1538	1724	1866	2025	2352	2701				
		OVERALL DIMENSIONS			SEAT DIMENSIONS			BACK DIMENSIONS										
		W	D	H	W	D	H	W	H									
			25.5	25	44.5	19	17.5	28.5	18	16	RTA 00							
 <p>Armless Bar Height Stool COM Yardage: 1.25 Freight Class: 250 Product Weight (lbs.): 33 Cubic Feet Per Carton: 15.75 Cubic Feet Per Carton: 18.5</p>	Upholstered Back Does not stack. Ergonomic Features: M, N M, N	6361	907	956	996	1052	1133	1170	1243	1359	1449	1549	1751	1970				
		6361MO	963	1041	1103	1191	1321	1380	1499	1683	1826	1985	2312	2660				
		OVERALL DIMENSIONS			SEAT DIMENSIONS			BACK DIMENSIONS										
		W	D	H	W	D	H	W	H									
			21	25	44.5	19	17.5	28.5	18	16	RTA 00							
 <p>Bar Counter Height Stool w/Arms COM Yardage: 1.25 Freight Class: 300 Product Weight (lbs.): 33 Cubic Feet Per Carton: 18.5</p>	Upholstered Back Does not stack. Ergonomic Features: M, N	6362	949	998	1037	1093	1174	1209	1283	1398	1487	1589	1792	2009				
		6362MO	1004	1082	1144	1232	1361	1421	1538	1724	1866	2025	2352	2701				
		OVERALL DIMENSIONS			SEAT DIMENSIONS			BACK DIMENSIONS										
		W	D	H	W	D	H	W	H									
			25.5	24.5	40.5	19	17.5	24.5	18	16	RTA 00							
 <p>Armless Counter Height Stool COM Yardage: 1.25 Freight Class: 250 Product Weight (lbs.): 31 Cubic Feet Per Carton: 14.50</p>	Upholstered Back Does not stack. Ergonomic Features: M, N	6363	907	956	996	1052	1133	1170	1243	1359	1449	1549	1751	1970				
		6363MO	963	1041	1103	1191	1321	1380	1499	1683	1826	1985	2312	2660				
		OVERALL DIMENSIONS			SEAT DIMENSIONS			BACK DIMENSIONS										
		W	D	H	W	D	H	W	H									
			21	25	40.5	19	17.5	24.5	18	16	RTA 00							

WILLOW



model W5AUUG
Armchair, Upholstered Seat & Back



Wipeable shroud edge does not collect debris



No visible brackets or upholstery staples

Arm Options



Waterfall Arm (WFA)



Forward Grip Assist (GAA)

	Willow Chair Stacking Capability	
	Stacks on floor	Stacks on dolly
Four leg arm and armless chairs with glides only		
Poly/poly chairs	up to 6 high	up to 10 high
Upholstered chairs	up to 4 high	up to 8 high
Bariatric Models	up to 4 high	up to 8 high
Four leg bar and counter stools		
Stools with arms	Does not stack	N/A
Armless stools	up to 4 high	N/A

Plastic Component Finish Matching Chart		
Chair Types	Seat Shroud	Arms and Back Shroud
Poly back and seat	Matches seat/back	Matches seat/back
Upholstered back and seat	Specify	Specify
Poly back/upholstered seat	Specify	Specify
Upholstered back/poly seat	Matches seat	Specify



For linking tables, see page 265.

EXAMPLE WILLOW ORDER CODE:

W5AUU	PU75	NS	PU75	WFA	BLK
-------	------	----	------	-----	-----

Model # Back Textile Seat Seat Textile Arm Style Seat Shroud Finish

CHM	ST	BLK	NS	NB
-----	----	-----	----	----

Frame Finish Glide Type Glide Finish Back seams Moisture Barrier

STANDARD FEATURES

- Willow's durable design and open, welcoming form will ensure years of use. Freestanding chairs are available with four legs or sled base, in seated standard or bariatric widths. Additional models include hip, counter and bar height stools. Freestanding and corner, in-line and end tables are also available to complement the line.
- Seated height chairs may be ganged with ganging brackets or with in-line and corner tables.
- Plastic seats and backs, reinforced nylon arms, back shrouds and seat shrouds are available in a wide range of colors. See finish chart for matching color components.
- Tubular steel frame is available in 20 paint finishes and 4 metallic finishes (upcharge applies).
- Frame design features a wall saver leg to prevent contact with walls.
- Active weight capacity is 300 lbs. for four-leg seating with casters, 400 lbs. for seating on glides and 600 lbs. for 30" wide bariatric and parent/child models.
- Plastic seat shrouds are standard on all models.
- Upholstered seats have no seams for ease of cleaning.
- Four-leg chairs with glides are stackable, see matrix. Stacking of caster models is not recommended due to damage to plastic and upholstery.
- Armless counter and bar height stools are stackable on the floor only. See chart for details.
- Four-leg and stool models are available with a variety of glide types. Glides must be chosen to best suit flooring type and site conditions. For more information, refer to glide selection chart.
- Tables used with Willow armchairs require 28" clearance under the surface top; counter height stools require 34.25" clearance; bar height stools require 40.25" clearance.
- Sled base models have nylon colored glides, non-marking natural glides for use on most floor surfaces, or no glides for use on carpeted floors.
- For healthcare textiles, visit the website at globalfurnituregroup.com.
- Check textile availability prior to specifying upholstery material.
- The series is available to specify with two textiles on upholstered seat and back models. For pricing, start with the base price and add applicable graded textile upcharges for the back and the seat.
- The blended textile matrix does not apply to this series.
- The series is designed for use across a range of facilities and is covered under Global's limited lifetime warranty for single-shift use. Specify from approved textiles.
- Shipped fully assembled.

OPTIONAL FEATURES





- Additional weight (**CW**) of 24 lbs. is available. Weighted four-leg chairs are not stackable.
- Power/USB units are available, ordered separately, for use with in-line, corner and end tables. See model for details.
- Tables are pre-drilled for field installation of undermount power. Clamp mount units are available. Order power units separately for field installation.
- Moisture barrier may be specified on seats.
- Sled base models offer a floor mount (**FM**) option. See upcharges. Mounting hardware not included.





Add option codes in the following order:

- Model number**
Enter model number.
- Back, Seat and Seat Shroud Finish** (plastic back and seat models)
Plastic finishes:

(BZB) Buzz Blue	(KAL) Kalua
(CCT) Cactus	(LAB) Latte
(CRO) Carrot	(J52) Mocha
(IVC) Cloud	(BLK) Night
(DJN) Dijon	(SND) Sand
(EGP) Eggplant	(SAR) Scarlet
(FRO) Fog	(SHW) Shadow
(FRO) Frost	(TOA) Toast
(INK) Ink	
- Back Finish** (plastic back and upholstered seat models)
See Plastic finishes.
- Back Textile** (for upholstered back models)
Specify back textile.
- Seat Textile** (for upholstered seat models)
(NS) Seamless seat
Specify seat textile.
- Arm Style** (for chairs with arms)
(WFA) Waterfall arm
(GAA) Grip assist arm. Add \$33.
- Arm and Back Shroud Finish**
See Plastic finishes.
- Seat and Seat Shroud Finish** (for upholstered back and plastic seat models).
See Plastic finishes.
- Leg Type** (for sled base models)
(NF) No floor mount
(FM) Floor mounted. Add \$12.
- Frame finish**
Paint finishes:
Black (**TBL**), Buzz Blue (**TBZ**), Cactus (**TCC**), Carrot (**TCR**), Cloud (**TIV**), Designer White (**TDW**), Dijon (**TDJ**), Eggplant (**TEG**), Fog (**TFO**), Frost (**TFR**), Ink (**TIN**), Kalua (**TKA**), Latte (**TLA**), Mocha (**TMO**), Nevada (**TNE**), Sand (**TSN**), Scarlet (**TSR**), Shadow (**TSH**), Toast (**TOA**) and Tungsten (**TTU**).
Metallic finishes:
(CHM) Chrome. Add \$67
(BCH) Brushed Chrome. Add \$217
(SBR) Satin Brass. Add \$317
(ACO) Antique Copper. Add \$317.
- Glide type** (four leg glides)
(ST) Nylon, colored glide for most surfaces
(NM) White, non-marking Nylon glide for most surfaces
(SG) Steel cushion glide for carpeted surfaces. Add \$34.
(FG) Felt glide for most hard floor surfaces. Add \$34.
(RG) Rubber, non-slip glide for most hard floor surfaces. Add \$34.
- Glide type** (sled bases)
(ST) Nylon, colored glide for most surfaces
(NM) White, non-marking Nylon glide for most surfaces
(XG) No glide for carpeted surfaces
- Glide Finish** (ST glides)
(BLK) Black
(SND) Sand
- Caster Type** (caster models)
(DC) 2" caster for carpeted surface
(RC) 2" caster for most hard floor surfaces. Add \$50.
- Back Seams**
(NS) No sealed back seams
(SBS) Sealed back seams
- Moisture Barrier** (on seat)
(NB) No moisture barrier.
(MB) Moisture barrier. Add \$101. For bariatric, add \$152.
- Additional Weight**
(NC) No counterweight.
(CW) Counterweight. Add \$737.

DESCRIPTION	FEATURES		MODEL#		STANDARD TEXTILE GRADES			
	GLIDES							
	Standard colored (ST) + non-marking (NM) glides - standard height		Steel cushion (SG) glides - 0.313" higher than standard		Felt pad (FG) glides - 0.375" higher than standard		Rubber non-slip (RG) glides - 0.563" higher than standard	
	SEAT HEIGHT (in)	ARM HEIGHT (in)	SEAT HEIGHT (in)	ARM HEIGHT (in)	SEAT HEIGHT (in)	ARM HEIGHT (in)	SEAT HEIGHT (in)	ARM HEIGHT (in)
ARMCHAIRS								
Plastic seat, standard arms	17	26.75	17.31	27.06	17.38	27.13	17.56	27.31
Plastic seat, grip assist arms	17	27	17.31	27.31	17.38	27.38	17.56	27.56
Upholstered seat, standard arms	18.25	26.75	18.56	27.06	18.63	27.13	18.81	27.31
Upholstered seat, grip assist arms	18.25	27	18.56	27.31	18.63	27.38	18.81	27.56
COUNTER STOOLS WITH ARMS								
Plastic seat, standard arms	23.25	33	23.56	33.31	23.63	33.38	23.81	33.56
Plastic seat, grip assist arms	23.25	33.25	23.56	33.56	23.63	33.63	23.81	33.81
Upholstered seat, standard arms	24.25	33	24.56	33.31	24.63	33.38	24.81	33.56
Upholstered seat, grip assist arms	24.25	33.25	24.56	33.56	24.63	33.63	24.81	33.81
BAR STOOLS WITH ARMS								
Plastic seat, standard arms	29.25	39	29.56	39.31	29.63	39.38	29.81	39.56
Plastic seat, grip assist arms	29.25	39.25	29.56	39.56	29.63	39.63	29.81	39.81
Upholstered seat, standard arms	30.25	39	30.56	39.31	30.63	39.38	30.81	39.56
Upholstered seat, grip assist arms	30.25	39.25	30.56	39.56	30.63	39.63	30.81	39.81

DESCRIPTION	FEATURES	MODEL#	STANDARD TEXTILE GRADES											
 <p>Armchair, Polypropylene Seat and Back COM Yardage: n/a Freight Class: 250 Product Weight (lbs.): 20.88 Cubic Feet Per Carton: 5.56</p>		List Price												
	W5APPG with glides	\$533												
	W5APPC with casters	\$670												
				OVERALL DIMENSIONS			SEAT DIMENSIONS			BACK DIMENSIONS				
			W	D	H	W	D	H	W	H				
			24.25	23.5	32	17.75	17.5	17	16	16				
	Active weight with casters 300 lbs.; does not stack. Active weight with glides 400 lbs.; stacks 6 high on floor. 2 per carton (pricing and specifications are for one seat unit)													
 <p>Armchair, Upholstered Back and Polypropylene Seat COM Yardage: 0.5 Freight Class: 250 Product Weight (lbs.): 21.88 Cubic Feet Per Carton: 5.56</p>		1/COM	2	3	4	5	6	7	8	9	10	11	12	
	W5AUPG with glides	\$627	\$643	\$656	\$674	\$700	\$711	\$734	\$769	\$796	\$825	\$885	\$949	
	W5AUPC with casters	\$739	\$755	\$768	\$786	\$812	\$823	\$846	\$881	\$908	\$937	\$997	\$1061	
				OVERALL DIMENSIONS			SEAT DIMENSIONS			BACK DIMENSIONS				
			W	D	H	W	D	H	W	H				
			24.25	21.75	32.25	17.75	16.75	17	16.5	16				
	Active weight with casters 300 lbs.; does not stack. Active weight with glides 400 lbs.; stacks 4 high on floor. Add \$15 for (SBS) 2 per carton (pricing and specifications are for one seat unit)													
 <p>Armchair, Polypropylene Back and Upholstered Seat COM Yardage: 0.75 Freight Class: 250 Product Weight (lbs.): 21.38 Cubic Feet Per Carton: 5.56</p>		1/COM	2	3	4	5	6	7	8	9	10	11	12	
	W5APUG with glides	\$627	\$651	\$670	\$698	\$737	\$753	\$787	\$840	\$880	\$924	\$1014	\$1110	
	W5APUC with casters	\$739	\$763	\$782	\$810	\$849	\$865	\$899	\$952	\$992	\$1036	\$1126	\$1222	
				OVERALL DIMENSIONS			SEAT DIMENSIONS			BACK DIMENSIONS				
			W	D	H	W	D	H	W	H				
			24.25	23.5	32	18.25	17.75	18.25	16	15.25				
	Active weight with casters 300 lbs.; does not stack. Active weight with glides 400 lbs.; stacks 4 high on floor. 2 per carton (pricing and specifications are for one seat unit)													
 <p>Armchair, Upholstered Seat and Back COM Yardage: Back: 0.5; Seat: 0.75 Freight Class: 250 Product Weight (lbs.): 21.88 Cubic Feet Per Carton: 5.56</p>		1/COM	2	3	4	5	6	7	8	9	10	11	12	
	W5AUUG with glides	Base Price: \$659 Seat upcharge: +0 Back upcharge: +0	+ \$24	+ \$43	+ \$71	+ \$110	+ \$126	+ \$160	+ \$213	+ \$253	+ \$297	+ \$387	+ \$483	
	W5AUUC with casters	Base Price: \$802 Seat upcharge: +0 Back upcharge: +0	+ \$16	+ \$29	+ \$47	+ \$73	+ \$84	+ \$107	+ \$142	+ \$169	+ \$198	+ \$258	+ \$322	
				OVERALL DIMENSIONS			SEAT DIMENSIONS			BACK DIMENSIONS				
			W	D	H	W	D	H	W	H				
			24.25	22	32.25	18.25	17	18.25	16.5	15.25				
	Active weight with casters 300 lbs.; does not stack. Active weight with glides 400 lbs.; stacks 4 high on floor. Add \$15 for (SBS). 2 per carton (pricing and specifications are for one seat unit)													

DESCRIPTION	FEATURES	MODEL#	STANDARD TEXTILE GRADES											
 <p>Armless Chair, Polypropylene Seat and Back COM Yardage: n/a Freight Class: 250 Product Weight (lbs.): 18 Cubic Feet Per Carton: 4.63</p>		List Price												
	W5NPPG with glides	\$486												
	W5NPPC with casters	\$621												
				OVERALL DIMENSIONS			SEAT DIMENSIONS			BACK DIMENSIONS				
			W	D	H	W	D	H	W	H				
			20.75	23.5	32	17.75	17.5	17	16	16				
	Active weight with casters 300 lbs.; does not stack. Active weight with glides 400 lbs.; stacks 6 high on floor. 2 per carton (pricing and specifications are for one seat unit)													
 <p>Armless Chair, Upholstered Back and Polypropylene Seat COM Yardage: 0.5 Freight Class: 250 Product Weight (lbs.): 18.5 Cubic Feet Per Carton: 4.63</p>		1/COM	2	3	4	5	6	7	8	9	10	11	12	
	W5NUPG with glides	\$578	\$594	\$607	\$625	\$651	\$662	\$685	\$720	\$747	\$776	\$836	\$900	
	W5NUPC with casters	\$689	\$705	\$718	\$736	\$762	\$773	\$796	\$831	\$858	\$887	\$947	\$1011	
				OVERALL DIMENSIONS			SEAT DIMENSIONS			BACK DIMENSIONS				
			W	D	H	W	D	H	W	H				
			20.75	23.5	32.25	17.75	16.75	17	16.5	16				
	Active weight with casters 300 lbs.; does not stack. Active weight with glides 400 lbs.; stacks 4 high on floor. Add \$15 for (SBS) 2 per carton (pricing and specifications are for one seat unit)													
 <p>Armless Chair, Polypropylene Back and Upholstered Seat COM Yardage: 0.75 Freight Class: 250 Product Weight (lbs.): 18.5 Cubic Feet Per Carton: 4.63</p>		1/COM	2	3	4	5	6	7	8	9	10	11	12	
	W5NPUG with glides	\$578	\$602	\$621	\$649	\$688	\$704	\$738	\$791	\$831	\$875	\$965	\$1061	
	W5NPUC with casters	\$689	\$713	\$732	\$760	\$799	\$815	\$849	\$902	\$942	\$986	\$1076	\$1172	
				OVERALL DIMENSIONS			SEAT DIMENSIONS			BACK DIMENSIONS				
			W	D	H	W	D	H	W	H				
			20.75	23.5	32	18.25	17.75	18.25	16	15.25				
	Active weight with casters 300 lbs.; does not stack. Active weight with glides 400 lbs.; stacks 4 high on floor. 2 per carton (pricing and specifications are for one seat unit)													
 <p>Armless Chair, Upholstered Seat and Back COM Yardage: Back: 0.5; Seat: 0.75 Freight Class: 150 Product Weight (lbs.): 19 Cubic Feet Per Carton: 4.63</p>		1/COM	2	3	4	5	6	7	8	9	10	11	12	
	W5NUUG with glides	Base Price: \$612 Seat upcharge: +0 Back upcharge: +0	+0	+\$24	+\$43	+\$71	+\$110	+\$126	+\$160	+\$213	+\$253	+\$297	+\$387	+\$483
	W5NUUC with casters	Base Price: \$752 Seat upcharge: +0 Back upcharge: +0	+0	+\$16	+\$29	+\$47	+\$73	+\$84	+\$107	+\$142	+\$169	+\$198	+\$258	+\$322
				OVERALL DIMENSIONS			SEAT DIMENSIONS			BACK DIMENSIONS				
			W	D	H	W	D	H	W	H				
			20.75	23.5	32.25	18.25	17	18.25	16.5	15.25				
	Active weight with casters 300 lbs.; does not stack. Active weight with glides 400 lbs.; stacks 4 high on floor. Add \$15 for (SBS). 2 per carton (pricing and specifications are for one seat unit)													

DESCRIPTION	FEATURES	MODEL#													
		1/COM	2	3	4	5	6	7	8	9	10	11	12		
 <p>Bariatric Armchair, Upholstered Seat and Back COM Yardage: Back: 0.75; Seat: 1 Freight Class: 250 Product Weight (lbs.): 41 Cubic Feet Per Carton: 20.5</p>	W530AUU	Base Price:	\$1034												
		Seat upcharge:	+0	+\$32	+\$57	+\$94	+\$146	+\$168	+\$213	+\$284	+\$337	+\$395	+\$516	+\$643	
		Back upcharge:	+0	+\$24	+\$43	+\$71	+\$110	+\$126	+\$160	+\$213	+\$253	+\$297	+\$387	+\$483	
				OVERALL DIMENSIONS			SEAT DIMENSIONS			BACK DIMENSIONS					
				W	D	H	W	D	H	W	H				
				35.25	23.5	32.25	29	17	18.25	26.75	15.25				
				Active weight 600 lbs. Stacks 4 high on floor. Caster model not available. Add \$23 for (SBS). One per carton (pricing and specifications are for one seat unit)											

DESCRIPTION	FEATURES	MODEL#													
		1/COM	2	3	4	5	6	7	8	9	10	11	12		
 <p>Bariatric Armless Chair, Upholstered Seat and Back COM Yardage: Back: 0.75; Seat: 1 Freight Class: 250 Product Weight (lbs.): 37.5 Cubic Feet Per Carton: 16.75</p>	W530NUU	Base Price:	\$985												
		Seat upcharge:	+0	+\$32	+\$57	+\$94	+\$146	+\$168	+\$213	+\$284	+\$337	+\$395	+\$516	+\$643	
		Back upcharge:	+0	+\$24	+\$43	+\$71	+\$110	+\$126	+\$160	+\$213	+\$253	+\$297	+\$387	+\$483	
				OVERALL DIMENSIONS			SEAT DIMENSIONS			BACK DIMENSIONS					
				W	D	H	W	D	H	W	H				
				31.75	23.5	32.25	29	17	0	26.75	15.25				
				Active weight 600 lbs. Stacks 4 high on floor. Caster model not available. Add \$23 for (SBS). One per carton (pricing and specifications are for one seat unit)											

DESCRIPTION	FEATURES	MODEL#													
		1/COM	2	3	4	5	6	7	8	9	10	11	12		
 <p>Armchair, Sled Base, Polypropylene Seat and Back COM Yardage: n/a Freight Class: 250 Product Weight (lbs.): 29.5 Cubic Feet Per Carton: 13.25</p>	W6APP	List Price	\$684												
				OVERALL DIMENSIONS			SEAT DIMENSIONS			BACK DIMENSIONS					
				W	D	H	W	D	H	W	H				
				24.25	23.75	32	17.75	17.75	17.75	16	16				
				Active weight 400 lbs. Does not stack.											

DESCRIPTION	FEATURES	MODEL#													
		1/COM	2	3	4	5	6	7	8	9	10	11	12		
 <p>Armchair, Sled Base, Upholstered Back and Polypropylene Seat COM Yardage: 0.5 Freight Class: 250 Product Weight (lbs.): 30 Cubic Feet Per Carton: 13.25</p>	W6AUP		\$752	\$768	\$781	\$799	\$825	\$836	\$859	\$894	\$921	\$950	\$1010	\$1074	
				OVERALL DIMENSIONS			SEAT DIMENSIONS			BACK DIMENSIONS					
				W	D	H	W	D	H	W	H				
				24.25	23.75	32.25	17.75	17.75	17.75	16.5	16				
				Active weight 400 lbs. Does not stack. Add \$15 for (SBS).											

DESCRIPTION	FEATURES	MODEL#													
		1/COM	2	3	4	5	6	7	8	9	10	11	12		
 <p>Armchair, Sled Base, Polypropylene Back and Upholstered Seat COM Yardage: 0.75 Freight Class: 250 Product Weight (lbs.): 30 Cubic Feet Per Carton: 13.25</p>	W6APU		\$752	\$776	\$795	\$823	\$862	\$878	\$912	\$965	\$1005	\$1049	\$1139	\$1235	
				OVERALL DIMENSIONS			SEAT DIMENSIONS			BACK DIMENSIONS					
				W	D	H	W	D	H	W	H				
				24.25	23.75	32	18.25	17.75	18.25	16	15.25				
				Active weight 400 lbs. Does not stack.											

DESCRIPTION	FEATURES	MODEL#	STANDARD TEXTILE GRADES													
			1/COM	2	3	4	5	6	7	8	9	10	11	12		
	W6AUU	Base Price:	\$815													
		Seat upcharge:	+0	+\$24	+\$43	+\$71	+\$110	+\$126	+\$160	+\$213	+\$253	+\$297	+\$387	+\$483		
		Back upcharge:	+0	+\$32	+\$57	+\$94	+\$146	+\$168	+\$213	+\$284	+\$337	+\$395	+\$516	+\$643		
			OVERALL DIMENSIONS			SEAT DIMENSIONS			BACK DIMENSIONS							
			W	D	H	W	D	H	W	H						
			24.25	23.75	32.25	18.25	16.5	18.25	16.5	15.25						
Armchair, Sled Base, Upholstered Seat and Back			Active weight 400 lbs. Does not stack.													
COM Yardage: Back: 0.5; Seat: 0.75			Add \$15 for (SBS).													
Freight Class: 250																
Product Weight (lbs.): 30.5																
Cubic Feet Per Carton: 13.25																

DESCRIPTION	FEATURES	MODEL#	STANDARD TEXTILE GRADES													
			1/COM	2	3	4	5	6	7	8	9	10	11	12		
	W6NPP		List Price													
			\$634													
				OVERALL DIMENSIONS			SEAT DIMENSIONS			BACK DIMENSIONS						
			W	D	H	W	D	H	W	H						
			20.75	23.5	32	17.75	17.75	17.75	16	16						
Armless Chair, Sled Base, Polypropylene Seat and Back			Active weight 400 lbs. Does not stack.													
COM Yardage: n/a																
Freight Class: 250																
Product Weight (lbs.): 26.5																
Cubic Feet Per Carton: 11.75																

DESCRIPTION	FEATURES	MODEL#	STANDARD TEXTILE GRADES												
			1/COM	2	3	4	5	6	7	8	9	10	11	12	
	W6NUP		\$703	\$719	\$732	\$750	\$776	\$787	\$810	\$845	\$872	\$901	\$961	\$1025	
				OVERALL DIMENSIONS			SEAT DIMENSIONS			BACK DIMENSIONS					
				W	D	H	W	D	H	W	H				
			20.75	23.5	32.25	17.75	17.75	17.75	16.5	16					
Armless Chair, Sled Base, Upholstered Back and Polypropylene Seat			Active weight 400 lbs. Does not stack.												
COM Yardage: n/a			Add \$15 for (SBS)												
Freight Class: 250															
Product Weight (lbs.): 27															
Cubic Feet Per Carton: 11.75															

DESCRIPTION	FEATURES	MODEL#	STANDARD TEXTILE GRADES											
			1/COM	2	3	4	5	6	7	8	9	10	11	12
	W6NPU		List Price											
			\$703	\$727	\$746	\$774	\$813	\$829	\$863	\$916	\$956	\$1000	\$1090	\$1186
				OVERALL DIMENSIONS			SEAT DIMENSIONS			BACK DIMENSIONS				
			W	D	H	W	D	H	W	H				
			20.75	23.5	32	18.25	17.75	18.25	16	15.25				
Armless Chair, Sled Base, Polypropylene Back and Upholstered Seat			Active weight 400 lbs. Does not stack.											
COM Yardage: 0.75														
Freight Class: 250														
Product Weight (lbs.): 27														
Cubic Feet Per Carton: 11.75														

DESCRIPTION	FEATURES	MODEL#	STANDARD TEXTILE GRADES												
			1/COM	2	3	4	5	6	7	8	9	10	11	12	
	W6NUU	Base Price:	\$766												
		Seat upcharge:	+0	+\$24	+\$43	+\$71	+\$110	+\$126	+\$160	+\$213	+\$253	+\$297	+\$387	+\$483	
		Back upcharge:	+0	+\$16	+\$29	+\$47	+\$73	+\$84	+\$107	+\$142	+\$169	+\$198	+\$258	+\$322	
			OVERALL DIMENSIONS			SEAT DIMENSIONS			BACK DIMENSIONS						
			W	D	H	W	D	H	W	H					
			20.75	23.5	32.25	18.25	16.5	18.25	16.5	15.25					
Armless Chair, Sled Base, Upholstered Seat and Back			Active weight 400 lbs. Does not stack.												
COM Yardage: Back: 0.5; Seat: 0.75			Add \$15 for (SBS).												
Freight Class: 250															
Product Weight (lbs.): 27.5															
Cubic Feet Per Carton: 11.75															





DESCRIPTION	FEATURES	MODEL#	STANDARD TEXTILE GRADES										
			1/COM	2	3	4	5	6	7	8	9	10	11
 <p>Counter Stool with Arms, Upholstered Seat and Back COM Yardage: Back: 0.5; Seat: 0.75 Freight Class: 250 Product Weight (lbs.): 33.5 Cubic Feet Per Carton: 15</p>	<p>W5CSAUU Base Price: \$880 Seat upcharge: +\$24 Back upcharge: +\$16</p>	<p>1/COM 2 3 4 5 6 7 8 9 10 11 12</p>	<p>OVERALL DIMENSIONS</p>			<p>SEAT DIMENSIONS</p>			<p>BACK DIMENSIONS</p>				
			W	D	H	W	D	H	W	H			
			24.25	23.5	38.25	18.25	17	24.25	16.5	15.25			
<p>Active weight 400 lbs. Does not stack. Add \$15 for (SBS).</p>													

DESCRIPTION	FEATURES	MODEL#	STANDARD TEXTILE GRADES										
			1/COM	2	3	4	5	6	7	8	9	10	11
 <p>Armless Counter Stool, Polypropylene Seat and Back COM Yardage: n/a Freight Class: 250 Product Weight (lbs.): 29.5 Cubic Feet Per Carton: 13.75</p>	<p>W5CSNPP</p>	<p>1/COM 2 3 4 5 6 7 8 9 10 11 12</p>	<p>OVERALL DIMENSIONS</p>			<p>SEAT DIMENSIONS</p>			<p>BACK DIMENSIONS</p>				
			W	D	H	W	D	H	W	H			
			21.75	23.5	38.25	17.75	17.15	23.25	16	16			
<p>Active weight 400 lbs. Stacks 4 high on floor.</p>													

DESCRIPTION	FEATURES	MODEL#	STANDARD TEXTILE GRADES										
			1/COM	2	3	4	5	6	7	8	9	10	11
 <p>Armless Counter Stool, Upholstered Back and Polypropylene Seat COM Yardage: 0.5 Freight Class: 250 Product Weight (lbs.): 30 Cubic Feet Per Carton: 13.75</p>	<p>W5CSNUP</p>	<p>1/COM 2 3 4 5 6 7 8 9 10 11 12</p>	<p>OVERALL DIMENSIONS</p>			<p>SEAT DIMENSIONS</p>			<p>BACK DIMENSIONS</p>				
			W	D	H	W	D	H	W	H			
			21.75	23.5	38.25	17.75	16.5	23.25	16.5	16			
<p>Active weight 400 lbs. Stacks 4 high on floor. Add \$15 for (SBS).</p>													

DESCRIPTION	FEATURES	MODEL#	STANDARD TEXTILE GRADES										
			1/COM	2	3	4	5	6	7	8	9	10	11
 <p>Armless Counter Stool, Polypropylene Back and Upholstered Seat COM Yardage: 0.75 Freight Class: 250 Product Weight (lbs.): 30 Cubic Feet Per Carton: 13.75</p>	<p>W5CSNPU</p>	<p>1/COM 2 3 4 5 6 7 8 9 10 11 12</p>	<p>OVERALL DIMENSIONS</p>			<p>SEAT DIMENSIONS</p>			<p>BACK DIMENSIONS</p>				
			W	D	H	W	D	H	W	H			
			21.75	23.5	38.25	18.25	17.75	24.25	16	15.25			
<p>Active weight 400 lbs. Stacks 4 high on floor.</p>													

DESCRIPTION	FEATURES	MODEL#	STANDARD TEXTILE GRADES										
			1/COM	2	3	4	5	6	7	8	9	10	11
 <p>Armless Counter Stool, Upholstered Seat and Back COM Yardage: Back: 0.5; Seat: 0.75 Freight Class: 250 Product Weight (lbs.): 30.5 Cubic Feet Per Carton: 13.75</p>	<p>W5CSNUU Base Price: \$830 Seat upcharge: +\$24 Back upcharge: +\$16</p>	<p>1/COM 2 3 4 5 6 7 8 9 10 11 12</p>	<p>OVERALL DIMENSIONS</p>			<p>SEAT DIMENSIONS</p>			<p>BACK DIMENSIONS</p>				
			W	D	H	W	D	H	W	H			
			21.75	23.5	38.25	18.25	17	24.25	16.5	15.25			
<p>Active weight 400 lbs. Stacks 4 high on floor. Add \$15 for (SBS).</p>													

DESCRIPTION	FEATURES	MODEL#	STANDARD TEXTILE GRADES																																																	
 <p>Bar Stool with Arms, Polypropylene Seat and Back COM Yardage: n/a Freight Class: 250 Product Weight (lbs.): 34.5 Cubic Feet Per Carton: 17</p>	<p>W5BSAPP</p> <p>Active weight 400 lbs. Stacks 4 high on floor.</p>	List Price																																																		
		\$759																																																		
		<table border="1"> <thead> <tr> <th colspan="3">OVERALL DIMENSIONS</th> <th colspan="3">SEAT DIMENSIONS</th> <th colspan="2">BACK DIMENSIONS</th> </tr> <tr> <th>W</th> <th>D</th> <th>H</th> <th>W</th> <th>D</th> <th>H</th> <th>W</th> <th>H</th> </tr> </thead> <tbody> <tr> <td>24.25</td> <td>23.5</td> <td>44</td> <td>17.75</td> <td>17.5</td> <td>29.25</td> <td>16</td> <td>16</td> </tr> </tbody> </table>			OVERALL DIMENSIONS			SEAT DIMENSIONS			BACK DIMENSIONS		W	D	H	W	D	H	W	H	24.25	23.5	44	17.75	17.5	29.25	16	16																								
OVERALL DIMENSIONS			SEAT DIMENSIONS			BACK DIMENSIONS																																														
W	D	H	W	D	H	W	H																																													
24.25	23.5	44	17.75	17.5	29.25	16	16																																													
 <p>Bar Stool with Arms, Upholstered Back and Polypropylene Seat COM Yardage: 0.5 Freight Class: 250 Product Weight (lbs.): 35 Cubic Feet Per Carton: 17</p>	<p>W5BSAUP</p> <p>Active weight 400 lbs. Stacks 4 high on floor. Add \$15 for (SBS).</p>	1/COM 2 3 4 5 6 7 8 9 10 11 12																																																		
		<table border="1"> <tbody> <tr> <td>\$828</td> <td>\$844</td> <td>\$857</td> <td>\$875</td> <td>\$901</td> <td>\$912</td> <td>\$935</td> <td>\$970</td> <td>\$997</td> <td>\$1026</td> <td>\$1086</td> <td>\$1150</td> </tr> </tbody> </table>												\$828	\$844	\$857	\$875	\$901	\$912	\$935	\$970	\$997	\$1026	\$1086	\$1150																											
		\$828	\$844	\$857	\$875	\$901	\$912	\$935	\$970	\$997	\$1026	\$1086	\$1150																																							
<table border="1"> <thead> <tr> <th colspan="3">OVERALL DIMENSIONS</th> <th colspan="3">SEAT DIMENSIONS</th> <th colspan="2">BACK DIMENSIONS</th> </tr> <tr> <th>W</th> <th>D</th> <th>H</th> <th>W</th> <th>D</th> <th>H</th> <th>W</th> <th>H</th> </tr> </thead> <tbody> <tr> <td>24.25</td> <td>23.5</td> <td>44.5</td> <td>17.75</td> <td>16.5</td> <td>29.25</td> <td>16.5</td> <td>16</td> </tr> </tbody> </table>			OVERALL DIMENSIONS			SEAT DIMENSIONS			BACK DIMENSIONS		W	D	H	W	D	H	W	H	24.25	23.5	44.5	17.75	16.5	29.25	16.5	16																										
OVERALL DIMENSIONS			SEAT DIMENSIONS			BACK DIMENSIONS																																														
W	D	H	W	D	H	W	H																																													
24.25	23.5	44.5	17.75	16.5	29.25	16.5	16																																													
 <p>Bar Stool with Arms, Polypropylene Back and Upholstered Seat COM Yardage: 0.75 Freight Class: 250 Product Weight (lbs.): 35 Cubic Feet Per Carton: 17</p>	<p>W5BSAPU</p> <p>Active weight 400 lbs. Stacks 4 high on floor.</p>	1/COM 2 3 4 5 6 7 8 9 10 11 12																																																		
		<table border="1"> <tbody> <tr> <td>\$828</td> <td>\$852</td> <td>\$871</td> <td>\$899</td> <td>\$938</td> <td>\$954</td> <td>\$988</td> <td>\$1041</td> <td>\$1081</td> <td>\$1125</td> <td>\$1215</td> <td>\$1311</td> </tr> </tbody> </table>												\$828	\$852	\$871	\$899	\$938	\$954	\$988	\$1041	\$1081	\$1125	\$1215	\$1311																											
		\$828	\$852	\$871	\$899	\$938	\$954	\$988	\$1041	\$1081	\$1125	\$1215	\$1311																																							
<table border="1"> <thead> <tr> <th colspan="3">OVERALL DIMENSIONS</th> <th colspan="3">SEAT DIMENSIONS</th> <th colspan="2">BACK DIMENSIONS</th> </tr> <tr> <th>W</th> <th>D</th> <th>H</th> <th>W</th> <th>D</th> <th>H</th> <th>W</th> <th>H</th> </tr> </thead> <tbody> <tr> <td>24.25</td> <td>23.5</td> <td>44</td> <td>18.25</td> <td>17.5</td> <td>30.25</td> <td>16</td> <td>15.25</td> </tr> </tbody> </table>			OVERALL DIMENSIONS			SEAT DIMENSIONS			BACK DIMENSIONS		W	D	H	W	D	H	W	H	24.25	23.5	44	18.25	17.5	30.25	16	15.25																										
OVERALL DIMENSIONS			SEAT DIMENSIONS			BACK DIMENSIONS																																														
W	D	H	W	D	H	W	H																																													
24.25	23.5	44	18.25	17.5	30.25	16	15.25																																													
 <p>Bar Stool with Arms, Upholstered Seat and Back COM Yardage: Back: 0.5; Seat: 0.75 Freight Class: 250 Product Weight (lbs.): 35.5 Cubic Feet Per Carton: 17</p>	<p>W5BSAUU</p> <p>Base Price: Seat upcharge: Back upcharge:</p>	1/COM 2 3 4 5 6 7 8 9 10 11 12																																																		
		<table border="1"> <tbody> <tr> <td>\$891</td> <td></td> <td></td> <td></td> <td></td> <td></td> <td></td> <td></td> <td></td> <td></td> <td></td> <td></td> <td></td> </tr> <tr> <td>+0</td> <td>+\$24</td> <td>+\$43</td> <td>+\$71</td> <td>+\$110</td> <td>+\$126</td> <td>+\$160</td> <td>+\$213</td> <td>+\$253</td> <td>+\$297</td> <td>+\$387</td> <td>+\$483</td> <td></td> </tr> <tr> <td>+0</td> <td>+\$16</td> <td>+\$29</td> <td>+\$47</td> <td>+\$73</td> <td>+\$84</td> <td>+\$107</td> <td>+\$142</td> <td>+\$169</td> <td>+\$198</td> <td>+\$258</td> <td>+\$322</td> <td></td> </tr> </tbody> </table>												\$891													+0	+\$24	+\$43	+\$71	+\$110	+\$126	+\$160	+\$213	+\$253	+\$297	+\$387	+\$483		+0	+\$16	+\$29	+\$47	+\$73	+\$84	+\$107	+\$142	+\$169	+\$198	+\$258	+\$322	
		\$891																																																		
+0	+\$24	+\$43	+\$71	+\$110	+\$126	+\$160	+\$213	+\$253	+\$297	+\$387	+\$483																																									
+0	+\$16	+\$29	+\$47	+\$73	+\$84	+\$107	+\$142	+\$169	+\$198	+\$258	+\$322																																									
<table border="1"> <thead> <tr> <th colspan="3">OVERALL DIMENSIONS</th> <th colspan="3">SEAT DIMENSIONS</th> <th colspan="2">BACK DIMENSIONS</th> </tr> <tr> <th>W</th> <th>D</th> <th>H</th> <th>W</th> <th>D</th> <th>H</th> <th>W</th> <th>H</th> </tr> </thead> <tbody> <tr> <td>24.25</td> <td>23.5</td> <td>44.5</td> <td>18.25</td> <td>16.75</td> <td>30.25</td> <td>16.5</td> <td>15.25</td> </tr> </tbody> </table>			OVERALL DIMENSIONS			SEAT DIMENSIONS			BACK DIMENSIONS		W	D	H	W	D	H	W	H	24.25	23.5	44.5	18.25	16.75	30.25	16.5	15.25																										
OVERALL DIMENSIONS			SEAT DIMENSIONS			BACK DIMENSIONS																																														
W	D	H	W	D	H	W	H																																													
24.25	23.5	44.5	18.25	16.75	30.25	16.5	15.25																																													
 <p>Armless Bar Stool, Polypropylene Seat and Back COM Yardage: n/a Freight Class: 250 Product Weight (lbs.): 31.5 Cubic Feet Per Carton: 15.75</p>	<p>W5BSNPP</p> <p>Active weight 400 lbs. Stacks 4 high on floor.</p>	List Price																																																		
		\$710																																																		
		<table border="1"> <thead> <tr> <th colspan="3">OVERALL DIMENSIONS</th> <th colspan="3">SEAT DIMENSIONS</th> <th colspan="2">BACK DIMENSIONS</th> </tr> <tr> <th>W</th> <th>D</th> <th>H</th> <th>W</th> <th>D</th> <th>H</th> <th>W</th> <th>H</th> </tr> </thead> <tbody> <tr> <td>20.75</td> <td>23.5</td> <td>44</td> <td>17.75</td> <td>17.5</td> <td>29.25</td> <td>16</td> <td>16</td> </tr> </tbody> </table>			OVERALL DIMENSIONS			SEAT DIMENSIONS			BACK DIMENSIONS		W	D	H	W	D	H	W	H	20.75	23.5	44	17.75	17.5	29.25	16	16																								
OVERALL DIMENSIONS			SEAT DIMENSIONS			BACK DIMENSIONS																																														
W	D	H	W	D	H	W	H																																													
20.75	23.5	44	17.75	17.5	29.25	16	16																																													





DESCRIPTION	FEATURES	MODEL#											
		1/COM	2	3	4	5	6	7	8	9	10	11	12
	W5BSNUP	\$779	\$795	\$808	\$826	\$852	\$863	\$886	\$921	\$948	\$977	\$1037	\$1101
		OVERALL DIMENSIONS			SEAT DIMENSIONS			BACK DIMENSIONS					
		W	D	H	W	D	H	W	H				
		20.75	23.5	44.5	17.75	16.5	29.25	16.5	16				
Armless Bar Stool, Upholstered Back and Polypropylene Seat COM Yardage: 0.5 Freight Class: 250 Product Weight (lbs.): 32 Cubic Feet Per Carton: 15.75	Active weight 400 lbs. Stacks 4 high on floor. Add \$15 for (SBS).												

DESCRIPTION	FEATURES	MODEL#											
		1/COM	2	3	4	5	6	7	8	9	10	11	12
	W5BSNPU	\$779	\$803	\$822	\$850	\$889	\$905	\$939	\$992	\$1032	\$1076	\$1166	\$1262
		OVERALL DIMENSIONS			SEAT DIMENSIONS			BACK DIMENSIONS					
		W	D	H	W	D	H	W	H				
		20.75	23.5	44	18.25	17.5	30.25	16	15.25				
Armless Bar Stool, Polypropylene Back and Upholstered Seat COM Yardage: 0.75 Freight Class: 250 Product Weight (lbs.): 32 Cubic Feet Per Carton: 15.75	Active weight 400 lbs. Stacks 4 high on floor.												

DESCRIPTION	FEATURES	MODEL#											
		1/COM	2	3	4	5	6	7	8	9	10	11	12
	W5BSNUU	Base Price: \$842											
		Seat upcharge: +0	+\$24	+\$43	+\$71	+\$110	+\$126	+\$160	+\$213	+\$253	+\$297	+\$387	+\$483
		Back upcharge: +0	+\$16	+\$29	+\$47	+\$73	+\$84	+\$107	+\$142	+\$169	+\$198	+\$258	+\$322
		OVERALL DIMENSIONS			SEAT DIMENSIONS			BACK DIMENSIONS					
		W	D	H	W	D	H	W	H				
		20.75	23.5	44.5	18.25	16.75	30.25	16.5	15.25				
Armless Bar Stool, Upholstered Seat and Back COM Yardage: Back: 0.5; Seat: 0.75 Freight Class: 250 Product Weight (lbs.): 32.5 Cubic Feet Per Carton: 15.75	Active weight 400 lbs. Stacks 4 high on floor. Add \$15 for (SBS).												

DESCRIPTION	FEATURES	MODEL#											
		List Price											
	W524APP	\$771											
		OVERALL DIMENSIONS			SEAT DIMENSIONS			BACK DIMENSIONS					
		W	D	H	W	D	H	W	H				
		24.25	24.25	38	17.75	17.5	22.25	16	16				
Hip Chair, Polypropylene Seat and Back COM Yardage: n/a Freight Class: 250 Product Weight (lbs.): 35.5 Cubic Feet Per Carton: 17.75	Active weight 400 lbs. Does not stack.												

DESCRIPTION	FEATURES	MODEL#											
		1/COM	2	3	4	5	6	7	8	9	10	11	12
	W524AUP	\$839	\$855	\$868	\$886	\$912	\$923	\$946	\$981	\$1008	\$1037	\$1097	\$1161
		OVERALL DIMENSIONS			SEAT DIMENSIONS			BACK DIMENSIONS					
		W	D	H	W	D	H	W	H				
		24.25	24.25	38.25	17.75	16.5	22.25	16.5	16.25				
Hip Chair, Upholstered Back and Polypropylene Seat COM Yardage: 0.5 Freight Class: 250 Product Weight (lbs.): 36 Cubic Feet Per Carton: 17.75	Active weight 400 lbs. Does not stack. Add \$15 for (SBS).												

DESCRIPTION	FEATURES	MODEL#													
		1/COM	2	3	4	5	6	7	8	9	10	11	12		
 <p>Hip Chair, Polypropylene Back and Upholstered Seat COM Yardage: 0.75 Freight Class: 250 Product Weight (lbs.): 36 Cubic Feet Per Carton: 17.75</p>	<p>Active weight 400 lbs. Does not stack.</p>	\$839	\$863	\$882	\$910	\$949	\$965	\$999	\$1052	\$1092	\$1136	\$1226	\$1322		
		OVERALL DIMENSIONS			SEAT DIMENSIONS			BACK DIMENSIONS							
		W	D	H	W	D	H	W	H						
		24.25	24.25	38	18.25	17.5	23.25	16	15.25						
 <p>Hip Chair, Upholstered Seat and Back COM Yardage: Back: 0.5; Seat: 0.75 Freight Class: 250 Product Weight (lbs.): 36.5 Cubic Feet Per Carton: 17.75</p>	<p>Active weight 400 lbs. Does not stack. Add \$15 for (SBS).</p>	1/COM	2	3	4	5	6	7	8	9	10	11	12		
		W524AUU	Base Price:	\$902											
			Seat upcharge:	+0	+\$24	+\$43	+\$71	+\$110	+\$126	+\$160	+\$213	+\$253	+\$297	+\$387	+\$483
			Back upcharge:	+0	+\$16	+\$29	+\$47	+\$73	+\$84	+\$107	+\$142	+\$169	+\$198	+\$258	+\$322
OVERALL DIMENSIONS			SEAT DIMENSIONS			BACK DIMENSIONS									
W	D	H	W	D	H	W	H								
24.25	24.25	38.25	18.25	16.5	23.25	16.5	15.25								
 <p>Bariatric Hip Chair, Upholstered Seat and Back COM Yardage: Back: 0.75; Seat: 1 Freight Class: 250 Product Weight (lbs.): 50 Cubic Feet Per Carton: 23.75</p>	<p>Active weight 600 lbs. Does not stack. Add \$23 for (SBS).</p>	1/COM	2	3	4	5	6	7	8	9	10	11	12		
		W324AUU	Base Price:	\$1188											
			Seat upcharge:	+0	+\$32	+\$57	+\$94	+\$146	+\$168	+\$213	+\$284	+\$337	+\$395	+\$516	+\$643
			Back upcharge:	+0	+\$24	+\$43	+\$71	+\$110	+\$126	+\$160	+\$213	+\$253	+\$297	+\$387	+\$483
OVERALL DIMENSIONS			SEAT DIMENSIONS			BACK DIMENSIONS									
W	D	H	W	D	H	W	H								
35.25	24.25	38.5	29	17.5	23.25	26.75	15.25								
 <p>Dolly COM Yardage: n/a Freight Class: 150 Product Weight (lbs.): 16 Cubic Feet Per Carton: 3.5</p>	<p>Accommodates 10 standard 4-legged chairs.</p>	List Price													
		WDOL	\$348												
		OVERALL DIMENSIONS			SEAT DIMENSIONS			BACK DIMENSIONS							
		W	D	H	W	D	H	W	H						
22	23.75	9.25													
 <p>Bariatric Dolly COM Yardage: n/a Freight Class: 250 Product Weight (lbs.): 19 Cubic Feet Per Carton: 5</p>	<p>Accommodates 4 bariatric 4-legged chairs.</p>	List Price													
		WDOL30	\$386												
		OVERALL DIMENSIONS			SEAT DIMENSIONS			BACK DIMENSIONS							
		W	D	H	W	D	H	W	H						
32.12	23.75	9.25													

WILLOW LINKING TABLES



WPT12G
120 degree corner linking table



WPT12GL
End linking table, left



For Willow seating, see page 254.

STANDARD FEATURES







- Linking tables can be used together in any combination with Willow four-leg or sled chairs to create a wide variety of layouts.
- Connecting hardware is included.
- Legs and ganging brackets are available in 20 paint finishes and 4 plated finishes.
- All tables are laminate, choose thermally fused or high pressure, and feature a flat edge with edgeband.
- Tables are available with a variety of glide types. Glides must be chosen to best suit flooring type and site conditions. See Glide Type.
- All tables (except 9" In-line Linking) are pre-drilled for center front, field installed, undermount power. Specified separately.
- Undermount power unit (SU2P10U) includes 1 AC and 2 USB-A charging ports with a 10' power cord and 3-prong plug, specify Jet Black or White. Power units do not link.
- Clamp mount (SU2P10C) power, with 1 AC and 2 USB-A charging ports with a 10' power cord, available Jet Black or White. These units can be mounted on the back edge of all linking tables. Specified separately for field installation. Power units do not link.

Add option codes in the following order:

- **Model number**
Enter model number.
- **Surface Type**
(**TFL**) Thermally fused laminate
(**HPL**) High pressure laminate
- **Top finish**
(**ACJ**) Absolute Acajou
(**ASN**) Asian Night
(**AWC**) Avant Cherry
(**AWH**) Avant Honey
(**BLK**) Black
(**BRC**) Brushed Cobalt
(**BZD**) Blizzard
(**CGY**) Custom Grey
(**CMB**) Clear Maple
(**DES**) Dark Espresso
(**DWT**) Designer White
(**FAS**) Fashionista
(**FCL**) First Class
(**NBL**) Noce Biondo
(**NGL**) Noce Grigio
(**NEL**) Noce Leggero
(**NML**) Noce Medio
(**QTM**) Quartered Mahogany
(**SBY**) Sheer Beauty
(**SDT**) Stonedust
(**SGG**) Storm Grey
(**WCR**) Winter Cherry
(**WHC**) White Chocolate
(**WHE**) Walnut Heights
- **Leg Finish** (for tables with legs)
Paint finishes:
Black (**TBL**), Buzz Blue (**TBZ**), Cactus (**TCC**), Carrot (**TCR**), Cloud (**TIV**), Designer White (**TDW**), Dijon (**TDJ**), Eggplant (**TEG**), Fog (**TFO**), Frost (**TFR**), Ink (**TIN**), Kalua (**TKA**), Latte (**TLA**), Mocha (**TMO**), Nevada (**TNE**), Sand (**TSN**), Scarlet (**TSR**), Shadow (**TSH**), Toast (**TOA**) and Tungsten (**TTU**).
Plated finishes:
(**CHM**) Chrome. Add \$42.
(**BCH**) Brushed Chrome. Add \$147.
(**SBR**) Satin Brass. Add \$217.
(**ACO**) Antique Copper. Add \$217.
- **Bracket Finish** (for linking tables and ganging bracket)
Paint finishes:
Black (**TBL**), Cloud (**TIV**), Designer White (**TDW**), Fog (**TFO**), Frost (**TFR**), Kalua (**TKA**), Latte (**TLA**), Mocha (**TMO**), Nevada (**TNE**), Sand (**TSN**), Shadow (**TSH**), Toast (**TOA**) and Tungsten (**TTU**).
- **Glide type** (for models with legs)
(**ST**) Nylon colored glide for most surfaces
(**NM**) White, non-marking Nylon glide for most surfaces
(**SG**) Steel cushion glide for carpeted surfaces. Add \$8 for models with one leg. Add \$15 for models with two legs.
(**FG**) Felt glide for most hard floor surfaces. Add \$8 for models with one leg. Add \$15 for models with two legs.
(**RG**) Rubber, non-slip glide for most hard floor surfaces. Add \$8 for models with one leg. Add \$15 for models with two legs.
- **Glide Finish** (for ST glides only)
(**BLK**) Black
(**SND**) Sand

EXAMPLE WILLOW TABLE ORDER CODE:

WPT90G	HPL	ACJ	-CHM	-ST	-SND
Model #	Surface type	Top finish	Leg finish	Glide type	Glide finish

TABLES	MODEL#	DIMENSIONS	FREIGHT CLASS	WT/LBS.	CUBIC FT.	LIST PRICE
 <p>90° Corner Linking Table</p>	WPT90G	26.12 x 26.12 x 17.62	100	24	2.6	\$561
						<ul style="list-style-type: none"> • Pricing shown for a thermally fused laminate top (LP). • For a high pressure laminate top (HP), add \$144. <p>Coordinating edge on laminate surfaces with metal frame and legs. Must be connected to a four-leg or sled base chair. Includes one set of U-channel connectors and hardware. 1 per carton. Shipped KD for assembly on site.</p>
 <p>120° Corner Linking Table</p>	WPT12G	31 x 12.62 x 17.5	92.5	16.5	1.5	\$482
						<ul style="list-style-type: none"> • Pricing shown for a thermally fused laminate top (LP). • For a high pressure laminate top (HP), add \$92. <p>Coordinating edge on laminate surfaces with metal frame and legs. Must be connected to a four-leg or sled base chair. Includes one set of U-channel connectors and hardware. 1 per carton. Shipped KD for assembly on site.</p>
 <p>16" In-Line Linking Table</p>	WPT16G	15 x 16 x 2.75	85	12	0.9	\$315
						<ul style="list-style-type: none"> • Pricing shown for a thermally fused laminate top (LP). • For a high pressure laminate top (HP), add \$58. <p>Coordinating edge on laminate surfaces with metal frame and legs. Must be connected to a four-leg or sled base chair. Includes one set of U-channel connectors and hardware. 1 per carton. Shipped KD for assembly on site.</p>
 <p>9" In-Line Linking Table</p>	WPT09G		85	8.5	0.7	\$245
						<ul style="list-style-type: none"> • Pricing shown for a thermally fused laminate top (LP). • For a high pressure laminate top (HP), add \$41. <p>Coordinating edge on laminate surfaces with metal frame and legs. Must be connected to a four-leg or sled base chair. Includes one set of U-channel connectors and hardware. 1 per carton. Shipped KD for assembly on site.</p>
 <p>End Linking Table</p>	WPT EGL (Left)	15 x 14 x 17.62	85	13	1	\$489
	WPT EGR (Right)	15 x 14 x 17.62	85	13	1	\$489
						<ul style="list-style-type: none"> • Pricing shown for a thermally fused laminate top (LP). • For a high pressure laminate top (HP), add \$55. <p>Coordinating edge on laminate surfaces with metal frame and legs. Must be connected to a four-leg or sled base chair. Includes one set of U-channel connectors and hardware. 1 per carton. Shipped KD for assembly on site.</p>
 <p>Ganging Bracket</p>	WPGBRK	9 x 15 x 1.25	300	2	2	\$108
						<p>For use between two seated height arm or armless chairs where table top is not desired. Not for use with stools. Does not accept power units. 1 per carton.</p>

TABLES	MODEL#	DIMENSIONS	FREIGHT CLASS	WT/LBS.	CUBIC FT.	LIST PRICE
--------	--------	------------	---------------	---------	-----------	------------



Power Unit, Clamp Attachment

SU2P10C			70	0.01	0.5	\$557
---------	--	--	----	------	-----	--------------

Tamper-resistant clamp mount power, with 1 AC and 2 USB-A charging ports with a 10' power cord and 3-prong plug. Available in Jet Black or White. Can be mounted on the back edge of all linking tables. Must be specified separately for field installation. Power units do not link.



Power Unit, Under Mount Attachment

SU2P10U			70	0.01	2	\$527
---------	--	--	----	------	---	--------------

Tamper-resistant undermount power, with 1 AC and 2 USB-A charging ports with a 10' power cord and 3-prong plug. Available in Jet Black or White. Must be specified separately for field installation. Power units do not link.

ZOMA™



model 6656



model 6657



STANDARD FEATURES

- Design sensitive guest seating featuring a wide flat, flared arms and elliptical tubular construction.
- The back of the chair is heavily compound curved to provide comfort and support in multiple seating positions.
- No visible back attachment hardware. Backs are attached using concealed hardware only.
- The outer back is upholstered in the same material selection as the rest of the chair.
- Arms are wide and full length, offering support to help stabilize the user as they sit in or exit chairs.
- The gently curved arms are made from incredibly strong black fiberglass reinforced nylon.
- The rugged frame is made from welded elliptical (oval) steel tubing 1.5" wide.
- Chairs are "Wall Safe," rear legs hit the baseboard first leaving clearance between the back of the chair and the wall; Thus saving both the chair and the wall from damage. Legs flair out to the rear to provide additional support.

- Zoma is equipped with a polypropylene seat shroud that helps stabilize chairs when stacked and avoid frame imprints on upholstered seats.
- Stacks up to 4 high on the floor or on a dolly (2125WS).
- Standard glide is a durable Black Polypropylene oval glide.
- Check textile availability prior to specifying upholstery material.

OPTIONAL FEATURES

- Frame is standard in a choice of Black (**TBL**), Shadow (**TSH**) or Tungsten (**TTU**) Finish must be specified. A chrome frame is optionally available. Please Specify (**CHM**), add \$44.
- A durable polypropylene outer back shroud is available at no charge. Optional shroud is Black only. Please specify (**PSB**).
- For chairs used on hard surface floors PLEASE SPECIFY Opaque (**off White**), Non-Marking Glides (**NM**).

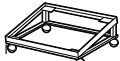
DESCRIPTION	FEATURES	MODEL#	STANDARD TEXTILE GRADES													
			1	2	3	4	5	6	7	8	9	10	11	12		
 <p>Armchair COM Yardage: 1.25 Freight Class: 250 Product Weight (lbs.): 28 Cubic Feet Per Carton: 13.75</p>	<p>Stacks 4 high on floor or dolly.</p> <p>Ergonomic Features: M, N</p>	6656	\$616	\$663	\$700	\$749	\$824	\$851	\$915	\$1038	\$1098	\$1210	\$1368	\$1561		
		OVERALL DIMENSIONS			SEAT DIMENSIONS			BACK DIMENSIONS								
		W	D	H	W	D	H	W	H							
		26.5	24	32.5	20	19	17	18	15							
 <p>Armless Side Chair COM Yardage: 1.25 Freight Class: 250 Product Weight (lbs.): 26 Cubic Feet Per Carton: 11.75</p>	<p>Stacks 4 high on floor or dolly.</p> <p>Ergonomic Features: M, N</p>	6657	\$562	\$608	\$645	\$694	\$770	\$796	\$859	\$984	\$1044	\$1156	\$1313	\$1506		
		OVERALL DIMENSIONS			SEAT DIMENSIONS			BACK DIMENSIONS								
		W	D	H	W	D	H	W	H							
		22.5	24	32.5	20	19	17	18	15							
 <p>Dolly COM Yardage: N/A Freight Class: 150 Product Weight (lbs.): 16 Cubic Feet Per Carton: 3.8</p>		2125WS	\$452	-	-	-	-	-	-	-	-	-	-	-		
		OVERALL DIMENSIONS			SEAT DIMENSIONS			BACK DIMENSIONS								
		W	D	H	W	D	H	W	H							
		23.25	24.75	12.25	-	-	-	-	-							

lounge

Ballara	270	Drift	318	River+	364
Braden	282	Jeo	336	Sirena	396
Bridges II Collaborative Seating	285	Kate	339	Venture	400
calidon	293	Lux	340	Vitrola	403
calidon tables	296	ML	342	Wind	405
Camino	299	ML Park	344	Wind Linear	407
Citi	304	Prairie	345		
Citi Square	309	River	346		

BALLARA™



model 9751

model 9751NA & 9757L



Quilted Seat Option
See optional features for more details.



model 9752NA Two Seat Sofa, 9755 Corner Table, 9751NA Lounge Chair, 9757L Left Tablet

STANDARD FEATURES

- An all inclusive, modular series which includes seating, storage, power, tables and tablets.
- Fulfill many space planning scenarios including corner, in-line, open concept as well as traditional reception.
- Furniture pieces, seating or tables can be used as stand alone items or linked together with ganging brackets to create infinite configurations.
- Four high back (banquette) models available in two different heights (42" or 48") and two sizes (two-seat or three-seat armless sofas).
- Banquettes are available as table back models (TB) which are equipped with an 8" laminate back table shelf.
- Tablets can be mounted outside or between seats to accommodate various work and collaborative settings. Tablets have a 14" round surface and come with a 2-point locking mechanism for easy handling and stability.
- Fixed cushions are accented by a metal base and frame.
- Tables features durable and matching 3mm edges.
- Power modules include one power outlet and two USB ports and can be mounted under any seat or table. Wire management is included.
- All models are standard with Black polypropylene foot glides.
- Check textile availability prior to specifying upholstery material.

OPTIONAL FEATURES

- Quilted Seat (Q) is available. Backless stools, add \$107 each. Single seat models, add \$212. Two seater sofa, add \$417. Three seater sofa, add \$626.
- **Seating and Table Frame Finish:** All chair frames, table frames, tablet metal components, ganging brackets and power modules are available in the following finishes
(TBL) Black
(TDW) Designer White
(TTU) Tungsten
(CHM) Chrome. **Upcharge varies.**
(BCH) Brushed Chrome. **Upcharge varies.**
Please Specify.

- Brushed Chrome (BCH) and Chrome (CHM) are available at an upcharge. Add \$225 for counter height and bar height stools. Add \$242 for single seat lounge chairs. Add \$321 for two seat sofas. Add \$401 for three seat sofas. Add \$242 for storage/end tables. Add \$321 for storage/coffee tables. Add \$124 for tablets. Add \$31 for ganging brackets. Add \$24 for power modules.
- **Table Tops**
Corner tables, storage tables and tablets are offered in the following High Pressure Laminate finishes:
(ACJ) Absolute Acajou (ASN) Asian Night
(AWC) Avant Cherry (AWH) Avant Honey
(BLK) Black (BRC) Brushed Cobalt
(BZD) Blizzard (CMB) Clear Maple
(CGY) Custom Grey (DES) Dark Espresso
(DWT) Designer White (FAS) Fashionista
(FCL) First Class (NBL) Noce Biondo
(NGL) Noce Grigio (NML) Noce Medio
(NML) Noce Medio (QTM) Quartered Mahogany
(SBY) Sheer Beauty (SDT) Stonedust
(SOG) Storm Grey (WHE) Walnut Heights
(WHE) Walnut Heights (WCR) Winter Cherry
(WHC) White Chocolate (WCR) Winter Cherry

SAMPLE LAYOUTS

Layout A



Qty	Model Number	Description	Dimensions	List Price
1	9751L	Lounge Chair - Left Arm	28.5 x 29.5 x 30	2110
1	9751R	Lounge Chair - Right Arm	28.5 x 29.5 x 30	2110
1	9755	Corner Table	27.25 x 27.25 x 16.5	840
2	9759	Ganging Bracket	1 x 0.75 x 10	25 x 2
SAMPLE LAYOUT TOTAL IN STANDARD FRAME FINISHES				\$5,110
SAMPLE LAYOUT TOTAL IN OPTIONAL FRAME FINISHES				\$5,898

SAMPLE LAYOUTS

Layout B



Qty	Model Number	Description	Dimensions	List Price
1	9751L	Lounge Chair - Left Arm	28.5 x 29.5 x 30	2110
1	9751R	Lounge Chair - Right Arm	28.5 x 29.5 x 30	2110
1	9755	Corner Table	27.25 x 27.25 x 16.5	840
2	9759	Ganging Bracket	1 x 0.75 x 10	25 x 2

SAMPLE LAYOUT TOTAL IN STANDARD BLACK FRAME \$5,110
SAMPLE LAYOUT TOTAL IN OPTIONAL FRAME FINISHES \$5,898

Layout C



Qty	Model Number	Description	Dimensions	List Price
1	9751L	Lounge Chair - Left Arm	28.5 x 29.5 x 30	2110
1	9751R	Lounge Chair - Right Arm	28.5 x 29.5 x 30	2110
1	9751NA	Lounge Chair - No Arms	27.5 x 29.5 x 30	1749
2	9755	Corner Table	27.25 x 27.25 x 16.5	840 x 2
4	9759	Ganging Bracket	1 x 0.75 x 10	25 x 4

SAMPLE LAYOUT TOTAL IN STANDARD BLACK FRAME \$7,749
SAMPLE LAYOUT TOTAL IN OPTIONAL FRAME FINISHES \$9,083

Layout D



Qty	Model Number	Description	Dimensions	List Price
1	9751L	Lounge Chair - Left Arm	28.5 x 29.5 x 30	2110
1	9751R	Lounge Chair - Right Arm	28.5 x 29.5 x 30	2110
1	9751NA	Lounge Chair - Armless	27.5 x 29.5 x 30	1749
2	9755	Corner Table	27.25 x 27.25 x 16.5	840 x 2
1	9757L	Left Tablet	14 x 14 x 17.25	646
1	9758R	Right Tablet	14 x 14 x 17.25	646
4	9759	Ganging Bracket	1 x 0.75 x 10	25 x 4

SAMPLE LAYOUT TOTAL IN STANDARD BLACK FRAME \$9041
SAMPLE LAYOUT TOTAL IN OPTIONAL FRAME FINISHES \$10,623

Layout E



Qty	Model Number	Description	Dimensions	List Price
1	9752L-OB	Two Seat Sofa Open Back - Left Arm	55 x 29.5 x 30	3437
1	9752NA	Two Seat Sofa - Armless	54 x 29.5 x 30	3157
1	9754	Storage Table	27.25 x 27.25 x 16.5	1333
1	9755	Corner Table	27.25 x 27.25 x 16.5	840
1	9757R	Right Tablet	14 x 14 x 17.25	646
2	9759	Ganging Bracket	1 x 0.75 x 10	25 x 2

SAMPLE LAYOUT TOTAL IN STANDARD BLACK FRAME \$9463
SAMPLE LAYOUT TOTAL IN OPTIONAL FRAME FINISHES \$11,060

SAMPLE LAYOUTS

Layout F

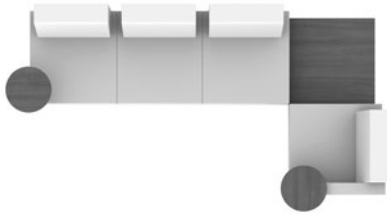

Qty	Model Number	Description	Dimensions	List Price
1	9753NA-OB	Three Seat Sofa Open Back - Armless	80.5 x 29.5 x 30	4426
1	9751L	Lounge Chair - Left Arm	28.5 x 29.5 x 30	2110
1	9755	Corner Table	27.25 x 27.25 x 16.5	840
1	9757L	Left Tablet	14 x 14 x 17.25	646
1	9758R	Right Tablet	14 x 14 x 17.25	646
2	9759	Ganging Bracket	1 x 0.75 x 10	25 x 2

SAMPLE LAYOUT TOTAL IN STANDARD FRAME FINISHES

\$8,718

SAMPLE LAYOUT TOTAL IN OPTIONAL FRAME FINISHES

\$9,913

Layout G



Qty	Model Number	Description	Dimensions	List Price
1	9753NA-OB	Three Seat Sofa Open Back - Armless	80.5 x 29.5 x 30	4426
1	9751	Lounge Chair	29.5 x 29.5 x 30	2467
1	9755	Corner Table	27.25 x 27.25 x 16.5	840
1	9757L	Left Tablet	14 x 14 x 17.25	646
1	9759	Ganging Bracket	1 x 0.75 x 10	25 x 1

SAMPLE LAYOUT TOTAL IN STANDARD FRAME FINISHES

\$8,404

SAMPLE LAYOUT TOTAL IN OPTIONAL FRAME FINISHES

\$9,444

Layout H



Qty	Model Number	Description	Dimensions	List Price
1	9751L	Lounge Chair - Left Arm	28.5 x 29.5 x 30	2110
1	9751R	Lounge Chair - Right Arm	28.5 x 29.5 x 30	2110
1	9751NA	Lounge Chair - No Arms	27.5 x 29.5 x 30	1749
2	9755	Corner Table	27.25 x 27.25 x 16.5	840 x 2
4	9759	Ganging Bracket	1 x 0.75 x 10	25 x 4

SAMPLE LAYOUT TOTAL IN STANDARD FRAME FINISHES

\$7,749

SAMPLE LAYOUT TOTAL IN OPTIONAL FRAME FINISHES

\$9,083

Layout I

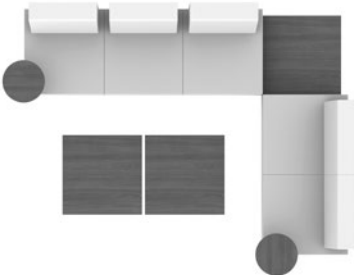

Qty	Model Number	Description	Dimensions	List Price
1	9753NA-OB	Three Seat Sofa Open Back - Armless	80.5 x 29.5 x 30	4426
1	9752NA	Two Seat Sofa - Armless	54 x 29.5 x 30	3157
2	9754	Storage Table	27.25 x 27.25 x 16.5	1333 x 2
1	9755	Corner Table	27.25 x 27.25 x 16.5	840
1	9757L	Left Tablet	14 x 14 x 17.25	646
1	9758R	Right Tablet	14 x 14 x 17.25	646
2	9759	Ganging Bracket	1 x 0.75 x 10	25 x 2

SAMPLE LAYOUT TOTAL IN STANDARD FRAME FINISHES

\$12,431

SAMPLE LAYOUT TOTAL IN OPTIONAL FRAME FINISHES

\$14,189

SAMPLE LAYOUTS

Layout J

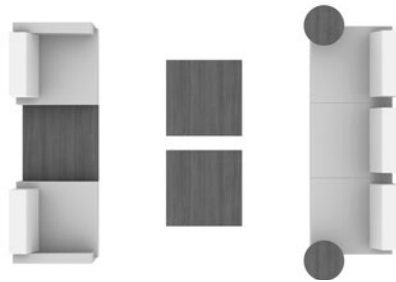

Qty	Model Number	Description	Dimensions	List Price
1	9753NA-OB	Three Seat Sofa Open Back - Armless	80.5 x 29.5 x 30	4426
1	9751L	Lounge Chair - Left Arm	28.5 x 29.5 x 30	2110
1	9751R	Lounge Chair - Right Arm	28.5 x 29.5 x 30	2110
2	9754	Storage Table	27.25 x 27.25 x 16.5	1333 x2
1	9755	Corner Table	27.25 x 27.25 x 16.5	840
1	9757L	Left Tablet	14 x 14 x 17.25	646
1	9758R	Right Tablet	14 x 14 x 17.25	646
2	9759	Ganging Bracket	1 x 0.75 x 10	25 x 2

SAMPLE LAYOUT TOTAL IN STANDARD FRAME FINISHES \$13,494
SAMPLE LAYOUT TOTAL IN OPTIONAL FRAME FINISHES \$15,415

Layout K



Qty	Model Number	Description	Dimensions	List Price
2	9753NA-OB	Three Seat Sofa Open Back - Armless	80.5 x 29.5 x 30	4426 x 2
2	9755	Corner Table	27.25 x 27.25 x 16.5	840 x 2
2	9759	Ganging Bracket	1 x 0.75 x 10	25 x 2

SAMPLE LAYOUT TOTAL IN STANDARD FRAME FINISHES \$10,582
SAMPLE LAYOUT TOTAL IN OPTIONAL FRAME FINISHES \$11,930

Layout L



Qty	Model Number	Description	Dimensions	List Price
1	9752NA	Two Seat Sofa - Armless	54 x 29.5 x 30	3157
1	9751L	Lounge Chair - Left Arm	28.5 x 29.5 x 30	2110
1	9751R	Lounge Chair - Right Arm	28.5 x 29.5 x 30	2110
2	9755	Corner Table	27.25 x 27.25 x 16.5	840 x 2
4	9759	Ganging Bracket	1 x 0.75 x 10	25 x 4

SAMPLE LAYOUT TOTAL IN STANDARD FRAME FINISHES \$9,157
SAMPLE LAYOUT TOTAL IN OPTIONAL FRAME FINISHES \$10,570

Layout M

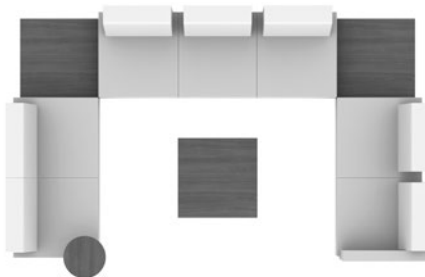

Qty	Model Number	Description	Dimensions	List Price
1	9753NA-OB	Three Seat Sofa Open Back - Armless	80.5 x 29.5 x 30	4426
1	9752L-OB	Two Seat Sofa Open Back - Left Arm	55 x 29.5 x 30	3437
1	9752NA	Two Seat Sofa - Armless	54 x 29.5 x 30	3157
2	9755	Corner Table	27.25 x 27.25 x 16.5	840 x 2
1	9754	Storage Table	27.25 x 27.25 x 16.5	1333
1	9758R	Right Tablet	14 x 14 x 17.25	646
4	9759	Ganging Bracket	1 x 0.75 x 10	25 x 4

SAMPLE LAYOUT TOTAL IN STANDARD FRAME FINISHES \$14,779
SAMPLE LAYOUT TOTAL IN OPTIONAL FRAME FINISHES \$16,796

SAMPLE LAYOUTS

Layout N



Qty	Model Number	Description	Dimensions	List Price
1	9753NA-OB	Three Seat Sofa Open Back - Armless	80.5 x 29.5 x 30	4426
1	9751L	Lounge Chair - Left Arm	28.5 x 29.5 x 30	2110
1	9751R	Lounge Chair - Right Arm	28.5 x 29.5 x 30	2110
2	9755	Corner Table	27.25 x 27.25 x 16.5	840 x 2
4	9759	Ganging Bracket	1 x 0.75 x 10	25 x 4

SAMPLE LAYOUT TOTAL IN STANDARD FRAME FINISHES \$10,426
SAMPLE LAYOUT TOTAL IN OPTIONAL FRAME FINISHES \$11,919

Layout O

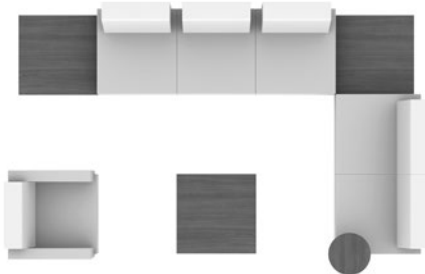

Qty	Model Number	Description	Dimensions	List Price
1	9753NA-OB	Three Seat Sofa Open Back - Armless	80.5 x 29.5 x 30	4426
1	9752NA	Two Seat Sofa - Armless	54 x 29.5 x 30	3157
1	9751	Lounge Chair	29.5 x 29.5 x 30	2467
1	9754	Storage Table	27.25 x 27.25 x 16.5	1333
2	9755	Corner Table	27.25 x 27.25 x 16.5	840 x 2
1	9757L	Left Tablet	14 x 14 x 17.25	646
3	9759	Ganging Bracket	1 x 0.75 x 10	25 x 3

SAMPLE LAYOUT TOTAL IN STANDARD FRAME FINISHES \$13,784
SAMPLE LAYOUT TOTAL IN OPTIONAL FRAME FINISHES \$15,691

Layout P

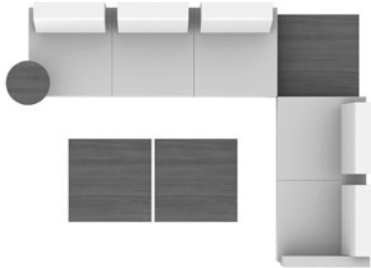

Qty	Model Number	Description	Dimensions	List Price
1	9753NA-OB	Three Seat Sofa Open Back - Armless	80.5 x 29.5 x 30	4426
1	9752L-OB	Two Seat Sofa Open Back - Left Arm	55 x 29.5 x 30	3437
2	9754	Storage Table	27.25 x 27.25 x 16.5	1333 x 2
1	9755	Corner Table	27.25 x 27.25 x 16.5	840
1	9758R	Right Tablet	14 x 14 x 17.25	646
2	9759	Ganging Bracket	1 x 0.75 x 10	25 x 2

SAMPLE LAYOUT TOTAL IN STANDARD FRAME FINISHES \$12,065
SAMPLE LAYOUT TOTAL IN OPTIONAL FRAME FINISHES \$13,699



Lounge Chair
 COM Yardage: 4.25
 Freight Class: 250
 Product Weight (lbs.): 71
 Cubic Feet Per Carton: 21.5

	1	2	3	4	5	6	7	8	9	10	11	12
9751	2467	2604	2709	2870	3093	3175	3373	3749	3930	4282	4756	5348

OVERALL DIMENSIONS			SEAT DIMENSIONS			BACK DIMENSIONS	
W	D	H	W	D	H	W	H
30.5	31	30	24	20.5	18.5	22	12.5

RTA 00



9751R



9751L

Lounge Chair - One Arm
 COM Yardage: 3.25
 Freight Class: 250
 Product Weight (lbs.): 61
 Cubic Feet Per Carton: 20

Ganging clip required for sectional use

	1	2	3	4	5	6	7	8	9	10	11	12
9751R	2110	2223	2312	2445	2634	2724	2895	3168	3378	3611	4605	5120
9751L												

OVERALL DIMENSIONS			SEAT DIMENSIONS			BACK DIMENSIONS	
W	D	H	W	D	H	W	H
28.5	31	30	24	20.5	18.5	22	12.5

RTA 00

DESCRIPTION	FEATURES	MODEL#	STANDARD TEXTILE GRADES											
			1	2	3	4	5	6	7	8	9	10	11	12
 <p>Lounge Chair - Armless COM Yardage: 2.25 Freight Class: 250 Product Weight (lbs.): 51 Cubic Feet Per Carton: 18.75</p>	Ganging clip required for sectional use	9751NA	1749	1832	1893	1986	2118	2180	2300	2490	2638	2802	3138	3498
		OVERALL DIMENSIONS			SEAT DIMENSIONS			BACK DIMENSIONS						
		W	D	H	W	D	H	W	H					
		26.5	31	30	24	20.5	18.5	22	12.5					
			RTA 00											

DESCRIPTION	FEATURES	MODEL#	STANDARD TEXTILE GRADES											
			1	2	3	4	5	6	7	8	9	10	11	12
 <p>Corner Unit COM Yardage: 3 Freight Class: 250 Product Weight (lbs.): 72 Cubic Feet Per Carton: 18.5</p>	Ganging clip required for sectional use	9764	2268	2387	2477	2617	2816	2887	3061	3390	3549	3855	4271	4790
		OVERALL DIMENSIONS			SEAT DIMENSIONS			BACK DIMENSIONS						
		W	D	H	W	D	H	W	H					
		28.5	28.5	30	22	20.5	18.5	22	12.5					
			RTA 00											

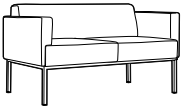
DESCRIPTION	FEATURES	MODEL#	STANDARD TEXTILE GRADES											
			1	2	3	4	5	6	7	8	9	10	11	12
 <p>Two Seat Sofa COM Yardage: 6.25 Freight Class: 250 Product Weight (lbs.): 111 Cubic Feet Per Carton: 37.5</p>		9752	3883	4088	4247	4486	4823	4944	5241	5806	6077	6601	7315	8207
		OVERALL DIMENSIONS			SEAT DIMENSIONS			BACK DIMENSIONS						
		W	D	H	W	D	H	W	H					
		56	31	30	48	20.5	18.5	44	12.5					
			RTA 00											

DESCRIPTION	FEATURES	MODEL#	STANDARD TEXTILE GRADES												
			1	2	3	4	5	6	7	8	9	10	11	12	
 <p>Two Seat Sofa - One Arm COM Yardage: 5 Freight Class: 250 Product Weight (lbs.): 101 Cubic Feet Per Carton: 36.25</p>	Ganging clip required for sectional use	9752R	3476	3644	3779	3978	4257	4359	4607	5076	5305	5741	6336	7076	
		9752L													
		OVERALL DIMENSIONS			SEAT DIMENSIONS			BACK DIMENSIONS							
		W	D	H	W	D	H	W	H						
54	31	30	48	20.5	18.5	44	12.5								
			RTA 00												

DESCRIPTION	FEATURES	MODEL#	STANDARD TEXTILE GRADES											
			1	2	3	4	5	6	7	8	9	10	11	12
 <p>Two Seat Sofa - Armless COM Yardage: 4 Freight Class: 250 Product Weight (lbs.): 91 Cubic Feet Per Carton: 35.5</p>	Ganging clip required for sectional use	9752NA	3157	3295	3400	3561	3787	3868	4066	4442	4622	4973	5449	6041
		OVERALL DIMENSIONS			SEAT DIMENSIONS			BACK DIMENSIONS						
		W	D	H	W	D	H	W	H					
		52	31	30	48	20.5	18.5	44	12.5					
			RTA 00											

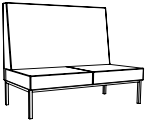

DESCRIPTION	FEATURES	MODEL#	STANDARD TEXTILE GRADES												
			1	2	3	4	5	6	7	8	9	10	11	12	
	Ganging clip required for sectional use	9752NAHB42	2865	3143	3363	3692	4157	4377	4802	5475	5996	6573	7763	9030	
		OVERALL DIMENSIONS			SEAT DIMENSIONS			BACK DIMENSIONS							
		W	D	H	W	D	H	W	H						
Two Seat Sofa - 42" High Back COM Yardage: 8 Freight Class: 250 Product Weight (lbs.): 120 Cubic Feet Per Carton: 48.5			52	31	42	48	20.5	18.5	44	24.5					
			RTA 00												

DESCRIPTION	FEATURES	MODEL#	STANDARD TEXTILE GRADES												
			1	2	3	4	5	6	7	8	9	10	11	12	
	Ganging clip required for sectional use	9752NAHB42TB	4030	4238	4402	4646	4993	5155	5469	5969	6356	6784	7667	8608	
		OVERALL DIMENSIONS			SEAT DIMENSIONS			BACK DIMENSIONS							
		W	D	H	W	D	H	W	H						
Two Seat Sofa - 42" High Back w/36" H Table Shelf COM Yardage: 6 Freight Class: 250 Product Weight (lbs.): 111 Cubic Feet Per Carton: 35.25			52	41	42	48	20.5	18.5	44	24.5					
			RTA 00												



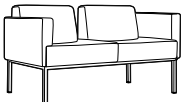

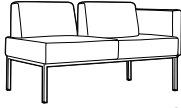
DESCRIPTION	FEATURES	MODEL#	STANDARD TEXTILE GRADES												
			1	2	3	4	5	6	7	8	9	10	11	12	
	Ganging clip required for sectional use	9752NAHB48	\$2964	\$3268	\$3508	\$3868	\$4376	\$4618	\$5080	\$5818	\$6387	\$7019	\$8320	\$9707	
		OVERALL DIMENSIONS			SEAT DIMENSIONS			BACK DIMENSIONS							
		W	D	H	W	D	H	W	H						
Two Seat Sofa - 48" High Back COM Yardage: 6 Freight Class: 250 Product Weight (lbs.): 130 Cubic Feet Per Carton: 35.25			52	31	48	48	20.5	18.5	44	30.5					
			RTA 00												

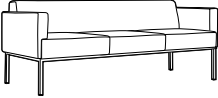
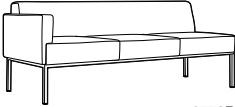
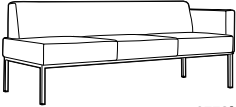
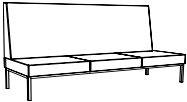

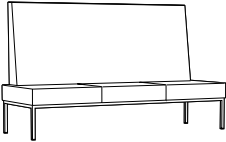
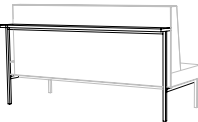
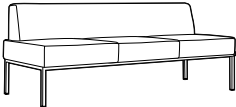
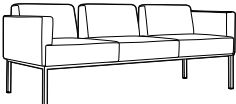
DESCRIPTION	FEATURES	MODEL#	STANDARD TEXTILE GRADES												
			1	2	3	4	5	6	7	8	9	10	11	12	
	Ganging clip required for sectional use	9752NAHB48TB	\$4129	\$4336	\$4500	\$4744	\$5091	\$5253	\$5567	\$6067	\$6453	\$6882	\$7764	\$8704	
		OVERALL DIMENSIONS			SEAT DIMENSIONS			BACK DIMENSIONS							
		W	D	H	W	D	H	W	H						
Two Seat Sofa - 48" High Back w/42" H Table Shelf COM Yardage: 8.75 Freight Class: 250 Product Weight (lbs.): 145 Cubic Feet Per Carton: 71.25			52	41	48	48	20.5	18.5	44	30.5					
			RTA 00												

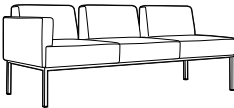
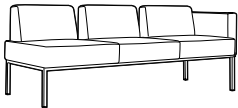
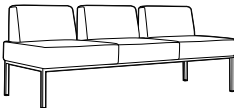

DESCRIPTION	FEATURES	MODEL#	STANDARD TEXTILE GRADES												
			1	2	3	4	5	6	7	8	9	10	11	12	
		9752-OB	3840	4042	4201	4440	4779	4899	5194	5760	6032	6557	7271	8159	
		OVERALL DIMENSIONS			SEAT DIMENSIONS			BACK DIMENSIONS							
		W	D	H	W	D	H	W	H						
Two Seat Sofa - Open Back COM Yardage: 6.25 Freight Class: 250 Product Weight (lbs.): 111 Cubic Feet Per Carton: 35.25			56	29.5	30	54	20.5	18.5	48	12.5					
			RTA 00												



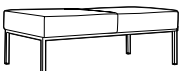
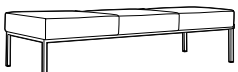

DESCRIPTION	FEATURES	MODEL#	STANDARD TEXTILE GRADES											
			1	2	3	4	5	6	7	8	9	10	11	12
 <p>9752R-OB</p>	 <p>9752L-OB</p>	<p>9752R-OB 9752L-OB</p>	3437	3605	3738	3938	4219	4321	4568	5038	5265	5702	6297	5702
			<p>OVERALL DIMENSIONS</p> <p>W D H</p>			<p>SEAT DIMENSIONS</p> <p>W D H</p>			<p>BACK DIMENSIONS</p> <p>W H</p>					
<p>Two Seat Sofa - Open Back - One Arm COM Yardage: 5.25 Freight Class: 250 Product Weight (lbs.): 101 Cubic Feet Per Carton: 36.25</p>	Ganging clip required for sectional use		54	31	30	48	20.5	18.5	44	12.5				
			RTA 00											
			3115	3252	3358	3518	3744	3823	4022	4400	4580	4930	5404	5996
	<p>OVERALL DIMENSIONS</p> <p>W D H</p>			<p>SEAT DIMENSIONS</p> <p>W D H</p>			<p>BACK DIMENSIONS</p> <p>W H</p>							
<p>Two Seat Sofa - Open Back - Armless COM Yardage: 4.25 Freight Class: 250 Product Weight (lbs.): 91 Cubic Feet Per Carton: 35.5</p>			52	31	30	48	20.5	18.5	44	12.5				
			RTA 00											
			5194	5512	5766	6146	6687	6941	7429	8208	8810	9477	10852	12318
	<p>OVERALL DIMENSIONS</p> <p>W D H</p>			<p>SEAT DIMENSIONS</p> <p>W D H</p>			<p>BACK DIMENSIONS</p> <p>W H</p>							
<p>Three Seat Sofa COM Yardage: 9.5 Freight Class: 250 Product Weight (lbs.): 153 Cubic Feet Per Carton: 54.5</p>			82.5	31	30	76.5	20.5	18.5	66	12.5				
			RTA 00											
 <p>9753R</p>	 <p>9753L</p>	<p>9753R 9753L</p>	4854	5133	5356	5685	6156	6375	6801	7480	8005	8585	9783	11059
			<p>OVERALL DIMENSIONS</p> <p>W D H</p>			<p>SEAT DIMENSIONS</p> <p>W D H</p>			<p>BACK DIMENSIONS</p> <p>W H</p>					
<p>Three Seat Sofa - One Arm COM Yardage: 8.25 Freight Class: 250 Product Weight (lbs.): 143 Cubic Feet Per Carton: 54.5</p>	Ganging clip required for sectional use		81.5	31	30	80.5	20.5	18.5	74	12.5				
			RTA 00											
			4316	4730	5057	5552	6252	6580	7214	8224	9004	9868	11651	13554
	<p>OVERALL DIMENSIONS</p> <p>W D H</p>			<p>SEAT DIMENSIONS</p> <p>W D H</p>			<p>BACK DIMENSIONS</p> <p>W H</p>							
<p>Three Seat Sofa - 42" High Back COM Yardage: 12.25 Freight Class: 300 Product Weight (lbs.): 143 Cubic Feet Per Carton: 72.50</p>	Ganging clip required for sectional use		80.5	31	42	74	20.5	18.5	74	24.5				
			RTA 00											

DESCRIPTION	FEATURES	MODEL#	STANDARD TEXTILE GRADES											
			1	2	3	4	5	6	7	8	9	10	11	12
 <p>Three Seat Sofa - 42" High Back w/36"H Table Shelf COM Yardage: 9 Freight Class: 300 Product Weight (lbs.): 158 Cubic Feet Per Carton: 93.50</p>	Ganging clip required for sectional use	9753NAHB42TB	5676	5978	6216	6576	7085	7325	7785	8521	9087	9717	11015	12398
			OVERALL DIMENSIONS			SEAT DIMENSIONS			BACK DIMENSIONS					
			W	D	H	W	D	H	W	H				
			80.5	41	42	74	20.5	18.5	74	24.5				
			RTA 00											
 <p>Three Seat Sofa - 48" High Back COM Yardage: 13.25 Freight Class: 250 Product Weight (lbs.): 168 Cubic Feet Per Carton: 82.25</p>	Ganging clip required for sectional use	9753NAHB48	4593	5042	5397	5932	6688	7044	7729	8821	9665	10600	12528	14585
			OVERALL DIMENSIONS			SEAT DIMENSIONS			BACK DIMENSIONS					
			W	D	H	W	D	H	W	H				
			80.5	31	48	74	20.5	18.5	74	30.5				
			RTA 00											
 <p>Three Seat Sofa - 48" High Back w/42"H Table Shelf COM Yardage: 9 Freight Class: 300 Product Weight (lbs.): 158 Cubic Feet Per Carton: 106</p>	Ganging clip required for sectional use	9753NAHB48TB	5953	6313	6555	6918	7435	7679	8146	8893	9469	10106	11423	12826
			OVERALL DIMENSIONS			SEAT DIMENSIONS			BACK DIMENSIONS					
			W	D	H	W	D	H	W	H				
			80.5	41	48	74	20.5	18.5	74	30.5				
			RTA 00											
 <p>Three Seat Sofa - Armless COM Yardage: 7 Freight Class: 250 Product Weight (lbs.): 133 Cubic Feet Per Carton: 51.5</p>	Ganging clip required for sectional use	9753NA	4471	4708	4896	5177	5577	5764	6127	6706	7151	7645	8664	9751
			OVERALL DIMENSIONS			SEAT DIMENSIONS			BACK DIMENSIONS					
			W	D	H	W	D	H	W	H				
			80.5	31	30	80.5	20.5	18.5	74	12.5				
			RTA 00											
 <p>Three Seat Sofa - Open Back COM Yardage: 8 Freight Class: 250 Product Weight (lbs.): 153 Cubic Feet Per Carton: 54.5</p>		9753-OB	5157	5423	5638	5957	6407	6568	6964	7718	8081	8780	9731	10914
			OVERALL DIMENSIONS			SEAT DIMENSIONS			BACK DIMENSIONS					
			W	D	H	W	D	H	W	H				
			82.5	31	30	80.5	20.5	18.5	74	12.5				
			RTA 00											

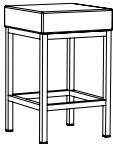
DESCRIPTION	FEATURES	MODEL#	STANDARD TEXTILE GRADES											
			1	2	3	4	5	6	7	8	9	10	11	12
 <p>9753R-OB</p> <p>Three Seat Sofa - Open Back - One Arm COM Yardage: 7 Freight Class: 250 Product Weight (lbs.): 143 Cubic Feet Per Carton: 54.5</p>	 <p>9753L-OB</p> <p>Ganging clip required for sectional use</p>	<p>9753R-OB 4810 5046 5232 5510 5905 6046 6392 7053 7371 7981 8813 9851</p> <p>9753L-OB</p>	OVERALL DIMENSIONS			SEAT DIMENSIONS			BACK DIMENSIONS					
			W	D	H	W	D	H	W	H				
			81.5	31	30	80.5	20.5	17.5	74	12.5				
			RTA 00											
 <p>9753NA-OB</p> <p>Three Seat Sofa - Open Back - Armless COM Yardage: 6.25 Freight Class: 250 Product Weight (lbs.): 133 Cubic Feet Per Carton: 51.5</p>	<p>Ganging clip required for sectional use</p>	<p>9753NA-OB 4426 4631 4790 5029 5366 5487 5784 6349 6622 7144 7859 8750</p>	OVERALL DIMENSIONS			SEAT DIMENSIONS			BACK DIMENSIONS					
			W	D	H	W	D	H	W	H				
			80.5	31	30	80.5	20.5	17.5	74	12.5				
			RTA 00											
 <p>9754</p> <p>Storage Table COM Yardage: N/A Freight Class: 125 Product Weight (lbs.): 65 Cubic Feet Per Carton: 11.5</p>	<p>Ganging clip required for sectional use</p>	<p>9754 1333 - - - - - - - - - - - -</p>	OVERALL DIMENSIONS			SEAT DIMENSIONS			BACK DIMENSIONS					
			W	D	H	W	D	H	W	H				
			27.25	27.25	16.5	-	-	-	-	-	-	-	-	
			RTA 00											
 <p>9755</p> <p>Corner Table COM Yardage: N/A Freight Class: 150 Product Weight (lbs.): 40 Cubic Feet Per Carton: 8</p>	<p>Ganging clip required for sectional use</p>	<p>9755 840 - - - - - - - - - - - -</p>	OVERALL DIMENSIONS			SEAT DIMENSIONS			BACK DIMENSIONS					
			W	D	H	W	D	H	W	H				
			27.25	27.25	12.5	-	-	-	-	-	-	-	-	
			RTA 00											
 <p>9759</p> <p>Ganging Bracket COM Yardage: N/A Freight Class: 70 Product Weight (lbs.): 0.52 Cubic Feet Per Carton: 0.02</p>	<p>Only one set is needed per connection.</p>	<p>9759 25 - - - - - - - - - - - -</p>	OVERALL DIMENSIONS			SEAT DIMENSIONS			BACK DIMENSIONS					
			W	D	H	W	D	H	W	H				
			1	0.75	10	-	-	-	-	-	-	-	-	
			RTA 00											
			FedEx 											

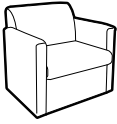
DESCRIPTION	FEATURES	MODEL#	STANDARD TEXTILE GRADES											
			1	2	3	4	5	6	7	8	9	10	11	12
 <p>Tablet COM Yardage: N/A Freight Class: 150 Product Weight (lbs.): 12 Cubic Feet Per Carton: 2.5</p>	Mounts underneath of seating.	9757L	646	-	-	-	-	-	-	-	-	-	-	
		9758R	-	-	-	-	-	-	-	-	-	-	-	
		OVERALL DIMENSIONS			SEAT DIMENSIONS			BACK DIMENSIONS						
		W	D	H	W	D	H	W	H					
			14	17.25	14	-	-	-	-	-				
			RTA 1			FedEx			UPS					
 <p>Power Module COM Yardage: N/A Freight Class: 125 Product Weight (lbs.): 3 Cubic Feet Per Carton: 0.5</p>	Mounts underneath of seating or tables.	9760	\$407	-	-	-	-	-	-	-	-	-	-	
		10 Ft. power cord												
		OVERALL DIMENSIONS			SEAT DIMENSIONS			BACK DIMENSIONS						
		W	D	H	W	D	H	W	H					
			6	2.75	2.75	-	-	-	-	-				
			RTA 00			FedEx			UPS					
 <p>One Seat Bench COM Yardage: 2 Freight Class: 250 Product Weight (lbs.): 37 Cubic Feet Per Carton: 10.75</p>	Ganging clip required for sectional use	9761	1309	1379	1433	1514	1628	1683	1786	1953	2082	2223	2517	2828
		OVERALL DIMENSIONS			SEAT DIMENSIONS			BACK DIMENSIONS						
		W	D	H	W	D	H	W	H					
					27.5	28.5	17.5	-	-	-	-	-		
			RTA 00											
 <p>Two Seat Bench COM Yardage: 4 Freight Class: 250 Product Weight (lbs.): 57 Cubic Feet Per Carton: 21.25</p>	Ganging clip required for sectional use	9762	2329	2467	2575	2738	2970	3079	3287	3620	3878	4164	4752	5379
		OVERALL DIMENSIONS			SEAT DIMENSIONS			BACK DIMENSIONS						
		W	D	H	W	D	H	W	H					
					54	28.5	17.5	-	-	-	-	-		
			RTA 00											
 <p>Three Seat Bench COM Yardage: 6 Freight Class: 250 Product Weight (lbs.): 80 Cubic Feet Per Carton: 29.5</p>	Ganging clip required for sectional use	9763	3296	3501	3660	3901	4244	4405	4713	5206	5585	6009	6878	7808
		OVERALL DIMENSIONS			SEAT DIMENSIONS			BACK DIMENSIONS						
		W	D	H	W	D	H	W	H					
					80.5	28.5	17.5	-	-	-	-	-		
			RTA 00											

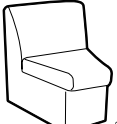
DESCRIPTION	FEATURES	MODEL#	STANDARD TEXTILE GRADES												
			1	2	3	4	5	6	7	8	9	10	11	12	
 <p>Coffee Storage Table (2 Seat Length) COM Yardage: N/A Freight Class: 150 Product Weight (lbs.): 112 Cubic Feet Per Carton: 20.5</p>	Ganging clip required for sectional use	9765	2430	-	-	-	-	-	-	-	-	-	-	-	
		OVERALL DIMENSIONS			SEAT DIMENSIONS			BACK DIMENSIONS							
		W	D	H	W	D	H	W	H						
		53.75	27.25	16.5	-	-	-	-	-						
			RTA 00												
 <p>Coffee Table (2 Seat Length) COM Yardage: N/A Freight Class: 150 Product Weight (lbs.): 68 Cubic Feet Per Carton: 17.75</p>		9766	1572	-	-	-	-	-	-	-	-	-	-		
	OVERALL DIMENSIONS			SEAT DIMENSIONS			BACK DIMENSIONS								
	W	D	H	W	D	H	W	H							
	54	27.5	13	-	-	-	-	-							
			RTA 00												
 <p>24" Stool COM Yardage: 0.75 Freight Class: 150 Product Weight (lbs.): 22 Cubic Feet Per Carton: 4.75</p>		9769S24	\$858	\$885	\$905	\$934	\$977	\$997	\$1036	\$1096	\$1143	\$1195	\$1303	\$1419	
	OVERALL DIMENSIONS			SEAT DIMENSIONS			BACK DIMENSIONS								
	W	D	H	W	D	H	W	H							
	15	15	24	15	15	3	-	-							
			RTA 00												
 <p>30" Stool COM Yardage: .50 Freight Class: 150 Product Weight (lbs.): 23 Cubic Feet Per Carton: 5.5</p>		9769S30	\$935	\$962	\$982	\$1011	\$1053	\$1073	\$1110	\$1170	\$1216	\$1268	\$1372	\$1485	
	OVERALL DIMENSIONS			SEAT DIMENSIONS			BACK DIMENSIONS								
	W	D	H	W	D	H	W	H							
	15	15	30	15	15	30	-	-							
			RTA 00												

DESCRIPTION	FEATURES	MODEL#	STANDARD TEXTILE GRADES											
			1	2	3	4	5	6	7	8	9	10	11	12
 <p>Single Seater - Right Arm COM Yardage: 3.75 Freight Class: 250 Product Weight (lbs.): 45 Cubic Feet Per Carton: 16.5</p>		7870R	921	1071	1187	1365	1613	1701	1920	2335	2536	2919	3444	4098
			OVERALL DIMENSIONS			SEAT DIMENSIONS			BACK DIMENSIONS					
			W	D	H	W	D	H	W	H				
			27	27.5	30	24	19.5	16.5	24	13.5				
			RTA 00											
 <p>Single Seater - with Arms COM Yardage: 4.75 Freight Class: 250 Product Weight (lbs.): 52 Cubic Feet Per Carton: 16.5</p>		7871	1136	1308	1445	1647	1936	2039	2290	2776	3006	3453	4062	4817
			OVERALL DIMENSIONS			SEAT DIMENSIONS			BACK DIMENSIONS					
			W	D	H	W	D	H	W	H				
			30	27.5	30	24	19.5	16.5	24	13.5				
			RTA 00											
 <p>60° Inside Corner Unit COM Yardage: 2.75 Freight Class: 300 Product Weight (lbs.): 31 Cubic Feet Per Carton: 16.5</p>		7872	746	859	944	1073	1253	1322	1479	1785	1929	2213	2597	3076
			OVERALL DIMENSIONS			SEAT DIMENSIONS			BACK DIMENSIONS					
			W	D	H	W	D	H	W	H				
			24	27.5	30	20	19.5	16.5	15	13.5				
			RTA 00											
 <p>30° Inside Corner Unit COM Yardage: 2.75 Freight Class: 300 Product Weight (lbs.): 31 Cubic Feet Per Carton: 16.5</p>		7873	746	859	944	1073	1253	1322	1479	1785	1929	2213	2597	3076
			OVERALL DIMENSIONS			SEAT DIMENSIONS			BACK DIMENSIONS					
			W	D	H	W	D	H	W	H				
			24	27.5	30	16	19.5	16.5	21.5	13.5				
			RTA 00											
 <p>Table - 24\" Square w/Upholstered Sides COM Yardage: 1.75 Freight Class: 125 Product Weight (lbs.): 38 Cubic Feet Per Carton: 6.25</p>		7874	610	682	736	817	933	977	1077	1271	1363	1544	1788	2093
			OVERALL DIMENSIONS			SEAT DIMENSIONS			BACK DIMENSIONS					
			W	D	H	W	D	H	W	H				
			24	24	14.5	-	-	-	-	-				
			RTA 00											

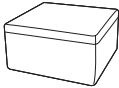
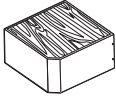

DESCRIPTION	FEATURES	MODEL#	STANDARD TEXTILE GRADES											
			1	2	3	4	5	6	7	8	9	10	11	12
 <p>Foot Stool/Single Bench - 24" Square COM Yardage: 1.75 Freight Class: 125 Product Weight (lbs.): 38 Cubic Feet Per Carton: 6.25</p>		7874FS	695	781	845	945	1084	1133	1256	1488	1599	1815	2109	2474
			OVERALL DIMENSIONS			SEAT DIMENSIONS			BACK DIMENSIONS					
			W	D	H	W	D	H	W	H				
			24	24	17.5	-	-	-	-	-				
			RTA 00											
 <p>Corner Table - 17" Square w/Upholstered Sides COM Yardage: 1.75 Freight Class: 125 Product Weight (lbs.): 38 Cubic Feet Per Carton: 6.25</p>		7880	831	901	955	1035	1146	1198	1299	1463	1587	1726	2012	2316
			OVERALL DIMENSIONS			SEAT DIMENSIONS			BACK DIMENSIONS					
			W	D	H	W	D	H	W	H				
			24	24	14.5	-	-	-	-	-				
			RTA 00											

BRIDGES II COLLABORATIVE SEATING



model BRTSE2424B



model BRTSE6060B



model BRTS2448F

STANDARD FEATURES

- For all Bridges II components, please see the Bridges II section of the Desking Price Book.
- Bridges collaborative seating collection consists of seating, privacy screens, tables, tablets and power.
- It is a versatile modular furniture series which can be configured into many space planning scenarios, including corner, in-line, open concept, traditional reception, as well as secluded seating with high privacy partitions.
- Furniture pieces can be used as stand alone items or can be mechanically linked together to form a variety of seating configurations.
- Seat and backrest can be integrated with Bridges tables.
- Corner tables and in-line 6" table modules double as power delivery centers.
- Dedicated seat backrests feature dual USB charging port.
- Some in line 6" table modules are furnished with grommets to support tablets.
- Legs are available in standard Bridges metal painted finishes and anodized aluminum finish.
- Bridges Collaborative Seating upholstery features a single stitch, thick white thread around the edges. The white, wide stitch along with crisp corners are part of its distinctive personality.
- In order to achieve crisp edges and to minimize "pillow" effect caused by taut fabric, the upholstery material has been applied deliberately loose, which may over time, produce puckering of the upholstery surface material. This can be easily corrected by stretching the fabric by hand or during vacuuming.
- Freestanding 17"h table. Central partition divides space under top surface into two 11" deep compartments.

- In order to efficiently utilize fabric yield, all 60" seats and backs feature a seam in the middle. The double stitch seam is sewn with a thin thread, closely matching the upholstery material in color.
- Some complicated fabric patterns prevent pattern matching and will be upholstered without the seam at the discretion of the factory.
- Should you require no middle seam by cutting into the roll, please specify "NO SEAM" at time of your order.
- Check textile availability prior to specifying upholstery material.

OPTIONAL FEATURES

- Optional Anodized Aluminum Leg on all models. Add \$74.
- Models BRTS2406BT and BRTS2406BPT include 9.5" x 14.5" swivel tablet. If top is specified in high pressure laminate, tablet will also be manufactured in high pressure laminate.
- Bridges II tables and tablets are offered in the following laminate finishes: Absolute Acajou (ACJ), Asian Night (ASN), Avant Cherry (AWC), Avant Honey (AWH), Black (BLK), Brushed Cobalt (BRC), Clear Maple (CMB), Custom Grey (CGY), Dark Espresso (DES), Designer White (DWT), Fashionista (FAS), First Class (FCL), Noce Biondo (NBL), Noce Grigio (NGL), Noce Leggero (NEL), Noce Medio (NML), Quartered Mahogany (QTM), Sheer Beauty (SBY) Storm Grey (SOG), Walnut Heights (WHE), White Chocolate (WHC) and Winter Cherry (WCR). Please Specify.

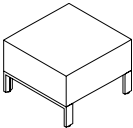
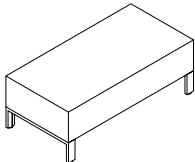
DESCRIPTION	FEATURES	MODEL#	STANDARD TEXTILE GRADES											
			1	2	3	4	5	6	7	8	9	10	11	12
 <p>Lounge Seat - 24" COM Yardage: 1.25 Freight Class: 150 Product Weight (lbs.): 22.70 Cubic Feet Per Carton: 5.57</p>		BRTSE24NB	787	863	863	911	979	1010	1072	1170	1246	1330	1501	1686
			OVERALL DIMENSIONS			SEAT DIMENSIONS			BACK DIMENSIONS					
			W	D	H	W	D	H	W	H				
			24	24	17	-	-	-	-	-				
		RTA 00												
 <p>Lounge Seat - 48" COM Yardage: 2 Freight Class: 250 Product Weight (lbs.): 36.90 Cubic Feet Per Carton: 11.33</p>		BRTSE48NB	1433	1553	1553	1630	1737	1789	1888	2045	2164	2300	2577	2870
			OVERALL DIMENSIONS			SEAT DIMENSIONS			BACK DIMENSIONS					
			W	D	H	W	D	H	W	H				
			24	48	17	-	-	-	-	-				
		RTA 00												

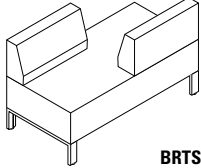
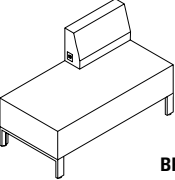
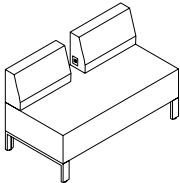
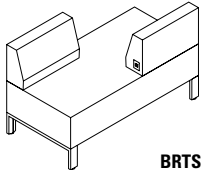
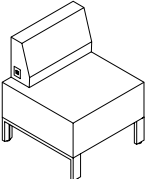
DESCRIPTION	FEATURES	MODEL#	STANDARD TEXTILE GRADES											
 <p>BRTSE2448BODR</p> <p>Lounge Seat, Two 24" Offset Backrests COM Yardage: 4 Freight Class: 250 Product Weight (lbs.): 46.5 Cubic Feet Per Carton: 19.33</p>			1	2	3	4	5	6	7	8	9	10	11	12
		BRTSE2448BODR	2336	2570	2570	2724	2940	3043	3241	3554	3794	4065	4618	5206
		BRTSE2448BODL	2336	2468	2570	2724	2940	3043	3241	3554	3794	4065	4618	5206
			OVERALL DIMENSIONS			SEAT DIMENSIONS			BACK DIMENSIONS					
			W	D	H	W	D	H	W	H				
			24	48	29	-	-	-	-	-				
			RTA 00											
 <p>BRTSE2148EBR</p> <p>Lounge Seat, 21" USB Backrest COM Yardage: 3 Freight Class: 250 Product Weight (lbs.): 33 Cubic Feet Per Carton: 9.67</p>			1	2	3	4	5	6	7	8	9	10	11	12
		BRTSE2148EBR	2184	2287	2363	2475	2639	2716	2863	3100	3280	3479	3896	4338
		BRTSE2148EBL	2184	2287	2363	2475	2639	2716	2863	3100	3280	3479	3896	4338
			OVERALL DIMENSIONS			SEAT DIMENSIONS			BACK DIMENSIONS					
			W	D	H	W	D	H	W	H				
			24	48	29	-	-	-	-	-				
			RTA 00											
 <p>BRTSE2148E2B</p> <p>Lounge Seat, Two 21" USB Backrests COM Yardage: 4 Freight Class: 250 Product Weight (lbs.): 57 Cubic Feet Per Carton: 19.33</p>			1	2	3	4	5	6	7	8	9	10	11	12
		BRTSE2148E2B	2934	3066	3165	3319	3536	3641	3838	4151	4392	4660	5213	5803
			OVERALL DIMENSIONS			SEAT DIMENSIONS			BACK DIMENSIONS					
			W	D	H	W	D	H	W	H				
			24	48	29	-	-	-	-	-				
			RTA 00											
 <p>BRTSE2148EBODR</p> <p>Lounge Seat, Two Offset USB Backrests COM Yardage: 4 Freight Class: 250 Product Weight (lbs.): 57 Cubic Feet Per Carton: 19.33</p>			1	2	3	4	5	6	7	8	9	10	11	12
		BRTSE2148EBODR	2934	3066	3165	3319	3536	3641	3838	4151	4392	4660	5213	5803
		BRTSE2148EBODL	2934	3066	3165	3319	3536	3641	3838	4151	4392	4660	5213	5803
			OVERALL DIMENSIONS			SEAT DIMENSIONS			BACK DIMENSIONS					
			W	D	H	H	W	D	H	WH				
			24	48	29	-	-	-	-	-				
			RTA 00											
 <p>BRTSE2124EBR</p> <p>Lounge Seat, 21" USB Backrest COM Yardage: 2.25 Freight Class: 250 Product Weight (lbs.): 46.10 Cubic Feet Per Carton: 19.33</p>			1	2	3	4	5	6	7	8	9	10	11	12
		BRTSE2124EBR	2934	1614	1673	1757	1879	1939	2049	2225	2360	2512	2824	3154
		BRTSE2124EBL	1538	1614	1673	1757	1879	1939	2049	2225	2360	2512	2824	3154
			OVERALL DIMENSIONS			SEAT DIMENSIONS			BACK DIMENSIONS					
			W	D	H	W	D	H	W	H				
			24	24	29	-	-	-	-	-				
			RTA 00											

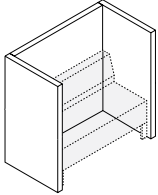
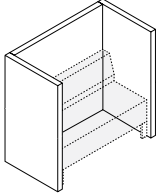
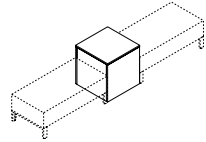
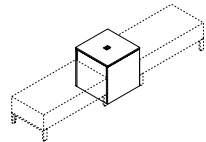
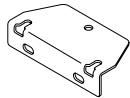
DESCRIPTION	FEATURES	MODEL#	STANDARD TEXTILE GRADES											
			1	2	3	4	5	6	7	8	9	10	11	12
 <p>Seat Privacy Partitions - 24" COM Yardage: Freight Class: 300 Product Weight (lbs.): 32 Cubic Feet Per Carton: 24.08</p>	<p>Fully 3 - Part Kit Seating not included. Panel textiles only.</p>	BRTPP2424L2	2199	-	-	-	-	-	-	-	-	-	-	-
		OVERALL DIMENSIONS			SEAT DIMENSIONS			BACK DIMENSIONS						
		W	D	H	W	D	H	W	H					
		53	28.7	50	-	-	-	-	-					
			RTA 00											
 <p>Seat Privacy Partitions - 48" COM Yardage: Freight Class: 400 Product Weight (lbs.): 41 Cubic Feet Per Carton: 44.01</p>	<p>Fully 3 - Part Kit Seating not included.</p>	BRTPP2448L2	2813	-	-	-	-	-	-	-	-	-	-	
		OVERALL DIMENSIONS			SEAT DIMENSIONS			BACK DIMENSIONS						
		W	D	H	W	D	H	W	H					
		53	28.7	50	-	-	-	-	-					
			RTA 00											
 <p>Square Table Block - No Power COM Yardage: N/A Freight Class: 250 Product Weight (lbs.): 32 Cubic Feet Per Carton: 12.04</p>	<p>Freestanding Table. Seating not included. Includes 2 brackets and screws</p>	BRTS2424B	619	-	-	-	-	-	-	-	-	-		
		OVERALL DIMENSIONS			SEAT DIMENSIONS			BACK DIMENSIONS						
		W	D	H	W	D	H	W	H					
		24	24	25	-	-	-	-	-					
			RTA 00											
 <p>Square Table Block w/ Center Power COM Yardage: N/A Freight Class: 125 Product Weight (lbs.): 59.30 Cubic Feet Per Carton: 8.33</p>	<p>Freestanding Table. Seating not included. Includes 2 brackets and screws</p>	BRTS2424BP	619	-	-	-	-	-	-	-	-	-		
		OVERALL DIMENSIONS			SEAT DIMENSIONS			BACK DIMENSIONS						
		W	D	H	W	D	H	W	H					
		24	24	25	-	-	-	-	-					
			RTA 00											
 <p>Square Table Block Ganging Bracket Kit COM Yardage: N/A Freight Class: 70 Product Weight (lbs.): 0.05 Cubic Feet Per Carton: 0.01</p>	<p>Includes 2 brackets and screws. Black Only.</p>	BRTSTBG	47	-	-	-	-	-	-	-	-	-		
		OVERALL DIMENSIONS			SEAT DIMENSIONS			BACK DIMENSIONS						
		W	D	H	W	D	H	W	H					
		2.5	5	1.1	-	-	-	-	-					
			RTA 00											

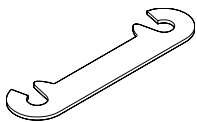
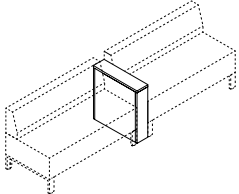
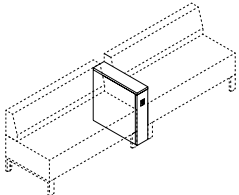
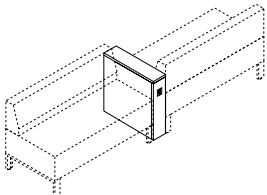
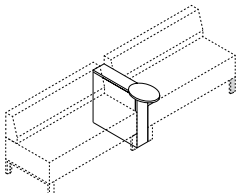
DESCRIPTION	FEATURES	MODEL#	STANDARD TEXTILE GRADES													
			1	2	3	4	5	6	7	8	9	10	11	12		
 <p>Ganging Bracket Kit COM Yardage: N/A Freight Class: 70 Product Weight (lbs.): 0.03 Cubic Feet Per Carton: 0.01</p>		BRTSTSB	21	-	-	-	-	-	-	-	-	-	-	-		
			OVERALL DIMENSIONS			SEAT DIMENSIONS			BACK DIMENSIONS							
			W	D	H	W	D	H	W	H						
			29.5	6	17	-	-	-	-	-						
			RTA 00													
 <p>Inline 6" Table Block COM Yardage: N/A Freight Class: 92.50 Product Weight (lbs.): 21 Cubic Feet Per Carton: 2.08</p>	Must use with seating. Seating not included. Includes 2 brackets and screws	BRTS2406B	531	-	-	-	-	-	-	-	-	-	-	-		
			OVERALL DIMENSIONS			SEAT DIMENSIONS			BACK DIMENSIONS							
			W	D	H	W	D	H	W	H						
			24	6	25	-	-	-	-	-						
			RTA 00													
 <p>Inline 6" Table Block w/ Front Power COM Yardage: N/A Freight Class: 92.50 Product Weight (lbs.): 23.30 Cubic Feet Per Carton: 2.08</p>	Must use with seating. Seating not included. Includes 2 brackets and screws	BRTS2406BP	1144	-	-	-	-	-	-	-	-	-	-	-		
			OVERALL DIMENSIONS			SEAT DIMENSIONS			BACK DIMENSIONS							
			W	D	H	W	D	H	W	H						
			24	6	25	-	-	-	-	-						
			RTA 00													
 <p>Inline 6" Table Block w/ Front & Rear Power COM Yardage: N/A Freight Class: 92.50 Product Weight (lbs.): 24.30 Cubic Feet Per Carton: 2.08</p>	Must use with seating. Seating not included. Includes 2 brackets and screws	BRTS2406B2P	1758	-	-	-	-	-	-	-	-	-	-	-		
			OVERALL DIMENSIONS			SEAT DIMENSIONS			BACK DIMENSIONS							
			W	D	H	W	D	H	W	H						
			24	6	25	-	-	-	-	-						
			RTA 00													
 <p>Inline 6" Table Block w/ Tablet Arm COM Yardage: N/A Freight Class: 85 Product Weight (lbs.): 25.60 Cubic Feet Per Carton: 2.08</p>	Must use with seating. Seating not included. Includes 2 brackets and screws	BRTS2406BT	1014	-	-	-	-	-	-	-	-	-	-	-		
			OVERALL DIMENSIONS			SEAT DIMENSIONS			BACK DIMENSIONS							
			W	D	H	W	D	H	W	H						
			24	6	25	-	-	-	-	-						
			RTA 00													

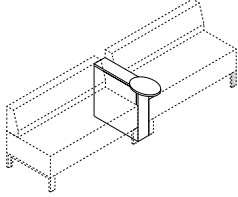
DESCRIPTION	FEATURES	MODEL#	STANDARD TEXTILE GRADES													
			1	2	3	4	5	6	7	8	9	10	11	12		
 <p>Inline 6" Table Block w/ Front Power & Tablet Arm COM Yardage: N/A Freight Class: 92.50 Product Weight (lbs.): 24.30 Cubic Feet Per Carton: 2.08</p>	<p>Must use with seating. Seating not included. Includes 2 brackets and screws</p>	<p>BRTS2406BPT</p>	1627	-	-	-	-	-	-	-	-	-	-	-		
			OVERALL DIMENSIONS			SEAT DIMENSIONS			BACK DIMENSIONS							
			W	D	H	W	D	H	W	H						
24	6	25	-	-	-	-	-									
			RTA 00													

CALIDON



GC36305
Wood Lounge Single Seat, Open Arms



GC36301
Wood Guest Single Seat, Open Arms



GC36308
Wood Lounge Single Seat, Closed Arms



For Calidon tables, see page 296

EXAMPLE CALIDON ORDER CODE:

GC36308	PU75	AAM	NBS
Model #	Textile	Frame Finish	Sealed Back Seams
NSS	NB	NM	SRT
Sealed Seat Seams	Moisture Barrier	Glides	Power

STANDARD FEATURES

- Calidon series consists of wood frame guest, lounge, bariatric and bench seating in addition to fully upholstered lounge seating. Freestanding and tandem/bridge tables also available to complement the line.
- Calidon is designed for the rigors of high use environments. Lounge units include metal frame supports.
- The seating in this series is available to specify with two textiles, one for the seat cushion and one for the back and arms (see model image).
- For pricing, start with the base price and add both back/arms graded textile upcharge and the seat graded textile upcharge.
- Frame design features a wall saver leg to prevent back contact and damage to walls.
- All guest and lounge chairs feature a clean out between seat and back, replaceable seat cushions and tall legs for ease of cleaning.
- For added comfort, seats are standard with high density Ultracell foam.
- Active weight capacity up to 400 lbs/seat for standard seating; up to 600 lbs for bariatric seating.
- For healthcare textiles, visit the website at globalfurnituregroup.com.
- Textiles with a minimum of 100,000 double rubs must be specified to meet Global's 24/7 warranty coverage.
- Can be upholstered in standard Global textiles if Healthcare 24/7 warranty compliance is not required.
- For alternate textile applications, contact Global specials. The Blended Textile matrix does not apply to this series.
- Tandem table models connect to guest seating only. See Calidon tables.
- No seating or bench models gang together.
- Shipped fully assembled.

OPTIONAL FEATURES

- All guest and lounge models can be specified with or without armcaps. Urethane armcaps are available on Wood arm guest and lounge chairs. Solid surface armcaps are available on all chair models. Armcaps are field replaceable, securely fastened with metal-to-metal connectors. Armcaps cannot be retrofitted in the field on units with no existing armcaps.
- Fully upholstered lounge chairs can be specified with a tamperproof Black power/USB unit, which includes one AC outlet, two 10 watt USB ports, and a 10 ft long power cord. Power is factory installed and must be specified at time of order. Add **\$237** each. Power locations vary by model. See power location diagram.
- For moisture barrier on seat, specify **(MB)**. Upcharges vary, see model.
- To add sealed seams, specify **(SBS)** for seat back and arms and/or **(SSS)** for seat. Upcharges vary, see model.
- A tamperproof power unit is available to specify in various locations on closed arm lounge models only. See diagrams.

SUGGESTED APPLICATIONS



- Guest seating
- Lobby/Lounge
- Treatment/Exam rooms



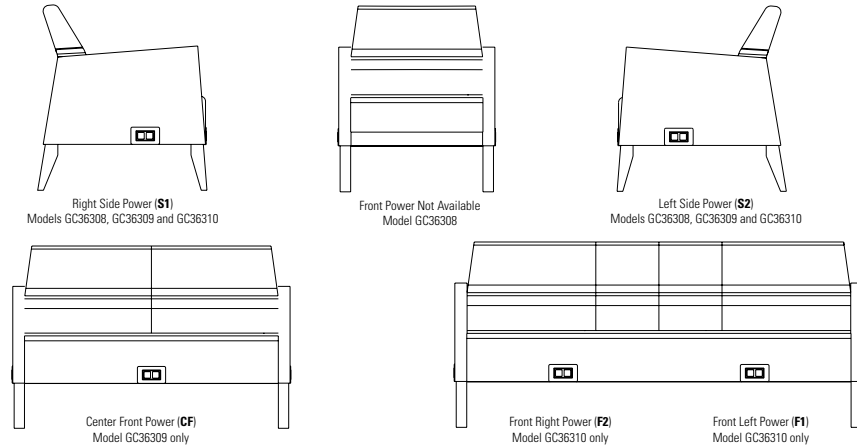

Please add option codes in the following order:





- **Model number**
See models.
For Calidon tables, refer to calidon tables 296
- **Back/Arm Textile**
Specify textile code. See model grade upcharges.
- **Seat Textile**
Specify textile code. See model grade upcharges.
- **Armcap option**
(FNA) No armcaps
(FAC) With armcaps. Upcharges vary, see model.
- **Frame finish**
(AAM) Absolute
(CJM) Charcoal Java
(ACM) Cherry
(EMM) Empire Mahogany
(EOM) English Oak
(ECM) Espresso Cafe
(TFM) Fruitwood
(HGM) Grey
(HOM) Harvest Oak
(AHM) Honey
(JOM) Jet Onyx
(LHM) Light Honey
(TMM) Mahogany
(AVM) Maple
(MWM) Medium Walnut
(ASM) Night
(NBM) Noce Biondo
(NGM) Noce Grigio
(NEM) Noce Leggero
(NMM) Noce Medio
(SBM) Sandy Beach
(SKM) Shaker Cherry
(SOM) Silver Oak
(TWM) Walnut
(WTM) WC Cream
(WHM) White
(WCM) Winter Cherry
- **Armcap finish**
(SSU) Urethane (for wood arm models of guest and lounge seating with FAC specified).
Urethane finishes (upcharges vary, see model):
(BLK) Black
(J52) Mocha
(KAL) Kalua
(SHW) Shadow
(LAB) Latte
(TOA) Toast
(CO) Solid Surface (for all wood and fully upholstered arm models with FAC specified). Solid Surface Finishes:
Grade 1: (Upcharges vary, see model)
(SWH) Designer White
Grade 2: (Upcharges vary, see model)
(SBT) Beige Tempest
(SBX) Black Onyx Mirage
(SMG) Milk Glass Spectra
(SFW) Frosty White Mirage
(SHS) Hot Stone
(SNM) Northern Melange
- **Sealed Back Seams** (Contact Customer Care for approved textiles.)
(NBS) No sealed back seams
(SBS) Sealed back seams. Upcharges vary, see model.
- **Sealed Seat Seams** (Contact Customer Care for approved textiles.)
(NSS) No sealed seat seams
(SSS) Sealed seat seams. Upcharges vary, see model.
- **Glides**
(NM) Non-marking
(NS) Non-slip
Guest single seat, bariatric and lounge chairs, add \$29.
Guest two seater, Add \$44.
Guest three seater, add \$56.
- **Moisture Barrier** (seat only) (Not available with Sealed Seams)
(NB) No moisture barrier
(MB) Moisture barrier. Upcharges vary, see model.
- **Power/USB unit position** (lounge models only). Add **\$237**.
(NPM) No power
(TPM) Tamperproof power unit
(J) Black
(SRT) Side right
(SLT) Side left
(FLT) Front left (three seater only)
(FRT) Front right (three seater only)
(CRF) Center front (two seater only)
(SLR) Side left and right. Add **\$472**.
(FLR) Front left and right. Add **\$472**.

POWER LOCATION DIAGRAM



DESCRIPTION	MODEL#/ FEATURES	STANDARD TEXTILE GRADES												
		1/COM	2	3	4	5	6	7	8	9	10	11	12	
 Wood Guest Single Seat COM Yardage: Back: 0.9; Seat: 1 Freight Class: 250 Product Weight (lbs.): 38 Cubic Feet Per Carton: 16.5	GC36301	Base Price:	\$1195											
	Back upcharge:	+0	+\$29	+\$52	+\$85	+\$132	+\$152	+\$192	+\$256	+\$304	+\$356	+\$465	+\$579	
	Seat upcharge:	+0	+\$32	+\$57	+\$94	+\$146	+\$168	+\$213	+\$284	+\$337	+\$395	+\$516	+\$643	
	OVERALL DIMENSIONS													
		W	D	H	W	D	H	W	H	W	H			
Active weight 400 lbs.		23.5	26.5	34.5	21.5	18	18	21.5	16.5					
Add \$111 for Urethane armcaps Add \$372 for (CO) Grade 1 armcaps Add \$414 for (CO) Grade 2 armcaps Add \$126 for (MB) Add \$27 for (SSS), \$38 for (SBS)														
 Wood Guest Two Seater, Full Center Arm COM Yardage: Back: 1.8; Seat: 2 Freight Class: 250 Product Weight (lbs.): 68 Cubic Feet Per Carton: 31.75	GC36302	Base Price:	\$2211											
	Back upcharge:	+0	+\$58	+\$103	+\$170	+\$263	+\$303	+\$384	+\$512	+\$607	+\$711	+\$929	+\$1158	
	Seat upcharge:	+0	+\$64	+\$114	+\$188	+\$292	+\$336	+\$426	+\$568	+\$674	+\$790	+\$1032	+\$1286	
	OVERALL DIMENSIONS													
		W	D	H	W	D	H	W	H	W	H			
Active weight 400 lbs./seat		46	26.5	34.5	21.5	18	18	21.5	16.5					
Add \$167 for Urethane armcaps Add \$585 for (CO) Grade 1 armcap Add \$621 for (CO) Grade 2 armcaps Add \$250 for (MB) Add \$53 for (SSS), \$75 for (SBS)														
 Wood Guest Three Seater, Full Center Arms COM Yardage: Back: 2.7; Seat: 3 Freight Class: 250 Product Weight (lbs.): 101 Cubic Feet Per Carton: 47.5	GC36303	Base Price:	\$3255											
	Back upcharge:	+0	+\$87	+\$154	+\$254	+\$395	+\$454	+\$576	+\$767	+\$910	+\$1067	+\$1394	+\$1737	
	Seat upcharge:	+0	+\$96	+\$171	+\$282	+\$438	+\$504	+\$639	+\$852	+\$1011	+\$1185	+\$1548	+\$1929	
	OVERALL DIMENSIONS													
		W	D	H	W	D	H	W	H	W	H			
Active weight 400 lbs./seat		68	26.5	34.5	21.5	18	18	21.5	16.5					
Add \$222 for Urethane armcaps Add \$780 for (CO) Grade 1 armcaps Add \$828 for (CO) Grade 2 armcaps Add \$373 for (MB) Add \$79 for (SSS), \$112 for (SBS)														

DESCRIPTION	MODEL#/ FEATURES	STANDARD TEXTILE GRADES											
		1/COM	2	3	4	5	6	7	8	9	10	11	12
 <p>Wood Guest Bariatric Chair, COM Yardage: Back: 1.25; Seat: 1.25 Freight Class: 250 Product Weight (lbs.): 55 Cubic Feet Per Carton: 22.25</p>	GC36304 Base Price:	\$1827											
	Back upcharge:	+0	+\$40	+\$72	+\$118	+\$183	+\$210	+\$267	+\$355	+\$422	+\$494	+\$645	+\$804
	Seat upcharge:	+0	+\$40	+\$72	+\$118	+\$183	+\$210	+\$267	+\$355	+\$422	+\$494	+\$645	+\$804
	Active weight 600 lbs.	OVERALL DIMENSIONS			SEAT DIMENSIONS			BACK DIMENSIONS					
		W	D	H	W	D	H	W	H				
	32.75	26.5	34.5				31	18	18	30.5	16.5		
 <p>Wood Lounge Single Seat COM Yardage: Back: 1.25; Seat: 1.25 Freight Class: 250 Product Weight (lbs.): 49 Cubic Feet Per Carton: 18.25</p>	GC36305 Base Price:	\$1670											
	Back upcharge:	+0	+\$40	+\$72	+\$118	+\$183	+\$210	+\$267	+\$355	+\$422	+\$494	+\$645	+\$804
	Seat upcharge:	+0	+\$40	+\$72	+\$118	+\$183	+\$210	+\$267	+\$355	+\$422	+\$494	+\$645	+\$804
	Active weight 400 lbs.	OVERALL DIMENSIONS			SEAT DIMENSIONS			BACK DIMENSIONS					
		W	D	H	W	D	H	W	H				
	25.75	29.5	32.5				24	21	16	23.5	16.5		
 <p>Wood Lounge Two Seater COM Yardage: Back: 1.75; Seat: 2.25 Freight Class: 250 Product Weight (lbs.): 77 Cubic Feet Per Carton: 32.75</p>	GC36306 Base Price:	\$2348											
	Back upcharge:	+0	+\$56	+\$100	+\$165	+\$256	+\$294	+\$373	+\$497	+\$590	+\$692	+\$903	+\$1126
	Seat upcharge:	+0	+\$72	+\$129	+\$212	+\$329	+\$378	+\$480	+\$639	+\$759	+\$889	+\$1161	+\$1447
	Active weight 400 lbs./seat	OVERALL DIMENSIONS			SEAT DIMENSIONS			BACK DIMENSIONS					
		W	D	H	W	D	H	W	H				
	47.5	29.5	32.5				45	21	16	44.5	16.5		
 <p>Wood Lounge Three Seater, COM Yardage: Back: 2.5; Seat: 2.75 Freight Class: 250 Product Weight (lbs.): 109 Cubic Feet Per Carton: 50.75</p>	GC36307 Base Price:	\$2936											
	Back upcharge:	+0	+\$80	+\$143	+\$235	+\$365	+\$420	+\$533	+\$710	+\$843	+\$988	+\$1290	+\$1608
	Seat upcharge:	+0	+\$88	+\$157	+\$259	+\$402	+\$462	+\$586	+\$781	+\$927	+\$1087	+\$1419	+\$1769
	Active weight 400 lbs./seat	OVERALL DIMENSIONS			SEAT DIMENSIONS			BACK DIMENSIONS					
		W	D	H	W	D	H	W	H				
	70.5	29.5	32.5				68	21	16	67.5	16.5		
 <p>Fully Upholstered Wood Lounge Single Seat COM Yardage: Back/Arm: 2.75; Seat: 1.25 Freight Class: 250 Product Weight (lbs.): 58 Cubic Feet Per Carton: 18.75</p>	GC36308 Base Price:	\$1893											
	Back/Arm upcharge:	+0	+\$88	+\$157	+\$259	+\$402	+\$462	+\$586	+\$781	+\$927	+\$1087	+\$1419	+\$1769
	Seat upcharge:	+0	+\$40	+\$72	+\$118	+\$183	+\$210	+\$267	+\$355	+\$422	+\$494	+\$645	+\$804
	Active weight 400 lbs.	OVERALL DIMENSIONS			SEAT DIMENSIONS			BACK DIMENSIONS					
		W	D	H	W	D	H	W	H				
	27.5	29.5	33.5				24	21	16	23.5	17.5		

DESCRIPTION	MODEL#/ FEATURES	STANDARD TEXTILE GRADES												
		1/COM	2	3	4	5	6	7	8	9	10	11	12	
 <p>Fully Upholstered Wood Lounge Two Seater COM Yardage: Back/Arm: 3.5; Seat: 2.25 Freight Class: 250 Product Weight (lbs.): 89 Cubic Feet Per Carton: 33.75</p>	GC36309 Base Price:	\$2545												
	Back/Arm upcharge:	+0	+\$112	+\$200	+\$329	+\$511	+\$588	+\$746	+\$994	+\$1180	+\$1383	+\$1806	+\$2251	
	Seat upcharge:	+0	+\$72	+\$129	+\$212	+\$329	+\$378	+\$480	+\$639	+\$759	+\$889	+\$1161	+\$1447	
	Active weight 400 lbs./seat													
		OVERALL DIMENSIONS	SEAT DIMENSIONS			BACK DIMENSIONS								
	W D H	W	D	H	W	D	H	W	H					
	49.5 29.5 33.5	44.5	18	16	45.5	17.5								
	Add \$403 for (CO) Grade 1 armcaps Add \$431 for (CO) Grade 2 armcaps Add \$250 for (MB) Add \$52 for (SSS), \$160 for (SBS) Power/USB unit available.													
 <p>Fully Upholstered Wood Lounge Three Seater COM Yardage: Back/Arm: 4.25; Seat: 2.75 Freight Class: 250 Product Weight (lbs.): 123 Cubic Feet Per Carton: 52</p>	GC36310 Base Price:	\$3196												
	Back/Arm upcharge:	+0	+\$136	+\$243	+\$400	+\$621	+\$714	+\$906	+\$1207	+\$1433	+\$1679	+\$2193	+\$2733	
	Seat upcharge:	+0	+\$88	+\$157	+\$259	+\$402	+\$462	+\$586	+\$781	+\$927	+\$1087	+\$1419	+\$1769	
	Active weight 400 lbs./seat													
		OVERALL DIMENSIONS	SEAT DIMENSIONS			BACK DIMENSIONS								
	W D H	W	D	H	W	D	H	W	H					
	71.5 29.5 33.5	66.5	18	16	67.5	17.5								
	Add \$403 for (CO) Grade 1 armcaps Add \$431 for (CO) Grade 2 armcaps Add \$373 for (MB) Add \$86 for (SSS), \$179 for (SBS) Power/USB unit available.													
 <p>Single Seat Bench COM Yardage: 1 Freight Class: 150 Product Weight (lbs.): 41 Cubic Feet Per Carton: 10</p>	GC36311 Base Price:	\$1279												
	Seat upcharge:	+0	+\$32	+\$57	+\$94	+\$146	+\$168	+\$213	+\$284	+\$337	+\$395	+\$516	+\$643	
	Active weight 400 lbs.													
		OVERALL DIMENSIONS	SEAT DIMENSIONS			BACK DIMENSIONS								
		W D H	W	D	H	W	D	H	W	H				
	24 28 18	24	26.75	18										
	Add \$126 for (MB) Add \$31 for (SSS)													
 <p>Two Seat Bench COM Yardage: 2 Freight Class: 250 Product Weight (lbs.): 61 Cubic Feet Per Carton: 18.75</p>	GC36312 Base Price:	\$2023												
	Seat upcharge:	+0	+\$64	+\$114	+\$188	+\$292	+\$336	+\$426	+\$568	+\$674	+\$790	+\$1032	+\$1286	
	Active weight 400 lbs./seat													
		OVERALL DIMENSIONS	SEAT DIMENSIONS			BACK DIMENSIONS								
		W D H	W	D	H	W	D	H	W	H				
	48 28 18	48	26.75	18										
	Add \$250 for (MB) Add \$61 for (SSS)													
 <p>Three Seat Bench COM Yardage: 3 Freight Class: 250 Product Weight (lbs.): 97 Cubic Feet Per Carton: 27.75</p>	GC36313 Base Price:	\$2414												
	Seat upcharge:	+0	+\$96	+\$171	+\$282	+\$438	+\$504	+\$639	+\$852	+\$1011	+\$1185	+\$1548	+\$1929	
	Active weight 400 lbs./seat													
		OVERALL DIMENSIONS	SEAT DIMENSIONS			BACK DIMENSIONS								
		W D H	W	D	H	W	D	H	W	H				
	72 28 18	72	26.75	18										
	Add \$373 for (MB) Add \$89 for (SSS)													

CALIDON TABLES



Square end table - 22"
GC36314



Rectangular Coffee Table
GC36317



Tandem Side Table, Right
GC36319R



For Calidon seating, refer to page 293

EXAMPLE CALIDON TABLE ORDER CODE:

GC36319R	-HP	-ACJ	-CNT
Model #	Top material	Laminate finish	Power

TABLE TOP FINISHES:

See finishes section for solid wood/laminate coordination chart.

Thermally fused laminate (LP):

- Absolute Acajou (ACJ)
- Asian Night (ASN)
- Avant Cherry (AWC)
- Avant Honey (AWH)
- Black (BLK)
- Blizzard (BZD)
- Brushed Cobalt (BRC)
- Clear Maple (CMB)
- Custom Grey (CGY)
- Dark Espresso (DES)
- Designer White (DWT)
- Fashionista (FAS)
- First Class (FCL)
- Noce Biondo (NBL)
- Noce Grigio (NGL)
- Noce Leggero (NEL)
- Noce Medio (NML)
- Quartered Mahogany (QTM)
- Sheer Beauty (SBY)
- Stonedust (SDT)
- Walnut Heights (WHE)
- White Chocolate (WHC)
- Winter Cherry (WCR)

High pressure laminate (HP):

- Absolute Acajou (ACJ)
- Asian Night (ASN)
- Avant Cherry (AWC)
- Avant Honey (AWH)
- Black (BLK)
- Blizzard (BZD)
- Brushed Cobalt (BRC)
- Clear Maple (CMB)
- Custom Grey (CGY)
- Dark Espresso (DES)
- Designer White (DWT)
- Fashionista (FAS)
- First Class (FCL)
- Noce Biondo (NBL)
- Noce Grigio (NGL)
- Noce Leggero (NEL)
- Noce Medio (NML)
- Quartered Mahogany (QTM)
- Sheer Beauty (SBY)
- Stonedust (SDT)
- Walnut Heights (WHE)
- White Chocolate (WHC)
- Winter Cherry (WCR)

Solid Surface* (CO):

- Grade 1:**
(SWH) Designer White
- Grade 2:**
(SBT) Beige Tempest
(SBX) Black Onyx Mirage
(SMG) Milk Glass Spectra
(SFW) Frosty White Mirage
(SHS) Hot Stone
(SNM) Northern Melange

*For detailed material information, please reference WilsonArt's Solid Surface collection.

TABLE STANDARD FEATURES

- Designed as part of the Calidon seating series, Calidon tables coordinate with a range of lounge and guest seating.
- A variety of wood leg tables are available, including various height end tables, coffee tables and tandem tables.
- Wood legs/frames are specifiable Global solid wood seating finishes.
- Table tops are 1" thick, available in thermally fused laminate (LP), high pressure laminate (HP), and solid surface (CO). Upcharges vary, see model for pricing.
- Laminate top tables include color coordinating vinyl edge band.
- Tandem/bridge table models (GC36318 to GC36321) connect to Calidon guest seating only and include ganging brackets.
- Tandem tables are specified left or right, as seated.

TABLE OPTIONAL FEATURES

- A tamperproof tabletop power unit may be specified on laminate top, tandem and square end tables only. Specify **CNT**. Add **\$358**. The power unit is located centered 1.5" from the edge of the surface. See power location diagrams for reference.

SUGGESTED APPLICATIONS







- Lounge/Lobby
- Resident rooms
- Patient rooms
- Private office

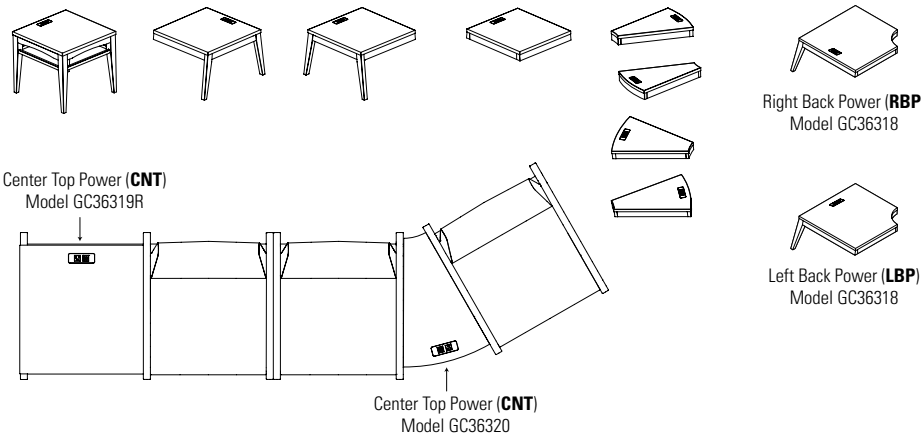



Please add option codes in the following order:

- Table model number**
GC36314 to GC36317 Freestanding tables
GC36318 to GC36321 Tandem/bridge tables
GC36324 to GC36326 23"H Freestanding tables
For Calidon seating, refer to page 293
- Top Material (tables)**
(LP) Thermally fused laminate. Specify finish - See LP finishes.
(HP) High pressure laminate. Upcharges vary - see model. Specify finish - see HP finishes.
(CO) Solid surface. Upcharges vary - see model. Specify finish - see CO finishes and grades.
- Leg finish**
(AAM) Absolute (MWM) Medium Walnut
(CJM) Charcoal Java (ASM) Night
(ACM) Cherry (NBM) Noce Biondo
(EMM) Empire Mahogany (NGM) Noce Grigio
(EOM) English Oak (NEM) Noce Leggero
(ECM) Espresso Cafe (NMM) Noce Medio
(TFM) Fruitwood (SBM) Sandy Beach
(HGM) Grey (SKM) Shaker Cherry
(HOM) Harvest Oak (SOM) Silver Oak
(AHM) Honey (TWM) Walnut
(JOM) Jet Onyx (WTM) WC Cream
(LHM) Light Honey (WHM) White
(TMM) Mahogany (WCM) Winter Cherry
(AVM) Maple
- Power/USB unit position** (laminate tandem and end tables with laminate tops only).
(NPM) No power
(CNT) Center top power. Jet Black. Add **\$358**.
(RBP) Right back top power. Jet Black. Add **\$358**.
(LBP) Left back top power. Jet Black. Add **\$358**.

POWER LOCATION DIAGRAM

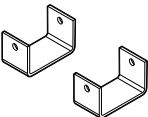

TABLES	MODEL#	DIMENSIONS	FREIGHT CLASS	WT/LBS.	CUBIC FT.	LIST PRICE
	GC36314	22 x 22 x 20.25	150	36	7.75	\$826
Square End Table, 22" x 22" x 20.25" H		<ul style="list-style-type: none"> • Pricing shown for a thermally fused laminate top (LP). • For a high pressure laminate top (HP), add \$65. • For a solid surface top (CO), add \$1071 for Grade 1 and add \$1315 for Grade 2. <p>Coordinating edge on laminate surfaces with solid wood frame and legs. 1 per carton. Power/USB unit can be specified in the surface of laminate top tables (CNT). Add \$358.</p>				
	GC36324	22 x 22 x 23	150	23.5	6.75	\$977
Square End Table, 22" x 22" x 23" H		<ul style="list-style-type: none"> • Pricing shown for a thermally fused laminate top (LP). • For a high pressure laminate top (HP), add \$65. • For a solid surface top (CO), add \$1071 for Grade 1 and add \$1315 for Grade 2. <p>Coordinating edge on laminate surfaces with solid wood frame and legs. 1 per carton. Power/USB unit can be specified in the surface of laminate top tables (CNT). Add \$358.</p>				
	GC36325	22 x 12 x 23	125	34	10.75	\$841
Rectangular End Table, 23" H		<ul style="list-style-type: none"> • Pricing shown for a thermally fused laminate top (LP). • For a high pressure laminate top (HP), add \$54. • For a solid surface top (CO), add \$884 for Grade 1 and add \$1061 for Grade 2. <p>Coordinating edge on laminate surfaces with solid wood frame and legs. 1 per carton. Power/USB unit can be specified in the surface of laminate top tables (CNT). Add \$358.</p>				
	GC36326	24 x 25 x 23	150	34	12.75	\$1082
Corner 30° End Table, 23" H		<ul style="list-style-type: none"> • Pricing shown for a thermally fused laminate top (LP). • For a high pressure laminate top (HP), add \$70. • For a solid surface top (CO), add \$1215 for Grade 1 and add \$1464 for Grade 2. <p>Coordinating edge on laminate surfaces with solid wood frame and legs. 1 per carton. Power/USB unit can be specified in the surface of laminate top tables (CNT). Add \$358.</p>				
	GC36315	24 x 24 x 17.25	250	37	9.5	\$857
Square Coffee Table, 24"		<ul style="list-style-type: none"> • Pricing shown for a thermally fused laminate top (LP). • For a high pressure laminate top (HP), add \$65. • For a solid surface top (CO), add \$1300 for Grade 1 and add \$1605 for Grade 2. <p>Coordinating edge on laminate surfaces with solid wood frame and legs. 1 per carton.</p>				
	GC36316	36 x 36 x 17.25	250	65	18.25	\$1025
Square Coffee Table, 36"		<ul style="list-style-type: none"> • Pricing shown for a thermally fused laminate top (LP). • For a high pressure laminate top (HP), add \$140. • For a solid surface top (CO), add \$2979 for Grade 1 and add \$3589 for Grade 2. <p>Coordinating edge on laminate surfaces with solid wood frame and legs. 1 per carton.</p>				
	GC36317	24 x 48 x 17.25	250	56	16.5	\$1123
Rectangular Coffee Table		<ul style="list-style-type: none"> • Pricing shown for a thermally fused laminate top (LP). • For a high pressure laminate top (HP), add \$127. • For a solid surface top (CO), add \$2481 for Grade 1 and add \$2894 for Grade 2. <p>Coordinating edge on laminate surfaces with solid wood frame and legs. 1 per carton.</p>				

TABLES	MODEL#	DIMENSIONS	FREIGHT CLASS	WT/LBS.	CUBIC FT.	LIST PRICE
	GC36318	31.25 x 31.25 x 15.75	250	46	14.5	\$1025
Corner Table, 90°		<ul style="list-style-type: none"> • Pricing shown for a thermally fused laminate top (LP). • For a high pressure laminate top (HP), add \$104. • For a solid surface top (CO), add \$2576 for Grade 1 and add \$3079 for Grade 2. <p>Coordinating edge on laminate surfaces with solid wood frame and legs. Must be connected between two guest chairs. Includes two sets of U-channel connectors and hardware. 1 per carton. Power/USB unit can be specified in the surface of laminate top tables (RBP) or (LBP). Add \$358. See power location diagram for placement.</p>				
	GC36319L	26.5 x 22.25 x 15.75	250	20	6.75	\$715
Tandem Side Table, Left		<ul style="list-style-type: none"> • Pricing shown for a thermally fused laminate top (LP). • For a high pressure laminate top (HP), add \$65. • For a solid surface top (CO), add \$1089 for Grade 1 and add \$1311 for Grade 2. <p>Coordinating edge on laminate surfaces with solid wood frame and legs. Must be connected to a guest chair. Includes one set of U-channel connectors and hardware. 1 per carton. Power/USB unit can be specified in the surface of laminate top tables (CNT). Add \$358.</p>				
	GC36319R	26.5 x 22.25 x 15.75	250	20	6.75	\$715
Tandem Side Table, Right		<ul style="list-style-type: none"> • Pricing shown for a thermally fused laminate top (LP). • For a high pressure laminate top (HP), add \$65. • For a solid surface top (CO), add \$1089 for Grade 1 and add \$1311 for Grade 2. <p>Coordinating edge on laminate surfaces with solid wood frame and legs. Must be connected to a guest chair. Includes one set of U-channel connectors and hardware. 1 per carton. Power/USB unit can be specified in the surface of laminate top tables (CNT). Add \$358.</p>				
	GC36320	22.5 x 15.75 x 3	92.5	16	1.5	\$563
Corner Table, 30 Degree		<ul style="list-style-type: none"> • Pricing shown for a thermally fused laminate top (LP). • For a high pressure laminate top (HP), add \$65. • For a solid surface top (CO), add \$910 for Grade 1 and add \$1093 for Grade 2. <p>Coordinating edge on laminate surfaces with solid wood frame and legs. Must be connected between two guest chairs. Includes two sets of U-channel connectors and hardware. 1 per carton. Power/USB unit can be specified in the surface of laminate top tables (CNT). Add \$358.</p>				
	GC36321	21 x 23.5 x 3	92.5	20	1.9	\$597
In-Line Table, Square		<ul style="list-style-type: none"> • Pricing shown for a thermally fused laminate top (LP). • For a high pressure laminate top (HP), add \$65. • For a solid surface top (CO), add \$942 for Grade 1 and add \$1161 for Grade 2. <p>Coordinating edge on laminate surfaces with solid wood frame and legs. Must be connected between two guest chairs. Includes two sets of U-channel connectors and hardware. 1 per carton. Power/USB unit can be specified in the surface of laminate top tables (CNT). Add \$358.</p>				
	GC36322	2.87 x 1.5 x 1.62	70	0.75	0.03	\$48
U-Channel (set of 2)		Includes hardware. 4 sets per carton.				

CAMINO



models shown: 5471-CP Lounge Chair, 5475-W End Table, 5472-CP Two Seat Sofa.



model 5471-CP



model 5476-W





model 5485-W





STANDARD FEATURES



- A transitional soft seating series composed of one, two and three seat units. The series also offers tables with coordinating details and finishes.
- Frame is a heavy duty, interlocking plywood, puzzle box construction suitable for public environments.
- The soft seating leg system utilizes a continuous visible frame between the front and rear leg. Each leg frame is bolted directly to the sofa frame with large bolts to provide a very durable leg construction.
- Legs are equipped with translucent non marking glides as standard. Suitable for both carpet and hard surface flooring.
- Seating features as standard, decorative double stitch detail, which make seams lay flat and add extra seam strength.
- Cushions are highly resilient foam and seats are equipped with a synthetic rubberized sheet webbing suspension system for extra comfort. Cushions are fixed and non-removable.
- Tables are made with a choice of tops: Genuine Wood tops (**W**) with a reverse beveled edge, Thermally Fused Laminate tops (**LP**) with matching PVC edging or High Pressure Laminate top (**HP**) with matching PVC edging. Custom high pressure laminate finishes will be considered upon requested.
- Regardless of top chosen all tables have wood aprons and a unique tapered leg design.
- Some table assembly required, see RTA code with each item below.
- Measurement shown for weight is for one unit, measurement for volume is per carton.
- Check textile availability prior to specifying upholstery material.



OPTIONAL FEATURES

- Optional cushions and arms can have tailored piping details.
- For piping made in fabric matching the rest of the upholstery fabric please use **MP** models (matching piping after the model number). This is no upcharge.
- For contrast piping made in a fabric that does not match the rest of the upholstery fabric, you can specify any grade 1 or 2 upholstery material for this purpose, please see model numbers ending in **CP** which reflect the appropriate upcharge.
- For contrast piping in a fabric higher than grade 2, you must ask for a special quotation. Per unit price will vary depending on the number of units being ordered.
- Seating unit and tables come with a choice of wood legs or a polished cast aluminum. The table leg finishes coordinate with the legs on the soft seating units.
- Seating and tables with polished aluminum legs are shown as separate skus.
- Tops finishes coordinate with the laminate finishes for Global Desking and wood seating finishes. Specify laminate finishes from the Adaptabilities or Zira sections of the price list.
- Wood legs for seating are available in select Global wood seating finishes - see seating finishes. Only finishes ending in "**M**" are available for this series.

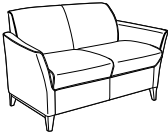
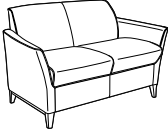
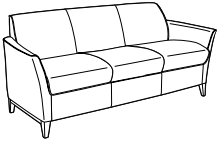
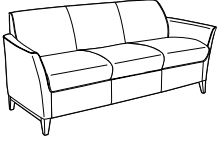
DESCRIPTION	FEATURES	MODEL#	STANDARD TEXTILE GRADES											
			1	2	3	4	5	6	7	8	9	10	11	12
 <p>Lounge Chair w/ Wood Legs COM Yardage: 4 Freight Class: 250 Product Weight (lbs.): 60 Cubic Feet Per Carton: 19.25</p>	No Piping.	5471	2626	2782	2903	3082	3340	3459	3694	4064	4348	4668	5321	6018
		OVERALL DIMENSIONS			SEAT DIMENSIONS			BACK DIMENSIONS						
		W	D	H	W	D	H	W	H					
		29.5	29	30.5	21	19.5	18	20	11.5					
		RTA.00												
 <p>Lounge Chair w/ Wood Legs & Piping COM Yardage: 4 Freight Class: 250 Product Weight (lbs.): 60 Cubic Feet Per Carton: 19.25</p>	CP = Contrast Piping MP = Matching Piping	5471-CP	2827	2983	3104	3283	3541	3660	3895	4265	4549	4869	5522	6219
		5471-MP	2626	2782	2903	3082	3340	3459	3694	4064	4348	4668	5321	6018
		OVERALL DIMENSIONS			SEAT DIMENSIONS			BACK DIMENSIONS						
		W	D	H	W	D	H	W	H					
			29.5	29	30.5	21	19.5	18	20	11.5				
		RTA.00												

DESCRIPTION	FEATURES	MODEL#	STANDARD TEXTILE GRADES												
			1	2	3	4	5	6	7	8	9	10	11	12	
 <p>End Table - 21"x 21" Square w/Wood Legs COM Yardage: N/A Freight Class: 100 Product Weight (lbs.): 20 Cubic Feet Per Carton: 2.1</p>			1511	-	-	-	-	-	-	-	-	-	-	-	
			1662	-	-	-	-	-	-	-	-	-	-	-	
			1830	-	-	-	-	-	-	-	-	-	-	-	
			LP = Laminate Top HP = High Pressure Laminate Top W = Wood Top												
			OVERALL DIMENSIONS			SEAT DIMENSIONS			BACK DIMENSIONS						
		W	D	H	W	D	H	W	H						
		21	21	17.5	-	-	-	-	-						
		RTA 8		FedEx		UPS									
 <p>End Table - 24" Round w/Wood Legs COM Yardage: N/A Freight Class: 92.5 Product Weight (lbs.): 21 Cubic Feet Per Carton: 2.1</p>			1563	-	-	-	-	-	-	-	-	-	-		
			1716	-	-	-	-	-	-	-	-	-	-		
			1988	-	-	-	-	-	-	-	-	-	-		
			LP = Laminate Top HP = High Pressure Laminate Top W = Wood Top												
			OVERALL DIMENSIONS			SEAT DIMENSIONS			BACK DIMENSIONS						
		W	D	H	W	D	H	W	H						
		24	24	17.5	-	-	-	-	-						
		RTA 8		FedEx		UPS									
 <p>Coffee Table - 32" Round w/Wood Legs COM Yardage: N/A Freight Class: 125 Product Weight (lbs.): 35 Cubic Feet Per Carton: 4.4</p>			2361	-	-	-	-	-	-	-	-	-	-		
			2510	-	-	-	-	-	-	-	-	-	-		
			2985	-	-	-	-	-	-	-	-	-	-		
			LP = Laminate Top HP = High Pressure Laminate Top W = Wood Top												
			OVERALL DIMENSIONS			SEAT DIMENSIONS			BACK DIMENSIONS						
		W	D	H	W	D	H	W	H						
		32	32	17.5	-	-	-	-	-						
		RTA 8		FedEx		UPS									
 <p>Lounge Chair w/Aluminum Legs COM Yardage: 4 Freight Class: 250 Product Weight (lbs.): 62 Cubic Feet Per Carton: 19.25</p>	No Piping.		5481	2626	2782	2903	3082	3340	3459	3694	4064	4348	4668	5321	6018
			OVERALL DIMENSIONS			SEAT DIMENSIONS			BACK DIMENSIONS						
			W	D	H	W	D	H	W	H					
			29.5	29	30.5	21	19.5	18	20	11.5					
			RTA 00												
 <p>Lounge Chair w/Aluminum Legs COM Yardage: 4 Freight Class: 250 Product Weight (lbs.): 62 Cubic Feet Per Carton: 19.25</p>	CP = Contrast Piping. MP = Matching Piping.		5481-CP	2827	2983	3104	3283	3541	3660	3895	4265	4549	4869	5522	6219
			5481-MP	2626	2782	2903	3082	3340	3459	3694	4064	4348	4668	5321	6018
			OVERALL DIMENSIONS			SEAT DIMENSIONS			BACK DIMENSIONS						
			W	D	H	W	D	H	W	H					
			29.5	29	30.5	21	19.5	18	20	11.5					
		RTA 00													

DESCRIPTION	FEATURES	MODEL#	STANDARD TEXTILE GRADES											
			1	2	3	4	5	6	7	8	9	10	11	12
 <p>Two Seat Sofa w/ Aluminum Legs COM Yardage: 5.75 Freight Class: 250 Product Weight (lbs.): 86 Cubic Feet Per Carton: 36</p>	No Piping.	5482	3721	3943	4115	4375	4744	4916	5252	5785	6194	6652	7591	8596
			OVERALL DIMENSIONS			SEAT DIMENSIONS			BACK DIMENSIONS					
			W	D	H	W	D	H	W	H				
			51	29	30.5	42	19.5	18	41	11.5				
			RTA 00											
 <p>Two Seat Sofa w/ Aluminum Legs COM Yardage: 5.75 Freight Class: 250 Product Weight (lbs.): 86 Cubic Feet Per Carton: 36</p>	CP = Contrast Piping. MP = Matching Piping.	5482-CP	3987	4209	4381	4209	4381	4641	5010	5182	5518	6051	6460	8862
			5482-MP	3721	3943	4115	4375	4744	4916	5252	5785	6194	6652	7591
		OVERALL DIMENSIONS			SEAT DIMENSIONS			BACK DIMENSIONS						
		W	D	H	W	D	H	W	H					
51	29	30.5	42	19.5	18	41	11.5							
			RTA 00											
 <p>Three Seat Sofa w/ Aluminum Legs COM Yardage: 7.5 Freight Class: 250 Product Weight (lbs.): 112 Cubic Feet Per Carton: 50.25</p>	No Piping.	5483	4816	5103	5327	5103	6148	6375	6811	7506	8044	8638	9865	11173
			OVERALL DIMENSIONS			SEAT DIMENSIONS			BACK DIMENSIONS					
			W	D	H	W	D	H	W	H				
			71	29	30.5	63	19.5	18	62	11.5				
			RTA 00											
 <p>Three Seat Sofa w/Aluminum Legs COM Yardage: 7.5 Freight Class: 250 Product Weight (lbs.): 112 Cubic Feet Per Carton: 50.25</p>	CP = Contrast Piping. MP = Matching Piping.	5483-CP	5147	5434	5659	6000	6479	6706	7143	7837	8375	11504	10196	11504
			5483-MP	4816	5103	5327	5669	6148	6375	6811	7506	8044	8638	9865
		OVERALL DIMENSIONS			SEAT DIMENSIONS			BACK DIMENSIONS						
		W	D	H	W	D	H	W	H					
30.5	29	30.5	63	19.5	18	62	11.5							
			RTA 00											
 <p>Coffee Table - 22" x 48" Rectangular w/Aluminum Legs COM Yardage: N/A Freight Class: 92.5 Product Weight (lbs.): 46 Cubic Feet Per Carton: 4</p>		5484-LP	2142	-	-	-	-	-	-	-	-	-	-	
			5484-HP	2291	-	-	-	-	-	-	-	-	-	-
		5484-W	2731	-	-	-	-	-	-	-	-	-	-	
		OVERALL DIMENSIONS			SEAT DIMENSIONS			BACK DIMENSIONS						
W	D	H	W	D	H	W	H							
22	48	17.5	-	-	-	-	-							
			RTA 6											

DESCRIPTION	FEATURES	MODEL#	STANDARD TEXTILE GRADES												
			1	2	3	4	5	6	7	8	9	10	11	12	
 <p>End Table - 21" x 21" Square w/Aluminum Legs COM Yardage: N/A Freight Class: 85 Product Weight (lbs.): 26 Cubic Feet Per Carton: 2.1</p>			1	2	3	4	5	6	7	8	9	10	11	12	
	5485-LP	1623	-	-	-	-	-	-	-	-	-	-	-	-	
	5485-HP	1774	-	-	-	-	-	-	-	-	-	-	-	-	
	5485-W	1942	-	-	-	-	-	-	-	-	-	-	-	-	
	LP = Laminate Top HP = High Pressure Laminate Top W = Wood Top														
	OVERALL DIMENSIONS			SEAT DIMENSIONS			BACK DIMENSIONS								
	W D H			W D H			W H								
	21 21 17.5			-			-								
	RTA 8			FedEx			ups								
	 <p>End Table - 24" Round w/Aluminum Legs COM Yardage: N/A Freight Class: 85 Product Weight (lbs.): 27 Cubic Feet Per Carton: 2.1</p>			1	2	3	4	5	6	7	8	9	10	11	12
5486-LP		1676	-	-	-	-	-	-	-	-	-	-	-	-	
5486-HP		1827	-	-	-	-	-	-	-	-	-	-	-	-	
5486-W		2101	-	-	-	-	-	-	-	-	-	-	-	-	
LP = Laminate Top HP = High Pressure Laminate Top W = Wood Top															
OVERALL DIMENSIONS			SEAT DIMENSIONS			BACK DIMENSIONS									
W D H			W D H			W H									
24 24 17.5			-			-									
RTA 8			FedEx			ups									
 <p>Coffee Table - 32" Round w/Aluminum Legs COM Yardage: N/A Freight Class: 100 Product Weight (lbs.): 41 Cubic Feet Per Carton: 4.4</p>				1	2	3	4	5	6	7	8	9	10	11	12
	5487-LP	2473	-	-	-	-	-	-	-	-	-	-	-	-	
	5487-HP	2623	-	-	-	-	-	-	-	-	-	-	-	-	
	5487-W	3098	-	-	-	-	-	-	-	-	-	-	-	-	
	LP = Laminate Top HP = High Pressure Laminate Top W = Wood Top														
	OVERALL DIMENSIONS			SEAT DIMENSIONS			BACK DIMENSIONS								
	W D H			W D H			W H								
	32 32 17.5			-			-								
	RTA 8														

CITI™



model 7875LTL (BK) model 7889



Citi Modular Group & Tables - Shown in Tungsten



5" tubular metal leg (shown in Tungsten) 5" tapered wood leg (shown in Maple)

STANDARD FEATURES

- Fully upholstered contemporary design, complements the timeless decor of many offices. Proportions are compact, 31" deep, and work well in public spaces.
- All models have fixed, non-removable cushions.
- For increased durability with a softer sit, a highly resilient, high density Ultracell foam (UCO option is available. See upcharges.
- Arm height on all models is 25".
- Casters are not available on this series.
- Citi seating and table legs are 5" high tubular metal. Seating also available with wood, tapered, softened square legs.
- Citi table tops are available in either tempered glass or laminate.
- Laminate tablet seating models (TL suffix) are available specified as seated. Specify right (RTL) or left (LTL). For additional tablet arm models, contact CustomerCare for pricing. The tablet is 0.75" thick with thermally fused laminate and measure 12"D x 16.5"W.
- Ganging brackets (7892) are sold separately.
- Ganging brackets are to be used on armless seating if interconnection to another armless seating unit is required. Bench and ottomans only gang to other benches/ottomans, cannot gang with seating units. Brackets come with a template for installation.
- Upholstery options: fabric, vinyl or leather. Starting at grade 5 pricing. Leather models feature a stitch detail across the seat and/or back cushions, if applicable.
- If you would like fabric/vinyl on the shell of the chair with leather seat and back cushions or other combinations, please complete "Multi Fabric" Form and submit with your order. Multi Fabric grade will apply.

Add option codes in the following order:

- Model Number**
Specify model number.

- Seat Foam Upgrade** (add option to end of model number)
(RF) Standard Foam
(UC) Soft Ultracell foam. For Lounge and corner chairs add \$137; Two Seat Sofas add \$269; Three Seat Sofas add \$403.
- Leg Type** (Lounge only)
(MTL) Metal Legs
(WDL) Wood Legs. Add \$315
- Leg Finish:**
Metal leg finish (lounge and tables):
(TBL) Black
(TTU) Tungsten
(CHM) Chrome. **Add \$110.**
Wood leg finish (lounge only):
(AAM) Absolute (BKM) Black
(ACM) Cherry (EOM) English Oak
(ECM) Espresso Cafe (TFM) Fruitwood
(HGM) Gray (AHM) Honey
(TMM) Mahogany (AVM) Maple
(MWM) Medium Walnut (NLW) Natural Walnut
(ASM) Night (NBM) Noce Biondo
(NGM) Noce Grigio (NEM) Noce Leggero
(NMM) Noce Medio (SKM) Shaker Cherry
(TWM) Walnut (WTM) WC Cream
(WHM) White (WCM) Winter Cherry
- Glide Type** (wood legs)
(NM) White, non-marking nylon glide for most surfaces
(SG) Steel cushioned glide for carpeted surfaces. Add \$34.
(RG) Non-slip rubber glide for most hard floor surfaces. Add \$34.
(FG) Felt glide for most hard floor surfaces. Add \$34.
- Laminate Finish** (tables and tablets)
(ACJ) Absolute Acajou (ASN) Asian Night
(AVC) Avant Cherry (AVH) Avant Honey
(BLK) Black (BRC) Brushed Cobalt
(BZD) Blizzard (CGY) Custom Grey
(CMB) Clear Maple (DES) Dark Espresso
(DWT) Designer White (FAS) Fashionista
(FCL) First Class (NBL) Noce Biondo
(NEL) Noce Leggero (NGL) Noce Grigio
(NML) Noce Medio
(QTM) Quartered Mahogany
(SBY) Sheer Beauty (SDT) Stonedust
(SOG) Storm Grey (WCR) Winter Cherry
(WHC) White Chocolate (WHE) Walnut Heights

SAMPLE LAYOUTS

Layout A

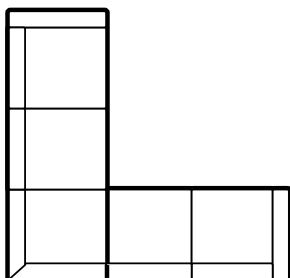



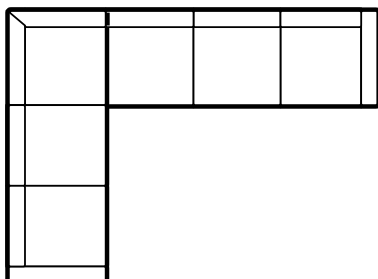

Qty	Model Number	Description	Dimensions	List Price
1	7890LNB	Two Seat Sofa w/Left Arm	48 x 31 x 30.75	2133
1	7862	Corner Seat	37 x 37 x 31	2316
1	7890RNB	Two Seat Sofa w/Right Arm	48 x 31 x 30.75	2133
2	7892	Ganging Bracket	0.5 x 3.87 x 2	32
SAMPLE LAYOUT TOTAL IN STANDARD FEET FINISH				\$6,614

Layout B

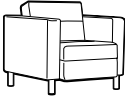
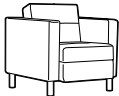

Qty	Model Number	Description	Dimensions	List Price
1	7890RNB	Two Seat Sofa w/Right Arm	48 x 31 x 30.75	2133
1	7862	Corner Seat	37 x 37 x 31	2316
1	7891LNB	Three Seat Sofa w/Left Arm	77 x 31 x 30.75	2850
2	7892	Ganging Bracket	0.5 x 3.87 x 2	32 x 2
SAMPLE LAYOUT TOTAL IN STANDARD FEET FINISH				\$7,363

DESCRIPTION	FEATURES	MODEL#	STANDARD TEXTILE GRADES											
			1	2	3	4	5	6	7	8	9	10	11	12
 <p>Ganging Bracket COM Yardage: N/a Freight Class: 70 Product Weight (lbs.): 0.25 Cubic Feet Per Carton: 0.01</p>	<p>Kit includes 2 brackets, 4 screws and a template.</p>	7892	32	-	-	-	-	-	-	-	-	-	-	-
		OVERALL DIMENSIONS			SEAT DIMENSIONS			BACK DIMENSIONS						
		W	D	H	W	D	H	W	H					
		-	-	-	-	-	-	-	-					
		  												
 <p>Corner Seat COM Yardage: 6.25 Freight Class: 250 Product Weight (lbs.): 65 Cubic Feet Per Carton: 30.25</p>		7862	-	-	-	-	2316	2487	2810	3390	3722	4257	5069	6036
		OVERALL DIMENSIONS			SEAT DIMENSIONS			BACK DIMENSIONS						
		W	D	H	W	D	H	W	H					
		37	37	30.75	26	26	17.5	26	13.5					
														
 <p>Large Lounge Chair - for 6'+ Tall Users COM Yardage: 5.50 Freight Class: 250 Product Weight (lbs.): 70 Cubic Feet Per Carton: 24.25</p>		7864	-	-	-	-	2054	-	-	2998	3291	3762	4476	5328
		OVERALL DIMENSIONS			SEAT DIMENSIONS			BACK DIMENSIONS						
		W	D	H	W	D	H	W	H					
		34	33	30	23	20	19	23	13.5					
														
 <p>Lounge Chair COM Yardage: 4.5 Freight Class: 250 Product Weight (lbs.): 67 Cubic Feet Per Carton: 21</p>		7875	-	-	-	-	1517	1646	1885	2318	2562	2958	3559	4278
		OVERALL DIMENSIONS			SEAT DIMENSIONS			BACK DIMENSIONS						
		W	D	H	W	D	H	W	H					
		30	31	30	21	19.5	17.5	21	12.5					
														
 <p>7875LTL 7875RTL</p> <p>Lounge Chair w/Laminate Tablet COM Yardage: 4.5 Freight Class: 250 Product Weight (lbs.): 75 Cubic Feet Per Carton: 22.5</p>		7875LTL 7875RTL	-	-	-	-	2275	2405	2651	3089	3338	3746	4360	5089
		OVERALL DIMENSIONS			SEAT DIMENSIONS			BACK DIMENSIONS						
		W	D	H	W	D	H	W	H					
		31.5	33.5	33.5	21	19.5	17.5	21	12.5					
														

DESCRIPTION	FEATURES	MODEL#	STANDARD TEXTILE GRADES											
			1	2	3	4	5	6	7	8	9	10	11	12



Lounge Chair- Armless
 COM Yardage: 3
 Freight Class: 250
 Product Weight (lbs.): 45
 Cubic Feet Per Carton: 15.5

7895	-	-	-	-	1519	1605	1758	2037	2196	2453	2842	3307
-------------	---	---	---	---	------	------	------	------	------	------	------	------

OVERALL DIMENSIONS			SEAT DIMENSIONS			BACK DIMENSIONS	
W	D	H	W	D	H	W	H
22	31	30.75	21	19.5	17.5	21	14

RTA 00

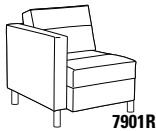

Lounge Chair- Single Arm
 COM Yardage: 4
 Freight Class: 250
 Product Weight (lbs.): 65
 Cubic Feet Per Carton: 21

7901L	-	-	-	-	1829	1939	2143	2467	2715	2995	3568	4176
7901R	-	-	-	-	-	-	-	-	-	-	-	-

OVERALL DIMENSIONS			SEAT DIMENSIONS			BACK DIMENSIONS	
W	D	H	H	W	D	H	WH
26	31	30	22	19.5	17.5	22	12.5

RTA 00

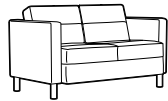

Two Seat Sofa
 COM Yardage: 6.25
 Freight Class: 250
 Product Weight (lbs.): 125
 Cubic Feet Per Carton: 36

7876	-	-	-	-	2046	2225	2554	3150	3494	4044	4881	5880
-------------	---	---	---	---	------	------	------	------	------	------	------	------

OVERALL DIMENSIONS			SEAT DIMENSIONS			BACK DIMENSIONS	
W	D	H	W	D	H	W	H
51.25	31	30	42.5	19.5	17.5	42.5	12.5

RTA 00



Two Seat Sofa - Armless
 COM Yardage: 5
 Freight Class: 250
 Product Weight (lbs.): 93
 Cubic Feet Per Carton: 36

7896	-	-	-	-	1890	2028	2286	2751	3015	3446	4093	4866
-------------	---	---	---	---	------	------	------	------	------	------	------	------

OVERALL DIMENSIONS			SEAT DIMENSIONS			BACK DIMENSIONS	
W	D	H	W	D	H	W	H
43.25	31	30.75	42.5	19.5	17.5	42.5	12.5

RTA 00

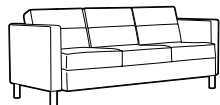





Three Seat Sofa
 COM Yardage: 8.75
 Freight Class: 250
 Product Weight (lbs.): 163
 Cubic Feet Per Carton: 50.25



7877	-	-	-	-	2575	2820	3287	4125	4602	5375	6547	7939
-------------	---	---	---	---	------	------	------	------	------	------	------	------



OVERALL DIMENSIONS			SEAT DIMENSIONS			BACK DIMENSIONS	
W	D	H	W	D	H	W	H
72.5	31	30	63.5	19.5	17.5	63.5	12.5

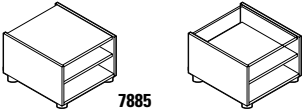

RTA 00



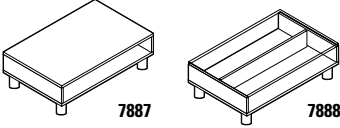

DESCRIPTION	FEATURES	MODEL#	STANDARD TEXTILE GRADES											
			1	2	3	4	5	6	7	8	9	10	11	12
 <p>Three Seat Sofa - Armless COM Yardage: 7.25 Freight Class: 250 Product Weight (lbs.): 131 Cubic Feet Per Carton: 50.25</p>		7897	-	-	-	-	2488	2686	3063	3733	4117	4739	5680	6803
			OVERALL DIMENSIONS			SEAT DIMENSIONS			BACK DIMENSIONS					
			W	D	H	W	D	H	W	H				
			64.5	31	30.75	63.5	19.5	17.5	63.5	12.5				
		RTA 00												

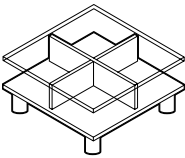
DESCRIPTION	FEATURES	MODEL#	STANDARD TEXTILE GRADES											
			1	2	3	4	5	6	7	8	9	10	11	12
 <p>Ottoman COM Yardage: 1.5 Freight Class: 250 Product Weight (lbs.): 27 Cubic Feet Per Carton: 7.5</p>		7879	-	-	-	-	587	632	712	859	942	1080	1283	1526
			OVERALL DIMENSIONS			SEAT DIMENSIONS			BACK DIMENSIONS					
			W	D	H	W	D	H	W	H				
			22	22	17	-	-	17	-	-				
		RTA 00	 											

DESCRIPTION	FEATURES	MODEL#	STANDARD TEXTILE GRADES												
			1	2	3	4	5	6	7	8	9	10	11	12	
 <p>End Table COM Yardage: N/A Freight Class: 100 Product Weight (lbs.): 53 Cubic Feet Per Carton: 6</p>		7885	827	-	-	-	-	-	-	-	-	-	-	-	
			Laminate												
			7886	1166	-	-	-	-	-	-	-	-	-	-	-
				Glass Top											
			OVERALL DIMENSIONS			SEAT DIMENSIONS			BACK DIMENSIONS						
			W	D	H	W	D	H	W	H					
			20	24	20	-	-	-	-	-					
		RTA 1	 												

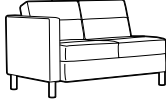
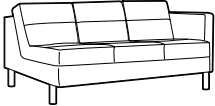
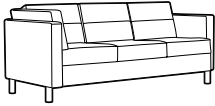
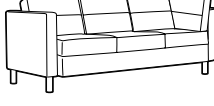
DESCRIPTION	FEATURES	MODEL#	STANDARD TEXTILE GRADES												
			1	2	3	4	5	6	7	8	9	10	11	12	
 <p>Coffee Table Rectangular COM Yardage: N.A Freight Class: 100 Product Weight (lbs.): 60 Cubic Feet Per Carton: 6.5</p>		7887	863	-	-	-	-	-	-	-	-	-	-	-	
			Laminate												
			7888	1343	-	-	-	-	-	-	-	-	-	-	-
				Glass Top											
			OVERALL DIMENSIONS			SEAT DIMENSIONS			BACK DIMENSIONS						
			W	D	H	W	D	H	W	H					
			40	20	15	-	-	-	-	-					
		RTA 1	 												

DESCRIPTION	FEATURES	MODEL#	STANDARD TEXTILE GRADES												
			1	2	3	4	5	6	7	8	9	10	11	12	
 <p>Coffee Table Square COM Yardage: N/A Freight Class: 92.5 Product Weight (lbs.): 90 Cubic Feet Per Carton: 8.75</p>		7889	1630	-	-	-	-	-	-	-	-	-	-	-	
			Glass Top												
				OVERALL DIMENSIONS			SEAT DIMENSIONS			BACK DIMENSIONS					
				W	D	H	W	D	H	W	H				
			33	33	15	-	-	-	-	-					
		RTA 1	 												

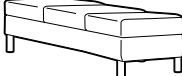
DESCRIPTION	FEATURES	MODEL#	STANDARD TEXTILE GRADES												
			1	2	3	4	5	6	7	8	9	10	11	12	
 7890LNB	 7890RNB	7890LNB 7890RNB	-	-	-	-	2133	2283	2569	3081	3370	3843	4560	5415	
			OVERALL DIMENSIONS W D H			SEAT DIMENSIONS W D H			BACK DIMENSIONS W H						
Two Seat Sofa - No Connector COM Yardage: 5.25 Freight Class: 250 Product Weight (lbs.): 107 Cubic Feet Per Carton: 36			**Intended to be free standing. No connecting hardware.												
			RTA 00												
 7891LNB	 7891RNB	7891LNB 7891RNB	-	-	-	-	2850	3048	3425	4095	4479	5101	6042	7165	
			OVERALL DIMENSIONS W D H			SEAT DIMENSIONS W D H			BACK DIMENSIONS W H						
Three Seat Sofa - No Connector COM Yardage: 7.25 Freight Class: 250 Product Weight (lbs.): 138 Cubic Feet Per Carton: 50.25			**Intended to be free standing. No connecting hardware.												
			RTA 00												
 7891L-RCNB	 7891R-RCNB	7891L-RCNB 7891R-RCNB	-	-	-	-	3433	3674	4137	4964	5437	6203	7361	8744	
			OVERALL DIMENSIONS W D H			SEAT DIMENSIONS W D H			BACK DIMENSIONS W H						
Three Seat Sofa - No Connector COM Yardage: 8.5 Freight Class: 250 Product Weight (lbs.): 154 Cubic Feet Per Carton: 55.5			**Intended to be free standing. No connecting hardware.												
			RTA 00												
			7893	-	-	-	-	1165	1231	1351	1574	1698	1899	2206	2574
	OVERALL DIMENSIONS W D H			SEAT DIMENSIONS W D H			BACK DIMENSIONS W H								
Two Seat Bench COM Yardage: 2.25 Freight Class: 250 Product Weight (lbs.): 42 Cubic Feet Per Carton: 11.5			**Intended to be free standing. No connecting hardware.												
			RTA 00												
												 			
			7894	-	-	-	-	1663	1773	1977	2340	2549	2891	3399	4008
	OVERALL DIMENSIONS W D H			SEAT DIMENSIONS W D H			BACK DIMENSIONS W H								
Three Seat Bench COM Yardage: 3.75 Freight Class: 250 Product Weight (lbs.): 62 Cubic Feet Per Carton: 16.75			**Intended to be free standing. No connecting hardware.												
			RTA 00												

CITI™ SQUARE



model S7875LT



Sample Layout A - Models shown: S7875UC and S7911



Sample Layout B - Models shown: S7890RUC, S7862UC (2), S7897UC, S7890LUC and S7912

STANDARD FEATURES

- Fully upholstered lounge series with a complete range of sectional components for all applications. Proportions are compact, 31" and 33.5" deep so it works well in public spaces.
- All models have fixed, non-removable cushions.
- Upholstery options: fabric, vinyl and leather. Leather models may feature a horizontal stitch detail across the seat and/or back cushions if applicable.
- The 5 inch high leg frame for seating and occasional tables lightens the look, it is available in Tungsten (S1) as standard or optionally available in Black (S2) Please specify finish, no upcharge added.
- Casters are not available on this series.
- Arm height on all models is 25"
- Tablet arms are made from thermally fused laminate, measure 12"D x 16.5"W 3/4" thick. Available right hand seated (RT), left Hand seated (LT) or both right and left hand (LRT).
- Ganging Brackets are sold separately. Ganging brackets are to be used on armless seating if interconnection to another armless seating unit is required. Bench and ottomans only gang to other benches/ottomans, cannot gang with seating units.
- Brackets come with a template for installation: unless noted otherwise all armless skus are equipped with the steel on steel connectors to receive this bracket.
- Upholstery options: fabric, vinyl and leather. Leather models feature a horizontal stitch detail across the seat and/or back cushions if applicable.
- Check textile availability prior to specifying upholstery material.
- If you would like fabric/vinyl on the shell of the chair with leather seat and back cushions or other combinations, please complete "Multi Fabric" Form and submit with your order. Multi Fabric grade will apply.
- Measurement shown for weight is for one unit. Measurement for volume is per carton.

OPTIONAL FEATURES

- Seating and Table Leg Finishes**
Metal legs are available in the following finishes:
(TBL) Black (TBZ) Buzz Blue
(TCC) Cactus (TCR) Carrot
(TDJ) Dijon (TDW) Designer White
(TEG) Eggplant (TFO) Fog

- (TFR) Frost (TIV) Cloud (TLA) Latte (TOA) Toast (TSH) Shadow (TSR) Scarlet (CHM) Chrome. Add \$205 (ACO) Antique Copper. Add \$458 for corner units. Add \$342 for single seat units. Add \$558 for two seat units. Add \$558 for three seat units. Add \$669 for four seat units. (BCH) Brushed Chrome. Add \$300 for corner units. Add \$215 for single seat units. Add \$329 for two seat units. Add \$329 for three seat units. Add \$389 for four seat units. (SBR) Satin Brass. Add \$458 for corner units. Add \$342 for single seat units. Add \$558 for two seat units. Add \$558 for three seat units. Add \$669 for four seat units.
- (TIN) Ink (TKA) Kalua (TMO) Mocha (TNE) Nevada (TSN) Sand (TTU) Tungsten
- Laminate Tables and Tablet arms are made with high pressure laminate and are offered in the following finishes: Absolute Acajou (ACJ), Asian Night (ASN), Avant Cherry (AWC), Avant Honey (AWH), Black (BLK), Blizzard (BZD), Brushed Cobalt (BRC), Clear Maple (CMB), Custom Grey (CGY), Dark Espresso (DES), Designer White (DWT), Fashionista (FAS), First Class (FCL), Noce Biondo (NBL), Noce Grigio (NGL), Noce Leggero (NEL), Noce Medio (NML), Quartered Mahogany (QTM), Sheer Beauty (SBY), Stonedust (SDT), Walnut Heights (WHE), White Chocolate (WHC) and Winter Cherry (WCR). Please Specify. Custom high pressure laminate finishes will be considered upon request.
- For high resilient, high density Ultracell foam on seat, specify (UC) after the model number. One Seater, add \$137. Two Seater, add \$269. Three Seater, add \$403, and Four Seater, add \$536
- Power/USB modules are available in the Citi Square tables. Each module includes a double power outlet and two USB terminals. It is equipped with a 6' long three-prong power cord with standard three prong plug. The Power monuments are available in Jet Black (J1) or White (W1). Add \$945 per unit. Please see Electrical Placement below for predetermined locations.

ELECTRICAL PLACEMENT

Coffee/End Tables: Predetermined Location is on the end/side of the unit J1 (black) or W1 (white).

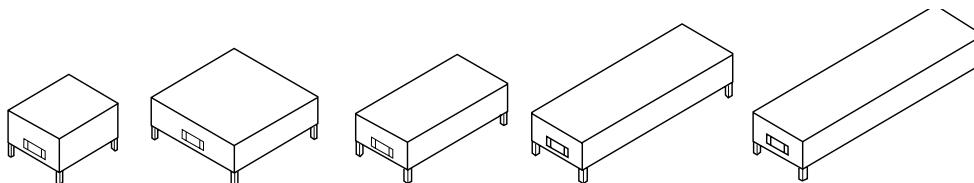

	1	2	3	4	5	6	7	8	9	10	11	12
7892	32	-	-	-	-	-	-	-	-	-	-	-



Ganging Bracket
COM Yardage: N/A
Freight Class: 70
Product Weight (lbs.): 00.25
Cubic Feet Per Carton: 00.01

Two brackets included.
Only one set is needed per connection.

OVERALL DIMENSIONS			SEAT DIMENSIONS			BACK DIMENSIONS	
W	D	H	W	D	H	W	H
0.5	3.87	2	-	-	-	-	-



DESCRIPTION	FEATURES	MODEL#	STANDARD TEXTILE GRADES											
			1	2	3	4	5	6	7	8	9	10	11	12

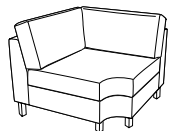

Linking Corner Unit
 COM Yardage: 6.25
 Freight Class: 250
 Product Weight (lbs.): 75
 Cubic Feet Per Carton: 30.25

No ganging hardware
 Armless side(s) can be equipped
 with ganging brackets, model 7892.

OVERALL DIMENSIONS			SEAT DIMENSIONS			BACK DIMENSIONS		
W	D	H	W	D	H	W	H	
37	37	31	26	26	17.5	26	13.5	

RTA 00



Single Seat w/Arms
 COM Yardage: 4.5
 Freight Class: 250
 Product Weight (lbs.): 81
 Cubic Feet Per Carton: 21

Free standing unit only.

OVERALL DIMENSIONS			SEAT DIMENSIONS			BACK DIMENSIONS		
W	D	H	W	D	H	W	H	
30	31	30	21	19.5	17.5	21	12.5	

RTA 00

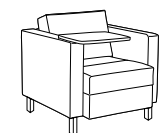

S7875RT

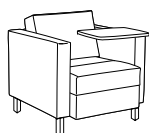

S7875LT

Single Seat w/Arms & Laminate Tablet
 COM Yardage: 4.5
 Freight Class: 250
 Product Weight (lbs.): 89
 Cubic Feet Per Carton: 22.5

Free standing unit only.
 Tablets are Right Hand Seated (RT)
 or Left Hand Seated (LT).

OVERALL DIMENSIONS			SEAT DIMENSIONS			BACK DIMENSIONS		
W	D	H	W	D	H	W	H	
31.5	33.5	30	21	19.5	17.5	21	12.5	

RTA 00

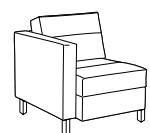

S7901R

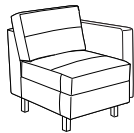

S7901L

Single Seat w/One Arm
 COM Yardage: 4
 Freight Class: 250
 Product Weight (lbs.): 65
 Cubic Feet Per Carton: 21

No ganging hardware.
 Armless side can be equipped
 with ganging brackets, model 7892.
 Arms are Right Hand Seated (RT)
 or Left Hand Seated (LT).

OVERALL DIMENSIONS			SEAT DIMENSIONS			BACK DIMENSIONS		
W	D	H	W	D	H	W	H	
26	31	30.75	21	19.5	17.5	21	12.5	

RTA 00



S7901RRT

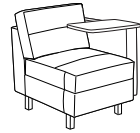



S7901LLT



Single Seat w/One Arm & Laminate Tablet
 COM Yardage: 4
 Freight Class: 250
 Product Weight (lbs.): 73
 Cubic Feet Per Carton: 22.5

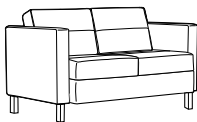
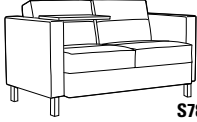
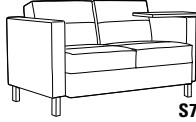
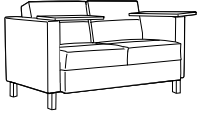
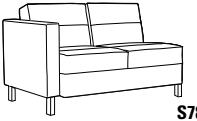

No ganging hardware.
 Armless side(s) can be equipped
 with ganging brackets, model 7892.
 Tablets are Arms are Right Hand Seated (RT)
 or Left Hand Seated (LT).

OVERALL DIMENSIONS			SEAT DIMENSIONS			BACK DIMENSIONS		
W	D	H	W	D	H	W	H	
27.5	31	30.75	21	19.5	17.5	21	12.5	

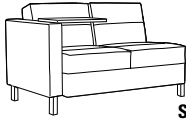
RTA 00

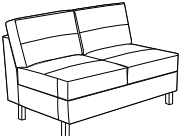
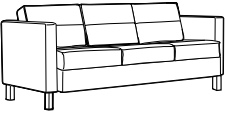
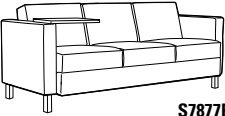
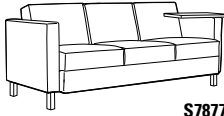
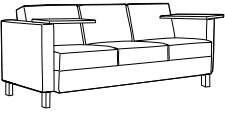
DESCRIPTION	FEATURES	MODEL#	STANDARD TEXTILE GRADES											
			1	2	3	4	5	6	7	8	9	10	11	12
 <p>Armless Single Seat COM Yardage: 3 Freight Class: 2250 Product Weight (lbs.): 45 Cubic Feet Per Carton: 15.5</p>	<p>No ganging hardware. Armless side(s) can be equipped with ganging brackets, model 7892.</p>	S7895	-	-	-	-	1829	1923	2096	2377	2590	2830	3320	3844
		OVERALL DIMENSIONS			SEAT DIMENSIONS			BACK DIMENSIONS						
		W	D	H	W	D	H	W	H					
		22	31	30.75	21	18.5	17.5	21	12.5					
		RTA 00												
 <p>Two Seater w/Arms COM Yardage: 6.25 Freight Class: 250 Product Weight (lbs.): 122 Cubic Feet Per Carton: 36</p>	<p>Free standing unit only.</p>	S7876	-	-	-	-	2588	2783	3145	3725	4169	4665	5689	6778
		OVERALL DIMENSIONS			SEAT DIMENSIONS			BACK DIMENSIONS						
		W	D	H	W	D	H	W	H					
		51.25	31	30	42.5	19.5	17.5	42.5	12.5					
		RTA 00												
 <p>S7876RT</p>  <p>S7876LT</p> <p>Two Seater w/Arms & Laminate Tablet COM Yardage: 6.25 Freight Class: 250 Product Weight (lbs.): 130 Cubic Feet Per Carton: 41.25</p>	<p>Free standing unit only. Tablets are Right Hand Seated (RT) or Left Hand Seated (LT).</p>	S7876RT	-	-	-	-	3208	3401	3765	4342	4789	5285	6309	7398
		S7876LT	-	-	-	-	3208	3401	3765	4342	4789	5285	6309	7398
		OVERALL DIMENSIONS			SEAT DIMENSIONS			BACK DIMENSIONS						
		W	D	H	W	D	H	W	H					
		52.75	33.5	30	42.5	19.5	17.5	42.5	12.5					
RTA 00														
 <p>Two Seater w/Arms & Laminate Tablets COM Yardage: 6.25 Freight Class: 250 Product Weight (lbs.): 138 Cubic Feet Per Carton: 41.25</p>	<p>Free standing unit only. With both Left and Right Tablets.</p>	S7876LRT	-	-	-	-	3829	4022	4386	4963	5410	5906	6930	8019
		OVERALL DIMENSIONS			SEAT DIMENSIONS			BACK DIMENSIONS						
		W	D	H	W	D	H	W	H					
		54.25	33.5	30	42.5	19.5	17.5	42.5	12.5					
		RTA 00												
 <p>S7890R</p>  <p>S7890L</p> <p>Two Seater w/One Arm COM Yardage: 5.25 Freight Class: 250 Product Weight (lbs.): 106 Cubic Feet Per Carton: 36</p>	<p>No ganging hardware. Armless side can be equipped with ganging brackets, model 7892. Arms are Right Hand Seated (RT) or Left Hand Seated (LT).</p>	S7890R	-	-	-	-	2403	2565	2870	3357	3732	4151	5007	5924
		S7890L	-	-	-	-	2403	2565	2870	3357	3732	4151	5007	5924
		OVERALL DIMENSIONS			SEAT DIMENSIONS			BACK DIMENSIONS						
		W	D	H	W	D	H	W	H					
		47.25	31	30.75	42.5	19.5	17.5	42.5	13.25					
RTA 00														

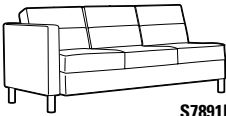
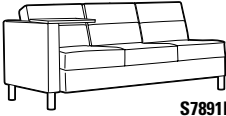
DESCRIPTION	FEATURES	MODEL#	STANDARD TEXTILE GRADES														
			1	2	3	4	5	6	7	8	9	10	11	12			
 <p>S7890RRT</p>	 <p>S7890LLT</p>	<p>S7890RRT</p> <p>S7890LLT</p>	-	-	-	-	3022	3184	3489	3976	4351	4769	5626	6542			
			-	-	-	-	3022	3184	3489	3976	4351	4769	5626	6542			
<p>Two Seater w/One Arm and Laminate Tablet</p> <p>COM Yardage: 5.25 Freight Class: 250 Product Weight (lbs.): 114 Cubic Feet Per Carton: 41.25</p>			<p>No ganging hardware. Armless side(s) can be equipped with ganging brackets, model 7892. Tablets are Arms are Right Hand Seated (RT) or Left Hand Seated (LT).</p>			48.75	33.5	30.75	42.5	19.5	17.5	42.5	13.25				
			RTA 00														
 <p>S7896</p>		<p>S7896</p>	-	-	-	-	2403	2559	2848	3313	3671	4069	4886	5756			
			-	-	-	-	2403	2559	2848	3313	3671	4069	4886	5756			
<p>Armless Two Seater</p> <p>COM Yardage: 5 Freight Class: 250 Product Weight (lbs.): 43.25 Cubic Feet Per Carton: 36</p>			<p>No ganging hardware. Armless side(s) can be equipped with ganging brackets, model 7892.</p>			43.25	31	30.75	42.5	19.5	17.5	42.5	13.25				
			RTA 00														
 <p>S7877</p>		<p>S7877</p>	-	-	-	-	3351	3618	4128	4941	5564	6260	7689	9216			
			-	-	-	-	3351	3618	4128	4941	5564	6260	7689	9216			
<p>Three Seater w/Arms</p> <p>COM Yardage: 8.75 Freight Class: 250 Product Weight (lbs.): 163 Cubic Feet Per Carton: 50.25</p>			<p>Free standing unit only.</p>			72.5	31	30	63.5	19.5	17.5	63.5	12.5				
			RTA 00														
 <p>S7877RT</p>	 <p>S7877LT</p>	<p>S7877RT</p> <p>S7877LT</p>	-	-	-	-	3969	4235	4746	5559	6182	6878	8307	9834			
			-	-	-	-	3969	4235	4746	5559	6182	6878	8307	9834			
<p>Three Seater w/Arms and Laminate Tablet</p> <p>COM Yardage: 8.75 Freight Class: 250 Product Weight (lbs.): 171 Cubic Feet Per Carton: 55.5</p>			<p>Free standing unit only. Tablets are Right Hand Seated (RT) or Left Hand Seated (LT).</p>			74	33.5	30	63.5	19.5	17.5	63.5	12.5				
			RTA 00														
 <p>S7877LRT</p>		<p>S7877LRT</p>	-	-	-	-	4588	4854	5365	6178	6801	7497	8926	10453			
			-	-	-	-	4588	4854	5365	6178	6801	7497	8926	10453			
<p>Three Seater w/Arms and Laminate Tablets</p> <p>COM Yardage: 8.75 Freight Class: 250 Product Weight (lbs.): 250 Cubic Feet Per Carton: 55.5</p>			<p>Free standing unit only. With both Left and Right Tablets.</p>			75.5	33.5	30	63.5	19.5	17.5	63.5	12.5				
			RTA 00														

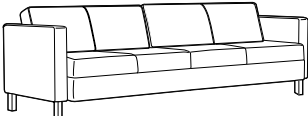
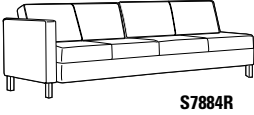
DESCRIPTION	FEATURES	MODEL#	STANDARD TEXTILE GRADES											
			1	2	3	4	5	6	7	8	9	10	11	12
 <p>S7891R</p> <p>Three Seater w/One Arm COM Yardage: 7.25 Freight Class: 250 Product Weight (lbs.): 147 Cubic Feet Per Carton: 50.25</p>	<p>No ganging hardware. Armless side can be equipped with ganging brackets, model 7892. Arms are Right Hand Seated (RT) or Left Hand Seated (LT) .</p>	S7891R	-	-	-	-	3245	3468	3889	4564	5081	5656	6842	8105
		S7891L	-	-	-	-	3245	3468	3889	4564	5081	5656	6842	8105
OVERALL DIMENSIONS			SEAT DIMENSIONS			BACK DIMENSIONS								
W D H			W D H			W H								
68.5 31 30.75			63.5 19.5 17.5			63.5 13.25								
RTA 00														
 <p>S7891RRT</p> <p>Three Seater w/One Arm and Laminate Tablet COM Yardage: 7.25 Freight Class: 250 Product Weight (lbs.): 155 Cubic Feet Per Carton: 55.25</p>	<p>No ganging hardware. Armless side(s) can be equipped with ganging brackets, model 7892. Tablets are Arms are Right Hand Seated (RT) or Left Hand Seated (LT).</p>	S7891RRT	-	-	-	-	3864	4087	4507	5183	5700	6275	7461	8724
		S7891LLT	-	-	-	-	3864	4087	4507	5183	5700	6275	7461	8724
OVERALL DIMENSIONS			SEAT DIMENSIONS			BACK DIMENSIONS								
W D H			W D H			W H								
70 33.5 30.75			63.5 19.5 17.5			63.5 13.25								
RTA 00														
 <p>S7897</p> <p>Armless Three Seater COM Yardage: 7.25 Freight Class: 250 Product Weight (lbs.): 131 Cubic Feet Per Carton: 50.25</p>	<p>No ganging hardware. Armless side(s) can be equipped with ganging brackets, model 7892.</p>	S7897	-	-	-	-	3245	3468	3889	4564	5081	5656	6842	8105
		S7897	-	-	-	-	3245	3468	3889	4564	5081	5656	6842	8105
OVERALL DIMENSIONS			SEAT DIMENSIONS			BACK DIMENSIONS								
W D H			W D H			W H								
64.5 31 30.75			63.5 19.5 17.5			63.5 13.25								
RTA 00														
 <p>S7884</p> <p>Four Seater w/Arms COM Yardage: 10.25 Freight Class: 250 Product Weight (lbs.): 204 Cubic Feet Per Carton: 69</p>	<p>Free standing unit only.</p>	S7884	-	-	-	-	4929	5243	5839	6789	7520	8335	10010	11798
		S7884	-	-	-	-	4929	5243	5839	6789	7520	8335	10010	11798
OVERALL DIMENSIONS			SEAT DIMENSIONS			BACK DIMENSIONS								
W D H			W D H			W H								
93.5 31 30			84 19.5 17.5			84 12.5								
RTA 00														
 <p>S7884R</p> <p>Four Seater w/One Arm COM Yardage: 9.5 Freight Class: 250 Product Weight (lbs.): 188 Cubic Feet Per Carton: 69</p>	<p>No ganging hardware. Armless side can be equipped with ganging brackets, model 7892. Arms are Right Hand Seated (RT) or Left Hand Seated (LT) .</p>	S7884R	-	-	-	-	4823	5112	5666	6545	7225	7980	9532	11189
		S7884L	-	-	-	-	4823	5112	5666	6545	7225	7980	9532	11189
OVERALL DIMENSIONS			SEAT DIMENSIONS			BACK DIMENSIONS								
W D H			W D H			W H								
89.5 31 30.75			84 19.5 17.5			84 12.5								
RTA 00														

DESCRIPTION FEATURES MODEL# STANDARD TEXTILE GRADES

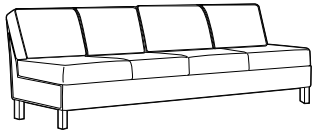

Armless Four Seater
 COM Yardage: 8.75
 Freight Class: 250
 Product Weight (lbs.): 172
 Cubic Feet Per Carton: 61.5

No ganging hardware.
 Armless side(s) can be equipped with ganging brackets, model 7892.

MODEL#	1	2	3	4	5	6	7	8	9	10	11	12
S7884NA	-	-	-	-	4823	5089	5600	6413	7036	7732	9161	10688
OVERALL DIMENSIONS			SEAT DIMENSIONS			BACK DIMENSIONS						
W	D	H	W	D	H	W	H					
85.5	31	30.75	84	19.5	17.5	84	12.5					
RTA 00												

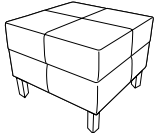

Square Ottoman
 COM Yardage: 1.5
 Freight Class: 250
 Product Weight (lbs.): 27
 Cubic Feet Per Carton: 7.5

No ganging hardware.
 Side(s) can be equipped with ganging brackets, model 7892.
 Does not gang to seating units.

MODEL#	1	2	3	4	5	6	7	8	9	10	11	12
S7879	-	-	-	-	759	807	896	1036	1144	1262	1508	1768
OVERALL DIMENSIONS			SEAT DIMENSIONS			BACK DIMENSIONS						
W	D	H	W	D	H	W	H					
22	22	17	-	-	17	-	-					
RTA 00												

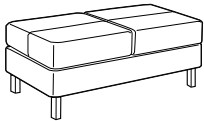

Two Seater Bench
 COM Yardage: 2.25
 Freight Class: 250
 Product Weight (lbs.): 42
 Cubic Feet Per Carton: 11.5

No ganging hardware.
 Side(s) can be equipped with ganging brackets, model 7892.
 Does not gang to seating units.

MODEL#	1	2	3	4	5	6	7	8	9	10	11	12
S7893	-	-	-	-	1458	1530	1663	1870	2033	2210	2577	2970
OVERALL DIMENSIONS			SEAT DIMENSIONS			BACK DIMENSIONS						
W	D	H	W	D	H	W	H					
43	21.5	17	-	-	17	-	-					
RTA 00												

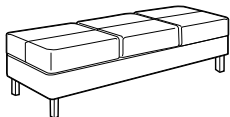

Three Seater Bench
 COM Yardage: 3.75
 Freight Class: 250
 Product Weight (lbs.): 62
 Cubic Feet Per Carton: 16.75

No ganging hardware.
 Side(s) can be equipped with ganging brackets, model 7892.
 Does not gang to seating units.

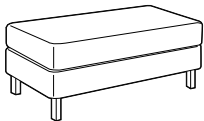

MODEL#	1	2	3	4	5	6	7	8	9	10	11	12
S7894	-	-	-	-	2076	2194	2412	2759	3027	3325	3937	4591
OVERALL DIMENSIONS			SEAT DIMENSIONS			BACK DIMENSIONS						
W	D	H	W	D	H	W	H					
64.5	21.5	17	-	-	17	-	-					
RTA 00												



Two Seater Bench - Single Cushion
 COM Yardage: 2.25
 Freight Class: 250
 Product Weight (lbs.): 42
 Cubic Feet Per Carton: 11.5

No ganging hardware.
 Side(s) can be equipped with ganging brackets, model 7892.
 Does not gang to seating units.

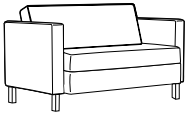
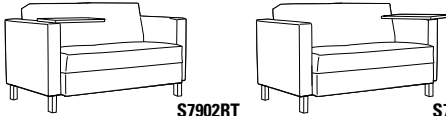
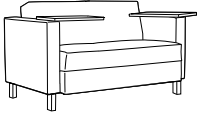
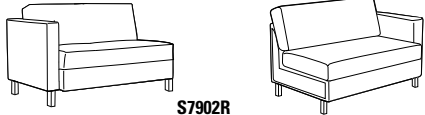
MODEL#	1	2	3	4	5	6	7	8	9	10	11	12
S7905	-	-	-	-	1146	1218	1351	1558	1717	1898	2265	2658
OVERALL DIMENSIONS			SEAT DIMENSIONS			BACK DIMENSIONS						
W	D	H	W	D	H	W	H					
43	21.5	17	-	-	17	-	-					
RTA 00												

DESCRIPTION	FEATURES	MODEL#	STANDARD TEXTILE GRADES											
			1	2	3	4	5	6	7	8	9	10	11	12
 <p>Two Seater w/Arms - Single Cushion COM Yardage: 6.5 Freight Class: 250 Product Weight (lbs.): 122 Cubic Feet Per Carton: 36</p>	Free standing unit only.	S7902	-	-	-	-	2588	2783	3145	3725	4169	4665	5689	6778
		OVERALL DIMENSIONS			SEAT DIMENSIONS			BACK DIMENSIONS						
		W	D	H	W	D	H	W	H					
		51.25	31	30	42.5	19.5	17.5	42.5	12.5					
			RTA 00											
 <p>S7902RT S7902LT</p> <p>Two Seater w/Arms & Lam. Tablet - Single Cushion COM Yardage: 5.25 Freight Class: 250 Product Weight (lbs.): 114 Cubic Feet Per Carton: 36</p>	Free standing unit only. Tablets are Right Hand Seated (RT) or Left Hand Seated (LT).	S7902RT	-	-	-	-	3208	2543	2543	4389	2543	5371	6432	7566
		S7902LT	-	-	-	-	3208	2543	2543	4389	2543	5371	6432	7566
		OVERALL DIMENSIONS			SEAT DIMENSIONS			BACK DIMENSIONS						
		W	D	H	W	D	H	W	H					
48.75	33.5	30.75	42.5	19.5	17.5	42.5	13.25							
			RTA 00											
 <p>Two Seater w/Arms & Lam. Tablets - Single Cushion COM Yardage: 6.5 Freight Class: 250 Product Weight (lbs.): 127 Cubic Feet Per Carton: 41.25</p>	Free standing unit only. With both Left and Right Tablets.	S7902LRT	-	-	-	-	3829	4028	4409	5010	5475	5992	7053	8187
		OVERALL DIMENSIONS			SEAT DIMENSIONS			BACK DIMENSIONS						
		W	D	H	W	D	H	W	H					
		54.25	33.5	30	42.5	19.5	17.5	42.5	12.5					
			RTA 00											
 <p>S7902R S7902L</p> <p>Two Seater w/One Arm - Single Cushion COM Yardage: 5.25 Freight Class: 250 Product Weight (lbs.): 114 Cubic Feet Per Carton: 36</p>	No ganging hardware. Armless side can be equipped with ganging brackets, model 7892. Arms are Right Hand Seated (RT) or Left Hand Seated (LT).	S7902R	-	-	-	-	2403	2565	2870	3357	3732	4151	5007	5924
		S7902L	-	-	-	-	2403	2565	2870	3357	3732	4151	5007	5924
		OVERALL DIMENSIONS			SEAT DIMENSIONS			BACK DIMENSIONS						
		W	D	H	W	D	H	W	H					
47.25	31	30.75	42.5	19.5	17.5	42.5	13.25							
			RTA 00											
 <p>S7902RRT S902LLT</p> <p>Two Seater w/One Arm & Lam. Tablet - Single Cushion COM Yardage: 5.25 Freight Class: 250 Product Weight (lbs.): 114 Cubic Feet Per Carton: 36</p>	Free standing unit only. Tablets are Right Hand Seated (RT) or Left Hand Seated (LT).	S7902RRT	-	-	-	-	3022	3184	3489	3976	4351	4769	5626	6542
		S902LLT	-	-	-	-	3022	3184	3489	3976	4351	4769	5626	6542
		OVERALL DIMENSIONS			SEAT DIMENSIONS			BACK DIMENSIONS						
		W	D	H	W	D	H	W	H					
48.75	33.5	30.75	42.5	19.5	17.5	42.5	13.25							
			RTA 00											

DESCRIPTION	FEATURES	MODEL#	STANDARD TEXTILE GRADES											
			1	2	3	4	5	6	7	8	9	10	11	12

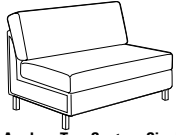

Armless Two Seater - Single Cushion
 COM Yardage: 6.5
 Freight Class: 250
 Product Weight (lbs.): 90
 Cubic Feet Per Carton: 36

No ganging hardware.
 Armless side(s) can be equipped with ganging brackets, model 7892.

S7902NA	-	-	-	-	2403	2543	2806	3222	3544	3903	4638	5421
----------------	---	---	---	---	------	------	------	------	------	------	------	------

OVERALL DIMENSIONS			SEAT DIMENSIONS			BACK DIMENSIONS	
W	D	H	W	D	H	W	H
43.25	31	30.75	42.5	19.5	17.5	42.5	13.25

RTA 00

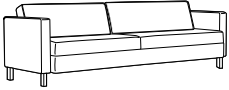

Four Seater w/Arms - Duo Cushion
 COM Yardage: 10.25
 Freight Class: 250
 Product Weight (lbs.): 204
 Cubic Feet Per Carton: 69

Free standing unit only.

S7904	-	-	-	-	4929	5243	5839	6789	7520	8335	10010	11798
--------------	---	---	---	---	------	------	------	------	------	------	-------	-------

OVERALL DIMENSIONS			SEAT DIMENSIONS			BACK DIMENSIONS	
W	D	H	W	D	H	W	H
93.5	31	30	84	19.5	17.5	84	12.5

RTA 00

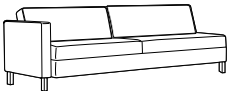

S7904R

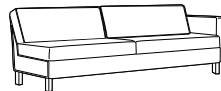

S7904L

Four Seater w/One Arm - Duo Cushion
 COM Yardage: 9.5
 Freight Class: 250
 Product Weight (lbs.): 188
 Cubic Feet Per Carton: 61.5

No ganging hardware.
 Armless side can be equipped with ganging brackets, model 7892.
 Arms are Right Hand Seated (RT) or Left Hand Seated (LT) .

S7904R	-	-	-	-	4823	5112	5666	6545	7225	7980	9532	11189
S7904L	-	-	-	-	4823	5112	5666	6545	7225	7980	9532	11189

OVERALL DIMENSIONS			SEAT DIMENSIONS			BACK DIMENSIONS	
W	D	H	W	D	H	W	H
89.5	31	30.75	84	19.5	17.5	84	12.5

RTA 00

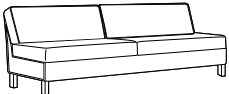

Armless Four Seater - Single Cushion
 COM Yardage: 8.75
 Freight Class: 250
 Product Weight (lbs.): 172
 Cubic Feet Per Carton: 61.5

No ganging hardware.
 Armless side(s) can be equipped with ganging brackets, model 7892.

S7904NA	-	-	-	-	4823	5089	5600	6413	7036	7732	9161	10688
----------------	---	---	---	---	------	------	------	------	------	------	------	-------

OVERALL DIMENSIONS			SEAT DIMENSIONS			BACK DIMENSIONS	
W	D	H	W	D	H	W	H
85.5	31	30.75	84	19.5	17.5	84	12.5

RTA 00

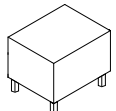

Cube End Table
 COM Yardage: N/A
 Freight Class: 100
 Product Weight (lbs.): 51
 Cubic Feet Per Carton: 5.5

Free standing unit only.
 No ganging hardware.
 For Power/USB module please see electrical placement chart.

S7911	1915	-	-	-	-	-	-	-	-	-	-	-
--------------	------	---	---	---	---	---	---	---	---	---	---	---

OVERALL DIMENSIONS			SEAT DIMENSIONS			BACK DIMENSIONS	
W	D	H	W	D	H	W	H
20	24	16	-	-	-	-	-

RTA 00

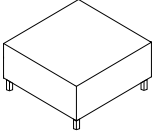
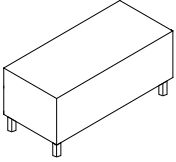
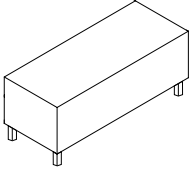
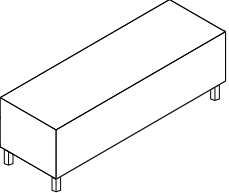
DESCRIPTION	FEATURES	MODEL#	STANDARD TEXTILE GRADES													
			1	2	3	4	5	6	7	8	9	10	11	12		
 <p>Cube Square Coffee Table COM Yardage: N/A Freight Class: 100 Product Weight (lbs.): 86 Cubic Feet Per Carton: 10.75</p>	<p>Free standing unit only. No ganging hardware. For Power/USB module please see electrical placement chart.</p>	<p>S7912 2433</p>	-	-	-	-	-	-	-	-	-	-	-			
			OVERALL DIMENSIONS			SEAT DIMENSIONS			BACK DIMENSIONS							
			W	D	H	W	D	H	W	H						
			33	33	14	-	-	-	-	-						
			RTA 00													
 <p>Cube 40" Coffee Table COM Yardage: N/A Freight Class: 100 Product Weight (lbs.): 66 Cubic Feet Per Carton: 8</p>	<p>Free standing unit only. No ganging hardware. For Power/USB module please see electrical placement chart.</p>	<p>S7913 2303</p>	-	-	-	-	-	-	-	-	-	-	-			
			OVERALL DIMENSIONS			SEAT DIMENSIONS			BACK DIMENSIONS							
			W	D	H	W	D	H	W	H						
			40	20	14	-	-	-	-	-						
			RTA 00													
 <p>Cube Extended 60" Coffee Table COM Yardage: N/A Freight Class: 125 Product Weight (lbs.): 93 Cubic Feet Per Carton: 12</p>	<p>Free standing unit only. No ganging hardware. For Power/USB module please see electrical placement chart.</p>	<p>S7915 3008</p>	-	-	-	-	-	-	-	-	-	-	-			
			OVERALL DIMENSIONS			SEAT DIMENSIONS			BACK DIMENSIONS							
			W	D	H	W	D	H	W	H						
			60	20	14	-	-	-	-	-						
			RTA 00													
 <p>Cube Extended 72" Coffee Table COM Yardage: N/A Freight Class: 125 Product Weight (lbs.): 107 Cubic Feet Per Carton: 14.25</p>	<p>Free standing unit only. No ganging hardware. For Power/USB module please see electrical placement chart.</p>	<p>S7916 3078</p>	-	-	-	-	-	-	-	-	-	-	-			
			OVERALL DIMENSIONS			SEAT DIMENSIONS			BACK DIMENSIONS							
			W	D	H	W	D	H	W	H						
			72	20	14	-	-	-	-	-						
			RTA 00													

DRIFT



Wood Base model 8030
Side Chair w/4 Leg



Side Chair, Sled Base
Arm Patches model 8023P



Chrome Base model 8034
Low Back Lounge Chair



Wood Base model 8037
Mid Back Lounge Chair



Ottoman model 8026



Wood Base model 8052
Counter Stool



For Drift tables, see page page 331

EXAMPLE OF TABLE ORDER CODE:

8030P	WA50	WA50	R11	NM	AAM
Model Number	Back/Arm Textile	Seat Textile	Patch Textile	Seat Height	Base Finish

NM	NBS	NSS	NB
Glide Type	Sealed Back Seams	Sealed Seat Seams	Moisture Barrier

5-Star Base Mechanism

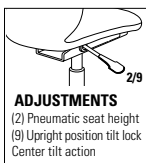

ADJUSTMENTS
(2) Pneumatic seat height
(9) Upright position tilt lock
Center tilt action

Ergonomic features:
B, C, S, U



Flip Forward Seat
"F" suffix models





STANDARD FEATURES





- Drift's soft seat and contoured back and arms provide the perfect balance of style and comfort. Side chairs are available in six base types: sled, wood 4-leg, wood 4-prong swivel, chrome 4-prong swivel, high 4-star swivel and 5-star base on casters.
- Lounge chairs are available in four base types: sled, wood 4-leg, wood 4-star swivel and Chrome 4-prong swivel.
- Counter and bar height stools are available with three base types: sled, wood 4-leg, and Chrome 4-star swivel.
- Wood bases are made from Beechwood and are available in all standard wood finishes.
- Wood base seating models are standard with White non-marking polycarbonate glides. See Glide Type for additional glide options.
- Sled bases are standard in painted metal or Chrome finish. See Frame Finish for upcharges.
- Sled base models are standard with clear polycarbonate glides. See Glide Type for additional glide options.
- Chrome swivel bases are available in polished Chrome only. Lounge models with Chrome swivel bases swivel 360deg, available in swivel or self-centering swivel.
- Lounge seating is available with 17" seat height with a classic lounge angle or 18" seat height with a reduced back angle for ease of sitting and standing.
- Side chairs with 5-star base and casters swivel 360 degrees, are height adjustable with 4" range and include a tilting mechanism with upright tilt lock. Base is Polished Aluminum with C114 Carpet or C114R hard floor, dual wheel casters. See upcharges.
- Ottomans have a weighted bottom to maintain upright position. Specify Top and Side textile separately. Glides are White, non-marking.
- For increased durability on side and lounge seating, P and PH suffix models are available with arm and head patches. These high touch areas are covered in Global's Release vinyl. Specify Release color.
- For ease of cleaning, Side and Lounge Chair models with "F" suffix have flip-forward seats. Material under seat matches seat textile selection. (Stools and side chairs with high 4- star and 5-star bases have fixed seat cushions only.)
- Sealed seams are available on chair backs and/ or seats (with upcharge). For sealed seams on Ottoman, specify Ottoman (8026S), available only in sealed seam approved textiles.
- A moisture barrier may be added to seat cushions only (with upcharge). Not available with sealed seams.
- Upholstery options: fabric, vinyl, or leather.
- All Drift seating is assembled using tamper proof screws.
- Drift seating is available to specify with two textiles, one for the seat cushion and one for the back and arms (see model image).
- For pricing, start with the base price and add both back/arms graded textile upcharge and the seat graded textile upcharge.
- The Blended Textile matrix does not apply to this series.
- Drift seating is designed for 300lb capacity.
- Shipped fully assembled.
- See finishes section in Price List for solid wood/ laminate coordination chart.





Add option codes in the following order:







- **Model Number**
Specify model number.
- **Back/Arm Textile**
Specify textile code. See model grade upcharges.
- **Seat Textile**
Specify textile code. See model grade upcharges.
- **Arm and Head Patch Textile** (For P and PH suffix models)
Release Vinyl only





- **Seat Height** (lounge models only):
(S17) 17" Seat height
(S18) 18" Seat height
- **Base Finish** (wood base models)
(AAM) Absolute (BKM) Black
(ACM) Cherry (EOM) English Oak
(ECM) Espresso Cafe (TFM) Fruitwood
(HGM) Grey (AHM) Honey
(TMM) Mahogany (AVM) Maple
(NLW) Natural Walnut (MVM) Medium Walnut
(ASM) Night (NBM) Noce Biondo
(NGM) Noce Grigio (NEM) Noce Leggero
(NMM) Noce Medio (SKM) Shaker Cherry
(TWM) Walnut (WTM) WC Cream
(WHM) White (WCM) Winter Cherry
- **Base Finish** (sled base models)
(TBL) Black (TBZ) Buzz Blue
(TCC) Cactus (TCR) Carrot
(TDJ) Dijon (TDW) Designer White
(TEG) Eggplant (TFO) Fog
(TFR) Frost (TIN) Ink
(TIV) Cloud (TKA) Kalua
(TLA) Latte (TOA) Toast
(TNE) Nevada (TSH) Shadow
(TSN) Sand (TSR) Scarlet
(TTU) Tungsten
Metallics: Side/Lounge Counter Bar
(CHM) Chrome. Add \$42 \$84 \$84
- **Base Finish** (5-star base only)
(A7) Polish Aluminum
- **Cylinder Selection** (Chrome swivel lounge models):
(DSC) Swivel cylinder
(DAC) Self-centering cylinder
- **Glide Type** (wood base seating)
(NM) White, non-marking nylon for most hard floor surfaces (standard)
(SG) Steel cushioned glides for carpeted surfaces. Add \$34
(RG) Non-slip, rubber glides for most hard floor surfaces. Add \$34
(FG) Felt glides for most hard floor surfaces. Add \$34
- **Glide Type** (sled base seating)
(CG) Clear, polycarbonate glide for most surfaces (standard)
(XG) No glide for carpeted surfaces
(FG) Felt glide for most hard surfaces. Add \$31
(SG) Steel cushioned glide for carpeted surfaces. Add \$34
(RG) Non-slip rubber glide for most hard surfaces. Add \$34
- **Glide Type** (High, 4-Star base side chairs)
(NM) White Polyethylene non-marking glide for most surfaces
(FG) Felt Glide for most hard floor surfaces. Add \$34
- **Caster Type** (5-star base side chairs)
(DC) 2" Caster for carpeted surfaces
(RC) 2" Caster for hard floor surfaces. Add \$50
- **Sealed Back Seams** (contact customer care for approved textiles)
(NBS) No sealed back seam
(SBS) Sealed back seams. See model for upcharge.
- **Sealed Seat Seams** (contact customer care for approved textiles)
(NSS) No sealed seat seams
(SSS) Sealed seat seams. See model for upcharge.
- **Moisture Barrier** (not available with sealed seams)
(NB) No moisture barrier
(MB) Moisture barrier (seat only). Add \$101

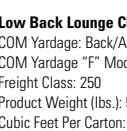



DESCRIPTION	MODEL#/ FEATURES	STANDARD TEXTILE GRADES											
		1/COM	2	3	4	5	6	7	8	9	10	11	12
 <p>Ottoman COM Yardage: Top: .5; Side: 1.5 Freight Class: 250 Product Weight (lbs.): 31 Cubic Feet Per Carton: 8.5</p>	8026 Base Price: \$911 8026S Base Price: \$1101 Shell upcharge: +0 Seat upcharge: +0												
	For sealed seams on full Ottoman, select 8026S model and select approved textile.												
 <p>Side Chair, Sled Base COM Yardage: Back/Arms: 1.25; Seat: .75 COM Yardage "F" Model: Back/Arms: 1.25; Seat 1 Freight Class: 250 Product Weight (lbs.): 31 Cubic Feet Per Carton: 13.25</p>	8023 Base Price: \$1819 Back/Arm upcharge: +0 Seat upcharge: +0												
	8023F Base Price: \$2070 Back/Arm upcharge: +0 Seat upcharge: +0												
	"F" model = Flip Forward Seat for ease of cleaning												
	Add \$36 for (SBS) Add \$27 for (SSS); \$44 (F model)												
 <p>Side Chair, Sled Base, Arm Patches COM Yardage: Back/Arms: 1.25; Seat: .75 COM Yardage "F" Model: Back/Arms: 1.25; Seat 1 Freight Class: 250 Product Weight (lbs.): 31 Cubic Feet Per Carton: 13.25</p>	8023P Base Price: \$1844 Back/Arm upcharge: +0 Seat upcharge: +0												
	8023PF Base Price: \$2095 Back/Arm upcharge: +0 Seat upcharge: +0												
	"F" model = Flip Forward Seat for ease of cleaning												
	Add \$54 for (SBS) Add \$27 for (SSS); \$44 (F model)												
 <p>Side Chair, 4 Leg Wood Base COM Yardage: Back/Arms: 1.25; Seat: .75 COM Yardage "F" Model: Back/Arms: 1.25; Seat 1 Freight Class: 300 Product Weight (lbs.): 31 Cubic Feet Per Carton: 15.75</p>	8030 Base Price: \$1622 Back/Arm upcharge: +0 Seat upcharge: +0												
	8030F Base Price: \$1867 Back/Arm upcharge: +0 Seat upcharge: +0												
	"F" model = Flip Forward Seat for ease of cleaning												
	Add \$36 for (SBS) Add \$27 for (SSS); \$44 (F model)												





DESCRIPTION	MODEL#/ FEATURES	STANDARD TEXTILE GRADES													
		1/COM	2	3	4	5	6	7	8	9	10	11	12		
 <p>Side Chairs, 4 Leg Wood Base, Arm Patches COM Yardage: Back/Arms: 1.25; Seat: .75 COM Yardage "F" Model: Back/Arms: 1.25; Seat 1 Freight Class: 250 Product Weight (lbs.): 28 Cubic Feet Per Carton: 13.25</p>	8030P Base Price:	\$1647													
	Back/Arm upcharge:	+0	+40	+72	+118	+183	+210	+267	+355	+422	+494	+645	+804		
	Seat upcharge:	+0	+24	+43	+71	+110	+126	+160	+213	+253	+297	+387	+483		
	8030PF Base Price:	\$1892													
	Back/Arm upcharge:	+0	+40	+72	+118	+183	+210	+267	+355	+422	+494	+645	+804		
	Seat upcharge:	+0	+32	+57	+94	+146	+168	+213	+284	+337	+395	+516	+643		
	OVERALL DIMENSIONS		W	D	H	SEAT DIMENSIONS			W	D	H	BACK DIMENSIONS		W	H
			24.5	23	31	18	17.5	18	15	13					
	"F" model = Flip Forward Seat for ease of cleaning														
	Add \$54 for (SBS) Add \$27 for (SSS); \$44 (F model)		RTA 00		1 per carton										
 <p>Side Chair, Wood Swivel Base COM Yardage: Back/Arms: 1.25; Seat: .75 COM Yardage "F" Model: Back/Arms: 1.25; Seat 1 Freight Class: 300 Product Weight (lbs.): 31 Cubic Feet Per Carton: 15.75</p>	8031 Base Price:	\$1883													
	Back/Arm upcharge:	+0	+40	+72	+118	+183	+210	+267	+355	+422	+494	+645	+804		
	Seat upcharge:	+0	+24	+43	+71	+110	+126	+160	+213	+253	+297	+387	+483		
	8031F Base Price:	\$2128													
	Back/Arm upcharge:	+0	+40	+72	+118	+183	+210	+267	+355	+422	+494	+645	+804		
	Seat upcharge:	+0	+32	+57	+94	+146	+168	+213	+284	+337	+395	+516	+643		
	OVERALL DIMENSIONS		W	D	H	SEAT DIMENSIONS			W	D	H	BACK DIMENSIONS		W	H
			24.5	23	31	18	17.5	18	15	13					
	"F" model = Flip Forward Seat for ease of cleaning														
	Add \$36 for (SBS) Add \$27 for (SSS); \$44 (F model)		RTA 00		FedEx				ups		1 per carton				
 <p>Side Chair, Wood Swivel Base, Arm Patches COM Yardage: Back/Arms: 1.25; Seat: .75 COM Yardage "F" Model: Back/Arms: 1.25; Seat 1 Freight Class: 250 Product Weight (lbs.): 33 Cubic Feet Per Carton: 13.25</p>	8031P Base Price:	\$1908													
	Back/Arm upcharge:	+0	+40	+72	+118	+183	+210	+267	+355	+422	+494	+645	+804		
	Seat upcharge:	+0	+24	+43	+71	+110	+126	+160	+213	+253	+297	+387	+483		
	8031PF Base Price:	\$2153													
	Back/Arm upcharge:	+0	+40	+72	+118	+183	+210	+267	+355	+422	+494	+645	+804		
	Seat upcharge:	+0	+32	+57	+94	+146	+168	+213	+284	+337	+395	+516	+643		
	OVERALL DIMENSIONS		W	D	H	SEAT DIMENSIONS			W	D	H	BACK DIMENSIONS		W	H
			24.5	23	31	18	17.5	18	15	13					
	"F" model = Flip Forward Seat for ease of cleaning														
	Add \$54 for (SBS) Add \$27 for (SSS); \$44 (F model)		RTA 00		1 per carton										
 <p>Side Chair, Chrome Swivel Base COM Yardage: Back/Arms: 1.25; Seat: .75 COM Yardage "F" Model: Back/Arms: 1.25; Seat 1 Freight Class: 300 Product Weight (lbs.): 31 Cubic Feet Per Carton: 15.75</p>	8032 Base Price:	\$1927													
	Back/Arm upcharge:	+0	+40	+72	+118	+183	+210	+267	+355	+422	+494	+645	+804		
	Seat upcharge:	+0	+24	+43	+71	+110	+126	+160	+213	+253	+297	+387	+483		
	8032F Base Price:	\$2172													
	Back/Arm upcharge:	+0	+32	+57	+94	+146	+168	+213	+284	+337	+395	+516	+643		
	Seat upcharge:	+0	+40	+72	+118	+183	+210	+267	+355	+422	+494	+645	+804		
	OVERALL DIMENSIONS		W	D	H	SEAT DIMENSIONS			W	D	H	BACK DIMENSIONS		W	H
			24.5	23	31	18	17.5	18	15	13					
	"F" model = Flip Forward Seat for ease of cleaning														
	Add \$36 for (SBS) Add \$27 for (SSS); \$44 (F model)		RTA 00		1 per carton										





DESCRIPTION	MODEL#/ FEATURES	STANDARD TEXTILE GRADES													
		1/COM	2	3	4	5	6	7	8	9	10	11	12		
 <p>Side Chair, Chrome Swivel Base, Arm Patches COM Yardage: Back/Arms: 1.25; Seat: .75 COM Yardage "F" Model: Back/Arms: 1.25; Seat: 1 Freight Class: 250 Product Weight (lbs.): 33 Cubic Feet Per Carton: 13.25</p>	8032P	Base Price:	\$1952												
	Back/Arm upcharge:	+0	+24	+43	+71	+110	+126	+160	+213	+253	+297	+387	+483		
	Seat upcharge:	+0	+40	+72	+118	+183	+210	+267	+355	+422	+494	+645	+804		
	8032PF	Base Price:	\$2196												
	Back/Arm upcharge:	+0	+40	+72	+118	+183	+210	+267	+355	+422	+494	+645	+804		
	Seat upcharge:	+0	+32	+57	+94	+146	+168	+213	+284	+337	+395	+516	+643		
	OVERALL DIMENSIONS		W	D	H	SEAT DIMENSIONS			W	D	H	BACK DIMENSIONS		W	H
			24.5	23	31	18	17.5	18	15	13					
	"F" model = Flip Forward Seat for ease of cleaning														
	Add \$54 for (SBS) Add \$27 for (SSS); \$44 (F model)		<div style="display: flex; justify-content: space-between; align-items: center;"> RTA 00 1 per carton </div>												
 <p>Side Chair, High 4 Star Swivel Base COM Yardage: Back/Arms: 1.25; Seat: .75 Freight Class: 300 Product Weight (lbs.): 31 Cubic Feet Per Carton: 15.75</p>	8021	Base Price:	\$1894												
	Back/Arm upcharge:	+0	+40	+72	+118	+183	+210	+267	+355	+422	+494	+645	+804		
	Seat upcharge:	+0	+24	+43	+71	+110	+126	+160	+213	+253	+297	+387	+483		
	OVERALL DIMENSIONS		W	D	H	SEAT DIMENSIONS			W	D	H	BACK DIMENSIONS		W	H
			24.5	23	32	18	17.5	18.5	15	13					
	Fixed seat cushion only.														
	Add \$36 for (SBS) Add \$27 for (SSS)		<div style="display: flex; justify-content: space-between; align-items: center;"> RTA 00 1 per carton </div>												
	 <p>Side Chair, High 4 Star Swivel Base, Arm Patches COM Yardage: Back/Arms: 1.25; Seat: .75 Freight Class: 250 Product Weight (lbs.): 35.5 Cubic Feet Per Carton: 13.25</p>	8021P	Base Price:	\$1919											
		Back/Arm upcharge:	+0	+40	+72	+118	+183	+210	+267	+355	+422	+494	+645	+804	
		Seat upcharge:	+0	+24	+43	+71	+110	+126	+160	+213	+253	+297	+387	+483	
OVERALL DIMENSIONS		W	D	H	SEAT DIMENSIONS			W	D	H	BACK DIMENSIONS		W	H	
		24.5	23	32	18	17.5	18.5	15	13						
Fixed seat cushion only.															
Add \$354 for (SBS) Add \$27 for (SSS)		<div style="display: flex; justify-content: space-between; align-items: center;"> RTA 00 1 per carton </div>													
 <p>Side Chair, Swivel Tilt, 5 Star Base and Casters COM Yardage: Back/Arms: 1.25; Seat: .75 Freight Class: 300 Product Weight (lbs.): 31 Cubic Feet Per Carton: 15.75</p>		8022	Base Price:	\$2065											
		Back/Arm upcharge:	+0	+40	+72	+118	+183	+210	+267	+355	+422	+494	+645	+804	
		Seat upcharge:	+0	+24	+43	+71	+110	+126	+160	+213	+253	+297	+387	+483	
	OVERALL DIMENSIONS		W	D	H	SEAT DIMENSIONS			W	D	H	BACK DIMENSIONS		W	H
			24.5	23	32.5	18	17.5	15	15	13					
	Tilting mechanism with tilt lock. Fixed seat cushion only.														
	Add \$36 for (SBS) Add \$27 for (SSS)		<div style="display: flex; justify-content: space-between; align-items: center;"> RTA 00 1 per carton </div>												





DESCRIPTION	MODEL#/ FEATURES	STANDARD TEXTILE GRADES												
		1/COM	2	3	4	5	6	7	8	9	10	11	12	
 <p>Side Chair, Swivel Tilt, 5 Star Base, Arm Patches and Casters COM Yardage: Back/Arms: 1.25; Seat: .75 Freight Class: 250 Product Weight (lbs.): 37.5 Cubic Feet Per Carton: 15.75</p>	8022P Base Price: \$2090 Back/Arm upcharge: +0 Seat upcharge: +0													
	Tilting mechanism with tilt lock. Fixed seat cushion only.	24.5	23	32.5	18	17.5	15	15	13					
	Add \$54 for (SBS) Add \$27 for (SSS)													
		RTA 00	1 per carton											
 <p>Low Back Lounge Chair, Sled Base COM Yardage: Back/Arms: 2.25; Seat: 1 COM Yardage "F" Model: Back/Arms: 2.25; Seat: 1.25 Freight Class: 250 Product Weight (lbs.): 52 Cubic Feet Per Carton: 19.25</p>	8024 Base Price: \$2191 Back/Arm upcharge: +0 Seat upcharge: +0													
	"F" model = Flip Forward Seat for ease of cleaning	29	30	33	21.5	20	17	21	16					
	Add \$75 for (SBS) Add \$32 for (SSS); \$48 (F model)													
		RTA 00	1 per carton											
 <p>Low Back Lounge Chair, Sled Base, Arm Patches COM Yardage: Back/Arms: 2.25; Seat: 1 COM Yardage "F" Model: Back/Arms: 2.25; Seat: 1.25 Freight Class: 250 Product Weight (lbs.): 52 Cubic Feet Per Carton: 19.25</p>	8024F Base Price: \$2442 Back/Arm upcharge: +0 Seat upcharge: +0													
	"F" model = Flip Forward Seat for ease of cleaning	29	30	33	21.5	20	17	21	16					
	Add \$75 for (SBS) Add \$32 for (SSS); \$48 (F model)													
		RTA 00	1 per carton											
 <p>Low Back Lounge Chair, Sled Base, 4 Leg Wood Base COM Yardage: Back/Arms: 2.25; Seat: 1 COM Yardage "F" Model: Back/Arms: 2.75; Seat: 1.25 Freight Class: 250 Product Weight (lbs.): 53.5 Cubic Feet Per Carton: 19</p>	8024P Base Price: \$2216 Back/Arm upcharge: +0 Seat upcharge: +0													
	"F" model = Flip Forward Seat for ease of cleaning	29	30	33	21.5	20	17	21	16					
	Add \$39 for (SBS) Add \$32 for (SSS); \$48 (F model)													
		RTA 00	1 per carton											
 <p>Low Back Lounge Chair, 4 Leg Wood Base COM Yardage: Back/Arms: 2.25; Seat: 1 COM Yardage "F" Model: Back/Arms: 2.75; Seat: 1.25 Freight Class: 250 Product Weight (lbs.): 53.5 Cubic Feet Per Carton: 19</p>	8025 Base Price: \$2884 Back/Arm upcharge: +0 Seat upcharge: +0													
	"F" model = Flip Forward Seat for ease of cleaning	29	30	33	21.5	20	17	21	16					
	Add \$75 for (SBS) Add \$32 for (SSS); \$48 (F model)													
		RTA 00	1 per carton											
 <p>Low Back Lounge Chair, 4 Leg Wood Base COM Yardage: Back/Arms: 2.25; Seat: 1 COM Yardage "F" Model: Back/Arms: 2.75; Seat: 1.25 Freight Class: 250 Product Weight (lbs.): 53.5 Cubic Feet Per Carton: 19</p>	8025F Base Price: \$3135 Back/Arm upcharge: +0 Seat upcharge: +0													
	"F" model = Flip Forward Seat for ease of cleaning	29	30	33	21.5	20	17	21	16					
	Add \$75 for (SBS) Add \$32 for (SSS); \$48 (F model)													
		RTA 00	1 per carton											





DESCRIPTION	MODEL#/ FEATURES	STANDARD TEXTILE GRADES													
		1/COM	2	3	4	5	6	7	8	9	10	11	12		
 <p>Low Back Lounge Chair, 4 Leg Wood Base, Arm Patches COM Yardage: Back/Arms: 2.25; Seat: 1 COM Yardage "F" Model: Back/Arms: 2.75; Seat: 1.25 Freight Class: 250 Product Weight (lbs.): 53.5 Cubic Feet Per Carton: 19</p>	8025P	Base Price:	\$2909												
	Back/Arm upcharge:	+0	+72	+129	+212	+329	+378	+480	+639	+759	+889	+1161	+1447		
	Seat upcharge:	+0	+32	+57	+94	+146	+168	+213	+284	+337	+395	+516	+643		
	8025PF	Base Price:	\$3160												
	Back/Arm upcharge:	+0	+88	+157	+259	+402	+462	+586	+781	+927	+1087	+1419	+1769		
	Seat upcharge:	+0	+40	+72	+118	+183	+210	+267	+355	+422	+494	+645	+804		
	OVERALL DIMENSIONS		W	D	H	SEAT DIMENSIONS			W	D	H	BACK DIMENSIONS		W	H
			29	30	33	21.5	20	17	21	16					
	"F" model = Flip Forward Seat for ease of cleaning Add \$93 for (SBS) Add \$32 for (SSS); \$48 (F model)					RTA 00	1 per carton								
	 <p>Low Back Lounge Chair, Wood Swivel Base COM Yardage: Back: 2.25; Seat: 1 COM Yardage "F" Model: Back/Arms: 2.75; Seat: 1.25 Freight Class: 250 Product Weight (lbs.): 53 Cubic Feet Per Carton: 19</p>	8033	Base Price:	\$2640											
Back/Arm upcharge:		+0	+72	+129	+212	+329	+378	+480	+639	+759	+889	+1161	+1447		
Seat upcharge:		+0	+32	+57	+94	+146	+168	+213	+284	+337	+395	+516	+643		
8033F		Base Price:	\$2891												
Back/Arm upcharge:		+0	+88	+157	+259	+402	+462	+586	+781	+927	+1087	+1419	+1769		
Seat upcharge:		+0	+40	+72	+118	+183	+210	+267	+355	+422	+494	+645	+804		
OVERALL DIMENSIONS		W	D	H	SEAT DIMENSIONS			W	D	H	BACK DIMENSIONS		W	H	
		29	30	33	21.5	20	17	21	16						
"F" model = Flip Forward Seat for ease of cleaning Add \$75 for (SBS) Add \$32 for (SSS); \$48 (F model)					RTA 00	per carton									
 <p>Low Back Lounge Chair, Wood Swivel Base, Arm Patches COM Yardage: Back: 2.25; Seat: 1 COM Yardage "F" Model: Back/Arms: 2.75; Seat: 1.25 Freight Class: 250 Product Weight (lbs.): 53 Cubic Feet Per Carton: 19</p>		8033P	Base Price:	\$2665											
	Back/Arm upcharge:	+0	+72	+129	+212	+329	+378	+480	+639	+759	+889	+1161	+1447		
	Seat upcharge:	+0	+32	+57	+94	+146	+168	+213	+284	+337	+395	+516	+643		
	8033PF	Base Price:	\$2917												
	Back/Arm upcharge:	+0	+88	+157	+259	+402	+462	+586	+781	+927	+1087	+1419	+1769		
	Seat upcharge:	+0	+40	+72	+118	+183	+210	+267	+355	+422	+494	+645	+804		
	OVERALL DIMENSIONS		W	D	H	SEAT DIMENSIONS			W	D	H	BACK DIMENSIONS		W	H
			29	30	33	21.5	20	17	21	16					
	"F" model = Flip Forward Seat for ease of cleaning Add \$93 for (SBS) Add \$32 for (SSS); \$48 (F model)					RTA 00	per carton								
	 <p>Low Back Lounge Chair, Chrome Swivel Base COM Yardage: Back: 2.25; Seat: 1 COM Yardage "F" Model: Back/Arms: 2.75; Seat: 1.25 Freight Class: 250 Product Weight (lbs.): 59 Cubic Feet Per Carton: 19.25</p>	8034	Base Price:	\$2652											
Back/Arm upcharge:		+0	+72	+129	+212	+329	+378	+480	+639	+759	+889	+1161	+1447		
Seat upcharge:		+0	+32	+57	+94	+146	+168	+213	+284	+337	+395	+516	+643		
8034F		Base Price:	\$2903												
Back/Arm upcharge:		+0	+88	+129	+259	+402	+462	+586	+781	+927	+1087	+1419	+1769		
Seat upcharge:		+0	+40	+72	+118	+183	+210	+267	+355	+422	+494	+645	+804		
OVERALL DIMENSIONS		W	D	H	SEAT DIMENSIONS			W	D	H	BACK DIMENSIONS		W	H	
		29	30	33	21.5	20	17	21	16						
"F" model = Flip Forward Seat for ease of cleaning Add \$75 for (SBS) Add \$32 for (SSS); \$48 (F model)					RTA 00	1 per carton									

DESCRIPTION	MODEL#/ FEATURES	STANDARD TEXTILE GRADES												
		1/COM	2	3	4	5	6	7	8	9	10	11	12	
 <p>Low Back Lounge Chair, Chrome Swivel Base, Arm Patches COM Yardage: Back: 2.25; Seat: 1 COM Yardage "F" Model: Back/Arms: 2.75; Seat: 1.25 Freight Class: 250 Product Weight (lbs.): 59 Cubic Feet Per Carton: 19.25</p>	8034P Base Price:	\$2677												
	Back/Arm upcharge:	+0	+72	+129	+212	+329	+378	+480	+639	+759	+889	+1161	+1447	
	Seat upcharge:	+0	+32	+57	+94	+146	+168	+213	+284	+337	+395	+516	+643	
	8034PF Base Price:	\$2928												
	Back/Arm upcharge:	+0	+88	+157	+259	+402	+462	+586	+781	+927	+1087	+1419	+1769	
	Seat upcharge:	+0	+40	+72	+118	+183	+210	+267	+355	+422	+494	+645	+804	
			OVERALL DIMENSIONS			SEAT DIMENSIONS			BACK DIMENSIONS					
			W	D	H	W	D	H	W	H				
			29	30	33	21.5	20	17	21	16				
	<p>"F" model = Flip Forward Seat for ease of cleaning</p> <p>Add \$93 for (SBS) Add \$32 for (SSS); \$48 (F model)</p>													
					RTA 00		1 per carton							
 <p>Mid Back Lounge Chair, Sled Base COM Yardage: Back: 2.5; Seat: 1 COM Yardage "F" Model: Back/Arms: 3; Seat: 1.25 Freight Class: 250 Product Weight (lbs.): 52 Cubic Feet Per Carton: 25.5</p>	8016 Base Price:	\$2437												
	Back/Arm upcharge:	+0	+80	+143	+235	+365	+420	+533	+710	+843	+988	+1290	+1608	
	Seat upcharge:	+0	+32	+57	+94	+146	+168	+213	+284	+337	+395	+516	+643	
	8016F Base Price:	\$2688												
	Back/Arm upcharge:	+0	+96	+171	+282	+438	+504	+639	+852	+1011	+1185	+1548	+1929	
	Seat upcharge:	+0	+40	+72	+118	+183	+210	+267	+355	+422	+494	+645	+804	
			OVERALL DIMENSIONS			SEAT DIMENSIONS			BACK DIMENSIONS					
			W	D	H	W	D	H	W	H				
			29	31.5	38.5	21.5	20	17	21	21.5				
	<p>"F" model = Flip Forward Seat for ease of cleaning</p> <p>Add \$81 for (SBS) Add \$32 for (SSS); \$48 (F model)</p>													
					RTA 00		1 per carton							
 <p>Mid Back Lounge Chair, Sled Base, Arm Patches COM Yardage: Back: 2.5; Seat: 1 COM Yardage "F" Model: Back/Arms: 3; Seat: 1.25 Freight Class: 250 Product Weight (lbs.): 52 Cubic Feet Per Carton: 25.5</p>	8016P Base Price:	\$2462												
	Back/Arm upcharge:	+0	+80	+143	+235	+365	+420	+533	+710	+843	+988	+1290	+1608	
	Seat upcharge:	+0	+32	+57	+94	+146	+168	+213	+284	+337	+395	+516	+643	
	8016PF Base Price:	\$2713												
	Back/Arm upcharge:	+0	+96	+171	+282	+438	+504	+639	+852	+1011	+1185	+1548	+1929	
	Seat upcharge:	+0	+40	+72	+94	+183	+210	+267	+355	+422	+494	+645	+804	
			OVERALL DIMENSIONS			SEAT DIMENSIONS			BACK DIMENSIONS					
			W	D	H	W	D	H	W	H				
			29	31.5	38.5	21.5	20	17	21	21.5				
	<p>"F" model = Flip Forward Seat for ease of cleaning</p> <p>Add \$99 for (SBS) Add \$32 for (SSS); \$48 (F model)</p>													
					RTA 00		1 per carton							
 <p>Mid Back Lounge Chair, 4 Leg Wood Base COM Yardage: Back: 2.5; Seat: 1 COM Yardage "F" Model: Back/Arms: 3; Seat: 1.25 Freight Class: 250 Product Weight (lbs.): 53.5 Cubic Feet Per Carton: 25.5</p>	8027 Base Price:	\$3120												
	Back/Arm upcharge:	+0	+80	+143	+235	+365	+420	+533	+710	+843	+988	+1290	+1608	
	Seat upcharge:	+0	+32	+57	+94	+146	+168	+213	+284	+337	+395	+516	+643	
	8027F Base Price:	\$3371												
	Back/Arm upcharge:	+0	+96	+171	+282	+438	+504	+639	+852	+1011	+1185	+1548	+1929	
	Seat upcharge:	+0	+40	+72	+118	+183	+210	+267	+355	+422	+494	+645	+804	
			OVERALL DIMENSIONS			SEAT DIMENSIONS			BACK DIMENSIONS					
			W	D	H	W	D	H	W	H				
			29	31.5	38.5	21.5	20	17	21	21.5				
	<p>"F" model = Flip Forward Seat for ease of cleaning</p> <p>Add \$81 for (SBS) Add \$32 for (SSS); \$48 (F model)</p>													
					RTA 00		1 per carton							

DESCRIPTION	MODEL#/ FEATURES	STANDARD TEXTILE GRADES												
		1/COM	2	3	4	5	6	7	8	9	10	11	12	
 <p>Mid Back Lounge Chair, 4 Leg Wood Base, Arm Patches COM Yardage: Back: 2.5; Seat: 1 COM Yardage "F" Model: Back/Arms: 3; Seat: 1.25 Freight Class: 250 Product Weight (lbs.): 53.5 Cubic Feet Per Carton: 25.5</p>	8027P	Base Price:	\$3145											
		Back/Arm upcharge:	+0	+80	+143	+235	+365	+420	+533	+710	+843	+988	+1290	+1608
		Seat upcharge:	+0	+32	+57	+94	+146	+168	+213	+284	+337	+395	+516	+643
	8027PF	Base Price:	\$3396											
		Back/Arm upcharge:	+0	+96	+171	+282	+438	+504	+639	+852	+1011	+1185	+1548	+1929
		Seat upcharge:	+0	+40	+72	+118	+183	+210	+267	+355	+422	+494	+645	+804
		OVERALL DIMENSIONS			SEAT DIMENSIONS			BACK DIMENSIONS						
			W	D	H	W	D	H	W	H				
			29	31.5	38.5	21.5	20	17	21	21.5				
		"F" model = Flip Forward Seat for ease of cleaning												
	Add \$99 for (SBS) Add \$32 for (SSS); \$48 (F model)													
 <p>Mid Back Lounge Chair, Wood Swivel Base COM Yardage: Back: 2.5; Seat: 1 COM Yardage "F" Model: Back/Arms: 3; Seat: 1.25 Freight Class: 250 Product Weight (lbs.): 54 Cubic Feet Per Carton: 25.5</p>	8035	Base Price:	\$2745											
		Back/Arm upcharge:	+0	+80	+143	+235	+365	+420	+533	+710	+843	+988	+1290	+1608
		Seat upcharge:	+0	+32	+57	+94	+146	+168	+213	+284	+337	+395	+516	+643
	8035F	Base Price:	\$2996											
		Back/Arm upcharge:	+0	+96	+171	+282	+438	+504	+639	+852	+1011	+1185	+1548	+1929
		Seat upcharge:	+0	+40	+72	+118	+183	+210	+267	+355	+422	+494	+645	+804
		OVERALL DIMENSIONS			SEAT DIMENSIONS			BACK DIMENSIONS						
			W	D	H	W	D	H	W	H				
			29	31.5	38.5	21.5	20	17	21	21.5				
		"F" model = Flip Forward Seat for ease of cleaning												
	Add \$81 for (SBS) Add \$32 for (SSS); \$48 (F model)													
 <p>Mid Back Lounge Chair, Wood Swivel Base, Arm Patches COM Yardage: Back: 2.5; Seat: 1 COM Yardage "F" Model: Back/Arms: 3; Seat: 1.25 Freight Class: 250 Product Weight (lbs.): 54 Cubic Feet Per Carton: 25.5</p>	8035P	Base Price:	\$2770											
		Back/Arm upcharge:	+0	+80	+143	+235	+365	+420	+533	+710	+843	+988	+1290	+1608
		Seat upcharge:	+0	+32	+57	+94	+146	+168	+213	+284	+337	+395	+516	+643
	8035PF	Base Price:	\$3021											
		Back/Arm upcharge:	+0	+96	+171	+282	+438	+504	+639	+852	+1011	+1185	+1548	+1929
		Seat upcharge:	+0	+40	+72	+118	+183	+210	+267	+355	+422	+494	+645	+804
		OVERALL DIMENSIONS			SEAT DIMENSIONS			BACK DIMENSIONS						
			W	D	H	W	D	H	W	H				
			29	31.5	38.5	21.5	20	17	21	21.5				
		"F" model = Flip Forward Seat for ease of cleaning												
	Add \$99 for (SBS) Add \$32 for (SSS); \$48 (F model)													
 <p>Mid Back Lounge Chair, Chrome Swivel Base COM Yardage: Back: 2.5; Seat: 1 COM Yardage "F" Model: Back/Arms: 3; Seat: 1.25 Freight Class: 250 Product Weight (lbs.): 60 Cubic Feet Per Carton: 25.5</p>	8036	Base Price:	\$2762											
		Back/Arm upcharge:	+0	+80	+143	+235	+365	+420	+533	+710	+843	+988	+1290	+1608
		Seat upcharge:	+0	+32	+57	+94	+146	+168	+213	+284	+337	+395	+516	+643
	8036F	Base Price:	\$3013											
		Back/Arm upcharge:	+0	+96	+171	+282	+438	+504	+639	+852	+1011	+1185	+1548	+1929
		Seat upcharge:	+0	+40	+72	+118	+183	+210	+267	+355	+422	+494	+645	+804
		OVERALL DIMENSIONS			SEAT DIMENSIONS			BACK DIMENSIONS						
			W	D	H	W	D	H	W	H				
			29	31.5	38.5	21.5	20	17	21	21.5				
		"F" model = Flip Forward Seat for ease of cleaning												
	Add \$81 for (SBS) Add \$32 for (SSS); \$48 (F model)													

DESCRIPTION	MODEL#/ FEATURES	STANDARD TEXTILE GRADES											
		1/COM	2	3	4	5	6	7	8	9	10	11	12
 <p>Mid Back Lounge Chair, Chrome Swivel Base, Arm Patches COM Yardage: Back: 2.5; Seat: 1 COM Yardage "F" Model: Back/Arms: 3; Seat: 1.25 Freight Class: 250 Product Weight (lbs.): 60 Cubic Feet Per Carton: 25.5</p>	<p>8036P Base Price: \$2787 Back/Arm upcharge: +0 Seat upcharge: +0</p>	+80	+143	+235	+365	+420	+533	+710	+843	+988	+1290	+1608	
	<p>8036PF Base Price: \$3038 Back/Arm upcharge: +0 Seat upcharge: +0</p>	+96	+171	+282	+438	+504	+639	+852	+1011	+1185	+1548	+1929	
	OVERALL DIMENSIONS			SEAT DIMENSIONS			BACK DIMENSIONS						
	W D H			W D H			W H						
	29 31.5 38.5			21.5 20 17			21 21.5						
	"F" model = Flip Forward Seat for ease of cleaning			RTA 00			1 per carton						
	Add \$99 for (SBS) Add \$32 for (SSS); \$48 (F model)												
	 <p>High Back Lounge Chair, Sled Base COM Yardage: Back: 2.75; Seat: 1 COM Yardage "F" Model: Back/Arms: 3.25; Seat: 1.25 Freight Class: 300 Product Weight (lbs.): 56 Cubic Feet Per Carton: 28.25</p>	<p>8028 Base Price: \$2778 Back/Arm upcharge: +0 Seat upcharge: +0</p>	+88	+157	+259	+402	+462	+586	+781	+927	+1087	+1419	+1769
		<p>8028F Base Price: \$3029 Back/Arm upcharge: +0 Seat upcharge: +0</p>	+104	+186	+306	+475	+546	+693	+923	+1096	+1284	+1677	+2090
		OVERALL DIMENSIONS			SEAT DIMENSIONS			BACK DIMENSIONS					
W D H			W D H			W H							
29 31.5 44.5			21.5 20 17			21 27.5							
"F" model = Flip Forward Seat for ease of cleaning			RTA 00			1 per carton							
Add \$84 for (SBS) Add \$32 for (SSS); \$48 (F model)													
 <p>High Back Lounge Chair, Sled Base, Arm Patches COM Yardage: Back: 2.75; Seat: 1 COM Yardage "F" Model: Back/Arms: 3.25; Seat: 1.25 Freight Class: 300 Product Weight (lbs.): 56 Cubic Feet Per Carton: 28.25</p>		<p>8028P Base Price: \$2829 Back/Arm upcharge: +0 Seat upcharge: +0</p>	+88	+157	+259	+402	+462	+586	+781	+927	+1087	+1419	+1769
		<p>8028PF Base Price: \$3080 Back/Arm upcharge: +0 Seat upcharge: +0</p>	+104	+186	+306	+475	+546	+693	+923	+1096	+1284	+1677	+2090
		OVERALL DIMENSIONS			SEAT DIMENSIONS			BACK DIMENSIONS					
	W D H			W D H			W H						
	29 31.5 44.5			21.5 20 17			21 27.5						
	"F" model = Flip Forward Seat for ease of cleaning			RTA 00			1 per carton						
	Add \$102 for (SBS) Add \$32 for (SSS); \$48 (F model)												
	 <p>High Back Lounge Chair, Sled Base, Arm and Head Patches COM Yardage: Back: 2.75; Seat: 1 COM Yardage "F" Model: Back/Arms: 3.25; Seat: 1.25 Freight Class: 300 Product Weight (lbs.): 56 Cubic Feet Per Carton: 28.25</p>	<p>8028PH Base Price: \$2879 Back/Arm upcharge: +0 Seat upcharge: +0</p>	+88	+157	+259	+402	+462	+586	+781	+927	+1087	+1419	+1769
		<p>8028PHF Base Price: \$3130 Back/Arm upcharge: +0 Seat upcharge: +0</p>	+104	+186	+306	+475	+546	+693	+923	+1096	+1284	+1677	+2090
		OVERALL DIMENSIONS			SEAT DIMENSIONS			BACK DIMENSIONS					
W D H			W D H			W H							
29 31.5 44.5			21.5 20 17			21 27.5							
"F" model = Flip Forward Seat for ease of cleaning			RTA 00			1 per carton							
Add \$123 for (SBS) Add \$32 for (SSS); \$48 (F model)													

DESCRIPTION	MODEL#/ FEATURES	STANDARD TEXTILE GRADES												
		1/COM	2	3	4	5	6	7	8	9	10	11	12	
 <p>High Back Lounge Chair, 4 Leg Wood Base COM Yardage: Back: 2.75; Seat: 1 COM Yardage "F" Model: Back/Arms: 3.25; Seat: 1.25 Freight Class: 250 Product Weight (lbs.): 56.5 Cubic Feet Per Carton: 28.25</p>	8029 Base Price:	\$3477												
	Back/Arm upcharge:	+0	+88	+157	+259	+402	+462	+586	+781	+927	+1087	+1419	+1769	
	Seat upcharge:	+0	+32	+57	+94	+146	+168	+213	+284	+337	+395	+516	+643	
	8029F Base Price:	\$3728												
	Back/Arm upcharge:	+0	+104	+186	+306	+475	+546	+693	+923	+1096	+1284	+1677	+2090	
	Seat upcharge:	+0	+40	+72	+118	+183	+210	+267	+355	+422	+494	+645	+804	
	OVERALL DIMENSIONS													
	W D H		29	31.5	44.5							21		27.5
	"F" model = Flip Forward Seat for ease of cleaning													
	Add \$84 for (SBS) Add \$32 for (SSS); \$48 (F model)													
 <p>High Back Lounge Chair, 4 Leg Wood Base, Arm Patches COM Yardage: Back: 2.75; Seat: 1 COM Yardage "F" Model: Back/Arms: 3.25; Seat: 1.25 Freight Class: 250 Product Weight (lbs.): 56.5 Cubic Feet Per Carton: 28.25</p>	8029P Base Price:	\$3527												
	Back/Arm upcharge:	+0	+88	+157	+259	+402	+462	+586	+781	+927	+1087	+1419	+1769	
	Seat upcharge:	+0	+32	+57	+94	+146	+168	+213	+284	+337	+395	+516	+643	
	8029PF Base Price:	\$3778												
	Back/Arm upcharge:	+0	+104	+186	+306	+475	+546	+693	+923	+1096	+1284	+1677	+2090	
	Seat upcharge:	+0	+40	+72	+118	+183	+210	+267	+355	+422	+494	+645	+804	
	OVERALL DIMENSIONS													
	W D H		29	31.5	44.5							21		27.5
	"F" model = Flip Forward Seat for ease of cleaning													
	Add \$102 for (SBS) Add \$32 for (SSS); \$48 (F model)													
 <p>High Back Lounge Chair, 4 Leg Wood Base, Arm and Head Patches COM Yardage: Back: 2.75; Seat: 1 COM Yardage "F" Model: Back/Arms: 3.25; Seat: 1.25 Freight Class: 250 Product Weight (lbs.): 56.5 Cubic Feet Per Carton: 28.25</p>	8029PH Base Price:	\$3577												
	Back/Arm upcharge:	+0	+88	+157	+259	+402	+462	+586	+781	+927	+1087	+1419	+1769	
	Seat upcharge:	+0	+32	+57	+94	+146	+168	+213	+284	+337	+395	+516	+643	
	8029PHF Base Price:	\$3828												
	Back/Arm upcharge:	+0	+104	+186	+306	+475	+546	+693	+923	+1096	+1284	+1677	+2090	
	Seat upcharge:	+0	+40	+72	+118	+183	+210	+267	+355	+422	+494	+645	+804	
	OVERALL DIMENSIONS													
	W D H		29	31.5	44.5							21		27.5
	"F" model = Flip Forward Seat for ease of cleaning													
	Add \$123 for (SBS) Add \$32 for (SSS); \$48 (F model)													
 <p>High Back Lounge Chair, Wood Swivel Base COM Yardage: Back: 2.75; Seat: 1 COM Yardage "F" Model: Back/Arms: 3.25; Seat: 1.25 Freight Class: 250 Product Weight (lbs.): 57 Cubic Feet Per Carton: 28.25</p>	8037 Base Price:	\$3000												
	Back/Arm upcharge:	+0	+88	+157	+259	+402	+462	+586	+781	+927	+1087	+1419	+1769	
	Seat upcharge:	+0	+32	+57	+94	+146	+168	+213	+284	+337	+395	+516	+643	
	8037F Base Price:	\$3251												
	Back/Arm upcharge:	+0	+104	+186	+306	+475	+546	+693	+923	+1096	+1284	+1677	+2090	
	Seat upcharge:	+0	+40	+72	+118	+183	+210	+267	+355	+422	+494	+645	+804	
	OVERALL DIMENSIONS													
	W D H		29	31.5	44.5							21		27.5
	"F" model = Flip Forward Seat for ease of cleaning													
	Add \$84 for (SBS) Add \$32 for (SSS); \$48 (F model)													

DESCRIPTION	MODEL#/ FEATURES	STANDARD TEXTILE GRADES											
		1/COM	2	3	4	5	6	7	8	9	10	11	12
	8037P Base Price:	\$3050											
	Back/Arm upcharge:	+0	+88	+157	+259	+402	+462	+586	+781	+927	+1087	+1419	+1769
	Seat upcharge:	+0	+32	+57	+94	+146	+168	+213	+284	+337	+395	+516	+643
	8037PF Base Price:	\$3301											
	Back/Arm upcharge:	+0	+104	+186	+306	+475	+546	+693	+923	+1096	+1284	+1677	+2090
	Seat upcharge:	+0	+40	+72	+118	+183	+210	+267	+355	+422	+494	+645	+804
	OVERALL DIMENSIONS			SEAT DIMENSIONS			BACK DIMENSIONS						
	W D H			W D H			W H						
	29 31.5 44.5			21.5 20 17			21 27.5						
	<p>"F" model = Flip Forward Seat for ease of cleaning</p> <p>Add \$102 for (SBS) Add \$32 for (SSS); \$48 (F model)</p>			RTA 00	1 per carton								
	8037PH Base Price:	\$3100											
	Back/Arm upcharge:	+0	+88	+157	+259	+402	+462	+586	+781	+927	+1087	+1419	+1769
	Seat upcharge:	+0	+32	+57	+94	+146	+168	+213	+284	+337	+395	+516	+643
	8037PHF Base Price:	\$3352											
	Back/Arm upcharge:	+0	+104	+186	+306	+475	+546	+693	+923	+1096	+1284	+1677	+2090
	Seat upcharge:	+0	+40	+72	+118	+183	+210	+267	+355	+422	+494	+645	+804
	OVERALL DIMENSIONS			SEAT DIMENSIONS			BACK DIMENSIONS						
	W D H			W D H			W H						
	29 31.5 44.5			21.5 20 17			21 27.5						
	<p>"F" model = Flip Forward Seat for ease of cleaning</p> <p>Add \$132 for (SBS) Add \$32 for (SSS); \$48 (F model)</p>			RTA 00	1 per carton								
	8038 Base Price:	\$3017											
	Back/Arm upcharge:	+0	+88	+157	+259	+402	+462	+586	+781	+927	+1087	+1419	+1769
	Seat upcharge:	+0	+32	+57	+94	+146	+168	+213	+284	+337	+395	+516	+643
	8038F Base Price:	\$3269											
	Back/Arm upcharge:	+0	+104	+186	+306	+475	+546	+693	+923	+1096	+1284	+1677	+2090
	Seat upcharge:	+0	+40	+72	+118	+183	+210	+267	+355	+422	+494	+645	+804
	OVERALL DIMENSIONS			SEAT DIMENSIONS			BACK DIMENSIONS						
	W D H			W D H			W H						
	29 31.5 44.5			21.5 20 17			21 27.5						
	<p>"F" model = Flip Forward Seat for ease of cleaning</p> <p>Add \$84 for (SBS) Add \$32 for (SSS); \$48 (F model)</p>			RTA 00	1 per carton 1 per carton								
	8038P Base Price:	\$3068											
	Back/Arm upcharge:	+0	+88	+157	+259	+402	+462	+586	+781	+927	+1087	+1419	+1769
	Seat upcharge:	+0	+32	+57	+94	+146	+168	+213	+284	+337	+395	+516	+643
	8038PF Base Price:	\$3319											
	Back/Arm upcharge:	+0	+104	+186	+306	+475	+546	+693	+923	+1096	+1284	+1677	+2090
	Seat upcharge:	+0	+40	+72	+118	+183	+210	+267	+355	+422	+494	+645	+804
	OVERALL DIMENSIONS			SEAT DIMENSIONS			BACK DIMENSIONS						
	W D H			W D H			W H						
	29 31.5 44.5			21.5 20 17			21 27.5						
	<p>"F" model = Flip Forward Seat for ease of cleaning</p> <p>Add \$102 for (SBS) Add \$32 for (SSS); \$48 (F model)</p>			RTA 00	1 per carton 1 per carton								

DESCRIPTION	MODEL#/ FEATURES	STANDARD TEXTILE GRADES												
		1/COM	2	3	4	5	6	7	8	9	10	11	12	
 <p>Bar Stool, Wood Base COM Yardage: Back: 1; Seat: .5 Freight Class: 250 Product Weight (lbs.): 30 Cubic Feet Per Carton: 11</p>	8055	Base Price:	\$2084											
		Back/Arm upcharge:	+0	+32	+57	+94	+146	+168	+213	+284	+337	+395	+516	+643
		Seat upcharge:	+0	+16	+29	+47	+73	+84	+107	+142	+169	+198	+258	+322
		OVERALL DIMENSIONS												
		W D H	19.25	20	40	15.5	15.75	30	12.5	10				
		Add \$32 for (SBS)												
		Add \$20 for (SSS)												
					RTA 00	FedEx								
													1 per carton	

 <p>Bar Stool, Chrome Swivel Base COM Yardage: Back: 1; Seat: .5 Freight Class: 250 Product Weight (lbs.): 45.5 Cubic Feet Per Carton: 13.25</p>	8056	Base Price:	\$2514											
		Back/Arm upcharge:	+0	+32	+57	+94	+146	+168	+213	+284	+337	+395	+516	+643
		Seat upcharge:	+0	+16	+29	+47	+73	+84	+107	+142	+169	+198	+258	+322
		OVERALL DIMENSIONS												
		W D H	19.25	20	40	15.5	15.75	30	12.5	10				
		Add \$32 for (SBS)												
		Add \$20 for (SSS)												
					RTA 00									
													1 per carton	

DRIFT TABLES



model 8041R2616C
26"W x 16"H Round Table,
Laminate Surface, Flat Edge,
Chrome Base



model 8042SQ2816I
28"W x 16"H Square Table,
Laminate Surface, Flat Edge,
Sled Base



Model 8042SQ2816W
28"W x 16"H Square Table,
Laminate Surface, Flat Edge
Wood Base



For Drift seating, see page 318

EXAMPLE OF TABLE ORDER CODE:

8041R2616I	TFL	ACJ	TBL	CG
Model Number	Surface Type	Top HPL Finish	Base Finish (Sled Base)	Glide Type (Sled Base)

STANDARD FEATURES

- Tables are available in three shapes, multiple sizes, two edge styles, three top materials and three base types including: sled, wood and polished Chrome bases.
- Table bases are fixed and do not swivel.
- Wood bases are made from beechwood and are available in all standard wood finishes.
- Sled bases are standard in painted metal.
- Chrome base tables are available in polished Chrome only.
- All table tops are available with flat edge. High pressure laminate (HPL) and solid surface top tables are also available with knife edge.
- Laminate flat edge tops are available in either (TFL) 1" thick thermally fused laminate with 2mm edgeband or (HPL) 1-1/16" thick high pressure laminate with 2mm edgeband, with upcharge.
- Laminate knife edge tops are 1-3/16" thick with 2.5mm edgeband, available in high pressure laminate (HPL) only.
- Solid surface tabletops are 1.25" thick, available on models with flat or knife edge. For detailed material information, please reference WilsonArt's Solid Surface collection.
- Wood and Chrome bases are equipped with White non-marking polycarbonate glides suitable for most hard and carpeted floor surfaces.
- Sled bases are available with clear polycarbonate glides, standard.
- Wood and sled bases may be specified with a variety of optional glide types to suit various flooring materials. (See Glide Types for additional glide options and upcharges.)
- Tables are shipped fully assembled.

Add option codes in the following order:

- **Model Number**
Specify model number
- **Surface Type** (Laminate, Flat Edge Tables)
(TFL) Thermally fused laminate
(HPL) High pressure laminate
- **Top Finish** (TFL or HPL laminate, flat edge tables and HPL laminate knife edge tables only)
HPL upcharges apply -see model
(ACJ) Absolute Acajou (ASN) Asian Night
(AWC) Avant Cherry (AWH) Avant Honey
(BLK) Black (BRC) Brushed Cobalt
(BZD) Blizzard (CGY) Custom Grey
(CMB) Clear Maple (DES) Dark Espresso
(DWT) Designer White (FAS) Fashionista
(FCL) First Class (NBL) Noce Biondo
(NGL) Noce Grigio (NEL) Noce Leggero
(NML) Noce Medio
(QTM) Quartered Mahogany
(SBY) Sheer Beauty (SDT) Stonedust
(SOG) Storm Grey (WHE) Walnut Heights
(WHC) White Chocolate (WCR) Winter Cherry
- **Top Finish** (solid surface, flat and knife edge tables)
Grade 1
(SWH) Designer White
Grade 2, Upcharge applicable, see models.
(SBT) Beige Tempest
(SBX) Black Onyx Mirage
(SMG) Milk Glass Spectra
(SFW) Frosty White Mirage
(SHS) Hot Stone
(SNM) Northern Melange
- **Base finish** (sled base models only)
Paint finishes:
(TBL) Black (TTU) Tungsten
(TSH) Shadow (TDW) Designer White
(TNE) Nevada (TLA) Latte
(TKA) Kalua (TMO) Mocha
(TOA) Toast (TFO) Fog
(TIV) Cloud (TSN) Sand
(TFR) Frost (TDJ) Dijon
(TCR) Carrot (TSR) Scarlet
(TCC) Cactus (TBZ) Buzz Blue
(TEG) Eggplant (TIN) Ink

Metallic finish:
(CHM) Chrome. Add \$42
- **Base Finish** (Chrome base only)
(CHM) Chrome
- **Glide Type** (sled base)
(CG) Clear, polycarbonate glide for most floor surfaces (standard)
(XG) No glide for carpeted surfaces, no charge
(SG) Steel cushioned glide for carpeted surface. Add \$34
(RG) Rubber, non-slip glide for most hard floor surfaces. Add \$34
(FG) Felt glide for most hard floor surfaces. Add \$34
- **Glide Type** (wood base)
(NM) White non-marking nylon glide for most surfaces (standard)
(SG) Steel cushioned glides for carpeted surfaces. Add \$34.
(RG) Non-slip rubber glides for most hard floor surfaces. Add \$34.
(FG) Felt glides for most hard floor surfaces. Add \$34.

ROUND LAPTOP TABLES FOR OFFSET BASE



Round Table with Sled Base

MODEL#	DIMENSIONS	FREIGHT CLASS	WT/LBS.	CUBIC FT.	LIST PRICE	HP ADD	GR. 2 ADD
--------	------------	---------------	---------	-----------	------------	--------	-----------

D x W x H

Laminate, flat edge (TFL laminate)

8041R2616I	26 x 26 x 16	250	35	10.25	\$561	\$98	n/a
8041R3016I	30 x 30 x 16	250	44	13	\$591	\$115	n/a
8041R2120I	21 x 21 x 20	250	29	8.75	\$587	\$97	n/a

Laminate, knife edge (HPL laminate)

8041R2616IK	26 x 26 x 16	250	35	10.25	\$1199	n/a	n/a
8041R3016IK	30 x 30 x 16	250	44	13	\$1284	n/a	n/a
8041R2120IK	21 x 21 x 20	250	29	8.75	\$996	n/a	n/a

Solid surface, flat edge

8041R2616ISF	26 x 26 x 16	150	48	10.25	\$2343	n/a	\$158
8041R3016ISF	30 x 30 x 16	150	61	13	\$2522	n/a	\$218
8041R2120ISF	21 x 21 x 20	150	37.5	8.75	\$2204	n/a	\$109

Solid surface, knife edge

8041R2616ISK	26 x 26 x 16	150	48	10.25	\$2397	n/a	\$169
8041R3016ISK	30 x 30 x 16	150	61	13	\$2603	n/a	\$234
8041R2120ISK	21 x 21 x 20	150	37.5	8.75	\$2302	n/a	\$115

Finished height will vary depending on material top. Shipped fully assembled in 1 carton.



Square Table with Sled Base

Laminate, flat edge (TFL laminate)

8042SQ2216I	22 x 22 x 16	150	34	8	\$561	\$98	n/a
8042SQ2816I	28 x 28 x 16	250	44	11.75	\$591	\$115	n/a
8042SQ1920I	19 x 19 x 20	250	29	7.75	\$568	\$88	n/a

Laminate, knife edge (HPL laminate)

8042SQ2216IK	22 x 22 x 16	150	34	8	\$996	n/a	n/a
8042SQ2816IK	28 x 28 x 16	250	44	11.75	\$1248	n/a	n/a
8042SQ1920IK	19 x 19 x 20	250	29	7.75	\$955	n/a	n/a

Solid surface, flat edge

8042SQ2216ISF	22 x 22 x 16	150	39.5	8	\$2065	n/a	\$136
8042SQ2816ISF	28 x 28 x 16	150	62.5	11.75	\$2365	n/a	\$218
8042SQ1920ISF	19 x 19 x 20	150	38	7.75	\$1976	n/a	\$164

Solid surface, knife edge

8042SQ2216ISK	22 x 22 x 16	150	39.5	8	\$2397	n/a	\$164
8042SQ2816ISK	28 x 28 x 16	150	62.5	11.75	\$2819	n/a	\$245
8042SQ1920ISK	19 x 19 x 20	150	38	7.75	\$2302	n/a	\$120

Finished height will vary depending on material top. Shipped fully assembled in 1 carton.

ROUND LAPTOP TABLES FOR OFFSET BASE

MODEL# DIMENSIONS FREIGHT CLASS WT/LBS. CUBIC FT. LIST PRICE HP ADD GR. 2 ADD

D x W x H



Oval Table with Sled Base

Laminate, flat edge (TFL laminate)

80430V2616I	26 x 22 x 16	150	36.5	8.75	\$561	\$98	n/a
80430V3116I	31 x 26 x 16	250	46	11.75	\$591	\$115	n/a
80430V2220I	22 x 18 x 20	250	34	10.75	\$587	\$97	n/a

Laminate, knife edge (HPL laminate)

80430V2616IK	26 x 22 x 16	150	36.5	8.75	\$1199	n/a	n/a
80430V3116IK	31 x 26 x 16	250	46	11.75	\$1365	n/a	n/a
80430V2220IK	22 x 18 x 20	250	34	10.75	\$1113	n/a	n/a

Solid surface, flat edge

80430V2616ISF	26 x 22 x 16	150	42	8.75	\$2343	n/a	\$158
80430V3116ISF	31 x 26 x 16	150	60	11.75	\$2522	n/a	\$218
80430V2220ISF	22 x 18 x 20	250	38	10.75	\$2204	n/a	\$109

Solid surface, knife edge

80430V2616ISK	26 x 22 x 16	150	42	8.75	\$2397	n/a	\$169
80430V3116ISK	31 x 26 x 16	150	60	11.75	\$2603	n/a	\$234
80430V2220ISK	22 x 18 x 20	250	38	10.75	\$2302	n/a	\$115

Finished height will vary depending on material top. Shipped fully assembled in 1 carton.



Round Table with Polished Chrome Base

Laminate, flat edge (TFL laminate)

8041R2616C	26 x 26 x 16	250	38	10.75	\$1058	\$98	n/a
8041R3016C	30 x 30 x 16	250	45	13	\$1088	\$115	n/a

Laminate, knife edge (HPL laminate)

8041R2616CK	26 x 26 x 16	250	38	10.75	\$1696	n/a	n/a
8041R3016CK	30 x 30 x 16	250	45	13	\$1782	n/a	n/a

Solid surface, flat edge

8041R2616CSF	26 x 26 x 16	150	51	10.75	\$2840	n/a	\$158
8041R3016CSF	30 x 30 x 16	150	62.5	13	\$3019	n/a	\$218

Solid surface, knife edge

8041R2616CSK	26 x 26 x 16	150	51	10.75	\$2894	n/a	\$169
8041R3016CSK	30 x 30 x 16	250	31.25	13	\$3101	n/a	\$234

Finished height will vary depending on material top. Shipped fully assembled in 1 carton.



Round Table with Wood Base

Laminate, flat edge (TFL laminate)

8041R2616W	26 x 26 x 16	250	32	10.75	\$1204	\$98	n/a
8041R3016W	30 x 30 x 16	250	40	13	\$1234	\$115	n/a

Laminate, knife edge (HPL laminate)

8041R2616WK	26 x 26 x 16	250	32	10.75	\$1842	n/a	n/a
8041R3016WK	30 x 30 x 16	250	40	13	\$1927	n/a	n/a

Solid surface, flat edge

8041R2616WSF	26 x 26 x 16	150	45.5	10.75	\$2985	n/a	\$158
8041R3016WSF	30 x 30 x 16	150	57.5	13	\$3165	n/a	\$218

Solid surface, knife edge

8041R2616WSK	26 x 26 x 16	150	45.5	10.75	\$3040	n/a	\$169
8041R3016WSK	30 x 30 x 16	150	57.5	13	\$3246	n/a	\$234

Finished height will vary depending on material top. Shipped fully assembled in 1 carton.



ROUND LAPTOP TABLES FOR OFFSET BASE



Square Table with Polished Chrome Base

MODEL#	DIMENSIONS	FREIGHT CLASS	WT/LBS.	CUBIC FT.	LIST PRICE	HP ADD	GR. 2 ADD
D x W x H							
Laminate, flat edge (TFL laminate)							
8042SQ2216C	22.75 x 22.75 x 16	150	36	7.75	\$1058	\$98	n/a
8042SQ2816C	28.5 x 28.5 x 16	250	45	11.5	\$1088	\$115	n/a
Laminate, knife edge (HPL laminate)							
8042SQ2216CK	22.75 x 22.75 x 16	150	36	7.75	\$1493	n/a	n/a
8042SQ2816CK	28.5 x 28.5 x 16	250	45	11.5	\$1588	n/a	n/a
Solid surface, flat edge							
8042SQ2216CSF	22.75 x 22.75 x 16	150	41	7.75	\$2563	n/a	\$136
8042SQ2816CSF	28.5 x 28.5 x 16	150	57.5	11.5	\$2862	n/a	\$218
Solid surface, knife edge							
8042SQ2216CSK	22.75 x 22.75 x 16	150	41	7.75	\$2894	n/a	\$164
8042SQ2816CSK	28.5 x 28.5 x 16	150	57.5	11.5	\$3316	n/a	\$245

Finished height will vary depending on material top. Shipped fully assembled in 1 carton.



Square Table with Wood Base

Laminate, flat edge (HPL laminate)							
8042SQ2216W	22.75 x 22.75 x 16	250	30	7.75	\$1204	\$98	n/a
8042SQ2816W	28.5 x 28.5 x 16	250	39	11.5	\$1234	\$115	n/a
Laminate, knife edge (HPL laminate)							
8042SQ2216WK	22.75 x 22.75 x 16	250	30	7.75	\$1639	n/a	n/a
8042SQ2816WK	28.5 x 28.5 x 16	250	39	11.5	\$1734	n/a	n/a
Solid surface, flat edge							
8042SQ2216WSF	22.75 x 22.75 x 16	150	36	7.75	\$2708	n/a	\$136
8042SQ2816WSF	28.5 x 28.5 x 16	150	59	11.5	\$3008	n/a	\$218
Solid surface, knife edge							
8042SQ2216WSK	22.75 x 22.75 x 16	150	36	7.75	\$3040	n/a	\$164
8042SQ2816WSK	28.5 x 28.5 x 16	150	59	11.5	\$3462	n/a	\$245

Finished height will vary depending on material top. Shipped fully assembled in 1 carton.

ROUND LAPTOP TABLES FOR OFFSET BASE **MODEL#** **DIMENSIONS** **FREIGHT CLASS** **WT/LBS.** **CUBIC FT.** **LIST PRICE** **HP ADD** **GR. 2 ADD**



Oval Table with Polished Chrome Base

D x W x H

Laminate, flat edge

80430V2616C	26 x 22 x 16	150	38	9.25	\$1058	\$98	n/a
80430V3116C	31 x 26 x 16	250	44	11.75	\$1088	\$115	n/a

Laminate, knife edge

80430V2616CK	26 x 22 x 16	150	38	9.25	\$1696	n/a	n/a
80430V3116CK	31 x 26 x 16	250	44	11.75	\$1862	n/a	n/a

Solid surface, flat edge

80430V2616CSF	26 x 22 x 16	150	49.5	9.25	\$2840	n/a	\$158
80430V3116CSF	31 x 26 x 16	150	61.5	11.75	\$3019	n/a	\$218

Solid surface, knife edge

80430V2616CSK	26 x 22 x 16	150	49.5	9.25	\$2894	n/a	\$169
80430V3116CSK	31 x 26 x 16	150	61.5	11.75	\$3101	n/a	\$234

Finished height will vary depending on material top. Shipped fully assembled in 1 carton.



Oval Table with Wood Base

Laminate, flat edge

80430V2616W	26 x 22 x 16	250	32	9.25	\$1204	\$98	n/a
80430V3116W	31 x 26 x 16	250	39	11.75	\$1234	\$115	n/a

Laminate, knife edge

80430V2616WK	26 x 22 x 16	250	32	9.25	\$1842	n/a	n/a
80430V3116WK	31 x 26 x 16	250	39	11.75	\$2008	n/a	n/a

Solid surface, flat edge

80430V2616WSF	26 x 22 x 16	150	44.5	9.25	\$2985	n/a	\$158
80430V3116WSF	31 x 26 x 16	150	56.5	11.75	\$3165	n/a	\$218

Solid surface, knife edge

80430V2616WSK	26 x 22 x 16	150	44.5	9.25	\$3040	n/a	\$169
80430V3116WSK	31 x 26 x 16	150	56.5	11.75	\$3246	n/a	\$234

Finished height will vary depending on material top. Shipped fully assembled in 1 carton.

JEO



model 8434



model 8433-4



Optional Quilted Stitch Back (Q).



Optional 5 prong base with glides (G).



model 8435-2224





model 8436-1330







STANDARD FEATURES



- Jeo is a contemporary, retro - inspired series with versatility for a variety of workplace applications.
- The tailored box styling functions well in lounge, conferencing, collaboration and side/guest environments.
- Three seating models: swivel tilter with a 5 prong caster base, a swivel self-centering return with a stationary round pedestal base or a matching four legged Arm Chair.
- Model 8433-4 is standard with a five prong Black nylon base with carpet casters (C1).
- Model 8437 is standard with Black four-legged frame.
- Jeo also offers two styles of matching pedestal base occasional tables with a round or square laminate top, available in two height sizes --- 15" and 22" high.
- Upholstery options: fabric, vinyl, leather or a combination of two or more materials. The upholstery surfaces are seamed together with tailored double stitch detailing.
- Check textile availability prior to specifying upholstery material.

OPTIONAL FEATURES

- Chairs are available with an Optional Quilted Stitch back. Please specify (Q). Add \$212.
- Model 8433-4 has an optional five prong Aluminum base. specify (AL). Add \$63.
- Optional 5 prong Aluminum base with hard glides. Please specify (C7).
- Optional soft casters are available on the 5 prong base. Please specify (C9R) . Add \$72.
- Model 8434 round pedestal base available in Chrome (CHM) or Brushed Chrome (BCH). Please specify.
- Model 8437 has optional Chrome (CHM) or Brushed Chrome (BCH) four-legged frame.
- Occasional tables are available in the following laminate finishes to coordinate with Global Desking and wood seating: Absolute Acajou (ACJ), Asian Night (ASN), Avant Cherry (AWC), Avant Honey (AWH), Black (BLK), Blizzard (BZD), Brushed Cobalt (BRC), Clear Maple (CMB), Custom Grey (CGY), Dark Espresso (DES), Designer White (DWT), Fashionista (FAS), First Class (FCL), Noce Biondo (NBL), Noce Grigio (NGL), Noce Leggero (NEL), Noce Medio (NML), Quartered Mahogany (QTM), Sheer Beauty (SBY), Stonedust (SDT), Walnut Heights (WHE), White Chocolate (WHC), and Winter Cherry (WCR). Please Specify.

DESCRIPTION	FEATURES	MODEL#	STANDARD TEXTILE GRADES													
			1	2	3	4	5	6	7	8	9	10	11	12		
 <p>Self-Centering Lounge Chair on Pedestal Base COM Yardage: 2.75 Freight Class: 250 Product Weight (lbs.): 50 Cubic Feet Per Carton: 22</p>	Ergonomic Features: C	8434	2345	2435	2505	2609	2757	2809	2938	3184	3305	3532	3843	4229		
		OVERALL DIMENSIONS			SEAT DIMENSIONS			BACK DIMENSIONS								
		W	D	H	W	D	H	W	H							
	26	25	30-32.5	20	19	16.5-19	20	15								
 <p>Swivel Tilter Chair COM Yardage: 2.75 Freight Class: 250 Product Weight (lbs.): 50 Cubic Feet Per Carton: 22</p>	Ergonomic Features: A, B, C, S	8433-4	1591	1703	1788	1918	2101	2187	2353	2616	2822	3048	3515	4013		
		OVERALL DIMENSIONS			SEAT DIMENSIONS			BACK DIMENSIONS								
		W	D	H	W	D	H	W	H							
	26	25	30-32.5	20	19	16.5-19	20	15								
 <p>Arm Chair COM Yardage: 2.75 Freight Class: 250 Product Weight (lbs.): 50 Cubic Feet Per Carton: 22</p>		8437	1549	1649	1724	1838	1997	2074	2219	2451	2629	2827	3238	3673		
	OVERALL DIMENSIONS			SEAT DIMENSIONS			BACK DIMENSIONS									
	W	D	H	W	D	H	W	H								
	26	25	34	20	19	18	20	15								

DESCRIPTION	FEATURES	MODEL#	STANDARD TEXTILE GRADES												
			1	2	3	4	5	6	7	8	9	10	11	12	
 <p>15" H Round End Table - 24" Dia. Top on Pedestal Base COM Yardage: n/a Freight Class: 150 Product Weight (lbs.): 44 Cubic Feet Per Carton: 10</p>		8435-1524	1442												
				OVERALL DIMENSIONS			SEAT DIMENSIONS			BACK DIMENSIONS					
					W	Dia.	H	W	D	H	W	H			
				24		15									
															
 <p>15" H Round Coffee Table - 30" Dia. Top on Pedestal Base COM Yardage: n/a Freight Class: 150 Product Weight (lbs.): 44 Cubic Feet Per Carton: 10</p>		8435-1530	1683												
				OVERALL DIMENSIONS			SEAT DIMENSIONS			BACK DIMENSIONS					
					W	Dia.	H	W	D	H	W	H			
				30		15									
 <p>22" H Round End Table - 24" Dia. Top on Pedestal Base COM Yardage: n/a Freight Class: 150 Product Weight (lbs.): 44 Cubic Feet Per Carton: 10</p>		8435-2224	1579												
				OVERALL DIMENSIONS			SEAT DIMENSIONS			BACK DIMENSIONS					
					W	Dia.	H	W	D	H	W	H			
				24		22									
															
 <p>22" H Round Coffee Table - 30" Dia. Top on Pedestal Base COM Yardage: n/a Freight Class: 150 Product Weight (lbs.): 44 Cubic Feet Per Carton: 10</p>		8435-2230	1819												
				OVERALL DIMENSIONS			SEAT DIMENSIONS			BACK DIMENSIONS					
					W	Dia.	H	W	D	H	W	H			
				30		22									
 <p>15" H Square End Table - 24" Top on Pedestal Base COM Yardage: n/a Freight Class: 150 Product Weight (lbs.): 44 Cubic Feet Per Carton: 10</p>		8436-1524	1442												
				OVERALL DIMENSIONS			SEAT DIMENSIONS			BACK DIMENSIONS					
					W	D	H	W	D	H	W	H			
				24	24	15									

DESCRIPTION	FEATURES	MODEL#	STANDARD TEXTILE GRADES														
			1	2	3	4	5	6	7	8	9	10	11	12			
 <p>15" H Square End Coffee - 30" Top on Pedestal Base COM Yardage: n/a Freight Class: 150 Product Weight (lbs.): 44 Cubic Feet Per Carton: 10</p>		8436-1530	1683														
 <p>22" H Square End Table - 24" Top on Pedestal Base COM Yardage: n/a Freight Class: 150 Product Weight (lbs.): 44 Cubic Feet Per Carton: 10</p>		8436-2224	1579														
 <p>22" H Square End Coffee - 30" Top on Pedestal Base COM Yardage: n/a Freight Class: 150 Product Weight (lbs.): 44 Cubic Feet Per Carton: 10</p>		8436-2230	1819														

KATE®



model 2811-4







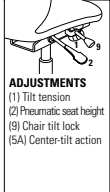

model 2811-8

STANDARD FEATURES

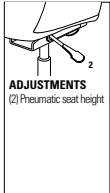
- A contemporary, yet retro series featuring sculpted seat and back cushions.
- Fully upholstered closed arms offer a unique style and function in the workplace.
- Models are standard with a five legged Polished Aluminum base.
- C10 casters are standard.
- Check textile availability prior to specifying upholstery material.

OPTIONAL FEATURES

- An optional Black injection molded base is available at no upcharge, please specify (BK).
- There are no caster options for this series. C7 glides can be specified at no upcharge.
- For hard surface flooring please specify C10R. Add \$66.
- For fully assembled in box, specify SU. Add \$76.

DESCRIPTION	FEATURES	MODEL#	STANDARD TEXTILE GRADES																																			
			1	2	3	4	5	6	7	8	9	10	11	12																								
 <p>MB Tilter COM Yardage: 3.75 Freight Class: 250 Product Weight (lbs.): 47 Cubic Feet Per Carton: 15.75</p>	 <p>ADJUSTMENTS (1) Tilt tension (2) Pneumatic seat height (9) Chair tilt lock (5A) Center-tilt action</p>	<p>Ergonomic Features: A, B, C, N</p>	<table border="1"> <thead> <tr> <th colspan="3">OVERALL DIMENSIONS</th> <th colspan="3">SEAT DIMENSIONS</th> <th colspan="2">BACK DIMENSIONS</th> </tr> <tr> <th>W</th><th>D</th><th>H</th> <th>W</th><th>D</th><th>H</th> <th>W</th><th>H</th> </tr> </thead> <tbody> <tr> <td>26</td><td>24.5</td><td>33</td> <td>17.5</td><td>18</td><td>17.5-21.50</td> <td>19</td><td>15.5</td> </tr> </tbody> </table>												OVERALL DIMENSIONS			SEAT DIMENSIONS			BACK DIMENSIONS		W	D	H	W	D	H	W	H	26	24.5	33	17.5	18	17.5-21.50	19	15.5
			OVERALL DIMENSIONS			SEAT DIMENSIONS			BACK DIMENSIONS																													
			W	D	H	W	D	H	W	H																												
			26	24.5	33	17.5	18	17.5-21.50	19	15.5																												
<p>RTA 00</p>																																						
<table border="1"> <thead> <tr> <th>1</th><th>2</th><th>3</th><th>4</th><th>5</th><th>6</th><th>7</th><th>8</th><th>9</th><th>10</th><th>11</th><th>12</th> </tr> </thead> <tbody> <tr> <td>2811-4</td><td>\$1412</td><td>\$1549</td><td>\$1660</td><td>\$1824</td><td>\$2055</td><td>\$2141</td><td>\$2342</td><td>\$2732</td><td>\$2918</td><td>\$3277</td><td>\$3767</td><td>\$4374</td> </tr> </tbody> </table>												1	2	3	4	5	6	7	8	9	10	11	12	2811-4	\$1412	\$1549	\$1660	\$1824	\$2055	\$2141	\$2342	\$2732	\$2918	\$3277	\$3767	\$4374		
1	2	3	4	5	6	7	8	9	10	11	12																											
2811-4	\$1412	\$1549	\$1660	\$1824	\$2055	\$2141	\$2342	\$2732	\$2918	\$3277	\$3767	\$4374																										
<p>FedEx </p>																																						
 <p>MB Swivel COM Yardage: 3.75 Freight Class: 250 Product Weight (lbs.): 43 Cubic Feet Per Carton: 15.75</p>	 <p>ADJUSTMENTS (2) Pneumatic seat height</p>	<p>Ergonomic Features: C, N</p>	<table border="1"> <thead> <tr> <th colspan="3">OVERALL DIMENSIONS</th> <th colspan="3">SEAT DIMENSIONS</th> <th colspan="2">BACK DIMENSIONS</th> </tr> <tr> <th>W</th><th>D</th><th>H</th> <th>W</th><th>D</th><th>H</th> <th>W</th><th>H</th> </tr> </thead> <tbody> <tr> <td>26</td><td>24.5</td><td>33</td> <td>17.5</td><td>18</td><td>17.5-21.50</td> <td>19</td><td>15.5</td> </tr> </tbody> </table>												OVERALL DIMENSIONS			SEAT DIMENSIONS			BACK DIMENSIONS		W	D	H	W	D	H	W	H	26	24.5	33	17.5	18	17.5-21.50	19	15.5
			OVERALL DIMENSIONS			SEAT DIMENSIONS			BACK DIMENSIONS																													
			W	D	H	W	D	H	W	H																												
			26	24.5	33	17.5	18	17.5-21.50	19	15.5																												
<p>RTA 00</p>																																						
<table border="1"> <thead> <tr> <th>1</th><th>2</th><th>3</th><th>4</th><th>5</th><th>6</th><th>7</th><th>8</th><th>9</th><th>10</th><th>11</th><th>12</th> </tr> </thead> <tbody> <tr> <td>2811-8</td><td>\$1362</td><td>\$1504</td><td>\$1615</td><td>\$1776</td><td>\$2008</td><td>\$2094</td><td>\$2296</td><td>\$2685</td><td>\$2871</td><td>\$3229</td><td>\$3719</td><td>\$4327</td> </tr> </tbody> </table>												1	2	3	4	5	6	7	8	9	10	11	12	2811-8	\$1362	\$1504	\$1615	\$1776	\$2008	\$2094	\$2296	\$2685	\$2871	\$3229	\$3719	\$4327		
1	2	3	4	5	6	7	8	9	10	11	12																											
2811-8	\$1362	\$1504	\$1615	\$1776	\$2008	\$2094	\$2296	\$2685	\$2871	\$3229	\$3719	\$4327																										
<p>FedEx </p>																																						
 <p>Armchair COM Yardage: 3.75 Freight Class: 250 Product Weight (lbs.): 42 Cubic Feet Per Carton: 15.75</p>	<p>Ergonomic Features: N</p>	<table border="1"> <thead> <tr> <th colspan="3">OVERALL DIMENSIONS</th> <th colspan="3">SEAT DIMENSIONS</th> <th colspan="2">BACK DIMENSIONS</th> </tr> <tr> <th>W</th><th>D</th><th>H</th> <th>W</th><th>D</th><th>H</th> <th>W</th><th>H</th> </tr> </thead> <tbody> <tr> <td>26.5</td><td>26.5</td><td>33.5</td> <td>17.5</td><td>18</td><td>18</td> <td>19</td><td>15.5</td> </tr> </tbody> </table>												OVERALL DIMENSIONS			SEAT DIMENSIONS			BACK DIMENSIONS		W	D	H	W	D	H	W	H	26.5	26.5	33.5	17.5	18	18	19	15.5	
		OVERALL DIMENSIONS			SEAT DIMENSIONS			BACK DIMENSIONS																														
		W	D	H	W	D	H	W	H																													
		26.5	26.5	33.5	17.5	18	18	19	15.5																													
<p>RTA 00</p>																																						
<table border="1"> <thead> <tr> <th>1</th><th>2</th><th>3</th><th>4</th><th>5</th><th>6</th><th>7</th><th>8</th><th>9</th><th>10</th><th>11</th><th>12</th> </tr> </thead> <tbody> <tr> <td>2813</td><td>\$1543</td><td>\$1676</td><td>\$1782</td><td>\$1937</td><td>\$2158</td><td>\$2237</td><td>\$2431</td><td>\$2801</td><td>\$2979</td><td>\$3322</td><td>\$3787</td><td>\$4367</td> </tr> </tbody> </table>												1	2	3	4	5	6	7	8	9	10	11	12	2813	\$1543	\$1676	\$1782	\$1937	\$2158	\$2237	\$2431	\$2801	\$2979	\$3322	\$3787	\$4367		
1	2	3	4	5	6	7	8	9	10	11	12																											
2813	\$1543	\$1676	\$1782	\$1937	\$2158	\$2237	\$2431	\$2801	\$2979	\$3322	\$3787	\$4367																										
<p>FedEx </p>																																						
 <p>Ottoman COM Yardage: 1.5 Freight Class: 250 Product Weight (lbs.): 22 Cubic Feet Per Carton: 6</p>	<p>Ergonomic Features: N</p>	<table border="1"> <thead> <tr> <th colspan="3">OVERALL DIMENSIONS</th> <th colspan="3">SEAT DIMENSIONS</th> <th colspan="2">BACK DIMENSIONS</th> </tr> <tr> <th>W</th><th>D</th><th>H</th> <th>W</th><th>D</th><th>H</th> <th>W</th><th>H</th> </tr> </thead> <tbody> <tr> <td>23.5</td><td>18.75</td><td>17.75</td> <td>20.5</td><td>18.5</td><td>17-22</td> <td>20</td><td>21</td> </tr> </tbody> </table>												OVERALL DIMENSIONS			SEAT DIMENSIONS			BACK DIMENSIONS		W	D	H	W	D	H	W	H	23.5	18.75	17.75	20.5	18.5	17-22	20	21	
		OVERALL DIMENSIONS			SEAT DIMENSIONS			BACK DIMENSIONS																														
		W	D	H	W	D	H	W	H																													
		23.5	18.75	17.75	20.5	18.5	17-22	20	21																													
<p>RTA 00</p>																																						
<table border="1"> <thead> <tr> <th>1</th><th>2</th><th>3</th><th>4</th><th>5</th><th>6</th><th>7</th><th>8</th><th>9</th><th>10</th><th>11</th><th>12</th> </tr> </thead> <tbody> <tr> <td>2814</td><td>\$966</td><td>\$1024</td><td>\$1065</td><td>\$1126</td><td>\$1214</td><td>\$1247</td><td>\$1324</td><td>\$1472</td><td>\$1544</td><td>\$1680</td><td>\$1867</td><td>\$2098</td> </tr> </tbody> </table>												1	2	3	4	5	6	7	8	9	10	11	12	2814	\$966	\$1024	\$1065	\$1126	\$1214	\$1247	\$1324	\$1472	\$1544	\$1680	\$1867	\$2098		
1	2	3	4	5	6	7	8	9	10	11	12																											
2814	\$966	\$1024	\$1065	\$1126	\$1214	\$1247	\$1324	\$1472	\$1544	\$1680	\$1867	\$2098																										
<p>FedEx </p>																																						

LUX



model LX2426AC



model LX8033S

STANDARD FEATURES

- Contemporary styling featuring luxurious cushioning.
- Sofa cushions are removable.
- Fully upholstered. Wood legs with non marking clear glides.
- Cylindrical bolsters included with lounge chair models. One bolster on single seat lounge chair and two bolsters on two-seat and three-seat sofas.
- This item may require a longer lead time. Please contact your Global sales representative for further information.
- Check textile availability prior to specifying upholstery material.

OPTIONAL FEATURES

- Wood frames are available in Absolute (AAM), Black (BKM), Cherry (ACM), English Oak (EOM), Espresso Cafe (ECM), Fruitwood (TFM), Gray (HGM), Honey (AHM), Mahogany (TMM), Maple (AVM), Medium Walnut (MWM), Night (ASM), Natural Walnut (NLW), Noce Biondo (NBM), Noce Grigio (NGM), Noce Leggero (NEM), Noce Medio (NMM), Shaker Cherry (SKM), Walnut (TWM), WC Cream (WTM), White (WHM) and Winter Cherry (WCM). Please Specify. Genuine maple faced veneers and solids are used.

DESCRIPTION	FEATURES	MODEL#	STANDARD TEXTILE GRADES											
-------------	----------	--------	-------------------------	--	--	--	--	--	--	--	--	--	--	--



Side Chair
COM Yardage: 3
Freight Class: 150
Product Weight (lbs.): 36
Cubic Feet Per Carton: 17.75

	1	2	3	4	5	6	7	8	9	10	11	12
LX2226SC	1089	1203	1249	1321	1420	1453	1540	1704	1784	1938	2145	2405

OVERALL DIMENSIONS			SEAT DIMENSIONS			BACK DIMENSIONS	
W	D	H	W	D	H	W	H
25	27.75	36	19	19.5	19.5	19	18

RTA 00



Armchair
COM Yardage: 3
Freight Class: 250
Product Weight (lbs.): 40
Cubic Feet Per Carton: 17.75

	1	2	3	4	5	6	7	8	9	10	11	12
LX2426AC	1414	1533	1626	1763	1959	2051	2229	2513	2731	2973	3472	4005

OVERALL DIMENSIONS			SEAT DIMENSIONS			BACK DIMENSIONS	
W	D	H	W	D	H	W	H
26	27.75	36	19	19.5	19.5	19	18

RTA 00



Lounge Chair
COM Yardage: 8.50
Freight Class: 250
Product Weight (lbs.): 77
Cubic Feet Per Carton: 30.25

	1	2	3	4	5	6	7	8	9	10	11	12
LX3433CH	2754	3050	3286	3640	4142	4380	4832	5558	6118	6739	8017	9381

OVERALL DIMENSIONS			SEAT DIMENSIONS			BACK DIMENSIONS	
W	D	H	W	D	H	W	H
35	34	33	-	-	-	-	-

RTA 00



Ottoman
COM Yardage: 2.5
Freight Class: 250
Product Weight (lbs.): 48
Cubic Feet Per Carton: 18.25

	1	2	3	4	5	6	7	8	9	10	11	12
LX3636OTT	2630	2843	2908	3006	3151	3197	3324	3559	3673	3890	4189	4559

OVERALL DIMENSIONS			SEAT DIMENSIONS			BACK DIMENSIONS	
W	D	H	W	D	H	W	H
36	36	16	-	-	-	-	-

RTA 00

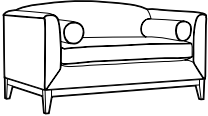
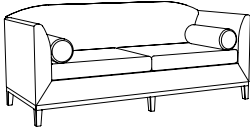
DESCRIPTION	FEATURES	MODEL#	STANDARD TEXTILE GRADES												
			1	2	3	4	5	6	7	8	9	10	11	12	
 <p>Two Seat Sofa w/Cylindrical bolsters. COM Yardage: 12 Freight Class: 250 Product Weight (lbs.): 105 Cubic Feet Per Carton: 50.25</p>		LX6033S	2843	3260	3594	4092	4800	5132	5775	6797	7585	8461	10263	12187	
		OVERALL DIMENSIONS			SEAT DIMENSIONS			BACK DIMENSIONS							
		W	D	H	W	D	H	W	H						
		61	34	33	20	18.5	18.5	20	16						
			RTA 00												
 <p>Three Seat Sofa w/Cylindrical bolsters. COM Yardage: 14.75 Freight Class: 300 Product Weight (lbs.): 125 Cubic Feet Per Carton: 66.25</p>		LX8033S	4092	4756	5126	5687	6474	6758	7449	8769	9403	10628	12290	14365	
		OVERALL DIMENSIONS			SEAT DIMENSIONS			BACK DIMENSIONS							
		W	D	H	W	D	H	W	H						
		81	34	33	20	18.5	18.5	20	16						
			RTA 00												

ML™



model ML2630

STANDARD FEATURES

- Modern seating with a distinctive retro design.
- Features a steel tube frame, legs and arms.
- Fully upholstered continuous seat and back cushions.
- Standard with non marring, Black glides.
- Check textile availability prior to specifying upholstery material.

OPTIONAL FEATURES

- Available in five frame finish options. Please specify Chrome (**CHM**), Brushed Chrome (**BCH**), Black (**TBL**), Designer White (**TDW**) or Tungsten (**TTU**). No upcharge applies. Please specify.

DESCRIPTION	FEATURES	MODEL#	STANDARD TEXTILE GRADES											
-------------	----------	--------	-------------------------	--	--	--	--	--	--	--	--	--	--	--



Counter Height Stool - 24" Seat Height

COM Yardage: 1
Freight Class: 250
Product Weight (lbs.): 22
Cubic Feet Per Carton: 5.75

	1	2	3	4	5	6	7	8	9	10	11	12
ML171724	1581	1604	1618	1644	1673	1688	1718	1764	1799	1840	1922	2009

OVERALL DIMENSIONS			SEAT DIMENSIONS			BACK DIMENSIONS	
W	D	H	W	D	H	W	H
18	19	24	17	16	23	-	-

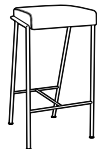

Bar Height Stool - 30" Seat Height

COM Yardage: 1
Freight Class: 250
Product Weight (lbs.): 23
Cubic Feet Per Carton: 8

	1	2	3	4	5	6	7	8	9	10	11	12
ML171730	1631	1652	1666	1689	1717	1729	1754	1802	1827	1872	1934	2012

OVERALL DIMENSIONS			SEAT DIMENSIONS			BACK DIMENSIONS	
W	D	H	W	D	H	W	H
18	20.5	30	17	16	29	-	-

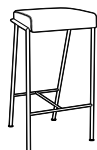

Bar Height Stool - 33" Seat Height

COM Yardage: 1
Freight Class: 250
Product Weight (lbs.): 24
Cubic Feet Per Carton: 9

	1	2	3	4	5	6	7	8	9	10	11	12
ML171733	1663	1762	1777	1796	1823	1834	1860	1905	1928	1972	2031	2106

OVERALL DIMENSIONS			SEAT DIMENSIONS			BACK DIMENSIONS	
W	D	H	W	D	H	W	H
18	21.5	33	17	16	32	-	-





Ottoman

COM Yardage: 1.25
Freight Class: 150
Product Weight (lbs.): 28
Cubic Feet Per Carton: 5.75

	1	2	3	4	5	6	7	8	9	10	11	12
ML2121	1122	1212	1239	1279	1336	1356	1404	1499	1545	1630	1751	1899

OVERALL DIMENSIONS			SEAT DIMENSIONS			BACK DIMENSIONS	
W	D	H	W	D	H	W	H
21	21	17	-	-	-	-	-



DESCRIPTION	FEATURES	MODEL#	STANDARD TEXTILE GRADES											
			1	2	3	4	5	6	7	8	9	10	11	12
 <p>Dining Chair COM Yardage: 1.75 Freight Class: 250 Product Weight (lbs.): 33 Cubic Feet Per Carton: 14.75</p>		ML2326	1317	1450	1503	1582	1695	1735	1835	2023	2113	2288	2526	2824
			OVERALL DIMENSIONS			SEAT DIMENSIONS			BACK DIMENSIONS					
			W	D	H	W	D	H	W	H				
			23.25	29.5	29.75	20	18.5	18.5	20	16				
			RTA 00											
 <p>Lounge Chair COM Yardage: 2.5 Freight Class: 250 Product Weight (lbs.): 54 Cubic Feet Per Carton: 21.25</p>		ML2630	1976	2158	2224	2323	2462	2513	2639	2875	2986	3206	3503	3873
			OVERALL DIMENSIONS			SEAT DIMENSIONS			BACK DIMENSIONS					
			W	D	H	W	D	H	W	H				
			26	34.5	35	23	20	18.5	18.5	20.5				
			RTA 00											

ML PARK



model ML4634CH



model ML8634

STANDARD FEATURES

- Armless modern lounge seating with a distinctive retro design.
- Features beautiful aluminum legs with Black glides.
- Fully upholstered continuous seat and back cushions with distinctive seams.
- Check textile availability prior to specifying upholstery material.

OPTIONAL FEATURES

- Optional fixed back cushion (FC) is available on lounge models with upcharge. Please specify. Model ML4634, add \$182. Model ML6634, add \$241. Model ML8634, add \$299.
- Available in five leg finish options. Specify: Black (TBL), Brushed Aluminum (BAL), Designer White (TDW), Polished Aluminum (ALU) or Tungsten (TTU). No upcharge applies.

DESCRIPTION	FEATURES	MODEL#	STANDARD TEXTILE GRADES											
			1	2	3	4	5	6	7	8	9	10	11	12



Ottoman
COM Yardage: 1.50
Freight Class: 150
Product Weight (lbs.): 28
Cubic Feet Per Carton: 5.75

ML2634	2177	2230	2271	2333	2420	2462	2541	2667	2763	2872	3095	3331
---------------	------	------	------	------	------	------	------	------	------	------	------	------

OVERALL DIMENSIONS			SEAT DIMENSIONS			BACK DIMENSIONS	
W	D	H	W	D	H	W	H
21	26.75	18.25	26.75	-	20	-	-

RTA 00



Lounge Chair
COM Yardage: 7.25
Freight Class: 250
Product Weight (lbs.): 54
Cubic Feet Per Carton: 21.25

ML4634	3731	3964	4144	4414	4802	4980	5329	5886	6314	6790	7771	8818
---------------	------	------	------	------	------	------	------	------	------	------	------	------

OVERALL DIMENSIONS			SEAT DIMENSIONS			BACK DIMENSIONS	
W	D	H	W	D	H	W	H
26	34.5	35	42.75	22	19	27	13

RTA 00

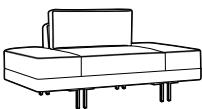

Two Seat Sofa
COM Yardage: 7.50
Freight Class: 250
Product Weight (lbs.): 132
Cubic Feet Per Carton: 52

ML6634	4028	4491	4701	5022	5471	5636	6028	6781	7145	7843	8797	9981
---------------	------	------	------	------	------	------	------	------	------	------	------	------

OVERALL DIMENSIONS			SEAT DIMENSIONS			BACK DIMENSIONS	
W	D	H	W	D	H	W	H
66	36	32	66	22	19	27	13

RTA 00

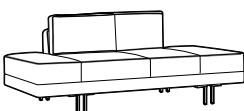

Three Seat Sofa
COM Yardage: 11
Freight Class: 250
Product Weight (lbs.): 132
Cubic Feet Per Carton: 52

ML8634	5314	5937	6229	6666	7288	7511	8051	9088	9587	10549	11856	13488
---------------	------	------	------	------	------	------	------	------	------	-------	-------	-------

OVERALL DIMENSIONS			SEAT DIMENSIONS			BACK DIMENSIONS	
W	D	H	W	D	H	W	H
66	36	32	86	22	19	52	13

RTA 00

PRAIRIE™



model 3481



model 3482

STANDARD FEATURES

- Featuring, gently barrel shaped arms that provide an attractive appearance.
- Fully upholstered. Tapered wood skirt and legs.
- Series includes lounge chair, two seat and three seat sofa.
- Check textile availability prior to specifying upholstery material.

OPTIONAL FEATURES

- Tapered wood legs are available in Absolute (AAM), Black (BKM), Cherry (ACM), Espresso Cafe (ECM), English Oak (EOM), Fruitwood (TFM), Gray (HGM), Honey (AHM), Mahogany (TMM), Maple (AVM), Medium Walnut (MWVM), Natural Walnut (NLW), Night (ASM), Noce Biondo (NBM), Noce Grigio (NGM), Noce Leggero (NEM), Noce Medio (NMM), Shaker Cherry (SKM), Walnut (TWM), WC Cream (WTM), White (WHM) and Winter Cherry (WCM). Please specify. Genuine maple faced veneers and solids are used.

STITCH DETAIL WHEN UPHOLSTERED IN ALL LEATHER - ILLUSTRATIONS BELOW

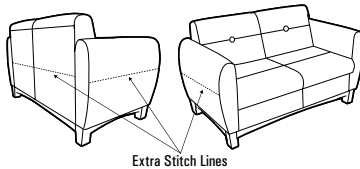

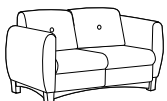
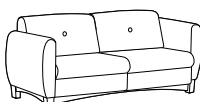
DESCRIPTION	FEATURES	MODEL#	STANDARD TEXTILE GRADES											
			1	2	3	4	5	6	7	8	9	10	11	12
 Lounge Chair COM Yardage: 4.25 Freight Class: 150 Product Weight (lbs.): 80 Cubic Feet Per Carton: 19.25		3481	2129	2313	2457	2671	2977	3085	3348	3855	4103	4570	5212	6008
			OVERALL DIMENSIONS			SEAT DIMENSIONS			BACK DIMENSIONS					
			W	D	H	W	D	H	W	H				
			32	29	30.5	21	19	16	21	14.5				
			RTA 00											
 Two Seat Sofa COM Yardage: 6.25 Freight Class: 250 Product Weight (lbs.): 106 Cubic Feet Per Carton: 41.25		3482	3021	3258	3443	3720	4119	4258	4602	5262	5576	6191	7022	8061
			OVERALL DIMENSIONS			SEAT DIMENSIONS			BACK DIMENSIONS					
			W	D	H	W	D	H	W	H				
			52.5	29	30.5	42	19	16	42	14.5				
			RTA 00											
 Three Seat Sofa COM Yardage: 9.5 Freight Class: 250 Product Weight (lbs.): 150 Cubic Feet Per Carton: 55.5		3483	3798	4127	4388	4780	5337	5599	6103	6907	7528	8216	9635	11148
			OVERALL DIMENSIONS			SEAT DIMENSIONS			BACK DIMENSIONS					
			W	D	H	W	D	H	W	H				
			73.5	29	30.5	63.5	19	16	63.5	14.5				
			RTA 00											

RIVER™



Sample Layout



Sample Layout

STANDARD FEATURES

- A modular seating series that is composed of modular linking units in straight, curved and corner units. Soft seating models are available with standard height, high and extended high backs. All linking units can be used together in any combination to create a wide variety of layouts.
- The unique tapered legs (swaged legs) are made of welded steel, heavy duty construction, with each leg bolted directly to the frame. The extremely robust construction insures trouble free performance in any environment. All units except for the Laptop Tables have the same leg height of 6.5". The leg height makes it easier to clean under the product.
- Each leg is standard with adjustable black nylon leveling glides and are non-marking. Wood legs and casters are not available.
- All cushions are fixed and non-removable (cushions will not migrate). Perimeter seams feature a decorative single stitch detail, which makes seams lay flat and adds extra seam strength.
- Seating frames are heavy duty with interlocking plywood, puzzle box construction, made for rugged active environments. Seats are high density with highly resilient foam and are equipped with a synthetic rubberized webbing suspension system for extra comfort.
- Front edge or face of the seat, angles slightly inward, so feet have freedom of movement and shoe heels don't rub on the seat. This inward slanting matches the inward angles of the back. Benches and connecting end tables also reflect the inward angles on the front and back faces, so all units coordinate in visual appearance.
- For use in high traffic applications as well as 24/7 environments or for models with 600 lb. standard weight capacity, clean out space between seat and back and /or modular arms, please see the River-series.
- Most units can be ganged together with a quick connect, disconnect feature. Ganging hardware is standard and is factory installed. Ganging hardware swivels out of sight when not in use.

OPTIONAL FEATURES

- Most tables and seating units can be specified with Power/USB terminals, which includes two power outlets, two double USB terminals and a black 60" three-prong power cord. Each Power/USB module is set in predetermined locations, as shown in the electrical illustrations below. Electrical units must be factory installed.
- To add a Power/USB module: From the electrical illustrations below, please specify **J1, W1, J2, W2, J3, W4, J4, W4, J6 or W6** after the product model number. Please note on seating units, if both right and left locations are required, add both **J1/J3 or W1/W3** to the model number. Add \$945 for each module/location required.
- Power/USB modules are available with either Jet Black (**J**) face plate with black Power/USB receptacles or with a White (**W**) face plate with white Power/USB receptacles.
- Tables are made with high pressure laminate and are offered in the following finishes: Absolute Acajou (**ACJ**), Asian Night (**ASN**), Avant Cherry (**AWC**), Avant Honey (**AWH**), Blizzard (**BZD**), Clear Maple (**CMB**), Custom Grey (**CGY**), Dark Espresso (**DES**), Designer White (**DWT**), Fashionista (**FAS**), First Class (**FCL**), Noce Biondo (**NBL**), Noce Grigio (**NGL**), Noce Leggero (**NEL**), Noce Medio (**NML**), Quartered Mahogany (**QTM**), Sheer Beauty (**SBY**), Stonedust (**SDT**), Walnut Heights (**WHE**), White Chocolate (**WHC**) and Winter Cherry (**WCR**). Please Specify. Custom High Pressure laminate finishes will be considered upon request.
- **Seating and Table Leg Finish**

(CHM) Chrome	(TBL) Black
(TDW) Designer White	(TFO) Fog
(TFR) Frost	(TIV) Cloud
(TLA) Latte	(TMO) Mocha
(TNE) Nevada	(TOA) Toast
(TSH) Shadow	(TSN) Sand
(TTU) Tungsten	(TKA) Kalua
- Check textile availability prior to specifying upholstery material. Leather not available on River series.
- If more than one fabric or a fabric/vinyl combination is required, please fill out a "Seating Multiple Textile" form, specifying each fabric location. Please contact Customer Care for more information.

ELECTRICAL PLACEMENT

Soft Seating

Locations available on left side J1 (black) or W1 (white), right side J3 (black), or W3 (white) or both sides J1/J3 (black) or W1/W3 (white).

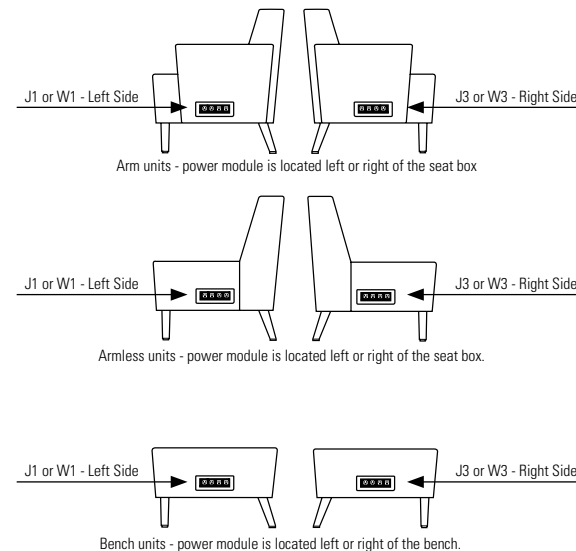

Coffee/End Tables

Primary location is on the top of the unit, centered J2 (black) or W2 (white). Secondary Location is end/side of the unit J1 (black) or W1 (white).

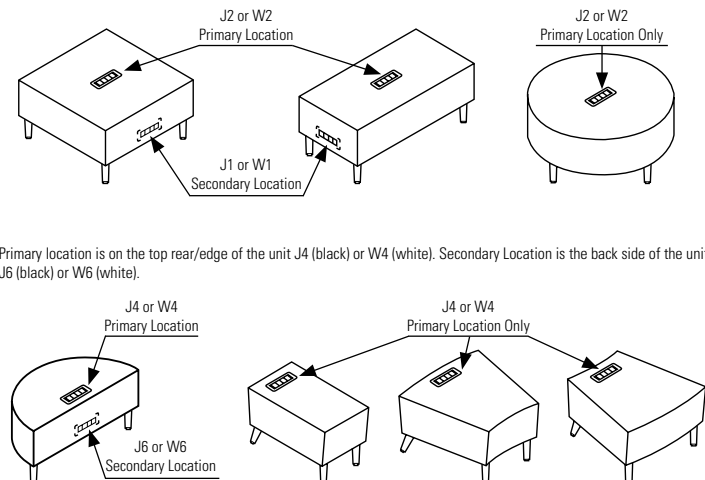

SAMPLE LAYOUTS

RVR101 (Layout 1)

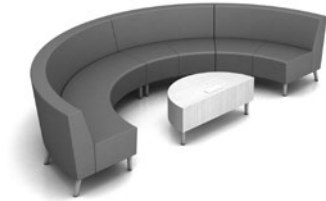

Qty	Model Number	Description	Dimensions	List Price
4	7710NA	Armless IS Curve - Two Seat - Standard Back	55 x 29.5 x 32	3258 x 4
1	7737W6	42" Half Round Laminate Coffee Table w/ W6 Rear Power/USB Module	42 x 21 x 17 upcharge	1384 945

SAMPLE LAYOUT TOTAL (Starting at Grade 1) \$15,361

RVR102 (Layout 2)



Qty	Model Number	Description	Dimensions	List Price
8	7714NA	Armless OS Curve - Two Seater - High Back	54 x 29.5 x 41.5	3885 x 8

SAMPLE LAYOUT TOTAL (Starting at Grade 1) \$31,080

RVR103 (Layout 3)

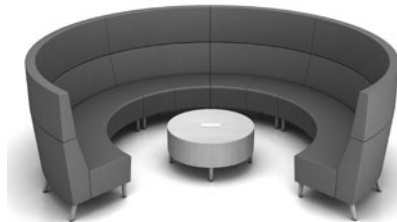

Qty	Model Number	Description	Dimensions	List Price
6	7712NA	Armless IS Curve - Two Seater - Extended Back	55 x 29.5 x 47	4553 x 6
1	7734W2	36" Dia - Round Laminate Coffee Table w/ W2 Center Power/USB Module	36 x 36 x 17 upcharge	1612 945

SAMPLE LAYOUT TOTAL (Starting at Grade 1) \$29,875

RVR104 (Layout 4)



Qty	Model Number	Description	Dimensions	List Price
2	7712NA	Armless IS Curve - Two Seater - Extended Back	55 x 29.5 x 47	4553 x 2
2	7712NAW3	Armless IS Curve - Two Seater - Extended Back w/ W3 Right Power/USB Module	55 x 29.5 x 47 upcharge	4553 x 2 825 x 2
2	7726	IS Curve - Two Seater Bench	54 x 28 x 17.5	2765 x 2
1	7734	36" Dia - Round Laminate Coffee Table	36 x 36 x 17	1612

SAMPLE LAYOUT TOTAL (Starting at Grade 1) \$27,244

RVR105 (Layout 5)



Qty	Model Number	Description	Dimensions	List Price
3	7711NA	Armless IS Curve - Two Seater - High Back	55 x 29.5 x 41.5	4137 x 3
3	7712NAW3	Armless IS Curve - Two Seater - Extended Back w/ W3 Right Power/USB Module	55 x 29.5 x 47 upcharge	4553 x 3 825 x 2
1	7738	Rectangular Laminate End Table	15 x 27.25 x 17	1309
2	7743	18" Dia. Round Laminate Laptop Table	18 x 18 x 25.25	792 x 2

SAMPLE LAYOUT TOTAL (Starting at Grade 1) \$30,853

SAMPLE LAYOUTS

RVR106 (Layout 6)



Qty	Model Number	Description	Dimensions	List Price
1	7709R	Three Seater - Extended Back w/Right Arm	75 x 29.5 x 47	6199
1	7709L	Three Seater - Extended Back w/Left Arm	75 x 29.5 x 47	6199
1	7718	Armless Corner Unit - Extended Back	38 x 38 x 47	5339
1	7732W2	36" Square Laminate Coffee Table w/ W2 Center Power/USB Module	36 x 36 x 17 upcharge	1477 945

SAMPLE LAYOUT TOTAL (Starting at Grade 1) \$20,159

RVR107 (Layout 7)



Qty	Model Number	Description	Dimensions	List Price
1	7704NA	Armless Two Seater - Standard. Back	75x 29.5 x 47	2820
2	7716	Armless Corner Unit - Standard. Back	75 x 29.5 x 47	3980 x 2
1	7725	Two Seater Bench	75x 29.5 x 47	2036
1	7728	Square Single Seater Bench	75 x 29.5 x 17.5	1392
1	7731	30" Square Laminate Coffee Table	75 x 30 x 47	1300

SAMPLE LAYOUT TOTAL (Starting at Grade 1) \$15,508

RVR108 (Layout 8)



Qty	Model Number	Description	Dimensions	List Price
2	7708NAW3	Armless Three Seater - High Back w/ W3 Right Power/USB Module	75 x 29.5 x 41.5 upcharge	5345 x 2 945 x 2
2	7708NAW1	Armless Three Seater - High Back w/ W1 Left Power/USB Module	72.5 x 29.5 x 41.5 upcharge	5345 x 2 945 x 2
2	7745	16" Square Laminate Laptop Table	16 x 16 x 25.25	810 x 2

SAMPLE LAYOUT TOTAL (Starting at Grade 1) \$26,780

RVR109 (Layout 9)



Qty	Model Number	Description	Dimensions	List Price
2	7702	Lounge Chair - High Back w/Arms	29.5 x 29.5 x 41.5	3016 x 2
1	7708NAW1	Armless Three Seater - High Back w/ W1 Left Power/USB Module	72.5 x 29.5 x 41.5 upcharge	5345 945
1	7708NAW3	Armless Three Seater - High Back w/ W3 Right Power/USB Module	72.5 x 29.5 x 41.5 upcharge	5345 945
1	7733	Rectangular Laminate Coffee Table	40 x 20 x 17	1306

SAMPLE LAYOUT TOTAL (Starting at Grade 1) \$19,918

RVR110 (Layout 10)



Qty	Model Number	Description	Dimensions	List Price
1	7705NAW3	Armless Two Seater - High Back w/ W3 Right Power/USB Module	48.5 x 29.5 x 41.5 upcharge	3456 945
1	7705NAW1	Armless Two Seater - High Back w/ W1 Left Power/USB Module	48.5 x 29.5 x 41.5 upcharge	3456 945
1	7708NA	Armless Three Seater - High Back	72.5 x 29.5 x 41.5	5345
1	7708NAW3	Armless Three Seater - High Back w/ W3 Right Power/USB Module	72.5 x 29.5 x 41.5 upcharge	5345 945
1	7708NAW1	Armless Three Seater - High Back w/ W1 Left Power/USB Module	72.5 x 29.5 x 41.5 upcharge	5345 945
2	7717	Armless Corner Unit - High Back	38 x 38 x 41.5	5041 x 2
3	7745	16" Square Laminate Laptop Table	16 x 16 x 25.25	810 x 3

SAMPLE LAYOUT TOTAL (Starting at Grade 1) \$39,239

DESCRIPTION	FEATURES	MODEL#	STANDARD TEXTILE GRADES		
RVR111 (Layout 11) 	Qty	Model Number	Description	Dimensions	List Price
	2	7701NA	Armless One Seater - Standard Back	24.5 x 29.5x 32	1807 x 2
	4	7710NA	Armless IS Curve - Two Seat - Standard Back	55 x 29.5 x 32	3258 x 4
	2	7743	18" Dia. Round Laminate Laptop Table	18 x 18 x 25.25	792 x 2
SAMPLE LAYOUT TOTAL (Starting at Grade 1)					\$18,230

RVR112 (Layout 12) 	Qty	Model Number	Description	Dimensions	List Price
	2	7711NA	Armless IS Curve - Two Seater - High Back	55 x 29.5 x 41.5	4137 x 2
	6	7712NA	Armless IS Curve - Two Seater - Extended Back	55 x 29.5 x 47	4553 x 6
	1	7709NA	Armless Three Seater - Extended Back	72.5 x 29.5 x 47	5786
	2	7734	36" Dia - Round Laminate Coffee Table	36 x 36 x 17	1612 x 2
SAMPLE LAYOUT TOTAL (Starting at Grade 1)					\$44,602

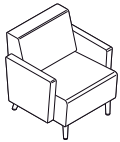

Lounge Chair - Standard Back w/Arms
 COM Yardage: 4
 Freight Class: 250
 Product Weight (lbs.): 57
 Cubic Feet Per Carton: 22.5

For Power/USB module please see electrical placement chart. No ganging hardware.

	1	2	3	4	5	6	7	8	9	10	11	12
7701	2631	2790	2916	3103	3368	3463	3695	4138	4351	4761	5321	6018

OVERALL DIMENSIONS			SEAT DIMENSIONS			BACK DIMENSIONS	
W	D	H	W	D	H	W	H
29.5	29.5	32	24	19	18	24	14

RTA 00

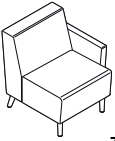

7701L (Left Arm)

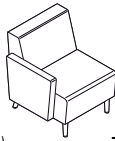

7701R (Right Arm)

Lounge Chair - Standard w/One Arm
 COM Yardage: 3.25
 Freight Class: 250
 Product Weight (lbs.): 47
 Cubic Feet Per Carton: 22.5

For Power/USB module please see electrical placement chart. Includes ganging hardware (1 side).

	1	2	3	4	5	6	7	8	9	10	11	12
7701L	2225	2357	2459	2612	2825	2905	3092	3453	3625	3960	4414	4981
7701R	2225	2357	2459	2612	2825	2905	3092	3453	3625	3960	4414	4981

OVERALL DIMENSIONS			SEAT DIMENSIONS			BACK DIMENSIONS	
W	D	H	W	D	H	W	H
27	29.5	32	24	19	18	24	14

RTA 00

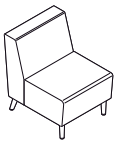

Armless Lounge Chair - Standard Back
 COM Yardage: 2.5
 Freight Class: 300
 Product Weight (lbs.): 37
 Cubic Feet Per Carton: 22.5

For Power/USB module please see electrical placement chart. Includes ganging hardware (2 sides).

	1	2	3	4	5	6	7	8	9	10	11	12
7701NA	1807	1910	1987	2104	2271	2331	2477	2751	2886	3142	3492	3928

OVERALL DIMENSIONS			SEAT DIMENSIONS			BACK DIMENSIONS	
W	D	H	W	D	H	W	H
24.5	29.5	32	24	19	18	24	14

RTA 00

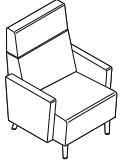
DESCRIPTION	FEATURES	MODEL#	STANDARD TEXTILE GRADES												
			1	2	3	4	5	6	7	8	9	10	11	12	
 <p>Lounge Chair - High Back w/Arms COM Yardage: 4.5 Freight Class: 250 Product Weight (lbs.): 61 Cubic Feet Per Carton: 28.25</p>	<p>For Power/USB module please see electrical placement chart. No ganging hardware.</p>	7702	3016	3196	3337	3548	3846	3955	4213	4712	4953	5416	6044	6827	
		OVERALL DIMENSIONS			SEAT DIMENSIONS			BACK DIMENSIONS							
		W	D	H	W	D	H	W	H						
			29.5	29.5	41.5	24	19	18	24	24					
			RTA 00												

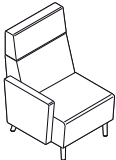
DESCRIPTION	FEATURES	MODEL#	STANDARD TEXTILE GRADES											
			1	2	3	4	5	6	7	8	9	10	11	12
  <p>7702L (Left Arm) 7702R (Right Arm)</p> <p>Lounge Chair - High Back w/One Arm COM Yardage: 4.5 Freight Class: 250 Product Weight (lbs.): 61 Cubic Feet Per Carton: 28.25</p>	<p>For Power/USB module please see electrical placement chart. Includes ganging hardware (1 side).</p>	7702L	2609	2761	2876	3054	3302	3390	3608	4023	4224	4609	5133	5787
		7702R	2609	2761	2876	3054	3302	3390	3608	4023	4224	4609	5133	5787
		OVERALL DIMENSIONS			SEAT DIMENSIONS			BACK DIMENSIONS						
			W	D	H	W	D	H	W	H				
			29.5	29.5	41.5	24	19	18	24	24				
			RTA 00											

DESCRIPTION	FEATURES	MODEL#	STANDARD TEXTILE GRADES												
			1	2	3	4	5	6	7	8	9	10	11	12	
 <p>Armless Lounge Chair - High Back COM Yardage: 3 Freight Class: 300 Product Weight (lbs.): 41 Cubic Feet Per Carton: 28.25</p>	<p>For Power/USB module please see electrical placement chart. Includes ganging hardware (2 sides).</p>	7702NA	2193	2316	2408	2548	2746	2818	2994	3326	3485	3794	4213	4737	
		OVERALL DIMENSIONS			SEAT DIMENSIONS			BACK DIMENSIONS							
		W	D	H	W	D	H	W	H						
			24.5	29.5	41.5	24	19	18	24	24					
			RTA 00												

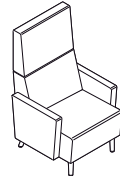
DESCRIPTION	FEATURES	MODEL#	STANDARD TEXTILE GRADES												
			1	2	3	4	5	6	7	8	9	10	11	12	
 <p>Lounge Chair - Extended Back w/Arms COM Yardage: 4.75 Freight Class: 250 Product Weight (lbs.): 68 Cubic Feet Per Carton: 32.75</p>	<p>For Power/USB module please see electrical placement chart. No ganging hardware.</p>	7703	3494	3681	3831	4054	4369	4483	4758	5284	5538	6026	6688	7516	
		OVERALL DIMENSIONS			SEAT DIMENSIONS			BACK DIMENSIONS							
		W	D	H	W	D	H	W	H						
			29.5	29.5	47	24	19	18	24	29					
			RTA 00												

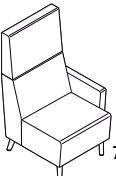
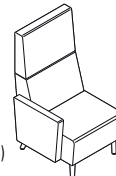
DESCRIPTION	FEATURES	MODEL#	STANDARD TEXTILE GRADES											
			1	2	3	4	5	6	7	8	9	10	11	12
  <p>7703L (Left Arm) 7703R (Right Arm)</p> <p>Lounge Chair - Extended Back w/One Arm COM Yardage: 4 Freight Class: 300 Product Weight (lbs.): 58 Cubic Feet Per Carton: 32.75</p>	<p>For Power/USB module please see electrical placement chart. Includes ganging hardware (1 side).</p>	7703L	3088	3247	3373	3560	3823	3919	4149	4594	4808	5218	5777	6475
		7703R	3088	3247	3373	3560	3823	3919	4149	4594	4808	5218	5777	6475
		OVERALL DIMENSIONS			SEAT DIMENSIONS			BACK DIMENSIONS						
			W	D	H	W	D	H	W	H				
			29.5	29.5	47	24	19	18	24	29				
			RTA 00											

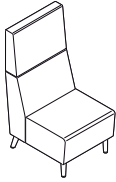
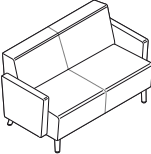
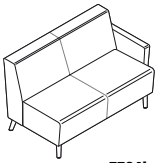
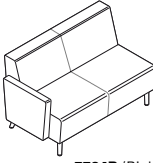
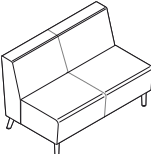
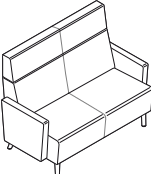
DESCRIPTION	FEATURES	MODEL#	STANDARD TEXTILE GRADES											
			1	2	3	4	5	6	7	8	9	10	11	12
 <p>Armless Lounge Chair - Extended Back COM Yardage: 3.25 Freight Class: 300 Product Weight (lbs.): 48 Cubic Feet Per Carton: 32.75</p>	For Power/USB module please see electrical placement chart. Includes ganging hardware (2 sides).	7703NA	2672	2802	2905	3058	3272	3350	3539	3899	4071	4406	4859	5425
			OVERALL DIMENSIONS			SEAT DIMENSIONS			BACK DIMENSIONS					
			W	D	H	W	D	H	W	H				
			24.5	29.5	47	24	19	18	24	29				
			RTA 00											
 <p>Two Seater - Standard Back w/Arms COM Yardage: 5.5 Freight Class: 250 Product Weight (lbs.): 95 Cubic Feet Per Carton: 39</p>	For Power/USB module please see electrical placement chart. No ganging hardware.	7704	3636	3854	4025	4281	4647	4778	5098	5709	5998	6564	7332	8290
			OVERALL DIMENSIONS			SEAT DIMENSIONS			BACK DIMENSIONS					
			W	D	H	W	D	H	W	H				
			53.5	29.5	32	48	19	18	48	14				
			RTA 00											
 <p>7704L (Left Arm)</p>  <p>7704R (Right Arm)</p> <p>Two Seater - Standard Back w/One Arm COM Yardage: 4.75 Freight Class: 300 Product Weight (lbs.): 85 Cubic Feet Per Carton: 39</p>	For Power/USB module please see electrical placement chart. Includes ganging hardware (1 side).	7704L 7704R	3235	3424	3574	3796	4112	4225	4501	5026	5280	5768	6432	7260
			OVERALL DIMENSIONS			SEAT DIMENSIONS			BACK DIMENSIONS					
			W	D	H	W	D	H	W	H				
			51	29.5	32	48	19	18	48	14				
			RTA 00											
 <p>Armless Two Seater - Standard Back COM Yardage: 4.25 Freight Class: 300 Product Weight (lbs.): 75 Cubic Feet Per Carton: 39</p>	For Power/USB module please see electrical placement chart. Includes ganging hardware (2 sides).	7704NA	2820	2991	3125	3324	3605	3705	3952	4422	4650	5086	5681	6421
			OVERALL DIMENSIONS			SEAT DIMENSIONS			BACK DIMENSIONS					
			W	D	H	W	D	H	W	H				
			48.5	29.5	32	48	19	18	48	14				
			RTA 00											
 <p>Two Seater - High Back w/Arms COM Yardage: 6.5 Freight Class: 300 Product Weight (lbs.): 97 Cubic Feet Per Carton: 54</p>	For Power/USB module please see electrical placement chart. No ganging hardware.	7705	4279	4538	4740	5046	5474	5629	6009	6728	7073	7742	8650	9781
			OVERALL DIMENSIONS			SEAT DIMENSIONS			BACK DIMENSIONS					
			W	D	H	W	D	H	W	H				
			53.5	29.5	41.5	48	19	18	48	24				
			RTA 00											

DESCRIPTION FEATURES MODEL# STANDARD TEXTILE GRADES



7705L (Left Arm)

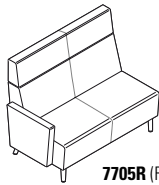

7705R (Right Arm)

Two Seater - High Back w/One Arm
 COM Yardage: 5.75
 Freight Class: 300
 Product Weight (lbs.): 87
 Cubic Feet Per Carton: 54

For Power/USB module please see electrical placement chart. Includes ganging hardware (1 side).

	1	2	3	4	5	6	7	8	9	10	11	12
7705L	3871	4098	4278	4546	4929	5065	5400	6036	6343	6933	7737	8740
7705R	3871	4098	4278	4546	4929	5065	5400	6036	6343	6933	7737	8740

OVERALL DIMENSIONS			SEAT DIMENSIONS			BACK DIMENSIONS	
W	D	H	W	D	H	W	H

51	29.5	41.5	48	19	18	48	24
----	------	------	----	----	----	----	----

RTA 00

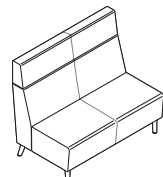

Armless Two Seater - High Back
 COM Yardage: 5.25
 Freight Class: 300
 Product Weight (lbs.): 77
 Cubic Feet Per Carton: 54

For Power/USB module please see electrical placement chart. Includes ganging hardware (2 sides).

	1	2	3	4	5	6	7	8	9	10	11	12
7705NA	3456	3664	3829	4076	4422	4549	4853	5434	5715	6253	6986	7902

OVERALL DIMENSIONS			SEAT DIMENSIONS			BACK DIMENSIONS	
W	D	H	W	D	H	W	H

48.5	29.5	41.5	48	19	18	48	24
------	------	------	----	----	----	----	----

RTA 00

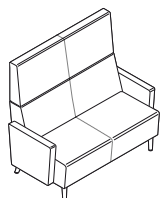

Two Seater - Extended Back w/Arms
 COM Yardage: 7
 Freight Class: 300
 Product Weight (lbs.): 107
 Cubic Feet Per Carton: 56.75

For Power/USB module please see electrical placement chart. No ganging hardware.

	1	2	3	4	5	6	7	8	9	10	11	12
7706	4516	4794	5012	5341	5805	5973	6376	7152	7525	8246	9222	10440

OVERALL DIMENSIONS			SEAT DIMENSIONS			BACK DIMENSIONS	
W	D	H	W	D	H	W	H

53.5	29.5	47	48	19	18	48	29
------	------	----	----	----	----	----	----

RTA 00

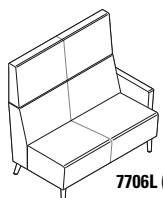

7706L (Left Arm)

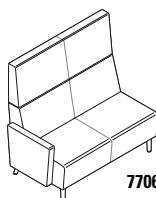

7706R (Right Arm)

Two Seater - Extended Back w/One Arm
 COM Yardage: 6.25
 Freight Class: 300
 Product Weight (lbs.): 97
 Cubic Feet Per Carton: 56.75

For Power/USB module please see electrical placement chart. Includes ganging hardware (1 side).

	1	2	3	4	5	6	7	8	9	10	11	12
7706L	4108	4356	4551	4843	5258	5404	5768	6462	6793	7438	8311	9398
7706R	4108	4356	4551	4843	5258	5404	5768	6462	6793	7438	8311	9398

OVERALL DIMENSIONS			SEAT DIMENSIONS			BACK DIMENSIONS	
W	D	H	W	D	H	W	H

51	29.5	47	48	19	18	48	29
----	------	----	----	----	----	----	----

RTA 00

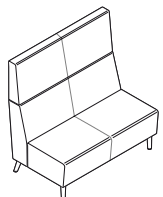

Armless Two Seater - Extended Back
 COM Yardage: 5.75
 Freight Class: 300
 Product Weight (lbs.): 87
 Cubic Feet Per Carton: 56.75



For Power/USB module please see electrical placement chart. Includes ganging hardware (2 sides).

	1	2	3	4	5	6	7	8	9	10	11	12
7706NA	3690	3918	4098	4367	4749	4885	5220	5856	6163	6753	7557	8560

OVERALL DIMENSIONS			SEAT DIMENSIONS			BACK DIMENSIONS	
W	D	H	W	D	H	W	H

48.5	29.5	47	48	19	18	48	29
------	------	----	----	----	----	----	----

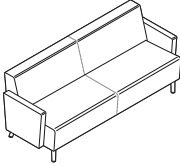
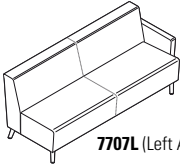
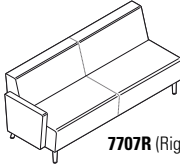
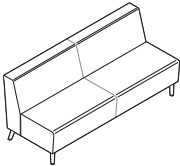
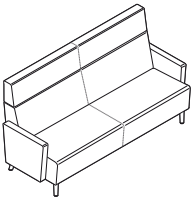
RTA 00

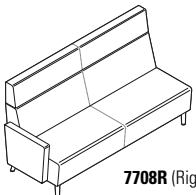
DESCRIPTION	FEATURES	MODEL#	STANDARD TEXTILE GRADES													
			1	2	3	4	5	6	7	8	9	10	11	12		
 <p>Three Seater - Standard Back w/Arms COM Yardage: 8.25 Freight Class: 250 Product Weight (lbs.): 139 Cubic Feet Per Carton: 55.5</p>	<p>For Power/USB module please see electrical placement chart. No ganging hardware.</p>	7707	5406	5729	5990	6375	6922	7117	7596	8511	8951	9800	10952	12388		
		OVERALL DIMENSIONS			SEAT DIMENSIONS			BACK DIMENSIONS								
		W	D	H	W	D	H	W	H							
		77.5	29.5	32	72	19	18	72	14							
			RTA 00													
 <p>7707L (Left Arm)</p>  <p>7707R (Right Arm)</p> <p>Three Seater - Standard Back w/One Arm COM Yardage: 7.75 Freight Class: 250 Product Weight (lbs.): 129 Cubic Feet Per Carton: 55.5</p>	<p>For Power/USB module please see electrical placement chart. Includes ganging hardware (1 side).</p>	7707L	5001	5306	5548	5911	6424	6611	7059	7916	8330	9127	10209	11559		
		7707R	5001	5306	5548	5911	6424	6611	7059	7916	8330	9127	10209	11559		
		OVERALL DIMENSIONS			SEAT DIMENSIONS			BACK DIMENSIONS								
		W	D	H	W	D	H	W	H							
75	29.5	32	72	19	18	72	14									
			RTA 00													
 <p>Armless Three Seater - Standard Back COM Yardage: 7 Freight Class: 250 Product Weight (lbs.): 119 Cubic Feet Per Carton: 55.5</p>	<p>For Power/USB module please see electrical placement chart. Includes ganging hardware (2 sides).</p>	7707NA	4584	4863	5080	5410	5874	6040	6445	7221	7594	8314	9291	10512		
		OVERALL DIMENSIONS			SEAT DIMENSIONS			BACK DIMENSIONS								
		W	D	H	W	D	H	W	H							
		72.5	29.5	32	72	19	18	72	14							
			RTA 00													
 <p>Three Seater - High Back w/Arms COM Yardage: 10.5 Freight Class: 250 Product Weight (lbs.): 148 Cubic Feet Per Carton: 69.75</p>	<p>For Power/USB module please see electrical placement chart. No ganging hardware.</p>	7708	6162	6575	6902	7395	8089	8341	8948	10112	10673	11750	13219	15047		
		OVERALL DIMENSIONS			SEAT DIMENSIONS			BACK DIMENSIONS								
		W	D	H	W	D	H	W	H							
		77.5	29.5	41.5	72	19	18	72	24							
			RTA 00													
 <p>7708L (Left Arm)</p>  <p>7708R (Right Arm)</p> <p>Three Seater - High Back w/One Arm COM Yardage: 9.75 Freight Class: 300 Product Weight (lbs.): 139 Cubic Feet Per Carton: 69.75</p>	<p>For Power/USB module please see electrical placement chart. Includes ganging hardware (1 side).</p>	7708L	5761	6146	6451	6905	7551	7785	8349	9429	9949	10951	12314	14013		
		7708R	5761	6146	6451	6905	7551	7785	8349	9429	9949	10951	12314	14013		
		OVERALL DIMENSIONS			SEAT DIMENSIONS			BACK DIMENSIONS								
		W	D	H	W	D	H	W	H							
75	29.5	41.5	72	19	18	72	24									
			RTA 00													

DESCRIPTION FEATURES MODEL# STANDARD TEXTILE GRADES

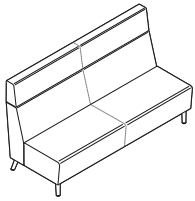

Armless Three Seater - High Back
 COM Yardage: 9.25
 Freight Class: 300
 Product Weight (lbs.): 126
 Cubic Feet Per Carton: 69.75

For Power/USB module please see electrical placement chart. Includes ganging hardware (2 sides).

MODEL#	1	2	3	4	5	6	7	8	9	10	11	12
7708NA	5345	5712	5999	6433	7046	7268	7801	8828	9322	10271	11563	13175

OVERALL DIMENSIONS			SEAT DIMENSIONS			BACK DIMENSIONS	
W	D	H	W	D	H	W	H
72.5	29.5	41.5	72	19	18	72	24

RTA 00

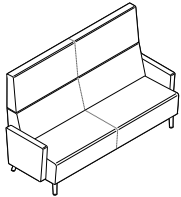

Three Seater - Extended Back w/Arms
 COM Yardage: 11
 Freight Class: 300
 Product Weight (lbs.): 144
 Cubic Feet Per Carton: 78.75

For Power/USB module please see electrical placement chart. No ganging hardware.

MODEL#	1	2	3	4	5	6	7	8	9	10	11	12
7709	6610	7044	7386	7902	8632	8893	9532	10749	11335	12467	14004	15919

OVERALL DIMENSIONS			SEAT DIMENSIONS			BACK DIMENSIONS	
W	D	H	W	D	H	W	H
77.5	29.5	47	72	19	18	72	29

RTA 00



7709L (Left Arm)

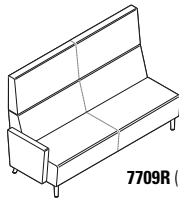

7709R (Right Arm)

Three Seater - Extended Back w/One Arm
 COM Yardage: 10.5
 Freight Class: 300
 Product Weight (lbs.): 134
 Cubic Feet Per Carton: 78.75

For Power/USB module please see electrical placement chart. Includes ganging hardware (1 side).

MODEL#	1	2	3	4	5	6	7	8	9	10	11	12
7709L	6199	6613	6939	7432	8128	8378	8988	10149	10707	11787	13254	15082
7709R	6199	6613	6939	7432	8128	8378	8988	10149	10707	11787	13254	15082

OVERALL DIMENSIONS			SEAT DIMENSIONS			BACK DIMENSIONS	
W	D	H	W	D	H	W	H
75	29.5	47	72	19	18	72	29

RTA 00

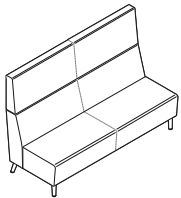

Armless Three Seater - Extended Back
 COM Yardage: 9.75
 Freight Class: 300
 Product Weight (lbs.): 124
 Cubic Feet Per Carton: 78.75

For Power/USB module please see electrical placement chart. Includes ganging hardware (2 sides).

MODEL#	1	2	3	4	5	6	7	8	9	10	11	12
7709NA	5786	6171	6476	6930	7576	7810	8373	9454	9974	10976	12340	14038

OVERALL DIMENSIONS			SEAT DIMENSIONS			BACK DIMENSIONS	
W	D	H	W	D	H	W	H
72.5	29.5	47	72	19	18	72	29

RTA 00

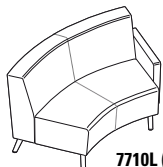

7710L (Left Arm)

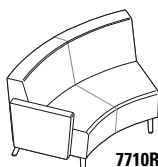

7710R (Right Arm)

IS Curve - Two Seater - Standard Back w/One Arm
 COM Yardage: 5.25
 Freight Class: 250
 Product Weight (lbs.): 88
 Cubic Feet Per Carton: 43

For Power/USB module please see electrical placement chart. Includes ganging hardware (1 side).

MODEL#	1	2	3	4	5	6	7	8	9	10	11	12
7710L	3676	3888	4049	4296	4644	4769	5074	5654	5936	6473	7206	8122
7710R	3676	3888	4049	4296	4644	4769	5074	5654	5936	6473	7206	8122

OVERALL DIMENSIONS			SEAT DIMENSIONS			BACK DIMENSIONS	
W	D	H	W	D	H	W	H
57	29.5	32	42	19	18	51	14

RTA 00

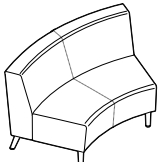
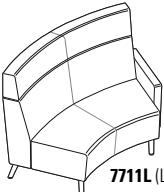
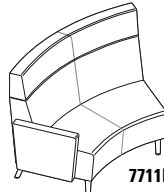
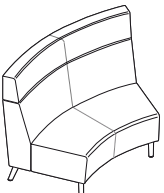
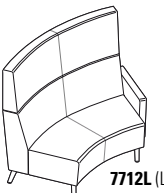
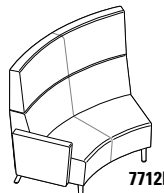
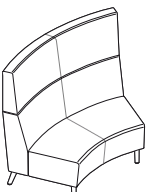
DESCRIPTION	FEATURES	MODEL#	STANDARD TEXTILE GRADES													
			1	2	3	4	5	6	7	8	9	10	11	12		
 <p>Armless IS Curve - Two Seat - Standard Back COM Yardage: 4.5 Freight Class: 300 Product Weight (lbs.): 78 Cubic Feet Per Carton: 43</p>	<p>For Power/USB module please see electrical placement chart. Includes ganging hardware (2 sides).</p>	7710NA	3258	3437	3576	3789	4088	4195	4455	4954	5194	5656	6286	7068		
		OVERALL DIMENSIONS			SEAT DIMENSIONS			BACK DIMENSIONS								
		W	D	H	W	D	H	W	H							
		55	29.5	32	42	19	18	51	14							
			RTA 00													
 <p>7711L (Left Arm)</p>  <p>7711R (Right Arm)</p> <p>IS Curve - Two Seater - High Back w/One Arm COM Yardage: 6.5 Freight Class: 300 Product Weight (lbs.): 94 Cubic Feet Per Carton: 54</p>	<p>For Power/USB module please see electrical placement chart. Includes ganging hardware (1 side).</p>	7711L	4553	4811	5014	5318	5748	5902	6279	7000	7346	8015	8921	10055		
		7711R	4553	4811	5014	5318	5748	5902	6279	7000	7346	8015	8921	10055		
		OVERALL DIMENSIONS			SEAT DIMENSIONS			BACK DIMENSIONS								
		W	D	H	W	D	H	W	H							
			RTA 00													
 <p>Armless IS Curve - Two Seater - High Back COM Yardage: 6 Freight Class: 300 Product Weight (lbs.): 84 Cubic Feet Per Carton: 54</p>	<p>For Power/USB module please see electrical placement chart. Includes ganging hardware (2 sides).</p>	7711NA	4137	4376	4565	4845	5241	5386	5734	6400	6718	7334	8172	9218		
		OVERALL DIMENSIONS			SEAT DIMENSIONS			BACK DIMENSIONS								
		W	D	H	W	D	H	W	H							
		55	29.5	41.5	42	19	18	51	24							
			RTA 00													
 <p>7712L (Left Arm)</p>  <p>7712R (Right Arm)</p> <p>IS Curve - Two Seater - Extended Back w/One Arm COM Yardage: 7 Freight Class: 300 Product Weight (lbs.): 99 Cubic Feet Per Carton: 62.75</p>	<p>For Power/USB module please see electrical placement chart. Includes ganging hardware (1 side).</p>	7712L	4967	5244	5462	5790	6255	6421	6826	7603	7975	8696	9673	10891		
		7712R	4967	5244	5462	5790	6255	6421	6826	7603	7975	8696	9673	10891		
		OVERALL DIMENSIONS			SEAT DIMENSIONS			BACK DIMENSIONS								
		W	D	H	W	D	H	W	H							
			RTA 00													
 <p>Armless IS Curve - Two Seater - Extended Back COM Yardage: 6.75 Freight Class: 29.5 Product Weight (lbs.): 89 Cubic Feet Per Carton: 6.75</p>	<p>For Power/USB module please see electrical placement chart. Includes ganging hardware (2 sides).</p>	7712NA	4553	4819	5030	5346	5793	5954	6346	7095	7455	8150	9091	10266		
		OVERALL DIMENSIONS			SEAT DIMENSIONS			BACK DIMENSIONS								
		W	D	H	W	D	H	W	H							
		55	29.5	47	42	19	18	51	29							
			RTA 00													

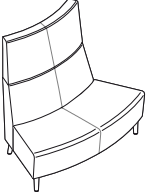
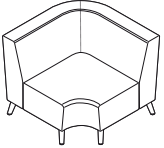
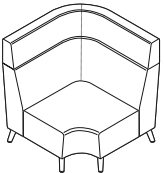
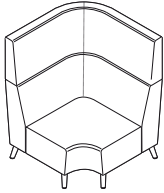
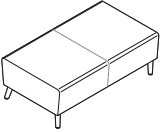
DESCRIPTION	FEATURES	MODEL#	STANDARD TEXTILE GRADES											
			1	2	3	4	5	6	7	8	9	10	11	12
 <p>Armless OS Curve - Two Seater - Ext. High Back COM Yardage: 6.75 Freight Class: 300 Product Weight (lbs.): 83 Cubic Feet Per Carton: 62.75</p>	<p>For Power/USB module please see electrical placement chart. Includes ganging hardware (2 sides).</p>	<p>7715NA</p>	4271	4537	4750	5064	5511	5672	6064	6814	7173	7868	8809	9986
			OVERALL DIMENSIONS			SEAT DIMENSIONS			BACK DIMENSIONS					
			W	D	H	W	D	H	W	H				
			54	29.5	47	48	19	18	36	28				
			RTA 00											
 <p>Armless Corner Unit - Standard Back COM Yardage: 5.5 Freight Class: 300 Product Weight (lbs.): 75 Cubic Feet Per Carton: 49</p>	<p>For Power/USB module please see electrical placement chart. Includes ganging hardware (2 sides).</p>	<p>7716</p>	3980	4199	4373	4627	4995	5124	5443	6054	6345	6912	7681	8637
			OVERALL DIMENSIONS			SEAT DIMENSIONS			BACK DIMENSIONS					
			W	D	H	W	D	H	W	H				
			38	38	32	24	19	18	24	14				
			RTA 00											
 <p>Armless Corner Unit - High Back COM Yardage: 7.75 Freight Class: 300 Product Weight (lbs.): 82 Cubic Feet Per Carton: 49</p>	<p>For Power/USB module please see electrical placement chart. Includes ganging hardware (2 sides).</p>	<p>7717</p>	5041	5346	5588	5952	6467	6651	7099	7959	8371	9168	10250	11599
			OVERALL DIMENSIONS			SEAT DIMENSIONS			BACK DIMENSIONS					
			W	D	H	W	D	H	W	H				
			38	38	41.5	24	19	18	24	24				
			RTA 00											
 <p>Armless Corner Unit - Extended Back COM Yardage: 8.5 Freight Class: 300 Product Weight (lbs.): 88 Cubic Feet Per Carton: 49</p>	<p>For Power/USB module please see electrical placement chart. Includes ganging hardware (2 sides).</p>	<p>7718</p>	5339	5674	5939	6337	6900	7103	7596	8537	8991	9865	11052	12532
			OVERALL DIMENSIONS			SEAT DIMENSIONS			BACK DIMENSIONS					
			W	D	H	W	D	H	W	H				
			38	38	47	24	19	18	24	29				
			RTA 00											
 <p>Two Seater Bench COM Yardage: 2.25 Freight Class: 300 Product Weight (lbs.): 41 Cubic Feet Per Carton: 21.25</p>	<p>For Power/USB module please see electrical placement chart. Includes ganging hardware (2 sides).</p>	<p>7725</p>	2036	2129	2200	2303	2453	2508	2638	2888	3006	3239	3553	3944
			OVERALL DIMENSIONS			SEAT DIMENSIONS			BACK DIMENSIONS					
			W	D	H	W	D	H	W	H				
			48.5	28	17.5									
			RTA 00											

DESCRIPTION FEATURES MODEL# STANDARD TEXTILE GRADES

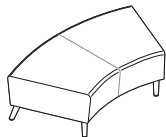

IS Curve - Two Seater Bench
COM Yardage: 3
Freight Class: 300
Product Weight (lbs.): 41
Cubic Feet Per Carton: 21.25

For Power/USB module please see electrical placement chart. Includes ganging hardware (2 sides).

MODEL#	1	2	3	4	5	6	7	8	9	10	11	12
7726	2765	2888	2981	3120	3318	3391	3566	3898	4057	4366	4785	5309

OVERALL DIMENSIONS			SEAT DIMENSIONS			BACK DIMENSIONS	
W	D	H	W	D	H	W	H

54 28 17.5

RTA 00

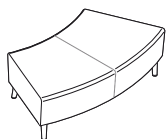

OS Curve - Two Seater Bench
COM Yardage: 3
Freight Class: 300
Product Weight (lbs.): 41
Cubic Feet Per Carton: 21.25

For Power/USB module please see electrical placement chart. Includes ganging hardware (2 sides).

MODEL#	1	2	3	4	5	6	7	8	9	10	11	12
7727	2765	2888	2981	3120	3318	3391	3566	3898	4057	4366	4785	5309

OVERALL DIMENSIONS			SEAT DIMENSIONS			BACK DIMENSIONS	
W	D	H	W	D	H	W	H

54 28 17.5

RTA 00

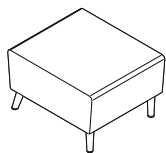

Square Single Seater Bench
COM Yardage: 1.75
Freight Class: 250
Product Weight (lbs.): 30
Cubic Feet Per Carton: 9.25

For Power/USB module please see electrical placement chart. Includes ganging hardware (2 sides).

MODEL#	1	2	3	4	5	6	7	8	9	10	11	12
7728	1392	1464	1518	1600	1715	1759	1859	2055	2147	2326	2572	2875

OVERALL DIMENSIONS			SEAT DIMENSIONS			BACK DIMENSIONS	
W	D	H	W	D	H	W	H

24.5 28 17.5

RTA 00

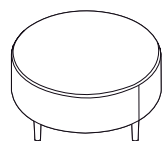

36" Dia. - Round Bench
COM Yardage: 3
Freight Class: 250
Product Weight (lbs.): 46
Cubic Feet Per Carton: 18.25

No Power/USB module. No ganging hardware.

MODEL#	1	2	3	4	5	6	7	8	9	10	11	12
7729	2043	2166	2259	2400	2599	2672	2845	3176	3336	3644	4063	4587

OVERALL DIMENSIONS			SEAT DIMENSIONS			BACK DIMENSIONS	
W	D	H	W	D	H	W	H

36 36 17.5

RTA 00

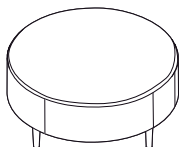

42" Dia. - Round Bench
COM Yardage: 3.25
Freight Class: 250
Product Weight (lbs.): 50
Cubic Feet Per Carton: 22

No Power/USB module. No ganging hardware.

MODEL#	1	2	3	4	5	6	7	8	9	10	11	12
7730	2351	2480	2583	2737	2949	3026	3215	3578	3750	4083	4536	5103

OVERALL DIMENSIONS			SEAT DIMENSIONS			BACK DIMENSIONS	
W	D	H	W	D	H	W	H

42 42 17.5

RTA 00

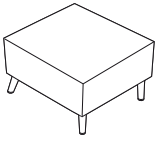
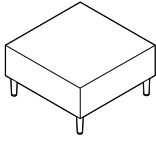
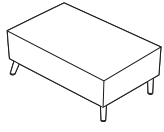
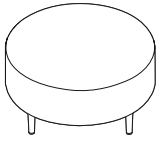
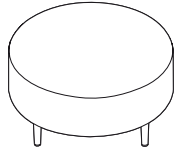
DESCRIPTION	FEATURES	MODEL#	STANDARD TEXTILE GRADES													
			1	2	3	4	5	6	7	8	9	10	11	12		
 <p>30" Square Laminate Coffee Table COM Yardage: N/A Freight Class: 150 Product Weight (lbs.): 61 Cubic Feet Per Carton: 11.5</p>	<p>For Power/USB module please see electrical placement chart. No ganging hardware.</p>	7731	1300													
			OVERALL DIMENSIONS			SEAT DIMENSIONS			BACK DIMENSIONS							
			W	D	H	W	D	H	W	H						
			30	30	17											
			RTA 00													
 <p>36" Square Laminate Coffee Table COM Yardage: N/A Freight Class: 150 Product Weight (lbs.): 85 Cubic Feet Per Carton: 16.5</p>	<p>For Power/USB module please see electrical placement chart. No ganging hardware.</p>	7732	1477													
			OVERALL DIMENSIONS			SEAT DIMENSIONS			BACK DIMENSIONS							
			W	D	H	W	D	H	W	H						
			36	36	17											
			RTA 00													
 <p>Rectangular Laminate Coffee Table COM Yardage: N/A Freight Class: 150 Product Weight (lbs.): 55 Cubic Feet Per Carton: 11.5</p>	<p>For Power/USB module please see electrical placement chart. No ganging hardware.</p>	7733	1306													
			OVERALL DIMENSIONS			SEAT DIMENSIONS			BACK DIMENSIONS							
			W	D	H	W	D	H	W	H						
			40	20	17											
			RTA 00													
 <p>36" Dia. - Round Laminate Coffee Table COM Yardage: N/A Freight Class: 250 Product Weight (lbs.): 63 Cubic Feet Per Carton: 16.5</p>	<p>For Power/USB module please see electrical placement chart. No ganging hardware.</p>	7734	1612													
			OVERALL DIMENSIONS			SEAT DIMENSIONS			BACK DIMENSIONS							
			W	D	H	W	D	H	W	H						
			36	36	17											
			RTA 00													
 <p>42" Dia. - Round Laminate Coffee Table COM Yardage: N/A Freight Class: 250 Product Weight (lbs.): 85 Cubic Feet Per Carton: 22</p>	<p>For Power/USB module please see electrical placement chart. No ganging hardware.</p>	7735	1762													
			OVERALL DIMENSIONS			SEAT DIMENSIONS			BACK DIMENSIONS							
			W	D	H	W	D	H	W	H						
			42	42	17											
			RTA 00													

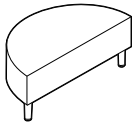
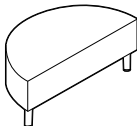
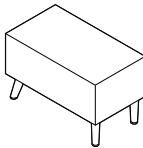
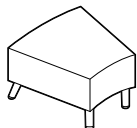
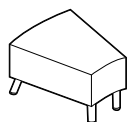
DESCRIPTION	FEATURES	MODEL#	STANDARD TEXTILE GRADES											
			1	2	3	4	5	6	7	8	9	10	11	12
 <p>36" Half Round Laminate Coffee Table COM Yardage: N/A Freight Class: 150 Product Weight (lbs.): 37 Cubic Feet Per Carton: 8.5</p>	<p>For Power/USB module please see electrical placement chart. No ganging hardware.</p>	7736	1143											
			OVERALL DIMENSIONS W D H			SEAT DIMENSIONS W D H			BACK DIMENSIONS W H					
			36 18 17											
			<div style="border: 1px solid black; padding: 2px;">RTA 00</div>											
 <p>42" Half Round Laminate Coffee Table COM Yardage: N/A Freight Class: 150 Product Weight (lbs.): 48 Cubic Feet Per Carton: 11.5</p>	<p>For Power/USB module please see electrical placement chart. No ganging hardware.</p>	7737	1384											
			OVERALL DIMENSIONS W D H			SEAT DIMENSIONS W D H			BACK DIMENSIONS W H					
			42 21 17											
			<div style="border: 1px solid black; padding: 2px;">RTA 00</div>											
 <p>Rectangular Laminate End Table COM Yardage: N/A Freight Class: 125 Product Weight (lbs.): 34 Cubic Feet Per Carton: 5.5</p>	<p>For Power/USB module please see electrical placement chart. Includes ganging hardware (2 sides).</p>	7738	1309											
			OVERALL DIMENSIONS W D H			SEAT DIMENSIONS W D H			BACK DIMENSIONS W H					
			15 27.25 17											
			<div style="border: 1px solid black; padding: 2px;">RTA 00</div>											
 <p>IS Curve Wide Wedge Laminate End Table COM Yardage: N/A Freight Class: 150 Product Weight (lbs.): 50 Cubic Feet Per Carton: 9.5</p>	<p>For Power/USB module please see electrical placement chart. Includes ganging hardware (2 sides).</p>	7739	1728											
			OVERALL DIMENSIONS W D H			SEAT DIMENSIONS W D H			BACK DIMENSIONS W H					
			27.25 27.25 17											
			<div style="border: 1px solid black; padding: 2px;">RTA 00</div>											
 <p>IS Curve Narrow Wedge Laminate End Table COM Yardage: N/A Freight Class: 150 Product Weight (lbs.): 34 Cubic Feet Per Carton: 6.5</p>	<p>For Power/USB module please see electrical placement chart. Includes ganging hardware (2 sides).</p>	7740	1400											
			OVERALL DIMENSIONS W D H			SEAT DIMENSIONS W D H			BACK DIMENSIONS W H					
			18.25 27.25 17											
			<div style="border: 1px solid black; padding: 2px;">RTA 00</div>											

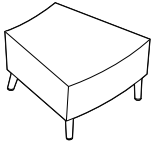
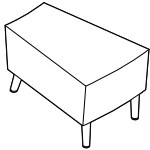
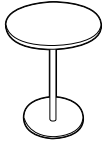
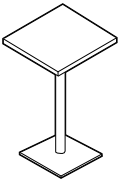
DESCRIPTION	FEATURES	MODEL#	STANDARD TEXTILE GRADES											
			1	2	3	4	5	6	7	8	9	10	11	12
 <p>OS Curve - Wide Wedge Laminate End Table COM Yardage: N/A Freight Class: 150 Product Weight (lbs.): 50 Cubic Feet Per Carton: 9.5</p>	For Power/USB module please see electrical placement chart. Includes ganging hardware (2 sides).	7741 1728	OVERALL DIMENSIONS			SEAT DIMENSIONS			BACK DIMENSIONS					
			W	D	H	W	D	H	W	H				
			27.25	27.25	17									
			RTA 00											
 <p>OS Curve - Narrow Wedge Laminate End Table COM Yardage: N/A Freight Class: 150 Product Weight (lbs.): 34 Cubic Feet Per Carton: 6.5</p>	For Power/USB module please see electrical placement chart. Includes ganging hardware (2 sides).	7742 1400	OVERALL DIMENSIONS			SEAT DIMENSIONS			BACK DIMENSIONS					
			W	D	H	W	D	H	W	H				
			18.25	27.25	17									
			RTA 00											
 <p>18" Dia. Round Laminate Laptop Table COM Yardage: N/A Freight Class: 150 Product Weight (lbs.): 32 Cubic Feet Per Carton: 6</p>	No Power/USB module. No ganging hardware.	7743 792	OVERALL DIMENSIONS			SEAT DIMENSIONS			BACK DIMENSIONS					
			W	D	H	W	D	H	W	H				
			18	18	25.25									
			RTA 00											
 <p>16" Square Laminate Laptop Table COM Yardage: N/A Freight Class: 125 Product Weight (lbs.): 36 Cubic Feet Per Carton: 6</p>	No Power/USB module. No ganging hardware.	7745 810	OVERALL DIMENSIONS			SEAT DIMENSIONS			BACK DIMENSIONS					
			W	D	H	W	D	H	W	H				
			16	16	25.25									
			RTA 00											

RIVER™ PERSONAL HARBOR



Sample Layout

ELECTRICAL PLACEMENT

Locations available on left side J1 (black) or W1 (white), right side J3 (black) or W3 (white) or both sides J1/J3 (black) or W1/W3 (white).

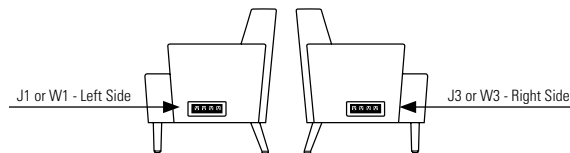

Personal Harbor - power module is located left or right of the seat box

DESCRIPTION

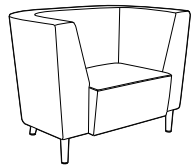

Personal Harbor - Standard Back

COM Yardage: 5.5
Freight Class: 150
Product Weight (lbs.): 50
Cubic Feet Per Carton: 9.5

For Power/USB module please see electrical placement chart. Freestanding unit only.

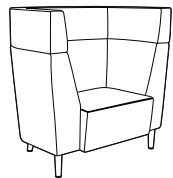

Personal Harbor - High Back

COM Yardage: 7.09
Freight Class: 150
Product Weight (lbs.): 86
Cubic Feet Per Carton: 9.5

For Power/USB module please see electrical placement chart. Freestanding unit only.

RIVER™ PERSONAL HARBOR

STANDARD FEATURES

- River Personal Harbor is a line extension of the popular River modular seating series. For modular series see River price book pages.
- The freestanding soft seating models are available with standard height, high and extended high backs.
- The unique tapered legs (swaged legs) are made of welded steel, heavy duty construction, with each leg bolted directly to the frame. The extremely robust construction insures trouble free performance in any environment. All units have the same leg height of 6.5". The leg height makes it easier to clean under the product.
- Each leg is standard with adjustable black nylon leveling glides and are non-marking. Wood legs and casters are not available.
- All cushions are fixed and non-removable (cushions will not migrate). Perimeter seams feature a decorative single stitch detail, which makes seams lay flat and adds extra seam strength.
- Seating frames are heavy duty with interlocking plywood, puzzle box construction, made for rugged active environments. Seats are high density with highly resilient foam and are equipped with a synthetic rubberized webbing suspension system for extra comfort.
- Front edge or face of the seat, angles slightly inward, so feet have freedom of movement and shoe heels don't rub on the seat. This inward slanting matches the inward angles of the back. Benches and connecting end tables also reflect the inward angles on the front and back faces, so all units coordinate in visual appearance.
- High Traffic (**HT**) units are rated at 350 lbs. active load per seat and 24/7 use. These units have the same puzzle box frame construction except that the framing wood is 1" thick, rotary cut, birch plywood and all arms, seat and back cushions are made with Ultracell Foam.
- High Traffic (**HT**) models are recommend to be specified in textiles that meet or exceed 100,000 double rubs for added abrasion performance.

- Check textile availability prior to specifying upholstery material. Leather not available on River Personal Harbor.

OPTIONAL FEATURES

- Seating units can be specified with Power/USB terminals, which includes two power outlets, two double USB terminals and a black 60" three-prong power cord. Each Power/USB module is set in predetermined locations, as shown in the electrical illustrations below. Electrical units must be factory installed.
- To add a Power/USB module: From the electrical illustrations below, please specify **J1, W1, J2, W2, J3, W4, J4, W4, J6** or **W6** after the product model number. Please note on seating units, if both right and left locations are required, add both **J1/J3** or **W1/W3** to the model number. Add \$945 for each module/location required.
- Power/USB modules are available with either Jet Black (**J**) face plate with black Power/USB receptacles or with a White (**W**) face plate with white Power/USB receptacles.
- Leg finish**
(**CHM**) Chrome (TBL) Black
(**TDW**) Designer White (TFO) Fog
(**TFR**) Frost (TIV) Cloud
(**TKA**) Kalua (TLA) Latte
(**TMO**) Mocha (TNE) Nevada
(**TOA**) Toast (TSH) Shadow
(**TSN**) Sand (TTU) Tungsten
- If more than one fabric or a fabric/vinyl combination is required, please fill out a "Seating Multiple Textile" form, specifying each fabric location. Please contact Customer Care for more information.

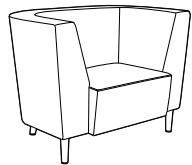
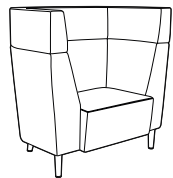
DESCRIPTION	FEATURES	MODEL#	STANDARD TEXTILE GRADES											
			1	2	3	4	5	6	7	8	9	10	11	12
 Personal Harbor - Standard Back COM Yardage: 5.5 Freight Class: 150 Product Weight (lbs.): 50 Cubic Feet Per Carton: 9.5	For Power/USB module please see electrical placement chart. Freestanding unit only.	7746 RTA 00	\$3866	\$4092	\$4271	\$4541	\$4922	\$5103	\$5448	\$5998	\$6423	\$6895	\$7867	\$8904
			OVERALL DIMENSIONS			SEAT DIMENSIONS			BACK DIMENSIONS					
			W	D	H	W	D	H	W	H				
			45	29.5	32	24	19	18	27	14				
 Personal Harbor - High Back COM Yardage: 7.09 Freight Class: 150 Product Weight (lbs.): 86 Cubic Feet Per Carton: 9.5	For Power/USB module please see electrical placement chart. Freestanding unit only.	7747 RTA 00	\$5435	\$5753	\$6005	\$6384	\$6922	\$7174	\$7660	\$8438	\$9036	\$9700	\$11072	\$12532
			OVERALL DIMENSIONS			SEAT DIMENSIONS			BACK DIMENSIONS					
			W	D	H	W	D	H	W	H				
			45	29.5	41.5	24	19	18	27	24				

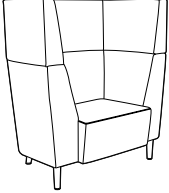
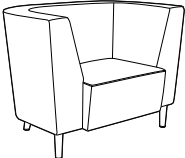
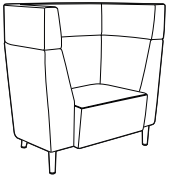
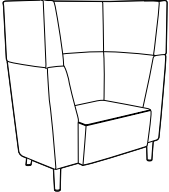
DESCRIPTION	FEATURES	MODEL#	STANDARD TEXTILE GRADES											
			1	2	3	4	5	6	7	8	9	10	11	12
 <p>Personal Harbor - Extended Back COM Yardage: 8.5 Freight Class: 150 Product Weight (lbs.): 102 Cubic Feet Per Carton: 9.5</p>	<p>For Power/USB module please see electrical placement chart. Freestanding unit only.</p>	7748	\$6114	\$6462	\$6739	\$7157	\$7744	\$8022	\$8556	\$9407	\$10064	\$10794	\$12295	\$13896
		OVERALL DIMENSIONS			SEAT DIMENSIONS			BACK DIMENSIONS						
		W	D	H	W	D	H	W	H					
		45	29.5	47	24	19	18	27	29					
			RTA 00											
 <p>Personal Harbor - Standard Back COM Yardage: 5.5 Freight Class: 150 Product Weight (lbs.): 50 Cubic Feet Per Carton: 9.5</p>	<p>High Traffic model For Power/USB module please see electrical placement chart. Freestanding unit only.</p>	7786	\$4416	\$4643	\$4821	\$5091	\$5472	\$5653	\$5999	\$6551	\$6976	\$7447	\$8420	\$9457
		OVERALL DIMENSIONS			SEAT DIMENSIONS			BACK DIMENSIONS						
		W	D	H	W	D	H	W	H					
		45	29.5	32	24	19	18	27	14					
			RTA 00											
 <p>Personal Harbor - High Back COM Yardage: 7.09 Freight Class: 150 Product Weight (lbs.): 86 Cubic Feet Per Carton: 9.5</p>	<p>High Traffic model For Power/USB module please see electrical placement chart. Freestanding unit only.</p>	7787	\$6144	\$6462	\$6714	\$7094	\$7631	\$7884	\$8370	\$9148	\$9745	\$10410	\$11781	\$13239
		OVERALL DIMENSIONS			SEAT DIMENSIONS			BACK DIMENSIONS						
		W	D	H	W	D	H	W	H					
		45	29.5	41.5	24	19	18	27	24					
			RTA 00											
 <p>Personal Harbor - Extended Back COM Yardage: 8.5 Freight Class: 150 Product Weight (lbs.): 102 Cubic Feet Per Carton: 9.5</p>	<p>High Traffic model For Power/USB module please see electrical placement chart. Freestanding unit only.</p>	7788	\$6664	\$7013	\$7290	\$7707	\$8295	\$8574	\$9106	\$9958	\$10617	\$11345	\$12846	\$14449
		OVERALL DIMENSIONS			SEAT DIMENSIONS			BACK DIMENSIONS						
		W	D	H	W	D	H	W	H					
		45	29.5	47	24	19	18	27	29					
			RTA 00											

R RIVER+ SEATING

RIVER+ SEATING



Lounge Chair, High Back
model R27802



120 Corner, Standard Back
model R27824S



Loop arm
R2770

River+ Benches, Tables & Media Hearths



For River+ benches, please see page 383
For River+ media hearths, please see page 392
For River+ tables, please see page 388

EXAMPLE RIVER+ SEATING ORDER CODE:

R27802	-CE90	-FOG	-	-S6	-
Model number	Back, arm and seat textile	Connector finish	Shelf finish	Leg Selection	Counterweight

-CHM	-SSB
Leg finish	Bottom selection

Additional Options specify at end of order code.	SPECIFY CODE
Additional weight See each model for amount of added weight and upcharge.	CW
Sealed back seams Upcharges vary, see model.	SBS
Sealed seat seams Upcharges vary, see model.	SSS
Power unit finish Jet Black White	J W
Power/USB unit position (see electrical placement images, not available on corner units) Front left Front right Side left Side right Center back (models with shelf only)	\$661 per unit F1 F2 S1 S2 CB
Tamperproof fasteners Upcharges vary, see model.	TP
Moisture barrier Upcharges vary, see model.	MB
Accessory hook finish (for models with shelf) Night (BLK) Fog (FOG) Latte (LAB)	NHK FHK LHK

STANDARD FEATURES

- A modular series that is composed of straight, curved and corner sections.
- Models with the same seat height can be ganged on ends with no upholstered arms. Ganging hardware is standard on armless ends of models (factory installed) and swivels out of the way when not in use.
- Seating frames are constructed of heavy duty plywood, and are made for active environments. Seats are high density with highly resilient foam.
- River+ seating is rated for an active weight up to 600 lbs. per seat and 24/7 use.
- For 24/7 use and/or heavy duty application use, Global's Heavy Duty warranty is only on models specified with performance textiles, rated for 150,000 double rubs or more.
- A clean-out gap is created by seat-to-back connector brackets available in three finishes.
- The standard, 6.5" tapered legs are made of welded steel. Front legs of River+ lounge models are straight. Back legs are angled.
- Models with a shelf are only available with 6.5" high legs. Back legs on these models are standard with (E6) EXTENDED legs.
- Legs include Black nylon, non-marking, height adjustable glides.
- Upholstery options include fabric or vinyl. Leather upholstery is not available.
- All units are shipped fully assembled.
- Arms on upholstered arm models are factory installed and not removable.
- Modular, aluminum loop arms are sold separately and available with or without nylon armcaps. These relocatable arms are field installed at any seat to back connector location.
- A 10" deep, 1" thick shelf is available on the back of corner, curved, two and three seat models in many thermally fused laminate finishes with matching edge.
- Shelf supports are aluminum with accessory hook in three finishes. Weight capacity: Shelf - 50lbs per seat; Hook - 20lbs each.
- Back shelf heights align with the model's back height. See shelf heights diagrams for details.
- Check textile availability prior to specifying upholstery material.
- The series is available to specify with two textiles, one for the seat cushion and one for the back, arms and front rail (see model image).
- For pricing, start with the base price and add both back/arms graded textile upcharge and the seat graded textile upcharge.
- The blended textile matrix does not apply to this series.

OPTIONAL FEATURES

- Optional 6.5" floor mount legs (F6) are available. Shelf back models are available with EXTENDED floor mount legs (F6).
- Optional 8" (S8) and 8" floor mount legs (F8) are available on models without shelves. Seat heights change to 19" high. Upcharges vary.
- To match back legs of shelf-back models with models without shelf, select (C6) leg with counterweight. Upcharges vary.
- Up to two power units are available on seating models, except 90 and 120 corner units. Add \$661 upcharge per unit.
- Each power unit includes one AC outlet and two USB-A, 10 watt charging ports. Location options include front or side. Back power location option available on models with back shelf (except corners). See electrical placement diagrams.
- Power units are available in either Jet Black (J) or White (W) with 120", three-prong matching cords.
- Sealed seams are available only for approved coated textiles. Specify (SSS) for sealed seat seams or (SBS) for sealed back and arm seams. Contact customer care for details. See models for upcharge.
- To reduce ease of movement, counterweights can be added to any model. Specify (CW). See individual model for weight and upcharge.

LOUNGE

- For improved housekeeping and infection control practices, the underside of the seat can be finished with black vinyl and sealed to prevent penetration of liquids. Specify (SP) - see each model for upcharge.
- Steel bottom option provides tamperproof protection (includes tamperproof screws). Specify (BS). Upcharges vary. Note: electrical option and ganging are not available with steel bottom.

Add option codes in the following order:

- **Model number**
Specify model number.
- **Back/Arm Textile**
Specify textile code. See model grade upcharges.
- **Seat Textile**
Specify textile code. See model grade upcharges.
- **Seat to back connector finish (NGT)** Night (BLK). No upcharge.
(FOG) Fog. No upcharge.
(LAB) Latte. No upcharge.
- **Back shelf finish** (for "S" models with shelf)
See colors shown on website.
- **Accessory hook finish** (for "S" models with shelf)
(NHK) Night (BLK)
(FHK) Fog (FOG)
(LHK) Latte (LAB)
- **Leg selection** (models without shelf):
(S6) Standard seat height (17.5"), 6.5" leg w/adjustable glides. No upcharge.
(S8) High seat (19"), 8" leg w/adjustable glides. No upcharge.
(F6) Standard seat height (17.5"), 6.5" leg w/floor mount. Add \$100 for straight units; \$125 for curved, corner units.
(F8) High seat (19"), 8" leg w/floor mount. Add \$100 for straight units; \$125 for curved, corner units.
- **Leg selection** (for "S" models with shelf):
(E6) Standard seat height (17.5"), 6.5" EXTENDED leg with adjustable glides.
(C6) Standard seat height (17.5"), 6.5" leg, includes counterweight. Matches S6 leg. Upcharges vary, see model.
(F6) Standard seat height (17.5"), 6.5" EXTENDED leg w/floor mount. Add \$100 for straight unit; \$125 for curved, corner units.
- **Leg finish**
(CHM) Chrome
(TDW) Designer White
(TFR) Frost
(TKA) Kalua
(TMO) Mocha
(TOA) Toast
(TSN) Sand
(TBL) Black
(TFO) Fog
(TIV) Cloud
(TLA) Latte
(TNE) Nevada
(TSH) Shadow
(TTU) Tungsten
- **Additional weight**
(CU) No counterweight.
(CW) Counterweight. Upcharges vary, see model.
- **Bottom selection**
(SSB) Standard seat bottom
(SP) Vinyl sealed bottom with staple strip. Upcharges vary, see model.*
(BS) Steel bottom. Upcharges vary, see model.**
- **Sealed back and arm seams**
(SBS) Sealed back seams. Upcharges vary, see model.
- **Sealed seat seams**
(SSS) Sealed seat seams. Upcharges vary, see model.
- **Moisture barrier**
(MB) Moisture Barrier. Upcharges vary, see model.
- **Power/USB unit position. Add \$661 per unit.**
(NP) No power (no upcharge)
(F1) Front left
(S1) Side left
(CB) Center back (models with shelf only)
(F2) Front right
(S2) Side right
- **Power unit finish**
(J) Jet Black
(W) White
- **Tamperproof fasteners**
(TP) Tamperproof fasteners. Upcharges vary, see model.

*linking hardware is lowered to clear the staple strip.
Units will only gang with other units with sealed bottom.
**cannot be combined with linking hardware or power units

SHELF HEIGHTS

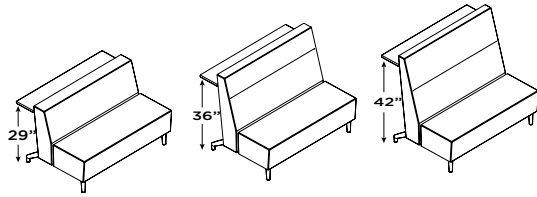

Standard height

High back

Extended high back

DIMENSIONS

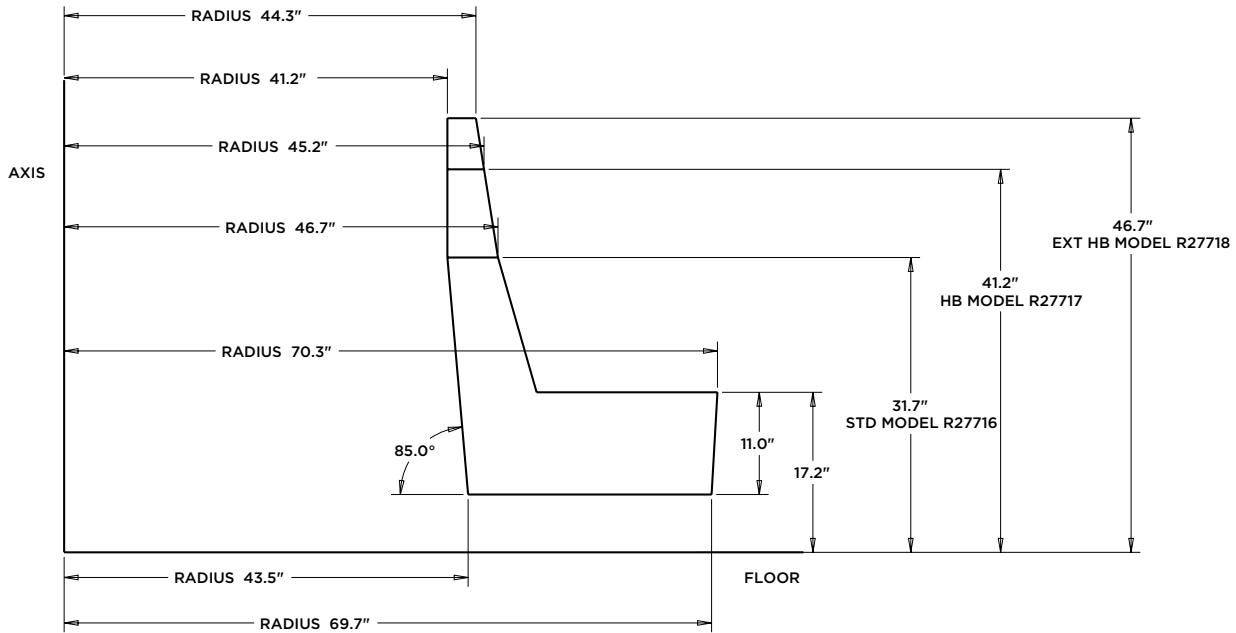

ELECTRICAL PLACEMENT

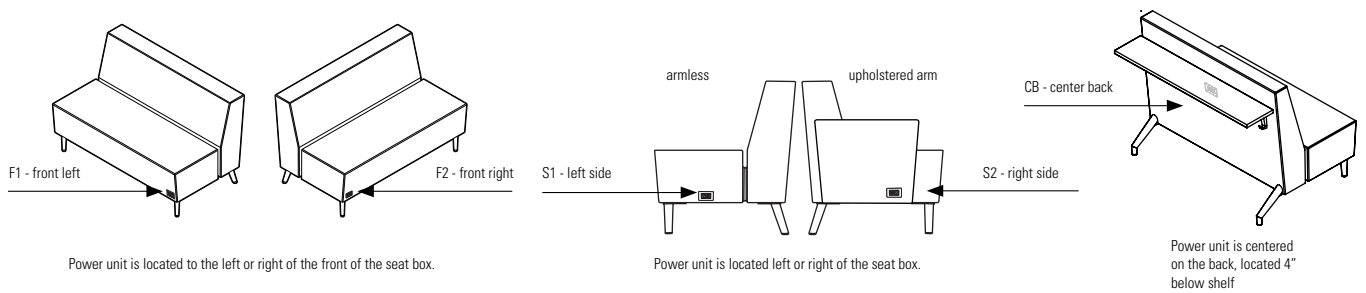

DESCRIPTION MODEL#/ FEATURES STANDARD TEXTILE GRADES



R27801

Lounge Chair - Standard Back
COM Yardage: Back: 2; Seat: 1.75
Freight class: 250
Product weight (lbs.): 61
Cubic feet per carton: 19.75

R27801 Base Price:
Back upcharge:
Seat upcharge:

For power/USB unit, see electrical placement chart. Includes ganging hardware (2 sides).
Add \$65 for (SSS), \$70 (SBS)
Add \$632 for 36 lbs. (CW)
Add \$103 for (SP) or \$486 for (BS)
Add \$40 for (TP)
Add \$127 for (MB)

1/COM	2	3	4	5	6	7	8	9	10	11	12	
\$2064												
	+0	+\$64	+\$114	+\$188	+\$292	+\$336	+\$426	+\$568	+\$674	+\$790	+\$1032	+\$1286
	+0	+\$56	+\$100	+\$165	+\$256	+\$294	+\$373	+\$497	+\$590	+\$692	+\$903	+\$1126
OVERALL DIMENSIONS			SEAT DIMENSIONS			BACK DIMENSIONS						
W	D	H	W	D	H	W	H					
26	30	32	26	19	18	26	14					
RTA 00 1 per carton												



R27801B

Lounge Chair - Standard Back
COM Yardage: Back: 4; Seat: 1.75
Freight class: 250
Product weight (lbs.): 82
Cubic feet per carton: 24.5

R27801B Base Price:
Back/Arm upcharge:
Seat upcharge:

For power/USB unit, see electrical placement chart. Ganging not available.
Add \$65 for (SSS), \$123 (SBS)
Add \$632 for 36 lbs. (CW)
Add \$103 for (SP) or \$486 for (BS)
Add \$40 for (TP)
Add \$127 for (MB)

1/COM	2	3	4	5	6	7	8	9	10	11	12	
\$2801												
	+0	+\$128	+\$228	+\$376	+\$584	+\$672	+\$852	+\$1136	+\$1348	+\$1580	+\$2064	+\$2572
	+0	+\$56	+\$100	+\$165	+\$256	+\$294	+\$373	+\$497	+\$590	+\$692	+\$903	+\$1126
OVERALL DIMENSIONS			SEAT DIMENSIONS			BACK DIMENSIONS						
W	D	H	W	D	H	W	H					
33	30	32	26	19	18	26	14					
RTA 00 1 per carton												



R27801L

R27801R

Lounge Chair - Standard Back
COM Yardage: Back: 3; Seat: 1.75
Freight class: 250
Product weight (lbs.): 72
Cubic feet per carton: 24.5

R27801L Base Price:
R27801R Base Price:
Back/Arm upcharge:
Seat upcharge:

For power/USB unit, see electrical placement chart. Includes ganging hardware (1 side).
Add \$65 for (SSS), \$96 (SBS)
Add \$632 for 36 lbs. (CW)
Add \$103 for (SP) or \$486 for (BS)
Add \$40 for (TP)
Add \$127 for (MB)

1/COM	2	3	4	5	6	7	8	9	10	11	12	
\$2434												
	+0	+\$96	+\$171	+\$282	+\$438	+\$504	+\$639	+\$852	+\$1011	+\$1185	+\$1548	+\$1929
	+0	+\$56	+\$100	+\$165	+\$256	+\$294	+\$373	+\$497	+\$590	+\$692	+\$903	+\$1126
OVERALL DIMENSIONS			SEAT DIMENSIONS			BACK DIMENSIONS						
W	D	H	W	D	H	W	H					
29.5	30	32	26	19	18	26	14					
RTA 00 1 per carton												



R27802

Lounge Chair - High Back
COM Yardage: Back: 2.75; Seat: 1.75
Freight class: 250
Product weight: 71
Cubic feet per carton: 24.75

R27802 Base Price:
Back upcharge:
Seat upcharge:

For power/USB unit, see electrical placement chart. Includes ganging hardware (2 sides).
Add \$65 for (SSS), \$99 for (SBS)
Add \$632 for 36 lbs. (CW)
Add \$103 for (SP) or \$486 for (BS)
Add \$40 for (TP)
Add \$127 for (MB)

1/COM	2	3	4	5	6	7	8	9	10	11	12	
\$2420												
	+0	+\$88	+\$157	+\$259	+\$402	+\$462	+\$586	+\$781	+\$927	+\$1087	+\$1419	+\$1769
	+0	+\$56	+\$100	+\$165	+\$256	+\$294	+\$373	+\$497	+\$590	+\$692	+\$903	+\$1126
OVERALL DIMENSIONS			SEAT DIMENSIONS			BACK DIMENSIONS						
W	D	H	W	D	H	W	H					
26	30.5	41.5	26	19	18	26	23.5					
RTA 00 1 per carton												



R27802B

Lounge Chair - High Back
COM Yardage: Back: 4.75; Seat: 1.75
Freight class: 250
Product weight: 88.5
Cubic feet per carton: 31.25

R27802B Base Price:
Back/Arm upcharge:
Seat upcharge:

For power/USB unit, see electrical placement chart. Ganging not available.
Add \$65 for (SSS), \$151 for (SBS)
Add \$632 for 36 lbs. (CW)
Add \$103 for (SP) or \$486 for (BS)
Add \$40 for (TP)
Add \$127 for (MB)

1/COM	2	3	4	5	6	7	8	9	10	11	12	
\$3156												
	+0	+\$152	+\$271	+\$447	+\$694	+\$798	+\$1012	+\$1349	+\$1601	+\$1877	+\$2451	+\$3055
	+0	+\$56	+\$100	+\$165	+\$256	+\$294	+\$373	+\$497	+\$590	+\$692	+\$903	+\$1126
OVERALL DIMENSIONS			SEAT DIMENSIONS			BACK DIMENSIONS						
W	D	H	W	D	H	W	H					
33	30.5	41.5	26	19	18	26	23.5					
RTA 00 1 per carton												

DESCRIPTION MODEL#/ FEATURES STANDARD TEXTILE GRADES

		STANDARD TEXTILE GRADES																																																										
		1/COM	2	3	4	5	6	7	8	9	10	11	12																																															
 <p>R27802L R27802R</p> <p>Lounge Chair - High Back COM Yardage: Back: 3.75; Seat: 1.75 Freight class: 250 Product weight: 78.5 Cubic feet per carton: 31.25</p>	<p>R27802L Base Price: \$2788 R27802R Base Price: \$2788</p> <p>Back/Arm upcharge: +0 Seat upcharge: +0</p> <p>For power/USB unit, see electrical placement chart. Includes ganging hardware (1 side). Add \$65 for (SSS), \$125 (SBS) Add \$632 for 36 lbs. (CW) Add \$103 for (SP) or \$486 for (BS) Add \$40 for (TP) Add \$127 for (MB)</p>	<table border="1"> <thead> <tr> <th colspan="3">OVERALL DIMENSIONS</th> <th colspan="3">SEAT DIMENSIONS</th> <th colspan="3">BACK DIMENSIONS</th> </tr> <tr> <th>W</th> <th>D</th> <th>H</th> <th>W</th> <th>D</th> <th>H</th> <th>W</th> <th>H</th> <th colspan="5"></th> </tr> </thead> <tbody> <tr> <td>29.5</td> <td>30.5</td> <td>41.5</td> <td>26</td> <td>19</td> <td>18</td> <td>26</td> <td>23.5</td> <td colspan="5"></td> </tr> <tr> <td colspan="12" style="text-align: center;">RTA 00 1 per carton</td> </tr> </tbody> </table>												OVERALL DIMENSIONS			SEAT DIMENSIONS			BACK DIMENSIONS			W	D	H	W	D	H	W	H						29.5	30.5	41.5	26	19	18	26	23.5						RTA 00 1 per carton											
		OVERALL DIMENSIONS			SEAT DIMENSIONS			BACK DIMENSIONS																																																				
W	D	H	W	D	H	W	H																																																					
29.5	30.5	41.5	26	19	18	26	23.5																																																					
RTA 00 1 per carton																																																												

		STANDARD TEXTILE GRADES																																																										
		1/COM	2	3	4	5	6	7	8	9	10	11	12																																															
 <p>R27803</p> <p>Lounge Chair - Extended Back COM Yardage: Back: 3; Seat: 1.75 Freight class: 250 Product weight: 81 Cubic feet per carton: 28</p>	<p>R27803 Base Price: \$2877</p> <p>Back upcharge: +0 Seat upcharge: +0</p> <p>For power/USB unit, see electrical placement chart. Includes ganging hardware (2 sides). Add \$65 for (SSS), \$105 for (SBS) Add \$632 for 36 lbs. (CW) Add \$103 for (SP) or \$486 for (BS) Add \$40 for (TP) Add \$127 for (MB)</p>	<table border="1"> <thead> <tr> <th colspan="3">OVERALL DIMENSIONS</th> <th colspan="3">SEAT DIMENSIONS</th> <th colspan="3">BACK DIMENSIONS</th> </tr> <tr> <th>W</th> <th>D</th> <th>H</th> <th>W</th> <th>D</th> <th>H</th> <th>W</th> <th>H</th> <th colspan="5"></th> </tr> </thead> <tbody> <tr> <td>26</td> <td>31</td> <td>47</td> <td>26</td> <td>19</td> <td>18</td> <td>26</td> <td>29</td> <td colspan="5"></td> </tr> <tr> <td colspan="12" style="text-align: center;">RTA 00 1 per carton</td> </tr> </tbody> </table>												OVERALL DIMENSIONS			SEAT DIMENSIONS			BACK DIMENSIONS			W	D	H	W	D	H	W	H						26	31	47	26	19	18	26	29						RTA 00 1 per carton											
		OVERALL DIMENSIONS			SEAT DIMENSIONS			BACK DIMENSIONS																																																				
W	D	H	W	D	H	W	H																																																					
26	31	47	26	19	18	26	29																																																					
RTA 00 1 per carton																																																												

		STANDARD TEXTILE GRADES																																																										
		1/COM	2	3	4	5	6	7	8	9	10	11	12																																															
 <p>R27803B</p> <p>Lounge Chair - Extended Back COM Yardage: Back: 5; Seat: 1.75 Freight class: 250 Product weight (lbs.): 101.5 Cubic feet per carton: 35</p>	<p>R27803B Base Price: \$3614</p> <p>Back/Arm upcharge: +0 Seat upcharge: +0</p> <p>For power/USB unit, see electrical placement chart. Ganging not available. Add \$65 for (SSS), \$158 (SBS) Add \$632 for 36 lbs. (CW) Add \$103 for (SP) or \$486 for (BS) Add \$40 for (TP) Add \$127 for (MB)</p>	<table border="1"> <thead> <tr> <th colspan="3">OVERALL DIMENSIONS</th> <th colspan="3">SEAT DIMENSIONS</th> <th colspan="3">BACK DIMENSIONS</th> </tr> <tr> <th>W</th> <th>D</th> <th>H</th> <th>W</th> <th>D</th> <th>H</th> <th>W</th> <th>H</th> <th colspan="5"></th> </tr> </thead> <tbody> <tr> <td>33</td> <td>31</td> <td>47</td> <td>26</td> <td>19</td> <td>18</td> <td>26</td> <td>29</td> <td colspan="5"></td> </tr> <tr> <td colspan="12" style="text-align: center;">RTA 00 1 per carton</td> </tr> </tbody> </table>												OVERALL DIMENSIONS			SEAT DIMENSIONS			BACK DIMENSIONS			W	D	H	W	D	H	W	H						33	31	47	26	19	18	26	29						RTA 00 1 per carton											
		OVERALL DIMENSIONS			SEAT DIMENSIONS			BACK DIMENSIONS																																																				
W	D	H	W	D	H	W	H																																																					
33	31	47	26	19	18	26	29																																																					
RTA 00 1 per carton																																																												





		STANDARD TEXTILE GRADES																																																										
		1/COM	2	3	4	5	6	7	8	9	10	11	12																																															
 <p>R27803L R27803R</p> <p>Lounge Chair - Extended Back COM Yardage: Back: 4; Seat: 1.75 Freight class: 250 Product weight (lbs.): 91.5 Cubic feet per carton: 35</p>	<p>R27803L Base Price: \$3246 R27803R Base Price: \$3246</p> <p>Back/Arm upcharge: +0 Seat upcharge: +0</p> <p>For power/USB unit, see electrical placement chart. Includes ganging hardware (1 side). Add \$65 for (SSS), \$131 (SBS) Add \$632 for 36 lbs. (CW) Add \$103 for (SP) or \$486 for (BS) Add \$40 for (TP) Add \$127 for (MB)</p>	<table border="1"> <thead> <tr> <th colspan="3">OVERALL DIMENSIONS</th> <th colspan="3">SEAT DIMENSIONS</th> <th colspan="3">BACK DIMENSIONS</th> </tr> <tr> <th>W</th> <th>D</th> <th>H</th> <th>W</th> <th>D</th> <th>H</th> <th>W</th> <th>H</th> <th colspan="5"></th> </tr> </thead> <tbody> <tr> <td>29.5</td> <td>31</td> <td>47</td> <td>26</td> <td>19</td> <td>18</td> <td>26</td> <td>29</td> <td colspan="5"></td> </tr> <tr> <td colspan="12" style="text-align: center;">RTA 00 1 per carton</td> </tr> </tbody> </table>												OVERALL DIMENSIONS			SEAT DIMENSIONS			BACK DIMENSIONS			W	D	H	W	D	H	W	H						29.5	31	47	26	19	18	26	29						RTA 00 1 per carton											
		OVERALL DIMENSIONS			SEAT DIMENSIONS			BACK DIMENSIONS																																																				
W	D	H	W	D	H	W	H																																																					
29.5	31	47	26	19	18	26	29																																																					
RTA 00 1 per carton																																																												





DESCRIPTION	MODEL#/ FEATURES	STANDARD TEXTILE GRADES												
		1/COM	2	3	4	5	6	7	8	9	10	11	12	
 <p>R27804</p> <p>Two Seater - Standard Back COM Yardage: Back: 2.75; Seat: 2 Freight class: 250 Product weight: 113 133 shelf model Cubic feet per carton: 37.5 51shelf model</p>	<p>R27804S</p> <p>For power/USB unit, see electrical placement chart. Includes ganging hardware (2 sides). Add \$96 for (SSS), \$119 for (SBS) Add \$1260 for 72 lbs. (CW), (C6) Add \$196 for (SP) or \$773 for (BS) Add \$40 for (TP) Add \$252 for (MB)</p>	Base Price:	\$3217											
		Base Price:	\$3942											
		Back upcharge:	+0	+\$88	+\$157	+\$259	+\$402	+\$462	+\$586	+\$781	+\$927	+\$1087	+\$1419	+\$1769
		Seat upcharge:	+0	+\$64	+\$114	+\$188	+\$292	+\$336	+\$426	+\$568	+\$674	+\$790	+\$1032	+\$1286
		Shelf: 52W 10D 1H												
		OVERALL DIMENSIONS	W	D	H	W	D	H	W	D	H	W	H	
			52	30	32	52	19	18	52			14		
		RTA 00											1 per carton	

DESCRIPTION	MODEL#/ FEATURES	STANDARD TEXTILE GRADES												
		1/COM	2	3	4	5	6	7	8	9	10	11	12	
 <p>R27804B</p> <p>Two Seater - Standard Back COM Yardage: Back: 4.75; Seat: 2 Freight class: 250 Product weight: 133 154 shelf model Cubic feet per carton: 42.5 57.5 shelf model</p>	<p>R27804SB</p> <p>For power/USB unit, see electrical placement chart. Ganging not available. Add \$96 for (SSS), \$171 for (SBS) Add \$1260 for 72 lbs. (CW), (C6) Add \$196 for (SP) or \$773 for (BS) Add \$40 for (TP) Add \$252 for (MB)</p>	Base Price:	\$3953											
		Base Price:	\$4679											
		Back/Arm upcharge:	+0	+\$152	+\$271	+\$447	+\$694	+\$798	+\$1012	+\$1349	+\$1601	+\$1877	+\$2451	+\$3055
		Seat upcharge:	+0	+\$64	+\$114	+\$188	+\$292	+\$336	+\$426	+\$568	+\$674	+\$790	+\$1032	+\$1286
		Shelf: 52W 10D 1H												
		OVERALL DIMENSIONS	W	D	H	W	D	H	W	D	H	W	H	
			59	30	32	52	19	18	52			14		
		RTA 00											1 per carton	

DESCRIPTION	MODEL#/ FEATURES	STANDARD TEXTILE GRADES												
		1/COM	2	3	4	5	6	7	8	9	10	11	12	
 <p>R27804L</p> <p>Two Seater - Standard Back COM Yardage: Back: 3.75; Seat: 2 Freight class: 250 Product weight: 123 Cubic feet per carton: 42.5</p>	<p>R27804R</p> <p>For power/USB unit, see electrical placement chart. Includes ganging hardware (1 side). Add \$96 for (SSS), \$145 for (SBS) Add \$1260 for 72 lbs. (CW), (C6) Add \$196 for (SP) or \$773 for (BS) Add \$40 for (TP) Add \$252 for (MB)</p>	Base Price:	\$3584											
		Base Price:	\$3584											
		Back/Arm upcharge:	+0	+\$120	+\$214	+\$353	+\$548	+\$630	+\$799	+\$1065	+\$1264	+\$1482	+\$1935	+\$2412
		Seat upcharge:	+0	+\$64	+\$114	+\$188	+\$292	+\$336	+\$426	+\$568	+\$674	+\$790	+\$1032	+\$1286
		Shelf: 52W 10D 1H												
		OVERALL DIMENSIONS	W	D	H	W	D	H	W	D	H	W	H	
			55.5	30	32	52	19	18	52			14		
		RTA 00											1 per carton	

DESCRIPTION	MODEL#/ FEATURES	STANDARD TEXTILE GRADES												
		1/COM	2	3	4	5	6	7	8	9	10	11	12	
 <p>R27804SL</p> <p>Two Seater - Standard Back COM Yardage: Back: 3.75; Seat: 2 Freight class: 250 Product weight: 144 Cubic feet per carton: 57.5</p>	<p>R27804SR</p> <p>For power/USB unit, see electrical placement chart. Includes ganging hardware (1 side). Add \$96 for (SSS), \$145 for (SBS) Add \$1260 for 72 lbs. (CW), (C6) Add \$196 for (SP) or \$773 for (BS) Add \$40 for (TP) Add \$252 for (MB)</p>	Base Price:	\$4311											
		Base Price:	\$4311											
		Back/Arm upcharge:	+0	+\$120	+\$214	+\$353	+\$548	+\$630	+\$799	+\$1065	+\$1264	+\$1482	+\$1935	+\$2412
		Seat upcharge:	+0	+\$64	+\$114	+\$188	+\$292	+\$336	+\$426	+\$568	+\$674	+\$790	+\$1032	+\$1286
		Shelf: 52W 10D 1H												
		OVERALL DIMENSIONS	W	D	H	W	D	H	W	D	H	W	H	
			55.5	40.5	32	52	19	18	52			14		
		RTA 00											1 per carton	

DESCRIPTION	MODEL#/ FEATURES	STANDARD TEXTILE GRADES												
		1/COM	2	3	4	5	6	7	8	9	10	11	12	
 <p>R27805</p> <p>Two Seater - High Back COM Yardage: Back: 3.50; Seat: 2 Freight class: 250 Product weight: 138 139 shelf model Cubic feet per carton: 47.25 64.75 shelf model</p>	<p>R27805S</p> <p>For power/USB unit, see electrical placement chart. Includes ganging hardware (1 sides) Add \$96 for (SSS), \$157for (SBS) Add \$1260 for 72 lbs. (CW), (C6) Add \$196 for (SP) or \$773 for (BS) Add \$40 for (TP) Add \$252 for (MB)</p>	Base Price:	\$3914											
		Back Price:	\$4638											
		Back upcharge:	+0	+\$112	+\$200	+\$329	+\$511	+\$588	+\$746	+\$994	+\$1180	+\$1383	+\$1806	+\$2251
		Seat upcharge:	+0	+\$64	+\$114	+\$188	+\$292	+\$336	+\$426	+\$568	+\$674	+\$790	+\$1032	+\$1286
		Shelf: 52W 10D 1H												
		OVERALL DIMENSIONS			SEAT DIMENSIONS			BACK DIMENSIONS						
		W	D	H	W	D	H	W	H					
		52	30.5	41.5	52	19	18	52	23.5					
		RTA 00		1 per carton										
 <p>R27805B</p> <p>Two Seater - High Back COM Yardage: Back: 5.50; Seat: 2 Freight class: 250 Product weight: 138 159 shelf model Cubic feet per carton: 54 73 shelf model</p>	<p>R27805SB</p> <p>For power/USB unit, see electrical placement chart. Ganging not available. Add \$96 for (SSS), \$209 for (SBS) Add \$1260 for 72 lbs. (CW), (C6) Add \$196 for (SP) or \$773 for (BS) Add \$40 for (TP) Add \$252 for (MB)</p>	Base Price:	\$4651											
		Back Price:	\$5376											
		Back/Arm upcharge:	+0	+\$176	+\$314	+\$517	+\$803	+\$924	+\$1172	+\$1562	+\$1854	+\$2173	+\$2838	+\$3537
		Seat upcharge:	+0	+\$64	+\$114	+\$188	+\$292	+\$336	+\$426	+\$568	+\$674	+\$790	+\$1032	+\$1286
		Shelf: 52W 10D 1H												
		OVERALL DIMENSIONS			SEAT DIMENSIONS			BACK DIMENSIONS						
		W	D	H	W	D	H	W	H					
		59	30.5	41.5	52	19	18	52	23.5					
		RTA 00		1 per carton										
 <p>R27805L</p> <p>Two Seater - High Back COM Yardage: Back: 4.50; Seat: 2 Freight class: 250 Product weight: 128 Cubic feet per carton: 54</p>	<p>R27805R</p> <p>For power/USB unit, see electrical placement chart. Includes ganging hardware (1 side). Add \$96 for (SSS), \$209 for (SBS) Add \$1260 for 72 lbs. (CW), (C6) Add \$196 for (SP) or \$773 for (BS) Add \$40 for (TP) Add \$252 for (MB)</p>	Base Price:	\$4282											
		Back Price:	\$4282											
		Back/Arm upcharge:	+0	+\$144	+\$257	+\$423	+\$657	+\$756	+\$959	+\$1278	+\$1517	+\$1778	+\$2322	+\$2894
		Seat upcharge:	+0	+\$64	+\$114	+\$188	+\$292	+\$336	+\$426	+\$568	+\$674	+\$790	+\$1032	+\$1286
		Shelf: 52W 10D 1H												
		OVERALL DIMENSIONS			SEAT DIMENSIONS			BACK DIMENSIONS						
		W	D	H	W	D	H	W	H					
		55.5	30.5	41.5	52	19	18	52	23.5					
		RTA 00		1 per carton										
 <p>R27805SL</p> <p>Two Seater - High Back COM Yardage: Back: 4.50; Seat: 2 Freight class: 250 Product weight: 149 Cubic feet per carton: 73</p>	<p>R27805SR</p> <p>For power/USB unit, see electrical placement chart. Includes ganging hardware (1 side). Add \$96 for (SSS), \$209 for (SBS) Add \$1260 for 72 lbs. (CW), (C6) Add \$196 for (SP) or \$773 for (BS) Add \$40 for (TP) Add \$252 for (MB)</p>	Base Price:	\$5007											
		Back Price:	\$5007											
		Back/Arm upcharge:	+0	+\$144	+\$257	+\$423	+\$657	+\$756	+\$959	+\$1278	+\$1517	+\$1778	+\$2322	+\$2894
		Seat upcharge:	+0	+\$64	+\$114	+\$188	+\$292	+\$336	+\$426	+\$568	+\$674	+\$790	+\$1032	+\$1286
		Shelf: 52W 10D 1H												
		OVERALL DIMENSIONS			SEAT DIMENSIONS			BACK DIMENSIONS						
		W	D	H	W	D	H	W	H					
		55.5	41	41.5	52	19	18	52	23.5					
		RTA 00		1 per carton										





DESCRIPTION		MODEL#/ FEATURES		STANDARD TEXTILE GRADES																																		
				1/COM	2	3	4	5	6	7	8	9	10	11	12																							
	<p>R27807</p> <p>R27807S</p>	<p>Base Price: \$5043</p> <p>Base Price: \$6002</p> <p>Back upcharge: +0</p> <p>Seat upcharge: +0</p>	<p>Shelf: 52W 10D 1H</p> <table border="1"> <thead> <tr> <th colspan="3">OVERALL DIMENSIONS</th> <th colspan="3">SEAT DIMENSIONS</th> <th colspan="2">BACK DIMENSIONS</th> </tr> <tr> <th>W</th> <th>D</th> <th>H</th> <th>W</th> <th>D</th> <th>H</th> <th>W</th> <th>H</th> </tr> </thead> <tbody> <tr> <td>78</td> <td>30</td> <td>32</td> <td>78</td> <td>19</td> <td>18</td> <td>78</td> <td>14</td> </tr> </tbody> </table>												OVERALL DIMENSIONS			SEAT DIMENSIONS			BACK DIMENSIONS		W	D	H	W	D	H	W	H	78	30	32	78	19	18	78	14
			OVERALL DIMENSIONS			SEAT DIMENSIONS			BACK DIMENSIONS																													
W	D	H	W	D	H	W	H																															
78	30	32	78	19	18	78	14																															
<p>Three Seater - Standard Back COM Yardage: Back: 4.50; Seat: 3.50 Freight class: 250 Product weight: 152 173 shelf model Cubic feet per carton: 55.5 173 shelf model</p>		<p>For power/USB unit, see electrical placement chart. Includes ganging hardware (2 sides). Add \$117 for (SSS), \$138 for (SBS) Add \$1260 for 72 lbs. (CW), (C6) Add \$294 for (SP) or \$1063 for (BS) Add \$40 for (TP) Add \$375 for (MB)</p>																																				
	<p>R27807B</p> <p>R27807SB</p>	<p>Base Price: \$5781</p> <p>Base Price: \$6740</p> <p>Back/Arm upcharge: +0</p> <p>Seat upcharge: +0</p>	<p>Shelf: 52W 10D 1H</p> <table border="1"> <thead> <tr> <th colspan="3">OVERALL DIMENSIONS</th> <th colspan="3">SEAT DIMENSIONS</th> <th colspan="2">BACK DIMENSIONS</th> </tr> <tr> <th>W</th> <th>D</th> <th>H</th> <th>W</th> <th>D</th> <th>H</th> <th>W</th> <th>H</th> </tr> </thead> <tbody> <tr> <td>85</td> <td>30</td> <td>32</td> <td>78</td> <td>19</td> <td>18</td> <td>78</td> <td>14</td> </tr> </tbody> </table>												OVERALL DIMENSIONS			SEAT DIMENSIONS			BACK DIMENSIONS		W	D	H	W	D	H	W	H	85	30	32	78	19	18	78	14
			OVERALL DIMENSIONS			SEAT DIMENSIONS			BACK DIMENSIONS																													
W	D	H	W	D	H	W	H																															
85	30	32	78	19	18	78	14																															
<p>Three Seater - Standard Back COM Yardage: Back: 6.50; Seat: 3.50 Freight class: 250 Product weight: 170 193 shelf model Cubic feet per carton: 60.5 79.75 shelf model</p>		<p>For power/USB unit, see electrical placement chart. Ganging not available. Add \$117 for (SSS), \$189 for (SBS) Add \$1260 for 72 lbs. (CW), (C6) Add \$294 for (SP) or \$1063 for (BS) Add \$40 for (TP) Add \$375 for (MB)</p>																																				
	<p>R27807L</p> <p>R27807R</p>	<p>Base Price: \$5412</p> <p>Base Price: \$5412</p> <p>Back/Arm upcharge: +0</p> <p>Seat upcharge: +0</p>	<table border="1"> <thead> <tr> <th colspan="3">OVERALL DIMENSIONS</th> <th colspan="3">SEAT DIMENSIONS</th> <th colspan="2">BACK DIMENSIONS</th> </tr> <tr> <th>W</th> <th>D</th> <th>H</th> <th>W</th> <th>D</th> <th>H</th> <th>W</th> <th>H</th> </tr> </thead> <tbody> <tr> <td>81.5</td> <td>30</td> <td>32</td> <td>78</td> <td>19</td> <td>18</td> <td>78</td> <td>14</td> </tr> </tbody> </table>												OVERALL DIMENSIONS			SEAT DIMENSIONS			BACK DIMENSIONS		W	D	H	W	D	H	W	H	81.5	30	32	78	19	18	78	14
			OVERALL DIMENSIONS			SEAT DIMENSIONS			BACK DIMENSIONS																													
W	D	H	W	D	H	W	H																															
81.5	30	32	78	19	18	78	14																															
<p>Three Seater - Standard Back COM Yardage: Back: 5.50; Seat: 3.50 Freight class: 250 Product weight: 160 Cubic feet per carton: 60.5</p>		<p>For power/USB unit, see electrical placement chart. Includes ganging hardware (2 sides). Add \$117 for (SSS), \$164 for (SBS) Add \$1260 for 72 lbs. (CW), (C6) Add \$294 for (SP) or \$1063 for (BS) Add \$40 for (TP) Add \$375 for (MB)</p>																																				
	<p>R27807SL</p> <p>R27807SR</p>	<p>Base Price: \$6371</p> <p>Base Price: \$6371</p> <p>Back/Arm upcharge: +0</p> <p>Seat upcharge: +0</p>	<p>Shelf: 52W 10D 1H</p> <table border="1"> <thead> <tr> <th colspan="3">OVERALL DIMENSIONS</th> <th colspan="3">SEAT DIMENSIONS</th> <th colspan="2">BACK DIMENSIONS</th> </tr> <tr> <th>W</th> <th>D</th> <th>H</th> <th>W</th> <th>D</th> <th>H</th> <th>W</th> <th>H</th> </tr> </thead> <tbody> <tr> <td>81.5</td> <td>40.5</td> <td>32</td> <td>78</td> <td>19</td> <td>18</td> <td>78</td> <td>14</td> </tr> </tbody> </table>												OVERALL DIMENSIONS			SEAT DIMENSIONS			BACK DIMENSIONS		W	D	H	W	D	H	W	H	81.5	40.5	32	78	19	18	78	14
			OVERALL DIMENSIONS			SEAT DIMENSIONS			BACK DIMENSIONS																													
W	D	H	W	D	H	W	H																															
81.5	40.5	32	78	19	18	78	14																															
<p>Three Seater - Standard Back COM Yardage: Back: 5.50; Seat: 3.50 Freight class: 250 Product weight: 183 Cubic feet per carton: 79.75</p>		<p>For power/USB unit, see electrical placement chart. Includes ganging hardware (2 sides). Add \$117 for (SSS), \$164 for (SBS) Add \$1260 for 72 lbs. (CW), (C6) Add \$294 for (SP) or \$1063 for (BS) Add \$40 for (TP) Add \$375 for (MB)</p>																																				





DESCRIPTION	MODEL#/ FEATURES	STANDARD TEXTILE GRADES											
		1/COM	2	3	4	5	6	7	8	9	10	11	12
 <p>R27808</p> <p>Three Seater - High Back COM Yardage: Back: 5.75; Seat: 3.50 Freight class: 250 Product weight: 177 201 shelf model Cubic feet per carton: 69.75 95.5 shelf model</p>	<p>R27808 Base Price: \$5882</p> <p>R27808S Base Price: \$6842</p> <p>Back upcharge: +0</p> <p>Seat upcharge: +0</p> <p>Shelf: 52W 10D 1H</p>												
		<p>For power/USB unit, see electrical placement chart. Includes ganging hardware (2 sides). Add \$117 for (SSS), \$184 for (SBS) Add \$1260 for 72 lbs. (CW), (C6) Add \$294 for (SP) or \$1063 for (BS) Add \$40 for (TP) Add \$375 for (MB)</p>			<p>OVERALL DIMENSIONS</p> <p>W D H</p>			<p>SEAT DIMENSIONS</p> <p>W D H</p>			<p>BACK DIMENSIONS</p> <p>W H</p>		
		<p>78 30.5 41.5</p>			<p>78 19 18</p>			<p>78 23.5</p>			<p>RTA 00 1 per carton</p>		





DESCRIPTION	MODEL#/ FEATURES	STANDARD TEXTILE GRADES											
		1/COM	2	3	4	5	6	7	8	9	10	11	12
 <p>R27808B</p> <p>Three Seater - High Back COM Yardage: Back: 7.75; Seat: 3.50 Freight class: 250 Product weight: 190.5 221.5 shelf model Cubic feet per carton: 69.75 101.5 shelf model</p>	<p>R27808B Base Price: \$6620</p> <p>R27808SB Base Price: \$7580</p> <p>Back/Arm upcharge: +0</p> <p>Seat upcharge: +0</p> <p>Shelf: 52W 10D 1H</p>												
		<p>For power/USB unit, see electrical placement chart. Ganging not available. Add \$117 for (SSS), \$237 for (SBS) Add \$1260 for 72 lbs. (CW), (C6) Add \$294 for (SP) or \$1063 for (BS) Add \$40 for (TP) Add \$375 for (MB)</p>			<p>OVERALL DIMENSIONS</p> <p>W D H</p>			<p>SEAT DIMENSIONS</p> <p>W D H</p>			<p>BACK DIMENSIONS</p> <p>W H</p>		
		<p>85 30.5 41.5</p>			<p>78 19 18</p>			<p>78 23.5</p>			<p>RTA 00 1 per carton</p>		

DESCRIPTION	MODEL#/ FEATURES	STANDARD TEXTILE GRADES											
		1/COM	2	3	4	5	6	7	8	9	10	11	12
 <p>R27808L</p> <p>Three Seater - High Back COM Yardage: Back: 6.75; Seat: 3.50 Freight class: 250 Product weight: 180.5 Cubic feet per carton: 76.75</p>	<p>R27808L Base Price: \$6250</p> <p>R27808R Base Price: \$6250</p> <p>Back/Arm upcharge: +0</p> <p>Seat upcharge: +0</p> <p>Shelf: 52W 10D 1H</p>												
		<p>For power/USB unit, see electrical placement chart. Includes ganging hardware (2 sides). Add \$117 for (SSS), \$237 for (SBS) Add \$1260 for 72 lbs. (CW), (C6) Add \$294 for (SP) or \$1063 for (BS) Add \$40 for (TP) Add \$375 for (MB)</p>			<p>OVERALL DIMENSIONS</p> <p>W D H</p>			<p>SEAT DIMENSIONS</p> <p>W D H</p>			<p>BACK DIMENSIONS</p> <p>W H</p>		
		<p>81.5 30.5 41.5</p>			<p>78 19 18</p>			<p>78 23.5</p>			<p>RTA 00 1 per carton</p>		

DESCRIPTION	MODEL#/ FEATURES	STANDARD TEXTILE GRADES											
		1/COM	2	3	4	5	6	7	8	9	10	11	12
 <p>R27808SL</p> <p>Three Seater - High Back COM Yardage: Back: 6.75; Seat: 3.50 Freight class: 250 Product weight: 211.5 Cubic feet per carton: 101.5</p>	<p>R27808SL Base Price: \$7211</p> <p>R27808SR Base Price: \$7211</p> <p>Back/Arm upcharge: +0</p> <p>Seat upcharge: +0</p> <p>Shelf: 52W 10D 1H</p>												
		<p>For power/USB unit, see electrical placement chart. Includes ganging hardware (2 sides). Add \$117 for (SSS), \$237 for (SBS) Add \$1260 for 72 lbs. (CW), (C6) Add \$294 for (SP) or \$1063 for (BS) Add \$40 for (TP) Add \$375 for (MB)</p>			<p>OVERALL DIMENSIONS</p> <p>W D H</p>			<p>SEAT DIMENSIONS</p> <p>W D H</p>			<p>BACK DIMENSIONS</p> <p>W H</p>		
		<p>81.5 41 41.5</p>			<p>78 19 18</p>			<p>78 23.5</p>			<p>RTA 00 1 per carton</p>		

DESCRIPTION	MODEL#/ FEATURES	STANDARD TEXTILE GRADES												
		1/COM	2	3	4	5	6	7	8	9	10	11	12	
 <p>R27809 R27809S</p> <p>Three Seater - Extended Back COM Yardage: Back: 6.50; Seat: 3.50 Freight class: 250 Product weight: 165 198 shelf model Cubic feet per carton: 79.25 108.5 shelf model</p>	<p>R27809 Base Price: \$6381</p> <p>R27809S Base Price: \$7340</p> <p>Back upcharge: +0</p> <p>Seat upcharge: +0</p> <p>For power/USB unit, see electrical placement chart. Includes ganging hardware (2 sides). Add \$117 for (SSS), \$196 for (SBS) Add \$1260 for 72 lbs. (CW), (C6) Add \$294 for (SP) or \$1063 for (BS) Add \$40 for (TP) Add \$375 for (MB)</p>	<p>\$6381</p> <p>\$7340</p> <p>+0 +\$208 +\$371 +\$611 +\$949 +\$1092+\$1385 +\$1846 +\$2191 +\$2568 +\$3354 +\$4180</p> <p>+0 +\$112 +\$200 +\$329 +\$511 +\$588 +\$746 +\$994 +\$1180 +\$1383 +\$1806 +\$2251</p>	<p>OVERALL DIMENSIONS</p> <p>W D H</p>			<p>SEAT DIMENSIONS</p> <p>W D H</p>			<p>BACK DIMENSIONS</p> <p>W H</p>					
				78	31	47	78	19	18	78	29			
			<p>RTA 00</p>			1 per carton								
 <p>R27809B R27809SB</p> <p>Three Seater - Extended Back COM Yardage: Back: 7.50; Seat: 3.50 Freight class: 250 Product weight: 190 220 shelf model Cubic feet per carton: 86.25 114 shelf model</p>	<p>R27809B Base Price: \$7117</p> <p>R27809SB Base Price: \$8076</p> <p>Back/Arm upcharge: +0</p> <p>Seat upcharge: +0</p> <p>For power/USB unit, see electrical placement chart. Ganging not available. Add \$117 for (SSS), \$248 for (SBS) Add \$1260 for 72 lbs. (CW), (C6) Add \$294 for (SP) or \$1063 for (BS) Add \$40 for (TP) Add \$375 for (MB)</p>	<p>\$7117</p> <p>\$8076</p> <p>+0 +\$272 +\$485 +\$799 +\$1241 +\$1428+\$1811 +\$2414 +\$2865 +\$3358 +\$4386 +\$5466</p> <p>+0 +\$112 +\$200 +\$329 +\$511 +\$588 +\$746 +\$994 +\$1180 +\$1383 +\$1806 +\$2251</p>	<p>OVERALL DIMENSIONS</p> <p>W D H</p>			<p>SEAT DIMENSIONS</p> <p>W D H</p>			<p>BACK DIMENSIONS</p> <p>W H</p>					
				85	31	47	78	19	18	78	29			
			<p>RTA 00</p>			1 per carton								
 <p>R27809L R27809R</p> <p>Three Seater - Extended Back COM Yardage: Back: 7.50; Seat: 3.50 Freight class: 250 Product weight: 180 Cubic feet per carton: 86.25</p>	<p>R27809L Base Price: \$6749</p> <p>R27809R Base Price: \$6749</p> <p>Back/Arm upcharge: +0</p> <p>Seat upcharge: +0</p> <p>For power/USB unit, see electrical placement chart. Includes ganging hardware (1 side). Add \$117 for (SSS), \$222 for (SBS) Add \$1260 for 72 lbs. (CW), (C6) Add \$294 for (SP) or \$1063 for (BS) Add \$40 for (TP) Add \$375 for (MB)</p>	<p>\$6749</p> <p>\$6749</p> <p>+0 +\$240 +\$428 +\$705 +\$1095 +\$1260+\$1598 +\$2130 +\$2528 +\$2963 +\$3870 +\$4823</p> <p>+0 +\$112 +\$200 +\$329 +\$511 +\$588 +\$746 +\$994 +\$1180 +\$1383 +\$1806 +\$2251</p>	<p>OVERALL DIMENSIONS</p> <p>W D H</p>			<p>SEAT DIMENSIONS</p> <p>W D H</p>			<p>BACK DIMENSIONS</p> <p>W H</p>					
				81.5	31	47	78	19	18	78	29			
			<p>RTA 00</p>			1 per carton								
 <p>R27809SL R27809SR</p> <p>Three Seater - Extended Back COM Yardage: Back: 7.50; Seat: 3.50 Freight class: 250 Product weight: 210 Cubic feet per carton: 114</p>	<p>R27809SL Base Price: \$7708</p> <p>R27809SR Base Price: \$7708</p> <p>Back/Arm upcharge: +0</p> <p>Seat upcharge: +0</p> <p>For power/USB unit, see electrical placement chart. Includes ganging hardware (1 side). Add \$117 for (SSS), \$222 for (SBS) Add \$1260 for 72 lbs. (CW), (C6) Add \$294 for (SP) or \$1063 for (BS) Add \$40 for (TP) Add \$375 for (MB)</p>	<p>\$7708</p> <p>\$7708</p> <p>+0 +\$240 +\$428 +\$705 +\$1095 +\$1260+\$1598 +\$2130 +\$2528 +\$2963 +\$3870 +\$4823</p> <p>+0 +\$112 +\$200 +\$329 +\$511 +\$588 +\$746 +\$994 +\$1180 +\$1383 +\$1806 +\$2251</p>	<p>OVERALL DIMENSIONS</p> <p>W D H</p>			<p>SEAT DIMENSIONS</p> <p>W D H</p>			<p>BACK DIMENSIONS</p> <p>W H</p>					
				81.5	41.5	47	78	19	18	78	29			
			<p>RTA 00</p>			1 per carton								

DESCRIPTION	MODEL#/ FEATURES	STANDARD TEXTILE GRADES											
		1/COM	2	3	4	5	6	7	8	9	10	11	12
 <p>R27810</p> <p>Bariatric Lounge Chair - Standard Back COM Yardage: Back: 2.25; Seat: 2 Freight class: 250 Product weight: 90 Cubic feet per carton: 28.75</p>	<p>R27810 Base Price: \$3150</p> <p>Back upcharge: +0</p> <p>Seat upcharge: +0</p>	+0	+\$72	+\$129	+\$212	+\$329	+\$378	+\$480	+\$639	+\$759	+\$889	+\$1161	+\$1447
	<p>For power/USB unit, see electrical placement chart. Includes ganging hardware (2 sides). Add \$70 for (SSS), \$86 for (SBS) Add \$632 for 36 lbs. (CW) Add \$138 for (SP) or \$678 for (BS) Add \$40 for (TP) Add \$188 for (MB)</p>	<p>OVERALL DIMENSIONS</p> <p>W D H</p>			<p>SEAT DIMENSIONS</p> <p>W D H</p>			<p>BACK DIMENSIONS</p> <p>W H</p>					
		39	30	32	39	19	18	39	14				
		RTA 00	1 per carton										
 <p>R27810B</p> <p>Bariatric Lounge Chair - Standard Back COM Yardage: Back: 4.25; Seat: 2 Freight class: 250 Product weight: 108 Cubic feet per carton: 33</p>	<p>R27810B Base Price: \$3886</p> <p>Back/Arm upcharge: +0</p> <p>Seat upcharge: +0</p>	+0	+\$136	+\$243	+\$400	+\$621	+\$714	+\$906	+\$1207	+\$1433	+\$1679	+\$2193	+\$2733
	<p>For power/USB unit, see electrical placement chart. Ganging not available. Add \$70 for (SSS), \$139 for (SBS) Add \$632 for 36 lbs. (CW) Add \$138 for (SP) or \$678 for (BS) Add \$40 for (TP) Add \$188 for (MB)</p>	<p>OVERALL DIMENSIONS</p> <p>W D H</p>			<p>SEAT DIMENSIONS</p> <p>W D H</p>			<p>BACK DIMENSIONS</p> <p>W H</p>					
		46	30	32	39	19	18	39	14				
		RTA 00	1 per carton										
 <p>R27810L</p> <p>Bariatric Lounge Chair - Standard Back COM Yardage: Back: 3.25; Seat: 2 Freight class: 250 Product weight: 98 Cubic feet per carton: 33</p>	<p>R27810L Base Price: \$3518</p> <p>R27810R Base Price: \$3518</p> <p>Back/Arm upcharge: +0</p> <p>Seat upcharge: +0</p>	+0	+\$104	+\$186	+\$306	+\$475	+\$546	+\$693	+\$923	+\$1096	+\$1284	+\$1677	+\$2090
	<p>For power/USB unit, see electrical placement chart. Includes ganging hardware (1 side). Add \$70 for (SSS), \$112 for (SBS) Add \$632 for 36 lbs. (CW) Add \$138 for (SP) or \$678 for (BS) Add \$40 for (TP) Add \$188 for (MB)</p>	<p>OVERALL DIMENSIONS</p> <p>W D H</p>			<p>SEAT DIMENSIONS</p> <p>W D H</p>			<p>BACK DIMENSIONS</p> <p>W H</p>					
		42.5	30	32	39	19	18	39	14				
		RTA 00	1 per carton										
 <p>R27811</p> <p>Bariatric Lounge Chair - High Back COM Yardage: Back: 2.75; Seat: 2 Freight class: 250 Product weight: 98 Cubic feet per carton: 36</p>	<p>R27811 Base Price: \$3504</p> <p>Back upcharge: +0</p> <p>Seat upcharge: +0</p>	+0	+\$88	+\$157	+\$259	+\$402	+\$462	+\$586	+\$781	+\$927	+\$1087	+\$1419	+\$4341
	<p>For power/USB unit, see electrical placement chart. Includes ganging hardware (2 sides). Add \$70 for (SSS), \$110 for (SBS) Add \$632 for 36 lbs. (CW), (C6) Add \$138 for (SP) or \$678 for (BS) Add \$40 for (TP) Add \$188 for (MB)</p>	<p>OVERALL DIMENSIONS</p> <p>W D H</p>			<p>SEAT DIMENSIONS</p> <p>W D H</p>			<p>BACK DIMENSIONS</p> <p>W H</p>					
		39	30.5	41.5	39	19	18	39	23.5				
		RTA 00	1 per carton										





DESCRIPTION	MODEL#/ FEATURES	STANDARD TEXTILE GRADES											
		1/COM	2	3	4	5	6	7	8	9	10	11	12
 <p>R27811B</p> <p>Bariatric Lounge Chair - High Back COM Yardage: Back: 4.75; Seat: 2 Freight class: 250 Product weight: 117.5 Cubic feet per carton: 42.25</p>	R27811B	Base Price:	\$4239										
	Back/Arm upcharge:	+0	+\$152	+\$271	+\$447	+\$694	+\$798	+\$1012	+\$1349	+\$1601	+\$1877	+\$2451	+\$3055
	Seat upcharge:	+0	+\$64	+\$114	+\$188	+\$292	+\$336	+\$426	+\$568	+\$674	+\$790	+\$1032	+\$1286
	For power/USB unit, see electrical placement chart. Ganging not available.												
	Add \$70 for (SSS), \$162 for (SBS)												
	Add \$632 for 36 lbs. (CW), (C6)												
	Add \$138 for (SP) or \$678 for (BS)												
	Add \$40 for (TP)												
	Add \$188 for (MB)												
 <p>R27811L R27811R</p> <p>Bariatric Lounge Chair - High Back COM Yardage: Back: 3.75; Seat: 2 Freight class: 250 Product weight: 107.5 Cubic feet per carton: 42.25</p>	R27811L	Base Price:	\$3872										
	R27811R	Base Price:	\$3872										
	Back/Arm upcharge:	+0	+\$120	+\$214	+\$353	+\$548	+\$630	+\$799	+\$1065	+\$1264	+\$1482	+\$1935	+\$2412
	Seat upcharge:	+0	+\$64	+\$114	+\$188	+\$292	+\$336	+\$426	+\$568	+\$674	+\$790	+\$1032	+\$1286
	For power/USB unit, see electrical placement chart. Includes ganging hardware (1 side).												
	Add \$70 for (SSS), \$137 for (SBS)												
	Add \$632 for 36 lbs. (CW), (C6)												
	Add \$138 for (SP) or \$678 for (BS)												
	Add \$40 for (TP)												
	Add \$188 for (MB)												
 <p>R27812</p> <p>Bariatric Lounge Chair - Extended Back COM Yardage: Back: 3.25; Seat: 2 Freight class: 250 Product weight: 115 Cubic feet per carton: 41</p>	R27812	Base Price:	\$3709										
	Back upcharge:	+0	+\$104	+\$186	+\$306	+\$475	+\$546	+\$693	+\$923	+\$1096	+\$1284	+\$1677	+\$2090
	Seat upcharge:	+0	+\$64	+\$114	+\$188	+\$292	+\$336	+\$426	+\$568	+\$674	+\$790	+\$1032	+\$1286
	For power/USB unit, see electrical placement chart. Includes ganging hardware (2 sides).												
	Add \$70 for (SSS), \$119 for (SBS)												
	Add \$632 for 36 lbs. (CW), (C6)												
	Add \$138 for (SP) or \$678 for (BS)												
	Add \$40 for (TP)												
	Add \$188 for (MB)												
 <p>R27812B</p> <p>Bariatric Lounge Chair - Extended Back COM Yardage: Back: 5.25; Seat: 2 Freight class: 250 Product weight: 132.5 Cubic feet per carton: 47.25</p>	R27812B	Base Price:	\$4446										
	Back/Arm upcharge:	+0	+\$168	+\$300	+\$494	+\$767	+\$882	+\$1119	+\$1491	+\$1770	+\$2074	+\$2709	+\$3376
	Seat upcharge:	+0	+\$64	+\$114	+\$188	+\$292	+\$336	+\$426	+\$568	+\$674	+\$790	+\$1032	+\$1286
	For power/USB unit, see electrical placement chart. Ganging not available.												
	Add \$70 for (SSS), \$171 for (SBS)												
	Add \$632 for 36 lbs. (CW), (C6)												
	Add \$138 for (SP) or \$678 for (BS)												
	Add \$40 for (TP)												
	Add \$188 for (MB)												



DESCRIPTION	MODEL#/ FEATURES	STANDARD TEXTILE GRADES												
		1/COM	2	3	4	5	6	7	8	9	10	11	12	
 <p>R27812L</p> <p>Bariatric Lounge Chair - Extended Back COM Yardage: Back: 4.25; Seat: 2 Freight class: 250 Product weight: 122.5 Cubic feet per carton: 47.25</p>	<p>R27812R</p> <p>For power/USB unit, see electrical placement chart. Includes ganging hardware (1 side). Add \$70 for (SSS), \$145 for (SBS) Add \$632 for 36 lbs. (CW), (C6) Add \$138 for (SP) or \$678 for (BS) Add \$40 for (TP) Add \$188 for (MB)</p>	Base Price:	\$4079											
		Back/Arm upcharge:	+0	+\$136	+\$243	+\$400	+\$621	+\$714	+\$906	+\$1207	+\$1433	+\$1679	+\$2193	+\$2733
		Seat upcharge:	+0	+\$64	+\$114	+\$188	+\$292	+\$336	+\$426	+\$568	+\$674	+\$790	+\$1032	+\$1286
		OVERALL DIMENSIONS	W	D	H	SEAT DIMENSIONS			BACK DIMENSIONS					
			42.5	31	47	39	19	18	39	29				
			RTA 00		1 per carton									



DESCRIPTION	MODEL#/ FEATURES	STANDARD TEXTILE GRADES												
		1/COM	2	3	4	5	6	7	8	9	10	11	12	
 <p>R27815</p> <p>Inside Curve Two Seater - Standard Back COM Yardage: Back: 3; Seat: 2 Freight class: 250 Product weight: 93 119 shelf model Cubic feet per carton: 42.75 63.5 shelf model</p>	<p>R27815S</p> <p>For power/USB unit, see electrical placement chart. Includes ganging hardware (2 sides). Add \$86 for (SSS), \$119 for (SBS) Add \$1260 for 72 lbs. (CW), (C6) Add \$174 for (SP) or \$773 for (BS) Add \$40 for (TP) Add \$252 for (MB)</p>	Base Price:	\$3395											
		Back upcharge:	+0	+\$96	+\$171	+\$282	+\$438	+\$504	+\$639	+\$852	+\$1011	+\$1185	+\$1548	+\$1929
		Seat upcharge:	+0	+\$64	+\$114	+\$188	+\$292	+\$336	+\$426	+\$568	+\$674	+\$790	+\$1032	+\$1286
			Shelf: 52W 10D 1H											
		OVERALL DIMENSIONS	W	D	H	SEAT DIMENSIONS			BACK DIMENSIONS					
			50.5	30	32	42	19	18	51	14				
			RTA 00		1 per carton									



DESCRIPTION	MODEL#/ FEATURES	STANDARD TEXTILE GRADES												
		1/COM	2	3	4	5	6	7	8	9	10	11	12	
 <p>R27815L</p> <p>Inside Curve Two Seater - Standard Back COM Yardage: Back: 4; Seat: 2 Freight class: 250 Product weight: 102 Cubic feet per carton: 43.5</p>	<p>R27815R</p> <p>For power/USB unit, see electrical placement chart. Includes ganging hardware (1 side). Add \$86 for (SSS), \$145 for (SBS) Add \$1260 for 72 lbs. (CW), (C6) Add \$174 for (SP) or \$773 for (BS) Add \$40 for (TP) Add \$252 for (MB)</p>	Base Price:	\$3764											
		Back/Arm upcharge:	+0	+\$128	+\$228	+\$376	+\$584	+\$672	+\$852	+\$1136	+\$1348	+\$1580	+\$2064	+\$2572
		Seat upcharge:	+0	+\$64	+\$114	+\$188	+\$292	+\$336	+\$426	+\$568	+\$674	+\$790	+\$1032	+\$1286
		OVERALL DIMENSIONS	W	D	H	SEAT DIMENSIONS			BACK DIMENSIONS					
			54	30	32	42	19	18	51	14				
			RTA 00		1 per carton									



DESCRIPTION	MODEL#/ FEATURES	STANDARD TEXTILE GRADES												
		1/COM	2	3	4	5	6	7	8	9	10	11	12	
 <p>R27815SL</p> <p>Inside Curve Two Seater - Standard Back COM Yardage: Back: 4; Seat: 2 Freight class: 250 Product weight: 102 128 shelf model Cubic feet per carton: 43.5 65 shelf model</p>	<p>R27815SR</p> <p>For power/USB unit, see electrical placement chart. Includes ganging hardware (1 side). Add \$86 for (SSS), \$145 for (SBS) Add \$1260 for 72 lbs. (CW), (C6) Add \$174 for (SP) or \$773 for (BS) Add \$40 for (TP) Add \$252 for (MB)</p>	Base Price:	\$4816											
		Back/Arm upcharge:	+0	+\$128	+\$228	+\$376	+\$584	+\$672	+\$852	+\$1136	+\$1348	+\$1580	+\$2064	+\$2572
		Seat upcharge:	+0	+\$64	+\$114	+\$188	+\$292	+\$336	+\$426	+\$568	+\$674	+\$790	+\$1032	+\$1286
			Shelf: 52W 10D 1H											
		OVERALL DIMENSIONS	W	D	H	SEAT DIMENSIONS			BACK DIMENSIONS					
			61.5	40.5	32	42	19	18	51	14				
			RTA 00		1 per carton									





DESCRIPTION	MODEL#/ FEATURES	STANDARD TEXTILE GRADES												
		1/COM	2	3	4	5	6	7	8	9	10	11	12	
 <p>R27816 R27816S</p> <p>Inside Curve Two Seater - High Back COM Yardage: Back: 3.50; Seat: 2 Freight class: 300 Product weight: 106 132 shelf model Cubic feet per carton: 53.75 79.75 shelf model</p>	<p>R27816 R27816S</p> <p>For power/USB unit, see electrical placement chart. Includes ganging hardware (2 sides). Add \$86 for (SSS), \$157 for (SBS) Add \$1260 for 72 lbs. (CW), (C6) Add \$174 for (SP) or \$773 for (BS) Add \$40 for (TP) Add \$252 for (MB)</p>	Base Price:	\$4419											
		Base Price:	\$5406											
		Back upcharge:	+0	+\$112	+\$200	+\$329	+\$511	+\$588	+\$746	+\$994	+\$1180	+\$1383	+\$1806	+\$2251
		Seat upcharge:	+0	+\$64	+\$114	+\$188	+\$292	+\$336	+\$426	+\$568	+\$674	+\$790	+\$1032	+\$1286
		Shelf: 52W 10D 1H												
		OVERALL DIMENSIONS	SEAT DIMENSIONS			BACK DIMENSIONS								
		W	D	H	W	D	H	W	H					
		51	30.5	41.5	42	19	18	51	23.5					
		RTA 00	1 per carton											
 <p>R27816L R27816R</p> <p>Inside Curve Two Seater - High Back COM Yardage: Back: 4.50; Seat: 2 Freight class: 250 Product weight: 115 Cubic feet per carton: 55.5</p>	<p>R27816L R27816R</p> <p>For power/USB unit, see electrical placement chart. Includes ganging hardware (1 side). Add \$86 for (SSS), \$183 for (SBS) Add \$1260 for 72 lbs. (CW), (C6) Add \$174 for (SP) or \$773 for (BS) Add \$40 for (TP) Add \$252 for (MB)</p>	Base Price:	\$4788											
		Base Price:	\$4788											
		Back/Arm upcharge:	+0	+\$144	+\$257	+\$423	+\$657	+\$756	+\$959	+\$1278	+\$1517	+\$1778	+\$2322	+\$2894
		Seat upcharge:	+0	+\$64	+\$114	+\$188	+\$292	+\$336	+\$426	+\$568	+\$674	+\$790	+\$1032	+\$1286
		Shelf: 52W 10D 1H												
		OVERALL DIMENSIONS	SEAT DIMENSIONS			BACK DIMENSIONS								
		W	D	H	W	D	H	W	H					
		54.5	30.5	41.5	42	19	18	51	23.5					
		RTA 00	1 per carton											
 <p>R27816SL R27816SR</p> <p>Inside Curve Two Seater - High Back COM Yardage: Back: 4.50; Seat: 2 Freight class: 250 Product weight: 141.5 Cubic feet per carton: 82.5</p>	<p>R27816SL R27816SR</p> <p>For power/USB unit, see electrical placement chart. Includes ganging hardware (1 side). Add \$86 for (SSS), \$183 for (SBS) Add \$1260 for 72 lbs. (CW), (C6) Add \$174 for (SP) or \$773 for (BS) Add \$40 for (TP) Add \$252 for (MB)</p>	Base Price:	\$5775											
		Base Price:	\$5775											
		Back/Arm upcharge:	+0	+\$144	+\$257	+\$423	+\$657	+\$756	+\$959	+\$1278	+\$1517	+\$1778	+\$2322	+\$2894
		Seat upcharge:	+0	+\$64	+\$114	+\$188	+\$292	+\$336	+\$426	+\$568	+\$674	+\$790	+\$1032	+\$1286
		Shelf: 52W 10D 1H												
		OVERALL DIMENSIONS	SEAT DIMENSIONS			BACK DIMENSIONS								
		W	D	H	W	D	H	W	H					
		62	41	41.5	42	19	18	51	23.5					
		RTA 00	1 per carton											
 <p>R27817 R27817S</p> <p>Inside Curve Two Seater - Extended Back COM Yardage: Back: 4; Seat: 2 Freight class: 300 Product weight: 118 139 shelf model Cubic feet per carton: 61 90.5 shelf model</p>	<p>R27817 R27817S</p> <p>For power/USB unit, see electrical placement chart. Includes ganging hardware (2 sides). Add \$86 for (SSS), \$168 for (SBS) Add \$1260 for 72 lbs. (CW), (C6) Add \$174 for (SP) or \$773 for (BS) Add \$40 for (TP) Add \$252 for (MB)</p>	Base Price:	\$4681											
		Base Price:	\$5669											
		Back upcharge:	+0	+\$128	+\$228	+\$376	+\$584	+\$672	+\$852	+\$1136	+\$1348	+\$1580	+\$2064	+\$2572
		Seat upcharge:	+0	+\$64	+\$114	+\$188	+\$292	+\$336	+\$426	+\$568	+\$674	+\$790	+\$1032	+\$1286
		Shelf: 52W 10D 1H												
		OVERALL DIMENSIONS	SEAT DIMENSIONS			BACK DIMENSIONS								
		W	D	H	W	D	H	W	H					
		51.5	31	47	42	19	18	51	29					
		RTA 00	1 per carton											





DESCRIPTION	MODEL#/ FEATURES	STANDARD TEXTILE GRADES											
		1/COM	2	3	4	5	6	7	8	9	10	11	12
  R27817L Inside Curve Two Seater - Extended Back COM Yardage: Back: 5; Seat: 2 Freight class: 300 Product weight: 122 Cubic feet per carton: 62.25	R27817L Base Price: \$5049 R27817R Base Price: \$5049 Back/Arm upcharge: +0 Seat upcharge: +0 For power/USB unit, see electrical placement chart. Includes ganging hardware (1 side). Add \$86 for (SSS), \$195 for (SBS) Add \$1260 for 72 lbs. (CW), (C6) Add \$174 for (SP) or \$773 for (BS) Add \$40 for (TP) Add \$252 for (MB)	\$5049											
		+0	+\$160	+\$285	+\$470	+\$730	+\$840	+\$1065	+\$1420	+\$1685	+\$1975	+\$2580	+\$3215
		+0	+\$64	+\$114	+\$188	+\$292	+\$336	+\$426	+\$568	+\$674	+\$790	+\$1032	+\$1286
		OVERALL DIMENSIONS W D H			SEAT DIMENSIONS W D H			BACK DIMENSIONS W H					
		54	31	47	42	19	18	51	29				
		RTA 00		1 per carton									





DESCRIPTION	MODEL#/ FEATURES	STANDARD TEXTILE GRADES											
		1/COM	2	3	4	5	6	7	8	9	10	11	12
  R27817SL Inside Curve Two Seater - Extended Back COM Yardage: Back: 5; Seat: 2 Freight class: 300 Product weight: 149 Cubic feet per carton: 92.75	R27817SL Base Price: \$6038 R27817SR Base Price: \$6038 Back/Arm upcharge: +0 Seat upcharge: +0 For power/USB unit, see electrical placement chart. Includes ganging hardware (1 side). Add \$86 for (SSS), \$195 for (SBS) Add \$1260 for 72 lbs. (CW), (C6) Add \$174 for (SP) or \$773 for (BS) Add \$40 for (TP) Add \$252 for (MB)	\$6038											
		+0	+\$160	+\$285	+\$470	+\$730	+\$840	+\$1065	+\$1420	+\$1685	+\$1975	+\$2580	+\$3215
		+0	+\$64	+\$114	+\$188	+\$292	+\$336	+\$426	+\$568	+\$674	+\$790	+\$1032	+\$1286
		Shelf: 52W 10D 1H											
		OVERALL DIMENSIONS W D H			SEAT DIMENSIONS W D H			BACK DIMENSIONS W H					
		62.5	41.5	47	42	19	18	51	29				
		RTA 00		1 per carton									







DESCRIPTION	MODEL#/ FEATURES	STANDARD TEXTILE GRADES											
		1/COM	2	3	4	5	6	7	8	9	10	11	12
  R27818 Outside Curve Two Seater - Standard Back COM Yardage: Back: 2.25; Seat: 2 Freight class: 4.25 Product weight: 93 107 shelf model Cubic feet per carton: 42.75 63.5 shelf model	R27818 Base Price: \$3311 R27818S Base Price: \$4300 Back upcharge: +0 Seat upcharge: +0 For power/USB unit, see electrical placement chart. Includes ganging hardware (2 sides). Add \$93 for (SSS), \$104 for (SBS) Add \$1260 for 72 lbs. (CW), (C6) Add \$174 for (SP) or \$871 for (BS) Add \$40 for (TP) Add \$252 for (MB)	\$3311											
		+0	+\$72	+\$129	+\$212	+\$329	+\$378	+\$480	+\$639	+\$759	+\$889	+\$1161	+\$1447
		+0	+\$64	+\$114	+\$188	+\$292	+\$336	+\$426	+\$568	+\$674	+\$790	+\$1032	+\$1286
		Shelf: 52W 10D 1H											
		OVERALL DIMENSIONS W D H			SEAT DIMENSIONS W D H			BACK DIMENSIONS W H					
		50	30	32	50	19	18	36	14				
		RTA 00		1 per carton									

DESCRIPTION	MODEL#/ FEATURES	STANDARD TEXTILE GRADES											
		1/COM	2	3	4	5	6	7	8	9	10	11	12
  R27818L Outside Curve Two Seater - Standard Back COM Yardage: Back: 3.25; Seat: 2 Freight class: 5.25 Product weight: 102 Cubic feet per carton: 43.5	R27818L Base Price: \$3679 R27818R Base Price: \$3679 Back/Arm upcharge: +0 Seat upcharge: +0 For power/USB unit, see electrical placement chart. Includes ganging hardware (1 side). Add \$93 for (SSS), \$130 for (SBS) Add \$1260 for 72 lbs. (CW), (C6) Add \$174 for (SP) or \$871 for (BS) Add \$40 for (TP) Add \$252 for (MB)	\$3679											
		+0	+\$104	+\$186	+\$306	+\$475	+\$546	+\$693	+\$923	+\$1096	+\$1284	+\$1677	+\$2090
		+0	+\$64	+\$114	+\$188	+\$292	+\$336	+\$426	+\$568	+\$674	+\$790	+\$1032	+\$1286
		Shelf: 52W 10D 1H											
		OVERALL DIMENSIONS W D H			SEAT DIMENSIONS W D H			BACK DIMENSIONS W H					
		53.5	30	32	50	19	18	36	14				
		RTA 00		1 per carton									

DESCRIPTION	MODEL#/ FEATURES	STANDARD TEXTILE GRADES																																							
		1/COM	2	3	4	5	6	7	8	9	10	11	12																												
 <p>R27818SL</p> <p>Outside Curve Two Seater - Standard Back COM Yardage: Back 3.25; Seat: 2 Freight class: 5.25 Product weight: 116 Cubic feet per carton: 65</p>	<p>R27818SL Base Price: \$4668 R27818SR Base Price: \$4668</p> <p>Back/Arm upcharge: +0 Seat upcharge: +0</p> <p>Shelf: 52W 10D 1H</p> <p>For power/USB unit, see electrical placement chart. Includes ganging hardware (1 side). Add \$93 for (SSS), \$130 for (SBS) Add \$1260 for 72 lbs. (CW), (C6) Add \$174 for (SP) or \$871 for (BS) Add \$40 for (TP) Add \$252 for (MB)</p>																																								
		<table border="1"> <thead> <tr> <th colspan="3">OVERALL DIMENSIONS</th> <th colspan="3">SEAT DIMENSIONS</th> <th colspan="2">BACK DIMENSIONS</th> </tr> <tr> <th>W</th> <th>D</th> <th>H</th> <th>W</th> <th>D</th> <th>H</th> <th>W</th> <th>H</th> </tr> </thead> <tbody> <tr> <td>53.5</td> <td>40.5</td> <td>32</td> <td>50</td> <td>19</td> <td>18</td> <td>36</td> <td>14</td> </tr> <tr> <td colspan="3" style="text-align: center;">RTA 00</td> <td colspan="5" style="text-align: center;">1 per carton</td> <td></td> </tr> </tbody> </table>	OVERALL DIMENSIONS			SEAT DIMENSIONS			BACK DIMENSIONS		W	D	H	W	D	H	W	H	53.5	40.5	32	50	19	18	36	14	RTA 00			1 per carton											
OVERALL DIMENSIONS			SEAT DIMENSIONS			BACK DIMENSIONS																																			
W	D	H	W	D	H	W	H																																		
53.5	40.5	32	50	19	18	36	14																																		
RTA 00			1 per carton																																						
 <p>R27819</p> <p>Outside Curve Two Seater - High Back COM Yardage: Back 3.25; Seat: 2 Freight class: 300 Product weight: 101 115 shelf model Cubic feet per carton: 53.75 79.75 shelf model</p>	<p>R27819 Base Price: \$3942 R27819S Base Price: \$4932</p> <p>Back upcharge: +0 Seat upcharge: +0</p> <p>Shelf: 52W 10D 1H</p> <p>For power/USB unit, see electrical placement chart. Includes ganging hardware (2 sides). Add \$93 for (SSS), \$135 for (SBS) Add \$1260 for 72 lbs. (CW), (C6) Add \$174 for (SP) or \$871 for (BS) Add \$40 for (TP) Add \$252 for (MB)</p>																																								
		<table border="1"> <thead> <tr> <th colspan="3">OVERALL DIMENSIONS</th> <th colspan="3">SEAT DIMENSIONS</th> <th colspan="2">BACK DIMENSIONS</th> </tr> <tr> <th>W</th> <th>D</th> <th>H</th> <th>W</th> <th>D</th> <th>H</th> <th>W</th> <th>H</th> </tr> </thead> <tbody> <tr> <td>50</td> <td>30.5</td> <td>41.5</td> <td>50</td> <td>19</td> <td>18</td> <td>32</td> <td>23.5</td> </tr> <tr> <td colspan="3" style="text-align: center;">RTA 00</td> <td colspan="5" style="text-align: center;">1 per carton</td> <td></td> </tr> </tbody> </table>	OVERALL DIMENSIONS			SEAT DIMENSIONS			BACK DIMENSIONS		W	D	H	W	D	H	W	H	50	30.5	41.5	50	19	18	32	23.5	RTA 00			1 per carton											
OVERALL DIMENSIONS			SEAT DIMENSIONS			BACK DIMENSIONS																																			
W	D	H	W	D	H	W	H																																		
50	30.5	41.5	50	19	18	32	23.5																																		
RTA 00			1 per carton																																						
 <p>R27819L</p> <p>Outside Curve Two Seater - High Back COM Yardage: Back 4.25; Seat: 2 Freight class: 300 Product weight: 110 Cubic feet per carton: 55.5</p>	<p>R27819L Base Price: \$4311 R27819R Base Price: \$4311</p> <p>Back/Arm upcharge: +0 Seat upcharge: +0</p> <p>Shelf: 52W 10D 1H</p> <p>For power/USB unit, see electrical placement chart. Includes ganging hardware (1 side). Add \$93 for (SSS), \$161 for (SBS) Add \$1260 for 72 lbs. (CW), (C6) Add \$174 for (SP) or \$871 for (BS) Add \$40 for (TP) Add \$252 for (MB)</p>																																								
		<table border="1"> <thead> <tr> <th colspan="3">OVERALL DIMENSIONS</th> <th colspan="3">SEAT DIMENSIONS</th> <th colspan="2">BACK DIMENSIONS</th> </tr> <tr> <th>W</th> <th>D</th> <th>H</th> <th>W</th> <th>D</th> <th>H</th> <th>W</th> <th>H</th> </tr> </thead> <tbody> <tr> <td>53.5</td> <td>30.5</td> <td>41.5</td> <td>50</td> <td>19</td> <td>18</td> <td>32</td> <td>23.5</td> </tr> <tr> <td colspan="3" style="text-align: center;">RTA 00</td> <td colspan="5" style="text-align: center;">1 per carton</td> <td></td> </tr> </tbody> </table>	OVERALL DIMENSIONS			SEAT DIMENSIONS			BACK DIMENSIONS		W	D	H	W	D	H	W	H	53.5	30.5	41.5	50	19	18	32	23.5	RTA 00			1 per carton											
OVERALL DIMENSIONS			SEAT DIMENSIONS			BACK DIMENSIONS																																			
W	D	H	W	D	H	W	H																																		
53.5	30.5	41.5	50	19	18	32	23.5																																		
RTA 00			1 per carton																																						
 <p>R27819SL</p> <p>Outside Curve Two Seater - High Back COM Yardage: Back 4.25; Seat: 2 Freight class: 300 Product weight: 124.5 Cubic feet per carton: 82.5</p>	<p>R27819SL Base Price: \$5300 R27819SR Base Price: \$5300</p> <p>Back/Arm upcharge: +0 Seat upcharge: +0</p> <p>Shelf: 52W 10D 1H</p> <p>For power/USB unit, see electrical placement chart. Includes ganging hardware (1 side). Add \$93 for (SSS), \$161 for (SBS) Add \$1260 for 72 lbs. (CW), (C6) Add \$174 for (SP) or \$871 for (BS) Add \$40 for (TP) Add \$252 for (MB)</p>																																								
		<table border="1"> <thead> <tr> <th colspan="3">OVERALL DIMENSIONS</th> <th colspan="3">SEAT DIMENSIONS</th> <th colspan="2">BACK DIMENSIONS</th> </tr> <tr> <th>W</th> <th>D</th> <th>H</th> <th>W</th> <th>D</th> <th>H</th> <th>W</th> <th>H</th> </tr> </thead> <tbody> <tr> <td>53.5</td> <td>41</td> <td>41.5</td> <td>50</td> <td>19</td> <td>18</td> <td>32</td> <td>23.5</td> </tr> <tr> <td colspan="3" style="text-align: center;">RTA 00</td> <td colspan="5" style="text-align: center;">1 per carton</td> <td></td> </tr> </tbody> </table>	OVERALL DIMENSIONS			SEAT DIMENSIONS			BACK DIMENSIONS		W	D	H	W	D	H	W	H	53.5	41	41.5	50	19	18	32	23.5	RTA 00			1 per carton											
OVERALL DIMENSIONS			SEAT DIMENSIONS			BACK DIMENSIONS																																			
W	D	H	W	D	H	W	H																																		
53.5	41	41.5	50	19	18	32	23.5																																		
RTA 00			1 per carton																																						

DESCRIPTION		MODEL#/ FEATURES		STANDARD TEXTILE GRADES																								
				1/COM	2	3	4	5	6	7	8	9	10	11	12													
 <p>R27820</p> <p>Outside Curve Two Seater - Extended Back COM Yardage: Back 4.25; Seat: 2 Freight class: 300 Product weight: 109 120 shelf Cubic feet per carton: 61 90.5 shelf</p>	<p>R27820S</p> <p>For power/USB unit, see electrical placement chart. Includes ganging hardware (2 sides). Add \$93 for (SSS), \$144 for (SBS) Add \$1260 for 72 lbs. (CW), (C6) Add \$174 for (SP) or \$871 for (BS) Add \$40 for (TP) Add \$252 for (MB)</p>	<p>R27820 Base Price: \$4342</p> <p>R27820S Base Price: \$5250</p> <p>Back upcharge: +0 +\$136 +\$243 +\$400 +\$621 +\$714 +\$906 +\$1207 +\$1433 +\$1679 +\$2193 +\$2733</p> <p>Seat upcharge: +0 +\$64 +\$114 +\$188 +\$292 +\$336 +\$426 +\$568 +\$674 +\$790 +\$1032 +\$1286</p>	Shelf: 52W 10D 1H																									
		<p>OVERALL DIMENSIONS</p> <table border="1"> <thead> <tr> <th>W</th> <th>D</th> <th>H</th> </tr> </thead> <tbody> <tr> <td>50</td> <td>31</td> <td>47</td> </tr> </tbody> </table>			W	D	H	50	31	47	<p>SEAT DIMENSIONS</p> <table border="1"> <thead> <tr> <th>W</th> <th>D</th> <th>H</th> </tr> </thead> <tbody> <tr> <td>50</td> <td>19</td> <td>18</td> </tr> </tbody> </table>			W	D	H	50	19	18	<p>BACK DIMENSIONS</p> <table border="1"> <thead> <tr> <th>W</th> <th>H</th> </tr> </thead> <tbody> <tr> <td>28</td> <td>29</td> </tr> </tbody> </table>							W	H
W	D	H																										
50	31	47																										
W	D	H																										
50	19	18																										
W	H																											
28	29																											
<p>RTA 00 1 per carton</p>																												
 <p>R27820L</p> <p>Outside Curve Two Seater - Extended Back COM Yardage: Back 5.25; Seat: 2 Freight class: 300 Product weight: 113 Cubic feet per carton: 62.25</p>	<p>R27820R</p> <p>For power/USB unit, see electrical placement chart. Includes ganging hardware (1 side). Add \$93 for (SSS), \$170 for (SBS) Add \$1260 for 72 lbs. (CW), (C6) Add \$174 for (SP) or \$871 for (BS) Add \$40 for (TP) Add \$252 for (MB)</p>	<p>R27820L Base Price: \$4710</p> <p>R27820R Base Price: \$4710</p> <p>Back/Arm upcharge: +0 +\$168 +\$300 +\$494 +\$767 +\$882 +\$1119 +\$1491 +\$1770 +\$2074 +\$2709 +\$3376</p> <p>Seat upcharge: +0 +\$64 +\$114 +\$188 +\$292 +\$336 +\$426 +\$568 +\$674 +\$790 +\$1032 +\$1286</p>	Shelf: 52W 10D 1H																									
		<p>OVERALL DIMENSIONS</p> <table border="1"> <thead> <tr> <th>W</th> <th>D</th> <th>H</th> </tr> </thead> <tbody> <tr> <td>53.5</td> <td>31</td> <td>47</td> </tr> </tbody> </table>			W	D	H	53.5	31	47	<p>SEAT DIMENSIONS</p> <table border="1"> <thead> <tr> <th>W</th> <th>D</th> <th>H</th> </tr> </thead> <tbody> <tr> <td>50</td> <td>19</td> <td>18</td> </tr> </tbody> </table>			W	D	H	50	19	18	<p>BACK DIMENSIONS</p> <table border="1"> <thead> <tr> <th>W</th> <th>H</th> </tr> </thead> <tbody> <tr> <td>28</td> <td>29</td> </tr> </tbody> </table>							W	H
W	D	H																										
53.5	31	47																										
W	D	H																										
50	19	18																										
W	H																											
28	29																											
<p>RTA 00 1 per carton</p>																												
 <p>R27820SL</p> <p>Outside Curve Two Seater - Extended Back COM Yardage: Back 5.25; Seat: 2 Freight class: 300 Product weight: 113 130 shelf Cubic feet per carton: 62.25 92.75 shelf</p>	<p>R27820SR</p> <p>For power/USB unit, see electrical placement chart. Includes ganging hardware (1 side). Add \$93 for (SSS), \$170 for (SBS) Add \$1260 for 72 lbs. (CW), (C6) Add \$174 for (SP) or \$871 for (BS) Add \$40 for (TP) Add \$252 for (MB)</p>	<p>R27820SL Base Price: \$5620</p> <p>R27820SR Base Price: \$5620</p> <p>Back/Arm upcharge: +0 +\$168 +\$300 +\$494 +\$767 +\$882 +\$1119 +\$1491 +\$1770 +\$2074 +\$2709 +\$3376</p> <p>Seat upcharge: +0 +\$64 +\$114 +\$188 +\$292 +\$336 +\$426 +\$568 +\$674 +\$790 +\$1032 +\$1286</p>	Shelf: 52W 10D 1H																									
		<p>OVERALL DIMENSIONS</p> <table border="1"> <thead> <tr> <th>W</th> <th>D</th> <th>H</th> </tr> </thead> <tbody> <tr> <td>53.5</td> <td>41.5</td> <td>47</td> </tr> </tbody> </table>			W	D	H	53.5	41.5	47	<p>SEAT DIMENSIONS</p> <table border="1"> <thead> <tr> <th>W</th> <th>D</th> <th>H</th> </tr> </thead> <tbody> <tr> <td>50</td> <td>19</td> <td>18</td> </tr> </tbody> </table>			W	D	H	50	19	18	<p>BACK DIMENSIONS</p> <table border="1"> <thead> <tr> <th>W</th> <th>H</th> </tr> </thead> <tbody> <tr> <td>28</td> <td>29</td> </tr> </tbody> </table>							W	H
W	D	H																										
53.5	41.5	47																										
W	D	H																										
50	19	18																										
W	H																											
28	29																											
<p>RTA 00 1 per carton</p>																												
 <p>R27821</p> <p>90 Corner - Standard Back COM Yardage: Back 4; Seat: 2 Freight class: 250 Product weight: 105 137 shelf Cubic feet per carton: 35.5 63 shelf</p>	<p>R27821S</p> <p>No power/USB unit. Includes ganging hardware (2 sides). Add \$67 for (SSS), \$129 for (SBS) Add \$1260 for 72 lbs. (CW), (C6) Add \$174 for (SP) or \$871 for (BS) Add \$40 for (TP) Add \$252 for (MB)</p>	<p>R27821 Base Price: \$4379</p> <p>R27821S Base Price: \$5766</p> <p>Back upcharge: +0 +\$128 +\$228 +\$376 +\$584 +\$672 +\$852 +\$1136 +\$1348 +\$1580 +\$2064 +\$2572</p> <p>Seat upcharge: +0 +\$64 +\$114 +\$188 +\$292 +\$336 +\$426 +\$568 +\$674 +\$790 +\$1032 +\$1286</p>	Shelf: 52W 10D 1H																									
		<p>OVERALL DIMENSIONS</p> <table border="1"> <thead> <tr> <th>W</th> <th>D</th> <th>H</th> </tr> </thead> <tbody> <tr> <td>37.5</td> <td>37.5</td> <td>32</td> </tr> </tbody> </table>			W	D	H	37.5	37.5	32	<p>SEAT DIMENSIONS</p> <table border="1"> <thead> <tr> <th>W</th> <th>D</th> <th>H</th> </tr> </thead> <tbody> <tr> <td>24</td> <td>19</td> <td>18</td> </tr> </tbody> </table>			W	D	H	24	19	18	<p>BACK DIMENSIONS</p> <table border="1"> <thead> <tr> <th>W</th> <th>H</th> </tr> </thead> <tbody> <tr> <td>24</td> <td>14</td> </tr> </tbody> </table>							W	H
W	D	H																										
37.5	37.5	32																										
W	D	H																										
24	19	18																										
W	H																											
24	14																											
<p>RTA 00 1 per carton</p>																												

DESCRIPTION	MODEL#/ FEATURES	STANDARD TEXTILE GRADES												
		1/COM	2	3	4	5	6	7	8	9	10	11	12	
 <p>R27822</p> <p>90 Corner - High Back COM Yardage: Back 5.75; Seat: 2 Freight class: 250 Product weight: 119 154 shelf Cubic feet per carton: 44.5 79.24 shelf</p>	<p>R27822S</p> <p>No power/USB unit. Includes ganging hardware (2 sides). Add \$67 for (SSS), \$172 for (SBS) Add \$1260 for 72 lbs. (CW), (C6) Add \$174 for (SP) or \$871 for (BS) Add \$40 for (TP) Add \$252 for (MB)</p>	Base Price:	\$5215											
		Base Price:	\$6600											
		Back upcharge:	+0	+\$184	+\$328	+\$541	+\$840	+\$966	+\$1225	+\$1633	+\$1938	+\$2272	+\$2967	+\$3698
		Seat upcharge:	+0	+\$64	+\$114	+\$188	+\$292	+\$336	+\$426	+\$568	+\$674	+\$790	+\$1032	+\$1286
		Shelf: 52W 10D 1H												
		OVERALL DIMENSIONS	W	D	H	SEAT DIMENSIONS			BACK DIMENSIONS					
			38.5	38.5	41.5	24	19	18	24	23.5				
			RTA 00		1 per carton									
 <p>R27823</p> <p>90 Corner - Extended Back COM Yardage: Back 6.25; Seat: 2 Freight class: 250 Product weight: 128 160 shelf Cubic feet per carton: 50.5 90 shelf</p>	<p>R27823S</p> <p>No power/USB unit. Includes ganging hardware (2 sides). Add \$67 for (SSS), \$179 for (SBS) Add \$1260 for 36 lbs. (CW), (C6) Add \$174 for (SP) or \$871 for (BS) Add \$40 for (TP) Add \$252 for (MB)</p>	Base Price:	\$5735											
		Base Price:	\$7122											
		Back upcharge:	+0	+\$200	+\$357	+\$588	+\$913	+\$1050	+\$1332	+\$1775	+\$2107	+\$2469	+\$3225	+\$2733
		Seat upcharge:	+0	+\$64	+\$114	+\$188	+\$292	+\$336	+\$426	+\$568	+\$674	+\$790	+\$1032	+\$1286
		Shelf: 52W 10D 1H												
		OVERALL DIMENSIONS	W	D	H	SEAT DIMENSIONS			BACK DIMENSIONS					
			39	39	47	24	19	18	24	29				
			RTA 00		1 per carton									
 <p>R27824</p> <p>120 Corner - Standard Back COM Yardage: Back 4; Seat: 2 Freight class: 250 Product weight: 109 138 shelf Cubic feet per carton: 48.25 68.5 shelf</p>	<p>R27824S</p> <p>No power/USB unit. Includes ganging hardware (2 sides). Add \$89 for (SSS), \$126 for (SBS) Add \$1260 for 36 lbs. (CW), (C6) Add \$216 for (SP) or \$964 for (BS) Add \$40 for (TP) Add \$252 for (MB)</p>	Base Price:	\$4533											
		Base Price:	\$5922											
		Back upcharge:	+0	+\$128	+\$228	+\$376	+\$584	+\$672	+\$852	+\$1136	+\$1348	+\$1580	+\$2064	+\$2572
		Seat upcharge:	+0	+\$64	+\$114	+\$188	+\$292	+\$336	+\$426	+\$568	+\$674	+\$790	+\$1032	+\$1286
		Shelf: 52W 10D 1H												
		OVERALL DIMENSIONS	W	D	H	SEAT DIMENSIONS			BACK DIMENSIONS					
			52.5	30	32	52	19	18	52	14				
			RTA 00		1 per carton									
 <p>R27825</p> <p>120 Corner - High Back COM Yardage: Back 5.75; Seat: 2 Freight class: 300 Product weight: 118 144 shelf Cubic feet per carton: 60.5 86 shelf</p>	<p>R27825S</p> <p>No power/USB unit. Includes ganging hardware (2 sides). Add \$89 for (SSS), \$164 for (SBS) Add \$1260 for 36 lbs. (CW), (C6) Add \$216 for (SP) or \$964 for (BS) Add \$40 for (TP) Add \$252 for (MB)</p>	Base Price:	\$5304											
		Base Price:	\$6693											
		Back upcharge:	+0	+\$184	+\$328	+\$541	+\$840	+\$966	+\$1225	+\$1633	+\$1938	+\$2272	+\$2967	+\$3698
		Seat upcharge:	+0	+\$64	+\$114	+\$188	+\$292	+\$336	+\$426	+\$568	+\$674	+\$790	+\$1032	+\$1286
		Shelf: 52W 10D 1H												
		OVERALL DIMENSIONS	W	D	H	SEAT DIMENSIONS			BACK DIMENSIONS					
			53.5	30.5	41.5	41	21	18	51	23.5				
			RTA 00		1 per carton									

DESCRIPTION	MODEL#/ FEATURES	STANDARD TEXTILE GRADES											
		1/COM	2	3	4	5	6	7	8	9	10	11	12
 <p>R27826</p> <p>120 Corner - Extended Back COM Yardage: Back 6.25; Seat: 2 Freight class: 300 Product weight: 123 144 shelf Cubic feet per carton: 68.75 97.75 shelf</p>	<p>R27826 Base Price: \$5755 R27826S Base Price: \$7141</p> <p>Back upcharge: +0 +\$200 +\$357 +\$588 +\$913 +\$1050+\$1332 +\$1775 +\$2107 +\$2469 +\$3225 +\$4019 Seat upcharge: +0 +\$64 +\$114 +\$188 +\$292 +\$336 +\$426 +\$568 +\$674 +\$790 +\$1032 +\$1286</p> <p>Shelf: 52W 10D 1H</p>	OVERALL DIMENSIONS W D H			SEAT DIMENSIONS W D H			BACK DIMENSIONS W H					
		54	31.5	47	41	21	18	51	29	RTA 00 1 per carton			
<p>No power/USB unit. Includes ganging hardware (2 sides). Add \$89 for (SSS), \$175 for (SBS) Add \$1260 for 36 lbs. (CW), (C6) Add \$216 for (SP) or \$964 for (BS) Add \$40 for (TP) Add \$252 for (MB)</p>													
 <p>Loop Arm COM Yardage: N/A Freight class: 92.5 Product weight (lbs.): 6.3 Cubic feet per carton: 0.6</p>	<p>Attachment hardware included. Polished Aluminum arms sold separately (1 pc).</p> <p>Armcap finish options: (NGT) Night, (FOG) Fog, (LAB) Latte</p>	OVERALL DIMENSIONS W D H			SEAT DIMENSIONS W D H			BACK DIMENSIONS W H					
		2.5	14	19.5	-	-	-	-	-	RTA 1   1 per carton			
<p>List price</p> <p>R2770 \$332</p>													
 <p>Loop Arm w/Armcap COM Yardage: N/A Freight class: 92.5 Product weight (lbs.): 6.61 Cubic feet per carton: 0.6</p>	<p>Attachment hardware included. Polished Aluminum arms sold separately (1 pc).</p> <p>Armcap finish options: (NGT) Night, (FOG) Fog, (LAB) Latte</p>	OVERALL DIMENSIONS W D H			SEAT DIMENSIONS W D H			BACK DIMENSIONS W H					
		2.5	14	19.5	-	-	-	-	-	RTA 1   1 per carton			
<p>List price</p> <p>R2771 \$378</p>													

LOUNGE

RIVER+ BENCHES

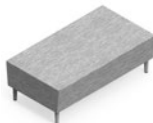

Two Seater Bench
model R27832

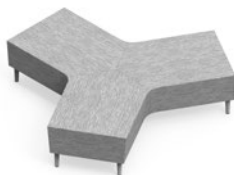

Y Bench
model R27842



42" Round Bench
model R27845

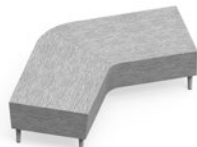

Inside Curve Boomerang Bench
model R27840

River+ Seating, Tables & Media Hearths



For River+ seating, please see page 364

For River+ tables, please see page 388

For River+ media hearths, please see page 392

EXAMPLE RIVER+ BENCH ORDER CODE:

R27832	-CE90	-S6	-AS	-CH	-	-SP
Model number	Textile	Leg selection	Leg angle	Leg finish	Additional weight	Bottom selection

-	-	-F1	-W
Sealed Seams	Moisture barrier	Power/USB position	Power finish

Additional Options specify at end of order code.	SPECIFY CODE
Tamperproof fasteners Upcharges vary, see model.	TP
Moisture barrier Upcharges vary, see model.	MB

*linking hardware is lowered to clear the staple strip.
Units will only gang with other units with sealed bottom.
**cannot be combined with linking hardware or power units

ELECTRICAL PLACEMENT

Straight benches

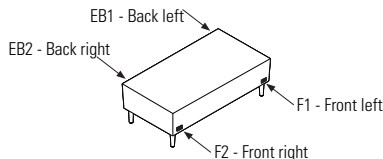

Y bench

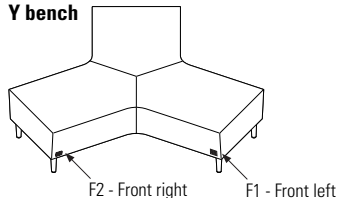

Curved benches

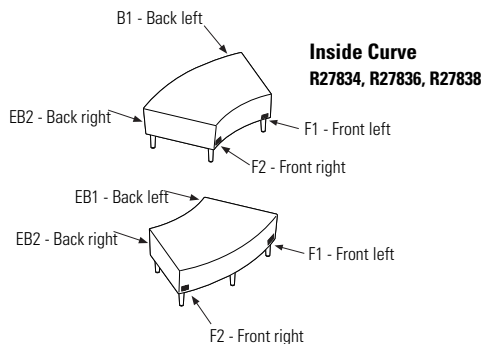

Boomerang benches

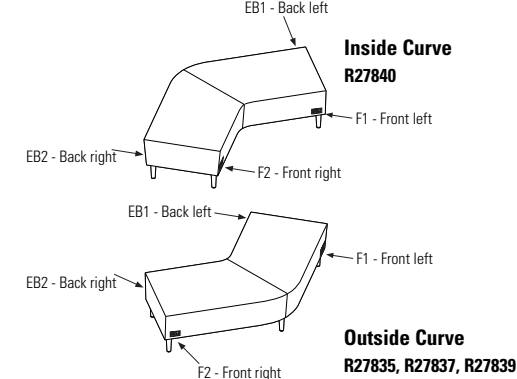

STANDARD FEATURES

- A modular series that is composed of straight, and curved sections, as well as freestanding units.
- Linking units can be used together in any combination to create a wide variety of layouts. Ganging hardware is standard and is factory installed. Ganging hardware swivels out of the way when not in use.
- The standard, 6.5" tapered legs are made of welded steel.
- Legs are straight (vertical) as standard. Linking models are optionally available with angled back legs to match River+ seating units.
- Legs include Black nylon, non-marking, height adjustable glides.
- River+ is rated for an active weight up to 600 lbs. per seat and 24/7 use.
- For 24/7 use and/or heavy duty application use, Global's Heavy Duty warranty is applicable on models specified with performance textiles, rated for 150,000 double rubs.
- Check textile availability prior to specifying upholstery material. Leather not available on River+ series.
- All units are shipped fully assembled.

OPTIONAL FEATURES

- Legs are available in 3" and 8" heights with no upcharge. All heights are available with fixed-to-floor option. Please specify. Add \$100. Fastening hardware not included.
- Steel bottom provides tamperproof protection (includes tamperproof screws). Specify **(BS)** - see each model for upcharge.**
- Up to two power units are available on straight, Y, curved and boomerang benches.
- Each power unit includes one AC outlet and two USB-a, 10-watt charging ports.
- Power location options include front or back. See electrical placement diagrams. Electrical units must be factory installed. Add \$661 per unit.
- Power units are available in either Jet Black **(J)** or White **(W)** with 120", three-prong matching cords.
- To add sealed seams to your product, specify **(SLS)** - see each model for upcharge.
- To match leg angles with lounge seating, straight front and angled back 6.5" or 8" legs are available on straight, curved, corner, and boomerang units. Specify **(SA)**. No upcharge.
- Products can be weighted to reduce the ease of movement. For additional weight options, specify **(CW)** - see each model for available additional weight and upcharge.
- The underside of the seat can be finished with PVC (vinyl) and sealed to prevent penetration of liquids. Specify **(SP)** - see each model for upcharge.*

RIVER+ BENCHES R

Please add option codes in the following order:

- Model number**
R27831 to R27833 Straight benches
R27834 to R27835 Curved benches
R27836 to R27839 Corner benches
R27840 to R27841 Boomerang benches
R27842 Y bench
R27843 to R27846 Round non-linking benches
R27847 to R27850 Square non-linking benches
- Textile**
Specify textile code.
- Leg selection**
(S6) Standard seat height (17.5"), 6.5" leg w/ adjustable glides. No upcharge.
(S3) Low seat (14"), 3" leg w/adjustable glides. No upcharge.
(S8) High seat (19"), 8" leg w/adjustable glides. No upcharge.
(F6) Standard seat height (17.5"), 6.5" leg, fixed to floor. Add \$100.
(F3) Low seat (14"), 3" leg, fixed to floor. Add \$100.
(F8) High seat (19"), 8" leg, fixed to floor. Add \$100.
- Leg angle**
(AST) Straight legs. No upcharge.
(SA) Straight front legs, angled back legs (available only for 6.5" and 8" high legs on straight, curved, corner and boomerang units). No upcharge.
- Leg finish**
(CHM) Chrome
(TDW) Designer White
(TFR) Frost
(TLA) Latte
(TNE) Nevada
(TSH) Shadow
(TTU) Tungsten
(TBL) Black
(TFO) Fog
(TIV) Cloud
(TMO) Mocha
(TOA) Toast
(TSN) Sand
- Additional weight**
(CW) Additional weight. Upcharges vary, see model.
- Bottom selection**
(SSB) Standard bottom.
(SP) Vinyl sealed bottom w/staple strip. Upcharges vary, see model.*
(BS) Steel bottom. Upcharges vary, see model.**
- Sealed seams**
(SLS) Sealed seams. Upcharges vary, see model.
- Moisture barrier**
(MB) Upcharges vary, see model.
- Power/USB unit position** (straight, curved, boomerang and Y benches only, as shown below). Add \$661 per unit.
(NP) No power (no upcharge)
(F1) Front left
(F2) Front right
(EB1) Back left
(EB2) Back right
- Power unit finish**
(J) Jet Black
(W) White
- Tamperproof fasteners**
(TP) Upcharges vary, see model.



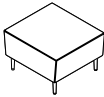
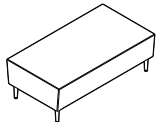
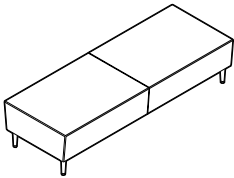
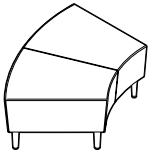
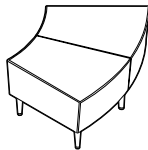

DESCRIPTION	FEATURES	MODEL#	STANDARD TEXTILE GRADES														
			1	2	3	4	5	6	7	8	9	10	11	12			
 <p>Single Seater Bench COM Yardage: 1.75 Freight class: 1.75 Product weight: 48 Cubic feet per carton: 10.5</p>	<p>For power/USB unit, see electrical placement chart.</p> <p>Includes ganging hardware (2 sides).</p> <p>Add \$69 for (SLS) Add \$100 for (F6, F3, or F8) Add \$632 for 36 lbs. (CW) Add \$80 for (SP) or \$367 for (BS) Add \$40 for (TP) Add \$127 for (MB)</p>	<p>R27831</p>	1392	1448	1492	1557	1648	1686	1765	1889	1982	2084	2295	2518			
			OVERALL DIMENSIONS			SEAT DIMENSIONS			BACK DIMENSIONS								
			W	D	H	W	D	H	W	H							
	26	28.5	17.5	-	-	-	-	-									
	RTA 00	1 per carton															
 <p>Two Seater Bench COM Yardage: 2.75 Freight class: 250 Product weight: 65 Cubic feet per carton: 20.5</p>	<p>For power/USB unit, see electrical placement chart.</p> <p>Includes ganging hardware (2 sides).</p> <p>Add \$84 for (SLS) Add \$100 for (F6, F3, or F8) Add \$1260 for 72 lbs. (CW) Add \$125 for (SP) or \$607 for (BS) Add \$40 for (TP) Add \$252 for (MB)</p>	<p>R27832</p>	2036	2124	2193	2295	2438	2498	2622	2817	2963	3123	3455	3805			
			OVERALL DIMENSIONS			SEAT DIMENSIONS			BACK DIMENSIONS								
			W	D	H	W	D	H	W	H							
	52	28.5	17.5	-	-	-	-	-									
	RTA 00	1 per carton															
 <p>Three Seater Bench COM Yardage: 4.5 Freight class: 4.5 Product weight: 103 Cubic feet per carton: 30.25</p>	<p>For power/USB unit, see electrical placement chart.</p> <p>Includes ganging hardware (2 sides).</p> <p>Add \$123 for (SLS) Add \$100 for (F6, F3, or F8) Add \$1260 for 72 lbs. (CW) Add \$174 for (SP) or \$773 for (BS) Add \$40 for (TP) Add \$375 for (MB)</p>	<p>R27833</p>	3202	3346	3459	3625	3859	3958	4161	4480	4719	4980	5524	6096			
			OVERALL DIMENSIONS			SEAT DIMENSIONS			BACK DIMENSIONS								
			W	D	H	W	D	H	W	H							
	78	28.5	17.5	-	-	-	-	-									
	RTA 00	1 per carton															
 <p>Inside Curve Two Seater Bench COM Yardage: 3 Freight class: 250 Product weight: 60 Cubic feet per carton: 22.75</p>	<p>For power/USB unit, see electrical placement chart.</p> <p>Includes ganging hardware (2 sides).</p> <p>Add \$75 for (SLS) Add \$100 for (F6, F3, or F8) Add \$1262 for 72 lbs. (CW) Add \$125 for (SP) or \$486 for (BS) Add \$49 for (TP) Add \$252 for (MB)</p>	<p>R27834</p>	2765	2861	2936	3047	3203	3269	3404	3617	3776	3950	4313	4694			
			OVERALL DIMENSIONS			SEAT DIMENSIONS			BACK DIMENSIONS								
			W	D	H	W	D	H	W	H							
	50	30.5	17.5	-	-	-	-	-									
	RTA 00	1 per carton															
 <p>Outside Curve Two Seater Bench COM Yardage: 3 Freight class: 250 Product weight: 60 Cubic feet per carton: 22.75</p>	<p>For power/USB unit, see electrical placement chart.</p> <p>Includes ganging hardware (2 sides).</p> <p>Add \$75 for (SLS) Add \$100 for (F6, F3, or F8) Add \$1263 for 72 lbs. (CW) Add \$125 for (SP) or \$486 for (BS) Add \$49 for (TP) Add \$252 for (MB)</p>	<p>R27835</p>	2765	2861	2936	3047	3203	3269	3404	3617	3776	3950	4313	4694			
			OVERALL DIMENSIONS			SEAT DIMENSIONS			BACK DIMENSIONS								
			W	D	H	W	D	H	W	H							
	50	30.5	17.5	-	-	-	-	-									
	RTA 00	1 per carton															

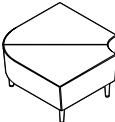
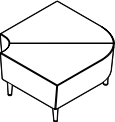
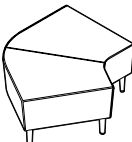
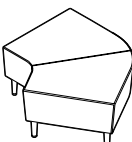
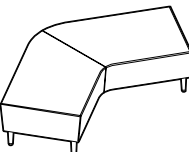
Options: (SLS) Sealed seams
(F6, F3, F8) Floor mount legs
(CW) Counterweight
(SP) Vinyl sealed bottom
(BS) Steel bottom
(TP) Tamperproof
(MB) Moisture barrier

DESCRIPTION	FEATURES	MODEL#	STANDARD TEXTILE GRADES													
			1	2	3	4	5	6	7	8	9	10	11	12		
 <p>90° Inside Curve Corner Bench COM Yardage: 3.25 Freight class: 250 Product weight: 60 Cubic feet per carton: 17.25</p>	<p>For power/USB unit, see electrical placement chart.</p> <p>Includes ganging hardware (2 sides).</p> <p>Add \$75 for (SLS) Add \$100 for (F6, F3, or F8) Add \$632 for 36 lbs. (CW) Add \$145 for (SP) or \$565 for (BS) Add \$49 for (TP) Add \$252 for (MB)</p>	R27836	2758	2862	2944	3064	3233	3304	3451	3681	3854	4042	4435	4848		
		OVERALL DIMENSIONS			SEAT DIMENSIONS			BACK DIMENSIONS								
		W	D	H	W	D	H	W	H							
		36.5	36.5	17.5	-	-	-	-	-							
			RTA 00	1 per carton												
 <p>90° Outside Curve Corner Bench COM Yardage: 3.25 Freight class: 250 Product weight: 60 Cubic feet per carton: 17.25</p>	<p>For power/USB unit, see electrical placement chart.</p> <p>Includes ganging hardware (2 sides).</p> <p>Add \$75 for (SLS) Add \$100 for (F6, F3, or F8) Add \$633 for 36 lbs. (CW) Add \$145 for (SP) or \$565 for (BS) Add \$49 for (TP) Add \$252 for (MB)</p>	R27837	2758	2862	2944	3064	3233	3304	3451	3681	3854	4042	4435	4848		
		OVERALL DIMENSIONS			SEAT DIMENSIONS			BACK DIMENSIONS								
		W	D	H	W	D	H	W	H							
		36.5	36.5	17.5	-	-	-	-	-							
			RTA 00	1 per carton												
 <p>120° Inside Curve Corner Bench COM Yardage: 3.5 Freight class: 250 Product weight: 57 Cubic feet per carton: 26.75</p>	<p>For power/USB unit, see electrical placement chart.</p> <p>Includes ganging hardware (2 sides).</p> <p>Add \$79 for (SLS) Add \$100 for (F6, F3, or F8) Add \$634 for 36 lbs. (CW) Add \$138 for (SP) or \$621 for (BS) Add \$49 for (TP) Add \$252 for (MB)</p>	R27838	2758	2870	2958	3087	3269	3346	3504	3752	3938	4141	4564	5009		
		OVERALL DIMENSIONS			SEAT DIMENSIONS			BACK DIMENSIONS								
		W	D	H	W	D	H	W	H							
		36.5	51.5	17.5	-	-	-	-	-							
			RTA 00	1 per carton												
 <p>120° Outside Curve Corner Bench COM Yardage: 3.5 Freight class: 250 Product weight: 57 Cubic feet per carton: 26.75</p>	<p>For power/USB unit, see electrical placement chart.</p> <p>Includes ganging hardware (2 sides).</p> <p>Add \$79 for (SLS) Add \$100 for (F6, F3, or F8) Add \$636 for 36 lbs. (CW) Add \$138 for (SP) or \$621 for (BS) Add \$49 for (TP) Add \$252 for (MB)</p>	R27839	2758	2870	2958	3087	3269	3346	3504	3752	3938	4141	4564	5009		
		OVERALL DIMENSIONS			SEAT DIMENSIONS			BACK DIMENSIONS								
		W	D	H	W	D	H	W	H							
		36.5	51.5	17.5	-	-	-	-	-							
			RTA 00	1 per carton												
 <p>Inside Curve Boomerang Bench COM Yardage: 5.25 Freight class: 250 Product weight: 126 Cubic feet per carton: 47.75</p>	<p>For power/USB unit, see electrical placement chart.</p> <p>Includes ganging hardware (2 sides).</p> <p>Add \$117 for (SLS) Add \$100 for (F6, F3, or F8) Add \$1260 for 72 lbs. (CW) Add \$202 for (SP) or \$1092 for (BS) Add \$49 for (TP) Add \$375 for (MB)</p>	R27840	4266	4434	4566	4760	5033	5148	5385	5757	6036	6340	6975	7642		
		OVERALL DIMENSIONS			SEAT DIMENSIONS			BACK DIMENSIONS								
		W	D	H	W	D	H	W	H							
		82	45	17.5	-	-	-	-	-							
			RTA 00	1 per carton												

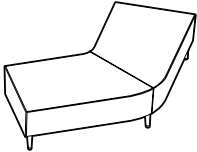
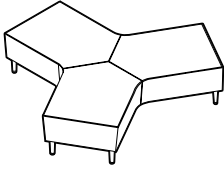
Options: **(SLS)** Sealed seams
(F6, F3, F8) Floor mount legs
(CW) Counterweight
(SP) Vinyl sealed bottom
(BS) Steel bottom
(TP) Tamperproof
(MB) Moisture barrier

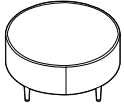
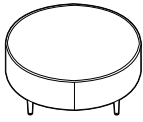
DESCRIPTION	FEATURES	MODEL#	STANDARD TEXTILE GRADES														
			1	2	3	4	5	6	7	8	9	10	11	12			
 <p>Outside Curve Boomerang Bench COM Yardage: 5.25 Freight class: 250 Product weight: 126 Cubic feet per carton: 47.75</p>	<p>For power/USB unit, see electrical placement chart.</p> <p>Includes ganging hardware (2 sides).</p> <p>Add \$117 for (SLS) Add \$100 for (F6, F3, or F8) Add \$1260 for 72 lbs. (CW) Add \$202 for (SP) or \$1092 for (BS) Add \$49 for (TP) Add \$375 for (MB)</p>	<p>R27841</p>	4266	4434	4566	4760	5033	5148	5385	5757	6036	6340	6975	7642			
			OVERALL DIMENSIONS			SEAT DIMENSIONS			BACK DIMENSIONS								
			W	D	H	W	D	H	W	H							
			82	45	17.5	-	-	-	-	-							
			RTA 00	1 per carton													
 <p>Y Bench COM Yardage: 8 Freight class: 250 Product weight: 203 Cubic feet per carton: 101.2</p>	<p>For power/USB unit, see electrical placement chart.</p> <p>Includes ganging hardware (2 sides).</p> <p>Add \$195 for (SLS) Add \$100 for (F6, F3, or F8) Add \$945 for 54 lbs. (CW) Add \$303 for (SP) or \$1354 for (BS) Add \$69 for (TP) Add \$501 for (MB)</p>	<p>R27842</p>	6870	7126	7326	7622	8038	8214	8574	9142	9566	10030	10998	12014			
			OVERALL DIMENSIONS			SEAT DIMENSIONS			BACK DIMENSIONS								
			W	D	H	W	D	H	W	H							
			82	70	17.5	-	-	-	-	-							
			RTA 00	1 per carton													
 <p>18" Dia. Round Bench COM Yardage: 1 Freight class: 150 Product weight: 25 Cubic feet per carton: 4.7</p>	<p>No power/USB unit.</p> <p>Freestanding unit only.</p> <p>Add \$46 for (SLS) Add \$100 for (F6, F3, or F8) Not available (CW) Add \$117 for (SP), (BS) not available Add \$40 for (TP) Add \$127 for (MB)</p>	<p>R27843</p>	853	885	910	947	999	1021	1066	1137	1190	1248	1369	1496			
			OVERALL DIMENSIONS			SEAT DIMENSIONS			BACK DIMENSIONS								
			W	D	H	W	D	H	W	H							
			18	18	17.5	-	-	-	-	-							
			RTA 00	1 per carton													
 <p>36" Dia. Round Bench COM Yardage: 3.25 Freight class: 250 Product weight: 50 Cubic feet per carton: 18.25</p>	<p>No power/USB unit.</p> <p>Freestanding unit only.</p> <p>Add \$69 for (SLS) Add \$100 for (F6, F3, or F8) Add \$632 for 36 lbs. (CW) Add \$182 for (SP) or \$621 for (BS) Add \$40 for (TP) Add \$127 for (MB)</p>	<p>R27844</p>	2043	2147	2229	2349	2518	2589	2736	2966	3139	3327	3720	4133			
			OVERALL DIMENSIONS			SEAT DIMENSIONS			BACK DIMENSIONS								
			W	D	H	W	D	H	W	H							
			36	36	17.5	-	-	-	-	-							
			RTA 00	1 per carton													
 <p>42" Dia. Round Bench COM Yardage: 3.5 Freight class: 250 Product weight: 55 Cubic feet per carton: 23</p>	<p>No power/USB unit.</p> <p>Freestanding unit only.</p> <p>Add \$75 for (SLS) Add \$100 for (F6, F3, or F8) Add \$1260 for 72 lbs. (CW) Add \$202 for (SP) or \$686 for (BS) Add \$40 for (TP) Add \$252 for (MB)</p>	<p>R27845</p>	2351	2463	2551	2680	2862	2939	3097	3345	3531	3734	4157	4602			
			OVERALL DIMENSIONS			SEAT DIMENSIONS			BACK DIMENSIONS								
			W	D	H	W	D	H	W	H							
			42	42	17.5	-	-	-	-	-							
			RTA 00	1 per carton													

Options: (SLS) Sealed seams (F6, F3, F8) Floor mount legs (CW) Counterweight (SP) Vinyl sealed bottom (BS) Steel bottom (TP) Tamperproof (MB) Moisture barrier

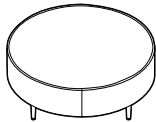
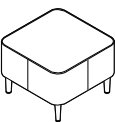
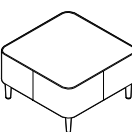
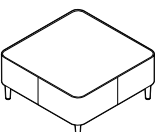
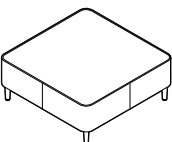
DESCRIPTION	FEATURES	MODEL#	STANDARD TEXTILE GRADES													
			1	2	3	4	5	6	7	8	9	10	11	12		
 <p>48" Dia. Round Bench COM Yardage: 3.75 Freight class: 250 Product weight: 65 Cubic feet per carton: 30</p>	No power/USB unit. Freestanding unit only. Add \$84 for (SLS) Add \$100 for (F6, F3, or F8) Add \$1260 for 72 lbs. (CW) Add \$224 for (SP) or \$729 for (BS) Add \$40 for (TP) Add \$375 for (MB)	R27846	2651	2771	2865	3004	3199	3281	3450	3716	3915	4133	4586	5063		
		OVERALL DIMENSIONS			SEAT DIMENSIONS			BACK DIMENSIONS								
		W	D	H	W	D	H	W	H							
		48	48	17.5	-	-	-	-	-							
			RTA 00	1 per carton												
 <p>24" Square Bench COM Yardage: 1.5 Freight class: 250 Product weight: 30 Cubic feet per carton: 8</p>	No power/USB unit. Freestanding unit only. Add \$60 for (SLS) Add \$100 for (F6, F3, or F8) Add \$632 for 36 lbs. (CW) Add \$125 for (SP) or \$281 for (BS) Add \$40 for (TP) Add \$127 for (MB)	R27847	1165	1213	1251	1306	1384	1417	1485	1591	1671	1758	1939	2130		
		OVERALL DIMENSIONS			SEAT DIMENSIONS			BACK DIMENSIONS								
		W	D	H	W	D	H	W	H							
		24	24	17.5	-	-	-	-	-							
			RTA 00	1 per carton												
 <p>30" Square Bench COM Yardage: 2.75 Freight class: 250 Product weight: 40 Cubic feet per carton: 12.25</p>	No power/USB unit. Freestanding unit only. Add \$69 for (SLS) Add \$100 for (F6, F3, or F8) Add \$632 for 36 lbs. (CW) Add \$174 for (SP) or \$196 for (BS) Add \$40 for (TP) Add \$127 for (MB)	R27848	1538	1626	1695	1797	1940	2000	2124	2319	2465	2625	2957	3307		
		OVERALL DIMENSIONS			SEAT DIMENSIONS			BACK DIMENSIONS								
		W	D	H	W	D	H	W	H							
		30	30	17.5	-	-	-	-	-							
			RTA 00	1 per carton												
 <p>36" Square Bench COM Yardage: 3 Freight class: 250 Product weight: 50 Cubic feet per carton: 18.25</p>	No power/USB unit. Freestanding unit only. Add \$75 for (SLS) Add \$100 for (F6, F3, or F8) Add \$1260 for 72 lbs. (CW) Add \$187 for (SP) or \$457 for (BS) Add \$40 for (TP) Add \$252 for (MB)	R27849	1917	2013	2088	2199	2355	2421	2556	2769	2928	3102	3465	3846		
		OVERALL DIMENSIONS			SEAT DIMENSIONS			BACK DIMENSIONS								
		W	D	H	W	D	H	W	H							
		36	36	17.5	-	-	-	-	-							
			RTA 00	1 per carton												
 <p>42" Square Bench COM Yardage: 3.25 Freight class: 250 Product weight: 60 Cubic feet per carton: 23</p>	No power/USB unit. Freestanding unit only. Add \$86 for (SLS) Add \$100 for (F6, F3, or F8) Add \$1260 for 72 lbs. (CW) Add \$208 for (SP) or \$637 for (BS) Add \$40 for (TP) Add \$375 for (MB)	R27850	2329	2433	2515	2635	2804	2875	3022	3252	3425	3613	4006	4419		
		OVERALL DIMENSIONS			SEAT DIMENSIONS			BACK DIMENSIONS								
		W	D	H	W	D	H	W	H							
		42	42	17.5	-	-	-	-	-							
			RTA 00	1 per carton												

Options: **(SLS)** Sealed seams
(F6, F3, F8) Floor mount legs
(CW) Counterweight
(SP) Vinyl sealed bottom
(BS) Steel bottom
(TP) Tamperproof
(MB) Moisture barrier

RIVER+ TABLES

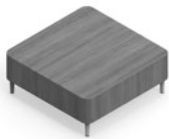

42" Square Coffee Table
model R27858



Outside Curve End Table
model R27864



18" Dia. Round Laptop Table
model 7743

River+ Seating, Benches & Media Hearths



For River+ seating, please see page 364
For River+ benches, please see page 383
For River+ media hearths, please see page 392

STANDARD FEATURES

- A modular series that is composed of straight and curved sections, as well as freestanding units.
- Linking units can be used together in any combination with River+ seating and bench units to create a wide variety of layouts. Ganging hardware is standard and is factory installed. Ganging hardware swivels out of the way when not in use.
- Front and back faces of end (linking) tables angles slightly inwards. This inward slant matches the inward angles of River seating so all units coordinate in visual appearance.
- The standard 6.5", welded steel legs are straight (vertical) as standard. Linking models are optionally available with an angled back leg to visually align with River+ seating units.
- Legs include Black nylon, non-marking, height adjustable glides.
- Tables are made with high pressure laminate. Custom high pressure laminate finishes will be considered upon request.
- Laptop tables have 1" thick laminate tops.
- Laptop table painted metal base finishes are available in Black and Tungsten only.

OPTIONAL FEATURES

- Legs of coffee and end (linking) tables are available in 3" (**S3**) and 8" (**S8**) heights. All leg heights are available with fixed-to-floor (**F3**) and (**F8**) options. Add \$100.
- To match adjacent lounge seating, straight front and angled back 6.5" or 8" legs are available on linking/end tables. Specify (**SA**). No upcharge.
- Power units are available on all tables except laptop tables. Each unit includes one AC outlet and two USB-a,10 watt charging ports. Add \$661 upcharge per unit.
- Power location options include top, front or end. See electrical placement diagrams. Electrical units must be factory installed.
- Power units are available in either Jet Black (**J**) or White (**W**) with 120", three-prong matching cords.
- Most products can be weighted to reduce the ease of movement. For additional weight options, specify (**CW**). See each model for available additional weight and upcharge.

Please add option codes in the following order:

- **Model number**
R27855 to R27858 Square coffee tables
R27859 Rectangular coffee table
R27860 to R27861 Round coffee tables
R27862 to R27864 Linking/end tables
7443 and 7745 Freestanding tables
- **Laminate finishes**
(ACJ) Absolute Acajou **(ASN)** Asian Night
(AWC) Avant Cherry **(AWH)** Avant Honey
(BLK) Black **(BRC)** Brushed Cobalt
(BZD) Blizzard **(CGY)** Custom Grey
(CMB) Clear Maple **(DES)** Dark Espresso
(DWT) Designer White **(FAS)** Fashionista
(FCL) First Class
(NBL) Noce Biondo **(NGL)** Noce Grigio
(NEL) Noce Leggero **(NML)** Noce Medio
(QTM) Quartered Mahogany
(SBY) Sheer Beauty **(SDT)** Stonedust
(SOG) Storm Grey **(WCR)** Winter Cherry
(WHC) White Chocolate **(WHE)** Walnut Heights (colors shown on website)
- **Leg selection**
(S6) Standard height (6.5") w/adjustable glides. No upcharge.
(S3) Low (3") w/adjustable glides. No upcharge.
(S8) High (8") w/adjustable glides. No upcharge.
(F6) Standard height (6.5"), fixed to floor. Add \$100.
(F3) Low (3"), fixed to floor. Add \$100.
(F8) High (8"), fixed to floor. Add \$100.
- **Leg angle** (linking/end tables only)
(AST) Straight legs. No upcharge.
(SA) Straight front legs, angled back legs. No upcharge.
- **Leg finish**
(CHM) Chrome **(TBL)** Black
(TDW) Designer White **(TFO)** Fog
(TFR) Frost **(TIV)** Cloud
(TLA) Latte **(TMO)** Mocha
(TNE) Nevada **(TOA)** Toast
(TSH) Shadow **(TSN)** Sand
(TTU) Tungsten
- **Additional weight**
(CW) Additional weight. Upcharges vary, see model.
- **Power/USB unit position** (coffee and linking/end tables only, as shown below).
Add \$661 per unit.
(NP) No power (no upcharge)
(LE1) Left end (coffee table only)
(LE2) Right end (coffee table only)
(F3) Front center (coffee table only)
(T1) Top
- **Power unit finish**
(J) Jet Black
(W) White
- **(TP) Tamperproof fasteners.** Add \$160.

EXAMPLE RIVER+ TABLE ORDER CODE:

R27858	-ACJ	-S6	-AS	-CM	-	-T1	-W	-
Model number	Laminate	Leg selection	Leg angle	Leg finish	Additional weight	Power/USB	Power finish	Fasteners

ELECTRICAL PLACEMENT

Coffee Tables

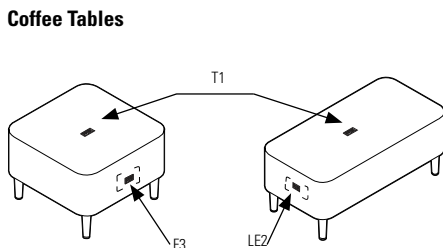

Linking Tables

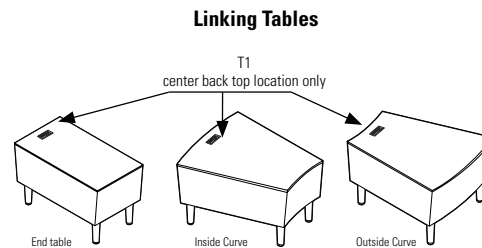

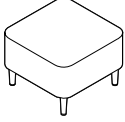
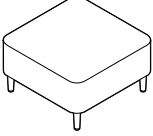
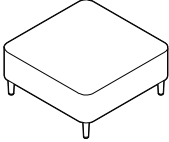
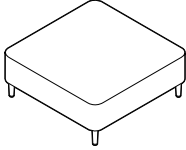
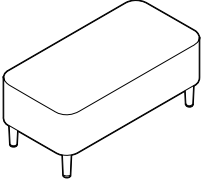
DESCRIPTION	FEATURES	MODEL#	STANDARD TEXTILE GRADES																							
 <p>24" Square Coffee Table COM: N/A Freight class: 250 Product weight: 40 Cubic feet per carton: 10.7</p>	<p>For power/USB unit, see electrical placement chart.</p> <p>Freestanding unit only. Add \$511 for 36 lbs. (CW)</p>	List price																								
		R27855	1484																							
		<table border="1"> <thead> <tr> <th colspan="3">OVERALL DIMENSIONS</th> <th colspan="3">SEAT DIMENSIONS</th> <th colspan="2">BACK DIMENSIONS</th> </tr> <tr> <th>W</th> <th>D</th> <th>H</th> <th>W</th> <th>D</th> <th>H</th> <th>W</th> <th>H</th> </tr> </thead> <tbody> <tr> <td>24</td> <td>24</td> <td>17</td> <td>-</td> <td>-</td> <td>-</td> <td>-</td> <td>-</td> </tr> </tbody> </table>			OVERALL DIMENSIONS			SEAT DIMENSIONS			BACK DIMENSIONS		W	D	H	W	D	H	W	H	24	24	17	-	-	-
OVERALL DIMENSIONS			SEAT DIMENSIONS			BACK DIMENSIONS																				
W	D	H	W	D	H	W	H																			
24	24	17	-	-	-	-	-																			
 <p>30" Square Coffee Table COM: N/A Freight class: 250 Product weight: 53 Cubic feet per carton: 15.3</p>	<p>For power/USB unit, see electrical placement chart.</p> <p>Freestanding unit only. Add \$383 for 27 lbs. (CW)</p>	List price																								
		R27856	1563																							
		<table border="1"> <thead> <tr> <th colspan="3">OVERALL DIMENSIONS</th> <th colspan="3">SEAT DIMENSIONS</th> <th colspan="2">BACK DIMENSIONS</th> </tr> <tr> <th>W</th> <th>D</th> <th>H</th> <th>W</th> <th>D</th> <th>H</th> <th>W</th> <th>H</th> </tr> </thead> <tbody> <tr> <td>30</td> <td>30</td> <td>17</td> <td>-</td> <td>-</td> <td>-</td> <td>-</td> <td>-</td> </tr> </tbody> </table>			OVERALL DIMENSIONS			SEAT DIMENSIONS			BACK DIMENSIONS		W	D	H	W	D	H	W	H	30	30	17	-	-	-
OVERALL DIMENSIONS			SEAT DIMENSIONS			BACK DIMENSIONS																				
W	D	H	W	D	H	W	H																			
30	30	17	-	-	-	-	-																			
 <p>36" Square Coffee Table COM: N/A Freight class: 250 Product weight: 75 Cubic feet per carton: 20.6</p>	<p>For power/USB unit, see electrical placement chart.</p> <p>Freestanding unit only. No counterweight.</p>	List price																								
		R27857	1791																							
		<table border="1"> <thead> <tr> <th colspan="3">OVERALL DIMENSIONS</th> <th colspan="3">SEAT DIMENSIONS</th> <th colspan="2">BACK DIMENSIONS</th> </tr> <tr> <th>W</th> <th>D</th> <th>H</th> <th>W</th> <th>D</th> <th>H</th> <th>W</th> <th>H</th> </tr> </thead> <tbody> <tr> <td>36</td> <td>36</td> <td>17</td> <td>-</td> <td>-</td> <td>-</td> <td>-</td> <td>-</td> </tr> </tbody> </table>			OVERALL DIMENSIONS			SEAT DIMENSIONS			BACK DIMENSIONS		W	D	H	W	D	H	W	H	36	36	17	-	-	-
OVERALL DIMENSIONS			SEAT DIMENSIONS			BACK DIMENSIONS																				
W	D	H	W	D	H	W	H																			
36	36	17	-	-	-	-	-																			
 <p>42" Square Coffee Table COM: N/A Freight class: 150 Product weight: 115 Cubic feet per carton: 26.7</p>	<p>For power/USB unit, see electrical placement chart.</p> <p>Freestanding unit only. No counterweight.</p>	List price																								
		R27858	1991																							
		<table border="1"> <thead> <tr> <th colspan="3">OVERALL DIMENSIONS</th> <th colspan="3">SEAT DIMENSIONS</th> <th colspan="2">BACK DIMENSIONS</th> </tr> <tr> <th>W</th> <th>D</th> <th>H</th> <th>W</th> <th>D</th> <th>H</th> <th>W</th> <th>H</th> </tr> </thead> <tbody> <tr> <td>42</td> <td>42</td> <td>17</td> <td>-</td> <td>-</td> <td>-</td> <td>-</td> <td>-</td> </tr> </tbody> </table>			OVERALL DIMENSIONS			SEAT DIMENSIONS			BACK DIMENSIONS		W	D	H	W	D	H	W	H	42	42	17	-	-	-
OVERALL DIMENSIONS			SEAT DIMENSIONS			BACK DIMENSIONS																				
W	D	H	W	D	H	W	H																			
42	42	17	-	-	-	-	-																			
 <p>Rectangular Coffee Table COM: N/A Freight class: 250 Product weight: 55 Cubic feet per carton: 14.2</p>	<p>For power/USB unit, see electrical placement chart.</p> <p>Freestanding unit only. Add 256 for 18 lbs. (CW)</p>	List price																								
		R27859	1626																							
		<table border="1"> <thead> <tr> <th colspan="3">OVERALL DIMENSIONS</th> <th colspan="3">SEAT DIMENSIONS</th> <th colspan="2">BACK DIMENSIONS</th> </tr> <tr> <th>W</th> <th>D</th> <th>H</th> <th>W</th> <th>D</th> <th>H</th> <th>W</th> <th>H</th> </tr> </thead> <tbody> <tr> <td>40</td> <td>20</td> <td>17</td> <td>-</td> <td>-</td> <td>-</td> <td>-</td> <td>-</td> </tr> </tbody> </table>			OVERALL DIMENSIONS			SEAT DIMENSIONS			BACK DIMENSIONS		W	D	H	W	D	H	W	H	40	20	17	-	-	-
OVERALL DIMENSIONS			SEAT DIMENSIONS			BACK DIMENSIONS																				
W	D	H	W	D	H	W	H																			
40	20	17	-	-	-	-	-																			

Options: (CW) Counterweight

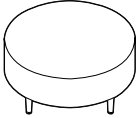
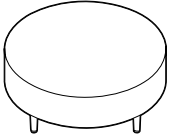
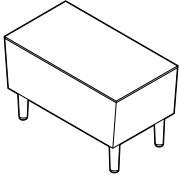
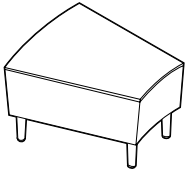
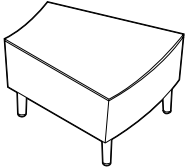
DESCRIPTION	FEATURES	MODEL#	STANDARD TEXTILE GRADES																											
 <p>36" Dia. Round Coffee Table COM: N/A Freight class: 150 Product weight: 63 Cubic feet per carton: 15.3</p>	<p>For power/USB unit, see electrical placement chart.</p> <p>Freestanding unit only. Add \$256 for 18 lbs. (CW)</p>	List price																												
		R27860	1927																											
		<table border="1"> <thead> <tr> <th colspan="3">OVERALL DIMENSIONS</th> <th colspan="3">SEAT DIMENSIONS</th> <th colspan="2">BACK DIMENSIONS</th> </tr> <tr> <th>W</th> <th>D</th> <th>H</th> <th>W</th> <th>D</th> <th>H</th> <th>W</th> <th>H</th> </tr> </thead> <tbody> <tr> <td>36</td> <td>36</td> <td>17</td> <td>-</td> <td>-</td> <td>-</td> <td>-</td> <td>-</td> </tr> </tbody> </table>		OVERALL DIMENSIONS			SEAT DIMENSIONS			BACK DIMENSIONS		W	D	H	W	D	H	W	H	36	36	17	-	-	-	-	-	<table border="1"> <thead> <tr> <th colspan="2">RTA 00</th> </tr> </thead> <tbody> <tr> <td>1 per carton</td> </tr> </tbody> </table>		RTA 00
OVERALL DIMENSIONS			SEAT DIMENSIONS			BACK DIMENSIONS																								
W	D	H	W	D	H	W	H																							
36	36	17	-	-	-	-	-																							
RTA 00																														
1 per carton																														
 <p>42" Dia. Round Coffee Table COM: N/A Freight class: 150 Product weight: 85 Cubic feet per carton: 20.6</p>	<p>For power/USB unit, see electrical placement chart.</p> <p>Freestanding unit only. No counterweight.</p>	List price																												
		R27861	2113																											
		<table border="1"> <thead> <tr> <th colspan="3">OVERALL DIMENSIONS</th> <th colspan="3">SEAT DIMENSIONS</th> <th colspan="2">BACK DIMENSIONS</th> </tr> <tr> <th>W</th> <th>D</th> <th>H</th> <th>W</th> <th>D</th> <th>H</th> <th>W</th> <th>H</th> </tr> </thead> <tbody> <tr> <td>42</td> <td>42</td> <td>17</td> <td>-</td> <td>-</td> <td>-</td> <td>-</td> <td>-</td> </tr> </tbody> </table>		OVERALL DIMENSIONS			SEAT DIMENSIONS			BACK DIMENSIONS		W	D	H	W	D	H	W	H	42	42	17	-	-	-	-	-	<table border="1"> <thead> <tr> <th colspan="2">RTA 00</th> </tr> </thead> <tbody> <tr> <td>1 per carton</td> </tr> </tbody> </table>		RTA 00
OVERALL DIMENSIONS			SEAT DIMENSIONS			BACK DIMENSIONS																								
W	D	H	W	D	H	W	H																							
42	42	17	-	-	-	-	-																							
RTA 00																														
1 per carton																														
 <p>Rectangular End Table COM: N/A Freight class: 300 Product weight: 40 Cubic feet per carton: 20.6</p>	<p>For power/USB unit, see electrical placement chart.</p> <p>Includes ganging hardware (2 sides). Add \$511 for 36 lbs. (CW)</p>	List price																												
		R27862	1578																											
		<table border="1"> <thead> <tr> <th colspan="3">OVERALL DIMENSIONS</th> <th colspan="3">SEAT DIMENSIONS</th> <th colspan="2">BACK DIMENSIONS</th> </tr> <tr> <th>W</th> <th>D</th> <th>H</th> <th>W</th> <th>D</th> <th>H</th> <th>W</th> <th>H</th> </tr> </thead> <tbody> <tr> <td>28</td> <td>15</td> <td>17</td> <td>-</td> <td>-</td> <td>-</td> <td>-</td> <td>-</td> </tr> </tbody> </table>		OVERALL DIMENSIONS			SEAT DIMENSIONS			BACK DIMENSIONS		W	D	H	W	D	H	W	H	28	15	17	-	-	-	-	-	<table border="1"> <thead> <tr> <th colspan="2">RTA 00</th> </tr> </thead> <tbody> <tr> <td>1 per carton</td> </tr> </tbody> </table>		RTA 00
OVERALL DIMENSIONS			SEAT DIMENSIONS			BACK DIMENSIONS																								
W	D	H	W	D	H	W	H																							
28	15	17	-	-	-	-	-																							
RTA 00																														
1 per carton																														
 <p>Inside Curve End Table COM: N/A Freight class: 250 Product weight: 47 Cubic feet per carton: 13.3</p>	<p>For power/USB unit, see electrical placement chart.</p> <p>Includes ganging hardware (2 sides). Add \$511 for 36 lbs. (CW)</p>	List price																												
		R27863	2073																											
		<table border="1"> <thead> <tr> <th colspan="3">OVERALL DIMENSIONS</th> <th colspan="3">SEAT DIMENSIONS</th> <th colspan="2">BACK DIMENSIONS</th> </tr> <tr> <th>W</th> <th>D</th> <th>H</th> <th>W</th> <th>D</th> <th>H</th> <th>W</th> <th>H</th> </tr> </thead> <tbody> <tr> <td>28</td> <td>17</td> <td>17</td> <td>-</td> <td>-</td> <td>-</td> <td>-</td> <td>-</td> </tr> </tbody> </table>		OVERALL DIMENSIONS			SEAT DIMENSIONS			BACK DIMENSIONS		W	D	H	W	D	H	W	H	28	17	17	-	-	-	-	-	<table border="1"> <thead> <tr> <th colspan="2">RTA 00</th> </tr> </thead> <tbody> <tr> <td>1 per carton</td> </tr> </tbody> </table>		RTA 00
OVERALL DIMENSIONS			SEAT DIMENSIONS			BACK DIMENSIONS																								
W	D	H	W	D	H	W	H																							
28	17	17	-	-	-	-	-																							
RTA 00																														
1 per carton																														
 <p>Outside Curve End Table COM: N/A Freight class: 250 Product weight: 47 Cubic feet per carton: 13.3</p>	<p>For power/USB unit, see electrical placement chart.</p> <p>Includes ganging hardware (2 sides). Add \$511 for 36 lbs. (CW)</p>	List price																												
		R27864	2073																											
		<table border="1"> <thead> <tr> <th colspan="3">OVERALL DIMENSIONS</th> <th colspan="3">SEAT DIMENSIONS</th> <th colspan="2">BACK DIMENSIONS</th> </tr> <tr> <th>W</th> <th>D</th> <th>H</th> <th>W</th> <th>D</th> <th>H</th> <th>W</th> <th>H</th> </tr> </thead> <tbody> <tr> <td>28</td> <td>17</td> <td>17</td> <td>-</td> <td>-</td> <td>-</td> <td>-</td> <td>-</td> </tr> </tbody> </table>		OVERALL DIMENSIONS			SEAT DIMENSIONS			BACK DIMENSIONS		W	D	H	W	D	H	W	H	28	17	17	-	-	-	-	-	<table border="1"> <thead> <tr> <th colspan="2">RTA 00</th> </tr> </thead> <tbody> <tr> <td>1 per carton</td> </tr> </tbody> </table>		RTA 00
OVERALL DIMENSIONS			SEAT DIMENSIONS			BACK DIMENSIONS																								
W	D	H	W	D	H	W	H																							
28	17	17	-	-	-	-	-																							
RTA 00																														
1 per carton																														

Options: (CW) Counterweight

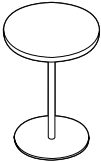
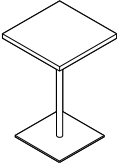
DESCRIPTION	FEATURES	MODEL#	STANDARD TEXTILE GRADES						
 <p>18" Dia. Round Laptop Table COM: N/A Freight class: 150 Product weight: 32 Cubic feet per carton: 6</p>	No power/USB unit.	List price							
		7743	792						
		OVERALL DIMENSIONS			SEAT DIMENSIONS			BACK DIMENSIONS	
		W	D	H	W	D	H	W	H
		18	18	25.25	-	-	-	-	-
			RTA 00	1 per carton					
 <p>16" Square Laptop Table COM: N/A Freight class: 125 Product weight: 36 Cubic feet per carton: 6</p>	No power/USB unit.	List price							
		7745	810						
		OVERALL DIMENSIONS			SEAT DIMENSIONS			BACK DIMENSIONS	
		W	D	H	W	D	H	W	H
		16	16	25.25	-	-	-	-	-
			RTA 00	1 per carton					

RIVER+ MEDIA HEARTH



Media Hearth with Sliding Laminate Doors - 84" model R27877

River+ Seating, Tables & Benches



For River+ seating, please see page 364
 For River+ tables, please see page 388.
 For River+ benches, please see page 383

STANDARD FEATURES

- A fully finished media center with features and finishes that coordinate with River+ seating, benches and tables. The fully finished back supports ease of planning.
- The 6.5" legs match River+ tapered legs. Legs are straight on the front and angled on the back.
- Legs include Black nylon, non-marking, height adjustable glides.
- Two hidden grommets are standard on the unit. One grommet is centered on the back panel, behind the monitor location. The other is beneath the unit, allowing cables to route from the monitor, through the unit, to the floor.
- Models are available with open shelving or closed, with sliding laminate or glass doors.
- Monitors, mounts and power are not included.
- See Suggested Maximum Monitor Diagonal Sizes chart for recommended maximum dimensions.
- To mount flatscreen or monitor to media hearth, use fixed mounting hardware only; not for use with articulating or extendable arm mounting hardware. Combined weight of mounting hardware and monitor or flatscreen not to exceed 75 lbs.
- Media hearths are made with thermally fused laminates. Specify from the many finishes listed. Custom, high pressure laminate finishes will be considered upon request.

OPTIONAL FEATURES

- An optional user access grommet is available for the top of the storage shelf, allowing cable routing for user access. Specify center grommet (GP2). Add \$96.
- Optional 6.5" floor mount legs are available. Add \$100. Mounting hardware not included.

Please add option codes in the following order:

- **Model number**
R27870 to R27874 Media hearth with open shelf.
R27875 to R27879 Media hearth with sliding laminate doors.
R27880 to R27884 Media hearth with sliding glass doors.
- **Laminate finishes**
(ACJ) Absolute Acajou **(ASN)** Asian Night
(AWC) Avant Cherry **(AWH)** Avant Honey
(BLK) Black **(BRC)** Brushed Cobalt
(CMB) Clear Maple **(DES)** Dark Espresso
(DWT) Designer White **(FAS)** Fashionista
(FCL) First Class
(NBL) Noce Biondo **(NGL)** Noce Grigio
(NEL) Noce Leggero **(NML)** Noce Medio
(QTM) Quartered Mahogany
(SBY) Sheer Beauty **(SOG)** Storm Grey
(WCR) Winter Cherry **(WHC)** White Chocolate
(WHE) Walnut Heights
 (colors shown on website)
- **Leg selection**
(S6) Standard height (6.5") w/adjustable glides. No upcharge.
(F6) Standard height (6.5"), floor mount. Add \$100.
- **Leg finish**
(CHM) Chrome **(TBL)** Black
(TDW) Designer White **(TFO)** Fog
(TFR) Frost **(TIV)** Cloud
(TLA) Latte **(TMO)** Mocha
(TNE) Nevada **(TOA)** Toast
(TSH) Shadow **(TSN)** Sand
(TTU) Tungsten
- **Grommet**
(GP2) Center grommet. Add \$96..

EXAMPLE RIVER+ MEDIA HEARTH ORDER CODE:

R27870	-ACJ	-S6	-CH	-
Model number	Laminate finish	Leg selection	Leg finish	Grommet

SUGGESTED MAXIMUM MONITOR DIAGONAL SIZES			
(measurements to be verified by end user)			
Model	Width	Overall usable area	Monitor diagonal dim.
R27870, R27875, R27880	60"	60 W x 37 H	60"
R27871, R27876, R27881	72"	72 W x 37 H	65"
R27872, R27877, R27882	84"	84 W x 37 H	65"
R27873, R27878, R27883	96"	96 W x 37 H	65"
R27874, R27879, R27884	96"	96 W x 37 H	2 x 50"

GROMMET PLACEMENT

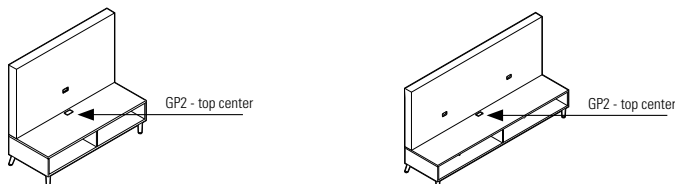

*Optional grommet is always located in the center of the top of the storage shelf (near the vertical surface).

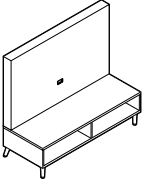
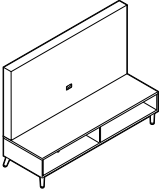
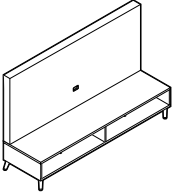
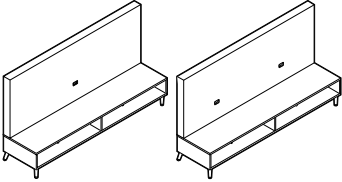
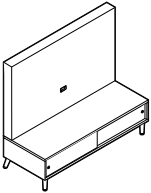
DESCRIPTION	FEATURES	MODEL#	STANDARD TEXTILE GRADES								
 <p>Media Hearth with Open Shelf - 60" COM: N/A Freight class: 150 Product weight: 170.5 Cubic feet per carton: 14.37</p>			List price								
		R27870	4047								
				OVERALL DIMENSIONS			SEAT DIMENSIONS			BACK DIMENSIONS	
				W	D	H	W	D	H	W	H
			60	24	54	-	-	-	-	-	
						RTA 1 2 cartons					
 <p>Media Hearth with Open Shelf - 72" COM: N/A Freight class: 150 Product weight: 189 Cubic feet per carton: 17.15</p>			List price								
		R27871	4177								
				OVERALL DIMENSIONS			SEAT DIMENSIONS			BACK DIMENSIONS	
				W	D	H	W	D	H	W	H
			72	24	54	-	-	-	-	-	
						RTA 1 2 cartons					
 <p>Media Hearth with Open Shelf - 84" COM: N/A Freight class: 150 Product weight: 209 Cubic feet per carton: 19.94</p>			List price								
		R27872	4478								
				OVERALL DIMENSIONS			SEAT DIMENSIONS			BACK DIMENSIONS	
				W	D	H	W	D	H	W	H
			84	24	54	-	-	-	-	-	
						RTA 1 2 cartons					
 <p>Media Hearth with Open Shelf - 96" COM: N/A Freight class: 150 Product weight: 231.5 Cubic feet per carton: 22.72</p>			List price								
		R27873	4676								
		R27874	4761								
				Dual Monitor							
			OVERALL DIMENSIONS			SEAT DIMENSIONS			BACK DIMENSIONS		
			W	D	H	W	D	H	W	H	
			96	24	54	-	-	-	-	-	
						RTA 1 2 cartons					
 <p>Media Hearth with Sliding Laminate Doors - 60" COM: N/A Freight class: 150 Product weight: 170.5 Cubic feet per carton: 14.37</p>			List price								
		R27875	5247								
				OVERALL DIMENSIONS			SEAT DIMENSIONS			BACK DIMENSIONS	
				W	D	H	W	D	H	W	H
			60	24	54	-	-	-	-	-	
						RTA 1 2 cartons					

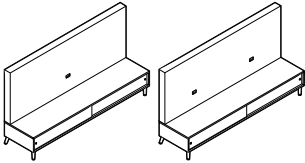
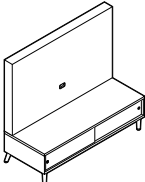
DESCRIPTION	FEATURES	MODEL#	STANDARD TEXTILE GRADES								
 <p>Media Hearth with Sliding Laminate Doors - 72" COM: N/A Freight class: 150 Product weight: 189 Cubic feet per carton: 17.15</p>			List price								
		R27876	5528								
				OVERALL DIMENSIONS			SEAT DIMENSIONS			BACK DIMENSIONS	
				W	D	H	W	D	H	W	H
			72	24	54	-	-	-	-	-	
						RTA 1		2 cartons			
 <p>Media Hearth with Sliding Laminate Doors - 84" COM: N/A Freight class: 150 Product weight: 209 Cubic feet per carton: 19.94</p>			List price								
		R27877	5838								
				OVERALL DIMENSIONS			SEAT DIMENSIONS			BACK DIMENSIONS	
				W	D	H	W	D	H	W	H
			84	24	54	-	-	-	-	-	
						RTA 1		2 cartons			
 <p>Media Hearth with Sliding Laminate Doors - 96" COM: N/A Freight class: 150 Product weight: 231.5 Cubic feet per carton: 22.72</p>			List price								
		R27878	6047								
		R27879	6123	Dual Monitor							
				OVERALL DIMENSIONS			SEAT DIMENSIONS			BACK DIMENSIONS	
			W	D	H	W	D	H	W	H	
			96	24	54	-	-	-	-	-	
						RTA 1		2 cartons			
 <p>Media Hearth with Sliding Glass Doors - 60" COM: N/A Freight class: 150 Product weight: 170.5 Cubic feet per carton: 14.37</p>			List price								
		R27880	5575								
				OVERALL DIMENSIONS			SEAT DIMENSIONS			BACK DIMENSIONS	
				W	D	H	W	D	H	W	H
			60	24	54	-	-	-	-	-	
						RTA 1		2 cartons			
 <p>Media Hearth with Sliding Glass Doors - 72" COM: N/A Freight class: 150 Product weight: 189 Cubic feet per carton: 17.15</p>			List price								
		R27881	5852								
				OVERALL DIMENSIONS			SEAT DIMENSIONS			BACK DIMENSIONS	
				W	D	H	W	D	H	W	H
			72	24	54	-	-	-	-	-	
						RTA 1		2 cartons			

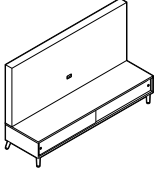
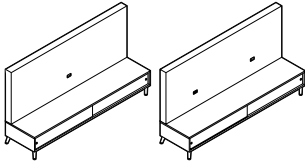
DESCRIPTION	FEATURES	MODEL#	STANDARD TEXTILE GRADES							
 <p>Media Hearth with Sliding Glass Doors - 84" COM: N/A Freight class: 150 Product weight: 209 Cubic feet per carton: 19.94</p>			List price							
		R27882	6186							
				OVERALL DIMENSIONS		SEAT DIMENSIONS			BACK DIMENSIONS	
				W	D	H	W	D	H	W
			84	24	54	-	-	-	-	-
						RTA 1 2 cartons				
 <p>Media Hearth with Sliding Glass Doors - 96" COM: N/A Freight class: 150 Product weight: 231.5 Cubic feet per carton: 22.72</p>			List price							
		R27883	6571							
		R27884	6647	Dual Monitor						
				OVERALL DIMENSIONS		SEAT DIMENSIONS			BACK DIMENSIONS	
			W	D	H	W	D	H	W	H
			96	24	54	-	-	-	-	-
						RTA 1 2 cartons				

SIRENA™



models 3371 Lounge Chairs, 3373 Two Seat Sofa, 3400 Coffee Table, and 3402 End Table



model 3371



model 3372CTRL

STANDARD FEATURES

- Modern club style seating includes: lounge chair, two and three seat sofas.
- Complete with Modern tables for reception areas, meeting rooms, and private office use.
- Lounge seating distinctive round style feet are finished in Black Only.
- All models have fixed, non-removable seat cushions with arm height at 25" in the front.
- Casters are available on lounge chairs only. **C1M** casters are standard.
- Please note leather models offer additional stitch details.
- Check textile availability prior to specifying upholstery material.
- When ordering models with tablet, specify for left hand or for right hand tablet. See models below.
- Laminate Tops, are 1.5" thick.
- Table legs are 1.5" steel tubing, tapered toward the bottom to 7/8", equipped with self-leveling, pivoting steel glides.



OPTIONAL FEATURES

- Laminate tables, tablets and bookshelves are offered in the following laminate finishes: Absolute Acajou (**ACJ**), Asian Night (**ASN**), Avant Cherry (**AWC**), Avant Honey (**AWH**), Blizzard (**BZD**), Clear Maple (**CMB**), Custom Grey (**CGY**), Dark Espresso (**DES**), Designer White (**DWT**), Fashionista (**FAS**), First Class (**FCL**), Noce Biondo (**NBL**), Noce Grigio (**NGL**), Noce Leggero (**NEL**), Noce Medio (**NML**), Quartered Mahogany (**QTM**), Sheer Beauty (**SBY**), Stonedust (**SDT**), Walnut Heights (**WHE**), White Chocolate (**WHC**) and Winter Cherry (**WCR**). Please Specify.
- Table legs are available in Tungsten (**TTU**), Shadow (**TSH**), Black (**TBL**) at no upcharge. Not available in Chrome.

STITCH DETAIL WHEN UPHOLSTERED IN ALL LEATHER - ILLUSTRATIONS BELOW

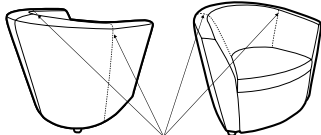

Extra Stitch Lines

Lounge Chair

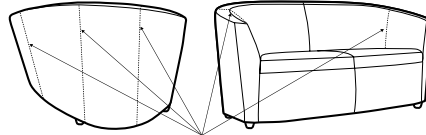

Extra Stitch Lines

Two and Three Seater Sofas

DESCRIPTION

FEATURES

MODEL#

STANDARD TEXTILE GRADES



Lounge Chair Fabric
COM Yardage: 4.25
Freight Class: 250
Product Weight (lbs.): 52
Cubic Feet Per Carton: 19.25

	1	2	3	4	5	6	7	8	9	10	11	12
3371	-	1730	1853	2027	2280	2373	2593	3007	3212	3596	4130	4789

OVERALL DIMENSIONS			SEAT DIMENSIONS			BACK DIMENSIONS	
W	D	H	W	D	H	W	H
30.5	29.5	28.5	20	20	17.5	19	11.5

RTA 00















Lounge Chair w/Casters
COM Yardage: 4.25
Freight Class: 250
Product Weight (lbs.): 52
Cubic Feet Per Carton: 19.25

	1	2	3	4	5	6	7	8	9	10	11	12
3371C	-	1861	1990	2175	2441	2539	2770	3203	3420	3822	4379	5071

OVERALL DIMENSIONS			SEAT DIMENSIONS			BACK DIMENSIONS	
W	D	H	W	D	H	W	H
30.5	29.5	29.5	20	20	17.5	19	11.5

RTA 00

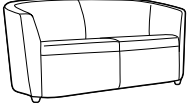
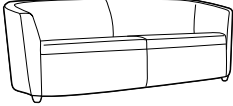
DESCRIPTION	FEATURES	MODEL#	STANDARD TEXTILE GRADES											
			1	2	3	4	5	6	7	8	9	10	11	12
 3371LTL	 3371RTL	3371LTL 3371RTL	-	2497	2623	2811	3074	3172	3403	3838	4055	4454	5015	5707
			OVERALL DIMENSIONS W D H			SEAT DIMENSIONS W D H			BACK DIMENSIONS W H					
Lounge Chair w/Laminate Tablet COM Yardage: 4.25 Freight Class: 250 Product Weight (lbs.): 58 Cubic Feet Per Carton: 19.25			RTA 00											
 3371CLTL	 3371CRTL	3371CLTL 3371CRTL	-	2640	2768	2954	3217	3315	3549	3979	4198	4597	5158	5850
			OVERALL DIMENSIONS W D H			SEAT DIMENSIONS W D H			BACK DIMENSIONS W H					
Lounge Chair w/Casters & Laminate Tablet COM Yardage: 4.25 Freight Class: 250 Product Weight (lbs.): 62 Cubic Feet Per Carton: 19.25			RTA 00											
		3372	-	2304	2427	2601	2854	2947	3167	3581	3786	4170	4704	5363
	OVERALL DIMENSIONS W D H			SEAT DIMENSIONS W D H			BACK DIMENSIONS W H							
Lounge Chair w/Laminate Book Shelf COM Yardage: 4.25 Freight Class: 250 Product Weight (lbs.): 55 Cubic Feet Per Carton: 19.25			RTA 00											
		3372C	-	2526	2649	2823	3076	3169	3389	3803	4008	4392	4926	5585
	OVERALL DIMENSIONS W D H			SEAT DIMENSIONS W D H			BACK DIMENSIONS W H							
Lounge Chair w/Casters & Laminate Book Shelf COM Yardage: 4.25 Freight Class: 250 Product Weight (lbs.): 55 Cubic Feet Per Carton: 19.25			RTA 00											
 3372LTL	 3372RTL	3372LTL 3372RTL	-	3004	3127	3301	3554	3647	3867	4281	4486	4870	5404	6063
			OVERALL DIMENSIONS W D H			SEAT DIMENSIONS W D H			BACK DIMENSIONS W H					
Lounge Chair w/Laminate Tablet/Book Shelf COM Yardage: 4.25 Freight Class: 250 Product Weight (lbs.): 66 Cubic Feet Per Carton: 19.25			RTA 00											

DESCRIPTION	FEATURES	MODEL#	STANDARD TEXTILE GRADES											
			1	2	3	4	5	6	7	8	9	10	11	12
 3372CLTL	 3372CRTL	3372CLTL 3372CRTL	-	3152	3275	3449	3702	3795	4015	4429	4634	5019	5552	6211
			OVERALL DIMENSIONS W D H			SEAT DIMENSIONS W D H			BACK DIMENSIONS W H					
Lounge Chair w/ Casters & Laminate Table/Book Shelf COM Yardage: 4.25 Freight Class: 250 Product Weight (lbs.): 66 Cubic Feet Per Carton: 19.25			32.5	29.5	28.5	20	20	17.5	19	11.5				
			<div style="background-color: black; color: white; padding: 2px; display: inline-block;">RTA 00</div>											
		3373	-	3247	3446	3738	4151	4306	4669	5346	5688	6321	7197	8280
			OVERALL DIMENSIONS W D H			SEAT DIMENSIONS W D H			BACK DIMENSIONS W H					
Two Seat Sofa COM Yardage: 7 Freight Class: 300 Product Weight (lbs.): 92 Cubic Feet Per Carton: 48			62	29.5	28.5	53	20	17.5	53	11.5				
			<div style="background-color: black; color: white; padding: 2px; display: inline-block;">RTA 00</div>											
		3374	-	3904	4122	4444	4902	5077	5475	6228	6606	7304	8275	9474
			OVERALL DIMENSIONS W D H			SEAT DIMENSIONS W D H			BACK DIMENSIONS W H					
Three Seat Sofa COM Yardage: 7.75 Freight Class: 300 Product Weight (lbs.): 107 Cubic Feet Per Carton: 55.5			81.5	29.5	28.5	72.5	20	17.5	72.5	11.5				
			<div style="background-color: black; color: white; padding: 2px; display: inline-block;">RTA 00</div>											
		3400	1856	-	-	-	-	-	-	-	-	-	-	-
			OVERALL DIMENSIONS W D H			SEAT DIMENSIONS W D H			BACK DIMENSIONS W H					
Coffee Table - 48" Laminate Top COM Yardage: N/A Freight Class: 250 Product Weight (lbs.): 52 Cubic Feet Per Carton: 17.25			48	22	14.5	-	-	-	-	-				
			<div style="background-color: black; color: white; padding: 2px; display: inline-block;">RTA 00</div>											
		3401	2052	-	-	-	-	-	-	-	-	-	-	-
			OVERALL DIMENSIONS W D H			SEAT DIMENSIONS W D H			BACK DIMENSIONS W H					
Coffee Table - 56" Laminate Top COM Yardage: N/A Freight Class: 175 Product Weight (lbs.): 60 Cubic Feet Per Carton: 19			56	22	15	-	-	-	-	-				
			<div style="background-color: black; color: white; padding: 2px; display: inline-block;">RTA 00</div>											

DESCRIPTION	FEATURES	MODEL#	STANDARD TEXTILE GRADES													
			1	2	3	4	5	6	7	8	9	10	11	12		
		3402	1489	-	-	-	-	-	-	-	-	-	-	-	-	-



End Table - Laminate Top
 COM Yardage: N/A
 Freight Class: 250
 Product Weight (lbs.): 26
 Cubic Feet Per Carton: 7.75

OVERALL DIMENSIONS			SEAT DIMENSIONS			BACK DIMENSIONS	
W	D	H	W	D	H	W	H
17	22	14.5	-	-	-	-	-

RTA 00



VENTURE



48"W Two Seater Banquette model 8506-48



78"W Three Seater Banquette model 8506-78



60"W Four Seater Banquette, Double Back model 8508-60

EXAMPLE VENTURE ORDER CODE:

8506-48	EL58	TBL
Model #	Textile	Leg Finish

STANDARD FEATURES

- Venture is a solid and durable banquette seating series.
- Banquettes are available with or without fully upholstered backs. Open back banquettes are intended to be placed against walls or in other layouts where the back will not be visible.
- Heavy duty frame has plywood construction suitable for public environments. For 24/7 use environments, must use approved textiles with 100,000 double-rubs and above.
- Cushions are made with highly resilient foam and seats are equipped with a synthetic rubberized webbing suspension system for extra comfort.
- Cushions are fixed and non-removable.
- Ganging bracket kit (8509) gangs single back models 'back to back'. Standard in Black. Contains two brackets
- Legs are metal painted and Chrome with Black glides, suitable for carpet and hard surface flooring. Closed back models are fully upholstered for use in open settings and to support reconfiguration.
- Open back models are available for use against walls or for ganging back to back. They and have a Black outer back protective dust cover.

- Partial assembly (KD) packaging is optional on Double Back models to allow the unit to fit through standard doors. Assembly instructions are included.
- Check textile availability prior to specifying upholstery material.

Note: Double-sided models (8508-48 to 8508-78) measure 55" deep, 48" high and weigh over 100 lbs. They may require coordination for special handling and accommodation through doorway and elevators.

OPTIONAL FEATURES:

Add option codes in the following order

- **Model Number**
- **Back and seat textile**
Specify textile code.
- **Leg Finish.** No upcharge
(CHM) Chrome
(TBL) Black
(TLA) Latte
(TTU) Tungsten
- **Package options.** No upcharge
Available on Double Back models.
(ST) Standard Fully assembled
(KD) Knocked Down

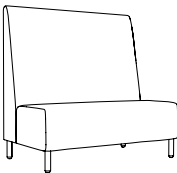
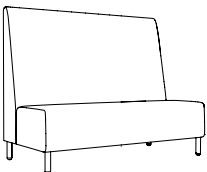
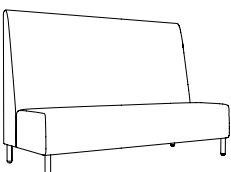
DESCRIPTION	FEATURES	MODEL #	STANDARD TEXTILE GRADES											
			1	2	3	4	5	6	7	8	9	10	11	12
 <p>48"W Two Seater Banquette, Closed Back COM Yardage: 6.75 Freight Class: 300 Product weight (lbs): 104 Cubic Feet Per Carton: 50.75</p>		8506-48	3002	3237	3419	3688	4068	4228	4557	5074	5461	5883	6765	7691
			OVERALL DIMENSIONS			SEAT DIMENSIONS			BACK DIMENSIONS					
			W	D	H	W	D	H	W	H				
			48	28	48	48	19	18	48	30				
				RTA 00		1 per carton								
 <p>60"W Two Seater Banquette, Closed Back COM Yardage: 8 Freight Class: 250 Product weight (lbs): 127 Cubic Feet Per Carton: 62.75</p>		8506-60	3579	3856	4072	4392	4841	5031	5420	6033	6491	6992	8038	9135
			OVERALL DIMENSIONS			SEAT DIMENSIONS			BACK DIMENSIONS					
			W	D	H	W	D	H	W	H				
			60	28	48	60	19	18	60	30				
				RTA 00		1 per carton								
 <p>72"W Three Seater Banquette, Closed Back COM Yardage: 9 Freight Class: 250 Product weight (lbs): 153 Cubic Feet Per Carton: 75</p>		8506-72	3813	4125	4368	4727	5233	5446	5884	6574	7089	7653	8829	10063
			OVERALL DIMENSIONS			SEAT DIMENSIONS			BACK DIMENSIONS					
			W	D	H	W	D	H	W	H				
			72	28	48	72	19	18	72	30				
				RTA 00		1 per carton								

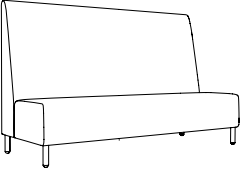
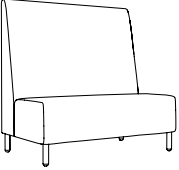
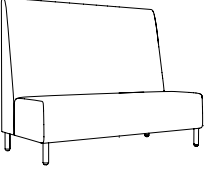
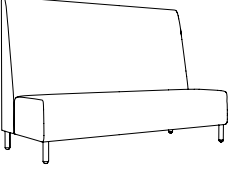
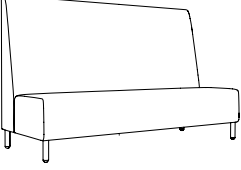
DESCRIPTION	FEATURES	MODEL#	STANDARD TEXTILE GRADES											
			1	2	3	4	5	6	7	8	9	10	11	12
 <p>78"W Three Seater Banquette, Closed Back COM Yardage: 10 Freight Class: 250 Product weight (lbs): 163 Cubic Feet Per Carton: 79.75</p>		8506-78	4182	4528	4798	5198	5759	5997	6483	7250	7822	8448	9755	11127
	OVERALL DIMENSIONS			SEAT DIMENSIONS			BACK DIMENSIONS							
	W	D	H	W	D	H	W	H						
	78	28	48	78	19	18	78	30						
			RTA 00		1 per carton									
 <p>48"W Two Seater Banquette, Open Back COM Yardage: 5 Freight Class: 250 Product weight (lbs): 105 Cubic Feet Per Carton: 50.75</p>		8507-48	2825	2998	3133	3333	3614	3733	3976	4359	4645	4958	5612	6298
	OVERALL DIMENSIONS			SEAT DIMENSIONS			BACK DIMENSIONS							
	W	D	H	W	D	H	W	H						
	48	28	48	48	19	18	48	30						
			RTA 00		1 per carton									
 <p>60"W Two Seater Banquette, Open Back COM Yardage: 6 Freight Class: 250 Product weight (lbs): 127 Cubic Feet Per Carton: 62.75</p>		8507-60	3217	3425	3588	3827	4164	4306	4599	5058	5402	5778	6561	7385
	OVERALL DIMENSIONS			SEAT DIMENSIONS			BACK DIMENSIONS							
	W	D	H	W	D	H	W	H						
	60	28	48	60	19	18	60	30						
			RTA 00		1 per carton									
 <p>72"W Three Seater Banquette, Open Back COM Yardage: 7 Freight Class: 250 Product weight (lbs): 153 Cubic Feet Per Carton: 75</p>		8507-72	3606	3848	4037	4317	4710	4877	5217	5754	6154	6593	7507	8468
	OVERALL DIMENSIONS			SEAT DIMENSIONS			BACK DIMENSIONS							
	W	D	H	W	D	H	W	H						
	72	28	48	72	19	18	72	30						
			RTA 00		1 per carton									
 <p>78"W Three Seater Banquette, Open Back COM Yardage: 8 Freight Class: 250 Product weight (lbs): 163 Cubic Feet Per Carton: 79.75</p>		8507-78	3961	4238	4455	4774	5223	5413	5803	6415	6874	7375	8420	9518
	OVERALL DIMENSIONS			SEAT DIMENSIONS			BACK DIMENSIONS							
	W	D	H	W	D	H	W	H						
	78	28	48	78	19	18	78	30						
			RTA 00		1 per carton									

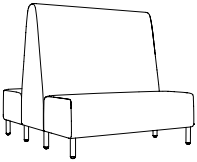
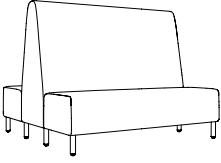
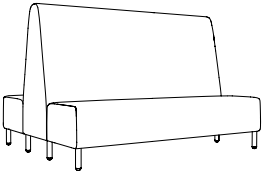
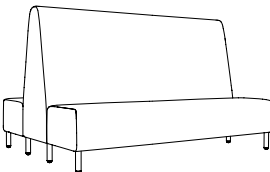
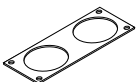
DESCRIPTION	FEATURES	MODEL#	STANDARD TEXTILE GRADES											
			1	2	3	4	5	6	7	8	9	10	11	12
 <p>48"W Four Seater Banquette, Double Back COM Yardage: 9 Freight Class: 300 Product weight (lbs): 163 Cubic Feet Per Carton: 89.75</p>	optional (KD) packaging (no upcharge)	8508-48	5449	5761	6005	6364	6870	7082	7521	8210	8726	9290	10465	11701
			OVERALL DIMENSIONS W D H			SEAT DIMENSIONS W D H			BACK DIMENSIONS W H					
			48	55	48	48	19	18	48	30				
			RTA 00			1 per carton								
 <p>60"W Four Seater Banquette, Double Back COM Yardage: 10 Freight Class: 300 Product weight (lbs): 198 Cubic Feet Per Carton: 111</p>	optional (KD) packaging (no upcharge)	8508-60	6313	6659	6929	7329	7890	8128	8614	9381	9953	10579	11886	13258
			OVERALL DIMENSIONS W D H			SEAT DIMENSIONS W D H			BACK DIMENSIONS W H					
			60	55	48	60	19	18	60	30				
			RTA 00			1 per carton								
 <p>72"W Six Seater Banquette, Double Back COM Yardage: 11 Freight Class: 300 Product weight (lbs): 242 Cubic Feet Per Carton: 132.5</p>	optional (KD) packaging (no upcharge)	8508-72	7496	7877	8175	8614	9232	9492	10028	10870	11501	12190	13627	15136
			OVERALL DIMENSIONS W D H			SEAT DIMENSIONS W D H			BACK DIMENSIONS W H					
			72	55	48	72	19	18	72	30				
			RTA 00			1 per carton								
 <p>78"W Six Seater Banquette, Double Back COM Yardage: 12 Freight Class: 300 Product weight (lbs): 255 Cubic Feet Per Carton: 141.7</p>	optional (KD) packaging (no upcharge)	8508-78	8377	8792	9117	9597	10271	10555	11139	12058	12746	13498	15065	16712
			OVERALL DIMENSIONS W D H			SEAT DIMENSIONS W D H			BACK DIMENSIONS W H					
			78	55	48	78	19	18	78	30				
			RTA 00			1 per carton								
 <p>Ganging Bracket Kit COM Yardage: n/a Freight Class: 70 Product weight (lbs): 0.5 Cubic Feet Per Carton: 0.1</p>	Includes two brackets	8509	List price											
			2.5	6	0.25	-	-	-	-	-				
			RTA 00			1 per carton								

VITROLA



Vitrola is offered in two back heights, standard lounge and high back lounge, along with two and three seat sofa models.



Matching ottoman and accent pillow to complete the offering.

STANDARD FEATURES

- Classic soft seating upholstery design with swooping arms.
- Available in standard Lounge, High Back Lounge along with Two and Three Seat Sofa models.
- Matching Ottoman and Accent Pillow complete the offering.
- Fully upholstered with piping details at the bottom of frame.
- Seat cushions are fixed or sewn tight.
- Standard in tapered maple wood legs. Standard in tapered maple wood legs. Legs are equipped with White non-marking glides as standard. Suitable for both carpet and hard surface flooring.
- Back upholstery is continuous without seams. In the event the textile cannot be railroaded, stitch lines will be required (one for 2 seater and two for 3 seater).
- All models ship fully assembled.
- Check textile availability prior to specifying upholstery material.

OPTION CODES

Please add option codes in the following order:

- **Model number**
8271 Lounge Chair
8272 Two Seat Sofa
8273 Three Seat Sofa
8274 Ottoman
8275 High Back Lounge Chair
8276 Accent Pillow
- **Fabric**
Specify fabric code.
- **Wood Legs**
(AA) Absolute **(AAM)**
(BM) Black **(BKM)**
(CM) Cherry **(ACM)**
(EO) English Oak **(EOM)**
(EC) Espresso Café **(ECM)**
(HG) Grey **(HGM)**
(HO) Honey **(AHM)**
(TM) Mahogany **(TMM)**
(VM) Maple **(AVM)**
(MM) Medium Walnut **(MWM)**
(NL) Natural Walnut **(NLW)**
(SN) Night **(ASM)**
(BI) Noce Biondo **(NBM)**
(GI) Noce Grigio **(NGM)**
(EI) Noce Leggero **(NEM)**
(MI) Noce Medio **(NMM)**,
(SK) Shaker Cherry **(SKM)**
(TF) Fruitwood **(TFM)**
(TW) Walnut **(TWM)**
(WC) WC Cream **(WTM)**
(WH) White **(WHM)**
(WE) Winter Cherry **(WCM)**
(colors shown on website).

EXAMPLE OF ORDER CODE:

8271	WA50	HG
Model Number	Fabric	Wood Legs

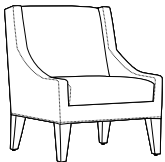
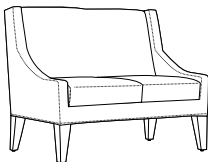
DESCRIPTION	FEATURES	MODEL#	STANDARD TEXTILE GRADES											
			1	2	3	4	5	6	7	8	9	10	11	12
 <p>Lounge Chair COM Yardage: 5.25 Freight Class: 150 Product Weight (lbs.): 90 Cubic Feet Per Carton: 20.25</p>		8271	\$1602	\$1795	\$1945	\$2169	\$2491	\$2644	\$2933	\$3397	\$3754	\$4150	\$4967	\$5840
			OVERALL DIMENSIONS			SEAT DIMENSIONS			BACK DIMENSIONS					
			W	D	H	W	D	H	W	H				
			28	31	34	22	21	17.5	22	18				
			RTA 00											
 <p>Two Seat Sofa COM Yardage: 7.25 Freight Class: 250 Product Weight (lbs.): 107 Cubic Feet Per Carton: 36.5</p>		8272	\$2629	\$2934	\$3174	\$3536	\$4050	\$4292	\$4757	\$5499	\$6069	\$6705	\$8015	\$9409
			OVERALL DIMENSIONS			SEAT DIMENSIONS			BACK DIMENSIONS					
			W	D	H	W	D	H	W	H				
			51	31	34	44	21	17.5	44	18				
			RTA 00											

WIND™



models 3361 Lounge chair & 3362 Two seat sofa, with 3357 Coffee table.

ADDITIONAL STITCH DETAIL - ILLUSTRATIONS BELOW

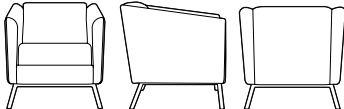

Standard Detailing - when upholstered in FABRIC or VINYL

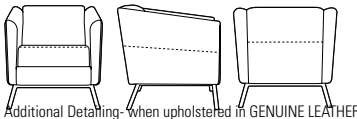

Additional Detailing - when upholstered in GENUINE LEATHER

STANDARD FEATURES

- Compact, contemporary design includes a raised modern version of the traditional lounge chair that is scaled down for smaller spaces.
- Chair and table legs is standard in Chrome.
- There are no caster options for the Wind series.
- Wind tables complement the modern decor of many office environments.
- Check textile availability prior to specifying upholstery material.

OPTIONAL FEATURES

Seating and Table Frame Finish

- (CHM) Chrome (TBL) Black (TCC) Cactus (TCR) Carrot (TDJ) Dijon (TDW) Designer White (TEG) Eggplant (TFO) Fog (TFR) Frost (TIN) Ink (TIV) Cloud (TKA) Kalua (TLA) Latte (TMO) Mocha (TOA) Toast (TNE) Nevada (TSH) Shadow (TSN) Sand (TSR) Scarlet (TTU) Tungsten (ACO) Antique Chrome. Add \$331 for lounge chair. Add \$414 for two seat sofa. Add \$485 for three seat sofa. Add \$162 for tables.
- (BCH) Brushed Chrome. Add \$156 for lounge chair. Add \$189 for two seat sofa. Add \$212 for three seat sofa. Add \$108 for tables.
- (SBR) Satin Brass. Add \$331 for lounge chair. Add \$414 for two seat sofa. Add \$485 for three seat

sofa. Add \$162 for tables.

Table Tops

- Table tops are available in the following laminate finishes:
 - (ACJ) Absolute Acajou (ASN) Asian Night (AWC) Avant Cherry (AWH) Avant Honey (BLK) Black (BRC) Brushed Cobalt (BZD) Blizzard (CGY) Custom Grey (CMB) Clear Maple (DES) Dark Espresso (DWT) Designer White (FAS) Fashionista (FCL) First Class (FNG) Noce Grigio (NBL) Noce Biondo (NGL) Noce Grigio (NEL) Noce Leggero (NML) Noce Medio (QTM) Quartered Mahogany (SBY) Sheer Beauty (SDT) Stonedust (SOG) Storm Grey (WHE) Walnut Heights (WCR) Winter Cherry (WHC) White Chocolate (WCH) White Cherry
- Table tops (models 3366, 3367, 3368, 3870, and 3871) are available in high pressure laminate at a 20% upcharge. Please specify (HPL) in addition to the finish.

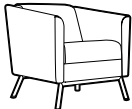
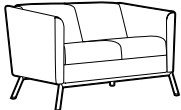
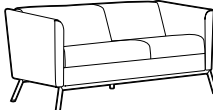
DESCRIPTION	FEATURES	MODEL#	STANDARD TEXTILE GRADES											
			1	2	3	4	5	6	7	8	9	10	11	12
 <p>Lounge Chair COM Yardage: 4.5 Freight Class: 250 Product Weight (lbs.): 62 Cubic Feet Per Carton: 16.5</p>		3361	-	2546	2679	2873	3146	3247	3488	3939	4166	4582	5164	5883
			OVERALL DIMENSIONS			SEAT DIMENSIONS			BACK DIMENSIONS					
			W	D	H	W	D	H	W	H				
			27.5	29	28.5	19.5	19	17	19	12				
			RTA 00											
 <p>Two Seat Sofa COM Yardage: 6.75 Freight Class: 250 Product Weight (lbs.): 102 Cubic Feet Per Carton: 30</p>		3362	-	3383	3582	3868	4278	4436	4793	5470	5806	6434	7308	8384
			OVERALL DIMENSIONS			SEAT DIMENSIONS			BACK DIMENSIONS					
			W	D	H	W	D	H	W	H				
			54.5	29	28.5	46.5	19	17	46.5	12				
			RTA 00											
 <p>Three Seat Sofa COM Yardage: 9 Freight Class: 250 Product Weight (lbs.): 135 Cubic Feet Per Carton: 42.5</p>		3363	-	4217	4471	4847	5375	5577	6043	6916	7355	8165	9292	10689
			OVERALL DIMENSIONS			SEAT DIMENSIONS			BACK DIMENSIONS					
			W	D	H	W	D	H	W	H				
			78	29	28.5	70.5	19	17	70.5	12				
			RTA 00											

DESCRIPTION	FEATURES	MODEL#	STANDARD TEXTILE GRADES													
			1	2	3	4	5	6	7	8	9	10	11	12		
 <p>End Table COM Yardage: N/A Freight Class: 250 Product Weight (lbs.): 36 Cubic Feet Per Carton: 11.5</p>		3366	933	-	-	-	-	-	-	-	-	-	-	-	-	-
			OVERALL DIMENSIONS			SEAT DIMENSIONS			BACK DIMENSIONS							
			W	D	H	W	D	H	W	H						
			24	24	17	-	-	-	-	-						
			RTA 00													
 <p>Rectangular Coffee Table COM Yardage: N/A Freight Class: 250 Product Weight (lbs.): 52 Cubic Feet Per Carton: 16</p>		3367	1234	-	-	-	-	-	-	-	-	-	-	-	-	-
			OVERALL DIMENSIONS			SEAT DIMENSIONS			BACK DIMENSIONS							
			W	D	H	W	D	H	W	H						
			48	20	15	-	-	-	-	-						
			RTA 00													
 <p>Square Coffee Table COM Yardage: N/A Freight Class: 250 Product Weight (lbs.): 66 Cubic Feet Per Carton: 22</p>		3368	1670	-	-	-	-	-	-	-	-	-	-	-	-	-
			OVERALL DIMENSIONS			SEAT DIMENSIONS			BACK DIMENSIONS							
			W	D	H	W	D	H	W	H						
			36	36	15	-	-	-	-	-						
			RTA 00													
 <p>Round Table COM Yardage: N/A Freight Class: 250 Product Weight (lbs.): 35 Cubic Feet Per Carton: 11.5</p>		3870	1020	-	-	-	-	-	-	-	-	-	-	-	-	-
			OVERALL DIMENSIONS			SEAT DIMENSIONS			BACK DIMENSIONS							
			W	D	H	W	D	H	W	H						
			24	24	17	-	-	-	-	-						
			RTA 00  													
 <p>Round Coffee Table COM Yardage: N/A Freight Class: 250 Product Weight (lbs.): 57 Cubic Feet Per Carton: 22</p>		3871	1501	-	-	-	-	-	-	-	-	-	-	-	-	-
			OVERALL DIMENSIONS			SEAT DIMENSIONS			BACK DIMENSIONS							
			W	D	H	W	D	H	W	H						
			36	36	15	-	-	-	-	-						
			RTA 00													

LOUNGE

WIND™ LINEAR



models 3363R and 3363L with 3882 bridge table, 3360 table attaching bracket kit and two 3380 coffee tables

WIND™ LINEAR W

STANDARD FEATURES

- Wind Linear is an extension of the Wind lounge series with an emphasis on expansive, clean lines. Wind Linear tables complement the modern decor of many offices.
- This modular furniture series includes single arm and armless sofas, benches, bridges and tables
- Seating and freestanding tables can be used as stand-alone products. Seating units can be linked together using bridge tables to create infinite configurations. Note: an upholstered seat unit cannot be linked with another upholstered seat unit.
- Chair and table legs are standard in Chrome.
- There are no caster options for the Wind Linear series.
- Table 'bridges' can mount outside or in-between seats to accommodate various work and collaborative settings. Requires table attaching bracket kit (3360).
- Please note Bridge End Table (model 3882) is only to be used with Chairs and/or Sofa models. Not usable with Bench or Ottoman Models.
- Please note Bridge Table (model 3884) is only to be used with Bench models 3361B and/or Ottoman models 3363B.
- Check textile availability prior to specifying upholstery material.

OPTIONAL FEATURES

- Wind Linear table models are offered in laminate finishes to coordinate with Global casegoods and wood seating.
- **Table Tops**
Table tops are available in the following laminate finishes:

(ACJ) Absolute Acajou	(ASN) Asian Night
(AWC) Avant Cherry	(AWH) Avant Honey
(BLK) Black	(BRC) Brushed Cobalt
(BZD) Blizzard	(CGY) Custom Grey
(CMB) Clear Maple	(DES) Dark Espresso
(DWT) Designer White	(FAS) Fashionista
(FCL) First Class	(NBL) Noce Biondo
(NGL) Noce Grigio	(NML) Noce Medio
(NEL) Noce Leggero	(OTM) Quartered Mahogany
(SBY) Sheer Beauty	(SDT) Stonedust
(SOG) Storm Grey	(WHE) Walnut Heights
(WHC) White Chocolate	(WCR) Winter Cherry
- Table tops are not available in high pressure laminate.
- Chair and Table legs are available in Tungsten (TUN), Charcoal (CHR) and Black (BLK) finishes at no up charge.

SAMPLE LAYOUTS

Layout A



Qty	Model Number	Description	Dimensions	List Price
1	3361R	Single Seater - Right Arm	39.5 x 29 x 28.5	2695
1	3361L	Single Seater - Left Arm	39.5 x 29 x 28.5	2695
1	3363NA	Single Sofa - Armless	72 x 29 x 28.5	3590
1	3881R	Bridge Corner Table - Right	25 x 25 x 12	1743
1	3881L	Bridge Corner Table - Left	25 x 25 x 12	1743
2	3360	Table Bracket Kit - 1 Kit per table		193 x 2

SAMPLE LAYOUT TOTAL IN STANDARD BLACK FRAME

\$12,852

Layout B



Qty	Model Number	Description	Dimensions	List Price
1	3361R	Single Seater - Right Arm	39.5 x 29 x 28.5	2695
1	3361L	Single Seater - Left Arm	39.5 x 29 x 28.5	2695
1	3361NA	Single Seater - Armless	36.5 x 29 x 28.5	2382
2	3882	Bridge End Table	25 x 20 x 12	952 x 2
2	3360	Table Bracket Kit - 1 Kit per table		193 x 2

SAMPLE LAYOUT TOTAL IN STANDARD BLACK FRAME

\$10,062

DESCRIPTION

FEATURES

MODEL#

STANDARD TEXTILE GRADES

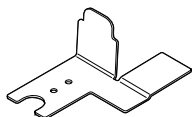

Table Bracket Kit

COM Yardage: N/A
Freight Class: 70
Product Weight (lbs.): 1.5
Cubic Feet Per Carton: 0.03 (1 Kit per carton)

Includes 4 brackets and hardware.
Use with models 3381R, 3381L, & 3382.

	1	2	3	4	5	6	7	8	9	10	11	12
3360	193	-	-	-	-	-	-	-	-	-	-	-

OVERALL DIMENSIONS

W D H

SEAT DIMENSIONS

W D H



BACK DIMENSIONS

W H







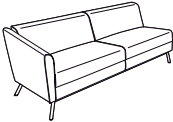
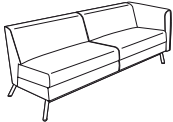
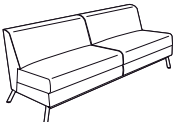

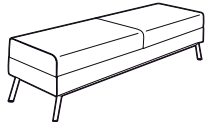
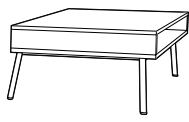
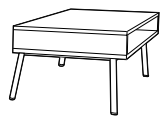
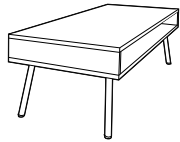
-	-	-	-	-	-	-	-	-	-	-	-	-
---	---	---	---	---	---	---	---	---	---	---	---	---

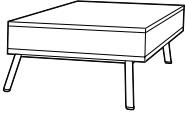
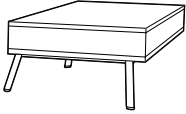
RTA 00

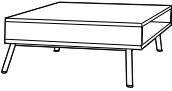
FedEx UPS

DESCRIPTION	FEATURES	MODEL#	STANDARD TEXTILE GRADES												
			1	2	3	4	5	6	7	8	9	10	11	12	
 3361R  3361L	<p>Single Seater - w/ Left or Right Arm COM Yardage: 4.75 Freight Class: 250 Product Weight (lbs.): 72 Cubic Feet Per Carton: 28.5</p>	<p>3361R 3361L</p>	-	2695	2832	3030	3310	3415	3659	4121	4351	4782	5377	6114	
			<p>OVERALL DIMENSIONS W D H</p>			<p>SEAT DIMENSIONS W D H</p>			<p>BACK DIMENSIONS W H</p>						
			39.5	29	28.5	36	19	17	36	12					
			RTA 00												
 3361NA	<p>Single Seater - Armless COM Yardage: 3.25 Freight Class: 250 Product Weight (lbs.): 58 Cubic Feet Per Carton: 28.5</p>	<p>3361NA</p>	-	2382	2476	2614	2805	2877	3045	3360	3515	3811	4221	4720	
			<p>OVERALL DIMENSIONS W D H</p>			<p>SEAT DIMENSIONS W D H</p>			<p>BACK DIMENSIONS W H</p>						
			36.5	29	28.5	36.5	19	17.5	36.5	12					
			RTA 00												
 3363R  3363L	<p>Single Sofa - w/ Left or Right Arm COM Yardage: 7.75 Freight Class: 250 Product Weight (lbs.): 120 Cubic Feet Per Carton: 41</p>	<p>3363R 3363L</p>	-	4035	4254	4578	5034	5208	5607	6360	6738	7436	8407	9610	
			<p>OVERALL DIMENSIONS W D H</p>			<p>SEAT DIMENSIONS W D H</p>			<p>BACK DIMENSIONS W H</p>						
			75	29	28.5	71	19	17	71	12					
			RTA 00												
 3363NA	<p>Single Sofa - Armless COM Yardage: 6.5 Freight Class: 250 Product Weight (lbs.): 111 Cubic Feet Per Carton: 39.25</p>	<p>3363NA</p>	-	3590	3774	4045	4426	4574	4910	5539	5856	6444	7258	8264	
			<p>OVERALL DIMENSIONS W D H</p>			<p>SEAT DIMENSIONS W D H</p>			<p>BACK DIMENSIONS W H</p>						
			72	29	28.5	72	19	17	72	12					
			RTA 00												

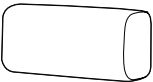
DESCRIPTION	FEATURES	MODEL#	STANDARD TEXTILE GRADES												
			1	2	3	4	5	6	7	8	9	10	11	12	
 <p>Ottoman COM Yardage: 1.75 Freight Class: 150 Product Weight (lbs.): 50 Cubic Feet Per Carton: 12.5</p>		3361B	-	1771	1823	1897	2004	2052	2147	2301	2417	2548	2818	3104	
			OVERALL DIMENSIONS			SEAT DIMENSIONS			BACK DIMENSIONS						
			W	D	H	W	D	H	W	H					
			35.5	20.5	17.5	-	-	-	-	-					
			RTA 00												
 <p>Bench COM Yardage: 3.5 Freight Class: 150 Product Weight (lbs.): 80 Cubic Feet Per Carton: 18.75</p>		3363B	-	2726	2852	2949	3095	3303	3373	3556	3900	4067	4386	4820	
			OVERALL DIMENSIONS			SEAT DIMENSIONS			BACK DIMENSIONS						
			W	D	H	W	D	H	W	H					
			72	20.5	17.5	-	-	-	-	-					
			RTA 00												
 <p>Side Table - Rectangular COM Yardage: N/A Freight Class: 250 Product Weight (lbs.): 38 Cubic Feet Per Carton: 11.5</p>	Freestanding.	3878	1334	-	-	-	-	-	-	-	-	-	-	-	
				OVERALL DIMENSIONS			SEAT DIMENSIONS			BACK DIMENSIONS					
				W	D	H	W	D	H	W	H				
				20	25	16	-	-	-	-	-				
			RTA 00												
 <p>Side Table - 25" Square COM Yardage: N/A Freight Class: 250 Product Weight (lbs.): 40 Cubic Feet Per Carton: 11.5</p>	Freestanding.	3879	1455	-	-	-	-	-	-	-	-	-	-	-	
				OVERALL DIMENSIONS			SEAT DIMENSIONS			BACK DIMENSIONS					
				W	D	H	W	D	H	W	H				
				25	25	16	-	-	-	-	-				
			RTA 00												
 <p>Coffee Table - 54" COM Yardage: N/A Freight Class: 250 Product Weight (lbs.): 52 Cubic Feet Per Carton: 16</p>	Freestanding.	3880	1623	-	-	-	-	-	-	-	-	-	-	-	
				OVERALL DIMENSIONS			SEAT DIMENSIONS			BACK DIMENSIONS					
				W	D	H	W	D	H	W	H				
				20	54	15	-	-	-	-	-				
			RTA 00												

DESCRIPTION	FEATURES	MODEL#	STANDARD TEXTILE GRADES											
			1	2	3	4	5	6	7	8	9	10	11	12
 <p>3881R</p> <p>Bridge Corner Table COM Yardage: - Freight Class: 250 Product Weight (lbs.): 33 Cubic Feet Per Carton: 11.5</p>	 <p>3881L</p> <p>Require Bracket Kit (3360).</p>	<p>3881R 1743</p> <p>3881L</p>												
			<p>OVERALL DIMENSIONS</p> <p>W D H</p> <p>25 25 12</p>			<p>SEAT DIMENSIONS</p> <p>W D H</p> <p>- - -</p>			<p>BACK DIMENSIONS</p> <p>W H</p> <p>- -</p>					
			<p>RTA 00</p>											
 <p>3882</p> <p>Bridge End Table COM Yardage: N/A Freight Class: 250 Product Weight (lbs.): 25 Cubic Feet Per Carton: 3.4</p>	<p>Require Bracket Kit (3360). To be used with Chair and Sofa models. Not usable with Bench or Ottoman Models</p>	<p>3882 952</p>												
			<p>OVERALL DIMENSIONS</p> <p>W D H</p> <p>20 25 5</p>			<p>SEAT DIMENSIONS</p> <p>W D H</p> <p>- - -</p>			<p>BACK DIMENSIONS</p> <p>W H</p> <p>- -</p>					
			<p>RTA 00</p>											
 <p>3883</p> <p>Low Side Table COM Yardage: N/A Freight Class: 250 Product Weight (lbs.): 32 Cubic Feet Per Carton: 11.5</p>	<p>Freestanding.</p>	<p>3883 1321</p>												
			<p>OVERALL DIMENSIONS</p> <p>W D H</p> <p>20 25 12</p>			<p>SEAT DIMENSIONS</p> <p>W D H</p> <p>- - -</p>			<p>BACK DIMENSIONS</p> <p>W H</p> <p>- -</p>					
			<p>RTA 00</p>											
 <p>3884</p> <p>Bridge Table - 20" Square COM Yardage: N/A Freight Class: 125 Product Weight (lbs.): 23 Cubic Feet Per Carton: 3.4</p>	<p>Require Bracket Kit (3360). To be used with models 3361B and/or 3363B.</p>	<p>3884 886</p>												
			<p>OVERALL DIMENSIONS</p> <p>W D H</p> <p>20 20 5</p>			<p>SEAT DIMENSIONS</p> <p>W D H</p> <p>- - -</p>			<p>BACK DIMENSIONS</p> <p>W H</p> <p>- -</p>					
			<p>RTA 00  </p>											
 <p>3885</p> <p>Bolster Cushion COM Yardage: 1 Freight Class: 70 Product Weight (lbs.): 1.5 Cubic Feet Per Carton: 1.3</p>	<p>1 Loose Cushion.</p>	<p>3885 - 249 282 322 381 406 456 554 602 692 816 972</p>												
			<p>OVERALL DIMENSIONS</p> <p>W D H</p> <p>16 5 7</p>			<p>SEAT DIMENSIONS</p> <p>W D H</p> <p>- - -</p>			<p>BACK DIMENSIONS</p> <p>W H</p> <p>- -</p>					
			<p>RTA 00  </p>											

heavy duty/24hr

Concorde Executive 24HR	418	Malaga TS	415	Truform TS	417
Granada TS	414	ObusForme Comfort TS	416	Vion TS	423
Granada Deluxe TS	415	Robust	421		
G1 Ergo Select TS	419	Saxon	422		





model TS3140-3 Malaga



model TS5451-3 Truform

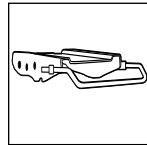

Multi-Depth Mechanism
Standard on all models. Allows seat to move forward and backward over a 2" range with 5 locking positions to provide a more shallow or deeper seat.



All models, except Truform, have outer back panels retained by trim screws for extra security.



All models, except Truform, have standard clear vinyl bumper guards around their outside backs.

STANDARD FEATURES

- The **TS** models are available within standard series. **TS** stands for "Three Shift" and each of the TS models are rated for 24-7 applications as well as weight rated up to 350 pounds.
- Multi-tilter models feature a heavy duty mechanism.
- All models are standard with either Ultracell or molded heavy duty seat foam.
- All models have a heavy duty 3" wide back upright.
- All models, except Truform, have outer back panels retained by trim screws for extra security.
- All models, except Truform have standard clear vinyl bumper guards around their outside backs.
- Multi-tilters standard with Pneumatic seat height and sliding seat depth adjustment (**MD**). Forward and rearward seat tilt with infinite lock and free floating back angle control. Tilt tension control.
- Heavy duty height adjustable stools are standard with fixed back. Seat depth and pneumatic seat height adjustments. Swivels with adjustable chrome footring.
- Grade 2 and above textiles (or 100,000+ double rubs) are recommended for 24-7 applications.
- Check textile availability prior to specifying upholstery material.

OPTIONAL FEATURES

- An optional abrasion-resistant outer back fabric (polyester) is available (excludes Truform) (**BKB**). Resistant to impact damage. Available in Black only. Add \$23.

DESCRIPTION FEATURES MODEL# STANDARD TEXTILE GRADES



LB Heavy Duty Multi-Tilter Plain Back Ratchet Back
COM Yardage: 1.50
Freight Class: 150
Product Weight (lbs.): 52
Cubic Feet Per Carton: 9.25

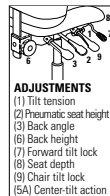

Granada TS

Ergonomic Features:
A, B, C, D, E, F, G, H, M, N, Q, S



	1	2	3	4	5	6	7	8	9	10	11	12
TS3121	1572	1633	1677	1741	1836	1868	1949	2105	2178	2324	2520	2764

OVERALL DIMENSIONS			SEAT DIMENSIONS			BACK DIMENSIONS	
W	D	H	W	D	H	W	H
26	24.5	37.75	20.5	17-19.5	16.5-20.5	19	19-22



HB Heavy Duty Multi-Tilter Plain Back Ratchet Back
COM Yardage: 1.75
Freight Class: 150
Product Weight (lbs.): 55
Cubic Feet Per Carton: 9.25

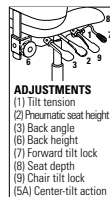

Granada TS

Ergonomic Features:
A, B, C, D, E, F, G, H, M, N, Q, S



	1	2	3	4	5	6	7	8	9	10	11	12
TS3123	1717	1784	1837	1913	2021	2058	2153	2334	2423	2590	2819	3101

OVERALL DIMENSIONS			SEAT DIMENSIONS			BACK DIMENSIONS	
W	D	H	W	D	H	W	H
26	24.5	39.75	20.5	17-19.5	16.5-20.5	19	19-22



LB Heavy Duty Multi-Tilter Plain Back
COM Yardage: 1.50
Freight Class: 125
Product Weight (lbs.): 58
Cubic Feet Per Carton: 9.25

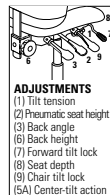









Granada TS

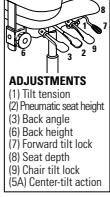

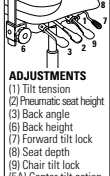

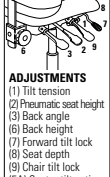

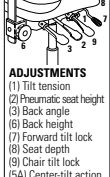
Ergonomic Features:
A, B, C, D, E, F, G, H, M, N, Q, S

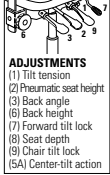

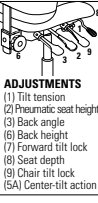

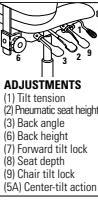
	1	2	3	4	5	6	7	8	9	10	11	12
TS3212	1228	1289	1332	1396	1491	1522	1604	1759	1834	1979	2173	2416

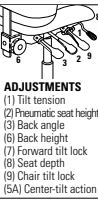
OVERALL DIMENSIONS			SEAT DIMENSIONS			BACK DIMENSIONS	
W	D	H	W	D	H	W	H
26	24	40.	20.5	17-19.5	17.5-21.5	19	21.5-25.5

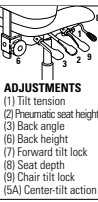
DESCRIPTION	FEATURES	MODEL#	STANDARD TEXTILE GRADES																									
			1	2	3	4	5	6	7	8	9	10	11	12														
 <p>HB Heavy Duty Multi-Tilter Plain Back COM Yardage: 1.75 Freight Class: 150 Product Weight (lbs.): 57 Cubic Feet Per Carton: 10.50</p>	 <p>ADJUSTMENTS (1) Tilt tension (2) Pneumatic seat height (3) Back angle (6) Back height (7) Forward tilt lock (8) Seat depth (9) Chair tilt lock (5A) Center-tilt action</p>	Granada TS	Ergonomic Features: A, B, C, D, E, F, G, H, M, N, Q, S	<table border="1"> <tr> <td>TS3217</td> <td>1352</td> <td>1421</td> <td>1470</td> <td>1547</td> <td>1656</td> <td>1693</td> <td>1788</td> <td>1971</td> <td>2056</td> <td>2225</td> <td>2454</td> <td>2735</td> </tr> </table>												TS3217	1352	1421	1470	1547	1656	1693	1788	1971	2056	2225	2454	2735
				TS3217	1352	1421	1470	1547	1656	1693	1788	1971	2056	2225	2454	2735												
				OVERALL DIMENSIONS			SEAT DIMENSIONS			BACK DIMENSIONS																		
				W	D	H	W	D	H	W		H																
26	24.5	43	20.5	17-19.5	17.5-21.5	19		21.5-25.5																				
			RTA 2	FedEx		UPS																						
 <p>HB Heavy Duty Multi-Tilter COM Yardage: 2 Freight Class: 125 Product Weight (lbs.): 65 Cubic Feet Per Carton: 9.25</p>	 <p>ADJUSTMENTS (1) Tilt tension (2) Pneumatic seat height (3) Back angle (6) Back height (7) Forward tilt lock (8) Seat depth (9) Chair tilt lock (5A) Center-tilt action</p>	Granada Deluxe TS	Ergonomic Features: A, B, C, E, F, H, M, N, Q, S	<table border="1"> <tr> <td>TS1170-3</td> <td>1384</td> <td>1451</td> <td>1502</td> <td>1579</td> <td>1688</td> <td>1726</td> <td>1820</td> <td>2001</td> <td>2088</td> <td>2257</td> <td>2485</td> <td>2767</td> </tr> </table>												TS1170-3	1384	1451	1502	1579	1688	1726	1820	2001	2088	2257	2485	2767
				TS1170-3	1384	1451	1502	1579	1688	1726	1820	2001	2088	2257	2485	2767												
				OVERALL DIMENSIONS			SEAT DIMENSIONS			BACK DIMENSIONS																		
				W	D	H	W	D	H	W		H																
26	23.5	45	21	18-20.5	17.5-21.5	20		23-28.25																				
			RTA 2	FedEx		UPS																						
 <p>MB Heavy Duty Multi-Tilter COM Yardage: 1.75 Freight Class: 125 Product Weight (lbs.): 63 Cubic Feet Per Carton: 9.25</p>	 <p>ADJUSTMENTS (1) Tilt tension (2) Pneumatic seat height (3) Back angle (6) Back height (7) Forward tilt lock (8) Seat depth (9) Chair tilt lock (5A) Center-tilt action</p>	Granada Deluxe TS	Ergonomic Features: A, B, C, E, F, H, M, N, Q, S	<table border="1"> <tr> <td>TS1171-3</td> <td>\$1259</td> <td>\$1322</td> <td>\$1363</td> <td>\$1427</td> <td>\$1521</td> <td>\$1553</td> <td>\$1635</td> <td>\$1791</td> <td>\$1864</td> <td>\$2010</td> <td>\$2204</td> <td>\$2447</td> </tr> </table>												TS1171-3	\$1259	\$1322	\$1363	\$1427	\$1521	\$1553	\$1635	\$1791	\$1864	\$2010	\$2204	\$2447
				TS1171-3	\$1259	\$1322	\$1363	\$1427	\$1521	\$1553	\$1635	\$1791	\$1864	\$2010	\$2204	\$2447												
				OVERALL DIMENSIONS			SEAT DIMENSIONS			BACK DIMENSIONS																		
				W	D	H	W	D	H	W		H																
26	23.5	41	21	18-20.5	17.5-21.5	20		19-24.25																				
			RTA 2	FedEx		UPS																						
 <p>HB Heavy Duty Multi-Tilter COM Yardage: 1.75 Freight Class: 125 Product Weight (lbs.): 63 Cubic Feet Per Carton: 9.25</p>	 <p>ADJUSTMENTS (1) Tilt tension (2) Pneumatic seat height (3) Back angle (6) Back height (7) Forward tilt lock (8) Seat depth (9) Chair tilt lock (5A) Center-tilt action</p>	Malaga TS	Ergonomic Features: A, B, C, D, E, F, G, H, M, N, Q, S	<table border="1"> <tr> <td>TS3140-3</td> <td>\$1616</td> <td>\$1683</td> <td>\$1736</td> <td>\$1812</td> <td>\$1920</td> <td>\$1957</td> <td>\$2052</td> <td>\$2235</td> <td>\$2322</td> <td>\$2490</td> <td>\$2718</td> <td>\$2999</td> </tr> </table>												TS3140-3	\$1616	\$1683	\$1736	\$1812	\$1920	\$1957	\$2052	\$2235	\$2322	\$2490	\$2718	\$2999
				TS3140-3	\$1616	\$1683	\$1736	\$1812	\$1920	\$1957	\$2052	\$2235	\$2322	\$2490	\$2718	\$2999												
				OVERALL DIMENSIONS			SEAT DIMENSIONS			BACK DIMENSIONS																		
				W	D	H	W	D	H	W		H																
26	25	44	20	17.5-20	16.5-20.5	18.5		25-27.25																				
			RTA 2	FedEx		UPS																						
 <p>LB Heavy Duty Multi-Tilter COM Yardage: 60 Freight Class: 125 Product Weight (lbs.): 60 Cubic Feet Per Carton: 9.25</p>	 <p>ADJUSTMENTS (1) Tilt tension (2) Pneumatic seat height (3) Back angle (6) Back height (7) Forward tilt lock (8) Seat depth (9) Chair tilt lock (5A) Center-tilt action</p>	Malaga TS	Ergonomic Features: A, B, C, D, E, F, G, H, M, N, Q, S	<table border="1"> <tr> <td>TS3141-3</td> <td>\$1489</td> <td>\$1547</td> <td>\$1591</td> <td>\$1656</td> <td>\$1749</td> <td>\$1782</td> <td>\$1865</td> <td>\$2019</td> <td>\$2093</td> <td>\$2238</td> <td>\$2433</td> <td>\$2679</td> </tr> </table>												TS3141-3	\$1489	\$1547	\$1591	\$1656	\$1749	\$1782	\$1865	\$2019	\$2093	\$2238	\$2433	\$2679
				TS3141-3	\$1489	\$1547	\$1591	\$1656	\$1749	\$1782	\$1865	\$2019	\$2093	\$2238	\$2433	\$2679												
				OVERALL DIMENSIONS			SEAT DIMENSIONS			BACK DIMENSIONS																		
				W	D	H	W	D	H	W		H																
25	24.5	39.75	20	17.5-20	16.5-20.5	18.5		20.5-22.75																				
			RTA 1	FedEx		UPS																						

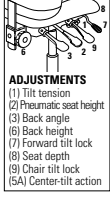
DESCRIPTION	FEATURES	MODEL#	STANDARD TEXTILE GRADES																													
			1	2	3	4	5	6	7	8	9	10	11	12																		
 <p>HB Heavy Duty Multi -Tilter COM Yardage: 2.25 Freight Class: 125 Product Weight (lbs.): 74 Cubic Feet Per Carton: 11</p>	 <p>ADJUSTMENTS (1) Tilt tension (2) Pneumatic seat height (3) Back angle (6) Back height (7) Forward tilt lock (8) Seat depth (9) Chair tilt lock (5A) Center-tilt action</p>	<p>ObusForme Comfort TS</p> <p>Ergonomic Features: A, C, E, F, H, M, N, S</p>	<table border="1"> <tr> <td>TS1240-3</td> <td>1479</td> <td>1571</td> <td>1636</td> <td>1738</td> <td>1882</td> <td>1950</td> <td>2081</td> <td>2289</td> <td>2449</td> <td>2630</td> <td>2997</td> <td>3389</td> </tr> </table>												TS1240-3	1479	1571	1636	1738	1882	1950	2081	2289	2449	2630	2997	3389					
			TS1240-3	1479	1571	1636	1738	1882	1950	2081	2289	2449	2630	2997	3389																	
			<table border="1"> <tr> <th colspan="3">OVERALL DIMENSIONS</th> <th colspan="3">SEAT DIMENSIONS</th> <th colspan="2">BACK DIMENSIONS</th> </tr> <tr> <th>W</th> <th>D</th> <th>H</th> <th>W</th> <th>D</th> <th>H</th> <th>W</th> <th>H</th> </tr> <tr> <td>26</td> <td>25</td> <td>48</td> <td>21</td> <td>17.5-20</td> <td>16-20</td> <td>19</td> <td>27</td> </tr> </table>			OVERALL DIMENSIONS			SEAT DIMENSIONS			BACK DIMENSIONS		W	D	H	W	D	H	W	H	26	25	48	21	17.5-20	16-20	19	27	<p>RTA 2</p> <p>FedEx</p> <p>ups</p>		
			OVERALL DIMENSIONS			SEAT DIMENSIONS			BACK DIMENSIONS																							
W	D	H	W	D	H	W	H																									
26	25	48	21	17.5-20	16-20	19	27																									
 <p>MB Heavy Duty Multi -Tilter COM Yardage: 2 Freight Class: 125 Product Weight (lbs.): 71 Cubic Feet Per Carton: 10.50</p>	 <p>ADJUSTMENTS (1) Tilt tension (2) Pneumatic seat height (3) Back angle (6) Back height (7) Forward tilt lock (8) Seat depth (9) Chair tilt lock (5A) Center-tilt action</p>	<p>ObusForme Comfort TS</p> <p>Ergonomic Features: A, C, E, F, H, M, N, S</p>	<table border="1"> <tr> <td>TS1241-3</td> <td>1411</td> <td>1494</td> <td>1556</td> <td>1649</td> <td>1782</td> <td>1828</td> <td>1945</td> <td>2166</td> <td>2273</td> <td>2480</td> <td>2758</td> <td>3107</td> </tr> </table>												TS1241-3	1411	1494	1556	1649	1782	1828	1945	2166	2273	2480	2758	3107					
			TS1241-3	1411	1494	1556	1649	1782	1828	1945	2166	2273	2480	2758	3107																	
			<table border="1"> <tr> <th colspan="3">OVERALL DIMENSIONS</th> <th colspan="3">SEAT DIMENSIONS</th> <th colspan="2">BACK DIMENSIONS</th> </tr> <tr> <th>W</th> <th>D</th> <th>H</th> <th>W</th> <th>D</th> <th>H</th> <th>W</th> <th>H</th> </tr> <tr> <td>26</td> <td>25</td> <td>44</td> <td>21</td> <td>17.5-20</td> <td>16-20</td> <td>19.5</td> <td>22-27.25</td> </tr> </table>			OVERALL DIMENSIONS			SEAT DIMENSIONS			BACK DIMENSIONS		W	D	H	W	D	H	W	H	26	25	44	21	17.5-20	16-20	19.5	22-27.25	<p>RTA 2</p> <p>FedEx</p> <p>ups</p>		
			OVERALL DIMENSIONS			SEAT DIMENSIONS			BACK DIMENSIONS																							
W	D	H	W	D	H	W	H																									
26	25	44	21	17.5-20	16-20	19.5	22-27.25																									
 <p>HB Heavy Duty Multi -Tilter with Schukra COM Yardage: 2.25 Freight Class: 125 Product Weight (lbs.): 74 Cubic Feet Per Carton: 11</p>	 <p>ADJUSTMENTS (1) Tilt tension (2) Pneumatic seat height (3) Back angle (6) Back height (7) Forward tilt lock (8) Seat depth (9) Chair tilt lock (5A) Center-tilt action</p>	<p>ObusForme Comfort TS</p> <p>Ergonomic Features: A, C, E, F, H, M, N, S</p>	<table border="1"> <tr> <td>TS1260-3</td> <td>1638</td> <td>1730</td> <td>1800</td> <td>1904</td> <td>2054</td> <td>2109</td> <td>2240</td> <td>2490</td> <td>2608</td> <td>2839</td> <td>3155</td> <td>3546</td> </tr> </table>												TS1260-3	1638	1730	1800	1904	2054	2109	2240	2490	2608	2839	3155	3546					
			TS1260-3	1638	1730	1800	1904	2054	2109	2240	2490	2608	2839	3155	3546																	
			<table border="1"> <tr> <th colspan="3">OVERALL DIMENSIONS</th> <th colspan="3">SEAT DIMENSIONS</th> <th colspan="2">BACK DIMENSIONS</th> </tr> <tr> <th>W</th> <th>D</th> <th>H</th> <th>W</th> <th>D</th> <th>H</th> <th>W</th> <th>H</th> </tr> <tr> <td>26</td> <td>25</td> <td>48</td> <td>21</td> <td>17.5-20</td> <td>16-20</td> <td>19.5</td> <td>27-32.25</td> </tr> </table>			OVERALL DIMENSIONS			SEAT DIMENSIONS			BACK DIMENSIONS		W	D	H	W	D	H	W	H	26	25	48	21	17.5-20	16-20	19.5	27-32.25	<p>RTA 2</p> <p>FedEx</p> <p>ups</p>		
			OVERALL DIMENSIONS			SEAT DIMENSIONS			BACK DIMENSIONS																							
W	D	H	W	D	H	W	H																									
26	25	48	21	17.5-20	16-20	19.5	27-32.25																									
 <p>MB Heavy Duty Multi -Tilter with Schukra COM Yardage: 2 Freight Class: 125 Product Weight (lbs.): 69 Cubic Feet Per Carton: 10.50</p>	 <p>ADJUSTMENTS (1) Tilt tension (2) Pneumatic seat height (3) Back angle (6) Back height (7) Forward tilt lock (8) Seat depth (9) Chair tilt lock (5A) Center-tilt action</p>	<p>ObusForme Comfort TS</p> <p>Ergonomic Features: A, C, E, F, H, M, N, S</p>	<table border="1"> <tr> <td>TS1261-3</td> <td>1575</td> <td>1658</td> <td>1720</td> <td>1813</td> <td>1946</td> <td>1992</td> <td>2109</td> <td>2330</td> <td>2437</td> <td>2644</td> <td>2922</td> <td>3271</td> </tr> </table>												TS1261-3	1575	1658	1720	1813	1946	1992	2109	2330	2437	2644	2922	3271					
			TS1261-3	1575	1658	1720	1813	1946	1992	2109	2330	2437	2644	2922	3271																	
			<table border="1"> <tr> <th colspan="3">OVERALL DIMENSIONS</th> <th colspan="3">SEAT DIMENSIONS</th> <th colspan="2">BACK DIMENSIONS</th> </tr> <tr> <th>W</th> <th>D</th> <th>H</th> <th>W</th> <th>D</th> <th>H</th> <th>W</th> <th>H</th> </tr> <tr> <td>26</td> <td>25</td> <td>44</td> <td>21</td> <td>17.5-20</td> <td>16-20</td> <td>19.5</td> <td>22</td> </tr> </table>			OVERALL DIMENSIONS			SEAT DIMENSIONS			BACK DIMENSIONS		W	D	H	W	D	H	W	H	26	25	44	21	17.5-20	16-20	19.5	22	<p>RTA 2</p> <p>FedEx</p> <p>ups</p>		
			OVERALL DIMENSIONS			SEAT DIMENSIONS			BACK DIMENSIONS																							
W	D	H	W	D	H	W	H																									
26	25	44	21	17.5-20	16-20	19.5	22																									

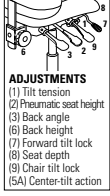
DESCRIPTION	FEATURES	MODEL#	STANDARD TEXTILE GRADES											
			1	2	3	4	5	6	7	8	9	10	11	12
 <p>HB Heavy Duty Multi - Tilter COM Yardage: 2 Freight Class: 125 Product Weight (lbs.): 63 Cubic Feet Per Carton: 10.50</p>	 <p>ADJUSTMENTS (1) Tilt tension (2) Pneumatic seat height (3) Back angle (6) Back height (7) Forward tilt lock (8) Seat depth (9) Chair tilt lock (5A) Center-tilt action</p>	TS5450-3	1132	1206	1260	1346	1468	1510	1616	1816	1913	2100	2352	2670
			OVERALL DIMENSIONS			SEAT DIMENSIONS			BACK DIMENSIONS					
			W	D	H	W	D	H	W	H				
			26	25	42	20	18-20.5	16.5-20.5	20	23.5-26				
			RTA 2	FedEx		ups								
 <p>MB Heavy Duty Multi - Tilter COM Yardage: 1.75 Freight Class: 150 Product Weight (lbs.): 60 Cubic Feet Per Carton: 10.50</p>	 <p>ADJUSTMENTS (1) Tilt tension (2) Pneumatic seat height (3) Back angle (6) Back height (7) Forward tilt lock (8) Seat depth (9) Chair tilt lock (5A) Center-tilt action</p>	TS5451-3	1093	1159	1210	1282	1388	1427	1519	1696	1779	1943	2165	2440
			OVERALL DIMENSIONS			SEAT DIMENSIONS			BACK DIMENSIONS					
			W	D	H	W	D	H	W	H				
			26	25	38.5	20	18-20.5	16.5-20.5	20	20-22.5				
			RTA 2	FedEx		ups								

CONCORDE™ EXECUTIVE 24HR



model 2424



Push Button

Location within reach increases your adjustment. Promotes good posture as you move to various positions.



STANDARD FEATURES



- All adjustments are made with button controls that are conveniently located in full view, for easy use.
- Compound curved molded foam seat and back cushions.
- Seat cushion with Velcro attachment is easily removed and replaced.
- Rated for Multi-Shift use for persons up to 350 pounds.
- Standard with Allen-bolted width adjustable arms (Allen key included). Arms adjust 1 1/4" wider on each side, a total of 2 1/2" extra width.
- Pneumatic seat height adjustment and 5 - position tilt lock. Tilt tension control.

- Ratchet style back height adjustment.
- All models are standard with a reinforced five-legged, injection molded base with **C10** casters, Black (**BK**) Only.
- Check textile availability prior to specifying upholstery material.

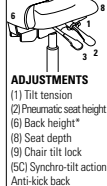
OPTIONAL FEATURES

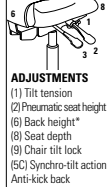
- Models are not available with **C7** glides.

DESCRIPTION	FEATURES	MODEL#	STANDARD TEXTILE GRADES											
			1	2	3	4	5	6	7	8	9	10	11	12
 <p>HB Synchro - Tilter Concorde Executive 24HR COM Yardage: 2.50 Freight Class: 250 Product Weight (lbs.): 78 Cubic Feet Per Carton: 23.50</p>	 <p>ADJUSTMENTS (1) Tilt tension (2) Pneumatic seat height (6) Back height* (8) Seat depth (9) Chair tilt lock (5C) Synchro-tilt action Anti-kick back</p>	<p>Seat depth Adjust: 16" to 18"</p> <p>Ergonomic Features: A, B, C, D, E, L, M, N, Q, T</p>	<p>2424</p>											
			<p>OVERALL DIMENSIONS</p> <p>W D H</p>			<p>SEAT DIMENSIONS</p> <p>W D H</p>			<p>BACK DIMENSIONS</p> <p>W H</p>					
			28.5	27	50	21	17.5-19	18-22	21	28-31				
			<p>RTA 00</p>											
 <p>HB Synchro - Tilter Concorde Executive 24HR COM Yardage: 2.50 Freight Class: 250 Product Weight (lbs.): 78 Cubic Feet Per Carton: 23.50</p>	 <p>ADJUSTMENTS (1) Tilt tension (2) Pneumatic seat height (6) Back height* (8) Seat depth (9) Chair tilt lock (5C) Synchro-tilt action Anti-kick back</p>	<p>Additional seat depth: 1"</p> <p>Ergonomic Features: A, B, C, D, E, L, M, N, Q, T</p>	<p>2424-18</p>											
			<p>OVERALL DIMENSIONS</p> <p>W D H</p>			<p>SEAT DIMENSIONS</p> <p>W D H</p>			<p>BACK DIMENSIONS</p> <p>W H</p>					
			28.5	27	50	21	17.5-19	18-22	21	28-31				
			<p>RTA 00</p>											

DESCRIPTION	FEATURES	MODEL#	STANDARD TEXTILE GRADES											
			1	2	3	4	5	6	7	8	9	10	11	12
 <p>Medium Back</p> <p>COM Yardage: 1.65 Freight Class: 125 Product Weight (lbs.): 66 Cubic Feet Per Carton: 10.50</p>	<p>See series notes for mechanism options.</p>	TS7331	1437	1500	1542	1612	1709	1753	1841	1980	2088	2209	2453	2715
			OVERALL DIMENSIONS			SEAT DIMENSIONS			BACK DIMENSIONS					
			W	D	H	W	D	H	W	H				
			24	21.5	42	19.75	15.5-18.5	17.5-21.5	19	22				
						RTA 1			1 per carton					
 <p>High Back</p> <p>COM Yardage: 1.75 Freight Class: 125 Product Weight (lbs.): 68 Cubic Feet Per Carton: 10.50</p>	<p>See series notes for mechanism options.</p>	TS7332	1507	1572	1620	1692	1796	1844	1937	2087	2202	2329	2591	2873
			OVERALL DIMENSIONS			SEAT DIMENSIONS			BACK DIMENSIONS					
			W	D	H	W	D	H	W	H				
			24.5	23	45.5	16.5-18.75	15.5-18.5	17.5-21.5	19	24.5				
						RTA 1			1 per carton					
 <p>Extended High Back</p> <p>COM Yardage: 2 Freight Class: 125 Product Weight (lbs.): 70 Cubic Feet Per Carton: 11</p>	<p>See series notes for mechanism options.</p>	TS7333	1576	1650	1705	1790	1908	1963	2071	2241	2375	2519	2823	3146
			OVERALL DIMENSIONS			SEAT DIMENSIONS			BACK DIMENSIONS					
			W	D	H	W	D	H	W	H				
			26	24	51	16.5-18.75	15.5-18.5	17.5-21.5	19	27				
						RTA 1			1 per carton					

ROBUST





model 2527

STANDARD FEATURES

- Heavy duty chair rated for multi shift users up to 500 pounds.
- Standard with a six prong, oval tubular steel base (32" in diameter) in Black (BK) Only.
- Standard with a solid steel loop style arm. The arm is vinyl dipped to be warm to the touch and impact absorbent.
- Arms are width adjustable for an extra 2" on each side, providing additional room and comfort for users.
- There are no arm options for this series.
- Side tension adjustment can be reached from a seated position.
- Standard with Ultracell high density, high resilient foam on seat and back.
- Large diameter 3" black casters, providing easier mobility.
- Casters are suitable for hard surface flooring or carpet. There are no caster options for this series.
- Standard pneumatic seat height adjustment. Forward and rearward seat tilt with infinite lock and free floating back angle control. Tilt tension control.
- This series has a two-tone fabric combination as standard. Trim is always Dobby, Black (DB42) fabric.

OPTIONAL FEATURES

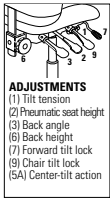
- Upholstered in fabric only. Check textile availability prior to specifying.
- An optional abrasion-resistant outer back fabric (polyester) is available (BKB). Resistant to impact damage. Available in Black only. Add \$23.

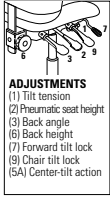
DESCRIPTION	FEATURES	MODEL#	STANDARD TEXTILE GRADES													
			1	2	3	4	5	6	7	8	9	10	11	12		
 <p>HB Heavy Duty Multi-Tilter COM Yardage: 3.25 Freight Class: 250 Product Weight (lbs.): 118 Cubic Feet Per Carton: 33.50</p>	 <p>ADJUSTMENTS (1) Tilt tension (2) Pneumatic seat height (3) Back angle (6) Back height (7) Forward tilt lock (9) Chair tilt lock (5A) Center-tilt action</p> <p>Ergonomic Features: A, B, C, F, G, M, N, S</p>	2526	-	2725	2817	2953	3147	3218	3385	3701	3858	4151	4560	5062		
		OVERALL DIMENSIONS			SEAT DIMENSIONS			BACK DIMENSIONS								
		W	D	H	W	D	H	W	H							
29	27.5	50.5	25.5	20	16.5-20.5	22	30									
 <p>MB Heavy Duty Multi-Tilter COM Yardage: 3 Freight Class: 250 Product Weight (lbs.): 114 Cubic Feet Per Carton: 29.50</p>	 <p>ADJUSTMENTS (1) Tilt tension (2) Pneumatic seat height (3) Back angle (6) Back height (7) Forward tilt lock (9) Chair tilt lock (5A) Center-tilt action</p> <p>Ergonomic Features: A, B, C, F, G, M, N, S</p>	2527	-	2542	2628	2751	2929	2995	3152	3443	3589	3859	4236	4700		
		OVERALL DIMENSIONS			SEAT DIMENSIONS			BACK DIMENSIONS								
		W	D	H	W	D	H	W	H							
29	26.5	42.5	25.5	20	16.5-20.5	22	24									

SAXON



model 2512-3



Back

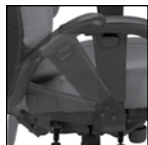

Arm Feature

Arms are designed to flip up and accommodate people wearing equipment belts.

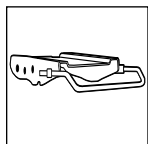

Multi-Depth Mechanism

Standard on all models. Allows seat to move forward and backward over a 2" range with 5 locking positions to provide a more shallow or deeper seat.

STANDARD FEATURES

- A contoured molded, dual cushion, Ultracell foam seat and heavily padded back provides exceptional comfort.
- Rated for multi-shift use by persons up to 350lbs.
- Abrasion resistant outer back fabric (polyester) is standard. Resistant to impact damage. Available in Black only.
- Standard with a black nylon molded base with dual wheel carpet casters (C10). Select hard floor casters (C10R) for use on most hard surfaces, add \$66.
- Standard with VL fold-up arms to accommodate users' equipment belts.
- Arms standard with Vari-Width Adapter Plates (WA).
- Back upright is 3" standard, with 2.25", five-position, ratchet back height adjustment.
- Side activated sliding seat depth adjustment (MD) is standard.
- Saxon is covered under Global's Heavy Duty Warranty for 12 years, 24/7 use environments. Fabrics with a minimum of 100,000 double rubs required.
- Upholstery options: fabric and coated textiles only. Coated textiles may feature stitch detail across the seat and/or back cushions, if applicable.

OPTIONAL FEATURES

- **AC10** casters are standard. Please see page 430 for additional caster options. Optional caster may be priced higher than the standard casters and will incur an upcharge. Lower priced optional casters will not be credited.

DESCRIPTION



HB Heavy Duty Multi-Tilter

COM Yardage: 2.25
 Freight Class: 150
 Product Weight (lbs.): 60
 Cubic Feet Per Carton: 13

FEATURES

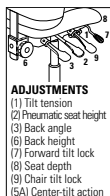

- ADJUSTMENTS**
- (1) Tilt tension
 - (2) Pneumatic seat height
 - (3) Back angle
 - (5) Back height
 - (6) Forward tilt lock
 - (7) Forward tilt lock
 - (8) Seat depth
 - (9) Chair tilt lock
 - (5A) Center-tilt action

Ergonomic Features:
 A, B, C, M, N, S

MODEL#

STANDARD TEXTILE GRADES

	1	2	3	4	5	6	7	8	9	10	11	12
2512-3	-	1820	1890	1987	2129	2181	2303	2532	2649	2861	3158	3521

OVERALL DIMENSIONS			SEAT DIMENSIONS			BACK DIMENSIONS	
W	D	H	W	D	H	W	H
27.5	25	39.5	22.5	19-21.5	18-22	20	19.5-22



VION



model TS6321-3



model TS6331-3

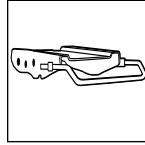

Multi-Depth Mechanism
Allows seat to move forward and backward over a 2" range with 5 locking positions to provide a more shallow or deeper seat.

VION FINISHES - TASK SEATING				
Back Frame	Base	Specify Code	Arm Option	Specify Code
Black	Black	BLK no upcharge	Adj. "T" arm (Black) Adj. "T" arm, fixed armcap (Black) Adj. "T" arm (Black , Chrome accent) Adj. "T" arm, fixed armcap (Black , Chrome accent)	AS AF AC A
Black	Polished Aluminum	BAU Add \$167	Fixed "C" arm (Black) Fixed "C" arm (Polished Aluminum)	C CA - Add \$202
Shadow	Shadow	SHW Add \$76	Adj. "T" arm (Shadow) Adj. "T" arm, fixed armcap (Shadow) Adj. "T" arm (Shadow , Chrome accent) Adj. "T" arm, fixed armcap (Shadow , Chrome accent)	SHA SHF SHR SHD
Shadow	Polished Aluminum	SAU Add \$241	Fixed "C" arm (Shadow) Fixed "C" arm (Polished Aluminum)	SHC CA - Add \$202
Fog	Fog	FOG Add \$376	Adj. "T" arm (Fog) Adj. "T" arm, fixed armcap (Fog) Adj. "T" arm (Fog , Chrome accent) Adj. "T" arm, fixed armcap (Fog , Chrome accent)	FA FF FC CF
Fog	Polished Aluminum	FAU Add \$241	Fixed "C" arm (Fog) Fixed "C" arm (Polished Aluminum)	CC CA - Add \$202









* All arms have Black SSU Armcaps.

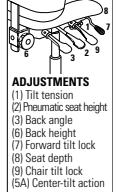



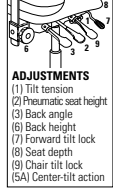

STANDARD FEATURES

- The TS models are available within standard Vion series. TS stands for "Three Shift" and each of the TS models are rated for 24-7 applications as well as weight rated up to 350 pounds.
- Multi-Tilter models, feature a heavy duty mechanism.
- Multi-Tilters are standard with Pneumatic seat height and sliding seat depth adjustment. Forward and rearward seat tilt with infinite lock and free floating back angle control. Tilt tension control.
- Side activated sliding seat depth adjustment (MD) is standard on Multi-Tilter. Provides 2" of seat depth adjustment.
- Heavy duty height adjustable stools are standard with fixed back. Seat depth and pneumatic seat height adjustments. Swivels with adjustable chrome footring.
- All models are standard with either Ultracell or molded heavy duty seat foam.
- All models have a heavy duty 3" wide back upright.
- All models are standard with height and width adjustable arms (**AS**) that feature a front to back sliding armcap.
- Mesh back models are available in 10 standard Vion colors: Aqua (**MS75**), Black (**MS69**), Black Cherry (**MS76**), Blue (**MS72**), Dust (**MS77**), Ivory (**MS78**), Natural (**MS74**), Paprika (**MS79**), Rope (**MS73**) and Stone (**MS71**).
- Mesh back models will always feature black fabric (Jenny **JN02**) on the back side.
- Check textile availability prior to specifying upholstery material. Materials must meet or exceed 100,000 double rubs to comply with Globals Heavy Duty seating textile warranty.

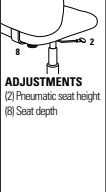
OPTIONAL FEATURES

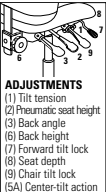
- Vion back frames, arms and bases are available in three colors: Black, Shadow and Fog. See Vion finishes chart for options and upcharges. Armcaps are always Black.
- Mesh back models are also available in 10 Dimension Mesh colors: Black (**DBK**), Fog (**DST**), Chalk (**DCL**), Shadow (**DGM**), Charcoal (**DCH**), Sand (**DSB**), Cobalt (**DCO**), Pool Blue (**DPB**), Citrus (**DCT**) and Berry (**DBE**). Add \$27
- Upholstered back models offer a Matching Outer (**MO**) upholstery option. Due to the additional material needed, these models are listed separately and are priced differently than the standard upholstered back models.
- Two featured "T" arm options that include height and width adjusting arms, one with sliding arm caps (**AS**) and one without sliding arm caps (**AF**). Also, available is a stylish fixed urethane arm (**C**) for conference/management environments.
- Optional Lumbar Pad can be added at the time of order. Please specify **LP**. Add \$40. Lumbar Pad can also be order after sale as a kit, specify model 6339 at \$43 list. The Lumbar Pad is adjustable up to 3".
- Optional Memory Foam available on Vion Seats. Please specify **MF**. Add \$117.
- B7A** Polished aluminum base and matching chrome arm accent on either **AS** or **AF** arms. Please specify **ALU** and **AC**. Add \$152.

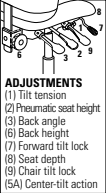
DESCRIPTION	FEATURES	MODEL#	STANDARD TEXTILE GRADES																																	
			1	2	3	4	5	6	7	8	9	10	11	12																						
 <p>HB Heavy Duty Multi - Tilter - Mesh Back COM Yardage: 1.75 Freight Class: 150 Product Weight (lbs.): 49 Cubic Feet Per Carton: 9.75</p>	 <p>ADJUSTMENTS (1) Tilt tension (2) Pneumatic seat height (3) Back angle (6) Back height (7) Forward tilt lock (8) Seat depth (9) Chair tilt lock (5A) Center-tilt action</p>	<p>Vion TS</p> <p>Ergonomic Features: A, B, C, E, F, G, H, M, N, Q, U, S</p>	<table border="1"> <tr> <td>TS6321-3</td> <td>1293</td> <td>1330</td> <td>1358</td> <td>1399</td> <td>1458</td> <td>1479</td> <td>1530</td> <td>1629</td> <td>1678</td> <td>1768</td> <td>1893</td> <td>2046</td> </tr> </table>												TS6321-3	1293	1330	1358	1399	1458	1479	1530	1629	1678	1768	1893	2046									
			TS6321-3	1293	1330	1358	1399	1458	1479	1530	1629	1678	1768	1893	2046																					
			<table border="1"> <thead> <tr> <th colspan="3">OVERALL DIMENSIONS</th> <th colspan="3">SEAT DIMENSIONS</th> <th colspan="3">BACK DIMENSIONS</th> </tr> <tr> <th>W</th> <th>D</th> <th>H</th> <th>W</th> <th>D</th> <th>H</th> <th>W</th> <th>H</th> <th></th> </tr> </thead> <tbody> <tr> <td>25.5</td> <td>24</td> <td>41</td> <td>20</td> <td>17-19.5</td> <td>17.5-21.5</td> <td>19</td> <td>21.5-24</td> <td></td> </tr> </tbody> </table>			OVERALL DIMENSIONS			SEAT DIMENSIONS			BACK DIMENSIONS			W	D	H	W	D	H	W	H		25.5	24	41	20	17-19.5	17.5-21.5	19	21.5-24		<p>RTA 2  </p>			
			OVERALL DIMENSIONS			SEAT DIMENSIONS			BACK DIMENSIONS																											
W	D	H	W	D	H	W	H																													
25.5	24	41	20	17-19.5	17.5-21.5	19	21.5-24																													
<table border="1"> <tr> <th>1</th> <th>2</th> <th>3</th> <th>4</th> <th>5</th> <th>6</th> <th>7</th> <th>8</th> <th>9</th> <th>10</th> <th>11</th> <th>12</th> </tr> <tr> <td>TS6322-3</td> <td>1242</td> <td>1280</td> <td>1308</td> <td>1349</td> <td>1409</td> <td>1429</td> <td>1480</td> <td>1579</td> <td>1628</td> <td>1718</td> <td>1844</td> <td>1997</td> </tr> </table>												1	2	3	4	5	6	7	8	9	10	11	12	TS6322-3	1242	1280	1308	1349	1409	1429	1480	1579	1628	1718	1844	1997
1	2	3	4	5	6	7	8	9	10	11	12																									
TS6322-3	1242	1280	1308	1349	1409	1429	1480	1579	1628	1718	1844	1997																								
<table border="1"> <thead> <tr> <th colspan="3">OVERALL DIMENSIONS</th> <th colspan="3">SEAT DIMENSIONS</th> <th colspan="3">BACK DIMENSIONS</th> </tr> <tr> <th>W</th> <th>D</th> <th>H</th> <th>W</th> <th>D</th> <th>H</th> <th>W</th> <th>H</th> <th></th> </tr> </thead> <tbody> <tr> <td>25.5</td> <td>24</td> <td>39</td> <td>20</td> <td>17-19.5</td> <td>17.5-21.5</td> <td>19</td> <td>21.5-24</td> <td></td> </tr> </tbody> </table>			OVERALL DIMENSIONS			SEAT DIMENSIONS			BACK DIMENSIONS			W	D	H	W	D	H	W	H		25.5	24	39	20	17-19.5	17.5-21.5	19	21.5-24		<p>RTA 2  </p>						
OVERALL DIMENSIONS			SEAT DIMENSIONS			BACK DIMENSIONS																														
W	D	H	W	D	H	W	H																													
25.5	24	39	20	17-19.5	17.5-21.5	19	21.5-24																													
 <p>MB Heavy Duty Multi - Tilter - Mesh Back COM Yardage: 1.75 Freight Class: 150 Product Weight (lbs.): 49 Cubic Feet Per Carton: 9.75</p>	 <p>ADJUSTMENTS (1) Tilt tension (2) Pneumatic seat height (3) Back angle (6) Back height (7) Forward tilt lock (8) Seat depth (9) Chair tilt lock (5A) Center-tilt action</p>	<p>Vion TS</p> <p>Ergonomic Features: A, B, C, E, F, G, H, M, N, Q, U, S</p>	<table border="1"> <tr> <td>TS6322-3</td> <td>1242</td> <td>1280</td> <td>1308</td> <td>1349</td> <td>1409</td> <td>1429</td> <td>1480</td> <td>1579</td> <td>1628</td> <td>1718</td> <td>1844</td> <td>1997</td> </tr> </table>												TS6322-3	1242	1280	1308	1349	1409	1429	1480	1579	1628	1718	1844	1997									
			TS6322-3	1242	1280	1308	1349	1409	1429	1480	1579	1628	1718	1844	1997																					
			<table border="1"> <thead> <tr> <th colspan="3">OVERALL DIMENSIONS</th> <th colspan="3">SEAT DIMENSIONS</th> <th colspan="3">BACK DIMENSIONS</th> </tr> <tr> <th>W</th> <th>D</th> <th>H</th> <th>W</th> <th>D</th> <th>H</th> <th>W</th> <th>H</th> <th></th> </tr> </thead> <tbody> <tr> <td>25.5</td> <td>24</td> <td>39</td> <td>20</td> <td>17-19.5</td> <td>17.5-21.5</td> <td>19</td> <td>21.5-24</td> <td></td> </tr> </tbody> </table>			OVERALL DIMENSIONS			SEAT DIMENSIONS			BACK DIMENSIONS			W	D	H	W	D	H	W	H		25.5	24	39	20	17-19.5	17.5-21.5	19	21.5-24		<p>RTA 2  </p>			
			OVERALL DIMENSIONS			SEAT DIMENSIONS			BACK DIMENSIONS																											
W	D	H	W	D	H	W	H																													
25.5	24	39	20	17-19.5	17.5-21.5	19	21.5-24																													

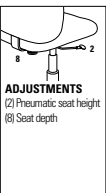
DESCRIPTION	FEATURES	MODEL#	STANDARD TEXTILE GRADES														
			1	2	3	4	5	6	7	8	9	10	11	12			
 <p>MB Heavy Duty Stool - Mesh Back COM Yardage: 1.75 Freight Class: 150 Product Weight (lbs.): 49 Cubic Feet Per Carton: 9.75</p>	 <p>ADJUSTMENTS (2) Pneumatic seat height (8) Seat depth</p>	S6328-6	999	1042	1072	1117	1184	1207	1265	1376	1430	1532	1672	1848			
			OVERALL DIMENSIONS			SEAT DIMENSIONS			BACK DIMENSIONS								
			W	D	H	W	D	H	W	H							
			25.5	24	48	20	17.5	23.5-33.5	19	21.5-24							
<p>Vion S</p> <p>Ergonomic Features: C, E, H, M, N, Q, U</p>	<p>RTA 2</p> <p>FedEx</p> <p>UPS</p>																
		 <p>HB Heavy Duty Multi - Tilter - Upholstered Back COM Yardage: 1.75 Freight Class: 150 Product Weight (lbs.): 49 Cubic Feet Per Carton: 9.75</p>	 <p>ADJUSTMENTS (1) Tilt tension (2) Pneumatic seat height (3) Back angle (6) Back height (7) Forward tilt lock (8) Seat depth (9) Chair tilt lock (SA) Center-tilt action</p>	TS6331-3	1427	1475	1510	1560	1634	1663	1724	1850	1908	2023	2178	2370	
					TS6331-3MO	1483	1556	1611	1695	1814	1869	1976	2146	2277	2424	2725	3045
						OVERALL DIMENSIONS			SEAT DIMENSIONS			BACK DIMENSIONS					
W	D				H	W	D	H	W	H							
25.5	24	41	20	17-19.5	17.5-21.5	19	21.5-24										
<p>Vion TS</p> <p>Ergonomic Features: A, B, C, E, F, G, H, M, N, Q, U, S</p>	<p>RTA 2</p> <p>FedEx</p> <p>UPS</p>																
		 <p>MB Heavy Duty Multi - Tilter - Upholstered Back COM Yardage: 1.75 Freight Class: 150 Product Weight (lbs.): 49 Cubic Feet Per Carton: 9.75</p>	 <p>ADJUSTMENTS (1) Tilt tension (2) Pneumatic seat height (3) Back angle (6) Back height (7) Forward tilt lock (8) Seat depth (9) Chair tilt lock (SA) Center-tilt action</p>	TS6332-3	1376	1423	1456	1508	1582	1610	1672	1798	1855	1970	2126	2318	
					TS6332-3MO	1436	1515	1576	1668	1794	1853	1972	2157	2299	2458	2785	3134
						OVERALL DIMENSIONS			SEAT DIMENSIONS			BACK DIMENSIONS					
W	D				H	W	D	H	W	H							
25.5	24	41	20	17-19.5	17.5-21.5	19	21.5-24										
<p>Vion TS</p> <p>Ergonomic Features: A, B, C, E, F, G, H, M, N, Q, U, S</p>	<p>RTA 2</p> <p>FedEx</p> <p>UPS</p>																
		 <p>MB Heavy Duty Height Adjustable Stool Upholstered Back COM Yardage: 1 Freight Class: 150 Product Weight (lbs.): 47 Cubic Feet Per Carton: 10.50</p>	 <p>ADJUSTMENTS (2) Pneumatic seat height (8) Seat depth</p>	S6338-6	1122	1174	1212	1272	1355	1384	1457	1596	1660	1792	1966	2183	
					OVERALL DIMENSIONS			SEAT DIMENSIONS			BACK DIMENSIONS						
					W	D	H	W	D	H	W	H					
25.5	24				48	20	17.5	23.5-33.5	18.5	21							
<p>Vion S</p> <p>Ergonomic Features: C, E, M, N</p>	<p>RTA 2</p> <p>FedEx</p> <p>UPS</p>																

arm and caster options



HOW TO SELECT ARMRESTS

Global has a wide selection of armrest to suit almost every work task. Armrest are an important feature of a chair. They reduce stress an tension on the spine, neck and shoulder muscles by supporting the weight of your arms. This makes you more comfortable and ultimately more productive. Height, width and angle adjustable armrests enable you to position your arms at a comfortable working position, based on the task at hand.

COMFORT TIPS

- Wrists should be in a straight or neutral position - avoid bending your wrists
- When mousing, use whole arm movements instead of flexing your wrist.
- Rest your palm on the mouse pad for support.

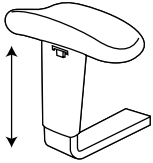

HEIGHT ADJUSTABLE ARMS

- A full range of arms is available with armcaps in self-skinned urethane (SSU).
- Use the features available on Global's adjustable arms to accommodate your ergonomic requirements.

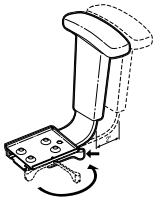

VARI-WIDTH ARM

- Features maximum comfort while enabling you to maintain top productivity levels.
- Easy to use levers enable you to adjust the distance between armrests quickly and simply. An ergonomic feature, Vari-Width maximizes shoulder support as it accommodates the specific width requirements of each user.
- Metal adapter plates provide width adjustability. One adapter plate is attached under each side of the seat. Arms are inserted into the adapter plates.
- Arms extend outward up to 2" on each side. A lever locks each arm in any position.
- Vari-Width is available only with Global's height adjustable arms. The arm chart (on the following pages) specifies all arm options available for the Vari-Width series. Vari-Width is standard on many chairs; they can also be retroactively installed on chairs.
- When ordering, please specify series, arm and **(WA)** ie. Loover 2660-0 **(G5)** and **(WA)**. When ordering as retrofit, please specify **2660-0-WA**.

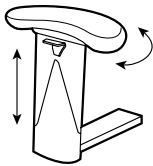

ROTATING ARMCAPS

Rotating armcaps articulate inward and/or outward. This positions the arm to support mousing or keyboarding activities. Rotating armcaps can also be used to narrow the space between the arms for slender people seeking arm support while keyboarding.

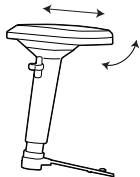

SLIDING ARMCAPS

Select arms have sliding armcaps. They can slide over top of the seat to narrow the space between the arms for smaller users. Sliding armcaps also slide forward for arm support for larger users or slide to the rear allowing slender users to sit closer to their worksurface.

OPTIONAL ARMS

Purchased separately from the chair. Cost listed below arm descriptions. Refer to chart for series compatibility.



AS

Height and width adjustable forward and backward sliding armcaps.

\$273

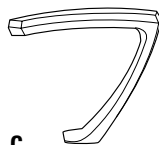

C

Fixed height and stylish "C" arm. Self-skinned urethane. Black only.

\$273

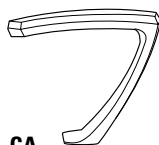

CA

Fixed height and stylish "C" arm. Polished Aluminum.

\$430

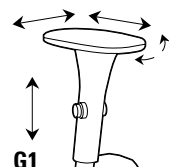

G1

Height and width adjustable forward and backward sliding armcaps. Self-skinned urethane pad rotates inward.

\$273



G2

Special low rise version of G3 arm, positions 1" lower but retains all G3 functions.

\$273

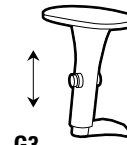

G3

Height and width adjustable forward and backward sliding armcaps. Self-skinned urethane pad rotates inward 30 degrees.

\$273



G4

Height adjustable "T" style Graphic arm. Self-Skinned Urethane (SSU) armcap. Slides forward and back.

\$273



G5

Lockable, highly adjustable armcap slides forward and backward, cap slides over seat 3/4" each side, cap rotates inward & outward. Soft (SSU) arm pad.

\$273



G6

Special low rise version of G5 arm, positions 1" lower but retains all G5 arm functions.

\$273

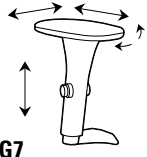

G7

Wider highly adjustable armcap slides forward and backward, cap slides over seat 3/4" each side. Cap rotates inward. Soft SSU arm pad. Curved corners and sides.

\$273

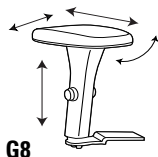

G8

Special low rise version of G7 arm, positions 1" lower but retains all G7 functions.

\$273

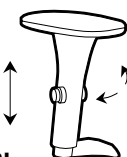

GL

Width adjustable forward and backward sliding armcaps.

\$273

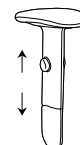

SC

Height adjustable forward swept arms with kidney shaped armcaps. Self-skinned urethane.

\$238

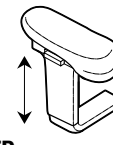

TD

Height adjustable "T" arms with teardrop shaped armcaps. Self-skinned urethane.

\$238



T6

Height adj. T arm. Rotates 360. Self-skinned urethane.

\$318

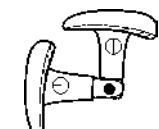

ZT

Height adjustable "T" arms, teardrop shaped. Swings away and folds. Self-skinned urethane.

\$290



3B

Height Adjustable "T" arm with soft touch Self-Skinned Urethane (SSU) armcap.

\$238

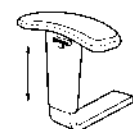

3N

Height adjustable "T" arms with curved shaped armcaps. Self-skinned urethane. Available in Black only.

\$195

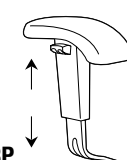

3P

Height adjustable "waterfall edge" arms. Self-skinned urethane. Available in Black Only.

\$303



3R

Hard durometer. Height Adjustable "T" arm with Concave Oval soft touch Self-Skinned Urethane (SSU) armcap.

\$238

ARM SELECTIONS

SERIES \ ARM	STD	AS	C	CA	G1	G2	G3	G4	G5	G6	G7	G8
ASPEN	AS		NA	NA	0	NA	0	0	0	NA	0	0
ENTERPRISE	TD	96	NA	NA	43	43	43	43	43	43	NA	NA
GOAL	3N	NR	89	NA	NR	NR	NR	NR	NR	NR	NR	NR
GRAHAM	3N	96	NA	NA	90	90	90	90	90	90	NA	NA
GRANADA	3N	96	NA	NA	90	90	90	90	90	90	NR	NR
GRANADA DELUXE	3B	96	NA	NA	43	43	43	43	43	43	NA	NA
GRAPHIC	G4	0	0	NA	0	NA	0		0	NA	0	0
LOOVER	G5	0	0	145	0	0	0	0	STD	0	0	0
MALAGA	TD	96	NA	NA	43	43	43	43	43	43	NA	NA
OBUSFORME COMFORT	G3	0	NA	NA	0	0	STD	0	0	0	0	0
SAXON	VL	0	NA	NA	0	0	0	0	0	0	0	0
SUPRA X	SC	96	43	NA	43	43	43	43	43	43	NA	NA
SYNOPSIS	3B	96	43	NA	43	43	43	43	43	43	NA	NA
TRIUMPH	G1	0	NA	NA	STD	NA	0	0	0	NA	NA	NA
TRUFORM	SC	96	43	NA	43	43	43	43	43	43	43	NA
TYE	3N	96	NA	NA	90	90	90	90	90	90	90	NA
VION	AS/C	STD	STD	202	0	0	0	0	0	0	0	0
WEEV	GL	0	0	NA	0	0	0	0	0	0	0	0

NOTE: ARMCHAIRS HAVE FIXED ARMS WHICH ARE NOT INTERCHANGEABLE WITH ADJUSTABLE ARMS LISTED ABOVE.
 * INDICATES THAT ARMS CANNOT BE USED WITH "WA" ARM WIDTH ADAPTER.

\$0 = AVAILABLE AT NO ADDITIONAL CHARGE

NA = NOT AVAILABLE

NR = OPTION NOT RECOMMENDED

SERIES \ ARMS	STD	GL	SC	TD	T6	ZT	3B	3N	3P	3R	WA
ASPEN	AS	0	NR	NR	NA	NA	NR	NR	NR	NR	STD
ENTERPRISE	TD	43	0	0	115	63	0	0	0	0	STD
GOAL	3N	NR	49	52	NR	107	49	STD	52	49	NA
GRAHAM	3N	90	52	52	162	110	49	STD	49	49	NA
GRANADA	3N	90	52	52	162	110	49	STD	49	49	STD
GRANADA DELUXE	3B	43	0	0	115	63	STD	0	0	0	STD
GRAPHIC	G4	0	0	NR	75	23	NR	NR	NR	NR	STD
LOOVER	G5	0	0	0	0	NA	0	0	0	0	0
MALAGA	TD	43	0	STD	115	63	0	0	0	0	STD
OBUSFORME COMFORT	G3	0	0	0	75	23	0	0	0	0	STD
SAXON	VL	0	0	NR	56	NR	0	0	0	0	NA
SUPRA X	SC	43	STD	0	115	63	0	0	0	0	STD
SYNOPSIS	3B	43	0	0	15	63	STD	0	0	0	STD
TRIUMPH	G1	0	NA	NA	NA	NA	NA	NA	NA	NA	NA
TRUFORM	SC	43	STD	0	115	63	0	0	0	0	NA
TYE	3N	90	52	52	162	110	52	STD	52	52	NA
VION	AS/C	0	0	0	75	NA	0	0	0	0	0
WEEV	GL	STD	0	0	75	23	0	0	0	0	STD

NOTE: ARMCHAIRS HAVE FIXED ARMS WHICH ARE NOT INTERCHANGEABLE WITH ADJUSTABLE ARMS LISTED ABOVE.
 * INDICATES THAT ARMS CANNOT BE USED WITH "WA" ARM WIDTH ADAPTER.

\$0 = AVAILABLE AT NO ADDITIONAL CHARGE

NA = NOT AVAILABLE

NR = OPTION NOT RECOMMENDED

CASTER SELECTIONS

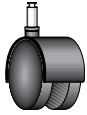

C1 2" Dual Wheel Caster Black Carpeted Floor 1 each \$19
set of 5 \$83

Available on: Softcurve and Traditional bases.



C7 Slipper Glide (allows chair to remain at caster height) Black Any surface 1 each \$19
set of 5 \$83

Available on: All bases



C9R 2 1/2" Dual Wheel Rubber Coated Caster Black Vinyl, Marble, Hardwood Floor 1 each \$34
set of 5 \$152

Available on: All bases



C10 2" Integrated Dual Wheel Caster Black Carpeted Floor 1 each \$31
set of 5 \$135



C10R Integrated Dual Wheel Rubber Coated Caster Black Vinyl, Marble, Hardwood Floor 1 each \$44
set of 5 \$198

Available on: Concorde, Graham, Malaga, and Tamiri bases only.



C14R Automatic Locking Rubber Caster (while sitting) Black Any surface* 1 each \$88
set of 5 \$354

Available on: All bases



C15 Manual Locking Caster (individual) Black Carpeted Floor 1 each \$40
set of 5 \$183

Available on: All bases

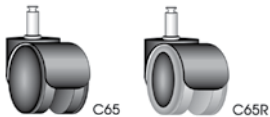











C65 2" Dual Wheel Caster Black Carpeted Floor 1 each \$26
set of 5 \$83

C65R 2" Dual Wheel Rubber Coated Caster Black Vinyl, Marble, Hardwood Floor 1 each \$37
set of 5 \$152

Available on: All bases (except wood base chairs).

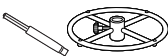
CASTER NOTES:

- The casters shown above are sold in sets for replacement purposes. This price list can also be used to calculate the upcharge to change casters at time of ordering a chair. Optional casters may be priced higher than the standard casters for your chair and the difference will be charged. Lower priced casters will not be credited.
- All casters are not appropriate for all flooring surfaces. Please consult with your sales representative or Global Customer Service representative for special situations that can be verified with the caster manufacturer. Alternative casters, if needed, may require an upcharge.
- *Recommended for use on hard surface floors.

	MODEL #	MODEL NAME
	3G	3" cylinder Soft Descent™ pneumatic lift cylinder with 3 inch travel range. This lift cannot be used on synchro-tilter (-0) and multi-tilter (-3) mechanisms due to operational interference with controls.
	4F	Fixed height swivel spindle #4 Fixed height, swivel only. Seat height is determined by the spindle length which is preset at the factory and cannot be changed.
	4L	4" cylinder, low rise Soft Descent™ low rise, pneumatic lift cylinder with 4 inch travel range.
	5F	Fixed height swivel spindle #5 Fixed height, swivel only. Seat height is determined by the spindle length which is preset at the factory and cannot be changed.
	5L	5" cylinder, low rise Soft Descent™ low rise, pneumatic lift cylinder with 5 inch travel range.
	7G	7" cylinder Soft Descent™ pneumatic lift cylinder with 7 inch travel range. Lift allows most users to sit at both desk and counter heights. Seats may be too tall for shorter users at desk height.
	7R	7" cylinder with 20" Chrome footrest Soft Descent™ pneumatic lift cylinder with 7 inch travel range and adjustable footrest. Lift allows most users to sit at both desk and counter heights. Seats may be too tall for shorter users at desk height (refer to cylinder chart on page 432).
	SC	Self-centering, height auto-return Center and height return pneumatic lift cylinder with 2 inch travel range. Chair always swivels back to face the original direction so groups of chairs remain aligned. The seat height may be lowered by occupant, but chairs return to the maximum seat height when user exits the chair.
	SH	Height auto-return, swivel Height return pneumatic lift cylinder with 2 inch travel range. The seat height may be lowered by occupant, but chairs return to the maximum seat height when user exits the chair.
	SN	Height auto-return, non-swivel Height return pneumatic lift cylinder with 2 inch travel range. The seat height may be lowered by occupant, but chairs return to the maximum seat height when user exits the chair. Lift does not swivel.

CYLINDER NOTES:

- All cylinders are not appropriate for all mechanisms. Please refer to the following chart for compatibility and effect on minimum seat height.
- For cylinder upcharges and replacement costs, please contact Customer Service.

CYLINDER SELECTIONS





SERIES	CYLINDER	STD	3G	4L	4F	5L	5F	7G	7R	SC	SH	SN
	Mechanism											
ACCORD	-2	4L	NA	STD	NA	+1.5	NA	+1.0	NA	NA	NA	NA
	-4	4G*	NA	NA	+0.5	NA	+1.0	+1.0	NA	+1.5	+1.5	+1.5
ASPEN	-3	4L	-0.75	STD	NA	+1.5	NA	+2.0	NA	NA	NA	NA
G1 ERGO SELECT	-0	4L	N/A	STD	NA	+1.5	NA	NA	NA	NA	NA	NA
	-3	4L	N/A	STD	NA	+1.5	NA	+2.0	NA	NA	NA	NA
	-8	4L	N/A	STD	NA	+1.5	NA	+2.0	NA	NA	NA	NA
G20		5L	-2.25	-1.5	NA	STD	NA	+1.0	NA	NA	NA	NA
GRANADA DELUXE	-2,-3	4L	NA	STD	NA	+1.5	NA	+2.0	NA	NA	NA	NA
	-5	4L	-0.75	STD	NA	+1.5	NA	+2.0	NA	NA	NA	NA
LOOVER	-3	4L	-0.75	STD	NA	+1.5	NA	+2.0	NA	NA	NA	NA
	-4	5L	-2.25	-1.5	NA	STD	+1.0	+1.0	+1.0	+1.75	+1.75	+1.75
	-8	5L	-2.25	-1.5	NA	STD	+1.0	+1.0	+1.0	+2.0	+2.0	+2.0
LURAY	-2	4L	NA	STD	NA	+1.5	NA	NA	NA	NA	NA	NA
	-4	5L	NA	-1.5	+0.5	STD	+1.0	+1.0	NA	+1.5	+1.5	+1.5
MALAGA	-1,-4	5L	-2.25	-1.5	NA	STD	NA	+1.0	NA	NA	NA	NA
	-2,-3	5L	NA	-1.5	NA	STD	NA	+1.0	NA	NA	NA	NA
NOVELLO		5L	-2.25	-1.5	NA	STD	NA	+1.0	NA	NA	NA	NA
OBUSFORME COMFORT	-2,-3	4L	NA	STD	NA	+1.5	NA	+2.0	NA	NA	NA	NA
	-5	4L	-0.75	STD	NA	+1.5	NA	NA	NA	NA	NA	NA
PREFER		4G*	-1.75	-1.25	+0	+0.25	+1.0	+0.75	+0.75	NA	NA	NA
ROMA		4L*	-0.75	STD	NA	+1.5	+2.5	+2.0	NA	+2.0	+2.0	+2.0
SOFTCURVE LM	-1	5L	NA	-1.5	NA	STD	NA	NA	NA	NA	NA	NA
	-2,-3	4L	NA	STD	NA	+1.5	NA	NA	NA	NA	NA	NA
	-4	5L	NA	-1.5	NA	STD	+0.5	NA	NA	+2.0	+2.0	+2.0
SOLAR		4L*	NA	NA	+0.0	NA	+1.0	NA	NA	NA	NA	NA
SORA	-8	4L	-0.75	STD	NA	+1.5	NA	+2.0	+2.0	NA	NA	NA
SPREE		5L	-2.25	-1.5	NA	STD	NA	+1.0	NA	NA	NA	NA
SUPRA-X	-1,-4,-5	5L	-2.25	-1.5	NA	STD	NA	+1.0	NA	NA	NA	NA
	-3	5L	NA	-1.5	NA	STD	NA	+1.0	NA	NA	NA	NA
SYNOPSIS	-3	5L	NA	-1.5	NA	STD	NA	+1.0	NA	NA	NA	NA
	-4	5L	-2.25	-1.5	NA	STD	+1.0	+1.0	NA	+2.25	+2.25	+2.25
TRIUMPH	-3,-8	4L*	-0.75	STD	NA	+1.5	NA	+2.0	NA	NA	NA	NA
TRUFORM	-0	5L	NA	-1.5	NA	STD	NA	NA	NA	NA	NA	NA
	-3	5L	NA	-1.5	NA	STD	NA	+1.0	NA	NA	NA	NA
	-1,-4,-5	5L	NA	-1.5	NA	STD	NA	+1.0	NA	NA	NA	NA
	-8	5L	-2.25	-1.5	NA	STD	NA	+1.0	NA	NA	NA	NA
VION	-3	5L	-2.25	-1.5	NA	STD	NA	+1.0	+1.0	+1.75	+1.75	+1.5
	-4	5L	-2.25	-1.5	NA	STD	+1.0	+1.0	+1.0	+1.0	+1.0	+1.5
	-8	5L	-2.25	-1.5	NA	STD	+0.5	+1.0	NA	NA	NA	+1.5
WEEV	-3,-4,-8	5L	-2.25	-1.5	NA	STD	NA	+1.0	NA	NA	NA	NA

NOTE: CHART VALUES INDICATE CHANGE FROM STANDARD MINIMUM SEAT HEIGHT (IN INCHES).

3G AND 7G CYLINDERS ARE NOT AVAILABLE FOR USE WITH -0 SYNCHRO-TILT MECHANISM.

*SPECIAL CYLINDER

DUET AND POPCORN GLIDE SELECTIONS

GLIDES	SURFACE	CARPET	VINYL SHEET	LVT	VCT	RUBBER	CORK	HARDWOOD	LAMINATE	CERAMIC TILE, STONE	MARBLE, GRANITE	CONCRETE
NO GLIDE (XG): The plain Chrome sled based frame slides easily and silently over carpeted surfaces. Note: do not use in damp areas.												
		●	NR	NR	NR	●	NR	NR	NR	NR	NR	NR
CLEAR POLYCARBONATE GLIDE (CG): The polycarbonate glide is easy to move over most flooring. It does not leave marks and it reduces noise on hard surfaces.												
		●	NR	NR	NR	●	NR	NR	NR	NR	NR	●
STAINLESS STEEL PAD ON POLYCARBONATE GLIDE (SG): The stainless steel bottomed glide slides easily. It is extremely durable, reduces floor contact and noise on hard surfaces.												
		●	NR	NR	NR	●	NR	NR	NR	NR	NR	NR
FELT PAD ON POLY CARBONATE GLIDE (FG): The felt bottomed glide moves silently and smoothly on hard surface flooring. Helps to prevent floor damage.												
		NR	●	●	●	NR	●	NR	●	NR	NR	NR
RUBBER NO SLIP PAD ON POLY CARBONATE GLIDE (RG): The rubber bottomed glide is slip-resistant. It grips flooring, reduces movement, scratching and eliminates noise.												
		NR	●	●	●	NR	NR	●	●	●	●	NR

NOTE: THE ABOVE IS ONLY A GUIDELINE BASED ON CLEAN AND PROPERLY FINISHED FLOORS. GLIDES THAT ARE NOT RECOMMENDED FOR USE WILL NOT BE COVERED BY GLOBAL'S LIFETIME WARRANTY. SITE CONDITIONS CAN DRAMATICALLY AFFECT HOW APPROPRIATE A GLIDE IS FOR ANY APPLICATION. REGULAR INSPECTION OF GLIDES IS CRITICAL TO PREVENTING FLOOR DAMAGE. SEE DESCRIPTIONS BELOW.

● = BEST FOR APPLICATION

NR = OPTION NOT RECOMMENDED

NO GLIDE (XG): The plain Chrome sled based frame slides easily and silently over carpeted surfaces. Note: do not use in damp areas.
CLEAR POLYCARBONATE GLIDE (CG): The polycarbonate glide is easy to move over most flooring. It does not leave marks and it reduces noise on hard surfaces.
STAINLESS STEEL PAD ON POLYCARBONATE GLIDE (SG): The stainless steel bottomed glide slides easily. It is extremely durable, reduces floor contact and noise on hard surfaces.
FELT PAD ON POLYCARBONATE GLIDE (FG): The felt bottomed glide moves silently and smoothly on hard surface flooring. Helps to prevent floor damage.
RUBBER NO SLIP PAD ON POLYCARBONATE GLIDE (RG): The rubber bottomed glide is slip-resistant. It grips flooring, reduces movement, scratching and eliminates noise.

specialty

Academic Task 435

Industrial Clean Room 441

Industrial Seating 437

Industrial Wipe Down 442

Industrial ESD 439

Academic Arms + Casters 445

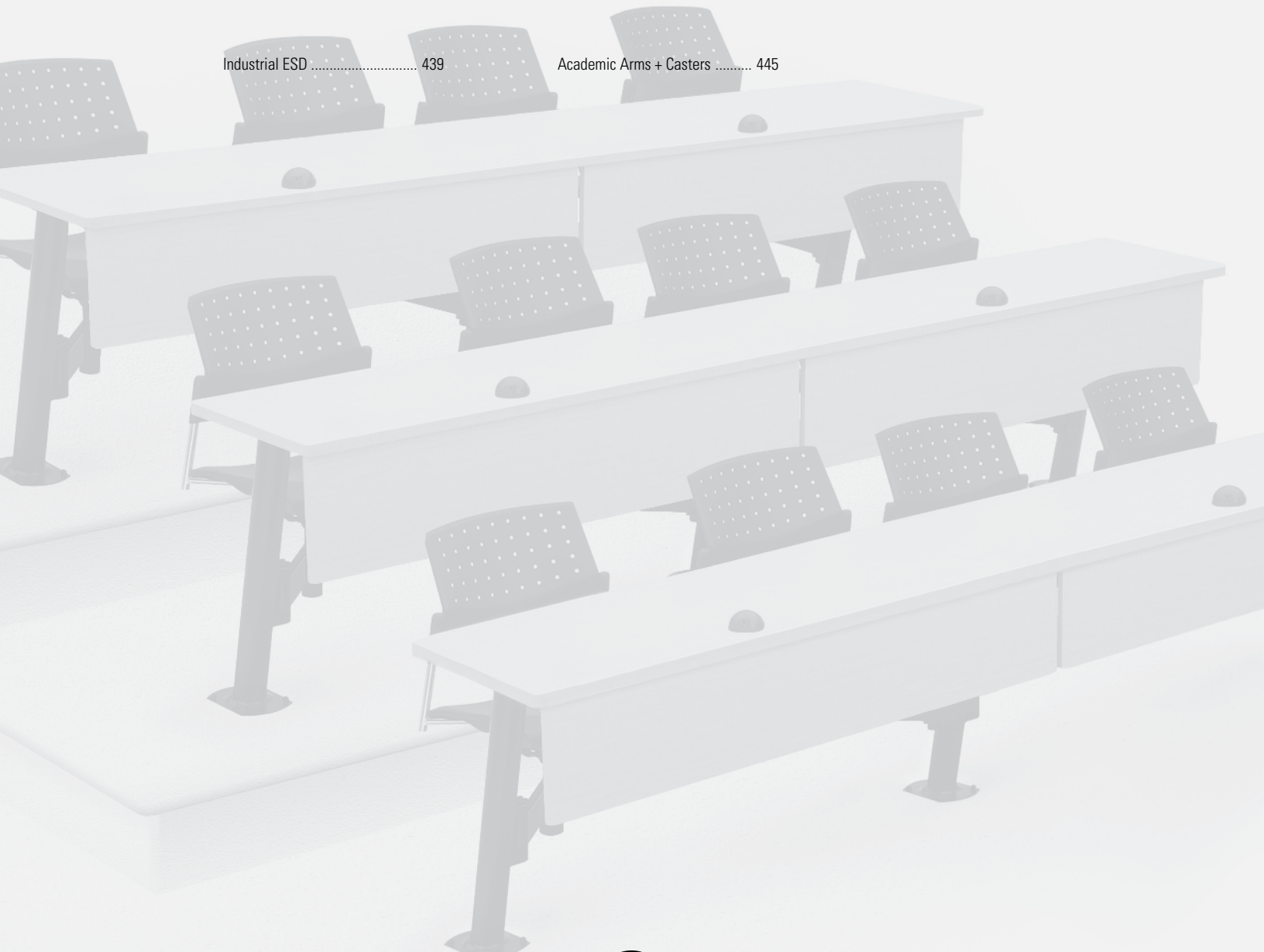

ACADEMIC TASK SEATING







model S2237-6 (3N) Goal

STANDARD FEATURES

- Durable task seating designed to sustain years of use in educational and training room applications.
- The back bar is welded to the chair mechanism and the backrest is permanently fixed in height and angle.
- Standard with adjustable height T-arms with curved urethane armcaps (3N) in Black Only.
- All models are standard with a five-legged, injection molded base.
- Base and frame available in Black (BK) Only.
- C65 casters are standard.
- Vari-Width Adapter Plate (WA) (This is a Standard Feature for Granada models. An Option for Goal models. Add \$87. Available when chair is ordered with adjustable height arms. Allows each arm to move outward an additional 2" (for a total of 4" extra seat width) and locks with the use of an easy to maneuver lever.
- Check textile availability prior to specifying upholstery material.

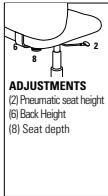
OPTIONAL FEATURES

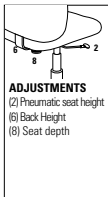
- See next page for additional arm options.
- Please see page 430 for additional caster options. Optional casters may be priced higher than the standard casters for your chair and the difference will be charged. Lower priced optional casters will not be credited.
- Vinyl Bumper Guard: This is a standard feature for Granada, Malaga, & Goal. As an option on ObusForme & Supra X. Add \$22. Available with back edge vinyl bumper guard option (VBG).
- Granada Models Only: Black base with chrome footring. Specify "B3". Add \$123.

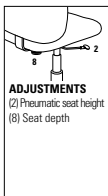
DESCRIPTION	FEATURES	MODEL#	STANDARD TEXTILE GRADES																														
			1	2	3	4	5	6	7	8	9	10	11	12																			
 <p>LB Task w/3N Arms COM Yardage: 1.5 Freight Class: 250 Product Weight (lbs.): 41 Cubic Feet Per Carton: 10.75</p>	 <p>ADJUSTMENTS (2) Pneumatic seat height (6) Back Height (8) Seat depth</p>	<p>Goal</p> <p>Ergonomic Features: C, H, N</p>	<table border="1"> <tr> <td>S2237-6</td> <td>638</td> <td>699</td> <td>740</td> <td>805</td> <td>893</td> <td>927</td> <td>1007</td> <td>1160</td> <td>1231</td> <td>1370</td> <td>1563</td> <td>1804</td> </tr> </table>												S2237-6	638	699	740	805	893	927	1007	1160	1231	1370	1563	1804						
			S2237-6	638	699	740	805	893	927	1007	1160	1231	1370	1563	1804																		
			<table border="1"> <tr> <th colspan="3">OVERALL DIMENSIONS</th> <th colspan="3">SEAT DIMENSIONS</th> <th colspan="3">BACK DIMENSIONS</th> </tr> <tr> <th>W</th> <th>D</th> <th>H</th> <th>W</th> <th>D</th> <th>H</th> <th>W</th> <th>H</th> </tr> <tr> <td>24</td> <td>23.5</td> <td>37.5</td> <td>20.5</td> <td>17</td> <td>16-21</td> <td>18.5</td> <td>19</td> </tr> </table>			OVERALL DIMENSIONS			SEAT DIMENSIONS			BACK DIMENSIONS			W	D	H	W	D	H	W	H	24	23.5	37.5	20.5	17	16-21	18.5	19	<p>RTA 2</p> <p>FedEx UPS</p>		
			OVERALL DIMENSIONS			SEAT DIMENSIONS			BACK DIMENSIONS																								
W	D	H	W	D	H	W	H																										
24	23.5	37.5	20.5	17	16-21	18.5	19																										
 <p>LB Task Armless COM Yardage: 1.50 Freight Class: 250 Product Weight (lbs.): 35 Cubic Feet Per Carton: 9</p>	 <p>ADJUSTMENTS (2) Pneumatic seat height (6) Back Height (8) Seat depth</p>	<p>Goal</p> <p>Ergonomic Features: C, H, N</p>	<table border="1"> <tr> <td>S2239-6</td> <td>506</td> <td>567</td> <td>608</td> <td>671</td> <td>764</td> <td>795</td> <td>875</td> <td>1028</td> <td>1097</td> <td>1240</td> <td>1431</td> <td>1674</td> </tr> </table>												S2239-6	506	567	608	671	764	795	875	1028	1097	1240	1431	1674						
			S2239-6	506	567	608	671	764	795	875	1028	1097	1240	1431	1674																		
			<table border="1"> <tr> <th colspan="3">OVERALL DIMENSIONS</th> <th colspan="3">SEAT DIMENSIONS</th> <th colspan="3">BACK DIMENSIONS</th> </tr> <tr> <th>W</th> <th>D</th> <th>H</th> <th>W</th> <th>D</th> <th>H</th> <th>W</th> <th>H</th> </tr> <tr> <td>20</td> <td>23.5</td> <td>37.5</td> <td>20.5</td> <td>17</td> <td>16-21</td> <td>18.5</td> <td>19</td> </tr> </table>			OVERALL DIMENSIONS			SEAT DIMENSIONS			BACK DIMENSIONS			W	D	H	W	D	H	W	H	20	23.5	37.5	20.5	17	16-21	18.5	19	<p>RTA 2</p> <p>FedEx UPS</p>		
			OVERALL DIMENSIONS			SEAT DIMENSIONS			BACK DIMENSIONS																								
W	D	H	W	D	H	W	H																										
20	23.5	37.5	20.5	17	16-21	18.5	19																										
 <p>LB Task Chair Armless/Plain Back COM Yardage: 1.5 Freight Class: 250 Product Weight (lbs.): 34 Cubic Feet Per Carton: 9.75</p>	 <p>ADJUSTMENTS (2) Pneumatic seat height (8) Seat depth</p>	<p>Granada</p> <p>Ergonomic Features: C, M, N</p>	<table border="1"> <tr> <td>S3254</td> <td>741</td> <td>804</td> <td>845</td> <td>908</td> <td>997</td> <td>1031</td> <td>1112</td> <td>1264</td> <td>1334</td> <td>1475</td> <td>1670</td> <td>1909</td> </tr> </table>												S3254	741	804	845	908	997	1031	1112	1264	1334	1475	1670	1909						
			S3254	741	804	845	908	997	1031	1112	1264	1334	1475	1670	1909																		
			<table border="1"> <tr> <th colspan="3">OVERALL DIMENSIONS</th> <th colspan="3">SEAT DIMENSIONS</th> <th colspan="3">BACK DIMENSIONS</th> </tr> <tr> <th>W</th> <th>D</th> <th>H</th> <th>W</th> <th>D</th> <th>H</th> <th>W</th> <th>H</th> </tr> <tr> <td>20.5</td> <td>24.5</td> <td>38</td> <td>20.5</td> <td>18.5</td> <td>16.5-21.5</td> <td>19</td> <td>18.5</td> </tr> </table>			OVERALL DIMENSIONS			SEAT DIMENSIONS			BACK DIMENSIONS			W	D	H	W	D	H	W	H	20.5	24.5	38	20.5	18.5	16.5-21.5	19	18.5	<p>RTA 2</p> <p>FedEx UPS</p>		
			OVERALL DIMENSIONS			SEAT DIMENSIONS			BACK DIMENSIONS																								
W	D	H	W	D	H	W	H																										
20.5	24.5	38	20.5	18.5	16.5-21.5	19	18.5																										

EXPLANATION OF VARIOUS INDUSTRIAL APPLICATIONS

This section presents only some of the possibilities that are available. Please contact your Sales Representative for additional information.



50 - INDUSTRIAL

Designed for heavier duty intensive environments such as those found in factories, assembly lines and dispatch offices. Seating features durable components including heavy gauge steel construction, chromed chip/corrosion/humidity resistant pneumatic lift cylinders and frames, heavy duty bases, weight activated interval safety casters for hard floors or encased levelling glides, wear resistant fabric or easy clean vinyl upholstery.



64 - WIPE DOWN

Furniture designed for dry food manufacturers, hospitals and forensic labs requiring regular and immediate clean up of dust,dirt or powder. Upholstery of any kind is unacceptable here. Features include comfortable Black self-skinned polyurethane seats and backs, chip/corroionn/humidity resistant pneumatic lift cylinders and frames,safety casters or glides. Some "Wipe Down" products may also be available with ESD.

FABRIC APPLICATION GRID

APPLICATION	FABRIC/VINYL
50 - Industrial	<p>Grade 1 (fabric): Terrace, Waterfall</p> <p>Grade 2 (fabric): Imprint</p> <p>Grade 2 (vinyl): Allante FFree, Luxhide, MorCare™ Collection (Abbey, Arc, Aristo, Cinema, Nomad, Verve, Vitality)</p>
Wipe Down - 64	No upholstery required, seats are molded self-skinned urethane (SSU) foam.

9

INDUSTRIAL SEATING



model 3212-50 (3N)

model 3288-50 (3N)



50 - Industrial
Designed for heavy duty environments found in factories, assembly lines and dispatch offices. See page 416 for available fabrics.

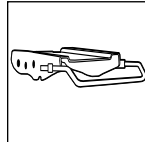

Multi-Depth Mechanism
Standard on Granada models. Allows seat to move forward and backward over a 2" range with 5 locking positions to provide a more shallow or deeper seat.









* Images shown are for illustration purposes only.

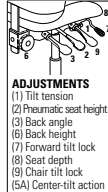



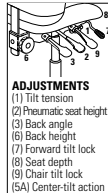

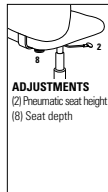

STANDARD FEATURES

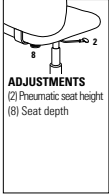

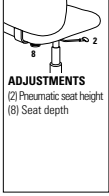

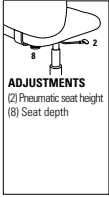
- *Industrial models have a chrome back upright.
- Granada models feature a molded seat and contoured back with enhanced lumbar support.
- Standard with adjustable height T-arms with curved urethane armcaps (3N) in Black Only.
- Chrome chip/corrosion/humidity resistant pneumatic lift cylinders and frames.
- Chairs have a 5" chrome pneumatic cylinder, stools have a 10" chrome pneumatic cylinder.
- All chairs and stools have chrome back uprights.
- Clear protective back bumper (full surround) is standard on all models.
- Standard with a five-legged, heavy duty molded base in Black.
- **C10R** casters are standard on Granada models and Minotaur stools.
- Minotaur models are standard with a five-legged, heavy duty base with metal hub and **C7R** casters.
- Heavy Duty Bench Stools are standard with non-slip rubber glides.
- Check textile availability prior to specifying upholstery material.

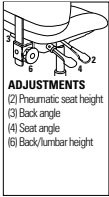

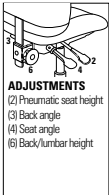

OPTIONAL FEATURES

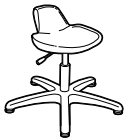

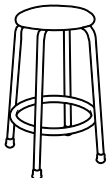

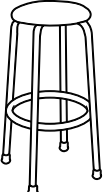

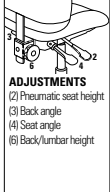

- See back of this section for additional arm or caster options.
- Optional casters may be priced higher than the standard casters for your chair and the difference will be charged. Lower priced optional casters will not be credited.

DESCRIPTION	FEATURES	MODEL#	STANDARD TEXTILE GRADES											
			1	2	3	4	5	6	7	8	9	10	11	12
 LB Multi-Tilter COM Yardage: 1.5 Freight Class: 150 Product Weight (lbs.): 52 Cubic Feet Per Carton: 13	 ADJUSTMENTS (1) Tilt tension (2) Pneumatic seat height (3) Back angle (6) Back height (7) Forward tilt lock (8) Seat depth (9) Chair tilt lock (5A) Center-tilt action	3212-50	-	1809	1855	1917	2011	-	-	-	-	-	-	
			OVERALL DIMENSIONS			SEAT DIMENSIONS			BACK DIMENSIONS					
			W	D	H	W	D	H	W	H				
			25.5	24	40	20.5	17-19.5	18-23	19	17.5-21.5				
			RTA 2											
			Ergonomic Features: A, B, C, D, E, F, G, H, M, N, Q, S											
 HB Multi-Tilter COM Yardage: 1.75 Freight Class: 250 Product Weight (lbs.): 55 Cubic Feet Per Carton: 15.5	 ADJUSTMENTS (1) Tilt tension (2) Pneumatic seat height (3) Back angle (6) Back height (7) Forward tilt lock (8) Seat depth (9) Chair tilt lock (5A) Center-tilt action	3217-50	-	1867	1931	2014	2134	-	-	-	-	-	-	
			OVERALL DIMENSIONS			SEAT DIMENSIONS			BACK DIMENSIONS					
			W	D	H	W	D	H	W	H				
			25.5	24.5	43	20.5	17-19.5	18-23	19	21.5-25.5				
			RTA 2											
			Ergonomic Features: A, B, C, D, E, F, G, H, M, N, Q, S											
 LB Task - Armless COM Yardage: 1.5 Freight Class: 250 Product Weight (lbs.): 32 Cubic Feet Per Carton: 13	 ADJUSTMENTS (2) Pneumatic seat height (8) Seat depth	3254-50	-	1257	1303	1367	1462	-	-	-	-	-	-	
			OVERALL DIMENSIONS			SEAT DIMENSIONS			BACK DIMENSIONS					
			W	D	H	W	D	H	W	H				
			20.5	24	38	20.5	17-19.5	17-22	19	19				
			RTA 2											
			Ergonomic Features: C, E, M, N											

DESCRIPTION	FEATURES	MODEL#	STANDARD TEXTILE GRADES																																
			1	2	3	4	5	6	7	8	9	10	11	12																					
 <p>LB Task - w/3N Arms COM Yardage: 1.5 Freight Class: 250 Product Weight (lbs.): 40 Cubic Feet Per Carton: 13</p>	 <p>ADJUSTMENTS (2) Pneumatic seat height (8) Seat depth</p>	<p>Granada</p> <p>Ergonomic Features: C, E, M, N</p>	<table border="1"> <tr> <td>3255-50</td> <td>-</td> <td>1439</td> <td>1485</td> <td>1552</td> <td>1641</td> <td>-</td> <td>-</td> <td>-</td> <td>-</td> <td>-</td> <td>-</td> <td>-</td> <td>-</td> </tr> </table>												3255-50	-	1439	1485	1552	1641	-	-	-	-	-	-	-	-							
			3255-50	-	1439	1485	1552	1641	-	-	-	-	-	-	-	-																			
			<table border="1"> <tr> <th colspan="3">OVERALL DIMENSIONS</th> <th colspan="3">SEAT DIMENSIONS</th> <th colspan="3">BACK DIMENSIONS</th> </tr> <tr> <th>W</th> <th>D</th> <th>H</th> <th>W</th> <th>D</th> <th>H</th> <th>W</th> <th colspan="2">H</th> </tr> <tr> <td>25.5</td> <td>24</td> <td>38</td> <td>20.5</td> <td>17-19.5</td> <td>17-22</td> <td>19</td> <td colspan="2">19</td> </tr> </table>			OVERALL DIMENSIONS			SEAT DIMENSIONS			BACK DIMENSIONS			W	D	H	W	D	H	W	H		25.5	24	38	20.5	17-19.5	17-22	19	19		<p>RTA 2</p> <p>FedEx UPS</p>		
			OVERALL DIMENSIONS			SEAT DIMENSIONS			BACK DIMENSIONS																										
W	D	H	W	D	H	W	H																												
25.5	24	38	20.5	17-19.5	17-22	19	19																												
 <p>Stool Task - Armless COM Yardage: 1.5 Freight Class: 250 Product Weight (lbs.): 37 Cubic Feet Per Carton: 13</p>	 <p>ADJUSTMENTS (2) Pneumatic seat height (8) Seat depth</p>	<p>Granada</p> <p>Ergonomic Features: C, E, M, N</p>	<table border="1"> <tr> <td>3256-50</td> <td>-</td> <td>1447</td> <td>1494</td> <td>1557</td> <td>1649</td> <td>-</td> <td>-</td> <td>-</td> <td>-</td> <td>-</td> <td>-</td> <td>-</td> <td>-</td> </tr> </table>												3256-50	-	1447	1494	1557	1649	-	-	-	-	-	-	-	-							
			3256-50	-	1447	1494	1557	1649	-	-	-	-	-	-	-	-																			
			<table border="1"> <tr> <th colspan="3">OVERALL DIMENSIONS</th> <th colspan="3">SEAT DIMENSIONS</th> <th colspan="3">BACK DIMENSIONS</th> </tr> <tr> <th>W</th> <th>D</th> <th>H</th> <th>W</th> <th>D</th> <th>H</th> <th>W</th> <th colspan="2">H</th> </tr> <tr> <td>20.5</td> <td>24</td> <td>48</td> <td>20.5</td> <td>17.5-19</td> <td>24-34</td> <td>19</td> <td colspan="2">19</td> </tr> </table>			OVERALL DIMENSIONS			SEAT DIMENSIONS			BACK DIMENSIONS			W	D	H	W	D	H	W	H		20.5	24	48	20.5	17.5-19	24-34	19	19		<p>RTA 2</p> <p>FedEx UPS</p>		
			OVERALL DIMENSIONS			SEAT DIMENSIONS			BACK DIMENSIONS																										
W	D	H	W	D	H	W	H																												
20.5	24	48	20.5	17.5-19	24-34	19	19																												
 <p>Stool Task - w/3N Arms COM Yardage: 1.5 Freight Class: 250 Product Weight (lbs.): 43 Cubic Feet Per Carton: 15.75</p>	 <p>ADJUSTMENTS (2) Pneumatic seat height (8) Seat depth</p>	<p>Granada</p> <p>Ergonomic Features: C, E, H, M, N, Q</p>	<table border="1"> <tr> <td>3257-50</td> <td>-</td> <td>1627</td> <td>1673</td> <td>1740</td> <td>1828</td> <td>-</td> <td>-</td> <td>-</td> <td>-</td> <td>-</td> <td>-</td> <td>-</td> <td>-</td> </tr> </table>												3257-50	-	1627	1673	1740	1828	-	-	-	-	-	-	-	-							
			3257-50	-	1627	1673	1740	1828	-	-	-	-	-	-	-	-																			
			<table border="1"> <tr> <th colspan="3">OVERALL DIMENSIONS</th> <th colspan="3">SEAT DIMENSIONS</th> <th colspan="3">BACK DIMENSIONS</th> </tr> <tr> <th>W</th> <th>D</th> <th>H</th> <th>W</th> <th>D</th> <th>H</th> <th>W</th> <th colspan="2">H</th> </tr> <tr> <td>25.5</td> <td>24</td> <td>48</td> <td>20.5</td> <td>17.5-19</td> <td>24-34</td> <td>19</td> <td colspan="2">19</td> </tr> </table>			OVERALL DIMENSIONS			SEAT DIMENSIONS			BACK DIMENSIONS			W	D	H	W	D	H	W	H		25.5	24	48	20.5	17.5-19	24-34	19	19		<p>RTA 2</p>		
			OVERALL DIMENSIONS			SEAT DIMENSIONS			BACK DIMENSIONS																										
W	D	H	W	D	H	W	H																												
25.5	24	48	20.5	17.5-19	24-34	19	19																												
 <p>Stool Operator - Armless COM Yardage: 1.5 Freight Class: 250 Product Weight (lbs.): 44 Cubic Feet Per Carton: 13</p>	 <p>ADJUSTMENTS (2) Pneumatic seat height (3) Back angle (4) Seat angle (6) Back/lumbar height</p>	<p>Granada</p> <p>Ergonomic Features: C, D, F, G, M, N</p>	<table border="1"> <tr> <td>3278-50</td> <td>-</td> <td>1736</td> <td>1781</td> <td>1844</td> <td>1938</td> <td>-</td> <td>-</td> <td>-</td> <td>-</td> <td>-</td> <td>-</td> <td>-</td> <td>-</td> </tr> </table>												3278-50	-	1736	1781	1844	1938	-	-	-	-	-	-	-	-							
			3278-50	-	1736	1781	1844	1938	-	-	-	-	-	-	-	-																			
			<table border="1"> <tr> <th colspan="3">OVERALL DIMENSIONS</th> <th colspan="3">SEAT DIMENSIONS</th> <th colspan="3">BACK DIMENSIONS</th> </tr> <tr> <th>W</th> <th>D</th> <th>H</th> <th>W</th> <th>D</th> <th>H</th> <th>W</th> <th colspan="2">H</th> </tr> <tr> <td>20.5</td> <td>23.5</td> <td>48</td> <td>20.5</td> <td>17.5</td> <td>24-34</td> <td>19</td> <td colspan="2">17.5-21</td> </tr> </table>			OVERALL DIMENSIONS			SEAT DIMENSIONS			BACK DIMENSIONS			W	D	H	W	D	H	W	H		20.5	23.5	48	20.5	17.5	24-34	19	17.5-21		<p>RTA 2</p> <p>FedEx UPS</p>		
			OVERALL DIMENSIONS			SEAT DIMENSIONS			BACK DIMENSIONS																										
W	D	H	W	D	H	W	H																												
20.5	23.5	48	20.5	17.5	24-34	19	17.5-21																												
 <p>Stool Operator - w/3N Arms COM Yardage: 1.5 Freight Class: 250 Product Weight (lbs.): 52 Cubic Feet Per Carton: 15.75</p>	 <p>ADJUSTMENTS (2) Pneumatic seat height (3) Back angle (4) Seat angle (6) Back/lumbar height</p>	<p>Granada</p> <p>Ergonomic Features: C, D, F, G, H, M, N, Q</p>	<table border="1"> <tr> <td>3288-50</td> <td>-</td> <td>1914</td> <td>1960</td> <td>2024</td> <td>2116</td> <td>-</td> <td>-</td> <td>-</td> <td>-</td> <td>-</td> <td>-</td> <td>-</td> <td>-</td> </tr> </table>												3288-50	-	1914	1960	2024	2116	-	-	-	-	-	-	-	-							
			3288-50	-	1914	1960	2024	2116	-	-	-	-	-	-	-	-																			
			<table border="1"> <tr> <th colspan="3">OVERALL DIMENSIONS</th> <th colspan="3">SEAT DIMENSIONS</th> <th colspan="3">BACK DIMENSIONS</th> </tr> <tr> <th>W</th> <th>D</th> <th>H</th> <th>W</th> <th>D</th> <th>H</th> <th>W</th> <th colspan="2">H</th> </tr> <tr> <td>25.5</td> <td>23.5</td> <td>48</td> <td>20.5</td> <td>17.5</td> <td>24-34</td> <td>19</td> <td colspan="2">17.5-21</td> </tr> </table>			OVERALL DIMENSIONS			SEAT DIMENSIONS			BACK DIMENSIONS			W	D	H	W	D	H	W	H		25.5	23.5	48	20.5	17.5	24-34	19	17.5-21		<p>RTA 2</p>		
			OVERALL DIMENSIONS			SEAT DIMENSIONS			BACK DIMENSIONS																										
W	D	H	W	D	H	W	H																												
25.5	23.5	48	20.5	17.5	24-34	19	17.5-21																												

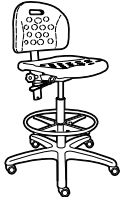
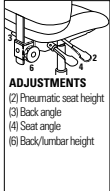
DESCRIPTION	FEATURES	MODEL#	STANDARD TEXTILE GRADES											
			1	2	3	4	5	6	7	8	9	10	11	12
 <p>Minotaur - Work Stool COM Yardage: 0.75 Freight Class: 300 Product Weight (lbs.): 14 Cubic Feet Per Carton: 9.75</p>	5" Pneumatic Ergonomic Features: C	9602-50	-	664	689	722	763	-	-	-	-	-	-	
		OVERALL DIMENSIONS W D H			SEAT DIMENSIONS W D H			BACK DIMENSIONS W H						
		14	14	17.5	14	-	15-20	-	-					
		RTA 00 FedEx UPS												
 <p>Minotaur - Work Stool COM Yardage: 0.75 Freight Class: 300 Product Weight (lbs.): 16 Cubic Feet Per Carton: 13</p>	10" Pneumatic Ergonomic Features: C	9604-50	-	756	781	814	855	-	-	-	-	-	-	
		OVERALL DIMENSIONS W D H			SEAT DIMENSIONS W D H			BACK DIMENSIONS W H						
		14	14	26.5	14	-	21.5-31.5	-	-					
		RTA 00 FedEx UPS												
 <p>Minotaur - Work Stool COM Yardage: N/A Freight Class: 300 Product Weight (lbs.): 16 Cubic Feet Per Carton: 13</p>	5" Pneumatic Ergonomic Features: C	9611-50	949	-	-	-	-	-	-	-	-	-	-	
		OVERALL DIMENSIONS W D H			SEAT DIMENSIONS W D H			BACK DIMENSIONS W H						
		14	14	24.5	14	-	15-20	-	-					
		RTA 00 FedEx UPS												
 <p>Minotaur - Work Stool COM Yardage: N/A Freight Class: 300 Product Weight (lbs.): 18 Cubic Feet Per Carton: 13</p>	10" Pneumatic Ergonomic Features: C	9612-50	1016	-	-	-	-	-	-	-	-	-	-	
		OVERALL DIMENSIONS W D H			SEAT DIMENSIONS W D H			BACK DIMENSIONS W H						
		14	14	31	14	-	21.5-31.5	-	-					
		RTA 00 FedEx UPS												
 <p>Minotaur - Heavy Duty Work Stool COM Yardage: N/A Freight Class: 300 Product Weight (lbs.): 18 Cubic Feet Per Carton: 13</p>		9624-50	-	521	546	579	620	-	-	-	-	-	-	
		OVERALL DIMENSIONS W D H			SEAT DIMENSIONS W D H			BACK DIMENSIONS W H						
		14	14	27.5	14	-	27.5	-	-					
		RTA 00 FedEx UPS												

DESCRIPTION	FEATURES	MODEL#	STANDARD TEXTILE GRADES												
			1	2	3	4	5	6	7	8	9	10	11	12	
 <p>Minotaur - Heavy Duty Work Stool COM Yardage: 0.75 Freight Class: 250 Product Weight (lbs.): 19 Cubic Feet Per Carton: 5.5</p>		9632-50	-	562	587	620	662	-	-	-	-	-	-	-	-
 <p>Minotaur - Work Stool Task COM Yardage: N/A Freight Class: 250 Product Weight (lbs.): 26 Cubic Feet Per Carton: 13</p>	5" Pneumatic	9662-50	1085	-	-	-	-	-	-	-	-	-	-	-	-
	Ergonomic Features: C, E														
 <p>Minotaur - Work Stool Task COM Yardage: N/A Freight Class: 250 Product Weight (lbs.): 33 Cubic Feet Per Carton: 13</p>	10" Pneumatic	9663-50	1291	-	-	-	-	-	-	-	-	-	-	-	-
	Ergonomic Features: C, E														
 <p>Minotaur - Stool Posture Task COM Yardage: N/A Freight Class: 250 Product Weight (lbs.): 30 Cubic Feet Per Carton: 13</p>	5" Pneumatic	9664-50	1223	-	-	-	-	-	-	-	-	-	-	-	-
	Ergonomic Features: C, D														
 <p>Minotaur - Stool Posture Task COM Yardage: N/A Freight Class: 250 Product Weight (lbs.): 33 Cubic Feet Per Carton: 13</p>	10" Pneumatic	9665-50	1427	-	-	-	-	-	-	-	-	-	-	-	-
	Ergonomic Features: C, D														

DESCRIPTION	FEATURES	MODEL#	STANDARD TEXTILE GRADES											
			1	2	3	4	5	6	7	8	9	10	11	12
 <p>Minotaur - Stool Operator COM Yardage: N/A Freight Class: 250 Product Weight (lbs.): 34 Cubic Feet Per Carton: 13</p>	 <p>ADJUSTMENTS (2) Pneumatic seat height (3) Back angle (4) Seat angle (6) Back/lumbar height</p>	9666-50	1411	-	-	-	-	-	-	-	-	-	-	-
		OVERALL DIMENSIONS			SEAT DIMENSIONS			BACK DIMENSIONS						
		W	D	H	W	D	H	W	H					
		18	20.5	32	18	17	15-20	16.5	12.5-19					
		  												
 <p>Minotaur - Stool Operator COM Yardage: N/A Freight Class: 250 Product Weight (lbs.): 35 Cubic Feet Per Carton: 13</p>	 <p>ADJUSTMENTS (2) Pneumatic seat height (3) Back angle (4) Seat angle (6) Back/lumbar height</p>	9667-50	1618	-	-	-	-	-	-	-	-	-	-	
		OVERALL DIMENSIONS			SEAT DIMENSIONS			BACK DIMENSIONS						
		W	D	H	W	D	H	W	H					
		18	20.5	42	18	17	21-31	16.5	12.5-19					
		  												

WIPE DOWN - SEATING



model 9632-64



model 9667-64



64 - Wipe Down
Furniture designed for dry food manufacturers, hospitals and forensic labs requiring regular and immediate clean up of dust, dirt or powder.













* Images shown are for illustration purposes only.



STANDARD FEATURES

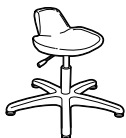





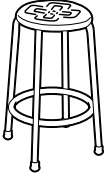
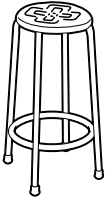

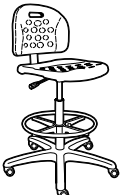





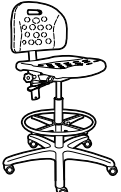

- *Wipe Down models have a black pneumatic cylinder.
- Minotaur Wipe Down models have comfortable Black, self-skinned polyurethane seats and backs.
- Chip/corrosion/humidity resistant pneumatic lift cylinders and frames.
- Stools have a 5" or 10" black pneumatic cylinder.
- All chairs have a chrome back upright.
- Standard with a five-legged, heavy duty molded base in Black.
- No arms are available for any work stools.
- All Bench Stools have chrome frames.
- Work Stools are shipped fully set-up.

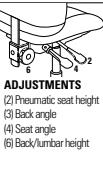
OPTIONAL FEATURES

- Work stools are available with optional **C5** casters at no charge. Please Specify.
- See back of this section for additional arm or caster options.
- Optional casters may be priced higher than the standard casters for your chair and the difference will be charged. Lower priced optional casters will not be credited

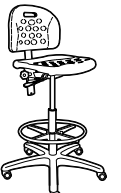
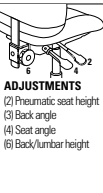
DESCRIPTION	FEATURES	MODEL#	STANDARD TEXTILE GRADES												
			1	2	3	4	5	6	7	8	9	10	11	12	
 <p>Minotaur - Work Stool COM Yardage: N/A Freight Class: 250 Product Weight (lbs.): 14 Cubic Feet Per Carton: 6.5</p>	5" Pneumatic Ergonomic Features: C	9602-64	\$685	-	-	-	-	-	-	-	-	-	-	-	
		OVERALL DIMENSIONS W D H			SEAT DIMENSIONS W D H			BACK DIMENSIONS W H							
		14	14	17.5	14	-	15-20	-	-						
															
 <p>Minotaur - Work Stool COM Yardage: N/A Freight Class: 250 Product Weight (lbs.): 16 Cubic Feet Per Carton: 6.5</p>	10" Pneumatic Ergonomic Features: C	9604-64	\$756	-	-	-	-	-	-	-	-	-	-		
		OVERALL DIMENSIONS W D H			SEAT DIMENSIONS W D H			BACK DIMENSIONS W H							
		14	14	26.5	14	-	21.5-31.5	-	-						
															
 <p>Minotaur - Work Stool COM Yardage: N/A Freight Class: 250 Product Weight (lbs.): 16 Cubic Feet Per Carton: 6.5</p>	5" Pneumatic Ergonomic Features: C	9611-64	\$825	-	-	-	-	-	-	-	-	-	-		
		OVERALL DIMENSIONS W D H			SEAT DIMENSIONS W D H			BACK DIMENSIONS W H							
		14	14	24.5	14	-	15-20	-	-						
															

DESCRIPTION	FEATURES	MODEL#	STANDARD TEXTILE GRADES											
			1	2	3	4	5	6	7	8	9	10	11	12
 <p>Minotaur - Work Stool COM Yardage: N/A Freight Class: 250 Product Weight (lbs.): 18 Cubic Feet Per Carton: 8.25</p>	<p>10" Pneumatic</p> <p>Ergonomic Features: C</p>	9612-64	\$891	-	-	-	-	-	-	-	-	-	-	-
		<p>OVERALL DIMENSIONS</p> <p>W D H</p>			<p>SEAT DIMENSIONS</p> <p>W D H</p>			<p>BACK DIMENSIONS</p> <p>W H</p>						
		14	14	31	14	-	21.5-31.5	-	-					
		<p>RTA 00</p>			<p>FedEx ups</p>									
 <p>Minotaur - Heavy Duty Work Stool COM Yardage: N/A Freight Class: 250 Product Weight (lbs.): 17 Cubic Feet Per Carton: 5.5</p>		9624-64	\$685	-	-	-	-	-	-	-	-	-	-	
		<p>OVERALL DIMENSIONS</p> <p>W D H</p>			<p>SEAT DIMENSIONS</p> <p>W D H</p>			<p>BACK DIMENSIONS</p> <p>W H</p>						
		16	16	27.5	14	-	27.5	-	-					
		<p>RTA 00</p>			<p>FedEx ups</p>									
 <p>Minotaur - Heavy Duty Work Stool COM Yardage: N/A Freight Class: 250 Product Weight (lbs.): 19 Cubic Feet Per Carton: 5.5</p>		9632-64	\$715	-	-	-	-	-	-	-	-	-	-	
		<p>OVERALL DIMENSIONS</p> <p>W D H</p>			<p>SEAT DIMENSIONS</p> <p>W D H</p>			<p>BACK DIMENSIONS</p> <p>W H</p>						
		16	16	32.5	14	-	32.5	-	-					
		<p>RTA 00</p>			<p>FedEx ups</p>									
 <p>Minotaur - Work Stool Task COM Yardage: N/A Freight Class: 250 Product Weight (lbs.): 26 Cubic Feet Per Carton: 13</p>	<p>5" Pneumatic</p> <p>Ergonomic Features: C, E</p>	9662-64	\$962	-	-	-	-	-	-	-	-	-	-	
		<p>OVERALL DIMENSIONS</p> <p>W D H</p>			<p>SEAT DIMENSIONS</p> <p>W D H</p>			<p>BACK DIMENSIONS</p> <p>W H</p>						
		18	21	32	18	16.5-19	14-19	16.5	16					
		<p>RTA 00</p>			<p>FedEx ups</p>									
 <p>Minotaur - Work Stool Task COM Yardage: N/A Freight Class: 250 Product Weight (lbs.): 33 Cubic Feet Per Carton: 13</p>	<p>10" Pneumatic</p> <p>Ergonomic Features: C, E</p>	9663-64	\$1166	-	-	-	-	-	-	-	-	-	-	
		<p>OVERALL DIMENSIONS</p> <p>W D H</p>			<p>SEAT DIMENSIONS</p> <p>W D H</p>			<p>BACK DIMENSIONS</p> <p>W H</p>						
		18	20.5	42	18	16.5-19	20-30	16.5	16.5					
		<p>RTA 00</p>			<p>FedEx ups</p>									

DESCRIPTION	FEATURES	MODEL#	STANDARD TEXTILE GRADES											
			1	2	3	4	5	6	7	8	9	10	11	12
 Minotaur - Stool Posture Task COM Yardage: N/A Freight Class: 250 Product Weight (lbs.): 30 Cubic Feet Per Carton: 13	5" Pneumatic Ergonomic Features: C, D	9664-64 \$1098	-	-	-	-	-	-	-	-	-	-	-	
			OVERALL DIMENSIONS W D H			SEAT DIMENSIONS W D H			BACK DIMENSIONS W H					
			18	20	32	18	16	14-19	16.5	12.5-19				
			  											
 Minotaur - Stool Posture Task COM Yardage: N/A Freight Class: 250 Product Weight (lbs.): 33 Cubic Feet Per Carton: 13	10" Pneumatic Ergonomic Features: C, D	9665-64 \$1302	-	-	-	-	-	-	-	-	-	-		
			OVERALL DIMENSIONS W D H			SEAT DIMENSIONS W D H			BACK DIMENSIONS W H					
			18	20	42	18	16	20.5-30.5	16.5	12.5-19				
			  											
 Minotaur - Stool Operator COM Yardage: N/A Freight Class: 250 Product Weight (lbs.): 34 Cubic Feet Per Carton: 13	 <p>ADJUSTMENTS (2) Pneumatic seat height (3) Back angle (4) Seat angle (6) Back/lumbar height</p>	9666-64 \$1291	-	-	-	-	-	-	-	-	-	-		
			OVERALL DIMENSIONS W D H			SEAT DIMENSIONS W D H			BACK DIMENSIONS W H					
			18	20.5	32	18	17	15-20	16.5	12.5-19				
			  											
 Minotaur - Stool Operator COM Yardage: N/A Freight Class: 250 Product Weight (lbs.): 35 Cubic Feet Per Carton: 13	 <p>ADJUSTMENTS (2) Pneumatic seat height (3) Back angle (4) Seat angle (6) Back/lumbar height</p>	9667-64 \$1496	-	-	-	-	-	-	-	-	-	-		
			OVERALL DIMENSIONS W D H			SEAT DIMENSIONS W D H			BACK DIMENSIONS W H					
			18	20.5	42	18	17	21-31	16.5	12.5-19				
			  											

ACADEMIC REPLACEMENT ARMS

(For Task Seating models ONLY)
 Arms other than those provided as standard on your chair.
 Refer to chart below for availability by series.

	STD	AL	F	O	OJ	TD	ZH	3N	4J	4M	4T	GL	9B	9S
GOAL	3N	NR	NR	42	106	42	NR	STD	139	77	77	NR	201	NR
GRANADA	3N	83	201	42	106	42	0	STD	139	77	77	77	201	106

\$0 = AVAILABLE AT NO ADDITIONAL CHARGE

NR = OPTION NOT RECOMMENDED

INDUSTRIAL REPLACEMENT ARMS

Optional arms for INDUSTRIAL and ESD seating ONLY.

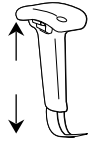
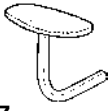
 <p>3N</p>	Industrial Seating Series	Options	*Replacement Arm Price	**Optional Arm Price
	Adjustable height T-arm, Curved	urethane	STD	\$228
 <p>2Z</p>	Industrial Seating Series	Options	*Replacement Arm Price	**Optional Arm Price
	Fixed height T-arm, Kidney Shaped	upholstered	STD (ESD Models)	\$115

Notes:

* Use this column to select another arm other than the one provided on your chair.

** Use this column to select arms for a chair that doesn't come with arms.

INDUSTRIAL CASTER SELECTIONS SPECIALTY



C5	Large Ball Caster	Chrome Hood/ Black Ball	Hard Floor	1 each	\$23
-----------	-------------------	----------------------------	------------	--------	-------------

Available as a substitute for C56 glides on Wipe Down Work stools at no charge.



C7R	Slipper Glide		All surface except ESD	1 each	\$25
------------	---------------	--	---------------------------	--------	-------------

Standard on Industrial and Wipe Down Minotaur Work stools.

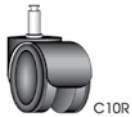

C10R	Integrated Dual Wheel Rubber Coated Caster	Black	Vinyl, Marble, Hardwood Floor	1 each	\$44
-------------	---	-------	----------------------------------	--------	-------------

Standard on Industrial , Wipe Down Minotaur stools and Granada models



C39R	Dual Wheel, Hard Floor Safety Caster w/Interval Brake	Galvanized Steel Axle w/Chrome Plated Hood Zinc die cast frame)	Hard Floor Surfaces	1 each	\$69
-------------	---	--	---------------------	--------	-------------

Standard on Industrial chairs and stools. Weight activated release brake helps to prevent chair from moving when not in use.



C65R	2" Dual Wheel Rubber Coated Caster	Black	All surfaces except ESD	1 each	\$37
-------------	---------------------------------------	-------	----------------------------	--------	-------------

INDUSTRIAL CASTERS NOTES:

- Prices listed for Industrial Casters are upcharges when substituted on Industrial chair orders.
- Industrial Casters are not suitable for use on standard Global seating products.
- All casters are not appropriate for all flooring surfaces. Please consult with your Sales Representative or Global Customer Care for special situations that can be verified with the caster manufacturer. Alternate casters, if needed, may require an upcharge.

PLEASE SPECIFY ALL SUBSTITUTIONS AND OPTIONS.

textiles and finishes

Care and Cleaning

TEXTILES

Fabrics: To extend the life of your seating upholstered in fabric, regularly dust the chair to prevent airborne particles from penetrating the fabric surface.

For light soiling, use a damp cloth and blot the spot with very slight pressure, taking care never to soak the fabric. Dry with a clean cloth by blotting - never rub fabric. More intense stains can be treated the same way, but with a mild detergent. Always test fabric first in an unseen area before using any cleaning method.

Leather: For regular cleaning, simply use a soft damp cloth, taking care not to soak the leather. For more thorough treatment, soak a soft cloth in mild soap solution and wipe surface in a light circular motion. Repeat with clean water. Allow to dry and polish with a soft dry cloth. Do not use detergents, aerosol sprays or other polishes.

Various Care and Cleaning Methods

- **Water-Based Cleaner:** Spot clean, using the foam only from a water-based cleaning agent, such as a mild detergent or non-solvent upholstery shampoo product. Apply foam with a soft brush in a circular motion. Vacuum when dry. Pretest small area before proceeding.
- **Solvent Cleaner:** Spot clean, using a mild water-free solvent or dry cleaning product. Clean only in a well-ventilated room and avoid any product containing carbon tetrachloride or other toxic materials. Pre-test a small area before proceeding.
- **Water/Solvent Cleaner:** Spot clean with amid solvent, an upholstery shampoo, or the foam from a mild detergent. When using a solvent or dry cleaning product, follow instructions carefully and clean only in a well-ventilated room. Avoid any product that contains carbon tetrachloride or other toxic materials. With either method, pretest a small area before proceeding.
- **Vacuum Only:** Clean this fabric only by vacuuming or light brushing to prevent accumulation of dust and grime. Water-based foam cleaning agents of any kind may cause excessive shrinking, staining, or distortion of the surface pile and therefore, should not be used.
- **Crypton Cleaning:** Generally stains are removed with plain water and powdered enzyme detergent. Upholstery foam shampoo, water-based cleaning products and germicidal detergents can be used. Be sure to remove all residue from cleaning products with clean water. Do not use solvent-based cleaners or dry cleaning products.

HARD SURFACES

Wood Veneer Finishes: Waxing or polishing catalyzed finishes is not recommended because this will give a greasy, cloudy or uneven appearance to the product and could void your warranty. Global's conversion varnish is best cleaned by wiping the surface with a damp cloth, followed by a soft dry cloth in the direction of the grain. If the surfaces are heavily soiled, a gentle product like "Windex" can be used, following the same instructions as above.

Laminate & Painted Metal Finishes: Using a soft cloth, simply wipe the surface with a mild soap solution or glass cleaner. Always use a dry cloth and circular motion to prevent streaks.

TEXTILES & FINISHES

Textile Price Grades - Global Textiles

Grade 1	Carrera, Dobby, Fusion, Illusion, Jenny, Quilt, Terrace, Trak, Urban, Waterfall, Wavelength
Grade 2	Allante FRee, Elevate, Etch, GC Linen, Imprint, Luxhide, Release
Grade 3	Non standard GLOBAL textiles
Grade 4	Non standard GLOBAL textiles
Grade 6	Novaro Genuine Leather, non standard GLOBAL textiles
Grade 7	Non standard GLOBAL textiles
Grade 8	Non standard GLOBAL textiles
Grade 9	Non standard GLOBAL textiles
Grade 11	Non standard GLOBAL textiles
Grade 10	Non standard GLOBAL textiles
Grade 12	Non standard GLOBAL textiles

Please refer to individual seating series for availability of a particular textile.

The charts above do not include Textiles offered by Alliance Partners: Architex, Arc-Com Fabrics, Designtex, Green Hides, LDI Interiors, Luum Textiles, Maharam, Mayer Fabrics, Momentum, and Ultrafabrics.

Blend Seating Textiles

The grid below outlines the grade structure for using multiple textiles on select seating series. Blended textiles occur when one textile is chosen for one part of the chair and a different textile is selected for another part of the chair, resulting in a revised "blended grade".

NOT FOR USE with Calidon, Drift, Erin, Noetic, River+ or Willow. See series price list pages for applicable pricing.

For specification and pricing for more than two different textiles, please contact Global CustomerCare for approval process and pricing.

FIRST TEXTILE SELECTED

		FIRST TEXTILE SELECTED																	
		1	2	3	4	5	6	7	8	9	10	11	12	13	14	15	16	17	18
SECOND TEXTILE SELECTED	1	1																	
	2	2	2																
	3	3	3	3															
	4	3	4	4	4														
	5	4	4	5	5	5													
	6	5	5	5	6	6	6												
	7	5	6	6	6	7	7	7											
	8	6	6	7	7	7	8	8	8										
	9	7	7	7	8	8	8	9	9	9									
	10	8	8	8	8	9	9	9	10	10	10								
	11	9	9	9	9	9	10	10	10	11	11	11							
	12	10	10	10	10	10	10	11	11	11	12	12	12						
	13	11	11	11	11	11	11	12	12	12	12	13	13	13					
	14	11	12	12	12	12	12	12	13	13	13	13	14	14	14				
	15	12	12	13	13	13	13	13	13	14	14	14	14	15	15	15			
	16	13	13	13	14	14	14	14	14	14	15	15	15	15	16	16	16		
	17	14	14	14	14	15	15	15	15	15	15	16	16	16	16	17	17	17	
	18	15	15	15	15	15	16	16	16	16	16	16	17	17	17	17	18	18	18

Textile and Color Listings

Grade 1

Carrera 100% Polyester

CE84 Zest	CE85 Savannah	CE86 Slate	CE87 Rainforest	CE88 Aspen	CE89 Dune	CE90 Flannel
CE91 Azure	CE92 Chili	CE93 Jute	CE95 Ink	CE96 Sangria	CE97 Java	CE98 Charcoal

Dobby 96% Recycled Polyester / 4% Virgin Polyester

DB30 Snowcap	DB31 Bonsai	DB32 Cloud	DB33 Sand	DB34 Pewter	DB35 Santa Fe	DB36 Corfu
DB37 Medium Taupe	DB38 Charcoal	DB39 Berry	DB40 Royal	DB41 Titanium	DB42 Black	

Fusion 90% Virgin Polyester / 10% Post-Consumer Recycled Polyester

FU71 Tangerine	FU72 Fresh	FU73 Moss	FU74 Tomato	FU75 Aqua	FU76 Sandstone	FU77 Granite
FU78 Poppy	FU79 Cadet	FU80 Oasis	FU81 Graphite	FU82 Viola	FU83 Cobalt	FU84 Flax
FU85 Carbon						

Illusion 100% Virgin Polyester

II01 Cappuccino	II02 Paprika	II03 Tropic	II04 Wicker	II05 Hemp	II06 Cayenne	II07 Maui
II08 Dusk	II09 Smoke	II10 Currant	II11 Fiji	II12 Ozone	II13 Ebony	

Jenny 100% Polyester

JN01 Midnight	JN02 Ebony	JN03 Slate	JN07 Vermilion	JN08 Admiral	JN11 Charcoal	JN25 Silver Lining
JN26 Oatmeal	JN27 Sunflower	JN28 Cascade	JN29 Harvest	JN30 Melon	JN31 Berry	JN32 Green Grass
JN33 Roast						

Quilt 100% Polyester

QL10 Black	QL11 Charcoal Grey	QL14 Navy	QL16 Wine	QL19 Silver	QL20 Feather	QL21 Dune
QL22 Meadow	QL23 Cadet	QL24 Geranium	QL25 Daisy	QL26 Quest	QL27 Punch	QL28 Tangerine
QL29 Cocoa						

Terrace 70% Virgin Polyester / 30% Post-Consumer Recycled Polyester

TC61 Tigerlily	TC62 Shadow	TC63 Cobble	TC64 Cherry Blossom	TC65 Bluebell	TC66 Apple	TC67 Haze
TC68 Cerise	TC69 Twilight	TC70 Wintergreen	TC71 Ironwork	TC72 Pine Cone	TC73 Flirt	TC74 Echo
TC75 Glacier						

Trak 100% Recycled Polyester

TK40 Taupe	TK41 Mustard	TK42 Latte	TK43 Cement	TK44 Silver	TK45 Copper	TK46 Teal
TK47 Apple	TK48 Steel	TK49 Merlot	TK50 Midnight Sky	TK51 Mocha	TK52 Carbon	

Urban 62% Recycled Polyester / 32% Polyester

UR10 Red Rose	UR11 Ocean Blue	UR12 Blue Bayou	UR13 Green Grass	UR14 Sandcastle	UR15 Beach Day	UR16 Boardwalk
UR17 Earth	UR18 Brown Ridge	UR19 White Sand	UR20 Granite Rock	UR21 Gravel Road	UR22 Black Coal	

Waterfall 60% Virgin Polyester / 40% Post-Consumer Recycled Polyester

WA40 Trance	WA41 Tryst	WA42 Splash	WA43 Victoria	WA44 Imagine	WA45 Sky	WA46 Rainforest
WA47 Rumble	WA48 Prism	WA49 Tranquility	WA50 Grand	WA51 Rushing	WA52 Magestic	WA53 Pacific
WA54 Dance						

Wavelength 100% Virgin Polyester

WV01 Lime	WV02 Mint	WV03 Stone	WV04 Flame	WV05 Mykonos	WV06 Savannah	WV07 Mesa
WV08 Plasma	WV09 Cancun	WV10 Quartz	WV11 Moonrock	WV12 Rubine	WV13 Corfu	WV14 Bluejay
WV14 Panther						

Grade 2

Elevate 80% Post-Consumer Recycled Polyester / 20% Rayon

EL51 Halo	EL52 Dove	EL53 Safari	EL54 Sunglow	EL55 Margarita	EL56 Fiji	EL57 Mist
EL58 Blaze	EL59 Wasabi	EL60 Mystic	EL61 Mica	EL62 Cherry	EL63 Scuba	EL64 Lapis
EL65 Onyx						

Etch 80% Post-Consumer Recycled Polyester / 20% Rayon

ET81 Drift	ET82 Citron	ET83 Calypso	ET84 Mandarin	ET85 Crisp	ET86 Iris	ET87 Nickel
ET88 Paprika	ET89 Nutmeg	ET90 Marine	ET91 Magnet	ET92 Infrared	ET93 Espresso	ET94 Indigo
ET95 Anthracite						

Imprint 100% Post-Consumer Polyester

IM70 Almond	IM71 Cork	IM72 Sand	IM73 Currie	IM74 Candy Apple	IM75 Ocean	IM76 Navy
IM77 Green Tea	IM78 Celery	IM79 Oregon	IM80 Walnut	IM81 Paprika	IM82 Graphite	IM83 Slate
IM84 Licorice						

TEXTILES & FINISHES

Grade 2 (Vinyl) For availability of chair series in Vinyl, please contact a Global Sales Representative.

Allante FFree 100% Vinyl Face / 100% Polyester Backing

A01F Illusion	A02F Bright White	A03F White Crush	A04F Ivory	A05F Ice	A06F Bleached Sand	A07F Taupe Fawn
A08F Warm Smoke	A09F Autumn Rain	A10F Cookie	A11F Sierra Brick	A12F Gibraltar	A13F Chateau Grey	A14F Garden Green
A15F Oasis Green	A16F Ink Black	A17F Purple Impulse	A18F Italian Rose	A19F Mountain Sky	A20F Old Navy	A21F Galaxy
A22F Red Truffle	A23F Chocolate Sundae	A24F Province Blue	A25F Eclipse			

GC Linen 100% Vinyl Face

LE50 Potters Clay	LE51 Pearl	LE52 Tan	LE53 Storm	LE54 Butter	LE55 Haystack	LE56 Ganache
LE57 Sunset	LE58 Burnt Orange	LE59 Cayenne	LE60 Navy	LE61 Bamboo	LE62 Gray	LE63 Charcoal
LE64 Moss						

Luxhide 100% Vinyl Face / Bonded Leather Backing

BL20 Black	BL22 Parchment	BL23 Saddle	BL24 Dark Brown	BL26 Burgundy	BL27 Charcoal	BL28 White
BL34 Light Grey						

Release 100% Vinyl Face

RL11 White	RL12 Chalk	RL13 Stone	RL14 Taupe	RL15 Orange	RL16 Country	RL17 Tuscan
RL18 Cottage	RL19 Yellow	RL21 Red Barn	RL22 Brave Red	RL23 Gypsy Red	RL24 Cajun	RL25 Vineyard
RL26 Olive	RL27 Bonsai	RL28 Summer's Dream	RL29 Calico	RL31 Green	RL32 Blue	RL33 Black
RL34 Cool Grey	RL35 Thunder Grey	RL36 Navy	RL37 Dark Chocolate	RL38 Espresso		

Grade 6

Novaro Genuine Leather 100% Leather

NO50 Ash	NO51 Asphalt	NO52 Bison	NO53 Blueberry	NO54 Cloud	NO55 Clove	NO56 Cordovan
NO57 Doe	NO58 Linen	NO59 Marina	NO60 Phantom	NO61 Pigeon	NO62 Scarlet	NO63 Turtle
NO64 Wheat						

Panel Fabrics

GRADE 2

Lola 100% Polyester.

LL11 Medium Taupe	LL12 Caramel Cream	LL14 Blue Mist	LL35 Spray	LL36 Granite	LL37 Cinder	LL38 Sandstone
-------------------	--------------------	----------------	------------	--------------	-------------	----------------

GRADE 3

Anchorage 65% Pre-consumer Polyester / 35% Post-consumer Polyester

AN40 Birch	AN41 Green Apple	AN42 Lapis	AN43 Straw	AN44 Wolf	AN45 Goose	AN46 Angora
AN47 Cumin	AN48 Asteroid	AN49 Geranium	AN50 Thistle	AN51 Graphite	AN52 Slate	AN53 Quarry Blue
AN54 Onyx	AN55 Pumpkin	AN56 Red Delicious	AN57 Sunshine	AN59 Waterfall	AN61 Vanilla	AN62 Cobalt
AN64 Cloud						

Merge 100% Polyester / 75% Post-consumer Recycled Polyester

MG20 Fawn	MG21 Marshmallow	MG22 Driftwood	MG23 Dove	MG24 Graphite	MG25 Slate	MG26 Eucalyptus
MG27 Fire Engine	MG28 Mediterranean	MG29 Midnight				

FINISHES

Seating Finishes - Metal: Please consult each Seating Series for finish availability.

Antique Copper (ACO)	Black (TBL)	Brushed Chrome (BCH)	Buzz Blue (TBZ)	Cactus (TCC)	Carrot (TCR)	Cloud (TIV)	Chrome (CHM)
Designer White (TDW)	Dijon (TDJ)	Eggplant (TEG)	Fog (TFO)	Frost (TFR)	Ink (TIN)	Kalua (TKA)	Shadow (TSH)
Latte (TLA)	Mocha (TMO)	Nevada (TNE)	Sand (TSN)	Satin Brass (SBR)	Scarlet (TSR)		
Toast	(TOA)	Tungsten (TT)					

Seating Finishes - Plastic (Duet, Popcorn, and Sonic)

Buzz Blue (BZB)	Cactus (CCT)	Carrot (CRO)	Cloud (IVC)	Dijon (DJN)	Eggplant (EGP)	Fog (FOG)
Frost (FRO)	Ink (INK)	Latte (LAB)	Night (BLK)	Sand (SND)	Scarlet (SAR)	Shadow (SHW)

Seating Finishes - Wood Seating finishes will not necessarily match Casegoods finishes. This is due to the fact that Seating and Casegoods finishes use different wood species and are manufactured at multiple locations.

Absolute (AAM)	Black (BKM)	Cherry (ACM)	Espresso Cafe (ECM)	English Oak (EOM)	Fruitwood (TFM)	Gray (HGM)
Honey (AHM)	Mahogany (TMM)	Maple (AVM)	Medium Walnut (MWM)	Natural Walnut (NLW)	Night (ASM)	Noce Biondo (NBM)
Noce Grigio (NGM)	Noce Leggero (NEM)	Noce Medio (NMM)	Shaker Cherry (SKM)	Walnut (TWM)	WC Cream (WTM)	White (WHM)
Winter Cherry (WCM)						

Desks, Workstations, Tables and Accessories - Laminate

Absolute Acajou (ACJ)	Asian Night (ASN)	Avant Cherry (AWC)	Avant Honey (AWH)	Black (BLK)	Blizzard (BZD)	Brushed Cobalt (BRC)
Clear Maple (CMB)	Custom Grey (CGY)	Dark Espresso (DES)	Designer White (DWT)	Fashionista (FAS)	First Class (FCL)	Noce Biondo (NBL)
Noce Grigio (NGL)	Noce Leggero (NEL)	Noce Medio (NML)	Quartered Mahogany (QTM)	Sheer Beauty (SBY)	Stonedust (SDT)	Storm Grey (SOG)
Walnut Heights (WHE)	White Chocolate (WHC)	Winter Cherry (WCR)				

Desks, Workstations, Tables and Accessories - Wood Veneer

Amber Cherry (ACW)	Almond Cherry (AMW)	Biscotti (BTW)	Cocoa Walnut (CAW)	Coral (CRW)	Dark Cherry (DCW)	Dark Walnut (DWW)
Espresso Walnut (EWW)	Evening Oak (EVW)	Grey on Oak (GRW)	Hazelnut (HAW)	Java (JAW)	Latte Walnut (LTW)	Mahogany on Walnut (MHW)
Milestone (MTW)	Natural Maple (MPW)	Natural Walnut (NLW)	Red Cherry (RCW)	Umber Walnut (ULW)	Vintage Cherry (VNW)	Walnut (WLW)
Warm Cherry (WCW)	White Maple (WMW)					

Metal File + Storage Finishes

Business Grey (BGR)	Black Coffee Textured (BKC)	Black (BLK)	Bone (BNE)	Blizzard Textured (BZD)	Charcoal (CHR)
Claret (CLT)	Dark Chocolate Textured (DCH)	Desert Putty (DPT)	Designer White (DWT)	Fog (FOG)	Grey (GRY)
Light Grey (LGR)	Ice (ICE)	Ivory (IVR)	Mocha Textured (MCH)	Metro (MET)	Moss (MOS)
Nevada (NEV)	Navy (NVY)	Oyster (OYS)	Stonedust Textured (SDT)	Storm Grey (SGR)	Silver (SIL)
Sky (SKY)	Stone (STN)	Taupe (TPE)	Tahiti Sand (TSA)	Tungsten (TUN)	Willow (WIL)

TEXTILES & FINISHES

Solid Wood and Laminate Coordinating Colors

Solid Wood Colors

Absolute (AAM)
 Black (BKM)
 Cherry (ACM)
 Espresso Cafe (ECM)
 Fruitwood (TFM)
 Gray (HGM)
 Honey (AHM)
 Mahogany (TMM)
 Maple (AVM)
 Medium Walnut (MWM)
 Night (ASM)
 Noce Biondo (NBM)
 Noce Grigio (NGM)
 Noce Leggero (NEM)
 Noce Medio (NMM)
 Walnut (TWM)
 WC Cream (WTM)
 White (WHM)
 Winter Cherry (WCM)

Laminate Colors

Absolute Acajou (ACJ)
 Black (BLK)
 Avant Cherry (AWC)
 Dark Espresso (DES)

 Avant Honey (AWH)
 Quartered Mahogany (QTM)
 Clear Maple (CMB)

 Asian Night (ASN)
 Noce Biondo (NBL)
 Noce Leggero (NEL)
 Noce Leggero (NEL)
 Noce Medio (NML)

 White Chocolate (WHC)
 Designer White (DWT)
 Winter Cherry (WCR)

DRIFT TABLE FINISHES COORDINATION CHART			
HPL TOP FINISH		COORDINATING WOOD BASE FINISH	
ACJ**	Absolute Acajou	AAM	Absolute
ASN**	Asian Night	ASM	Night
AWC**	Avant Cherry	ACM	Cherry
AWH**	Avant Honey	AHM	Honey
BLK**	Black	BKM	Black
CMB**	Clear Maple	AVM*	Maple
DES**	Dark Espresso	ECM	Espresso Cafe
DWT**	Designer White	WHM	White
NBL**	Noce Biondo	NBM	Noce Biondo
NEL**	Noce Leggero	NEM	Noce Leggero
NGL**	Noce Grigio	NGM	Noce Grigio
NML**	Noce Medio	NMM	Noce Medio
QTM**	Quartered Mahogany	TMM	Mahogany
WCR**	Winter Cherry	WCM	Winter Cherry
WHC**	White Chocolate	WTM	WC Cream
WHE**	Walnut Heights	MWM	Medium Walnut
HPL TOP FINISHES WITH NO COORDINATING WOOD BASE FINISHES		WOOD BASE FINISHES WITH NO COORDINATING HPL TOP FINISHES	
BRC**	Brushed Cobalt	EOM	English Oak
BZD**	Blizzard	NLW	Natural Walnut
CGY**	Custom Grey	SKM	Shaker Cherry
FAS**	Fashionista	TFM	Fruitwood
FCL**	First Class	TWM	Walnut
SBY**	Sheer Beauty	HGM	Grey
SDT**	Stone Dust		
SOG**	Storm Grey		

**Chrome base models are available for all HPL Top Finishes

Please note that these finishes are coordinating and not exact matches. Please reach out to your Global Sales Representative for physical samples of finishes prior to ordering.

METAL LEG, FRAME + BASE FINISH CHART

	paint finishes																				plated finishes			
	Black	Tungsten	Shadow	Latte	Mocha	Kalua	Toast	Designer White	Nevada	Fog	Cloud	Sand	Frost	Dijon	Carrot	Scarlet	Cactus	Buzz Blue	Eggplant	Ink	Chrome	Brushed Chrome	Satin Brass	Antique Copper
OLD FINISH CODE	BLK	TUN	SHW	LAB	J52	KAL	TOA	DWT	NEV	FOG	IVC	-	-	-	-	-	-	-	-	-	CH	BSC	-	-
NEW FINISH CODE	TBL	TTU	TSH	TLA	TMO	TKA	TOA	TDW	TNE	TFO	TIV	TSN	TFR	TDJ	TCR	TSR	TCC	TBZ	TEG	TIN	CHM	BCH	SBR	ACO
GUEST SEATING																								
Caprice	•	•	•	•	•	•	•	•	•	•	•	•	•	•	•	•	•	•	•	•	•*	•*	•*	•*
Comet	•	•	•	•	•	•	•	•	•	•	•	•	•	•	•	•	•	•	•	•	•*			
Diplomat	•	•	•																		•*			
Drift (sled bases)	•	•	•	•	•	•	•	•	•	•	•	•	•	•	•	•	•	•	•	•	•*			
Lite	•	•	•	•	•	•	•	•	•	•	•	•	•	•	•	•	•	•	•	•	•*	•*	•*	•*
Marche	•	•*																			•*	•*		
Moda (four leg)	•*	•*	Also available in three woodgrain patterns																		•			
Sas	•	•																			•*			
Sidero	•	•	•	•	•	•	•	•	•	•	•	•									•*			
Solo (models 5225 + 5226)	•	•	•																		•*			
Supra (armchairs)	•	•																			•*			
Twilight	•	•																						
Tye (armchair)	•	•																			•*			
Willow	•	•	•	•	•	•	•	•	•	•	•	•	•	•	•	•	•	•	•	•	•*	•*	•*	•*
STACKING/NESTING CHAIRS																								
Duet (sled bases)																					•			
Moda (stacking)																					•			
Popcorn (sled bases)																					•			
Rebound	•	•	•	•	•	•	•	•	•	•	•	•	•	•	•	•	•	•	•	•	•*	•*	•*	•*
Roma Nester	•	•	•																		•*			
Sonic (four leg + sled bases)	•	•	•	•	•	•	•	•	•	•	•	•	•	•	•	•	•	•	•	•	•			
Spritz (four leg bases)	•	•	•																		•*			
Stream (multi-purpose)	•	•	•	•	•	•	•	•	•	•	•	•	•	•	•	•	•	•	•	•	•*	•*	•*	•*
Vion (multi-purpose)	•	•	•							•											•*			
Zoma	•	•	•																		•*			
LOUNGE SEATING																								
Ballara	•	•						•													•*	•*		
Citi	•	•																			•*			
Citi Square	•	•	•	•	•	•	•	•	•	•	•	•	•	•	•	•	•	•	•	•	•*	•*	•*	•*
Drift (sled bases)	•	•	•	•	•	•	•	•	•	•	•	•	•	•	•	•	•	•	•	•	•*			
Jeo (pedestal bases on chairs and tables)																					•	•		
Jeo (armchair, model 8437)	•	•						•													•*	•*		
ML	•	•						•													•	•		
ML Park	•	•						•	Also available in Polished Aluminum (ALU) and Brushed Aluminum (BAL)															
River	•	•	•	•	•	•	•	•	•	•	•	•	•								•			
River+ (legs)	•	•	•	•	•	•	•	•	•	•	•	•	•								•			
Sirena (table legs)	•	•																						
Venture	•	•		•																	•			
Wind	•	•	•	•	•	•	•	•	•	•	•	•	•	•	•	•	•	•	•	•	•	•*	•*	•*
Wind Linear	•	•	•	•	•	•	•	•	•	•	•	•	•	•	•	•	•	•	•	•	•	•*	•*	•*

* Upcharge required for this finish selection.

C.O.M. INSTRUCTIONS

COM and Graded-In Textiles:

Global will evaluate the textile to determine its possible use on our furniture. An approved COM or Graded-In textile does not warrant or guarantee the performance of the textile. Warranty claims for COM upholstery material will fall to the original vendor of the fabric, Global is not responsible for costs associated with recovering or replacement.

COM Approval and Ordering Instructions

All COM requests must be submitted to Global for preliminary approval prior to acceptance of an order. Approval signifies only such material can be applied to the products they are intended. Approval does not constitute any responsibility nor any warranty on behalf of Global as to the appearance, behavior or durability of the COM.

To request review and approval of a COM textile:

1. Reference the [Global Textile Search](#) tool to verify if your COM is a pre-approved alliance partner textile.
2. Complete the electronic COM Authorization at [Global COM Submittal Form](#).
3. An acknowledgment email will be sent which includes a COM request number. Check for emails from webedi@globalfurnituregroup.com
4. If the manufacturer of the textile is **NOT** part of our Alliance Textile Partnership, send a fabric memo sample (minimum 6" x 6") with the COM request number to:

Ship memo	Global Furniture Group
Sample with	COM Sample Review Department
Req. # to:	17 West Stow Road Marlton, NJ 08053

Global Alliance partners include ArcCom, Architex, CF Stinson, CTL Prescott Leather, DesignTex, EnviroLeather, Green Hides, Knoll Textiles, LUUM, Maharam, Momentum Textiles, Mayer, Morbern and Ultrafabrics

5. If approved, an email will be sent indicating the textile approval, the required yardage, the Global orderable textile code and the ship to address for sending the COM yardage for production. Check for emails from webedi@globalfurnituregroup.com
6. To order, submit furniture order with approved orderable textile code to Global Furniture Group.
7. Order required textile yardage from textile manufacturer:

Ship Fabric	See Approval email for shipping address	Include on PO to Mill:	Global approved textile code XXXX. Use Trans American as inbound customs broker 1-800-333-0465
-------------	--	------------------------	---

8. Upon receipt of textile yardage, a confirmation email will be sent. Check for emails from webedi@globalfurnituregroup.com
9. Email comrequest@Globalfurnituregroup.com with all inquiries.

COM orders will be scheduled for production only upon receipt of production yardage.

COM Application

In the absence of any application instructions, Global will apply the textile in what it determines to be the best manner and cannot be held responsible after upholstering. Excess COM materials will be discarded at the discretion of Global unless otherwise instructed by the customer at the time the order is placed.

COM Yardage Requirements

Upon approval of the submitted COM, Global will provide yardage requirements for the product model submitted. Yardage requirements shown in the List Price Book are based on plain, non-directional, 54" wide textile that is being cut up the roll. If the COM is to be railroaded, please note on the COM Authorization form.

The following chart is provided as a budgeting tool for our customers to estimate costs associated with yardage purchase. Final yardage requirement is evaluated and provided by Global on the final approval form. **Global is not responsible where additional materials must be ordered.**

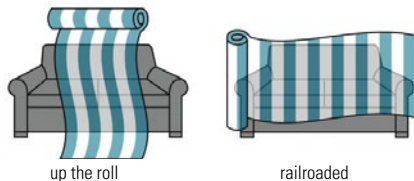

For 2-way repeats, ranges are calculate by using the higher repeat . (i.e if the repeat is 13v x 15h you would use 15h to calculate the extra yardage needed).

Repeat	Horizontal repeat	Vertical repeat	2-Way repeat in 2 directions
1/4" - 5"	Add 10%	Add 15%	Add 15%
6" - 9"	Add 15%	Add 18%	Add 20%
10" - 13"	Add 30%	Add 35%	Add 40%
14" - 19"	Add 45%	Add 55%	Add 60%

Sealed Seams (Vinyl textile only):

This process increases the strength and integrity of the seam for Vinyl textiles, providing additional protection against moisture penetration through the seam and can prevent insects from entering the interior of the upholstered piece through the seams.

Testing must be conducted on every Vinyl textile and approval must be confirmed prior to acceptance of an order requesting sealed seams. When sealed seams are requested on the COM form, and if the vinyl textile is not an alliance partner, please contact Customer Care on where to submit the 1 yard of material needed for evaluation.

Note: Moisture barrier is not an option in conjunction with sealed seams.

CUSTOMER INFORMATION (To be filled by the Dealer) Use one form per fabric
Note: Incomplete information may delay or prevent approval

Dealer/Company Name: Email:

Address: City: Postal Code:

Contact Name: Phone:

P.O.#: Contract #: Date:

Design Specifier of Record (often requested by Mill for Sales Commissions):

FABRIC INFORMATION

1. Fabric Name (series/style#):
 Fabric color name and description (including specifically designed):

2. Mill/Manufacturer name:

3. Specified fabric's country of origin (if available):

4. Fabric Specification/data sheet (if available please upload and disregard step 5) Attached?
 Yes, skip Step # 5, No, complete Step # 5.

5. Fabric content (% Cotton, % Polyester, etc.):

Fabric Width: Pattern Repeat: Warp/Vertical Fill/Horizontal

Railroaded? Yes No FR Chemical? Yes No PROP65 Compliant? Yes No Contains PFAS? Yes No

FABRIC APPLICATION INFORMATION

Chair Model	Qty.	Multi Fabric	Special instructions for CS and buyer	Special Instruction (e.g. reverse side, off direction/railroad pattern, sealed seam, moisture barrier etc.)
<input type="text"/>	<input type="text"/>	Yes <input type="radio"/>	<input type="text"/>	Sealed seam: Yes <input type="radio"/> No <input type="radio"/>
<input type="text"/>	<input type="text"/>	(Drawing attached)	<input type="text"/>	Off Direction/rail road pattern: Yes <input type="radio"/> No <input type="radio"/>
<input type="text"/>	<input type="text"/>	No <input type="radio"/>	<input type="text"/>	No match repeat: Yes <input type="radio"/> No <input type="radio"/>
<input type="text"/>	<input type="text"/>		<input type="text"/>	Moisture barrier: Yes <input type="radio"/> No <input type="radio"/>
				Inside out: Yes <input type="radio"/> No <input type="radio"/>
				Random match: Yes <input type="radio"/> No <input type="radio"/>
				Excess material instructions: <input type="text"/>
				Other options: Yes <input type="radio"/> No <input type="radio"/>

FABRIC DIRECTION



*Please click on the image above to select the direction for the fabrics for the seat and back.

New fabric request
 Attach textile sample (8"x 8" swatch) in correct direction and side

Previously approved fabric
 Previous Global Approval/order #
 Attach textile sample (8"x 8" swatch) in correct direction and side

USA CUSTOMER
 Mail to: Customer Service Rep., 17 West Stow RD #3116 MARLTON, NJ 08053, USA

THINK GLOBAL / THINK GREEN



LEVEL 3 CERTIFIED
Many programs in various categories



LEED PARTNERSHIP PROGRAM
Products can help you earn credits



GREENGUARD CERTIFIED
Gold

THE ENVIRONMENT We believe now more than ever, that it is our responsibility to protect the environment and our precious natural resources for future generations. The growing importance of energy and environmental concerns continues to challenge us in this ever changing marketplace.

As an industry leader, Global continues to take proactive steps towards reducing the negative impacts on the environment. We are building "healthier" offices; investing in Research & Development and new technologies; reducing waste and the consumption of energy; and improving the quality of the air we breathe, all which can have a significant impact on our quality of life.



Epoxy Powder coating process is solvent free. No harmful VOC's or lead. No toxins are released into the atmosphere.

Global's recycled fabrics offer affordable, environmentally responsible alternatives to commercial textiles. We recycle 35,000 lbs of fabric offcuts weekly.



powder paint process:
98% paint recovery and reuse

more recycled fabric
less to the landfill

talk to us about our
leed partnership program

we've diverted
90% of our wood waste from landfill in four years



Global has the products and resources to help your projects achieve LEED certification.

New technology allows us to reduce glue usage by 50%. In addition, our polyurethane glue reduces emissions and requires less energy to apply.



TERMS & CONDITIONS

This illustrated price list has been designed to facilitate fast reference and easy use. All products are categorized into "seating", "desks", "files", "panels", "tables" and "modular furniture", and are listed numerically within their categories. The line drawings match actual photographs (where possible) to aid in instant recognition of the total range within a series.

Sales of Global-The Total Office ("Global") products are made only on Global's standard terms and conditions of sale which are contained in this Price Book. These standard terms and conditions may be modified or supplemented only by a separately written document signed by Global's authorized personnel at its head office in Marlton, NJ. Any term or condition contained in any purchase order or other form used by dealer/purchaser to order goods (including standard, printed language) which is different from, in addition to, or in any way inconsistent with Global's standard terms and conditions shall be of no force or effect whatsoever.

All illustrations, specifications and prices in this book are based on the latest product information available at the time of publication. Global reserves the right to make changes, at any time and without prior notice, to prices, colors, materials, specifications and models offered.

Description

Each product shown or described in this price list is standard Global product. Variations are noted at the beginning of each series. Any variations from what is standard may require additional delivery time and cost and may affect the warranty given. Sizes and weights shown are approximate and are subject to slight changes from time to time.

Prices and Payment

The prices shown in this book, as well as those quoted by Global, are in United States dollars for orders shipped to destinations in the U.S. and Mexico.

If shipping date requested is more than 90 days from date of order, Global shall have the right to use published list prices effective at the time of shipment.

Orders are invoiced at the time of shipment. Terms of payment are net 30 days from date of invoice (1% 15 days) unless otherwise stated. The customer agrees that Global shall have the right to enforce a charge amounting to 1.5% per month (18% per year) on invoices outstanding more than 30 days.

If dealer/purchaser's most recent annual net volume is less than \$5,000.00, payment must be made in advance.

Any products sold by Global shall remain the personal property of Global until fully paid.

Prices are suggested list prices only and are subject to change without notice. Global will, however, attempt to keep dealer/purchasers up-to-date on all developments including price changes.

Taxes

All prices shown in this book are exclusive of sales, use, excise and other applicable taxes and are the dealer/purchaser's responsibility as per the invoice issued by Global. If dealer/purchaser claims an exemption from such taxes, it shall be the dealer/purchaser's responsibility to furnish Global with an appropriate exemption certificate at time of order.

Ordering Information

To avoid errors and/or duplication Global requires that all orders be submitted in writing. All orders submitted to Global in writing will be acknowledged on Global's acknowledgement forms governing the transaction. The details appearing

on this acknowledgement will describe the items to be shipped and the approximate shipping date. It is the dealer/purchaser's responsibility to determine that the information in the acknowledgement is correct. In the event of an error, the dealer/purchaser must notify Global immediately by telephone followed by written confirmation. Shipping dates are assigned to orders based on the item having the longest manufacturing lead time.

When ordering, please provide the following information:

- 1) Account number (if possible)
- 2) P.O. number
- 3) "Bill to" and "ship to" name and address
- 4) Complete model number
- 5) Description
- 6) Options:
 - a. Upholstery fabric type and color (specify by name and number)
 - b. Color of paint finish, laminate or wood (if applicable)
 - c. Trim options (frame)
 - d. Arms
 - e. Base, Casters
 - f. Mechanism
 - g. Accessories

Dealer/purchaser is responsible for providing correct information when placing an order. Orders with incorrect information (finish, etc.) will be scheduled for manufacturing upon receipt of complete information.

All phone orders must be confirmed in writing by the customer within 7 days.

To prevent a delay in processing orders, please specify delivery routing.

Changes and Cancellations

After the date of Global's acknowledgement of a dealer/purchaser's order, the order may not be changed or cancelled by dealer/purchaser without the written consent of Global. Special order items, C.O.M. and fabric-covered items already in production are not subject to change or cancellation under any circumstances. Fabric-covered items are considered to be in production once the fabric is scheduled for cutting. Other standard items already in production are subject to a minimum 35% cancellation charge.

Errors and Omissions

All quotations, acknowledgements and invoices are subject to corrections for any errors and omissions.

FINISHES

Wood Finishes

For custom stain requests, submit a special request for quotation. Non-standard wood finish orders will incur a one time charge of \$250 net to dealer per matching custom wood stain. This one time fee will be valid for 5 years from the time of matching. After 5 years, a new \$250 net to dealer charge will apply. All custom wood stain products will receive a 10% list per unit upcharge, included on the special quote. Requests with unit quantities of 30 or more, may be considered for reduced or eliminated upcharge. At time of order, a 3" x 3" color sample is required to be submitted with order. Extended order lead time is required for custom matching and approval process.

File Finishes

All non-standard finishes must be approved by Global prior to acceptance of order and may be subject to an upcharge.

Laminated Tops - Pricing for all non-standard finishes and sizes must be provided by Global Customer Service and may be subject to an upcharge.

Desk Finishes

Because the distinctive characteristics and the nature of wood products cause variations, exact matches are not always possible.

Global has launched a finishes program between marketing companies within the Global Group to match products as best as possible when same finishes are specified.

C.O.M. (Customers Own Material)

Use of Customer's Own Material must be approved by Global prior to acceptance of order. Please refer to page 455 of the Price Book and fill out the Authorization Request Form. Photocopy and use this form as often as necessary. The customer must provide a 12" x 12" fabric sample and advise how the fabric is to be applied. **Fabric yardage requirement will be advised by the factory, and additional yardage may be required if pattern requires matching.** Yardage shown in the List Price Book does not allow for pattern repeat/matching. Send to the address provided on shipping document upon approval from Global. If C.O.M. is difficult to apply or if product shall be modified, extra charges shall be made. Global reserves the right to cancel an order at any time if C.O.M. is inadequate for any reason. Customer's Own Material must be shipped freight and duties paid to our factory. Such shipment must be fully identified with purchaser's order number, RGA # provided by Global, and the item for which material is intended. Performance of C.O.M. when applied to product is the sole responsibility of the purchaser. Global's standard product warranty shall not apply to C.O.M. Use of C.O.M. will not reduce the published list price.

Textile Grading

All products are priced according to their standard fabric and fabric grade. Lower grade fabrics are available (unless otherwise specified) at same price as standard.

The listing of prices for each model indicates the prices for higher upholstery grades. Prices are based on yardage in imperial measurements.

TEXTILE PRICE GRADES - GLOBAL TEXTILES

Grade	Upholstery (Seating Fabrics)
1	Carrera, Dobby, Fusion, Illusion, Jenny, Quilt, Terrace, Trak, Urban, Waterfall, Wavelength
2	Allante FRee, Elevate, Etch, GC Linen, Imprint, Luxhide, Release
6	Novaro Genuine Leather
Grade	Upholstery (Panel Fabrics)
2	Lola
3	Anchorage, Merge

The charts above do not include Textiles offered by Alliance Partners: Arc-Com Fabrics, CF Stinson, Designtex, Knoll Textiles, Green Hides, LDI Interiors, Luum Textiles, Maharam, Mayer Fabrics, Momentum, and Ultrafabrics.

Upholstery Coverings

Slight variations in color may occur between dye lots. Although Global attempts to minimize these variances, they do occur and must be accepted as normal and will not be considered defects.

Yardage

Required yardage (ydg) is based on unmatched materials with widths of 54" for seating, 63" for GPS panels. Yardage calculations are based on imperial measurements.

Arms

A wide selection of arms are available for some series. See Arm Charts for details.

Delays

Global's shipping confirmation will state a shipping date which is Global's best estimate at the time the order is acknowledged. However, Global shall not incur any obligation or liability to Purchaser for failure to ship by specified date unless Global has agreed to an unequivocal shipping date in a separately signed written document executed by its authorized personnel at its head office. In addition, Global shall not be liable for any loss or damage resulting from any delay or failure in shipment or other failure to perform all or any part of the agreement between the parties with respect to the goods shown on the face of the order acknowledgement where such delay, failure, loss or damage is the proximate result of any act of any governmental authority or political subdivision thereof, revolution, riot, civil disorder or disturbance, delay or default in transportation, strike disputes among or between labor unions or other labor disputes, delay or inability in obtaining materials and facilities, fire, flood, act of God or any cause not within the reasonable control of the company, whether of the class of causes enumerated or otherwise.

F.O.B.

F.O.B. point is Global's Factory, Downsview, Ontario, Canada, or any Global Regional Distribution Center.

FedEx and UPS Shipments

Seating products marked with a FedEx or UPS symbol are packaged for shipment via FedEx or UPS.

Handling

A \$25. net handling charge per shipment will be applied for orders of less than \$2000. List that are not able to be shipped via FedEx or UPS.

Special Delivery Requirements

Global's delivered pricing provides for dock delivery during normal business hours (considered to be 8 am to 4 pm Monday through Friday) to customer/end user only. Additional delivery requirements such as inside delivery, lift gate, limited access sites, installations and weekend deliveries will incur an additional expense and will be the responsibility of the dealer.

Service

Service requests are normally the responsibility of Global's authorized dealers. Where this cannot be accomplished on a local level, service problems should be referred to Global's Customer Service Department in the nearest distribution center.

Returns

No returns of goods will be accepted without written consent and shipping instruction of Global. A minimum re-stocking charge of 35% is made on all authorized returns for credit or refund, provided goods are received by Global in the condition in which they left the factory. This may increase depending on the type of product. Global's Return Goods Authorization (R.G.A.) numbers must appear prominently on all authorized

returns. Global will not be responsible for freight costs. No credit will be given if goods cannot be reused as new. Special order items, non-stock items and C.O.M. products are in no event subject to return. All returns must be approved and authorized in writing by Global Customer Service. Global reserves the right to refuse delivery of any unauthorized returns.

Claims

All goods are sold F.O.B. plant or Global Distribution Center. Global is not responsible for damage which occurs in transit (or in storage). The carrier signs for all goods received in apparently good order. It is the dealer/purchaser's responsibility to examine goods upon receipt and to file any claims with the carrier for losses or damage to the product occurring during transit, including concealed damage.

Any claims made against Global for apparent defects, errors or shortages must be made by the dealer/purchaser, in writing, within 15 working days after any delivery. Failure by the dealer/purchaser to make any claim against Global within 15 days shall constitute acceptance of the goods and a waiver of any apparent defects, errors or shortages.

Suspension

In the event that the dealer/purchaser defaults in the payment of any sum due to Global, or in the event the dealer/purchaser's financial condition becomes unsatisfactory to Global, Global shall have the right to defer or discontinue shipment of any goods until such time as the default is cured or the dealer/purchaser provides assurance of payment to Global.

Copyright

All catalogs, photographs, drawings, price lists and other printed material are protected by copyright. All rights reserved.

Trademarks

All trademarks are owned by GlobalFurniture Group other than OBUSFORME™ which is owned by OBUSFORME LTD. and are used under license. OBUSFORME® and the distinctive backrest design are registered trademarks of OBUSFORME LTD.

Designs and Patents

Many of the products produced by Global are protected by design registrations, design patents and/or patents. Design and specifications are subject to change, discontinuance or additions without notice.

Cubic Measure

The stated cubage is an approximate cubic foot measure to calculate freight costs. The figure shown is the volume for one carton and is subject to change without notice. It is most economical to purchase the specified number per carton.

Combined Shipments

Global will make every effort to combine shipments and orders on written request. However, Global cannot be held responsible where such request is not complied with.

Offer of Sale

Possession of this price list or any other literature shall not imply the company's willingness to sell to the holder and shall not be construed as a direct offer of sale.

If a conflict arises between: (i) prices found in software support packages furnished to the customer by Global or by any other source on behalf of Global; and (ii) Global's current printed price lists, then the most current shall prevail.

Disclaimer

All dimensions are in inches. Prices shown are current manufacturer's suggested list prices at the time of printing. All applicable taxes are extra. Descriptions, specifications and prices are subject to change without notice. Errors and omissions are subject to correction.

Flammability

The foam used in Global chairs meets the requirements of California TB117. In addition to the foam, upholstery materials must also meet the California TB117 smolder resistant requirements. Please contact Customer Care to determine if a selected textile meets the California TB117 requirement.

This list price book is effective as of January 1, 2023.

For periodic updates, please check the PDF at www.globalfurnituregroup.com/resources. Global warrants that all commercial products are free from defects in material and workmanship, for the life of the product, to the original purchaser.

LIFETIME WARRANTY

Global will repair or replace, at Global's option, as the sole remedy for any defect covered by the warranty. The warranty applies to products manufactured after March 22, 2016.

Global makes no warranty that any of its products are suitable for any particular purpose and makes no other warranties, express or implied, other than those set out here. As codes and standards vary from one jurisdiction to another, references to compliance are solely for convenience and without any representation as to accuracy or suitability. Users must verify the suitability of such information or product for their specific application. In no event shall Global be liable in either tort or contract for any loss or direct, special, incidental, consequential, or exemplary damages. The warranty applies to single shift, standard commercial usage, defined as a standard eight (8) hour day, forty (40) hour week for users weighing up to 300 pounds.

General Commercial Seating

Global's warranty for general commercial seating covers all chair components including pneumatic cylinders, bases, casters, glides, frames, arms, plastic seats, backs and other structural components.

Exceptions to the warranty for general commercial seating are as follows:

- Foam, textiles (as sampled on Global branded and textile program cards), mesh material and electrical devices, are warranted for five (5) Years
- Control mechanisms are warranted for twelve (12) Years
- Heavy duty seating and Indoor/Outdoor Furniture are not defined as General commercial seating (see below for warranty exceptions)

Heavy Duty Seating

Global offers products designed for multiple shift applications (24 hours a day / 7 days a week) and larger individuals weighing up to 400, 500 and/or 600 pounds (depending on series and/or model). Global warrants these products for twelve (12) years to the original purchaser. All components (including control mechanisms, pneumatic cylinders, bases, casters, glides, frames, arms, plastic seats/backs, etc.) are covered for 24/7 applications under the warranty. The exceptions are foam, upholstery and textiles, which are covered for five (5) years. Fabric or upholstery material on these products must exceed 100,000 double rubs for the textile portion of the warranty to apply. Heavy Duty product series that apply under this warranty can be found in the Heavy Duty section of this list price book.

Outdoor Furniture

Global offers products designed for use indoors or outdoors. Global warrants these products for three (3) years to the original purchaser. This warranty applies to single shift (eight (8) hour day, forty (40) hour week) for users weighing up to 275 pounds, unless noted otherwise. Outdoor furniture must be stored indoors during inclement or extreme weather such as extreme cold, extreme heat, or excessive wind.

Exceptions to the warranty for indoor/outdoor furniture is as follows:

- Only Global branded textiles and Alliance Partner carded textile program materials expressly identified for outdoor application are covered for three (3) years when used outdoors.

Global's Warranty does not apply (for any product category) to the following:

- Products not purchased directly from authorized Global resellers
- Nominal or normal amount of wear and tear that can occur over time
- Failures which result from negligence, abuse, accident or misuse
- Failure to apply, install or maintain products according to Global's written instructions and warnings
- Modifications, attachments or repair methods not approved by Global
- Damage caused by a carrier in transit, or delivery/installation contractors
- The matching of colors, grains or textures (wood, leather, etc.) of natural materials
- Products exposed to extreme hot or cold temperatures or excessively dry or humid environments
- Colorfastness or the matching of color of textiles, dye lots of textile can vary
- Damage by markings or staining; damage by sharp objects or imprinting from instruments
- Damage to textiles or laminate and wood surfaces/edges from exposure to sunlight (including UV rays)
- Products used for rental purposes
- Purchased parts are warranted for one (1) year
- Failure to follow specific cleaning and disinfecting instructions posted on globalfurnituregroup.com

Seating Warranty Summary

Seating Type	Components Warranty For Original Purchaser	Use Time For Warranty Coverage	Exceptions
General Commercial Seating	Lifetime	8 Hours/5 Days Per Week	Foam/Upholstery/Textiles/Mesh/Electrical Devices - 5 Years Control Mechanisms - 12 Years
Heavy Duty Seating	12 Years	24 Hours/7 Days Per Week	Foam/Upholstery/Textiles - 5 Years
Indoor/Outdoor Furniture	3 Years	8 Hours/5 Days Per Week	Outdoor Use Textiles – 3 Years

Textiles

Global warrants Global branded textiles and Alliance Partner carded textile programs inclusive of fabrics, vinyls and leather products for five (5) years. Global does not warrant COM (Customer Own Materials) or graded-in materials (non-carded) and purchased by Global for a customer. For graded-in or COM products, please contact the textile supplier for performance information and warranty details. Please refer to our website at globalfurnituregroup.com for detailed information on cleaning and disinfecting procedures. Improper usage of disinfecting/cleaning products may void the warranty.

Global textiles and finishes are updated periodically to meet the demand and trends of the market. As a result, some textiles and finishes may be discontinued by Global or the manufacturer. In the event that a textile or finish is discontinued, Global will make every reasonable effort to provide an alternative product(s) of comparable function.

Files, Desks, Modular Furniture, Tables, Panels & Accessories

Global warrants all components of metal storage and filing, laminate and wood veneer desks, laminate and wood veneer tables, metal leg components and panels for the lifetime of the product to the original purchaser.

The warranty applies to single shift, standard commercial usage, defined as a standard eight (8) hour day, forty (40) hour week. Load restrictions apply, refer to individual product descriptions.

Exceptions to the warranty for files/desks/tables and panels are as follows:

- Electrical devices, panel and tackboard textiles, adjustable keyboard mechanisms, non-electrical table mechanisms, monitor arms, lecterns, coat trees and task lights - five (5) years
- Laminate folding tables - one (1) year
- Motorized electrical components - two (2) years

Files, Desks, Modular Furniture, Tables, Panels & Accessories Warranty Summary

Product Type	Components Warranty For Original Purchaser	Exceptions
Metal storage and filing	Lifetime	none
Laminate/wood veneer desks and modular furniture	Lifetime	tackboard textiles, electrical devices, task lights - 5 years
Boardroom, conference and training tables	Lifetime	electrical devices - 5 years moving parts - 5 years
Panels	Lifetime	panel textiles, electrical devices, task lights - 5 years
Coat racks and lecterns	5 years	none
Folding tables (laminate & molded)	1 year	none
Height adjustable tables	5 years	motorized parts (on electrical tables) - 2 years

Global's Warranty does not apply (for any product category) to the following:

- Products not purchased directly from authorized Global resellers
- Nominal or normal amount of wear and tear that can occur over time
- Failures which result from negligence, abuse, accident or misuse
- Failure to apply, install or maintain products according to Global's written instructions and warnings
- Modifications, attachments or repair methods not approved by Global
- Damage caused by a carrier in transit, or delivery/installation contractors
- The matching of colors, grains or textures (wood, leather, etc.) of natural materials
- Products exposed to extreme hot or cold temperatures or excessively dry or humid environments
- Colorfastness or the matching of color of textiles, dye lots of textile can vary
- Damage by markings or staining; damage by sharp objects or imprinting from instruments
- Damage to textiles or laminate and wood surfaces/edges from exposure to sunlight (including UV rays)
- Products used for rental purposes
- Purchased parts are warranted for one (1) year
- Failure to follow specific cleaning and disinfecting instructions posted on globalfurnituregroup.com

Global's warranty does not cover the costs of transportation or labor. Repair or replacement will be at Global's option.

Global makes no warranty that any of its products are suitable for any particular purpose and makes no other warranties, express or implied, other than those set out here. As codes and standards vary from one jurisdiction to another, references to compliance are solely for convenience and without any representation as to accuracy or suitability. Users must verify the suitability of such information or product for their specific application. In no event shall Global be liable in either tort or contract for any loss or direct, special, incidental, consequential, or exemplary damages.

Global's warranty applies to products sold within the United States of America, Mexico, the Commonwealth of Puerto Rico and Canada.

Global US Headquarters/Distribution Center

17 West Stow Road, P.O. Box 562
 Marlton, New Jersey U.S.A. 08053
 T (856) 596-3390
 T (800) 220-1900

A \$25 net handling charge per shipment
 will be applied for non-UPSable orders of
 less than \$2,000 list.

Showrooms**Atlanta**

10 10th Street
 Suite 150
 Atlanta, GA 30309
 T (404) 879-0998

Boston

One Harbor Street
 Suite 104
 Boston, MA 02210
 T (617) 406-5435

Chicago

222 Merchandise
 Mart Plaza
 10th Floor, Suite 1035
 Chicago, IL 60654
 T (312) 755-0843

Miami

112 NE 41st Street
 6th floor
 Miami, FL 33137

New York City

386 Park Avenue South
 7th floor
 New York, NY 10016
 T (212) 545-9900

Philadelphia

1735 Market Street
 38th Floor
 Philadelphia PA, 19103
 T (215) 861-0963

New Jersey (Southern)

119 West Greentree Road
 Marlton, NJ 08053
 T (856) 596-3390

Phoenix

4675 E Cotton Center Blvd.
 Suite 165
 Phoenix, AZ 85040
 T (602) 426-0666
 T (602) 426-0777

Washington, DC

1130 Connecticut Avenue
 10th Floor, Suite 1000
 Washington, DC 20036
 T (202) 659-0230
 T (202) 659-0236

Distribution Centers**Atlanta Area**

6715 Maple Ave.
 Suite 100
 Buford, GA 30518
 T (678) 602-4130

Baltimore Area

Troy Hill
 Corporate Center
 7030 Troy Hill Drive
 Elkridge, MD 21075
 T (410) 379-8021

Chicago Area

27W501 North Ave.
 Suite 300
 West Chicago, IL 60185
 T (630) 681-2818

Cincinnati Area

8712 LeSaint Drive
 Fairfield, OH 45014
 T (513) 777-0009

Dallas Area

2025 West Beltline Road
 #100
 Carrollton, TX 75006
 T (972) 236-1366

Denver Area

16401 East 33rd Drive
 Suite 50
 Aurora, CO 80011
 T (303) 340-1617

Ft. Lauderdale Area

560 Sawgrass
 Corporate Pkwy
 Sunrise, FL 33325
 T (954) 846-8888

Houston Area

7865 Northcourt Road
 Suite 200
 Houston, TX 77040
 T (713) 695-5777

Los Angeles Area

3629 Workman Mill Road
 Whittier, CA 90601
 T (562) 484-9686

Seattle Area

Oakesdale Commerce Ctr.
 820 Southwest 34th Street
 Building W7, Suite A
 Renton, WA 98057
 T (425) 291-9282

Kansas City Area

11617 West 81st Street
 Lenexa, KS 66214
 T (913) 310-9963

Tampa Area

10351 Windhorst Road
 Tampa, FL 33619
 T (813) 621-6272



globalfurnituregroup.com

