

lounge

Ballara	272	Jeo	338	Venture	401
Braden	284	Kate	341	Vitrola	404
Bridges II Collaborative Seating	287	Lux	342	Wind Seating	406
calidon	295	ML	344	Wind Tables	408
calidon tables	298	ML Park	346	Wind Linear	410
Camino	301	Prairie	347	Wind Linear Tables	415
Citi	306	Rambler	348		
Citi Square	311	River	351		
Drift	320	River+	369		
Drift Tables	333	Sirena	397		

BALLARA™



model 9751

model 9751NA & 9757L



Quilted Seat Option
See optional features for more details.



model 9752NA Two Seat Sofa, 9755 Corner Table, 9751NA Lounge Chair, 9757L Left Tablet

STANDARD FEATURES

- An all inclusive, modular series which includes seating, storage, power, tables and tablets.
- Fulfill many space planning scenarios including corner, in-line, open concept as well as traditional reception.
- Furniture pieces, seating or tables can be used as stand alone items or linked together with ganging brackets to create infinite configurations.
- Four high back (banquette) models available in two different heights (42" or 48") and two sizes (two-seat or three-seat armless sofas).
- Banquettes are available as table back models (TB) which are equipped with an 8" laminate back table shelf.
- Tablets can be mounted outside or between seats to accommodate various work and collaborative settings. Tablets have a 14" round surface and come with a 2-point locking mechanism for easy handling and stability.
- Fixed cushions are accented by a metal base and frame.
- Tables features durable and matching 3mm edges.
- Power modules include one power outlet and two USB ports and can be mounted under any seat or table. Wire management is included.
- All models are standard with Black polypropylene foot glides.
- Check textile availability prior to specifying upholstery material.

OPTIONAL FEATURES

- Quilted Seat (Q) is available. Backless stools, add \$107 each. Single seat models, add \$212. Two seater sofa, add \$417. Three seater sofa, add \$626.
- **Seating and Table Frame Finish:** All chair frames, table frames, tablet metal components, ganging brackets and power modules are available in the following finishes
(TBL) Black
(TDW) Designer White
(TTU) Tungsten
(CHM) Chrome. **Upcharge varies.**
(BCH) Brushed Chrome. **Upcharge varies.**
Please Specify.

- Brushed Chrome (BCH) and Chrome (CHM) are available at an upcharge. Add \$225 for counter height and bar height stools. Add \$242 for single seat lounge chairs. Add \$321 for two seat sofas. Add \$401 for three seat sofas. Add \$242 for storage/end tables. Add \$321 for storage/coffee tables. Add \$124 for tablets. Add \$31 for ganging brackets. Add \$24 for power modules.
- **Table Tops**
Corner tables, storage tables and tablets are offered in the following High Pressure Laminate finishes:
(ACJ) Absolute Acajou (ASN) Asian Night
(AWC) Avant Cherry (AWH) Avant Honey
(BLK) Black (BRC) Brushed Cobalt
(BZD) Blizzard (CMB) Clear Maple
(CGY) Custom Grey (DES) Dark Espresso
(DWT) Designer White (FAS) Fashionista
(FCL) First Class (NBL) Noce Biondo
(NGL) Noce Grigio (NEL) Noce Leggero
(NML) Noce Medio
(QTM) Quartered Mahogany
(SBY) Sheer Beauty (SDT) Stonedust
(SOG) Storm Grey (WHE) Walnut Heights
(WHC) White Chocolate (WCR) Winter Cherry

SAMPLE LAYOUTS

Layout A



Qty	Model Number	Description	Dimensions	List Price
1	9751L	Lounge Chair - Left Arm	28.5 x 29.5 x 30	2110
1	9751R	Lounge Chair - Right Arm	28.5 x 29.5 x 30	2110
1	9755	Corner Table	27.25 x 27.25 x 16.5	840
2	9759	Ganging Bracket	1 x 0.75 x 10	25 x 2
SAMPLE LAYOUT TOTAL IN STANDARD FRAME FINISHES				\$5,110
SAMPLE LAYOUT TOTAL IN OPTIONAL FRAME FINISHES				\$5,898

SAMPLE LAYOUTS

Layout B



Qty	Model Number	Description	Dimensions	List Price
1	9751L	Lounge Chair - Left Arm	28.5 x 29.5 x 30	2110
1	9751R	Lounge Chair - Right Arm	28.5 x 29.5 x 30	2110
1	9755	Corner Table	27.25 x 27.25 x 16.5	840
2	9759	Ganging Bracket	1 x 0.75 x 10	25 x 2

SAMPLE LAYOUT TOTAL IN STANDARD BLACK FRAME \$5,110
SAMPLE LAYOUT TOTAL IN OPTIONAL FRAME FINISHES \$5,898

Layout C

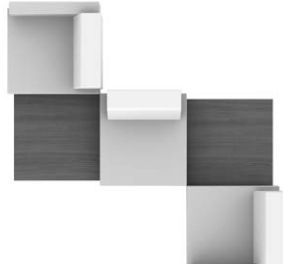

Qty	Model Number	Description	Dimensions	List Price
1	9751L	Lounge Chair - Left Arm	28.5 x 29.5 x 30	2110
1	9751R	Lounge Chair - Right Arm	28.5 x 29.5 x 30	2110
1	9751NA	Lounge Chair - No Arms	27.5 x 29.5 x 30	1749
2	9755	Corner Table	27.25 x 27.25 x 16.5	840 x 2
4	9759	Ganging Bracket	1 x 0.75 x 10	25 x 4

SAMPLE LAYOUT TOTAL IN STANDARD BLACK FRAME \$7,749
SAMPLE LAYOUT TOTAL IN OPTIONAL FRAME FINISHES \$9,083

Layout D



Qty	Model Number	Description	Dimensions	List Price
1	9751L	Lounge Chair - Left Arm	28.5 x 29.5 x 30	2110
1	9751R	Lounge Chair - Right Arm	28.5 x 29.5 x 30	2110
1	9751NA	Lounge Chair - Armless	27.5 x 29.5 x 30	1749
2	9755	Corner Table	27.25 x 27.25 x 16.5	840 x 2
1	9757L	Left Tablet	14 x 14 x 17.25	646
1	9758R	Right Tablet	14 x 14 x 17.25	646
4	9759	Ganging Bracket	1 x 0.75 x 10	25 x 4

SAMPLE LAYOUT TOTAL IN STANDARD BLACK FRAME \$9041
SAMPLE LAYOUT TOTAL IN OPTIONAL FRAME FINISHES \$10,623

Layout E



Qty	Model Number	Description	Dimensions	List Price
1	9752L-OB	Two Seat Sofa Open Back - Left Arm	55 x 29.5 x 30	3437
1	9752NA	Two Seat Sofa - Armless	54 x 29.5 x 30	3157
1	9754	Storage Table	27.25 x 27.25 x 16.5	1333
1	9755	Corner Table	27.25 x 27.25 x 16.5	840
1	9757R	Right Tablet	14 x 14 x 17.25	646
2	9759	Ganging Bracket	1 x 0.75 x 10	25 x 2

SAMPLE LAYOUT TOTAL IN STANDARD BLACK FRAME \$9463
SAMPLE LAYOUT TOTAL IN OPTIONAL FRAME FINISHES \$11,060

SAMPLE LAYOUTS

Layout F

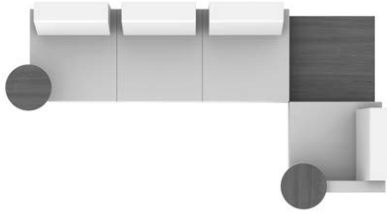

Qty	Model Number	Description	Dimensions	List Price
1	9753NA-OB	Three Seat Sofa Open Back - Armless	80.5 x 29.5 x 30	4426
1	9751L	Lounge Chair - Left Arm	28.5 x 29.5 x 30	2110
1	9755	Corner Table	27.25 x 27.25 x 16.5	840
1	9757L	Left Tablet	14 x 14 x 17.25	646
1	9758R	Right Tablet	14 x 14 x 17.25	646
2	9759	Ganging Bracket	1 x 0.75 x 10	25 x 2

SAMPLE LAYOUT TOTAL IN STANDARD FRAME FINISHES

\$8,718

SAMPLE LAYOUT TOTAL IN OPTIONAL FRAME FINISHES

\$9,913

Layout G



Qty	Model Number	Description	Dimensions	List Price
1	9753NA-OB	Three Seat Sofa Open Back - Armless	80.5 x 29.5 x 30	4426
1	9751	Lounge Chair	29.5 x 29.5 x 30	2467
1	9755	Corner Table	27.25 x 27.25 x 16.5	840
1	9757L	Left Tablet	14 x 14 x 17.25	646
1	9759	Ganging Bracket	1 x 0.75 x 10	25 x 1

SAMPLE LAYOUT TOTAL IN STANDARD FRAME FINISHES

\$8,404

SAMPLE LAYOUT TOTAL IN OPTIONAL FRAME FINISHES

\$9,444

Layout H



Qty	Model Number	Description	Dimensions	List Price
1	9751L	Lounge Chair - Left Arm	28.5 x 29.5 x 30	2110
1	9751R	Lounge Chair - Right Arm	28.5 x 29.5 x 30	2110
1	9751NA	Lounge Chair - No Arms	27.5 x 29.5 x 30	1749
2	9755	Corner Table	27.25 x 27.25 x 16.5	840 x 2
4	9759	Ganging Bracket	1 x 0.75 x 10	25 x 4

SAMPLE LAYOUT TOTAL IN STANDARD FRAME FINISHES

\$7,749

SAMPLE LAYOUT TOTAL IN OPTIONAL FRAME FINISHES

\$9,083

Layout I

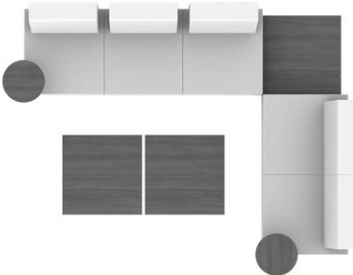

Qty	Model Number	Description	Dimensions	List Price
1	9753NA-OB	Three Seat Sofa Open Back - Armless	80.5 x 29.5 x 30	4426
1	9752NA	Two Seat Sofa - Armless	54 x 29.5 x 30	3157
2	9754	Storage Table	27.25 x 27.25 x 16.5	1333 x 2
1	9755	Corner Table	27.25 x 27.25 x 16.5	840
1	9757L	Left Tablet	14 x 14 x 17.25	646
1	9758R	Right Tablet	14 x 14 x 17.25	646
2	9759	Ganging Bracket	1 x 0.75 x 10	25 x 2

SAMPLE LAYOUT TOTAL IN STANDARD FRAME FINISHES

\$12,431

SAMPLE LAYOUT TOTAL IN OPTIONAL FRAME FINISHES

\$14,189

SAMPLE LAYOUTS

Layout J

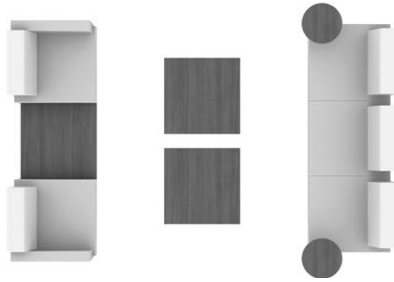

Qty	Model Number	Description	Dimensions	List Price
1	9753NA-OB	Three Seat Sofa Open Back - Armless	80.5 x 29.5 x 30	4426
1	9751L	Lounge Chair - Left Arm	28.5 x 29.5 x 30	2110
1	9751R	Lounge Chair - Right Arm	28.5 x 29.5 x 30	2110
2	9754	Storage Table	27.25 x 27.25 x 16.5	1333 x2
1	9755	Corner Table	27.25 x 27.25 x 16.5	840
1	9757L	Left Tablet	14 x 14 x 17.25	646
1	9758R	Right Tablet	14 x 14 x 17.25	646
2	9759	Ganging Bracket	1 x 0.75 x 10	25 x 2

SAMPLE LAYOUT TOTAL IN STANDARD FRAME FINISHES \$13,494
SAMPLE LAYOUT TOTAL IN OPTIONAL FRAME FINISHES \$15,415

Layout K



Qty	Model Number	Description	Dimensions	List Price
2	9753NA-OB	Three Seat Sofa Open Back - Armless	80.5 x 29.5 x 30	4426 x 2
2	9755	Corner Table	27.25 x 27.25 x 16.5	840 x 2
2	9759	Ganging Bracket	1 x 0.75 x 10	25 x 2

SAMPLE LAYOUT TOTAL IN STANDARD FRAME FINISHES \$10,582
SAMPLE LAYOUT TOTAL IN OPTIONAL FRAME FINISHES \$11,930

Layout L



Qty	Model Number	Description	Dimensions	List Price
1	9752NA	Two Seat Sofa - Armless	54 x 29.5 x 30	3157
1	9751L	Lounge Chair - Left Arm	28.5 x 29.5 x 30	2110
1	9751R	Lounge Chair - Right Arm	28.5 x 29.5 x 30	2110
2	9755	Corner Table	27.25 x 27.25 x 16.5	840 x 2
4	9759	Ganging Bracket	1 x 0.75 x 10	25 x 4

SAMPLE LAYOUT TOTAL IN STANDARD FRAME FINISHES \$9,157
SAMPLE LAYOUT TOTAL IN OPTIONAL FRAME FINISHES \$10,570

Layout M



Qty	Model Number	Description	Dimensions	List Price
1	9753NA-OB	Three Seat Sofa Open Back - Armless	80.5 x 29.5 x 30	4426
1	9752L-OB	Two Seat Sofa Open Back - Left Arm	55 x 29.5 x 30	3437
1	9752NA	Two Seat Sofa - Armless	54 x 29.5 x 30	3157
2	9755	Corner Table	27.25 x 27.25 x 16.5	840 x 2
1	9754	Storage Table	27.25 x 27.25 x 16.5	1333
1	9758R	Right Tablet	14 x 14 x 17.25	646
4	9759	Ganging Bracket	1 x 0.75 x 10	25 x 4

SAMPLE LAYOUT TOTAL IN STANDARD FRAME FINISHES \$14,779
SAMPLE LAYOUT TOTAL IN OPTIONAL FRAME FINISHES \$16,796

SAMPLE LAYOUTS

Layout N

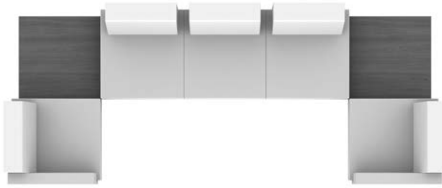

Qty	Model Number	Description	Dimensions	List Price
1	9753NA-OB	Three Seat Sofa Open Back - Armless	80.5 x 29.5 x 30	4426
1	9751L	Lounge Chair - Left Arm	28.5 x 29.5 x 30	2110
1	9751R	Lounge Chair - Right Arm	28.5 x 29.5 x 30	2110
2	9755	Corner Table	27.25 x 27.25 x 16.5	840 x 2
4	9759	Ganging Bracket	1 x 0.75 x 10	25 x 4

SAMPLE LAYOUT TOTAL IN STANDARD FRAME FINISHES \$10,426
SAMPLE LAYOUT TOTAL IN OPTIONAL FRAME FINISHES \$11,919

Layout O

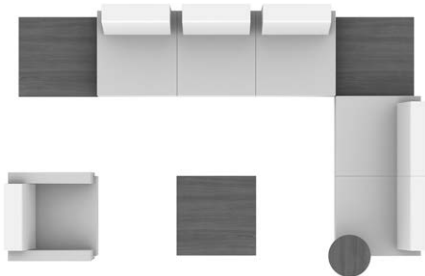

Qty	Model Number	Description	Dimensions	List Price
1	9753NA-OB	Three Seat Sofa Open Back - Armless	80.5 x 29.5 x 30	4426
1	9752NA	Two Seat Sofa - Armless	54 x 29.5 x 30	3157
1	9751	Lounge Chair	29.5 x 29.5 x 30	2467
1	9754	Storage Table	27.25 x 27.25 x 16.5	1333
2	9755	Corner Table	27.25 x 27.25 x 16.5	840 x 2
1	9757L	Left Tablet	14 x 14 x 17.25	646
3	9759	Ganging Bracket	1 x 0.75 x 10	25 x 3

SAMPLE LAYOUT TOTAL IN STANDARD FRAME FINISHES \$13,784
SAMPLE LAYOUT TOTAL IN OPTIONAL FRAME FINISHES \$15,691

Layout P

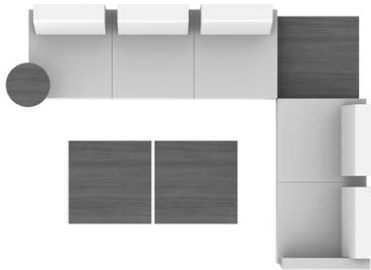

Qty	Model Number	Description	Dimensions	List Price
1	9753NA-OB	Three Seat Sofa Open Back - Armless	80.5 x 29.5 x 30	4426
1	9752L-OB	Two Seat Sofa Open Back - Left Arm	55 x 29.5 x 30	3437
2	9754	Storage Table	27.25 x 27.25 x 16.5	1333 x 2
1	9755	Corner Table	27.25 x 27.25 x 16.5	840
1	9758R	Right Tablet	14 x 14 x 17.25	646
2	9759	Ganging Bracket	1 x 0.75 x 10	25 x 2

SAMPLE LAYOUT TOTAL IN STANDARD FRAME FINISHES \$12,065
SAMPLE LAYOUT TOTAL IN OPTIONAL FRAME FINISHES \$13,699



Lounge Chair
 COM Yardage: 4.25
 Freight Class: 250
 Product Weight (lbs.): 71
 Cubic Feet Per Carton: 21.5

	1	2	3	4	5	6	7	8	9	10	11	12
9751	2467	2604	2709	2870	3093	3175	3373	3749	3930	4282	4756	5348

OVERALL DIMENSIONS			SEAT DIMENSIONS			BACK DIMENSIONS	
W	D	H	W	D	H	W	H
30.5	31	30	24	20.5	18.5	22	12.5

RTA 00



9751R

9751L

Lounge Chair - One Arm
 COM Yardage: 3.25
 Freight Class: 250
 Product Weight (lbs.): 61
 Cubic Feet Per Carton: 20

Ganging clip required for sectional use

	1	2	3	4	5	6	7	8	9	10	11	12
9751R	2110	2223	2312	2445	2634	2724	2895	3168	3378	3611	4605	5120
9751L												

OVERALL DIMENSIONS			SEAT DIMENSIONS			BACK DIMENSIONS	
W	D	H	W	D	H	W	H
28.5	31	30	24	20.5	18.5	22	12.5

RTA 00

DESCRIPTION	FEATURES	MODEL#	STANDARD TEXTILE GRADES											
			1	2	3	4	5	6	7	8	9	10	11	12
 Lounge Chair - Armless COM Yardage: 2.25 Freight Class: 250 Product Weight (lbs.): 51 Cubic Feet Per Carton: 18.75	Ganging clip required for sectional use	9751NA	1749	1832	1893	1986	2118	2180	2300	2490	2638	2802	3138	3498
		OVERALL DIMENSIONS			SEAT DIMENSIONS			BACK DIMENSIONS						
		W	D	H	W	D	H	W	H					
		26.5	31	30	24	20.5	18.5	22	12.5					
			RTA 00											

DESCRIPTION	FEATURES	MODEL#	STANDARD TEXTILE GRADES											
			1	2	3	4	5	6	7	8	9	10	11	12
 Corner Unit COM Yardage: 3 Freight Class: 250 Product Weight (lbs.): 72 Cubic Feet Per Carton: 18.5	Ganging clip required for sectional use	9764	2268	2387	2477	2617	2816	2887	3061	3390	3549	3855	4271	4790
		OVERALL DIMENSIONS			SEAT DIMENSIONS			BACK DIMENSIONS						
		W	D	H	W	D	H	W	H					
		28.5	28.5	30	22	20.5	18.5	22	12.5					
			RTA 00											

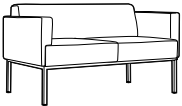
DESCRIPTION	FEATURES	MODEL#	STANDARD TEXTILE GRADES											
			1	2	3	4	5	6	7	8	9	10	11	12
 Two Seat Sofa COM Yardage: 6.25 Freight Class: 250 Product Weight (lbs.): 111 Cubic Feet Per Carton: 37.5		9752	3883	4088	4247	4486	4823	4944	5241	5806	6077	6601	7315	8207
		OVERALL DIMENSIONS			SEAT DIMENSIONS			BACK DIMENSIONS						
		W	D	H	W	D	H	W	H					
		56	31	30	48	20.5	18.5	44	12.5					
			RTA 00											

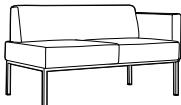
DESCRIPTION	FEATURES	MODEL#	STANDARD TEXTILE GRADES											
			1	2	3	4	5	6	7	8	9	10	11	12
  Two Seat Sofa - One Arm COM Yardage: 5 Freight Class: 250 Product Weight (lbs.): 101 Cubic Feet Per Carton: 36.25	Ganging clip required for sectional use	9752R 9752L	3476	3644	3779	3978	4257	4359	4607	5076	5305	5741	6336	7076
		OVERALL DIMENSIONS			SEAT DIMENSIONS			BACK DIMENSIONS						
		W	D	H	W	D	H	W	H					
		54	31	30	48	20.5	18.5	44	12.5					
			RTA 00											

DESCRIPTION	FEATURES	MODEL#	STANDARD TEXTILE GRADES											
			1	2	3	4	5	6	7	8	9	10	11	12
 Two Seat Sofa - Armless COM Yardage: 4 Freight Class: 250 Product Weight (lbs.): 91 Cubic Feet Per Carton: 35.5	Ganging clip required for sectional use	9752NA	3157	3295	3400	3561	3787	3868	4066	4442	4622	4973	5449	6041
		OVERALL DIMENSIONS			SEAT DIMENSIONS			BACK DIMENSIONS						
		W	D	H	W	D	H	W	H					
		52	31	30	48	20.5	18.5	44	12.5					
			RTA 00											

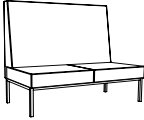

DESCRIPTION	FEATURES	MODEL#	STANDARD TEXTILE GRADES												
			1	2	3	4	5	6	7	8	9	10	11	12	
	Ganging clip required for sectional use	9752NAHB42	2865	3143	3363	3692	4157	4377	4802	5475	5996	6573	7763	9030	
		OVERALL DIMENSIONS			SEAT DIMENSIONS			BACK DIMENSIONS							
		W	D	H	W	D	H	W	H						
Two Seat Sofa - 42" High Back COM Yardage: 8 Freight Class: 250 Product Weight (lbs.): 120 Cubic Feet Per Carton: 48.5			52	31	42	48	20.5	18.5	44	24.5					
			RTA 00												

DESCRIPTION	FEATURES	MODEL#	STANDARD TEXTILE GRADES												
			1	2	3	4	5	6	7	8	9	10	11	12	
	Ganging clip required for sectional use	9752NAHB42TB	4030	4238	4402	4646	4993	5155	5469	5969	6356	6784	7667	8608	
		OVERALL DIMENSIONS			SEAT DIMENSIONS			BACK DIMENSIONS							
		W	D	H	W	D	H	W	H						
Two Seat Sofa - 42" High Back w/36" H Table Shelf COM Yardage: 6 Freight Class: 250 Product Weight (lbs.): 111 Cubic Feet Per Carton: 35.25			52	41	42	48	20.5	18.5	44	24.5					
			RTA 00												



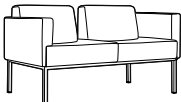

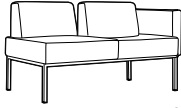
DESCRIPTION	FEATURES	MODEL#	STANDARD TEXTILE GRADES												
			1	2	3	4	5	6	7	8	9	10	11	12	
	Ganging clip required for sectional use	9752NAHB48	\$2964	\$3268	\$3508	\$3868	\$4376	\$4618	\$5080	\$5818	\$6387	\$7019	\$8320	\$9707	
		OVERALL DIMENSIONS			SEAT DIMENSIONS			BACK DIMENSIONS							
		W	D	H	W	D	H	W	H						
Two Seat Sofa - 48" High Back COM Yardage: 6 Freight Class: 250 Product Weight (lbs.): 130 Cubic Feet Per Carton: 35.25			52	31	48	48	20.5	18.5	44	30.5					
			RTA 00												

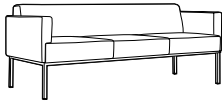
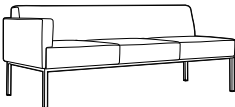
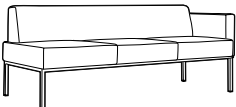
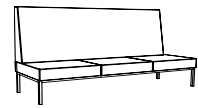

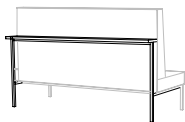
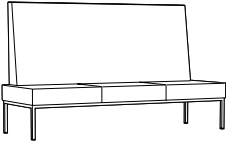
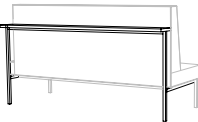
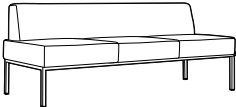
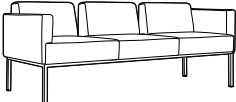
DESCRIPTION	FEATURES	MODEL#	STANDARD TEXTILE GRADES												
			1	2	3	4	5	6	7	8	9	10	11	12	
	Ganging clip required for sectional use	9752NAHB48TB	\$4129	\$4336	\$4500	\$4744	\$5091	\$5253	\$5567	\$6067	\$6453	\$6882	\$7764	\$8704	
		OVERALL DIMENSIONS			SEAT DIMENSIONS			BACK DIMENSIONS							
		W	D	H	W	D	H	W	H						
Two Seat Sofa - 48" High Back w/42" H Table Shelf COM Yardage: 8.75 Freight Class: 250 Product Weight (lbs.): 145 Cubic Feet Per Carton: 71.25			52	41	48	48	20.5	18.5	44	30.5					
			RTA 00												

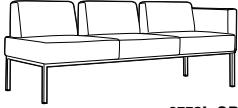
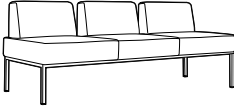
DESCRIPTION	FEATURES	MODEL#	STANDARD TEXTILE GRADES												
			1	2	3	4	5	6	7	8	9	10	11	12	
		9752-OB	3840	4042	4201	4440	4779	4899	5194	5760	6032	6557	7271	8159	
		OVERALL DIMENSIONS			SEAT DIMENSIONS			BACK DIMENSIONS							
		W	D	H	W	D	H	W	H						
Two Seat Sofa - Open Back COM Yardage: 6.25 Freight Class: 250 Product Weight (lbs.): 111 Cubic Feet Per Carton: 35.25			56	29.5	30	54	20.5	18.5	48	12.5					
			RTA 00												

DESCRIPTION	FEATURES	MODEL#	STANDARD TEXTILE GRADES											
			1	2	3	4	5	6	7	8	9	10	11	12
 <p>9752R-OB</p>	 <p>9752L-OB</p>	<p>9752R-OB 9752L-OB</p>	3437	3605	3738	3938	4219	4321	4568	5038	5265	5702	6297	5702
			<p>OVERALL DIMENSIONS</p> <p>W D H</p>			<p>SEAT DIMENSIONS</p> <p>W D H</p>			<p>BACK DIMENSIONS</p> <p>W H</p>					
<p>Two Seat Sofa - Open Back - One Arm COM Yardage: 5.25 Freight Class: 250 Product Weight (lbs.): 101 Cubic Feet Per Carton: 36.25</p>	Ganging clip required for sectional use		54	31	30	48	20.5	18.5	44	12.5				
			RTA 00											
			3115	3252	3358	3518	3744	3823	4022	4400	4580	4930	5404	5996
	<p>OVERALL DIMENSIONS</p> <p>W D H</p>			<p>SEAT DIMENSIONS</p> <p>W D H</p>			<p>BACK DIMENSIONS</p> <p>W H</p>							
<p>Two Seat Sofa - Open Back - Armless COM Yardage: 4.25 Freight Class: 250 Product Weight (lbs.): 91 Cubic Feet Per Carton: 35.5</p>			52	31	30	48	20.5	18.5	44	12.5				
			RTA 00											
			5194	5512	5766	6146	6687	6941	7429	8208	8810	9477	10852	12318
	<p>OVERALL DIMENSIONS</p> <p>W D H</p>			<p>SEAT DIMENSIONS</p> <p>W D H</p>			<p>BACK DIMENSIONS</p> <p>W H</p>							
<p>Three Seat Sofa COM Yardage: 9.5 Freight Class: 250 Product Weight (lbs.): 153 Cubic Feet Per Carton: 54.5</p>			82.5	31	30	76.5	20.5	18.5	66	12.5				
			RTA 00											
 <p>9753R</p>	 <p>9753L</p>	<p>9753R 9753L</p>	4854	5133	5356	5685	6156	6375	6801	7480	8005	8585	9783	11059
			<p>OVERALL DIMENSIONS</p> <p>W D H</p>			<p>SEAT DIMENSIONS</p> <p>W D H</p>			<p>BACK DIMENSIONS</p> <p>W H</p>					
<p>Three Seat Sofa - One Arm COM Yardage: 8.25 Freight Class: 250 Product Weight (lbs.): 143 Cubic Feet Per Carton: 54.5</p>	Ganging clip required for sectional use		81.5	31	30	80.5	20.5	18.5	74	12.5				
			RTA 00											
			\$4316	\$4730	\$5057	\$5552	\$6252	\$6580	\$7214	\$8224	\$9004	\$9868	\$11651	\$13554
	<p>OVERALL DIMENSIONS</p> <p>W D H</p>			<p>SEAT DIMENSIONS</p> <p>W D H</p>			<p>BACK DIMENSIONS</p> <p>W H</p>							
<p>Three Seat Sofa - 42" High Back COM Yardage: 12.25 Freight Class: 300 Product Weight (lbs.): 143 Cubic Feet Per Carton: 72.50</p>	Ganging clip required for sectional use		80.5	31	42	74	20.5	18.5	74	24.5				
			RTA 00											

DESCRIPTION	FEATURES	MODEL#	STANDARD TEXTILE GRADES													
			1	2	3	4	5	6	7	8	9	10	11	12		
 <p>Three Seat Sofa - 42" High Back w/36"H Table Shelf COM Yardage: 9 Freight Class: 300 Product Weight (lbs.): 158 Cubic Feet Per Carton: 93.50</p>	Ganging clip required for sectional use	9753NAHB42TB	5676	5978	6216	6576	7085	7325	7785	8521	9087	9717	11015	12398		
			OVERALL DIMENSIONS			SEAT DIMENSIONS			BACK DIMENSIONS							
			W	D	H	W	D	H	W	H						
			80.5	41	42	74	20.5	18.5	74	24.5						
			RTA 00													
 <p>Three Seat Sofa - 48" High Back COM Yardage: 13.25 Freight Class: 250 Product Weight (lbs.): 168 Cubic Feet Per Carton: 82.25</p>	Ganging clip required for sectional use	9753NAHB48	4593	5042	5397	5932	6688	7044	7729	8821	9665	10600	12528	14585		
			OVERALL DIMENSIONS			SEAT DIMENSIONS			BACK DIMENSIONS							
			W	D	H	W	D	H	W	H						
			80.5	31	48	74	20.5	18.5	74	30.5						
			RTA 00													
 <p>Three Seat Sofa - 48" High Back w/42"H Table Shelf COM Yardage: 9 Freight Class: 300 Product Weight (lbs.): 158 Cubic Feet Per Carton: 106</p>	Ganging clip required for sectional use	9753NAHB48TB	5953	6313	6555	6918	7435	7679	8146	8893	9469	10106	11423	12826		
			OVERALL DIMENSIONS			SEAT DIMENSIONS			BACK DIMENSIONS							
			W	D	H	W	D	H	W	H						
			80.5	41	48	74	20.5	18.5	74	30.5						
			RTA 00													
 <p>Three Seat Sofa - Armless COM Yardage: 7 Freight Class: 250 Product Weight (lbs.): 133 Cubic Feet Per Carton: 51.5</p>	Ganging clip required for sectional use	9753NA	4471	4708	4896	5177	5577	5764	6127	6706	7151	7645	8664	9751		
			OVERALL DIMENSIONS			SEAT DIMENSIONS			BACK DIMENSIONS							
			W	D	H	W	D	H	W	H						
			80.5	31	30	80.5	20.5	18.5	74	12.5						
			RTA 00													
 <p>Three Seat Sofa - Open Back COM Yardage: 8 Freight Class: 250 Product Weight (lbs.): 153 Cubic Feet Per Carton: 54.5</p>	Ganging clip required for sectional use	9753-OB	5157	5423	5638	5957	6407	6568	6964	7718	8081	8780	9731	10914		
			OVERALL DIMENSIONS			SEAT DIMENSIONS			BACK DIMENSIONS							
			W	D	H	W	D	H	W	H						
			82.5	31	30	80.5	20.5	18.5	74	12.5						
			RTA 00													

DESCRIPTION	FEATURES	MODEL#	STANDARD TEXTILE GRADES											
			1	2	3	4	5	6	7	8	9	10	11	12
 <p>9753R-OB</p> <p>Three Seat Sofa - Open Back - One Arm COM Yardage: 7 Freight Class: 250 Product Weight (lbs.): 143 Cubic Feet Per Carton: 54.5</p>	 <p>9753L-OB</p> <p>Ganging clip required for sectional use</p>	<p>9753R-OB 4810 5046 5232 5510 5905 6046 6392 7053 7371 7981 8813 9851</p> <p>9753L-OB</p>	OVERALL DIMENSIONS			SEAT DIMENSIONS			BACK DIMENSIONS					
			W	D	H	W	D	H	W	H				
			81.5	31	30	80.5	20.5	17.5	74	12.5				
			RTA 00											
 <p>9753NA-OB</p> <p>Three Seat Sofa - Open Back - Armless COM Yardage: 6.25 Freight Class: 250 Product Weight (lbs.): 133 Cubic Feet Per Carton: 51.5</p>	<p>Ganging clip required for sectional use</p>	<p>9753NA-OB 4426 4631 4790 5029 5366 5487 5784 6349 6622 7144 7859 8750</p>	OVERALL DIMENSIONS			SEAT DIMENSIONS			BACK DIMENSIONS					
			W	D	H	W	D	H	W	H				
			80.5	31	30	80.5	20.5	17.5	74	12.5				
			RTA 00											
 <p>9754</p> <p>Storage Table COM Yardage: N/A Freight Class: 125 Product Weight (lbs.): 65 Cubic Feet Per Carton: 11.5</p>	<p>Ganging clip required for sectional use</p>	<p>9754 1333 - - - - - - - - - - - -</p>	OVERALL DIMENSIONS			SEAT DIMENSIONS			BACK DIMENSIONS					
			W	D	H	W	D	H	W	H				
			27.25	27.25	16.5	-	-	-	-	-	-	-	-	
			RTA 00											
 <p>9755</p> <p>Corner Table COM Yardage: N/A Freight Class: 150 Product Weight (lbs.): 40 Cubic Feet Per Carton: 8</p>	<p>Ganging clip required for sectional use</p>	<p>9755 840 - - - - - - - - - - - -</p>	OVERALL DIMENSIONS			SEAT DIMENSIONS			BACK DIMENSIONS					
			W	D	H	W	D	H	W	H				
			27.25	27.25	12.5	-	-	-	-	-	-	-	-	
			RTA 00											
 <p>9759</p> <p>Ganging Bracket COM Yardage: N/A Freight Class: 70 Product Weight (lbs.): 0.52 Cubic Feet Per Carton: 0.02</p>	<p>Only one set is needed per connection.</p>	<p>9759 25 - - - - - - - - - - - -</p>	OVERALL DIMENSIONS			SEAT DIMENSIONS			BACK DIMENSIONS					
			W	D	H	W	D	H	W	H				
			1	0.75	10	-	-	-	-	-	-	-	-	
			RTA 00											

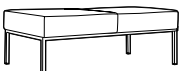
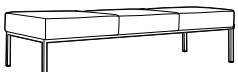
DESCRIPTION	FEATURES	MODEL#	STANDARD TEXTILE GRADES													
			1	2	3	4	5	6	7	8	9	10	11	12		
 <p>Tablet COM Yardage: N/A Freight Class: 150 Product Weight (lbs.): 12 Cubic Feet Per Carton: 2.5</p>	Mounts underneath of seating.	9757L	646	-	-	-	-	-	-	-	-	-	-	-	-	
		9758R	-	-	-	-	-	-	-	-	-	-	-	-	-	
		OVERALL DIMENSIONS			SEAT DIMENSIONS			BACK DIMENSIONS								
		W	D	H	W	D	H	W	H							
			14	17.25	14	-	-	-	-	-	-	-	-	-	-	
			RTA 1			FedEx			UPS							
 <p>Power Module COM Yardage: N/A Freight Class: 125 Product Weight (lbs.): 3 Cubic Feet Per Carton: 0.5</p>	Mounts underneath of seating or tables.	9760	\$407	-	-	-	-	-	-	-	-	-	-	-	-	
		10 Ft. power cord														
		OVERALL DIMENSIONS			SEAT DIMENSIONS			BACK DIMENSIONS								
		W	D	H	W	D	H	W	H							
			6	2.75	2.75	-	-	-	-	-	-	-	-	-	-	
			RTA 00			FedEx			UPS							
 <p>One Seat Bench COM Yardage: 2 Freight Class: 250 Product Weight (lbs.): 37 Cubic Feet Per Carton: 10.75</p>	Ganging clip required for sectional use	9761	1309	1379	1433	1514	1628	1683	1786	1953	2082	2223	2517	2828		
		OVERALL DIMENSIONS			SEAT DIMENSIONS			BACK DIMENSIONS								
		W	D	H	W	D	H	W	H							
					27.5	28.5	17.5	-	-	-	-	-	-	-	-	-
			RTA 00													
 <p>Two Seat Bench COM Yardage: 4 Freight Class: 250 Product Weight (lbs.): 57 Cubic Feet Per Carton: 21.25</p>	Ganging clip required for sectional use	9762	2329	2467	2575	2738	2970	3079	3287	3620	3878	4164	4752	5379		
		OVERALL DIMENSIONS			SEAT DIMENSIONS			BACK DIMENSIONS								
		W	D	H	W	D	H	W	H							
					54	28.5	17.5	-	-	-	-	-	-	-	-	-
			RTA 00													
 <p>Three Seat Bench COM Yardage: 6 Freight Class: 250 Product Weight (lbs.): 80 Cubic Feet Per Carton: 29.5</p>	Ganging clip required for sectional use	9763	3296	3501	3660	3901	4244	4405	4713	5206	5585	6009	6878	7808		
		OVERALL DIMENSIONS			SEAT DIMENSIONS			BACK DIMENSIONS								
		W	D	H	W	D	H	W	H							
					80.5	28.5	17.5	-	-	-	-	-	-	-	-	-
			RTA 00													

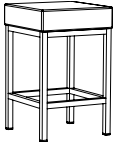
DESCRIPTION	FEATURES	MODEL#	STANDARD TEXTILE GRADES												
			1	2	3	4	5	6	7	8	9	10	11	12	
 <p>Coffee Storage Table (2 Seat Length) COM Yardage: N/A Freight Class: 150 Product Weight (lbs.): 112 Cubic Feet Per Carton: 20.5</p>	Ganging clip required for sectional use	9765	2430	-	-	-	-	-	-	-	-	-	-	-	
		OVERALL DIMENSIONS			SEAT DIMENSIONS			BACK DIMENSIONS							
		W	D	H	W	D	H	W	H						
		53.75	27.25	16.5	-	-	-	-	-						
		RTA 00													
 <p>Coffee Table (2 Seat Length) COM Yardage: N/A Freight Class: 150 Product Weight (lbs.): 68 Cubic Feet Per Carton: 17.75</p>		9766	1572	-	-	-	-	-	-	-	-	-	-	-	
	OVERALL DIMENSIONS			SEAT DIMENSIONS			BACK DIMENSIONS								
	W	D	H	W	D	H	W	H							
	54	27.5	13	-	-	-	-	-							
		RTA 00													
 <p>24" Stool COM Yardage: 0.75 Freight Class: 150 Product Weight (lbs.): 22 Cubic Feet Per Carton: 4.75</p>		9769S24	\$858	\$885	\$905	\$934	\$977	\$997	\$1036	\$1096	\$1143	\$1195	\$1303	\$1419	
	OVERALL DIMENSIONS			SEAT DIMENSIONS			BACK DIMENSIONS								
	W	D	H	W	D	H	W	H							
	15	15	24	15	15	3	-	-							
		RTA 00													
 <p>30" Stool COM Yardage: .50 Freight Class: 150 Product Weight (lbs.): 23 Cubic Feet Per Carton: 5.5</p>		9769S30	\$935	\$962	\$982	\$1011	\$1053	\$1073	\$1110	\$1170	\$1216	\$1268	\$1372	\$1485	
	OVERALL DIMENSIONS			SEAT DIMENSIONS			BACK DIMENSIONS								
	W	D	H	W	D	H	W	H							
	15	15	30	15	15	30	-	-							
		RTA 00													

BRADEN™



model 7871



model 7870R, 7870, 7870L

STANDARD FEATURES

- A flexible modular seating system that is exceptionally durable. Combine these seating components into a configuration that suits your space.
- Braden uses a unique ganging feature which locks units solidly together, but allows them to be separated and reconfigured when necessary. Locking "Pins" will always be on the left side of a ganging unit, while the pin receptacle will always be on the right side, seated.
- Check textile availability prior to specifying upholstery material.

OPTIONAL FEATURES

- For ganging hardware please use the following codes: Add "GB" for both sides. Add "GR" for right side seated only. Add "GL" for left side seated only. Add "GC" for corner units only, both sides.
- For highly resilient, high density Ultracell foam on seat, Please specify (UC) after the model number. Add \$73 for the seat. Add \$143 for the seat and back.
- Optional Non-slip glide for hard surface flooring. Please specify (NSG). Add \$35.
- Model 7874 Table (top) is offered in all the standard laminates. Please specify.

DESCRIPTION FEATURES MODEL# STANDARD TEXTILE GRADES

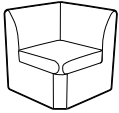

Corner Unit
COM Yardage: 16.5
Freight Class:
Product Weight (lbs.): 38
Cubic Feet Per Carton: 16.5

MODEL#	1	2	3	4	5	6	7	8	9	10	11	12
7867	1300	1456	1577	1756	2014	2133	2368	2738	3022	3342	3995	4692

OVERALL DIMENSIONS			SEAT DIMENSIONS			BACK DIMENSIONS	
W	D	H	W	D	H	W	H
24	27.5	30	20	17	20.5	19.5	12.5

RTA 00



Single Seater
COM Yardage: 2.75
Freight Class:
Product Weight (lbs.): 26
Cubic Feet Per Carton: 16.5

MODEL#	1	2	3	4	5	6	7	8	9	10	11	12
7868	351	421	475	555	666	718	819	983	1107	1246	1532	1836

OVERALL DIMENSIONS			SEAT DIMENSIONS			BACK DIMENSIONS	
W	D	H	W	D	H	W	H
24	27.5	30					

RTA 00



Single Seater
COM Yardage: 2.75
Freight Class: 250
Product Weight (lbs.): 38
Cubic Feet Per Carton: 16.5

MODEL#	1	2	3	4	5	6	7	8	9	10	11	12
7870	808	921	1006	1135	1315	1384	1541	1847	1991	2275	2659	3138

OVERALL DIMENSIONS			SEAT DIMENSIONS			BACK DIMENSIONS	
W	D	H	W	D	H	W	H
24	27.5	30	24	19.5	16.5	24	13.5

RTA 00







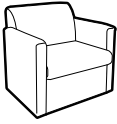

Single Seater - Left Arm
COM Yardage: 3.75
Freight Class: 250
Product Weight (lbs.): 45
Cubic Feet Per Carton: 16.5

MODEL#	1	2	3	4	5	6	7	8	9	10	11	12
7870L	921	1071	1187	1365	1613	1701	1920	2335	2536	2919	3444	4098

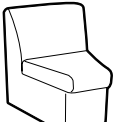
OVERALL DIMENSIONS			SEAT DIMENSIONS			BACK DIMENSIONS	
W	D	H	W	D	H	W	H
27	27.5	30	24	19.5	16.5	24	13.5

RTA 00

DESCRIPTION	FEATURES	MODEL#	STANDARD TEXTILE GRADES											
			1	2	3	4	5	6	7	8	9	10	11	12
 <p>Single Seater - Right Arm COM Yardage: 3.75 Freight Class: 250 Product Weight (lbs.): 45 Cubic Feet Per Carton: 16.5</p>		7870R	921	1071	1187	1365	1613	1701	1920	2335	2536	2919	3444	4098
			OVERALL DIMENSIONS			SEAT DIMENSIONS			BACK DIMENSIONS					
			W	D	H	W	D	H	W	H				
			27	27.5	30	24	19.5	16.5	24	13.5				
			RTA 00											
 <p>Single Seater - with Arms COM Yardage: 4.75 Freight Class: 250 Product Weight (lbs.): 52 Cubic Feet Per Carton: 16.5</p>		7871	1136	1308	1445	1647	1936	2039	2290	2776	3006	3453	4062	4817
			OVERALL DIMENSIONS			SEAT DIMENSIONS			BACK DIMENSIONS					
			W	D	H	W	D	H	W	H				
			30	27.5	30	24	19.5	16.5	24	13.5				
			RTA 00											
 <p>Corner Unit COM Yardage: 2.75 Freight Class: 300 Product Weight (lbs.): 31 Cubic Feet Per Carton: 16.5</p>		7872	746	859	944	1073	1253	1322	1479	1785	1929	2213	2597	3076
			OVERALL DIMENSIONS			SEAT DIMENSIONS			BACK DIMENSIONS					
			W	D	H	W	D	H	W	H				
			24	27.5	30	20	19.5	16.5	15	13.5				
			RTA 00											
 <p>Corner Unit COM Yardage: 2.75 Freight Class: 300 Product Weight (lbs.): 31 Cubic Feet Per Carton: 16.5</p>		7873	746	859	944	1073	1253	1322	1479	1785	1929	2213	2597	3076
			OVERALL DIMENSIONS			SEAT DIMENSIONS			BACK DIMENSIONS					
			W	D	H	W	D	H	W	H				
			24	27.5	30	16	19.5	16.5	21.5	13.5				
			RTA 00											
 <p>Table - 24" Square w/Upholstered Sides COM Yardage: 1.75 Freight Class: 125 Product Weight (lbs.): 38 Cubic Feet Per Carton: 6.25</p>		7874	610	682	736	817	933	977	1077	1271	1363	1544	1788	2093
			OVERALL DIMENSIONS			SEAT DIMENSIONS			BACK DIMENSIONS					
			W	D	H	W	D	H	W	H				
			24	24	14.5	-	-	-	-	-				
			RTA 00											
			 											

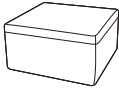
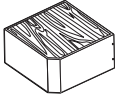
DESCRIPTION	FEATURES	MODEL#	STANDARD TEXTILE GRADES											
			1	2	3	4	5	6	7	8	9	10	11	12
 <p>Foot Stool/Single Bench - 24" Square COM Yardage: 1.75 Freight Class: 125 Product Weight (lbs.): 38 Cubic Feet Per Carton: 6.25</p>		7874FS	695	781	845	945	1084	1133	1256	1488	1599	1815	2109	2474
			OVERALL DIMENSIONS			SEAT DIMENSIONS			BACK DIMENSIONS					
			W	D	H	W	D	H	W	H				
			24	24	17.5	-	-	-	-	-				
			RTA 00											
 <p>Corner Table - 17" Square w/Upholstered Sides COM Yardage: 1.75 Freight Class: 125 Product Weight (lbs.): 38 Cubic Feet Per Carton: 6.25</p>		7880	831	901	955	1035	1146	1198	1299	1463	1587	1726	2012	2316
			OVERALL DIMENSIONS			SEAT DIMENSIONS			BACK DIMENSIONS					
			W	D	H	W	D	H	W	H				
			24	24	14.5	-	-	-	-	-				
			RTA 00											

BRIDGES II COLLABORATIVE SEATING



model BRTSE2424B



model BRTSE6060B



model BRTS2448F

STANDARD FEATURES

- For all Bridges II components, please see the Bridges II section of the Desking Price Book.
- Bridges collaborative seating collection consists of seating, privacy screens, tables, tablets and power.
- It is a versatile modular furniture series which can be configured into many space planning scenarios, including corner, in-line, open concept, traditional reception, as well as secluded seating with high privacy partitions.
- Furniture pieces can be used as stand alone items or can be mechanically linked together to form a variety of seating configurations.
- Seat and backrest can be integrated with Bridges tables.
- Corner tables and in-line 6" table modules double as power delivery centers.
- Dedicated seat backrests feature dual USB charging port.
- Some in line 6" table modules are furnished with grommets to support tablets.
- Legs are available in standard Bridges metal painted finishes and anodized aluminum finish.
- Bridges Collaborative Seating upholstery features a single stitch, thick white thread around the edges. The white, wide stitch along with crisp corners are part of its distinctive personality.
- In order to achieve crisp edges and to minimize "pillow" effect caused by taut fabric, the upholstery material has been applied deliberately loose, which may over time, produce puckering of the upholstery surface material. This can be easily corrected by stretching the fabric by hand or during vacuuming.
- Freestanding 17"h table. Central partition divides space under top surface into two 11" deep compartments.

- In order to efficiently utilize fabric yield, all 60" seats and backs feature a seam in the middle. The double stitch seam is sewn with a thin thread, closely matching the upholstery material in color.
- Some complicated fabric patterns prevent pattern matching and will be upholstered without the seam at the discretion of the factory.
- Should you require no middle seam by cutting into the roll, please specify "NO SEAM" at time of your order.
- Check textile availability prior to specifying upholstery material.

OPTIONAL FEATURES

- Optional Anodized Aluminum Leg on all models. Add \$74.
- Models BRTS2406BT and BRTS2406BPT include 9.5" x 14.5" swivel tablet. If top is specified in high pressure laminate, tablet will also be manufactured in high pressure laminate.
- Bridges II tables and tablets are offered in the following laminate finishes: Absolute Acajou (ACJ), Asian Night (ASN), Avant Cherry (AWC), Avant Honey (AWH), Black (BLK), Brushed Cobalt (BRC), Clear Maple (CMB), Custom Grey (CGY), Dark Espresso (DES), Designer White (DWT), Fashionista (FAS), First Class (FCL), Noce Biondo (NBL), Noce Grigio (NGL), Noce Leggero (NEL), Noce Medio (NML), Quartered Mahogany (QTM), Sheer Beauty (SBY) Storm Grey (SOG), Walnut Heights (WHE), White Chocolate (WHC) and Winter Cherry (WCR). Please Specify.

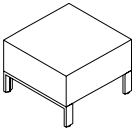
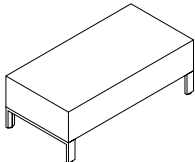
DESCRIPTION	FEATURES	MODEL#	STANDARD TEXTILE GRADES											
			1	2	3	4	5	6	7	8	9	10	11	12
 <p>Lounge Seat - 24" COM Yardage: 1.25 Freight Class: 150 Product Weight (lbs.): 22.70 Cubic Feet Per Carton: 5.57</p>		BRTSE24NB	787	863	863	911	979	1010	1072	1170	1246	1330	1501	1686
			OVERALL DIMENSIONS			SEAT DIMENSIONS			BACK DIMENSIONS					
			W	D	H	W	D	H	W	H				
			24	24	17	-	-	-	-	-				
		RTA 00												
 <p>Lounge Seat - 48" COM Yardage: 2 Freight Class: 250 Product Weight (lbs.): 36.90 Cubic Feet Per Carton: 11.33</p>		BRTSE48NB	1433	1553	1553	1630	1737	1789	1888	2045	2164	2300	2577	2870
			OVERALL DIMENSIONS			SEAT DIMENSIONS			BACK DIMENSIONS					
			W	D	H	W	D	H	W	H				
			48	24	17	-	-	-	-	-				
		RTA 00												

DESCRIPTION	FEATURES	MODEL#	STANDARD TEXTILE GRADES											
			1	2	3	4	5	6	7	8	9	10	11	12

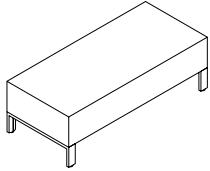

Lounge Seat - 60"
 COM Yardage: 2
 Freight Class: 250
 Product Weight (lbs.): 47
 Cubic Feet Per Carton: 14.17

BRTSE60NB	1659	1743	1807	1901	2039	2101	2225	2421	2572	2741	3084	3454
------------------	------	------	------	------	------	------	------	------	------	------	------	------

OVERALL DIMENSIONS			SEAT DIMENSIONS			BACK DIMENSIONS	
W	D	H	W	D	H	W	H
60	24	17	-	-	-	-	-

RTA 00

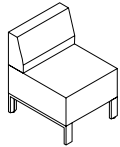

Lounge Seat, Full Backrest - 24"
 COM Yardage: 2.25
 Freight Class: 250
 Product Weight (lbs.): 33
 Cubic Feet Per Carton: 9.57

BRTSE2424B	1239	1373	1373	1458	1580	1638	1749	1925	2061	2213	2525	2855
-------------------	------	------	------	------	------	------	------	------	------	------	------	------

OVERALL DIMENSIONS			SEAT DIMENSIONS			BACK DIMENSIONS	
W	D	H	W	D	H	W	H
24	24	29	-	-	-	-	-

RTA 00

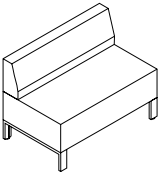

Lounge Seat, Full Backrest - 48"
 COM Yardage: 3.5
 Freight Class: 250
 Product Weight (lbs.): 55.50
 Cubic Feet Per Carton: 19.33

BRTSE4848B	2286	2491	2491	2625	2817	2905	3076	3350	3562	3797	4282	4797
-------------------	------	------	------	------	------	------	------	------	------	------	------	------

OVERALL DIMENSIONS			SEAT DIMENSIONS			BACK DIMENSIONS	
W	D	H	W	D	H	W	H
48	24	29	-	-	-	-	-

RTA 00

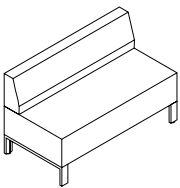

Lounge Seat, Full Backrest - 60"
 COM Yardage: 4.5
 Freight Class: 250
 Product Weight (lbs.): 70
 Cubic Feet Per Carton: 24.17

BRTSE6060B	2649	2912	2912	3084	3327	3443	3666	4018	4288	4590	5214	5878
-------------------	------	------	------	------	------	------	------	------	------	------	------	------

OVERALL DIMENSIONS			SEAT DIMENSIONS			BACK DIMENSIONS	
W	D	H	W	D	H	W	H
60	60	29	-	-	-	-	-

RTA 00

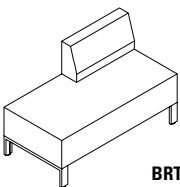

BRTSE2448BR

Lounge Seat, 24" Offset Backrest
 COM Yardage: 3
 Freight Class: 250
 Product Weight (lbs.): 46.1
 Cubic Feet Per Carton: 19.33

BRTSE2448BR	1884	2063	2063	2175	2339	2416	2563	2800	2980	3179	3596	4038
--------------------	------	------	------	------	------	------	------	------	------	------	------	------

BRTSE2448BL	1884	2063	2063	2175	2339	2416	2563	2800	2980	3179	3596	4038
--------------------	------	------	------	------	------	------	------	------	------	------	------	------

OVERALL DIMENSIONS			SEAT DIMENSIONS			BACK DIMENSIONS	
W	D	H	W	D	H	W	H
48	24	29	-	-	-	-	-

RTA 00

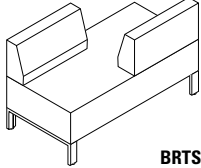
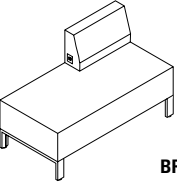
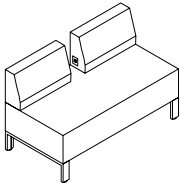
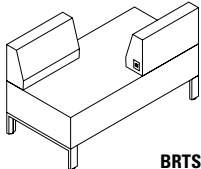
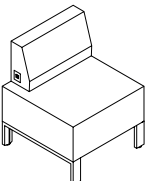
DESCRIPTION	FEATURES	MODEL#	STANDARD TEXTILE GRADES											
			1	2	3	4	5	6	7	8	9	10	11	12
 <p>BRTSE2448BODR</p> <p>Lounge Seat, Two 24" Offset Backrests COM Yardage: 4 Freight Class: 250 Product Weight (lbs.): 46.5 Cubic Feet Per Carton: 19.33</p>		BRTSE2448BODR	2336	2570	2570	2724	2940	3043	3241	3554	3794	4065	4618	5206
		BRTSE2448BODL	2336	2468	2570	2724	2940	3043	3241	3554	3794	4065	4618	5206
			OVERALL DIMENSIONS			SEAT DIMENSIONS			BACK DIMENSIONS					
			W	D	H	W	D	H	W	H				
			48	24	29	-	-	-	-	-				
			RTA 00											
 <p>BRTSE2148EBR</p> <p>Lounge Seat, 21" USB Backrest COM Yardage: 3 Freight Class: 250 Product Weight (lbs.): 33 Cubic Feet Per Carton: 9.67</p>			1	2	3	4	5	6	7	8	9	10	11	12
		BRTSE2148EBR	2184	2287	2363	2475	2639	2716	2863	3100	3280	3479	3896	4338
		BRTSE2148EBL	2184	2287	2363	2475	2639	2716	2863	3100	3280	3479	3896	4338
			OVERALL DIMENSIONS			SEAT DIMENSIONS			BACK DIMENSIONS					
			W	D	H	W	D	H	W	H				
			48	24	29	-	-	-	-	-				
			RTA 00											
 <p>BRTSE2148E2B</p> <p>Lounge Seat, Two 21" USB Backrests COM Yardage: 4 Freight Class: 250 Product Weight (lbs.): 57 Cubic Feet Per Carton: 19.33</p>			1	2	3	4	5	6	7	8	9	10	11	12
		BRTSE2148E2B	2934	3066	3165	3319	3536	3641	3838	4151	4392	4660	5213	5803
			OVERALL DIMENSIONS			SEAT DIMENSIONS			BACK DIMENSIONS					
			W	D	H	W	D	H	W	H				
			48	24	29	-	-	-	-	-				
			RTA 00											
 <p>BRTSE2148EBODR</p> <p>Lounge Seat, Two Offset USB Backrests COM Yardage: 4 Freight Class: 250 Product Weight (lbs.): 57 Cubic Feet Per Carton: 19.33</p>			1	2	3	4	5	6	7	8	9	10	11	12
		BRTSE2148EBODR	2934	3066	3165	3319	3536	3641	3838	4151	4392	4660	5213	5803
		BRTSE2148EBODL	2934	3066	3165	3319	3536	3641	3838	4151	4392	4660	5213	5803
			OVERALL DIMENSIONS			SEAT DIMENSIONS			BACK DIMENSIONS					
			W	D	H	W	D	H	W	H				
			48	24	29	-	-	-	-	-				
			RTA 00											
 <p>BRTSE2124EBR</p> <p>Lounge Seat, 21" USB Backrest COM Yardage: 2.25 Freight Class: 250 Product Weight (lbs.): 46.10 Cubic Feet Per Carton: 19.33</p>			1	2	3	4	5	6	7	8	9	10	11	12
		BRTSE2124EBR	2934	1614	1673	1757	1879	1939	2049	2225	2360	2512	2824	3154
		BRTSE2124EBL	1538	1614	1673	1757	1879	1939	2049	2225	2360	2512	2824	3154
			OVERALL DIMENSIONS			SEAT DIMENSIONS			BACK DIMENSIONS					
			W	D	H	W	D	H	W	H				
			48	24	29	-	-	-	-	-				
			RTA 00											

DESCRIPTION FEATURES MODEL# STANDARD TEXTILE GRADES

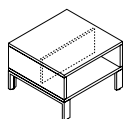

Low Table - 24"
 COM Yardage: N/A
 Freight Class: 125
 Product Weight (lbs.): 40.70
 Cubic Feet Per Carton: 5.67

MODEL#	1	2	3	4	5	6	7	8	9	10	11	12
BRTST2424F	880	-	-	-	-	-	-	-	-	-	-	-

OVERALL DIMENSIONS			SEAT DIMENSIONS			BACK DIMENSIONS	
W	D	H	W	D	H	W	H
24	24	17	-	-	-	-	-

RTA 00

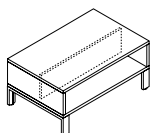

Low Table - 48"
 COM Yardage: N/A
 Freight Class: 125
 Product Weight (lbs.): 69
 Cubic Feet Per Carton: 11.33

MODEL#	1	2	3	4	5	6	7	8	9	10	11	12
BRTST2448F	880	-	-	-	-	-	-	-	-	-	-	-

OVERALL DIMENSIONS			SEAT DIMENSIONS			BACK DIMENSIONS	
W	D	H	W	D	H	W	H
48	24	17	-	-	-	-	-

RTA 00

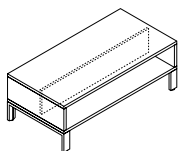

Low Table - 60"
 COM Yardage: N/A
 Freight Class: 150
 Product Weight (lbs.): 83.60
 Cubic Feet Per Carton: 14.17

MODEL#	1	2	3	4	5	6	7	8	9	10	11	12
BRTST2460F	880	-	-	-	-	-	-	-	-	-	-	-

OVERALL DIMENSIONS			SEAT DIMENSIONS			BACK DIMENSIONS	
W	D	H	W	D	H	W	H
60	24	17	-	-	-	-	-

RTA 00

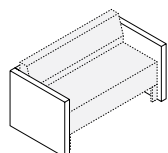

Seat Partitions - 24"
 COM Yardage:
 Freight Class: 250
 Product Weight (lbs.): 32
 Cubic Feet Per Carton: 12.04

MODEL#	1	2	3	4	5	6	7	8	9	10	11	12
BRTPP2424L1	1452	-	-	-	-	-	-	-	-	-	-	-

OVERALL DIMENSIONS			SEAT DIMENSIONS			BACK DIMENSIONS	
W	D	H	W	D	H	W	H
29	28.7	25	-	-	-	-	-

RTA 00

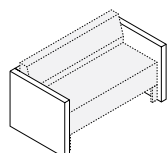

Seat Partitions - 48"
 COM Yardage:
 Freight Class: 300
 Product Weight (lbs.): 41
 Cubic Feet Per Carton: 22.01

MODEL#	1	2	3	4	5	6	7	8	9	10	11	12
BRTPP2448L1	1941	-	-	-	-	-	-	-	-	-	-	-

OVERALL DIMENSIONS			SEAT DIMENSIONS			BACK DIMENSIONS	
W	D	H	W	D	H	W	H
53	28.7	25	-	-	-	-	-

RTA 00

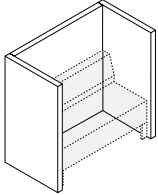
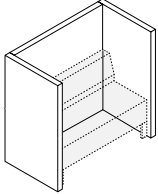
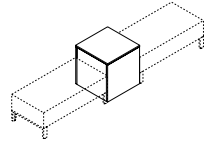
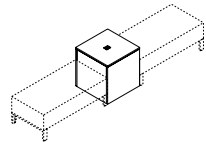
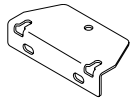
DESCRIPTION	FEATURES	MODEL#	STANDARD TEXTILE GRADES											
			1	2	3	4	5	6	7	8	9	10	11	12
 <p>Seat Privacy Partitions - 24" COM Yardage: Freight Class: 300 Product Weight (lbs.): 32 Cubic Feet Per Carton: 24.08</p>	<p>Fully 3 - Part Kit Seating not included. Panel textiles only.</p>	BRTPP2424L2	2199	-	-	-	-	-	-	-	-	-	-	-
		OVERALL DIMENSIONS			SEAT DIMENSIONS			BACK DIMENSIONS						
		W	D	H	W	D	H	W	H					
		29	28.7	50	-	-	-	-	-					
			RTA 00											
 <p>Seat Privacy Partitions - 48" COM Yardage: Freight Class: 400 Product Weight (lbs.): 41 Cubic Feet Per Carton: 44.01</p>	<p>Fully 3 - Part Kit Seating not included.</p>	BRTPP2448L2	2813	-	-	-	-	-	-	-	-	-	-	
		OVERALL DIMENSIONS			SEAT DIMENSIONS			BACK DIMENSIONS						
		W	D	H	W	D	H	W	H					
		53	28.7	50	-	-	-	-	-					
			RTA 00											
 <p>Square Table Block - No Power COM Yardage: N/A Freight Class: 250 Product Weight (lbs.): 32 Cubic Feet Per Carton: 12.04</p>	<p>Freestanding Table. Seating not included. Includes 2 brackets and screws</p>	BRTS2424B	619	-	-	-	-	-	-	-	-	-		
		OVERALL DIMENSIONS			SEAT DIMENSIONS			BACK DIMENSIONS						
		W	D	H	W	D	H	W	H					
		24	24	25	-	-	-	-	-					
			RTA 00											
 <p>Square Table Block w/ Center Power COM Yardage: N/A Freight Class: 125 Product Weight (lbs.): 59.30 Cubic Feet Per Carton: 8.33</p>	<p>Freestanding Table. Seating not included. Includes 2 brackets and screws</p>	BRTS2424BP	619	-	-	-	-	-	-	-	-	-		
		OVERALL DIMENSIONS			SEAT DIMENSIONS			BACK DIMENSIONS						
		W	D	H	W	D	H	W	H					
		24	24	25	-	-	-	-	-					
			RTA 00											
 <p>Square Table Block Ganging Bracket Kit COM Yardage: N/A Freight Class: 70 Product Weight (lbs.): 0.05 Cubic Feet Per Carton: 0.01</p>	<p>Includes 2 brackets and screws. Black Only.</p>	BRTSTBG	47	-	-	-	-	-	-	-	-	-		
		OVERALL DIMENSIONS			SEAT DIMENSIONS			BACK DIMENSIONS						
		W	D	H	W	D	H	W	H					
		5	2.4	1.1	-	-	-	-	-					
			RTA 00											

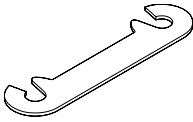
DESCRIPTION	FEATURES	MODEL#	STANDARD TEXTILE GRADES														
			1	2	3	4	5	6	7	8	9	10	11	12			
	Ganging Bracket Kit COM Yardage: N/A Freight Class: 70 Product Weight (lbs.): 0.03 Cubic Feet Per Carton: 0.01	BRTSTSB	21	-	-	-	-	-	-	-	-	-	-	-			
			OVERALL DIMENSIONS			SEAT DIMENSIONS			BACK DIMENSIONS								
			W	D	H	W	D	H	W	H							
			6	1.3	0.1	-	-	-	-	-	-						
			RTA 00														

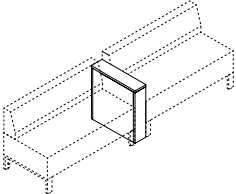
DESCRIPTION	FEATURES	MODEL#	STANDARD TEXTILE GRADES														
			1	2	3	4	5	6	7	8	9	10	11	12			
	Inline 6" Table Block COM Yardage: N/A Freight Class: 92.50 Product Weight (lbs.): 21 Cubic Feet Per Carton: 2.08	BRTS2406B	531	-	-	-	-	-	-	-	-	-	-	-			
			OVERALL DIMENSIONS			SEAT DIMENSIONS			BACK DIMENSIONS								
			W	D	H	W	D	H	W	H							
			6	24	25	-	-	-	-	-	-						
			RTA 00														
			Must use with seating. Seating not included. Includes 2 brackets and screws														

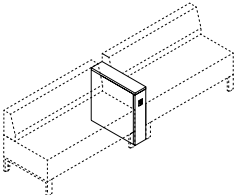
DESCRIPTION	FEATURES	MODEL#	STANDARD TEXTILE GRADES														
			1	2	3	4	5	6	7	8	9	10	11	12			
	Inline 6" Table Block w/ Front Power COM Yardage: N/A Freight Class: 92.50 Product Weight (lbs.): 23.30 Cubic Feet Per Carton: 2.08	BRTS2406BP	1144	-	-	-	-	-	-	-	-	-	-	-			
			OVERALL DIMENSIONS			SEAT DIMENSIONS			BACK DIMENSIONS								
			W	D	H	W	D	H	W	H							
			6	24	25	-	-	-	-	-	-						
			RTA 00														
			Must use with seating. Seating not included. Includes 2 brackets and screws														

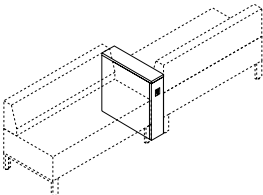
DESCRIPTION	FEATURES	MODEL#	STANDARD TEXTILE GRADES														
			1	2	3	4	5	6	7	8	9	10	11	12			
	Inline 6" Table Block w/ Front & Rear Power COM Yardage: N/A Freight Class: 92.50 Product Weight (lbs.): 24.30 Cubic Feet Per Carton: 2.08	BRTS2406B2P	1758	-	-	-	-	-	-	-	-	-	-	-			
			OVERALL DIMENSIONS			SEAT DIMENSIONS			BACK DIMENSIONS								
			W	D	H	W	D	H	W	H							
			6	24	25	-	-	-	-	-	-						
			RTA 00														
			Must use with seating. Seating not included. Includes 2 brackets and screws														

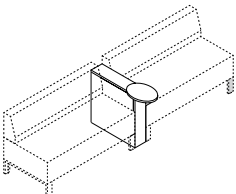
DESCRIPTION	FEATURES	MODEL#	STANDARD TEXTILE GRADES														
			1	2	3	4	5	6	7	8	9	10	11	12			
	Inline 6" Table Block w/ Tablet Arm COM Yardage: N/A Freight Class: 85 Product Weight (lbs.): 25.60 Cubic Feet Per Carton: 2.08	BRTS2406BT	1014	-	-	-	-	-	-	-	-	-	-	-			
			OVERALL DIMENSIONS			SEAT DIMENSIONS			BACK DIMENSIONS								
			W	D	H	W	D	H	W	H							
			6	24	25	-	-	-	-	-	-						
			RTA 00														
			Must use with seating. Seating not included. Includes 2 brackets and screws														

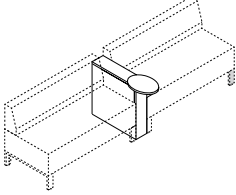
DESCRIPTION	FEATURES	MODEL#	STANDARD TEXTILE GRADES																										
			1	2	3	4	5	6	7	8	9	10	11	12															
 <p>Inline 6" Table Block w/ Front Power & Tablet Arm COM Yardage: N/A Freight Class: 92.50 Product Weight (lbs.): 24.30 Cubic Feet Per Carton: 2.08</p>	<p>Must use with seating. Seating not included. Includes 2 brackets and screws</p>	BRTS2406BPT	1627	-	-	-	-	-	-	-	-	-	-	-															
		<table border="1"> <thead> <tr> <th colspan="3">OVERALL DIMENSIONS</th> <th colspan="3">SEAT DIMENSIONS</th> <th colspan="2">BACK DIMENSIONS</th> </tr> <tr> <th>W</th> <th>D</th> <th>H</th> <th>W</th> <th>D</th> <th>H</th> <th>W</th> <th>H</th> </tr> </thead> <tbody> <tr> <td>6</td> <td>24</td> <td>25</td> <td>-</td> <td>-</td> <td>-</td> <td>-</td> <td>-</td> </tr> </tbody> </table>			OVERALL DIMENSIONS			SEAT DIMENSIONS			BACK DIMENSIONS		W	D	H	W	D	H	W	H	6	24	25	-	-	-	-	-	<p>RTA 00</p>
OVERALL DIMENSIONS			SEAT DIMENSIONS			BACK DIMENSIONS																							
W	D	H	W	D	H	W	H																						
6	24	25	-	-	-	-	-																						

CALIDON



GC36305
Wood Lounge Single Seat, Open Arms



GC36301
Wood Guest Single Seat, Open Arms



GC36308
Wood Lounge Single Seat, Closed Arms



For Calidon tables, see page 298

EXAMPLE CALIDON ORDER CODE:

GC36308	PU75	AAM	NBS
Model #	Textile	Frame Finish	Sealed Back Seams
NSS	NB	NM	SRT
Sealed Seat Seams	Moisture Barrier	Glides	Power

STANDARD FEATURES

- Calidon series consists of wood frame guest, lounge, bariatric and bench seating in addition to fully upholstered lounge seating. Freestanding and tandem/bridge tables also available to complement the line.
- Calidon is designed for the rigors of high use environments. Lounge units include metal frame supports.
- The seating in this series is available to specify with two textiles, one for the seat cushion and one for the back and arms (see model image).
- For pricing, start with the base price and add both back/arms graded textile upcharge and the seat graded textile upcharge.
- Frame design features a wall saver leg to prevent back contact and damage to walls.
- All guest and lounge chairs feature a clean out between seat and back, replaceable seat cushions and tall legs for ease of cleaning.
- For added comfort, seats are standard with high density Ultracell foam.
- Active weight capacity up to 400 lbs/seat for standard seating; up to 600 lbs for bariatric seating.
- For healthcare textiles, visit the website at globalfurnituregroup.com.
- Textiles with a minimum of 100,000 double rubs must be specified to meet Global's 24/7 warranty coverage.
- Can be upholstered in standard Global textiles if Healthcare 24/7 warranty compliance is not required.
- For alternate textile applications, contact Global specials. The Blended Textile matrix does not apply to this series.
- Tandem table models connect to guest seating only. See Calidon tables.
- No seating or bench models gang together.
- Shipped fully assembled.

OPTIONAL FEATURES

- All guest and lounge models can be specified with or without armcaps. Urethane armcaps are available on Wood arm guest and lounge chairs. Solid surface armcaps are available on all chair models. Armcaps are field replaceable, securely fastened with metal-to-metal connectors. Armcaps cannot be retrofitted in the field on units with no existing armcaps.
- Fully upholstered lounge chairs can be specified with a tamperproof Black power/USB unit, which includes one AC outlet, two 10 watt USB ports, and a 10 ft long power cord. Power is factory installed and must be specified at time of order. Add **\$237** each. Power locations vary by model. See power location diagram.
- For moisture barrier on seat, specify **(MB)**. Upcharges vary, see model.
- To add sealed seams, specify **(SBS)** for seat back and arms and/or **(SSS)** for seat. Upcharges vary, see model.
- A tamperproof power unit is available to specify in various locations on closed arm lounge models only. See diagrams.

SUGGESTED APPLICATIONS



- Guest seating
- Lobby/Lounge
- Treatment/Exam rooms



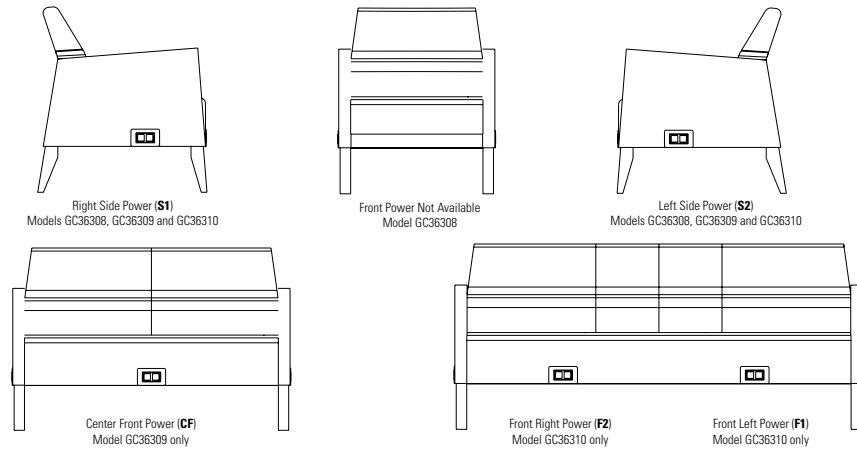

Please add option codes in the following order:





- **Model number**
See models.
For Calidon tables, refer to calidon tables 298
- **Back/Arm Textile**
Specify textile code. See model grade upcharges.
- **Seat Textile**
Specify textile code. See model grade upcharges.
- **Armcap option**
(FNA) No armcaps
(FAC) With armcaps. Upcharges vary, see model.
- **Frame finish**
(AAM) Absolute
(CJM) Charcoal Java
(ACM) Cherry
(EMM) Empire Mahogany
(EOM) English Oak
(ECM) Espresso Cafe
(TFM) Fruitwood
(HGM) Grey
(HOM) Harvest Oak
(AHM) Honey
(JOM) Jet Onyx
(LHM) Light Honey
(TMM) Mahogany
(AVM) Maple
(MWM) Medium Walnut
(ASM) Night
(NBM) Noce Biondo
(NGM) Noce Grigio
(NEM) Noce Leggero
(NMM) Noce Medio
(SBM) Sandy Beach
(SKM) Shaker Cherry
(SOM) Silver Oak
(TWM) Walnut
(WTM) WC Cream
(WHM) White
(WCM) Winter Cherry
- **Armcap finish**
(SSU) Urethane (for wood arm models of guest and lounge seating with FAC specified).
Urethane finishes (upcharges vary, see model):
(BLK) Black
(J52) Mocha
(KAL) Kalua
(SHW) Shadow
(LAB) Latte
(TOA) Toast
(CO) Solid Surface (for all wood and fully upholstered arm models with FAC specified). Solid Surface Finishes:
Grade 1: (Upcharges vary, see model)
(SWH) Designer White
Grade 2: (Upcharges vary, see model)
(SBT) Beige Tempest
(SBX) Black Onyx Mirage
(SMG) Milk Glass Spectra
(SFW) Frosty White Mirage
(SHS) Hot Stone
(SNM) Northern Melange
- **Sealed Back Seams** (Contact Customer Care for approved textiles.)
(NBS) No sealed back seams
(SBS) Sealed back seams. Upcharges vary, see model.
- **Sealed Seat Seams** (Contact Customer Care for approved textiles.)
(NSS) No sealed seat seams
(SSS) Sealed seat seams. Upcharges vary, see model.
- **Glides**
(NM) Non-marking
(NS) Non-slip
Guest single seat, bariatric and lounge chairs, add \$29.
Guest two seater, Add \$44.
Guest three seater, add \$56.
- **Moisture Barrier** (seat only) (Not available with Sealed Seams)
(NB) No moisture barrier
(MB) Moisture barrier. Upcharges vary, see model.
- **Power/USB unit position** (lounge models only). Add **\$237**.
(NPM) No power
(TPM) Tamperproof power unit
(J) Black
(SRT) Side right
(SLT) Side left
(FLT) Front left (three seater only)
(FRT) Front right (three seater only)
(CRF) Center front (two seater only)
(SLR) Side left and right. Add **\$472**.
(FLR) Front left and right. Add **\$472**.

POWER LOCATION DIAGRAM



DESCRIPTION	MODEL#/ FEATURES	STANDARD TEXTILE GRADES													
		1/COM	2	3	4	5	6	7	8	9	10	11	12		
 Wood Guest Single Seat COM Yardage: Back: 0.9; Seat: 1 Freight Class: 250 Product Weight (lbs.): 38 Cubic Feet Per Carton: 16.5	GC36301 Base Price: Back upcharge: Seat upcharge: Active weight 400 lbs.	\$1195													
		+0	+\$29	+\$52	+\$85	+\$132	+\$152	+\$192	+\$256	+\$304	+\$356	+\$465	+\$579		
		+0	+\$32	+\$57	+\$94	+\$146	+\$168	+\$213	+\$284	+\$337	+\$395	+\$516	+\$643		
		OVERALL DIMENSIONS			SEAT DIMENSIONS			BACK DIMENSIONS							
		W	D	H	W	D	H	W	H	23.5	26.5	34.5	21.5	18	18
 Wood Guest Two Seater, Full Center Arm COM Yardage: Back: 1.8; Seat: 2 Freight Class: 250 Product Weight (lbs.): 68 Cubic Feet Per Carton: 31.75	GC36302 Base Price: Back upcharge: Seat upcharge: Active weight 400 lbs./seat	\$2211													
		+0	+\$58	+\$103	+\$170	+\$263	+\$303	+\$384	+\$512	+\$607	+\$711	+\$929	+\$1158		
		+0	+\$64	+\$114	+\$188	+\$292	+\$336	+\$426	+\$568	+\$674	+\$790	+\$1032	+\$1286		
		OVERALL DIMENSIONS			SEAT DIMENSIONS			BACK DIMENSIONS							
		W	D	H	W	D	H	W	H	46	26.5	34.5	21.5	18	18
 Wood Guest Three Seater, Full Center Arms COM Yardage: Back: 2.7; Seat: 3 Freight Class: 250 Product Weight (lbs.): 101 Cubic Feet Per Carton: 47.5	GC36303 Base Price: Back upcharge: Seat upcharge: Active weight 400 lbs./seat	\$3255													
		+0	+\$87	+\$154	+\$254	+\$395	+\$454	+\$576	+\$767	+\$910	+\$1067	+\$1394	+\$1737		
		+0	+\$96	+\$171	+\$282	+\$438	+\$504	+\$639	+\$852	+\$1011	+\$1185	+\$1548	+\$1929		
		OVERALL DIMENSIONS			SEAT DIMENSIONS			BACK DIMENSIONS							
		W	D	H	W	D	H	W	H	68	26.5	34.5	21.5	18	18

DESCRIPTION	MODEL#/ FEATURES	STANDARD TEXTILE GRADES											
		1/COM	2	3	4	5	6	7	8	9	10	11	12
 <p>Wood Guest Bariatric Chair, COM Yardage: Back: 1.25; Seat: 1.25 Freight Class: 250 Product Weight (lbs.): 55 Cubic Feet Per Carton: 22.25</p>	GC36304 Base Price:	\$1827											
	Back upcharge:	+0	+\$40	+\$72	+\$118	+\$183	+\$210	+\$267	+\$355	+\$422	+\$494	+\$645	+\$804
	Seat upcharge:	+0	+\$40	+\$72	+\$118	+\$183	+\$210	+\$267	+\$355	+\$422	+\$494	+\$645	+\$804
	Active weight 600 lbs.	OVERALL DIMENSIONS			SEAT DIMENSIONS			BACK DIMENSIONS					
		W	D	H	W	D	H	W	H				
	32.75	26.5	34.5				31	18	18	30.5	16.5		
 <p>Wood Lounge Single Seat COM Yardage: Back: 1.25; Seat: 1.25 Freight Class: 250 Product Weight (lbs.): 49 Cubic Feet Per Carton: 18.25</p>	GC36305 Base Price:	\$1670											
	Back upcharge:	+0	+\$40	+\$72	+\$118	+\$183	+\$210	+\$267	+\$355	+\$422	+\$494	+\$645	+\$804
	Seat upcharge:	+0	+\$40	+\$72	+\$118	+\$183	+\$210	+\$267	+\$355	+\$422	+\$494	+\$645	+\$804
	Active weight 400 lbs.	OVERALL DIMENSIONS			SEAT DIMENSIONS			BACK DIMENSIONS					
		W	D	H	W	D	H	W	H				
	25.75	29.5	32.5				24	21	16	23.5	16.5		
 <p>Wood Lounge Two Seater COM Yardage: Back: 1.75; Seat: 2.25 Freight Class: 250 Product Weight (lbs.): 77 Cubic Feet Per Carton: 32.75</p>	GC36306 Base Price:	\$2348											
	Back upcharge:	+0	+\$56	+\$100	+\$165	+\$256	+\$294	+\$373	+\$497	+\$590	+\$692	+\$903	+\$1126
	Seat upcharge:	+0	+\$72	+\$129	+\$212	+\$329	+\$378	+\$480	+\$639	+\$759	+\$889	+\$1161	+\$1447
	Active weight 400 lbs./seat	OVERALL DIMENSIONS			SEAT DIMENSIONS			BACK DIMENSIONS					
		W	D	H	W	D	H	W	H				
	47.5	29.5	32.5				45	21	16	44.5	16.5		
 <p>Wood Lounge Three Seater, COM Yardage: Back: 2.5; Seat: 2.75 Freight Class: 250 Product Weight (lbs.): 109 Cubic Feet Per Carton: 50.75</p>	GC36307 Base Price:	\$2936											
	Back upcharge:	+0	+\$80	+\$143	+\$235	+\$365	+\$420	+\$533	+\$710	+\$843	+\$988	+\$1290	+\$1608
	Seat upcharge:	+0	+\$88	+\$157	+\$259	+\$402	+\$462	+\$586	+\$781	+\$927	+\$1087	+\$1419	+\$1769
	Active weight 400 lbs./seat	OVERALL DIMENSIONS			SEAT DIMENSIONS			BACK DIMENSIONS					
		W	D	H	W	D	H	W	H				
	70.5	29.5	32.5				68	21	16	67.5	16.5		
 <p>Fully Upholstered Wood Lounge Single Seat COM Yardage: Back/Arm: 2.75; Seat: 1.25 Freight Class: 250 Product Weight (lbs.): 58 Cubic Feet Per Carton: 18.75</p>	GC36308 Base Price:	\$1893											
	Back/Arm upcharge:	+0	+\$88	+\$157	+\$259	+\$402	+\$462	+\$586	+\$781	+\$927	+\$1087	+\$1419	+\$1769
	Seat upcharge:	+0	+\$40	+\$72	+\$118	+\$183	+\$210	+\$267	+\$355	+\$422	+\$494	+\$645	+\$804
	Active weight 400 lbs.	OVERALL DIMENSIONS			SEAT DIMENSIONS			BACK DIMENSIONS					
		W	D	H	W	D	H	W	H				
	27.5	29.5	33.5				24	21	16	23.5	17.5		

DESCRIPTION	MODEL#/ FEATURES	STANDARD TEXTILE GRADES											
		1/COM	2	3	4	5	6	7	8	9	10	11	12
 <p>Fully Upholstered Wood Lounge Two Seater COM Yardage: Back/Arm: 3.5; Seat: 2.25 Freight Class: 250 Product Weight (lbs.): 89 Cubic Feet Per Carton: 33.75</p>	GC36309 Base Price:	\$2545											
	Back/Arm upcharge:	+0	+\$112	+\$200	+\$329	+\$511	+\$588	+\$746	+\$994	+\$1180	+\$1383	+\$1806	+\$2251
	Seat upcharge:	+0	+\$72	+\$129	+\$212	+\$329	+\$378	+\$480	+\$639	+\$759	+\$889	+\$1161	+\$1447
	Active weight 400 lbs./seat	OVERALL DIMENSIONS			SEAT DIMENSIONS			BACK DIMENSIONS					
		W	D	H	W	D	H	W	H				
	49.5	29.5	33.5	44.5	18	16	45.5	17.5					
	<p>Add \$403 for (CO) Grade 1 armcaps Add \$431 for (CO) Grade 2 armcaps Add \$250 for (MB) Add \$52 for (SSS), \$160 for (SBS) Power/USB unit available.</p>												
 <p>Fully Upholstered Wood Lounge Three Seater COM Yardage: Back/Arm: 4.25; Seat: 2.75 Freight Class: 250 Product Weight (lbs.): 123 Cubic Feet Per Carton: 52</p>	GC36310 Base Price:	\$3196											
	Back/Arm upcharge:	+0	+\$136	+\$243	+\$400	+\$621	+\$714	+\$906	+\$1207	+\$1433	+\$1679	+\$2193	+\$2733
	Seat upcharge:	+0	+\$88	+\$157	+\$259	+\$402	+\$462	+\$586	+\$781	+\$927	+\$1087	+\$1419	+\$1769
	Active weight 400 lbs./seat	OVERALL DIMENSIONS			SEAT DIMENSIONS			BACK DIMENSIONS					
		W	D	H	W	D	H	W	H				
	71.5	29.5	33.5	66.5	18	16	67.5	17.5					
	<p>Add \$403 for (CO) Grade 1 armcaps Add \$431 for (CO) Grade 2 armcaps Add \$373 for (MB) Add \$86 for (SSS), \$179 for (SBS) Power/USB unit available.</p>												
 <p>Single Seat Bench COM Yardage: 1 Freight Class: 150 Product Weight (lbs.): 41 Cubic Feet Per Carton: 10</p>	GC36311 Base Price:	\$1279											
	Seat upcharge:	+0	+\$32	+\$57	+\$94	+\$146	+\$168	+\$213	+\$284	+\$337	+\$395	+\$516	+\$643
	Active weight 400 lbs.	OVERALL DIMENSIONS			SEAT DIMENSIONS			BACK DIMENSIONS					
		W	D	H	W	D	H	W	H				
		24	28	18	24	26.75	18						
	<p>Add \$126 for (MB) Add \$31 for (SSS)</p>												
 <p>Two Seat Bench COM Yardage: 2 Freight Class: 250 Product Weight (lbs.): 61 Cubic Feet Per Carton: 18.75</p>	GC36312 Base Price:	\$2023											
	Seat upcharge:	+0	+\$64	+\$114	+\$188	+\$292	+\$336	+\$426	+\$568	+\$674	+\$790	+\$1032	+\$1286
	Active weight 400 lbs./seat	OVERALL DIMENSIONS			SEAT DIMENSIONS			BACK DIMENSIONS					
		W	D	H	W	D	H	W	H				
		48	28	18	48	26.75	18						
	<p>Add \$250 for (MB) Add \$61 for (SSS)</p>												
 <p>Three Seat Bench COM Yardage: 3 Freight Class: 250 Product Weight (lbs.): 97 Cubic Feet Per Carton: 27.75</p>	GC36313 Base Price:	\$2414											
	Seat upcharge:	+0	+\$96	+\$171	+\$282	+\$438	+\$504	+\$639	+\$852	+\$1011	+\$1185	+\$1548	+\$1929
	Active weight 400 lbs./seat	OVERALL DIMENSIONS			SEAT DIMENSIONS			BACK DIMENSIONS					
		W	D	H	W	D	H	W	H				
		72	28	18	72	26.75	18						
	<p>Add \$373 for (MB) Add \$89 for (SSS)</p>												

CALIDON TABLES



Square end table - 22"
GC36314



Rectangular Coffee Table
GC36317



Tandem Side Table, Right
GC36319R



For Calidon seating, refer to page 295

EXAMPLE CALIDON TABLE ORDER CODE:

GC36319R	-HP	-ACJ	-CNT
Model #	Top material	Laminate finish	Power

TABLE TOP FINISHES:

See finishes section for solid wood/laminate coordination chart.

Thermally fused laminate (LP):

- Absolute Acajou (ACJ)
- Asian Night (ASN)
- Avant Cherry (AWC)
- Avant Honey (AWH)
- Black (BLK)
- Blizzard (BZD)
- Brushed Cobalt (BRC)
- Clear Maple (CMB)
- Custom Grey (CGY)
- Dark Espresso (DES)
- Designer White (DWT)
- Fashionista (FAS)
- First Class (FCL)
- Noce Biondo (NBL)
- Noce Grigio (NGL)
- Noce Leggero (NEL)
- Noce Medio (NML)
- Quartered Mahogany (QTM)
- Sheer Beauty (SBY)
- Stonedust (SDT)
- Walnut Heights (WHE)
- White Chocolate (WHC)
- Winter Cherry (WCR)

TABLE STANDARD FEATURES

- Designed as part of the Calidon seating series, Calidon tables coordinate with a range of lounge and guest seating.
- A variety of wood leg tables are available, including various height end tables, coffee tables and tandem tables.
- Wood legs/frames are specifiable Global solid wood seating finishes.
- Table tops are 1" thick, available in thermally fused laminate (LP), high pressure laminate (HP), and solid surface (CO). Upcharges vary, see model for pricing.
- Laminate top tables include color coordinating vinyl edge band.
- Tandem/bridge table models (GC36318 to GC36321) connect to Calidon guest seating only and include ganging brackets.
- Tandem tables are specified left or right, as seated.

TABLE OPTIONAL FEATURES

- A tamperproof tabletop power unit may be specified on laminate top, tandem and square end tables only. Specify **CNT**. Add **\$358**. The power unit is located centered 1.5" from the edge of the surface. See power location diagrams for reference.

SUGGESTED APPLICATIONS

- Lounge/Lobby
- Resident rooms
- Patient rooms
- Private office

Please add option codes in the following order:

- Table model number**
GC36314 to GC36317 Freestanding tables
GC36318 to GC36321 Tandem/bridge tables
GC36324 to GC36326 23"H Freestanding tables
For Calidon seating, refer to page 295
- Top Material (tables)**
(LP) Thermally fused laminate. Specify finish - See LP finishes.
(HP) High pressure laminate. Upcharges vary - see model. Specify finish - see HP finishes.
(CO) Solid surface. Upcharges vary - see model. Specify finish - see CO finishes and grades.
- Leg finish**
(AAM) Absolute (MWM) Medium Walnut
(CJM) Charcoal Java (ASM) Night
(ACM) Cherry (NBM) Noce Biondo
(EMM) Empire Mahogany (NGM) Noce Grigio
(EOM) English Oak (NEM) Noce Leggero
(ECM) Espresso Cafe (NMM) Noce Medio
(TFM) Fruitwood (SBM) Sandy Beach
(HGM) Grey (SKM) Shaker Cherry
(HOM) Harvest Oak (SOM) Silver Oak
(AHM) Honey (TWM) Walnut
(JOM) Jet Onyx (WTM) WC Cream
(LHM) Light Honey (WHM) White
(TMM) Mahogany (WCM) Winter Cherry
(AVM) Maple
- Power/USB unit position** (laminate tandem and end tables with laminate tops only).
(NPM) No power
(CNT) Center top power. Jet Black. Add **\$358**.
(RBP) Right back top power. Jet Black. Add **\$358**.
(LBP) Left back top power. Jet Black. Add **\$358**.

High pressure laminate (HP):







- Absolute Acajou (ACJ)
- Asian Night (ASN)
- Avant Cherry (AWC)
- Avant Honey (AWH)
- Black (BLK)
- Blizzard (BZD)
- Brushed Cobalt (BRC)
- Clear Maple (CMB)
- Custom Grey (CGY)
- Dark Espresso (DES)
- Designer White (DWT)
- Fashionista (FAS)
- First Class (FCL)
- Noce Biondo (NBL)
- Noce Grigio (NGL)
- Noce Leggero (NEL)
- Noce Medio (NML)
- Quartered Mahogany (QTM)
- Sheer Beauty (SBY)
- Stonedust (SDT)
- Walnut Heights (WHE)
- White Chocolate (WHC)
- Winter Cherry (WCR)

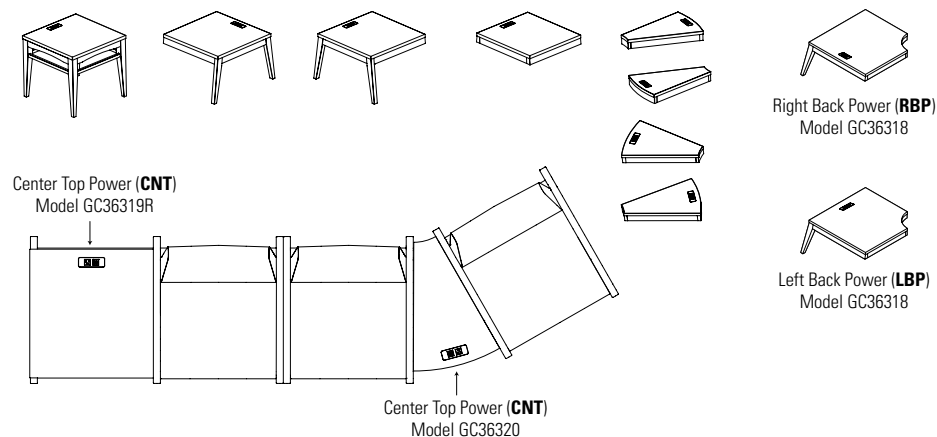



Solid Surface* (CO):

- Grade 1:**
(SWH) Designer White
 - Grade 2:**
(SBT) Beige Tempest
(SBX) Black Onyx Mirage
(SMG) Milk Glass Spectra
(SFW) Frosty White Mirage
(SHS) Hot Stone
(SNM) Northern Melange
- *For detailed material information, please reference WilsonArt's Solid Surface collection.

POWER LOCATION DIAGRAM

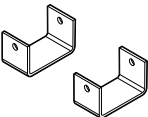

TABLES	MODEL#	DIMENSIONS	FREIGHT CLASS	WT/LBS.	CUBIC FT.	LIST PRICE
 <p>Square End Table, 22" x 22" x 20.25" H</p>	GC36314	22 x 22 x 20.25	150	36	7.75	\$826
		<ul style="list-style-type: none"> • Pricing shown for a thermally fused laminate top (LP). • For a high pressure laminate top (HP), add \$65. • For a solid surface top (CO), add \$1071 for Grade 1 and add \$1315 for Grade 2. <p>Coordinating edge on laminate surfaces with solid wood frame and legs. 1 per carton. Power/USB unit can be specified in the surface of laminate top tables (CNT). Add \$358.</p>				
 <p>Square End Table, 22" x 22" x 23" H</p>	GC36324	22 x 22 x 23	150	23.5	6.75	\$977
		<ul style="list-style-type: none"> • Pricing shown for a thermally fused laminate top (LP). • For a high pressure laminate top (HP), add \$65. • For a solid surface top (CO), add \$1071 for Grade 1 and add \$1315 for Grade 2. <p>Coordinating edge on laminate surfaces with solid wood frame and legs. 1 per carton. Power/USB unit can be specified in the surface of laminate top tables (CNT). Add \$358.</p>				
 <p>Rectangular End Table, 23" H</p>	GC36325	22 x 12 x 23	125	34	10.75	\$841
		<ul style="list-style-type: none"> • Pricing shown for a thermally fused laminate top (LP). • For a high pressure laminate top (HP), add \$54. • For a solid surface top (CO), add \$884 for Grade 1 and add \$1061 for Grade 2. <p>Coordinating edge on laminate surfaces with solid wood frame and legs. 1 per carton. Power/USB unit can be specified in the surface of laminate top tables (CNT). Add \$358.</p>				
 <p>Corner 30° End Table, 23" H</p>	GC36326	24 x 25 x 23	150	34	12.75	\$1082
		<ul style="list-style-type: none"> • Pricing shown for a thermally fused laminate top (LP). • For a high pressure laminate top (HP), add \$70. • For a solid surface top (CO), add \$1215 for Grade 1 and add \$1464 for Grade 2. <p>Coordinating edge on laminate surfaces with solid wood frame and legs. 1 per carton. Power/USB unit can be specified in the surface of laminate top tables (CNT). Add \$358.</p>				
 <p>Square Coffee Table, 24"</p>	GC36315	24 x 24 x 17.25	250	37	9.5	\$857
		<ul style="list-style-type: none"> • Pricing shown for a thermally fused laminate top (LP). • For a high pressure laminate top (HP), add \$65. • For a solid surface top (CO), add \$1300 for Grade 1 and add \$1605 for Grade 2. <p>Coordinating edge on laminate surfaces with solid wood frame and legs. 1 per carton.</p>				
 <p>Square Coffee Table, 36"</p>	GC36316	36 x 36 x 17.25	250	65	18.25	\$1025
		<ul style="list-style-type: none"> • Pricing shown for a thermally fused laminate top (LP). • For a high pressure laminate top (HP), add \$140. • For a solid surface top (CO), add \$2979 for Grade 1 and add \$3589 for Grade 2. <p>Coordinating edge on laminate surfaces with solid wood frame and legs. 1 per carton.</p>				
 <p>Rectangular Coffee Table</p>	GC36317	24 x 48 x 17.25	250	56	16.5	\$1123
		<ul style="list-style-type: none"> • Pricing shown for a thermally fused laminate top (LP). • For a high pressure laminate top (HP), add \$127. • For a solid surface top (CO), add \$2481 for Grade 1 and add \$2894 for Grade 2. <p>Coordinating edge on laminate surfaces with solid wood frame and legs. 1 per carton.</p>				

TABLES	MODEL#	DIMENSIONS	FREIGHT CLASS	WT/LBS.	CUBIC FT.	LIST PRICE
 <p>Corner Table, 90°</p>	GC36318	31.25 x 31.25 x 15.75	250	46	14.5	\$1025
						<ul style="list-style-type: none"> • Pricing shown for a thermally fused laminate top (LP). • For a high pressure laminate top (HP), add \$104. • For a solid surface top (CO), add \$2576 for Grade 1 and add \$3079 for Grade 2. <p>Coordinating edge on laminate surfaces with solid wood frame and legs. Must be connected between two guest chairs. Includes two sets of U-channel connectors and hardware. 1 per carton. Power/USB unit can be specified in the surface of laminate top tables (RBP) or (LBP). Add \$358. See power location diagram for placement.</p>
 <p>Tandem Side Table, Left</p>	GC36319L	26.5 x 22.25 x 15.75	250	20	6.75	\$715
						<ul style="list-style-type: none"> • Pricing shown for a thermally fused laminate top (LP). • For a high pressure laminate top (HP), add \$65. • For a solid surface top (CO), add \$1089 for Grade 1 and add \$1311 for Grade 2. <p>Coordinating edge on laminate surfaces with solid wood frame and legs. Must be connected to a guest chair. Includes one set of U-channel connectors and hardware. 1 per carton. Power/USB unit can be specified in the surface of laminate top tables (CNT). Add \$358.</p>
 <p>Tandem Side Table, Right</p>	GC36319R	26.5 x 22.25 x 15.75	250	20	6.75	\$715
						<ul style="list-style-type: none"> • Pricing shown for a thermally fused laminate top (LP). • For a high pressure laminate top (HP), add \$65. • For a solid surface top (CO), add \$1089 for Grade 1 and add \$1311 for Grade 2. <p>Coordinating edge on laminate surfaces with solid wood frame and legs. Must be connected to a guest chair. Includes one set of U-channel connectors and hardware. 1 per carton. Power/USB unit can be specified in the surface of laminate top tables (CNT). Add \$358.</p>
 <p>Corner Table, 30 Degree</p>	GC36320	22.5 x 15.75 x 3	92.5	16	1.5	\$563
						<ul style="list-style-type: none"> • Pricing shown for a thermally fused laminate top (LP). • For a high pressure laminate top (HP), add \$65. • For a solid surface top (CO), add \$910 for Grade 1 and add \$1093 for Grade 2. <p>Coordinating edge on laminate surfaces with solid wood frame and legs. Must be connected between two guest chairs. Includes two sets of U-channel connectors and hardware. 1 per carton. Power/USB unit can be specified in the surface of laminate top tables (CNT). Add \$358.</p>
 <p>In-Line Table, Square</p>	GC36321	21 x 23.5 x 3	92.5	20	1.9	\$597
						<ul style="list-style-type: none"> • Pricing shown for a thermally fused laminate top (LP). • For a high pressure laminate top (HP), add \$65. • For a solid surface top (CO), add \$942 for Grade 1 and add \$1161 for Grade 2. <p>Coordinating edge on laminate surfaces with solid wood frame and legs. Must be connected between two guest chairs. Includes two sets of U-channel connectors and hardware. 1 per carton. Power/USB unit can be specified in the surface of laminate top tables (CNT). Add \$358.</p>
 <p>U-Channel (set of 2)</p>	GC36322	2.87 x 1.5 x 1.62	70	0.75	0.03	\$48
						Includes hardware. 4 sets per carton.

CAMINO



models shown: 5471-CP Lounge Chair, 5475-W End Table, 5472-CP Two Seat Sofa.



model 5471-CP



model 5476-W





model 5485-W

STANDARD FEATURES

- A transitional soft seating series composed of one, two and three seat units. The series also offers tables with coordinating details and finishes.
- Frame is a heavy duty, interlocking plywood, puzzle box construction suitable for public environments.
- The soft seating leg system utilizes a continuous visible frame between the front and rear leg. Each leg frame is bolted directly to the sofa frame with large bolts to provide a very durable leg construction.
- Legs are equipped with translucent non marking glides as standard. Suitable for both carpet and hard surface flooring.
- Seating features as standard, decorative double stitch detail, which make seams lay flat and add extra seam strength.
- Cushions are highly resilient foam and seats are equipped with a synthetic rubberized sheet webbing suspension system for extra comfort. Cushions are fixed and non-removable.
- Tables are made with a choice of tops: Genuine Wood tops (**W**) with a reverse beveled edge, Thermally Fused Laminate tops (**LP**) with matching PVC edging or High Pressure Laminate top (**HP**) with matching PVC edging. Custom high pressure laminate finishes will be considered upon requested.
- Regardless of top chosen all tables have wood aprons and a unique tapered leg design.
- Some table assembly required, see RTA code with each item below.
- Measurement shown for weight is for one unit, measurement for volume is per carton.
- Check textile availability prior to specifying upholstery material.

OPTIONAL FEATURES

- Optional cushions and arms can have tailored piping details.
- For piping made in fabric matching the rest of the upholstery fabric please use **MP** models (matching piping after the model number). This is no upcharge.
- For contrast piping made in a fabric that does not match the rest of the upholstery fabric, you can specify any grade 1 or 2 upholstery material for this purpose, please see model numbers ending in **CP** which reflect the appropriate upcharge.
- For contrast piping in a fabric higher than grade 2, you must ask for a special quotation. Per unit price will vary depending on the number of units being ordered.
- Seating unit and tables come with a choice of wood legs or a polished cast aluminum. The table leg finishes coordinate with the legs on the soft seating units.
- Seating and tables with polished aluminum legs are shown as separate skus.
- Tops finishes coordinate with the laminate finishes for Global Desking and wood seating finishes. Specify laminate finishes from the Adaptabilities or Zira sections of the price list.
- Wood legs for seating are available in select Global wood seating finishes - see seating finishes. Only finishes ending in **"M"** are available for this series.

DESCRIPTION	FEATURES	MODEL#	STANDARD TEXTILE GRADES											
			1	2	3	4	5	6	7	8	9	10	11	12
 <p>Lounge Chair w/ Wood Legs COM Yardage: 4 Freight Class: 250 Product Weight (lbs.): 60 Cubic Feet Per Carton: 19.25</p>	No Piping.	5471	2626	2782	2903	3082	3340	3459	3694	4064	4348	4668	5321	6018
		OVERALL DIMENSIONS			SEAT DIMENSIONS			BACK DIMENSIONS						
		W	D	H	W	D	H	W	H					
		29.5	29	30.5	21	19.5	18	20	11.5					
		RTA 00												
 <p>Lounge Chair w/ Wood Legs & Piping COM Yardage: 4 Freight Class: 250 Product Weight (lbs.): 60 Cubic Feet Per Carton: 19.25</p>	CP = Contrast Piping MP = Matching Piping	5471-CP	2827	2983	3104	3283	3541	3660	3895	4265	4549	4869	5522	6219
		5471-MP	2626	2782	2903	3082	3340	3459	3694	4064	4348	4668	5321	6018
		OVERALL DIMENSIONS			SEAT DIMENSIONS			BACK DIMENSIONS						
		W	D	H	W	D	H	W	H					
			29.5	29	30.5	21	19.5	18	20	11.5				
		RTA 00												

DESCRIPTION **FEATURES** **MODEL#** **STANDARD TEXTILE GRADES**

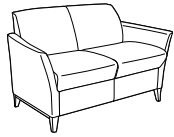

Two Seat Sofa w/ Wood Legs
COM Yardage: 5.75
Freight Class: 250
Product Weight (lbs.): 84
Cubic Feet Per Carton: 36

No Piping.

	1	2	3	4	5	6	7	8	9	10	11	12
--	---	---	---	---	---	---	---	---	---	----	----	----

5472	3721	3943	4115	4375	4744	4916	5252	5785	6194	6652	7591	8596
-------------	------	------	------	------	------	------	------	------	------	------	------	------

OVERALL DIMENSIONS			SEAT DIMENSIONS			BACK DIMENSIONS	
W	D	H	W	D	H	W	H

51	29	30.5	42	19.5	18	41	11.5
----	----	------	----	------	----	----	------

RTA 00

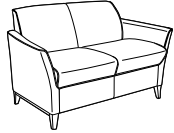

Two Seat Sofa w/ Wood Legs
COM Yardage: 5.75
Freight Class: 250
Product Weight (lbs.): 84
Cubic Feet Per Carton: 36

CP = Contrast Piping
MP = Matching Piping

	1	2	3	4	5	6	7	8	9	10	11	12
--	---	---	---	---	---	---	---	---	---	----	----	----

5472-CP	3987	4209	4381	4641	5010	5182	5518	6051	6460	6918	7857	8862
----------------	------	------	------	------	------	------	------	------	------	------	------	------

5472-MP	3721	3943	4115	4375	4744	4916	5252	5785	6194	6652	7591	8596
----------------	------	------	------	------	------	------	------	------	------	------	------	------

OVERALL DIMENSIONS			SEAT DIMENSIONS			BACK DIMENSIONS	
W	D	H	W	D	H	W	H

51	29	30.5	42	19.5	18	41	11.5
----	----	------	----	------	----	----	------

RTA 00

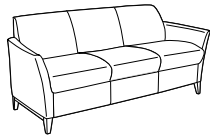

Three Seat Sofa w/ Wood Legs
COM Yardage: 7.5
Freight Class: 250
Product Weight (lbs.): 110
Cubic Feet Per Carton: 50.25

No Piping.

	1	2	3	4	5	6	7	8	9	10	11	12
--	---	---	---	---	---	---	---	---	---	----	----	----

5473	4816	5103	5327	5669	6148	6375	6811	7506	8044	8638	9865	11173
-------------	------	------	------	------	------	------	------	------	------	------	------	-------

OVERALL DIMENSIONS			SEAT DIMENSIONS			BACK DIMENSIONS	
W	D	H	W	D	H	W	H

71	29	30.5	63	19.5	18	62	11.5
----	----	------	----	------	----	----	------

RTA 00

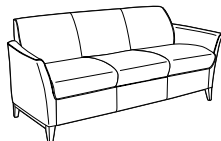

Three Seat Sofa w/ Wood Legs
COM Yardage: 7.5
Freight Class: 250
Product Weight (lbs.): 110
Cubic Feet Per Carton: 50.25

CP = Contrast Piping
MP = Matching Piping

	1	2	3	4	5	6	7	8	9	10	11	12
--	---	---	---	---	---	---	---	---	---	----	----	----

5473-CP	5147	5433	5659	6000	6479	6706	7143	7837	8375	8969	10196	11504
----------------	------	------	------	------	------	------	------	------	------	------	-------	-------

5473-MP	4816	5103	5327	5669	6148	6375	6811	7506	8044	8638	9865	11173
----------------	------	------	------	------	------	------	------	------	------	------	------	-------

OVERALL DIMENSIONS			SEAT DIMENSIONS			BACK DIMENSIONS	
W	D	H	W	D	H	W	H

71	29	30.5	63	19.5	18	62	11.5
----	----	------	----	------	----	----	------

RTA 00

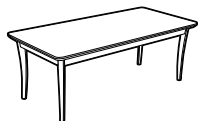

Coffee Table - 22" x 48" Rectangular w/Wood Legs
COM Yardage: N/A
Freight Class: 92.5
Product Weight (lbs.): 40
Cubic Feet Per Carton: 4

	1	2	3	4	5	6	7	8	9	10	11	12
--	---	---	---	---	---	---	---	---	---	----	----	----

5474-LP	2030	-	-	-	-	-	-	-	-	-	-	-
----------------	------	---	---	---	---	---	---	---	---	---	---	---

5474-HP	2177	-	-	-	-	-	-	-	-	-	-	-
----------------	------	---	---	---	---	---	---	---	---	---	---	---

5474-W	2619	-	-	-	-	-	-	-	-	-	-	-
---------------	------	---	---	---	---	---	---	---	---	---	---	---

LP = Laminate Top HP = High Pressure Laminate Top W = Wood Top

OVERALL DIMENSIONS			SEAT DIMENSIONS			BACK DIMENSIONS	
W	D	H	W	D	H	W	H

22	48	17.5	-	-	-	-	-
----	----	------	---	---	---	---	---

RTA 8





DESCRIPTION	FEATURES	MODEL#	STANDARD TEXTILE GRADES													
			1	2	3	4	5	6	7	8	9	10	11	12		
 <p>End Table - 21" x 21" Square w/Wood Legs COM Yardage: N/A Freight Class: 100 Product Weight (lbs.): 20 Cubic Feet Per Carton: 2.1</p>			1511	-	-	-	-	-	-	-	-	-	-	-	-	
			5475-HP	1662	-	-	-	-	-	-	-	-	-	-	-	-
			5475-W	1830	-	-	-	-	-	-	-	-	-	-	-	-
			LP = Laminate Top HP = High Pressure Laminate Top W = Wood Top													
			OVERALL DIMENSIONS			SEAT DIMENSIONS			BACK DIMENSIONS							
			W	D	H	W	D	H	W	H						
			21	21	17.5	-	-	-	-	-						
			RTA 8 FedEx UPS													



DESCRIPTION	FEATURES	MODEL#	STANDARD TEXTILE GRADES													
			1	2	3	4	5	6	7	8	9	10	11	12		
 <p>End Table - 24" Round w/Wood Legs COM Yardage: N/A Freight Class: 92.5 Product Weight (lbs.): 21 Cubic Feet Per Carton: 2.1</p>			1563	-	-	-	-	-	-	-	-	-	-	-	-	
			5476-HP	1716	-	-	-	-	-	-	-	-	-	-	-	-
			5476-W	1988	-	-	-	-	-	-	-	-	-	-	-	-
			LP = Laminate Top HP = High Pressure Laminate Top W = Wood Top													
			OVERALL DIMENSIONS			SEAT DIMENSIONS			BACK DIMENSIONS							
			W	D	H	W	D	H	W	H						
			24	24	17.5	-	-	-	-	-						
			RTA 8 FedEx UPS													

DESCRIPTION	FEATURES	MODEL#	STANDARD TEXTILE GRADES													
			1	2	3	4	5	6	7	8	9	10	11	12		
 <p>Coffee Table - 32" Round w/Wood Legs COM Yardage: N/A Freight Class: 125 Product Weight (lbs.): 35 Cubic Feet Per Carton: 4.4</p>			2361	-	-	-	-	-	-	-	-	-	-	-	-	
			5477-HP	2510	-	-	-	-	-	-	-	-	-	-	-	-
			5477-W	2985	-	-	-	-	-	-	-	-	-	-	-	-
			LP = Laminate Top HP = High Pressure Laminate Top W = Wood Top													
			OVERALL DIMENSIONS			SEAT DIMENSIONS			BACK DIMENSIONS							
			W	D	H	W	D	H	W	H						
			32	32	17.5	-	-	-	-	-						
			RTA 8													

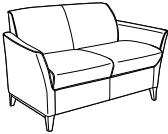
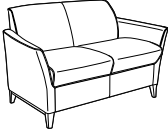
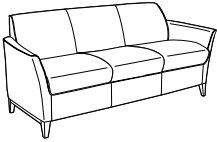
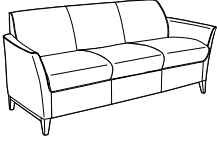
DESCRIPTION	FEATURES	MODEL#	STANDARD TEXTILE GRADES													
			1	2	3	4	5	6	7	8	9	10	11	12		
 <p>Lounge Chair w/Aluminum Legs COM Yardage: 4 Freight Class: 250 Product Weight (lbs.): 62 Cubic Feet Per Carton: 19.25</p>			5481	2626	2782	2903	3082	3340	3459	3694	4064	4348	4668	5321	6018	
			OVERALL DIMENSIONS			SEAT DIMENSIONS			BACK DIMENSIONS							
			W	D	H	W	D	H	W	H						
			29.5	29	30.5	21	19.5	18	20	11.5						
			RTA 00													

DESCRIPTION	FEATURES	MODEL#	STANDARD TEXTILE GRADES													
			1	2	3	4	5	6	7	8	9	10	11	12		
 <p>Lounge Chair w/Aluminum Legs COM Yardage: 4 Freight Class: 250 Product Weight (lbs.): 62 Cubic Feet Per Carton: 19.25</p>			5481-CP	2827	2983	3104	3283	3541	3660	3895	4265	4549	4869	5522	6219	
			5481-MP	2626	2782	2903	3082	3340	3459	3694	4064	4348	4668	5321	6018	
			OVERALL DIMENSIONS			SEAT DIMENSIONS			BACK DIMENSIONS							
			W	D	H	W	D	H	W	H						
			29.5	29	30.5	21	19.5	18	20	11.5						
			RTA 00													

DESCRIPTION	FEATURES	MODEL#	STANDARD TEXTILE GRADES											
			1	2	3	4	5	6	7	8	9	10	11	12
 Two Seat Sofa w/ Aluminum Legs COM Yardage: 5.75 Freight Class: 250 Product Weight (lbs.): 86 Cubic Feet Per Carton: 36	No Piping.	5482	3721	3943	4115	4375	4744	4916	5252	5785	6194	6652	7591	8596
			OVERALL DIMENSIONS			SEAT DIMENSIONS			BACK DIMENSIONS					
			W	D	H	W	D	H	W	H				
			51	29	30.5	42	19.5	18	41	11.5				
			RTA 00											
 Two Seat Sofa w/ Aluminum Legs COM Yardage: 5.75 Freight Class: 250 Product Weight (lbs.): 86 Cubic Feet Per Carton: 36	CP = Contrast Piping. MP = Matching Piping.	5482-CP 5482-MP	3987	4209	4381	4209	4381	4641	5010	5182	5518	6051	6460	8862
			OVERALL DIMENSIONS			SEAT DIMENSIONS			BACK DIMENSIONS					
			W	D	H	W	D	H	W	H				
			51	29	30.5	42	19.5	18	41	11.5				
			RTA 00											
 Three Seat Sofa w/ Aluminum Legs COM Yardage: 7.5 Freight Class: 250 Product Weight (lbs.): 112 Cubic Feet Per Carton: 50.25	No Piping.	5483	4816	5103	5327	5103	6148	6375	6811	7506	8044	8638	9865	11173
			OVERALL DIMENSIONS			SEAT DIMENSIONS			BACK DIMENSIONS					
			W	D	H	W	D	H	W	H				
			71	29	30.5	63	19.5	18	62	11.5				
			RTA 00											
 Three Seat Sofa w/Aluminum Legs COM Yardage: 7.5 Freight Class: 250 Product Weight (lbs.): 112 Cubic Feet Per Carton: 50.25	CP = Contrast Piping. MP = Matching Piping.	5483-CP 5483-MP	5147	5434	5659	6000	6479	6706	7143	7837	8375	11504	10196	11504
			OVERALL DIMENSIONS			SEAT DIMENSIONS			BACK DIMENSIONS					
			W	D	H	W	D	H	W	H				
			30.5	29	30.5	63	19.5	18	62	11.5				
			RTA 00											
 Coffee Table - 22" x 48" Rectangular w/Aluminum Legs COM Yardage: N/A Freight Class: 92.5 Product Weight (lbs.): 46 Cubic Feet Per Carton: 4		5484-LP 5484-HP 5484-W	2142	-	-	-	-	-	-	-	-	-	-	-
			OVERALL DIMENSIONS			SEAT DIMENSIONS			BACK DIMENSIONS					
			W	D	H	W	D	H	W	H				
			22	48	17.5	-	-	-	-	-				
			RTA 6											

DESCRIPTION	FEATURES	MODEL#	STANDARD TEXTILE GRADES												
			1	2	3	4	5	6	7	8	9	10	11	12	
 <p>End Table - 21" x 21" Square w/Aluminum Legs COM Yardage: N/A Freight Class: 85 Product Weight (lbs.): 26 Cubic Feet Per Carton: 2.1</p>															
	5485-LP	1623	-	-	-	-	-	-	-	-	-	-	-	-	
	5485-HP	1774	-	-	-	-	-	-	-	-	-	-	-	-	
	5485-W	1942	-	-	-	-	-	-	-	-	-	-	-	-	
	LP = Laminate Top HP = High Pressure Laminate Top W = Wood Top														
	OVERALL DIMENSIONS			SEAT DIMENSIONS			BACK DIMENSIONS								
	W D H			W D H			W H								
	21 21 17.5			-			-								
	RTA 8			FedEx			ups								
	 <p>End Table - 24" Round w/Aluminum Legs COM Yardage: N/A Freight Class: 85 Product Weight (lbs.): 27 Cubic Feet Per Carton: 2.1</p>														
5486-LP		1676	-	-	-	-	-	-	-	-	-	-	-	-	
5486-HP		1827	-	-	-	-	-	-	-	-	-	-	-	-	
5486-W		2101	-	-	-	-	-	-	-	-	-	-	-	-	
LP = Laminate Top HP = High Pressure Laminate Top W = Wood Top															
OVERALL DIMENSIONS			SEAT DIMENSIONS			BACK DIMENSIONS									
W D H			W D H			W H									
24 24 17.5			-			-									
RTA 8			FedEx			ups									
 <p>Coffee Table - 32" Round w/Aluminum Legs COM Yardage: N/A Freight Class: 100 Product Weight (lbs.): 41 Cubic Feet Per Carton: 4.4</p>															
	5487-LP	2473	-	-	-	-	-	-	-	-	-	-	-	-	
	5487-HP	2623	-	-	-	-	-	-	-	-	-	-	-	-	
	5487-W	3098	-	-	-	-	-	-	-	-	-	-	-	-	
	LP = Laminate Top HP = High Pressure Laminate Top W = Wood Top														
	OVERALL DIMENSIONS			SEAT DIMENSIONS			BACK DIMENSIONS								
	W D H			W D H			W H								
	32 32 17.5			-			-								
	RTA 8														

CITI™



model 7875LTL (BK)



model 7889



Citi Modular Group & Tables - Shown in Tungsten



5" tubular metal leg (shown in Tungsten)



5" tapered wood leg (shown in Maple)

STANDARD FEATURES

- Fully upholstered contemporary design, complements the timeless decor of many offices. Proportions are compact, 31" deep, and work well in public spaces.
- All models have fixed, non-removable cushions.
- For increased durability with a softer sit, a highly resilient, high density Ultracell foam (UCO option is available. See upcharges.
- Arm height on all models is 25".
- Casters are not available on this series.
- Citi seating and table legs are 5" high tubular metal. Seating also available with wood, tapered, softened square legs.
- Citi table tops are available in either tempered glass or laminate.
- Laminate tablet seating models (TL suffix) are available specified as seated. Specify right (RTL) or left (LTL). For additional tablet arm models, contact CustomerCare for pricing. The tablet is 0.75" thick with thermally fused laminate and measure 12"D x 16.5"W.
- Ganging brackets (7892) are sold separately.
- Ganging brackets are to be used on armless seating if interconnection to another armless seating unit is required. Bench and ottomans only gang to other benches/ottomans, cannot gang with seating units. Brackets come with a template for installation.
- Upholstery options: fabric, vinyl or leather. Starting at grade 5 pricing. Leather models feature a stitch detail across the seat and/or back cushions, if applicable.
- If you would like fabric/vinyl on the shell of the chair with leather seat and back cushions or other combinations, please complete "Multi Fabric" Form and submit with your order. Multi Fabric grade will apply.

Add option codes in the following order:

- Model Number**
Specify model number.

- Seat Foam Upgrade** (add option to end of model number)
(RF) Standard Foam
(UC) Soft Ultracell foam. For Lounge and corner chairs add \$137; Two Seat Sofas add \$269; Three Seat Sofas add \$403.
- Leg Type** (Lounge only)
(MTL) Metal Legs
(WDL) Wood Legs. Add \$315
- Leg Finish:**
Metal leg finish (lounge and tables):
(TBL) Black
(TTU) Tungsten
(CHM) Chrome. **Add \$110.**
Wood leg finish (lounge only):
(AAM) Absolute (BKM) Black
(ACM) Cherry (EOM) English Oak
(ECM) Espresso Cafe (TFM) Fruitwood
(HGM) Gray (AHM) Honey
(TMM) Mahogany (AVM) Maple
(MWM) Medium Walnut (NLW) Natural Walnut
(ASM) Night (NBM) Noce Biondo
(NGM) Noce Grigio (NEM) Noce Leggero
(NMM) Noce Medio (SKM) Shaker Cherry
(TWM) Walnut (WTM) WC Cream
(WHM) White (WCM) Winter Cherry
- Glide Type** (wood legs)
(NM) White, non-marking nylon glide for most surfaces
(SG) Steel cushioned glide for carpeted surfaces. Add \$34.
(RG) Non-slip rubber glide for most hard floor surfaces. Add \$34.
(FG) Felt glide for most hard floor surfaces. Add \$34.
- Laminate Finish** (tables and tablets)
(ACJ) Absolute Acajou (ASN) Asian Night
(AVC) Avant Cherry (AVH) Avant Honey
(BLK) Black (BRC) Brushed Cobalt
(BZD) Blizzard (CGY) Custom Grey
(CMB) Clear Maple (DES) Dark Espresso
(DWT) Designer White (FAS) Fashionista
(FCL) First Class (NBL) Noce Biondo
(NEL) Noce Leggero (NGL) Noce Grigio
(NML) Noce Medio
(QTM) Quartered Mahogany
(SBY) Sheer Beauty (SDT) Stonedust
(SOG) Storm Grey (WCR) Winter Cherry
(WHC) White Chocolate (WHE) Walnut Heights

SAMPLE LAYOUTS

Layout A

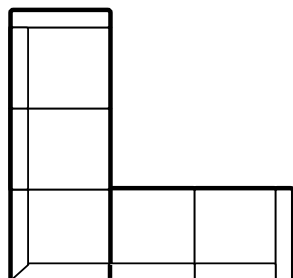



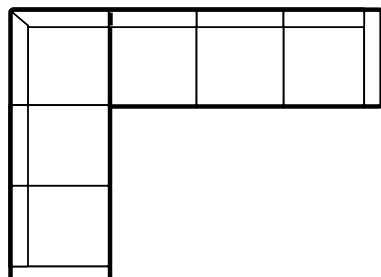

Qty	Model Number	Description	Dimensions	List Price
1	7890LNB	Two Seat Sofa w/Left Arm	48 x 31 x 30.75	2133
1	7862	Corner Seat	37 x 37 x 31	2316
1	7890RNB	Two Seat Sofa w/Right Arm	48 x 31 x 30.75	2133
2	7892	Ganging Bracket	0.5 x 3.87 x 2	32
SAMPLE LAYOUT TOTAL IN STANDARD FEET FINISH				\$6,614

Layout B

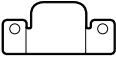

Qty	Model Number	Description	Dimensions	List Price
1	7890RNB	Two Seat Sofa w/Right Arm	48 x 31 x 30.75	2133
1	7862	Corner Seat	37 x 37 x 31	2316
1	7891LNB	Three Seat Sofa w/Left Arm	77 x 31 x 30.75	2850
2	7892	Ganging Bracket	0.5 x 3.87 x 2	32 x 2
SAMPLE LAYOUT TOTAL IN STANDARD FEET FINISH				\$7,363

DESCRIPTION	FEATURES	MODEL#	STANDARD TEXTILE GRADES											
			1	2	3	4	5	6	7	8	9	10	11	12
 <p>Ganging Bracket COM Yardage: N/a Freight Class: 70 Product Weight (lbs.): 0.25 Cubic Feet Per Carton: 0.01</p>	<p>Kit includes 2 brackets, 4 screws and a template.</p>	7892	32	-	-	-	-	-	-	-	-	-	-	
		OVERALL DIMENSIONS			SEAT DIMENSIONS			BACK DIMENSIONS						
		W	D	H	W	D	H	W	H					
		-	-	-	-	-	-	-	-					
			<div style="display: flex; align-items: center; gap: 10px;"> RTA 00   </div>											

DESCRIPTION	FEATURES	MODEL#	STANDARD TEXTILE GRADES											
			1	2	3	4	5	6	7	8	9	10	11	12
 <p>Corner Seat COM Yardage: 6.25 Freight Class: 250 Product Weight (lbs.): 65 Cubic Feet Per Carton: 30.25</p>		7862	-	-	-	-	2316	2487	2810	3390	3722	4257	5069	6036
		OVERALL DIMENSIONS			SEAT DIMENSIONS			BACK DIMENSIONS						
		W	D	H	W	D	H	W	H					
		37	37	30.75	26	26	17.5	26	13.5					
			<div style="display: flex; align-items: center; gap: 10px;"> RTA 00 </div>											

DESCRIPTION	FEATURES	MODEL#	STANDARD TEXTILE GRADES											
			1	2	3	4	5	6	7	8	9	10	11	12
 <p>Large Lounge Chair - for 6'+ Tall Users COM Yardage: 5.50 Freight Class: 250 Product Weight (lbs.): 70 Cubic Feet Per Carton: 24.25</p>		7864	-	-	-	-	2054	-	-	2998	3291	3762	4476	5328
		OVERALL DIMENSIONS			SEAT DIMENSIONS			BACK DIMENSIONS						
		W	D	H	W	D	H	W	H					
		34	33	30	23	20	19	23	13.5					
			<div style="display: flex; align-items: center; gap: 10px;"> RTA 00 </div>											

DESCRIPTION	FEATURES	MODEL#	STANDARD TEXTILE GRADES											
			1	2	3	4	5	6	7	8	9	10	11	12
 <p>Lounge Chair COM Yardage: 4.5 Freight Class: 250 Product Weight (lbs.): 67 Cubic Feet Per Carton: 21</p>		7875	-	-	-	-	1517	1646	1885	2318	2562	2958	3559	4278
		OVERALL DIMENSIONS			SEAT DIMENSIONS			BACK DIMENSIONS						
		W	D	H	W	D	H	W	H					
		30	31	30	21	19.5	17.5	21	12.5					
			<div style="display: flex; align-items: center; gap: 10px;"> RTA 00 </div>											

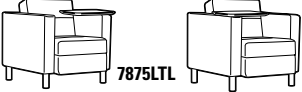
DESCRIPTION	FEATURES	MODEL#	STANDARD TEXTILE GRADES											
			1	2	3	4	5	6	7	8	9	10	11	12
 <p>Lounge Chair w/Laminate Tablet COM Yardage: 4.5 Freight Class: 250 Product Weight (lbs.): 75 Cubic Feet Per Carton: 22.5</p>		7875LTL 7875RTL	-	-	-	-	2275	2405	2651	3089	3338	3746	4360	5089
		OVERALL DIMENSIONS			SEAT DIMENSIONS			BACK DIMENSIONS						
		W	D	H	W	D	H	W	H					
		31.5	33.5	33.5	21	19.5	17.5	21	12.5					
			<div style="display: flex; align-items: center; gap: 10px;"> RTA 00 </div>											

DESCRIPTION	FEATURES	MODEL#	STANDARD TEXTILE GRADES											
			1	2	3	4	5	6	7	8	9	10	11	12



Lounge Chair - Armless
 COM Yardage: 3
 Freight Class: 250
 Product Weight (lbs.): 45
 Cubic Feet Per Carton: 15.5

7895	-	-	-	-	1519	1605	1758	2037	2196	2453	2842	3307
-------------	---	---	---	---	------	------	------	------	------	------	------	------

OVERALL DIMENSIONS			SEAT DIMENSIONS			BACK DIMENSIONS	
W	D	H	W	D	H	W	H
22	31	30.75	21	19.5	17.5	21	14

RTA 00

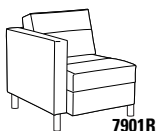

Lounge Chair - Single Arm
 COM Yardage: 4
 Freight Class: 250
 Product Weight (lbs.): 65
 Cubic Feet Per Carton: 21

7901L	-	-	-	-	1829	1939	2143	2467	2715	2995	3568	4176
7901R	-	-	-	-	-	-	-	-	-	-	-	-

OVERALL DIMENSIONS			SEAT DIMENSIONS			BACK DIMENSIONS	
W	D	H	H	W	D	H	WH
26	31	30	22	19.5	17.5	22	12.5

RTA 00

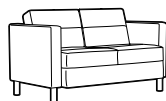

Two Seat Sofa
 COM Yardage: 6.25
 Freight Class: 250
 Product Weight (lbs.): 125
 Cubic Feet Per Carton: 36

7876	-	-	-	-	2046	2225	2554	3150	3494	4044	4881	5880
-------------	---	---	---	---	------	------	------	------	------	------	------	------

OVERALL DIMENSIONS			SEAT DIMENSIONS			BACK DIMENSIONS	
W	D	H	W	D	H	W	H
51.25	31	30	42.5	19.5	17.5	42.5	12.5

RTA 00



Two Seat Sofa - Armless
 COM Yardage: 5
 Freight Class: 250
 Product Weight (lbs.): 93
 Cubic Feet Per Carton: 36

7896	-	-	-	-	1890	2028	2286	2751	3015	3446	4093	4866
-------------	---	---	---	---	------	------	------	------	------	------	------	------

OVERALL DIMENSIONS			SEAT DIMENSIONS			BACK DIMENSIONS	
W	D	H	W	D	H	W	H
43.25	31	30.75	42.5	19.5	17.5	42.5	12.5

RTA 00

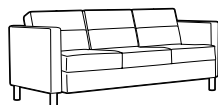











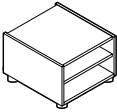
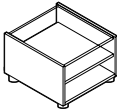

Three Seat Sofa
 COM Yardage: 8.75
 Freight Class: 250
 Product Weight (lbs.): 163
 Cubic Feet Per Carton: 50.25

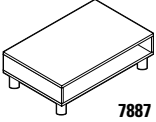
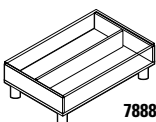
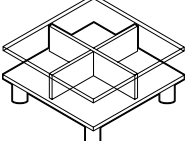
7877	-	-	-	-	2575	2820	3287	4125	4602	5375	6547	7939
-------------	---	---	---	---	------	------	------	------	------	------	------	------

OVERALL DIMENSIONS			SEAT DIMENSIONS			BACK DIMENSIONS	
W	D	H	W	D	H	W	H
72.5	31	30	63.5	19.5	17.5	63.5	12.5

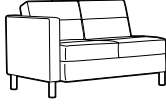
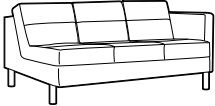
RTA 00

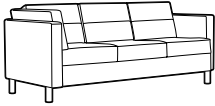
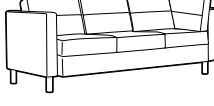
DESCRIPTION	FEATURES	MODEL#	STANDARD TEXTILE GRADES												
			1	2	3	4	5	6	7	8	9	10	11	12	
 <p>Three Seat Sofa - Armless COM Yardage: 7.25 Freight Class: 250 Product Weight (lbs.): 131 Cubic Feet Per Carton: 50.25</p>		7897	-	-	-	-	2488	2686	3063	3733	4117	4739	5680	6803	
			OVERALL DIMENSIONS			SEAT DIMENSIONS			BACK DIMENSIONS						
			W	D	H	W	D	H	W	H					
			64.5	31	30.75	63.5	19.5	17.5	63.5	12.5					
			RTA 00												
 <p>Ottoman COM Yardage: 1.5 Freight Class: 250 Product Weight (lbs.): 27 Cubic Feet Per Carton: 7.5</p>		7879	-	-	-	-	587	632	712	859	942	1080	1283	1526	
			OVERALL DIMENSIONS			SEAT DIMENSIONS			BACK DIMENSIONS						
			W	D	H	W	D	H	W	H					
			22	22	17	-	-	17	-	-					
			RTA 00												
			 												
  <p>End Table COM Yardage: N/A Freight Class: 100 Product Weight (lbs.): 53 Cubic Feet Per Carton: 6</p>			1	2	3	4	5	6	7	8	9	10	11	12	
		7885	827	-	-	-	-	-	-	-	-	-	-	-	-
		7886	1166	-	-	-	-	-	-	-	-	-	-	-	-
			OVERALL DIMENSIONS			SEAT DIMENSIONS			BACK DIMENSIONS						
		W	D	H	W	D	H	W	H						
		20	24	20	-	-	-	-	-						
			RTA 1												
			 												
  <p>Coffee Table Rectangular COM Yardage: N.A Freight Class: 100 Product Weight (lbs.): 60 Cubic Feet Per Carton: 6.5</p>			1	2	3	4	5	6	7	8	9	10	11	12	
		7887	863	-	-	-	-	-	-	-	-	-	-	-	-
		7888	1343	-	-	-	-	-	-	-	-	-	-	-	-
			OVERALL DIMENSIONS			SEAT DIMENSIONS			BACK DIMENSIONS						
		W	D	H	W	D	H	W	H						
		40	20	15	-	-	-	-	-						
			RTA 1												
 <p>Coffee Table Square COM Yardage: N/A Freight Class: 92.5 Product Weight (lbs.): 90 Cubic Feet Per Carton: 8.75</p>			1	2	3	4	5	6	7	8	9	10	11	12	
		7889	1630	-	-	-	-	-	-	-	-	-	-	-	-
			OVERALL DIMENSIONS			SEAT DIMENSIONS			BACK DIMENSIONS						
			W	D	H	W	D	H	W	H					
		33	33	15	-	-	-	-	-						
			RTA 1												

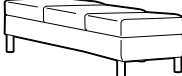
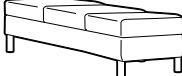
DESCRIPTION	FEATURES	MODEL#	STANDARD TEXTILE GRADES											
			1	2	3	4	5	6	7	8	9	10	11	12
 7890LNB  7890RNB	<p>Two Seat Sofa - No Connector COM Yardage: 5.25 Freight Class: 250 Product Weight (lbs.): 107 Cubic Feet Per Carton: 36</p> <p>**Intended to be free standing. No connecting hardware.</p>	7890LNB	-	-	-	-	2133	2283	2569	3081	3370	3843	4560	5415
		7890RNB												
			OVERALL DIMENSIONS			SEAT DIMENSIONS			BACK DIMENSIONS					
			W	D	H	W	D	H	W	H				
			0	0	0	42.5	19.5	17.5	42.5	13.25				
			RTA 00											
 7891LNB  7891RNB	<p>Three Seat Sofa - No Connector COM Yardage: 7.25 Freight Class: 250 Product Weight (lbs.): 138 Cubic Feet Per Carton: 50.25</p> <p>**Intended to be free standing. No connecting hardware.</p>	7891LNB	-	-	-	-	2850	3048	3425	4095	4479	5101	6042	7165
		7891RNB												
			OVERALL DIMENSIONS			SEAT DIMENSIONS			BACK DIMENSIONS					
			W	D	H	W	D	H	W	H				
			0	0	0	63.5	19.5	17.5	63.5	13.25				
			RTA 00											
 7891L-RCNB  7891R-RCNB	<p>Three Seat Sofa - No Connector COM Yardage: 8.5 Freight Class: 250 Product Weight (lbs.): 154 Cubic Feet Per Carton: 55.5</p> <p>**Intended to be free standing. No connecting hardware.</p>	7891L-RCNB	-	-	-	-	3433	3674	4137	4964	5437	6203	7361	8744
		7891R-RCNB												
			OVERALL DIMENSIONS			SEAT DIMENSIONS			BACK DIMENSIONS					
			W	D	H	W	D	H	W	H				
			0	0	0	60	19.5	17.5	60	13.25				
			RTA 00											
 7893	<p>Two Seat Bench COM Yardage: 2.25 Freight Class: 250 Product Weight (lbs.): 42 Cubic Feet Per Carton: 11.5</p>	7893	-	-	-	-	1165	1231	1351	1574	1698	1899	2206	2574
			OVERALL DIMENSIONS			SEAT DIMENSIONS			BACK DIMENSIONS					
			W	D	H	W	D	H	W	H				
			43	21.5	17	-	-	17	-	-				
			RTA 00  											
 7894	<p>Three Seat Bench COM Yardage: 3.75 Freight Class: 250 Product Weight (lbs.): 62 Cubic Feet Per Carton: 16.75</p>	7894	-	-	-	-	1663	1773	1977	2340	2549	2891	3399	4008
			OVERALL DIMENSIONS			SEAT DIMENSIONS			BACK DIMENSIONS					
			W	D	H	W	D	H	W	H				
			64.5	21.5	17	-	-	17	-	-				
			RTA 00											

CITI™ SQUARE



model S7875LT



Sample Layout A - Models shown: S7875UC and S7911



Sample Layout B - Models shown: S7890RUC, S7862UC (2), S7897UC, S7890LUC and S7912

STANDARD FEATURES

- Fully upholstered lounge series with a complete range of sectional components for all applications. Proportions are compact, 31" and 33.5" deep so it works well in public spaces.
- All models have fixed, non-removable cushions.
- Upholstery options: fabric, vinyl and leather. Leather models may feature a horizontal stitch detail across the seat and/or back cushions if applicable.
- The 5 inch high leg frame for seating and occasional tables lightens the look, it is available in Tungsten (S1) as standard or optionally available in Black (S2) Please specify finish, no upcharge added.
- Casters are not available on this series.
- Arm height on all models is 25"
- Tablet arms are made from thermally fused laminate, measure 12"D x 16.5"W 3/4" thick. Available right hand seated (RT), left Hand seated (LT) or both right and left hand (LRT).
- Ganging Brackets are sold separately. Ganging brackets are to be used on armless seating if interconnection to another armless seating unit is required. Bench and ottomans only gang to other benches/ottomans, cannot gang with seating units.
- Brackets come with a template for installation: unless noted otherwise all armless skus are equipped with the steel on steel connectors to receive this bracket.
- Upholstery options: fabric, vinyl and leather. Leather models feature a horizontal stitch detail across the seat and/or back cushions if applicable.
- Check textile availability prior to specifying upholstery material.
- If you would like fabric/vinyl on the shell of the chair with leather seat and back cushions or other combinations, please complete "Multi Fabric" Form and submit with your order. Multi Fabric grade will apply.
- Measurement shown for weight is for one unit. Measurement for volume is per carton.

OPTIONAL FEATURES

- Seating and Table Leg Finishes**
Metal legs are available in the following finishes:
(TBL) Black (TBZ) Buzz Blue
(TCC) Cactus (TCR) Carrot
(TDJ) Dijon (TDW) Designer White
(TEG) Eggplant (TFO) Fog

- (TFR) Frost (TIV) Cloud (TLA) Latte (TOA) Toast (TSH) Shadow (TSR) Scarlet (CHM) Chrome. Add \$205 (ACO) Antique Copper. Add \$458 for corner units. Add \$342 for single seat units. Add \$558 for two seat units. Add \$558 for three seat units. Add \$669 for four seat units. (BCH) Brushed Chrome. Add \$300 for corner units. Add \$215 for single seat units. Add \$329 for two seat units. Add \$329 for three seat units. Add \$389 for four seat units. (SBR) Satin Brass. Add \$458 for corner units. Add \$342 for single seat units. Add \$558 for two seat units. Add \$558 for three seat units. Add \$669 for four seat units.
- (TIN) Ink (TKA) Kalua (TMO) Mocha (TNE) Nevada (TSN) Sand (TTU) Tungsten
- Laminate Tables and Tablet arms are made with high pressure laminate and are offered in the following finishes: Absolute Acajou (ACJ), Asian Night (ASN), Avant Cherry (AWC), Avant Honey (AWH), Black (BLK), Blizzard (BZD), Brushed Cobalt (BRC), Clear Maple (CMB), Custom Grey (CGY), Dark Espresso (DES), Designer White (DWT), Fashionista (FAS), First Class (FCL), Noce Biondo (NBL), Noce Grigio (NGL), Noce Leggero (NEL), Noce Medio (NML), Quartered Mahogany (QTM), Sheer Beauty (SBY), Stonedust (SDT), Walnut Heights (WHE), White Chocolate (WHC) and Winter Cherry (WCR). Please Specify. Custom high pressure laminate finishes will be considered upon request.
- For high resilient, high density Ultracell foam on seat, specify (UC) after the model number. One Seater, add \$137. Two Seater, add \$269. Three Seater, add \$403, and Four Seater, add \$536
- Power/USB modules are available in the Citi Square tables. Each module includes a double power outlet and two USB terminals. It is equipped with a 6' long three-prong power cord with standard three prong plug. The Power monuments are available in Jet Black (J1) or White (W1). Add \$945 per unit. Please see Electrical Placement below for predetermined locations.

ELECTRICAL PLACEMENT

Coffee/End Tables: Predetermined Location is on the end/side of the unit J1 (black) or W1 (white).

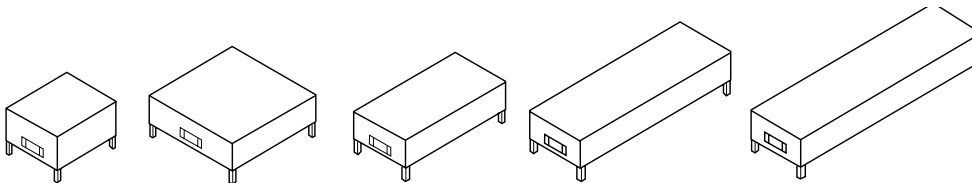

	1	2	3	4	5	6	7	8	9	10	11	12
7892	32	-	-	-	-	-	-	-	-	-	-	-



Ganging Bracket
COM Yardage: N/A
Freight Class: 70
Product Weight (lbs.): 00.25
Cubic Feet Per Carton: 00.01

Two brackets included.
Only one set is needed per connection.

OVERALL DIMENSIONS			SEAT DIMENSIONS			BACK DIMENSIONS	
W	D	H	W	D	H	W	H
0.5	3.87	2	-	-	-	-	-

DESCRIPTION	FEATURES	MODEL#	STANDARD TEXTILE GRADES											
			1	2	3	4	5	6	7	8	9	10	11	12

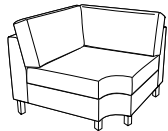

Linking Corner Unit
 COM Yardage: 6.25
 Freight Class: 250
 Product Weight (lbs.): 75
 Cubic Feet Per Carton: 30.25

No ganging hardware.
 Armless side(s) can be equipped with ganging brackets, model 7892.

S7862	-	-	-	-	2588	2783	3145	3725	4169	4665	5689	6778
--------------	---	---	---	---	------	------	------	------	------	------	------	------

OVERALL DIMENSIONS			SEAT DIMENSIONS			BACK DIMENSIONS	
W	D	H	W	D	H	W	H
37	37	31	26	26	17.5	26	13.5

RTA 00

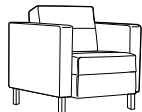

Single Seat w/Arms
 COM Yardage: 4.5
 Freight Class: 250
 Product Weight (lbs.): 81
 Cubic Feet Per Carton: 21

Free standing unit only.

S7875	-	-	-	-	1829	1969	2232	2648	2970	3329	4064	4847
--------------	---	---	---	---	------	------	------	------	------	------	------	------

OVERALL DIMENSIONS			SEAT DIMENSIONS			BACK DIMENSIONS	
W	D	H	W	D	H	W	H
30	31	30	21	19.5	17.5	21	12.5

RTA 00



S7875RT

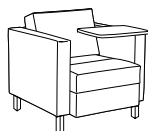

S7875LT

Single Seat w/Arms & Laminate Tablet
 COM Yardage: 4.5
 Freight Class: 250
 Product Weight (lbs.): 89
 Cubic Feet Per Carton: 22.5

Free standing unit only.
 Tablets are Right Hand Seated (RT) or Left Hand Seated (LT).

S7875RT	-	-	-	-	2448	2588	2851	3267	3587	3948	4683	5466
S7875LT	-	-	-	-	2448	2588	2851	3267	3587	3948	4683	5466

OVERALL DIMENSIONS			SEAT DIMENSIONS			BACK DIMENSIONS	
W	D	H	W	D	H	W	H
31.5	33.5	30	21	19.5	17.5	21	12.5

RTA 00

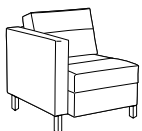

S7901R



S7901L

Single Seat w/One Arm
 COM Yardage: 4
 Freight Class: 250
 Product Weight (lbs.): 65
 Cubic Feet Per Carton: 21

No ganging hardware.
 Armless side can be equipped with ganging brackets, model 7892.
 Arms are Right Hand Seated (RT) or Left Hand Seated (LT).

S7901R	-	-	-	-	1829	1939	2143	2467	2715	2995	3568	4176
S7901L	-	-	-	-	1829	1939	2143	2467	2715	2995	3568	4176

OVERALL DIMENSIONS			SEAT DIMENSIONS			BACK DIMENSIONS	
W	D	H	W	D	H	W	H
26	31	30.75	21	19.5	17.5	21	12.5

RTA 00



S7901RRT



S7901LLT



Single Seat w/One Arm & Laminate Tablet
 COM Yardage: 4
 Freight Class: 250
 Product Weight (lbs.): 73
 Cubic Feet Per Carton: 22.5



No ganging hardware.
 Armless side(s) can be equipped with ganging brackets, model 7892.
 Tablets are Arms are Right Hand Seated (RT) or Left Hand Seated (LT).

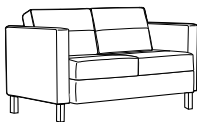
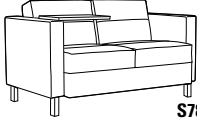
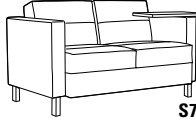
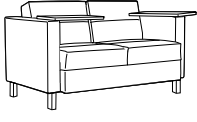
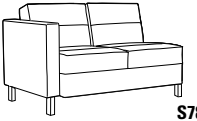

S7901RRT	-	-	-	-	2448	2762	1783	3086	3334	3614	4187	4795
S7901LLT	-	-	-	-	2448	2558	2762	3086	3334	3614	4187	4795

OVERALL DIMENSIONS			SEAT DIMENSIONS			BACK DIMENSIONS	
W	D	H	W	D	H	W	H
27.5	31	30.75	21	19.5	17.5	21	12.5

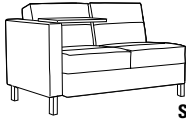
RTA 00

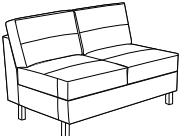
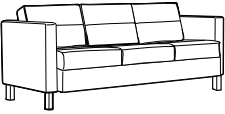
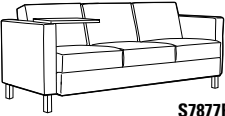
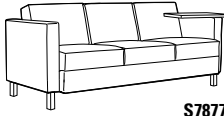
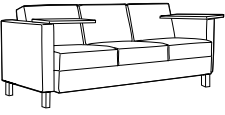
DESCRIPTION	FEATURES	MODEL#	STANDARD TEXTILE GRADES											
			1	2	3	4	5	6	7	8	9	10	11	12
 Armless Single Seat COM Yardage: 3 Freight Class: 2250 Product Weight (lbs.): 45 Cubic Feet Per Carton: 15.5	No ganging hardware. Armless side(s) can be equipped with ganging brackets, model 7892.	S7895	-	-	-	-	1829	1923	2096	2377	2590	2830	3320	3844
		OVERALL DIMENSIONS			SEAT DIMENSIONS			BACK DIMENSIONS						
		W	D	H	W	D	H	W	H					
		22	31	30.75	21	18.5	17.5	21	12.5					
		RTA 00												
 Two Seater w/Arms COM Yardage: 6.25 Freight Class: 250 Product Weight (lbs.): 122 Cubic Feet Per Carton: 36	Free standing unit only.	S7876	-	-	-	-	2588	2783	3145	3725	4169	4665	5689	6778
		OVERALL DIMENSIONS			SEAT DIMENSIONS			BACK DIMENSIONS						
		W	D	H	W	D	H	W	H					
		51.25	31	30	42.5	19.5	17.5	42.5	12.5					
		RTA 00												
  Two Seater w/Arms & Laminate Tablet COM Yardage: 6.25 Freight Class: 250 Product Weight (lbs.): 130 Cubic Feet Per Carton: 41.25	Free standing unit only. Tablets are Right Hand Seated (RT) or Left Hand Seated (LT).	S7876RT	-	-	-	-	3208	3401	3765	4342	4789	5285	6309	7398
		S7876LT	-	-	-	-	3208	3401	3765	4342	4789	5285	6309	7398
		OVERALL DIMENSIONS			SEAT DIMENSIONS			BACK DIMENSIONS						
		W	D	H	W	D	H	W	H					
		52.75	33.5	30	42.5	19.5	17.5	42.5	12.5					
RTA 00														
 Two Seater w/Arms & Laminate Tablets COM Yardage: 6.25 Freight Class: 250 Product Weight (lbs.): 138 Cubic Feet Per Carton: 41.25	Free standing unit only. With both Left and Right Tablets.	S7876LRT	-	-	-	-	3829	4022	4386	4963	5410	5906	6930	8019
		OVERALL DIMENSIONS			SEAT DIMENSIONS			BACK DIMENSIONS						
		W	D	H	W	D	H	W	H					
		54.25	33.5	30	42.5	19.5	17.5	42.5	12.5					
		RTA 00												
  Two Seater w/One Arm COM Yardage: 5.25 Freight Class: 250 Product Weight (lbs.): 106 Cubic Feet Per Carton: 36	No ganging hardware. Armless side can be equipped with ganging brackets, model 7892. Arms are Right Hand Seated (RT) or Left Hand Seated (LT).	S7890R	-	-	-	-	2403	2565	2870	3357	3732	4151	5007	5924
		S7890L	-	-	-	-	2403	2565	2870	3357	3732	4151	5007	5924
		OVERALL DIMENSIONS			SEAT DIMENSIONS			BACK DIMENSIONS						
		W	D	H	W	D	H	W	H					
		47.25	31	30.75	42.5	19.5	17.5	42.5	13.25					
RTA 00														

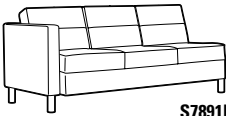
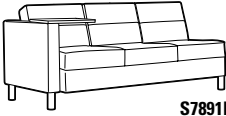
DESCRIPTION	FEATURES	MODEL#	STANDARD TEXTILE GRADES											
			1	2	3	4	5	6	7	8	9	10	11	12
 <p>S7890RRT</p>	 <p>S7890LLT</p>	<p>S7890RRT</p> <p>S7890LLT</p>	-	-	-	-	3022	3184	3489	3976	4351	4769	5626	6542
			-	-	-	-	3022	3184	3489	3976	4351	4769	5626	6542
<p>Two Seater w/One Arm and Laminate Tablet COM Yardage: 5.25 Freight Class: 250 Product Weight (lbs.): 114 Cubic Feet Per Carton: 41.25</p>			<p>No ganging hardware. Armless side(s) can be equipped with ganging brackets, model 7892. Tablets are Arms are Right Hand Seated (RT) or Left Hand Seated (LT).</p>			<p>OVERALL DIMENSIONS W D H</p>			<p>SEAT DIMENSIONS W D H</p>			<p>BACK DIMENSIONS W H</p>		
			48.75	33.5	30.75	42.5	19.5	17.5	42.5	13.25	<p>RTA 00</p>			
 <p>S7896</p>		<p>S7896</p>	-	-	-	-	2403	2559	2848	3313	3671	4069	4886	5756
			-	-	-	-	2403	2559	2848	3313	3671	4069	4886	5756
<p>Armless Two Seater COM Yardage: 5 Freight Class: 250 Product Weight (lbs.): 43.25 Cubic Feet Per Carton: 36</p>			<p>No ganging hardware. Armless side(s) can be equipped with ganging brackets, model 7892.</p>			<p>OVERALL DIMENSIONS W D H</p>			<p>SEAT DIMENSIONS W D H</p>			<p>BACK DIMENSIONS W H</p>		
			43.25	31	30.75	42.5	19.5	17.5	42.5	13.25	<p>RTA 00</p>			
 <p>S7877</p>		<p>S7877</p>	-	-	-	-	3351	3618	4128	4941	5564	6260	7689	9216
			-	-	-	-	3351	3618	4128	4941	5564	6260	7689	9216
<p>Three Seater w/Arms COM Yardage: 8.75 Freight Class: 250 Product Weight (lbs.): 163 Cubic Feet Per Carton: 50.25</p>			<p>Free standing unit only.</p>			<p>OVERALL DIMENSIONS W D H</p>			<p>SEAT DIMENSIONS W D H</p>			<p>BACK DIMENSIONS W H</p>		
			72.5	31	30	63.5	19.5	17.5	63.5	12.5	<p>RTA 00</p>			
 <p>S7877RT</p>	 <p>S7877LT</p>	<p>S7877RT</p> <p>S7877LT</p>	-	-	-	-	3969	4235	4746	5559	6182	6878	8307	9834
			-	-	-	-	3969	4235	4746	5559	6182	6878	8307	9834
<p>Three Seater w/Arms and Laminate Tablet COM Yardage: 8.75 Freight Class: 250 Product Weight (lbs.): 171 Cubic Feet Per Carton: 55.5</p>			<p>Free standing unit only. Tablets are Right Hand Seated (RT) or Left Hand Seated (LT).</p>			<p>OVERALL DIMENSIONS W D H</p>			<p>SEAT DIMENSIONS W D H</p>			<p>BACK DIMENSIONS W H</p>		
			74	33.5	30	63.5	19.5	17.5	63.5	12.5	<p>RTA 00</p>			
 <p>S7877LRT</p>		<p>S7877LRT</p>	-	-	-	-	4588	4854	5365	6178	6801	7497	8926	10453
			-	-	-	-	4588	4854	5365	6178	6801	7497	8926	10453
<p>Three Seater w/Arms and Laminate Tablets COM Yardage: 8.75 Freight Class: 250 Product Weight (lbs.): 250 Cubic Feet Per Carton: 55.5</p>			<p>Free standing unit only. With both Left and Right Tablets.</p>			<p>OVERALL DIMENSIONS W D H</p>			<p>SEAT DIMENSIONS W D H</p>			<p>BACK DIMENSIONS W H</p>		
			75.5	33.5	30	63.5	19.5	17.5	63.5	12.5	<p>RTA 00</p>			

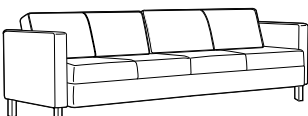
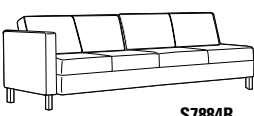
DESCRIPTION	FEATURES	MODEL#	STANDARD TEXTILE GRADES											
			1	2	3	4	5	6	7	8	9	10	11	12
 <p>S7891R</p> <p>Three Seater w/One Arm COM Yardage: 7.25 Freight Class: 250 Product Weight (lbs.): 147 Cubic Feet Per Carton: 50.25</p>	<p>No ganging hardware. Armless side can be equipped with ganging brackets, model 7892. Arms are Right Hand Seated (RT) or Left Hand Seated (LT) .</p>	S7891R	-	-	-	-	3245	3468	3889	4564	5081	5656	6842	8105
		S7891L	-	-	-	-	3245	3468	3889	4564	5081	5656	6842	8105
		OVERALL DIMENSIONS			SEAT DIMENSIONS			BACK DIMENSIONS						
		W	D	H	W	D	H	W	H					
68.5	31	30.75	63.5	19.5	17.5	63.5	13.25							
			RTA 00											
 <p>S7891RRT</p> <p>Three Seater w/One Arm and Laminate Tablet COM Yardage: 7.25 Freight Class: 250 Product Weight (lbs.): 155 Cubic Feet Per Carton: 55.25</p>	<p>No ganging hardware. Armless side(s) can be equipped with ganging brackets, model 7892. Tablets are Arms are Right Hand Seated (RT) or Left Hand Seated (LT).</p>	S7891RRT	-	-	-	-	3864	4087	4507	5183	5700	6275	7461	8724
		S7891LLT	-	-	-	-	3864	4087	4507	5183	5700	6275	7461	8724
		OVERALL DIMENSIONS			SEAT DIMENSIONS			BACK DIMENSIONS						
		W	D	H	W	D	H	W	H					
70	33.5	30.75	63.5	19.5	17.5	63.5	13.25							
			RTA 00											
 <p>S7897</p> <p>Armless Three Seater COM Yardage: 7.25 Freight Class: 250 Product Weight (lbs.): 131 Cubic Feet Per Carton: 50.25</p>	<p>No ganging hardware. Armless side(s) can be equipped with ganging brackets, model 7892.</p>	S7897	-	-	-	-	3245	3468	3889	4564	5081	5656	6842	8105
		OVERALL DIMENSIONS			SEAT DIMENSIONS			BACK DIMENSIONS						
		W	D	H	W	D	H	W	H					
		64.5	31	30.75	63.5	19.5	17.5	63.5	13.25					
			RTA 00											
 <p>S7884</p> <p>Four Seater w/Arms COM Yardage: 10.25 Freight Class: 250 Product Weight (lbs.): 204 Cubic Feet Per Carton: 69</p>	<p>Free standing unit only.</p>	S7884	-	-	-	-	4929	5243	5839	6789	7520	8335	10010	11798
		OVERALL DIMENSIONS			SEAT DIMENSIONS			BACK DIMENSIONS						
		W	D	H	W	D	H	W	H					
		93.5	31	30	84	19.5	17.5	84	12.5					
			RTA 00											
 <p>S7884R</p> <p>Four Seater w/One Arm COM Yardage: 9.5 Freight Class: 250 Product Weight (lbs.): 188 Cubic Feet Per Carton: 69</p>	<p>No ganging hardware. Armless side can be equipped with ganging brackets, model 7892. Arms are Right Hand Seated (RT) or Left Hand Seated (LT) .</p>	S7884R	-	-	-	-	4823	5112	5666	6545	7225	7980	9532	11189
		S7884L	-	-	-	-	4823	5112	5666	6545	7225	7980	9532	11189
		OVERALL DIMENSIONS			SEAT DIMENSIONS			BACK DIMENSIONS						
		W	D	H	W	D	H	W	H					
89.5	31	30.75	84	19.5	17.5	84	12.5							
			RTA 00											

DESCRIPTION FEATURES MODEL# STANDARD TEXTILE GRADES

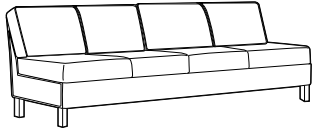

Armless Four Seater
 COM Yardage: 8.75
 Freight Class: 250
 Product Weight (lbs.): 172
 Cubic Feet Per Carton: 61.5

No ganging hardware.
 Armless side(s) can be equipped with ganging brackets, model 7892.

MODEL#	1	2	3	4	5	6	7	8	9	10	11	12
S7884NA	-	-	-	-	4823	5089	5600	6413	7036	7732	9161	10688
OVERALL DIMENSIONS			SEAT DIMENSIONS			BACK DIMENSIONS						
W	D	H	W	D	H	W	H					
85.5	31	30.75	84	19.5	17.5	84	12.5					
RTA 00												

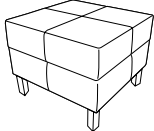

Square Ottoman
 COM Yardage: 1.5
 Freight Class: 250
 Product Weight (lbs.): 27
 Cubic Feet Per Carton: 7.5

No ganging hardware.
 Side(s) can be equipped with ganging brackets, model 7892.
 Does not gang to seating units.

MODEL#	1	2	3	4	5	6	7	8	9	10	11	12
S7879	-	-	-	-	759	807	896	1036	1144	1262	1508	1768
OVERALL DIMENSIONS			SEAT DIMENSIONS			BACK DIMENSIONS						
W	D	H	W	D	H	W	H					
22	22	17	-	-	17	-	-					
RTA 00												

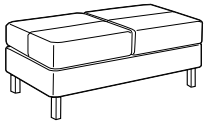

Two Seater Bench
 COM Yardage: 2.25
 Freight Class: 250
 Product Weight (lbs.): 42
 Cubic Feet Per Carton: 11.5

No ganging hardware.
 Side(s) can be equipped with ganging brackets, model 7892.
 Does not gang to seating units.

MODEL#	1	2	3	4	5	6	7	8	9	10	11	12
S7893	-	-	-	-	1458	1530	1663	1870	2033	2210	2577	2970
OVERALL DIMENSIONS			SEAT DIMENSIONS			BACK DIMENSIONS						
W	D	H	W	D	H	W	H					
43	21.5	17	-	-	17	-	-					
RTA 00												

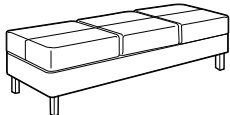

Three Seater Bench
 COM Yardage: 3.75
 Freight Class: 250
 Product Weight (lbs.): 62
 Cubic Feet Per Carton: 16.75

No ganging hardware.
 Side(s) can be equipped with ganging brackets, model 7892.
 Does not gang to seating units.



MODEL#	1	2	3	4	5	6	7	8	9	10	11	12
S7894	-	-	-	-	2076	2194	2412	2759	3027	3325	3937	4591
OVERALL DIMENSIONS			SEAT DIMENSIONS			BACK DIMENSIONS						
W	D	H	W	D	H	W	H					
64.5	21.5	17	-	-	17	-	-					
RTA 00												



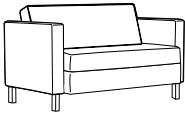
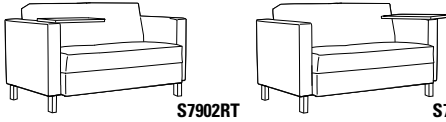
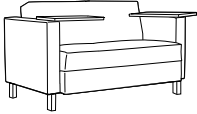
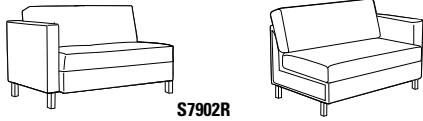

Two Seater Bench - Single Cushion
 COM Yardage: 2.25
 Freight Class: 250
 Product Weight (lbs.): 42
 Cubic Feet Per Carton: 11.5

No ganging hardware.
 Side(s) can be equipped with ganging brackets, model 7892.
 Does not gang to seating units.

MODEL#	1	2	3	4	5	6	7	8	9	10	11	12
S7905	-	-	-	-	1146	1218	1351	1558	1717	1898	2265	2658
OVERALL DIMENSIONS			SEAT DIMENSIONS			BACK DIMENSIONS						
W	D	H	W	D	H	W	H					
43	21.5	17	-	-	17	-	-					
RTA 00												

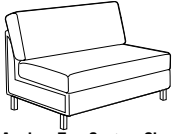
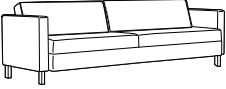
DESCRIPTION	FEATURES	MODEL#	STANDARD TEXTILE GRADES											
			1	2	3	4	5	6	7	8	9	10	11	12
 <p>Two Seater w/Arms - Single Cushion COM Yardage: 6.5 Freight Class: 250 Product Weight (lbs.): 122 Cubic Feet Per Carton: 36</p>	Free standing unit only.	S7902	-	-	-	-	2588	2783	3145	3725	4169	4665	5689	6778
		OVERALL DIMENSIONS			SEAT DIMENSIONS			BACK DIMENSIONS						
		W	D	H	W	D	H	W	H					
		51.25	31	30	42.5	19.5	17.5	42.5	12.5					
			RTA 00											
 <p>S7902RT S7902LT</p> <p>Two Seater w/Arms & Lam. Tablet - Single Cushion COM Yardage: 5.25 Freight Class: 250 Product Weight (lbs.): 114 Cubic Feet Per Carton: 36</p>	Free standing unit only. Tablets are Right Hand Seated (RT) or Left Hand Seated (LT).	S7902RT	-	-	-	-	3208	2543	2543	4389	2543	5371	6432	7566
		S7902LT	-	-	-	-	3208	2543	2543	4389	2543	5371	6432	7566
		OVERALL DIMENSIONS			SEAT DIMENSIONS			BACK DIMENSIONS						
		W	D	H	W	D	H	W	H					
48.75	33.5	30.75	42.5	19.5	17.5	42.5	13.25							
			RTA 00											
 <p>Two Seater w/Arms & Lam. Tablets - Single Cushion COM Yardage: 6.5 Freight Class: 250 Product Weight (lbs.): 127 Cubic Feet Per Carton: 41.25</p>	Free standing unit only. With both Left and Right Tablets.	S7902LRT	-	-	-	-	3829	4028	4409	5010	5475	5992	7053	8187
		OVERALL DIMENSIONS			SEAT DIMENSIONS			BACK DIMENSIONS						
		W	D	H	W	D	H	W	H					
		54.25	33.5	30	42.5	19.5	17.5	42.5	12.5					
			RTA 00											
 <p>S7902R S7902L</p> <p>Two Seater w/One Arm - Single Cushion COM Yardage: 5.25 Freight Class: 250 Product Weight (lbs.): 114 Cubic Feet Per Carton: 36</p>	No ganging hardware. Armless side can be equipped with ganging brackets, model 7892. Arms are Right Hand Seated (RT) or Left Hand Seated (LT).	S7902R	-	-	-	-	2403	2565	2870	3357	3732	4151	5007	5924
		S7902L	-	-	-	-	2403	2565	2870	3357	3732	4151	5007	5924
		OVERALL DIMENSIONS			SEAT DIMENSIONS			BACK DIMENSIONS						
		W	D	H	W	D	H	W	H					
47.25	31	30.75	42.5	19.5	17.5	42.5	13.25							
			RTA 00											
 <p>S7902RRT S902LLT</p> <p>Two Seater w/One Arm & Lam. Tablet - Single Cushion COM Yardage: 5.25 Freight Class: 250 Product Weight (lbs.): 114 Cubic Feet Per Carton: 36</p>	Free standing unit only. Tablets are Right Hand Seated (RT) or Left Hand Seated (LT).	S7902RRT	-	-	-	-	3022	3184	3489	3976	4351	4769	5626	6542
		S902LLT	-	-	-	-	3022	3184	3489	3976	4351	4769	5626	6542
		OVERALL DIMENSIONS			SEAT DIMENSIONS			BACK DIMENSIONS						
		W	D	H	W	D	H	W	H					
48.75	33.5	30.75	42.5	19.5	17.5	42.5	13.25							
			RTA 00											

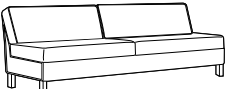
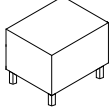
DESCRIPTION	FEATURES	MODEL#	STANDARD TEXTILE GRADES											
			1	2	3	4	5	6	7	8	9	10	11	12
 <p>Armless Two Seater - Single Cushion COM Yardage: 6.5 Freight Class: 250 Product Weight (lbs.): 90 Cubic Feet Per Carton: 36</p>	No ganging hardware. Armless side(s) can be equipped with ganging brackets, model 7892.	S7902NA	-	-	-	-	2403	2543	2806	3222	3544	3903	4638	5421
		OVERALL DIMENSIONS			SEAT DIMENSIONS			BACK DIMENSIONS						
		W	D	H	W	D	H	W	H					
		43.25	31	30.75	42.5	19.5	17.5	42.5	13.25					
			RTA 00											
 <p>Four Seater w/Arms - Duo Cushion COM Yardage: 10.25 Freight Class: 250 Product Weight (lbs.): 204 Cubic Feet Per Carton: 69</p>	Free standing unit only.	S7904	-	-	-	-	4929	5243	5839	6789	7520	8335	10010	11798
		OVERALL DIMENSIONS			SEAT DIMENSIONS			BACK DIMENSIONS						
		W	D	H	W	D	H	W	H					
		93.5	31	30	84	19.5	17.5	84	12.5					
			RTA 00											
 <p>S7904R S7904L</p> <p>Four Seater w/One Arm - Duo Cushion COM Yardage: 9.5 Freight Class: 250 Product Weight (lbs.): 188 Cubic Feet Per Carton: 61.5</p>	No ganging hardware. Armless side can be equipped with ganging brackets, model 7892. Arms are Right Hand Seated (RT) or Left Hand Seated (LT) .	S7904R	-	-	-	-	4823	5112	5666	6545	7225	7980	9532	11189
		S7904L	-	-	-	-	4823	5112	5666	6545	7225	7980	9532	11189
		OVERALL DIMENSIONS			SEAT DIMENSIONS			BACK DIMENSIONS						
		W	D	H	W	D	H	W	H					
			89.5	31	30.75	84	19.5	17.5	84	12.5				
			RTA 00											
 <p>Armless Four Seater - Single Cushion COM Yardage: 8.75 Freight Class: 250 Product Weight (lbs.): 172 Cubic Feet Per Carton: 61.5</p>	No ganging hardware. Armless side(s) can be equipped with ganging brackets, model 7892.	S7904NA	-	-	-	-	4823	5089	5600	6413	7036	7732	9161	10688
		OVERALL DIMENSIONS			SEAT DIMENSIONS			BACK DIMENSIONS						
		W	D	H	W	D	H	W	H					
		85.5	31	30.75	84	19.5	17.5	84	12.5					
			RTA 00											
 <p>Cube End Table COM Yardage: N/A Freight Class: 100 Product Weight (lbs.): 51 Cubic Feet Per Carton: 5.5</p>	Free standing unit only. No ganging hardware. For Power/USB module please see electrical placement chart.	S7911	1915	-	-	-	-	-	-	-	-	-	-	-
		OVERALL DIMENSIONS			SEAT DIMENSIONS			BACK DIMENSIONS						
		W	D	H	W	D	H	W	H					
		20	24	16	-	-	-	-	-					
			RTA 00											

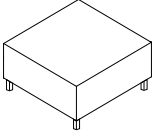
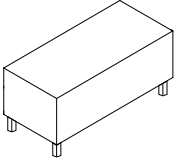
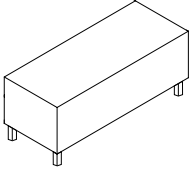
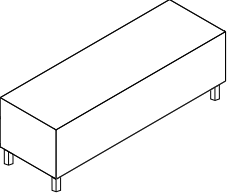
DESCRIPTION	FEATURES	MODEL#	STANDARD TEXTILE GRADES											
			1	2	3	4	5	6	7	8	9	10	11	12
 <p>Cube Square Coffee Table COM Yardage: N/A Freight Class: 100 Product Weight (lbs.): 86 Cubic Feet Per Carton: 10.75</p>	<p>Free standing unit only. No ganging hardware. For Power/USB module please see electrical placement chart.</p>	S7912	2433	-	-	-	-	-	-	-	-	-	-	-
		OVERALL DIMENSIONS			SEAT DIMENSIONS			BACK DIMENSIONS						
		W	D	H	W	D	H	W	H					
		33	33	14	-	-	-	-	-					
			RTA 00											
 <p>Cube 40" Coffee Table COM Yardage: N/A Freight Class: 100 Product Weight (lbs.): 66 Cubic Feet Per Carton: 8</p>	<p>Free standing unit only. No ganging hardware. For Power/USB module please see electrical placement chart.</p>	S7913	2303	-	-	-	-	-	-	-	-	-	-	
		OVERALL DIMENSIONS			SEAT DIMENSIONS			BACK DIMENSIONS						
		W	D	H	W	D	H	W	H					
		40	20	14	-	-	-	-	-					
			RTA 00											
 <p>Cube Extended 60" Coffee Table COM Yardage: N/A Freight Class: 125 Product Weight (lbs.): 93 Cubic Feet Per Carton: 12</p>	<p>Free standing unit only. No ganging hardware. For Power/USB module please see electrical placement chart.</p>	S7915	3008	-	-	-	-	-	-	-	-	-		
		OVERALL DIMENSIONS			SEAT DIMENSIONS			BACK DIMENSIONS						
		W	D	H	W	D	H	W	H					
		60	20	14	-	-	-	-	-					
			RTA 00											
 <p>Cube Extended 72" Coffee Table COM Yardage: N/A Freight Class: 125 Product Weight (lbs.): 107 Cubic Feet Per Carton: 14.25</p>	<p>Free standing unit only. No ganging hardware. For Power/USB module please see electrical placement chart.</p>	S7916	3078	-	-	-	-	-	-	-	-	-		
		OVERALL DIMENSIONS			SEAT DIMENSIONS			BACK DIMENSIONS						
		W	D	H	W	D	H	W	H					
		72	20	14	-	-	-	-	-					
			RTA 00											

DRIFT



Wood Base model 8030
Side Chair w/4 Leg



Side Chair, Sled Base
Arm Patches model 8023P



Chrome Base model 8034
Low Back Lounge Chair



Wood Base model 8037
Mid Back Lounge Chair



Ottoman model 8026



Wood Base model 8052
Counter Stool



For Drift tables, see page page 333

EXAMPLE OF TABLE ORDER CODE:

8030P	WA50	WA50	R11	NM	AAM
Model Number	Back/Arm Textile	Seat Textile	Patch Textile	Seat Height	Base Finish

NM	NBS	NSS	NB
Glide Type	Sealed Back Seams	Sealed Seat Seams	Moisture Barrier

5-Star Base Mechanism

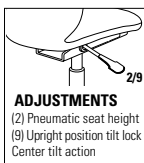

ADJUSTMENTS
(2) Pneumatic seat height
(9) Upright position tilt lock
Center tilt action

Ergonomic features:
B, C, S, U



Flip Forward Seat
"F" suffix models

STANDARD FEATURES

- Drift's soft seat and contoured back and arms provide the perfect balance of style and comfort. Side chairs are available in six base types: sled, wood 4-leg, wood 4-prong swivel, chrome 4-prong swivel, high 4-star swivel and 5-star base on casters.
- Lounge chairs are available in four base types: sled, wood 4-leg, wood 4-star swivel and Chrome 4-prong swivel.
- Counter and bar height stools are available with three base types: sled, wood 4-leg, and Chrome 4-star swivel.
- Wood bases are made from Beechwood and are available in all standard wood finishes.
- Wood base seating models are standard with White non-marking polycarbonate glides. See Glide Type for additional glide options.
- Sled bases are standard in painted metal or Chrome finish. See Frame Finish for upcharges.
- Sled base models are standard with clear polycarbonate glides. See Glide Type for additional glide options.
- Chrome swivel bases are available in polished Chrome only. Lounge models with Chrome swivel bases swivel 360deg, available in swivel or self-centering swivel.
- Lounge seating is available with 17" seat height with a classic lounge angle or 18" seat height with a reduced back angle for ease of sitting and standing.
- Side chairs with 5-star base and casters swivel 360 degrees, are height adjustable with 4" range and include a tilting mechanism with upright tilt lock. Base is Polished Aluminum with C114 Carpet or C114R hard floor, dual wheel casters. See upcharges.
- Ottomans have a weighted bottom to maintain upright position. Specify Top and Side textile separately. Glides are White, non-marking.
- For increased durability on side and lounge seating, P and PH suffix models are available with arm and head patches. These high touch areas are covered in Global's Release vinyl. Specify Release color.
- For ease of cleaning, Side and Lounge Chair models with "F" suffix have flip-forward seats. Material under seat matches seat textile selection. (Stools and side chairs with high 4- star and 5-star bases have fixed seat cushions only.)
- Sealed seams are available on chair backs and/ or seats (with upcharge). For sealed seams on Ottoman, specify Ottoman (8026S), available only in sealed seam approved textiles.
- A moisture barrier may be added to seat cushions only (with upcharge). Not available with sealed seams.
- Upholstery options: fabric, vinyl, or leather.
- All Drift seating is assembled using tamper proof screws.
- Drift seating is available to specify with two textiles, one for the seat cushion and one for the back and arms (see model image).
- For pricing, start with the base price and add both back/arms graded textile upcharge and the seat graded textile upcharge.
- The Blended Textile matrix does not apply to this series.
- Drift seating is designed for 300lb capacity.
- Shipped fully assembled.
- See finishes section in Price List for solid wood/ laminate coordination chart.

Add option codes in the following order:

- **Model Number**
Specify model number.
- **Back/Arm Textile**
Specify textile code. See model grade upcharges.
- **Seat Textile**
Specify textile code. See model grade upcharges.
- **Arm and Head Patch Textile** (For P and PH suffix models)
Release Vinyl only





- **Seat Height** (lounge models only):
(S17) 17" Seat height
(S18) 18" Seat height
- **Base Finish** (wood base models)
(AAM) Absolute (BKM) Black
(ACM) Cherry (EOM) English Oak
(ECM) Espresso Cafe (TFM) Fruitwood
(HGM) Grey (AHM) Honey
(TMM) Mahogany (AVM) Maple
(NLW) Natural Walnut (MVM) Medium Walnut
(ASM) Night (NBM) Noce Biondo
(NGM) Noce Grigio (NEM) Noce Leggero
(NMM) Noce Medio (SKM) Shaker Cherry
(TWM) Walnut (WTM) WC Cream
(WHM) White (WCM) Winter Cherry
- **Base Finish** (sled base models)
(TBL) Black (TBZ) Buzz Blue
(TCC) Cactus (TCR) Carrot
(TDJ) Dijon (TDW) Designer White
(TEG) Eggplant (TFO) Fog
(TFR) Frost (TIN) Ink
(TIV) Cloud (TKA) Kalua
(TLA) Latte (TOA) Toast
(TNE) Nevada (TSH) Shadow
(TSN) Sand (TSR) Scarlet
(TTU) Tungsten
Metallics: Side/Lounge Counter Bar
(CHM) Chrome. Add \$42 \$84 \$84
- **Base Finish** (5-star base only)
(A7) Polish Aluminum
- **Cylinder Selection** (Chrome swivel lounge models):
(DSC) Swivel cylinder
(DAC) Self-centering cylinder
- **Glide Type** (wood base seating)
(NM) White, non-marking nylon for most hard floor surfaces (standard)
(SG) Steel cushioned glides for carpeted surfaces. Add \$34
(RG) Non-slip, rubber glides for most hard floor surfaces. Add \$34
(FG) Felt glides for most hard floor surfaces. Add \$34
- **Glide Type** (sled base seating)
(CG) Clear, polycarbonate glide for most surfaces (standard)
(XG) No glide for carpeted surfaces
(FG) Felt glide for most hard surfaces. Add \$31
(SG) Steel cushioned glide for carpeted surfaces. Add \$34
(RG) Non-slip rubber glide for most hard surfaces. Add \$34
- **Glide Type** (High, 4-Star base side chairs)
(NM) White Polyethylene non-marking glide for most surfaces
(FG) Felt Glide for most hard floor surfaces. Add \$34
- **Caster Type** (5-star base side chairs)
(DC) 2" Caster for carpeted surfaces
(RC) 2" Caster for hard floor surfaces. Add \$50
- **Sealed Back Seams** (contact customer care for approved textiles)
(NBS) No sealed back seam
(SBS) Sealed back seams. See model for upcharge.
- **Sealed Seat Seams** (contact customer care for approved textiles)
(NSS) No sealed seat seams
(SSS) Sealed seat seams. See model for upcharge.
- **Moisture Barrier** (not available with sealed seams)
(NB) No moisture barrier
(MB) Moisture barrier (seat only). Add \$101





DESCRIPTION	MODEL#/ FEATURES	STANDARD TEXTILE GRADES												
		1/COM	2	3	4	5	6	7	8	9	10	11	12	
 Ottoman COM Yardage: Top: .5; Side: 1.5 Freight Class: 250 Product Weight (lbs.): 31 Cubic Feet Per Carton: 8.5	8026	Base Price:	\$911											
	8026S	Base Price:	\$1101											
		Shell upcharge:	+0	+48	+86	+141	+219	+252	+320	+426	+506	+593	+774	+965
		Seat upcharge:	+0	+16	+29	+47	+73	+84	+107	+142	+169	+198	+258	+322







DESCRIPTION	MODEL#/ FEATURES	STANDARD TEXTILE GRADES												
		1/COM	2	3	4	5	6	7	8	9	10	11	12	
 Side Chair, Sled Base COM Yardage: Back/Arms: 1.25; Seat: .75 COM Yardage "F" Model: Back/Arms: 1.25; Seat 1 Freight Class: 250 Product Weight (lbs.): 31 Cubic Feet Per Carton: 13.25	8023	Base Price:	\$1819											
		Back/Arm upcharge:	+0	+40	+72	+118	+183	+210	+267	+355	+422	+494	+645	+804
		Seat upcharge:	+0	+24	+43	+71	+110	+126	+160	+213	+253	+297	+387	+483





DESCRIPTION	MODEL#/ FEATURES	STANDARD TEXTILE GRADES												
		1/COM	2	3	4	5	6	7	8	9	10	11	12	
 Side Chair, Sled Base, Arm Patches COM Yardage: Back/Arms: 1.25; Seat: .75 COM Yardage "F" Model: Back/Arms: 1.25; Seat 1 Freight Class: 250 Product Weight (lbs.): 31 Cubic Feet Per Carton: 13.25	8023P	Base Price:	\$1844											
		Back/Arm upcharge:	+0	+40	+72	+118	+183	+210	+267	+355	+422	+494	+645	+804
		Seat upcharge:	+0	+24	+43	+71	+110	+126	+160	+213	+253	+297	+387	+483





DESCRIPTION	MODEL#/ FEATURES	STANDARD TEXTILE GRADES												
		1/COM	2	3	4	5	6	7	8	9	10	11	12	
 Side Chair, 4 Leg Wood Base COM Yardage: Back/Arms: 1.25; Seat: .75 COM Yardage "F" Model: Back/Arms: 1.25; Seat 1 Freight Class: 300 Product Weight (lbs.): 31 Cubic Feet Per Carton: 15.75	8030	Base Price:	\$1622											
		Back/Arm upcharge:	+0	+40	+72	+118	+183	+210	+267	+355	+422	+494	+645	+804
		Seat upcharge:	+0	+24	+43	+71	+110	+126	+160	+213	+253	+297	+387	+483





DESCRIPTION	MODEL#/ FEATURES	STANDARD TEXTILE GRADES																				
		1/COM	2	3	4	5	6	7	8	9	10	11	12									
 <p>Side Chairs, 4 Leg Wood Base, Arm Patches COM Yardage: Back/Arms: 1.25; Seat: .75 COM Yardage "F" Model: Back/Arms: 1.25; Seat 1 Freight Class: 250 Product Weight (lbs.): 28 Cubic Feet Per Carton: 13.25</p>	8030P	Base Price:	\$1647																			
		Back/Arm upcharge:	+0	+40	+72	+118	+183	+210	+267	+355	+422	+494	+645	+804								
		Seat upcharge:	+0	+24	+43	+71	+110	+126	+160	+213	+253	+297	+387	+483								
	8030PF	Base Price:	\$1892																			
		Back/Arm upcharge:	+0	+40	+72	+118	+183	+210	+267	+355	+422	+494	+645	+804								
		Seat upcharge:	+0	+32	+57	+94	+146	+168	+213	+284	+337	+395	+516	+643								
		OVERALL DIMENSIONS	W	D	H	SEAT DIMENSIONS			W	D	H	BACK DIMENSIONS		W	H							
		"F" model = Flip Forward Seat for ease of cleaning	24.5	23	31	18	17.5	18	15	13												
		Add \$54 for (SBS) Add \$27 for (SSS); \$44 (F model)																				
 <p>Side Chair, Wood Swivel Base COM Yardage: Back/Arms: 1.25; Seat: .75 COM Yardage "F" Model: Back/Arms: 1.25; Seat 1 Freight Class: 300 Product Weight (lbs.): 31 Cubic Feet Per Carton: 15.75</p>	8031	Base Price:	\$1883																			
		Back/Arm upcharge:	+0	+40	+72	+118	+183	+210	+267	+355	+422	+494	+645	+804								
		Seat upcharge:	+0	+24	+43	+71	+110	+126	+160	+213	+253	+297	+387	+483								
	8031F	Base Price:	\$2128																			
		Back/Arm upcharge:	+0	+40	+72	+118	+183	+210	+267	+355	+422	+494	+645	+804								
		Seat upcharge:	+0	+32	+57	+94	+146	+168	+213	+284	+337	+395	+516	+643								
		OVERALL DIMENSIONS	W	D	H	SEAT DIMENSIONS			W	D	H	BACK DIMENSIONS		W	H							
		"F" model = Flip Forward Seat for ease of cleaning	24.5	23	31	18	17.5	18	15	13												
		Add \$36 for (SBS) Add \$27 for (SSS); \$44 (F model)																				
 <p>Side Chair, Wood Swivel Base, Arm Patches COM Yardage: Back/Arms: 1.25; Seat: .75 COM Yardage "F" Model: Back/Arms: 1.25; Seat 1 Freight Class: 250 Product Weight (lbs.): 33 Cubic Feet Per Carton: 13.25</p>	8031P	Base Price:	\$1908																			
		Back/Arm upcharge:	+0	+40	+72	+118	+183	+210	+267	+355	+422	+494	+645	+804								
		Seat upcharge:	+0	+24	+43	+71	+110	+126	+160	+213	+253	+297	+387	+483								
	8031PF	Base Price:	\$2153																			
		Back/Arm upcharge:	+0	+40	+72	+118	+183	+210	+267	+355	+422	+494	+645	+804								
		Seat upcharge:	+0	+32	+57	+94	+146	+168	+213	+284	+337	+395	+516	+643								
		OVERALL DIMENSIONS	W	D	H	SEAT DIMENSIONS			W	D	H	BACK DIMENSIONS		W	H							
		"F" model = Flip Forward Seat for ease of cleaning	24.5	23	31	18	17.5	18	15	13												
		Add \$54 for (SBS) Add \$27 for (SSS); \$44 (F model)																				
 <p>Side Chair, Chrome Swivel Base COM Yardage: Back/Arms: 1.25; Seat: .75 COM Yardage "F" Model: Back/Arms: 1.25; Seat 1 Freight Class: 300 Product Weight (lbs.): 31 Cubic Feet Per Carton: 15.75</p>	8032	Base Price:	\$1927																			
		Back/Arm upcharge:	+0	+40	+72	+118	+183	+210	+267	+355	+422	+494	+645	+804								
		Seat upcharge:	+0	+24	+43	+71	+110	+126	+160	+213	+253	+297	+387	+483								
	8032F	Base Price:	\$2172																			
		Back/Arm upcharge:	+0	+32	+57	+94	+146	+168	+213	+284	+337	+395	+516	+643								
		Seat upcharge:	+0	+40	+72	+118	+183	+210	+267	+355	+422	+494	+645	+804								
		OVERALL DIMENSIONS	W	D	H	SEAT DIMENSIONS			W	D	H	BACK DIMENSIONS		W	H							
		"F" model = Flip Forward Seat for ease of cleaning	24.5	23	31	18	17.5	18	15	13												
		Add \$36 for (SBS) Add \$27 for (SSS); \$44 (F model)																				





DESCRIPTION	MODEL#/ FEATURES	STANDARD TEXTILE GRADES												
		1/COM	2	3	4	5	6	7	8	9	10	11	12	
 <p>Side Chair, Chrome Swivel Base, Arm Patches COM Yardage: Back/Arms: 1.25; Seat: .75 COM Yardage "F" Model: Back/Arms: 1.25; Seat: 1 Freight Class: 250 Product Weight (lbs.): 33 Cubic Feet Per Carton: 13.25</p>	8032P	Base Price:	\$1952											
	Back/Arm upcharge:	+0	+24	+43	+71	+110	+126	+160	+213	+253	+297	+387	+483	
	Seat upcharge:	+0	+40	+72	+118	+183	+210	+267	+355	+422	+494	+645	+804	
	8032PF	Base Price:	\$2196											
	Back/Arm upcharge:	+0	+40	+72	+118	+183	+210	+267	+355	+422	+494	+645	+804	
	Seat upcharge:	+0	+32	+57	+94	+146	+168	+213	+284	+337	+395	+516	+643	
	OVERALL DIMENSIONS		W	D	H	SEAT DIMENSIONS			BACK DIMENSIONS					
			24.5	23	31	W	D	H	W	H				
	"F" model = Flip Forward Seat for ease of cleaning		24.5	23	31	18	17.5	18	15	13				
	Add \$54 for (SBS) Add \$27 for (SSS); \$44 (F model)					RTA 00			1 per carton					
 <p>Side Chair, High 4 Star Swivel Base COM Yardage: Back/Arms: 1.25; Seat: .75 Freight Class: 300 Product Weight (lbs.): 31 Cubic Feet Per Carton: 15.75</p>	8021	Base Price:	\$1894											
	Back/Arm upcharge:	+0	+40	+72	+118	+183	+210	+267	+355	+422	+494	+645	+804	
	Seat upcharge:	+0	+24	+43	+71	+110	+126	+160	+213	+253	+297	+387	+483	
	OVERALL DIMENSIONS		W	D	H	SEAT DIMENSIONS			BACK DIMENSIONS					
			24.5	23	32	W	D	H	W	H				
	Fixed seat cushion only.		24.5	23	32	18	17.5	18.5	15	13				
	Add \$36 for (SBS) Add \$27 for (SSS)					RTA 00			1 per carton					
	 <p>Side Chair, High 4 Star Swivel Base, Arm Patches COM Yardage: Back/Arms: 1.25; Seat: .75 Freight Class: 250 Product Weight (lbs.): 35.5 Cubic Feet Per Carton: 13.25</p>	8021P	Base Price:	\$1919										
		Back/Arm upcharge:	+0	+40	+72	+118	+183	+210	+267	+355	+422	+494	+645	+804
		Seat upcharge:	+0	+24	+43	+71	+110	+126	+160	+213	+253	+297	+387	+483
OVERALL DIMENSIONS		W	D	H	SEAT DIMENSIONS			BACK DIMENSIONS						
		24.5	23	32	W	D	H	W	H					
Fixed seat cushion only.		24.5	23	32	18	17.5	18.5	15	13					
Add \$354 for (SBS) Add \$27 for (SSS)					RTA 00			1 per carton						
 <p>Side Chair, Swivel Tilt, 5 Star Base and Casters COM Yardage: Back/Arms: 1.25; Seat: .75 Freight Class: 300 Product Weight (lbs.): 31 Cubic Feet Per Carton: 15.75</p>		8022	Base Price:	\$2065										
		Back/Arm upcharge:	+0	+40	+72	+118	+183	+210	+267	+355	+422	+494	+645	+804
		Seat upcharge:	+0	+24	+43	+71	+110	+126	+160	+213	+253	+297	+387	+483
	OVERALL DIMENSIONS		W	D	H	SEAT DIMENSIONS			BACK DIMENSIONS					
			24.5	23	32.5	W	D	H	W	H				
	Tilting mechanism with tilt lock. Fixed seat cushion only.		24.5	23	32.5	18	17.5	15	15	13				
	Add \$36 for (SBS) Add \$27 for (SSS)					RTA 00			1 per carton					





DESCRIPTION	MODEL#/ FEATURES	STANDARD TEXTILE GRADES												
		1/COM	2	3	4	5	6	7	8	9	10	11	12	
 <p>Side Chair, Swivel Tilt, 5 Star Base, Arm Patches and Casters COM Yardage: Back/Arms: 1.25; Seat: .75 Freight Class: 250 Product Weight (lbs.): 37.5 Cubic Feet Per Carton: 15.75</p>	8022P Base Price: \$2090 Back/Arm upcharge: +0 Seat upcharge: +0													
	Tilting mechanism with tilt lock. Fixed seat cushion only.	24.5	23	32.5	18	17.5	15	15	13					
	Add \$54 for (SBS) Add \$27 for (SSS)													
		RTA 00	1 per carton											
 <p>Low Back Lounge Chair, Sled Base COM Yardage: Back/Arms: 2.25; Seat: 1 COM Yardage "F" Model: Back/Arms: 2.25; Seat: 1.25 Freight Class: 250 Product Weight (lbs.): 52 Cubic Feet Per Carton: 19.25</p>	8024 Base Price: \$2191 Back/Arm upcharge: +0 Seat upcharge: +0													
	"F" model = Flip Forward Seat for ease of cleaning	29	30	33	21.5	20	17	21	16					
	Add \$75 for (SBS) Add \$32 for (SSS); \$48 (F model)													
		RTA 00	1 per carton											
 <p>Low Back Lounge Chair, Sled Base, Arm Patches COM Yardage: Back/Arms: 2.25; Seat: 1 COM Yardage "F" Model: Back/Arms: 2.25; Seat: 1.25 Freight Class: 250 Product Weight (lbs.): 52 Cubic Feet Per Carton: 19.25</p>	8024P Base Price: \$2216 Back/Arm upcharge: +0 Seat upcharge: +0													
	"F" model = Flip Forward Seat for ease of cleaning	29	30	33	21.5	20	17	21	16					
	Add \$39 for (SBS) Add \$32 for (SSS); \$48 (F model)													
		RTA 00	1 per carton											
 <p>Low Back Lounge Chair, 4 Leg Wood Base COM Yardage: Back/Arms: 2.25; Seat: 1 COM Yardage "F" Model: Back/Arms: 2.75; Seat: 1.25 Freight Class: 250 Product Weight (lbs.): 53.5 Cubic Feet Per Carton: 19</p>	8025 Base Price: \$2884 Back/Arm upcharge: +0 Seat upcharge: +0													
	"F" model = Flip Forward Seat for ease of cleaning	29	30	33	21.5	20	17	21	16					
	Add \$75 for (SBS) Add \$32 for (SSS); \$48 (F model)													
		RTA 00	1 per carton											
 <p>Low Back Lounge Chair, 4 Leg Wood Base COM Yardage: Back/Arms: 2.25; Seat: 1 COM Yardage "F" Model: Back/Arms: 2.75; Seat: 1.25 Freight Class: 250 Product Weight (lbs.): 53.5 Cubic Feet Per Carton: 19</p>	8024PF Base Price: \$2467 Back/Arm upcharge: +0 Seat upcharge: +0													
	"F" model = Flip Forward Seat for ease of cleaning	29	30	33	21.5	20	17	21	16					
	Add \$39 for (SBS) Add \$32 for (SSS); \$48 (F model)													
		RTA 00	1 per carton											
 <p>Low Back Lounge Chair, 4 Leg Wood Base COM Yardage: Back/Arms: 2.25; Seat: 1 COM Yardage "F" Model: Back/Arms: 2.75; Seat: 1.25 Freight Class: 250 Product Weight (lbs.): 53.5 Cubic Feet Per Carton: 19</p>	8025F Base Price: \$3135 Back/Arm upcharge: +0 Seat upcharge: +0													
	"F" model = Flip Forward Seat for ease of cleaning	29	30	33	21.5	20	17	21	16					
	Add \$75 for (SBS) Add \$32 for (SSS); \$48 (F model)													
		RTA 00	1 per carton											





DESCRIPTION	MODEL#/ FEATURES	STANDARD TEXTILE GRADES													
		1/COM	2	3	4	5	6	7	8	9	10	11	12		
 <p>Low Back Lounge Chair, 4 Leg Wood Base, Arm Patches COM Yardage: Back/Arms: 2.25; Seat: 1 COM Yardage "F" Model: Back/Arms: 2.75; Seat: 1.25 Freight Class: 250 Product Weight (lbs.): 53.5 Cubic Feet Per Carton: 19</p>	8025P	Base Price:	\$2909												
	Back/Arm upcharge:	+0	+72	+129	+212	+329	+378	+480	+639	+759	+889	+1161	+1447		
	Seat upcharge:	+0	+32	+57	+94	+146	+168	+213	+284	+337	+395	+516	+643		
	8025PF	Base Price:	\$3160												
	Back/Arm upcharge:	+0	+88	+157	+259	+402	+462	+586	+781	+927	+1087	+1419	+1769		
	Seat upcharge:	+0	+40	+72	+118	+183	+210	+267	+355	+422	+494	+645	+804		
	OVERALL DIMENSIONS		W	D	H	SEAT DIMENSIONS			W	D	H	BACK DIMENSIONS		W	H
			29	30	33	21.5	20	17	21	16					
	"F" model = Flip Forward Seat for ease of cleaning Add \$93 for (SBS) Add \$32 for (SSS); \$48 (F model)					RTA 00		1 per carton							
	 <p>Low Back Lounge Chair, Wood Swivel Base COM Yardage: Back: 2.25; Seat: 1 COM Yardage "F" Model: Back/Arms: 2.75; Seat: 1.25 Freight Class: 250 Product Weight (lbs.): 53 Cubic Feet Per Carton: 19</p>	8033	Base Price:	\$2640											
Back/Arm upcharge:		+0	+72	+129	+212	+329	+378	+480	+639	+759	+889	+1161	+1447		
Seat upcharge:		+0	+32	+57	+94	+146	+168	+213	+284	+337	+395	+516	+643		
8033F		Base Price:	\$2891												
Back/Arm upcharge:		+0	+88	+157	+259	+402	+462	+586	+781	+927	+1087	+1419	+1769		
Seat upcharge:		+0	+40	+72	+118	+183	+210	+267	+355	+422	+494	+645	+804		
OVERALL DIMENSIONS		W	D	H	SEAT DIMENSIONS			W	D	H	BACK DIMENSIONS		W	H	
		29	30	33	21.5	20	17	21	16						
"F" model = Flip Forward Seat for ease of cleaning Add \$75 for (SBS) Add \$32 for (SSS); \$48 (F model)					RTA 00		per carton								
 <p>Low Back Lounge Chair, Wood Swivel Base, Arm Patches COM Yardage: Back: 2.25; Seat: 1 COM Yardage "F" Model: Back/Arms: 2.75; Seat: 1.25 Freight Class: 250 Product Weight (lbs.): 53 Cubic Feet Per Carton: 19</p>		8033P	Base Price:	\$2665											
	Back/Arm upcharge:	+0	+72	+129	+212	+329	+378	+480	+639	+759	+889	+1161	+1447		
	Seat upcharge:	+0	+32	+57	+94	+146	+168	+213	+284	+337	+395	+516	+643		
	8033PF	Base Price:	\$2917												
	Back/Arm upcharge:	+0	+88	+157	+259	+402	+462	+586	+781	+927	+1087	+1419	+1769		
	Seat upcharge:	+0	+40	+72	+118	+183	+210	+267	+355	+422	+494	+645	+804		
	OVERALL DIMENSIONS		W	D	H	SEAT DIMENSIONS			W	D	H	BACK DIMENSIONS		W	H
			29	30	33	21.5	20	17	21	16					
	"F" model = Flip Forward Seat for ease of cleaning Add \$93 for (SBS) Add \$32 for (SSS); \$48 (F model)					RTA 00		per carton							
	 <p>Low Back Lounge Chair, Chrome Swivel Base COM Yardage: Back: 2.25; Seat: 1 COM Yardage "F" Model: Back/Arms: 2.75; Seat: 1.25 Freight Class: 250 Product Weight (lbs.): 59 Cubic Feet Per Carton: 19.25</p>	8034	Base Price:	\$2652											
Back/Arm upcharge:		+0	+72	+129	+212	+329	+378	+480	+639	+759	+889	+1161	+1447		
Seat upcharge:		+0	+32	+57	+94	+146	+168	+213	+284	+337	+395	+516	+643		
8034F		Base Price:	\$2903												
Back/Arm upcharge:		+0	+88	+129	+259	+402	+462	+586	+781	+927	+1087	+1419	+1769		
Seat upcharge:		+0	+40	+72	+118	+183	+210	+267	+355	+422	+494	+645	+804		
OVERALL DIMENSIONS		W	D	H	SEAT DIMENSIONS			W	D	H	BACK DIMENSIONS		W	H	
		29	30	33	21.5	20	17	21	16						
"F" model = Flip Forward Seat for ease of cleaning Add \$75 for (SBS) Add \$32 for (SSS); \$48 (F model)					RTA 00		1 per carton								





DESCRIPTION	MODEL#/ FEATURES	STANDARD TEXTILE GRADES											
		1/COM	2	3	4	5	6	7	8	9	10	11	12
 <p>Low Back Lounge Chair, Chrome Swivel Base, Arm Patches COM Yardage: Back: 2.25; Seat: 1 COM Yardage "F" Model: Back/Arms: 2.75; Seat: 1.25 Freight Class: 250 Product Weight (lbs.): 59 Cubic Feet Per Carton: 19.25</p>	8034P Base Price:	\$2677											
	Back/Arm upcharge:	+0	+72	+129	+212	+329	+378	+480	+639	+759	+889	+1161	+1447
	Seat upcharge:	+0	+32	+57	+94	+146	+168	+213	+284	+337	+395	+516	+643
	8034PF Base Price:	\$2928											
	Back/Arm upcharge:	+0	+88	+157	+259	+402	+462	+586	+781	+927	+1087	+1419	+1769
	Seat upcharge:	+0	+40	+72	+118	+183	+210	+267	+355	+422	+494	+645	+804
		OVERALL DIMENSIONS		W	D	H	SEAT DIMENSIONS				BACK DIMENSIONS		
			29	30	33	21.5	20	17		21	16		
		"F" model = Flip Forward Seat for ease of cleaning											
		Add \$93 for (SBS) Add \$32 for (SSS); \$48 (F model)											
 <p>Mid Back Lounge Chair, Sled Base COM Yardage: Back: 2.5; Seat: 1 COM Yardage "F" Model: Back/Arms: 3; Seat: 1.25 Freight Class: 250 Product Weight (lbs.): 52 Cubic Feet Per Carton: 25.5</p>	8016 Base Price:	\$2437											
	Back/Arm upcharge:	+0	+80	+143	+235	+365	+420	+533	+710	+843	+988	+1290	+1608
	Seat upcharge:	+0	+32	+57	+94	+146	+168	+213	+284	+337	+395	+516	+643
	8016F Base Price:	\$2688											
	Back/Arm upcharge:	+0	+96	+171	+282	+438	+504	+639	+852	+1011	+1185	+1548	+1929
	Seat upcharge:	+0	+40	+72	+118	+183	+210	+267	+355	+422	+494	+645	+804
		OVERALL DIMENSIONS		W	D	H	SEAT DIMENSIONS				BACK DIMENSIONS		
			29	31.5	38.5	21.5	20	17		21	21.5		
		"F" model = Flip Forward Seat for ease of cleaning											
		Add \$81 for (SBS) Add \$32 for (SSS); \$48 (F model)											
 <p>Mid Back Lounge Chair, Sled Base, Arm Patches COM Yardage: Back: 2.5; Seat: 1 COM Yardage "F" Model: Back/Arms: 3; Seat: 1.25 Freight Class: 250 Product Weight (lbs.): 52 Cubic Feet Per Carton: 25.5</p>	8016P Base Price:	\$2462											
	Back/Arm upcharge:	+0	+80	+143	+235	+365	+420	+533	+710	+843	+988	+1290	+1608
	Seat upcharge:	+0	+32	+57	+94	+146	+168	+213	+284	+337	+395	+516	+643
	8016PF Base Price:	\$2713											
	Back/Arm upcharge:	+0	+96	+171	+282	+438	+504	+639	+852	+1011	+1185	+1548	+1929
	Seat upcharge:	+0	+40	+72	+94	+183	+210	+267	+355	+422	+494	+645	+804
		OVERALL DIMENSIONS		W	D	H	SEAT DIMENSIONS				BACK DIMENSIONS		
			29	31.5	38.5	21.5	20	17		21	21.5		
		"F" model = Flip Forward Seat for ease of cleaning											
		Add \$99 for (SBS) Add \$32 for (SSS); \$48 (F model)											
 <p>Mid Back Lounge Chair, 4 Leg Wood Base COM Yardage: Back: 2.5; Seat: 1 COM Yardage "F" Model: Back/Arms: 3; Seat: 1.25 Freight Class: 250 Product Weight (lbs.): 53.5 Cubic Feet Per Carton: 25.5</p>	8027 Base Price:	\$3120											
	Back/Arm upcharge:	+0	+80	+143	+235	+365	+420	+533	+710	+843	+988	+1290	+1608
	Seat upcharge:	+0	+32	+57	+94	+146	+168	+213	+284	+337	+395	+516	+643
	8027F Base Price:	\$3371											
	Back/Arm upcharge:	+0	+96	+171	+282	+438	+504	+639	+852	+1011	+1185	+1548	+1929
	Seat upcharge:	+0	+40	+72	+118	+183	+210	+267	+355	+422	+494	+645	+804
		OVERALL DIMENSIONS		W	D	H	SEAT DIMENSIONS				BACK DIMENSIONS		
			29	31.5	38.5	21.5	20	17		21	21.5		
		"F" model = Flip Forward Seat for ease of cleaning											
		Add \$81 for (SBS) Add \$32 for (SSS); \$48 (F model)											

DESCRIPTION	MODEL#/ FEATURES	STANDARD TEXTILE GRADES													
		1/COM	2	3	4	5	6	7	8	9	10	11	12		
 <p>Mid Back Lounge Chair, 4 Leg Wood Base, Arm Patches COM Yardage: Back: 2.5; Seat: 1 COM Yardage "F" Model: Back/Arms: 3; Seat: 1.25 Freight Class: 250 Product Weight (lbs.): 53.5 Cubic Feet Per Carton: 25.5</p>	8027P	Base Price:	\$3145												
	Back/Arm upcharge:	+0	+80	+143	+235	+365	+420	+533	+710	+843	+988	+1290	+1608		
	Seat upcharge:	+0	+32	+57	+94	+146	+168	+213	+284	+337	+395	+516	+643		
	8027PF	Base Price:	\$3396												
	Back/Arm upcharge:	+0	+96	+171	+282	+438	+504	+639	+852	+1011	+1185	+1548	+1929		
	Seat upcharge:	+0	+40	+72	+118	+183	+210	+267	+355	+422	+494	+645	+804		
	OVERALL DIMENSIONS		W	D	H	SEAT DIMENSIONS			W	D	H	BACK DIMENSIONS		W	H
			29	31.5	38.5	21.5	20	17				21	21.5		
	"F" model = Flip Forward Seat for ease of cleaning														
	Add \$99 for (SBS) Add \$32 for (SSS); \$48 (F model)					RTA 00									1 per carton
 <p>Mid Back Lounge Chair, Wood Swivel Base COM Yardage: Back: 2.5; Seat: 1 COM Yardage "F" Model: Back/Arms: 3; Seat: 1.25 Freight Class: 250 Product Weight (lbs.): 54 Cubic Feet Per Carton: 25.5</p>	8035	Base Price:	\$2745												
	Back/Arm upcharge:	+0	+80	+143	+235	+365	+420	+533	+710	+843	+988	+1290	+1608		
	Seat upcharge:	+0	+32	+57	+94	+146	+168	+213	+284	+337	+395	+516	+643		
	8035F	Base Price:	\$2996												
	Back/Arm upcharge:	+0	+96	+171	+282	+438	+504	+639	+852	+1011	+1185	+1548	+1929		
	Seat upcharge:	+0	+40	+72	+118	+183	+210	+267	+355	+422	+494	+645	+804		
	OVERALL DIMENSIONS		W	D	H	SEAT DIMENSIONS			W	D	H	BACK DIMENSIONS		W	H
			29	31.5	38.5	21.5	20	17				21	21.5		
	"F" model = Flip Forward Seat for ease of cleaning														
	Add \$81 for (SBS) Add \$32 for (SSS); \$48 (F model)					RTA 00									1 per carton
 <p>Mid Back Lounge Chair, Wood Swivel Base, Arm Patches COM Yardage: Back: 2.5; Seat: 1 COM Yardage "F" Model: Back/Arms: 3; Seat: 1.25 Freight Class: 250 Product Weight (lbs.): 54 Cubic Feet Per Carton: 25.5</p>	8035P	Base Price:	\$2770												
	Back/Arm upcharge:	+0	+80	+143	+235	+365	+420	+533	+710	+843	+988	+1290	+1608		
	Seat upcharge:	+0	+32	+57	+94	+146	+168	+213	+284	+337	+395	+516	+643		
	8035PF	Base Price:	\$3021												
	Back/Arm upcharge:	+0	+96	+171	+282	+438	+504	+639	+852	+1011	+1185	+1548	+1929		
	Seat upcharge:	+0	+40	+72	+118	+183	+210	+267	+355	+422	+494	+645	+804		
	OVERALL DIMENSIONS		W	D	H	SEAT DIMENSIONS			W	D	H	BACK DIMENSIONS		W	H
			29	31.5	38.5	21.5	20	17				21	21.5		
	"F" model = Flip Forward Seat for ease of cleaning														
	Add \$99 for (SBS) Add \$32 for (SSS); \$48 (F model)					RTA 00									1 per carton
 <p>Mid Back Lounge Chair, Chrome Swivel Base COM Yardage: Back: 2.5; Seat: 1 COM Yardage "F" Model: Back/Arms: 3; Seat: 1.25 Freight Class: 250 Product Weight (lbs.): 60 Cubic Feet Per Carton: 25.5</p>	8036	Base Price:	\$2762												
	Back/Arm upcharge:	+0	+80	+143	+235	+365	+420	+533	+710	+843	+988	+1290	+1608		
	Seat upcharge:	+0	+32	+57	+94	+146	+168	+213	+284	+337	+395	+516	+643		
	8036F	Base Price:	\$3013												
	Back/Arm upcharge:	+0	+96	+171	+282	+438	+504	+639	+852	+1011	+1185	+1548	+1929		
	Seat upcharge:	+0	+40	+72	+118	+183	+210	+267	+355	+422	+494	+645	+804		
	OVERALL DIMENSIONS		W	D	H	SEAT DIMENSIONS			W	D	H	BACK DIMENSIONS		W	H
			29	31.5	38.5	21.5	20	17				21	21.5		
	"F" model = Flip Forward Seat for ease of cleaning														
	Add \$81 for (SBS) Add \$32 for (SSS); \$48 (F model)					RTA 00									1 per carton

DESCRIPTION	MODEL#/ FEATURES	STANDARD TEXTILE GRADES											
		1/COM	2	3	4	5	6	7	8	9	10	11	12
 <p>Mid Back Lounge Chair, Chrome Swivel Base, Arm Patches COM Yardage: Back: 2.5; Seat: 1 COM Yardage "F" Model: Back/Arms: 3; Seat: 1.25 Freight Class: 250 Product Weight (lbs.): 60 Cubic Feet Per Carton: 25.5</p>	<p>8036P Base Price: \$2787 Back/Arm upcharge: +0 Seat upcharge: +0</p>	+80	+143	+235	+365	+420	+533	+710	+843	+988	+1290	+1608	
	<p>8036PF Base Price: \$3038 Back/Arm upcharge: +0 Seat upcharge: +0</p>	+96	+171	+282	+438	+504	+639	+852	+1011	+1185	+1548	+1929	
	OVERALL DIMENSIONS			SEAT DIMENSIONS			BACK DIMENSIONS						
	W D H			W D H			W H						
	29 31.5 38.5			21.5 20 17			21 21.5						
	"F" model = Flip Forward Seat for ease of cleaning			RTA 00			1 per carton						
	Add \$99 for (SBS) Add \$32 for (SSS); \$48 (F model)												
	 <p>High Back Lounge Chair, Sled Base COM Yardage: Back: 2.75; Seat: 1 COM Yardage "F" Model: Back/Arms: 3.25; Seat: 1.25 Freight Class: 300 Product Weight (lbs.): 56 Cubic Feet Per Carton: 28.25</p>	<p>8028 Base Price: \$2778 Back/Arm upcharge: +0 Seat upcharge: +0</p>	+88	+157	+259	+402	+462	+586	+781	+927	+1087	+1419	+1769
		<p>8028F Base Price: \$3029 Back/Arm upcharge: +0 Seat upcharge: +0</p>	+104	+186	+306	+475	+546	+693	+923	+1096	+1284	+1677	+2090
		OVERALL DIMENSIONS			SEAT DIMENSIONS			BACK DIMENSIONS					
W D H			W D H			W H							
29 31.5 44.5			21.5 20 17			21 27.5							
"F" model = Flip Forward Seat for ease of cleaning			RTA 00			1 per carton							
Add \$84 for (SBS) Add \$32 for (SSS); \$48 (F model)													
 <p>High Back Lounge Chair, Sled Base, Arm Patches COM Yardage: Back: 2.75; Seat: 1 COM Yardage "F" Model: Back/Arms: 3.25; Seat: 1.25 Freight Class: 300 Product Weight (lbs.): 56 Cubic Feet Per Carton: 28.25</p>		<p>8028P Base Price: \$2829 Back/Arm upcharge: +0 Seat upcharge: +0</p>	+88	+157	+259	+402	+462	+586	+781	+927	+1087	+1419	+1769
		<p>8028PF Base Price: \$3080 Back/Arm upcharge: +0 Seat upcharge: +0</p>	+104	+186	+306	+475	+546	+693	+923	+1096	+1284	+1677	+2090
		OVERALL DIMENSIONS			SEAT DIMENSIONS			BACK DIMENSIONS					
	W D H			W D H			W H						
	29 31.5 44.5			21.5 20 17			21 27.5						
	"F" model = Flip Forward Seat for ease of cleaning			RTA 00			1 per carton						
	Add \$102 for (SBS) Add \$32 for (SSS); \$48 (F model)												
	 <p>High Back Lounge Chair, Sled Base, Arm and Head Patches COM Yardage: Back: 2.75; Seat: 1 COM Yardage "F" Model: Back/Arms: 3.25; Seat: 1.25 Freight Class: 300 Product Weight (lbs.): 56 Cubic Feet Per Carton: 28.25</p>	<p>8028PH Base Price: \$2879 Back/Arm upcharge: +0 Seat upcharge: +0</p>	+88	+157	+259	+402	+462	+586	+781	+927	+1087	+1419	+1769
		<p>8028PHF Base Price: \$3130 Back/Arm upcharge: +0 Seat upcharge: +0</p>	+104	+186	+306	+475	+546	+693	+923	+1096	+1284	+1677	+2090
		OVERALL DIMENSIONS			SEAT DIMENSIONS			BACK DIMENSIONS					
W D H			W D H			W H							
29 31.5 44.5			21.5 20 17			21 27.5							
"F" model = Flip Forward Seat for ease of cleaning			RTA 00			1 per carton							
Add \$123 for (SBS) Add \$32 for (SSS); \$48 (F model)													

DESCRIPTION	MODEL#/ FEATURES	STANDARD TEXTILE GRADES												
		1/COM	2	3	4	5	6	7	8	9	10	11	12	
	8029 Base Price:	\$3477												
	Back/Arm upcharge:	+0	+88	+157	+259	+402	+462	+586	+781	+927	+1087	+1419	+1769	
	Seat upcharge:	+0	+32	+57	+94	+146	+168	+213	+284	+337	+395	+516	+643	
	8029F Base Price:	\$3728												
	Back/Arm upcharge:	+0	+104	+186	+306	+475	+546	+693	+923	+1096	+1284	+1677	+2090	
	Seat upcharge:	+0	+40	+72	+118	+183	+210	+267	+355	+422	+494	+645	+804	
	OVERALL DIMENSIONS													
	W D H		29	31.5	44.5									
	"F" model = Flip Forward Seat for ease of cleaning													
	Add \$84 for (SBS) Add \$32 for (SSS); \$48 (F model)													
	8029P Base Price:	\$3527												
	Back/Arm upcharge:	+0	+88	+157	+259	+402	+462	+586	+781	+927	+1087	+1419	+1769	
	Seat upcharge:	+0	+32	+57	+94	+146	+168	+213	+284	+337	+395	+516	+643	
	8029PF Base Price:	\$3778												
	Back/Arm upcharge:	+0	+104	+186	+306	+475	+546	+693	+923	+1096	+1284	+1677	+2090	
	Seat upcharge:	+0	+40	+72	+118	+183	+210	+267	+355	+422	+494	+645	+804	
	OVERALL DIMENSIONS													
	W D H		29	31.5	44.5									
	"F" model = Flip Forward Seat for ease of cleaning													
	Add \$102 for (SBS) Add \$32 for (SSS); \$48 (F model)													
	8029PH Base Price:	\$3577												
	Back/Arm upcharge:	+0	+88	+157	+259	+402	+462	+586	+781	+927	+1087	+1419	+1769	
	Seat upcharge:	+0	+32	+57	+94	+146	+168	+213	+284	+337	+395	+516	+643	
	8029PHF Base Price:	\$3828												
	Back/Arm upcharge:	+0	+104	+186	+306	+475	+546	+693	+923	+1096	+1284	+1677	+2090	
	Seat upcharge:	+0	+40	+72	+118	+183	+210	+267	+355	+422	+494	+645	+804	
	OVERALL DIMENSIONS													
	W D H		29	31.5	44.5									
	"F" model = Flip Forward Seat for ease of cleaning													
	Add \$123 for (SBS) Add \$32 for (SSS); \$48 (F model)													
	8037 Base Price:	\$3000												
	Back/Arm upcharge:	+0	+88	+157	+259	+402	+462	+586	+781	+927	+1087	+1419	+1769	
	Seat upcharge:	+0	+32	+57	+94	+146	+168	+213	+284	+337	+395	+516	+643	
	8037F Base Price:	\$3251												
	Back/Arm upcharge:	+0	+104	+186	+306	+475	+546	+693	+923	+1096	+1284	+1677	+2090	
	Seat upcharge:	+0	+40	+72	+118	+183	+210	+267	+355	+422	+494	+645	+804	
	OVERALL DIMENSIONS													
	W D H		29	31.5	44.5									
	"F" model = Flip Forward Seat for ease of cleaning													
	Add \$84 for (SBS) Add \$32 for (SSS); \$48 (F model)													

DESCRIPTION	MODEL#/ FEATURES	STANDARD TEXTILE GRADES											
		1/COM	2	3	4	5	6	7	8	9	10	11	12
	8037P Base Price:	\$3050											
	Back/Arm upcharge:	+0	+88	+157	+259	+402	+462	+586	+781	+927	+1087	+1419	+1769
	Seat upcharge:	+0	+32	+57	+94	+146	+168	+213	+284	+337	+395	+516	+643
	8037PF Base Price:	\$3301											
	Back/Arm upcharge:	+0	+104	+186	+306	+475	+546	+693	+923	+1096	+1284	+1677	+2090
	Seat upcharge:	+0	+40	+72	+118	+183	+210	+267	+355	+422	+494	+645	+804
	OVERALL DIMENSIONS			SEAT DIMENSIONS			BACK DIMENSIONS						
	W D H			W D H			W H						
	29 31.5 44.5			21.5 20 17			21 27.5						
	<p>High Back Lounge Chair, Wood Swivel Base, Arm Patches COM Yardage: Back: 2.75; Seat: 1 COM Yardage "F" Model: Back/Arms: 3.25; Seat: 1.25 Freight Class: 250 Product Weight (lbs.): 57 Cubic Feet Per Carton: 28.25</p>		<p>"F" model = Flip Forward Seat for ease of cleaning</p> <p>Add \$102 for (SBS) Add \$32 for (SSS); \$48 (F model)</p>		<p>RTA 00</p>		1 per carton						
	8037PH Base Price:	\$3100											
	Back/Arm upcharge:	+0	+88	+157	+259	+402	+462	+586	+781	+927	+1087	+1419	+1769
	Seat upcharge:	+0	+32	+57	+94	+146	+168	+213	+284	+337	+395	+516	+643
	8037PHF Base Price:	\$3352											
	Back/Arm upcharge:	+0	+104	+186	+306	+475	+546	+693	+923	+1096	+1284	+1677	+2090
	Seat upcharge:	+0	+40	+72	+118	+183	+210	+267	+355	+422	+494	+645	+804
	OVERALL DIMENSIONS			SEAT DIMENSIONS			BACK DIMENSIONS						
	W D H			W D H			W H						
	29 31.5 44.5			21.5 20 17			21 27.5						
	<p>High Back Lounge Chair, Wood Swivel Base, Arm and Head Patches COM Yardage: Back: 2.75; Seat: 1 COM Yardage "F" Model: Back/Arms: 3.25; Seat: 1.25 Freight Class: 250 Product Weight (lbs.): 57 Cubic Feet Per Carton: 28.25</p>		<p>"F" model = Flip Forward Seat for ease of cleaning</p> <p>Add \$132 for (SBS) Add \$32 for (SSS); \$48 (F model)</p>		<p>RTA 00</p>		1 per carton						
	8038 Base Price:	\$3017											
	Back/Arm upcharge:	+0	+88	+157	+259	+402	+462	+586	+781	+927	+1087	+1419	+1769
	Seat upcharge:	+0	+32	+57	+94	+146	+168	+213	+284	+337	+395	+516	+643
	8038F Base Price:	\$3269											
	Back/Arm upcharge:	+0	+104	+186	+306	+475	+546	+693	+923	+1096	+1284	+1677	+2090
	Seat upcharge:	+0	+40	+72	+118	+183	+210	+267	+355	+422	+494	+645	+804
	OVERALL DIMENSIONS			SEAT DIMENSIONS			BACK DIMENSIONS						
	W D H			W D H			W H						
	29 31.5 44.5			21.5 20 17			21 27.5						
	<p>High Back Lounge Chair, Chrome Swivel Base COM Yardage: Back: 2.75; Seat: 1 COM Yardage "F" Model: Back/Arms: 3.25; Seat: 1.25 Freight Class: 250 Product Weight (lbs.): 63 Cubic Feet Per Carton: 28.25</p>		<p>"F" model = Flip Forward Seat for ease of cleaning</p> <p>Add \$84 for (SBS) Add \$32 for (SSS); \$48 (F model)</p>		<p>RTA 00</p>		1 per carton 1 per carton						
	8038P Base Price:	\$3068											
	Back/Arm upcharge:	+0	+88	+157	+259	+402	+462	+586	+781	+927	+1087	+1419	+1769
	Seat upcharge:	+0	+32	+57	+94	+146	+168	+213	+284	+337	+395	+516	+643
	8038PF Base Price:	\$3319											
	Back/Arm upcharge:	+0	+104	+186	+306	+475	+546	+693	+923	+1096	+1284	+1677	+2090
	Seat upcharge:	+0	+40	+72	+118	+183	+210	+267	+355	+422	+494	+645	+804
	OVERALL DIMENSIONS			SEAT DIMENSIONS			BACK DIMENSIONS						
	W D H			W D H			W H						
	29 31.5 44.5			21.5 20 17			21 27.5						
	<p>High Back Lounge Chair, Chrome Swivel Base, Arm Patches COM Yardage: Back: 2.75; Seat: 1 COM Yardage "F" Model: Back/Arms: 3.25; Seat: 1.25 Freight Class: 250 Product Weight (lbs.): 63 Cubic Feet Per Carton: 28.25</p>		<p>"F" model = Flip Forward Seat for ease of cleaning</p> <p>Add \$102 for (SBS) Add \$32 for (SSS); \$48 (F model)</p>		<p>RTA 00</p>		1 per carton 1 per carton						

DESCRIPTION	MODEL#/ FEATURES	STANDARD TEXTILE GRADES													
		1/COM	2	3	4	5	6	7	8	9	10	11	12		
 <p>High Back Lounge Chair, Chrome Swivel Base, Arm and Head Patches COM Yardage: Back: 2.75; Seat: 1 COM Yardage "F" Model: Back/Arms: 3.25; Seat: 1.25 Freight Class: 250 Product Weight (lbs.): 63 Cubic Feet Per Carton: 28.25</p>	8038PH	Base Price:	\$3118												
		Back/Arm upcharge:	+0	+88	+157	+59	+402	+462	+586	+781	+927	+1087	+1419	+1769	
		Seat upcharge:	+0	+32	+57	+94	+146	+168	+213	+284	+337	+395	+516	+643	
	8038PHF	Base Price:	\$3369												
		Back/Arm upcharge:	+0	+104	+186	+306	+475	+546	+693	+923	+1096	+1284	+1677	+2090	
		Seat upcharge:	+0	+40	+72	+118	+183	+210	+267	+355	+422	+494	+645	+804	
		OVERALL DIMENSIONS			SEAT DIMENSIONS			BACK DIMENSIONS							
		W	D	H	W	D	H	W	H						
		29	31.5	44.5		21.5	20	17		21	27.5				
		Add \$123 for (SBS)		Add \$32 for (SSS); \$48 (F model)		RTA 00		1 per carton							
 <p>Counter Stool, Sled Base COM Yardage: Back: 1; Seat: .5 Freight Class: 250 Product Weight (lbs.): 32 Cubic Feet Per Carton: 9</p>	8051	Base Price:	\$1269												
		Back/Arm upcharge:	+0	+32	+57	+94	+146	+168	+213	+284	+337	+395	+516	+643	
		Seat upcharge:	+0	+16	+29	+47	+73	+84	+107	+142	+169	+198	+258	+322	
		OVERALL DIMENSIONS			SEAT DIMENSIONS			BACK DIMENSIONS							
		W	D	H	W	D	H	W	H						
		19.25	19	35		15.5	15.75	24.75		12.5	10				
		Add \$32 for (SBS)		Add \$20 for (SSS)		RTA 00		1 per carton							
	 <p>Counter Stool, Wood Base COM Yardage: Back: 1; Seat: .5 Freight Class: 250 Product Weight (lbs.): 28</p>	8052	Base Price:	\$1988											
			Back/Arm upcharge:	+0	+32	+57	+94	+146	+168	+213	+284	+337	+395	+516	+643
			Seat upcharge:	+0	+16	+29	+47	+73	+84	+107	+142	+169	+198	+258	+322
		OVERALL DIMENSIONS			SEAT DIMENSIONS			BACK DIMENSIONS							
		W	D	H	W	D	H	W	H						
		19.25	19	35		15.5	15.75	24.75		12.5	10				
		Add \$32 for (SBS)		Add \$20 for (SSS)		RTA 00		FedEx		ups		1 per carton			
 <p>Counter Stool, Chrome Swivel Base COM Yardage: Back: 1; Seat: .5 Freight Class: 250 Product Weight (lbs.): 43 Cubic Feet Per Carton: 11.5</p>		8053	Base Price:	\$2419											
			Back/Arm upcharge:	+0	+32	+57	+94	+146	+168	+213	+284	+337	+395	+516	+643
			Seat upcharge:	+0	+16	+29	+47	+73	+84	+107	+142	+169	+198	+258	+322
		OVERALL DIMENSIONS			SEAT DIMENSIONS			BACK DIMENSIONS							
		W	D	H	W	D	H	W	H						
		19.25	20	34.5		15.5	15.75	24.75		12.5	10				
		Add \$32 for (SBS)		Add \$20 for (SSS)		RTA 00		1 per carton							
	 <p>Bar Stool, Sled Base COM Yardage: Back: 1; Seat: .5 Freight Class: 250 Product Weight (lbs.): 34.5 Cubic Feet Per Carton: 11</p>	8054	Base Price:	\$1366											
			Back/Arm upcharge:	+0	+32	+57	+94	+146	+168	+213	+284	+337	+395	+516	+643
			Seat upcharge:	+0	+16	+29	+47	+73	+84	+107	+142	+169	+198	+258	+322
		OVERALL DIMENSIONS			SEAT DIMENSIONS			BACK DIMENSIONS							
		W	D	H	W	D	H	W	H						
		19.25	20	40.25		15.5	15.75	30.25		12.5	10				
		Add \$32 for (SBS)		Add \$20 for (SSS)		RTA 00		1 per carton							

DESCRIPTION	MODEL#/ FEATURES	STANDARD TEXTILE GRADES												
		1/COM	2	3	4	5	6	7	8	9	10	11	12	
 <p>Bar Stool, Wood Base COM Yardage: Back: 1; Seat: .5 Freight Class: 250 Product Weight (lbs.): 30 Cubic Feet Per Carton: 11</p>	8055	Base Price:	\$2084											
		Back/Arm upcharge:	+0	+32	+57	+94	+146	+168	+213	+284	+337	+395	+516	+643
		Seat upcharge:	+0	+16	+29	+47	+73	+84	+107	+142	+169	+198	+258	+322
		OVERALL DIMENSIONS												
		W D H	19.25	20	40	15.5	15.75	30	12.5	10				
		Add \$32 for (SBS)												
		Add \$20 for (SSS)												
					RTA 00	FedEx								
													1 per carton	

 <p>Bar Stool, Chrome Swivel Base COM Yardage: Back: 1; Seat: .5 Freight Class: 250 Product Weight (lbs.): 45.5 Cubic Feet Per Carton: 13.25</p>	8056	Base Price:	\$2514											
		Back/Arm upcharge:	+0	+32	+57	+94	+146	+168	+213	+284	+337	+395	+516	+643
		Seat upcharge:	+0	+16	+29	+47	+73	+84	+107	+142	+169	+198	+258	+322
		OVERALL DIMENSIONS												
		W D H	19.25	20	40	15.5	15.75	30	12.5	10				
		Add \$32 for (SBS)												
		Add \$20 for (SSS)												
					RTA 00									
													1 per carton	

DRIFT TABLES



model 8041R2616C
26"W x 16"H Round Table,
Laminate Surface, Flat Edge,
Chrome Base



model 8042SQ2816I
28"W x 16"H Square Table,
Laminate Surface, Flat Edge,
Sled Base



Model 8042SQ2816W
28"W x 16"H Square Table,
Laminate Surface, Flat Edge
Wood Base



For Drift seating, see page 320

EXAMPLE OF TABLE ORDER CODE:

8041R2616I	TFL	ACJ	TBL	CG
Model Number	Surface Type	Top HPL Finish	Base Finish (Sled Base)	Glide Type (Sled Base)

STANDARD FEATURES

- Tables are available in three shapes, multiple sizes, two edge styles, three top materials and three base types including: sled, wood and polished Chrome bases.
- Table bases are fixed and do not swivel.
- Wood bases are made from beechwood and are available in all standard wood finishes.
- Sled bases are standard in painted metal.
- Chrome base tables are available in polished Chrome only.
- All table tops are available with flat edge. High pressure laminate (HPL) and solid surface top tables are also available with knife edge.
- Laminate flat edge tops are available in either (TFL) 1" thick thermally fused laminate with 2mm edgeband or (HPL) 1-1/16" thick high pressure laminate with 2mm edgeband, with upcharge.
- Laminate knife edge tops are 1-3/16" thick with 2.5mm edgeband, available in high pressure laminate (HPL) only.
- Solid surface tabletops are 1.25" thick, available on models with flat or knife edge. For detailed material information, please reference WilsonArt's Solid Surface collection.
- Wood and Chrome bases are equipped with White non-marking polycarbonate glides suitable for most hard and carpeted floor surfaces.
- Sled bases are available with clear polycarbonate glides, standard.
- Wood and sled bases may be specified with a variety of optional glide types to suit various flooring materials. (See Glide Types for additional glide options and upcharges.)
- Tables are shipped fully assembled.

Add option codes in the following order:

- **Model Number**
Specify model number
- **Surface Type** (Laminate, Flat Edge Tables)
(TFL) Thermally fused laminate
(HPL) High pressure laminate
- **Top Finish** (TFL or HPL laminate, flat edge tables and HPL laminate knife edge tables only)
HPL upcharges apply -see model
(ACJ) Absolute Acajou (ASN) Asian Night
(AWC) Avant Cherry (AWH) Avant Honey
(BLK) Black (BRC) Brushed Cobalt
(BZD) Blizzard (CGY) Custom Grey
(CMB) Clear Maple (DES) Dark Espresso
(DWT) Designer White (FAS) Fashionista
(FCL) First Class (NBL) Noce Biondo
(NGL) Noce Grigio (NEL) Noce Leggero
(NML) Noce Medio
(QTM) Quartered Mahogany
(SBY) Sheer Beauty (SDT) Stonedust
(SOG) Storm Grey (WHE) Walnut Heights
(WHC) White Chocolate (WCR) Winter Cherry
- **Top Finish** (solid surface, flat and knife edge tables)
Grade 1
(SWH) Designer White
Grade 2, Upcharge applicable, see models.
(SBT) Beige Tempest
(SBX) Black Onyx Mirage
(SMG) Milk Glass Spectra
(SFW) Frosty White Mirage
(SHS) Hot Stone
(SNM) Northern Melange
- **Base finish** (sled base models only)
Paint finishes:
(TBL) Black (TTU) Tungsten
(TSH) Shadow (TDW) Designer White
(TNE) Nevada (TLA) Latte
(TKA) Kalua (TMO) Mocha
(TOA) Toast (TFO) Fog
(TIV) Cloud (TSN) Sand
(TFR) Frost (TDJ) Dijon
(TCR) Carrot (TSR) Scarlet
(TCC) Cactus (TBZ) Buzz Blue
(TEG) Eggplant (TIN) Ink

Metallic finish:
(CHM) Chrome. Add \$42
- **Base Finish** (Chrome base only)
(CHM) Chrome
- **Glide Type** (sled base)
(CG) Clear, polycarbonate glide for most floor surfaces (standard)
(XG) No glide for carpeted surfaces, no charge
(SG) Steel cushioned glide for carpeted surface. Add \$34
(RG) Rubber, non-slip glide for most hard floor surfaces. Add \$34
(FG) Felt glide for most hard floor surfaces. Add \$34
- **Glide Type** (wood base)
(NM) White non-marking nylon glide for most surfaces (standard)
(SG) Steel cushioned glides for carpeted surfaces. Add \$34.
(RG) Non-slip rubber glides for most hard floor surfaces. Add \$34.
(FG) Felt glides for most hard floor surfaces. Add \$34.

ROUND LAPTOP TABLES FOR OFFSET BASE



Round Table with Sled Base

MODEL#	DIMENSIONS	FREIGHT CLASS	WT/LBS.	CUBIC FT.	LIST PRICE	HP ADD	GR. 2 ADD
--------	------------	---------------	---------	-----------	------------	--------	-----------

D x W x H

Laminate, flat edge (TFL laminate)

8041R2616I	26 x 26 x 16	250	35	10.25	\$561	\$98	n/a
8041R3016I	30 x 30 x 16	250	44	13	\$591	\$115	n/a
8041R2120I	21 x 21 x 20	250	29	8.75	\$587	\$97	n/a

Laminate, knife edge (HPL laminate)

8041R2616IK	26 x 26 x 16	250	35	10.25	\$1199	n/a	n/a
8041R3016IK	30 x 30 x 16	250	44	13	\$1284	n/a	n/a
8041R2120IK	21 x 21 x 20	250	29	8.75	\$996	n/a	n/a

Solid surface, flat edge

8041R2616ISF	26 x 26 x 16	150	48	10.25	\$2343	n/a	\$158
8041R3016ISF	30 x 30 x 16	150	61	13	\$2522	n/a	\$218
8041R2120ISF	21 x 21 x 20	150	37.5	8.75	\$2204	n/a	\$109

Solid surface, knife edge

8041R2616ISK	26 x 26 x 16	150	48	10.25	\$2397	n/a	\$169
8041R3016ISK	30 x 30 x 16	150	61	13	\$2603	n/a	\$234
8041R2120ISK	21 x 21 x 20	150	37.5	8.75	\$2302	n/a	\$115

Finished height will vary depending on material top. Shipped fully assembled in 1 carton.



Square Table with Sled Base

Laminate, flat edge (TFL laminate)

8042SQ2216I	22 x 22 x 16	150	34	8	\$561	\$98	n/a
8042SQ2816I	28 x 28 x 16	250	44	11.75	\$591	\$115	n/a
8042SQ1920I	19 x 19 x 20	250	29	7.75	\$568	\$88	n/a

Laminate, knife edge (HPL laminate)

8042SQ2216IK	22 x 22 x 16	150	34	8	\$996	n/a	n/a
8042SQ2816IK	28 x 28 x 16	250	44	11.75	\$1248	n/a	n/a
8042SQ1920IK	19 x 19 x 20	250	29	7.75	\$955	n/a	n/a

Solid surface, flat edge

8042SQ2216ISF	22 x 22 x 16	150	39.5	8	\$2065	n/a	\$136
8042SQ2816ISF	28 x 28 x 16	150	62.5	11.75	\$2365	n/a	\$218
8042SQ1920ISF	19 x 19 x 20	150	38	7.75	\$1976	n/a	\$164

Solid surface, knife edge

8042SQ2216ISK	22 x 22 x 16	150	39.5	8	\$2397	n/a	\$164
8042SQ2816ISK	28 x 28 x 16	150	62.5	11.75	\$2819	n/a	\$245
8042SQ1920ISK	19 x 19 x 20	150	38	7.75	\$2302	n/a	\$120

Finished height will vary depending on material top. Shipped fully assembled in 1 carton.

ROUND LAPTOP TABLES FOR OFFSET BASE

MODEL# DIMENSIONS FREIGHT CLASS WT/LBS. CUBIC FT. LIST PRICE HP ADD GR. 2 ADD

D x W x H



Oval Table with Sled Base

Laminate, flat edge (TFL laminate)

80430V2616I	26 x 22 x 16	150	36.5	8.75	\$561	\$98	n/a
80430V3116I	31 x 26 x 16	250	46	11.75	\$591	\$115	n/a
80430V2220I	22 x 18 x 20	250	34	10.75	\$587	\$97	n/a

Laminate, knife edge (HPL laminate)

80430V2616IK	26 x 22 x 16	150	36.5	8.75	\$1199	n/a	n/a
80430V3116IK	31 x 26 x 16	250	46	11.75	\$1365	n/a	n/a
80430V2220IK	22 x 18 x 20	250	34	10.75	\$1113	n/a	n/a

Solid surface, flat edge

80430V2616ISF	26 x 22 x 16	150	42	8.75	\$2343	n/a	\$158
80430V3116ISF	31 x 26 x 16	150	60	11.75	\$2522	n/a	\$218
80430V2220ISF	22 x 18 x 20	250	38	10.75	\$2204	n/a	\$109

Solid surface, knife edge

80430V2616ISK	26 x 22 x 16	150	42	8.75	\$2397	n/a	\$169
80430V3116ISK	31 x 26 x 16	150	60	11.75	\$2603	n/a	\$234
80430V2220ISK	22 x 18 x 20	250	38	10.75	\$2302	n/a	\$115

Finished height will vary depending on material top. Shipped fully assembled in 1 carton.



Round Table with Polished Chrome Base

Laminate, flat edge (TFL laminate)

8041R2616C	26 x 26 x 16	250	38	10.75	\$1058	\$98	n/a
8041R3016C	30 x 30 x 16	250	45	13	\$1088	\$115	n/a

Laminate, knife edge (HPL laminate)

8041R2616CK	26 x 26 x 16	250	38	10.75	\$1696	n/a	n/a
8041R3016CK	30 x 30 x 16	250	45	13	\$1782	n/a	n/a

Solid surface, flat edge

8041R2616CSF	26 x 26 x 16	150	51	10.75	\$2840	n/a	\$158
8041R3016CSF	30 x 30 x 16	150	62.5	13	\$3019	n/a	\$218

Solid surface, knife edge

8041R2616CSK	26 x 26 x 16	150	51	10.75	\$2894	n/a	\$169
8041R3016CSK	30 x 30 x 16	250	31.25	13	\$3101	n/a	\$234

Finished height will vary depending on material top. Shipped fully assembled in 1 carton.



Round Table with Wood Base

Laminate, flat edge (TFL laminate)

8041R2616W	26 x 26 x 16	250	32	10.75	\$1204	\$98	n/a
8041R3016W	30 x 30 x 16	250	40	13	\$1234	\$115	n/a

Laminate, knife edge (HPL laminate)

8041R2616WK	26 x 26 x 16	250	32	10.75	\$1842	n/a	n/a
8041R3016WK	30 x 30 x 16	250	40	13	\$1927	n/a	n/a

Solid surface, flat edge

8041R2616WSF	26 x 26 x 16	150	45.5	10.75	\$2985	n/a	\$158
8041R3016WSF	30 x 30 x 16	150	57.5	13	\$3165	n/a	\$218

Solid surface, knife edge

8041R2616WSK	26 x 26 x 16	150	45.5	10.75	\$3040	n/a	\$169
8041R3016WSK	30 x 30 x 16	150	57.5	13	\$3246	n/a	\$234

Finished height will vary depending on material top. Shipped fully assembled in 1 carton.



ROUND LAPTOP TABLES FOR OFFSET BASE



Square Table with Polished Chrome Base

MODEL# DIMENSIONS FREIGHT CLASS WT/LBS. CUBIC FT. LIST PRICE HP ADD GR. 2 ADD

D x W x H

Laminate, flat edge (TFL laminate)

8042SQ2216C	22.75 x 22.75 x 16	150	36	7.75	\$1058	\$98	n/a
8042SQ2816C	28.5 x 28.5 x 16	250	45	11.5	\$1088	\$115	n/a

Laminate, knife edge (HPL laminate)

8042SQ2216CK	22.75 x 22.75 x 16	150	36	7.75	\$1493	n/a	n/a
8042SQ2816CK	28.5 x 28.5 x 16	250	45	11.5	\$1588	n/a	n/a

Solid surface, flat edge

8042SQ2216CSF	22.75 x 22.75 x 16	150	41	7.75	\$2563	n/a	\$136
8042SQ2816CSF	28.5 x 28.5 x 16	150	57.5	11.5	\$2862	n/a	\$218

Solid surface, knife edge

8042SQ2216CSK	22.75 x 22.75 x 16	150	41	7.75	\$2894	n/a	\$164
8042SQ2816CSK	28.5 x 28.5 x 16	150	57.5	11.5	\$3316	n/a	\$245

Finished height will vary depending on material top. Shipped fully assembled in 1 carton.



Square Table with Wood Base

Laminate, flat edge (HPL laminate)

8042SQ2216W	22.75 x 22.75 x 16	250	30	7.75	\$1204	\$98	n/a
8042SQ2816W	28.5 x 28.5 x 16	250	39	11.5	\$1234	\$115	n/a

Laminate, knife edge (HPL laminate)

8042SQ2216WK	22.75 x 22.75 x 16	250	30	7.75	\$1639	n/a	n/a
8042SQ2816WK	28.5 x 28.5 x 16	250	39	11.5	\$1734	n/a	n/a

Solid surface, flat edge

8042SQ2216WSF	22.75 x 22.75 x 16	150	36	7.75	\$2708	n/a	\$136
8042SQ2816WSF	28.5 x 28.5 x 16	150	59	11.5	\$3008	n/a	\$218

Solid surface, knife edge

8042SQ2216WSK	22.75 x 22.75 x 16	150	36	7.75	\$3040	n/a	\$164
8042SQ2816WSK	28.5 x 28.5 x 16	150	59	11.5	\$3462	n/a	\$245

Finished height will vary depending on material top. Shipped fully assembled in 1 carton.

ROUND LAPTOP TABLES FOR OFFSET BASE **MODEL#** **DIMENSIONS** **FREIGHT CLASS** **WT./LBS.** **CUBIC FT.** **LIST PRICE** **HP ADD** **GR. 2 ADD**



Oval Table with Polished Chrome Base

D x W x H

Laminate, flat edge

80430V2616C	26 x 22 x 16	150	38	9.25	\$1058	\$98	n/a
80430V3116C	31 x 26 x 16	250	44	11.75	\$1088	\$115	n/a

Laminate, knife edge

80430V2616CK	26 x 22 x 16	150	38	9.25	\$1696	n/a	n/a
80430V3116CK	31 x 26 x 16	250	44	11.75	\$1862	n/a	n/a

Solid surface, flat edge

80430V2616CSF	26 x 22 x 16	150	49.5	9.25	\$2840	n/a	\$158
80430V3116CSF	31 x 26 x 16	150	61.5	11.75	\$3019	n/a	\$218

Solid surface, knife edge

80430V2616CSK	26 x 22 x 16	150	49.5	9.25	\$2894	n/a	\$169
80430V3116CSK	31 x 26 x 16	150	61.5	11.75	\$3101	n/a	\$234

Finished height will vary depending on material top. Shipped fully assembled in 1 carton.



Oval Table with Wood Base

Laminate, flat edge

80430V2616W	26 x 22 x 16	250	32	9.25	\$1204	\$98	n/a
80430V3116W	31 x 26 x 16	250	39	11.75	\$1234	\$115	n/a

Laminate, knife edge

80430V2616WK	26 x 22 x 16	250	32	9.25	\$1842	n/a	n/a
80430V3116WK	31 x 26 x 16	250	39	11.75	\$2008	n/a	n/a

Solid surface, flat edge

80430V2616WSF	26 x 22 x 16	150	44.5	9.25	\$2985	n/a	\$158
80430V3116WSF	31 x 26 x 16	150	56.5	11.75	\$3165	n/a	\$218

Solid surface, knife edge

80430V2616WSK	26 x 22 x 16	150	44.5	9.25	\$3040	n/a	\$169
80430V3116WSK	31 x 26 x 16	150	56.5	11.75	\$3246	n/a	\$234

Finished height will vary depending on material top. Shipped fully assembled in 1 carton.

JEO



model 8434



model 8433-4



Optional Quilted Stitch Back (Q).



Optional 5 prong base with glides (G).



model 8435-2224





model 8436-1530







STANDARD FEATURES



- Jeo is a contemporary, retro - inspired series with versatility for a variety of workplace applications.
- The tailored box styling functions well in lounge, conferencing, collaboration and side/guest environments.
- Three seating models: swivel tilter with a 5 prong caster base, a swivel self-centering return with a stationary round pedestal base or a matching four legged Arm Chair.
- Model 8433-4 is standard with a five prong Black nylon base with carpet casters (C1).
- Model 8437 is standard with Black four-legged frame.
- Jeo also offers two styles of matching pedestal base occasional tables with a round or square laminate top, available in two height sizes --- 15" and 22" high.
- Upholstery options: fabric, vinyl, leather or a combination of two or more materials. The upholstery surfaces are seamed together with tailored double stitch detailing.
- Check textile availability prior to specifying upholstery material.

OPTIONAL FEATURES

- Chairs are available with an Optional Quilted Stitch back. Please specify (Q). Add \$212.
- Model 8433-4 has an optional five prong Aluminum base. specify (AL). Add \$63.
- Optional 5 prong Aluminum base with hard glides. Please specify (C7).
- Optional soft casters are available on the 5 prong base. Please specify (C9R) . Add \$72.
- Model 8434 round pedestal base available in Chrome (CHM) or Brushed Chrome (BCH). Please specify.
- Model 8437 has optional Chrome (CHM) or Brushed Chrome (BCH) four-legged frame.
- Occasional tables are available in the following laminate finishes to coordinate with Global Desking and wood seating: Absolute Acajou (ACJ), Asian Night (ASN), Avant Cherry (AWC), Avant Honey (AWH), Black (BLK), Blizzard (BZD), Brushed Cobalt (BRC), Clear Maple (CMB), Custom Grey (CGY), Dark Espresso (DES), Designer White (DWT), Fashionista (FAS), First Class (FCL), Noce Biondo (NBL), Noce Grigio (NGL), Noce Leggero (NEL), Noce Medio (NML), Quartered Mahogany (QTM), Sheer Beauty (SBY), Stonedust (SDT), Walnut Heights (WHE), White Chocolate (WHC), and Winter Cherry (WCR). Please Specify.

DESCRIPTION	FEATURES	MODEL#	STANDARD TEXTILE GRADES													
			1	2	3	4	5	6	7	8	9	10	11	12		
 <p>Self-Centering Lounge Chair on Pedestal Base COM Yardage: 2.75 Freight Class: 250 Product Weight (lbs.): 50 Cubic Feet Per Carton: 22</p>	Ergonomic Features: C	8434	2345	2435	2505	2609	2757	2809	2938	3184	3305	3532	3843	4229		
		OVERALL DIMENSIONS			SEAT DIMENSIONS			BACK DIMENSIONS								
		W	D	H	W	D	H	W	H							
	26	25	30-32.5	20	19	16.5-19	20	15								
 <p>Swivel Tilter Chair COM Yardage: 2.75 Freight Class: 250 Product Weight (lbs.): 50 Cubic Feet Per Carton: 22</p>	Ergonomic Features: A, B, C, S	8433-4	1591	1703	1788	1918	2101	2187	2353	2616	2822	3048	3515	4013		
		OVERALL DIMENSIONS			SEAT DIMENSIONS			BACK DIMENSIONS								
		W	D	H	W	D	H	W	H							
	26	25	30-32.5	20	19	16.5-19	20	15								
 <p>Arm Chair COM Yardage: 2.75 Freight Class: 250 Product Weight (lbs.): 50 Cubic Feet Per Carton: 22</p>		8437	1549	1649	1724	1838	1997	2074	2219	2451	2629	2827	3238	3673		
		OVERALL DIMENSIONS			SEAT DIMENSIONS			BACK DIMENSIONS								
		W	D	H	W	D	H	W	H							
	26	25	34	20	19	18	20	15								

DESCRIPTION	FEATURES	MODEL#	STANDARD TEXTILE GRADES												
			1	2	3	4	5	6	7	8	9	10	11	12	
 <p>15" H Round End Table - 24" Dia. Top on Pedestal Base COM Yardage: n/a Freight Class: 150 Product Weight (lbs.): 44 Cubic Feet Per Carton: 10</p>		8435-1524	1442												
				OVERALL DIMENSIONS			SEAT DIMENSIONS			BACK DIMENSIONS					
					W	Dia.	H	W	D	H	W	H			
				24		15									
															
 <p>15" H Round Coffee Table - 30" Dia. Top on Pedestal Base COM Yardage: n/a Freight Class: 150 Product Weight (lbs.): 44 Cubic Feet Per Carton: 10</p>		8435-1530	1683												
				OVERALL DIMENSIONS			SEAT DIMENSIONS			BACK DIMENSIONS					
					W	Dia.	H	W	D	H	W	H			
				30		15									
 <p>22" H Round End Table - 24" Dia. Top on Pedestal Base COM Yardage: n/a Freight Class: 150 Product Weight (lbs.): 44 Cubic Feet Per Carton: 10</p>		8435-2224	1579												
				OVERALL DIMENSIONS			SEAT DIMENSIONS			BACK DIMENSIONS					
					W	Dia.	H	W	D	H	W	H			
				24		22									
															
 <p>22" H Round Coffee Table - 30" Dia. Top on Pedestal Base COM Yardage: n/a Freight Class: 150 Product Weight (lbs.): 44 Cubic Feet Per Carton: 10</p>		8435-2230	1819												
				OVERALL DIMENSIONS			SEAT DIMENSIONS			BACK DIMENSIONS					
					W	Dia.	H	W	D	H	W	H			
				30		22									
 <p>15" H Square End Table - 24" Top on Pedestal Base COM Yardage: n/a Freight Class: 150 Product Weight (lbs.): 44 Cubic Feet Per Carton: 10</p>		8436-1524	1442												
				OVERALL DIMENSIONS			SEAT DIMENSIONS			BACK DIMENSIONS					
					W	D	H	W	D	H	W	H			
				24	24	15									

DESCRIPTION	FEATURES	MODEL#	STANDARD TEXTILE GRADES																
			1	2	3	4	5	6	7	8	9	10	11	12					
 <p>15" H Square End Coffee - 30" Top on Pedestal Base COM Yardage: n/a Freight Class: 150 Product Weight (lbs.): 44 Cubic Feet Per Carton: 10</p>		8436-1530	1683																
 <p>22" H Square End Table - 24" Top on Pedestal Base COM Yardage: n/a Freight Class: 150 Product Weight (lbs.): 44 Cubic Feet Per Carton: 10</p>		8436-2224	1579																
 <p>22" H Square End Coffee - 30" Top on Pedestal Base COM Yardage: n/a Freight Class: 150 Product Weight (lbs.): 44 Cubic Feet Per Carton: 10</p>		8436-2230	1819																

KATE®



model 2811-4







model 2811-8

STANDARD FEATURES

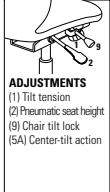
- A contemporary, yet retro series featuring sculpted seat and back cushions.
- Fully upholstered closed arms offer a unique style and function in the workplace.
- Models are standard with a five legged Polished Aluminum base.
- C10 casters are standard.
- Check textile availability prior to specifying upholstery material.

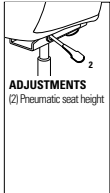
OPTIONAL FEATURES

- An optional Black injection molded base is available at no upcharge, please specify **(BK)**.
- There are no caster options for this series. C7 glides can be specified at no upcharge.
- For hard surface flooring please specify C10R. Add \$66.
- For fully assembled in box, specify **SU**. Add \$76.

DESCRIPTION	FEATURES	MODEL#	STANDARD TEXTILE GRADES													
			1	2	3	4	5	6	7	8	9	10	11	12		
 <p>MB Tilter COM Yardage: 3.75 Freight Class: 250 Product Weight (lbs.): 47 Cubic Feet Per Carton: 15.75</p> <p>Ergonomic Features: A, B, C, N</p>	 <p>ADJUSTMENTS (1) Tilt tension (2) Pneumatic seat height (9) Chair tilt lock (5A) Center-tilt action</p>	2811-4	\$1412	\$1549	\$1660	\$1824	\$2055	\$2141	\$2342	\$2732	\$2918	\$3277	\$3767	\$4374		
		OVERALL DIMENSIONS			SEAT DIMENSIONS			BACK DIMENSIONS								
		W	D	H	W	D	H	W	H							
		26	24.5	33	17.5	18	17.5-21.50	19	15.5							
			RTA 00													
 <p>MB Swivel COM Yardage: 3.75 Freight Class: 250 Product Weight (lbs.): 43 Cubic Feet Per Carton: 15.75</p> <p>Ergonomic Features: C, N</p>	 <p>ADJUSTMENTS (2) Pneumatic seat height</p>	2811-8	\$1362	\$1504	\$1615	\$1776	\$2008	\$2094	\$2296	\$2685	\$2871	\$3229	\$3719	\$4327		
		OVERALL DIMENSIONS			SEAT DIMENSIONS			BACK DIMENSIONS								
		W	D	H	W	D	H	W	H							
		26	24.5	33	17.5	18	17.5-21.50	19	15.5							
			RTA 00													
 <p>Armchair COM Yardage: 3.75 Freight Class: 250 Product Weight (lbs.): 42 Cubic Feet Per Carton: 15.75</p> <p>Ergonomic Features: N</p>		2813	\$1543	\$1676	\$1782	\$1937	\$2158	\$2237	\$2431	\$2801	\$2979	\$3322	\$3787	\$4367		
	OVERALL DIMENSIONS			SEAT DIMENSIONS			BACK DIMENSIONS									
	W	D	H	W	D	H	W	H								
	26.5	26.5	33.5	17.5	18	18	19	15.5								
			RTA 00													
 <p>Ottoman COM Yardage: 1.5 Freight Class: 250 Product Weight (lbs.): 22 Cubic Feet Per Carton: 6</p> <p>Ergonomic Features: N</p>		2814	\$966	\$1024	\$1065	\$1126	\$1214	\$1247	\$1324	\$1472	\$1544	\$1680	\$1867	\$2098		
	OVERALL DIMENSIONS			SEAT DIMENSIONS			BACK DIMENSIONS									
	W	D	H	W	D	H	W	H								
	23.5	18.75	17.75	20.5	18.5	17-22	20	21								
			RTA 00  													

LUX



model LX2426AC



model LX8033S

STANDARD FEATURES

- Contemporary styling featuring luxurious cushioning.
- Sofa cushions are removable.
- Fully upholstered. Wood legs with non marking clear glides.
- Cylindrical bolsters included with lounge chair models. One bolster on single seat lounge chair and two bolsters on two-seat and three-seat sofas.
- This item may require a longer lead time. Please contact your Global sales representative for further information.
- Check textile availability prior to specifying upholstery material.

OPTIONAL FEATURES

- Wood frames are available in Absolute (AAM), Black (BKM), Cherry (ACM), English Oak (EOM), Espresso Cafe (ECM), Fruitwood (TFM), Gray (HGM), Honey (AHM), Mahogany (TMM), Maple (AVM), Medium Walnut (MWM), Night (ASM), Natural Walnut (NLW), Noce Biondo (NBM), Noce Grigio (NGM), Noce Leggero (NEM), Noce Medio (NMM), Shaker Cherry (SKM), Walnut (TWM), WC Cream (WTM), White (WHM) and Winter Cherry (WCM). Please Specify. Genuine maple faced veneers and solids are used.

DESCRIPTION	FEATURES	MODEL#	STANDARD TEXTILE GRADES											
-------------	----------	--------	-------------------------	--	--	--	--	--	--	--	--	--	--	--



Side Chair
COM Yardage: 3
Freight Class: 150
Product Weight (lbs.): 36
Cubic Feet Per Carton: 17.75

	1	2	3	4	5	6	7	8	9	10	11	12
LX2226SC	1089	1203	1249	1321	1420	1453	1540	1704	1784	1938	2145	2405

OVERALL DIMENSIONS			SEAT DIMENSIONS			BACK DIMENSIONS	
W	D	H	W	D	H	W	H
25	27.75	36	19	19.5	19.5	19	18

RTA 00



Armchair
COM Yardage: 3
Freight Class: 250
Product Weight (lbs.): 40
Cubic Feet Per Carton: 17.75

	1	2	3	4	5	6	7	8	9	10	11	12
LX2426AC	1414	1533	1626	1763	1959	2051	2229	2513	2731	2973	3472	4005

OVERALL DIMENSIONS			SEAT DIMENSIONS			BACK DIMENSIONS	
W	D	H	W	D	H	W	H
26	27.75	36	19	19.5	19.5	19	18

RTA 00



Lounge Chair
COM Yardage: 8.50
Freight Class: 250
Product Weight (lbs.): 77
Cubic Feet Per Carton: 30.25

	1	2	3	4	5	6	7	8	9	10	11	12
LX3433CH	2754	3050	3286	3640	4142	4380	4832	5558	6118	6739	8017	9381

OVERALL DIMENSIONS			SEAT DIMENSIONS			BACK DIMENSIONS	
W	D	H	W	D	H	W	H
35	34	33	-	-	-	-	-

RTA 00



Ottoman
COM Yardage: 2.5
Freight Class: 250
Product Weight (lbs.): 48
Cubic Feet Per Carton: 18.25

	1	2	3	4	5	6	7	8	9	10	11	12
LX3636OTT	2630	2843	2908	3006	3151	3197	3324	3559	3673	3890	4189	4559

OVERALL DIMENSIONS			SEAT DIMENSIONS			BACK DIMENSIONS	
W	D	H	W	D	H	W	H
36	36	16	-	-	-	-	-

RTA 00

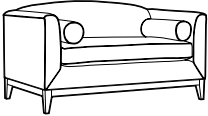
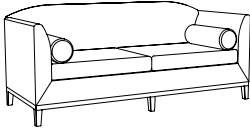
DESCRIPTION	FEATURES	MODEL#	STANDARD TEXTILE GRADES												
			1	2	3	4	5	6	7	8	9	10	11	12	
 <p>Two Seat Sofa w/Cylindrical bolsters. COM Yardage: 12 Freight Class: 250 Product Weight (lbs.): 105 Cubic Feet Per Carton: 50.25</p>		LX6033S	2843	3260	3594	4092	4800	5132	5775	6797	7585	8461	10263	12187	
		OVERALL DIMENSIONS			SEAT DIMENSIONS			BACK DIMENSIONS							
		W	D	H	W	D	H	W	H						
		61	34	33	20	18.5	18.5	20	16						
			RTA 00												
 <p>Three Seat Sofa w/Cylindrical bolsters. COM Yardage: 14.75 Freight Class: 300 Product Weight (lbs.): 125 Cubic Feet Per Carton: 66.25</p>		LX8033S	4092	4756	5126	5687	6474	6758	7449	8769	9403	10628	12290	14365	
		OVERALL DIMENSIONS			SEAT DIMENSIONS			BACK DIMENSIONS							
		W	D	H	W	D	H	W	H						
		81	34	33	20	18.5	18.5	20	16						
			RTA 00												

ML™



model ML2630

STANDARD FEATURES

- Modern seating with a distinctive retro design.
- Features a steel tube frame, legs and arms.
- Fully upholstered continuous seat and back cushions.
- Standard with non marring, Black glides.
- Check textile availability prior to specifying upholstery material.

OPTIONAL FEATURES

- Available in five frame finish options. Please specify Chrome (**CHM**), Brushed Chrome (**BCH**), Black (**TBL**), Designer White (**TDW**) or Tungsten (**TTU**). No upcharge applies. Please specify.

DESCRIPTION

FEATURES

MODEL#

STANDARD TEXTILE GRADES



Counter Height Stool - 24" Seat Height

COM Yardage: 1
Freight Class: 250
Product Weight (lbs.): 22
Cubic Feet Per Carton: 5.75

	1	2	3	4	5	6	7	8	9	10	11	12
--	---	---	---	---	---	---	---	---	---	----	----	----

ML171724	1581	1604	1618	1644	1673	1688	1718	1764	1799	1840	1922	2009
-----------------	------	------	------	------	------	------	------	------	------	------	------	------

OVERALL DIMENSIONS

W D H

18	19	24
----	----	----

SEAT DIMENSIONS

W D H

17	16	23
----	----	----

BACK DIMENSIONS

W H

-	-
---	---



Bar Height Stool - 30" Seat Height

COM Yardage: 1
Freight Class: 250
Product Weight (lbs.): 23
Cubic Feet Per Carton: 8

	1	2	3	4	5	6	7	8	9	10	11	12
--	---	---	---	---	---	---	---	---	---	----	----	----

ML171730	1631	1652	1666	1689	1717	1729	1754	1802	1827	1872	1934	2012
-----------------	------	------	------	------	------	------	------	------	------	------	------	------

OVERALL DIMENSIONS

W D H

18	20.5	30
----	------	----

SEAT DIMENSIONS

W D H

17	16	29
----	----	----

BACK DIMENSIONS

W H

-	-
---	---



Bar Height Stool - 33" Seat Height

COM Yardage: 1
Freight Class: 250
Product Weight (lbs.): 24
Cubic Feet Per Carton: 9

	1	2	3	4	5	6	7	8	9	10	11	12
--	---	---	---	---	---	---	---	---	---	----	----	----

ML171733	1663	1762	1777	1796	1823	1834	1860	1905	1928	1972	2031	2106
-----------------	------	------	------	------	------	------	------	------	------	------	------	------

OVERALL DIMENSIONS

W D H

18	21.5	33
----	------	----

SEAT DIMENSIONS

W D H

17	16	32
----	----	----

BACK DIMENSIONS

W H

-	-
---	---



Ottoman

COM Yardage: 1.25
Freight Class: 150
Product Weight (lbs.): 28
Cubic Feet Per Carton: 5.75

	1	2	3	4	5	6	7	8	9	10	11	12
--	---	---	---	---	---	---	---	---	---	----	----	----

ML2121	1122	1212	1239	1279	1336	1356	1404	1499	1545	1630	1751	1899
---------------	------	------	------	------	------	------	------	------	------	------	------	------

OVERALL DIMENSIONS

W D H

21	21	17
----	----	----

SEAT DIMENSIONS

W D H



-	-	-
---	---	---

BACK DIMENSIONS

W H

-	-
---	---



DESCRIPTION	FEATURES	MODEL#	STANDARD TEXTILE GRADES											
			1	2	3	4	5	6	7	8	9	10	11	12
 <p>Dining Chair COM Yardage: 1.75 Freight Class: 250 Product Weight (lbs.): 33 Cubic Feet Per Carton: 14.75</p>		ML2326	1317	1450	1503	1582	1695	1735	1835	2023	2113	2288	2526	2824
			OVERALL DIMENSIONS			SEAT DIMENSIONS			BACK DIMENSIONS					
			W	D	H	W	D	H	W	H				
			23.25	29.5	29.75	20	18.5	18.5	20	16				
			RTA 00											
 <p>Lounge Chair COM Yardage: 2.5 Freight Class: 250 Product Weight (lbs.): 54 Cubic Feet Per Carton: 21.25</p>		ML2630	1976	2158	2224	2323	2462	2513	2639	2875	2986	3206	3503	3873
			OVERALL DIMENSIONS			SEAT DIMENSIONS			BACK DIMENSIONS					
			W	D	H	W	D	H	W	H				
			26	34.5	35	23	20	18.5	18.5	20.5				
			RTA 00											

ML PARK



model ML4634CH



model ML8634

STANDARD FEATURES

- Armless modern lounge seating with a distinctive retro design.
- Features beautiful aluminum legs with Black glides.
- Fully upholstered continuous seat and back cushions with distinctive seams.
- Check textile availability prior to specifying upholstery material.

OPTIONAL FEATURES

- Optional fixed back cushion (FC) is available on lounge models with upcharge. Please specify. Model ML4634, add \$182. Model ML6634, add \$241. Model ML8634, add \$299.
- Available in five leg finish options. Specify: Black (TBL), Brushed Aluminum (BAL), Designer White (TDW), Polished Aluminum (ALU) or Tungsten (TTU). No upcharge applies.

DESCRIPTION	FEATURES	MODEL#	STANDARD TEXTILE GRADES											
			1	2	3	4	5	6	7	8	9	10	11	12



Ottoman
 COM Yardage: 1.50
 Freight Class: 150
 Product Weight (lbs.): 28
 Cubic Feet Per Carton: 5.75

ML2634	2177	2230	2271	2333	2420	2462	2541	2667	2763	2872	3095	3331
--------	------	------	------	------	------	------	------	------	------	------	------	------

OVERALL DIMENSIONS			SEAT DIMENSIONS			BACK DIMENSIONS	
W	D	H	W	D	H	W	H
21	26.75	18.25	26.75	-	20	-	-

RTA 00



Lounge Chair
 COM Yardage: 7.25
 Freight Class: 250
 Product Weight (lbs.): 54
 Cubic Feet Per Carton: 21.25

ML4634	3731	3964	4144	4414	4802	4980	5329	5886	6314	6790	7771	8818
--------	------	------	------	------	------	------	------	------	------	------	------	------

OVERALL DIMENSIONS			SEAT DIMENSIONS			BACK DIMENSIONS	
W	D	H	W	D	H	W	H
26	34.5	35	42.75	22	19	27	13

RTA 00

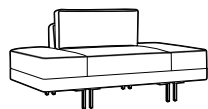

Two Seat Sofa
 COM Yardage: 7.50
 Freight Class: 250
 Product Weight (lbs.): 132
 Cubic Feet Per Carton: 52

ML6634	4028	4491	4701	5022	5471	5636	6028	6781	7145	7843	8797	9981
--------	------	------	------	------	------	------	------	------	------	------	------	------

OVERALL DIMENSIONS			SEAT DIMENSIONS			BACK DIMENSIONS	
W	D	H	W	D	H	W	H
66	36	32	66	22	19	27	13

RTA 00

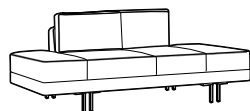

Three Seat Sofa
 COM Yardage: 11
 Freight Class: 250
 Product Weight (lbs.): 132
 Cubic Feet Per Carton: 52

ML8634	5314	5937	6229	6666	7288	7511	8051	9088	9587	10549	11856	13488
--------	------	------	------	------	------	------	------	------	------	-------	-------	-------

OVERALL DIMENSIONS			SEAT DIMENSIONS			BACK DIMENSIONS	
W	D	H	W	D	H	W	H
66	36	32	86	22	19	52	13

RTA 00

PRAIRIE™



model 3481



model 3482

STANDARD FEATURES

- Featuring, gently barrel shaped arms that provide an attractive appearance.
- Fully upholstered. Tapered wood skirt and legs.
- Series includes lounge chair, two seat and three seat sofa.
- Check textile availability prior to specifying upholstery material.

OPTIONAL FEATURES

- Tapered wood legs are available in Absolute (AAM), Black (BKM), Cherry (ACM), Espresso Cafe (ECM), English Oak (EOM), Fruitwood (TFM), Gray (HGM), Honey (AHM), Mahogany (TMM), Maple (AVM), Medium Walnut (MWVM), Natural Walnut (NLW), Night (ASM), Noce Biondo (NBM), Noce Grigio (NGM), Noce Leggero (NEM), Noce Medio (NMM), Shaker Cherry (SKM), Walnut (TWM), WC Cream (WTM), White (WHM) and Winter Cherry (WCM). Please specify. Genuine maple faced veneers and solids are used.

STITCH DETAIL WHEN UPHOLSTERED IN ALL LEATHER - ILLUSTRATIONS BELOW

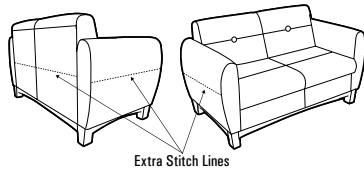

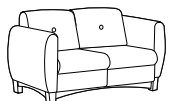
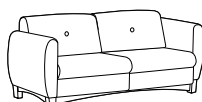
DESCRIPTION	FEATURES	MODEL#	STANDARD TEXTILE GRADES											
			1	2	3	4	5	6	7	8	9	10	11	12
 Lounge Chair COM Yardage: 4.25 Freight Class: 150 Product Weight (lbs.): 80 Cubic Feet Per Carton: 19.25		3481	2129	2313	2457	2671	2977	3085	3348	3855	4103	4570	5212	6008
			OVERALL DIMENSIONS			SEAT DIMENSIONS			BACK DIMENSIONS					
			W	D	H	W	D	H	W	H				
			32	29	30.5	21	19	16	21	14.5				
			RTA 00											
 Two Seat Sofa COM Yardage: 6.25 Freight Class: 250 Product Weight (lbs.): 106 Cubic Feet Per Carton: 41.25		3482	3021	3258	3443	3720	4119	4258	4602	5262	5576	6191	7022	8061
			OVERALL DIMENSIONS			SEAT DIMENSIONS			BACK DIMENSIONS					
			W	D	H	W	D	H	W	H				
			52.5	29	30.5	42	19	16	42	14.5				
			RTA 00											
 Three Seat Sofa COM Yardage: 9.5 Freight Class: 250 Product Weight (lbs.): 150 Cubic Feet Per Carton: 55.5		3483	3798	4127	4388	4780	5337	5599	6103	6907	7528	8216	9635	11148
			OVERALL DIMENSIONS			SEAT DIMENSIONS			BACK DIMENSIONS					
			W	D	H	W	D	H	W	H				
			73.5	29	30.5	63.5	19	16	63.5	14.5				
			RTA 00											

RAMBLER



Rectangular ottoman 26" x 52"
RA2652RE



Square ottoman 39" x 39"
RA3939SQ



Contrasting Textile Application.

STANDARD FEATURES





- The softened shapes of Ramble ottomans create mobile and stationary furniture landscapes for education, office and healthcare. This family of ottomans, available in numerous shapes and sizes, creates unique and inviting spaces for people to relax, socialize, work and study.
- These fully upholstered ottomans are available in square, rectangular and trapezoid shapes.
- Ottomans are standard at 17.5" seat height with 3" fixed legs or casters. A 15.5" seat height is achieved using the optional 1" leg.
- 3" and 1" poly legs are available in Night or Sand finish with white non-marking glides, standard. Various glide options are available to best suit flooring type and site conditions.
- For casters, select (CST) base type option and choose 2.5" black casters for either carpet or hard surfaces, see upcharge.
- An optional moisture barrier is available. Sealed seams are not available.
- Models do not gang.
- Upholstery options: fabric, coated textile or leather. Coated textile and leather models may feature stitch detail across the seat.
- Check textile availability prior to specifying upholstery material.
- Ottomans are available with contrasting textiles. Specify ottoman top separate from sides. For pricing, start with the base price and add applicable graded textile upcharges for the top and sides.
- Combining different material types (ex. coated textile and fabric) is not recommended due to different stretch resulting in potential for puckering.
- The blended textile matrix does not apply to this series.
- Active weight capacity 300 lbs.
- All models ship fully assembled.
- The series is designed for use across a range of facilities and is covered under Global's limited lifetime warranty for single-shift use.
- Model description dimensions are nominal. Actual dimensions are within .5 inches of nominal.





Please add option codes in the following order:

- **Model Number**
Specify model number
- **Top Textile Back**
Specify textile code
- **Side Textile**
Specify textile code
- **Base Type**
(1L) 1" Leg with 15.5" seat height
(3L) 3" Leg with 17.5" seat height
(CST) Casters with 17.5" seat height (please refer to upcharges below)
- **Leg Finish**
(BLK) Night
(SND) Sand
- **Caster Type**
(C112) 2.5" Black caster for carpeted surfaces. No upcharge.
(C112R) 2.5" Caster for most hard surfaces. Add \$57
- **Glide Type**
(NM) White, non-marking nylon glides for most surfaces. No upcharge.
(FG) Felt glides for most hard floor surfaces. Add \$34.
(RG) Rubber non-slip glides for most hard floor surfaces. Add \$34.
(SG) Steel cushioned glides for carpeted surfaces. Add \$34.
- **Moisture Barrier**
(NB) No moisture barrier
(MB) Moisture barrier. See model for upcharges.

EXAMPLE RAMBLER ORDER CODE:

RA2222SQ	WA50	VY20	3L	BLK	NM	NB
Model #	Top textile	Sides textile	Base type	Leg finish	Glide type	Moisture barrier

DESCRIPTION	FEATURES/ MODEL#	STANDARD TEXTILE GRADES											
		1/COM	2	3	4	5	6	7	8	9	10	11	12
 <p>Square Ottoman 22" x 22" COM Yardage: Top: 0.75; Side: 1 Freight Class: 150 Product Weight (lbs.): 38.5 Cubic Feet Per Carton: 6.5</p>	RA2222SQ Base Price:	\$716											
	Top upcharge:	+0	+\$24	+\$43	+\$71	+\$110	+\$126	+\$160	+\$213	+\$253	+\$297	+\$387	+\$483
	Side upcharge:	+0	+\$32	+\$57	+\$94	+\$146	+\$168	+\$213	+\$284	+\$337	+\$395	+\$516	+\$643
			OVERALL DIMENSIONS			SEAT DIMENSIONS			BACK DIMENSIONS				
		W	D	H	W	D	H	W	H				
		22	22	17.5	-	-	-	-	-				
		Add \$107 for moisture barrier (MB).											
		Width and depth may vary by up to .05 in.		RTA 00	1 per carton								
 <p>Square Ottoman 26" x 26" COM Yardage: Top: 0.75; Side: 1 Freight Class: 150 Product Weight (lbs.): 41 Cubic Feet Per Carton: 9.5</p>	RA2626SQ Base Price:	\$796											
	Top upcharge:	+0	+\$24	+\$43	+\$71	+\$110	+\$126	+\$160	+\$213	+\$253	+\$297	+\$387	+\$483
	Side upcharge:	+0	+\$32	+\$57	+\$94	+\$146	+\$168	+\$213	+\$284	+\$337	+\$395	+\$516	+\$643
			OVERALL DIMENSIONS			SEAT DIMENSIONS			BACK DIMENSIONS				
		W	D	H	W	D	H	W	H				
		26.5	26.5	17.5	-	-	-	-	-				
		Add \$107 for moisture barrier (MB).											
		Width and depth may vary by up to .05 in.		RTA 00	1 per carton								
 <p>Square Ottoman 39" x 39" COM Yardage: Top: 1.25; Side: 2.25 Freight Class: 250 Product Weight (lbs.): 74 Cubic Feet Per Carton: 19.5</p>	RA3939SQ Base Price:	\$1198											
	Top upcharge:	+0	+\$40	+\$72	+\$118	+\$183	+\$210	+\$267	+\$355	+\$422	+\$494	+\$645	+\$804
	Side upcharge:	+0	+\$72	+\$129	+\$212	+\$329	+\$378	+\$480	+\$639	+\$759	+\$889	+\$1161	+\$1447
			OVERALL DIMENSIONS			SEAT DIMENSIONS			BACK DIMENSIONS				
		W	D	H	W	D	H	W	H				
		39	39	17.5	-	-	-	-	-				
		Add \$213 for moisture barrier (MB).											
		Width and depth may vary by up to .05 in.		RTA 00	1 per carton								
 <p>Rectangular Ottoman 26" x 39" COM Yardage: Top: 1; Side: 1.5 Freight Class: 150 Product Weight (lbs.): 63 Cubic Feet Per Carton: 13.75</p>	RA2639RE Base Price:	\$1062											
	Top upcharge:	+0	+\$32	+\$57	+\$94	+\$146	+\$168	+\$213	+\$284	+\$337	+\$395	+\$516	+\$643
	Side upcharge:	+0	+\$48	+\$86	+\$141	+\$219	+\$252	+\$320	+\$426	+\$506	+\$593	+\$774	+\$965
			OVERALL DIMENSIONS			SEAT DIMENSIONS			BACK DIMENSIONS				
		W	D	H	W	D	H	W	H				
		39.5	26.5	17.5	-	-	-	-	-				
		Add \$160 for moisture barrier (MB).											
		Width and depth may vary by up to .05 in.		RTA 00	1 per carton								

DESCRIPTION	FEATURES	MODEL#											
		1/COM	2	3	4	5	6	7	8	9	10	11	12
 <p>Rectangular Ottoman 26" x 52" COM Yardage: Top: 1; Side: 1.5 Freight Class: 150 Product Weight (lbs.): 75 Cubic Feet Per Carton: 17.75</p>	RA2652RE Base Price:	\$1186											
	Top upcharge:	+0	+\$32	+\$57	+\$94	+\$146	+\$168	+\$213	+\$284	+\$337	+\$395	+\$516	+\$643
	Side upcharge:	+0	+\$48	+\$86	+\$141	+\$219	+\$252	+\$320	+\$426	+\$506	+\$593	+\$774	+\$965
			OVERALL DIMENSIONS			SEAT DIMENSIONS			BACK DIMENSIONS				
			W	D	H	W	D	H	W	H			
			52.5	26.5	17.5	-	-	-	-	-			
	Add \$160 for moisture barrier (MB).												
	Width and depth may vary by up to .05 in.												
 <p>Trapezoid Ottoman 26" x 26" COM Yardage: Top: .75; Side: 1.5 Freight Class: 250 Product Weight (lbs.): 37.5 Cubic Feet Per Carton: 9.5</p>	RA2626TR Base Price:	\$796											
	Top upcharge:	+0	+\$24	+\$43	+\$71	+\$110	+\$126	+\$160	+\$213	+\$253	+\$297	+\$387	+\$483
	Side upcharge:	+0	+\$48	+\$86	+\$141	+\$219	+\$252	+\$320	+\$426	+\$506	+\$593	+\$774	+\$965
			OVERALL DIMENSIONS			SEAT DIMENSIONS			BACK DIMENSIONS				
			W	D	H	W	D	H	W	H			
			27.5	27.5	17.5	-	-	-	-	-			
	Add \$160 for moisture barrier (MB).												
	Width and depth may vary by up to .05 in.												
 <p>Trapezoid Ottoman 26" x 39" COM Yardage: Top: 1; Side: 1.5 Freight Class: 150 Product Weight (lbs.): 67 Cubic Feet Per Carton: 13.75</p>	RA2639TR Base Price:	\$1062											
	Top upcharge:	+0	+\$32	+\$57	+\$94	+\$146	+\$168	+\$213	+\$284	+\$337	+\$395	+\$516	+\$643
	Side upcharge:	+0	+\$48	+\$86	+\$141	+\$219	+\$252	+\$320	+\$426	+\$506	+\$593	+\$774	+\$965
			OVERALL DIMENSIONS			SEAT DIMENSIONS			BACK DIMENSIONS				
			W	D	H	W	D	H	W	H			
			39	26	17.5	-	-	-	-	-			
	Add \$160 for moisture barrier (MB).												
	Width and depth may vary by up to .05 in.												
 <p>Trapezoid Ottoman 26" x 52" COM Yardage: Top: 1; Side: 1.5 Freight Class: 250 Product Weight (lbs.): 67.5 Cubic Feet Per Carton: 17.75</p>	RA2652TR Base Price:	\$1186											
	Top upcharge:	+0	+\$32	+\$57	+\$94	+\$146	+\$168	+\$213	+\$284	+\$337	+\$395	+\$516	+\$643
	Side upcharge:	+0	+\$48	+\$86	+\$141	+\$219	+\$252	+\$320	+\$426	+\$506	+\$593	+\$774	+\$965
			OVERALL DIMENSIONS			SEAT DIMENSIONS			BACK DIMENSIONS				
			W	D	H	W	D	H	W	H			
			52	26.5	17.5	-	-	-	-	-			
	Add \$160 for moisture barrier (MB).												
	Width and depth may vary by up to .05 in.												

RIVER™



Sample Layout



Sample Layout

STANDARD FEATURES

- A modular seating series that is composed of modular linking units in straight, curved and corner units. Soft seating models are available with standard height, high and extended high backs. All linking units can be used together in any combination to create a wide variety of layouts.
- The unique tapered legs (swaged legs) are made of welded steel, heavy duty construction, with each leg bolted directly to the frame. The extremely robust construction insures trouble free performance in any environment. All units except for the Laptop Tables have the same leg height of 6.5". The leg height makes it easier to clean under the product.
- Each leg is standard with adjustable black nylon leveling glides and are non-marking. Wood legs and casters are not available.
- All cushions are fixed and non-removable (cushions will not migrate). Perimeter seams feature a decorative single stitch detail, which makes seams lay flat and adds extra seam strength.
- Seating frames are heavy duty with interlocking plywood, puzzle box construction, made for rugged active environments. Seats are high density with highly resilient foam and are equipped with a synthetic rubberized webbing suspension system for extra comfort.
- Front edge or face of the seat, angles slightly inward, so feet have freedom of movement and shoe heels don't rub on the seat. This inward slanting matches the inward angles of the back. Benches and connecting end tables also reflect the inward angles on the front and back faces, so all units coordinate in visual appearance.
- For use in high traffic applications as well as 24/7 environments or for models with 600 lb. standard weight capacity, clean out space between seat and back and /or modular arms, please see the River+ series.
- Most units can be ganged together with a quick connect, disconnect feature. Ganging hardware is standard and is factory installed. Ganging hardware swivels out of sight when not in use.

OPTIONAL FEATURES

- Most tables and seating units can be specified with Power/USB terminals, which includes two power outlets, two double USB terminals and a black 60" three-prong power cord. Each Power/USB module is set in predetermined locations, as shown in the electrical illustrations below. Electrical units must be factory installed.
- To add a Power/USB module: From the electrical illustrations below, please specify **J1, W1, J2, W2, J3, W4, J4, W4, J6 or W6** after the product model number. Please note on seating units, if both right and left locations are required, add both **J1/J3 or W1/W3** to the model number. Add \$945 for each module/location required.
- Power/USB modules are available with either Jet Black (**J**) face plate with black Power/USB receptacles or with a White (**W**) face plate with white Power/USB receptacles.
- Tables are made with high pressure laminate and are offered in the following finishes: Absolute Acajou (**ACJ**), Asian Night (**ASN**), Avant Cherry (**AWC**), Avant Honey (**AWH**), Blizzard (**BZD**), Clear Maple (**CMB**), Custom Grey (**CGY**), Dark Espresso (**DES**), Designer White (**DWT**), Fashionista (**FAS**), First Class (**FCL**), Noce Biondo (**NBL**), Noce Grigio (**NGL**), Noce Leggero (**NEL**), Noce Medio (**NML**), Quartered Mahogany (**QTM**), Sheer Beauty (**SBY**), Stonedust (**SDT**), Walnut Heights (**WHE**), White Chocolate (**WHC**) and Winter Cherry (**WCR**). Please Specify. Custom High Pressure laminate finishes will be considered upon request.
- **Seating and Table Leg Finish**

(CHM) Chrome	(TBL) Black
(TDW) Designer White	(TFO) Fog
(TFR) Frost	(TIV) Cloud
(TLA) Latte	(TMO) Mocha
(TNE) Nevada	(TOA) Toast
(TSH) Shadow	(TSN) Sand
(TTU) Tungsten	(TKA) Kalua
- Check textile availability prior to specifying upholstery material. Leather not available on River series.
- If more than one fabric or a fabric/vinyl combination is required, please fill out a "Seating Multiple Textile" form, specifying each fabric location. Please contact Customer Care for more information.

ELECTRICAL PLACEMENT

Soft Seating

Locations available on left side J1 (black) or W1 (white), right side J3 (black), or W3 (white) or both sides J1/J3 (black) or W1/W3 (white).

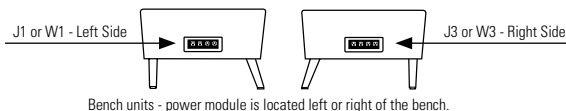
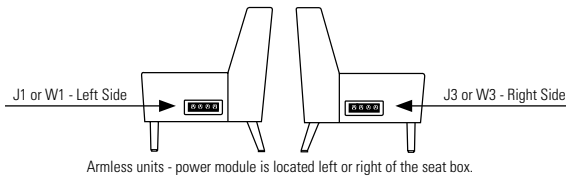
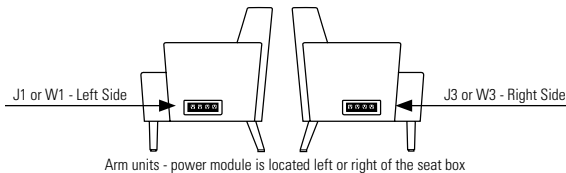

Coffee/End Tables

Primary location is on the top of the unit, centered J2 (black) or W2 (white). Secondary Location is end/side of the unit J1 (black) or W1 (white).

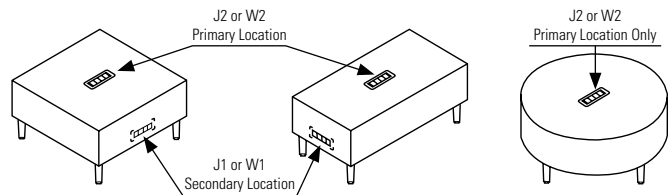

Primary location is on the top rear/edge of the unit J4 (black) or W4 (white). Secondary Location is the back side of the unit J6 (black) or W6 (white).

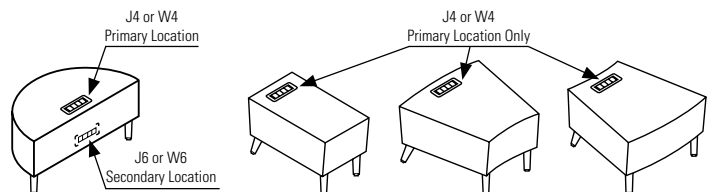

SAMPLE LAYOUTS

RVR101 (Layout 1)

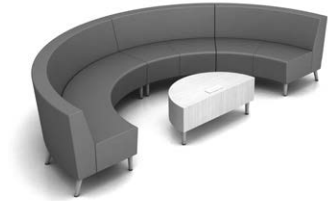

Qty	Model Number	Description	Dimensions	List Price
4	7710NA	Armless IS Curve - Two Seat - Standard Back	55 x 29.5 x 32	3258 x 4
1	7737W6	42" Half Round Laminate Coffee Table w/ W6 Rear Power/USB Module	42 x 21 x 17 upcharge	1384 945

SAMPLE LAYOUT TOTAL (Starting at Grade 1) \$15,361

RVR102 (Layout 2)



Qty	Model Number	Description	Dimensions	List Price
8	7714NA	Armless OS Curve - Two Seater - High Back	54x 29.5 x 41.5	3885 x 8

SAMPLE LAYOUT TOTAL (Starting at Grade 1) \$31,080

RVR103 (Layout 3)

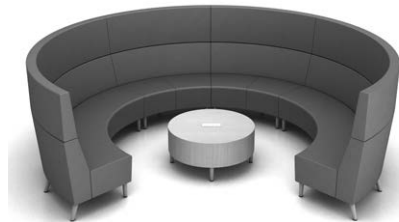

Qty	Model Number	Description	Dimensions	List Price
6	7712NA	Armless IS Curve - Two Seater - Extended Back	55 x 29.5 x 47	4553 x 6
1	7734W2	36" Dia - Round Laminate Coffee Table w/ W2 Center Power/USB Module	36 x 36 x 17 upcharge	1612 945

SAMPLE LAYOUT TOTAL (Starting at Grade 1) \$29,875

RVR104 (Layout 4)



Qty	Model Number	Description	Dimensions	List Price
2	7712NA	Armless IS Curve - Two Seater - Extended Back	55 x 29.5 x 47	4553 x 2
2	7712NAW3	Armless IS Curve - Two Seater - Extended Back w/ W3 Right Power/USB Module	55 x 29.5 x 47 upcharge	4553 x 2 825 x 2
2	7726	IS Curve - Two Seater Bench	54 x 28 x 17.5	2765 x 2
1	7734	36" Dia - Round Laminate Coffee Table	36 x 36 x 17	1612

SAMPLE LAYOUT TOTAL (Starting at Grade 1) \$27,244

RVR105 (Layout 5)



Qty	Model Number	Description	Dimensions	List Price
3	7711NA	Armless IS Curve - Two Seater - High Back	55 x 29.5 x 41.5	4137 x 3
3	7712NAW3	Armless IS Curve - Two Seater - Extended Back w/ W3 Right Power/USB Module	55 x 29.5 x 47 upcharge	4553 x 3 825 x 2
1	7738	Rectangular Laminate End Table	15 x 27.25 x 17	1309
2	7743	18" Dia. Round Laminate Laptop Table	18 x 18 x 25.25	792 x 2

SAMPLE LAYOUT TOTAL (Starting at Grade 1) \$30,853

SAMPLE LAYOUTS

RVR106 (Layout 6)



Qty	Model Number	Description	Dimensions	List Price
1	7709R	Three Seater - Extended Back w/Right Arm	75 x 29.5 x 47	6199
1	7709L	Three Seater - Extended Back w/Left Arm	75 x 29.5 x 47	6199
1	7718	Armless Corner Unit - Extended Back	38 x 38 x 47	5339
1	7732W2	36" Square Laminate Coffee Table w/ W2 Center Power/USB Module	36 x 36 x 17 upcharge	1477 945

SAMPLE LAYOUT TOTAL (Starting at Grade 1) \$20,159

RVR107 (Layout 7)



Qty	Model Number	Description	Dimensions	List Price
1	7704NA	Armless Two Seater - Standard. Back	75x 29.5 x 47	2820
2	7716	Armless Corner Unit - Standard. Back	75 x 29.5 x 47	3980 x 2
1	7725	Two Seater Bench	75x 29.5 x 47	2036
1	7728	Square Single Seater Bench	75 x 29.5 x 17.5	1392
1	7731	30" Square Laminate Coffee Table	75 x 30 x 47	1300

SAMPLE LAYOUT TOTAL (Starting at Grade 1) \$15,508

RVR108 (Layout 8)



Qty	Model Number	Description	Dimensions	List Price
2	7708NAW3	Armless Three Seater - High Back w/ W3 Right Power/USB Module	75 x 29.5 x 41.5 upcharge	5345 x 2 945 x 2
2	7708NAW1	Armless Three Seater - High Back w/ W1 Left Power/USB Module	72.5 x 29.5 x 41.5 upcharge	5345 x 2 945 x 2
2	7745	16" Square Laminate Laptop Table	16 x 16 x 25.25	810 x 2

SAMPLE LAYOUT TOTAL (Starting at Grade 1) \$26,780

RVR109 (Layout 9)



Qty	Model Number	Description	Dimensions	List Price
2	7702	Lounge Chair - High Back w/Arms	29.5 x 29.5 x 41.5	3016 x 2
1	7708NAW1	Armless Three Seater - High Back w/ W1 Left Power/USB Module	72.5 x 29.5 x 41.5 upcharge	5345 945
1	7708NAW3	Armless Three Seater - High Back w/ W3 Right Power/USB Module	72.5 x 29.5 x 41.5 upcharge	5345 945
1	7733	Rectangular Laminate Coffee Table	40 x 20 x 17	1306

SAMPLE LAYOUT TOTAL (Starting at Grade 1) \$19,918

RVR110 (Layout 10)



Qty	Model Number	Description	Dimensions	List Price
1	7705NAW3	Armless Two Seater - High Back w/ W3 Right Power/USB Module	48.5 x 29.5 x 41.5 upcharge	3456 945
1	7705NAW1	Armless Two Seater - High Back w/ W1 Left Power/USB Module	48.5 x 29.5 x 41.5 upcharge	3456 945
1	7708NA	Armless Three Seater - High Back	72.5 x 29.5 x 41.5	5345
1	7708NAW3	Armless Three Seater - High Back w/ W3 Right Power/USB Module	72.5 x 29.5 x 41.5 upcharge	5345 945
1	7708NAW1	Armless Three Seater - High Back w/ W1 Left Power/USB Module	72.5 x 29.5 x 41.5 upcharge	5345 945
2	7717	Armless Corner Unit - High Back	38 x 38 x 41.5	5041 x 2
3	7745	16" Square Laminate Laptop Table	16 x 16 x 25.25	810 x 3

SAMPLE LAYOUT TOTAL (Starting at Grade 1) \$39,239

DESCRIPTION	FEATURES	MODEL#	STANDARD TEXTILE GRADES			
RVR111 (Layout 11) 		Qty	Model Number	Description	Dimensions	List Price
		2	7701NA	Armless One Seater - Standard Back	24.5 x 29.5x 32	1807 x 2
		4	7710NA	Armless IS Curve - Two Seat - Standard Back	55 x 29.5 x 32	3258 x 4
		2	7743	18" Dia. Round Laminate Laptop Table	18 x 18 x 25.25	792 x 2
SAMPLE LAYOUT TOTAL (Starting at Grade 1)						\$18,230

RVR112 (Layout 12) 		Qty	Model Number	Description	Dimensions	List Price
		2	7711NA	Armless IS Curve - Two Seater - High Back	55 x 29.5 x 41.5	4137 x 2
		6	7712NA	Armless IS Curve - Two Seater - Extended Back	55 x 29.5 x 47	4553 x 6
		1	7709NA	Armless Three Seater - Extended Back	72.5 x 29.5 x 47	5786
		2	7734	36" Dia - Round Laminate Coffee Table	36 x 36 x 17	1612 x 2
SAMPLE LAYOUT TOTAL (Starting at Grade 1)						\$44,602

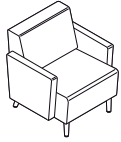

Lounge Chair - Standard Back w/Arms
 COM Yardage: 4
 Freight Class: 250
 Product Weight (lbs.): 57
 Cubic Feet Per Carton: 22.5

For Power/USB module please see electrical placement chart. No ganging hardware.

	1	2	3	4	5	6	7	8	9	10	11	12
7701	2631	2790	2916	3103	3368	3463	3695	4138	4351	4761	5321	6018

OVERALL DIMENSIONS			SEAT DIMENSIONS			BACK DIMENSIONS	
W	D	H	W	D	H	W	H
29.5	29.5	32	24	19	18	24	14

RTA 00

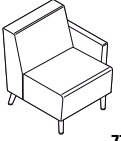

7701L (Left Arm)

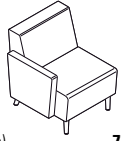

7701R (Right Arm)

Lounge Chair - Standard w/One Arm
 COM Yardage: 3.25
 Freight Class: 250
 Product Weight (lbs.): 47
 Cubic Feet Per Carton: 22.5

For Power/USB module please see electrical placement chart. Includes ganging hardware (1 side).

	1	2	3	4	5	6	7	8	9	10	11	12
7701L	2225	2357	2459	2612	2825	2905	3092	3453	3625	3960	4414	4981
7701R	2225	2357	2459	2612	2825	2905	3092	3453	3625	3960	4414	4981

OVERALL DIMENSIONS			SEAT DIMENSIONS			BACK DIMENSIONS	
W	D	H	W	D	H	W	H
27	29.5	32	24	19	18	24	14

RTA 00

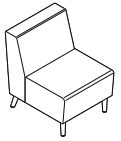





Armless Lounge Chair - Standard Back
 COM Yardage: 2.5
 Freight Class: 300
 Product Weight (lbs.): 37
 Cubic Feet Per Carton: 22.5

For Power/USB module please see electrical placement chart. Includes ganging hardware (2 sides).

	1	2	3	4	5	6	7	8	9	10	11	12
7701NA	1807	1910	1987	2104	2271	2331	2477	2751	2886	3142	3492	3928

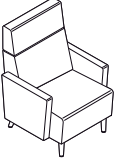
OVERALL DIMENSIONS			SEAT DIMENSIONS			BACK DIMENSIONS	
W	D	H	W	D	H	W	H
24.5	29.5	32	24	19	18	24	14

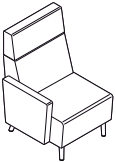
RTA 00

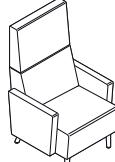
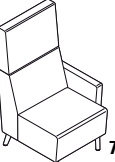
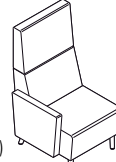
DESCRIPTION	FEATURES	MODEL#	STANDARD TEXTILE GRADES													
			1	2	3	4	5	6	7	8	9	10	11	12		
 <p>Lounge Chair - High Back w/Arms COM Yardage: 4.5 Freight Class: 250 Product Weight (lbs.): 61 Cubic Feet Per Carton: 28.25</p>	<p>For Power/USB module please see electrical placement chart. No ganging hardware.</p>	7702	3016	3196	3337	3548	3846	3955	4213	4712	4953	5416	6044	6827		
		OVERALL DIMENSIONS			SEAT DIMENSIONS			BACK DIMENSIONS								
		W	D	H	W	D	H	W	H							
		29.5	29.5	41.5	24	19	18	24	24							
		RTA 00														
  <p>7702L (Left Arm) 7702R (Right Arm)</p>	<p>For Power/USB module please see electrical placement chart. Includes ganging hardware (1 side).</p>	7702L	2609	2761	2876	3054	3302	3390	3608	4023	4224	4609	5133	5787		
		7702R	2609	2761	2876	3054	3302	3390	3608	4023	4224	4609	5133	5787		
		OVERALL DIMENSIONS			SEAT DIMENSIONS			BACK DIMENSIONS								
		W	D	H	W	D	H	W	H							
		RTA 00														
 <p>Armless Lounge Chair - High Back COM Yardage: 3 Freight Class: 300 Product Weight (lbs.): 41 Cubic Feet Per Carton: 28.25</p>	<p>For Power/USB module please see electrical placement chart. Includes ganging hardware (2 sides).</p>	7702NA	2193	2316	2408	2548	2746	2818	2994	3326	3485	3794	4213	4737		
		OVERALL DIMENSIONS			SEAT DIMENSIONS			BACK DIMENSIONS								
		W	D	H	W	D	H	W	H							
		24.5	29.5	41.5	24	19	18	24	24							
		RTA 00														
 <p>Lounge Chair - Extended Back w/Arms COM Yardage: 4.75 Freight Class: 250 Product Weight (lbs.): 68 Cubic Feet Per Carton: 32.75</p>	<p>For Power/USB module please see electrical placement chart. No ganging hardware.</p>	7703	3494	3681	3831	4054	4369	4483	4758	5284	5538	6026	6688	7516		
		OVERALL DIMENSIONS			SEAT DIMENSIONS			BACK DIMENSIONS								
		W	D	H	W	D	H	W	H							
		29.5	29.5	47	24	19	18	24	29							
		RTA 00														
  <p>7703L (Left Arm) 7703R (Right Arm)</p>	<p>For Power/USB module please see electrical placement chart. Includes ganging hardware (1 side).</p>	7703L	3088	3247	3373	3560	3823	3919	4149	4594	4808	5218	5777	6475		
		7703R	3088	3247	3373	3560	3823	3919	4149	4594	4808	5218	5777	6475		
		OVERALL DIMENSIONS			SEAT DIMENSIONS			BACK DIMENSIONS								
		W	D	H	W	D	H	W	H							
		RTA 00														

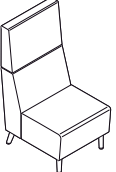
DESCRIPTION	FEATURES	MODEL#	STANDARD TEXTILE GRADES												
			1	2	3	4	5	6	7	8	9	10	11	12	
 <p>Armless Lounge Chair - Extended Back COM Yardage: 3.25 Freight Class: 300 Product Weight (lbs.): 48 Cubic Feet Per Carton: 32.75</p>	For Power/USB module please see electrical placement chart. Includes ganging hardware (2 sides).	7703NA	2672	2802	2905	3058	3272	3350	3539	3899	4071	4406	4859	5425	
		OVERALL DIMENSIONS			SEAT DIMENSIONS			BACK DIMENSIONS							
		W	D	H	W	D	H	W	H						
			24.5	29.5	47	24	19	18	24	29					
			RTA 00												

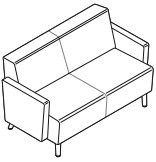
DESCRIPTION	FEATURES	MODEL#	STANDARD TEXTILE GRADES												
			1	2	3	4	5	6	7	8	9	10	11	12	
 <p>Two Seater - Standard Back w/Arms COM Yardage: 5.5 Freight Class: 250 Product Weight (lbs.): 95 Cubic Feet Per Carton: 39</p>	For Power/USB module please see electrical placement chart. No ganging hardware.	7704	3636	3854	4025	4281	4647	4778	5098	5709	5998	6564	7332	8290	
		OVERALL DIMENSIONS			SEAT DIMENSIONS			BACK DIMENSIONS							
		W	D	H	W	D	H	W	H						
			53.5	29.5	32	48	19	18	48	14					
			RTA 00												

DESCRIPTION	FEATURES	MODEL#	STANDARD TEXTILE GRADES											
			1	2	3	4	5	6	7	8	9	10	11	12
 <p>Two Seater - Standard Back w/One Arm COM Yardage: 4.75 Freight Class: 300 Product Weight (lbs.): 85 Cubic Feet Per Carton: 39</p>	For Power/USB module please see electrical placement chart. Includes ganging hardware (1 side).	7704L (Left Arm)	3235	3424	3574	3796	4112	4225	4501	5026	5280	5768	6432	7260
		7704R (Right Arm)	3235	3424	3574	3796	4112	4225	4501	5026	5280	5768	6432	7260
		OVERALL DIMENSIONS			SEAT DIMENSIONS			BACK DIMENSIONS						
			W	D	H	W	D	H	W	H				
			51	29.5	32	48	19	18	48	14				
			RTA 00											

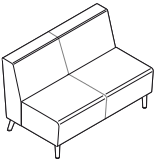
DESCRIPTION	FEATURES	MODEL#	STANDARD TEXTILE GRADES												
			1	2	3	4	5	6	7	8	9	10	11	12	
 <p>Armless Two Seater - Standard Back COM Yardage: 4.25 Freight Class: 300 Product Weight (lbs.): 75 Cubic Feet Per Carton: 39</p>	For Power/USB module please see electrical placement chart. Includes ganging hardware (2 sides).	7704NA	2820	2991	3125	3324	3605	3705	3952	4422	4650	5086	5681	6421	
		OVERALL DIMENSIONS			SEAT DIMENSIONS			BACK DIMENSIONS							
		W	D	H	W	D	H	W	H						
			48.5	29.5	32	48	19	18	48	14					
			RTA 00												

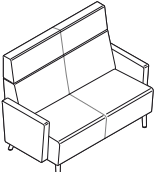
DESCRIPTION	FEATURES	MODEL#	STANDARD TEXTILE GRADES												
			1	2	3	4	5	6	7	8	9	10	11	12	
 <p>Two Seater - High Back w/Arms COM Yardage: 6.5 Freight Class: 300 Product Weight (lbs.): 97 Cubic Feet Per Carton: 54</p>	For Power/USB module please see electrical placement chart. No ganging hardware.	7705	4279	4538	4740	5046	5474	5629	6009	6728	7073	7742	8650	9781	
		OVERALL DIMENSIONS			SEAT DIMENSIONS			BACK DIMENSIONS							
		W	D	H	W	D	H	W	H						
			53.5	29.5	41.5	48	19	18	48	24					
			RTA 00												

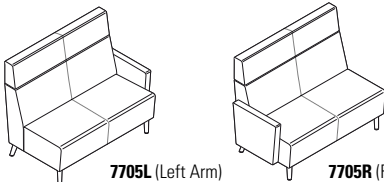
DESCRIPTION	FEATURES	MODEL#	STANDARD TEXTILE GRADES											
			1	2	3	4	5	6	7	8	9	10	11	12
 <p>7705L (Left Arm) 7705R (Right Arm)</p> <p>Two Seater - High Back w/One Arm COM Yardage: 5.75 Freight Class: 300 Product Weight (lbs.): 87 Cubic Feet Per Carton: 54</p> <p>For Power/USB module please see electrical placement chart. Includes ganging hardware (1 side).</p>		3871	4098	4278	4546	4929	5065	5400	6036	6343	6933	7737	8740	
		3871	4098	4278	4546	4929	5065	5400	6036	6343	6933	7737	8740	
			OVERALL DIMENSIONS			SEAT DIMENSIONS			BACK DIMENSIONS					
			W	D	H	W	D	H	W	H				
			51	29.5	41.5	48	19	18	48	24				
			RTA 00											

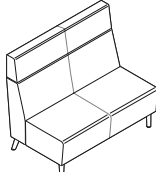
DESCRIPTION	FEATURES	MODEL#	STANDARD TEXTILE GRADES											
			1	2	3	4	5	6	7	8	9	10	11	12
 <p>7705NA</p> <p>Armless Two Seater - High Back COM Yardage: 5.25 Freight Class: 300 Product Weight (lbs.): 77 Cubic Feet Per Carton: 54</p> <p>For Power/USB module please see electrical placement chart. Includes ganging hardware (2 sides).</p>		3456	3664	3829	4076	4422	4549	4853	5434	5715	6253	6986	7902	
		3456	3664	3829	4076	4422	4549	4853	5434	5715	6253	6986	7902	
			OVERALL DIMENSIONS			SEAT DIMENSIONS			BACK DIMENSIONS					
			W	D	H	W	D	H	W	H				
			48.5	29.5	41.5	48	19	18	48	24				
			RTA 00											

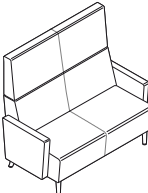
DESCRIPTION	FEATURES	MODEL#	STANDARD TEXTILE GRADES											
			1	2	3	4	5	6	7	8	9	10	11	12
 <p>7706</p> <p>Two Seater - Extended Back w/Arms COM Yardage: 7 Freight Class: 300 Product Weight (lbs.): 107 Cubic Feet Per Carton: 56.75</p> <p>For Power/USB module please see electrical placement chart. No ganging hardware.</p>		4516	4794	5012	5341	5805	5973	6376	7152	7525	8246	9222	10440	
		4516	4794	5012	5341	5805	5973	6376	7152	7525	8246	9222	10440	
			OVERALL DIMENSIONS			SEAT DIMENSIONS			BACK DIMENSIONS					
			W	D	H	W	D	H	W	H				
			53.5	29.5	47	48	19	18	48	29				
			RTA 00											

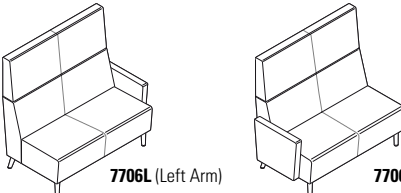
DESCRIPTION	FEATURES	MODEL#	STANDARD TEXTILE GRADES											
			1	2	3	4	5	6	7	8	9	10	11	12
 <p>7706L (Left Arm) 7706R (Right Arm)</p> <p>Two Seater - Extended Back w/One Arm COM Yardage: 6.25 Freight Class: 300 Product Weight (lbs.): 97 Cubic Feet Per Carton: 56.75</p> <p>For Power/USB module please see electrical placement chart. Includes ganging hardware (1 side).</p>		4108	4356	4551	4843	5258	5404	5768	6462	6793	7438	8311	9398	
		4108	4356	4551	4843	5258	5404	5768	6462	6793	7438	8311	9398	
			OVERALL DIMENSIONS			SEAT DIMENSIONS			BACK DIMENSIONS					
			W	D	H	W	D	H	W	H				
			51	29.5	47	48	19	18	48	29				
			RTA 00											

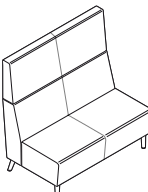
DESCRIPTION	FEATURES	MODEL#	STANDARD TEXTILE GRADES											
			1	2	3	4	5	6	7	8	9	10	11	12
 <p>7706NA</p> <p>Armless Two Seater - Extended Back COM Yardage: 5.75 Freight Class: 300 Product Weight (lbs.): 87 Cubic Feet Per Carton: 56.75</p> <p>For Power/USB module please see electrical placement chart. Includes ganging hardware (2 sides).</p>		3690	3918	4098	4367	4749	4885	5220	5856	6163	6753	7557	8560	
		3690	3918	4098	4367	4749	4885	5220	5856	6163	6753	7557	8560	
			OVERALL DIMENSIONS			SEAT DIMENSIONS			BACK DIMENSIONS					
			W	D	H	W	D	H	W	H				
			48.5	29.5	47	48	19	18	48	29				
			RTA 00											

DESCRIPTION FEATURES MODEL# STANDARD TEXTILE GRADES

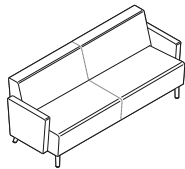

Three Seater - Standard Back w/Arms
 COM Yardage: 8.25
 Freight Class: 250
 Product Weight (lbs.): 139
 Cubic Feet Per Carton: 55.5

For Power/USB module please see electrical placement chart. No ganging hardware.

MODEL#	1	2	3	4	5	6	7	8	9	10	11	12
7707	5406	5729	5990	6375	6922	7117	7596	8511	8951	9800	10952	12388

OVERALL DIMENSIONS			SEAT DIMENSIONS			BACK DIMENSIONS	
W	D	H	W	D	H	W	H
77.5	29.5	32	72	19	18	72	14

RTA 00

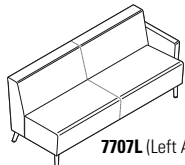

7707L (Left Arm)

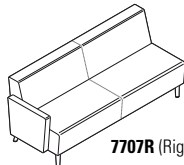

7707R (Right Arm)

Three Seater - Standard Back w/One Arm
 COM Yardage: 7.75
 Freight Class: 250
 Product Weight (lbs.): 129
 Cubic Feet Per Carton: 55.5

For Power/USB module please see electrical placement chart. Includes ganging hardware (1 side).

MODEL#	1	2	3	4	5	6	7	8	9	10	11	12
7707L	5001	5306	5548	5911	6424	6611	7059	7916	8330	9127	10209	11559
7707R	5001	5306	5548	5911	6424	6611	7059	7916	8330	9127	10209	11559

OVERALL DIMENSIONS			SEAT DIMENSIONS			BACK DIMENSIONS	
W	D	H	W	D	H	W	H
75	29.5	32	72	19	18	72	14

RTA 00

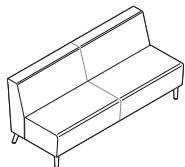

Armless Three Seater - Standard Back
 COM Yardage: 7
 Freight Class: 250
 Product Weight (lbs.): 119
 Cubic Feet Per Carton: 55.5

For Power/USB module please see electrical placement chart. Includes ganging hardware (2 sides).

MODEL#	1	2	3	4	5	6	7	8	9	10	11	12
7707NA	4584	4863	5080	5410	5874	6040	6445	7221	7594	8314	9291	10512

OVERALL DIMENSIONS			SEAT DIMENSIONS			BACK DIMENSIONS	
W	D	H	W	D	H	W	H
72.5	29.5	32	72	19	18	72	14

RTA 00

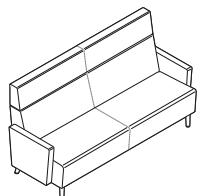

Three Seater - High Back w/Arms
 COM Yardage: 10.5
 Freight Class: 250
 Product Weight (lbs.): 148
 Cubic Feet Per Carton: 69.75

For Power/USB module please see electrical placement chart. No ganging hardware.

MODEL#	1	2	3	4	5	6	7	8	9	10	11	12
7708	6162	6575	6902	7395	8089	8341	8948	10112	10673	11750	13219	15047

OVERALL DIMENSIONS			SEAT DIMENSIONS			BACK DIMENSIONS	
W	D	H	W	D	H	W	H
77.5	29.5	41.5	72	19	18	72	24

RTA 00



7708L (Left Arm)

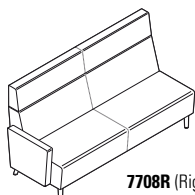

7708R (Right Arm)

Three Seater - High Back w/One Arm
 COM Yardage: 9.75
 Freight Class: 300
 Product Weight (lbs.): 139
 Cubic Feet Per Carton: 69.75

For Power/USB module please see electrical placement chart. Includes ganging hardware (1 side).

MODEL#	1	2	3	4	5	6	7	8	9	10	11	12
7708L	5761	6146	6451	6905	7551	7785	8349	9429	9949	10951	12314	14013
7708R	5761	6146	6451	6905	7551	7785	8349	9429	9949	10951	12314	14013

OVERALL DIMENSIONS			SEAT DIMENSIONS			BACK DIMENSIONS	
W	D	H	W	D	H	W	H
75	29.5	41.5	72	19	18	72	24

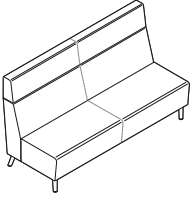

RTA 00

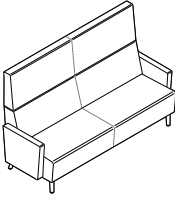
DESCRIPTION	FEATURES	MODEL#	STANDARD TEXTILE GRADES													
			1	2	3	4	5	6	7	8	9	10	11	12		
 <p>Armless Three Seater - High Back COM Yardage: 9.25 Freight Class: 300 Product Weight (lbs.): 126 Cubic Feet Per Carton: 69.75</p>	<p>For Power/USB module please see electrical placement chart. Includes ganging hardware (2 sides).</p>	7708NA	5345	5712	5999	6433	7046	7268	7801	8828	9322	10271	11563	13175		
		OVERALL DIMENSIONS			SEAT DIMENSIONS			BACK DIMENSIONS								
		W	D	H	W	D	H	W	H							
			72.5	29.5	41.5	72	19	18	72	24						
			RTA 00													

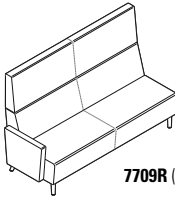
DESCRIPTION	FEATURES	MODEL#	STANDARD TEXTILE GRADES													
			1	2	3	4	5	6	7	8	9	10	11	12		
 <p>Three Seater - Extended Back w/Arms COM Yardage: 11 Freight Class: 300 Product Weight (lbs.): 144 Cubic Feet Per Carton: 78.75</p>	<p>For Power/USB module please see electrical placement chart. No ganging hardware.</p>	7709	6610	7044	7386	7902	8632	8893	9532	10749	11335	12467	14004	15919		
		OVERALL DIMENSIONS			SEAT DIMENSIONS			BACK DIMENSIONS								
		W	D	H	W	D	H	W	H							
			77.5	29.5	47	72	19	18	72	29						
			RTA 00													

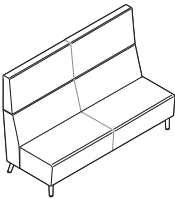
DESCRIPTION	FEATURES	MODEL#	STANDARD TEXTILE GRADES													
			1	2	3	4	5	6	7	8	9	10	11	12		
 <p>7709L (Left Arm)</p>  <p>7709R (Right Arm)</p> <p>Three Seater - Extended Back w/One Arm COM Yardage: 10.5 Freight Class: 300 Product Weight (lbs.): 134 Cubic Feet Per Carton: 78.75</p>	<p>For Power/USB module please see electrical placement chart. Includes ganging hardware (1 side).</p>	7709L	6199	6613	6939	7432	8128	8378	8988	10149	10707	11787	13254	15082		
		7709R	6199	6613	6939	7432	8128	8378	8988	10149	10707	11787	13254	15082		
		OVERALL DIMENSIONS			SEAT DIMENSIONS			BACK DIMENSIONS								
			W	D	H	W	D	H	W	H						
			75	29.5	47	72	19	18	72	29						
			RTA 00													

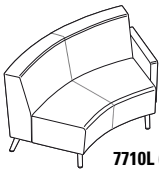
DESCRIPTION	FEATURES	MODEL#	STANDARD TEXTILE GRADES													
			1	2	3	4	5	6	7	8	9	10	11	12		
 <p>Armless Three Seater - Extended Back COM Yardage: 9.75 Freight Class: 300 Product Weight (lbs.): 124 Cubic Feet Per Carton: 78.75</p>	<p>For Power/USB module please see electrical placement chart. Includes ganging hardware (2 sides).</p>	7709NA	5786	6171	6476	6930	7576	7810	8373	9454	9974	10976	12340	14038		
		OVERALL DIMENSIONS			SEAT DIMENSIONS			BACK DIMENSIONS								
		W	D	H	W	D	H	W	H							
			72.5	29.5	47	72	19	18	72	29						
			RTA 00													

DESCRIPTION	FEATURES	MODEL#	STANDARD TEXTILE GRADES													
			1	2	3	4	5	6	7	8	9	10	11	12		
 <p>7710L (Left Arm)</p>  <p>7710R (Right Arm)</p> <p>IS Curve - Two Seater - Standard Back w/One Arm COM Yardage: 5.25 Freight Class: 250 Product Weight (lbs.): 88 Cubic Feet Per Carton: 43</p>	<p>For Power/USB module please see electrical placement chart. Includes ganging hardware (1 side).</p>	7710L	3676	3888	4049	4296	4644	4769	5074	5654	5936	6473	7206	8122		
		7710R	3676	3888	4049	4296	4644	4769	5074	5654	5936	6473	7206	8122		
		OVERALL DIMENSIONS			SEAT DIMENSIONS			BACK DIMENSIONS								
			W	D	H	W	D	H	W	H						
			57	29.5	32	42	19	18	51	14						
			RTA 00													

DESCRIPTION FEATURES MODEL# STANDARD TEXTILE GRADES

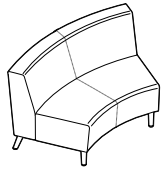

Armless IS Curve - Two Seat - Standard Back
 COM Yardage: 4.5
 Freight Class: 300
 Product Weight (lbs.): 78
 Cubic Feet Per Carton: 43

For Power/USB module please see electrical placement chart. Includes ganging hardware (2 sides).

MODEL#	1	2	3	4	5	6	7	8	9	10	11	12
7710NA	3258	3437	3576	3789	4088	4195	4455	4954	5194	5656	6286	7068

OVERALL DIMENSIONS			SEAT DIMENSIONS			BACK DIMENSIONS	
W	D	H	W	D	H	W	H
55	29.5	32	42	19	18	51	14

RTA 00

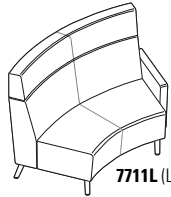

7711L (Left Arm)

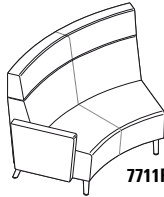

7711R (Right Arm)

IS Curve - Two Seater - High Back w/One Arm
 COM Yardage: 6.5
 Freight Class: 300
 Product Weight (lbs.): 94
 Cubic Feet Per Carton: 54

For Power/USB module please see electrical placement chart. Includes ganging hardware (1 side).

MODEL#	1	2	3	4	5	6	7	8	9	10	11	12
7711L	4553	4811	5014	5318	5748	5902	6279	7000	7346	8015	8921	10055

7711R	4553	4811	5014	5318	5748	5902	6279	7000	7346	8015	8921	10055
-------	------	------	------	------	------	------	------	------	------	------	------	-------

OVERALL DIMENSIONS			SEAT DIMENSIONS			BACK DIMENSIONS	
W	D	H	W	D	H	W	H
57	29.5	41.5	42	19	18	51	24

RTA 00

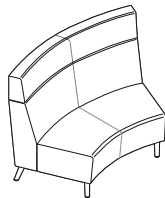

Armless IS Curve - Two Seater - High Back
 COM Yardage: 6
 Freight Class: 300
 Product Weight (lbs.): 84
 Cubic Feet Per Carton: 54

For Power/USB module please see electrical placement chart. Includes ganging hardware (2 sides).

MODEL#	1	2	3	4	5	6	7	8	9	10	11	12
7711NA	4137	4376	4565	4845	5241	5386	5734	6400	6718	7334	8172	9218

OVERALL DIMENSIONS			SEAT DIMENSIONS			BACK DIMENSIONS	
W	D	H	W	D	H	W	H
55	29.5	41.5	42	19	18	51	24

RTA 00

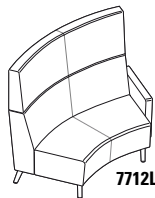

7712L (Left Arm)

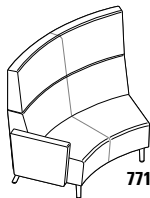

7712R (Right Arm)

IS Curve - Two Seater - Extended Back w/One Arm
 COM Yardage: 7
 Freight Class: 300
 Product Weight (lbs.): 99
 Cubic Feet Per Carton: 62.75

For Power/USB module please see electrical placement chart. Includes ganging hardware (1 side).

MODEL#	1	2	3	4	5	6	7	8	9	10	11	12
7712L	4967	5244	5462	5790	6255	6421	6826	7603	7975	8696	9673	10891

7712R	4967	5244	5462	5790	6255	6421	6826	7603	7975	8696	9673	10891
-------	------	------	------	------	------	------	------	------	------	------	------	-------

OVERALL DIMENSIONS			SEAT DIMENSIONS			BACK DIMENSIONS	
W	D	H	W	D	H	W	H
57	29.5	47	42	19	18	51	29

RTA 00

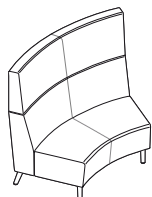



Armless IS Curve - Two Seater - Extended Back
 COM Yardage: 6.75
 Freight Class: 29.5
 Product Weight (lbs.): 89
 Cubic Feet Per Carton: 6.75

For Power/USB module please see electrical placement chart. Includes ganging hardware (2 sides).

MODEL#	1	2	3	4	5	6	7	8	9	10	11	12
7712NA	4553	4819	5030	5346	5793	5954	6346	7095	7455	8150	9091	10266

OVERALL DIMENSIONS			SEAT DIMENSIONS			BACK DIMENSIONS	
W	D	H	W	D	H	W	H
55	29.5	47	42	19	18	51	29

RTA 00

DESCRIPTION	FEATURES	MODEL#	STANDARD TEXTILE GRADES												
			1	2	3	4	5	6	7	8	9	10	11	12	
 <p>7713L (Left Arm)</p>	 <p>7713R (Right Arm)</p>		3676	3888	4049	4296	4644	4769	5074	5654	5936	6473	7206	8122	
			3676	3888	4049	4296	4644	4769	5074	5654	5936	6473	7206	8122	
OS Curve - Two Seater - Standard Back w/One Arm COM Yardage: 5.25 Freight Class: 300 Product Weight (lbs.): 82 Cubic Feet Per Carton: 43			For Power/USB module please see electrical placement chart. Includes ganging hardware (1 side).			OVERALL DIMENSIONS W D H			SEAT DIMENSIONS W D H			BACK DIMENSIONS W H			
			54.5	29.5	32	48	19	18	36	14	RTA 00				

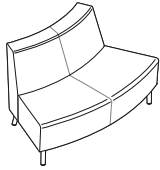
DESCRIPTION	FEATURES	MODEL#	STANDARD TEXTILE GRADES												
			1	2	3	4	5	6	7	8	9	10	11	12	
			3258	3437	3576	3790	4088	4195	4455	4954	5194	5656	6286	7068	
			3258	3437	3576	3790	4088	4195	4455	4954	5194	5656	6286	7068	
Armless OS Curve - Two Seater - Standard Back COM Yardage: 4.5 Freight Class: 300 Product Weight (lbs.): 72 Cubic Feet Per Carton: 43			For Power/USB module please see electrical placement chart. Includes ganging hardware (2 sides).			OVERALL DIMENSIONS W D H			SEAT DIMENSIONS W D H			BACK DIMENSIONS W H			
			54	29.5	32	48	19	18	36	14	RTA 00				

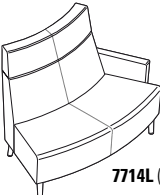
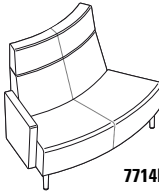
DESCRIPTION	FEATURES	MODEL#	STANDARD TEXTILE GRADES												
			1	2	3	4	5	6	7	8	9	10	11	12	
 <p>7714L (Left Arm)</p>	 <p>7714R (Right Arm)</p>		4292	4552	4754	5059	5489	5644	6022	6741	7086	7757	8664	9795	
			4292	4552	4754	5059	5489	5644	6022	6741	7086	7757	8664	9795	
OS Curve - Two Seater - High Back w/One Arm COM Yardage: 6.5 Freight Class: 300 Product Weight (lbs.): 88 Cubic Feet Per Carton: 54			For Power/USB module please see electrical placement chart. Includes ganging hardware (1 side).			OVERALL DIMENSIONS W D H			SEAT DIMENSIONS W D H			BACK DIMENSIONS W H			
			54.5	29.5	41.5	48	19	18	36	24	RTA 00				

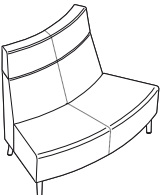
DESCRIPTION	FEATURES	MODEL#	STANDARD TEXTILE GRADES												
			1	2	3	4	5	6	7	8	9	10	11	12	
			3885	4123	4311	4591	4988	5133	5481	6145	6466	7082	7920	8965	
			3885	4123	4311	4591	4988	5133	5481	6145	6466	7082	7920	8965	
Armless OS Curve - Two Seater - High Back COM Yardage: 6 Freight Class: 300 Product Weight (lbs.): 78 Cubic Feet Per Carton: 54			For Power/USB module please see electrical placement chart. Includes ganging hardware (2 sides).			OVERALL DIMENSIONS W D H			SEAT DIMENSIONS W D H			BACK DIMENSIONS W H			
			54	29.5	41.5	48	19	18	36	24	RTA 00				

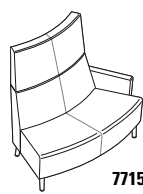
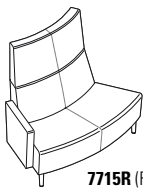
DESCRIPTION	FEATURES	MODEL#	STANDARD TEXTILE GRADES												
			1	2	3	4	5	6	7	8	9	10	11	12	
 <p>7715L (Left Arm)</p>	 <p>7715R (Right Arm)</p>		4686	4964	5182	5512	5975	6142	6547	7323	7695	8416	9393	10614	
			4686	4964	5182	5512	5975	6142	6547	7323	7695	8416	9393	10614	
OS Curve - Two Seater - Extended Back w/One Arm COM Yardage: 7 Freight Class: 300 Product Weight (lbs.): 93 Cubic Feet Per Carton: 62.75			For Power/USB module please see electrical placement chart. Includes ganging hardware (1 side).			OVERALL DIMENSIONS W D H			SEAT DIMENSIONS W D H			BACK DIMENSIONS W H			
			54.5	29.5	47	48	19	18	36	29	RTA 00				

DESCRIPTION FEATURES MODEL# STANDARD TEXTILE GRADES

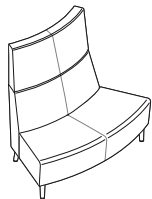

Armless OS Curve - Two Seater - Ext. High Back
 COM Yardage: 6.75
 Freight Class: 300
 Product Weight (lbs.): 83
 Cubic Feet Per Carton: 62.75

For Power/USB module please see electrical placement chart. Includes ganging hardware (2 sides).

MODEL#	1	2	3	4	5	6	7	8	9	10	11	12
7715NA	4271	4537	4750	5064	5511	5672	6064	6814	7173	7868	8809	9986

OVERALL DIMENSIONS			SEAT DIMENSIONS			BACK DIMENSIONS	
W	D	H	W	D	H	W	H
54	29.5	47	48	19	18	36	28

RTA 00

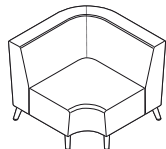

Armless Corner Unit - Standard Back
 COM Yardage: 5.5
 Freight Class: 300
 Product Weight (lbs.): 75
 Cubic Feet Per Carton: 49

For Power/USB module please see electrical placement chart. Includes ganging hardware (2 sides).

MODEL#	1	2	3	4	5	6	7	8	9	10	11	12
7716	3980	4199	4373	4627	4995	5124	5443	6054	6345	6912	7681	8637

OVERALL DIMENSIONS			SEAT DIMENSIONS			BACK DIMENSIONS	
W	D	H	W	D	H	W	H
38	38	32	24	19	18	24	14

RTA 00

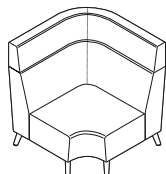

Armless Corner Unit - High Back
 COM Yardage: 7.75
 Freight Class: 300
 Product Weight (lbs.): 82
 Cubic Feet Per Carton: 49

For Power/USB module please see electrical placement chart. Includes ganging hardware (2 sides).

MODEL#	1	2	3	4	5	6	7	8	9	10	11	12
7717	5041	5346	5588	5952	6467	6651	7099	7959	8371	9168	10250	11599

OVERALL DIMENSIONS			SEAT DIMENSIONS			BACK DIMENSIONS	
W	D	H	W	D	H	W	H
38	38	41.5	24	19	18	24	24

RTA 00

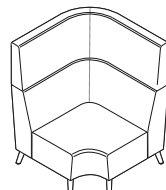

Armless Corner Unit - Extended Back
 COM Yardage: 8.5
 Freight Class: 300
 Product Weight (lbs.): 88
 Cubic Feet Per Carton: 49

For Power/USB module please see electrical placement chart. Includes ganging hardware (2 sides).

MODEL#	1	2	3	4	5	6	7	8	9	10	11	12
7718	5339	5674	5939	6337	6900	7103	7596	8537	8991	9865	11052	12532

OVERALL DIMENSIONS			SEAT DIMENSIONS			BACK DIMENSIONS	
W	D	H	W	D	H	W	H
38	38	47	24	19	18	24	29

RTA 00

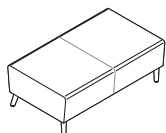

Two Seater Bench
 COM Yardage: 2.25
 Freight Class: 300
 Product Weight (lbs.): 41
 Cubic Feet Per Carton: 21.25

For Power/USB module please see electrical placement chart. Includes ganging hardware (2 sides).

MODEL#	1	2	3	4	5	6	7	8	9	10	11	12
7725	2036	2129	2200	2303	2453	2508	2638	2888	3006	3239	3553	3944

OVERALL DIMENSIONS			SEAT DIMENSIONS			BACK DIMENSIONS	
W	D	H	W	D	H	W	H
48.5	28	17.5					

RTA 00

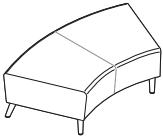
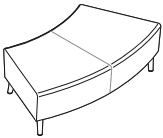
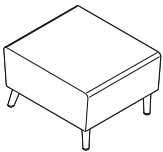
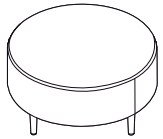
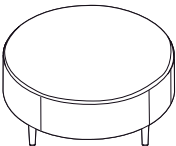
DESCRIPTION	FEATURES	MODEL#	STANDARD TEXTILE GRADES											
			1	2	3	4	5	6	7	8	9	10	11	12
 <p>IS Curve - Two Seater Bench COM Yardage: 3 Freight Class: 300 Product Weight (lbs.): 41 Cubic Feet Per Carton: 21.25</p>	<p>For Power/USB module please see electrical placement chart. Includes ganging hardware (2 sides).</p>	<p>7726</p>	2765	2888	2981	3120	3318	3391	3566	3898	4057	4366	4785	5309
			<p>OVERALL DIMENSIONS</p>			<p>SEAT DIMENSIONS</p>			<p>BACK DIMENSIONS</p>					
			W	D	H	W	D	H	W	H				
			54	28	17.5									
			<p>RTA 00</p>											
 <p>OS Curve - Two Seater Bench COM Yardage: 3 Freight Class: 300 Product Weight (lbs.): 41 Cubic Feet Per Carton: 21.25</p>	<p>For Power/USB module please see electrical placement chart. Includes ganging hardware (2 sides).</p>	<p>7727</p>	2765	2888	2981	3120	3318	3391	3566	3898	4057	4366	4785	5309
			<p>OVERALL DIMENSIONS</p>			<p>SEAT DIMENSIONS</p>			<p>BACK DIMENSIONS</p>					
			W	D	H	W	D	H	W	H				
			54	28	17.5									
			<p>RTA 00</p>											
 <p>Square Single Seater Bench COM Yardage: 1.75 Freight Class: 250 Product Weight (lbs.): 30 Cubic Feet Per Carton: 9.25</p>	<p>For Power/USB module please see electrical placement chart. Includes ganging hardware (2 sides).</p>	<p>7728</p>	1392	1464	1518	1600	1715	1759	1859	2055	2147	2326	2572	2875
			<p>OVERALL DIMENSIONS</p>			<p>SEAT DIMENSIONS</p>			<p>BACK DIMENSIONS</p>					
			W	D	H	W	D	H	W	H				
			24.5	28	17.5									
			<p>RTA 00</p>											
 <p>36" Dia. - Round Bench COM Yardage: 3 Freight Class: 250 Product Weight (lbs.): 46 Cubic Feet Per Carton: 18.25</p>	<p>No Power/USB module. No ganging hardware.</p>	<p>7729</p>	2043	2166	2259	2400	2599	2672	2845	3176	3336	3644	4063	4587
			<p>OVERALL DIMENSIONS</p>			<p>SEAT DIMENSIONS</p>			<p>BACK DIMENSIONS</p>					
			W	D	H	W	D	H	W	H				
			36	36	17.5									
			<p>RTA 00</p>											
 <p>42" Dia. - Round Bench COM Yardage: 3.25 Freight Class: 250 Product Weight (lbs.): 50 Cubic Feet Per Carton: 22</p>	<p>No Power/USB module. No ganging hardware.</p>	<p>7730</p>	2351	2480	2583	2737	2949	3026	3215	3578	3750	4083	4536	5103
			<p>OVERALL DIMENSIONS</p>			<p>SEAT DIMENSIONS</p>			<p>BACK DIMENSIONS</p>					
			W	D	H	W	D	H	W	H				
			42	42	17.5									
			<p>RTA 00</p>											

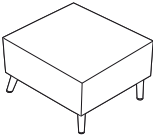
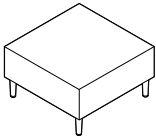
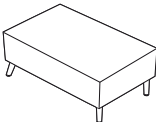
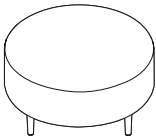
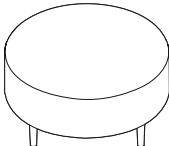
DESCRIPTION	FEATURES	MODEL#	STANDARD TEXTILE GRADES													
			1	2	3	4	5	6	7	8	9	10	11	12		
 <p>30" Square Laminate Coffee Table COM Yardage: N/A Freight Class: 150 Product Weight (lbs.): 61 Cubic Feet Per Carton: 11.5</p>	<p>For Power/USB module please see electrical placement chart. No ganging hardware.</p>	7731	1300													
		OVERALL DIMENSIONS			SEAT DIMENSIONS			BACK DIMENSIONS								
		W	D	H	W	D	H	W	H							
		30	30	17												
		RTA 00														
 <p>36" Square Laminate Coffee Table COM Yardage: N/A Freight Class: 150 Product Weight (lbs.): 85 Cubic Feet Per Carton: 16.5</p>	<p>For Power/USB module please see electrical placement chart. No ganging hardware.</p>	7732	1477													
		OVERALL DIMENSIONS			SEAT DIMENSIONS			BACK DIMENSIONS								
		W	D	H	W	D	H	W	H							
		36	36	17												
		RTA 00														
 <p>Rectangular Laminate Coffee Table COM Yardage: N/A Freight Class: 150 Product Weight (lbs.): 55 Cubic Feet Per Carton: 11.5</p>	<p>For Power/USB module please see electrical placement chart. No ganging hardware.</p>	7733	1306													
		OVERALL DIMENSIONS			SEAT DIMENSIONS			BACK DIMENSIONS								
		W	D	H	W	D	H	W	H							
		40	20	17												
		RTA 00														
 <p>36" Dia. - Round Laminate Coffee Table COM Yardage: N/A Freight Class: 250 Product Weight (lbs.): 63 Cubic Feet Per Carton: 16.5</p>	<p>For Power/USB module please see electrical placement chart. No ganging hardware.</p>	7734	1612													
		OVERALL DIMENSIONS			SEAT DIMENSIONS			BACK DIMENSIONS								
		W	D	H	W	D	H	W	H							
		36	36	17												
		RTA 00														
 <p>42" Dia. - Round Laminate Coffee Table COM Yardage: N/A Freight Class: 250 Product Weight (lbs.): 85 Cubic Feet Per Carton: 22</p>	<p>For Power/USB module please see electrical placement chart. No ganging hardware.</p>	7735	1762													
		OVERALL DIMENSIONS			SEAT DIMENSIONS			BACK DIMENSIONS								
		W	D	H	W	D	H	W	H							
		42	42	17												
		RTA 00														

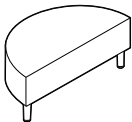
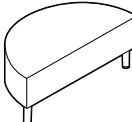
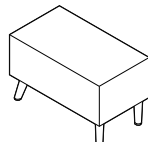
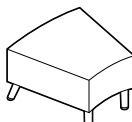
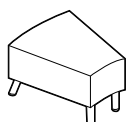
DESCRIPTION	FEATURES	MODEL#	STANDARD TEXTILE GRADES														
			1	2	3	4	5	6	7	8	9	10	11	12			
 <p>36" Half Round Laminate Coffee Table COM Yardage: N/A Freight Class: 150 Product Weight (lbs.): 37 Cubic Feet Per Carton: 8.5</p>	<p>For Power/USB module please see electrical placement chart. No ganging hardware.</p>	<p>7736 1143</p>															
			<p>OVERALL DIMENSIONS</p> <p>W D H</p>			<p>SEAT DIMENSIONS</p> <p>W D H</p>			<p>BACK DIMENSIONS</p> <p>W H</p>								
			<p>36 18 17</p>														
			<p>RTA 00</p>														
 <p>42" Half Round Laminate Coffee Table COM Yardage: N/A Freight Class: 150 Product Weight (lbs.): 48 Cubic Feet Per Carton: 11.5</p>	<p>For Power/USB module please see electrical placement chart. No ganging hardware.</p>	<p>7737 1384</p>															
			<p>OVERALL DIMENSIONS</p> <p>W D H</p>			<p>SEAT DIMENSIONS</p> <p>W D H</p>			<p>BACK DIMENSIONS</p> <p>W H</p>								
			<p>42 21 17</p>														
			<p>RTA 00</p>														
 <p>Rectangular Laminate End Table COM Yardage: N/A Freight Class: 125 Product Weight (lbs.): 34 Cubic Feet Per Carton: 5.5</p>	<p>For Power/USB module please see electrical placement chart. Includes ganging hardware (2 sides).</p>	<p>7738 1309</p>															
			<p>OVERALL DIMENSIONS</p> <p>W D H</p>			<p>SEAT DIMENSIONS</p> <p>W D H</p>			<p>BACK DIMENSIONS</p> <p>W H</p>								
			<p>15 27.25 17</p>														
			<p>RTA 00</p>														
 <p>IS Curve Wide Wedge Laminate End Table COM Yardage: N/A Freight Class: 150 Product Weight (lbs.): 50 Cubic Feet Per Carton: 9.5</p>	<p>For Power/USB module please see electrical placement chart. Includes ganging hardware (2 sides).</p>	<p>7739 1728</p>															
			<p>OVERALL DIMENSIONS</p> <p>W D H</p>			<p>SEAT DIMENSIONS</p> <p>W D H</p>			<p>BACK DIMENSIONS</p> <p>W H</p>								
			<p>27.25 27.25 17</p>														
			<p>RTA 00</p>														
 <p>IS Curve Narrow Wedge Laminate End Table COM Yardage: N/A Freight Class: 150 Product Weight (lbs.): 34 Cubic Feet Per Carton: 6.5</p>	<p>For Power/USB module please see electrical placement chart. Includes ganging hardware (2 sides).</p>	<p>7740 1400</p>															
			<p>OVERALL DIMENSIONS</p> <p>W D H</p>			<p>SEAT DIMENSIONS</p> <p>W D H</p>			<p>BACK DIMENSIONS</p> <p>W H</p>								
			<p>18.25 27.25 17</p>														
			<p>RTA 00</p>														

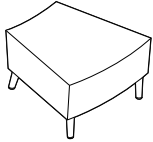
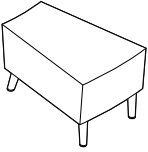
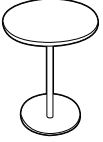
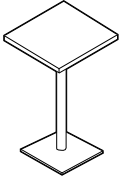
DESCRIPTION	FEATURES	MODEL#	STANDARD TEXTILE GRADES											
			1	2	3	4	5	6	7	8	9	10	11	12
 <p>OS Curve - Wide Wedge Laminate End Table COM Yardage: N/A Freight Class: 150 Product Weight (lbs.): 50 Cubic Feet Per Carton: 9.5</p>	For Power/USB module please see electrical placement chart. Includes ganging hardware (2 sides).	7741 1728	OVERALL DIMENSIONS			SEAT DIMENSIONS			BACK DIMENSIONS					
			W	D	H	W	D	H	W	H				
			27.25	27.25	17									
			RTA 00											
 <p>OS Curve - Narrow Wedge Laminate End Table COM Yardage: N/A Freight Class: 150 Product Weight (lbs.): 34 Cubic Feet Per Carton: 6.5</p>	For Power/USB module please see electrical placement chart. Includes ganging hardware (2 sides).	7742 1400	OVERALL DIMENSIONS			SEAT DIMENSIONS			BACK DIMENSIONS					
			W	D	H	W	D	H	W	H				
			18.25	27.25	17									
			RTA 00											
 <p>18" Dia. Round Laminate Laptop Table COM Yardage: N/A Freight Class: 150 Product Weight (lbs.): 32 Cubic Feet Per Carton: 6</p>	No Power/USB module. No ganging hardware.	7743 792	OVERALL DIMENSIONS			SEAT DIMENSIONS			BACK DIMENSIONS					
			W	D	H	W	D	H	W	H				
			18	18	25.25									
			RTA 00											
 <p>16" Square Laminate Laptop Table COM Yardage: N/A Freight Class: 125 Product Weight (lbs.): 36 Cubic Feet Per Carton: 6</p>	No Power/USB module. No ganging hardware.	7745 810	OVERALL DIMENSIONS			SEAT DIMENSIONS			BACK DIMENSIONS					
			W	D	H	W	D	H	W	H				
			16	16	25.25									
			RTA 00											

LOUNGE

RIVER™ PERSONAL HARBOR



Sample Layout

ELECTRICAL PLACEMENT

Locations available on left side J1 (black) or W1 (white), right side J3 (black) or W3 (white) or both sides J1/J3 (black) or W1/W3 (white).

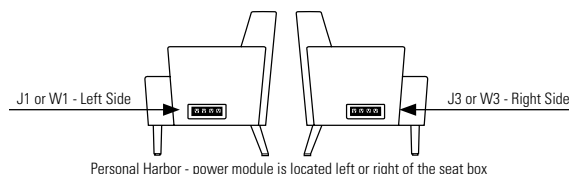

RIVER™ PERSONAL HARBOR R

STANDARD FEATURES

- River Personal Harbor is a line extension of the popular River modular seating series. For modular series see River price book pages.
- The freestanding soft seating models are available with standard height, high and extended high backs.
- The unique tapered legs (swaged legs) are made of welded steel, heavy duty construction, with each leg bolted directly to the frame. The extremely robust construction insures trouble free performance in any environment. All units have the same leg height of 6.5". The leg height makes it easier to clean under the product.
- Each leg is standard with adjustable black nylon leveling glides and are non-marking. Wood legs and casters are not available.
- All cushions are fixed and non-removable (cushions will not migrate). Perimeter seams feature a decorative single stitch detail, which makes seams lay flat and adds extra seam strength.
- Seating frames are heavy duty with interlocking plywood, puzzle box construction, made for rugged active environments. Seats are high density with highly resilient foam and are equipped with a synthetic rubberized webbing suspension system for extra comfort.
- Front edge or face of the seat, angles slightly inward, so feet have freedom of movement and shoe heels don't rub on the seat. This inward slanting matches the inward angles of the back. Benches and connecting end tables also reflect the inward angles on the front and back faces, so all units coordinate in visual appearance.
- High Traffic (**HT**) units are rated at 350 lbs. active load per seat and 24/7 use. These units have the same puzzle box frame construction except that the framing wood is 1" thick, rotary cut, birch plywood and all arms, seat and back cushions are made with Ultracell Foam.
- High Traffic (**HT**) models are recommend to be specified in textiles that meet or exceed 100,000 double rubs for added abrasion performance.

- Check textile availability prior to specifying upholstery material. Leather not available on River Personal Harbor.

OPTIONAL FEATURES

- Seating units can be specified with Power/USB terminals, which includes two power outlets, two double USB terminals and a black 60" three-prong power cord. Each Power/USB module is set in predetermined locations, as shown in the electrical illustrations below. Electrical units must be factory installed.
- To add a Power/USB module: From the electrical illustrations below, please specify **J1, W1, J2, W2, J3, W4, J4, W4, J6 or W6** after the product model number. Please note on seating units, if both right and left locations are required, add both **J1/J3 or W1/W3** to the model number. Add \$945 for each module/location required.
- Power/USB modules are available with either Jet Black (**J**) face plate with black Power/USB receptacles or with a White (**W**) face plate with white Power/USB receptacles.
- **Leg finish**

(CHM) Chrome	(TBL) Black
(TDW) Designer White	(TFO) Fog
(TFR) Frost	(TIV) Cloud
(TKA) Kalua	(TLA) Latte
(TMO) Mocha	(TNE) Nevada
(TOA) Toast	(TSH) Shadow
(TSN) Sand	(TTU) Tungsten
- If more than one fabric or a fabric/vinyl combination is required, please fill out a "Seating Multiple Textile" form, specifying each fabric location. Please contact Customer Care for more information.

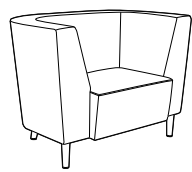
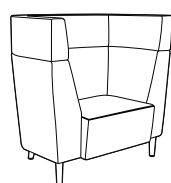
DESCRIPTION	FEATURES	MODEL#	STANDARD TEXTILE GRADES											
			1	2	3	4	5	6	7	8	9	10	11	12
 <p>Personal Harbor - Standard Back COM Yardage: 5.5 Freight Class: 150 Product Weight (lbs.): 50 Cubic Feet Per Carton: 9.5</p>	<p>For Power/USB module please see electrical placement chart. Freestanding unit only.</p>	<p>7746</p>	\$3866	\$4092	\$4271	\$4541	\$4922	\$5103	\$5448	\$5998	\$6423	\$6895	\$7867	\$8904
			OVERALL DIMENSIONS			SEAT DIMENSIONS			BACK DIMENSIONS					
			W	D	H	W	D	H	W	H				
	45	29.5	32	24	19	18	27	14						
 <p>Personal Harbor - High Back COM Yardage: 7.09 Freight Class: 150 Product Weight (lbs.): 86 Cubic Feet Per Carton: 9.5</p>	<p>For Power/USB module please see electrical placement chart. Freestanding unit only.</p>	<p>7747</p>	\$5435	\$5753	\$6005	\$6384	\$6922	\$7174	\$7660	\$8438	\$9036	\$9700	\$11072	\$12532
			OVERALL DIMENSIONS			SEAT DIMENSIONS			BACK DIMENSIONS					
			W	D	H	W	D	H	W	H				
	45	29.5	41.5	24	19	18	27	24						

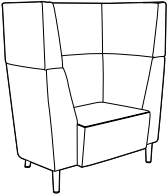
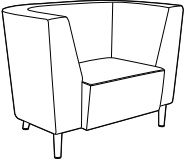
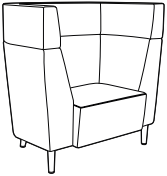
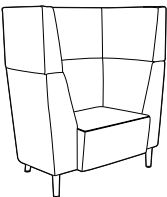
DESCRIPTION	FEATURES	MODEL#	STANDARD TEXTILE GRADES													
			1	2	3	4	5	6	7	8	9	10	11	12		
 <p>Personal Harbor - Extended Back COM Yardage: 8.5 Freight Class: 150 Product Weight (lbs.): 102 Cubic Feet Per Carton: 9.5</p>	<p>For Power/USB module please see electrical placement chart. Freestanding unit only.</p>	7748	\$6114	\$6462	\$6739	\$7157	\$7744	\$8022	\$8556	\$9407	\$10064	\$10794	\$12295	\$13896		
			OVERALL DIMENSIONS			SEAT DIMENSIONS			BACK DIMENSIONS							
			W	D	H	W	D	H	W	H						
			45	29.5	47	24	19	18	27	29						
			RTA 00													
 <p>Personal Harbor - Standard Back COM Yardage: 5.5 Freight Class: 150 Product Weight (lbs.): 50 Cubic Feet Per Carton: 9.5</p>	<p>High Traffic model For Power/USB module please see electrical placement chart. Freestanding unit only.</p>	7786	\$4416	\$4643	\$4821	\$5091	\$5472	\$5653	\$5999	\$6551	\$6976	\$7447	\$8420	\$9457		
			OVERALL DIMENSIONS			SEAT DIMENSIONS			BACK DIMENSIONS							
			W	D	H	W	D	H	W	H						
			45	29.5	32	24	19	18	27	14						
			RTA 00													
 <p>Personal Harbor - High Back COM Yardage: 7.09 Freight Class: 150 Product Weight (lbs.): 86 Cubic Feet Per Carton: 9.5</p>	<p>High Traffic model For Power/USB module please see electrical placement chart. Freestanding unit only.</p>	7787	\$6144	\$6462	\$6714	\$7094	\$7631	\$7884	\$8370	\$9148	\$9745	\$10410	\$11781	\$13239		
			OVERALL DIMENSIONS			SEAT DIMENSIONS			BACK DIMENSIONS							
			W	D	H	W	D	H	W	H						
			45	29.5	41.5	24	19	18	27	24						
			RTA 00													
 <p>Personal Harbor - Extended Back COM Yardage: 8.5 Freight Class: 150 Product Weight (lbs.): 102 Cubic Feet Per Carton: 9.5</p>	<p>High Traffic model For Power/USB module please see electrical placement chart. Freestanding unit only.</p>	7788	\$6664	\$7013	\$7290	\$7707	\$8295	\$8574	\$9106	\$9958	\$10617	\$11345	\$12846	\$14449		
			OVERALL DIMENSIONS			SEAT DIMENSIONS			BACK DIMENSIONS							
			W	D	H	W	D	H	W	H						
			45	29.5	47	24	19	18	27	29						
			RTA 00													

LOUNGE

RIVER+ SEATING



Lounge Chair, High Back model R27802



120 Corner, Standard Back model R27824S



Loop arm R2770

River+ Benches and Tables

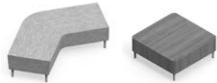

For River+ benches, please see page 388

For River+ tables, please see page 393

EXAMPLE RIVER+ SEATING ORDER CODE:

R27802	-CE90	-FOG	-	-S6	-
--------	-------	------	---	-----	---

Model number	Back, arm and seat textile	Connector finish	Shelf finish	Leg Selection	Counterweight
--------------	----------------------------	------------------	--------------	---------------	---------------

-CHM	-SSB
------	------

Leg finish	Bottom selection
------------	------------------

Additional Options specify at end of order code.	SPECIFY CODE
Additional weight See each model for amount of added weight and upcharge.	CW
Sealed back seams Upcharges vary, see model.	SBS
Sealed seat seams Upcharges vary, see model.	SSS
Power unit finish Jet Black White	J W
Power/USB unit position (see electrical placement images, not available on corner units) Front left Front right Side left Side right Center back (models with shelf only)	\$661 per unit F1 F2 S1 S2 CB
Tamperproof fasteners Upcharges vary, see model.	TP
Moisture barrier Upcharges vary, see model.	MB
Accessory hook finish (for models with shelf) Night (BLK) Fog (FOG) Latte (LAB)	NHK FHK LHK

*linking hardware is lowered to clear the staple strip.
Units will only gang with other units with sealed bottom.
**cannot be combined with linking hardware or power units

RIVER+ SEATING R

STANDARD FEATURES

- A modular series that is composed of straight, curved and corner sections.
- Models with the same seat height can be ganged on ends with no upholstered arms. Ganging hardware is standard on armless ends of models (factory installed) and swivels out of the way when not in use.
- Seating frames are constructed of heavy duty plywood, and are made for active environments. Seats are high density with highly resilient foam.
- River+ seating is rated for an active weight up to 600 lbs. per seat and 24/7 use.
- For 24/7 use and/or heavy duty application use, Global's Heavy Duty warranty is only on models specified with performance textiles, rated for 150,000 double rubs or more.
- A clean-out gap is created by seat-to-back connector brackets available in three finishes.
- The standard, 6.5" tapered legs are made of welded steel. Front legs of River+ lounge models are straight. Back legs are angled.
- Models with a shelf are only available with 6.5" high legs. Back legs on these models are standard with (E6) EXTENDED legs.
- Legs include Black nylon, non-marking, height adjustable glides.
- Upholstery options include fabric or vinyl. Leather upholstery is not available.
- All units are shipped fully assembled.
- Arms on upholstered arm models are factory installed and not removable.
- Modular, aluminum loop arms are sold separately and available with or without nylon armcaps. These relocatable arms are field installed at any seat to back connector location.
- A 10" deep, 1" thick shelf is available on the back of corner, curved, two and three seat models in many thermally fused laminate finishes with matching edge.
- Shelf supports are aluminum with accessory hook in three finishes. Weight capacity: Shelf - 50lbs per seat; Hook - 20lbs each.
- Back shelf heights align with the model's back height. See shelf heights diagrams for details.
- Check textile availability prior to specifying upholstery material.
- The series is available to specify with two textiles, one for the seat cushion and one for the back, arms and front rail (see model image).
- For pricing, start with the base price and add both back/arms graded textile upcharge and the seat graded textile upcharge.
- The blended textile matrix does not apply to this series.

OPTIONAL FEATURES

- Optional 6.5" floor mount legs (F6) are available. Shelf back models are available with EXTENDED floor mount legs (F6).
- Optional 8" (S8) and 8" floor mount legs (F8) are available on models without shelves. Seat heights change to 19" high. Upcharges vary.
- To match back legs of shelf-back models with models without shelf, select (C6) leg with counterweight. Upcharges vary.
- Up to two power units are available on seating models, except 90 and 120 corner units. Add \$661 upcharge per unit.
- Each power unit includes one AC outlet and two USB-A, 10 watt charging ports. Location options include front or side. Back power location option available on models with back shelf (except corners). See electrical placement diagrams.
- Power units are available in either Jet Black (J) or White (W) with 120", three-prong matching cords.
- Tamperproof fasteners can be requested for a higher level of safety. Please specify (TP) - see each model for upcharge. Ganging brackets are not included when Tamper Proof (TP) option is selected.
- Sealed seams are available only for approved coated textiles. Specify (SSS) for sealed seat seams or (SBS) for sealed back and arm seams. Contact customer care for details. See models for upcharge.

- To reduce ease of movement, counterweights can be added to any model. Specify (CW). See individual model for weight and upcharge.
- Underside of seat is standard with black lining (SB).
- For improved housekeeping and infection control practices, the underside of the seat can be finished with black vinyl and sealed to prevent penetration of liquids. Specify (SP) - see each model for upcharge.
- Steel bottom option provides tamperproof protection (includes tamperproof screws). Specify (BS). Upcharges vary. Note: electrical option and ganging are not available with steel bottom.
- Add option codes in the following order:
 - **Model number**
Specify model number.
 - **Back/Arm Textile**
Specify textile code. See model grade upcharges.
 - **Seat Textile**
Specify textile code. See model grade upcharges.
 - **Seat to back connector finish (NGT)** Night (BLK). No upcharge.
(FOG) Fog. No upcharge.
(LAB) Latte. No upcharge.
 - **Back shelf finish** (for "S" models with shelf)
See colors shown on website.
 - **Accessory hook finish** (for "S" models with shelf)
(NHK) Night (BLK)
(FHK) Fog (FOG)
(LHK) Latte (LAB)
 - **Leg selection** (models without shelf):
(S6) Standard seat height (17.5"), 6.5" leg w/adjustable glides. No upcharge.
(S8) High seat (19"), 8" leg w/adjustable glides. No upcharge.
(F6) Standard seat height (17.5"), 6.5" leg w/floor mount. Add \$100 for straight units; \$125 for curved, corner units.
(F8) High seat (19"), 8" leg w/floor mount. Add \$100 for straight units; \$125 for curved, corner units.
 - **Leg selection** (For "S" models with shelf):
(E6) Standard seat height (17.5"), 6.5" EXTENDED leg with adjustable glides.
(C6) Standard seat height (17.5"), 6.5" leg, includes counterweight. Matches S6 leg. Upcharges vary, see model.
(F6) Standard seat height (17.5"), 6.5" EXTENDED leg w/floor mount. Add \$100 for straight unit; \$125 for curved, corner units.
 - **Leg finish**
(CHM) Chrome **(TBL)** Black
(TDW) Designer White **(TFO)** Fog
(TFR) Frost **(TIV)** Cloud
(TKA) Kalua **(TLA)** Latte
(TMO) Mocha **(TNE)** Nevada
(TOA) Toast **(TSH)** Shadow
(TSN) Sand **(TTU)** Tungsten
 - **Additional weight**
(CU) No counterweight.
(CW) Counterweight. Upcharges vary, see model.
 - **Bottom selection**
(SSB) Standard seat bottom
(SP) Vinyl sealed bottom with staple strip. Upcharges vary, see model.*
(BS) Steel bottom. Upcharges vary, see model.**
 - **Sealed back and arm seams**
(SBS) Sealed back seams. Upcharges vary, see model.
 - **Sealed seat seams**
(SSS) Sealed seat seams. Upcharges vary, see model.
 - **Moisture barrier**
(MB) Moisture Barrier. Upcharges vary, see model.
 - **Power/USB unit position. Add \$661 per unit.**
(NP) No power (no upcharge)
(F1) Front left **(F2)** Front right
(S1) Side left **(S2)** Side right
(CB) Center back (models with shelf only)
 - **Power unit finish**
(J) Jet Black **(W)** White
 - **Tamperproof fasteners**
(TP) Tamperproof fasteners. Upcharges vary, see model.

SHELF HEIGHTS

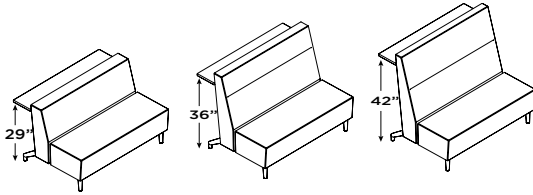

Standard height

High back

Extended high back

DIMENSIONS

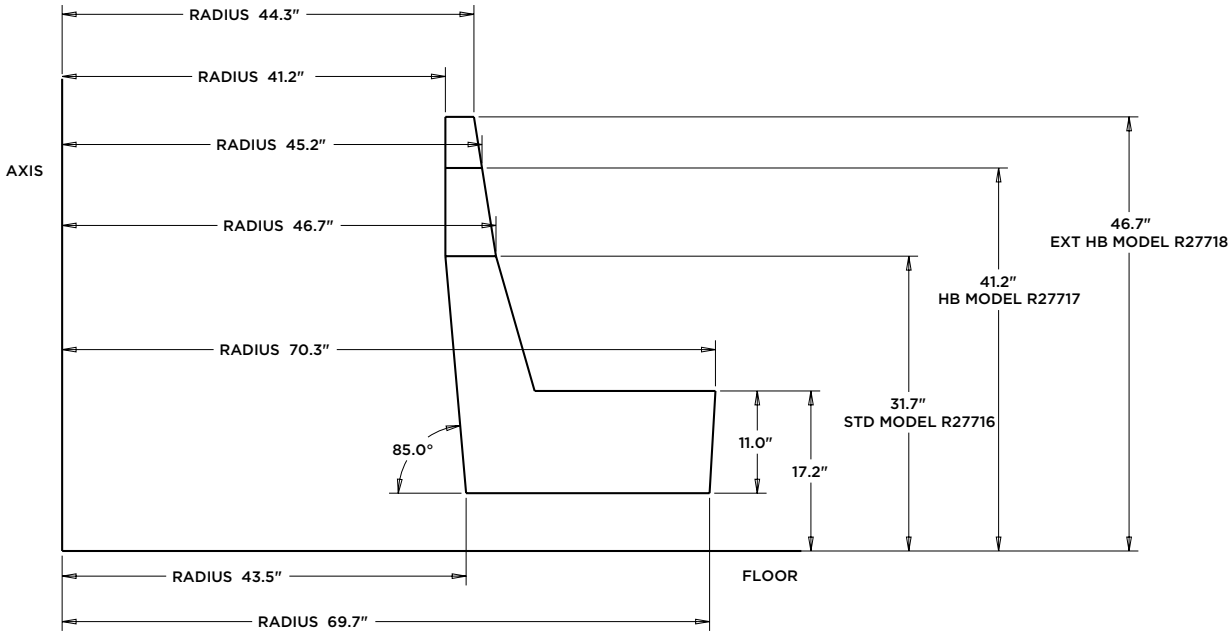



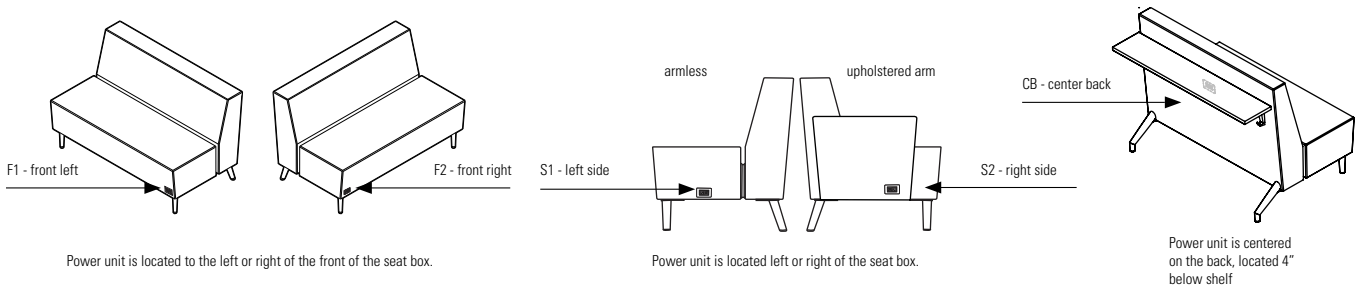

ELECTRICAL PLACEMENT



Power unit is located to the left or right of the front of the seat box.

Power unit is located left or right of the seat box.

Power unit is centered on the back, located 4" below shelf

DESCRIPTION	MODEL#/ FEATURES	STANDARD TEXTILE GRADES																																			
		1/COM	2	3	4	5	6	7	8	9	10	11	12																								
 <p>R27801</p> <p>Lounge Chair - Standard Back COM Yardage: Back: 2; Seat: 1.75 Freight class: 250 Product weight (lbs.): 61 Cubic feet per carton: 19.75</p>	R27801 Base Price:	\$2064																																			
	Back upcharge:	+0	+\$64	+\$114	+\$188	+\$292	+\$336	+\$426	+\$568	+\$674	+\$790	+\$1032	+\$1286																								
	Seat upcharge:	+0	+\$56	+\$100	+\$165	+\$256	+\$294	+\$373	+\$497	+\$590	+\$692	+\$903	+\$1126																								
	For power/USB unit, see electrical placement chart. Includes ganging hardware (2 sides). Add \$65 for (SSS), \$70 (SBS) Add \$632 for 36 lbs. (CW) Add \$103 for (SP) or \$486 for (BS) Add \$40 for (TP) Add \$127 for (MB)	<table border="1"> <thead> <tr> <th colspan="3">OVERALL DIMENSIONS</th> <th colspan="3">SEAT DIMENSIONS</th> <th colspan="2">BACK DIMENSIONS</th> </tr> <tr> <th>W</th> <th>D</th> <th>H</th> <th>W</th> <th>D</th> <th>H</th> <th>W</th> <th>H</th> </tr> </thead> <tbody> <tr> <td>26</td> <td>30</td> <td>32</td> <td>26</td> <td>19</td> <td>18</td> <td>26</td> <td>14</td> </tr> </tbody> </table>												OVERALL DIMENSIONS			SEAT DIMENSIONS			BACK DIMENSIONS		W	D	H	W	D	H	W	H	26	30	32	26	19	18	26	14
	OVERALL DIMENSIONS			SEAT DIMENSIONS			BACK DIMENSIONS																														
W	D	H	W	D	H	W	H																														
26	30	32	26	19	18	26	14																														
	<table border="1"> <tr> <td>RTA 00</td> <td colspan="11">1 per carton</td> </tr> </table>												RTA 00	1 per carton																							
RTA 00	1 per carton																																				
 <p>R27801B</p> <p>Lounge Chair - Standard Back COM Yardage: Back: 4; Seat: 1.75 Freight class: 250 Product weight (lbs.): 82 Cubic feet per carton: 24.5</p>	R27801B Base Price:	\$2801																																			
	Back/Arm upcharge:	+0	+\$128	+\$228	+\$376	+\$584	+\$672	+\$852	+\$1136	+\$1348	+\$1580	+\$2064	+\$2572																								
	Seat upcharge:	+0	+\$56	+\$100	+\$165	+\$256	+\$294	+\$373	+\$497	+\$590	+\$692	+\$903	+\$1126																								
	For power/USB unit, see electrical placement chart. Ganging not available. Add \$65 for (SSS), \$123 (SBS) Add \$632 for 36 lbs. (CW) Add \$103 for (SP) or \$486 for (BS) Add \$40 for (TP) Add \$127 for (MB)	<table border="1"> <thead> <tr> <th colspan="3">OVERALL DIMENSIONS</th> <th colspan="3">SEAT DIMENSIONS</th> <th colspan="2">BACK DIMENSIONS</th> </tr> <tr> <th>W</th> <th>D</th> <th>H</th> <th>W</th> <th>D</th> <th>H</th> <th>W</th> <th>H</th> </tr> </thead> <tbody> <tr> <td>33</td> <td>30</td> <td>32</td> <td>26</td> <td>19</td> <td>18</td> <td>26</td> <td>14</td> </tr> </tbody> </table>												OVERALL DIMENSIONS			SEAT DIMENSIONS			BACK DIMENSIONS		W	D	H	W	D	H	W	H	33	30	32	26	19	18	26	14
	OVERALL DIMENSIONS			SEAT DIMENSIONS			BACK DIMENSIONS																														
W	D	H	W	D	H	W	H																														
33	30	32	26	19	18	26	14																														
	<table border="1"> <tr> <td>RTA 00</td> <td colspan="11">1 per carton</td> </tr> </table>												RTA 00	1 per carton																							
RTA 00	1 per carton																																				
 <p>R27801L R27801R</p> <p>Lounge Chair - Standard Back COM Yardage: Back: 3; Seat: 1.75 Freight class: 250 Product weight (lbs.): 72 Cubic feet per carton: 24.5</p>	R27801L Base Price:	\$2434																																			
	R27801R Base Price:	\$2434																																			
	Back/Arm upcharge:	+0	+\$96	+\$171	+\$282	+\$438	+\$504	+\$639	+\$852	+\$1011	+\$1185	+\$1548	+\$1929																								
	Seat upcharge:	+0	+\$56	+\$100	+\$165	+\$256	+\$294	+\$373	+\$497	+\$590	+\$692	+\$903	+\$1126																								
	For power/USB unit, see electrical placement chart. Includes ganging hardware (1 side). Add \$65 for (SSS), \$96 (SBS) Add \$632 for 36 lbs. (CW) Add \$103 for (SP) or \$486 for (BS) Add \$40 for (TP) Add \$127 for (MB)	<table border="1"> <thead> <tr> <th colspan="3">OVERALL DIMENSIONS</th> <th colspan="3">SEAT DIMENSIONS</th> <th colspan="2">BACK DIMENSIONS</th> </tr> <tr> <th>W</th> <th>D</th> <th>H</th> <th>W</th> <th>D</th> <th>H</th> <th>W</th> <th>H</th> </tr> </thead> <tbody> <tr> <td>29.5</td> <td>30</td> <td>32</td> <td>26</td> <td>19</td> <td>18</td> <td>26</td> <td>14</td> </tr> </tbody> </table>												OVERALL DIMENSIONS			SEAT DIMENSIONS			BACK DIMENSIONS		W	D	H	W	D	H	W	H	29.5	30	32	26	19	18	26	14
OVERALL DIMENSIONS			SEAT DIMENSIONS			BACK DIMENSIONS																															
W	D	H	W	D	H	W	H																														
29.5	30	32	26	19	18	26	14																														
	<table border="1"> <tr> <td>RTA 00</td> <td colspan="11">1 per carton</td> </tr> </table>												RTA 00	1 per carton																							
RTA 00	1 per carton																																				
 <p>R27802</p> <p>Lounge Chair - High Back COM Yardage: Back: 2.75; Seat: 1.75 Freight class: 250 Product weight: 71 Cubic feet per carton: 24.75</p>	R27802 Base Price:	\$2420																																			
	Back upcharge:	+0	+\$88	+\$157	+\$259	+\$402	+\$462	+\$586	+\$781	+\$927	+\$1087	+\$1419	+\$1769																								
	Seat upcharge:	+0	+\$56	+\$100	+\$165	+\$256	+\$294	+\$373	+\$497	+\$590	+\$692	+\$903	+\$1126																								
	For power/USB unit, see electrical placement chart. Includes ganging hardware (2 sides). Add \$65 for (SSS), \$99 for (SBS) Add \$632 for 36 lbs. (CW) Add \$103 for (SP) or \$486 for (BS) Add \$40 for (TP) Add \$127 for (MB)	<table border="1"> <thead> <tr> <th colspan="3">OVERALL DIMENSIONS</th> <th colspan="3">SEAT DIMENSIONS</th> <th colspan="2">BACK DIMENSIONS</th> </tr> <tr> <th>W</th> <th>D</th> <th>H</th> <th>W</th> <th>D</th> <th>H</th> <th>W</th> <th>H</th> </tr> </thead> <tbody> <tr> <td>26</td> <td>30.5</td> <td>41.5</td> <td>26</td> <td>19</td> <td>18</td> <td>26</td> <td>23.5</td> </tr> </tbody> </table>												OVERALL DIMENSIONS			SEAT DIMENSIONS			BACK DIMENSIONS		W	D	H	W	D	H	W	H	26	30.5	41.5	26	19	18	26	23.5
	OVERALL DIMENSIONS			SEAT DIMENSIONS			BACK DIMENSIONS																														
W	D	H	W	D	H	W	H																														
26	30.5	41.5	26	19	18	26	23.5																														
	<table border="1"> <tr> <td>RTA 00</td> <td colspan="11">1 per carton</td> </tr> </table>												RTA 00	1 per carton																							
RTA 00	1 per carton																																				
 <p>R27802B</p> <p>Lounge Chair - High Back COM Yardage: Back: 4.75; Seat: 1.75 Freight class: 250 Product weight: 88.5 Cubic feet per carton: 31.25</p>	R27802B Base Price:	\$3156																																			
	Back/Arm upcharge:	+0	+\$152	+\$271	+\$447	+\$694	+\$798	+\$1012	+\$1349	+\$1601	+\$1877	+\$2451	+\$3055																								
	Seat upcharge:	+0	+\$56	+\$100	+\$165	+\$256	+\$294	+\$373	+\$497	+\$590	+\$692	+\$903	+\$1126																								
	For power/USB unit, see electrical placement chart. Ganging not available. Add \$65 for (SSS), \$151 for (SBS) Add \$632 for 36 lbs. (CW) Add \$103 for (SP) or \$486 for (BS) Add \$40 for (TP) Add \$127 for (MB)	<table border="1"> <thead> <tr> <th colspan="3">OVERALL DIMENSIONS</th> <th colspan="3">SEAT DIMENSIONS</th> <th colspan="2">BACK DIMENSIONS</th> </tr> <tr> <th>W</th> <th>D</th> <th>H</th> <th>W</th> <th>D</th> <th>H</th> <th>W</th> <th>H</th> </tr> </thead> <tbody> <tr> <td>33</td> <td>30.5</td> <td>41.5</td> <td>26</td> <td>19</td> <td>18</td> <td>26</td> <td>23.5</td> </tr> </tbody> </table>												OVERALL DIMENSIONS			SEAT DIMENSIONS			BACK DIMENSIONS		W	D	H	W	D	H	W	H	33	30.5	41.5	26	19	18	26	23.5
	OVERALL DIMENSIONS			SEAT DIMENSIONS			BACK DIMENSIONS																														
W	D	H	W	D	H	W	H																														
33	30.5	41.5	26	19	18	26	23.5																														
	<table border="1"> <tr> <td>RTA 00</td> <td colspan="11">1 per carton</td> </tr> </table>												RTA 00	1 per carton																							
RTA 00	1 per carton																																				

DESCRIPTION

MODEL#/ FEATURES





STANDARD TEXTILE GRADES

 <p>R27802L R27802R</p> <p>Lounge Chair - High Back COM Yardage: Back: 3.75; Seat: 1.75 Freight class: 250 Product weight: 78.5 Cubic feet per carton: 31.25</p>		<p>R27802L Base Price: \$2788 R27802R Base Price: \$2788</p> <p>Back/Arm upcharge: +0 Seat upcharge: +0</p> <p>For power/USB unit, see electrical placement chart. Includes ganging hardware (1 side). Add \$65 for (SSS), \$125 (SBS) Add \$632 for 36 lbs. (CW) Add \$103 for (SP) or \$486 for (BS) Add \$40 for (TP) Add \$127 for (MB)</p>		1/COM	2	3	4	5	6	7	8	9	10	11	12																				
				<p>OVERALL DIMENSIONS</p> <table border="1"> <tr> <th>W</th><th>D</th><th>H</th> <th>W</th><th>D</th><th>H</th> <th>W</th><th>H</th> </tr> <tr> <td>29.5</td><td>30.5</td><td>41.5</td> <td>26</td><td>19</td><td>18</td> <td>26</td><td>23.5</td> </tr> </table>		W	D	H	W	D	H	W	H	29.5	30.5	41.5	26	19	18	26	23.5	<p>SEAT DIMENSIONS</p> <table border="1"> <tr> <th>W</th><th>D</th><th>H</th> </tr> <tr> <td>26</td><td>19</td><td>18</td> </tr> </table>		W	D	H	26	19	18	<p>BACK DIMENSIONS</p> <table border="1"> <tr> <th>W</th><th>H</th> </tr> <tr> <td>26</td><td>23.5</td> </tr> </table>		W	H	26	23.5
				W	D	H	W	D	H	W	H																								
29.5	30.5	41.5	26	19	18	26	23.5																												
W	D	H																																	
26	19	18																																	
W	H																																		
26	23.5																																		
<p>RTA 00 1 per carton</p>																																			

 <p>R27803</p> <p>Lounge Chair - Extended Back COM Yardage: Back: 3; Seat: 1.75 Freight class: 250 Product weight: 81 Cubic feet per carton: 28</p>		<p>R27803 Base Price: \$2877</p> <p>Back upcharge: +0 Seat upcharge: +0</p> <p>For power/USB unit, see electrical placement chart. Includes ganging hardware (2 sides). Add \$65 for (SSS), \$105 for (SBS) Add \$632 for 36 lbs. (CW) Add \$103 for (SP) or \$486 for (BS) Add \$40 for (TP) Add \$127 for (MB)</p>		1/COM	2	3	4	5	6	7	8	9	10	11	12																				
				<p>OVERALL DIMENSIONS</p> <table border="1"> <tr> <th>W</th><th>D</th><th>H</th> <th>W</th><th>D</th><th>H</th> <th>W</th><th>H</th> </tr> <tr> <td>26</td><td>31</td><td>47</td> <td>26</td><td>19</td><td>18</td> <td>26</td><td>29</td> </tr> </table>		W	D	H	W	D	H	W	H	26	31	47	26	19	18	26	29	<p>SEAT DIMENSIONS</p> <table border="1"> <tr> <th>W</th><th>D</th><th>H</th> </tr> <tr> <td>26</td><td>19</td><td>18</td> </tr> </table>		W	D	H	26	19	18	<p>BACK DIMENSIONS</p> <table border="1"> <tr> <th>W</th><th>H</th> </tr> <tr> <td>26</td><td>29</td> </tr> </table>		W	H	26	29
				W	D	H	W	D	H	W	H																								
26	31	47	26	19	18	26	29																												
W	D	H																																	
26	19	18																																	
W	H																																		
26	29																																		
<p>RTA 00 1 per carton</p>																																			

 <p>R27803B</p> <p>Lounge Chair - Extended Back COM Yardage: Back: 5; Seat: 1.75 Freight class: 250 Product weight (lbs.): 101.5 Cubic feet per carton: 35</p>		<p>R27803B Base Price: \$3614</p> <p>Back/Arm upcharge: +0 Seat upcharge: +0</p> <p>For power/USB unit, see electrical placement chart. Ganging not available. Add \$65 for (SSS), \$158 (SBS) Add \$632 for 36 lbs. (CW) Add \$103 for (SP) or \$486 for (BS) Add \$40 for (TP) Add \$127 for (MB)</p>		1/COM	2	3	4	5	6	7	8	9	10	11	12																				
				<p>OVERALL DIMENSIONS</p> <table border="1"> <tr> <th>W</th><th>D</th><th>H</th> <th>W</th><th>D</th><th>H</th> <th>W</th><th>H</th> </tr> <tr> <td>33</td><td>31</td><td>47</td> <td>26</td><td>19</td><td>18</td> <td>26</td><td>29</td> </tr> </table>		W	D	H	W	D	H	W	H	33	31	47	26	19	18	26	29	<p>SEAT DIMENSIONS</p> <table border="1"> <tr> <th>W</th><th>D</th><th>H</th> </tr> <tr> <td>26</td><td>19</td><td>18</td> </tr> </table>		W	D	H	26	19	18	<p>BACK DIMENSIONS</p> <table border="1"> <tr> <th>W</th><th>H</th> </tr> <tr> <td>26</td><td>29</td> </tr> </table>		W	H	26	29
				W	D	H	W	D	H	W	H																								
33	31	47	26	19	18	26	29																												
W	D	H																																	
26	19	18																																	
W	H																																		
26	29																																		
<p>RTA 00 1 per carton</p>																																			

 <p>R27803L R27803R</p> <p>Lounge Chair - Extended Back COM Yardage: Back: 4; Seat: 1.75 Freight class: 250 Product weight (lbs.): 91.5 Cubic feet per carton: 35</p>		<p>R27803L Base Price: \$3246 R27803R Base Price: \$3246</p> <p>Back/Arm upcharge: +0 Seat upcharge: +0</p> <p>For power/USB unit, see electrical placement chart. Includes ganging hardware (1 side). Add \$65 for (SSS), \$131 (SBS) Add \$632 for 36 lbs. (CW) Add \$103 for (SP) or \$486 for (BS) Add \$40 for (TP) Add \$127 for (MB)</p>		1/COM	2	3	4	5	6	7	8	9	10	11	12																				
				<p>OVERALL DIMENSIONS</p> <table border="1"> <tr> <th>W</th><th>D</th><th>H</th> <th>W</th><th>D</th><th>H</th> <th>W</th><th>H</th> </tr> <tr> <td>29.5</td><td>31</td><td>47</td> <td>26</td><td>19</td><td>18</td> <td>26</td><td>29</td> </tr> </table>		W	D	H	W	D	H	W	H	29.5	31	47	26	19	18	26	29	<p>SEAT DIMENSIONS</p> <table border="1"> <tr> <th>W</th><th>D</th><th>H</th> </tr> <tr> <td>26</td><td>19</td><td>18</td> </tr> </table>		W	D	H	26	19	18	<p>BACK DIMENSIONS</p> <table border="1"> <tr> <th>W</th><th>H</th> </tr> <tr> <td>26</td><td>29</td> </tr> </table>		W	H	26	29
				W	D	H	W	D	H	W	H																								
29.5	31	47	26	19	18	26	29																												
W	D	H																																	
26	19	18																																	
W	H																																		
26	29																																		
<p>RTA 00 1 per carton</p>																																			

DESCRIPTION	MODEL#/ FEATURES	STANDARD TEXTILE GRADES												
		1/COM	2	3	4	5	6	7	8	9	10	11	12	
 <p>R27804</p> <p>Two Seater - Standard Back COM Yardage: Back: 2.75; Seat: 2 Freight class: 250 Product weight: 113 133 shelf model Cubic feet per carton: 37.5 51shelf model</p>	<p>R27804S</p> <p>For power/USB unit, see electrical placement chart. Includes ganging hardware (2 sides). Add \$96 for (SSS), \$119 for (SBS) Add \$1260 for 72 lbs. (CW), (C6) Add \$196 for (SP) or \$773 for (BS) Add \$40 for (TP) Add \$252 for (MB)</p>	Base Price:	\$3217											
		Base Price:	\$3942											
		Back upcharge:	+0	+\$88	+\$157	+\$259	+\$402	+\$462	+\$586	+\$781	+\$927	+\$1087	+\$1419	+\$1769
		Seat upcharge:	+0	+\$64	+\$114	+\$188	+\$292	+\$336	+\$426	+\$568	+\$674	+\$790	+\$1032	+\$1286
		Shelf: 52W 10D 1H												
		OVERALL DIMENSIONS			SEAT DIMENSIONS			BACK DIMENSIONS						
		W	D	H	W	D	H	W	H					
		52	30	32	52	19	18	52	14					
		RTA 00		1 per carton										
 <p>R27804B</p> <p>Two Seater - Standard Back COM Yardage: Back: 4.75; Seat: 2 Freight class: 250 Product weight: 133 154 shelf model Cubic feet per carton: 42.5 57.5 shelf model</p>	<p>R27804SB</p> <p>For power/USB unit, see electrical placement chart. Ganging not available. Add \$96 for (SSS), \$171 for (SBS) Add \$1260 for 72 lbs. (CW), (C6) Add \$196 for (SP) or \$773 for (BS) Add \$40 for (TP) Add \$252 for (MB)</p>	Base Price:	\$3953											
		Base Price:	\$4679											
		Back/Arm upcharge:	+0	+\$152	+\$271	+\$447	+\$694	+\$798	+\$1012	+\$1349	+\$1601	+\$1877	+\$2451	+\$3055
		Seat upcharge:	+0	+\$64	+\$114	+\$188	+\$292	+\$336	+\$426	+\$568	+\$674	+\$790	+\$1032	+\$1286
		Shelf: 52W 10D 1H												
		OVERALL DIMENSIONS			SEAT DIMENSIONS			BACK DIMENSIONS						
		W	D	H	W	D	H	W	H					
		59	30	32	52	19	18	52	14					
		RTA 00		1 per carton										
 <p>R27804L</p> <p>Two Seater - Standard Back COM Yardage: Back: 3.75; Seat: 2 Freight class: 250 Product weight: 123 Cubic feet per carton: 42.5</p>	<p>R27804R</p> <p>For power/USB unit, see electrical placement chart. Includes ganging hardware (1 side). Add \$96 for (SSS), \$145 for (SBS) Add \$1260 for 72 lbs. (CW), (C6) Add \$196 for (SP) or \$773 for (BS) Add \$40 for (TP) Add \$252 for (MB)</p>	Base Price:	\$3584											
		Base Price:	\$3584											
		Back/Arm upcharge:	+0	+\$120	+\$214	+\$353	+\$548	+\$630	+\$799	+\$1065	+\$1264	+\$1482	+\$1935	+\$2412
		Seat upcharge:	+0	+\$64	+\$114	+\$188	+\$292	+\$336	+\$426	+\$568	+\$674	+\$790	+\$1032	+\$1286
		Shelf: 52W 10D 1H												
		OVERALL DIMENSIONS			SEAT DIMENSIONS			BACK DIMENSIONS						
		W	D	H	W	D	H	W	H					
		55.5	30	32	52	19	18	52	14					
		RTA 00		1 per carton										
 <p>R27804SL</p> <p>Two Seater - Standard Back COM Yardage: Back: 3.75; Seat: 2 Freight class: 250 Product weight: 144 Cubic feet per carton: 57.5</p>	<p>R27804SR</p> <p>For power/USB unit, see electrical placement chart. Includes ganging hardware (1 side). Add \$96 for (SSS), \$145 for (SBS) Add \$1260 for 72 lbs. (CW), (C6) Add \$196 for (SP) or \$773 for (BS) Add \$40 for (TP) Add \$252 for (MB)</p>	Base Price:	\$4311											
		Base Price:	\$4311											
		Back/Arm upcharge:	+0	+\$120	+\$214	+\$353	+\$548	+\$630	+\$799	+\$1065	+\$1264	+\$1482	+\$1935	+\$2412
		Seat upcharge:	+0	+\$64	+\$114	+\$188	+\$292	+\$336	+\$426	+\$568	+\$674	+\$790	+\$1032	+\$1286
		Shelf: 52W 10D 1H												
		OVERALL DIMENSIONS			SEAT DIMENSIONS			BACK DIMENSIONS						
		W	D	H	W	D	H	W	H					
		55.5	40.5	32	52	19	18	52	14					
		RTA 00		1 per carton										

DESCRIPTION	MODEL#/ FEATURES	STANDARD TEXTILE GRADES												
		1/COM	2	3	4	5	6	7	8	9	10	11	12	
 <p>R27805</p> <p>Two Seater - High Back COM Yardage: Back: 3.50; Seat: 2 Freight class: 250 Product weight: 138 139 shelf model Cubic feet per carton: 47.25 64.75 shelf model</p>	<p>R27805S</p> <p>For power/USB unit, see electrical placement chart. Includes ganging hardware (1 sides) Add \$96 for (SSS), \$157for (SBS) Add \$1260 for 72 lbs. (CW), (C6) Add \$196 for (SP) or \$773 for (BS) Add \$40 for (TP) Add \$252 for (MB)</p>	Base Price:	\$3914											
		Base Price:	\$4638											
		Back upcharge:	+0	+\$112	+\$200	+\$329	+\$511	+\$588	+\$746	+\$994	+\$1180	+\$1383	+\$1806	+\$2251
		Seat upcharge:	+0	+\$64	+\$114	+\$188	+\$292	+\$336	+\$426	+\$568	+\$674	+\$790	+\$1032	+\$1286
		Shelf: 52W 10D 1H												
		OVERALL DIMENSIONS			SEAT DIMENSIONS			BACK DIMENSIONS						
		W	D	H	W	D	H	W	D	H				
		52	30.5	41.5	52	19	18	52				23.5		
		RTA 00		1 per carton										

DESCRIPTION	MODEL#/ FEATURES	STANDARD TEXTILE GRADES												
		1/COM	2	3	4	5	6	7	8	9	10	11	12	
 <p>R27805B</p> <p>Two Seater - High Back COM Yardage: Back: 5.50; Seat: 2 Freight class: 250 Product weight: 138 159 shelf model Cubic feet per carton: 54 73 shelf model</p>	<p>R27805SB</p> <p>For power/USB unit, see electrical placement chart. Ganging not available. Add \$96 for (SSS), \$209 for (SBS) Add \$1260 for 72 lbs. (CW), (C6) Add \$196 for (SP) or \$773 for (BS) Add \$40 for (TP) Add \$252 for (MB)</p>	Base Price:	\$4651											
		Base Price:	\$5376											
		Back/Arm upcharge:	+0	+\$176	+\$314	+\$517	+\$803	+\$924	+\$1172	+\$1562	+\$1854	+\$2173	+\$2838	+\$3537
		Seat upcharge:	+0	+\$64	+\$114	+\$188	+\$292	+\$336	+\$426	+\$568	+\$674	+\$790	+\$1032	+\$1286
		Shelf: 52W 10D 1H												
		OVERALL DIMENSIONS			SEAT DIMENSIONS			BACK DIMENSIONS						
		W	D	H	W	D	H	W	D	H				
		59	30.5	41.5	52	19	18	52				23.5		
		RTA 00		1 per carton										

DESCRIPTION	MODEL#/ FEATURES	STANDARD TEXTILE GRADES												
		1/COM	2	3	4	5	6	7	8	9	10	11	12	
 <p>R27805L</p> <p>Two Seater - High Back COM Yardage: Back: 4.50; Seat: 2 Freight class: 250 Product weight: 128 Cubic feet per carton: 54</p>	<p>R27805R</p> <p>For power/USB unit, see electrical placement chart. Includes ganging hardware (1 side). Add \$96 for (SSS), \$209 for (SBS) Add \$1260 for 72 lbs. (CW), (C6) Add \$196 for (SP) or \$773 for (BS) Add \$40 for (TP) Add \$252 for (MB)</p>	Base Price:	\$4282											
		Base Price:	\$4282											
		Back/Arm upcharge:	+0	+\$144	+\$257	+\$423	+\$657	+\$756	+\$959	+\$1278	+\$1517	+\$1778	+\$2322	+\$2894
		Seat upcharge:	+0	+\$64	+\$114	+\$188	+\$292	+\$336	+\$426	+\$568	+\$674	+\$790	+\$1032	+\$1286
		Shelf: 52W 10D 1H												
		OVERALL DIMENSIONS			SEAT DIMENSIONS			BACK DIMENSIONS						
		W	D	H	W	D	H	W	D	H				
		55.5	30.5	41.5	52	19	18	52				23.5		
		RTA 00		1 per carton										

DESCRIPTION	MODEL#/ FEATURES	STANDARD TEXTILE GRADES												
		1/COM	2	3	4	5	6	7	8	9	10	11	12	
 <p>R27805SL</p> <p>Two Seater - High Back COM Yardage: Back: 4.50; Seat: 2 Freight class: 250 Product weight: 149 Cubic feet per carton: 73</p>	<p>R27805SR</p> <p>For power/USB unit, see electrical placement chart. Includes ganging hardware (1 side). Add \$96 for (SSS), \$209 for (SBS) Add \$1260 for 72 lbs. (CW), (C6) Add \$196 for (SP) or \$773 for (BS) Add \$40 for (TP) Add \$252 for (MB)</p>	Base Price:	\$5007											
		Base Price:	\$5007											
		Back/Arm upcharge:	+0	+\$144	+\$257	+\$423	+\$657	+\$756	+\$959	+\$1278	+\$1517	+\$1778	+\$2322	+\$2894
		Seat upcharge:	+0	+\$64	+\$114	+\$188	+\$292	+\$336	+\$426	+\$568	+\$674	+\$790	+\$1032	+\$1286
		Shelf: 52W 10D 1H												
		OVERALL DIMENSIONS			SEAT DIMENSIONS			BACK DIMENSIONS						
		W	D	H	W	D	H	W	D	H				
		55.5	41	41.5	52	19	18	52				23.5		
		RTA 00		1 per carton										

DESCRIPTION MODEL#/ FEATURES STANDARD TEXTILE GRADES

	<p>R27806 R27806S</p> <p>Two Seater - Extended Back COM Yardage: Back: 3.50; Seat: 2 Freight class: 250 Product weight: 131 152 shelf model Cubic feet per carton: 53.75 72.75 shelf model</p>	<p>R27806 Base Price: \$4455 R27806S Base Price: \$5182</p> <p>Back upcharge: +0 Seat upcharge: +0</p> <p>For power/USB unit, see electrical placement chart. Includes ganging hardware (2 sides). Add \$96 for (SSS), \$168 for (SBS) Add \$1260 for 72 lbs. (CW), (C6) Add \$196 for (SP) or \$773 for (BS) Add \$40 for (TP) Add \$252 for (MB)</p>	1/COM	2	3	4	5	6	7	8	9	10	11	12
			<p>Back upcharge: +0 +\$112 +\$200 +\$329 +\$511 +\$588 +\$746 +\$994 +\$1180 +\$1383 +\$1806 +\$2251 Seat upcharge: +0 +\$64 +\$114 +\$188 +\$292 +\$336 +\$426 +\$568 +\$674 +\$790 +\$1032 +\$1286</p> <p>Shelf: 52W 10D 1H</p>	<p>OVERALL DIMENSIONS W D H</p>			<p>SEAT DIMENSIONS W D H</p>			<p>BACK DIMENSIONS W H</p>				
			52	31	47	52	19	18	52	29				
			RTA 00		1 per carton									

	<p>R27806B R27806SB</p> <p>Two Seater - Extended Back COM Yardage: Back: 6 Seat: 2 Freight class: 250 Product weight: 151 172 shelf model Cubic feet per carton: 60.5 82 shelf model</p>	<p>R27806B Base Price: \$5193 R27806SB Base Price: \$5918</p> <p>Back/Arm upcharge: +0 Seat upcharge: +0</p> <p>For power/USB unit, see electrical placement chart. Ganging not available. Add \$96 for (SSS), \$221 for (SBS) Add \$1260 for 72 lbs. (CW), (C6) Add \$196 for (SP) or \$773 for (BS) Add \$40 for (TP) Add \$252 for (MB)</p>	1/COM	2	3	4	5	6	7	8	9	10	11	12
			<p>Back/Arm upcharge: +0 +\$192 +\$342 +\$564 +\$876 +\$1008 +\$1278 +\$1704 +\$2022 +\$2370 +\$3096 +\$3858 Seat upcharge: +0 +\$64 +\$114 +\$188 +\$292 +\$336 +\$426 +\$568 +\$674 +\$790 +\$1032 +\$1286</p> <p>Shelf: 52W 10D 1H</p>	<p>OVERALL DIMENSIONS W D H</p>			<p>SEAT DIMENSIONS W D H</p>			<p>BACK DIMENSIONS W H</p>				
			59	31	47	52	19	18	52	29				
			RTA 00		1 per carton									

	<p>R27806L R27806R</p> <p>Two Seater - Extended Back COM Yardage: Back: 5; Seat: 2 Freight class: 250 Product weight: 141 Cubic feet per carton: 60.5</p>	<p>R27806L Base Price: \$4824 R27806R Base Price: \$5551</p> <p>Back/Arm upcharge: +0 Seat upcharge: +0</p> <p>For power/USB unit, see electrical placement chart. Includes ganging hardware (1 side). Add \$96 for (SSS), \$195 for (SBS) Add \$1260 for 72 lbs. (CW), (C6) Add \$196 for (SP) or \$773 for (BS) Add \$40 for (TP) Add \$252 for (MB)</p>	1/COM	2	3	4	5	6	7	8	9	10	11	12
			<p>Back/Arm upcharge: +0 +\$160 +\$285 +\$470 +\$730 +\$840 +\$1065 +\$1420 +\$1685 +\$1975 +\$2580 +\$3215 Seat upcharge: +0 +\$64 +\$114 +\$188 +\$292 +\$336 +\$426 +\$568 +\$674 +\$790 +\$1032 +\$1286</p>	<p>OVERALL DIMENSIONS W D H</p>			<p>SEAT DIMENSIONS W D H</p>			<p>BACK DIMENSIONS W H</p>				
			55.5	31	47	52	19	18	52	29				
			RTA 00		1 per carton									

	<p>R27806SL R27806SR</p> <p>Two Seater - Extended Back COM Yardage: Back: 5; Seat: 2 Freight class: 250 Product weight: 162 Cubic feet per carton: 82</p>	<p>R27806SL Base Price: \$5551 R27806SR Base Price: \$5551</p> <p>Back/Arm upcharge: +0 Seat upcharge: +0</p> <p>For power/USB unit, see electrical placement chart. Includes ganging hardware (1 side). Add \$96 for (SSS), \$195 for (SBS) Add \$1260 for 72 lbs. (CW), (C6) Add \$196 for (SP) or \$773 for (BS) Add \$40 for (TP) Add \$252 for (MB)</p>	1/COM	2	3	4	5	6	7	8	9	10	11	12
			<p>Back/Arm upcharge: +0 +\$160 +\$285 +\$470 +\$730 +\$840 +\$1065 +\$1420 +\$1685 +\$1975 +\$2580 +\$3215 Seat upcharge: +0 +\$64 +\$114 +\$188 +\$292 +\$336 +\$426 +\$568 +\$674 +\$790 +\$1032 +\$1286</p> <p>Shelf: 52W 10D 1H</p>	<p>OVERALL DIMENSIONS W D H</p>			<p>SEAT DIMENSIONS W D H</p>			<p>BACK DIMENSIONS W H</p>				
			55.5	41.5	47	52	19	18	52	29				
			RTA 00		1 per carton									

DESCRIPTION MODEL#/ FEATURES STANDARD TEXTILE GRADES



R27807

R27807 Base Price: **\$5043**
R27807S Base Price: **\$6002**
 Back upcharge: **+0**
 Seat upcharge: **+0**

1/COM	2	3	4	5	6	7	8	9	10	11	12
-------	---	---	---	---	---	---	---	---	----	----	----

	+\$144	+\$257	+\$423	+\$657	+\$756	+\$959	+\$1278	+\$1517	+\$1778	+\$2322	+\$2894
	+\$112	+\$200	+\$329	+\$511	+\$588	+\$746	+\$994	+\$1180	+\$1383	+\$1806	+\$2251

Shelf: 52W 10D 1H

For power/USB unit, see electrical placement chart. Includes ganging hardware (2 sides). Add \$117 for (SSS), \$138 for (SBS). Add \$1260 for 72 lbs. (CW), (C6). Add \$294 for (SP) or \$1063 for (BS). Add \$40 for (TP). Add \$375 for (MB).

OVERALL DIMENSIONS			SEAT DIMENSIONS			BACK DIMENSIONS	
W	D	H	W	D	H	W	H

78	30	32	78	19	18	78	14
----	----	----	----	----	----	----	----

RTA 00 1 per carton

Three Seater - Standard Back
 COM Yardage: Back: 4.50; Seat: 3.50
 Freight class: 250
 Product weight: 152 | 173 shelf model
 Cubic feet per carton: 55.5 | 173 shelf model



R27807B

R27807B Base Price: **\$5781**
R27807SB Base Price: **\$6740**
 Back/Arm upcharge: **+0**
 Seat upcharge: **+0**

1/COM	2	3	4	5	6	7	8	9	10	11	12
-------	---	---	---	---	---	---	---	---	----	----	----

	+\$208	+\$371	+\$611	+\$949	+\$1092	+\$1385	+\$1846	+\$2191	+\$2568	+\$3354	+\$4180
	+\$112	+\$200	+\$329	+\$511	+\$588	+\$746	+\$994	+\$1180	+\$1383	+\$1806	+\$2251

Shelf: 52W 10D 1H

For power/USB unit, see electrical placement chart. Ganging not available. Add \$117 for (SSS), \$189 for (SBS). Add \$1260 for 72 lbs. (CW), (C6). Add \$294 for (SP) or \$1063 for (BS). Add \$40 for (TP). Add \$375 for (MB).

OVERALL DIMENSIONS			SEAT DIMENSIONS			BACK DIMENSIONS	
W	D	H	W	D	H	W	H

85	30	32	78	19	18	78	14
----	----	----	----	----	----	----	----

RTA 00 1 per carton

Three Seater - Standard Back
 COM Yardage: Back: 6.50; Seat: 3.50
 Freight class: 250
 Product weight: 170 | 193 shelf model
 Cubic feet per carton: 60.5 | 79.75 shelf model



R27807L

R27807L Base Price: **\$5412**
R27807R Base Price: **\$5412**
 Back/Arm upcharge: **+0**
 Seat upcharge: **+0**

1/COM	2	3	4	5	6	7	8	9	10	11	12
-------	---	---	---	---	---	---	---	---	----	----	----

	+\$176	+\$314	+\$517	+\$803	+\$924	+\$1172	+\$1562	+\$1854	+\$2173	+\$2838	+\$3537
	+\$112	+\$200	+\$329	+\$511	+\$588	+\$746	+\$994	+\$1180	+\$1383	+\$1806	+\$2251

For power/USB unit, see electrical placement chart. Includes ganging hardware (2 sides). Add \$117 for (SSS), \$164 for (SBS). Add \$1260 for 72 lbs. (CW), (C6). Add \$294 for (SP) or \$1063 for (BS). Add \$40 for (TP). Add \$375 for (MB).

OVERALL DIMENSIONS			SEAT DIMENSIONS			BACK DIMENSIONS	
W	D	H	W	D	H	W	H

81.5	30	32	78	19	18	78	14
------	----	----	----	----	----	----	----

RTA 00 1 per carton

Three Seater - Standard Back
 COM Yardage: Back: 5.50; Seat: 3.50
 Freight class: 250
 Product weight: 160
 Cubic feet per carton: 60.5



R27807SL

R27807SL Base Price: **\$6371**
R27807SR Base Price: **\$6371**
 Back/Arm upcharge: **+0**
 Seat upcharge: **+0**

1/COM	2	3	4	5	6	7	8	9	10	11	12
-------	---	---	---	---	---	---	---	---	----	----	----

	+\$176	+\$314	+\$517	+\$803	+\$924	+\$1172	+\$1562	+\$1854	+\$2173	+\$2838	+\$3537
	+\$112	+\$200	+\$329	+\$511	+\$588	+\$746	+\$994	+\$1180	+\$1383	+\$1806	+\$2251

Shelf: 52W 10D 1H

For power/USB unit, see electrical placement chart. Includes ganging hardware (2 sides). Add \$117 for (SSS), \$164 for (SBS). Add \$1260 for 72 lbs. (CW), (C6). Add \$294 for (SP) or \$1063 for (BS). Add \$40 for (TP). Add \$375 for (MB).

OVERALL DIMENSIONS			SEAT DIMENSIONS			BACK DIMENSIONS	
W	D	H	W	D	H	W	H

81.5	40.5	32	78	19	18	78	14
------	------	----	----	----	----	----	----

RTA 00 1 per carton





Three Seater - Standard Back
 COM Yardage: Back: 5.50; Seat: 3.50
 Freight class: 250
 Product weight: 183
 Cubic feet per carton: 79.75

DESCRIPTION	MODEL#/ FEATURES	STANDARD TEXTILE GRADES																														
		1/COM	2	3	4	5	6	7	8	9	10	11	12																			
 <p>R27808 R27808S</p> <p>Three Seater - High Back COM Yardage: Back: 5.75; Seat: 3.50 Freight class: 250 Product weight: 177 201 shelf model Cubic feet per carton: 69.75 95.5 shelf model</p>	<p>R27808 Base Price: \$5882</p> <p>R27808S Base Price: \$6842</p> <p>Back upcharge: +0</p> <p>Seat upcharge: +0</p>																															
	<p>For power/USB unit, see electrical placement chart. Includes ganging hardware (2 sides). Add \$117 for (SSS), \$184 for (SBS) Add \$1260 for 72 lbs. (CW), (C6) Add \$294 for (SP) or \$1063 for (BS) Add \$40 for (TP) Add \$375 for (MB)</p>	<p>Shelf: 52W 10D 1H</p> <table border="1"> <thead> <tr> <th colspan="3">OVERALL DIMENSIONS</th> <th colspan="3">SEAT DIMENSIONS</th> <th colspan="2">BACK DIMENSIONS</th> </tr> <tr> <th>W</th> <th>D</th> <th>H</th> <th>W</th> <th>D</th> <th>H</th> <th>W</th> <th>H</th> </tr> </thead> <tbody> <tr> <td>78</td> <td>30.5</td> <td>41.5</td> <td>78</td> <td>19</td> <td>18</td> <td>78</td> <td>23.5</td> </tr> </tbody> </table> <p>RTA 00 1 per carton</p>	OVERALL DIMENSIONS			SEAT DIMENSIONS			BACK DIMENSIONS		W	D	H	W	D	H	W	H	78	30.5	41.5	78	19	18	78	23.5						
OVERALL DIMENSIONS			SEAT DIMENSIONS			BACK DIMENSIONS																										
W	D	H	W	D	H	W	H																									
78	30.5	41.5	78	19	18	78	23.5																									





DESCRIPTION	MODEL#/ FEATURES	STANDARD TEXTILE GRADES																														
		1/COM	2	3	4	5	6	7	8	9	10	11	12																			
 <p>R27808B R27808SB</p> <p>Three Seater - High Back COM Yardage: Back: 7.75; Seat: 3.50 Freight class: 250 Product weight: 190.5 221.5 shelf model Cubic feet per carton: 69.75 101.5 shelf model</p>	<p>R27808B Base Price: \$6620</p> <p>R27808SB Base Price: \$7580</p> <p>Back/Arm upcharge: +0</p> <p>Seat upcharge: +0</p>																															
	<p>For power/USB unit, see electrical placement chart. Ganging not available. Add \$117 for (SSS), \$237 for (SBS) Add \$1260 for 72 lbs. (CW), (C6) Add \$294 for (SP) or \$1063 for (BS) Add \$40 for (TP) Add \$375 for (MB)</p>	<p>Shelf: 52W 10D 1H</p> <table border="1"> <thead> <tr> <th colspan="3">OVERALL DIMENSIONS</th> <th colspan="3">SEAT DIMENSIONS</th> <th colspan="2">BACK DIMENSIONS</th> </tr> <tr> <th>W</th> <th>D</th> <th>H</th> <th>W</th> <th>D</th> <th>H</th> <th>W</th> <th>H</th> </tr> </thead> <tbody> <tr> <td>85</td> <td>30.5</td> <td>41.5</td> <td>78</td> <td>19</td> <td>18</td> <td>78</td> <td>23.5</td> </tr> </tbody> </table> <p>RTA 00 1 per carton</p>	OVERALL DIMENSIONS			SEAT DIMENSIONS			BACK DIMENSIONS		W	D	H	W	D	H	W	H	85	30.5	41.5	78	19	18	78	23.5						
OVERALL DIMENSIONS			SEAT DIMENSIONS			BACK DIMENSIONS																										
W	D	H	W	D	H	W	H																									
85	30.5	41.5	78	19	18	78	23.5																									

DESCRIPTION	MODEL#/ FEATURES	STANDARD TEXTILE GRADES																														
		1/COM	2	3	4	5	6	7	8	9	10	11	12																			
 <p>R27808L R27808R</p> <p>Three Seater - High Back COM Yardage: Back: 6.75; Seat: 3.50 Freight class: 250 Product weight: 180.5 Cubic feet per carton: 76.75</p>	<p>R27808L Base Price: \$6250</p> <p>R27808R Base Price: \$6250</p> <p>Back/Arm upcharge: +0</p> <p>Seat upcharge: +0</p>																															
	<p>For power/USB unit, see electrical placement chart. Includes ganging hardware (2 sides). Add \$117 for (SSS), \$237 for (SBS) Add \$1260 for 72 lbs. (CW), (C6) Add \$294 for (SP) or \$1063 for (BS) Add \$40 for (TP) Add \$375 for (MB)</p>	<p>Shelf: 52W 10D 1H</p> <table border="1"> <thead> <tr> <th colspan="3">OVERALL DIMENSIONS</th> <th colspan="3">SEAT DIMENSIONS</th> <th colspan="2">BACK DIMENSIONS</th> </tr> <tr> <th>W</th> <th>D</th> <th>H</th> <th>W</th> <th>D</th> <th>H</th> <th>W</th> <th>H</th> </tr> </thead> <tbody> <tr> <td>81.5</td> <td>30.5</td> <td>41.5</td> <td>78</td> <td>19</td> <td>18</td> <td>78</td> <td>23.5</td> </tr> </tbody> </table> <p>RTA 00 1 per carton</p>	OVERALL DIMENSIONS			SEAT DIMENSIONS			BACK DIMENSIONS		W	D	H	W	D	H	W	H	81.5	30.5	41.5	78	19	18	78	23.5						
OVERALL DIMENSIONS			SEAT DIMENSIONS			BACK DIMENSIONS																										
W	D	H	W	D	H	W	H																									
81.5	30.5	41.5	78	19	18	78	23.5																									

DESCRIPTION	MODEL#/ FEATURES	STANDARD TEXTILE GRADES																														
		1/COM	2	3	4	5	6	7	8	9	10	11	12																			
 <p>R27808SL R27808SR</p> <p>Three Seater - High Back COM Yardage: Back: 6.75; Seat: 3.50 Freight class: 250 Product weight: 211.5 Cubic feet per carton: 101.5</p>	<p>R27808SL Base Price: \$7211</p> <p>R27808SR Base Price: \$7211</p> <p>Back/Arm upcharge: +0</p> <p>Seat upcharge: +0</p>																															
	<p>For power/USB unit, see electrical placement chart. Includes ganging hardware (2 sides). Add \$117 for (SSS), \$237 for (SBS) Add \$1260 for 72 lbs. (CW), (C6) Add \$294 for (SP) or \$1063 for (BS) Add \$40 for (TP) Add \$375 for (MB)</p>	<p>Shelf: 52W 10D 1H</p> <table border="1"> <thead> <tr> <th colspan="3">OVERALL DIMENSIONS</th> <th colspan="3">SEAT DIMENSIONS</th> <th colspan="2">BACK DIMENSIONS</th> </tr> <tr> <th>W</th> <th>D</th> <th>H</th> <th>W</th> <th>D</th> <th>H</th> <th>W</th> <th>H</th> </tr> </thead> <tbody> <tr> <td>81.5</td> <td>41</td> <td>41.5</td> <td>78</td> <td>19</td> <td>18</td> <td>78</td> <td>23.5</td> </tr> </tbody> </table> <p>RTA 00 1 per carton</p>	OVERALL DIMENSIONS			SEAT DIMENSIONS			BACK DIMENSIONS		W	D	H	W	D	H	W	H	81.5	41	41.5	78	19	18	78	23.5						
OVERALL DIMENSIONS			SEAT DIMENSIONS			BACK DIMENSIONS																										
W	D	H	W	D	H	W	H																									
81.5	41	41.5	78	19	18	78	23.5																									

DESCRIPTION		MODEL#/ FEATURES		STANDARD TEXTILE GRADES												
				1/COM	2	3	4	5	6	7	8	9	10	11	12	
 <p>R27809 R27809S</p> <p>Three Seater - Extended Back COM Yardage: Back: 6.50; Seat: 3.50 Freight class: 250 Product weight: 165 198 shelf model Cubic feet per carton: 79.25 108.5 shelf model</p>	<p>R27809 R27809S</p> <p>Base Price: \$6381 Base Price: \$7340</p> <p>Back upcharge: +0 Seat upcharge: +0</p> <p>For power/USB unit, see electrical placement chart. Includes ganging hardware (2 sides). Add \$117 for (SSS), \$196 for (SBS) Add \$1260 for 72 lbs. (CW), (C6) Add \$294 for (SP) or \$1063 for (BS) Add \$40 for (TP) Add \$375 for (MB)</p>	1/COM	2	3	4	5	6	7	8	9	10	11	12			
		<p>Back upcharge: +0 +\$208 +\$371 +\$611 +\$949 +\$1092+\$1385 +\$1846 +\$2191 +\$2568 +\$3354 +\$4180</p> <p>Seat upcharge: +0 +\$112 +\$200 +\$329 +\$511 +\$588 +\$746 +\$994 +\$1180 +\$1383 +\$1806 +\$2251</p>	<p>OVERALL DIMENSIONS W D H</p>			<p>SEAT DIMENSIONS W D H</p>			<p>BACK DIMENSIONS W H</p>							
			78	31	47	78	19	18	78	29						
			RTA 00	1 per carton												
 <p>R27809B R27809SB</p> <p>Three Seater - Extended Back COM Yardage: Back: 7.50; Seat: 3.50 Freight class: 250 Product weight: 190 220 shelf model Cubic feet per carton: 86.25 114 shelf model</p>	<p>R27809B R27809SB</p> <p>Base Price: \$7117 Base Price: \$8076</p> <p>Back/Arm upcharge: +0 Seat upcharge: +0</p> <p>For power/USB unit, see electrical placement chart. Ganging not available. Add \$117 for (SSS), \$248 for (SBS) Add \$1260 for 72 lbs. (CW), (C6) Add \$294 for (SP) or \$1063 for (BS) Add \$40 for (TP) Add \$375 for (MB)</p>	1/COM	2	3	4	5	6	7	8	9	10	11	12			
		<p>Back/Arm upcharge: +0 +\$272 +\$485 +\$799 +\$1241 +\$1428+\$1811 +\$2414 +\$2865 +\$3358 +\$4386 +\$5466</p> <p>Seat upcharge: +0 +\$112 +\$200 +\$329 +\$511 +\$588 +\$746 +\$994 +\$1180 +\$1383 +\$1806 +\$2251</p>	<p>OVERALL DIMENSIONS W D H</p>			<p>SEAT DIMENSIONS W D H</p>			<p>BACK DIMENSIONS W H</p>							
			85	31	47	78	19	18	78	29						
			RTA 00	1 per carton												
 <p>R27809L R27809R</p> <p>Three Seater - Extended Back COM Yardage: Back: 7.50; Seat: 3.50 Freight class: 250 Product weight: 180 Cubic feet per carton: 86.25</p>	<p>R27809L R27809R</p> <p>Base Price: \$6749 Base Price: \$6749</p> <p>Back/Arm upcharge: +0 Seat upcharge: +0</p> <p>For power/USB unit, see electrical placement chart. Includes ganging hardware (1 side). Add \$117 for (SSS), \$222 for (SBS) Add \$1260 for 72 lbs. (CW), (C6) Add \$294 for (SP) or \$1063 for (BS) Add \$40 for (TP) Add \$375 for (MB)</p>	1/COM	2	3	4	5	6	7	8	9	10	11	12			
		<p>Back/Arm upcharge: +0 +\$240 +\$428 +\$705 +\$1095 +\$1260+\$1598 +\$2130 +\$2528 +\$2963 +\$3870 +\$4823</p> <p>Seat upcharge: +0 +\$112 +\$200 +\$329 +\$511 +\$588 +\$746 +\$994 +\$1180 +\$1383 +\$1806 +\$2251</p>	<p>OVERALL DIMENSIONS W D H</p>			<p>SEAT DIMENSIONS W D H</p>			<p>BACK DIMENSIONS W H</p>							
			81.5	31	47	78	19	18	78	29						
			RTA 00	1 per carton												
 <p>R27809SL R27809SR</p> <p>Three Seater - Extended Back COM Yardage: Back: 7.50; Seat: 3.50 Freight class: 250 Product weight: 210 Cubic feet per carton: 114</p>	<p>R27809SL R27809SR</p> <p>Base Price: \$7708 Base Price: \$7708</p> <p>Back/Arm upcharge: +0 Seat upcharge: +0</p> <p>For power/USB unit, see electrical placement chart. Includes ganging hardware (1 side). Add \$117 for (SSS), \$222 for (SBS) Add \$1260 for 72 lbs. (CW), (C6) Add \$294 for (SP) or \$1063 for (BS) Add \$40 for (TP) Add \$375 for (MB)</p>	1/COM	2	3	4	5	6	7	8	9	10	11	12			
		<p>Back/Arm upcharge: +0 +\$240 +\$428 +\$705 +\$1095 +\$1260+\$1598 +\$2130 +\$2528 +\$2963 +\$3870 +\$4823</p> <p>Seat upcharge: +0 +\$112 +\$200 +\$329 +\$511 +\$588 +\$746 +\$994 +\$1180 +\$1383 +\$1806 +\$2251</p>	<p>OVERALL DIMENSIONS W D H</p>			<p>SEAT DIMENSIONS W D H</p>			<p>BACK DIMENSIONS W H</p>							
			81.5	41.5	47	78	19	18	78	29						
			RTA 00	1 per carton												

Shelf: 52W 10D 1H

DESCRIPTION	MODEL#/ FEATURES	STANDARD TEXTILE GRADES												
		1/COM	2	3	4	5	6	7	8	9	10	11	12	
 <p>R27810</p> <p>Bariatric Lounge Chair - Standard Back COM Yardage: Back: 2.25; Seat: 2 Freight class: 250 Product weight: 90 Cubic feet per carton: 28.75</p>	R27810 Base Price:	\$3150												
	Back upcharge:	+0	+\$72	+\$129	+\$212	+\$329	+\$378	+\$480	+\$639	+\$759	+\$889	+\$1161	+\$1447	
	Seat upcharge:	+0	+\$64	+\$114	+\$188	+\$292	+\$336	+\$426	+\$568	+\$674	+\$790	+\$1032	+\$1286	
	For power/USB unit, see electrical placement chart. Includes ganging hardware (2 sides). Add \$70 for (SSS), \$86 for (SBS) Add \$632 for 36 lbs. (CW) Add \$138 for (SP) or \$678 for (BS) Add \$40 for (TP) Add \$188 for (MB)													
	OVERALL DIMENSIONS	W	D	H	SEAT DIMENSIONS			BACK DIMENSIONS						
	39	30	32	39	19	18	39	14						
	RTA 00	1 per carton												
 <p>R27810B</p> <p>Bariatric Lounge Chair - Standard Back COM Yardage: Back: 4.25; Seat: 2 Freight class: 250 Product weight: 108 Cubic feet per carton: 33</p>	R27810B Base Price:	\$3886												
	Back/Arm upcharge:	+0	+\$136	+\$243	+\$400	+\$621	+\$714	+\$906	+\$1207	+\$1433	+\$1679	+\$2193	+\$2733	
	Seat upcharge:	+0	+\$64	+\$114	+\$188	+\$292	+\$336	+\$426	+\$568	+\$674	+\$790	+\$1032	+\$1286	
	For power/USB unit, see electrical placement chart. Ganging not available. Add \$70 for (SSS), \$139 for (SBS) Add \$632 for 36 lbs. (CW) Add \$138 for (SP) or \$678 for (BS) Add \$40 for (TP) Add \$188 for (MB)													
	OVERALL DIMENSIONS	W	D	H	SEAT DIMENSIONS			BACK DIMENSIONS						
	46	30	32	39	19	18	39	14						
	RTA 00	1 per carton												
  <p>R27810L</p> <p>Bariatric Lounge Chair - Standard Back COM Yardage: Back: 3.25; Seat: 2 Freight class: 250 Product weight: 98 Cubic feet per carton: 33</p>	R27810L Base Price:	\$3518												
	R27810R Base Price:	\$3518												
	Back/Arm upcharge:	+0	+\$104	+\$186	+\$306	+\$475	+\$546	+\$693	+\$923	+\$1096	+\$1284	+\$1677	+\$2090	
	Seat upcharge:	+0	+\$64	+\$114	+\$188	+\$292	+\$336	+\$426	+\$568	+\$674	+\$790	+\$1032	+\$1286	
	For power/USB unit, see electrical placement chart. Includes ganging hardware (1 side). Add \$70 for (SSS), \$112 for (SBS) Add \$632 for 36 lbs. (CW) Add \$138 for (SP) or \$678 for (BS) Add \$40 for (TP) Add \$188 for (MB)													
OVERALL DIMENSIONS	W	D	H	SEAT DIMENSIONS			BACK DIMENSIONS							
	42.5	30	32	39	19	18	39	14						
	RTA 00	1 per carton												
 <p>R27811</p> <p>Bariatric Lounge Chair - High Back COM Yardage: Back: 2.75; Seat: 2 Freight class: 250 Product weight: 98 Cubic feet per carton: 36</p>	R27811 Base Price:	\$3504												
	Back upcharge:	+0	+\$88	+\$157	+\$259	+\$402	+\$462	+\$586	+\$781	+\$927	+\$1087	+\$1419	+\$4341	
	Seat upcharge:	+0	+\$112	+\$114	+\$188	+\$292	+\$336	+\$426	+\$568	+\$674	+\$790	+\$1032	+\$1286	
	For power/USB unit, see electrical placement chart. Includes ganging hardware (2 sides). Add \$70 for (SSS), \$110 for (SBS) Add \$632 for 36 lbs. (CW), (C6) Add \$138 for (SP) or \$678 for (BS) Add \$40 for (TP) Add \$188 for (MB)													
	OVERALL DIMENSIONS	W	D	H	SEAT DIMENSIONS			BACK DIMENSIONS						
	39	30.5	41.5	39	19	18	39	23.5						
	RTA 00	1 per carton												

DESCRIPTION MODEL#/ FEATURES STANDARD TEXTILE GRADES



R27811B

Bariatric Lounge Chair - High Back
 COM Yardage: Back: 4.75; Seat: 2
 Freight class: 250
 Product weight: 117.5
 Cubic feet per carton: 42.25

R27811B Base Price:
 Back/Arm upcharge:
 Seat upcharge:

1/COM	2	3	4	5	6	7	8	9	10	11	12
\$4239											
+0	+\$152	+\$271	+\$447	+\$694	+\$798	+\$1012	+\$1349	+\$1601	+\$1877	+\$2451	+\$3055
+0	+\$64	+\$114	+\$188	+\$292	+\$336	+\$426	+\$568	+\$674	+\$790	+\$1032	+\$1286

For power/USB unit, see electrical placement chart.
 Ganging not available.
 Add \$70 for (SSS), \$162 for (SBS)
 Add \$632 for 36 lbs. (CW), (C6)
 Add \$138 for (SP) or \$678 for (BS)
 Add \$40 for (TP)
 Add \$188 for (MB)

OVERALL DIMENSIONS			SEAT DIMENSIONS			BACK DIMENSIONS	
W	D	H	W	D	H	W	H
46	30.5	41.5	39	19	18	39	23.5
RTA 00			1 per carton				



R27811L

R27811R

Bariatric Lounge Chair - High Back
 COM Yardage: Back: 3.75; Seat: 2
 Freight class: 250
 Product weight: 107.5
 Cubic feet per carton: 42.25

R27811L Base Price:
R27811R Base Price:
 Back/Arm upcharge:
 Seat upcharge:

1/COM	2	3	4	5	6	7	8	9	10	11	12
\$3872											
+0	+\$120	+\$214	+\$353	+\$548	+\$630	+\$799	+\$1065	+\$1264	+\$1482	+\$1935	+\$2412
+0	+\$64	+\$114	+\$188	+\$292	+\$336	+\$426	+\$568	+\$674	+\$790	+\$1032	+\$1286

For power/USB unit, see electrical placement chart.
 Includes ganging hardware (1 side).
 Add \$70 for (SSS), \$137 for (SBS)
 Add \$632 for 36 lbs. (CW), (C6)
 Add \$138 for (SP) or \$678 for (BS)
 Add \$40 for (TP)
 Add \$188 for (MB)

OVERALL DIMENSIONS			SEAT DIMENSIONS			BACK DIMENSIONS	
W	D	H	W	D	H	W	H
42.5	30.5	41.5	39	19	18	39	23.5
RTA 00			1 per carton				



R27812

Bariatric Lounge Chair - Extended Back
 COM Yardage: Back: 3.25; Seat: 2
 Freight class: 250
 Product weight: 115
 Cubic feet per carton: 41

R27812 Base Price:
 Back upcharge:
 Seat upcharge:

1/COM	2	3	4	5	6	7	8	9	10	11	12
\$3709											
+0	+\$104	+\$186	+\$306	+\$475	+\$546	+\$693	+\$923	+\$1096	+\$1284	+\$1677	+\$2090
+0	+\$64	+\$114	+\$188	+\$292	+\$336	+\$426	+\$568	+\$674	+\$790	+\$1032	+\$1286

For power/USB unit, see electrical placement chart.
 Includes ganging hardware (2 sides).
 Add \$70 for (SSS), \$119 for (SBS)
 Add \$632 for 36 lbs. (CW), (C6)
 Add \$138 for (SP) or \$678 for (BS)
 Add \$40 for (TP)
 Add \$188 for (MB)

OVERALL DIMENSIONS			SEAT DIMENSIONS			BACK DIMENSIONS	
W	D	H	W	D	H	W	H
39	31	47	39	19	18	39	29
RTA 00			1 per carton				



R27812B

Bariatric Lounge Chair - Extended Back
 COM Yardage: Back: 5.25; Seat: 2
 Freight class: 250
 Product weight: 132.5
 Cubic feet per carton: 47.25

R27812B Base Price:
 Back/Arm upcharge:
 Seat upcharge:





1/COM	2	3	4	5	6	7	8	9	10	11	12
\$4446											
+0	+\$168	+\$300	+\$494	+\$767	+\$882	+\$1119	+\$1491	+\$1770	+\$2074	+\$2709	+\$3376
+0	+\$64	+\$114	+\$188	+\$292	+\$336	+\$426	+\$568	+\$674	+\$790	+\$1032	+\$1286





For power/USB unit, see electrical placement chart.
 Ganging not available.
 Add \$70 for (SSS), \$171 for (SBS)
 Add \$632 for 36 lbs. (CW), (C6)
 Add \$138 for (SP) or \$678 for (BS)
 Add \$40 for (TP)
 Add \$188 for (MB)





OVERALL DIMENSIONS			SEAT DIMENSIONS			BACK DIMENSIONS	
W	D	H	W	D	H	W	H
46	31	47	39	19	18	39	29
RTA 00			1 per carton				

LOUNGE

RIVER+ SEATING R

DESCRIPTION	MODEL#/ FEATURES	STANDARD TEXTILE GRADES											
		1/COM	2	3	4	5	6	7	8	9	10	11	12
 <p>R27812L</p> <p>Bariatric Lounge Chair - Extended Back COM Yardage: Back: 4.25; Seat: 2 Freight class: 250 Product weight: 122.5 Cubic feet per carton: 47.25</p>	<p>R27812R</p> <p>For power/USB unit, see electrical placement chart. Includes ganging hardware (1 side). Add \$70 for (SSS), \$145 for (SBS) Add \$632 for 36 lbs. (CW), (C6) Add \$138 for (SP) or \$678 for (BS) Add \$40 for (TP) Add \$188 for (MB)</p>	<p>R27812L Base Price: \$4079</p> <p>R27812R Base Price: \$4079</p> <p>Back/Arm upcharge: +0</p> <p>Seat upcharge: +0</p>											
		<p>OVERALL DIMENSIONS</p> <p>W D H</p> <p>42.5 31 47</p> <p>SEAT DIMENSIONS</p> <p>W D H</p> <p>39 19 18</p> <p>BACK DIMENSIONS</p> <p>W H</p> <p>39 29</p> <p>RTA 00 1 per carton</p>											
 <p>R27815</p> <p>Inside Curve Two Seater - Standard Back COM Yardage: Back: 3; Seat: 2 Freight class: 250 Product weight: 93 119 shelf model Cubic feet per carton: 42.75 63.5 shelf model</p>	<p>R27815S</p> <p>For power/USB unit, see electrical placement chart. Includes ganging hardware (2 sides). Add \$86 for (SSS), \$119 for (SBS) Add \$1260 for 72 lbs. (CW), (C6) Add \$174 for (SP) or \$773 for (BS) Add \$40 for (TP) Add \$252 for (MB)</p>	<p>R27815 Base Price: \$3395</p> <p>R27815S Base Price: \$4447</p> <p>Back upcharge: +0</p> <p>Seat upcharge: +0</p>											
		<p>Shelf: 52W 10D 1H</p> <p>OVERALL DIMENSIONS</p> <p>W D H</p> <p>50.5 30 32</p> <p>SEAT DIMENSIONS</p> <p>W D H</p> <p>42 19 18</p> <p>BACK DIMENSIONS</p> <p>W H</p> <p>51 14</p> <p>RTA 00 1 per carton</p>											
 <p>R27815L</p> <p>Inside Curve Two Seater - Standard Back COM Yardage: Back: 4; Seat: 2 Freight class: 250 Product weight: 102 Cubic feet per carton: 43.5</p>	<p>R27815R</p> <p>For power/USB unit, see electrical placement chart. Includes ganging hardware (1 side). Add \$86 for (SSS), \$145 for (SBS) Add \$1260 for 72 lbs. (CW), (C6) Add \$174 for (SP) or \$773 for (BS) Add \$40 for (TP) Add \$252 for (MB)</p>	<p>R27815L Base Price: \$3764</p> <p>R27815R Base Price: \$3764</p> <p>Back/Arm upcharge: +0</p> <p>Seat upcharge: +0</p>											
		<p>OVERALL DIMENSIONS</p> <p>W D H</p> <p>54 30 32</p> <p>SEAT DIMENSIONS</p> <p>W D H</p> <p>42 19 18</p> <p>BACK DIMENSIONS</p> <p>W H</p> <p>51 14</p> <p>RTA 00 1 per carton</p>											
 <p>R27815SL</p> <p>Inside Curve Two Seater - Standard Back COM Yardage: Back: 4; Seat: 2 Freight class: 250 Product weight: 102 128 shelf model Cubic feet per carton: 43.5 65 shelf model</p>	<p>R27815SR</p> <p>For power/USB unit, see electrical placement chart. Includes ganging hardware (1 side). Add \$86 for (SSS), \$145 for (SBS) Add \$1260 for 72 lbs. (CW), (C6) Add \$174 for (SP) or \$773 for (BS) Add \$40 for (TP) Add \$252 for (MB)</p>	<p>R27815SL Base Price: \$4816</p> <p>R27815SR Base Price: \$4816</p> <p>Back/Arm upcharge: +0</p> <p>Seat upcharge: +0</p>											
		<p>Shelf: 52W 10D 1H</p> <p>OVERALL DIMENSIONS</p> <p>W D H</p> <p>61.5 40.5 32</p> <p>SEAT DIMENSIONS</p> <p>W D H</p> <p>42 19 18</p> <p>BACK DIMENSIONS</p> <p>W H</p> <p>51 14</p> <p>RTA 00 1 per carton</p>											

DESCRIPTION		MODEL#/ FEATURES		STANDARD TEXTILE GRADES																																			
				1/COM	2	3	4	5	6	7	8	9	10	11	12																								
 <p>R27816</p> <p>Inside Curve Two Seater - High Back COM Yardage: Back: 3.50; Seat: 2 Freight class: 300 Product weight: 106 132 shelf model Cubic feet per carton: 53.75 79.75 shelf model</p>	<p>R27816S</p> <p>For power/USB unit, see electrical placement chart. Includes ganging hardware (2 sides). Add \$86 for (SSS), \$157 for (SBS) Add \$1260 for 72 lbs. (CW), (C6) Add \$174 for (SP) or \$773 for (BS) Add \$40 for (TP) Add \$252 for (MB)</p>	<p>R27816 Base Price: \$4419</p> <p>R27816S Base Price: \$5406</p> <p>Back upcharge: +0</p> <p>Seat upcharge: +0</p>	<p>\$4419</p> <p>\$5406</p> <p>+0</p> <p>+0</p>																																				
		<p>Shelf: 52W 10D 1H</p> <table border="1"> <thead> <tr> <th colspan="3">OVERALL DIMENSIONS</th> <th colspan="3">SEAT DIMENSIONS</th> <th colspan="2">BACK DIMENSIONS</th> </tr> <tr> <th>W</th> <th>D</th> <th>H</th> <th>W</th> <th>D</th> <th>H</th> <th>W</th> <th>H</th> </tr> </thead> <tbody> <tr> <td>51</td> <td>30.5</td> <td>41.5</td> <td>42</td> <td>19</td> <td>18</td> <td>51</td> <td>23.5</td> </tr> </tbody> </table> <p>RTA 00 1 per carton</p>				OVERALL DIMENSIONS			SEAT DIMENSIONS			BACK DIMENSIONS		W	D	H	W	D	H	W	H	51	30.5	41.5	42	19	18	51	23.5										
OVERALL DIMENSIONS			SEAT DIMENSIONS			BACK DIMENSIONS																																	
W	D	H	W	D	H	W	H																																
51	30.5	41.5	42	19	18	51	23.5																																
 <p>R27816L</p> <p>Inside Curve Two Seater - High Back COM Yardage: Back: 4.50; Seat: 2 Freight class: 250 Product weight: 115 Cubic feet per carton: 55.5</p>	<p>R27816SR</p> <p>For power/USB unit, see electrical placement chart. Includes ganging hardware (1 side). Add \$86 for (SSS), \$183 for (SBS) Add \$1260 for 72 lbs. (CW), (C6) Add \$174 for (SP) or \$773 for (BS) Add \$40 for (TP) Add \$252 for (MB)</p>	<p>R27816L Base Price: \$4788</p> <p>R27816SR Base Price: \$4788</p> <p>Back/Arm upcharge: +0</p> <p>Seat upcharge: +0</p>	<p>\$4788</p> <p>\$4788</p> <p>+0</p> <p>+0</p>																																				
		<p>Shelf: 52W 10D 1H</p> <table border="1"> <thead> <tr> <th colspan="3">OVERALL DIMENSIONS</th> <th colspan="3">SEAT DIMENSIONS</th> <th colspan="2">BACK DIMENSIONS</th> </tr> <tr> <th>W</th> <th>D</th> <th>H</th> <th>W</th> <th>D</th> <th>H</th> <th>W</th> <th>H</th> </tr> </thead> <tbody> <tr> <td>54.5</td> <td>30.5</td> <td>41.5</td> <td>42</td> <td>19</td> <td>18</td> <td>51</td> <td>23.5</td> </tr> </tbody> </table> <p>RTA 00 1 per carton</p>				OVERALL DIMENSIONS			SEAT DIMENSIONS			BACK DIMENSIONS		W	D	H	W	D	H	W	H	54.5	30.5	41.5	42	19	18	51	23.5										
OVERALL DIMENSIONS			SEAT DIMENSIONS			BACK DIMENSIONS																																	
W	D	H	W	D	H	W	H																																
54.5	30.5	41.5	42	19	18	51	23.5																																
 <p>R27816SL</p> <p>Inside Curve Two Seater - High Back COM Yardage: Back: 4.50; Seat: 2 Freight class: 250 Product weight: 141.5 Cubic feet per carton: 82.5</p>	<p>R27816SR</p> <p>For power/USB unit, see electrical placement chart. Includes ganging hardware (1 side). Add \$86 for (SSS), \$183 for (SBS) Add \$1260 for 72 lbs. (CW), (C6) Add \$174 for (SP) or \$773 for (BS) Add \$40 for (TP) Add \$252 for (MB)</p>	<p>R27816SL Base Price: \$5775</p> <p>R27816SR Base Price: \$5775</p> <p>Back/Arm upcharge: +0</p> <p>Seat upcharge: +0</p>	<p>\$5775</p> <p>\$5775</p> <p>+0</p> <p>+0</p>																																				
		<p>Shelf: 52W 10D 1H</p> <table border="1"> <thead> <tr> <th colspan="3">OVERALL DIMENSIONS</th> <th colspan="3">SEAT DIMENSIONS</th> <th colspan="2">BACK DIMENSIONS</th> </tr> <tr> <th>W</th> <th>D</th> <th>H</th> <th>W</th> <th>D</th> <th>H</th> <th>W</th> <th>H</th> </tr> </thead> <tbody> <tr> <td>62</td> <td>41</td> <td>41.5</td> <td>42</td> <td>19</td> <td>18</td> <td>51</td> <td>23.5</td> </tr> </tbody> </table> <p>RTA 00 1 per carton</p>				OVERALL DIMENSIONS			SEAT DIMENSIONS			BACK DIMENSIONS		W	D	H	W	D	H	W	H	62	41	41.5	42	19	18	51	23.5										
OVERALL DIMENSIONS			SEAT DIMENSIONS			BACK DIMENSIONS																																	
W	D	H	W	D	H	W	H																																
62	41	41.5	42	19	18	51	23.5																																
 <p>R27817</p> <p>Inside Curve Two Seater - Extended Back COM Yardage: Back: 4; Seat: 2 Freight class: 300 Product weight: 118 139 shelf model Cubic feet per carton: 61 90.5 shelf model</p>	<p>R27817S</p> <p>For power/USB unit, see electrical placement chart. Includes ganging hardware (2 sides). Add \$86 for (SSS), \$168 for (SBS) Add \$1260 for 72 lbs. (CW), (C6) Add \$174 for (SP) or \$773 for (BS) Add \$40 for (TP) Add \$252 for (MB)</p>	<p>R27817 Base Price: \$4681</p> <p>R27817S Base Price: \$5669</p> <p>Back upcharge: +0</p> <p>Seat upcharge: +0</p>	<p>\$4681</p> <p>\$5669</p> <p>+0</p> <p>+0</p>																																				
		<p>Shelf: 52W 10D 1H</p> <table border="1"> <thead> <tr> <th colspan="3">OVERALL DIMENSIONS</th> <th colspan="3">SEAT DIMENSIONS</th> <th colspan="2">BACK DIMENSIONS</th> </tr> <tr> <th>W</th> <th>D</th> <th>H</th> <th>W</th> <th>D</th> <th>H</th> <th>W</th> <th>H</th> </tr> </thead> <tbody> <tr> <td>51.5</td> <td>31</td> <td>47</td> <td>42</td> <td>19</td> <td>18</td> <td>51</td> <td>29</td> </tr> </tbody> </table> <p>RTA 00 1 per carton</p>				OVERALL DIMENSIONS			SEAT DIMENSIONS			BACK DIMENSIONS		W	D	H	W	D	H	W	H	51.5	31	47	42	19	18	51	29										
OVERALL DIMENSIONS			SEAT DIMENSIONS			BACK DIMENSIONS																																	
W	D	H	W	D	H	W	H																																
51.5	31	47	42	19	18	51	29																																





DESCRIPTION	MODEL#/ FEATURES	STANDARD TEXTILE GRADES											
		1/COM	2	3	4	5	6	7	8	9	10	11	12
 <p>R27817L</p> <p>Inside Curve Two Seater - Extended Back COM Yardage: Back: 5; Seat: 2 Freight class: 300 Product weight: 122 Cubic feet per carton: 62.25</p>	<p>R27817R</p> <p>For power/USB unit, see electrical placement chart. Includes ganging hardware (1 side). Add \$86 for (SSS), \$195 for (SBS) Add \$1260 for 72 lbs. (CW), (C6) Add \$174 for (SP) or \$773 for (BS) Add \$40 for (TP) Add \$252 for (MB)</p>	<p>R27817L Base Price: \$5049</p> <p>R27817R Base Price: \$5049</p> <p>Back/Arm upcharge: +0</p> <p>Seat upcharge: +0</p>											
		<p>OVERALL DIMENSIONS</p> <p>W D H</p> <p>54 31 47</p>	<p>SEAT DIMENSIONS</p> <p>W D H</p> <p>42 19 18</p>	<p>BACK DIMENSIONS</p> <p>W H</p> <p>51 29</p>	<p>RTA 00</p> <p>1 per carton</p>								
 <p>R27817SL</p> <p>Inside Curve Two Seater - Extended Back COM Yardage: Back: 5; Seat: 2 Freight class: 300 Product weight: 149 Cubic feet per carton: 92.75</p>	<p>R27817SR</p> <p>For power/USB unit, see electrical placement chart. Includes ganging hardware (1 side). Add \$86 for (SSS), \$195 for (SBS) Add \$1260 for 72 lbs. (CW), (C6) Add \$174 for (SP) or \$773 for (BS) Add \$40 for (TP) Add \$252 for (MB)</p>	<p>R27817SL Base Price: \$6038</p> <p>R27817SR Base Price: \$6038</p> <p>Back/Arm upcharge: +0</p> <p>Seat upcharge: +0</p>											
		<p>OVERALL DIMENSIONS</p> <p>W D H</p> <p>62.5 41.5 47</p>	<p>SEAT DIMENSIONS</p> <p>W D H</p> <p>42 19 18</p>	<p>BACK DIMENSIONS</p> <p>W H</p> <p>51 29</p>	<p>RTA 00</p> <p>1 per carton</p>								
 <p>R27818</p> <p>Outside Curve Two Seater - Standard Back COM Yardage: Back: 2.25; Seat: 2 Freight class: 4.25 Product weight: 93 107 shelf model Cubic feet per carton: 42.75 63.5 shelf model</p>	<p>R27818S</p> <p>For power/USB unit, see electrical placement chart. Includes ganging hardware (2 sides). Add \$93 for (SSS), \$104 for (SBS) Add \$1260 for 72 lbs. (CW), (C6) Add \$174 for (SP) or \$871 for (BS) Add \$40 for (TP) Add \$252 for (MB)</p>	<p>R27818 Base Price: \$3311</p> <p>R27818S Base Price: \$4300</p> <p>Back upcharge: +0</p> <p>Seat upcharge: +0</p>											
		<p>OVERALL DIMENSIONS</p> <p>W D H</p> <p>50 30 32</p>	<p>SEAT DIMENSIONS</p> <p>W D H</p> <p>50 19 18</p>	<p>BACK DIMENSIONS</p> <p>W H</p> <p>36 14</p>	<p>RTA 00</p> <p>1 per carton</p>								
 <p>R27818L</p> <p>Outside Curve Two Seater - Standard Back COM Yardage: Back: 3.25; Seat: 2 Freight class: 5.25 Product weight: 102 Cubic feet per carton: 43.5</p>	<p>R27818R</p> <p>For power/USB unit, see electrical placement chart. Includes ganging hardware (1 side). Add \$93 for (SSS), \$130 for (SBS) Add \$1260 for 72 lbs. (CW), (C6) Add \$174 for (SP) or \$871 for (BS) Add \$40 for (TP) Add \$252 for (MB)</p>	<p>R27818L Base Price: \$3679</p> <p>R27818R Base Price: \$3679</p> <p>Back/Arm upcharge: +0</p> <p>Seat upcharge: +0</p>											
		<p>OVERALL DIMENSIONS</p> <p>W D H</p> <p>53.5 30 32</p>	<p>SEAT DIMENSIONS</p> <p>W D H</p> <p>50 19 18</p>	<p>BACK DIMENSIONS</p> <p>W H</p> <p>36 14</p>	<p>RTA 00</p> <p>1 per carton</p>								

DESCRIPTION	MODEL#/ FEATURES	STANDARD TEXTILE GRADES																																										
		1/COM	2	3	4	5	6	7	8	9	10	11	12																															
 <p>R27818SL</p> <p>Outside Curve Two Seater - Standard Back COM Yardage: Back 3.25; Seat: 2 Freight class: 5.25 Product weight: 116 Cubic feet per carton: 65</p>	<p>R27818SL Base Price: \$4668 R27818SR Base Price: \$4668</p> <p>Back/Arm upcharge: +0 Seat upcharge: +0</p> <p>Shelf: 52W 10D 1H</p> <p>For power/USB unit, see electrical placement chart. Includes ganging hardware (1 side). Add \$93 for (SSS), \$130 for (SBS) Add \$1260 for 72 lbs. (CW), (C6) Add \$174 for (SP) or \$871 for (BS) Add \$40 for (TP) Add \$252 for (MB)</p>																																											
		<table border="1"> <thead> <tr> <th colspan="3">OVERALL DIMENSIONS</th> <th colspan="3">SEAT DIMENSIONS</th> <th colspan="2">BACK DIMENSIONS</th> </tr> <tr> <th>W</th> <th>D</th> <th>H</th> <th>W</th> <th>D</th> <th>H</th> <th>W</th> <th>H</th> </tr> </thead> <tbody> <tr> <td>53.5</td> <td>40.5</td> <td>32</td> <td>50</td> <td>19</td> <td>18</td> <td>36</td> <td>14</td> </tr> <tr> <td colspan="2">RTA 00</td> <td colspan="6">1 per carton</td> <td></td> </tr> </tbody> </table>	OVERALL DIMENSIONS			SEAT DIMENSIONS			BACK DIMENSIONS		W	D	H	W	D	H	W	H	53.5	40.5	32	50	19	18	36	14	RTA 00		1 per carton															
OVERALL DIMENSIONS			SEAT DIMENSIONS			BACK DIMENSIONS																																						
W	D	H	W	D	H	W	H																																					
53.5	40.5	32	50	19	18	36	14																																					
RTA 00		1 per carton																																										

DESCRIPTION	MODEL#/ FEATURES	STANDARD TEXTILE GRADES																																										
		1/COM	2	3	4	5	6	7	8	9	10	11	12																															
 <p>R27819</p> <p>Outside Curve Two Seater - High Back COM Yardage: Back 3.25; Seat: 2 Freight class: 300 Product weight: 101 115 shelf model Cubic feet per carton: 53.75 79.75 shelf model</p>	<p>R27819 Base Price: \$3942 R27819S Base Price: \$4932</p> <p>Back upcharge: +0 Seat upcharge: +0</p> <p>Shelf: 52W 10D 1H</p> <p>For power/USB unit, see electrical placement chart. Includes ganging hardware (2 sides). Add \$93 for (SSS), \$135 for (SBS) Add \$1260 for 72 lbs. (CW), (C6) Add \$174 for (SP) or \$871 for (BS) Add \$40 for (TP) Add \$252 for (MB)</p>																																											
		<table border="1"> <thead> <tr> <th colspan="3">OVERALL DIMENSIONS</th> <th colspan="3">SEAT DIMENSIONS</th> <th colspan="2">BACK DIMENSIONS</th> </tr> <tr> <th>W</th> <th>D</th> <th>H</th> <th>W</th> <th>D</th> <th>H</th> <th>W</th> <th>H</th> </tr> </thead> <tbody> <tr> <td>50</td> <td>30.5</td> <td>41.5</td> <td>50</td> <td>19</td> <td>18</td> <td>32</td> <td>23.5</td> </tr> <tr> <td colspan="2">RTA 00</td> <td colspan="6">1 per carton</td> <td></td> </tr> </tbody> </table>	OVERALL DIMENSIONS			SEAT DIMENSIONS			BACK DIMENSIONS		W	D	H	W	D	H	W	H	50	30.5	41.5	50	19	18	32	23.5	RTA 00		1 per carton															
OVERALL DIMENSIONS			SEAT DIMENSIONS			BACK DIMENSIONS																																						
W	D	H	W	D	H	W	H																																					
50	30.5	41.5	50	19	18	32	23.5																																					
RTA 00		1 per carton																																										

DESCRIPTION	MODEL#/ FEATURES	STANDARD TEXTILE GRADES																																										
		1/COM	2	3	4	5	6	7	8	9	10	11	12																															
 <p>R27819L</p> <p>Outside Curve Two Seater - High Back COM Yardage: Back 4.25; Seat: 2 Freight class: 300 Product weight: 110 Cubic feet per carton: 55.5</p>	<p>R27819L Base Price: \$4311 R27819R Base Price: \$4311</p> <p>Back/Arm upcharge: +0 Seat upcharge: +0</p> <p>Shelf: 52W 10D 1H</p> <p>For power/USB unit, see electrical placement chart. Includes ganging hardware (1 side). Add \$93 for (SSS), \$161 for (SBS) Add \$1260 for 72 lbs. (CW), (C6) Add \$174 for (SP) or \$871 for (BS) Add \$40 for (TP) Add \$252 for (MB)</p>																																											
		<table border="1"> <thead> <tr> <th colspan="3">OVERALL DIMENSIONS</th> <th colspan="3">SEAT DIMENSIONS</th> <th colspan="2">BACK DIMENSIONS</th> </tr> <tr> <th>W</th> <th>D</th> <th>H</th> <th>W</th> <th>D</th> <th>H</th> <th>W</th> <th>H</th> </tr> </thead> <tbody> <tr> <td>53.5</td> <td>30.5</td> <td>41.5</td> <td>50</td> <td>19</td> <td>18</td> <td>32</td> <td>23.5</td> </tr> <tr> <td colspan="2">RTA 00</td> <td colspan="6">1 per carton</td> <td></td> </tr> </tbody> </table>	OVERALL DIMENSIONS			SEAT DIMENSIONS			BACK DIMENSIONS		W	D	H	W	D	H	W	H	53.5	30.5	41.5	50	19	18	32	23.5	RTA 00		1 per carton															
OVERALL DIMENSIONS			SEAT DIMENSIONS			BACK DIMENSIONS																																						
W	D	H	W	D	H	W	H																																					
53.5	30.5	41.5	50	19	18	32	23.5																																					
RTA 00		1 per carton																																										

DESCRIPTION	MODEL#/ FEATURES	STANDARD TEXTILE GRADES																																										
		1/COM	2	3	4	5	6	7	8	9	10	11	12																															
 <p>R27819SL</p> <p>Outside Curve Two Seater - High Back COM Yardage: Back 4.25; Seat: 2 Freight class: 300 Product weight: 124.5 Cubic feet per carton: 82.5</p>	<p>R27819SL Base Price: \$5300 R27819SR Base Price: \$5300</p> <p>Back/Arm upcharge: +0 Seat upcharge: +0</p> <p>Shelf: 52W 10D 1H</p> <p>For power/USB unit, see electrical placement chart. Includes ganging hardware (1 side). Add \$93 for (SSS), \$161 for (SBS) Add \$1260 for 72 lbs. (CW), (C6) Add \$174 for (SP) or \$871 for (BS) Add \$40 for (TP) Add \$252 for (MB)</p>																																											
		<table border="1"> <thead> <tr> <th colspan="3">OVERALL DIMENSIONS</th> <th colspan="3">SEAT DIMENSIONS</th> <th colspan="2">BACK DIMENSIONS</th> </tr> <tr> <th>W</th> <th>D</th> <th>H</th> <th>W</th> <th>D</th> <th>H</th> <th>W</th> <th>H</th> </tr> </thead> <tbody> <tr> <td>53.5</td> <td>41</td> <td>41.5</td> <td>50</td> <td>19</td> <td>18</td> <td>32</td> <td>23.5</td> </tr> <tr> <td colspan="2">RTA 00</td> <td colspan="6">1 per carton</td> <td></td> </tr> </tbody> </table>	OVERALL DIMENSIONS			SEAT DIMENSIONS			BACK DIMENSIONS		W	D	H	W	D	H	W	H	53.5	41	41.5	50	19	18	32	23.5	RTA 00		1 per carton															
OVERALL DIMENSIONS			SEAT DIMENSIONS			BACK DIMENSIONS																																						
W	D	H	W	D	H	W	H																																					
53.5	41	41.5	50	19	18	32	23.5																																					
RTA 00		1 per carton																																										

DESCRIPTION		MODEL#/ FEATURES	STANDARD TEXTILE GRADES											
			1/COM	2	3	4	5	6	7	8	9	10	11	12
	<p>R27820</p> <p>Outside Curve Two Seater - Extended Back COM Yardage: Back 4.25; Seat: 2 Freight class: 300 Product weight: 109 120 shelf Cubic feet per carton: 61 90.5 shelf</p>	<p>R27820 Base Price: \$4342</p>												
		<p>R27820S Base Price: \$5250</p> <p>Back upcharge: +0 +\$136 +\$243 +\$400 +\$621 +\$714 +\$906 +\$1207 +\$1433 +\$1679 +\$2193 +\$2733</p> <p>Seat upcharge: +0 +\$64 +\$114 +\$188 +\$292 +\$336 +\$426 +\$568 +\$674 +\$790 +\$1032 +\$1286</p> <p>Shelf: 52W 10D 1H</p>	<p>OVERALL DIMENSIONS</p> <p>W D H</p>			<p>SEAT DIMENSIONS</p> <p>W D H</p>			<p>BACK DIMENSIONS</p> <p>W H</p>					
		<p>For power/USB unit, see electrical placement chart. Includes ganging hardware (2 sides). Add \$93 for (SSS), \$144 for (SBS) Add \$1260 for 72 lbs. (CW), (C6) Add \$174 for (SP) or \$871 for (BS) Add \$40 for (TP) Add \$252 for (MB)</p>	50	31	47	50	19	18	28	29				
			RTA 00	1 per carton										
	<p>R27820L</p> <p>Outside Curve Two Seater - Extended Back COM Yardage: Back 5.25; Seat: 2 Freight class: 300 Product weight: 113 Cubic feet per carton: 62.25</p>	<p>R27820L Base Price: \$4710</p>												
		<p>R27820R Base Price: \$4710</p> <p>Back/Arm upcharge: +0 +\$168 +\$300 +\$494 +\$767 +\$882 +\$1119 +\$1491 +\$1770 +\$2074 +\$2709 +\$3376</p> <p>Seat upcharge: +0 +\$64 +\$114 +\$188 +\$292 +\$336 +\$426 +\$568 +\$674 +\$790 +\$1032 +\$1286</p> <p>Shelf: 52W 10D 1H</p>	<p>OVERALL DIMENSIONS</p> <p>W D H</p>			<p>SEAT DIMENSIONS</p> <p>W D H</p>			<p>BACK DIMENSIONS</p> <p>W H</p>					
		<p>For power/USB unit, see electrical placement chart. Includes ganging hardware (1 side). Add \$93 for (SSS), \$170 for (SBS) Add \$1260 for 72 lbs. (CW), (C6) Add \$174 for (SP) or \$871 for (BS) Add \$40 for (TP) Add \$252 for (MB)</p>	53.5	31	47	50	19	18	28	29				
			RTA 00	1 per carton										
	<p>R27820SL</p> <p>Outside Curve Two Seater - Extended Back COM Yardage: Back 5.25; Seat: 2 Freight class: 300 Product weight: 113 130 shelf Cubic feet per carton: 62.25 92.75 shelf</p>	<p>R27820SL Base Price: \$5620</p>												
		<p>R27820SR Base Price: \$5620</p> <p>Back/Arm upcharge: +0 +\$168 +\$300 +\$494 +\$767 +\$882 +\$1119 +\$1491 +\$1770 +\$2074 +\$2709 +\$3376</p> <p>Seat upcharge: +0 +\$64 +\$114 +\$188 +\$292 +\$336 +\$426 +\$568 +\$674 +\$790 +\$1032 +\$1286</p> <p>Shelf: 52W 10D 1H</p>	<p>OVERALL DIMENSIONS</p> <p>W D H</p>			<p>SEAT DIMENSIONS</p> <p>W D H</p>			<p>BACK DIMENSIONS</p> <p>W H</p>					
		<p>For power/USB unit, see electrical placement chart. Includes ganging hardware (1 side). Add \$93 for (SSS), \$170 for (SBS) Add \$1260 for 72 lbs. (CW), (C6) Add \$174 for (SP) or \$871 for (BS) Add \$40 for (TP) Add \$252 for (MB)</p>	53.5	41.5	47	50	19	18	28	29				
			RTA 00	1 per carton										
	<p>R27821</p> <p>90 Corner - Standard Back COM Yardage: Back 4; Seat: 2 Freight class: 250 Product weight: 105 137 shelf Cubic feet per carton: 35.5 63 shelf</p>	<p>R27821 Base Price: \$4379</p>												
		<p>R27821S Base Price: \$5766</p> <p>Back upcharge: +0 +\$128 +\$228 +\$376 +\$584 +\$672 +\$852 +\$1136 +\$1348 +\$1580 +\$2064 +\$2572</p> <p>Seat upcharge: +0 +\$64 +\$114 +\$188 +\$292 +\$336 +\$426 +\$568 +\$674 +\$790 +\$1032 +\$1286</p> <p>Shelf: 52W 10D 1H</p>	<p>OVERALL DIMENSIONS</p> <p>W D H</p>			<p>SEAT DIMENSIONS</p> <p>W D H</p>			<p>BACK DIMENSIONS</p> <p>W H</p>					
		<p>No power/USB unit. Includes ganging hardware (2 sides). Add \$67 for (SSS), \$129 for (SBS) Add \$1260 for 72 lbs. (CW), (C6) Add \$174 for (SP) or \$871 for (BS) Add \$40 for (TP) Add \$252 for (MB)</p>	37.5	37.5	32	24	19	18	24	14				
			RTA 00	1 per carton										



DESCRIPTION MODEL#/ FEATURES STANDARD TEXTILE GRADES

		STANDARD TEXTILE GRADES														
		1/COM	2	3	4	5	6	7	8	9	10	11	12			
 <p>R27822</p> <p>90 Corner - High Back COM Yardage: Back 5.75; Seat: 2 Freight class: 250 Product weight: 119 154 shelf Cubic feet per carton: 44.5 79.24 shelf</p>	<p>R27822S</p> <p>No power/USB unit. Includes ganging hardware (2 sides). Add \$67 for (SSS), \$172 for (SBS) Add \$1260 for 72 lbs. (CW), (C6) Add \$174 for (SP) or \$871 for (BS) Add \$40 for (TP) Add \$252 for (MB)</p>	Base Price:	\$5215													
		Base Price:	\$6600													
		Back upcharge:	+0	+\$184	+\$328	+\$541	+\$840	+\$966	+\$1225	+\$1633	+\$1938	+\$2272	+\$2967	+\$3698		
		Seat upcharge:	+0	+\$64	+\$114	+\$188	+\$292	+\$336	+\$426	+\$568	+\$674	+\$790	+\$1032	+\$1286		
		Shelf: 52W 10D 1H														
		OVERALL DIMENSIONS			SEAT DIMENSIONS			BACK DIMENSIONS								
		W	D	H	W	D	H	W	H							
		38.5	38.5	41.5	24	19	18	24	23.5							
		RTA 00 1 per carton														

		STANDARD TEXTILE GRADES														
		1/COM	2	3	4	5	6	7	8	9	10	11	12			
 <p>R27823</p> <p>90 Corner - Extended Back COM Yardage: Back 6.25; Seat: 2 Freight class: 250 Product weight: 128 160 shelf Cubic feet per carton: 50.5 90 shelf</p>	<p>R27823S</p> <p>No power/USB unit. Includes ganging hardware (2 sides). Add \$67 for (SSS), \$179 for (SBS) Add \$1260 for 36 lbs. (CW), (C6) Add \$174 for (SP) or \$871 for (BS) Add \$40 for (TP) Add \$252 for (MB)</p>	Base Price:	\$5735													
		Base Price:	\$7122													
		Back upcharge:	+0	+\$200	+\$357	+\$588	+\$913	+\$1050	+\$1332	+\$1775	+\$2107	+\$2469	+\$3225	+\$2733		
		Seat upcharge:	+0	+\$64	+\$114	+\$188	+\$292	+\$336	+\$426	+\$568	+\$674	+\$790	+\$1032	+\$1286		
		Shelf: 52W 10D 1H														
		OVERALL DIMENSIONS			SEAT DIMENSIONS			BACK DIMENSIONS								
		W	D	H	W	D	H	W	H							
		39	39	47	24	19	18	24	29							
		RTA 00 1 per carton														

		STANDARD TEXTILE GRADES														
		1/COM	2	3	4	5	6	7	8	9	10	11	12			
 <p>R27824</p> <p>120 Corner - Standard Back COM Yardage: Back 4; Seat: 2 Freight class: 250 Product weight: 109 138 shelf Cubic feet per carton: 48.25 68.5 shelf</p>	<p>R27824S</p> <p>No power/USB unit. Includes ganging hardware (2 sides). Add \$89 for (SSS), \$126 for (SBS) Add \$1260 for 36 lbs. (CW), (C6) Add \$216 for (SP) or \$964 for (BS) Add \$40 for (TP) Add \$252 for (MB)</p>	Base Price:	\$4533													
		Base Price:	\$5922													
		Back upcharge:	+0	+\$128	+\$228	+\$376	+\$584	+\$672	+\$852	+\$1136	+\$1348	+\$1580	+\$2064	+\$2572		
		Seat upcharge:	+0	+\$64	+\$114	+\$188	+\$292	+\$336	+\$426	+\$568	+\$674	+\$790	+\$1032	+\$1286		
		Shelf: 52W 10D 1H														
		OVERALL DIMENSIONS			SEAT DIMENSIONS			BACK DIMENSIONS								
		W	D	H	W	D	H	W	H							
		52.5	30	32	52	19	18	52	14							
		RTA 00 1 per carton														

		STANDARD TEXTILE GRADES														
		1/COM	2	3	4	5	6	7	8	9	10	11	12			
 <p>R27825</p> <p>120 Corner - High Back COM Yardage: Back 5.75; Seat: 2 Freight class: 300 Product weight: 118 144 shelf Cubic feet per carton: 60.5 86 shelf</p>	<p>R27825S</p> <p>No power/USB unit. Includes ganging hardware (2 sides). Add \$89 for (SSS), \$164 for (SBS) Add \$1260 for 36 lbs. (CW), (C6) Add \$216 for (SP) or \$964 for (BS) Add \$40 for (TP) Add \$252 for (MB)</p>	Base Price:	\$5304													
		Base Price:	\$6693													
		Back upcharge:	+0	+\$184	+\$328	+\$541	+\$840	+\$966	+\$1225	+\$1633	+\$1938	+\$2272	+\$2967	+\$3698		
		Seat upcharge:	+0	+\$64	+\$114	+\$188	+\$292	+\$336	+\$426	+\$568	+\$674	+\$790	+\$1032	+\$1286		
		Shelf: 52W 10D 1H														
		OVERALL DIMENSIONS			SEAT DIMENSIONS			BACK DIMENSIONS								
		W	D	H	W	D	H	W	H							
		53.5	30.5	41.5	41	21	18	51	23.5							
		RTA 00 1 per carton														

DESCRIPTION	MODEL#/ FEATURES	STANDARD TEXTILE GRADES												
		1/COM	2	3	4	5	6	7	8	9	10	11	12	
 R27826 120 Corner - Extended Back COM Yardage: Back 6.25; Seat: 2 Freight class: 300 Product weight: 123 144 shelf Cubic feet per carton: 68.75 97.75 shelf	R27826S No power/USB unit. Includes ganging hardware (2 sides). Add \$89 for (SSS), \$175 for (SBS) Add \$1260 for 36 lbs. (CW), (C6) Add \$216 for (SP) or \$964 for (BS) Add \$40 for (TP) Add \$252 for (MB)	Base Price:	\$5755											
		Base Price:	\$7141											
		Back upcharge:	+0	+\$200	+\$357	+\$588	+\$913	+\$1050	+\$1332	+\$1775	+\$2107	+\$2469	+\$3225	+\$4019
		Seat upcharge:	+0	+\$64	+\$114	+\$188	+\$292	+\$336	+\$426	+\$568	+\$674	+\$790	+\$1032	+\$1286
		Shelf: 52W 10D 1H												
		OVERALL DIMENSIONS			SEAT DIMENSIONS			BACK DIMENSIONS						
		W	D	H	W	D	H	W	H					
		54	31.5	47	41	21	18	51	29					
		RTA 00		1 per carton										
 Loop Arm COM Yardage: N/A Freight class: 92.5 Product weight (lbs.): 6.3 Cubic feet per carton: 0.6	Attachment hardware included. Polished Aluminum arms sold separately (1 pc). Armcap finish options: (NGT) Night, (FOG) Fog, (LAB) Latte	List price												
		R2770	\$332											
		OVERALL DIMENSIONS			SEAT DIMENSIONS			BACK DIMENSIONS						
		W	D	H	W	D	H	W	H					
		2.5	14	19.5	-	-	-	-	-					
		RTA 1		1 per carton										
		FedEx ups												
 Loop Arm w/Armcap COM Yardage: N/A Freight class: 92.5 Product weight (lbs.): 6.61 Cubic feet per carton: 0.6	Attachment hardware included. Polished Aluminum arms sold separately (1 pc). Armcap finish options: (NGT) Night, (FOG) Fog, (LAB) Latte	List price												
		R2771	\$378											
		OVERALL DIMENSIONS			SEAT DIMENSIONS			BACK DIMENSIONS						
		W	D	H	W	D	H	W	H					
		2.5	14	19.5	-	-	-	-	-					
		RTA 1		1 per carton										
		FedEx ups												

R RIVER+ BENCHES

RIVER+ BENCHES

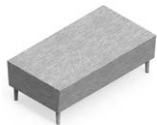

Two Seater Bench
model R27832



Y Bench
model R27842



42" Round Bench
model R27845



Inside Curve Boomerang Bench
model R27840

River+ Seating, Tables



For River+ seating, please see page 369
For River+ tables, please see page 393

EXAMPLE RIVER+ BENCH ORDER CODE:

R27832	-CE90	-S6	-AS	-CH	-	-SP
Model number	Textile	Leg selection	Leg angle	Leg finish	Additional weight	Bottom selection
-	-	-F1	-W			
Sealed Seams	Moisture barrier	Power/USB position	Power finish			

Additional Options specify at end of order code.	SPECIFY CODE
Tamperproof fasteners Upcharges vary, see model.	TP
Moisture barrier Upcharges vary, see model.	MB

*linking hardware is lowered to clear the staple strip.
Units will only gang with other units with sealed bottom.
**cannot be combined with linking hardware or power units

ELECTRICAL PLACEMENT

Straight benches

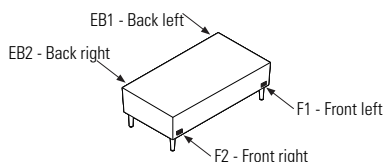

Y bench

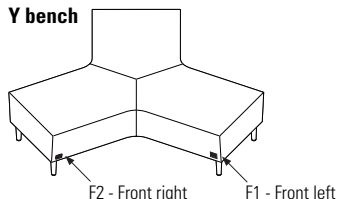

Curved benches

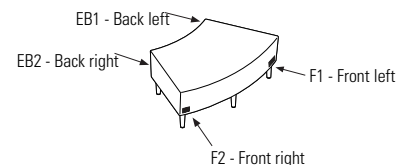
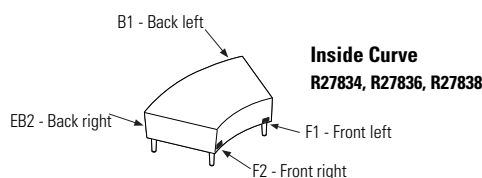

Boomerang benches

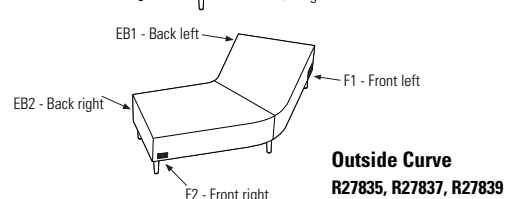
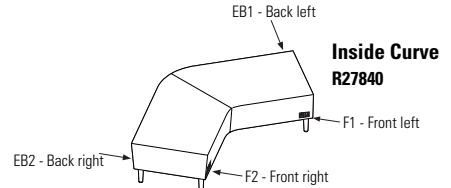

STANDARD FEATURES

- A modular series that is composed of straight, and curved sections, as well as freestanding units.
- Linking units can be used together in any combination to create a wide variety of layouts. Ganging hardware is standard and is factory installed. Ganging hardware swivels out of the way when not in use.
- The standard, 6.5" tapered legs are made of welded steel.
- Legs are straight (vertical) as standard. Linking models are optionally available with angled back legs to match River+ seating units.
- Legs include Black nylon, non-marking, height adjustable glides.
- River+ is rated for an active weight up to 600 lbs. per seat and 24/7 use.
- For 24/7 use and/or heavy duty application use, Global's Heavy Duty warranty is applicable on models specified with performance textiles, rated for 150,000 double rubs.
- Check textile availability prior to specifying upholstery material. Leather not available on River+ series.
- All units are shipped fully assembled.

OPTIONAL FEATURES

- Legs are available in 3" and 8" heights with no upcharge. All heights are available with fixed-to-floor option. Please specify. Add \$100. Fastening hardware not included.
- Steel bottom provides tamperproof protection (includes tamperproof screws). Specify **(BS)** - see each model for upcharge.**
- Up to two power units are available on straight, Y, curved and boomerang benches.
- Each power unit includes one AC outlet and two USB-a, 10-watt charging ports.
- Power location options include front or back. See electrical placement diagrams. Electrical units must be factory installed. Add \$661 per unit.
- Power units are available in either Jet Black **(J)** or White **(W)** with 120", three-prong matching cords.
- To add sealed seams to your product, specify **(SLS)** - see each model for upcharge.
- To match leg angles with lounge seating, straight front and angled back 6.5" or 8" legs are available on straight, curved, corner, and boomerang units. Specify **(SA)**. No upcharge.
- Products can be weighted to reduce the ease of movement. For additional weight options, specify **(CW)** - see each model for available additional weight and upcharge.
- The underside of the seat can be finished with PVC (vinyl) and sealed to prevent penetration of liquids. Specify **(SP)** - see each model for upcharge.*



LOUNGE

Please add option codes in the following order:

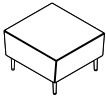
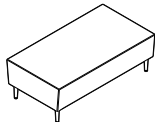
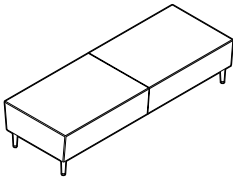
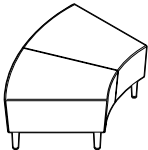
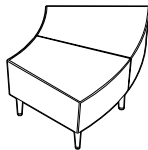

- Model number**
R27831 to R27833 Straight benches
R27834 to R27835 Curved benches
R27836 to R27839 Corner benches
R27840 to R27841 Boomerang benches
R27842 Y bench
R27843 to R27846 Round non-linking benches
R27847 to R27850 Square non-linking benches
- Textile**
Specify textile code.
- Leg selection**
(S6) Standard seat height (17.5"), 6.5" leg w/ adjustable glides. No upcharge.
(S3) Low seat (14"), 3" leg w/adjustable glides. No upcharge.
(S8) High seat (19"), 8" leg w/adjustable glides. No upcharge.
(F6) Standard seat height (17.5"), 6.5" leg, fixed to floor. Add \$100.
(F3) Low seat (14"), 3" leg, fixed to floor. Add \$100.
(F8) High seat (19"), 8" leg, fixed to floor. Add \$100.
- Leg angle**
(AST) Straight legs. No upcharge.
(SA) Straight front legs, angled back legs (available only for 6.5" and 8" high legs on straight, curved, corner and boomerang units). No upcharge.
- Leg finish**
(CHM) Chrome **(TBL)** Black
(TDW) Designer White **(TFO)** Fog
(TFR) Frost **(TIV)** Cloud
(TLA) Latte **(TMO)** Mocha
(TNE) Nevada **(TOA)** Toast
(TSH) Shadow **(TSN)** Sand
(TTU) Tungsten
- Additional weight**
(CW) Additional weight. Upcharges vary, see model.
- Bottom selection**
(SBS) Standard bottom.
(SP) Vinyl sealed bottom w/staple strip. Upcharges vary, see model.*
(BS) Steel bottom. Upcharges vary, see model.**
- Sealed seams**
(SLS) Sealed seams. Upcharges vary, see model.
- Moisture barrier**
(MB) Upcharges vary, see model.
- Power/USB unit position** (straight, curved, boomerang and Y benches only, as shown below). Add \$661 per unit.
(NP) No power (no upcharge)
(F1) Front left
(F2) Front right
(EB1) Back left
(EB2) Back right
- Power unit finish**
(J) Jet Black
(W) White
- Tamperproof fasteners**
(TP) Upcharges vary, see model.

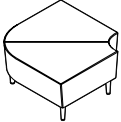
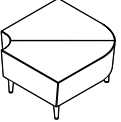
DESCRIPTION	FEATURES	MODEL#	STANDARD TEXTILE GRADES																									
			1	2	3	4	5	6	7	8	9	10	11	12														
 <p>Single Seater Bench COM Yardage: 1.75 Freight class: 1.75 Product weight: 48 Cubic feet per carton: 10.5</p>	<p>For power/USB unit, see electrical placement chart.</p> <p>Includes ganging hardware (2 sides).</p> <p>Add \$69 for (SLS) Add \$100 for (F6, F3, or F8) Add \$632 for 36 lbs. (CW) Add \$80 for (SP) or \$367 for (BS) Add \$40 for (TP) Add \$127 for (MB)</p>	R27831	1392	1448	1492	1557	1648	1686	1765	1889	1982	2084	2295	2518														
		<table border="1"> <thead> <tr> <th colspan="3">OVERALL DIMENSIONS</th> <th colspan="3">SEAT DIMENSIONS</th> <th colspan="2">BACK DIMENSIONS</th> </tr> <tr> <th>W</th><th>D</th><th>H</th> <th>W</th><th>D</th><th>H</th> <th>W</th><th>H</th> </tr> </thead> <tbody> <tr> <td>26</td><td>28.5</td><td>17.5</td> <td>-</td><td>-</td><td>-</td> <td>-</td><td>-</td> </tr> </tbody> </table>	OVERALL DIMENSIONS			SEAT DIMENSIONS			BACK DIMENSIONS		W	D	H	W	D	H	W	H	26	28.5	17.5	-	-	-	-	-	RTA 00	1 per carton
		OVERALL DIMENSIONS			SEAT DIMENSIONS			BACK DIMENSIONS																				
W	D	H	W	D	H	W	H																					
26	28.5	17.5	-	-	-	-	-																					
			1	2	3	4	5	6	7	8	9	10	11	12														
 <p>Two Seater Bench COM Yardage: 2.75 Freight class: 250 Product weight: 65 Cubic feet per carton: 20.5</p>	<p>For power/USB unit, see electrical placement chart.</p> <p>Includes ganging hardware (2 sides).</p> <p>Add \$84 for (SLS) Add \$100 for (F6, F3, or F8) Add \$1260 for 72 lbs. (CW) Add \$125 for (SP) or \$607 for (BS) Add \$40 for (TP) Add \$252 for (MB)</p>	R27832	2036	2124	2193	2295	2438	2498	2622	2817	2963	3123	3455	3805														
		<table border="1"> <thead> <tr> <th colspan="3">OVERALL DIMENSIONS</th> <th colspan="3">SEAT DIMENSIONS</th> <th colspan="2">BACK DIMENSIONS</th> </tr> <tr> <th>W</th><th>D</th><th>H</th> <th>W</th><th>D</th><th>H</th> <th>W</th><th>H</th> </tr> </thead> <tbody> <tr> <td>52</td><td>28.5</td><td>17.5</td> <td>-</td><td>-</td><td>-</td> <td>-</td><td>-</td> </tr> </tbody> </table>	OVERALL DIMENSIONS			SEAT DIMENSIONS			BACK DIMENSIONS		W	D	H	W	D	H	W	H	52	28.5	17.5	-	-	-	-	-	RTA 00	1 per carton
		OVERALL DIMENSIONS			SEAT DIMENSIONS			BACK DIMENSIONS																				
W	D	H	W	D	H	W	H																					
52	28.5	17.5	-	-	-	-	-																					
			1	2	3	4	5	6	7	8	9	10	11	12														
 <p>Three Seater Bench COM Yardage: 4.5 Freight class: 4.5 Product weight: 103 Cubic feet per carton: 30.25</p>	<p>For power/USB unit, see electrical placement chart.</p> <p>Includes ganging hardware (2 sides).</p> <p>Add \$123 for (SLS) Add \$100 for (F6, F3, or F8) Add \$1260 for 72 lbs. (CW) Add \$174 for (SP) or \$773 for (BS) Add \$40 for (TP) Add \$375 for (MB)</p>	R27833	3202	3346	3459	3625	3859	3958	4161	4480	4719	4980	5524	6096														
		<table border="1"> <thead> <tr> <th colspan="3">OVERALL DIMENSIONS</th> <th colspan="3">SEAT DIMENSIONS</th> <th colspan="2">BACK DIMENSIONS</th> </tr> <tr> <th>W</th><th>D</th><th>H</th> <th>W</th><th>D</th><th>H</th> <th>W</th><th>H</th> </tr> </thead> <tbody> <tr> <td>78</td><td>28.5</td><td>17.5</td> <td>-</td><td>-</td><td>-</td> <td>-</td><td>-</td> </tr> </tbody> </table>	OVERALL DIMENSIONS			SEAT DIMENSIONS			BACK DIMENSIONS		W	D	H	W	D	H	W	H	78	28.5	17.5	-	-	-	-	-	RTA 00	1 per carton
		OVERALL DIMENSIONS			SEAT DIMENSIONS			BACK DIMENSIONS																				
W	D	H	W	D	H	W	H																					
78	28.5	17.5	-	-	-	-	-																					
			1	2	3	4	5	6	7	8	9	10	11	12														
 <p>Inside Curve Two Seater Bench COM Yardage: 3 Freight class: 250 Product weight: 60 Cubic feet per carton: 22.75</p>	<p>For power/USB unit, see electrical placement chart.</p> <p>Includes ganging hardware (2 sides).</p> <p>Add \$75 for (SLS) Add \$100 for (F6, F3, or F8) Add \$1262 for 72 lbs. (CW) Add \$125 for (SP) or \$486 for (BS) Add \$49 for (TP) Add \$252 for (MB)</p>	R27834	2765	2861	2936	3047	3203	3269	3404	3617	3776	3950	4313	4694														
		<table border="1"> <thead> <tr> <th colspan="3">OVERALL DIMENSIONS</th> <th colspan="3">SEAT DIMENSIONS</th> <th colspan="2">BACK DIMENSIONS</th> </tr> <tr> <th>W</th><th>D</th><th>H</th> <th>W</th><th>D</th><th>H</th> <th>W</th><th>H</th> </tr> </thead> <tbody> <tr> <td>50</td><td>30.5</td><td>17.5</td> <td>-</td><td>-</td><td>-</td> <td>-</td><td>-</td> </tr> </tbody> </table>	OVERALL DIMENSIONS			SEAT DIMENSIONS			BACK DIMENSIONS		W	D	H	W	D	H	W	H	50	30.5	17.5	-	-	-	-	-	RTA 00	1 per carton
		OVERALL DIMENSIONS			SEAT DIMENSIONS			BACK DIMENSIONS																				
W	D	H	W	D	H	W	H																					
50	30.5	17.5	-	-	-	-	-																					
			1	2	3	4	5	6	7	8	9	10	11	12														
 <p>Outside Curve Two Seater Bench COM Yardage: 3 Freight class: 250 Product weight: 60 Cubic feet per carton: 22.75</p>	<p>For power/USB unit, see electrical placement chart.</p> <p>Includes ganging hardware (2 sides).</p> <p>Add \$75 for (SLS) Add \$100 for (F6, F3, or F8) Add \$1263 for 72 lbs. (CW) Add \$125 for (SP) or \$486 for (BS) Add \$49 for (TP) Add \$252 for (MB)</p>	R27835	2765	2861	2936	3047	3203	3269	3404	3617	3776	3950	4313	4694														
		<table border="1"> <thead> <tr> <th colspan="3">OVERALL DIMENSIONS</th> <th colspan="3">SEAT DIMENSIONS</th> <th colspan="2">BACK DIMENSIONS</th> </tr> <tr> <th>W</th><th>D</th><th>H</th> <th>W</th><th>D</th><th>H</th> <th>W</th><th>H</th> </tr> </thead> <tbody> <tr> <td>50</td><td>30.5</td><td>17.5</td> <td>-</td><td>-</td><td>-</td> <td>-</td><td>-</td> </tr> </tbody> </table>	OVERALL DIMENSIONS			SEAT DIMENSIONS			BACK DIMENSIONS		W	D	H	W	D	H	W	H	50	30.5	17.5	-	-	-	-	-	RTA 00	1 per carton
		OVERALL DIMENSIONS			SEAT DIMENSIONS			BACK DIMENSIONS																				
W	D	H	W	D	H	W	H																					
50	30.5	17.5	-	-	-	-	-																					
			1	2	3	4	5	6	7	8	9	10	11	12														

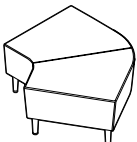
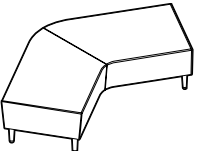
Options: **(SLS)** Sealed seams
(F6, F3, F8) Floor mount legs
(CW) Counterweight
(SP) Vinyl sealed bottom
(BS) Steel bottom
(TP) Tamperproof
(MB) Moisture barrier

DESCRIPTION	FEATURES	MODEL#	STANDARD TEXTILE GRADES												
			1	2	3	4	5	6	7	8	9	10	11	12	
 <p>90° Inside Curve Corner Bench COM Yardage: 3.25 Freight class: 250 Product weight: 60 Cubic feet per carton: 17.25</p>	<p>For power/USB unit, see electrical placement chart.</p> <p>Includes ganging hardware (2 sides).</p> <p>Add \$75 for (SLS) Add \$100 for (F6, F3, or F8) Add \$632 for 36 lbs. (CW) Add \$145 for (SP) or \$565 for (BS) Add \$49 for (TP) Add \$252 for (MB)</p>	R27836	2758	2862	2944	3064	3233	3304	3451	3681	3854	4042	4435	4848	
		OVERALL DIMENSIONS			SEAT DIMENSIONS			BACK DIMENSIONS							
		W	D	H	W	D	H	W	H						
		36.5	36.5	17.5	-	-	-	-	-						
			RTA 00	1 per carton											
 <p>90° Outside Curve Corner Bench COM Yardage: 3.25 Freight class: 250 Product weight: 60 Cubic feet per carton: 17.25</p>	<p>For power/USB unit, see electrical placement chart.</p> <p>Includes ganging hardware (2 sides).</p> <p>Add \$75 for (SLS) Add \$100 for (F6, F3, or F8) Add \$632 for 36 lbs. (CW) Add \$145 for (SP) or \$565 for (BS) Add \$49 for (TP) Add \$252 for (MB)</p>	R27837	2758	2862	2944	3064	3233	3304	3451	3681	3854	4042	4435	4848	
		OVERALL DIMENSIONS			SEAT DIMENSIONS			BACK DIMENSIONS							
		W	D	H	W	D	H	W	H						
		36.5	36.5	17.5	-	-	-	-	-						
			RTA 00	1 per carton											
 <p>120° Inside Curve Corner Bench COM Yardage: 3.5 Freight class: 250 Product weight: 57 Cubic feet per carton: 26.75</p>	<p>For power/USB unit, see electrical placement chart.</p> <p>Includes ganging hardware (2 sides).</p> <p>Add \$79 for (SLS) Add \$100 for (F6, F3, or F8) Add \$634 for 36 lbs. (CW) Add \$138 for (SP) or \$621 for (BS) Add \$49 for (TP) Add \$252 for (MB)</p>	R27838	2758	2870	2958	3087	3269	3346	3504	3752	3938	4141	4564	5009	
		OVERALL DIMENSIONS			SEAT DIMENSIONS			BACK DIMENSIONS							
		W	D	H	W	D	H	W	H						
		36.5	51.5	17.5	-	-	-	-	-						
			RTA 00	1 per carton											
 <p>120° Outside Curve Corner Bench COM Yardage: 3.5 Freight class: 250 Product weight: 57 Cubic feet per carton: 26.75</p>	<p>For power/USB unit, see electrical placement chart.</p> <p>Includes ganging hardware (2 sides).</p> <p>Add \$79 for (SLS) Add \$100 for (F6, F3, or F8) Add \$636 for 36 lbs. (CW) Add \$138 for (SP) or \$621 for (BS) Add \$49 for (TP) Add \$252 for (MB)</p>	R27839	2758	2870	2958	3087	3269	3346	3504	3752	3938	4141	4564	5009	
		OVERALL DIMENSIONS			SEAT DIMENSIONS			BACK DIMENSIONS							
		W	D	H	W	D	H	W	H						
		36.5	51.5	17.5	-	-	-	-	-						
			RTA 00	1 per carton											
 <p>Inside Curve Boomerang Bench COM Yardage: 5.25 Freight class: 250 Product weight: 126 Cubic feet per carton: 47.75</p>	<p>For power/USB unit, see electrical placement chart.</p> <p>Includes ganging hardware (2 sides).</p> <p>Add \$117 for (SLS) Add \$100 for (F6, F3, or F8) Add \$1260 for 72 lbs. (CW) Add \$202 for (SP) or \$1092 for (BS) Add \$49 for (TP) Add \$375 for (MB)</p>	R27840	4266	4434	4566	4760	5033	5148	5385	5757	6036	6340	6975	7642	
		OVERALL DIMENSIONS			SEAT DIMENSIONS			BACK DIMENSIONS							
		W	D	H	W	D	H	W	H						
		82	45	17.5	-	-	-	-	-						
			RTA 00	1 per carton											

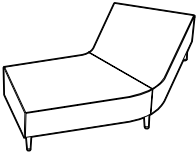
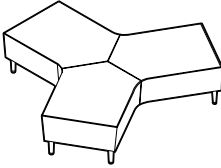
Options: **(SLS)** Sealed seams
(F6, F3, F8) Floor mount legs
(CW) Counterweight
(SP) Vinyl sealed bottom
(BS) Steel bottom
(TP) Tamperproof
(MB) Moisture barrier

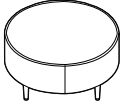
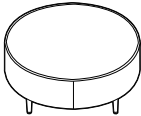
DESCRIPTION	FEATURES	MODEL#	STANDARD TEXTILE GRADES													
			1	2	3	4	5	6	7	8	9	10	11	12		
 <p>Outside Curve Boomerang Bench COM Yardage: 5.25 Freight class: 250 Product weight: 126 Cubic feet per carton: 47.75</p>	<p>For power/USB unit, see electrical placement chart.</p> <p>Includes ganging hardware (2 sides).</p> <p>Add \$117 for (SLS) Add \$100 for (F6, F3, or F8) Add \$1260 for 72 lbs. (CW) Add \$202 for (SP) or \$1092 for (BS) Add \$49 for (TP) Add \$375 for (MB)</p>	R27841	4266	4434	4566	4760	5033	5148	5385	5757	6036	6340	6975	7642		
			OVERALL DIMENSIONS			SEAT DIMENSIONS			BACK DIMENSIONS							
			W	D	H	W	D	H	W	H						
			82	45	17.5	-	-	-	-	-						
			RTA 00 1 per carton													
 <p>Y Bench COM Yardage: 8 Freight class: 250 Product weight: 203 Cubic feet per carton: 101.2</p>	<p>For power/USB unit, see electrical placement chart.</p> <p>Includes ganging hardware (2 sides).</p> <p>Add \$195 for (SLS) Add \$100 for (F6, F3, or F8) Add \$945 for 54 lbs. (CW) Add \$303 for (SP) or \$1354 for (BS) Add \$69 for (TP) Add \$501 for (MB)</p>	R27842	6870	7126	7326	7622	8038	8214	8574	9142	9566	10030	10998	12014		
			OVERALL DIMENSIONS			SEAT DIMENSIONS			BACK DIMENSIONS							
			W	D	H	W	D	H	W	H						
			82	70	17.5	-	-	-	-	-						
			RTA 00 1 per carton													
 <p>18" Dia. Round Bench COM Yardage: 1 Freight class: 150 Product weight: 25 Cubic feet per carton: 4.7</p>	<p>No power/USB unit.</p> <p>Freestanding unit only.</p> <p>Add \$46 for (SLS) Add \$100 for (F6, F3, or F8) Not available (CW) Add \$117 for (SP), (BS) not available Add \$40 for (TP) Add \$127 for (MB)</p>	R27843	853	885	910	947	999	1021	1066	1137	1190	1248	1369	1496		
			OVERALL DIMENSIONS			SEAT DIMENSIONS			BACK DIMENSIONS							
			W	D	H	W	D	H	W	H						
			18	18	17.5	-	-	-	-	-						
			RTA 00 1 per carton													
 <p>36" Dia. Round Bench COM Yardage: 3.25 Freight class: 250 Product weight: 50 Cubic feet per carton: 18.25</p>	<p>No power/USB unit.</p> <p>Freestanding unit only.</p> <p>Add \$69 for (SLS) Add \$100 for (F6, F3, or F8) Add \$632 for 36 lbs. (CW) Add \$182 for (SP) or \$621 for (BS) Add \$40 for (TP) Add \$127 for (MB)</p>	R27844	2043	2147	2229	2349	2518	2589	2736	2966	3139	3327	3720	4133		
			OVERALL DIMENSIONS			SEAT DIMENSIONS			BACK DIMENSIONS							
			W	D	H	W	D	H	W	H						
			36	36	17.5	-	-	-	-	-						
			RTA 00 1 per carton													
 <p>42" Dia. Round Bench COM Yardage: 3.5 Freight class: 250 Product weight: 55 Cubic feet per carton: 23</p>	<p>No power/USB unit.</p> <p>Freestanding unit only.</p> <p>Add \$75 for (SLS) Add \$100 for (F6, F3, or F8) Add \$1260 for 72 lbs. (CW) Add \$202 for (SP) or \$686 for (BS) Add \$40 for (TP) Add \$252 for (MB)</p>	R27845	2351	2463	2551	2680	2862	2939	3097	3345	3531	3734	4157	4602		
			OVERALL DIMENSIONS			SEAT DIMENSIONS			BACK DIMENSIONS							
			W	D	H	W	D	H	W	H						
			42	42	17.5	-	-	-	-	-						
			RTA 00 1 per carton													

Options: (SLS) Sealed seams (F6, F3, F8) Floor mount legs (CW) Counterweight (SP) Vinyl sealed bottom (BS) Steel bottom (TP) Tamperproof (MB) Moisture barrier

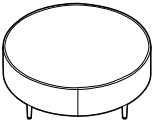
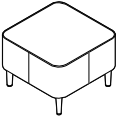
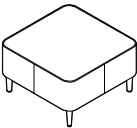
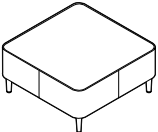
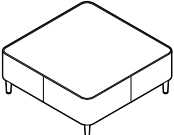
DESCRIPTION	FEATURES	MODEL#	STANDARD TEXTILE GRADES											
			1	2	3	4	5	6	7	8	9	10	11	12
 <p>48" Dia. Round Bench COM Yardage: 3.75 Freight class: 250 Product weight: 65 Cubic feet per carton: 30</p>	<p>No power/USB unit.</p> <p>Freestanding unit only.</p> <p>Add \$84 for (SLS) Add \$100 for (F6, F3, or F8) Add \$1260 for 72 lbs. (CW) Add \$224 for (SP) or \$729 for (BS) Add \$40 for (TP) Add \$375 for (MB)</p>	<p>R27846</p>	2651	2771	2865	3004	3199	3281	3450	3716	3915	4133	4586	5063
			<p>OVERALL DIMENSIONS</p> <p>W D H</p>			<p>SEAT DIMENSIONS</p> <p>W D H</p>			<p>BACK DIMENSIONS</p> <p>W H</p>					
			48	48	17.5	-	-	-	-	-	-	-	-	-
			<p>RTA 00 1 per carton</p>											
 <p>24" Square Bench COM Yardage: 1.5 Freight class: 250 Product weight: 30 Cubic feet per carton: 8</p>	<p>No power/USB unit.</p> <p>Freestanding unit only.</p> <p>Add \$60 for (SLS) Add \$100 for (F6, F3, or F8) Add \$632 for 36 lbs. (CW) Add \$125 for (SP) or \$281 for (BS) Add \$40 for (TP) Add \$127 for (MB)</p>	<p>R27847</p>	1165	1213	1251	1306	1384	1417	1485	1591	1671	1758	1939	2130
			<p>OVERALL DIMENSIONS</p> <p>W D H</p>			<p>SEAT DIMENSIONS</p> <p>W D H</p>			<p>BACK DIMENSIONS</p> <p>W H</p>					
			24	24	17.5	-	-	-	-	-	-	-	-	-
			<p>RTA 00 1 per carton</p>											
 <p>30" Square Bench COM Yardage: 2.75 Freight class: 250 Product weight: 40 Cubic feet per carton: 12.25</p>	<p>No power/USB unit.</p> <p>Freestanding unit only.</p> <p>Add \$69 for (SLS) Add \$100 for (F6, F3, or F8) Add \$632 for 36 lbs. (CW) Add \$174 for (SP) or \$196 for (BS) Add \$40 for (TP) Add \$127 for (MB)</p>	<p>R27848</p>	1538	1626	1695	1797	1940	2000	2124	2319	2465	2625	2957	3307
			<p>OVERALL DIMENSIONS</p> <p>W D H</p>			<p>SEAT DIMENSIONS</p> <p>W D H</p>			<p>BACK DIMENSIONS</p> <p>W H</p>					
			30	30	17.5	-	-	-	-	-	-	-	-	-
			<p>RTA 00 1 per carton</p>											
 <p>36" Square Bench COM Yardage: 3 Freight class: 250 Product weight: 50 Cubic feet per carton: 18.25</p>	<p>No power/USB unit.</p> <p>Freestanding unit only.</p> <p>Add \$75 for (SLS) Add \$100 for (F6, F3, or F8) Add \$1260 for 72 lbs. (CW) Add \$187 for (SP) or \$457 for (BS) Add \$40 for (TP) Add \$252 for (MB)</p>	<p>R27849</p>	1917	2013	2088	2199	2355	2421	2556	2769	2928	3102	3465	3846
			<p>OVERALL DIMENSIONS</p> <p>W D H</p>			<p>SEAT DIMENSIONS</p> <p>W D H</p>			<p>BACK DIMENSIONS</p> <p>W H</p>					
			36	36	17.5	-	-	-	-	-	-	-	-	-
			<p>RTA 00 1 per carton</p>											
 <p>42" Square Bench COM Yardage: 3.25 Freight class: 250 Product weight: 60 Cubic feet per carton: 23</p>	<p>No power/USB unit.</p> <p>Freestanding unit only.</p> <p>Add \$86 for (SLS) Add \$100 for (F6, F3, or F8) Add \$1260 for 72 lbs. (CW) Add \$208 for (SP) or \$637 for (BS) Add \$40 for (TP) Add \$375 for (MB)</p>	<p>R27850</p>	2329	2433	2515	2635	2804	2875	3022	3252	3425	3613	4006	4419
			<p>OVERALL DIMENSIONS</p> <p>W D H</p>			<p>SEAT DIMENSIONS</p> <p>W D H</p>			<p>BACK DIMENSIONS</p> <p>W H</p>					
			42	42	17.5	-	-	-	-	-	-	-	-	-
			<p>RTA 00 1 per carton</p>											

Options: **(SLS)** Sealed seams
(F6, F3, F8) Floor mount legs
(CW) Counterweight
(SP) Vinyl sealed bottom
(BS) Steel bottom
(TP) Tamperproof
(MB) Moisture barrier

RIVER+ TABLES

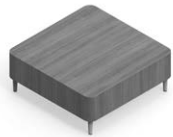

42" Square Coffee Table
model R27858



Outside Curve End Table
model R27864



18" Dia. Round Laptop Table
model 7743

River+ Seating and Benches



For River+ seating, please see page 369
For River+ benches, please see page 388

STANDARD FEATURES

- A modular series that is composed of straight and curved sections, as well as freestanding units.
- Linking units can be used together in any combination with River+ seating and bench units to create a wide variety of layouts. Ganging hardware is standard and is factory installed. Ganging hardware swivels out of the way when not in use.
- Front and back faces of end (linking) tables angles slightly inwards. This inward slant matches the inward angles of River seating so all units coordinate in visual appearance.
- The standard 6.5", welded steel legs are straight (vertical) as standard. Linking models are optionally available with an angled back leg to visually align with River+ seating units.
- Legs include Black nylon, non-marking, height adjustable glides.
- Tables are made with high pressure laminate. Custom high pressure laminate finishes will be considered upon request.
- Laptop tables have 1" thick laminate tops.
- Laptop table painted metal base finishes are available in Black and Tungsten only.

OPTIONAL FEATURES

- Legs of coffee and end (linking) tables are available in 3" (**S3**) and 8" (**S8**) heights. All leg heights are available with fixed-to-floor (**F3**) and (**F8**) options. Add \$100.
- To match adjacent lounge seating, straight front and angled back 6.5" or 8" legs are available on linking/end tables. Specify (**SA**). No upcharge.
- Power units are available on all tables except laptop tables. Each unit includes one AC outlet and two USB-a, 10 watt charging ports. Add \$661 upcharge per unit.
- Power location options include top, front or end. See electrical placement diagrams. Electrical units must be factory installed.
- Power units are available in either Jet Black (**J**) or White (**W**) with 120", three-prong matching cords.
- Most products can be weighted to reduce the ease of movement. For additional weight options, specify (**CW**). See each model for available additional weight and upcharge.

Please add option codes in the following order:

- **Model number**
R27855 to R27858 Square coffee tables
R27859 Rectangular coffee table
R27860 to R27861 Round coffee tables
R27862 to R27864 Linking/end tables
7443 and 7745 Freestanding tables
- **Laminate finishes**
(ACJ) Absolute Acajou **(ASN)** Asian Night
(AWC) Avant Cherry **(AWH)** Avant Honey
(BLK) Black **(BRC)** Brushed Cobalt
(BZD) Blizzard **(CGY)** Custom Grey
(CMB) Clear Maple **(DES)** Dark Espresso
(DWT) Designer White **(FAS)** Fashionista
(FCL) First Class
(NBL) Noce Biondo **(NGL)** Noce Grigio
(NEL) Noce Leggero **(NML)** Noce Medio
(QTM) Quartered Mahogany
(SBY) Sheer Beauty **(SDT)** Stonedust
(SOG) Storm Grey **(WCR)** Winter Cherry
(WHC) White Chocolate **(WHE)** Walnut Heights
(colors shown on website)
- **Leg selection**
(S6) Standard height (6.5") w/adjustable glides. No upcharge.
(S3) Low (3") w/adjustable glides. No upcharge.
(S8) High (8") w/adjustable glides. No upcharge.
(F6) Standard height (6.5"), fixed to floor. Add \$100.
(F3) Low (3"), fixed to floor. Add \$100.
(F8) High (8"), fixed to floor. Add \$100.
- **Leg angle** (linking/end tables only)
(AST) Straight legs. No upcharge.
(SA) Straight front legs, angled back legs. No upcharge.
- **Leg finish**
(CHM) Chrome **(TBL)** Black
(TDW) Designer White **(TFO)** Fog
(TFR) Frost **(TIV)** Cloud
(TLA) Latte **(TMO)** Mocha
(TNE) Nevada **(TOA)** Toast
(TSH) Shadow **(TSN)** Sand
(TTU) Tungsten
- **Additional weight**
(CW) Additional weight. Upcharges vary, see model.
- **Power/USB unit position** (coffee and linking/end tables only, as shown below).
Add \$661 per unit.
(NP) No power (no upcharge)
(LE1) Left end (coffee table only)
(LE2) Right end (coffee table only)
(F3) Front center (coffee table only)
(T1) Top
- **Power unit finish**
(J) Jet Black
(W) White
- **(TP) Tamperproof fasteners.** Add \$160.

EXAMPLE RIVER+ TABLE ORDER CODE:

R27858	-ACJ	-S6	-AS	-CM	-	-T1	-W	-
Model number	Laminate	Leg selection	Leg angle	Leg finish	Additional weight	Power/USB	Power finish	Fasteners

ELECTRICAL PLACEMENT

Coffee Tables

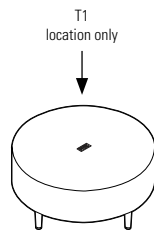
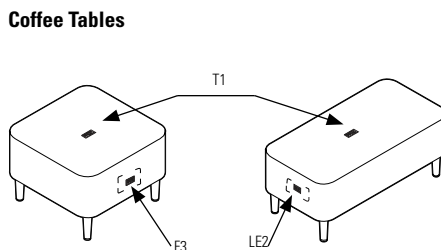

Linking Tables

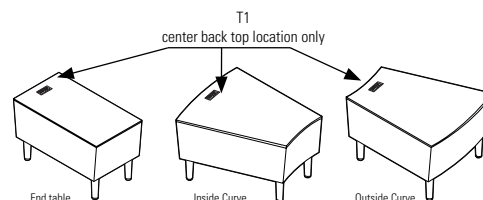

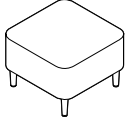
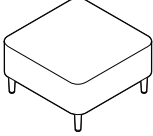
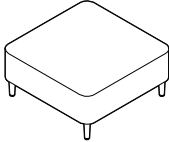
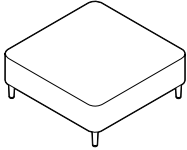
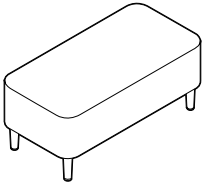
DESCRIPTION	FEATURES	MODEL#	STANDARD TEXTILE GRADES						
 <p>24" Square Coffee Table COM: N/A Freight class: 250 Product weight: 40 Cubic feet per carton: 10.7</p>	<p>For power/USB unit, see electrical placement chart.</p> <p>Freestanding unit only. Add \$511 for 36 lbs. (CW)</p>	List price							
		R27855	1484						
		OVERALL DIMENSIONS			SEAT DIMENSIONS			BACK DIMENSIONS	
		W	D	H	W	D	H	W	H
	24	24	17	-	-	-	-	-	
	RTA 00		1 per carton						
 <p>30" Square Coffee Table COM: N/A Freight class: 250 Product weight: 53 Cubic feet per carton: 15.3</p>	<p>For power/USB unit, see electrical placement chart.</p> <p>Freestanding unit only. Add \$383 for 27 lbs. (CW)</p>	List price							
		R27856	1563						
		OVERALL DIMENSIONS			SEAT DIMENSIONS			BACK DIMENSIONS	
		W	D	H	W	D	H	W	H
	30	30	17	-	-	-	-	-	
	RTA 00		1 per carton						
 <p>36" Square Coffee Table COM: N/A Freight class: 250 Product weight: 75 Cubic feet per carton: 20.6</p>	<p>For power/USB unit, see electrical placement chart.</p> <p>Freestanding unit only. No counterweight.</p>	List price							
		R27857	1791						
		OVERALL DIMENSIONS			SEAT DIMENSIONS			BACK DIMENSIONS	
		W	D	H	W	D	H	W	H
	36	36	17	-	-	-	-	-	
	RTA 00		1 per carton						
 <p>42" Square Coffee Table COM: N/A Freight class: 150 Product weight: 115 Cubic feet per carton: 26.7</p>	<p>For power/USB unit, see electrical placement chart.</p> <p>Freestanding unit only. No counterweight.</p>	List price							
		R27858	1991						
		OVERALL DIMENSIONS			SEAT DIMENSIONS			BACK DIMENSIONS	
		W	D	H	W	D	H	W	H
	42	42	17	-	-	-	-	-	
	RTA 00		1 per carton						
 <p>Rectangular Coffee Table COM: N/A Freight class: 250 Product weight: 55 Cubic feet per carton: 14.2</p>	<p>For power/USB unit, see electrical placement chart.</p> <p>Freestanding unit only. Add 256 for 18 lbs. (CW)</p>	List price							
		R27859	1626						
		OVERALL DIMENSIONS			SEAT DIMENSIONS			BACK DIMENSIONS	
		W	D	H	W	D	H	W	H
	40	20	17	-	-	-	-	-	
	RTA 00		1 per carton						

Options: **(CW)** Counterweight

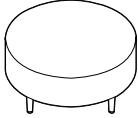
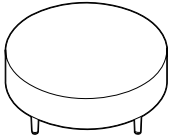
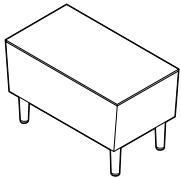
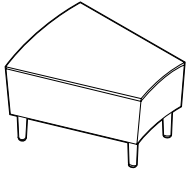
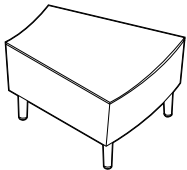
DESCRIPTION	FEATURES	MODEL#	STANDARD TEXTILE GRADES							
 <p>36" Dia. Round Coffee Table COM: N/A Freight class: 150 Product weight: 63 Cubic feet per carton: 15.3</p>	<p>For power/USB unit, see electrical placement chart.</p> <p>Freestanding unit only. Add \$256 for 18 lbs. (CW)</p>	<p>R27860</p>	List price							
			1927							
			OVERALL DIMENSIONS			SEAT DIMENSIONS			BACK DIMENSIONS	
			W	D	H	W	D	H	W	H
36	36	17	-	-	-	-	-			
		RTA 00	1 per carton							
 <p>42" Dia. Round Coffee Table COM: N/A Freight class: 150 Product weight: 85 Cubic feet per carton: 20.6</p>	<p>For power/USB unit, see electrical placement chart.</p> <p>Freestanding unit only. No counterweight.</p>	<p>R27861</p>	List price							
			2113							
			OVERALL DIMENSIONS			SEAT DIMENSIONS			BACK DIMENSIONS	
			W	D	H	W	D	H	W	H
42	42	17	-	-	-	-	-			
		RTA 00	1 per carton							
 <p>Rectangular End Table COM: N/A Freight class: 300 Product weight: 40 Cubic feet per carton: 20.6</p>	<p>For power/USB unit, see electrical placement chart.</p> <p>Includes ganging hardware (2 sides). Add \$511 for 36 lbs. (CW)</p>	<p>R27862</p>	List price							
			1578							
			OVERALL DIMENSIONS			SEAT DIMENSIONS			BACK DIMENSIONS	
			W	D	H	W	D	H	W	H
28	15	17	-	-	-	-	-			
		RTA 00	1 per carton							
 <p>Inside Curve End Table COM: N/A Freight class: 250 Product weight: 47 Cubic feet per carton: 13.3</p>	<p>For power/USB unit, see electrical placement chart.</p> <p>Includes ganging hardware (2 sides). Add \$511 for 36 lbs. (CW)</p>	<p>R27863</p>	List price							
			2073							
			OVERALL DIMENSIONS			SEAT DIMENSIONS			BACK DIMENSIONS	
			W	D	H	W	D	H	W	H
28	17	17	-	-	-	-	-			
		RTA 00	1 per carton							
 <p>Outside Curve End Table COM: N/A Freight class: 250 Product weight: 47 Cubic feet per carton: 13.3</p>	<p>For power/USB unit, see electrical placement chart.</p> <p>Includes ganging hardware (2 sides). Add \$511 for 36 lbs. (CW)</p>	<p>R27864</p>	List price							
			2073							
			OVERALL DIMENSIONS			SEAT DIMENSIONS			BACK DIMENSIONS	
			W	D	H	W	D	H	W	H
28	17	17	-	-	-	-	-			
		RTA 00	1 per carton							

Options: **(CW)** Counterweight

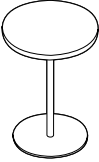
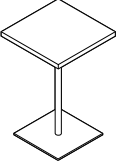
DESCRIPTION	FEATURES	MODEL#	STANDARD TEXTILE GRADES						
 <p>18" Dia. Round Laptop Table COM: N/A Freight class: 150 Product weight: 32 Cubic feet per carton: 6</p>	No power/USB unit.	List price							
		7743	792						
		OVERALL DIMENSIONS			SEAT DIMENSIONS			BACK DIMENSIONS	
		W	D	H	W	D	H	W	H
		18	18	25.25	-	-	-	-	-
	RTA 00	1 per carton							
 <p>16" Square Laptop Table COM: N/A Freight class: 125 Product weight: 36 Cubic feet per carton: 6</p>	No power/USB unit.	List price							
		7745	810						
		OVERALL DIMENSIONS			SEAT DIMENSIONS			BACK DIMENSIONS	
		W	D	H	W	D	H	W	H
		16	16	25.25	-	-	-	-	-
	RTA 00	1 per carton							

SIRENA™



models 3371 Lounge Chairs, 3373 Two Seat Sofa, 3400 Coffee Table, and 3402 End Table



model 3371



model 3372CTRL

STANDARD FEATURES

- Modern club style seating includes: lounge chair, two and three seat sofas.
- Complete with Modern tables for reception areas, meeting rooms, and private office use.
- Lounge seating distinctive round style feet are finished in Black Only.
- All models have fixed, non-removable seat cushions with arm height at 25" in the front.
- Casters are available on lounge chairs only. **C1M** casters are standard.
- Please note leather models offer additional stitch details.
- Check textile availability prior to specifying upholstery material.
- When ordering models with tablet, specify for left hand or for right hand tablet. See models below.
- Laminate Tops, are 1.5" thick.
- Table legs are 1.5" steel tubing, tapered toward the bottom to 7/8", equipped with self-leveling, pivoting steel glides.



OPTIONAL FEATURES

- Laminate tables, tablets and bookshelves are offered in the following laminate finishes: Absolute Acajou (**ACJ**), Asian Night (**ASN**), Avant Cherry (**AWC**), Avant Honey (**AWH**), Blizzard (**BZD**), Clear Maple (**CMB**), Custom Grey (**CGY**), Dark Espresso (**DES**), Designer White (**DWT**), Fashionista (**FAS**), First Class (**FCL**), Noce Biondo (**NBL**), Noce Grigio (**NGL**), Noce Leggero (**NEL**), Noce Medio (**NML**), Quartered Mahogany (**QTM**), Sheer Beauty (**SBY**), Stonedust (**SDT**), Walnut Heights (**WHE**), White Chocolate (**WHC**) and Winter Cherry (**WCR**). Please Specify.
- Table legs are available in Tungsten (**TTU**), Shadow (**TSH**), Black (**TBL**) at no upcharge. Not available in Chrome.

STITCH DETAIL WHEN UPHOLSTERED IN ALL LEATHER - ILLUSTRATIONS BELOW

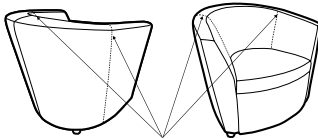



Extra Stitch Lines

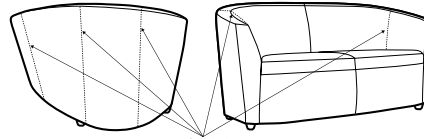





Lounge Chair







Extra Stitch Lines

Two and Three Seater Sofas

DESCRIPTION	FEATURES	MODEL#	STANDARD TEXTILE GRADES											
			1	2	3	4	5	6	7	8	9	10	11	12
 <p>Lounge Chair Fabric COM Yardage: 4.25 Freight Class: 250 Product Weight (lbs.): 52 Cubic Feet Per Carton: 19.25</p>		3371	-	1730	1853	2027	2280	2373	2593	3007	3212	3596	4130	4789
			OVERALL DIMENSIONS			SEAT DIMENSIONS			BACK DIMENSIONS					
			W	D	H	W	D	H	W	H				
			30.5	29.5	28.5	20	20	17.5	19	11.5				
			RTA 00											
 <p>Lounge Chair w/Casters COM Yardage: 4.25 Freight Class: 250 Product Weight (lbs.): 52 Cubic Feet Per Carton: 19.25</p>		3371C	-	1861	1990	2175	2441	2539	2770	3203	3420	3822	4379	5071
			OVERALL DIMENSIONS			SEAT DIMENSIONS			BACK DIMENSIONS					
			W	D	H	W	D	H	W	H				
			30.5	29.5	29.5	20	20	17.5	19	11.5				
			RTA 00											

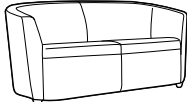
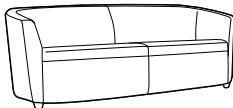
DESCRIPTION	FEATURES	MODEL#	STANDARD TEXTILE GRADES											
			1	2	3	4	5	6	7	8	9	10	11	12
 3371LTL	 3371RTL	3371LTL 3371RTL	-	2497	2623	2811	3074	3172	3403	3838	4055	4454	5015	5707
			OVERALL DIMENSIONS W D H			SEAT DIMENSIONS W D H			BACK DIMENSIONS W H					
			32.5	29.5	28.5	20	20	17.5	19	11.5				
			RTA 00											
 3371CLTL	 3371CRTL	3371CLTL 3371CRTL	-	2640	2768	2954	3217	3315	3549	3979	4198	4597	5158	5850
			OVERALL DIMENSIONS W D H			SEAT DIMENSIONS W D H			BACK DIMENSIONS W H					
			32	29.5	29.5	20	20	17.5	19	11.5				
			RTA 00											
		3372	-	2304	2427	2601	2854	2947	3167	3581	3786	4170	4704	5363
	OVERALL DIMENSIONS W D H			SEAT DIMENSIONS W D H			BACK DIMENSIONS W H							
			30.5	29.5	28.5	20	20	17.5	19	11.5				
			RTA 00											
		3372C	-	2526	2649	2823	3076	3169	3389	3803	4008	4392	4926	5585
	OVERALL DIMENSIONS W D H			SEAT DIMENSIONS W D H			BACK DIMENSIONS W H							
			30.5	29.5	28.5	20	20	17.5	19	11.5				
			RTA 00											
 3372LTL	 3372RTL	3372LTL 3372RTL	-	3004	3127	3301	3554	3647	3867	4281	4486	4870	5404	6063
			OVERALL DIMENSIONS W D H			SEAT DIMENSIONS W D H			BACK DIMENSIONS W H					
			32.5	29.5	28.5	20	20	17.5	19	11.5				
			RTA 00											

DESCRIPTION	FEATURES	MODEL#	STANDARD TEXTILE GRADES											
			1	2	3	4	5	6	7	8	9	10	11	12
 3372CLTL	 3372CRTL	3372CLTL 3372CRTL	-	3152	3275	3449	3702	3795	4015	4429	4634	5019	5552	6211
			OVERALL DIMENSIONS W D H			SEAT DIMENSIONS W D H			BACK DIMENSIONS W H					
Lounge Chair w/ Casters & Laminate Table/Book Shelf COM Yardage: 4.25 Freight Class: 250 Product Weight (lbs.): 66 Cubic Feet Per Carton: 19.25			RTA 00											
		3373	-	3247	3446	3738	4151	4306	4669	5346	5688	6321	7197	8280
			OVERALL DIMENSIONS W D H			SEAT DIMENSIONS W D H			BACK DIMENSIONS W H					
Two Seat Sofa COM Yardage: 7 Freight Class: 300 Product Weight (lbs.): 92 Cubic Feet Per Carton: 48			RTA 00											
		3374	-	3904	4122	4444	4902	5077	5475	6228	6606	7304	8275	9474
			OVERALL DIMENSIONS W D H			SEAT DIMENSIONS W D H			BACK DIMENSIONS W H					
Three Seat Sofa COM Yardage: 7.75 Freight Class: 300 Product Weight (lbs.): 107 Cubic Feet Per Carton: 55.5			RTA 00											
		3400	1856	-	-	-	-	-	-	-	-	-	-	-
			OVERALL DIMENSIONS W D H			SEAT DIMENSIONS W D H			BACK DIMENSIONS W H					
Coffee Table - 48" Laminate Top COM Yardage: N/A Freight Class: 250 Product Weight (lbs.): 52 Cubic Feet Per Carton: 17.25			RTA 00											
		3401	2052	-	-	-	-	-	-	-	-	-	-	-
			OVERALL DIMENSIONS W D H			SEAT DIMENSIONS W D H			BACK DIMENSIONS W H					
Coffee Table - 56" Laminate Top COM Yardage: N/A Freight Class: 175 Product Weight (lbs.): 60 Cubic Feet Per Carton: 19			RTA 00											

DESCRIPTION	FEATURES	MODEL#	STANDARD TEXTILE GRADES												
			1	2	3	4	5	6	7	8	9	10	11	12	
		3402	1489	-	-	-	-	-	-	-	-	-	-	-	-



End Table - Laminate Top
 COM Yardage: N/A
 Freight Class: 250
 Product Weight (lbs.): 26
 Cubic Feet Per Carton: 7.75

OVERALL DIMENSIONS			SEAT DIMENSIONS			BACK DIMENSIONS	
W	D	H	W	D	H	W	H
17	22	14.5	-	-	-	-	-

RTA 00



VENTURE



48\"/>



78\"/>



60\"/>

EXAMPLE VENTURE ORDER CODE:

8506-48	EL58	TBL
Model #	Textile	Leg Finish

STANDARD FEATURES

- Venture is a solid and durable banquette seating series.
 - Banquettes are available with or without fully upholstered backs. Open back banquettes are intended to be placed against walls or in other layouts where the back will not be visible.
 - Heavy duty frame has plywood construction suitable for public environments. For 24/7 use environments, must use approved textiles with 100,000 double-rubs and above.
 - Cushions are made with highly resilient foam and seats are equipped with a synthetic rubberized webbing suspension system for extra comfort.
 - Cushions are fixed and non-removable.
 - Ganging bracket kit (8509) gangs single back models 'back to back' or side-by-side and double back models side-to-side..Standard in Black. Contains two brackets
 - Legs are metal painted and Chrome with Black glides, suitable for carpet and hard surface flooring.Closed back models are fully upholstered for use in open settings and to support reconfiguration.
 - Open back models have a black outer back protective dust cover, to be used against walls or for ganging back-to-back.
 - Partial assembly (KD) packaging is optional on Double Back models to allow the unit to fit through standard doors. Assembly instructions are included.
 - Check textile availability prior to specifying upholstery material.
- Note:** Double-sided models (8508-48 to 8508-78) measure 55" deep, 48" high and weigh over 100 lbs. They may require coordination for special handling and accommodation through doorway and elevators.

OPTIONAL FEATURES:

Add option codes in the following order

- **Model Number**
- **Back and seat textile**
Specify textile code.
- **Leg Finish.** No upcharge
(CHM) Chrome
(TBL) Black
(TLA) Latte
(TTU) Tungsten
- **Package options.** No upcharge
Available on Double Back models.
(ST) Standard Fully assembled
(KD) Knocked Down

DESCRIPTION	FEATURES	MODEL #	STANDARD TEXTILE GRADES											
			1	2	3	4	5	6	7	8	9	10	11	12
<p>48\"/> COM Yardage: 6.75 Freight Class: 300 Product weight (lbs): 104 Cubic Feet Per Carton: 50.75</p>		8506-48	3002	3237	3419	3688	4068	4228	4557	5074	5461	5883	6765	7691
			OVERALL DIMENSIONS			SEAT DIMENSIONS			BACK DIMENSIONS					
			W	D	H	W	D	H	W	H				
			48	28	48	48	19	18	48	30				
			RTA 00		1 per carton									
<p>60\"/> COM Yardage: 8 Freight Class: 250 Product weight (lbs): 127 Cubic Feet Per Carton: 62.75</p>		8506-60	3579	3856	4072	4392	4841	5031	5420	6033	6491	6992	8038	9135
			OVERALL DIMENSIONS			SEAT DIMENSIONS			BACK DIMENSIONS					
			W	D	H	W	D	H	W	H				
			60	28	48	60	19	18	60	30				
			RTA 00		1 per carton									
<p>72\"/> COM Yardage: 9 Freight Class: 250 Product weight (lbs): 153 Cubic Feet Per Carton: 75</p>		8506-72	3813	4125	4368	4727	5233	5446	5884	6574	7089	7653	8829	10063
			OVERALL DIMENSIONS			SEAT DIMENSIONS			BACK DIMENSIONS					
			W	D	H	W	D	H	W	H				
			72	28	48	72	19	18	72	30				
			RTA 00		1 per carton									

DESCRIPTION	FEATURES	MODEL#	STANDARD TEXTILE GRADES											
			1	2	3	4	5	6	7	8	9	10	11	12
<p>78\"W Three Seater Banquette, Closed Back COM Yardage: 10 Freight Class: 250 Product weight (lbs): 163 Cubic Feet Per Carton: 79.75</p>		8506-78	4182	4528	4798	5198	5759	5997	6483	7250	7822	8448	9755	11127
			OVERALL DIMENSIONS			SEAT DIMENSIONS			BACK DIMENSIONS					
			W	D	H	W	D	H	W	H				
			78	28	48	78	19	18	78	30				
								RTA 00		1 per carton				
<p>48\"W Two Seater Banquette, Open Back COM Yardage: 5 Freight Class: 250 Product weight (lbs): 105 Cubic Feet Per Carton: 50.75</p>		8507-48	2825	2998	3133	3333	3614	3733	3976	4359	4645	4958	5612	6298
			OVERALL DIMENSIONS			SEAT DIMENSIONS			BACK DIMENSIONS					
			W	D	H	W	D	H	W	H				
			48	28	48	48	19	18	48	30				
								RTA 00		1 per carton				
<p>60\"W Two Seater Banquette, Open Back COM Yardage: 6 Freight Class: 250 Product weight (lbs): 127 Cubic Feet Per Carton: 62.75</p>		8507-60	3217	3425	3588	3827	4164	4306	4599	5058	5402	5778	6561	7385
			OVERALL DIMENSIONS			SEAT DIMENSIONS			BACK DIMENSIONS					
			W	D	H	W	D	H	W	H				
			60	28	48	60	19	18	60	30				
								RTA 00		1 per carton				
<p>72\"W Three Seater Banquette, Open Back COM Yardage: 7 Freight Class: 250 Product weight (lbs): 153 Cubic Feet Per Carton: 75</p>		8507-72	3606	3848	4037	4317	4710	4877	5217	5754	6154	6593	7507	8468
			OVERALL DIMENSIONS			SEAT DIMENSIONS			BACK DIMENSIONS					
			W	D	H	W	D	H	W	H				
			72	28	48	72	19	18	72	30				
								RTA 00		1 per carton				
<p>78\"W Three Seater Banquette, Open Back COM Yardage: 8 Freight Class: 250 Product weight (lbs): 163 Cubic Feet Per Carton: 79.75</p>		8507-78	3961	4238	4455	4774	5223	5413	5803	6415	6874	7375	8420	9518
			OVERALL DIMENSIONS			SEAT DIMENSIONS			BACK DIMENSIONS					
			W	D	H	W	D	H	W	H				
			78	28	48	78	19	18	78	30				
								RTA 00		1 per carton				

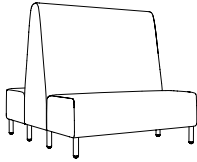
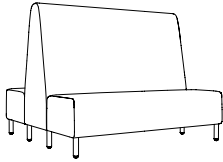
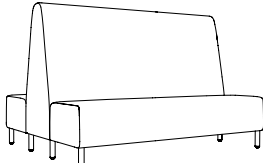
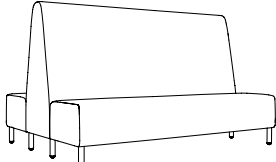
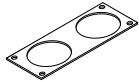
DESCRIPTION	FEATURES	MODEL#	STANDARD TEXTILE GRADES													
			1	2	3	4	5	6	7	8	9	10	11	12		
 <p>48" W Four Seater Banquette, Double Back COM Yardage: 9 Freight Class: 300 Product weight (lbs): 163 Cubic Feet Per Carton: 89.75</p>	optional (KD) packaging (no upcharge)	8508-48	5449	5761	6005	6364	6870	7082	7521	8210	8726	9290	10465	11701		
			OVERALL DIMENSIONS			SEAT DIMENSIONS			BACK DIMENSIONS							
			W	D	H	W	D	H	W	H						
			48	55	48	48	19	18	48	30						
			RTA 00			1 per carton										
 <p>60" W Four Seater Banquette, Double Back COM Yardage: 10 Freight Class: 300 Product weight (lbs): 198 Cubic Feet Per Carton: 111</p>	optional (KD) packaging (no upcharge)	8508-60	6313	6659	6929	7329	7890	8128	8614	9381	9953	10579	11886	13258		
			OVERALL DIMENSIONS			SEAT DIMENSIONS			BACK DIMENSIONS							
			W	D	H	W	D	H	W	H						
			60	55	48	60	19	18	60	30						
			RTA 00			1 per carton										
 <p>72" W Six Seater Banquette, Double Back COM Yardage: 11 Freight Class: 300 Product weight (lbs): 242 Cubic Feet Per Carton: 132.5</p>	optional (KD) packaging (no upcharge)	8508-72	7496	7877	8175	8614	9232	9492	10028	10870	11501	12190	13627	15136		
			OVERALL DIMENSIONS			SEAT DIMENSIONS			BACK DIMENSIONS							
			W	D	H	W	D	H	W	H						
			72	55	48	72	19	18	72	30						
			RTA 00			1 per carton										
 <p>78" W Six Seater Banquette, Double Back COM Yardage: 12 Freight Class: 300 Product weight (lbs): 255 Cubic Feet Per Carton: 141.7</p>	optional (KD) packaging (no upcharge)	8508-78	8377	8792	9117	9597	10271	10555	11139	12058	12746	13498	15065	16712		
			OVERALL DIMENSIONS			SEAT DIMENSIONS			BACK DIMENSIONS							
			W	D	H	W	D	H	W	H						
			78	55	48	78	19	18	78	30						
			RTA 00			1 per carton										
 <p>Ganging Bracket Kit COM Yardage: n/a Freight Class: 70 Product weight (lbs): 0.5 Cubic Feet Per Carton: 0.1</p>	Includes two brackets	8509	List price													
			92													
			OVERALL DIMENSIONS			SEAT DIMENSIONS			BACK DIMENSIONS							
			W	D	H	W	D	H	W	H						
2.5	6	0.25	-	-	-	-	-									
			RTA 00			1 per carton										

VITROLA



Vitrola is offered in two back heights, standard lounge and high back lounge, along with two and three seat sofa models.



Matching ottoman and accent pillow to complete the offering.

STANDARD FEATURES

- Classic soft seating upholstery design with swooping arms.
- Available in standard Lounge, High Back Lounge along with Two and Three Seat Sofa models.
- Matching Ottoman and Accent Pillow complete the offering.
- Fully upholstered with piping details at the bottom of frame.
- Seat cushions are fixed or sewn tight.
- Standard in tapered maple wood legs. Standard in tapered maple wood legs. Legs are equipped with White non-marking glides as standard. Suitable for both carpet and hard surface flooring.
- Back upholstery is continuous without seams. In the event the textile cannot be railroaded, stitch lines will be required (one for 2 seater and two for 3 seater).
- All models ship fully assembled.
- Check textile availability prior to specifying upholstery material.

OPTION CODES



Please add option codes in the following order:

- **Model number**
8271 Lounge Chair
8272 Two Seat Sofa
8273 Three Seat Sofa
8274 Ottoman
8275 High Back Lounge Chair
8276 Accent Pillow
- **Fabric**
Specify fabric code.
- **Wood Legs**
(AA) Absolute **(AAM)**
(BM) Black **(BKM)**
(CM) Cherry **(ACM)**
(EO) English Oak **(EOM)**
(EC) Espresso Café **(ECM)**
(HG) Grey **(HGM)**
(HO) Honey **(AHM)**
(TM) Mahogany **(TMM)**
(VM) Maple **(AVM)**
(MM) Medium Walnut **(MWM)**
(NL) Natural Walnut **(NLW)**
(SN) Night **(ASM)**
(BI) Noce Biondo **(NBM)**
(GI) Noce Grigio **(NGM)**
(EI) Noce Leggero **(NEM)**
(MI) Noce Medio **(NMM)**,
(SK) Shaker Cherry **(SKM)**
(TF) Fruitwood **(TFM)**
(TW) Walnut **(TWM)**
(WC) WC Cream **(WTM)**
(WH) White **(WHM)**
(WE) Winter Cherry **(WCM)**
(colors shown on website).

EXAMPLE OF ORDER CODE:

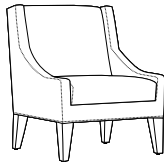
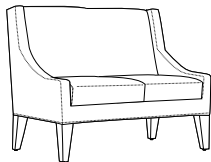
8271	WA50	HG
Model Number	Fabric	Wood Legs

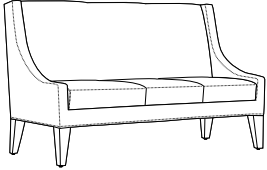
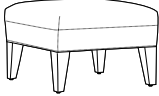
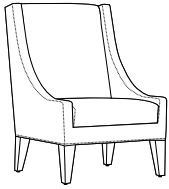
DESCRIPTION	FEATURES	MODEL#	STANDARD TEXTILE GRADES											
			1	2	3	4	5	6	7	8	9	10	11	12
 <p>Lounge Chair COM Yardage: 5.25 Freight Class: 150 Product Weight (lbs.): 90 Cubic Feet Per Carton: 20.25</p>		8271	\$1602	\$1795	\$1945	\$2169	\$2491	\$2644	\$2933	\$3397	\$3754	\$4150	\$4967	\$5840
			OVERALL DIMENSIONS			SEAT DIMENSIONS			BACK DIMENSIONS					
			W	D	H	W	D	H	W	H				
			28	31	34	22	21	17.5	22	18				
		RTA 00												
 <p>Two Seat Sofa COM Yardage: 7.25 Freight Class: 250 Product Weight (lbs.): 107 Cubic Feet Per Carton: 36.5</p>		8272	\$2629	\$2934	\$3174	\$3536	\$4050	\$4292	\$4757	\$5499	\$6069	\$6705	\$8015	\$9409
			OVERALL DIMENSIONS			SEAT DIMENSIONS			BACK DIMENSIONS					
			W	D	H	W	D	H	W	H				
			51	31	34	44	21	17.5	44	18				
		RTA 00												

DESCRIPTION	FEATURES	MODEL#	STANDARD TEXTILE GRADES											
			1	2	3	4	5	6	7	8	9	10	11	12
 <p>Three Seat Sofa COM Yardage: 9.25 Freight Class: 250 Product Weight (lbs.): 140 Cubic Feet Per Carton: 51.75</p>		8273	\$3419	\$3875	\$4238	\$4781	\$5551	\$5911	\$6611	\$7723	\$8579	\$9533	\$11496	\$13587
			OVERALL DIMENSIONS			SEAT DIMENSIONS			BACK DIMENSIONS					
			W	D	H	W	D	H	W	H				
			74.25	31	34	66	21	17.5	66	18				
			RTA 00											
 <p>Ottoman COM Yardage: 1.75 Freight Class: 250 Product Weight (lbs.): 20 Cubic Feet Per Carton: 8</p>		8274	\$921	\$1021	\$1096	\$1210	\$1369	\$1446	\$1591	\$1823	\$2001	\$2199	\$2610	\$3045
			OVERALL DIMENSIONS			SEAT DIMENSIONS			BACK DIMENSIONS					
			W	D	H	W	D	H	W	H				
			24	24	17	-	-	-	-	-				
			RTA 00											
 <p>High Back Lounge Chair COM Yardage: 6.25 Freight Class: 250 Product Weight (lbs.): 96 Cubic Feet Per Carton: 28.25</p>		8275	\$1928	\$2140	\$2305	\$2554	\$2907	\$3072	\$3393	\$3903	\$4296	\$4732	\$5633	\$6591
			OVERALL DIMENSIONS			SEAT DIMENSIONS			BACK DIMENSIONS					
			W	D	H	W	D	H	W	H				
			28	31	42	22	21	17.5	22	26				
			RTA 00											
 <p>Accent Pillow COM Yardage: 0.75 Freight Class: 150 Product Weight (lbs.): 4 Cubic Feet Per Carton: 1</p>		8276	\$191	\$217	\$238	\$266	\$309	\$329	\$366	\$427	\$473	\$525	\$632	\$744
			OVERALL DIMENSIONS			SEAT DIMENSIONS			BACK DIMENSIONS					
			W	D	H	W	D	H	W	H				
			23	6	8	-	-	-	-	-				
			RTA 00											
			FedEx		ups	1 per carton								

WIND™



models 3361 Lounge chair & 3362 Two seat sofa, with 3357 Coffee table.

ADDITIONAL STITCH DETAIL - ILLUSTRATIONS BELOW

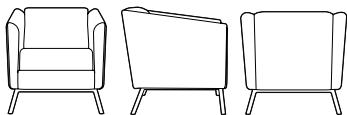

Standard Detailing - when upholstered in FABRIC or VINYL

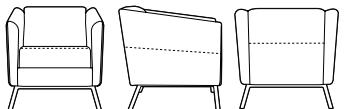

Additional Detailing - when upholstered in GENUINE LEATHER



Contrasting Textile Application



For Wind tables, see page 408

STANDARD FEATURES

- The Wind and Wind Linear series are compact, contemporary designed seating offering a raised, modern version of the traditional lounge chair; scaled down for smaller spaces.
- Wind is comprised of freestanding lounge chairs and tables.
- Wind Linear (see page 410 includes ganging seating and tables.
- Metal leg models (3361, 3362 and 3363) are available in plated and painted finishes noted.
- Wood leg models (3431, 3432 and 3433) are available in standard Global wood finishes.
- Wind tables are available with metal legs only.
- Metal legs are standard with Black glides and offer non-marking glides at no upcharge.
- Wood legs are standard with nonmarking glides and offer a variety of glide types for various flooring types. See list for types and upcharges.
- Casters are not available for Wind.
- Available with fabric, coated textile and leather upholstery; check approved textiles prior to ordering.
- The series is available with contrasting fabrics. Specify arms, back and front rail separate from seat cushion, see model image.
- For pricing, start with the base price and add both back/arms graded textile upcharge and the seat graded textile upcharge.
- For leather upholstery, note additional stitch details on seat and outside arm and back panels.
- Wind is covered under Global's Limited Lifetime Warranty.
- Wind seating has a 300 lb capacity.

Add option codes in the following order:

- **Model Number**
Specify model number.
3431 to 3433 Wood leg seating
3361 to 3363 Metal leg seating
- **Back and Arm Textile** (includes front rail)
Specify textile code.
- **Seat Textile**
Specify textile code.
- **Leg Finish** (metal legs)





(TBL) Black	(TBC) Buzz Blue
(TCC) Cactus	(TCR) Carrot
(TDJ) Dijon	(TDW) Designer White
(TEG) Eggplant	(TFO) Fog
(TFR) Frost	(TIN) Ink
(TIV) Cloud	(TKA) Kalua
(TLA) Latte	(TMO) Mocha
(TOA) Toast	(TNE) Nevada
(TSH) Shadow	(TSN) Sand
(TSR) Scarlet	(TTU) Tungsten
- **Metallics:** Lounge 2 Seat 3 Seat
(CHM) Chrome. No upcharge.
(ACO) Antique Chrome. Add\$331 \$414 \$485
(BCH) Brushed Chrome. Add \$156 \$189 \$212
(SBR) Satin Brass. Add \$331 \$414 \$485
- **Leg Finish** (wood legs)

(AAM) Absolute	(BKM) Black
(ACM) Cherry	(EOM) English Oak
(ECM) Espresso Cafe	(TFM) Fruitwood
(HGM) Grey	(AHM) Honey
(TMM) Mahogany	(AVM) Maple
(NLW) Natural Walnut	(MWM) Medium Walnut
(ASM) Night	(NBM) Noce Biondo
(NGM) Noce Grigio	(NEM) Noce Leggero
(NMM) Noce Medio	(SKM) Shaker Cherry
(TWM) Walnut	(WTM) WC Cream
(WHM) White	(WCM) Winter Cherry
- **Glide Type (metal legs)**
(GL) Black Glide for most surfaces (standard).
(NM) Non-Marking Glide for most surfaces. No upcharge.
- **Glide Type (wood legs)**
(NM) Non-marking glides for most surfaces (standard).
(SG) Steel cushioned glides for carpeted surfaces.. Add \$34
(RG) Rubber non-slip glides for most hard floor surfaces. Add \$34
(FG) Felt glides for most hard floor surfaces. Add \$34

DESCRIPTION	FEATURES	MODEL#	STANDARD TEXTILE GRADES													
			1	2	3	4	5	6	7	8	9	10	11	12		
	3431	Base Price:	\$2796													
		Back/Arm upcharge:	+0	+0	\$88	\$217	\$399	\$476	\$634	\$882	\$1068	\$1271	\$1694	\$2139		
		Seat upcharge:	+0	+0	\$25	\$62	\$114	\$136	\$181	\$252	\$305	\$363	\$484	\$611		
		OVERALL DIMENSIONS														
		SEAT DIMENSIONS														
		BACK DIMENSIONS														
		W	D	H	W	D	H	W	H							
		27.5	29	28.5	19.5	29	28.5	19	12							

Lounge Chair, Wood Legs
COM Yardage: Back: 3.5 ; Seat: 1
Freight Class: 250
Product Weight (lbs.): 59
Cubic Feet Per Carton: 16.5

RTA 00

DESCRIPTION	FEATURES	MODEL#	STANDARD TEXTILE GRADES											
			1	2	3	4	5	6	7	8	9	10	11	12
 <p>Two Seat Sofa, Wood Legs COM Yardage: Back: 5 ; Seat: 1.75 Freight Class: 250 Product Weight (lbs.): 98 Cubic Feet Per Carton: 30</p>	<p>3432 Base Price: \$3633 Back/Arm upcharge: Seat upcharge:</p>													
		+0	+0	\$125	\$310	\$570	\$680	\$905	\$1260	\$1525	\$1815	\$2420	\$3055	
		+0	+0	\$44	\$109	\$200	\$238	\$317	\$441	\$534	\$636	\$847	\$1070	
		OVERALL DIMENSIONS			SEAT DIMENSIONS			BACK DIMENSIONS						
		W	D	H	W	D	H	W	H					
54.5	29	28.5	46.5	29	28.5	46.5	12							
RTA 00														
 <p>Three Seat Sofa, Wood Legs COM Yardage: Back: 6 ; Seat: 3 Freight Class: 250 Product Weight (lbs.): 129 Cubic Feet Per Carton: 42.5</p>	<p>3433 Base Price: \$4467 Back/Arm upcharge: Seat upcharge:</p>													
		+0	+0	\$150	\$372	\$684	\$816	\$1086	\$1512	\$1830	\$2178	\$2904	\$3666	
		+0	+0	\$75	\$186	\$342	\$408	\$543	\$756	\$915	\$1089	\$1452	\$1833	
		OVERALL DIMENSIONS			SEAT DIMENSIONS			BACK DIMENSIONS						
		W	D	H	W	D	H	W	H					
78	29	28.5	70.5	29	28.5	70.5	12							
RTA 00														
 <p>Lounge Chair, Metal Legs COM Yardage: Back: 2.75 ; Seat: 1.75 Freight Class: 250 Product Weight (lbs.): 62 Cubic Feet Per Carton: 16.5</p>	<p>3361 Base Price: \$2546 Back/Arm upcharge: Seat upcharge:</p>													
		+0	+0	\$69	\$171	\$314	\$374	\$498	\$693	\$839	\$999	\$1331	\$1681	
		+0	+0	\$44	\$109	\$200	\$238	\$317	\$441	\$534	\$636	\$847	\$1070	
		OVERALL DIMENSIONS			SEAT DIMENSIONS			BACK DIMENSIONS						
		W	D	H	W	D	H	W	H					
27.5	29	28.5	19.5	19	17	19	12							
RTA 00														
 <p>Two Seat Sofa, Metal Legs COM Yardage: Back: 3.5 ; Seat: 3.25 Freight Class: 250 Product Weight (lbs.): 102 Cubic Feet Per Carton: 250</p>	<p>3362 Base Price: \$3383 Back/Arm upcharge: Seat upcharge:</p>													
		+0	+0	\$88	\$217	\$399	\$476	\$634	\$882	\$1068	\$1271	\$1694	\$2139	
		+0	+0	\$82	\$202	\$371	\$442	\$589	\$819	\$992	\$1180	\$1573	\$1986	
		OVERALL DIMENSIONS			SEAT DIMENSIONS			BACK DIMENSIONS						
		W	D	H	W	D	H	W	H					
54.5	29	28.5	46.5	19	17	46.5	12							
RTA 00														
 <p>Three Seat Sofa, Metal Legs COM Yardage: Back: 4.5 ; Seat: 4.5 Freight Class: 250 Product Weight (lbs.): 135 Cubic Feet Per Carton: 250</p>	<p>3363 Base Price: \$4217 Back/Arm upcharge: Seat upcharge:</p>													
		+0	+0	\$113	\$279	\$513	\$612	\$815	\$1134	\$1373	\$1634	\$2178	\$2750	
		+0	+0	\$113	\$279	\$513	\$612	\$815	\$1134	\$1373	\$1634	\$2178	\$2750	
		OVERALL DIMENSIONS			SEAT DIMENSIONS			BACK DIMENSIONS						
		W	D	H	W	D	H	W	H					
78	29	28.5	70.5	19	17	70.5	12							
RTA 00														

WIND™ TABLES



models 3361 Lounge chair & 3362 Two seat sofa, with 3357 Coffee table.





For Wind seating, see page 406

STANDARD FEATURES

- Wind tables compliment the modern decor of many environments, pairing naturally with Wind and Wind Linear lounge seating and other contemporary seating, such as Kate, Erin, and Marche.
- Metal Legs are available in plated and painted finishes noted.
- Table tops are standard with Thermally Fused Laminate (LPL). High Pressure Laminate (HPL) surface is available at a 20% upcharge.

Add option codes in the following order:

- **Model Number**
Specify model number.
3366 to 3371 Metal leg tables
- **Laminate Tops (LPL)**
(ACJ) Absolute Acajou (ASN) Asian Night
(AWC) Avant Cherry (AWH) Avant Honey
(BLK) Black (BRC) Brushed Cobalt
(BZD) Blizzard (CGY) Custom Grey
(CMB) Clear Maple (DES) Dark Espresso
(DWT) Designer White (FAS) Fashionista
(FCL) First Class (NBL) Noce Biondo
(INGL) Noce Grigio (NEL) Noce Leggero
(NML) Noce Medio
(QTM) Quartered Mahogany
(SBY) Sheer Beauty (SDT) Stonedust
(SOG) Storm Grey (WHE) Walnut Heights
(WHC) White Chocolate (WCR) Winter Cherry
- **Leg Finish (metal legs)**
(TBL) Black (TBZ) Buzz Blue
(TCC) Cactus (TCR) Carrot
(TDJ) Dijon (TDW) Designer White
(TEG) Eggplant (TFO) Fog
(TFR) Frost (TIN) Ink
(TIV) Cloud (TKA) Kalua
(TLA) Latte (TMO) Mocha
(TOA) Toast (TNE) Nevada
(TSH) Shadow (TSN) Sand
(TSR) Scarlet (TTU) Tungsten
Metallics:
(CHM) Chrome. No upcharge.
(ACO) Antique Chrome. Add\$162
(BCH) Brushed Chrome. Add \$212
(SBR) Satin Brass. Add \$162
- **Glide Type**
(GL) Black Glide for most surfaces (standard).
(NM) Non-Marking Glide for most surfaces. No upcharge.

DESCRIPTION	FEATURES	MODEL#	STANDARD TEXTILE GRADES											
			1	2	3	4	5	6	7	8	9	10	11	12
 End Table COM Yardage: N/A Freight Class: 250 Product Weight (lbs.): 36 Cubic Feet Per Carton: 11.5	3366 Laminate Top List Price: \$933	1	2	3	4	5	6	7	8	9	10	11	12	
														OVERALL DIMENSIONS
			24	24	17	-	-	-	-	-	-	-	-	-
			RTA 00											
 Rectangular Coffee Table COM Yardage: N/A Freight Class: 250 Product Weight (lbs.): 52 Cubic Feet Per Carton: 16	3367 Laminate Top List Price: \$1234	1	2	3	4	5	6	7	8	9	10	11	12	
														OVERALL DIMENSIONS
			48	20	15	-	-	-	-	-	-	-	-	-
			RTA 00											

DESCRIPTION	FEATURES	MODEL#	STANDARD TEXTILE GRADES														
			1	2	3	4	5	6	7	8	9	10	11	12			
	3368 Laminate Top	List Price: \$1670															
Square Coffee Table COM Yardage: N/A Freight Class: 250 Product Weight (lbs.): 66 Cubic Feet Per Carton: 22			OVERALL DIMENSIONS			SEAT DIMENSIONS			BACK DIMENSIONS								
			W	D	H	W	D	H	W	H							
			36	36	15	-	-	-	-	-							
			RTA 00														

DESCRIPTION	FEATURES	MODEL#	STANDARD TEXTILE GRADES														
			1	2	3	4	5	6	7	8	9	10	11	12			
	3870 Laminate Top	List Price: \$1020															
Round Table COM Yardage: N/A Freight Class: 250 Product Weight (lbs.): 35 Cubic Feet Per Carton: 11.5			OVERALL DIMENSIONS			SEAT DIMENSIONS			BACK DIMENSIONS								
			W	D	H	W	D	H	W	H							
			24	24	17	-	-	-	-	-							
			RTA 00 FedEx ups														

DESCRIPTION	FEATURES	MODEL#	STANDARD TEXTILE GRADES														
			1	2	3	4	5	6	7	8	9	10	11	12			
	3871 Laminate Top	List Price: \$1501															
Round Coffee Table COM Yardage: N/A Freight Class: 250 Product Weight (lbs.): 57 Cubic Feet Per Carton: 22			OVERALL DIMENSIONS			SEAT DIMENSIONS			BACK DIMENSIONS								
			W	D	H	W	D	H	W	H							
			36	36	15	-	-	-	-	-							
			RTA 00														

WIND™ LINEAR



models 3363R and 3363L with 3882 bridge table, 3360 table attaching bracket kit and two 3380 coffee tables



Contrasting Textile Application



For Wind Linear tables, see page 415

STANDARD FEATURES

- Wind Linear is an extension of the Wind lounge series with an emphasis on expansive, clean lines.
- Wind Linear tables complement the modern decor of many offices.
- This modular furniture series includes single arm and armless sofas and benches for use as freestanding or ganged seating. See ganging features below.
- Metal Leg models (3361L/R/NA, 3363L/R/NA, 3361B and 3363B) are available in plated and painted finishes noted.
- Wood Leg models (3431L/R/NA, 3433L/R/NA, 3434B and 3435B) are available in standard Global wood finishes, noted.
- Casters are not available on Wind Linear.
- Wind Linear tables are available with metal legs.
- A variety of glide types are available. Use glide chart for recommended glide use on various flooring types.
- Available with fabric, coated textile and leather upholstery; check approved textiles prior to ordering.
- The series is available with contrasting fabrics. Specify arms, back and front rail separate from seat cushion, see model image.
- For pricing, start with the base price and add both back/arms graded textile upcharge and the seat graded textile upcharge.
- For leather upholstery, note additional stitch details on seat and outside arm and back panels.
- Wind is covered under Global's Limited Lifetime Warranty.
- Wind Linear seating has a 300 lb capacity.

GANGING FEATURES

- Metal or wood leg seating gang to table 'bridges' and metal leg corner tables in-between seating units at armless ends. A table attaching bracket kit (3360) is required, specified separately and field installed. See Wind Linear Tables for details.
- Wood Leg seating models (only) offer a (GBS) ganging seat-to-seat option to gang seating together at armless ends (without tables). Option must be selected at the time of the order, the ganging bracket is factory installed and cannot be field installed. See above for ganging with tables.
- Benches and ottomans do not gang to seating models.

Add option codes in the following order:

- **Model Number**
Specify model number.
3361 to 3363 Metal leg seating
3431 to 3435 Wood leg seating
- **Back and Arm Textile** (includes front rail)
Specify textile code.
- **Seat Textile**
Specify textile code.
- **Leg Finish** (metal legs)

(TBL) Black	(TBZ) Buzz Blue
(TCC) Cactus	(TCR) Carrot
(TDJ) Dijon	(TDW) Designer White
(TEG) Eggplant	(TFO) Fog
(TFR) Frost	(TIN) Ink
(TIV) Cloud	(TKA) Kalua
(TLA) Latte	(TMO) Mocha
(TOA) Toast	(TSH) Shadow
(TSN) Sand	(TSR) Scarlet

Metallics: Lounge 2 Seat 3 Seat

(CHM) Chrome. No upcharge.		
(ACO) Antique Chrome. Add \$331	\$414	\$485
(BCH) Brushed Chrome. Add \$156	\$189	\$212
(SBR) Satin Brass. Add \$331	\$414	\$485
- **Leg Finish** (wood legs)

(AAM) Absolute	(BKM) Black
(ACM) Cherry	(EOM) English Oak
(ECM) Espresso Cafe	(TFM) Fruitwood
(HGM) Grey	(AHM) Honey
(TMM) Mahogany	(AVM) Maple
(NLW) Natural Walnut	(MWM) Medium Walnut
(ASM) Night	(NBM) Noce Biondo
(NGM) Noce Grigio	(NEM) Noce Leggero
(NMM) Noce Medio	(SKM) Shaker Cherry
(TWM) Walnut	(WTM) WC Cream
(WHM) White	(WCM) Winter Cherry
- **Glide Type** (metal legs)

(GL) Black Glide for most surfaces (standard)
(NM) Non-Marking Glide for most surfaces. No upcharge.
- **Glide Type** (wood legs)

(NM) Non-marking glides for most surfaces (standard).
(SG) Steel cushioned glides for carpeted surfaces. Add \$34
(RG) Rubber non-slip glides for most hard floor surfaces. Add \$34
(FG) Felt glides for most hard floor surfaces. Add \$34
- **Ganging** (wood leg seating - for ganging seat to seat)

(NG) No ganging (Standard)
(GBS) Ganging seat to seat. Add \$45

SAMPLE LAYOUTS

Layout A



Qty	Model Number	Description	Dimensions	List Price
1	3361R	Single Seater - Right Arm	39.5 x 29 x 28.5	2695
1	3361L	Single Seater - Left Arm	39.5 x 29 x 28.5	2695
1	3363NA	Single Sofa - Armless	72 x 29 x 28.5	3590
1	3881R	Bridge Corner Table - Right	25 x 25 x 12	1743
1	3881L	Bridge Corner Table - Left	25 x 25 x 12	1743
2	3360	Table Bracket Kit - 1 Kit per table		193 x 2

SAMPLE LAYOUT TOTAL IN STANDARD BLACK FRAME

\$12,852



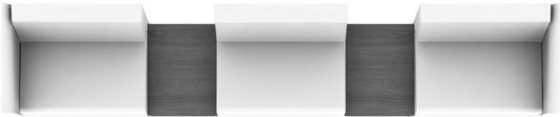

Layout B





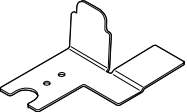

Qty	Model Number	Description	Dimensions	List Price
1	3361R	Single Seater - Right Arm	39.5 x 29 x 28.5	2695
1	3361L	Single Seater - Left Arm	39.5 x 29 x 28.5	2695
1	3361NA	Single Seater - Armless	36.5 x 29 x 28.5	2382
2	3882	Bridge End Table	25 x 20 x 12	952 x 2
2	3360	Table Bracket Kit - 1 Kit per table		193 x 2

SAMPLE LAYOUT TOTAL IN STANDARD BLACK FRAME

\$10,062

DESCRIPTION	FEATURES	MODEL#	STANDARD TEXTILE GRADES											
			1	2	3	4	5	6	7	8	9	10	11	12
 <p>Table Bracket Kit COM Yardage: N/A Freight Class: 70 Product Weight (lbs.): 1.5 Cubic Feet Per Carton: 0.03 (1 Kit per carton)</p>	<p>3360 List Price: \$193</p> <p>Includes 4 brackets and hardware. Use with models 3381R, 3361L, 3436R, 3436L, 3882 and 3884</p>	OVERALL DIMENSIONS			SEAT DIMENSIONS			BACK DIMENSIONS						
		W	D	H	W	D	H	W	H					
			-	-	-	-	-	-	-	-	-	-	-	
			<div style="display: flex; justify-content: space-between; align-items: center;"> RTA 00   </div>											
 <p>3361R 3361L</p> <p>Single Seater - w/ Left or Right Arm, Metal Legs COM Yardage: Back: 2.5 ; Seat: 2.25 Freight Class: 250 Product Weight (lbs.): 72 Cubic Feet Per Carton: 28.5</p>	<p>3361R/3361L Base Price: \$2695 Back/Arm upcharge: Seat upcharge:</p>	1	2	3	4	5	6	7	8	9	10	11	12	
		+0	+0	\$63	\$155	\$285	\$340	\$453	\$630	\$763	\$908	\$1210	\$1528	
		+0	+0	\$57	\$140	\$257	\$306	\$408	\$567	\$687	\$817	\$1089	\$1375	
			OVERALL DIMENSIONS			SEAT DIMENSIONS			BACK DIMENSIONS					
			W	D	H	W	D	H	W	H				
			39.5	29	28.5	36	19	17	36	12				
			<div style="display: flex; justify-content: space-between; align-items: center;"> RTA 00 </div>											

DESCRIPTION	FEATURES	MODEL#		STANDARD TEXTILE GRADES										
		1	2	3	4	5	6	7	8	9	10	11	12	
 <p>Single Seater - Armless, Metal Legs COM Yardage: Back: 1.5 ; Seat: 1.75 Freight Class: 250 Product Weight (lbs.): 58 Cubic Feet Per Carton: 28.5</p>	<p>3361NA Base Price: \$2382 Back/Arm upcharge: Seat upcharge:</p>													
		+0	+0	\$38	\$93	\$171	\$204	\$272	\$378	\$458	\$545	\$726	\$917	
		+0	+0	\$44	\$109	\$200	\$238	\$317	\$441	\$534	\$636	\$847	\$1070	
		OVERALL DIMENSIONS			SEAT DIMENSIONS			BACK DIMENSIONS						
		W	D	H	W	D	H	W	H					
		36.5	29	28.5	36.5	19	17	36.5	12					
		RTA 00												
 <p>Three Seat Sofa - w/ Left or Right Arm, Metal Legs COM Yardage: Back: 3.5 ; Seat: 2.50 Freight Class: 250 Product Weight (lbs.): 120 Cubic Feet Per Carton: 41</p>	<p>3363R/3363L Base Price: \$4035 Back/Arm upcharge: Seat upcharge:</p>													
		+0	+0	\$88	\$217	\$399	\$476	\$634	\$882	\$1068	\$1271	\$1694	\$2139	
		+0	+0	\$107	\$264	\$485	\$578	\$770	\$1071	\$1297	\$1543	\$2057	\$2597	
		OVERALL DIMENSIONS			SEAT DIMENSIONS			BACK DIMENSIONS						
		W	D	H	W	D	H	W	H					
		75	29	28.5	17	19	17	71	12					
		RTA 00												
 <p>Three Seat Sofa - Armless, Metal Legs COM Yardage: Back: 2.25 ; Seat: 4.25 Freight Class: 250 Product Weight (lbs.): 111 Cubic Feet Per Carton: 39.25</p>	<p>3363NA Base Price: \$3590 Back/Arm upcharge: Seat upcharge:</p>													
		+0	+0	\$57	\$140	\$257	\$306	\$408	\$567	\$687	\$817	\$1089	\$1375	
		+0	+0	\$107	\$264	\$485	\$578	\$770	\$1071	\$1297	\$1543	\$2057	\$2597	
		OVERALL DIMENSIONS			SEAT DIMENSIONS			BACK DIMENSIONS						
		W	D	H	W	D	H	W	H					
		72	29	28.5	72	19	17	72	12					
		RTA 00												
 <p>Ottoman, Metal Legs COM Yardage: 1.75 Freight Class: 150 Product Weight (lbs.): 50 Cubic Feet Per Carton: 12.5</p>	<p>3361B List Price: -</p>													
			\$1771	\$1815	\$1880	\$1971	\$2009	\$2088	\$2212	\$2305	\$2407	\$2618	\$2841	
		OVERALL DIMENSIONS			SEAT DIMENSIONS			BACK DIMENSIONS						
				W	D	H	W	D	H	W	H			
		35.5	20.5	17.5										
		RTA 00												
 <p>Bench, Metal Legs COM Yardage: 3.5 Freight Class: 150 Product Weight (lbs.): 80 Cubic Feet Per Carton: 18.75</p>	<p>3363B List Price: -</p>													
			\$2726	\$2814	\$2943	\$3125	\$3202	\$3360	\$3608	\$3794	\$3997	\$4420	\$4865	
		OVERALL DIMENSIONS			SEAT DIMENSIONS			BACK DIMENSIONS						
				W	D	H	W	D	H	W	H			
		72	20.5	17.5										
		RTA 00												

DESCRIPTION	FEATURES	MODEL#	STANDARD TEXTILE GRADES														
			1	2	3	4	5	6	7	8	9	10	11	12			
 <p>3431R 3431L</p> <p>Single Seater - w/ Left or Right Arm, Wood Legs COM Yardage: Back: 1.75 ; Seat: 3 Freight Class: 250 Product Weight (lbs.): 70 Cubic Feet Per Carton: 28.5</p>	<p>3431R/3431L Base Price: \$2945 Back/Arm upcharge: +0 +0 \$44 \$109 \$200 \$238 \$317 \$441 \$534 \$636 \$847 \$1070 Seat upcharge: +0 +0 \$75 \$186 \$342 \$408 \$543 \$756 \$915 \$1089 \$1452 \$1833</p>	OVERALL DIMENSIONS			SEAT DIMENSIONS			BACK DIMENSIONS									
		W	D	H	W	D	H	W	H								
			39.5	29	28.5	36	19	17	36	12							
			RTA 00														
 <p>3431NA</p> <p>Single Seater - Armless, Wood Legs COM Yardage: Back: 1.55 ; Seat: 1.7 Freight Class: 300 Product Weight (lbs.): 56 Cubic Feet Per Carton: 28.5</p>	<p>3431NA Base Price: \$2632 Back/Arm upcharge: +0 +0 \$39 \$97 \$177 \$211 \$281 \$391 \$473 \$563 \$751 \$948 Seat upcharge: +0 +0 \$43 \$106 \$194 \$232 \$308 \$429 \$519 \$618 \$823 \$1039</p>	OVERALL DIMENSIONS			SEAT DIMENSIONS			BACK DIMENSIONS									
		W	D	H	W	D	H	W	H								
			36.5	29	28.5	36.5	19	17	36.5	12							
			RTA 00														
 <p>3433R 3433L</p> <p>Three Seat Sofa w/ Left or Right Arm, Wood Legs COM Yardage: Back: 4.5 ; Seat: 3.25 Freight Class: 250 Product Weight (lbs.): 111 Cubic Feet Per Carton: 41</p>	<p>3433R/3433L Base Price: \$4285 Back/Arm upcharge: +0 +0 \$113 \$279 \$513 \$612 \$815 \$1134 \$1373 \$1634 \$2178 \$2750 Seat upcharge: +0 +0 \$82 \$202 \$371 \$442 \$589 \$819 \$992 \$1180 \$1573 \$1986</p>	OVERALL DIMENSIONS			SEAT DIMENSIONS			BACK DIMENSIONS									
		W	D	H	W	D	H	W	H								
			75	29	28.5	71	19	17	71	12							
			RTA 00														
 <p>3433NA</p> <p>Three Seat Sofa - Armless, Wood Legs COM Yardage: Back: 3.5 ; Seat: 3 Freight Class: 250 Product Weight (lbs.): 105 Cubic Feet Per Carton: 39.25</p>	<p>3433NA Base Price: \$3840 Back/Arm upcharge: +0 +0 \$88 \$217 \$399 \$476 \$634 \$882 \$1068 \$1271 \$1694 \$2139 Seat upcharge: +0 +0 \$75 \$186 \$342 \$408 \$543 \$756 \$915 \$1089 \$1452 \$1833</p>	OVERALL DIMENSIONS			SEAT DIMENSIONS			BACK DIMENSIONS									
		W	D	H	W	D	H	W	H								
			72	29	28.5	72	19	17	72	12							
			RTA 00														
 <p>3434B</p> <p>Ottoman, Wood Legs COM Yardage: 1.75 Freight Class: 250 Product Weight (lbs.): 48 Cubic Feet Per Carton: 12.5</p>	<p>3434B List Price: - \$2021 \$2065 \$2130 \$2221 \$2259 \$2338 \$2462 \$2555 \$2657 \$2868 \$3091</p>	OVERALL DIMENSIONS			SEAT DIMENSIONS			BACK DIMENSIONS									
		W	D	H	W	D	H	W	H								
			35.5	20.5	17.5												
			RTA 00														

DESCRIPTION	FEATURES	MODEL#			STANDARD TEXTILE GRADES								
		1	2	3	4	5	6	7	8	9	10	11	12



3435B	List Price:		\$2976	\$3064	\$3193	\$3375	\$3452	\$3610	\$3858	\$4044	\$4247	\$4670	\$5115
--------------	-------------	--	--------	--------	--------	--------	--------	--------	--------	--------	--------	--------	--------

OVERALL DIMENSIONS			SEAT DIMENSIONS			BACK DIMENSIONS	
W	D	H	W	D	H	W	H

72	20.5	17.5					
----	------	------	--	--	--	--	--

Specify (GBS) option for ganging seat-to-to seat. Add \$45

RTA 00

Bench, Wood Legs
 COM Yardage: 3.5
 Freight Class: 150
 Product Weight (lbs.): 76
 Cubic Feet Per Carton: 18.75

		1	2	3	4	5	6	7	8	9	10	11	12
--	--	---	---	---	---	---	---	---	---	---	----	----	----

3885	List Price:	-	\$249	\$274	\$311	\$363	\$385	\$430	\$501	\$554	\$612	\$733	\$860
-------------	-------------	---	-------	-------	-------	-------	-------	-------	-------	-------	-------	-------	-------

OVERALL DIMENSIONS			SEAT DIMENSIONS			BACK DIMENSIONS	
W	D	H	W	D	H	W	H

16	5	7					
----	---	---	--	--	--	--	--

1 Loose Cushion.

RTA 00

Bolster Cushion
 COM Yardage: 1
 Freight Class: 70
 Product Weight (lbs.): 1.5
 Cubic Feet Per Carton: 1.3

WIND™ LINEAR TABLES



models 3363R and 3363L with 3882 bridge table, 3360 table attaching bracket kit and two 3380 coffee tables



For Wind Linear seating, see page 410

STANDARD FEATURES



- Wind Linear is an extension of the Wind lounge series with an emphasis on expansive, clean lines of seating and tables.
- Tables are available with metal legs.
- Table tops are standard with Thermally Fused Laminate (LPL)
- A variety of table 'bridges' are designed to mount between seating (at armless ends), or between benches or ottomans. See Ganging Features below.
- A variety of glide types are available. Use glide chart for recommended glide use on various flooring types.





GANGING FEATURES

- Corner bridge tables and bridge end tables, models 3881R/L, 3882, 3883 and 3436R/L mount between chairs and sofa units only at armless ends. Specify Table Attaching Bracket Kit 3360 separately. (Not usable with bench or ottoman models.)
- Bridge tables (model 3884) mount between ottoman models 3434B and 3361B and/or bench models 3435B and 3363B. Specify Table Attaching Bracket Kit 3360 separately.

Add option codes in the following order:

- **Model Number**
Specify model number.
- **Laminate Tops (LPL)**
(ACJ) Absolute Acajou (ASN) Asian Night
(AWC) Avant Cherry (AWH) Avant Honey
(BLK) Black (BRC) Brushed Cobalt
(BZD) Blizzard (CGY) Custom Grey
(CMB) Clear Maple (DES) Dark Espresso
(DWT) Designer White (FAS) Fashionista
(FCL) First Class (NBL) Noce Biondo
(NGL) Noce Grigio (NEL) Noce Leggero
(NML) Noce Medio
(QTM) Quartered Mahogany
(SBY) Sheer Beauty (SDT) Stonedust
(SOG) Storm Grey (WHE) Walnut Heights
(WHC) White Chocolate (WCR) Winter Cherry
- **Leg Finish** (metal legs)
(TBL) Black (TBZ) Buzz Blue
(TCC) Cactus (TCR) Carrot
(TDJ) Dijon (TDW) Designer White
(TEG) Eggplant (TFO) Fog
(TFR) Frost (TIN) Ink
(TIV) Cloud (TKA) Kalua
(TLA) Latte (TMO) Mocha
(TOA) Toast (TNE) Nevada
(TSH) Shadow (TSN) Sand
(TSR) Scarlet (TTU) Tungsten
Metallics:
(CHM) Chrome. No upcharge.
(ACO) Antique Chrome. Add\$162
(BCH) Brushed Chrome. Add \$212
(SBR) Satin Brass. Add \$162
- **Glide Type**
(GL) Black Glide for most surfaces (standard).
(NM) Non-Marking Glide for most surfaces. No upcharge.

DESCRIPTION	FEATURES	MODEL#	STANDARD TEXTILE GRADES																								
			1	2	3	4	5	6	7	8	9	10	11	12													
 Side Table - Rectangular, Metal Legs COM Yardage: N/A Freight Class: 250 Product Weight (lbs.): 38 Cubic Feet Per Carton: 11.5	3878 Laminate Top List Price: \$1334 Freestanding	3878																									
			<table border="1"> <thead> <tr> <th colspan="3">OVERALL DIMENSIONS</th> <th colspan="3">SEAT DIMENSIONS</th> <th colspan="3">BACK DIMENSIONS</th> </tr> <tr> <th>W</th><th>D</th><th>H</th> <th>W</th><th>D</th><th>H</th> <th>W</th><th>H</th> </tr> </thead> <tbody> <tr> <td>20</td><td>25</td><td>16</td> <td>-</td><td>-</td><td>-</td> <td>-</td><td>-</td> </tr> </tbody> </table>			OVERALL DIMENSIONS			SEAT DIMENSIONS			BACK DIMENSIONS			W	D	H	W	D	H	W	H	20	25	16	-	-
OVERALL DIMENSIONS			SEAT DIMENSIONS			BACK DIMENSIONS																					
W	D	H	W	D	H	W	H																				
20	25	16	-	-	-	-	-																				
RTA 00																											
 Side Table - 25" Square, Metal Legs COM Yardage: N/A Freight Class: 250 Product Weight (lbs.): 40 Cubic Feet Per Carton: 11.5	3879 Laminate Top List Price: \$1455 Freestanding	3879																									
			<table border="1"> <thead> <tr> <th colspan="3">OVERALL DIMENSIONS</th> <th colspan="3">SEAT DIMENSIONS</th> <th colspan="3">BACK DIMENSIONS</th> </tr> <tr> <th>W</th><th>D</th><th>H</th> <th>W</th><th>D</th><th>H</th> <th>W</th><th>H</th> </tr> </thead> <tbody> <tr> <td>25</td><td>25</td><td>16</td> <td>-</td><td>-</td><td>-</td> <td>-</td><td>-</td> </tr> </tbody> </table>			OVERALL DIMENSIONS			SEAT DIMENSIONS			BACK DIMENSIONS			W	D	H	W	D	H	W	H	25	25	16	-	-
OVERALL DIMENSIONS			SEAT DIMENSIONS			BACK DIMENSIONS																					
W	D	H	W	D	H	W	H																				
25	25	16	-	-	-	-	-																				
RTA 00																											

DESCRIPTION	FEATURES	MODEL#	STANDARD TEXTILE GRADES														
			1	2	3	4	5	6	7	8	9	10	11	12			
 <p>Coffee Table - 54", Metal Legs COM Yardage: N/A Freight Class: 250 Product Weight (lbs.): 36 Cubic Feet Per Carton: 11.5</p>	<p>3880 List Price: \$1623 Laminate Top</p> <p>Freestanding</p>																
			OVERALL DIMENSIONS			SEAT DIMENSIONS			BACK DIMENSIONS								
			W	D	H	W	D	H	W	H							
			54	20	15	-	-	-	-	-							
RTA 00																	
 <p>3881R 3881L</p> <p>Bridge Corner Table, Metal Legs COM Yardage: N/A Freight Class: 250 Product Weight (lbs.): 33 Cubic Feet Per Carton: 11.5</p>	<p>3881R/3881L List Price: \$1743 Laminate Top</p> <p>Requires Bracket Kit (3360) to be used with Chair and Sofa models with metal legs.</p>																
			OVERALL DIMENSIONS			SEAT DIMENSIONS			BACK DIMENSIONS								
			W	D	H	W	D	H	W	H							
			25	25	12												
RTA 00																	
 <p>Bridge End Table COM Yardage: N/A Freight Class: 125 Product Weight (lbs.): 25 Cubic Feet Per Carton: 3.4</p>	<p>3882 List Price: \$952 Laminate Top</p> <p>Requires Bracket Kit (3360) to be used with Chair and Sofa models with metal legs.</p>																
			OVERALL DIMENSIONS			SEAT DIMENSIONS			BACK DIMENSIONS								
			W	D	H	W	D	H	W	H							
			20	25	5	-	-	-	-	-							
RTA 00																	
 <p>Low Side Table, Metal Legs COM Yardage: N/A Freight Class: 250 Product Weight (lbs.): 32 Cubic Feet Per Carton: 11.5</p>	<p>3883 List Price: \$1321 Laminate Top</p> <p>Freestanding</p>																
			OVERALL DIMENSIONS			SEAT DIMENSIONS			BACK DIMENSIONS								
			W	D	H	W	D	H	W	H							
			20	25	12	-	-	-	-	-							
RTA 00																	
 <p>Bridge Table - 20" Square COM Yardage: N/A Freight Class: 125 Product Weight (lbs.): 23 Cubic Feet Per Carton: 3.4</p>	<p>3884 List Price: \$886 Laminate Top</p> <p>Requires Bracket Kit (3360) to be used with Chair and Sofa models with metal legs.</p>																
			OVERALL DIMENSIONS			SEAT DIMENSIONS			BACK DIMENSIONS								
			W	D	H	W	D	H	W	H							
			20	20	5	-	-	-	-	-							
RTA 00																	

