

lounge

Ballara	258	Jeo	316	Venture	375
Braden	267	Kate	317	Vitrola	378
Bridges II Collaborative Seating	267	Lux	318	Wind Seating	380
calidon	275	ML	320	Wind Tables	382
calidon tables	278	ML Park	322	Wind Linear	384
Camino	281	Prairie	323	Wind Linear Tables	389
Citi	284	Rambler	324		
Citi Square	289	River	327		
Drift	298	River+	345		
Drift Tables	311	Sirena	372		

BALLARA™



model 9751



model 9751NA & 9757L



Quilted Seat Option
See optional features for more details.

STANDARD FEATURES

- An all inclusive, modular series which includes seating, storage, power, floating side tables and tablets.
- Fulfill many space planning scenarios including corner, in-line, open concept as well as traditional reception.
- Seating can be used as stand alone items or linked together with ganging brackets to create infinite configurations.
- Four high back (banquette) models available in two different heights (42" or 48") and two sizes (two-seat or three-seat armless sofas).
- Tablets can be mounted outside seats to accommodate various work and collaborative settings. Tablets have a 14" round surface and come with a 2-point locking mechanism for easy handling and stability.
- Floating tablets features durable and matching 3mm edges.
- Fixed cushions are accented by a metal base and frame.
- Power modules include one power outlet and two USB ports and can be mounted under any seat or table. Wire management is included.
- All models are standard with Black polypropylene foot glides.
- Check textile availability prior to specifying upholstery material.

OPTIONAL FEATURES

- Quilted Seat (**Q**) is available. Backless stools, add **\$113** each. Single seat models, add **\$224**. Two seater sofa, add **\$440**. Three seater sofa, add **\$661**.
- **Seating and Table Frame Finish:**
All chair frames, floating tablet metal components, ganging brackets and power modules are available in the following finishes
(**TBL**) Black
(**TDW**) Designer White
(**TTU**) Tungsten
(**CHM**) Chrome. **Upcharge varies.**
(**BCH**) Brushed Chrome. **Upcharge varies.**
Please Specify.

- Brushed Chrome (**BCH**) and Chrome (**CHM**) are available at an upcharge. Add **\$339** for counter height and bar height stools. Add **\$256** for single seat lounge chairs. Add **\$339** for two seat sofas. Add **\$424** for three seat sofas. Add **\$131** for tablets. Add **\$33** for ganging brackets. Add **\$26** for power modules.
- **Table Tops**
Floating tablets are offered in the following High Pressure Laminate finishes:
(**ACJ**) Absolute Acajou (**ASN**) Asian Night
(**AWC**) Avant Cherry (**AWH**) Avant Honey
(**BLK**) Black (**BRC**) Brushed Cobalt
(**BZD**) Blizzard (**CMB**) Clear Maple
(**CGY**) Custom Grey (**DES**) Dark Espresso
(**DWT**) Designer White (**FAS**) Fashionista
(**FCL**) First Class (**NBL**) Noce Biondo
(**NGL**) Noce Grigio (**NEL**) Noce Leggero
(**NML**) Noce Medio
(**QTM**) Quartered Mahogany
(**SBY**) Sheer Beauty (**SDT**) Stonedust
(**SOG**) Storm Grey (**WHE**) Walnut Heights
(**WHC**) White Chocolate (**WCR**) Winter Cherry

DESCRIPTION	FEATURES	MODEL#	STANDARD TEXTILE GRADES											
			1	2	3	4	5	6	7	8	9	10	11	12



Lounge Chair
COM Yardage: 4.25
Freight Class: 250
Product Weight (lbs.): 71
Cubic Feet Per Carton: 21.5

9751	2603	2748	2859	3029	3264	3350	3559	3956	4147	4518	5018	5643
-------------	------	------	------	------	------	------	------	------	------	------	------	------

OVERALL DIMENSIONS			SEAT DIMENSIONS			BACK DIMENSIONS	
W	D	H	W	D	H	W	H

30.5	31	30	24	20.5	18.5	22	12.5
------	----	----	----	------	------	----	------

RTA 00



9751R

9751L

Lounge Chair - One Arm
COM Yardage: 3.25
Freight Class: 250
Product Weight (lbs.): 61
Cubic Feet Per Carton: 20

Ganging clip required for sectional use

9751R	2227	2347	2441	2581	2780	2875	3056	3344	3565	3811	4860	5403
--------------	------	------	------	------	------	------	------	------	------	------	------	------

OVERALL DIMENSIONS			SEAT DIMENSIONS			BACK DIMENSIONS	
W	D	H	W	D	H	W	H

28.5	31	30	24	20.5	18.5	22	12.5
------	----	----	----	------	------	----	------

RTA 00

DESCRIPTION	FEATURES	MODEL#	STANDARD TEXTILE GRADES											
			1	2	3	4	5	6	7	8	9	10	11	12
 <p>Lounge Chair - Armless COM Yardage: 2.25 Freight Class: 250 Product Weight (lbs.): 51 Cubic Feet Per Carton: 18.75</p>	Ganging clip required for sectional use	9751NA	1846	1934	1998	2097	2236	2301	2428	2628	2784	2957	3312	3692
		OVERALL DIMENSIONS			SEAT DIMENSIONS			BACK DIMENSIONS						
		W	D	H	W	D	H	W	H					
		26.5	31	30	24	20.5	18.5	22	12.5					
			RTA 00											

DESCRIPTION	FEATURES	MODEL#	STANDARD TEXTILE GRADES											
			1	2	3	4	5	6	7	8	9	10	11	12
 <p>Corner Unit COM Yardage: 3 Freight Class: 250 Product Weight (lbs.): 72 Cubic Feet Per Carton: 18.5</p>	Ganging clip required for sectional use	9764	2393	2519	2614	2762	2972	3047	3230	3577	3745	4068	4507	5054
		OVERALL DIMENSIONS			SEAT DIMENSIONS			BACK DIMENSIONS						
		W	D	H	W	D	H	W	H					
		28.5	28.5	30	22	20.5	18.5	22	12.5					
			RTA 00											

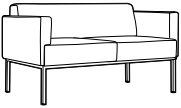
DESCRIPTION	FEATURES	MODEL#	STANDARD TEXTILE GRADES											
			1	2	3	4	5	6	7	8	9	10	11	12
 <p>Two Seat Sofa COM Yardage: 6.25 Freight Class: 250 Product Weight (lbs.): 111 Cubic Feet Per Carton: 37.5</p>		9752	4097	4314	4482	4734	5089	5217	5530	6126	6412	6965	7718	8659
		OVERALL DIMENSIONS			SEAT DIMENSIONS			BACK DIMENSIONS						
		W	D	H	W	D	H	W	H					
		56	31	30	48	20.5	18.5	44	12.5					
			RTA 00											

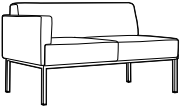
DESCRIPTION	FEATURES	MODEL#	STANDARD TEXTILE GRADES											
			1	2	3	4	5	6	7	8	9	10	11	12
 <p>Two Seat Sofa - One Arm COM Yardage: 5 Freight Class: 250 Product Weight (lbs.): 101 Cubic Feet Per Carton: 36.25</p>	Ganging clip required for sectional use	9752R	3668	3846	3988	4198	4492	4600	4862	5356	5598	6058	6686	7466
		OVERALL DIMENSIONS			SEAT DIMENSIONS			BACK DIMENSIONS						
		W	D	H	W	D	H	W	H					
		54	31	30	48	20.5	18.5	44	12.5					
			RTA 00											

DESCRIPTION	FEATURES	MODEL#	STANDARD TEXTILE GRADES											
			1	2	3	4	5	6	7	8	9	10	11	12
 <p>Two Seat Sofa - Armless COM Yardage: 4 Freight Class: 250 Product Weight (lbs.): 91 Cubic Feet Per Carton: 35.5</p>	Ganging clip required for sectional use	9752NA	3331	3477	3588	3758	3996	4082	4290	4687	4877	5247	5750	6374
		OVERALL DIMENSIONS			SEAT DIMENSIONS			BACK DIMENSIONS						
		W	D	H	W	D	H	W	H					
		52	31	30	48	20.5	18.5	44	12.5					
			RTA 00											

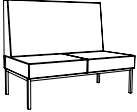

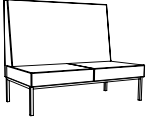
DESCRIPTION	FEATURES	MODEL#	STANDARD TEXTILE GRADES												
			1	2	3	4	5	6	7	8	9	10	11	12	
	Ganging clip required for sectional use	9752NAHB42	3023	3317	3549	3896	4387	4619	5067	5777	6327	6935	8191	9528	
		OVERALL DIMENSIONS			SEAT DIMENSIONS			BACK DIMENSIONS							
		W	D	H	W	D	H	W	H						
Two Seat Sofa - 42" High Back COM Yardage: 8 Freight Class: 250 Product Weight (lbs.): 120 Cubic Feet Per Carton: 48.5			52	31	42	48	20.5	18.5	44	24.5					
			RTA 00												

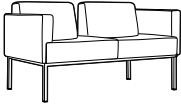
DESCRIPTION	FEATURES	MODEL#	STANDARD TEXTILE GRADES												
			1	2	3	4	5	6	7	8	9	10	11	12	
	Ganging clip required for sectional use	9752NAHB48	\$3128	\$3449	\$3702	\$4082	\$4618	\$4873	\$5361	\$6139	\$6740	\$7407	\$8779	\$10242	
		OVERALL DIMENSIONS			SEAT DIMENSIONS			BACK DIMENSIONS							
		W	D	H	W	D	H	W	H						
Two Seat Sofa - 48" High Back COM Yardage: 6 Freight Class: 250 Product Weight (lbs.): 130 Cubic Feet Per Carton: 35.25			52	31	48	48	20.5	18.5	44	30.5					
			RTA 00												

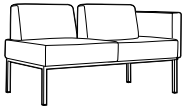
DESCRIPTION	FEATURES	MODEL#	STANDARD TEXTILE GRADES												
			1	2	3	4	5	6	7	8	9	10	11	12	
		9752-OB	4052	4266	4433	4685	5043	5170	5481	6078	6365	6919	7672	8609	
		OVERALL DIMENSIONS			SEAT DIMENSIONS			BACK DIMENSIONS							
		W	D	H	W	D	H	W	H						
Two Seat Sofa - Open Back COM Yardage: 6.25 Freight Class: 250 Product Weight (lbs.): 111 Cubic Feet Per Carton: 35.25			56	29.5	30	54	20.5	18.5	48	12.5					
			RTA 00												

DESCRIPTION	FEATURES	MODEL#	STANDARD TEXTILE GRADES												
			1	2	3	4	5	6	7	8	9	10	11	12	
 	Ganging clip required for sectional use	9752R-OB 9752L-OB	3627	3805	3945	4156	4453	4560	4821	5317	5556	6017	6645	6017	
		OVERALL DIMENSIONS			SEAT DIMENSIONS			BACK DIMENSIONS							
		W	D	H	W	D	H	W	H						
Two Seat Sofa - Open Back - One Arm COM Yardage: 5.25 Freight Class: 250 Product Weight (lbs.): 101 Cubic Feet Per Carton: 36.25			54	31	30	48	20.5	18.5	44	12.5					
			RTA 00												

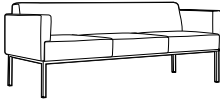
DESCRIPTION	FEATURES	MODEL#	STANDARD TEXTILE GRADES												
			1	2	3	4	5	6	7	8	9	10	11	12	
		9752NA-OB	3287	3432	3544	3713	3951	4034	4244	4643	4833	5202	5702	6327	
		OVERALL DIMENSIONS			SEAT DIMENSIONS			BACK DIMENSIONS							
		W	D	H	W	D	H	W	H						
Two Seat Sofa - Open Back - Armless COM Yardage: 4.25 Freight Class: 250 Product Weight (lbs.): 91 Cubic Feet Per Carton: 35.5			52	31	30	48	20.5	18.5	44	12.5					
			RTA 00												

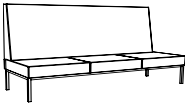
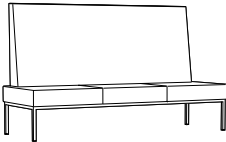
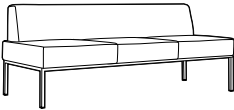
DESCRIPTION	FEATURES	MODEL#	STANDARD TEXTILE GRADES												
			1	2	3	4	5	6	7	8	9	10	11	12	
 Three Seat Sofa COM Yardage: 9.5 Freight Class: 250 Product Weight (lbs.): 153 Cubic Feet Per Carton: 54.5		9753	5480	5816	6084	6485	7056	7324	7838	8660	9295	9999	11450	12996	
			OVERALL DIMENSIONS			SEAT DIMENSIONS			BACK DIMENSIONS						
			W	D	H	W	D	H	W	H					
			82.5	31	30	76.5	20.5	18.5	66	12.5					
			RTA 00												
 Three Seat Sofa - One Arm COM Yardage: 8.25 Freight Class: 250 Product Weight (lbs.): 143 Cubic Feet Per Carton: 54.5	Ganging clip required for sectional use	9753R	5121	5416	5651	5998	6495	6726	7176	7892	8446	9058	10322	11668	
				OVERALL DIMENSIONS			SEAT DIMENSIONS			BACK DIMENSIONS					
				W	D	H	W	D	H	W	H				
				81.5	31	30	80.5	20.5	18.5	74	12.5				
			RTA 00												
 Three Seat Sofa - 42" High Back COM Yardage: 12.25 Freight Class: 300 Product Weight (lbs.): 143 Cubic Feet Per Carton: 72.50	Ganging clip required for sectional use	9753NAHB42	\$4554	\$4991	\$5336	\$5858	\$6597	\$6943	\$7612	\$8677	\$9500	\$10412	\$12293	\$14301	
				OVERALL DIMENSIONS			SEAT DIMENSIONS			BACK DIMENSIONS					
				W	D	H	W	D	H	W	H				
				80.5	31	42	74	20.5	18.5	74	24.5				
			RTA 00												
 Three Seat Sofa - 48" High Back COM Yardage: 13.25 Freight Class: 250 Product Weight (lbs.): 168 Cubic Feet Per Carton: 82.25	Ganging clip required for sectional use	9753NAHB48	4593	5042	5397	5932	6688	7044	7729	8821	9665	10600	12528	14585	
				OVERALL DIMENSIONS			SEAT DIMENSIONS			BACK DIMENSIONS					
				W	D	H	W	D	H	W	H				
				80.5	31	48	74	20.5	18.5	74	30.5				
			RTA 00												
 Three Seat Sofa - Armless COM Yardage: 7 Freight Class: 250 Product Weight (lbs.): 133 Cubic Feet Per Carton: 51.5	Ganging clip required for sectional use	9753NA	4717	4968	5166	5462	5884	6082	6465	7075	7545	8066	9141	10288	
				OVERALL DIMENSIONS			SEAT DIMENSIONS			BACK DIMENSIONS					
				W	D	H	W	D	H	W	H				
				80.5	31	30	80.5	20.5	18.5	74	12.5				
			RTA 00												

DESCRIPTION	FEATURES	MODEL#	STANDARD TEXTILE GRADES											
-------------	----------	--------	-------------------------	--	--	--	--	--	--	--	--	--	--	--

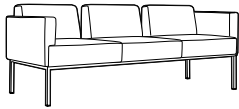

Three Seat Sofa - Open Back
 COM Yardage: 8
 Freight Class: 250
 Product Weight (lbs.): 153
 Cubic Feet Per Carton: 54.5

	1	2	3	4	5	6	7	8	9	10	11	12
9753-OB	5441	5722	5949	6285	6760	6930	7348	8143	8526	9264	10267	11515

OVERALL DIMENSIONS			SEAT DIMENSIONS			BACK DIMENSIONS	
W	D	H	W	D	H	W	H
82.5	31	30	80.5	20.5	18.5	74	12.5

RTA 00

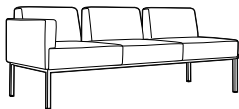

9753R-OB

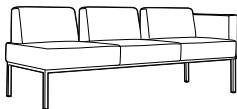

9753L-OB

Three Seat Sofa - Open Back - One Arm
 COM Yardage: 7
 Freight Class: 250
 Product Weight (lbs.): 143
 Cubic Feet Per Carton: 54.5

Ganging clip required for sectional use

	1	2	3	4	5	6	7	8	9	10	11	12
9753R-OB	5075	5324	5521	5814	6231	6379	6745	7442	7777	8421	9299	10394
9753L-OB												

OVERALL DIMENSIONS			SEAT DIMENSIONS			BACK DIMENSIONS	
W	D	H	W	D	H	W	H
81.5	31	30	80.5	20.5	17.5	74	12.5

RTA 00

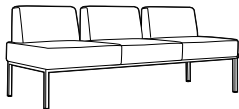

Three Seat Sofa - Open Back - Armless
 COM Yardage: 6.25
 Freight Class: 250
 Product Weight (lbs.): 133
 Cubic Feet Per Carton: 51.5

Ganging clip required for sectional use

	1	2	3	4	5	6	7	8	9	10	11	12
9753NA-OB	4670	4887	5055	5307	5662	5790	6103	6699	6987	7538	8292	9232

OVERALL DIMENSIONS			SEAT DIMENSIONS			BACK DIMENSIONS	
W	D	H	W	D	H	W	H
80.5	31	30	80.5	20.5	17.5	74	12.5

RTA 00



Ganging Bracket
 COM Yardage: N/A
 Freight Class: 70
 Product Weight (lbs.): .052
 Cubic Feet Per Carton: 0.02

Only one set is needed per connection.

	1	2	3	4	5	6	7	8	9	10	11	12
9759	27	-	-	-	-	-	-	-	-	-	-	-

OVERALL DIMENSIONS			SEAT DIMENSIONS			BACK DIMENSIONS	
W	D	H	W	D	H	W	H
1	0.75	10	-	-	-	-	-

RTA 00



9757L

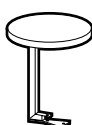

9758R

Tablet
 COM Yardage: N/A
 Freight Class: 150
 Product Weight (lbs.): 12
 Cubic Feet Per Carton: 2.5





Mounts underneath of seating.

	1	2	3	4	5	6	7	8	9	10	11	12
9757L	682	-	-	-	-	-	-	-	-	-	-	-
9758R												

OVERALL DIMENSIONS			SEAT DIMENSIONS			BACK DIMENSIONS	
W	D	H	W	D	H	W	H
14	17.25	14	-	-	-	-	-

RTA 1

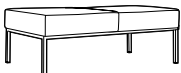

DESCRIPTION	FEATURES	MODEL#	STANDARD TEXTILE GRADES											
			1	2	3	4	5	6	7	8	9	10	11	12
 <p>9760</p> <p>Power Module COM Yardage: N/A Freight Class: 125 Product Weight (lbs.): 3 Cubic Feet Per Carton: 0.5</p>	Mounts underneath of seating or tables.	<p>9760</p> <p>\$430</p> <p>10 Ft. power cord</p>	1	2	3	4	5	6	7	8	9	10	11	12
			1	2	3	4	5	6	7	8	9	10	11	12
			1	2	3	4	5	6	7	8	9	10	11	12
			1	2	3	4	5	6	7	8	9	10	11	12
			OVERALL DIMENSIONS			SEAT DIMENSIONS			BACK DIMENSIONS					
			W	D	H	W	D	H	W	H				
			6	2.75	2.75	-	-	-	-	-				
			RTA 00			FedEx			ups					
 <p>9761</p> <p>One Seat Bench COM Yardage: 2 Freight Class: 250 Product Weight (lbs.): 37 Cubic Feet Per Carton: 10.75</p>	Ganging clip required for sectional use	<p>9761</p> <p>1381 1455 1512 1598 1718 1776 1885 2061 2197 2346 2656 2984</p>	1	2	3	4	5	6	7	8	9	10	11	12
			1	2	3	4	5	6	7	8	9	10	11	12
			1	2	3	4	5	6	7	8	9	10	11	12
			1	2	3	4	5	6	7	8	9	10	11	12
			OVERALL DIMENSIONS			SEAT DIMENSIONS			BACK DIMENSIONS					
			W	D	H	W	D	H	W	H				
			27.5	28.5	17.5	-	-	-	-	-				
			RTA 00											
 <p>9762</p> <p>Two Seat Bench COM Yardage: 4 Freight Class: 250 Product Weight (lbs.): 57 Cubic Feet Per Carton: 21.25</p>	Ganging clip required for sectional use	<p>9762</p> <p>2458 2604 2718 2890 3135 3250 3469 3821 4093 4394 5015 5676</p>	1	2	3	4	5	6	7	8	9	10	11	12
			1	2	3	4	5	6	7	8	9	10	11	12
			1	2	3	4	5	6	7	8	9	10	11	12
			1	2	3	4	5	6	7	8	9	10	11	12
			OVERALL DIMENSIONS			SEAT DIMENSIONS			BACK DIMENSIONS					
			W	D	H	W	D	H	W	H				
			54	28.5	17.5	-	-	-	-	-				
			RTA 00											
 <p>9763</p> <p>Three Seat Bench COM Yardage: 6 Freight Class: 250 Product Weight (lbs.): 80 Cubic Feet Per Carton: 29.5</p>	Ganging clip required for sectional use	<p>9763</p> <p>3478 3695 3863 4117 4479 4648 4973 5494 5893 6341 7258 8239</p>	1	2	3	4	5	6	7	8	9	10	11	12
			1	2	3	4	5	6	7	8	9	10	11	12
			1	2	3	4	5	6	7	8	9	10	11	12
			1	2	3	4	5	6	7	8	9	10	11	12
			OVERALL DIMENSIONS			SEAT DIMENSIONS			BACK DIMENSIONS					
			W	D	H	W	D	H	W	H				
			80.5	28.5	17.5	-	-	-	-	-				
			RTA 00											
 <p>9765</p> <p>Coffee Storage Table (2 Seat Length) COM Yardage: N/A Freight Class: 150 Product Weight (lbs.): 112 Cubic Feet Per Carton: 20.5</p>	Ganging clip required for sectional use	<p>9765</p> <p>2564 - - - - - - - - - - - -</p>	1	2	3	4	5	6	7	8	9	10	11	12
			1	2	3	4	5	6	7	8	9	10	11	12
			1	2	3	4	5	6	7	8	9	10	11	12
			1	2	3	4	5	6	7	8	9	10	11	12
			OVERALL DIMENSIONS			SEAT DIMENSIONS			BACK DIMENSIONS					
			W	D	H	W	D	H	W	H				
			53.75	27.25	16.5	-	-	-	-	-				
			RTA 00											

DESCRIPTION	FEATURES	MODEL#	STANDARD TEXTILE GRADES											
-------------	----------	--------	-------------------------	--	--	--	--	--	--	--	--	--	--	--



Coffee Table (2 Seat Length)
 COM Yardage: N/A
 Freight Class: 150
 Product Weight (lbs.): 68
 Cubic Feet Per Carton: 17.75

	1	2	3	4	5	6	7	8	9	10	11	12
9766	1659	-	-	-	-	-	-	-	-	-	-	-
OVERALL DIMENSIONS			SEAT DIMENSIONS			BACK DIMENSIONS						
W	D	H	W	D	H	W	D	H	W	H		
54	27.5	13	-	-	-	-	-	-	-	-		
RTA 00												

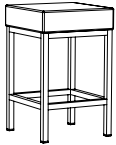

24" Stool
 COM Yardage: 0.75
 Freight Class: 150
 Product Weight (lbs.): 22
 Cubic Feet Per Carton: 4.75

	1	2	3	4	5	6	7	8	9	10	11	12
9769S24	\$906	\$935	\$956	\$987	\$1032	\$1053	\$1094	\$1158	\$1207	\$1262	\$1376	\$1498
OVERALL DIMENSIONS			SEAT DIMENSIONS			BACK DIMENSIONS						
W	D	H	W	D	H	W	D	H	W	H		
15	15	24	15	15	3	-	-	-	-	-		
RTA 00												

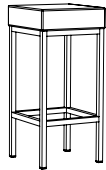

30" Stool
 COM Yardage: .50
 Freight Class: 150
 Product Weight (lbs.): 23
 Cubic Feet Per Carton: 5.5

	1	2	3	4	5	6	7	8	9	10	11	12
9769S30	\$987	\$1016	\$1037	\$1068	\$1112	\$1133	\$1172	\$1235	\$1284	\$1339	\$1449	\$1568
OVERALL DIMENSIONS			SEAT DIMENSIONS			BACK DIMENSIONS						
W	D	H	W	D	H	W	D	H	W	H		
15	15	30	15	15	30	-	-	-	-	-		
RTA 00												

BRADEN™



model 7871







model 7870R, 7870, 7870L



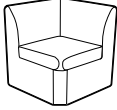

STANDARD FEATURES

- A flexible modular seating system that is exceptionally durable. Combine these seating components into a configuration that suits your space.
- Braden uses a unique ganging feature which locks units solidly together, but allows them to be separated and reconfigured when necessary. Locking "Pins" will always be on the left side of a ganging unit, while the pin receptacle will always be on the right side, seated.
- Check textile availability prior to specifying upholstery material.

OPTIONAL FEATURES

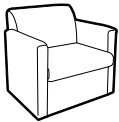
- For ganging hardware please use the following codes: Add "GB" for both sides. Add "GR" for right side seated only. Add "GL" for Left side seated only. Add "GC" for corner units only, both sides.
- For highly resilient, high density Ultracell foam on seat, Please specify (UC) after the model number. Add \$78 for the seat. Add \$151 for the seat and back.
- Optional Non-slip glide for hard surface flooring. Please specify (NSG). Add \$37.
- Model 7874 Table (top) is offered in all the standard laminates. Please specify.

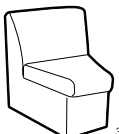
DESCRIPTION	FEATURES	MODEL#	STANDARD TEXTILE GRADES											
			1	2	3	4	5	6	7	8	9	10	11	12
 <p>Corner Unit COM Yardage: 16.5 Freight Class: Product Weight (lbs.): 38 Cubic Feet Per Carton: 16.5</p>		7867	1372	1537	1665	1854	2126	2251	2499	2890	3189	3527	4216	4951
			OVERALL DIMENSIONS			SEAT DIMENSIONS			BACK DIMENSIONS					
			W	D	H	W	D	H	W	H				
			24	27.5	30	20	17	20.5	19.5	12.5				
			RTA 00											
 <p>Single Seater COM Yardage: 2.75 Freight Class: 250 Product Weight (lbs.): 38 Cubic Feet Per Carton: 16.5</p>		7870	853	973	1062	1198	1388	1461	1627	1950	2102	2401	2806	3312
			OVERALL DIMENSIONS			SEAT DIMENSIONS			BACK DIMENSIONS					
			W	D	H	W	D	H	W	H				
			24	27.5	30	24	19.5	16.5	24	13.5				
			RTA 00											
 <p>Single Seater - Left Arm COM Yardage: 3.75 Freight Class: 250 Product Weight (lbs.): 45 Cubic Feet Per Carton: 16.5</p>		7870L	972	1131	1253	1441	1703	1795	2026	2464	2676	3080	3634	4324
			OVERALL DIMENSIONS			SEAT DIMENSIONS			BACK DIMENSIONS					
			W	D	H	W	D	H	W	H				
			27	27.5	30	24	19.5	16.5	24	13.5				
			RTA 00											
 <p>Single Seater - Right Arm COM Yardage: 3.75 Freight Class: 250 Product Weight (lbs.): 45 Cubic Feet Per Carton: 16.5</p>		7870R	972	1131	1253	1441	1703	1795	2026	2464	2676	3080	3634	4324
			OVERALL DIMENSIONS			SEAT DIMENSIONS			BACK DIMENSIONS					
			W	D	H	W	D	H	W	H				
			27	27.5	30	24	19.5	16.5	24	13.5				
			RTA 00											

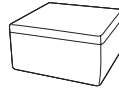
DESCRIPTION	FEATURES	MODEL#	STANDARD TEXTILE GRADES											
			1	2	3	4	5	6	7	8	9	10	11	12
 <p>Single Seater - with Arms COM Yardage: 4.75 Freight Class: 250 Product Weight (lbs.): 52 Cubic Feet Per Carton: 16.5</p>		7871	1199	1381	1525	1739	2043	2152	2417	2930	3172	3644	4286	5083
			OVERALL DIMENSIONS			SEAT DIMENSIONS			BACK DIMENSIONS					
			W	D	H	W	D	H	W	H				
			30	27.5	30	24	19.5	16.5	24	13.5				
			RTA 00											
 <p>Corner Unit COM Yardage: 2.75 Freight Class: 300 Product Weight (lbs.): 31 Cubic Feet Per Carton: 16.5</p>		7872	788	908	997	1133	1323	1396	1562	1885	2037	2336	2741	3247
			OVERALL DIMENSIONS			SEAT DIMENSIONS			BACK DIMENSIONS					
			W	D	H	W	D	H	W	H				
			24	27.5	30	20	19.5	16.5	15	13.5				
			RTA 00											
 <p>Corner Unit COM Yardage: 2.75 Freight Class: 300 Product Weight (lbs.): 31 Cubic Feet Per Carton: 16.5</p>		7873	788	908	997	1133	1323	1396	1562	1885	2037	2336	2741	3247
			OVERALL DIMENSIONS			SEAT DIMENSIONS			BACK DIMENSIONS					
			W	D	H	W	D	H	W	H				
			24	27.5	30	16	19.5	16.5	21.5	13.5				
			RTA 00											
 <p>Table - 24" Square w/Upholstered Sides COM Yardage: 1.75 Freight Class: 125 Product Weight (lbs.): 38 Cubic Feet Per Carton: 6.25</p>		7874	644	720	777	863	985	1032	1137	1342	1439	1630	1887	2209
			OVERALL DIMENSIONS			SEAT DIMENSIONS			BACK DIMENSIONS					
			W	D	H	W	D	H	W	H				
			24	24	14.5	-	-	-	-	-				
			RTA 00 FedEx ups											
 <p>Foot Stool/Single Bench - 24" Square COM Yardage: 1.75 Freight Class: 125 Product Weight (lbs.): 38 Cubic Feet Per Carton: 6.25</p>		7874FS	734	825	893	998	1145	1197	1326	1571	1688	1916	2226	2611
			OVERALL DIMENSIONS			SEAT DIMENSIONS			BACK DIMENSIONS					
			W	D	H	W	D	H	W	H				
			24	24	17.5	-	-	-	-	-				
			RTA 00											

BRIDGES II COLLABORATIVE SEATING



model BRTSE2424B



model BRTSE6060B



model BRTST2448F

STANDARD FEATURES

- For all Bridges II components, please see the Bridges II section of the Desking Price Book.
- Bridges collaborative seating collection consists of seating, privacy screens, tables, tablets and power.
- It is a versatile modular furniture series which can be configured into many space planning scenarios, including corner, in-line, open concept, traditional reception, as well as secluded seating with high privacy partitions.
- Furniture pieces can be used as stand alone items or can be mechanically linked together to form a variety of seating configurations.
- Seat and backrest can be integrated with Bridges tables.
- Corner tables and in-line 6" table modules double as power delivery centers.
- Dedicated seat backrests feature dual USB charging port.
- Some in line 6" table modules are furnished with grommets to support tablets.
- Legs are available in standard Bridges metal painted finishes and anodized aluminum finish.
- Bridges Collaborative Seating upholstery features a single stitch, thick white thread around the edges. The white, wide stitch along with crisp corners are part of its distinctive personality.
- In order to achieve crisp edges and to minimize "pillow" effect caused by taut fabric, the upholstery material has been applied deliberately loose, which may over time, produce puckering of the upholstery surface material. This can be easily corrected by stretching the fabric by hand or during vacuuming.
- Freestanding 17"h table. Central partition divides space under top surface into two 11" deep compartments.

- In order to efficiently utilize fabric yield, all 60" seats and backs feature a seam in the middle. The double stitch seam is sewn with a thin thread, closely matching the upholstery material in color.
- Some complicated fabric patterns prevent pattern matching and will be upholstered without the seam at the discretion of the factory.
- Should you require no middle seam by cutting into the roll, please specify "NO SEAM" at time of your order.
- Check textile availability prior to specifying upholstery material.

OPTIONAL FEATURES

- Optional Anodized Aluminum Leg on all models. Add \$79.
- Models BRTS2406BT and BRTS2406BPT include 9.5" x 14.5" swivel tablet. If top is specified in high pressure laminate, tablet will also be manufactured in high pressure laminate.
- Bridges II tables and tablets are offered in the following laminate finishes: Absolute Acajou (ACJ), Asian Night (ASN), Avant Cherry (AWC), Avant Honey (AWH), Black (BLK), Brushed Cobalt (BRC), Clear Maple (CMB), Custom Grey (CGY), Dark Espresso (DES), Designer White (DWT), Fashionista (FAS), First Class (FCL), Noce Biondo (NBL), Noce Grigio (NGL), Noce Leggero (NEL), Noce Medio (NML), Quartered Mahogany (QTM), Sheer Beauty (SBY) Storm Grey (SOG), Walnut Heights (WHE), White Chocolate (WHC) and Winter Cherry (WCR). Please Specify.

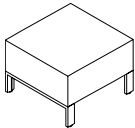
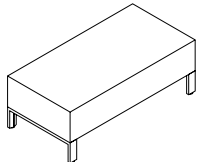
DESCRIPTION	FEATURES	MODEL#	STANDARD TEXTILE GRADES											
			1	2	3	4	5	6	7	8	9	10	11	12
 <p>Lounge Seat - 24" COM Yardage: 1.25 Freight Class: 150 Product Weight (lbs.): 22.70 Cubic Feet Per Carton: 5.57</p>		BRTSE24NB	839	920	920	972	1044	1077	1143	1247	1328	1418	1600	1797
			OVERALL DIMENSIONS			SEAT DIMENSIONS			BACK DIMENSIONS					
			W	D	H	W	D	H	W	H				
			24	24	17	-	-	-	-	-				
		RTA 00												
 <p>Lounge Seat - 48" COM Yardage: 2 Freight Class: 250 Product Weight (lbs.): 36.90 Cubic Feet Per Carton: 11.33</p>		BRTSE48NB	1527	1655	1655	1737	1851	1907	2012	2179	2306	2451	2746	3058
			OVERALL DIMENSIONS			SEAT DIMENSIONS			BACK DIMENSIONS					
			W	D	H	W	D	H	W	H				
			48	24	17	-	-	-	-	-				
		RTA 00												

DESCRIPTION	FEATURES	MODEL#	STANDARD TEXTILE GRADES											
			1	2	3	4	5	6	7	8	9	10	11	12

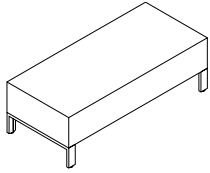

Lounge Seat - 60"
 COM Yardage: 2
 Freight Class: 250
 Product Weight (lbs.): 47
 Cubic Feet Per Carton: 14.17

BRTSE60NB	1767	1857	1925	2025	2172	2238	2370	2579	2740	2920	3285	3679
------------------	------	------	------	------	------	------	------	------	------	------	------	------

OVERALL DIMENSIONS			SEAT DIMENSIONS			BACK DIMENSIONS	
W	D	H	W	D	H	W	H
60	24	17	-	-	-	-	-

RTA 00

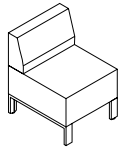

Lounge Seat, Full Backrest - 24"
 COM Yardage: 2.25
 Freight Class: 250
 Product Weight (lbs.): 33
 Cubic Feet Per Carton: 9.57

BRTSE2424B	1320	1463	1463	1554	1684	1745	1864	2051	2196	2358	2690	3042
-------------------	------	------	------	------	------	------	------	------	------	------	------	------

OVERALL DIMENSIONS			SEAT DIMENSIONS			BACK DIMENSIONS	
W	D	H	W	D	H	W	H
24	24	29	-	-	-	-	-

RTA 00

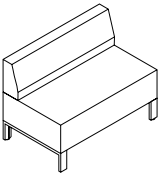

Lounge Seat, Full Backrest - 48"
 COM Yardage: 3.5
 Freight Class: 250
 Product Weight (lbs.): 55.50
 Cubic Feet Per Carton: 19.33

BRTSE4848B	2435	2654	2654	2797	3001	3095	3277	3569	3794	4045	4561	5110
-------------------	------	------	------	------	------	------	------	------	------	------	------	------

OVERALL DIMENSIONS			SEAT DIMENSIONS			BACK DIMENSIONS	
W	D	H	W	D	H	W	H
48	24	29	-	-	-	-	-

RTA 00

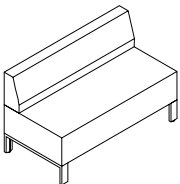

Lounge Seat, Full Backrest - 60"
 COM Yardage: 4.5
 Freight Class: 250
 Product Weight (lbs.): 70
 Cubic Feet Per Carton: 24.17

BRTSE6060B	2822	3103	3103	3286	3545	3668	3906	4280	4568	4890	5554	6261
-------------------	------	------	------	------	------	------	------	------	------	------	------	------

OVERALL DIMENSIONS			SEAT DIMENSIONS			BACK DIMENSIONS	
W	D	H	W	D	H	W	H
60	60	29	-	-	-	-	-

RTA 00

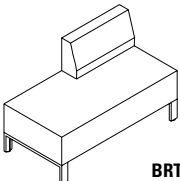

BRTSE2448BR

Lounge Seat, 24" Offset Backrest
 COM Yardage: 3
 Freight Class: 250
 Product Weight (lbs.): 46.1
 Cubic Feet Per Carton: 19.33

BRTSE2448BR	2007	2198	2198	2317	2492	2574	2731	2983	3175	3387	3831	4302
--------------------	------	------	------	------	------	------	------	------	------	------	------	------

BRTSE2448BL	2007	2198	2198	2317	2492	2574	2731	2983	3175	3387	3831	4302
--------------------	------	------	------	------	------	------	------	------	------	------	------	------

OVERALL DIMENSIONS			SEAT DIMENSIONS			BACK DIMENSIONS	
W	D	H	W	D	H	W	H
48	24	29	-	-	-	-	-

RTA 00

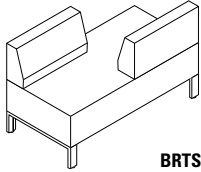
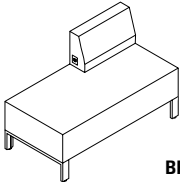
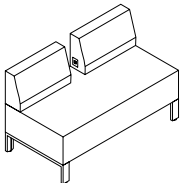
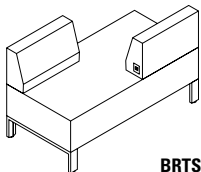
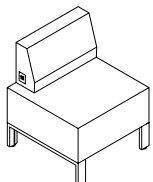
DESCRIPTION	FEATURES	MODEL#	STANDARD TEXTILE GRADES											
			1	2	3	4	5	6	7	8	9	10	11	12
 <p>BRTSE2448BODR</p> <p>Lounge Seat, Two 24" Offset Backrests COM Yardage: 4 Freight Class: 250 Product Weight (lbs.): 46.5 Cubic Feet Per Carton: 19.33</p>														
	BRTSE2448BODR	2488	2738	2738	2902	3132	3241	3452	3786	4041	4330	4919	5545	
	BRTSE2448BODL	2488	2629	2738	2902	3132	3241	3452	3786	4041	4330	4919	5545	
	OVERALL DIMENSIONS	W	D	H	SEAT DIMENSIONS			BACK DIMENSIONS						
	48	24	29	-	-	-	-	-						
	RTA 00													
 <p>BRTSE2148EBR</p> <p>Lounge Seat, 21" USB Backrest COM Yardage: 3 Freight Class: 250 Product Weight (lbs.): 33 Cubic Feet Per Carton: 9.67</p>														
	BRTSE2148EBR	2326	2436	2517	2636	2811	2893	3050	3302	3494	3706	4150	4621	
	BRTSE2148EBL	2326	2436	2517	2636	2811	2893	3050	3302	3494	3706	4150	4621	
	OVERALL DIMENSIONS	W	D	H	SEAT DIMENSIONS			BACK DIMENSIONS						
	48	24	29	-	-	-	-	-						
	RTA 00													
 <p>BRTSE2148E2B</p> <p>Lounge Seat, Two 21" USB Backrests COM Yardage: 4 Freight Class: 250 Product Weight (lbs.): 57 Cubic Feet Per Carton: 19.33</p>														
	BRTSE2148E2B	3125	3266	3372	3536	3767	3878	4088	4422	4678	4964	5553	6181	
	OVERALL DIMENSIONS	W	D	H	SEAT DIMENSIONS			BACK DIMENSIONS						
		48	24	29	-	-	-	-	-					
	RTA 00													
 <p>BRTSE2148EBODR</p> <p>Lounge Seat, Two Offset USB Backrests COM Yardage: 4 Freight Class: 250 Product Weight (lbs.): 57 Cubic Feet Per Carton: 19.33</p>														
	BRTSE2148EBODR	3125	3266	3372	3536	3767	3878	4088	4422	4678	4964	5553	6181	
	BRTSE2148EBODL	3125	3266	3372	3536	3767	3878	4088	4422	4678	4964	5553	6181	
	OVERALL DIMENSIONS	W	D	H	SEAT DIMENSIONS			BACK DIMENSIONS						
	48	24	29	-	-	-	-	-						
	RTA 00													
 <p>BRTSE2124EBR</p> <p>Lounge Seat, 21" USB Backrest COM Yardage: 2.25 Freight Class: 250 Product Weight (lbs.): 46.10 Cubic Feet Per Carton: 19.33</p>														
	BRTSE2124EBR	3125	1719	1782	1872	2002	2066	2183	2370	2514	2676	3008	3360	
	BRTSE2124EBL	1638	1719	1782	1872	2002	2066	2183	2370	2514	2676	3008	3360	
	OVERALL DIMENSIONS	W	D	H	SEAT DIMENSIONS			BACK DIMENSIONS						
	48	24	29	-	-	-	-	-						
	RTA 00													

DESCRIPTION	FEATURES	MODEL#	STANDARD TEXTILE GRADES											
			1	2	3	4	5	6	7	8	9	10	11	12

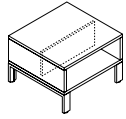

Low Table - 24"
 COM Yardage: N/A
 Freight Class: 125
 Product Weight (lbs.): 40.70
 Cubic Feet Per Carton: 5.67

BRTST2424F	938	-	-	-	-	-	-	-	-	-	-	-	-
-------------------	-----	---	---	---	---	---	---	---	---	---	---	---	---

OVERALL DIMENSIONS			SEAT DIMENSIONS			BACK DIMENSIONS	
W	D	H	W	D	H	W	H
24	24	17	-	-	-	-	-

RTA 00

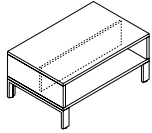

Low Table - 48"
 COM Yardage: N/A
 Freight Class: 125
 Product Weight (lbs.): 69
 Cubic Feet Per Carton: 11.33

BRTST2448F	938	-	-	-	-	-	-	-	-	-	-	-	-
-------------------	-----	---	---	---	---	---	---	---	---	---	---	---	---

OVERALL DIMENSIONS			SEAT DIMENSIONS			BACK DIMENSIONS	
W	D	H	W	D	H	W	H
48	24	17	-	-	-	-	-

RTA 00

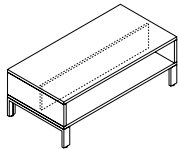

Low Table - 60"
 COM Yardage: N/A
 Freight Class: 150
 Product Weight (lbs.): 83.60
 Cubic Feet Per Carton: 14.17

BRTST2460F	938	-	-	-	-	-	-	-	-	-	-	-	-
-------------------	-----	---	---	---	---	---	---	---	---	---	---	---	---

OVERALL DIMENSIONS			SEAT DIMENSIONS			BACK DIMENSIONS	
W	D	H	W	D	H	W	H
60	24	17	-	-	-	-	-

RTA 00

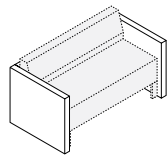

Seat Partitions - 24"
 COM Yardage:
 Freight Class: 250
 Product Weight (lbs.): 32
 Cubic Feet Per Carton: 12.04

BRTPP2424L1	1547	-	-	-	-	-	-	-	-	-	-	-	-
--------------------	------	---	---	---	---	---	---	---	---	---	---	---	---

OVERALL DIMENSIONS			SEAT DIMENSIONS			BACK DIMENSIONS	
W	D	H	W	D	H	W	H
29	28.7	25	-	-	-	-	-

RTA 00

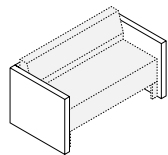

Seat Partitions - 48"
 COM Yardage:
 Freight Class: 300
 Product Weight (lbs.): 41
 Cubic Feet Per Carton: 22.01

BRTPP2448L1	2068	-	-	-	-	-	-	-	-	-	-	-	-
--------------------	------	---	---	---	---	---	---	---	---	---	---	---	---

OVERALL DIMENSIONS			SEAT DIMENSIONS			BACK DIMENSIONS	
W	D	H	W	D	H	W	H
53	28.7	25	-	-	-	-	-

RTA 00

LOUNGE

BRIDGES II COLLABORATIVE SEATING B

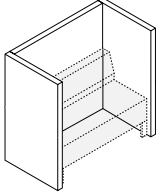
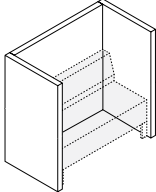
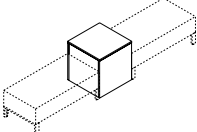
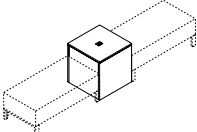
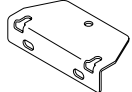
DESCRIPTION	FEATURES	MODEL#	STANDARD TEXTILE GRADES													
			1	2	3	4	5	6	7	8	9	10	11	12		
 <p>Seat Privacy Partitions - 24" COM Yardage: Freight Class: 300 Product Weight (lbs.): 32 Cubic Feet Per Carton: 24.08</p>	Fully 3 - Part Kit Seating not included. Panel textiles only.	BRTPP2424L2	2342	-	-	-	-	-	-	-	-	-	-	-		
			OVERALL DIMENSIONS			SEAT DIMENSIONS			BACK DIMENSIONS							
			W	D	H	W	D	H	W	H						
			29	28.7	50	-	-	-	-	-						
			RTA 00													
 <p>Seat Privacy Partitions - 48" COM Yardage: Freight Class: 400 Product Weight (lbs.): 41 Cubic Feet Per Carton: 44.01</p>	Fully 3 - Part Kit Seating not included.	BRTPP2448L2	2996	-	-	-	-	-	-	-	-	-	-	-		
			OVERALL DIMENSIONS			SEAT DIMENSIONS			BACK DIMENSIONS							
			W	D	H	W	D	H	W	H						
			53	28.7	50	-	-	-	-	-						
			RTA 00													
 <p>Square Table Block - No Power COM Yardage: N/A Freight Class: 250 Product Weight (lbs.): 32 Cubic Feet Per Carton: 12.04</p>	Freestanding Table. Seating not included. Includes 2 brackets and screws	BRTS2424B	660	-	-	-	-	-	-	-	-	-	-	-		
			OVERALL DIMENSIONS			SEAT DIMENSIONS			BACK DIMENSIONS							
			W	D	H	W	D	H	W	H						
			24	24	25	-	-	-	-	-						
			RTA 00													
 <p>Square Table Block w/ Center Power COM Yardage: N/A Freight Class: 125 Product Weight (lbs.): 59.30 Cubic Feet Per Carton: 8.33</p>	Freestanding Table. Seating not included. Includes 2 brackets and screws	BRTS2424BP	660	-	-	-	-	-	-	-	-	-	-	-		
			OVERALL DIMENSIONS			SEAT DIMENSIONS			BACK DIMENSIONS							
			W	D	H	W	D	H	W	H						
			24	24	25	-	-	-	-	-						
			RTA 00													
 <p>Square Table Block Ganging Bracket Kit COM Yardage: N/A Freight Class: 70 Product Weight (lbs.): 0.05 Cubic Feet Per Carton: 0.01</p>	Includes 2 brackets and screws. Black Only.	BRTSTBG	51	-	-	-	-	-	-	-	-	-	-	-		
			OVERALL DIMENSIONS			SEAT DIMENSIONS			BACK DIMENSIONS							
			W	D	H	W	D	H	W	H						
			5	2.4	1.1	-	-	-	-	-						
			RTA 00													

DESCRIPTION FEATURES MODEL# STANDARD TEXTILE GRADES

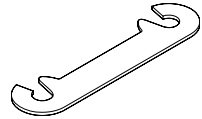

Ganging Bracket Kit
 COM Yardage: N/A
 Freight Class: 70
 Product Weight (lbs.): 0.03
 Cubic Feet Per Carton: 0.01

	1	2	3	4	5	6	7	8	9	10	11	12
BRTSTSB	23	-	-	-	-	-	-	-	-	-	-	-

OVERALL DIMENSIONS			SEAT DIMENSIONS			BACK DIMENSIONS	
W	D	H	W	D	H	W	H
6	1.3	0.1	-	-	-	-	-

RTA 00

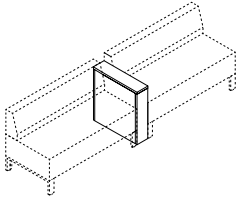

Inline 6" Table Block
 COM Yardage: N/A
 Freight Class: 92.50
 Product Weight (lbs.): 21
 Cubic Feet Per Carton: 2.08

Must use with seating.
 Seating not included.
 Includes 2 brackets and screws

	1	2	3	4	5	6	7	8	9	10	11	12
BRTS2406B	566	-	-	-	-	-	-	-	-	-	-	-

OVERALL DIMENSIONS			SEAT DIMENSIONS			BACK DIMENSIONS	
W	D	H	W	D	H	W	H
6	24	25	-	-	-	-	-

RTA 00

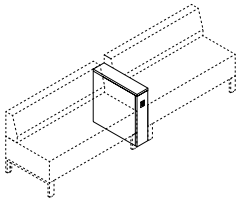

Inline 6" Table Block w/ Front Power
 COM Yardage: N/A
 Freight Class: 92.50
 Product Weight (lbs.): 23.30
 Cubic Feet Per Carton: 2.08

Must use with seating.
 Seating not included.
 Includes 2 brackets and screws

	1	2	3	4	5	6	7	8	9	10	11	12
BRTS2406BP	1219	-	-	-	-	-	-	-	-	-	-	-

OVERALL DIMENSIONS			SEAT DIMENSIONS			BACK DIMENSIONS	
W	D	H	W	D	H	W	H
6	24	25	-	-	-	-	-

RTA 00

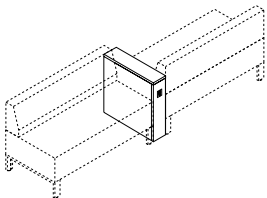

Inline 6" Table Block w/ Front & Rear Power
 COM Yardage: N/A
 Freight Class: 92.50
 Product Weight (lbs.): 24.30
 Cubic Feet Per Carton: 2.08

Must use with seating.
 Seating not included.
 Includes 2 brackets and screws

	1	2	3	4	5	6	7	8	9	10	11	12
BRTS2406B2P	1873	-	-	-	-	-	-	-	-	-	-	-

OVERALL DIMENSIONS			SEAT DIMENSIONS			BACK DIMENSIONS	
W	D	H	W	D	H	W	H
6	24	25	-	-	-	-	-

RTA 00

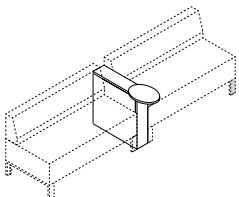

Inline 6" Table Block w/ Tablet Arm
 COM Yardage: N/A
 Freight Class: 85
 Product Weight (lbs.): 25.60
 Cubic Feet Per Carton: 2.08

Must use with seating.
 Seating not included.
 Includes 2 brackets and screws

	1	2	3	4	5	6	7	8	9	10	11	12
BRTS2406BT	1080	-	-	-	-	-	-	-	-	-	-	-

OVERALL DIMENSIONS			SEAT DIMENSIONS			BACK DIMENSIONS	
W	D	H	W	D	H	W	H
6	24	25	-	-	-	-	-

RTA 00

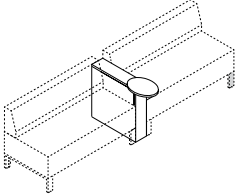
DESCRIPTION	FEATURES	MODEL#	STANDARD TEXTILE GRADES																										
			1	2	3	4	5	6	7	8	9	10	11	12															
 <p>Inline 6" Table Block w/ Front Power & Tablet Arm COM Yardage: N/A Freight Class: 92.50 Product Weight (lbs.): 24.30 Cubic Feet Per Carton: 2.08</p>	<p>Must use with seating. Seating not included. Includes 2 brackets and screws</p>	BRTS2406BPT	1733	-	-	-	-	-	-	-	-	-	-	-															
		<table border="1"> <thead> <tr> <th colspan="3">OVERALL DIMENSIONS</th> <th colspan="3">SEAT DIMENSIONS</th> <th colspan="2">BACK DIMENSIONS</th> </tr> <tr> <th>W</th> <th>D</th> <th>H</th> <th>W</th> <th>D</th> <th>H</th> <th>W</th> <th>H</th> </tr> </thead> <tbody> <tr> <td>6</td> <td>24</td> <td>25</td> <td>-</td> <td>-</td> <td>-</td> <td>-</td> <td>-</td> </tr> </tbody> </table>			OVERALL DIMENSIONS			SEAT DIMENSIONS			BACK DIMENSIONS		W	D	H	W	D	H	W	H	6	24	25	-	-	-	-	-	<p>RTA 00</p>
OVERALL DIMENSIONS			SEAT DIMENSIONS			BACK DIMENSIONS																							
W	D	H	W	D	H	W	H																						
6	24	25	-	-	-	-	-																						

CALIDON



GC36305
Wood Lounge Single Seat, Open Arms



GC36301
Wood Guest Single Seat, Open Arms



GC36308
Wood Lounge Single Seat, Closed Arms



For Calidon tables, see page 278

EXAMPLE CALIDON ORDER CODE:

GC36308	PU75	AAM	NBS
Model #	Textile	Frame Finish	Sealed Back Seams
NSS	NB	NM	SRT
Sealed Seat Seams	Moisture Barrier	Glides	Power

STANDARD FEATURES

- Calidon series consists of wood frame guest, lounge, bariatric and bench seating in addition to fully upholstered lounge seating. Freestanding and tandem/bridge tables also available to complement the line.
- Calidon is designed for the rigors of high use environments. Lounge units include metal frame supports.
- The seating in this series is available to specify with two textiles, one for the seat cushion and one for the back and arms (see model image).
- For pricing, start with the base price and add both back/arms graded textile upcharge and the seat graded textile upcharge.
- Frame design features a wall saver leg to prevent back contact and damage to walls.
- All guest and lounge chairs feature a clean out between seat and back, replaceable seat cushions and tall legs for ease of cleaning.
- For added comfort, seats are standard with high density Ultracell foam.
- Active weight capacity up to 400 lbs/seat for standard seating; up to 600 lbs for bariatric seating .
- For healthcare textiles, visit the website at globalfurnituregroup.com.
- Textiles with a minimum of 100,000 double rubs must be specified to meet Global's 24/7 warranty coverage.
- Can be upholstered in standard Global textiles if Healthcare 24/7 warranty compliance is not required.
- For alternate textile applications, contact Global specials. The Blended Textile matrix does not apply to this series.
- Tandem table models connect to guest seating only. See Calidon tables.
- No seating or bench models gang together.
- Shipped fully assembled.

OPTIONAL FEATURES

- All guest and lounge models can be specified with or without armcaps. Urethane armcaps are available on Wood arm guest and lounge chairs. Solid surface armcaps are available on all chair models. Armcaps are field replaceable, securely fastened with metal-to-metal connectors. Armcaps cannot be retrofitted in the field on units with no existing armcaps.
- Fully upholstered lounge chairs can be specified with a tamperproof Black power/USB unit, which includes one AC outlet, two 10 watt USB ports, and a 10 ft long power cord. Power is factory installed and must be specified at time of order. Add **\$251** each. Power locations vary by model. See power location diagram.
- For moisture barrier on seat, specify **(MB)**. Upcharges vary, see model.
- To add sealed seams, specify **(SBS)** for seat back and arms and/or **(SSS)** for seat. Upcharges vary, see model.
- A tamperproof power unit is available to specify in various locations on closed arm lounge models only. See diagrams.

SUGGESTED APPLICATIONS

- Guest seating
- Lobby/Lounge
- Treatment/Exam rooms

Please add option codes in the following order:

- **Model number**
See models.
For Calidon tables, refer to calidon tables 278
- **Back/Arm Textile**
Specify textile code. See model grade upcharges.
- **Seat Textile**
Specify textile code. See model grade upcharges.
- **Armcap option**
(FNA) No armcaps
(FAC) With armcaps. Upcharges vary, see model.
- **Frame finish**
(AAM) Absolute
(ACM) Cherry
(EOM) English Oak
(ECM) Espresso Cafe
(TFM) Fruitwood
(HGM) Grey
(AHM) Honey
(JOM) Jet Onyx
(TMM) Mahogany
(AVM) Maple
(MWM) Medium Walnut
(ASM) Night
(NBM) Noce Biondo
(NGM) Noce Grigio
(NEM) Noce Leggero
(NMM) Noce Medio
(SBM) Sandy Beach
(SKM) Shaker Cherry
(TWM) Walnut
(WTM) WC Cream
(WHM) White
(WCM) Winter Cherry
- **Armcap finish**
(SSU) Urethane (for wood arm models of guest and lounge seating with FAC specified).
Urethane finishes (upcharges vary, see model):
(BLK) Black
(J52) Mocha
(KAL) Kalua
(SHW) Shadow
(LAB) Latte
(TOA) Toast
(CO) Solid Surface (for all wood and fully upholstered arm models with FAC specified). Solid Surface Finishes:
Grade 1: (Upcharges vary, see model)
(SWH) Designer White
Grade 2: (Upcharges vary, see model)
(SBT) Beige Tempest
(SBX) Black Onyx Mirage
(SMG) Milk Glass Spectra
(SFW) Frosty White Mirage
(SHS) Hot Stone
(SNM) Northern Melange
- **Sealed Back Seams** (Contact Customer Care for approved textiles.)
(NBS) No sealed back seams
(SBS) Sealed back seams. Upcharges vary, see model.
- **Sealed Seat Seams** (Contact Customer Care for approved textiles.)
(NSS) No sealed seat seams
(SSS) Sealed seat seams. Upcharges vary, see model.
- **Glides**
(NM) Non-marking
(NS) Non-slip
Guest single seat, bariatric and lounge chairs, add \$31.
Guest two seater, Add \$47.
Guest three seater, add \$60.
- **Moisture Barrier** (seat only) (Not available with Sealed Seams)
(NB) No moisture barrier
(MB) Moisture barrier. Upcharges vary, see model.
- **Power/USB unit position** (lounge models only). Add **\$251**.
(NPM) No power
(TPM) Tamperproof power unit
(J) Black
(SRT) Side right
(SLT) Side left
(FLT) Front left (three seater only)
(FRT) Front right (three seater only)
(CRF) Center front (two seater only)
(SLR) Side left and right. Add **\$498**.
(FLR) Front left and right. Add **\$498**.

POWER LOCATION DIAGRAM

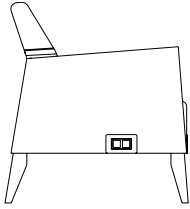

Right Side Power (SRT)
Models GC36308, GC36309 and GC36310

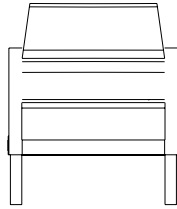

Front Power Not Available
Model GC36308

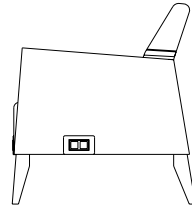

Left Side Power (SLT)
Models GC36308, GC36309 and GC36310

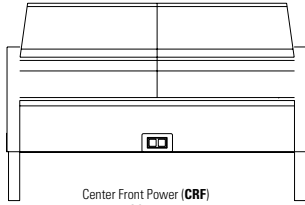

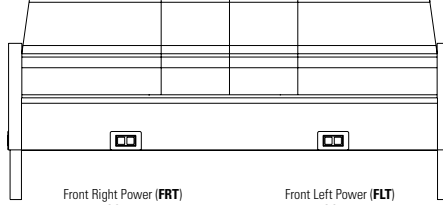

Center Front Power (CRF)
Model GC36309 only



Front Right Power (FRT)
Model GC36310 only

Front Left Power (FLT)
Model GC36310 only

DESCRIPTION	MODEL#/ FEATURES	STANDARD TEXTILE GRADES											
		1/COM	2	3	4	5	6	7	8	9	10	11	12
 <p>Wood Guest Single Seat COM Yardage: Back: 0.9; Seat: 1 Freight Class: 250 Product Weight (lbs.): 38 Cubic Feet Per Carton: 16.5</p>	GC36301	Base Price:	\$1261										
	Back upcharge:	+0	+\$31	+\$55	+\$90	+\$140	+\$161	+\$203	+\$271	+\$321	+\$376	+\$491	+\$611
	Seat upcharge:	+0	+\$34	+\$61	+\$100	+\$155	+\$178	+\$225	+\$300	+\$356	+\$417	+\$545	+\$679
	Active weight 400 lbs.												
			OVERALL DIMENSIONS			SEAT DIMENSIONS			BACK DIMENSIONS				
			W	D	H	W	D	H	W	H			
			23.5	26.5	34.5	21.5	18	18	21.5	16.5			
 <p>Wood Guest Two Seater, Full Center Arm COM Yardage: Back: 1.8; Seat: 2 Freight Class: 250 Product Weight (lbs.): 68 Cubic Feet Per Carton: 31.75</p>	GC36302	Base Price:	\$2333										
	Back upcharge:	+0	+\$62	+\$109	+\$180	+\$278	+\$320	+\$406	+\$541	+\$641	+\$751	+\$981	+\$1222
	Seat upcharge:	+0	+\$68	+\$121	+\$199	+\$309	+\$355	+\$450	+\$600	+\$712	+\$834	+\$1089	+\$1357
	Active weight 400 lbs./seat												
			OVERALL DIMENSIONS			SEAT DIMENSIONS			BACK DIMENSIONS				
			W	D	H	W	D	H	W	H			
			46	26.5	34.5	21.5	18	18	21.5	16.5			
 <p>Wood Guest Three Seater, Full Center Arms COM Yardage: Back: 2.7; Seat: 3 Freight Class: 250 Product Weight (lbs.): 101 Cubic Feet Per Carton: 47.5</p>	GC36303	Base Price:	\$3435										
	Back upcharge:	+0	+\$92	+\$163	+\$268	+\$417	+\$479	+\$608	+\$810	+\$961	+\$1126	+\$1471	+\$1833
	Seat upcharge:	+0	+\$102	+\$181	+\$298	+\$463	+\$532	+\$675	+\$899	+\$1067	+\$1251	+\$1634	+\$2036
	Active weight 400 lbs./seat												
			OVERALL DIMENSIONS			SEAT DIMENSIONS			BACK DIMENSIONS				
			W	D	H	W	D	H	W	H			
			68	26.5	34.5	21.5	18	18	21.5	16.5			

DESCRIPTION MODEL#/ FEATURES STANDARD TEXTILE GRADES



Wood Guest Bariatric Chair,
COM Yardage: Back: 1.25; Seat: 1.25
Freight Class: 250
Product Weight (lbs.): 55
Cubic Feet Per Carton: 22.25

GC36304 Base Price:
Back upcharge:
Seat upcharge:
Active weight 600 lbs.
Add \$235 for Urethane armcaps
Add \$412 for (CO) Grade 1 armcaps
Add \$437 for (CO) Grade 2 armcaps
Add \$198 for (MB)
Add \$29 for (SSS), \$47 for (SBS)

1/COM	2	3	4	5	6	7	8	9	10	11	12
\$1928											
+0	+\$43	+\$76	+\$125	+\$194	+\$222	+\$282	+\$375	+\$446	+\$522	+\$681	+\$849
+0	+\$43	+\$76	+\$125	+\$194	+\$222	+\$282	+\$375	+\$446	+\$522	+\$681	+\$849
OVERALL DIMENSIONS			SEAT DIMENSIONS			BACK DIMENSIONS					
W	D	H	W	D	H	W	H				
32.75	26.5	34.5	31	18	18	30.5	16.5				



Wood Lounge Single Seat
COM Yardage: Back: 1.25; Seat: 1.25
Freight Class: 250
Product Weight (lbs.): 49
Cubic Feet Per Carton: 18.25

GC36305 Base Price:
Back upcharge:
Seat upcharge:
Active weight 400 lbs.
Add \$177 for Urethane armcaps
Add \$432 for (CO) Grade 1 armcaps
Add \$457 for (CO) Grade 2 armcap
Add \$133 for (MB)
Add \$35 for (SSS), \$48 for (SBS)

1/COM	2	3	4	5	6	7	8	9	10	11	12
\$1762											
+0	+\$43	+\$76	+\$125	+\$194	+\$222	+\$282	+\$375	+\$446	+\$522	+\$681	+\$849
+0	+\$43	+\$76	+\$125	+\$194	+\$222	+\$282	+\$375	+\$446	+\$522	+\$681	+\$849
OVERALL DIMENSIONS			SEAT DIMENSIONS			BACK DIMENSIONS					
W	D	H	W	D	H	W	H				
25.75	29.5	32.5	24	21	16	23.5	16.5				



Wood Lounge Two Seater
COM Yardage: Back: 1.75; Seat: 2.25
Freight Class: 250
Product Weight (lbs.): 77
Cubic Feet Per Carton: 32.75

GC36306 Base Price:
Back upcharge:
Seat upcharge:
Active weight 400 lbs./seat
Add \$177 for Urethane armcaps
Add \$432 for (CO) Grade 1 armcaps
Add \$457 for (CO) Grade 2 armcaps
Add \$264 for (MB)
Add \$51 for (SSS), \$67 for (SBS)

1/COM	2	3	4	5	6	7	8	9	10	11	12
\$2478											
+0	+\$60	+\$106	+\$175	+\$271	+\$311	+\$394	+\$525	+\$623	+\$731	+\$953	+\$1188
+0	+\$76	+\$137	+\$224	+\$348	+\$399	+\$507	+\$675	+\$801	+\$938	+\$1225	+\$1527
OVERALL DIMENSIONS			SEAT DIMENSIONS			BACK DIMENSIONS					
W	D	H	W	D	H	W	H				
47.5	29.5	32.5	45	21	16	44.5	16.5				



Wood Lounge Three Seater,
COM Yardage: Back: 2.5; Seat: 2.75
Freight Class: 250
Product Weight (lbs.): 109
Cubic Feet Per Carton: 50.75

GC36307 Base Price:
Back upcharge:
Seat upcharge:
Active weight 400 lbs./seat
Add \$177 for Urethane armcaps
Add \$432 for (CO) Grade 1 armcaps
Add \$457 for (CO) Grade 2 armcaps
Add \$394 for (MB)
Add \$67 for (SSS), \$85 for (SBS)





1/COM	2	3	4	5	6	7	8	9	10	11	12
\$3098											
+0	+\$85	+\$151	+\$248	+\$386	+\$444	+\$563	+\$750	+\$890	+\$1043	+\$1361	+\$1697
+0	+\$93	+\$166	+\$274	+\$425	+\$488	+\$619	+\$824	+\$978	+\$1147	+\$1498	+\$1867
OVERALL DIMENSIONS			SEAT DIMENSIONS			BACK DIMENSIONS					
W	D	H	W	D	H	W	H				
70.5	29.5	32.5	68	21	16	67.5	16.5				



Fully Upholstered Wood Lounge Single Seat
COM Yardage: Back/Arm: 2.75; Seat: 1.25
Freight Class: 250
Product Weight (lbs.): 58
Cubic Feet Per Carton: 18.75

GC36308 Base Price:
Back/Arm upcharge:
Seat upcharge:
Active weight 400 lbs.
Add \$426 for (CO) Grade 1 armcaps
Add \$455 for (CO) Grade 2 armcaps
Add \$133 for (MB)
Add \$38 for (SSS), \$151 for (SBS)
Power/USB unit available.

1/COM	2	3	4	5	6	7	8	9	10	11	12
\$1998											
+0	+\$93	+\$166	+\$274	+\$425	+\$488	+\$619	+\$824	+\$978	+\$1147	+\$1498	+\$1867
+0	+\$43	+\$76	+\$125	+\$194	+\$222	+\$282	+\$375	+\$446	+\$522	+\$681	+\$849
OVERALL DIMENSIONS			SEAT DIMENSIONS			BACK DIMENSIONS					
W	D	H	W	D	H	W	H				
27.5	29.5	33.5	24	21	16	23.5	17.5				

DESCRIPTION	MODEL#/ FEATURES	STANDARD TEXTILE GRADES											
 <p>Fully Upholstered Wood Lounge Two Seater COM Yardage: Back/Arm: 3.5; Seat: 2.25 Freight Class: 250 Product Weight (lbs.): 89 Cubic Feet Per Carton: 33.75</p>	<p>GC36309 Base Price: \$2685 Back/Arm upcharge: Seat upcharge: Active weight 400 lbs./seat</p>	1/COM	2	3	4	5	6	7	8	9	10	11	12
		+0	+\$119	+\$211	+\$348	+\$540	+\$621	+\$788	+\$1049	+\$1245	+\$1460	+\$1906	+\$2375
		+0	+\$76	+\$137	+\$224	+\$348	+\$399	+\$507	+\$675	+\$801	+\$938	+\$1225	+\$1527
		OVERALL DIMENSIONS			SEAT DIMENSIONS			BACK DIMENSIONS					
		W	D	H	W	D	H	W	H				
		49.5	29.5	33.5	44.5	18	16	45.5	17.5				
	<p>Add \$426 for (CO) Grade 1 armcaps Add \$455 for (CO) Grade 2 armcaps Add \$264 for (MB) Add \$55 for (SSS), \$169 for (SBS) Power/USB unit available.</p>												
 <p>Fully Upholstered Wood Lounge Three Seater COM Yardage: Back/Arm: 4.25; Seat: 2.75 Freight Class: 250 Product Weight (lbs.): 123 Cubic Feet Per Carton: 52</p>	<p>GC36310 Base Price: \$3372 Back/Arm upcharge: Seat upcharge: Active weight 400 lbs./seat</p>	1/COM	2	3	4	5	6	7	8	9	10	11	12
		+0	+\$144	+\$257	+\$422	+\$656	+\$754	+\$956	+\$1274	+\$1512	+\$1772	+\$2314	+\$2884
		+0	+\$93	+\$166	+\$274	+\$425	+\$488	+\$619	+\$824	+\$978	+\$1147	+\$1498	+\$1867
		OVERALL DIMENSIONS			SEAT DIMENSIONS			BACK DIMENSIONS					
		W	D	H	W	D	H	W	H				
		71.5	29.5	33.5	66.5	18	16	67.5	17.5				
	<p>Add \$426 for (CO) Grade 1 armcaps Add \$455 for (CO) Grade 2 armcaps Add \$394 for (MB) Add \$70 for (SSS), \$189 for (SBS) Power/USB unit available.</p>												
 <p>Single Seat Bench COM Yardage: 1 Freight Class: 150 Product Weight (lbs.): 41 Cubic Feet Per Carton: 10</p>	<p>GC36311 Base Price: \$1350 Seat upcharge: Active weight 400 lbs.</p>	1/COM	2	3	4	5	6	7	8	9	10	11	12
		+0	+\$34	+\$61	+\$100	+\$155	+\$178	+\$225	+\$300	+\$356	+\$417	+\$545	+\$679
		OVERALL DIMENSIONS			SEAT DIMENSIONS			BACK DIMENSIONS					
				W	D	H	W	D	H	W	H		
		24	28	18	24	26.75	18						
	<p>Add \$133 for (MB) Add \$33 for (SSS)</p>												
 <p>Two Seat Bench COM Yardage: 2 Freight Class: 250 Product Weight (lbs.): 61 Cubic Feet Per Carton: 18.75</p>	<p>GC36312 Base Price: \$2135 Seat upcharge: Active weight 400 lbs./seat</p>	1/COM	2	3	4	5	6	7	8	9	10	11	12
		+0	+\$68	+\$121	+\$199	+\$309	+\$355	+\$450	+\$600	+\$712	+\$834	+\$1089	+\$1357
		OVERALL DIMENSIONS			SEAT DIMENSIONS			BACK DIMENSIONS					
				W	D	H	W	D	H	W	H		
		48	28	18	48	26.75	18						
	<p>Add \$264 for (MB) Add \$65 for (SSS)</p>												
 <p>Three Seat Bench COM Yardage: 3 Freight Class: 250 Product Weight (lbs.): 97 Cubic Feet Per Carton: 27.75</p>	<p>GC36313 Base Price: \$2547 Seat upcharge: Active weight 400 lbs./seat</p>	1/COM	2	3	4	5	6	7	8	9	10	11	12
		+0	+\$102	+\$181	+\$298	+\$463	+\$532	+\$675	+\$899	+\$1067	+\$1251	+\$1634	+\$2036
		OVERALL DIMENSIONS			SEAT DIMENSIONS			BACK DIMENSIONS					
				W	D	H	W	D	H	W	H		
		72	28	18	72	26.75	18						
	<p>Add \$394 for (MB) Add \$94 for (SSS)</p>												

CALIDON TABLES



Square end table - 22" GC36314



Rectangular Coffee Table GC36317



Tandem Side Table, Right GC36319R



For Calidon seating, refer to page 275

EXAMPLE CALIDON TABLE ORDER CODE:

GC36319R	-HP	-ACJ	-CNT
Model #	Top material	Laminated finish	Power

TABLE TOP FINISHES:

See finishes section for solid wood/laminate coordination chart.

Thermally fused laminate (LP):

- Absolute Acajou (ACJ)
- Asian Night (ASN)
- Avant Cherry (AWC)
- Avant Honey (AWH)
- Black (BLK)
- Blizzard (BZD)
- Brushed Cobalt (BRC)
- Clear Maple (CMB)
- Custom Grey (CGY)
- Dark Espresso (DES)
- Designer White (DWT)
- Fashionista (FAS)
- First Class (FCL)
- Noce Biondo (NBL)
- Noce Grigio (NGL)
- Noce Leggero (NEL)
- Noce Medio (NML)
- Quartered Mahogany (QTM)
- Sheer Beauty (SBY)
- Stonedust (SDT)
- Walnut Heights (WHE)
- White Chocolate (WHC)
- Winter Cherry (WCR)

High pressure laminate (HP):

- Absolute Acajou (ACJ)
- Asian Night (ASN)
- Avant Cherry (AWC)
- Avant Honey (AWH)
- Black (BLK)
- Blizzard (BZD)
- Brushed Cobalt (BRC)
- Clear Maple (CMB)
- Custom Grey (CGY)
- Dark Espresso (DES)
- Designer White (DWT)
- Fashionista (FAS)
- First Class (FCL)
- Noce Biondo (NBL)
- Noce Grigio (NGL)
- Noce Leggero (NEL)
- Noce Medio (NML)
- Quartered Mahogany (QTM)
- Sheer Beauty (SBY)
- Stonedust (SDT)
- Walnut Heights (WHE)
- White Chocolate (WHC)
- Winter Cherry (WCR)

Ultra matte high pressure laminate (UM):

- Black (BLK)
- Blizzard (BZD)
- Custom Grey (CGY)
- Designer White (DWT)
- Stonedust (SDT)
- Storm Grey (SOG)

Solid Surface* (CO):

- Grade 1: (SWH) Designer White
- Grade 2: (SBT) Beige Tempest (SBX) Black Onyx Mirage (SMG) Milk Glass Spectra (SFW) Frosty White Mirage (SHS) Hot Stone (SNM) Northern Melange

*For detailed material information, please reference WilsonArt's Solid Surface collection.

STANDARD FEATURES

- A variety of wood leg tables are available, including various height end tables, coffee tables and tandem tables.
- Wood legs/aprons are specifiable in Global solid wood seating finishes.
- Table tops are 1" thick, available in thermally fused laminate (LP), high pressure laminate (HP), ultra matte high pressure laminate (UM), and solid surface (CO). Upcharges vary, see model for pricing.
- Laminate top tables include 2mm color coordinating PVC edgeband.
- Tandem/bridge table models (GC36318 to GC36321) connect to Calidon guest seating only and include ganging brackets.
- Tandem tables are specified left or right, as seated.

OPTIONAL FEATURES

- A tamper resistant power/USB unit is optional for laminate top, tandem in-line, 30 degree, 90 degree and freestanding square end tables only. Unit is black; includes one AC outlet, two 10-watt USB-A ports, matching faceplate and a 10 ft. long 3-prong power cord. The power unit is located centered 1.5" from the edge of the surface. See power location diagrams for reference. Add \$378.

SUGGESTED APPLICATIONS





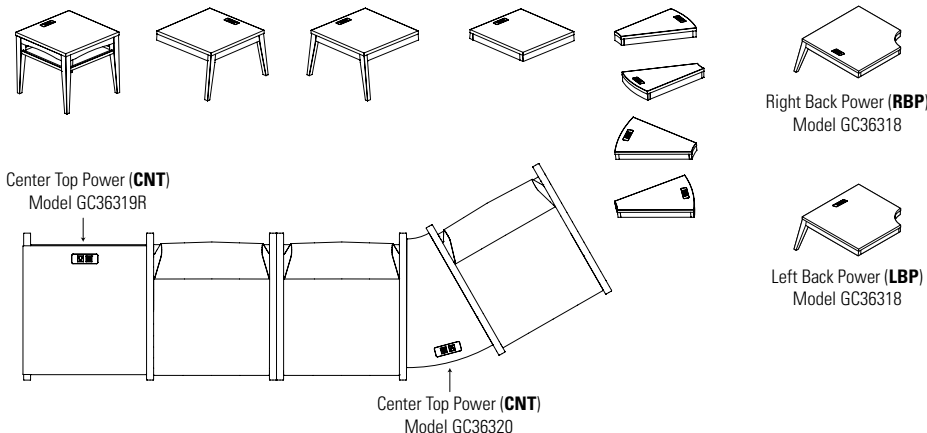

- Lounge/Lobby
- Resident rooms
- Patient rooms
- Private office

Please add option codes in the following order:

- **Model number**
GC36314 to GC36317 Freestanding tables
GC36318 to GC36321 Tandem/bridge tables
GC36324 to GC36326 23"H Freestanding tables
For Calidon seating, refer to page 274.
- **Top material**
(LP) Thermally fused laminate. Specify finish; see LP finishes.
(HP) High pressure laminate. Upcharges vary; see model. Specify finish; see HP finishes.
(UM) Ultra matte high pressure laminate. Upcharges vary; see model. Specify finish; see UM finishes.
(CO) Solid surface. Upcharges vary; see model. Specify finish; see CO finishes and grades.
- **Leg finish**
(AAM) Absolute (MWM) Medium Walnut
(BKM) Black (NLW) Natural Walnut
(ACM) Cherry (ASM) Night
(EOM) English Oak (NBM) Noce Biondo
(ECM) Espresso Cafe (NGM) Noce Grigio
(TFM) Fruitwood (NEM) Noce Leggero
(HGM) Grey (NMM) Noce Medio
(AHM) Honey (SBM) Sandy Beach
(JOM) Jet Onyx (SKM) Shaker Cherry
(TMM) Mahogany (TWM) Walnut
(AVM) Maple (WTM) WC Cream
(WHM) White (WCM) Winter Cherry
- **Power/USB unit position** (laminate tandem and end tables with laminate tops only).
(NPM) No power
(CNT) Center top power. Jet Black. Add \$378.
(RBP) Right back top power. Jet Black. Add \$378.
(LBP) Left back top power. Jet Black. Add \$378.

POWER LOCATION DIAGRAM



TABLES	MODEL#	DIMENSIONS	FREIGHT CLASS	WT/LBS.	CUBIC FT.	LIST PRICE
	GC36314	22 x 22 x 20.25	150	36	7.75	\$872
Square End Table, 22" x 22" x 20.25" H		<ul style="list-style-type: none"> • Pricing shown for a thermally fused laminate top (LP). • For a high pressure laminate top (HP), add \$69. • For an ultra matte high pressure laminate top (UM), add \$255. • For a solid surface top (CO), add \$1130 for Grade 1 and add \$1388 for Grade 2. <p>Coordinating edge on laminate surfaces with solid wood frame and legs. 1 per carton. Power/USB unit can be specified in the surface of laminate top tables (CNT). Add \$378.</p>				
	GC36324	22 x 22 x 23	150	23.5	6.75	\$1031
Square End Table, 22" x 22" x 23" H		<ul style="list-style-type: none"> • Pricing shown for a thermally fused laminate top (LP). • For a high pressure laminate top (HP), add \$69. • For an ultra matte high pressure laminate top (UM), add \$255. • For a solid surface top (CO), add \$1130 for Grade 1 and add \$1388 for Grade 2. <p>Coordinating edge on laminate surfaces with solid wood frame and legs. 1 per carton. Power/USB unit can be specified in the surface of laminate top tables (CNT). Add \$378.</p>				
	GC36325	22 x 12 x 23	125	34	10.75	\$888
Rectangular End Table, 23" H		<ul style="list-style-type: none"> • Pricing shown for a thermally fused laminate top (LP). • For a high pressure laminate top (HP), add \$57. • For an ultra matte high pressure laminate top (UM), add \$179. • For a solid surface top (CO), add \$933 for Grade 1 and add \$1120 for Grade 2. <p>Coordinating edge on laminate surfaces with solid wood frame and legs. 1 per carton. Power/USB unit can be specified in the surface of laminate top tables (CNT). Add \$378.</p>				
	GC36326	24 x 25 x 23	150	34	12.75	\$1142
Corner 30° End Table, 23" H		<ul style="list-style-type: none"> • Pricing shown for a thermally fused laminate top (LP). • For a high pressure laminate top (HP), add \$74. • For an ultra matte high pressure laminate top (UM), add \$255. • For a solid surface top (CO), add \$1282 for Grade 1 and add \$1545 for Grade 2. <p>Coordinating edge on laminate surfaces with solid wood frame and legs. 1 per carton. Power/USB unit can be specified in the surface of laminate top tables (CNT). Add \$378.</p>				
	GC36315	24 x 24 x 17.25	250	37	9.5	\$905
Square Coffee Table, 24" H		<ul style="list-style-type: none"> • Pricing shown for a thermally fused laminate top (LP). • For a high pressure laminate top (HP), add \$69. • For an ultra matte high pressure laminate top (UM), add \$255. • For a solid surface top (CO), add \$1372 for Grade 1 and add \$1694 for Grade 2. <p>Coordinating edge on laminate surfaces with solid wood frame and legs. 1 per carton.</p>				
	GC36316	36 x 36 x 17.25	250	65	18.25	\$1082
Square Coffee Table, 36" H		<ul style="list-style-type: none"> • Pricing shown for a thermally fused laminate top (LP). • For a high pressure laminate top (HP), add \$148. • For an ultra matte high pressure laminate top (UM), add \$357. • For a solid surface top (CO), add \$3143 for Grade 1 and add \$3787 for Grade 2. <p>Coordinating edge on laminate surfaces with solid wood frame and legs. 1 per carton.</p>				
	GC36317	24 x 48 x 17.25	250	56	16.5	\$1185
Rectangular Coffee Table		<ul style="list-style-type: none"> • Pricing shown for a thermally fused laminate top (LP). • For a high pressure laminate top (HP), add \$134. • For an ultra matte high pressure laminate top (UM), add \$357. • For a solid surface top (CO), add \$2618 for Grade 1 and add \$3054 for Grade 2. <p>Coordinating edge on laminate surfaces with solid wood frame and legs. 1 per carton.</p>				

TABLES	MODEL#	DIMENSIONS	FREIGHT CLASS	WT/LBS.	CUBIC FT.	LIST PRICE
--------	--------	------------	---------------	---------	-----------	------------



Corner Table, 90°

GC36318	31.25 x 31.25 x 15.75	250	46	14.5	\$1082
---------	-----------------------	-----	----	------	---------------

- Pricing shown for a thermally fused laminate top (LP).
- For a high pressure laminate top (HP), add \$110.
- For an ultra matte high pressure laminate top (UM), add \$255.
- For a solid surface top (CO), add \$2718 for Grade 1 and add \$3249 for Grade 2.

Coordinating edge on laminate surfaces with solid wood frame and legs. Must be connected between two guest chairs. Includes two sets of U-channel connectors and hardware. 1 per carton. Power/USB unit can be specified in the surface of laminate top tables (RBP) or (LBP). Add \$378. See power location diagram for placement.



Tandem Side Table, Left

GC36319L	26.5 x 22.25 x 15.75	250	20	6.75	\$755
----------	----------------------	-----	----	------	--------------

- Pricing shown for a thermally fused laminate top (LP).
- For a high pressure laminate top (HP), add \$69.
- For an ultra matte high pressure laminate top (UM), add \$255.
- For a solid surface top (CO), add \$1149 for Grade 1 and add \$1384 for Grade 2.

Coordinating edge on laminate surfaces with solid wood frame and legs. Must be connected to a guest chair. Includes one set of U-channel connectors and hardware. 1 per carton. Power/USB unit can be specified in the surface of laminate top tables (CNT). Add \$378.



Tandem Side Table, Right

GC36319R	26.5 x 22.25 x 15.75	250	20	6.75	\$755
----------	----------------------	-----	----	------	--------------

- Pricing shown for a thermally fused laminate top (LP).
- For a high pressure laminate top (HP), add \$69.
- For an ultra matte high pressure laminate top (UM), add \$255.
- For a solid surface top (CO), add \$1149 for Grade 1 and add \$1384 for Grade 2.

Coordinating edge on laminate surfaces with solid wood frame and legs. Must be connected to a guest chair. Includes one set of U-channel connectors and hardware. 1 per carton. Power/USB unit can be specified in the surface of laminate top tables (CNT). Add \$378.



Corner Table, 30 Degree

GC36320	22.5 x 15.75 x 3	92.5	16	1.5	\$594
---------	------------------	------	----	-----	--------------

- Pricing shown for a thermally fused laminate top (LP).
- For a high pressure laminate top (HP), add \$69.
- For an ultra matte high pressure laminate top (UM), add \$179.
- For a solid surface top (CO), add \$961 for Grade 1 and add \$1154 for Grade 2.

Coordinating edge on laminate surfaces with solid wood frame and legs. Must be connected between two guest chairs. Includes two sets of U-channel connectors and hardware. 1 per carton. Power/USB unit can be specified in the surface of laminate top tables (CNT). Add \$378.



In-Line Table, Square

GC36321	21 x 23.5 x 3	92.5	20	1.9	\$630
---------	---------------	------	----	-----	--------------

- Pricing shown for a thermally fused laminate top (LP).
- For a high pressure laminate top (HP), add \$69.
- For an ultra matte high pressure laminate top (UM), add \$255.
- For a solid surface top (CO), add \$994 for Grade 1 and add \$1225 for Grade 2.

Coordinating edge on laminate surfaces with solid wood frame and legs. Must be connected between two guest chairs. Includes two sets of U-channel connectors and hardware. 1 per carton. Power/USB unit can be specified in the surface of laminate top tables (CNT). Add \$378.

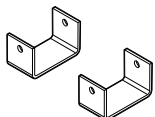

U-Channel (set of 2)

GC36322	2.87 x 1.5 x 1.62	70	0.75	0.03	\$51
---------	-------------------	----	------	------	-------------

Includes hardware. 4 sets per carton.

CAMINO



models shown: 5471-CP Lounge Chair, 5475-W End Table, 5472-CP Two Seat Sofa.





model 5471-CP



STANDARD FEATURES

- A transitional soft seating series composed of one, two and three seat units.
- Frame is a heavy duty, interlocking plywood, puzzle box construction suitable for public environments.
- The soft seating leg system utilizes a continuous visible frame between the front and rear leg. Each leg frame is bolted directly to the sofa frame with large bolts to provide a very durable leg construction.
- Legs are equipped with translucent non marking glides as standard. Suitable for both carpet and hard surface flooring.
- Seating features as standard, decorative double stitch detail, which make seams lay flat and add extra seam strength.
- Cushions are highly resilient foam and seats are equipped with a synthetic rubberized sheet webbing suspension system for extra comfort. Cushions are fixed and non-removable.
- Measurement shown for weight is for one unit, measurement for volume is per carton.
- Check textile availability prior to specifying upholstery material.

OPTIONAL FEATURES

- Optional cushions and arms can have tailored piping details.
- For piping made in fabric matching the rest of the upholstery fabric please use **MP** models (matching piping after the model number). This is no upcharge.
- For contrast piping made in a fabric that does not match the rest of the upholstery fabric, you can specify any grade 1 or 2 upholstery material for this purpose, please see model numbers ending in **CP** which reflect the appropriate upcharge.
- For contrast piping in a fabric higher than grade 2, you must ask for a special quotation. Per unit price will vary depending on the number of units being ordered.
- Seating unit come with a choice of wood legs or a polished cast aluminum.
- Seating with polished aluminum legs are shown as separate skus.
- Wood legs for seating are available in select Global wood seating finishes - see seating finishes. Only finishes ending in "**M**" are available for this series.

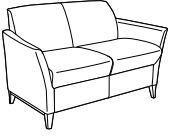
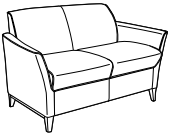
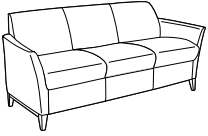
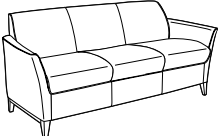
DESCRIPTION	FEATURES	MODEL#	STANDARD TEXTILE GRADES											
			1	2	3	4	5	6	7	8	9	10	11	12
 <p>Lounge Chair w/ Wood Legs COM Yardage: 4 Freight Class: 250 Product Weight (lbs.): 60 Cubic Feet Per Carton: 19.25</p>	No Piping.	5471	2771	2936	3064	3253	3525	3650	3898	4289	4588	4926	5615	6350
		OVERALL DIMENSIONS			SEAT DIMENSIONS			BACK DIMENSIONS						
		W	D	H	W	D	H	W	H					
		29.5	29	30.5	21	19.5	18	20	11.5					
			RTA.00											
 <p>Lounge Chair w/ Wood Legs & Piping COM Yardage: 4 Freight Class: 250 Product Weight (lbs.): 60 Cubic Feet Per Carton: 19.25</p>	CP = Contrast Piping MP = Matching Piping	5471-CP	2983	3148	3276	3465	3737	3862	4110	4501	4800	5138	5827	6562
		5471-MP	2771	2936	3064	3253	3525	3650	3898	4289	4588	4926	5615	6350
		OVERALL DIMENSIONS			SEAT DIMENSIONS			BACK DIMENSIONS						
		W	D	H	W	D	H	W	H					
			29.5	29	30.5	21	19.5	18	20	11.5				
			RTA.00											

DESCRIPTION	FEATURES	MODEL#	STANDARD TEXTILE GRADES											
			1	2	3	4	5	6	7	8	9	10	11	12
 <p>Two Seat Sofa w/ Wood Legs COM Yardage: 5.75 Freight Class: 250 Product Weight (lbs.): 84 Cubic Feet Per Carton: 36</p>	No Piping.	5472	3926	4161	4342	4616	5006	5187	5542	6104	6536	7019	8009	9070
			OVERALL DIMENSIONS			SEAT DIMENSIONS			BACK DIMENSIONS					
			W	D	H	W	D	H	W	H				
			51	29	30.5	42	19.5	18	41	11.5				
			RTA 00											
 <p>Two Seat Sofa w/ Wood Legs COM Yardage: 5.75 Freight Class: 250 Product Weight (lbs.): 84 Cubic Feet Per Carton: 36</p>	CP = Contrast Piping MP = Matching Piping	5472-CP 5472-MP	4207	4442	4623	4897	5287	5468	5823	6385	6817	7300	8290	9351
			OVERALL DIMENSIONS			SEAT DIMENSIONS			BACK DIMENSIONS					
			W	D	H	W	D	H	W	H				
			51	29	30.5	42	19.5	18	41	11.5				
			RTA 00											
 <p>Three Seat Sofa w/ Wood Legs COM Yardage: 7.5 Freight Class: 250 Product Weight (lbs.): 110 Cubic Feet Per Carton: 50.25</p>	No Piping.	5473	5081	5384	5621	5981	6487	6726	7186	7919	8487	9114	10408	11788
			OVERALL DIMENSIONS			SEAT DIMENSIONS			BACK DIMENSIONS					
			W	D	H	W	D	H	W	H				
			71	29	30.5	63	19.5	18	62	11.5				
			RTA 00											
 <p>Three Seat Sofa w/ Wood Legs COM Yardage: 7.5 Freight Class: 250 Product Weight (lbs.): 110 Cubic Feet Per Carton: 50.25</p>	CP = Contrast Piping MP = Matching Piping	5473-CP 5473-MP	5431	5733	5972	6331	6837	7076	7537	8269	8837	9464	10758	12138
			OVERALL DIMENSIONS			SEAT DIMENSIONS			BACK DIMENSIONS					
			W	D	H	W	D	H	W	H				
			71	29	30.5	63	19.5	18	62	11.5				
			RTA 00											
 <p>Lounge Chair w/ Aluminum Legs COM Yardage: 4 Freight Class: 250 Product Weight (lbs.): 62 Cubic Feet Per Carton: 19.25</p>	No Piping.	5481	2771	2936	3064	3253	3525	3650	3898	4289	4588	4926	5615	6350
			OVERALL DIMENSIONS			SEAT DIMENSIONS			BACK DIMENSIONS					
			W	D	H	W	D	H	W	H				
			29.5	29	30.5	21	19.5	18	20	11.5				
			RTA 00											

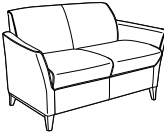
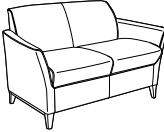
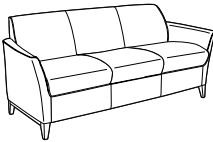
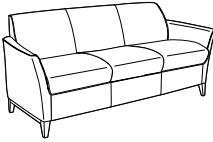
DESCRIPTION	FEATURES	MODEL#	STANDARD TEXTILE GRADES											
			1	2	3	4	5	6	7	8	9	10	11	12
 <p>Lounge Chair w/Aluminum Legs COM Yardage: 4 Freight Class: 250 Product Weight (lbs.): 62 Cubic Feet Per Carton: 19.25</p>	CP = Contrast Piping. MP = Matching Piping.	5481-CP	2983	3148	3276	3465	3737	3862	4110	4501	4800	5138	5827	6562
		5481-MP	2771	2936	3064	3253	3525	3650	3898	4289	4588	4926	5615	6350
		OVERALL DIMENSIONS			SEAT DIMENSIONS			BACK DIMENSIONS						
		W	D	H	W	D	H	W	H					
			29.5	29	30.5	21	19.5	18	20	11.5				
			RTA 00											
 <p>Two Seat Sofa w/ Aluminum Legs COM Yardage: 5.75 Freight Class: 250 Product Weight (lbs.): 86 Cubic Feet Per Carton: 36</p>	No Piping.	5482	3926	4161	4342	4616	5006	5187	5542	6104	6536	7019	8009	9070
		OVERALL DIMENSIONS			SEAT DIMENSIONS			BACK DIMENSIONS						
		W	D	H	W	D	H	W	H					
					51	29	30.5	42	19.5	18	41	11.5		
			RTA 00											
 <p>Two Seat Sofa w/ Aluminum Legs COM Yardage: 5.75 Freight Class: 250 Product Weight (lbs.): 86 Cubic Feet Per Carton: 36</p>	CP = Contrast Piping. MP = Matching Piping.	5482-CP	4207	4442	4623	4442	4623	4897	5287	5468	5823	6385	6817	9351
		5482-MP	3926	4161	4342	4616	5006	5187	5542	6104	6536	7019	8009	9070
		OVERALL DIMENSIONS			SEAT DIMENSIONS			BACK DIMENSIONS						
		W	D	H	W	D	H	W	H					
			51	29	30.5	42	19.5	18	41	11.5				
			RTA 00											
 <p>Three Seat Sofa w/ Aluminum Legs COM Yardage: 7.5 Freight Class: 250 Product Weight (lbs.): 112 Cubic Feet Per Carton: 50.25</p>	No Piping.	5483	5081	5384	5621	5384	6487	6726	7186	7919	8487	9114	10408	11788
		OVERALL DIMENSIONS			SEAT DIMENSIONS			BACK DIMENSIONS						
		W	D	H	W	D	H	W	H					
					71	29	30.5	63	19.5	18	62	11.5		
			RTA 00											
 <p>Three Seat Sofa w/Aluminum Legs COM Yardage: 7.5 Freight Class: 250 Product Weight (lbs.): 112 Cubic Feet Per Carton: 50.25</p>	CP = Contrast Piping. MP = Matching Piping.	5483-CP	5431	5734	5972	6331	6837	7076	7537	8269	8837	12138	10758	12138
		5483-MP	5081	5384	5621	5981	6487	6726	7186	7919	8487	9114	10408	11788
		OVERALL DIMENSIONS			SEAT DIMENSIONS			BACK DIMENSIONS						
		W	D	H	W	D	H	W	H					
			30.5	29	30.5	63	19.5	18	62	11.5				
			RTA 00											

CITI™



model 7875LTL (BK)



Citi Modular Group - Shown in Tungsten



5" tubular metal leg
(shown in Tungsten)



5" tapered wood leg
(shown in Maple)

STANDARD FEATURES

- Fully upholstered contemporary design, complements the timeless decor of many offices. Proportions are compact, 31" deep, and work well in public spaces.
- All models have fixed, non-removable cushions.
- For increased durability with a softer sit, a highly resilient, high density Ultracell foam (UC) option is available. See upcharges.
- Arm height on all models is 25".
- Casters are not available on this series.
- Citi seating and table legs are 5" high tubular metal. Seating also available with wood, tapered, softened square legs.
- Citi table tops are available in either tempered glass or laminate.
- Laminate tablet seating models (TL suffix) are available specified as seated. Specify right (RTL) or left (LTL). For additional tablet arm models, contact CustomerCare for pricing. The tablet is 0.75" thick with thermally fused laminate and measure 12"D x 16.5"W.
- Ganging brackets (7892) are sold separately.
- Ganging brackets are to be used on armless seating if interconnection to another armless seating unit is required. Bench and ottomans only gang to other benches/ottomans, cannot gang with seating units. Brackets come with a template for installation.
- Upholstery options: fabric, vinyl or leather. Starting at grade 5 pricing. Leather models feature a stitch detail across the seat and/or back cushions, if applicable.
- If you would like fabric/vinyl on the shell of the chair with leather seat and back cushions or other combinations, please complete "Multi Fabric" Form and submit with your order. Multi Fabric grade will apply.

Add option codes in the following order:

- Model Number**
Specify model number.

- Seat Foam Upgrade** (add option to end of model number)
(RF) Standard Foam
(UC) Soft Ultracell foam. For Lounge and corner chairs add \$145; Two Seat Sofas add \$284; Three Seat Sofas add \$426.
- Leg Type** (Lounge only)
(MTL) Metal Legs
(WDL) Wood Legs. Add \$333
- Leg Finish:**
Metal leg finish (lounge and tables):
(TBL) Black
(TTU) Tungsten
(CHM) Chrome. **Add \$117.**
Wood leg finish (lounge only):
(AAM) Absolute (BKM) Black
(ACM) Cherry (EOM) English Oak
(ECM) Espresso Cafe (TFM) Fruitwood
(HGM) Gray (AHM) Honey
(TMM) Mahogany (AVM) Maple
(MWM) Medium Walnut (NLW) Natural Walnut
(ASM) Night (NBM) Noce Biondo
(NGM) Noce Grigio (NEM) Noce Leggero
(NMM) Noce Medio (SKM) Shaker Cherry
(TWM) Walnut (WTM) WC Cream
(VHM) White (WCM) Winter Cherry
- Glide Type** (wood legs)
(NM) White, non-marking nylon glide for most surfaces
(SG) Steel cushioned glide for carpeted surfaces. Add \$36
(RG) Non-slip rubber glide for most hard floor surfaces. Add \$36.
(FG) Felt glide for most hard floor surfaces. Add \$36.
- Laminate Finish** (tables and tablets)
(ACJ) Absolute Acajou (ASN) Asian Night
(AVC) Avant Cherry (AVH) Avant Honey
(BLK) Black (BRC) Brushed Cobalt
(BZD) Blizzard (CGY) Custom Grey
(CMB) Clear Maple (DES) Dark Espresso
(DWT) Designer White (FAS) Fashionista
(FCL) First Class (NBL) Noce Biondo
(NEL) Noce Leggero (NGL) Noce Grigio
(NML) Noce Medio
(QTM) Quartered Mahogany
(SBY) Sheer Beauty (SDT) Stonedust
(SOG) Storm Grey (WCR) Winter Cherry
(WHC) White Chocolate (WHE) Walnut Heights

SAMPLE LAYOUTS

Layout A

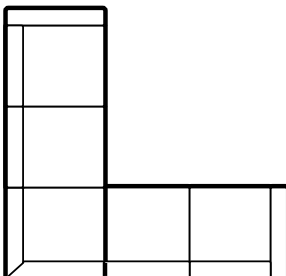





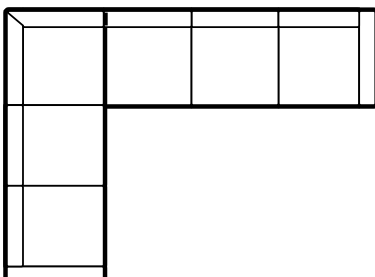

Qty	Model Number	Description	Dimensions	List Price
1	7890LNB	Two Seat Sofa w/Left Arm	48 x 31 x 30.75	2251
1	7862	Corner Seat	37 x 37 x 31	2444
1	7890RNB	Two Seat Sofa w/Right Arm	48 x 31 x 30.75	2251
2	7892	Ganging Bracket	0.5 x 3.87 x 2	34
SAMPLE LAYOUT TOTAL IN STANDARD FEET FINISH				\$6,980

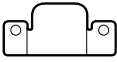

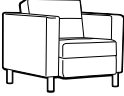
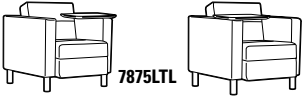

Layout B

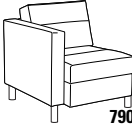
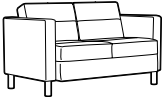

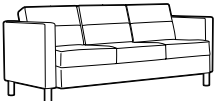

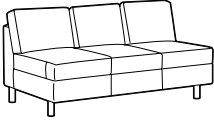
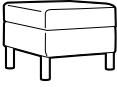

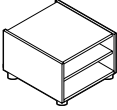

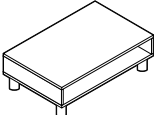

Qty	Model Number	Description	Dimensions	List Price
1	7890RNB	Two Seat Sofa w/Right Arm	48 x 31 x 30.75	2251
1	7862	Corner Seat	37 x 37 x 31	2444
1	7891LNB	Three Seat Sofa w/Left Arm	77 x 31 x 30.75	3007
2	7892	Ganging Bracket	0.5 x 3.87 x 2	34 x 2
SAMPLE LAYOUT TOTAL IN STANDARD FEET FINISH				\$7,770

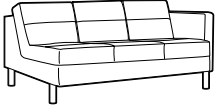
DESCRIPTION	FEATURES	MODEL#	STANDARD TEXTILE GRADES											
			1	2	3	4	5	6	7	8	9	10	11	12
 <p>Ganging Bracket COM Yardage: N/a Freight Class: 70 Product Weight (lbs.): 0.25 Cubic Feet Per Carton: 0.01</p>	<p>Kit includes 2 brackets, 4 screws and a template.</p>	7892	34	-	-	-	-	-	-	-	-	-	-	
		OVERALL DIMENSIONS			SEAT DIMENSIONS			BACK DIMENSIONS						
		W	D	H	W	D	H	W	H					
			RTA 00		FedEx		UPS							
 <p>Corner Seat COM Yardage: 6.25 Freight Class: 250 Product Weight (lbs.): 65 Cubic Feet Per Carton: 30.25</p>		7862	-	-	-	-	2444	2625	2966	3578	3928	4492	5349	6369
	OVERALL DIMENSIONS			SEAT DIMENSIONS			BACK DIMENSIONS							
	W	D	H	W	D	H	W	H						
	37	37	30.75	26	26	17.5	26	13.5						
			RTA 00											
 <p>Large Lounge Chair - for 6'+ Tall Users COM Yardage: 5.50 Freight Class: 250 Product Weight (lbs.): 70 Cubic Feet Per Carton: 24.25</p>		7864	-	-	-	-	2167	-	-	3163	3473	3969	4723	5622
	OVERALL DIMENSIONS			SEAT DIMENSIONS			BACK DIMENSIONS							
	W	D	H	W	D	H	W	H						
	34	33	30	23	20	19	23	13.5						
			RTA 00											
 <p>Lounge Chair COM Yardage: 4.5 Freight Class: 250 Product Weight (lbs.): 67 Cubic Feet Per Carton: 21</p>		7875	-	-	-	-	1601	1738	1990	2447	2704	3122	3756	4514
	OVERALL DIMENSIONS			SEAT DIMENSIONS			BACK DIMENSIONS							
	W	D	H	W	D	H	W	H						
	30	31	30	21	19.5	17.5	21	12.5						
			RTA 00											
 <p>Lounge Chair w/Laminate Tablet COM Yardage: 4.5 Freight Class: 250 Product Weight (lbs.): 75 Cubic Feet Per Carton: 22.5</p>		7875LTL 7875RTL	-	-	-	-	2401	2539	2798	3260	3523	3953	4601	5370
	OVERALL DIMENSIONS			SEAT DIMENSIONS			BACK DIMENSIONS							
	W	D	H	W	D	H	W	H						
	31.5	33.5	33.5	21	19.5	17.5	21	12.5						
			RTA 00											

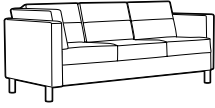
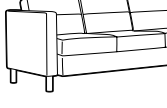
DESCRIPTION	FEATURES	MODEL#	STANDARD TEXTILE GRADES											
			1	2	3	4	5	6	7	8	9	10	11	12
 <p>Lounge Chair- Armless COM Yardage: 3 Freight Class: 250 Product Weight (lbs.): 45 Cubic Feet Per Carton: 15.5</p>		7895	-	-	-	-	1603	1694	1856	2150	2318	2589	2999	3490
			OVERALL DIMENSIONS			SEAT DIMENSIONS			BACK DIMENSIONS					
			W	D	H	W	D	H	W	H				
			22	31	30.75	21	19.5	17.5	21	14				
			RTA 00											
  <p>Lounge Chair- Single Arm COM Yardage: 4 Freight Class: 250 Product Weight (lbs.): 65 Cubic Feet Per Carton: 21</p>		7901L 7901R	-	-	-	-	1829	1939	2143	2467	2715	2995	3568	4176
			OVERALL DIMENSIONS			SEAT DIMENSIONS			BACK DIMENSIONS					
			W	D	H	H	W	D	H	W	H			
			26	31	30	22	19.5	17.5	22	12.5				
			RTA 00											
 <p>Two Seat Sofa COM Yardage: 6.25 Freight Class: 250 Product Weight (lbs.): 125 Cubic Feet Per Carton: 36</p>		7876	-	-	-	-	2159	2348	2695	3324	3687	4267	5150	6204
			OVERALL DIMENSIONS			SEAT DIMENSIONS			BACK DIMENSIONS					
			W	D	H	W	D	H	W	H				
			51.25	31	30	42.5	19.5	17.5	42.5	12.5				
			RTA 00											
 <p>Two Seat Sofa - Armless COM Yardage: 5 Freight Class: 250 Product Weight (lbs.): 93 Cubic Feet Per Carton: 36</p>		7896	-	-	-	-	1994	2140	2412	2903	3181	3636	4319	5134
			OVERALL DIMENSIONS			SEAT DIMENSIONS			BACK DIMENSIONS					
			W	D	H	W	D	H	W	H				
			43.25	31	30.75	42.5	19.5	17.5	42.5	12.5				
			RTA 00											
 <p>Three Seat Sofa COM Yardage: 8.75 Freight Class: 250 Product Weight (lbs.): 163 Cubic Feet Per Carton: 50.25</p>		7877	-	-	-	-	2717	2976	3469	4353	4856	5671	6908	8377
			OVERALL DIMENSIONS			SEAT DIMENSIONS			BACK DIMENSIONS					
			W	D	H	W	D	H	W	H				
			72.5	31	30	63.5	19.5	17.5	63.5	12.5				
			RTA 00											

DESCRIPTION	FEATURES	MODEL#	STANDARD TEXTILE GRADES												
			1	2	3	4	5	6	7	8	9	10	11	12	
 <p>Three Seat Sofa - Armless COM Yardage: 7.25 Freight Class: 250 Product Weight (lbs.): 131 Cubic Feet Per Carton: 50.25</p>		7897	-	-	-	-	2625	2834	3232	3939	4344	5000	5993	7178	
	OVERALL DIMENSIONS			SEAT DIMENSIONS			BACK DIMENSIONS								
	W D H			W D H			W H								
	64.5 31 30.75			63.5 19.5 17.5			63.5 12.5								
	RTA 00														
 <p>Ottoman COM Yardage: 1.5 Freight Class: 250 Product Weight (lbs.): 27 Cubic Feet Per Carton: 7.5</p>		7879	-	-	-	-	620	668	752	907	995	1141	1355	1611	
	OVERALL DIMENSIONS			SEAT DIMENSIONS			BACK DIMENSIONS								
	W D H			W D H			W H								
	22 22 17			-			17								
	RTA 00			 											
 <p>End Table, Laminate COM Yardage: N/A Freight Class: 100 Product Weight (lbs.): 53 Cubic Feet Per Carton: 6</p>		7885	873	-	-	-	-	-	-	-	-	-	-	-	
	OVERALL DIMENSIONS			SEAT DIMENSIONS			BACK DIMENSIONS								
	W D H			W D H			W H								
	20 24 20			-			-								
	RTA 1			 											
 <p>Coffee Table Rectangular COM Yardage: N/A Freight Class: 100 Product Weight (lbs.): 60 Cubic Feet Per Carton: 6.5</p>		7887	911	-	-	-	-	-	-	-	-	-	-	-	
	OVERALL DIMENSIONS			SEAT DIMENSIONS			BACK DIMENSIONS								
	W D H			W D H			W H								
	40 20 15			-			-								
	RTA 1														

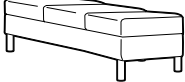
DESCRIPTION	FEATURES	MODEL#	STANDARD TEXTILE GRADES											
			1	2	3	4	5	6	7	8	9	10	11	12
 7890LNB  7890RNB	**Intended to be free standing. No connecting hardware.	7890LNB	-	-	-	-	2251	2410	2711	3252	3557	4056	4812	5714
		7890RNB												
Two Seat Sofa - No Connector COM Yardage: 5.25 Freight Class: 250 Product Weight (lbs.): 107 Cubic Feet Per Carton: 36			OVERALL DIMENSIONS W D H			SEAT DIMENSIONS W D H			BACK DIMENSIONS W H					
			0	0	0		42.5	19.5	17.5		42.5		13.25	
			<div style="border: 1px solid black; padding: 2px; display: inline-block;">RTA 00</div>											
 7891LNB  7891RNB	**Intended to be free standing. No connecting hardware.	7891LNB	-	-	-	-	3007	3216	3614	4321	4726	5382	6375	7560
		7891RNB												
Three Seat Sofa - No Connector COM Yardage: 7.25 Freight Class: 250 Product Weight (lbs.): 138 Cubic Feet Per Carton: 50.25			OVERALL DIMENSIONS W D H			SEAT DIMENSIONS W D H			BACK DIMENSIONS W H					
			0	0	0		63.5	19.5	17.5		63.5		13.25	
			<div style="border: 1px solid black; padding: 2px; display: inline-block;">RTA 00</div>											
 7891L-RCNB  7891R-RCNB	**Intended to be free standing. No connecting hardware.	7891L-RCNB	-	-	-	-	3622	3877	4365	5238	5737	6545	7767	9226
		7891R-RCNB												
Three Seat Sofa - No Connector COM Yardage: 8.5 Freight Class: 250 Product Weight (lbs.): 154 Cubic Feet Per Carton: 55.5			OVERALL DIMENSIONS W D H			SEAT DIMENSIONS W D H			BACK DIMENSIONS W H					
			0	0	0		60	19.5	17.5		60		13.25	
			<div style="border: 1px solid black; padding: 2px; display: inline-block;">RTA 00</div>											
 7893		7893	-	-	-	-	1230	1300	1427	1662	1793	2005	2329	2717
Two Seat Bench COM Yardage: 2.25 Freight Class: 250 Product Weight (lbs.): 42 Cubic Feet Per Carton: 11.5			OVERALL DIMENSIONS W D H			SEAT DIMENSIONS W D H			BACK DIMENSIONS W H					
			43	21.5	17		-	-	17		-		-	
			<div style="border: 1px solid black; padding: 2px; display: inline-block;">RTA 00</div>  											
 7894		7894	-	-	-	-	1755	1872	2087	2470	2690	3051	3587	4229
Three Seat Bench COM Yardage: 3.75 Freight Class: 250 Product Weight (lbs.): 62 Cubic Feet Per Carton: 16.75			OVERALL DIMENSIONS W D H			SEAT DIMENSIONS W D H			BACK DIMENSIONS W H					
			64.5	21.5	17		-	-	17		-		-	
			<div style="border: 1px solid black; padding: 2px; display: inline-block;">RTA 00</div>											

CITI™ SQUARE



model S7875LT



Sample Layout A - Models shown: S7875UC and S7911



Sample Layout B - Models shown: S7890RUC, S7862UC (2), S7897UC, S7890LUC and S7912

STANDARD FEATURES

- Fully upholstered lounge series with a complete range of sectional components for all applications. Proportions are compact, 31" and 33.5" deep so it works well in public spaces.
- All models have fixed, non-removable cushions.
- Upholstery options: fabric, vinyl and leather. Leather models may feature a horizontal stitch detail across the seat and/or back cushions if applicable.
- The 5 inch high leg frame for seating and occasional tables lightens the look, it is available in Tungsten (S1) as standard or optionally available in Black (S2) Please specify finish, no upcharge added.
- Casters are not available on this series.
- Arm height on all models is 25"
- Tablet arms are made from thermally fused laminate, measure 12"D x 16.5"W 3/4" thick. Available right hand seated (RT), left Hand seated (LT) or both right and left hand (LRT).
- Ganging Brackets are sold separately. Ganging brackets are to be used on armless seating if interconnection to another armless seating unit is required. Bench and ottomans only gang to other benches/ottomans, cannot gang with seating units.
- Brackets come with a template for installation: unless noted otherwise all armless skus are equipped with the steel on steel connectors to receive this bracket.
- Upholstery options: fabric, vinyl and leather. Leather models feature a horizontal stitch detail across the seat and/or back cushions if applicable.
- Check textile availability prior to specifying upholstery material.
- If you would like fabric/vinyl on the shell of the chair with leather seat and back cushions or other combinations, please complete "Multi Fabric" Form and submit with your order. Multi Fabric grade will apply.
- Measurement shown for weight is for one unit. Measurement for volume is per carton.

- (TFR) Frost
- (TIV) Cloud
- (TLA) Latte
- (TOA) Toast
- (TSH) Shadow
- (TSR) Scarlet
- (CHM) Chrome. Add \$217
- (TIN) Ink
- (TKA) Kalua
- (TMO) Mocha
- (TNE) Nevada
- (TSN) Sand
- (TTU) Tungsten

- (BCH) Brushed Chrome. Add \$317 for corner units. Add \$227 for single seat units. Add \$348 for two seat units. Add \$348 for three seat units. Add \$411 for four seat units.
- Laminate Tables and Tablet arms are made with high pressure laminate and are offered in the following finishes: Absolute Acajou (ACJ), Asian Night (ASN), Avant Cherry (AWC), Avant Honey (AWH), Black (BLK), Blizzard (BZD), Brushed Cobalt (BRC), Clear Maple (CMB), Custom Grey (CGY), Dark Espresso (DES), Designer White (DWT), Fashionista (FAS), First Class (FCL), Noce Biondo (NBL), Noce Grigio (NGL), Noce Leggero (NEL), Noce Medio (NML), Quartered Mahogany (QTM), Sheer Beauty (SBY), Storm Grey (SOG), Stonedust (SDT), Walnut Heights (WHE), White Chocolate (WHC) and Winter Cherry (WCR). Please Specify. Custom high pressure laminate finishes will be considered upon request.
- For high resilient, high density Ultracell foam on seat, specify (UC) after the model number. One Seater, add \$145. Two Seater, add \$284. Three Seater, add \$426, and Four Seater, add \$566
- Power/USB modules are available in the Citi Square tables. Each module includes a double power outlet and two USB terminals. It is equipped with a 6' long three-prong power cord with standard three prong plug. The Power monuments are available in Jet Black (J1) or White (W1). Add \$997 per unit. Please see Electrical Placement below for predetermined locations.

OPTIONAL FEATURES

- Seating and Table Leg Finishes**
Metal legs are available in the following finishes:
(TBL) Black (TBZ) Buzz Blue
(TCC) Cactus (TCR) Carrot
(TDJ) Dijon (TDW) Designer White
(TEG) Eggplant (TFO) Fog

ELECTRICAL PLACEMENT

Coffee/End Tables: Predetermined Location is on the end/side of the unit J1 (black) or W1 (white).

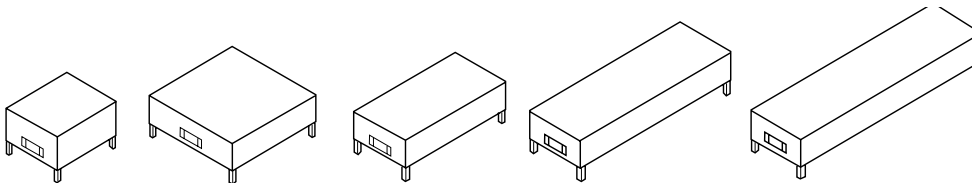

	1	2	3	4	5	6	7	8	9	10	11	12
7892	34	-	-	-	-	-	-	-	-	-	-	-





Ganging Bracket
COM Yardage: N/A
Freight Class: 70
Product Weight (lbs.): 00.25
Cubic Feet Per Carton: 00.01

Two brackets included.
Only one set is needed per connection.

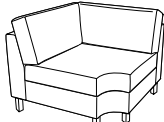
OVERALL DIMENSIONS			SEAT DIMENSIONS			BACK DIMENSIONS	
W	D	H	W	D	H	W	H
0.5	3.87	2	-	-	-	-	-

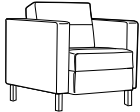

DESCRIPTION	FEATURES	MODEL#	STANDARD TEXTILE GRADES												
			1	2	3	4	5	6	7	8	9	10	11	12	
 <p>Linking Corner Unit COM Yardage: 6.25 Freight Class: 250 Product Weight (lbs.): 75 Cubic Feet Per Carton: 30.25</p>	No ganging hardware Armless side(s) can be equipped with ganging brackets, model 7892.	S7862	-	-	-	-	2731	2937	3319	3931	4399	4923	6003	7152	
			OVERALL DIMENSIONS			SEAT DIMENSIONS			BACK DIMENSIONS						
			W	D	H	W	D	H	W	H					
			37	37	31	26	26	17.5	26	13.5					
RTA 00															

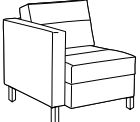

DESCRIPTION	FEATURES	MODEL#	STANDARD TEXTILE GRADES												
			1	2	3	4	5	6	7	8	9	10	11	12	
 <p>Single Seat w/Arms COM Yardage: 4.5 Freight Class: 250 Product Weight (lbs.): 81 Cubic Feet Per Carton: 21</p>	Free standing unit only.	S7875	-	-	-	-	1930	2078	2356	2795	3134	3513	4288	5114	
			OVERALL DIMENSIONS			SEAT DIMENSIONS			BACK DIMENSIONS						
			W	D	H	W	D	H	W	H					
			30	31	30	21	19.5	17.5	21	12.5					
RTA 00															

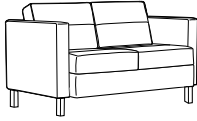
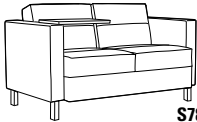
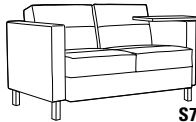
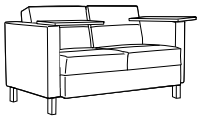
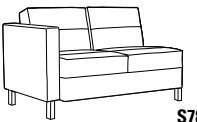

DESCRIPTION	FEATURES	MODEL#	STANDARD TEXTILE GRADES													
			1	2	3	4	5	6	7	8	9	10	11	12		
 <p>Single Seat w/Arms & Laminate Tablet COM Yardage: 4.5 Freight Class: 250 Product Weight (lbs.): 89 Cubic Feet Per Carton: 22.5</p>	Free standing unit only. Tablets are Right Hand Seated (RT) or Left Hand Seated (LT).	S7875RT	-	-	-	-	2583	2731	3009	3448	3785	4166	4941	5767		
			S7875LT	-	-	-	-	2583	2731	3009	3448	3785	4166	4941	5767	
				OVERALL DIMENSIONS			SEAT DIMENSIONS			BACK DIMENSIONS						
				W	D	H	W	D	H	W	H					
31.5	33.5	30		21	19.5	17.5	21	12.5								
RTA 00																

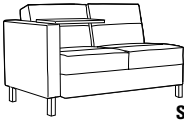

DESCRIPTION	FEATURES	MODEL#	STANDARD TEXTILE GRADES													
			1	2	3	4	5	6	7	8	9	10	11	12		
 <p>Single Seat w/One Arm COM Yardage: 4 Freight Class: 250 Product Weight (lbs.): 65 Cubic Feet Per Carton: 21</p>	No ganging hardware. Armless side can be equipped with ganging brackets, model 7892. Arms are Right Hand Seated (RT) or Left Hand Seated (LT).	S7901R	-	-	-	-	1930	2047	2262	2604	2865	3161	3765	4407		
			S7901L	-	-	-	-	1930	2047	2262	2604	2865	3161	3765	4407	
				OVERALL DIMENSIONS			SEAT DIMENSIONS			BACK DIMENSIONS						
				W	D	H	W	D	H	W	H					
26	31	30.75		21	19.5	17.5	21	12.5								
RTA 00																

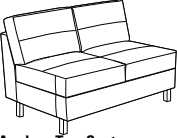
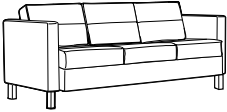
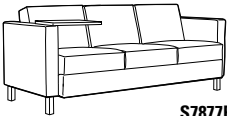
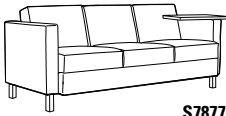
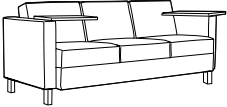

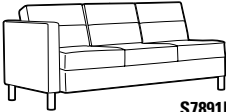
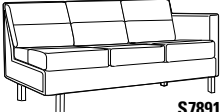
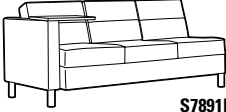
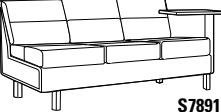
DESCRIPTION	FEATURES	MODEL#	STANDARD TEXTILE GRADES													
			1	2	3	4	5	6	7	8	9	10	11	12		
 <p>Single Seat w/One Arm & Laminate Tablet COM Yardage: 4 Freight Class: 250 Product Weight (lbs.): 73 Cubic Feet Per Carton: 22.5</p>	No ganging hardware. Armless side(s) can be equipped with ganging brackets, model 7892. Tablets are Arms are Right Hand Seated (RT) or Left Hand Seated (LT).	S7901RRT	-	-	-	-	2583	2915	1783	3257	3518	3814	4418	5060		
			S7901LLT	-	-	-	-	2583	2700	2915	3257	3518	3814	4418	5060	
				OVERALL DIMENSIONS			SEAT DIMENSIONS			BACK DIMENSIONS						
				W	D	H	W	D	H	W	H					
27.5	31	30.75		21	19.5	17.5	21	12.5								
RTA 00																

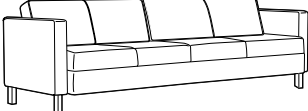
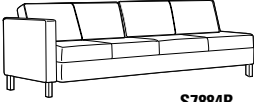
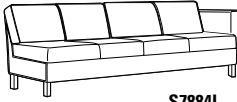
DESCRIPTION	FEATURES	MODEL#	STANDARD TEXTILE GRADES											
			1	2	3	4	5	6	7	8	9	10	11	12
 <p>Armless Single Seat COM Yardage: 3 Freight Class: 2250 Product Weight (lbs.): 45 Cubic Feet Per Carton: 15.5</p>	<p>No ganging hardware. Armless side(s) can be equipped with ganging brackets, model 7892.</p>	<p>S7895</p>	-	-	-	-	1930	2030	2212	2509	2733	2987	3504	4056
			OVERALL DIMENSIONS			SEAT DIMENSIONS			BACK DIMENSIONS					
			W	D	H	W	D	H	W		H			
			22	31	30.75	21	18.5	17.5	21		12.5			
			RTA 00											
 <p>Two Seater w/Arms COM Yardage: 6.25 Freight Class: 250 Product Weight (lbs.): 122 Cubic Feet Per Carton: 36</p>	<p>Free standing unit only.</p>	<p>S7876</p>	-	-	-	-	2731	2937	3319	3931	4399	4923	6003	7152
			OVERALL DIMENSIONS			SEAT DIMENSIONS			BACK DIMENSIONS					
			W	D	H	W	D	H	W		H			
			51.25	31	30	42.5	19.5	17.5	42.5		12.5			
			RTA 00											
 <p>S7876RT</p>  <p>S7876LT</p> <p>Two Seater w/Arms & Laminate Tablet COM Yardage: 6.25 Freight Class: 250 Product Weight (lbs.): 130 Cubic Feet Per Carton: 41.25</p>	<p>Free standing unit only. Tablets are Right Hand Seated (RT) or Left Hand Seated (LT).</p>	<p>S7876RT S7876LT</p>	-	-	-	-	3385	3589	3973	4582	5053	5577	6657	7806
			OVERALL DIMENSIONS			SEAT DIMENSIONS			BACK DIMENSIONS					
			W	D	H	W	D	H	W		H			
			52.75	33.5	30	42.5	19.5	17.5	42.5		12.5			
			RTA 00											
 <p>Two Seater w/Arms & Laminate Tablets COM Yardage: 6.25 Freight Class: 250 Product Weight (lbs.): 138 Cubic Feet Per Carton: 41.25</p>	<p>Free standing unit only. With both Left and Right Tablets.</p>	<p>S7876LRT</p>	-	-	-	-	4040	4244	4628	5237	5708	6232	7312	8461
			OVERALL DIMENSIONS			SEAT DIMENSIONS			BACK DIMENSIONS					
			W	D	H	W	D	H	W		H			
			54.25	33.5	30	42.5	19.5	17.5	42.5		12.5			
			RTA 00											
 <p>S7890R</p>  <p>S7890L</p> <p>Two Seater w/One Arm COM Yardage: 5.25 Freight Class: 250 Product Weight (lbs.): 106 Cubic Feet Per Carton: 36</p>	<p>No ganging hardware. Armless side can be equipped with ganging brackets, model 7892. Arms are Right Hand Seated (RT) or Left Hand Seated (LT).</p>	<p>S7890R S7890L</p>	-	-	-	-	2536	2707	3029	3543	3939	4381	5284	6251
			OVERALL DIMENSIONS			SEAT DIMENSIONS			BACK DIMENSIONS					
			W	D	H	W	D	H	W		H			
			47.25	31	30.75	42.5	19.5	17.5	42.5		13.25			
			RTA 00											

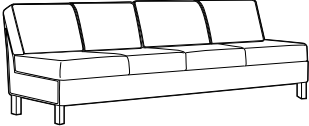
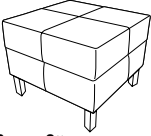
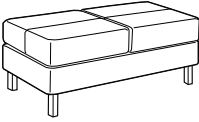
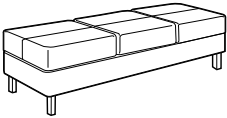
DESCRIPTION	FEATURES	MODEL#	STANDARD TEXTILE GRADES											
			1	2	3	4	5	6	7	8	9	10	11	12
 <p>S7890RRT</p>	 <p>S7890LLT</p>		-	-	-	-	3189	3360	3682	4196	4592	5033	5937	6903
			S7890LLT	-	-	-	-	3189	3360	3682	4196	4592	5033	5937
<p>Two Seater w/One Arm and Laminate Tablet COM Yardage: 5.25 Freight Class: 250 Product Weight (lbs.): 114 Cubic Feet Per Carton: 41.25</p>	<p>No ganging hardware. Armless side(s) can be equipped with ganging brackets, model 7892. Tablets are Arms are Right Hand Seated (RT) or Left Hand Seated (LT).</p>		OVERALL DIMENSIONS			SEAT DIMENSIONS			BACK DIMENSIONS					
			W	D	H	W	D	H	W	H				
			48.75	33.5	30.75	42.5	19.5	17.5	42.5	13.25				
			RTA 00											
 <p>Armless Two Seater COM Yardage: 5 Freight Class: 250 Product Weight (lbs.): 43.25 Cubic Feet Per Carton: 36</p>	<p>No ganging hardware. Armless side(s) can be equipped with ganging brackets, model 7892.</p>		-	-	-	-	2536	2701	3006	3497	3874	4294	5156	6074
			S7896	-	-	-	-	2536	2701	3006	3497	3874	4294	5156
<p>Armless Two Seater COM Yardage: 5 Freight Class: 250 Product Weight (lbs.): 43.25 Cubic Feet Per Carton: 36</p>	<p>No ganging hardware. Armless side(s) can be equipped with ganging brackets, model 7892.</p>		OVERALL DIMENSIONS			SEAT DIMENSIONS			BACK DIMENSIONS					
			W	D	H	W	D	H	W	H				
			43.25	31	30.75	42.5	19.5	17.5	42.5	13.25				
			RTA 00											
 <p>Three Seater w/Arms COM Yardage: 8.75 Freight Class: 250 Product Weight (lbs.): 163 Cubic Feet Per Carton: 50.25</p>	<p>Free standing unit only.</p>		-	-	-	-	3536	3818	4356	5214	5871	6605	8113	9724
			S7877	-	-	-	-	3536	3818	4356	5214	5871	6605	8113
<p>Three Seater w/Arms COM Yardage: 8.75 Freight Class: 250 Product Weight (lbs.): 163 Cubic Feet Per Carton: 50.25</p>	<p>Free standing unit only.</p>		OVERALL DIMENSIONS			SEAT DIMENSIONS			BACK DIMENSIONS					
			W	D	H	W	D	H	W	H				
			72.5	31	30	63.5	19.5	17.5	63.5	12.5				
			RTA 00											
 <p>S7877RT</p>	 <p>S7877LT</p>		-	-	-	-	4188	4469	5008	5866	6523	7257	8765	10376
			S7877LT	-	-	-	-	4188	4469	5008	5866	6523	7257	8765
<p>Three Seater w/Arms and Laminate Tablet COM Yardage: 8.75 Freight Class: 250 Product Weight (lbs.): 171 Cubic Feet Per Carton: 55.5</p>	<p>Free standing unit only. Tablets are Right Hand Seated (RT) or Left Hand Seated (LT).</p>		OVERALL DIMENSIONS			SEAT DIMENSIONS			BACK DIMENSIONS					
			W	D	H	W	D	H	W	H				
			74	33.5	30	63.5	19.5	17.5	63.5	12.5				
			RTA 00											
 <p>Three Seater w/Arms and Laminate Tablets COM Yardage: 8.75 Freight Class: 250 Product Weight (lbs.): 250 Cubic Feet Per Carton: 55.5</p>	<p>Free standing unit only. With both Left and Right Tablets.</p>		-	-	-	-	4841	5122	5661	6519	7176	7910	9418	11029
			S7877LRT	-	-	-	-	4841	5122	5661	6519	7176	7910	9418
<p>Three Seater w/Arms and Laminate Tablets COM Yardage: 8.75 Freight Class: 250 Product Weight (lbs.): 250 Cubic Feet Per Carton: 55.5</p>	<p>Free standing unit only. With both Left and Right Tablets.</p>		OVERALL DIMENSIONS			SEAT DIMENSIONS			BACK DIMENSIONS					
			W	D	H	W	D	H	W	H				
			75.5	33.5	30	63.5	19.5	17.5	63.5	12.5				
			RTA 00											

DESCRIPTION	FEATURES	MODEL#	STANDARD TEXTILE GRADES											
			1	2	3	4	5	6	7	8	9	10	11	12
 <p>S7891R</p> <p>Three Seater w/One Arm COM Yardage: 7.25 Freight Class: 250 Product Weight (lbs.): 147 Cubic Feet Per Carton: 50.25</p>	 <p>S7891L</p> <p>No ganging hardware. Armless side can be equipped with ganging brackets, model 7892. Arms are Right Hand Seated (RT) or Left Hand Seated (LT) .</p>	S7891R	-	-	-	-	3424	3660	4104	4816	5361	5968	7219	8552
		S7891L	-	-	-	-	3424	3660	4104	4816	5361	5968	7219	8552
<p>OVERALL DIMENSIONS</p> <p>W D H</p>			<p>SEAT DIMENSIONS</p> <p>W D H</p>			<p>BACK DIMENSIONS</p> <p>W H</p>								
68.5 31 30.75			63.5 19.5 17.5			63.5 13.25								
RTA 00														
 <p>S7891RRT</p> <p>Three Seater w/One Arm and Laminate Tablet COM Yardage: 7.25 Freight Class: 250 Product Weight (lbs.): 155 Cubic Feet Per Carton: 55.5</p>	 <p>S7891LLT</p> <p>No ganging hardware. Armless side(s) can be equipped with ganging brackets, model 7892. Tablets are Arms are Right Hand Seated (RT) or Left Hand Seated (LT).</p>	S7891RRT	-	-	-	-	4077	4313	4756	5469	6014	6621	7872	9205
		S7891LLT	-	-	-	-	4077	4313	4756	5469	6014	6621	7872	9205
<p>OVERALL DIMENSIONS</p> <p>W D H</p>			<p>SEAT DIMENSIONS</p> <p>W D H</p>			<p>BACK DIMENSIONS</p> <p>W H</p>								
70 33.5 30.75			63.5 19.5 17.5			63.5 13.25								
RTA 00														
 <p>S7897</p> <p>Armless Three Seater COM Yardage: 7.25 Freight Class: 250 Product Weight (lbs.): 131 Cubic Feet Per Carton: 50.25</p>	<p>No ganging hardware. Armless side(s) can be equipped with ganging brackets, model 7892.</p>	S7897	-	-	-	-	3424	3660	4104	4816	5361	5968	7219	8552
		<p>OVERALL DIMENSIONS</p> <p>W D H</p>			<p>SEAT DIMENSIONS</p> <p>W D H</p>			<p>BACK DIMENSIONS</p> <p>W H</p>						
64.5 31 30.75			63.5 19.5 17.5			63.5 13.25								
RTA 00														
 <p>S7884</p> <p>Four Seater w/Arms COM Yardage: 10.25 Freight Class: 250 Product Weight (lbs.): 204 Cubic Feet Per Carton: 69</p>	<p>Free standing unit only.</p>	S7884	-	-	-	-	5201	5533	6162	7164	7935	8795	10562	12448
		<p>OVERALL DIMENSIONS</p> <p>W D H</p>			<p>SEAT DIMENSIONS</p> <p>W D H</p>			<p>BACK DIMENSIONS</p> <p>W H</p>						
93.5 31 30			84 19.5 17.5			84 12.5								
RTA 00														
 <p>S7884R</p> <p>Four Seater w/One Arm COM Yardage: 9.5 Freight Class: 250 Product Weight (lbs.): 188 Cubic Feet Per Carton: 69</p>	 <p>S7884L</p> <p>No ganging hardware. Armless side can be equipped with ganging brackets, model 7892. Arms are Right Hand Seated (RT) or Left Hand Seated (LT) .</p>	S7884R	-	-	-	-	5089	5394	5979	6906	7624	8420	10057	11806
		S7884L	-	-	-	-	5089	5394	5979	6906	7624	8420	10057	11806
<p>OVERALL DIMENSIONS</p> <p>W D H</p>			<p>SEAT DIMENSIONS</p> <p>W D H</p>			<p>BACK DIMENSIONS</p> <p>W H</p>								
89.5 31 30.75			84 19.5 17.5			84 12.5								
RTA 00														

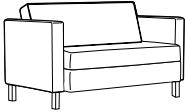
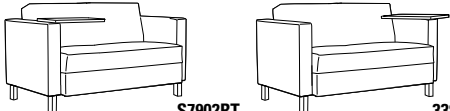
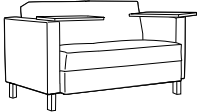
DESCRIPTION	FEATURES	MODEL#	STANDARD TEXTILE GRADES													
			1	2	3	4	5	6	7	8	9	10	11	12		
 <p>Armless Four Seater COM Yardage: 8.75 Freight Class: 250 Product Weight (lbs.): 172 Cubic Feet Per Carton: 61.5</p>	<p>No ganging hardware. Armless side(s) can be equipped with ganging brackets, model 7892.</p>	S7884NA	-	-	-	-	5089	5370	5909	6767	7424	8158	9666	11277		
			OVERALL DIMENSIONS			SEAT DIMENSIONS			BACK DIMENSIONS							
			W	D	H	W	D	H	W	H						
			85.5	31	30.75	84	19.5	17.5	84	12.5						
			RTA 00													
 <p>Square Ottoman COM Yardage: 1.5 Freight Class: 250 Product Weight (lbs.): 27 Cubic Feet Per Carton: 7.5</p>	<p>No ganging hardware. Side(s) can be equipped with ganging brackets, model 7892. Does not gang to seating units.</p>	S7879	-	-	-	-	801	852	946	1094	1208	1332	1592	1866		
			OVERALL DIMENSIONS			SEAT DIMENSIONS			BACK DIMENSIONS							
			W	D	H	W	D	H	W	H						
			22	22	17	-	-	17	-	-						
			RTA 00													
 <p>Two Seater Bench COM Yardage: 2.25 Freight Class: 250 Product Weight (lbs.): 42 Cubic Feet Per Carton: 11.5</p>	<p>No ganging hardware. Side(s) can be equipped with ganging brackets, model 7892. Does not gang to seating units.</p>	S7893	-	-	-	-	1539	1615	1756	1974	2146	2333	2720	3135		
			OVERALL DIMENSIONS			SEAT DIMENSIONS			BACK DIMENSIONS							
			W	D	H	W	D	H	W	H						
			43	21.5	17	-	-	17	-	-						
			RTA 00													
 <p>Three Seater Bench COM Yardage: 3.75 Freight Class: 250 Product Weight (lbs.): 62 Cubic Feet Per Carton: 16.75</p>	<p>No ganging hardware. Side(s) can be equipped with ganging brackets, model 7892. Does not gang to seating units.</p>	S7894	-	-	-	-	2191	2316	2546	2912	3195	3509	4155	4845		
			OVERALL DIMENSIONS			SEAT DIMENSIONS			BACK DIMENSIONS							
			W	D	H	W	D	H	W	H						
			64.5	21.5	17	-	-	17	-	-						
			RTA 00													
 <p>Two Seater Bench - Single Cushion COM Yardage: 2.25 Freight Class: 250 Product Weight (lbs.): 42 Cubic Feet Per Carton: 11.5</p>	<p>No ganging hardware. Side(s) can be equipped with ganging brackets, model 7892. Does not gang to seating units.</p>	S7905	-	-	-	-	1210	1286	1427	1645	1813	2004	2391	2806		
			OVERALL DIMENSIONS			SEAT DIMENSIONS			BACK DIMENSIONS							
			W	D	H	W	D	H	W	H						
			43	21.5	17	-	-	17	-	-						
			RTA 00													

DESCRIPTION	FEATURES	MODEL#	STANDARD TEXTILE GRADES											
			1	2	3	4	5	6	7	8	9	10	11	12
 <p>Two Seater w/Arms - Single Cushion COM Yardage: 6.5 Freight Class: 250 Product Weight (lbs.): 122 Cubic Feet Per Carton: 36</p>	Free standing unit only.	S7902	-	-	-	-	2731	2937	3319	3931	4399	4923	6003	7152
			OVERALL DIMENSIONS			SEAT DIMENSIONS			BACK DIMENSIONS					
			W	D	H	W	D	H	W	H				
			51.25	31	30	42.5	19.5	17.5	42.5	12.5				
			RTA 00											
 <p>Two Seater w/Arms & Lam. Tablet - Single Cushion COM Yardage: 5.25 Freight Class: 250 Product Weight (lbs.): 114 Cubic Feet Per Carton: 36</p>	Free standing unit only. Tablets are Right Hand Seated (RT) or Left Hand Seated (LT).	S7902RT S7902LT	-	-	-	-	3385	2684	2684	4631	2684	5667	6787	7983
			OVERALL DIMENSIONS			SEAT DIMENSIONS			BACK DIMENSIONS					
			W	D	H	W	D	H	W	H				
			48.75	33.5	30.75	42.5	19.5	17.5	42.5	13.25				
			RTA 00											
 <p>Two Seater w/Arms & Lam. Tablets - Single Cushion COM Yardage: 6.5 Freight Class: 250 Product Weight (lbs.): 127 Cubic Feet Per Carton: 41.25</p>	Free standing unit only. With both Left and Right Tablets.	S7902LRT	-	-	-	-	4040	4250	4652	5286	5777	6322	7442	8638
			OVERALL DIMENSIONS			SEAT DIMENSIONS			BACK DIMENSIONS					
			W	D	H	W	D	H	W	H				
			54.25	33.5	30	42.5	19.5	17.5	42.5	12.5				
			RTA 00											
 <p>Two Seater w/One Arm - Single Cushion COM Yardage: 5.25 Freight Class: 250 Product Weight (lbs.): 114 Cubic Feet Per Carton: 36</p>	No ganging hardware. Armless side can be equipped with ganging brackets, model 7892. Arms are Right Hand Seated (RT) or Left Hand Seated (LT).	S7902R S7902L	-	-	-	-	2536	2707	3029	3543	3939	4381	5284	6251
			OVERALL DIMENSIONS			SEAT DIMENSIONS			BACK DIMENSIONS					
			W	D	H	W	D	H	W	H				
			47.25	31	30.75	42.5	19.5	17.5	42.5	13.25				
			RTA 00											
 <p>Two Seater w/One Arm & Lam. Tablet - Single Cushion COM Yardage: 5.25 Freight Class: 250 Product Weight (lbs.): 114 Cubic Feet Per Carton: 36</p>	Free standing unit only. Tablets are Right Hand Seated (RT) or Left Hand Seated (LT).	S7902RRT S7902LLT	-	-	-	-	3189	3360	3682	4196	4592	5033	5937	6903
			OVERALL DIMENSIONS			SEAT DIMENSIONS			BACK DIMENSIONS					
			W	D	H	W	D	H	W	H				
			48.75	33.5	30.75	42.5	19.5	17.5	42.5	13.25				
			RTA 00											

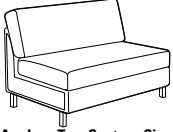
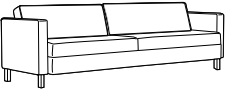
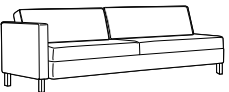
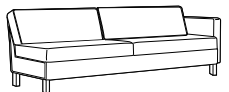
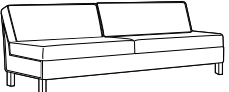
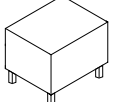
DESCRIPTION	FEATURES	MODEL#	STANDARD TEXTILE GRADES											
			1	2	3	4	5	6	7	8	9	10	11	12
 <p>Armless Two Seater - Single Cushion COM Yardage: 6.5 Freight Class: 250 Product Weight (lbs.): 90 Cubic Feet Per Carton: 36</p>	No ganging hardware. Armless side(s) can be equipped with ganging brackets, model 7892.	S7902NA	-	-	-	-	2536	2684	2962	3401	3740	4119	4894	5720
		OVERALL DIMENSIONS			SEAT DIMENSIONS			BACK DIMENSIONS						
		W	D	H	W	D	H	W	H					
		43.25	31	30.75	42.5	19.5	17.5	42.5	13.25					
			RTA 00											
 <p>Four Seater w/Arms - Duo Cushion COM Yardage: 10.25 Freight Class: 250 Product Weight (lbs.): 204 Cubic Feet Per Carton: 69</p>	Free standing unit only.	S7904	-	-	-	-	5201	5533	6162	7164	7935	8795	10562	12448
		OVERALL DIMENSIONS			SEAT DIMENSIONS			BACK DIMENSIONS						
		W	D	H	W	D	H	W	H					
		93.5	31	30	84	19.5	17.5	84	12.5					
			RTA 00											
 <p>S7904R</p>  <p>S7904L</p> <p>Four Seater w/One Arm - Duo Cushion COM Yardage: 9.5 Freight Class: 250 Product Weight (lbs.): 188 Cubic Feet Per Carton: 61.5</p>	No ganging hardware. Armless side can be equipped with ganging brackets, model 7892. Arms are Right Hand Seated (RT) or Left Hand Seated (LT) .	S7904R	-	-	-	-	5089	5394	5979	6906	7624	8420	10057	11806
		S7904L	-	-	-	-	5089	5394	5979	6906	7624	8420	10057	11806
		OVERALL DIMENSIONS			SEAT DIMENSIONS			BACK DIMENSIONS						
		W	D	H	W	D	H	W	H					
89.5	31	30.75	84	19.5	17.5	84	12.5							
			RTA 00											
 <p>Armless Four Seater - Single Cushion COM Yardage: 8.75 Freight Class: 250 Product Weight (lbs.): 172 Cubic Feet Per Carton: 61.5</p>	No ganging hardware. Armless side(s) can be equipped with ganging brackets, model 7892.	S7904NA	-	-	-	-	5089	5370	5909	6767	7424	8158	9666	11277
		OVERALL DIMENSIONS			SEAT DIMENSIONS			BACK DIMENSIONS						
		W	D	H	W	D	H	W	H					
		85.5	31	30.75	84	19.5	17.5	84	12.5					
			RTA 00											
 <p>Cube End Table COM Yardage: N/A Freight Class: 100 Product Weight (lbs.): 51 Cubic Feet Per Carton: 5.5</p>	Free standing unit only. No ganging hardware. For Power/USB module please see electrical placement chart.	S7911	2021	-	-	-	-	-	-	-	-	-	-	-
		OVERALL DIMENSIONS			SEAT DIMENSIONS			BACK DIMENSIONS						
		W	D	H	W	D	H	W	H					
		20	24	16	-	-	-	-	-					
			RTA 00											

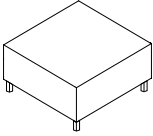
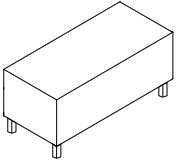
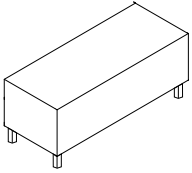
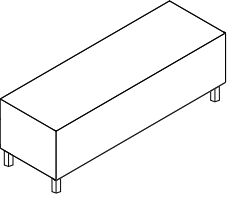
DESCRIPTION	FEATURES	MODEL#	STANDARD TEXTILE GRADES											
			1	2	3	4	5	6	7	8	9	10	11	12
 <p>Cube Square Coffee Table COM Yardage: N/A Freight Class: 100 Product Weight (lbs.): 86 Cubic Feet Per Carton: 10.75</p>	<p>Free standing unit only. No ganging hardware. For Power/USB module please see electrical placement chart.</p>	S7912	2567	-	-	-	-	-	-	-	-	-	-	-
		OVERALL DIMENSIONS			SEAT DIMENSIONS			BACK DIMENSIONS						
		W	D	H	W	D	H	W	H					
		33	33	14	-	-	-	-	-					
			RTA 00											
 <p>Cube 40" Coffee Table COM Yardage: N/A Freight Class: 100 Product Weight (lbs.): 66 Cubic Feet Per Carton: 8</p>	<p>Free standing unit only. No ganging hardware. For Power/USB module please see electrical placement chart.</p>	S7913	2430	-	-	-	-	-	-	-	-	-	-	
		OVERALL DIMENSIONS			SEAT DIMENSIONS			BACK DIMENSIONS						
		W	D	H	W	D	H	W	H					
		40	20	14	-	-	-	-	-					
			RTA 00											
 <p>Cube Extended 60" Coffee Table COM Yardage: N/A Freight Class: 125 Product Weight (lbs.): 93 Cubic Feet Per Carton: 12</p>	<p>Free standing unit only. No ganging hardware. For Power/USB module please see electrical placement chart.</p>	S7915	3174	-	-	-	-	-	-	-	-	-		
		OVERALL DIMENSIONS			SEAT DIMENSIONS			BACK DIMENSIONS						
		W	D	H	W	D	H	W	H					
		60	20	14	-	-	-	-	-					
			RTA 00											
 <p>Cube Extended 72" Coffee Table COM Yardage: N/A Freight Class: 125 Product Weight (lbs.): 107 Cubic Feet Per Carton: 14.25</p>	<p>Free standing unit only. No ganging hardware. For Power/USB module please see electrical placement chart.</p>	S7916	3248	-	-	-	-	-	-	-	-	-		
		OVERALL DIMENSIONS			SEAT DIMENSIONS			BACK DIMENSIONS						
		W	D	H	W	D	H	W	H					
		72	20	14	-	-	-	-	-					
			RTA 00											

DRIFT



Wood Base model 8030
Side Chair w/4 Leg



Side Chair, Sled Base
Arm Patches model 8023P



Chrome Base model 8034
Low Back Lounge Chair



Wood Base model 8037
Mid Back Lounge Chair



Ottoman model 8026



Wood Base model 8052
Counter Stool



For Drift tables, see page page 311

EXAMPLE OF TABLE ORDER CODE:

8030P	WA50	WA50	R11	NM	AAM
Model Number	Back/Arm Textile	Seat Textile	Patch Textile	Seat Height	Base Finish

NM	NBS	NSS	NB
Glide Type	Sealed Back Seams	Sealed Seat Seams	Moisture Barrier

5-Star Base Mechanism

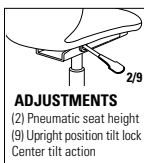

ADJUSTMENTS
(2) Pneumatic seat height
(9) Upright position tilt lock
Center tilt action

Ergonomic features:
B, C, S, U



Flip Forward Seat
"F" suffix models

STANDARD FEATURES

- Drift's soft seat and contoured back and arms provide the perfect balance of style and comfort. Side chairs are available in six base types: sled, wood 4-leg, wood 4-prong swivel, chrome 4-prong swivel, high 4-star swivel and 5-star base on casters.
- Lounge chairs are available in four base types: sled, wood 4-leg, wood 4-star swivel and Chrome 4-prong swivel.
- Counter and bar height stools are available with three base types: sled, wood 4-leg, and Chrome 4-star swivel.
- Wood bases are made from Beechwood and are available in all standard wood finishes.
- Wood base seating models are standard with White non-marking polycarbonate glides. See Glide Type for additional glide options.
- Sled bases are standard in painted metal or Chrome finish. See Frame Finish for upcharges.
- Sled base models are standard with clear polycarbonate glides. See Glide Type for additional glide options.
- Chrome swivel bases are available in polished Chrome only. Lounge models with Chrome swivel bases swivel 360deg, available in swivel or self-centering swivel.
- Lounge seating is available with 17" seat height with a classic lounge angle or 18" seat height with a reduced back angle for ease of sitting and standing.
- Side chairs with 5-star base and casters swivel 360 degrees, are height adjustable with 4" range and include a tilting mechanism with upright tilt lock. Base is Polished Aluminum with C114 Carpet or C114R hard floor, dual wheel casters. See upcharges.
- Ottomans have a weighted bottom to maintain upright position. Specify Top and Side textile separately. Glides are White, non-marking.
- For increased durability on side and lounge seating, P and PH suffix models are available with arm and head patches. These high touch areas are covered in Global's Release vinyl. Specify Release color.
- For ease of cleaning, Side and Lounge Chair models with "F" suffix have flip-forward seats. Material under seat matches seat textile selection. (Stools and side chairs with high 4- star and 5-star bases have fixed seat cushions only.)
- Sealed seams are available on chair backs and/ or seats (with upcharge). For sealed seams on Ottoman, specify Ottoman (8026S), available only in sealed seam approved textiles.
- A moisture barrier may be added to seat cushions only (with upcharge). Not available with sealed seams.
- Upholstery options: fabric, vinyl, or leather.
- All Drift seating is assembled using tamper proof screws.
- Drift seating is available to specify with two textiles, one for the seat cushion and one for the back and arms (see model image).
- For pricing, start with the base price and add both back/arms graded textile upcharge and the seat graded textile upcharge.
- The Blended Textile matrix does not apply to this series.
- Drift seating is designed for 300lb capacity.
- Shipped fully assembled.
- See finishes section in Price List for solid wood/ laminate coordination chart.

Add option codes in the following order:

- **Model Number**
Specify model number.
- **Back/Arm Textile**
Specify textile code. See model grade upcharges.
- **Seat Textile**
Specify textile code. See model grade upcharges.
- **Arm and Head Patch Textile** (For P and PH suffix models)
Release Vinyl only

- **Seat Height** (lounge models only):
(S17) 17" Seat height
(S18) 18" Seat height
- **Base Finish** (wood base models)
(AAM) Absolute (BKM) Black
(ACM) Cherry (EOM) English Oak
(ECM) Espresso Cafe (TFM) Fruitwood
(HGM) Grey (AHM) Honey
(TMM) Mahogany (AVM) Maple
(NLW) Natural Walnut (MVM) Medium Walnut
(ASM) Night (NBM) Noce Biondo
(NGM) Noce Grigio (NEM) Noce Leggero
(NMM) Noce Medio (SKM) Shaker Cherry
(TWM) Walnut (WTM) WC Cream
(WHM) White (WCM) Winter Cherry
- **Base Finish** (sled base models)
(TBL) Black (TBZ) Buzz Blue
(TCC) Cactus (TCR) Carrot
(TDJ) Dijon (TDW) Designer White
(TEG) Eggplant (TFO) Fog
(TFR) Frost (TIN) Ink
(TIV) Cloud (TKA) Kalua
(TLA) Latte (TOA) Toast
(TNE) Nevada (TSH) Shadow
(TSN) Sand (TSR) Scarlet
(TTU) Tungsten
Metallics: Side/Lounge Counter Bar
(CHM) Chrome. Add \$45 \$89 \$89
- **Base Finish** (5-star base only)
(A7) Polish Aluminum
- **Cylinder Selection** (Chrome swivel lounge models):
(DSC) Swivel cylinder
(DAC) Self-centering cylinder
- **Glide Type** (wood base seating)
(NM) White, non-marking nylon for most hard floor surfaces (standard)
(SG) Steel cushioned glides for carpeted surfaces. Add \$36
(RG) Non-slip, rubber glides for most hard floor surfaces. Add \$36
(FG) Felt glides for most hard floor surfaces. Add \$36
- **Glide Type** (sled base seating)
(CG) Clear, polycarbonate glide for most surfaces (standard)
(XG) No glide for carpeted surfaces
(FG) Felt glide for most hard surfaces. Add \$36
(SG) Steel cushioned glide for carpeted surfaces. Add \$36
(RG) Non-slip rubber glide for most hard surfaces. Add \$36
- **Glide Type** (High, 4-Star base side chairs)
(NM) White Polyethylene non-marking glide for most surfaces
(FG) Felt Glide for most hard floor surfaces. Add \$36
- **Caster Type** (5-star base side chairs)
(DC) 2" Caster for carpeted surfaces
(RC) 2" Caster for hard floor surfaces. Add \$53
- **Sealed Back Seams** (contact customer care for approved textiles)
(NBS) No sealed back seam
(SBS) Sealed back seams. See model for upcharge.
- **Sealed Seat Seams** (contact customer care for approved textiles)
(NSS) No sealed seat seams
(SSS) Sealed seat seams. See model for upcharge.
- **Moisture Barrier** (not available with sealed seams)
(NB) No moisture barrier
(MB) Moisture barrier (seat only). Add \$107

DESCRIPTION MODEL#/ FEATURES STANDARD TEXTILE GRADES



8030P	Base Price:	\$1738											
	Back/Arm upcharge:	+0	+\$43	+76	+125	+194	+222	+282	+375	+446	+522	+681	+849
	Seat upcharge:	+0	+\$26	+\$46	+\$75	+\$117	+\$133	+\$169	+\$225	+\$267	+\$314	+\$409	+\$510
8030PF	Base Price:	\$1997											
	Back/Arm upcharge:	+0	+\$43	+76	+125	+194	+222	+282	+375	+446	+522	+681	+849
	Seat upcharge:	+0	+\$34	+\$61	+\$100	+\$155	+\$178	+\$225	+\$300	+\$356	+\$417	+\$545	+\$679

OVERALL DIMENSIONS			SEAT DIMENSIONS			BACK DIMENSIONS	
W	D	H	W	D	H	W	H

Side Chairs, 4 Leg Wood Base, Arm Patches
 COM Yardage: Back/Arms: 1.25; Seat: .75
 COM Yardage "F" Model: Back/Arms: 1.25; Seat 1
 Freight Class: 250
 Product Weight (lbs.): 28
 Cubic Feet Per Carton: 13.25

"F" model = Flip Forward
 Seat for ease of cleaning
 Add \$57 for (SBS)
 Add \$29 for (SSS); \$47 (F model)

RTA 00 1 per carton



8031	Base Price:	\$1987											
	Back/Arm upcharge:	+0	+\$43	+76	+125	+194	+222	+282	+375	+446	+522	+681	+849
	Seat upcharge:	+0	+\$26	+\$46	+\$75	+\$117	+\$133	+\$169	+\$225	+\$267	+\$314	+\$409	+\$510
8031F	Base Price:	\$2246											
	Back/Arm upcharge:	+0	+\$43	+76	+125	+194	+222	+282	+375	+446	+522	+681	+849
	Seat upcharge:	+0	+\$34	+\$61	+\$100	+\$155	+\$178	+\$225	+\$300	+\$356	+\$417	+\$545	+\$679

OVERALL DIMENSIONS			SEAT DIMENSIONS			BACK DIMENSIONS	
W	D	H	W	D	H	W	H

Side Chair, Wood Swivel Base
 COM Yardage: Back/Arms: 1.25; Seat: .75
 COM Yardage "F" Model: Back/Arms: 1.25; Seat 1
 Freight Class: 300
 Product Weight (lbs.): 31
 Cubic Feet Per Carton: 15.75

"F" model = Flip Forward
 Seat for ease of cleaning
 Add \$38 for (SBS)
 Add \$29 for (SSS); \$47 (F model)

RTA 00 FedEx ups 1 per carton



8031P	Base Price:	\$2013											
	Back/Arm upcharge:	+0	+\$43	+76	+125	+194	+222	+282	+375	+446	+522	+681	+849
	Seat upcharge:	+0	+\$26	+\$46	+\$75	+\$117	+\$133	+\$169	+\$225	+\$267	+\$314	+\$409	+\$510
8031PF	Base Price:	\$2272											
	Back/Arm upcharge:	+0	+\$43	+76	+125	+194	+222	+282	+375	+446	+522	+681	+849
	Seat upcharge:	+0	+\$34	+\$61	+\$100	+\$155	+\$178	+\$225	+\$300	+\$356	+\$417	+\$545	+\$679

OVERALL DIMENSIONS			SEAT DIMENSIONS			BACK DIMENSIONS	
W	D	H	W	D	H	W	H

Side Chair, Wood Swivel Base, Arm Patches
 COM Yardage: Back/Arms: 1.25; Seat: .75
 COM Yardage "F" Model: Back/Arms: 1.25; Seat 1
 Freight Class: 250
 Product Weight (lbs.): 33
 Cubic Feet Per Carton: 13.25

"F" model = Flip Forward
 Seat for ease of cleaning
 Add \$57 for (SBS)
 Add \$29 for (SSS); \$47 (F model)

RTA 00 1 per carton







8032	Base Price:	\$2033											
	Back/Arm upcharge:	+0	+\$43	+76	+125	+194	+222	+282	+375	+446	+522	+681	+849
	Seat upcharge:	+0	+\$26	+\$46	+\$75	+\$117	+\$133	+\$169	+\$225	+\$267	+\$314	+\$409	+\$510
8032F	Base Price:	\$2292											
	Back/Arm upcharge:	+0	+\$34	+61	+100	+155	+178	+225	+300	+356	+417	+545	+679
	Seat upcharge:	+0	+\$43	+\$76	+\$125	+\$194	+\$222	+\$282	+\$375	+\$446	+\$522	+\$681	+\$849





OVERALL DIMENSIONS			SEAT DIMENSIONS			BACK DIMENSIONS	
W	D	H	W	D	H	W	H





Side Chair, Chrome Swivel Base
 COM Yardage: Back/Arms: 1.25; Seat: .75
 COM Yardage "F" Model: Back/Arms: 1.25; Seat 1
 Freight Class: 300
 Product Weight (lbs.): 31
 Cubic Feet Per Carton: 15.75





"F" model = Flip Forward
 Seat for ease of cleaning
 Add \$38 for (SBS)
 Add \$29 for (SSS); \$47 (F model)





RTA 00 1 per carton

DESCRIPTION	MODEL#/ FEATURES	STANDARD TEXTILE GRADES												
		1/COM	2	3	4	5	6	7	8	9	10	11	12	
 <p>Side Chair, Chrome Swivel Base, Arm Patches COM Yardage: Back/Arms: 1.25; Seat: .75 COM Yardage "F" Model: Back/Arms: 1.25; Seat: 1 Freight Class: 250 Product Weight (lbs.): 33 Cubic Feet Per Carton: 13.25</p>	8032P	Base Price:	\$2060											
	Back/Arm upcharge:	+0	+\$26	+\$46	+\$75	+\$117	+\$133	+\$169	+\$225	+\$267	+\$314	+\$409	+\$510	
	Seat upcharge:	+0	+\$43	+\$76	+\$125	+\$194	+\$222	+\$282	+\$375	+\$446	+\$522	+\$681	+\$849	
	8032PF	Base Price:	\$2317											
	Back/Arm upcharge:	+0	+\$43	+\$76	+\$125	+\$194	+\$222	+\$282	+\$375	+\$446	+\$522	+\$681	+\$849	
	Seat upcharge:	+0	+\$34	+\$61	+\$100	+\$155	+\$178	+\$225	+\$300	+\$356	+\$417	+\$545	+\$679	
			OVERALL DIMENSIONS				SEAT DIMENSIONS			BACK DIMENSIONS				
			W	D	H	W	D	H	W	H				
			24.5	23	31	18	17.5	18	15	13				
						RTA 00		1 per carton						
 <p>Side Chair, High 4 Star Swivel Base COM Yardage: Back/Arms: 1.25; Seat: .75 Freight Class: 300 Product Weight (lbs.): 31 Cubic Feet Per Carton: 15.75</p>	8021	Base Price:	\$1999											
	Back/Arm upcharge:	+0	+\$43	+\$76	+\$125	+\$194	+\$222	+\$282	+\$375	+\$446	+\$522	+\$681	+\$849	
	Seat upcharge:	+0	+\$26	+\$46	+\$75	+\$117	+\$133	+\$169	+\$225	+\$267	+\$314	+\$409	+\$510	
			OVERALL DIMENSIONS				SEAT DIMENSIONS			BACK DIMENSIONS				
			W	D	H	W	D	H	W	H				
			24.5	23	32	18	17.5	18.5	15	13				
						RTA 00		1 per carton						
	 <p>Side Chair, High 4 Star Swivel Base, Arm Patches COM Yardage: Back/Arms: 1.25; Seat: .75 Freight Class: 250 Product Weight (lbs.): 35.5 Cubic Feet Per Carton: 13.25</p>	8021P	Base Price:	\$2025										
		Back/Arm upcharge:	+0	+\$43	+\$76	+\$125	+\$194	+\$222	+\$282	+\$375	+\$446	+\$522	+\$681	+\$849
Seat upcharge:		+0	+\$26	+\$46	+\$75	+\$117	+\$133	+\$169	+\$225	+\$267	+\$314	+\$409	+\$510	
		OVERALL DIMENSIONS				SEAT DIMENSIONS			BACK DIMENSIONS					
		W	D	H	W	D	H	W	H					
		24.5	23	32	18	17.5	18.5	15	13					
					RTA 00		1 per carton							
 <p>Side Chair, Swivel Tilt, 5 Star Base and Casters COM Yardage: Back/Arms: 1.25; Seat: .75 Freight Class: 300 Product Weight (lbs.): 31 Cubic Feet Per Carton: 15.75</p>		8022	Base Price:	\$2179										
		Back/Arm upcharge:	+0	+\$43	+\$76	+\$125	+\$194	+\$222	+\$282	+\$375	+\$446	+\$522	+\$681	+\$849
	Seat upcharge:	+0	+\$26	+\$46	+\$75	+\$117	+\$133	+\$169	+\$225	+\$267	+\$314	+\$409	+\$510	
			OVERALL DIMENSIONS				SEAT DIMENSIONS			BACK DIMENSIONS				
			W	D	H	W	D	H	W	H				
			24.5	23	32.5	18	17.5	15	15	13				
						RTA 00		1 per carton						

DESCRIPTION	MODEL#/ FEATURES	STANDARD TEXTILE GRADES											
		1/COM	2	3	4	5	6	7	8	9	10	11	12
 <p>Side Chair, Swivel Tilt, 5 Star Base, Arm Patches and Casters COM Yardage: Back/Arms: 1.25; Seat: .75 Freight Class: 250 Product Weight (lbs.): 37.5 Cubic Feet Per Carton: 15.75</p>	8022P Base Price: \$2205 Back/Arm upcharge: +0 Seat upcharge: +0	+0	+\$43	+\$76	+\$125	+\$194	+\$222	+\$282	+\$375	+\$446	+\$522	+\$681	+\$849
		+0	+\$26	+\$46	+\$75	+\$117	+\$133	+\$169	+\$225	+\$267	+\$314	+\$409	+\$510
	Tilting mechanism with tilt lock. Fixed seat cushion only.	OVERALL DIMENSIONS W D H			SEAT DIMENSIONS W D H			BACK DIMENSIONS W H					
		24.5	23	32.5	18	17.5	15	15	13				
	Add \$57 for (SBS) Add \$29 for (SSS)												
 <p>Low Back Lounge Chair, Sled Base COM Yardage: Back/Arms: 2.25; Seat: 1 COM Yardage "F" Model: Back/Arms: 2.25; Seat: 1.25 Freight Class: 250 Product Weight (lbs.): 52 Cubic Feet Per Carton: 19.25</p>	8024 Base Price: \$2312 Back/Arm upcharge: +0 Seat upcharge: +0	+0	+\$76	+\$137	+\$224	+\$348	+\$399	+\$507	+\$675	+\$801	+\$938	+\$1225	+\$1527
	8024F Base Price: \$2577 Back/Arm upcharge: +0 Seat upcharge: +0	+0	+\$34	+\$61	+\$100	+\$155	+\$178	+\$225	+\$300	+\$356	+\$417	+\$545	+\$679
	"F" model = Flip Forward Seat for ease of cleaning	OVERALL DIMENSIONS W D H			SEAT DIMENSIONS W D H			BACK DIMENSIONS W H					
		29	30	33	21.5	20	17	21	16				
	Add \$80 for (SBS) Add \$34 for (SSS); \$51 (F model)												
 <p>Low Back Lounge Chair, Sled Base, Arm Patches COM Yardage: Back/Arms: 2.25; Seat: 1 COM Yardage "F" Model: Back/Arms: 2.25; Seat: 1.25 Freight Class: 250 Product Weight (lbs.): 52 Cubic Feet Per Carton: 19.25</p>	8024P Base Price: \$2338 Back/Arm upcharge: +0 Seat upcharge: +0	+0	+\$76	+\$137	+\$224	+\$348	+\$399	+\$507	+\$675	+\$801	+\$938	+\$1225	+\$1527
	8024PF Base Price: \$2603 Back/Arm upcharge: +0 Seat upcharge: +0	+0	+\$34	+\$61	+\$100	+\$155	+\$178	+\$225	+\$300	+\$356	+\$417	+\$545	+\$679
	"F" model = Flip Forward Seat for ease of cleaning	OVERALL DIMENSIONS W D H			SEAT DIMENSIONS W D H			BACK DIMENSIONS W H					
		29	30	33	21.5	20	17	21	16				
	Add \$99 for (SBS) Add \$34 for (SSS); \$51 (F model)												
 <p>Low Back Lounge Chair, 4 Leg Wood Base COM Yardage: Back/Arms: 2.25; Seat: 1 COM Yardage "F" Model: Back/Arms: 2.75; Seat: 1.25 Freight Class: 250 Product Weight (lbs.): 53.5 Cubic Feet Per Carton: 19</p>	8025 Base Price: \$3043 Back/Arm upcharge: +0 Seat upcharge: +0	+0	+\$76	+\$137	+\$224	+\$348	+\$399	+\$507	+\$675	+\$801	+\$938	+\$1225	+\$1527
	8025F Base Price: \$3308 Back/Arm upcharge: +0 Seat upcharge: +0	+0	+\$34	+\$61	+\$100	+\$155	+\$178	+\$225	+\$300	+\$356	+\$417	+\$545	+\$679
	"F" model = Flip Forward Seat for ease of cleaning	OVERALL DIMENSIONS W D H			SEAT DIMENSIONS W D H			BACK DIMENSIONS W H					
		29	30	33	21.5	20	17	21	16				
	Add \$80 for (SBS) Add \$34 for (SSS); \$51 (F model)												

DESCRIPTION	MODEL#/ FEATURES	STANDARD TEXTILE GRADES													
		1/COM	2	3	4	5	6	7	8	9	10	11	12		
 <p>Low Back Lounge Chair, 4 Leg Wood Base, Arm Patches COM Yardage: Back/Arms: 2.25; Seat: 1 COM Yardage "F" Model: Back/Arms: 2.75; Seat: 1.25 Freight Class: 250 Product Weight (lbs.): 53.5 Cubic Feet Per Carton: 19</p>	8025P	Base Price:	\$3069												
		Back/Arm upcharge:	+0	+\$76	+137	+224	+348	+399	+507	+675	+801	+938	+1225	+1527	
		Seat upcharge:	+0	+\$34	+\$61	+\$100	+\$155	+\$178	+\$225	+\$300	+\$356	+\$417	+\$545	+\$679	
	8025PF	Base Price:	\$3334												
		Back/Arm upcharge:	+0	+\$93	+166	+274	+425	+488	+619	+824	+978	+1147	+1498	+1867	
		Seat upcharge:	+0	+\$43	+\$76	+\$125	+\$194	+\$222	+\$282	+\$375	+\$446	+\$522	+\$681	+\$849	
		OVERALL DIMENSIONS			SEAT DIMENSIONS			BACK DIMENSIONS							
			W	D	H	W	D	H	W	H					
			29	30	33	21.5	20	17	21	16					
		"F" model = Flip Forward Seat for ease of cleaning				1 per carton									
	Add \$99 for (SBS) Add \$34 for (SSS); \$51 (F model)				RTA 00										
 <p>Low Back Lounge Chair, Wood Swivel Base COM Yardage: Back: 2.25; Seat: 1 COM Yardage "F" Model: Back/Arms: 2.75; Seat: 1.25 Freight Class: 250 Product Weight (lbs.): 53 Cubic Feet Per Carton: 19</p>	8033	Base Price:	\$2786												
		Back/Arm upcharge:	+0	+\$76	+137	+224	+348	+399	+507	+675	+801	+938	+1225	+1527	
		Seat upcharge:	+0	+\$34	+\$61	+\$100	+\$155	+\$178	+\$225	+\$300	+\$356	+\$417	+\$545	+\$679	
	8033F	Base Price:	\$3051												
		Back/Arm upcharge:	+0	+\$93	+166	+274	+425	+488	+619	+824	+978	+1147	+1498	+1867	
		Seat upcharge:	+0	+\$43	+\$76	+\$125	+\$194	+\$222	+\$282	+\$375	+\$446	+\$522	+\$681	+\$849	
		OVERALL DIMENSIONS			SEAT DIMENSIONS			BACK DIMENSIONS							
			W	D	H	W	D	H	W	H					
			29	30	33	21.5	20	17	21	16					
		"F" model = Flip Forward Seat for ease of cleaning				per carton									
	Add \$80 for (SBS) Add \$34 for (SSS); \$51 (F model)				RTA 00										
 <p>Low Back Lounge Chair, Wood Swivel Base, Arm Patches COM Yardage: Back: 2.25; Seat: 1 COM Yardage "F" Model: Back/Arms: 2.75; Seat: 1.25 Freight Class: 250 Product Weight (lbs.): 53 Cubic Feet Per Carton: 19</p>	8033P	Base Price:	\$2812												
		Back/Arm upcharge:	+0	+\$76	+137	+224	+348	+399	+507	+675	+801	+938	+1225	+1527	
		Seat upcharge:	+0	+\$34	+\$61	+\$100	+\$155	+\$178	+\$225	+\$300	+\$356	+\$417	+\$545	+\$679	
	8033PF	Base Price:	\$3078												
		Back/Arm upcharge:	+0	+\$93	+166	+274	+425	+488	+619	+824	+978	+1147	+1498	+1867	
		Seat upcharge:	+0	+\$43	+\$76	+\$125	+\$194	+\$222	+\$282	+\$375	+\$446	+\$522	+\$681	+\$849	
		OVERALL DIMENSIONS			SEAT DIMENSIONS			BACK DIMENSIONS							
			W	D	H	W	D	H	W	H					
			29	30	33	21.5	20	17	21	16					
		"F" model = Flip Forward Seat for ease of cleaning				per carton									
	Add \$99 for (SBS) Add \$34 for (SSS); \$51 (F model)				RTA 00										
 <p>Low Back Lounge Chair, Chrome Swivel Base COM Yardage: Back: 2.25; Seat: 1 COM Yardage "F" Model: Back/Arms: 2.75; Seat: 1.25 Freight Class: 250 Product Weight (lbs.): 59 Cubic Feet Per Carton: 19.25</p>	8034	Base Price:	\$2798												
		Back/Arm upcharge:	+0	+\$76	+137	+224	+348	+399	+507	+675	+801	+938	+1225	+1527	
		Seat upcharge:	+0	+\$34	+\$61	+\$100	+\$155	+\$178	+\$225	+\$300	+\$356	+\$417	+\$545	+\$679	
	8034F	Base Price:	\$3063												
		Back/Arm upcharge:	+0	+\$93	+166	+274	+425	+488	+619	+824	+978	+1147	+1498	+1867	
		Seat upcharge:	+0	+\$43	+\$76	+\$125	+\$194	+\$222	+\$282	+\$375	+\$446	+\$522	+\$681	+\$849	
		OVERALL DIMENSIONS			SEAT DIMENSIONS			BACK DIMENSIONS							
			W	D	H	W	D	H	W	H					
			29	30	33	21.5	20	17	21	16					
		"F" model = Flip Forward Seat for ease of cleaning				1 per carton									
	Add \$80 for (SBS) Add \$34 for (SSS); \$51 (F model)				RTA 00										

DESCRIPTION	MODEL#/ FEATURES	STANDARD TEXTILE GRADES												
		1/COM	2	3	4	5	6	7	8	9	10	11	12	
 <p>Low Back Lounge Chair, Chrome Swivel Base, Arm Patches COM Yardage: Back: 2.25; Seat: 1 COM Yardage "F" Model: Back/Arms: 2.75; Seat: 1.25 Freight Class: 250 Product Weight (lbs.): 59 Cubic Feet Per Carton: 19.25</p>	8034P Base Price: \$2825 Back/Arm upcharge: +0 Seat upcharge: +0													
	8034PF Base Price: \$3090 Back/Arm upcharge: +0 Seat upcharge: +0													
		OVERALL DIMENSIONS W D H			SEAT DIMENSIONS W D H			BACK DIMENSIONS W H						
	"F" model = Flip Forward Seat for ease of cleaning	29	30	33	21.5	20	17	21	16					
	Add \$99 for (SBS) Add \$34 for (SSS); \$51 (F model)	RTA 00			1 per carton									
	 <p>Mid Back Lounge Chair, Sled Base COM Yardage: Back: 2.5; Seat: 1 COM Yardage "F" Model: Back/Arms: 3; Seat: 1.25 Freight Class: 250 Product Weight (lbs.): 52 Cubic Feet Per Carton: 25.5</p>	8016 Base Price: \$2572 Back/Arm upcharge: +0 Seat upcharge: +0												
		8016F Base Price: \$2836 Back/Arm upcharge: +0 Seat upcharge: +0												
			OVERALL DIMENSIONS W D H			SEAT DIMENSIONS W D H			BACK DIMENSIONS W H					
		"F" model = Flip Forward Seat for ease of cleaning	29	31.5	38.5	21.5	20	17	21	21.5				
		Add \$86 for (SBS) Add \$34 for (SSS); \$51 (F model)	RTA 00			1 per carton								
 <p>Mid Back Lounge Chair, Sled Base, Arm Patches COM Yardage: Back: 2.5; Seat: 1 COM Yardage "F" Model: Back/Arms: 3; Seat: 1.25 Freight Class: 250 Product Weight (lbs.): 52 Cubic Feet Per Carton: 25.5</p>		8016P Base Price: \$2598 Back/Arm upcharge: +0 Seat upcharge: +0												
		8016PF Base Price: \$2863 Back/Arm upcharge: +0 Seat upcharge: +0												
			OVERALL DIMENSIONS W D H			SEAT DIMENSIONS W D H			BACK DIMENSIONS W H					
		"F" model = Flip Forward Seat for ease of cleaning	29	31.5	38.5	21.5	20	17	21	21.5				
		Add \$105 for (SBS) Add \$34 for (SSS); \$51 (F model)	RTA 00			1 per carton								
	 <p>Mid Back Lounge Chair, 4 Leg Wood Base COM Yardage: Back: 2.5; Seat: 1 COM Yardage "F" Model: Back/Arms: 3; Seat: 1.25 Freight Class: 250 Product Weight (lbs.): 53.5 Cubic Feet Per Carton: 25.5</p>	8027 Base Price: \$3292 Back/Arm upcharge: +0 Seat upcharge: +0												
		8027F Base Price: \$3557 Back/Arm upcharge: +0 Seat upcharge: +0												
			OVERALL DIMENSIONS W D H			SEAT DIMENSIONS W D H			BACK DIMENSIONS W H					
		"F" model = Flip Forward Seat for ease of cleaning	29	31.5	38.5	21.5	20	17	21	21.5				
		Add \$86 for (SBS) Add \$34 for (SSS); \$51 (F model)	RTA 00			1 per carton								





DESCRIPTION	MODEL#/ FEATURES	STANDARD TEXTILE GRADES												
		1/COM	2	3	4	5	6	7	8	9	10	11	12	
 <p>Mid Back Lounge Chair, 4 Leg Wood Base, Arm Patches COM Yardage: Back: 2.5; Seat: 1 COM Yardage "F" Model: Back/Arms: 3; Seat: 1.25 Freight Class: 250 Product Weight (lbs.): 53.5 Cubic Feet Per Carton: 25.5</p>	8027P Base Price:	\$3318												
	Back/Arm upcharge:	+0	+\$85	+\$151	+\$248	+\$386	+\$444	+\$563	+\$750	+\$890	+\$1043	+\$1361	+\$1697	
	Seat upcharge:	+0	+\$34	+\$61	+\$100	+\$155	+\$178	+\$225	+\$300	+\$356	+\$417	+\$545	+\$679	
	8027PF Base Price:	\$3583												
	Back/Arm upcharge:	+0	+\$102	+\$181	+\$298	+\$463	+\$532	+\$675	+\$899	+\$1067	+\$1251	+\$1634	+\$2036	
	Seat upcharge:	+0	+\$43	+\$76	+\$125	+\$194	+\$222	+\$282	+\$375	+\$446	+\$522	+\$681	+\$849	
	OVERALL DIMENSIONS													
	W D H													
	"F" model = Flip Forward Seat for ease of cleaning		29	31.5	38.5		21.5	20	17		21	21.5		
	Add \$105 for (SBS) Add \$34 for (SSS); \$51 (F model)													
 <p>Mid Back Lounge Chair, Wood Swivel Base COM Yardage: Back: 2.5; Seat: 1 COM Yardage "F" Model: Back/Arms: 3; Seat: 1.25 Freight Class: 250 Product Weight (lbs.): 54 Cubic Feet Per Carton: 25.5</p>	8035 Base Price:	\$2896												
	Back/Arm upcharge:	+0	+\$85	+\$151	+\$248	+\$386	+\$444	+\$563	+\$750	+\$890	+\$1043	+\$1361	+\$1697	
	Seat upcharge:	+0	+\$34	+\$61	+\$100	+\$155	+\$178	+\$225	+\$300	+\$356	+\$417	+\$545	+\$679	
	8035F Base Price:	\$3161												
	Back/Arm upcharge:	+0	+\$102	+\$181	+\$298	+\$463	+\$532	+\$675	+\$899	+\$1067	+\$1251	+\$1634	+\$2036	
	Seat upcharge:	+0	+\$43	+\$76	+\$125	+\$194	+\$222	+\$282	+\$375	+\$446	+\$522	+\$681	+\$849	
	OVERALL DIMENSIONS													
	W D H													
	"F" model = Flip Forward Seat for ease of cleaning		29	31.5	38.5		21.5	20	17		21	21.5		
	Add \$86 for (SBS) Add \$34 for (SSS); \$51 (F model)													
 <p>Mid Back Lounge Chair, Wood Swivel Base, Arm Patches COM Yardage: Back: 2.5; Seat: 1 COM Yardage "F" Model: Back/Arms: 3; Seat: 1.25 Freight Class: 250 Product Weight (lbs.): 54 Cubic Feet Per Carton: 25.5</p>	8035P Base Price:	\$2923												
	Back/Arm upcharge:	+0	+\$85	+\$151	+\$248	+\$386	+\$444	+\$563	+\$750	+\$890	+\$1043	+\$1361	+\$1697	
	Seat upcharge:	+0	+\$34	+\$61	+\$100	+\$155	+\$178	+\$225	+\$300	+\$356	+\$417	+\$545	+\$679	
	8035PF Base Price:	\$3188												
	Back/Arm upcharge:	+0	+\$102	+\$181	+\$298	+\$463	+\$532	+\$675	+\$899	+\$1067	+\$1251	+\$1634	+\$2036	
	Seat upcharge:	+0	+\$43	+\$76	+\$125	+\$194	+\$222	+\$282	+\$375	+\$446	+\$522	+\$681	+\$849	
	OVERALL DIMENSIONS													
	W D H													
	"F" model = Flip Forward Seat for ease of cleaning		29	31.5	38.5		21.5	20	17		21	21.5		
	Add \$105 for (SBS) Add \$34 for (SSS); \$51 (F model)													
 <p>Mid Back Lounge Chair, Chrome Swivel Base COM Yardage: Back: 2.5; Seat: 1 COM Yardage "F" Model: Back/Arms: 3; Seat: 1.25 Freight Class: 250 Product Weight (lbs.): 60 Cubic Feet Per Carton: 25.5</p>	8036 Base Price:	\$2914												
	Back/Arm upcharge:	+0	+\$85	+\$151	+\$248	+\$386	+\$444	+\$563	+\$750	+\$890	+\$1043	+\$1361	+\$1697	
	Seat upcharge:	+0	+\$34	+\$61	+\$100	+\$155	+\$178	+\$225	+\$300	+\$356	+\$417	+\$545	+\$679	
	8036F Base Price:	\$3179												
	Back/Arm upcharge:	+0	+\$102	+\$181	+\$298	+\$463	+\$532	+\$675	+\$899	+\$1067	+\$1251	+\$1634	+\$2036	
	Seat upcharge:	+0	+\$43	+\$76	+\$125	+\$194	+\$222	+\$282	+\$375	+\$446	+\$522	+\$681	+\$849	
	OVERALL DIMENSIONS													
	W D H													
	"F" model = Flip Forward Seat for ease of cleaning		29	31.5	38.5		21.5	20	17		21	21.5		
	Add \$86 for (SBS) Add \$34 for (SSS); \$51 (F model)													





DESCRIPTION	MODEL#/ FEATURES	STANDARD TEXTILE GRADES												
		1/COM	2	3	4	5	6	7	8	9	10	11	12	
	8036P Base Price:	\$2941												
	Back/Arm upcharge:	+0	+\$85	+\$151	+\$248	+\$386	+\$444	+\$563	+\$750	+\$890	+\$1043	+\$1361	+\$1697	
	Seat upcharge:	+0	+\$34	+\$61	+\$100	+\$155	+\$178	+\$225	+\$300	+\$356	+\$417	+\$545	+\$679	
	8036PF Base Price:	\$3206												
	Back/Arm upcharge:	+0	+\$102	+\$181	+\$298	+\$463	+\$532	+\$675	+\$899	+\$1067	+\$1251	+\$1634	+\$2036	
	Seat upcharge:	+0	+\$43	+\$76	+\$125	+\$194	+\$222	+\$282	+\$375	+\$446	+\$522	+\$681	+\$849	
	OVERALL DIMENSIONS			W	D	H	SEAT DIMENSIONS			W	D	H	BACK DIMENSIONS	
			29		31.5	38.5	21.5	20	17			21	21.5	
	"F" model = Flip Forward Seat for ease of cleaning													
	COM Yardage: Back: 2.5; Seat: 1 COM Yardage "F" Model: Back/Arms: 3; Seat: 1.25 Freight Class: 250 Product Weight (lbs.): 60 Cubic Feet Per Carton: 25.5		Add \$105 for (SBS) Add \$34 for (SSS); \$51 (F model)				RTA 00			1 per carton				







DESCRIPTION	MODEL#/ FEATURES	STANDARD TEXTILE GRADES												
		1/COM	2	3	4	5	6	7	8	9	10	11	12	
	8028 Base Price:	\$2931												
	Back/Arm upcharge:	+0	+\$93	+\$166	+\$274	+\$425	+\$488	+\$619	+\$824	+\$978	+\$1147	+\$1498	+\$1867	
	Seat upcharge:	+0	+\$34	+\$61	+\$100	+\$155	+\$178	+\$225	+\$300	+\$356	+\$417	+\$545	+\$679	
	8028F Base Price:	\$3196												
	Back/Arm upcharge:	+0	+\$110	+\$197	+\$323	+\$502	+\$577	+\$732	+\$974	+\$1157	+\$1355	+\$1770	+\$2205	
	Seat upcharge:	+0	+\$43	+\$76	+\$125	+\$194	+\$222	+\$282	+\$375	+\$446	+\$522	+\$681	+\$849	
	OVERALL DIMENSIONS			W	D	H	SEAT DIMENSIONS			W	D	H	BACK DIMENSIONS	
			29		31.5	44.5	21.5	20	17			21	27.5	
	"F" model = Flip Forward Seat for ease of cleaning													
	COM Yardage: Back: 2.75; Seat: 1 COM Yardage "F" Model: Back/Arms: 3.25; Seat: 1.25 Freight Class: 300 Product Weight (lbs.): 56 Cubic Feet Per Carton: 28.25		Add \$89 for (SBS) Add \$34 for (SSS); \$51 (F model)				RTA 00			1 per carton				

DESCRIPTION	MODEL#/ FEATURES	STANDARD TEXTILE GRADES												
		1/COM	2	3	4	5	6	7	8	9	10	11	12	
	8028P Base Price:	\$2985												
	Back/Arm upcharge:	+0	+\$93	+\$166	+\$274	+\$425	+\$488	+\$619	+\$824	+\$978	+\$1147	+\$1498	+\$1867	
	Seat upcharge:	+0	+\$34	+\$61	+\$100	+\$155	+\$178	+\$225	+\$300	+\$356	+\$417	+\$545	+\$679	
	8028PF Base Price:	\$3250												
	Back/Arm upcharge:	+0	+\$110	+\$197	+\$323	+\$502	+\$577	+\$732	+\$974	+\$1157	+\$1355	+\$1770	+\$2205	
	Seat upcharge:	+0	+\$43	+\$76	+\$125	+\$194	+\$222	+\$282	+\$375	+\$446	+\$522	+\$681	+\$849	
	OVERALL DIMENSIONS			W	D	H	SEAT DIMENSIONS			W	D	H	BACK DIMENSIONS	
			29		31.5	44.5	21.5	20	17			21	27.5	
	"F" model = Flip Forward Seat for ease of cleaning													
	COM Yardage: Back: 2.75; Seat: 1 COM Yardage "F" Model: Back/Arms: 3.25; Seat: 1.25 Freight Class: 300 Product Weight (lbs.): 56 Cubic Feet Per Carton: 28.25		Add \$108 for (SBS) Add \$34 for (SSS); \$51 (F model)				RTA 00			1 per carton				

DESCRIPTION	MODEL#/ FEATURES	STANDARD TEXTILE GRADES												
		1/COM	2	3	4	5	6	7	8	9	10	11	12	
	8028PH Base Price:	\$3038												
	Back/Arm upcharge:	+0	+\$93	+\$166	+\$274	+\$425	+\$488	+\$619	+\$824	+\$978	+\$1147	+\$1498	+\$1867	
	Seat upcharge:	+0	+\$34	+\$61	+\$100	+\$155	+\$178	+\$225	+\$300	+\$356	+\$417	+\$545	+\$679	
	8028PHF Base Price:	\$3303												
	Back/Arm upcharge:	+0	+\$110	+\$197	+\$323	+\$502	+\$577	+\$732	+\$974	+\$1157	+\$1355	+\$1770	+\$2205	
	Seat upcharge:	+0	+\$43	+\$76	+\$125	+\$194	+\$222	+\$282	+\$375	+\$446	+\$522	+\$681	+\$849	
	OVERALL DIMENSIONS			W	D	H	SEAT DIMENSIONS			W	D	H	BACK DIMENSIONS	
			29		31.5	44.5	21.5	20	17			21	27.5	
	"F" model = Flip Forward Seat for ease of cleaning													
	COM Yardage: Back: 2.75; Seat: 1 COM Yardage "F" Model: Back/Arms: 3.25; Seat: 1.25 Freight Class: 300 Product Weight (lbs.): 56 Cubic Feet Per Carton: 28.25		Add \$130 for (SBS) Add \$34 for (SSS); \$51 (F model)				RTA 00			1 per carton				

DESCRIPTION	MODEL#/ FEATURES	STANDARD TEXTILE GRADES											
		1/COM	2	3	4	5	6	7	8	9	10	11	12
 <p>High Back Lounge Chair, 4 Leg Wood Base COM Yardage: Back: 2.75; Seat: 1 COM Yardage "F" Model: Back/Arms: 3.25; Seat: 1.25 Freight Class: 250 Product Weight (lbs.): 56.5 Cubic Feet Per Carton: 28.25</p>	8029 Base Price:	\$3669											
	Back/Arm upcharge:	+0	+\$93	+166	+274	+425	+488	+619	+824	+978	+1147	+1498	+1867
	Seat upcharge:	+0	+\$34	+\$61	+\$100	+\$155	+\$178	+\$225	+\$300	+\$356	+\$417	+\$545	+\$679
	8029F Base Price:	\$3934											
	Back/Arm upcharge:	+0	+\$110	+197	+323	+502	+577	+732	+974	+1157	+1355	+1770	+2205
	Seat upcharge:	+0	+\$43	+\$76	+\$125	+\$194	+\$222	+\$282	+\$375	+\$446	+\$522	+\$681	+\$849
	OVERALL DIMENSIONS		SEAT DIMENSIONS			BACK DIMENSIONS							
	W D H		W D H			W H							
	29 31.5 44.5		21.5 20 17			21 27.5							
	"F" model = Flip Forward Seat for ease of cleaning		Add \$89 for (SBS) Add \$34 for (SSS); \$51 (F model)										
		RTA 00			1 per carton								
 <p>High Back Lounge Chair, 4 Leg Wood Base, Arm Patches COM Yardage: Back: 2.75; Seat: 1 COM Yardage "F" Model: Back/Arms: 3.25; Seat: 1.25 Freight Class: 250 Product Weight (lbs.): 56.5 Cubic Feet Per Carton: 28.25</p>	8029P Base Price:	\$3721											
	Back/Arm upcharge:	+0	+\$93	+166	+274	+425	+488	+619	+824	+978	+1147	+1498	+1867
	Seat upcharge:	+0	+\$34	+\$61	+\$100	+\$155	+\$178	+\$225	+\$300	+\$356	+\$417	+\$545	+\$679
	8029PF Base Price:	\$3986											
	Back/Arm upcharge:	+0	+\$110	+197	+323	+502	+577	+732	+974	+1157	+1355	+1770	+2205
	Seat upcharge:	+0	+\$43	+\$76	+\$125	+\$194	+\$222	+\$282	+\$375	+\$446	+\$522	+\$681	+\$849
	OVERALL DIMENSIONS		SEAT DIMENSIONS			BACK DIMENSIONS							
	W D H		W D H			W H							
	29 31.5 44.5		21.5 20 17			21 27.5							
	"F" model = Flip Forward Seat for ease of cleaning		Add \$108 for (SBS) Add \$34 for (SSS); \$51 (F model)										
		RTA 00			1 per carton								
 <p>High Back Lounge Chair, 4 Leg Wood Base, Arm and Head Patches COM Yardage: Back: 2.75; Seat: 1 COM Yardage "F" Model: Back/Arms: 3.25; Seat: 1.25 Freight Class: 250 Product Weight (lbs.): 56.5 Cubic Feet Per Carton: 28.25</p>	8029PH Base Price:	\$3774											
	Back/Arm upcharge:	+0	+\$93	+166	+274	+425	+488	+619	+824	+978	+1147	+1498	+1867
	Seat upcharge:	+0	+\$34	+\$61	+\$100	+\$155	+\$178	+\$225	+\$300	+\$356	+\$417	+\$545	+\$679
	8029PHF Base Price:	\$4039											
	Back/Arm upcharge:	+0	+\$110	+197	+323	+502	+577	+732	+974	+1157	+1355	+1770	+2205
	Seat upcharge:	+0	+\$43	+\$76	+\$125	+\$194	+\$222	+\$282	+\$375	+\$446	+\$522	+\$681	+\$849
	OVERALL DIMENSIONS		SEAT DIMENSIONS			BACK DIMENSIONS							
	W D H		W D H			W H							
	29 31.5 44.5		21.5 20 17			21 27.5							
	"F" model = Flip Forward Seat for ease of cleaning		Add \$130 for (SBS) Add \$34 for (SSS); \$51 (F model)										
		RTA 00			1 per carton								
 <p>High Back Lounge Chair, Wood Swivel Base COM Yardage: Back: 2.75; Seat: 1 COM Yardage "F" Model: Back/Arms: 3.25; Seat: 1.25 Freight Class: 250 Product Weight (lbs.): 57 Cubic Feet Per Carton: 28.25</p>	8037 Base Price:	\$3165											
	Back/Arm upcharge:	+0	+\$93	+166	+274	+425	+488	+619	+824	+978	+1147	+1498	+1867
	Seat upcharge:	+0	+\$34	+\$61	+\$100	+\$155	+\$178	+\$225	+\$300	+\$356	+\$417	+\$545	+\$679
	8037F Base Price:	\$3430											
	Back/Arm upcharge:	+0	+\$110	+197	+323	+502	+577	+732	+974	+1157	+1355	+1770	+2205
	Seat upcharge:	+0	+\$43	+\$76	+\$125	+\$194	+\$222	+\$282	+\$375	+\$446	+\$522	+\$681	+\$849
	OVERALL DIMENSIONS		SEAT DIMENSIONS			BACK DIMENSIONS							
	W D H		W D H			W H							
	29 31.5 44.5		21.5 20 17			21 27.5							
	"F" model = Flip Forward Seat for ease of cleaning		Add \$89 for (SBS) Add \$34 for (SSS); \$51 (F model)										
		RTA 00			1 per carton								

DESCRIPTION	MODEL#/ FEATURES	STANDARD TEXTILE GRADES												
		1/COM	2	3	4	5	6	7	8	9	10	11	12	
 <p>High Back Lounge Chair, Wood Swivel Base, Arm Patches COM Yardage: Back: 2.75; Seat: 1 COM Yardage "F" Model: Back/Arms: 3.25; Seat: 1.25 Freight Class: 250 Product Weight (lbs.): 57 Cubic Feet Per Carton: 28.25</p>	8037P Base Price:	\$3218												
	Back/Arm upcharge:	+0	+\$93	+166	+274	+425	+488	+619	+824	+978	+1147	+1498	+1867	
	Seat upcharge:	+0	+\$34	+\$61	+\$100	+\$155	+\$178	+\$225	+\$300	+\$356	+\$417	+\$545	+\$679	
	8037PF Base Price:	\$3483												
	Back/Arm upcharge:	+0	+\$110	+197	+323	+502	+577	+732	+974	+1157	+1355	+1770	+2205	
	Seat upcharge:	+0	+\$43	+\$76	+\$125	+\$194	+\$222	+\$282	+\$375	+\$446	+\$522	+\$681	+\$849	
	OVERALL DIMENSIONS													
	W D H													
	29 31.5 44.5													
	"F" model = Flip Forward Seat for ease of cleaning													
Add \$108 for (SBS) Add \$34 for (SSS); \$51 (F model)														
 <p>High Back Lounge Chair, Wood Swivel Base, Arm and Head Patches COM Yardage: Back: 2.75; Seat: 1 COM Yardage "F" Model: Back/Arms: 3.25; Seat: 1.25 Freight Class: 250 Product Weight (lbs.): 57 Cubic Feet Per Carton: 28.25</p>	8037PH Base Price:	\$3271												
	Back/Arm upcharge:	+0	+\$93	+166	+274	+425	+488	+619	+824	+978	+1147	+1498	+1867	
	Seat upcharge:	+0	+\$34	+\$61	+\$100	+\$155	+\$178	+\$225	+\$300	+\$356	+\$417	+\$545	+\$679	
	8037PHF Base Price:	\$3537												
	Back/Arm upcharge:	+0	+\$110	+197	+323	+502	+577	+732	+974	+1157	+1355	+1770	+2205	
	Seat upcharge:	+0	+\$43	+\$76	+\$125	+\$194	+\$222	+\$282	+\$375	+\$446	+\$522	+\$681	+\$849	
	OVERALL DIMENSIONS													
	W D H													
	29 31.5 44.5													
	"F" model = Flip Forward Seat for ease of cleaning													
Add \$130 for (SBS) Add \$34 for (SSS); \$51 (F model)														
 <p>High Back Lounge Chair, Chrome Swivel Base COM Yardage: Back: 2.75; Seat: 1 COM Yardage "F" Model: Back/Arms: 3.25; Seat: 1.25 Freight Class: 250 Product Weight (lbs.): 63 Cubic Feet Per Carton: 28.25</p>	8038 Base Price:	\$3183												
	Back/Arm upcharge:	+0	+\$93	+166	+274	+425	+488	+619	+824	+978	+1147	+1498	+1867	
	Seat upcharge:	+0	+\$34	+\$61	+\$100	+\$155	+\$178	+\$225	+\$300	+\$356	+\$417	+\$545	+\$679	
	8038F Base Price:	\$3449												
	Back/Arm upcharge:	+0	+\$110	+197	+323	+502	+577	+732	+974	+1157	+1355	+1770	+2205	
	Seat upcharge:	+0	+\$43	+\$76	+\$125	+\$194	+\$222	+\$282	+\$375	+\$446	+\$522	+\$681	+\$849	
	OVERALL DIMENSIONS													
	W D H													
	29 31.5 44.5													
	"F" model = Flip Forward Seat for ease of cleaning													
Add \$89 for (SBS) Add \$34 for (SSS); \$51 (F model)														
 <p>High Back Lounge Chair, Chrome Swivel Base, Arm Patches COM Yardage: Back: 2.75; Seat: 1 COM Yardage "F" Model: Back/Arms: 3.25; Seat: 1.25 Freight Class: 250 Product Weight (lbs.): 63 Cubic Feet Per Carton: 28.25</p>	8038P Base Price:	\$3237												
	Back/Arm upcharge:	+0	+\$93	+166	+274	+425	+488	+619	+824	+978	+1147	+1498	+1867	
	Seat upcharge:	+0	+\$34	+\$61	+\$100	+\$155	+\$178	+\$225	+\$300	+\$356	+\$417	+\$545	+\$679	
	8038PF Base Price:	\$3502												
	Back/Arm upcharge:	+0	+\$110	+197	+323	+502	+577	+732	+974	+1157	+1355	+1770	+2205	
	Seat upcharge:	+0	+\$43	+\$76	+\$125	+\$194	+\$222	+\$282	+\$375	+\$446	+\$522	+\$681	+\$849	
	OVERALL DIMENSIONS													
	W D H													
	29 31.5 44.5													
	"F" model = Flip Forward Seat for ease of cleaning													
Add \$108 for (SBS) Add \$34 for (SSS); \$51 (F model)														

DESCRIPTION	MODEL#/ FEATURES	STANDARD TEXTILE GRADES													
		1/COM	2	3	4	5	6	7	8	9	10	11	12		
 <p>High Back Lounge Chair, Chrome Swivel Base, Arm and Head Patches COM Yardage: Back: 2.75; Seat: 1 COM Yardage "F" Model: Back/Arms: 3.25; Seat: 1.25 Freight Class: 250 Product Weight (lbs.): 63 Cubic Feet Per Carton: 28.25</p>	8038PH	Base Price:	\$3290												
	Back/Arm upcharge:	+0	+\$93	+\$166	+\$274	+\$425	+\$488	+\$619	+\$824	+\$978	+\$1147	+\$1498	+\$1867		
	Seat upcharge:	+0	+\$34	+\$61	+\$100	+\$155	+\$178	+\$225	+\$300	+\$356	+\$417	+\$545	+\$679		
	8038PHF	Base Price:	\$3555												
	Back/Arm upcharge:	+0	+\$110	+\$197	+\$323	+\$502	+\$577	+\$732	+\$974	+\$1157	+\$1355	+\$1770	+\$2205		
	Seat upcharge:	+0	+\$43	+\$76	+\$125	+\$194	+\$222	+\$282	+\$375	+\$446	+\$522	+\$681	+\$849		
	OVERALL DIMENSIONS		W	D	H	SEAT DIMENSIONS			W	D	H	BACK DIMENSIONS		W	H
			29	31.5	44.5	21.5	20	17				21	27.5		
	"F" model = Flip Forward Seat for ease of cleaning														
	Add \$130 for (SBS) Add \$34 for (SSS); \$51 (F model)					RTA 00		1 per carton							
 <p>Counter Stool, Sled Base COM Yardage: Back: 1; Seat: 1 Freight Class: 250 Product Weight (lbs.): 32 Cubic Feet Per Carton: 9</p>	8051	Base Price:	\$1339												
	Back/Arm upcharge:	+0	+\$34	+\$61	+\$100	+\$155	+\$178	+\$225	+\$300	+\$356	+\$417	+\$545	+\$679		
	Seat upcharge:	+0	+\$17	+\$31	+\$50	+\$78	+\$89	+\$113	+\$150	+\$179	+\$209	+\$273	+\$340		
	OVERALL DIMENSIONS		W	D	H	SEAT DIMENSIONS			W	D	H	BACK DIMENSIONS		W	H
			19.25	19	35	15.5	15.75	24.75				12.5	10		
	Add \$34 for (SBS) Add \$22 for (SSS)					RTA 00		1 per carton							
	 <p>Counter Stool, Wood Base COM Yardage: Back: 1; Seat: 1 Freight Class: 250 Product Weight (lbs.): 28</p>	8052	Base Price:	\$2098											
		Back/Arm upcharge:	+0	+\$34	+\$61	+\$100	+\$155	+\$178	+\$225	+\$300	+\$356	+\$417	+\$545	+\$679	
		Seat upcharge:	+0	+\$17	+\$31	+\$50	+\$78	+\$89	+\$113	+\$150	+\$179	+\$209	+\$273	+\$340	
		OVERALL DIMENSIONS		W	D	H	SEAT DIMENSIONS			W	D	H	BACK DIMENSIONS		W
		19.25	19	35	15.5	15.75	24.75				12.5	10			
Add \$34 for (SBS) Add \$22 for (SSS)					RTA 00		FedEx   1 per carton								
 <p>Counter Stool, Chrome Swivel Base COM Yardage: Back: 1; Seat: 1 Freight Class: 250 Product Weight (lbs.): 43 Cubic Feet Per Carton: 11.5</p>		8053	Base Price:	\$2553											
		Back/Arm upcharge:	+0	+\$34	+\$61	+\$100	+\$155	+\$178	+\$225	+\$300	+\$356	+\$417	+\$545	+\$679	
		Seat upcharge:	+0	+\$17	+\$31	+\$50	+\$78	+\$89	+\$113	+\$150	+\$179	+\$209	+\$273	+\$340	
		OVERALL DIMENSIONS		W	D	H	SEAT DIMENSIONS			W	D	H	BACK DIMENSIONS		W
			19.25	20	34.5	15.5	15.75	24.75				12.5	10		
	Add \$34 for (SBS) Add \$22 for (SSS)					RTA 00		1 per carton							
	 <p>Bar Stool, Sled Base COM Yardage: Back: 1; Seat: 1 Freight Class: 250 Product Weight (lbs.): 34.5 Cubic Feet Per Carton: 11</p>	8054	Base Price:	\$1442											
		Back/Arm upcharge:	+0	+\$34	+\$61	+\$100	+\$155	+\$178	+\$225	+\$300	+\$356	+\$417	+\$545	+\$679	
		Seat upcharge:	+0	+\$17	+\$31	+\$50	+\$78	+\$89	+\$113	+\$150	+\$179	+\$209	+\$273	+\$340	
		OVERALL DIMENSIONS		W	D	H	SEAT DIMENSIONS			W	D	H	BACK DIMENSIONS		W
		19.25	20	40.25	15.5	15.75	30.25				12.5	10			
Add \$34 for (SBS) Add \$22 for (SSS)					RTA 00		1 per carton								

DESCRIPTION	MODEL#/ FEATURES	STANDARD TEXTILE GRADES												
		1/COM	2	3	4	5	6	7	8	9	10	11	12	
 <p>Bar Stool, Wood Base COM Yardage: Back: 1; Seat: .5 Freight Class: 250 Product Weight (lbs.): 30 Cubic Feet Per Carton: 11</p>	8055	Base Price:	\$2199											
		Back/Arm upcharge:	+0	+\$34	+61	+100	+155	+178	+225	+300	+356	+417	+545	+679
		Seat upcharge:	+0	+\$17	+\$31	+\$50	+\$78	+\$89	+\$113	+\$150	+\$179	+\$209	+\$273	+\$340
		OVERALL DIMENSIONS	SEAT DIMENSIONS			BACK DIMENSIONS								
		W D H	W	D	H	W	D	H	W	H				
	19.25	20	40	15.5	15.75	30	12.5	10						
		Add \$34 for (SBS) Add \$22 for (SSS)	RTA 00	FedEx	1 per carton									

 <p>Bar Stool, Chrome Swivel Base COM Yardage: Back: 1; Seat: .5 Freight Class: 250 Product Weight (lbs.): 45.5 Cubic Feet Per Carton: 13.25</p>	8056	Base Price:	\$2653											
		Back/Arm upcharge:	+0	+\$34	+61	+100	+155	+178	+225	+300	+356	+417	+545	+679
		Seat upcharge:	+0	+\$17	+\$31	+\$50	+\$78	+\$89	+\$113	+\$150	+\$179	+\$209	+\$273	+\$340
		OVERALL DIMENSIONS	SEAT DIMENSIONS			BACK DIMENSIONS								
		W D H	W	D	H	W	D	H	W	H				
	19.25	20	40	15.5	15.75	30	12.5	10						
		Add \$34 for (SBS) Add \$22 for (SSS)	RTA 00	1 per carton										

DRIFT TABLES



model 8041R2616C
26"W x 16"H Round Table,
Laminate Surface, Flat Edge,
Chrome Base



model 8042SQ2816I
28"W x 16"H Square Table,
Laminate Surface, Flat Edge,
Sled Base



Model 8042SQ2816W
28"W x 16"H Square Table,
Laminate Surface, Flat Edge
Wood Base



For Drift seating, see page 298

EXAMPLE OF TABLE ORDER CODE:

8041R2616I	TFL	ACJ	TBL	CG
Model Number	Surface Type	Top HPL Finish	Base Finish (Sled Base)	Glide Type (Sled Base)

STANDARD FEATURES

- Tables are available in three shapes, multiple sizes, two edge styles and three top materials. All offer three base option: sled, four-legged wood and a polished Chrome base.
- Table bases are fixed and do not swivel.
- Sled bases are available in two heights.
- Wood bases are made from beechwood and are available in all standard wood finishes.
- Sled bases are standard in paint and optionally available in Chrome. See upcharges.
- Chrome bases are available in polished chrome only.
- Table tops are available in either laminate or solid surface.
- Laminate flat edge tops are available in either a 1" thick thermally fused laminate (TFL) with 2mm edgeband or 1-1/16" thick high pressure laminate (HPL) or ultra matte high pressure laminate (UML) with 2mm edgeband (see models for upcharges).
- Laminate knife edge tops are only available in 1-3/16" thick high pressure laminate (HPL) or ultra matte high pressure laminate (UML) with 2.5mm edgeband.
- Solid surface table tops are 1.25" thick, available with flat or knife edge tops.
- Polished Chrome bases are equipped with White non-marking polycarbonate glides that are suitable for most hard and carpeted floor surfaces.
- Sled bases are available with clear polycarbonate glides, standard.
- Wood and sled bases may be specified with a variety of optional glide types to suit various flooring materials. (See Glide Types for additional glide options and upcharges.)
- Tables are shipped fully assembled.

Please specify based on the following criteria:

- **Model number** (suffix determines edge detail)
 - sled base models**
 - _____ **I** laminate flat edge
 - _____ **K** laminate knife edge
 - _____ **SF** solid surface flat edge
 - _____ **SK** solid surface knife edge
 - polished chrome base models**
 - _____ **C** laminate flat edge
 - _____ **CK** laminate knife edge
 - _____ **CSF** solid surface flat edge
 - _____ **CSK** solid surface knife edge
 - four-legged wood base models**
 - _____ **W** laminate flat edge
 - _____ **WK** laminate knife edge
 - _____ **WSF** solid surface flat edge
 - _____ **WSK** solid surface knife edge

Add option codes in the following order:

- **Top details**
 - LAMINATE**
 - Surface type** (laminate flat edge tables only)
 - (TFL) Thermally fused laminate
 - (HPL) High pressure laminate
 - (UML) High pressure laminate (*select colors only)
 - Top Finish** (see model for HPL or UML upcharges)

(ACJ) Absolute Acajou	(ASN) Asian Night
(AWC) Avant Cherry	(AWH) Avant Honey
(BLK) Black*	(BZD) Blizzard*
(BRC) Brushed Cobalt	(CMB) Clear Maple
(CGY) Custom Grey*	(DES) Dark Espresso
(DWT) Designer White*	(FAS) Fashionista
(FCL) First Class	(NBL) Noce Biondo
(NGL) Noce Grigio	(NEL) Noce Leggero
(NML), Noce Medio	(QTM) Quartered Mahogany
(SBY) Sheer Beauty	(SOG) Storm Grey*
(SDT) Stonedust*	(WCR) Winter Cherry
(WHC) White Chocolate	(WHE) Walnut Heights
 - SOLID SURFACE**
 - Top finish** (see model for grade 2 upcharges)
 - (SWH) Designer White - grade 1
 - (SBT) Beige Tempest - grade 2
 - (SBX) Black Onyx Mirage - grade 2
 - (SMG) Milk Glass Spectra - grade 2
 - (SFW) Frosty White Mirage - grade 2
 - (SHS) Hot Stone - grade 2
 - (SNM) Northern Melange - grade 2
 - **Base finish**
 - SLED BASE**
 - For leg frame finish options, please see page 433. Upcharges apply for the following plated finish:
 - (CHM) Chrome. Add \$42
 - WOOD BASE** (see coordination chart)

(AAM) Absolute	(NLW) Natural Walnut
(BKM) Black	(ASM) Night
(ACM) Cherry	(NBM) Noce Biondo
(EOM) English Oak	(NGM) Noce Grigio
(ECM) Espresso Cafe	(NEM) Noce Leggero
(TFM) Fruitwood	(NMM) Noce Medio
(HGM) Gray	(SKM) Shaker Cherry
(AHM) Honey	(TWM) Walnut
(TMM) Mahogany	(WTM) WC Cream
(AVM) Maple	(WHM) White
(MWM) Medium Walnut	(WCM) Winter Cherry
 - POLISHED CHROME BASE**
 - (CHM) Chrome.
 - **Glide type**
 - SLED BASE GLIDES**
 - (CG) Clear, polycarbonate glide for most floor surfaces (standard)
 - (XG) No glide for carpeted surfaces, no charge
 - (SG) Steel cushioned glide for carpeted surface. Add \$36
 - (RG) Rubber, non-slip glide for most hard floor surfaces. Add \$36
 - (FG) Felt glide for most hard floor surfaces. Add \$36
 - WOOD BASE GLIDES**
 - (NM) White non-marking nylon glide for most surfaces (standard)
 - (SG) Steel cushioned glides for carpeted surfaces. Add \$36.
 - (RG) Non-slip rubber glides for most hard floor surfaces. Add \$36.
 - (FG) Felt glides for most hard floor surfaces. Add \$36.



Round Table with Sled Base

MODEL#	DIMENSIONS	FREIGHT CLASS	WT/LBS.	CUBIC FT.	LIST PRICE	HPL ADD	UML ADD	GR. 2 ADD
D x W x H								
Laminate, flat edge (TFL laminate)								
8041R2616I	26 x 26 x 16	250	35	10.25	\$592	\$104	\$237	n/a
8041R3016I	30 x 30 x 16	250	44	13	\$624	\$122	\$237	n/a
8041R2120I	21 x 21 x 20	250	29	8.75	\$620	\$103	\$237	n/a
Laminate, knife edge (HPL laminate)								
8041R2616IK	26 x 26 x 16	250	35	10.25	\$1265	n/a	\$331	n/a
8041R3016IK	30 x 30 x 16	250	44	13	\$1355	n/a	\$331	n/a
8041R2120IK	21 x 21 x 20	250	29	8.75	\$1051	n/a	\$166	n/a
Solid surface, flat edge								
8041R2616ISF	26 x 26 x 16	150	48	10.25	\$2472	n/a	n/a	\$167
8041R3016ISF	30 x 30 x 16	150	61	13	\$2661	n/a	n/a	\$230
8041R2120ISF	21 x 21 x 20	150	37.5	8.75	\$2326	n/a	n/a	\$115
Solid surface, knife edge								
8041R2616ISK	26 x 26 x 16	150	48	10.25	\$2529	n/a	n/a	\$179
8041R3016ISK	30 x 30 x 16	150	61	13	\$2747	n/a	n/a	\$247
8041R2120ISK	21 x 21 x 20	150	37.5	8.75	\$2429	n/a	n/a	\$122

Finished height will vary depending on material top. Shipped fully assembled in 1 carton.



Square Table with Sled Base

Laminate, flat edge (TFL laminate)								
8042SQ2216I	22 x 22 x 16	150	34	8	\$592	\$104	\$237	n/a
8042SQ2816I	28 x 28 x 16	250	44	11.75	\$624	\$122	\$237	n/a
8042SQ1920I	19 x 19 x 20	250	29	7.75	\$600	\$93	\$237	n/a
Laminate, knife edge (HPL laminate)								
8042SQ2216IK	22 x 22 x 16	150	34	8	\$1051	n/a	\$166	n/a
8042SQ2816IK	28 x 28 x 16	250	44	11.75	\$1317	n/a	\$331	n/a
8042SQ1920IK	19 x 19 x 20	250	29	7.75	\$1008	n/a	\$166	n/a
Solid surface, flat edge								
8042SQ2216ISF	22 x 22 x 16	150	39.5	8	\$2179	n/a	n/a	\$144
8042SQ2816ISF	28 x 28 x 16	150	62.5	11.75	\$2496	n/a	n/a	\$230
8042SQ1920ISF	19 x 19 x 20	150	38	7.75	\$2085	n/a	n/a	\$174
Solid surface, knife edge								
8042SQ2216ISK	22 x 22 x 16	150	39.5	8	\$2529	n/a	n/a	\$174
8042SQ2816ISK	28 x 28 x 16	150	62.5	11.75	\$2975	n/a	n/a	\$259
8042SQ1920ISK	19 x 19 x 20	150	38	7.75	\$2429	n/a	n/a	\$127

Finished height will vary depending on material top. Shipped fully assembled in 1 carton.



Oval Table with Sled Base

MODEL#	DIMENSIONS	FREIGHT CLASS	WT./LBS.	CUBIC FT.	LIST PRICE	HPL ADD	UML ADD	GR. 2 ADD
D x W x H								
Laminate, flat edge (TFL laminate)								
80430V2616I	26 x 22 x 16	150	36.5	8.75	\$592	\$104	\$237	n/a
80430V3116I	31 x 26 x 16	250	46	11.75	\$624	\$122	\$237	n/a
80430V2220I	22 x 18 x 20	250	34	10.75	\$620	\$103	\$237	n/a
Laminate, knife edge (HPL laminate)								
80430V2616IK	26 x 22 x 16	150	36.5	8.75	\$1265	n/a	\$331	n/a
80430V3116IK	31 x 26 x 16	250	46	11.75	\$1441	n/a	\$331	n/a
80430V2220IK	22 x 18 x 20	250	34	10.75	\$1175	n/a	\$166	n/a
Solid surface, flat edge								
80430V2616ISF	26 x 22 x 16	150	42	8.75	\$2472	n/a	n/a	\$167
80430V3116ISF	31 x 26 x 16	150	60	11.75	\$2661	n/a	n/a	\$230
80430V2220ISF	22 x 18 x 20	250	38	10.75	\$2326	n/a	n/a	\$115
Solid surface, knife edge								
80430V2616ISK	26 x 22 x 16	150	42	8.75	\$2529	n/a	n/a	\$179
80430V3116ISK	31 x 26 x 16	150	60	11.75	\$2747	n/a	n/a	\$247
80430V2220ISK	22 x 18 x 20	250	38	10.75	\$2429	n/a	n/a	\$122

Finished height will vary depending on material top. Shipped fully assembled in 1 carton.



Round Table with Polished Chrome Base

Laminate, flat edge (TFL laminate)								
8041R2616C	26 x 26 x 16	250	38	10.75	\$1117	\$104	\$237	n/a
8041R3016C	30 x 30 x 16	250	45	13	\$1148	\$122	\$237	n/a
Laminate, knife edge (HPL laminate)								
8041R2616CK	26 x 26 x 16	250	38	10.75	\$1790	n/a	\$331	n/a
8041R3016CK	30 x 30 x 16	250	45	13	\$1881	n/a	\$331	n/a
Solid surface, flat edge								
8041R2616CSF	26 x 26 x 16	150	51	10.75	\$2997	n/a	n/a	\$167
8041R3016CSF	30 x 30 x 16	150	62.5	13	\$3186	n/a	n/a	\$230
Solid surface, knife edge								
8041R2616CSK	26 x 26 x 16	150	51	10.75	\$3054	n/a	n/a	\$179
8041R3016CSK	30 x 30 x 16	250	31.25	13	\$3272	n/a	n/a	\$247

Finished height will vary depending on material top. Shipped fully assembled in 1 carton.



Round Table with Wood Base

Laminate, flat edge (TFL laminate)								
8041R2616W	26 x 26 x 16	250	32	10.75	\$1271	\$104	\$237	n/a
8041R3016W	30 x 30 x 16	250	40	13	\$1302	\$122	\$237	n/a
Laminate, knife edge (HPL laminate)								
8041R2616WK	26 x 26 x 16	250	32	10.75	\$1944	n/a	\$331	n/a
8041R3016WK	30 x 30 x 16	250	40	13	\$2033	n/a	\$331	n/a
Solid surface, flat edge								
8041R2616WSF	26 x 26 x 16	150	45.5	10.75	\$3150	n/a	n/a	\$167
8041R3016WSF	30 x 30 x 16	150	57.5	13	\$3340	n/a	n/a	\$230
Solid surface, knife edge								
8041R2616WSK	26 x 26 x 16	150	45.5	10.75	\$3208	n/a	n/a	\$179
8041R3016WSK	30 x 30 x 16	150	57.5	13	\$3425	n/a	n/a	\$247

Finished height will vary depending on material top. Shipped fully assembled in 1 carton.



Square Table with Polished Chrome Base

MODEL#	DIMENSIONS	FREIGHT CLASS	WT/LBS.	CUBIC FT.	LIST PRICE	HPL ADD	UML ADD	GR. 2 ADD
--------	------------	---------------	---------	-----------	------------	---------	---------	-----------

D x W x H

Laminate, flat edge (TFL laminate)

8042SQ2216C	22.75 x 22.75 x 16	150	36	7.75	\$1117	\$104	\$237	n/a
8042SQ2816C	28.5 x 28.5 x 16	250	45	11.5	\$1148	\$122	\$237	n/a

Laminate, knife edge (HPL laminate)

8042SQ2216CK	22.75 x 22.75 x 16	150	36	7.75	\$1576	n/a	\$166	n/a
8042SQ2816CK	28.5 x 28.5 x 16	250	45	11.5	\$1676	n/a	\$331	n/a

Solid surface, flat edge

8042SQ2216CSF	22.75 x 22.75 x 16	150	41	7.75	\$2704	n/a	n/a	\$144
8042SQ2816CSF	28.5 x 28.5 x 16	150	57.5	11.5	\$3020	n/a	n/a	\$230

Solid surface, knife edge

8042SQ2216CSK	22.75 x 22.75 x 16	150	41	7.75	\$3054	n/a	n/a	\$174
8042SQ2816CSK	28.5 x 28.5 x 16	150	57.5	11.5	\$3499	n/a	n/a	\$259

Finished height will vary depending on material top. Shipped fully assembled in 1 carton.



Square Table with Wood Base

Laminate, flat edge (HPL laminate)

8042SQ2216W	22.75 x 22.75 x 16	250	30	7.75	\$1271	\$104	\$237	n/a
8042SQ2816W	28.5 x 28.5 x 16	250	39	11.5	\$1302	\$122	\$237	n/a

Laminate, knife edge (HPL laminate)

8042SQ2216WK	22.75 x 22.75 x 16	250	30	7.75	\$1730	n/a	\$166	n/a
8042SQ2816WK	28.5 x 28.5 x 16	250	39	11.5	\$1830	n/a	\$331	n/a

Solid surface, flat edge

8042SQ2216WSF	22.75 x 22.75 x 16	150	36	7.75	\$2857	n/a	n/a	\$144
8042SQ2816WSF	28.5 x 28.5 x 16	150	59	11.5	\$3174	n/a	n/a	\$230

Solid surface, knife edge

8042SQ2216WSK	22.75 x 22.75 x 16	150	36	7.75	\$3208	n/a	n/a	\$174
8042SQ2816WSK	28.5 x 28.5 x 16	150	59	11.5	\$3653	n/a	n/a	\$259

Finished height will vary depending on material top. Shipped fully assembled in 1 carton.



Oval Table with Polished Chrome Base

MODEL#	DIMENSIONS	FREIGHT CLASS	WT./LBS.	CUBIC FT.	LIST PRICE	HPL ADD	UML ADD	GR. 2 ADD
D x W x H								
Laminate, flat edge								
80430V2616C	26 x 22 x 16	150	38	9.25	\$1117	\$104	\$237	n/a
80430V3116C	31 x 26 x 16	250	44	11.75	\$1148	\$122	\$237	n/a
Laminate, knife edge								
80430V2616CK	26 x 22 x 16	150	38	9.25	\$1790	n/a	\$331	n/a
80430V3116CK	31 x 26 x 16	250	44	11.75	\$1965	n/a	\$331	n/a
Solid surface, flat edge								
80430V2616CSF	26 x 22 x 16	150	49.5	9.25	\$2997	n/a	n/a	\$167
80430V3116CSF	31 x 26 x 16	150	61.5	11.75	\$3186	n/a	n/a	\$230
Solid surface, knife edge								
80430V2616CSK	26 x 22 x 16	150	49.5	9.25	\$3054	n/a	n/a	\$179
80430V3116CSK	31 x 26 x 16	150	61.5	11.75	\$3272	n/a	n/a	\$247

Finished height will vary depending on material top. Shipped fully assembled in 1 carton.



Oval Table with Wood Base

Laminate, flat edge								
80430V2616W	26 x 22 x 16	250	32	9.25	\$1271	\$104	\$237	n/a
80430V3116W	31 x 26 x 16	250	39	11.75	\$1302	\$122	\$237	n/a
Laminate, knife edge								
80430V2616WK	26 x 22 x 16	250	32	9.25	\$1944	n/a	\$331	n/a
80430V3116WK	31 x 26 x 16	250	39	11.75	\$2119	n/a	\$331	n/a
Solid surface, flat edge								
80430V2616WSF	26 x 22 x 16	150	44.5	9.25	\$3150	n/a	n/a	\$167
80430V3116WSF	31 x 26 x 16	150	56.5	11.75	\$3340	n/a	n/a	\$230
Solid surface, knife edge								
80430V2616WSK	26 x 22 x 16	150	44.5	9.25	\$3208	n/a	n/a	\$179
80430V3116WSK	31 x 26 x 16	150	56.5	11.75	\$3425	n/a	n/a	\$247

Finished height will vary depending on material top. Shipped fully assembled in 1 carton.

JEO



model 8434



model 8433-4



Optional Quilted Stitch Back (Q).





Optional 5 prong base with glides (G).

STANDARD FEATURES

- Jeo is a contemporary, retro - inspired series with versatility for a variety of workplace applications.
- The tailored box styling functions well in lounge, conferencing, collaboration and side/guest environments.
- Three seating models: swivel tilter with a 5 prong caster base, a swivel self-centering return with a stationary round pedestal base or a matching four legged Arm Chair.
- Model 8433-4 is standard with a five prong Black nylon base with carpet casters (C1).
- Model 8437 is standard with Black four-legged frame.
- Upholstery options: fabric, vinyl, leather or a combination of two or more materials. The upholstery surfaces are seamed together with tailored double stitch detailing.
- Check textile availability prior to specifying upholstery material.

OPTIONAL FEATURES

- Chairs are available with an Optional Quilted Stitch back. Please specify (Q). Add \$212.
- Model 8433-4 has an optional five prong Aluminum base. specify (AL).
- Optional 5 prong Aluminum base with hard glides. Please specify (C7).
- Optional soft casters are available on the 5 prong base. Please specify (C9R) . Add \$76.
- Model 8434 round pedestal base available in Chrome (CHM) or Brushed Chrome (BCH). Please specify.
- Model 8437 has optional Chrome (CHM) or Brushed Chrome (BCH) four-legged frame.
- Occasional tables are available in the following laminate finishes to coordinate with Global Desking and wood seating: Absolute Acajou (ACJ), Asian Night (ASN), Avant Cherry (AWC), Avant Honey (AWH), Black (BLK), Blizzard (BZD), Brushed Cobalt (BRC), Clear Maple (CMB), Custom Grey (CGY), Dark Espresso (DES), Designer White (DWT), Fashionista (FAS), First Class (FCL), Noce Biondo (NBL), Noce Grigio (NGL), Noce Leggero (NEL), Noce Medio (NML), Quartered Mahogany (QTM), Sheer Beauty (SBY), Stonedust (SDT), Walnut Heights (WHE), White Chocolate (WHC), and Winter Cherry (WCR). Please Specify.

DESCRIPTION	FEATURES	MODEL#	STANDARD TEXTILE GRADES											
			1	2	3	4	5	6	7	8	9	10	11	12
 <p>Self-Centering Lounge Chair on Pedestal Base COM Yardage: 2.75 Freight Class: 250 Product Weight (lbs.): 50 Cubic Feet Per Carton: 22</p> <p>Ergonomic Features: C</p>		8434	2474	2569	2643	2753	2909	2964	3100	3360	3487	3727	4055	4462
			OVERALL DIMENSIONS			SEAT DIMENSIONS			BACK DIMENSIONS					
				W	D	H	W	D	H	W	H			
			26	25	30-32.5	20	19	16.5-19	20	15				
 <p>Swivel Tilter Chair COM Yardage: 2.75 Freight Class: 250 Product Weight (lbs.): 50 Cubic Feet Per Carton: 22</p> <p>Ergonomic Features: A, B, C, S</p>		8433-4	1679	1798	1887	2024	2218	2308	2483	2761	2978	3217	3709	4235
			OVERALL DIMENSIONS			SEAT DIMENSIONS			BACK DIMENSIONS					
				W	D	H	W	D	H	W	H			
			26	25	30-32.5	20	19	16.5-19	20	15				
 <p>Arm Chair COM Yardage: 2.75 Freight Class: 250 Product Weight (lbs.): 50 Cubic Feet Per Carton: 22</p>		8437	1635	1741	1820	1940	2108	2189	2342	2587	2775	2984	3417	3876
			OVERALL DIMENSIONS			SEAT DIMENSIONS			BACK DIMENSIONS					
				W	D	H	W	D	H	W	H			
			26	25	34	20	19	18	20	15				

KATE®



model 2811-4





model 2811-8

STANDARD FEATURES

- A contemporary, yet retro series featuring sculpted seat and back cushions.
- Fully upholstered closed arms offer a unique style and function in the workplace.
- Models are standard with a five legged Polished Aluminum base.
- C10 casters are standard.
- Check textile availability prior to specifying upholstery material.

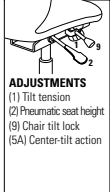
OPTIONAL FEATURES

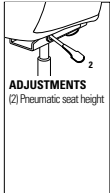
- An optional Black injection molded base is available at no upcharge, please specify (BK).
- There are no caster options for this series. C7 glides can be specified at no upcharge.
- For hard surface flooring please specify C10R. Add \$70.
- For fully assembled in box, specify SU. Add \$81.

DESCRIPTION	FEATURES	MODEL#	STANDARD TEXTILE GRADES																																			
			1	2	3	4	5	6	7	8	9	10	11	12																								
 <p>MB Tilter COM Yardage: 3.75 Freight Class: 250 Product Weight (lbs.): 47 Cubic Feet Per Carton: 15.75</p>	 <p>ADJUSTMENTS (1) Tilt tension (2) Pneumatic seat height (9) Chair tilt lock (5A) Center-tilt action</p>	<p>Ergonomic Features: A, B, C, N</p>	<table border="1"> <thead> <tr> <th colspan="3">OVERALL DIMENSIONS</th> <th colspan="3">SEAT DIMENSIONS</th> <th colspan="2">BACK DIMENSIONS</th> </tr> <tr> <th>W</th><th>D</th><th>H</th> <th>W</th><th>D</th><th>H</th> <th>W</th><th>H</th> </tr> </thead> <tbody> <tr> <td>26</td><td>24.5</td><td>33</td> <td>17.5</td><td>18</td><td>17.5-21.50</td> <td>19</td><td>15.5</td> </tr> </tbody> </table>												OVERALL DIMENSIONS			SEAT DIMENSIONS			BACK DIMENSIONS		W	D	H	W	D	H	W	H	26	24.5	33	17.5	18	17.5-21.50	19	15.5
			OVERALL DIMENSIONS			SEAT DIMENSIONS			BACK DIMENSIONS																													
			W	D	H	W	D	H	W	H																												
			26	24.5	33	17.5	18	17.5-21.50	19	15.5																												
<p>RTA 00</p>																																						
<table border="1"> <thead> <tr> <th>1</th><th>2</th><th>3</th><th>4</th><th>5</th><th>6</th><th>7</th><th>8</th><th>9</th><th>10</th><th>11</th><th>12</th> </tr> </thead> <tbody> <tr> <td>2811-4</td><td>\$1490</td><td>\$1635</td><td>\$1752</td><td>\$1925</td><td>\$2169</td><td>\$2260</td><td>\$2472</td><td>\$2883</td><td>\$3079</td><td>\$3458</td><td>\$3975</td><td>\$4615</td> </tr> </tbody> </table>												1	2	3	4	5	6	7	8	9	10	11	12	2811-4	\$1490	\$1635	\$1752	\$1925	\$2169	\$2260	\$2472	\$2883	\$3079	\$3458	\$3975	\$4615		
1	2	3	4	5	6	7	8	9	10	11	12																											
2811-4	\$1490	\$1635	\$1752	\$1925	\$2169	\$2260	\$2472	\$2883	\$3079	\$3458	\$3975	\$4615																										
<p>FedEx UPS</p>																																						
 <p>MB Swivel COM Yardage: 3.75 Freight Class: 250 Product Weight (lbs.): 43 Cubic Feet Per Carton: 15.75</p>	 <p>ADJUSTMENTS (2) Pneumatic seat height</p>	<p>Ergonomic Features: C, N</p>	<table border="1"> <thead> <tr> <th colspan="3">OVERALL DIMENSIONS</th> <th colspan="3">SEAT DIMENSIONS</th> <th colspan="2">BACK DIMENSIONS</th> </tr> <tr> <th>W</th><th>D</th><th>H</th> <th>W</th><th>D</th><th>H</th> <th>W</th><th>H</th> </tr> </thead> <tbody> <tr> <td>26</td><td>24.5</td><td>33</td> <td>17.5</td><td>18</td><td>17.5-21.50</td> <td>19</td><td>15.5</td> </tr> </tbody> </table>												OVERALL DIMENSIONS			SEAT DIMENSIONS			BACK DIMENSIONS		W	D	H	W	D	H	W	H	26	24.5	33	17.5	18	17.5-21.50	19	15.5
			OVERALL DIMENSIONS			SEAT DIMENSIONS			BACK DIMENSIONS																													
			W	D	H	W	D	H	W	H																												
			26	24.5	33	17.5	18	17.5-21.50	19	15.5																												
<p>RTA 00</p>																																						
<table border="1"> <thead> <tr> <th>1</th><th>2</th><th>3</th><th>4</th><th>5</th><th>6</th><th>7</th><th>8</th><th>9</th><th>10</th><th>11</th><th>12</th> </tr> </thead> <tbody> <tr> <td>2811-8</td><td>\$1437</td><td>\$1587</td><td>\$1704</td><td>\$1874</td><td>\$2119</td><td>\$2210</td><td>\$2423</td><td>\$2833</td><td>\$3029</td><td>\$3407</td><td>\$3924</td><td>\$4566</td> </tr> </tbody> </table>												1	2	3	4	5	6	7	8	9	10	11	12	2811-8	\$1437	\$1587	\$1704	\$1874	\$2119	\$2210	\$2423	\$2833	\$3029	\$3407	\$3924	\$4566		
1	2	3	4	5	6	7	8	9	10	11	12																											
2811-8	\$1437	\$1587	\$1704	\$1874	\$2119	\$2210	\$2423	\$2833	\$3029	\$3407	\$3924	\$4566																										
<p>FedEx UPS</p>																																						
 <p>Armchair COM Yardage: 3.75 Freight Class: 250 Product Weight (lbs.): 42 Cubic Feet Per Carton: 15.75</p>	<p>Ergonomic Features: N</p>	<table border="1"> <thead> <tr> <th colspan="3">OVERALL DIMENSIONS</th> <th colspan="3">SEAT DIMENSIONS</th> <th colspan="2">BACK DIMENSIONS</th> </tr> <tr> <th>W</th><th>D</th><th>H</th> <th>W</th><th>D</th><th>H</th> <th>W</th><th>H</th> </tr> </thead> <tbody> <tr> <td>26.5</td><td>26.5</td><td>33.5</td> <td>17.5</td><td>18</td><td>18</td> <td>19</td><td>15.5</td> </tr> </tbody> </table>												OVERALL DIMENSIONS			SEAT DIMENSIONS			BACK DIMENSIONS		W	D	H	W	D	H	W	H	26.5	26.5	33.5	17.5	18	18	19	15.5	
		OVERALL DIMENSIONS			SEAT DIMENSIONS			BACK DIMENSIONS																														
		W	D	H	W	D	H	W	H																													
		26.5	26.5	33.5	17.5	18	18	19	15.5																													
<p>RTA 00</p>																																						
<table border="1"> <thead> <tr> <th>1</th><th>2</th><th>3</th><th>4</th><th>5</th><th>6</th><th>7</th><th>8</th><th>9</th><th>10</th><th>11</th><th>12</th> </tr> </thead> <tbody> <tr> <td>2813</td><td>\$1628</td><td>\$1769</td><td>\$1881</td><td>\$2044</td><td>\$2277</td><td>\$2361</td><td>\$2565</td><td>\$2956</td><td>\$3143</td><td>\$3505</td><td>\$3996</td><td>\$4608</td> </tr> </tbody> </table>												1	2	3	4	5	6	7	8	9	10	11	12	2813	\$1628	\$1769	\$1881	\$2044	\$2277	\$2361	\$2565	\$2956	\$3143	\$3505	\$3996	\$4608		
1	2	3	4	5	6	7	8	9	10	11	12																											
2813	\$1628	\$1769	\$1881	\$2044	\$2277	\$2361	\$2565	\$2956	\$3143	\$3505	\$3996	\$4608																										
<p>FedEx UPS</p>																																						
 <p>Ottoman COM Yardage: 1.5 Freight Class: 250 Product Weight (lbs.): 22 Cubic Feet Per Carton: 6</p>	<p>Ergonomic Features: N</p>	<table border="1"> <thead> <tr> <th colspan="3">OVERALL DIMENSIONS</th> <th colspan="3">SEAT DIMENSIONS</th> <th colspan="2">BACK DIMENSIONS</th> </tr> <tr> <th>W</th><th>D</th><th>H</th> <th>W</th><th>D</th><th>H</th> <th>W</th><th>H</th> </tr> </thead> <tbody> <tr> <td>23.5</td><td>18.75</td><td>17.75</td> <td>20.5</td><td>18.5</td><td>17-22</td> <td>20</td><td>21</td> </tr> </tbody> </table>												OVERALL DIMENSIONS			SEAT DIMENSIONS			BACK DIMENSIONS		W	D	H	W	D	H	W	H	23.5	18.75	17.75	20.5	18.5	17-22	20	21	
		OVERALL DIMENSIONS			SEAT DIMENSIONS			BACK DIMENSIONS																														
		W	D	H	W	D	H	W	H																													
		23.5	18.75	17.75	20.5	18.5	17-22	20	21																													
<p>RTA 00</p>																																						
<table border="1"> <thead> <tr> <th>1</th><th>2</th><th>3</th><th>4</th><th>5</th><th>6</th><th>7</th><th>8</th><th>9</th><th>10</th><th>11</th><th>12</th> </tr> </thead> <tbody> <tr> <td>2814</td><td>\$1020</td><td>\$1082</td><td>\$1125</td><td>\$1189</td><td>\$1282</td><td>\$1317</td><td>\$1398</td><td>\$1554</td><td>\$1630</td><td>\$1774</td><td>\$1971</td><td>\$2215</td> </tr> </tbody> </table>												1	2	3	4	5	6	7	8	9	10	11	12	2814	\$1020	\$1082	\$1125	\$1189	\$1282	\$1317	\$1398	\$1554	\$1630	\$1774	\$1971	\$2215		
1	2	3	4	5	6	7	8	9	10	11	12																											
2814	\$1020	\$1082	\$1125	\$1189	\$1282	\$1317	\$1398	\$1554	\$1630	\$1774	\$1971	\$2215																										
<p>FedEx UPS</p>																																						

LUX



model LX2426AC



model LX8033S

STANDARD FEATURES

- Contemporary styling featuring luxurious cushioning.
- Sofa cushions are removable.
- Fully upholstered. Wood legs with non marking clear glides.
- Cylindrical bolsters included with lounge chair models. One bolster on single seat lounge chair and two bolsters on two-seat and three-seat sofas.
- This item may require a longer lead time. Please contact your Global sales representative for further information.
- Check textile availability prior to specifying upholstery material.

OPTIONAL FEATURES

- Wood frames are available in Absolute (**AAM**), Black (**BKM**), Cherry (**ACM**), English Oak (**EOM**), Espresso Cafe (**ECM**), Fruitwood (**TFM**), Gray (**HGM**), Honey (**AHM**), Mahogany (**TMM**), Maple (**AVM**), Medium Walnut (**MWWM**), Night (**ASM**), Natural Walnut (**NLW**), Noce Biondo (**NBM**), Noce Grigio (**NGM**), Noce Leggero (**NEM**), Noce Medio (**NMM**), Shaker Cherry (**SKM**), Walnut (**TWM**), WC Cream (**WTM**), White (**WHM**) and Winter Cherry (**WCM**). Please Specify. Genuine maple faced veneers and solids are used.

DESCRIPTION

FEATURES

MODEL#

STANDARD TEXTILE GRADES



Side Chair
COM Yardage: 3
Freight Class: 250
Product Weight (lbs.): 36
Cubic Feet Per Carton: 17.75

	1	2	3	4	5	6	7	8	9	10	11	12
LX2226SC	1149	1270	1318	1394	1499	1534	1625	1798	1883	2045	2264	2538

OVERALL DIMENSIONS			SEAT DIMENSIONS			BACK DIMENSIONS	
W	D	H	W	D	H	W	H
25	27.75	36	19	19.5	19.5	19	18

RTA 00



Armchair
COM Yardage: 3
Freight Class: 250
Product Weight (lbs.): 40
Cubic Feet Per Carton: 17.75

	1	2	3	4	5	6	7	8	9	10	11	12
LX2426AC	1492	1618	1716	1861	2067	2165	2352	2652	2882	3137	3664	4226

OVERALL DIMENSIONS			SEAT DIMENSIONS			BACK DIMENSIONS	
W	D	H	W	D	H	W	H
26	27.75	36	19	19.5	19.5	19	18

RTA 00



Lounge Chair
COM Yardage: 8.50
Freight Class: 250
Product Weight (lbs.): 77
Cubic Feet Per Carton: 30.25

	1	2	3	4	5	6	7	8	9	10	11	12
LX3433CH	2906	3219	3468	3841	4371	4622	5099	5865	6456	7111	8459	9898

OVERALL DIMENSIONS			SEAT DIMENSIONS			BACK DIMENSIONS	
W	D	H	W	D	H	W	H
35	34	33	-	-	-	-	-

RTA 00

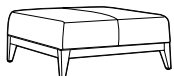

Ottoman
COM Yardage: 2.5
Freight Class: 250
Product Weight (lbs.): 48
Cubic Feet Per Carton: 18.25

	1	2	3	4	5	6	7	8	9	10	11	12
LX3636OTT	2775	3000	3069	3172	3325	3374	3508	3756	3876	4105	4420	4811

OVERALL DIMENSIONS			SEAT DIMENSIONS			BACK DIMENSIONS	
W	D	H	W	D	H	W	H
36	36	16	-	-	-	-	-

RTA 00

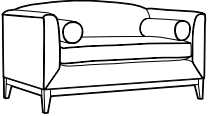
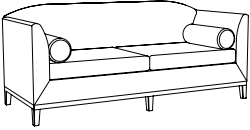
DESCRIPTION	FEATURES	MODEL#	STANDARD TEXTILE GRADES												
			1	2	3	4	5	6	7	8	9	10	11	12	
 <p>Two Seat Sofa w/Cylindrical bolsters. COM Yardage: 12 Freight Class: 250 Product Weight (lbs.): 105 Cubic Feet Per Carton: 50.25</p>		LX6033S	3000	3440	3793	4318	5065	5415	6094	7172	8003	8927	10829	12858	
			OVERALL DIMENSIONS			SEAT DIMENSIONS			BACK DIMENSIONS						
			W	D	H	W	D	H	W	H					
			61	34	33	20	18.5	18.5	20	16					
			RTA 00												
 <p>Three Seat Sofa w/Cylindrical bolsters. COM Yardage: 14.75 Freight Class: 300 Product Weight (lbs.): 125 Cubic Feet Per Carton: 66.25</p>		LX8033S	4318	5019	5409	6001	6832	7131	7860	9253	9922	11214	12967	15157	
			OVERALL DIMENSIONS			SEAT DIMENSIONS			BACK DIMENSIONS						
			W	D	H	W	D	H	W	H					
			81	34	33	20	18.5	18.5	20	16					
			RTA 00												

ML™







model ML2630



STANDARD FEATURES

- Modern seating with a distinctive retro design.
- Features a steel tube frame, legs and arms.
- Fully upholstered continuous seat and back cushions.
- Standard with non marring, Black glides.
- Check textile availability prior to specifying upholstery material.

OPTIONAL FEATURES

- Available in five frame finish options. Please specify Chrome (**CHM**), Brushed Chrome (**BCH**), Black (**TBL**), Designer White (**TDW**) or Tungsten (**TTU**). No upcharge applies. Please specify.

DESCRIPTION	FEATURES	MODEL#	STANDARD TEXTILE GRADES											
			1	2	3	4	5	6	7	8	9	10	11	12
 <p>Counter Height Stool - 24" Seat Height COM Yardage: 1 Freight Class: 250 Product Weight (lbs.): 22 Cubic Feet Per Carton: 5.75</p>		ML171724	1668	1693	1708	1735	1766	1781	1813	1862	1898	1942	2028	2120
			OVERALL DIMENSIONS			SEAT DIMENSIONS			BACK DIMENSIONS					
			W	D	H	W	D	H	W	H				
			18	19	24	17	16	23	-	-				
			RTA 00		FedEx		ups							
 <p>Bar Height Stool - 30" Seat Height COM Yardage: 1 Freight Class: 250 Product Weight (lbs.): 23 Cubic Feet Per Carton: 8</p>		ML171730	1721	1744	1758	1783	1812	1825	1851	1902	1928	1976	2041	2123
			OVERALL DIMENSIONS			SEAT DIMENSIONS			BACK DIMENSIONS					
			W	D	H	W	D	H	W	H				
			18	20.5	30	17	16	29	-	-				
			RTA 00		FedEx		ups							
 <p>Bar Height Stool - 33" Seat Height COM Yardage: 1 Freight Class: 250 Product Weight (lbs.): 24 Cubic Feet Per Carton: 9</p>		ML171733	1755	1860	1876	1896	1924	1936	1963	2011	2035	2081	2144	2223
			OVERALL DIMENSIONS			SEAT DIMENSIONS			BACK DIMENSIONS					
			W	D	H	W	D	H	W	H				
			18	21.5	33	17	16	32	-	-				
			RTA 00											
 <p>Ottoman COM Yardage: 1.25 Freight Class: 150 Product Weight (lbs.): 28 Cubic Feet Per Carton: 5.75</p>		ML2121	1184	1279	1308	1350	1410	1431	1482	1582	1631	1720	1848	2004
			OVERALL DIMENSIONS			SEAT DIMENSIONS			BACK DIMENSIONS					
			W	D	H	W	D	H	W	H				
			21	21	17	-	-	-	-	-				
			RTA 00											

DESCRIPTION	FEATURES	MODEL#	STANDARD TEXTILE GRADES											
			1	2	3	4	5	6	7	8	9	10	11	12
 <p>Dining Chair COM Yardage: 1.75 Freight Class: 250 Product Weight (lbs.): 33 Cubic Feet Per Carton: 14.75</p>		ML2326	1390	1531	1587	1670	1789	1831	1937	2135	2230	2415	2666	2980
			OVERALL DIMENSIONS			SEAT DIMENSIONS			BACK DIMENSIONS					
			W	D	H	W	D	H	W	H				
			23.25	29.5	29.75	20	18.5	18.5	20	16				
			RTA 00											
 <p>Lounge Chair COM Yardage: 2.5 Freight Class: 250 Product Weight (lbs.): 54 Cubic Feet Per Carton: 21.25</p>		ML2630	2085	2278	2347	2452	2598	2652	2785	3034	3151	3383	3696	4087
			OVERALL DIMENSIONS			SEAT DIMENSIONS			BACK DIMENSIONS					
			W	D	H	W	D	H	W	H				
			26	34.5	35	23	20	18.5	18.5	20.5				
			RTA 00											

ML PARK



model ML4634CH



model ML8634

STANDARD FEATURES

- Armless modern lounge seating with a distinctive retro design.
- Features beautiful aluminum legs with Black glides.
- Fully upholstered continuous seat and back cushions with distinctive seams.
- Check textile availability prior to specifying upholstery material.

OPTIONAL FEATURES

- Optional fixed back cushion (FC) is available on lounge models with upcharge. Please specify. Model ML4634, add \$193. Model ML6634, add \$255. Model ML8634, add \$316.
- Available in five leg finish options. Specify: Black (TBL), Brushed Aluminum (BAL), Designer White (TDW), Polished Aluminum (ALU) or Tungsten (TTU). No upcharge applies.

DESCRIPTION	FEATURES	MODEL#	STANDARD TEXTILE GRADES											
-------------	----------	--------	-------------------------	--	--	--	--	--	--	--	--	--	--	--



Ottoman

COM Yardage: 1.50
 Freight Class: 150
 Product Weight (lbs.): 28
 Cubic Feet Per Carton: 5.75

	1	2	3	4	5	6	7	8	9	10	11	12
ML2634	2297	2353	2397	2462	2554	2598	2682	2814	2916	3031	3266	3515

OVERALL DIMENSIONS			SEAT DIMENSIONS			BACK DIMENSIONS	
W	D	H	W	D	H	W	H
21	26.75	18.25	26.75	-	20	-	-

RTA 00



Lounge Chair

COM Yardage: 7.25
 Freight Class: 250
 Product Weight (lbs.): 54
 Cubic Feet Per Carton: 21.25

	1	2	3	4	5	6	7	8	9	10	11	12
ML4634	3937	4183	4373	4658	5067	5255	5623	6211	6663	7165	8200	9304

OVERALL DIMENSIONS			SEAT DIMENSIONS			BACK DIMENSIONS	
W	D	H	W	D	H	W	H
26	34.5	35	42.75	22	19	27	13

RTA 00



Two Seat Sofa

COM Yardage: 7.50
 Freight Class: 250
 Product Weight (lbs.): 132
 Cubic Feet Per Carton: 52

	1	2	3	4	5	6	7	8	9	10	11	12
ML6634	4250	4739	4961	5299	5773	5947	6360	7155	7539	8275	9282	10531

OVERALL DIMENSIONS			SEAT DIMENSIONS			BACK DIMENSIONS	
W	D	H	W	D	H	W	H
66	36	32	66	22	19	27	13

RTA 00



Three Seat Sofa

COM Yardage: 11
 Freight Class: 250
 Product Weight (lbs.): 132
 Cubic Feet Per Carton: 52

	1	2	3	4	5	6	7	8	9	10	11	12
ML8634	5607	6265	6573	7034	7690	7925	8495	9589	10116	11130	12509	14231

OVERALL DIMENSIONS			SEAT DIMENSIONS			BACK DIMENSIONS	
W	D	H	W	D	H	W	H
66	36	32	86	22	19	52	13

RTA 00

PRAIRIE™



model 3481



model 3482

STANDARD FEATURES

- Featuring, gently barrel shaped arms that provide an attractive appearance.
- Fully upholstered. Tapered wood skirt and legs.
- Series includes lounge chair, two seat and three seat sofa.
- Check textile availability prior to specifying upholstery material.

OPTIONAL FEATURES

- Tapered wood legs are available in Absolute (AAM), Black (BKM), Cherry (ACM), Espresso Cafe (ECM), English Oak (EOM), Fruitwood (TFM), Gray (HGM), Honey (AHM), Mahogany (TMM), Maple (AVM), Medium Walnut (MWVM), Natural Walnut (NLW), Night (ASM), Noce Biondo (NBM), Noce Grigio (NGM), Noce Leggero (NEM), Noce Medio (NMM), Shaker Cherry (SKM), Walnut (TWM), WC Cream (WTM), White (WHM) and Winter Cherry (WCM). Please specify. Genuine maple faced veneers and solids are used.

STITCH DETAIL WHEN UPHOLSTERED IN ALL LEATHER - ILLUSTRATIONS BELOW

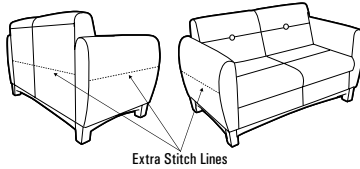

Extra Stitch Lines

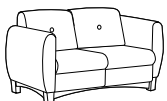
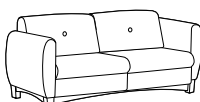
DESCRIPTION	FEATURES	MODEL#	STANDARD TEXTILE GRADES											
			1	2	3	4	5	6	7	8	9	10	11	12
 Lounge Chair COM Yardage: 4.25 Freight Class: 150 Product Weight (lbs.): 80 Cubic Feet Per Carton: 19.25		3481	2247	2442	2594	2819	3142	3256	3534	4068	4330	4823	5500	6340
			OVERALL DIMENSIONS			SEAT DIMENSIONS			BACK DIMENSIONS					
			W	D	H	W	D	H	W	H				
			32	29	30.5	21	19	16	21	14.5				
			RTA 00											
 Two Seat Sofa COM Yardage: 6.25 Freight Class: 250 Product Weight (lbs.): 106 Cubic Feet Per Carton: 41.25		3482	3188	3439	3634	3926	4347	4494	4856	5553	5884	6533	7410	8506
			OVERALL DIMENSIONS			SEAT DIMENSIONS			BACK DIMENSIONS					
			W	D	H	W	D	H	W	H				
			52.5	29	30.5	42	19	16	42	14.5				
			RTA 00											
 Three Seat Sofa COM Yardage: 9.5 Freight Class: 250 Product Weight (lbs.): 150 Cubic Feet Per Carton: 55.5		3483	4007	4355	4630	5044	5631	5908	6439	7287	7943	8668	10166	11762
			OVERALL DIMENSIONS			SEAT DIMENSIONS			BACK DIMENSIONS					
			W	D	H	W	D	H	W	H				
			73.5	29	30.5	63.5	19	16	63.5	14.5				
			RTA 00											

RAMBLER



Rectangular ottoman 26" x 52"
RA2652RE



Square ottoman 39" x 39"
RA3939SQ



Contrasting Textile Application.

STANDARD FEATURES





- The softened shapes of Ramble ottomans create mobile and stationary furniture landscapes for education, office and healthcare. This family of ottomans, available in numerous shapes and sizes, creates unique and inviting spaces for people to relax, socialize, work and study.
- These fully upholstered ottomans are available in square, rectangular and trapezoid shapes.
- Ottomans are standard at 17.5" seat height with 3" fixed legs or casters. A 15.5" seat height is achieved using the optional 1" leg.
- 3" and 1" poly legs are available in Night or Sand finish with white non-marking glides, standard. Various glide options are available to best suit flooring type and site conditions.
- For casters, select (CST) base type option and choose 2.5" black casters for either carpet or hard surfaces, see upcharge.
- An optional moisture barrier is available. Sealed seams are not available.
- Models do not gang.
- Upholstery options: fabric, coated textile or leather. Coated textile and leather models may feature stitch detail across the seat.
- Check textile availability prior to specifying upholstery material.
- Ottomans are available with contrasting textiles. Specify ottoman top separate from sides. For pricing, start with the base price and add applicable graded textile upcharges for the top and sides.
- Combining different material types (ex. coated textile and fabric) is not recommended due to different stretch resulting in potential for puckering.
- The blended textile matrix does not apply to this series.
- Active weight capacity 300 lbs.
- All models ship fully assembled.
- The series is designed for use across a range of facilities and is covered under Global's limited lifetime warranty for single-shift use.
- Model description dimensions are nominal. Actual dimensions are within .5 inches of nominal.





Please add option codes in the following order:

- **Model Number**
Specify model number
- **Top Textile Back**
Specify textile code
- **Side Textile**
Specify textile code
- **Base Type**
(1L) 1" Leg with 15.5" seat height
(3L) 3" Leg with 17.5" seat height
(CST) Casters with 17.5" seat height (please refer to upcharges below)
- **Leg Finish**
(BLK) Night
(SND) Sand
- **Caster Type**
(C112) 2.5" Black caster for carpeted surfaces. No upcharge.
(C112R) 2.5" Caster for most hard surfaces. Add \$57
- **Glide Type**
(NM) White, non-marking nylon glides for most surfaces. No upcharge.
(FG) Felt glides for most hard floor surfaces. Add \$34.
(RG) Rubber non-slip glides for most hard floor surfaces. Add \$34.
(SG) Steel cushioned glides for carpeted surfaces. Add \$34.
- **Moisture Barrier**
(NB) No moisture barrier
(MB) Moisture barrier. See model for upcharges.

EXAMPLE RAMBLER ORDER CODE:

RA2222SQ	WA50	VY20	3L	BLK	NM	NB
Model #	Top textile	Sides textile	Base type	Leg finish	Glide type	Moisture barrier

DESCRIPTION	FEATURES/ MODEL#	STANDARD TEXTILE GRADES												
		1/COM	2	3	4	5	6	7	8	9	10	11	12	
 <p>Square Ottoman 22" x 22" COM Yardage: Top: 0.75; Side: 1 Freight Class: 150 Product Weight (lbs.): 38.5 Cubic Feet Per Carton: 6.5</p>	RA2222SQ Base Price:	\$716												
	Top upcharge:	+0	+\$24	+\$43	+\$71	+\$110	+\$126	+\$160	+\$213	+\$253	+\$297	+\$387	+\$483	
	Side upcharge:	+0	+\$32	+\$57	+\$94	+\$146	+\$168	+\$213	+\$284	+\$337	+\$395	+\$516	+\$643	
				OVERALL DIMENSIONS			SEAT DIMENSIONS			BACK DIMENSIONS				
				W	D	H	W	D	H	W	H			
				22	22	17.5	-	-	-	-	-			
	Add \$107 for moisture barrier (MB).													
	Width and depth may vary by up to .05 in.			RTA 00	1 per carton									
	 <p>Square Ottoman 26" x 26" COM Yardage: Top: 0.75; Side: 1 Freight Class: 150 Product Weight (lbs.): 41 Cubic Feet Per Carton: 9.5</p>	RA2626SQ Base Price:	\$796											
		Top upcharge:	+0	+\$24	+\$43	+\$71	+\$110	+\$126	+\$160	+\$213	+\$253	+\$297	+\$387	+\$483
Side upcharge:		+0	+\$32	+\$57	+\$94	+\$146	+\$168	+\$213	+\$284	+\$337	+\$395	+\$516	+\$643	
			OVERALL DIMENSIONS			SEAT DIMENSIONS			BACK DIMENSIONS					
			W	D	H	W	D	H	W	H				
			26.5	26.5	17.5	-	-	-	-	-				
Add \$107 for moisture barrier (MB).														
Width and depth may vary by up to .05 in.			RTA 00	1 per carton										
 <p>Square Ottoman 39" x 39" COM Yardage: Top: 1.25; Side: 2.25 Freight Class: 250 Product Weight (lbs.): 74 Cubic Feet Per Carton: 19.5</p>		RA3939SQ Base Price:	\$1198											
		Top upcharge:	+0	+\$40	+\$72	+\$118	+\$183	+\$210	+\$267	+\$355	+\$422	+\$494	+\$645	+\$804
	Side upcharge:	+0	+\$72	+\$129	+\$212	+\$329	+\$378	+\$480	+\$639	+\$759	+\$889	+\$1161	+\$1447	
				OVERALL DIMENSIONS			SEAT DIMENSIONS			BACK DIMENSIONS				
				W	D	H	W	D	H	W	H			
				39	39	17.5	-	-	-	-	-			
	Add \$213 for moisture barrier (MB).													
	Width and depth may vary by up to .05 in.			RTA 00	1 per carton									
	 <p>Rectangular Ottoman 26" x 39" COM Yardage: Top: 1; Side: 1.5 Freight Class: 150 Product Weight (lbs.): 63 Cubic Feet Per Carton: 13.75</p>	RA2639RE Base Price:	\$1062											
		Top upcharge:	+0	+\$32	+\$57	+\$94	+\$146	+\$168	+\$213	+\$284	+\$337	+\$395	+\$516	+\$643
Side upcharge:		+0	+\$48	+\$86	+\$141	+\$219	+\$252	+\$320	+\$426	+\$506	+\$593	+\$774	+\$965	
			OVERALL DIMENSIONS			SEAT DIMENSIONS			BACK DIMENSIONS					
			W	D	H	W	D	H	W	H				
			39.5	26.5	17.5	-	-	-	-	-				
Add \$160 for moisture barrier (MB).														
Width and depth may vary by up to .05 in.			RTA 00	1 per carton										

DESCRIPTION	FEATURES	MODEL#	STANDARD TEXTILE GRADES													
			1/COM	2	3	4	5	6	7	8	9	10	11	12		
 <p>Rectangular Ottoman 26" x 52" COM Yardage: Top: 1; Side: 1.5 Freight Class: 150 Product Weight (lbs.): 75 Cubic Feet Per Carton: 17.75</p>	RA2652RE	Base Price:	\$1186													
		Top upcharge:	+0	+\$32	+\$57	+\$94	+\$146	+\$168	+\$213	+\$284	+\$337	+\$395	+\$516	+\$643		
		Side upcharge:	+0	+\$48	+\$86	+\$141	+\$219	+\$252	+\$320	+\$426	+\$506	+\$593	+\$774	+\$965		
				OVERALL DIMENSIONS			SEAT DIMENSIONS			BACK DIMENSIONS						
			W	D	H	W	D	H	W	H						
			52.5	26.5	17.5	-	-	-	-	-						
		Add \$160 for moisture barrier (MB).														
		Width and depth may vary by up to .05 in.	RTA 00													
													1 per carton			
 <p>Trapezoid Ottoman 26" x 26" COM Yardage: Top: .75; Side: 1.5 Freight Class: 250 Product Weight (lbs.): 37.5 Cubic Feet Per Carton: 9.5</p>	RA2626TR	Base Price:	\$796													
		Top upcharge:	+0	+\$24	+\$43	+\$71	+\$110	+\$126	+\$160	+\$213	+\$253	+\$297	+\$387	+\$483		
		Side upcharge:	+0	+\$48	+\$86	+\$141	+\$219	+\$252	+\$320	+\$426	+\$506	+\$593	+\$774	+\$965		
				OVERALL DIMENSIONS			SEAT DIMENSIONS			BACK DIMENSIONS						
			W	D	H	W	D	H	W	H						
			27.5	27.5	17.5	-	-	-	-	-						
		Add \$160 for moisture barrier (MB).														
		Width and depth may vary by up to .05 in.	RTA 00													
													1 per carton			
 <p>Trapezoid Ottoman 26" x 39" COM Yardage: Top: 1; Side: 1.5 Freight Class: 150 Product Weight (lbs.): 67 Cubic Feet Per Carton: 13.75</p>	RA2639TR	Base Price:	\$1062													
		Top upcharge:	+0	+\$32	+\$57	+\$94	+\$146	+\$168	+\$213	+\$284	+\$337	+\$395	+\$516	+\$643		
		Side upcharge:	+0	+\$48	+\$86	+\$141	+\$219	+\$252	+\$320	+\$426	+\$506	+\$593	+\$774	+\$965		
				OVERALL DIMENSIONS			SEAT DIMENSIONS			BACK DIMENSIONS						
			W	D	H	W	D	H	W	H						
			39	26	17.5	-	-	-	-	-						
		Add \$160 for moisture barrier (MB).														
		Width and depth may vary by up to .05 in.	RTA 00													
													1 per carton			
 <p>Trapezoid Ottoman 26" x 52" COM Yardage: Top: 1; Side: 1.5 Freight Class: 250 Product Weight (lbs.): 67.5 Cubic Feet Per Carton: 17.75</p>	RA2652TR	Base Price:	\$1186													
		Top upcharge:	+0	+\$32	+\$57	+\$94	+\$146	+\$168	+\$213	+\$284	+\$337	+\$395	+\$516	+\$643		
		Side upcharge:	+0	+\$48	+\$86	+\$141	+\$219	+\$252	+\$320	+\$426	+\$506	+\$593	+\$774	+\$965		
				OVERALL DIMENSIONS			SEAT DIMENSIONS			BACK DIMENSIONS						
			W	D	H	W	D	H	W	H						
			52	26.5	17.5	-	-	-	-	-						
		Add \$160 for moisture barrier (MB).														
		Width and depth may vary by up to .05 in.	RTA 00													
													1 per carton			

RIVER™



Sample Layout



Sample Layout

STANDARD FEATURES

- A modular seating series that is composed of modular linking units in straight, curved and corner units. Soft seating models are available with standard height, high and extended high backs. All linking units can be used together in any combination to create a wide variety of layouts.
- The unique tapered legs (swaged legs) are made of welded steel, heavy duty construction, with each leg bolted directly to the frame. The extremely robust construction insures trouble free performance in any environment. All units except for the Laptop Tables have the same leg height of 6.5". The leg height makes it easier to clean under the product.
- Each leg is standard with adjustable black nylon leveling glides and are non-marking. Wood legs and casters are not available.
- All cushions are fixed and non-removable (cushions will not migrate). Perimeter seams feature a decorative single stitch detail, which makes seams lay flat and adds extra seam strength.
- Seating frames are heavy duty with interlocking plywood, puzzle box construction, made for rugged active environments. Seats are high density with highly resilient foam and are equipped with a synthetic rubberized webbing suspension system for extra comfort.
- Front edge or face of the seat, angles slightly inward, so feet have freedom of movement and shoe heels don't rub on the seat. This inward slanting matches the inward angles of the back. Benches and connecting end tables also reflect the inward angles on the front and back faces, so all units coordinate in visual appearance.
- For use in high traffic applications as well as 24/7 environments or for models with 600 lb. standard weight capacity, clean out space between seat and back and /or modular arms, please see the River+ series.
- Most units can be ganged together with a quick connect, disconnect feature. Ganging hardware is standard and is factory installed. Ganging hardware swivels out of sight when not in use.

OPTIONAL FEATURES

- Most tables and seating units can be specified with Power/USB terminals, which includes two power outlets, two double USB terminals and a black 60" three-prong power cord. Each Power/USB module is set in predetermined locations, as shown in the electrical illustrations below. Electrical units must be factory installed.
- To add a Power/USB module: From the electrical illustrations below, please specify **J1, W1, J2, W2, J3, W4, J4, W4, J6** or **W6** after the product model number. Please note on seating units, if both right and left locations are required, add both **J1/J3** or **W1/W3** to the model number. Add \$997 for each module/location required.
- Power/USB modules are available with either Jet Black (**J**) face plate with black Power/USB receptacles or with a White (**W**) face plate with white Power/USB receptacles.
- Coffee, end and laptop tables are made with high pressure laminate and are offered in the following finishes: Absolute Acajou (**ACJ**), Asian Night (**ASN**), Avant Cherry (**AWC**), Avant Honey (**AWH**), Blizzard (**BZD**), Clear Maple (**CMB**), Custom Grey (**CGY**), Dark Espresso (**DES**), Designer White (**DWT**), Fashionista (**FAS**), First Class (**FCL**), Noce Biondo (**NBL**), Noce Grigio (**NGL**), Noce Leggero (**NEL**), Noce Medio (**NML**), Quartered Mahogany (**QTM**), Sheer Beauty (**SBY**), Stonedust (**SDT**), Walnut Heights (**WHE**), White Chocolate (**WHC**) and Winter Cherry (**WCR**). Please Specify. Custom High Pressure laminate finishes will be considered upon request.
- **Seating and Table Leg Finish**

(CHM) Chrome	(TBL) Black
(TDW) Designer White	(TFO) Fog
(TFR) Frost	(TIV) Cloud
(TLA) Latte	(TMO) Mocha
(TNE) Nevada	(TOA) Toast
(TSH) Shadow	(TSN) Sand
(TTU) Tungsten	(TKA) Kalua
- Check textile availability prior to specifying upholstery material. Leather not available on River series.
- If more than one fabric or a fabric/vinyl combination is required, please fill out a "Seating Multiple Textile" form, specifying each fabric location. Please contact Customer Care for more information.

ELECTRICAL PLACEMENT

Soft Seating

Locations available on left side J1 (black) or W1 (white), right side J3 (black), or W3 (white) or both sides J1/J3 (black) or W1/W3 (white).

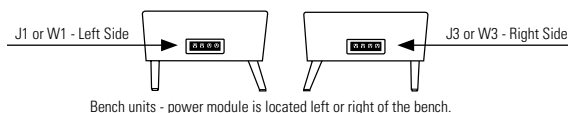
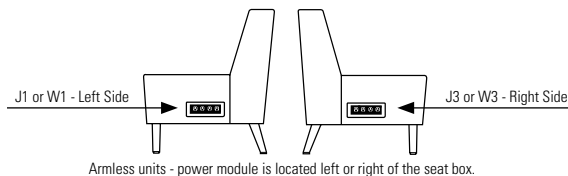
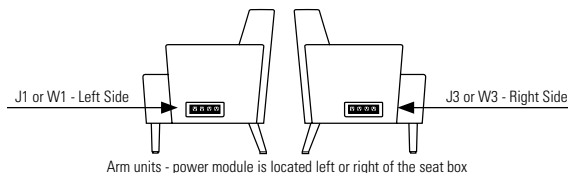

Coffee/End Tables

Primary location is on the top of the unit, centered J2 (black) or W2 (white). Secondary Location is end/side of the unit J1 (black) or W1 (white).

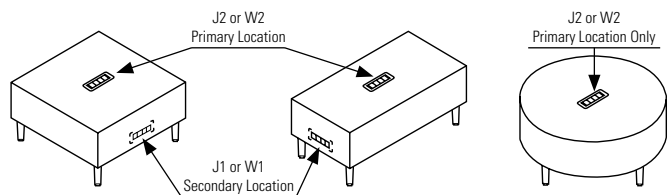

Primary location is on the top rear/edge of the unit J4 (black) or W4 (white). Secondary Location is the back side of the unit J6 (black) or W6 (white).

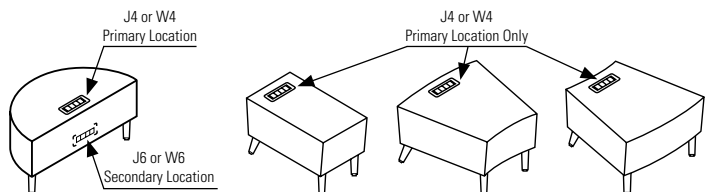

SAMPLE LAYOUTS

RVR101 (Layout 1)

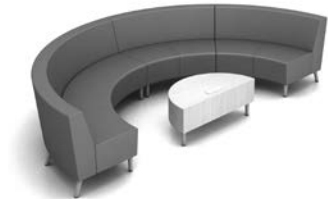

Qty	Model Number	Description	Dimensions	List Price
4	7710NA	Armless IS Curve - Two Seat - Standard Back	55 x 29.5 x 32	3438 x 4
1	7737W6	42" Half Round Laminate Coffee Table w/ W6 Rear Power/USB Module	42 x 21 x 17 upcharge	1461 997

SAMPLE LAYOUT TOTAL (Starting at Grade 1) \$16,210

RVR102 (Layout 2)



Qty	Model Number	Description	Dimensions	List Price
8	7714NA	Armless OS Curve - Two Seater - High Back	54x 29.5 x 41.5	4099 x 8

SAMPLE LAYOUT TOTAL (Starting at Grade 1) \$32,792

RVR103 (Layout 3)

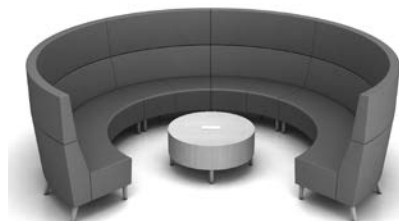

Qty	Model Number	Description	Dimensions	List Price
6	7712NA	Armless IS Curve - Two Seater - Extended Back	55 x 29.5 x 47	4804 x 6
1	7734W2	36" Dia - Round Laminate Coffee Table w/ W2 Center Power/USB Module	36 x 36 x 17 upcharge	1701 997

SAMPLE LAYOUT TOTAL (Starting at Grade 1) \$31,522

RVR104 (Layout 4)



Qty	Model Number	Description	Dimensions	List Price
2	7712NA	Armless IS Curve - Two Seater - Extended Back	55 x 29.5 x 47	4804 x 2
2	7712NAW3	Armless IS Curve - Two Seater - Extended Back w/ W3 Right Power/USB Module	55 x 29.5 x 47 upcharge	4804 x 2 997 x 2
2	7726	IS Curve - Two Seater Bench	54 x 28 x 17.5	2918 x 2
1	7734	36" Dia - Round Laminate Coffee Table	36 x 36 x 17	1701

SAMPLE LAYOUT TOTAL (Starting at Grade 1) \$28,747

RVR105 (Layout 5)



Qty	Model Number	Description	Dimensions	List Price
3	7711NA	Armless IS Curve - Two Seater - High Back	55 x 29.5 x 41.5	4365 x 3
3	7712NAW3	Armless IS Curve - Two Seater - Extended Back w/ W3 Right Power/USB Module	55 x 29.5 x 47 upcharge	4804 x 3 997 x 2
1	7738	Rectangular Laminate End Table	15 x 27.25 x 17	1381
2	7743	18" Dia. Round Laminate Laptop Table	18 x 18 x 25.25	836 x 2

SAMPLE LAYOUT TOTAL (Starting at Grade 1) \$32,554

SAMPLE LAYOUTS

RVR106 (Layout 6)



Qty	Model Number	Description	Dimensions	List Price
1	7709R	Three Seater - Extended Back w/Right Arm	75 x 29.5 x 47	6540
1	7709L	Three Seater - Extended Back w/Left Arm	75 x 29.5 x 47	6540
1	7718	Armless Corner Unit - Extended Back	38 x 38 x 47	5633
1	7732W2	36" Square Laminate Coffee Table w/ W2 Center Power/USB Module	36 x 36 x 17 upcharge	1559 997

SAMPLE LAYOUT TOTAL (Starting at Grade 1) \$21,217

RVR107 (Layout 7)



Qty	Model Number	Description	Dimensions	List Price
1	7704NA	Armless Two Seater - Standard. Back	75x 29.5 x 47	2976
2	7716	Armless Corner Unit - Standard. Back	75 x 29.5 x 47	4199 x 2
1	7725	Two Seater Bench	75x 29.5 x 47	2148
1	7728	Square Single Seater Bench	75 x 29.5 x 17.5	1469
1	7731	30" Square Laminate Coffee Table	75 x 30 x 47	1372

SAMPLE LAYOUT TOTAL (Starting at Grade 1) \$16,363

RVR108 (Layout 8)



Qty	Model Number	Description	Dimensions	List Price
2	7708NAW3	Armless Three Seater - High Back w/ W3 Right Power/USB Module	75 x 29.5 x 41.5 upcharge	5639 x 2 997 x 2
2	7708NAW1	Armless Three Seater - High Back w/ W1 Left Power/USB Module	72.5 x 29.5 x 41.5 upcharge	5639 x 2 997 x 2
2	7745	16" Square Laminate Laptop Table	16 x 16 x 25.25	855 x 2

SAMPLE LAYOUT TOTAL (Starting at Grade 1) \$28,248

RVR109 (Layout 9)



Qty	Model Number	Description	Dimensions	List Price
2	7702	Lounge Chair - High Back w/Arms	29.5 x 29.5 x 41.5	3182 x 2
1	7708NAW1	Armless Three Seater - High Back w/ W1 Left Power/USB Module	72.5 x 29.5 x 41.5 upcharge	5639 945
1	7708NAW3	Armless Three Seater - High Back w/ W3 Right Power/USB Module	72.5 x 29.5 x 41.5 upcharge	5639 945
1	7733	Rectangular Laminate Coffee Table	40 x 20 x 17	1378

SAMPLE LAYOUT TOTAL (Starting at Grade 1) \$21,014

RVR110 (Layout 10)



Qty	Model Number	Description	Dimensions	List Price
1	7705NAW3	Armless Two Seater - High Back w/ W3 Right Power/USB Module	48.5 x 29.5 x 41.5 upcharge	3647 997
1	7705NAW1	Armless Two Seater - High Back w/ W1 Left Power/USB Module	48.5 x 29.5 x 41.5 upcharge	3647 997
1	7708NA	Armless Three Seater - High Back	72.5 x 29.5 x 41.5	5639
1	7708NAW3	Armless Three Seater - High Back w/ W3 Right Power/USB Module	72.5 x 29.5 x 41.5 upcharge	5639 997
1	7708NAW1	Armless Three Seater - High Back w/ W1 Left Power/USB Module	72.5 x 29.5 x 41.5 upcharge	5639 997
2	7717	Armless Corner Unit - High Back	38 x 38 x 41.5	5319 x 2
3	7745	16" Square Laminate Laptop Table	16 x 16 x 25.25	855 x 3

SAMPLE LAYOUT TOTAL (Starting at Grade 1) \$41,402

DESCRIPTION	FEATURES	MODEL#	STANDARD TEXTILE GRADES		
RVR111 (Layout 11) 	Qty	Model Number	Description	Dimensions	List Price
	2	7701NA	Armless One Seater - Standard Back	24.5 x 29.5x 32	1907 x 2
	4	7710NA	Armless IS Curve - Two Seat - Standard Back	55 x 29.5 x 32	3438 x 4
	2	7743	18" Dia. Round Laminate Laptop Table	18 x 18 x 25.25	836 x 2
SAMPLE LAYOUT TOTAL (Starting at Grade 1)					\$19,238

RVR112 (Layout 12) 	Qty	Model Number	Description	Dimensions	List Price
	2	7711NA	Armless IS Curve - Two Seater - High Back	55 x 29.5 x 41.5	4365 x 2
	6	7712NA	Armless IS Curve - Two Seater - Extended Back	55 x 29.5 x 47	4804 x 6
	1	7709NA	Armless Three Seater - Extended Back	72.5 x 29.5 x 47	6105
	2	7734	36" Dia - Round Laminate Coffee Table	36 x 36 x 17	1701 x 2
SAMPLE LAYOUT TOTAL (Starting at Grade 1)					\$47,061

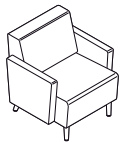

Lounge Chair - Standard Back w/Arms
 COM Yardage: 4
 Freight Class: 250
 Product Weight (lbs.): 57
 Cubic Feet Per Carton: 22.5

For Power/USB module please see electrical placement chart. No ganging hardware.

	1	2	3	4	5	6	7	8	9	10	11	12
7701	2776	2944	3077	3274	3554	3654	3899	4366	4591	5024	5614	6350

OVERALL DIMENSIONS			SEAT DIMENSIONS			BACK DIMENSIONS	
W	D	H	W	D	H	W	H
29.5	29.5	32	24	19	18	24	14

RTA 00

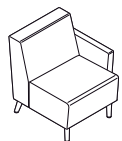

7701L (Left Arm)

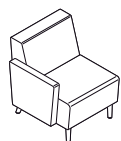

7701R (Right Arm)

Lounge Chair - Standard w/One Arm
 COM Yardage: 3.25
 Freight Class: 250
 Product Weight (lbs.): 47
 Cubic Feet Per Carton: 22.5

For Power/USB module please see electrical placement chart. Includes ganging hardware (1 side).

	1	2	3	4	5	6	7	8	9	10	11	12
7701L	2348	2488	2595	2757	2981	3066	3263	3644	3825	4179	4658	5256
7701R	2348	2488	2595	2757	2981	3066	3263	3644	3825	4179	4658	5256

OVERALL DIMENSIONS			SEAT DIMENSIONS			BACK DIMENSIONS	
W	D	H	W	D	H	W	H
27	29.5	32	24	19	18	24	14

RTA 00

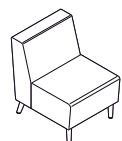





Armless Lounge Chair - Standard Back
 COM Yardage: 2.5
 Freight Class: 300
 Product Weight (lbs.): 37
 Cubic Feet Per Carton: 22.5

For Power/USB module please see electrical placement chart. Includes ganging hardware (2 sides).

	1	2	3	4	5	6	7	8	9	10	11	12
7701NA	1907	2016	2097	2221	2397	2460	2614	2903	3046	3316	3685	4145

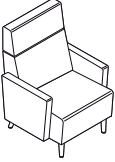
OVERALL DIMENSIONS			SEAT DIMENSIONS			BACK DIMENSIONS	
W	D	H	W	D	H	W	H
24.5	29.5	32	24	19	18	24	14

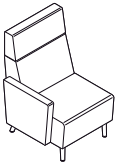
RTA 00

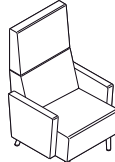
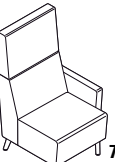
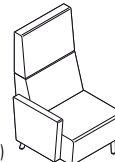
DESCRIPTION	FEATURES	MODEL#	STANDARD TEXTILE GRADES													
			1	2	3	4	5	6	7	8	9	10	11	12		
 <p>Lounge Chair - High Back w/Arms COM Yardage: 4.5 Freight Class: 250 Product Weight (lbs.): 61 Cubic Feet Per Carton: 28.25</p>	<p>For Power/USB module please see electrical placement chart. No ganging hardware.</p>	7702	3182	3372	3521	3744	4058	4173	4445	4972	5226	5714	6377	7203		
		OVERALL DIMENSIONS			SEAT DIMENSIONS			BACK DIMENSIONS								
		W	D	H	W	D	H	W	H							
		29.5	29.5	41.5	24	19	18	24	24							
		RTA 00														
 <p>7702L (Left Arm)</p>	 <p>7702R (Right Arm)</p>	7702L	2753	2914	3035	3223	3485	3577	3807	4245	4457	4863	5416	6106		
		OVERALL DIMENSIONS			SEAT DIMENSIONS			BACK DIMENSIONS								
		W	D	H	W	D	H	W	H							
		29.5	29.5	41.5	24	19	18	24	24							
		RTA 00														
 <p>Armless Lounge Chair - High Back COM Yardage: 3 Freight Class: 300 Product Weight (lbs.): 41 Cubic Feet Per Carton: 28.25</p>	<p>For Power/USB module please see electrical placement chart. Includes ganging hardware (2 sides).</p>	7702NA	2314	2444	2541	2689	2898	2974	3160	3510	3678	4004	4446	4998		
		OVERALL DIMENSIONS			SEAT DIMENSIONS			BACK DIMENSIONS								
		W	D	H	W	D	H	W	H							
		24.5	29.5	41.5	24	19	18	24	24							
		RTA 00														
 <p>Lounge Chair - Extended Back w/Arms COM Yardage: 4.75 Freight Class: 250 Product Weight (lbs.): 68 Cubic Feet Per Carton: 32.75</p>	<p>For Power/USB module please see electrical placement chart. No ganging hardware.</p>	7703	3687	3885	4043	4278	4611	4731	5021	5576	5844	6359	7057	7931		
		OVERALL DIMENSIONS			SEAT DIMENSIONS			BACK DIMENSIONS								
		W	D	H	W	D	H	W	H							
		29.5	29.5	47	24	19	18	24	29							
		RTA 00														
 <p>7703L (Left Arm)</p>	 <p>7703R (Right Arm)</p>	7703L	3258	3426	3559	3756	4034	4135	4378	4847	5073	5506	6095	6832		
		OVERALL DIMENSIONS			SEAT DIMENSIONS			BACK DIMENSIONS								
		W	D	H	W	D	H	W	H							
		29.5	29.5	47	24	19	18	24	29							
		RTA 00														

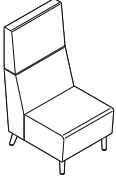
DESCRIPTION	FEATURES	MODEL#	STANDARD TEXTILE GRADES												
			1	2	3	4	5	6	7	8	9	10	11	12	
 <p>Armless Lounge Chair - Extended Back COM Yardage: 3.25 Freight Class: 300 Product Weight (lbs.): 48 Cubic Feet Per Carton: 32.75</p>	<p>For Power/USB module please see electrical placement chart. Includes ganging hardware (2 sides).</p>	7703NA	2819	2957	3065	3227	3452	3535	3734	4114	4295	4649	5127	5724	
		OVERALL DIMENSIONS			SEAT DIMENSIONS			BACK DIMENSIONS							
		W	D	H	W	D	H	W	H						
			24.5	29.5	47	24	19	18	24	29					
			RTA 00												

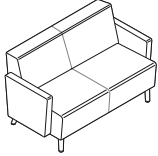
DESCRIPTION	FEATURES	MODEL#	STANDARD TEXTILE GRADES												
			1	2	3	4	5	6	7	8	9	10	11	12	
 <p>Two Seater - Standard Back w/Arms COM Yardage: 5.5 Freight Class: 250 Product Weight (lbs.): 95 Cubic Feet Per Carton: 39</p>	<p>For Power/USB module please see electrical placement chart. No ganging hardware.</p>	7704	3836	4066	4247	4517	4903	5041	5379	6024	6328	6926	7736	8746	
		OVERALL DIMENSIONS			SEAT DIMENSIONS			BACK DIMENSIONS							
		W	D	H	W	D	H	W	H						
			53.5	29.5	32	48	19	18	48	14					
			RTA 00												

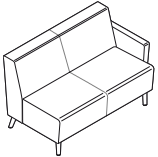
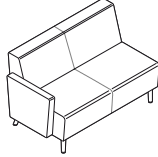
DESCRIPTION	FEATURES	MODEL#	STANDARD TEXTILE GRADES											
			1	2	3	4	5	6	7	8	9	10	11	12
 <p>7704L (Left Arm)</p>  <p>7704R (Right Arm)</p> <p>Two Seater - Standard Back w/One Arm COM Yardage: 4.75 Freight Class: 300 Product Weight (lbs.): 85 Cubic Feet Per Carton: 39</p>	<p>For Power/USB module please see electrical placement chart. Includes ganging hardware (1 side).</p>	7704L	3413	3613	3771	4005	4339	4458	4749	5303	5571	6086	6786	7660
		7704R	3413	3613	3771	4005	4339	4458	4749	5303	5571	6086	6786	7660
		OVERALL DIMENSIONS			SEAT DIMENSIONS			BACK DIMENSIONS						
			W	D	H	W	D	H	W	H				
			51	29.5	32	48	19	18	48	14				
			RTA 00											

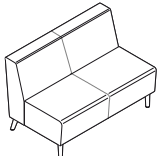
DESCRIPTION	FEATURES	MODEL#	STANDARD TEXTILE GRADES												
			1	2	3	4	5	6	7	8	9	10	11	12	
 <p>Armless Two Seater - Standard Back COM Yardage: 4.25 Freight Class: 300 Product Weight (lbs.): 75 Cubic Feet Per Carton: 39</p>	<p>For Power/USB module please see electrical placement chart. Includes ganging hardware (2 sides).</p>	7704NA	2976	3157	3298	3508	3805	3910	4171	4667	4907	5367	5995	6776	
		OVERALL DIMENSIONS			SEAT DIMENSIONS			BACK DIMENSIONS							
		W	D	H	W	D	H	W	H						
			48.5	29.5	32	48	19	18	48	14					
			RTA 00												

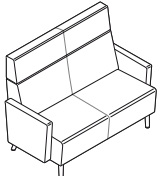
DESCRIPTION	FEATURES	MODEL#	STANDARD TEXTILE GRADES												
			1	2	3	4	5	6	7	8	9	10	11	12	
 <p>Two Seater - High Back w/Arms COM Yardage: 6.5 Freight Class: 300 Product Weight (lbs.): 97 Cubic Feet Per Carton: 54</p>	<p>For Power/USB module please see electrical placement chart. No ganging hardware.</p>	7705	4515	4789	5002	5325	5776	5940	6341	7099	7463	8169	9127	10320	
		OVERALL DIMENSIONS			SEAT DIMENSIONS			BACK DIMENSIONS							
		W	D	H	W	D	H	W	H						
			53.5	29.5	41.5	48	19	18	48	24					
			RTA 00												

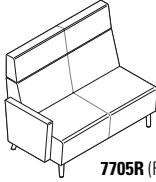
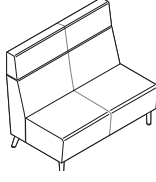
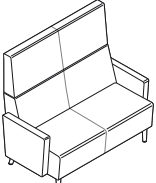
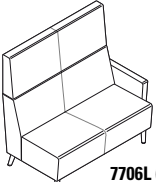
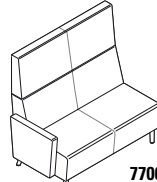
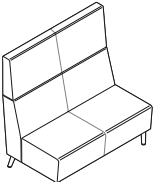
DESCRIPTION	FEATURES	MODEL#	STANDARD TEXTILE GRADES												
			1	2	3	4	5	6	7	8	9	10	11	12	
 7705L (Left Arm)	 7705R (Right Arm)		1	2	3	4	5	6	7	8	9	10	11	12	
		7705L	4084	4324	4514	4797	5201	5344	5698	6369	6692	7315	8163	9221	
Two Seater - High Back w/One Arm COM Yardage: 5.75 Freight Class: 300 Product Weight (lbs.): 87 Cubic Feet Per Carton: 54		For Power/USB module please see electrical placement chart. Includes ganging hardware (1 side).		OVERALL DIMENSIONS W D H			SEAT DIMENSIONS W D H			BACK DIMENSIONS W H					
		51	29.5	41.5	48	19	18	48	24	RTA 00					
			1	2	3	4	5	6	7	8	9	10	11	12	
	7705NA	3647	3867	4041	4302	4667	4801	5121	5734	6031	6598	7372	8338		
Armless Two Seater - High Back COM Yardage: 5.25 Freight Class: 300 Product Weight (lbs.): 77 Cubic Feet Per Carton: 54		For Power/USB module please see electrical placement chart. Includes ganging hardware (2 sides).		OVERALL DIMENSIONS W D H			SEAT DIMENSIONS W D H			BACK DIMENSIONS W H					
		48.5	29.5	41.5	48	19	18	48	24	RTA 00					
			1	2	3	4	5	6	7	8	9	10	11	12	
	7706	4765	5059	5289	5636	6125	6303	6728	7546	7940	8701	9730	11015		
Two Seater - Extended Back w/Arms COM Yardage: 7 Freight Class: 300 Product Weight (lbs.): 107 Cubic Feet Per Carton: 56.75		For Power/USB module please see electrical placement chart. No ganging hardware.		OVERALL DIMENSIONS W D H			SEAT DIMENSIONS W D H			BACK DIMENSIONS W H					
		53.5	29.5	47	48	19	18	48	29	RTA 00					
 7706L (Left Arm)	 7706R (Right Arm)		1	2	3	4	5	6	7	8	9	10	11	12	
		7706L	4334	4596	4802	5110	5548	5702	6086	6818	7167	7848	8769	9915	
Two Seater - Extended Back w/One Arm COM Yardage: 6.25 Freight Class: 300 Product Weight (lbs.): 97 Cubic Feet Per Carton: 56.75		For Power/USB module please see electrical placement chart. Includes ganging hardware (1 side).		OVERALL DIMENSIONS W D H			SEAT DIMENSIONS W D H			BACK DIMENSIONS W H					
		51	29.5	47	48	19	18	48	29	RTA 00					
			1	2	3	4	5	6	7	8	9	10	11	12	
	7706NA	3893	4134	4324	4608	5011	5154	5508	6179	6503	7125	7973	9031		
Armless Two Seater - Extended Back COM Yardage: 5.75 Freight Class: 300 Product Weight (lbs.): 87 Cubic Feet Per Carton: 56.75		For Power/USB module please see electrical placement chart. Includes ganging hardware (2 sides).		OVERALL DIMENSIONS W D H			SEAT DIMENSIONS W D H			BACK DIMENSIONS W H					
		48.5	29.5	47	48	19	18	48	29	RTA 00					

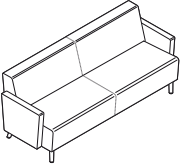
DESCRIPTION	FEATURES	MODEL#	STANDARD TEXTILE GRADES													
			1	2	3	4	5	6	7	8	9	10	11	12		
 <p>Three Seater - Standard Back w/Arms COM Yardage: 8.25 Freight Class: 250 Product Weight (lbs.): 139 Cubic Feet Per Carton: 55.5</p>	<p>For Power/USB module please see electrical placement chart. No ganging hardware.</p>	7707	5704	6045	6321	6727	7304	7510	8015	8980	9444	10340	11556	13071		
		OVERALL DIMENSIONS			SEAT DIMENSIONS			BACK DIMENSIONS								
		W	D	H	W	D	H	W	H							
			77.5	29.5	32	72	19	18	72	14						
RTA 00																

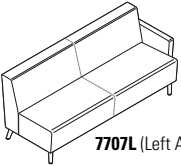
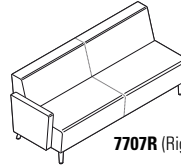
DESCRIPTION	FEATURES	MODEL#	STANDARD TEXTILE GRADES														
			1	2	3	4	5	6	7	8	9	10	11	12			
 <p>7707L (Left Arm)</p>  <p>7707R (Right Arm)</p> <p>Three Seater - Standard Back w/One Arm COM Yardage: 7.75 Freight Class: 250 Product Weight (lbs.): 129 Cubic Feet Per Carton: 55.5</p>	<p>For Power/USB module please see electrical placement chart. Includes ganging hardware (1 side).</p>	7707L	5277	5599	5855	6238	6779	6976	7449	8353	8790	9630	10772	12196			
					7707R	5277	5599	5855	6238	6779	6976	7449	8353	8790	9630	10772	12196
		OVERALL DIMENSIONS			SEAT DIMENSIONS			BACK DIMENSIONS									
			W	D	H	W	D	H	W	H							
			75	29.5	32	72	19	18	72	14							
RTA 00																	

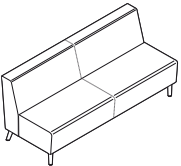
DESCRIPTION	FEATURES	MODEL#	STANDARD TEXTILE GRADES													
			1	2	3	4	5	6	7	8	9	10	11	12		
 <p>Armless Three Seater - Standard Back COM Yardage: 7 Freight Class: 250 Product Weight (lbs.): 119 Cubic Feet Per Carton: 55.5</p>	<p>For Power/USB module please see electrical placement chart. Includes ganging hardware (2 sides).</p>	7707NA	4837	5132	5361	5709	6198	6374	6801	7620	8013	8773	9803	11092		
		OVERALL DIMENSIONS			SEAT DIMENSIONS			BACK DIMENSIONS								
					W	D	H	W	D	H	W	H				
			72.5	29.5	32	72	19	18	72	14						
RTA 00																

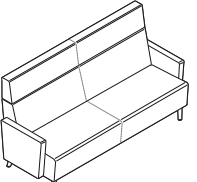
DESCRIPTION	FEATURES	MODEL#	STANDARD TEXTILE GRADES													
			1	2	3	4	5	6	7	8	9	10	11	12		
 <p>Three Seater - High Back w/Arms COM Yardage: 10.5 Freight Class: 250 Product Weight (lbs.): 148 Cubic Feet Per Carton: 69.75</p>	<p>For Power/USB module please see electrical placement chart. No ganging hardware.</p>	7708	6501	6937	7282	7802	8534	8800	9441	10669	11261	12397	13947	15875		
		OVERALL DIMENSIONS			SEAT DIMENSIONS			BACK DIMENSIONS								
					W	D	H	W	D	H	W	H				
			77.5	29.5	41.5	72	19	18	72	24						
RTA 00																

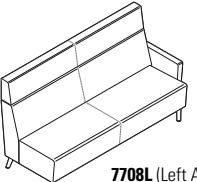
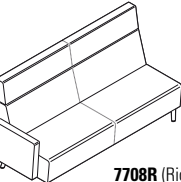
DESCRIPTION	FEATURES	MODEL#	STANDARD TEXTILE GRADES														
			1	2	3	4	5	6	7	8	9	10	11	12			
 <p>7708L (Left Arm)</p>  <p>7708R (Right Arm)</p> <p>Three Seater - High Back w/One Arm COM Yardage: 9.75 Freight Class: 300 Product Weight (lbs.): 139 Cubic Feet Per Carton: 69.75</p>	<p>For Power/USB module please see electrical placement chart. Includes ganging hardware (1 side).</p>	7708L	6078	6485	6806	7285	7967	8214	8809	9948	10497	11554	12992	14784			
					7708R	6078	6485	6806	7285	7967	8214	8809	9948	10497	11554	12992	14784
		OVERALL DIMENSIONS			SEAT DIMENSIONS			BACK DIMENSIONS									
			W	D	H	W	D	H	W	H							
			75	29.5	41.5	72	19	18	72	24							
RTA 00																	

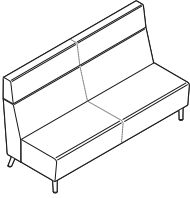
DESCRIPTION	FEATURES	MODEL#	STANDARD TEXTILE GRADES													
			1	2	3	4	5	6	7	8	9	10	11	12		
 <p>Armless Three Seater - High Back COM Yardage: 9.25 Freight Class: 300 Product Weight (lbs.): 126 Cubic Feet Per Carton: 69.75</p>	For Power/USB module please see electrical placement chart. Includes ganging hardware (2 sides).	7708NA	5639	6027	6329	6787	7434	7668	8231	9314	9835	10836	12199	13900		
		OVERALL DIMENSIONS			SEAT DIMENSIONS			BACK DIMENSIONS								
		W	D	H	W	D	H	W	H							
			72.5	29.5	41.5	72	19	18	72	24						
			RTA 00													

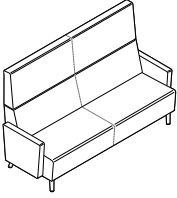
DESCRIPTION	FEATURES	MODEL#	STANDARD TEXTILE GRADES													
			1	2	3	4	5	6	7	8	9	10	11	12		
 <p>Three Seater - Extended Back w/Arms COM Yardage: 11 Freight Class: 300 Product Weight (lbs.): 144 Cubic Feet Per Carton: 78.75</p>	For Power/USB module please see electrical placement chart. No ganging hardware.	7709	6974	7432	7793	8338	9108	9383	10057	11341	11959	13154	14775	16795		
		OVERALL DIMENSIONS			SEAT DIMENSIONS			BACK DIMENSIONS								
		W	D	H	W	D	H	W	H							
			77.5	29.5	47	72	19	18	72	29						
			RTA 00													

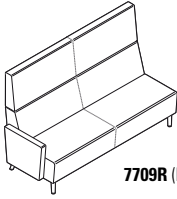
DESCRIPTION	FEATURES	MODEL#	STANDARD TEXTILE GRADES											
			1	2	3	4	5	6	7	8	9	10	11	12
 <p>7709L (Left Arm)</p>  <p>7709R (Right Arm)</p> <p>Three Seater - Extended Back w/One Arm COM Yardage: 10.5 Freight Class: 300 Product Weight (lbs.): 134 Cubic Feet Per Carton: 78.75</p>	For Power/USB module please see electrical placement chart. Includes ganging hardware (1 side).	7709L	6540	6977	7321	7841	8576	8839	9483	10708	11296	12436	13984	15912
		7709R	6540	6977	7321	7841	8576	8839	9483	10708	11296	12436	13984	15912
		OVERALL DIMENSIONS			SEAT DIMENSIONS			BACK DIMENSIONS						
W	D	H	W	D	H	W	H							
			75	29.5	47	72	19	18	72	29				
			RTA 00											

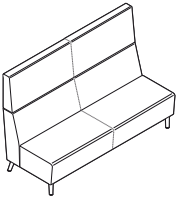
DESCRIPTION	FEATURES	MODEL#	STANDARD TEXTILE GRADES													
			1	2	3	4	5	6	7	8	9	10	11	12		
 <p>Armless Three Seater - Extended Back COM Yardage: 9.75 Freight Class: 300 Product Weight (lbs.): 124 Cubic Feet Per Carton: 78.75</p>	For Power/USB module please see electrical placement chart. Includes ganging hardware (2 sides).	7709NA	6105	6512	6833	7312	7994	8241	8835	9975	10524	11581	13020	14811		
		OVERALL DIMENSIONS			SEAT DIMENSIONS			BACK DIMENSIONS								
		W	D	H	W	D	H	W	H							
			72.5	29.5	47	72	19	18	72	29						
			RTA 00													

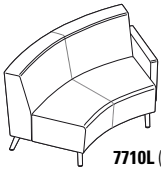
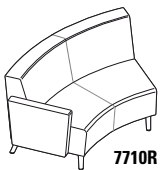
DESCRIPTION	FEATURES	MODEL#	STANDARD TEXTILE GRADES											
			1	2	3	4	5	6	7	8	9	10	11	12
 <p>7710L (Left Arm)</p>  <p>7710R (Right Arm)</p> <p>IS Curve - Two Seater - Standard Back w/One Arm COM Yardage: 5.25 Freight Class: 250 Product Weight (lbs.): 88 Cubic Feet Per Carton: 43</p>	For Power/USB module please see electrical placement chart. Includes ganging hardware (1 side).	7710L	3879	4103	4273	4534	4901	5033	5354	5966	6264	6830	7604	8570
		7710R	3879	4103	4273	4534	4901	5033	5354	5966	6264	6830	7604	8570
		OVERALL DIMENSIONS			SEAT DIMENSIONS			BACK DIMENSIONS						
W	D	H	W	D	H	W	H							
			57	29.5	32	42	19	18	51	14				
			RTA 00											

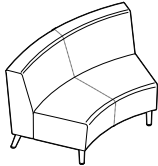
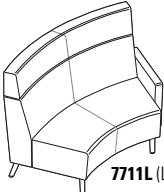
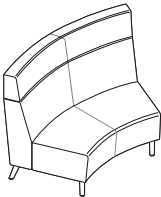
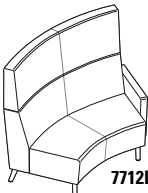
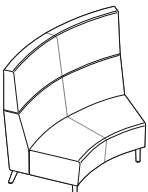
DESCRIPTION	FEATURES	MODEL#	STANDARD TEXTILE GRADES												
			1	2	3	4	5	6	7	8	9	10	11	12	
 <p>Armless IS Curve - Two Seat - Standard Back COM Yardage: 4.5 Freight Class: 300 Product Weight (lbs.): 78 Cubic Feet Per Carton: 43</p>	For Power/USB module please see electrical placement chart. Includes ganging hardware (2 sides).	7710NA	3438	3627	3774	3999	4314	4427	4701	5228	5481	5968	6633	7458	
		OVERALL DIMENSIONS			SEAT DIMENSIONS			BACK DIMENSIONS							
		W	D	H	W	D	H	W	H						
			55	29.5	32		42	19	18		51	14			
			RTA 00												
 <p>IS Curve - Two Seater - High Back w/One Arm COM Yardage: 6.5 Freight Class: 300 Product Weight (lbs.): 94 Cubic Feet Per Carton: 54</p>	For Power/USB module please see electrical placement chart. Includes ganging hardware (1 side).	7711L (Left Arm)	4804	5077	5291	5612	6065	6228	6625	7386	7751	8457	9413	10609	
		7711R (Right Arm)	4804	5077	5291	5612	6065	6228	6625	7386	7751	8457	9413	10609	
		OVERALL DIMENSIONS			SEAT DIMENSIONS			BACK DIMENSIONS							
W	D	H	W	D	H	W	H								
			57	29.5	41.5		42	19	18		51	24			
			RTA 00												
 <p>Armless IS Curve - Two Seater - High Back COM Yardage: 6 Freight Class: 300 Product Weight (lbs.): 84 Cubic Feet Per Carton: 54</p>	For Power/USB module please see electrical placement chart. Includes ganging hardware (2 sides).	7711NA	4365	4618	4817	5112	5530	5683	6050	6753	7088	7738	8622	9726	
		OVERALL DIMENSIONS			SEAT DIMENSIONS			BACK DIMENSIONS							
		W	D	H	W	D	H	W	H						
			55	29.5	41.5		42	19	18		51	24			
			RTA 00												
 <p>IS Curve - Two Seater - Extended Back w/One Arm COM Yardage: 7 Freight Class: 300 Product Weight (lbs.): 99 Cubic Feet Per Carton: 62.75</p>	For Power/USB module please see electrical placement chart. Includes ganging hardware (1 side).	7712L (Left Arm)	5241	5534	5764	6110	6600	6775	7203	8022	8415	9176	10206	11491	
		7712R (Right Arm)	5241	5534	5764	6110	6600	6775	7203	8022	8415	9176	10206	11491	
		OVERALL DIMENSIONS			SEAT DIMENSIONS			BACK DIMENSIONS							
W	D	H	W	D	H	W	H								
			57	29.5	47		42	19	18		51	29			
			RTA 00												
 <p>Armless IS Curve - Two Seater - Extended Back COM Yardage: 6.75 Freight Class: 29.5 Product Weight (lbs.): 89 Cubic Feet Per Carton: 6.75</p>	For Power/USB module please see electrical placement chart. Includes ganging hardware (2 sides).	7712NA	4804	5085	5308	5641	6113	6283	6696	7486	7866	8599	9592	10832	
		OVERALL DIMENSIONS			SEAT DIMENSIONS			BACK DIMENSIONS							
		W	D	H	W	D	H	W	H						
			55	29.5	47		42	19	18		51	29			
			RTA 00												

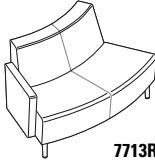
DESCRIPTION	FEATURES	MODEL#	STANDARD TEXTILE GRADES											
			1	2	3	4	5	6	7	8	9	10	11	12
 <p>7713L (Left Arm)</p>	 <p>7713R (Right Arm)</p>													
		7713L	3879	4103	4273	4534	4901	5033	5354	5966	6264	6830	7604	8570
		7713R	3879	4103	4273	4534	4901	5033	5354	5966	6264	6830	7604	8570
			OVERALL DIMENSIONS			SEAT DIMENSIONS			BACK DIMENSIONS					
			W	D	H	W	D	H	W	H				
			54.5	29.5	32	48	19	18	36	14				
			RTA 00											

OS Curve - Two Seater - Standard Back w/One Arm
 COM Yardage: 5.25
 Freight Class: 300
 Product Weight (lbs.): 82
 Cubic Feet Per Carton: 43

For Power/USB module please see electrical placement chart. Includes ganging hardware (1 side).

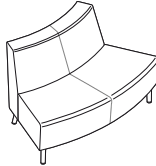
DESCRIPTION	FEATURES	MODEL#	STANDARD TEXTILE GRADES											
			1	2	3	4	5	6	7	8	9	10	11	12
 <p>7713NA</p>														
		7713NA	3438	3627	3774	4000	4314	4427	4701	5228	5481	5968	6633	7458
			OVERALL DIMENSIONS			SEAT DIMENSIONS			BACK DIMENSIONS					
			W	D	H	W	D	H	W	H				
			54	29.5	32	48	19	18	36	14				
			RTA 00											

Armless OS Curve - Two Seater - Standard Back
 COM Yardage: 4.5
 Freight Class: 300
 Product Weight (lbs.): 72
 Cubic Feet Per Carton: 43

For Power/USB module please see electrical placement chart. Includes ganging hardware (2 sides).

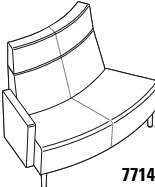
DESCRIPTION	FEATURES	MODEL#	STANDARD TEXTILE GRADES											
			1	2	3	4	5	6	7	8	9	10	11	12
 <p>7714L (Left Arm)</p>	 <p>7714R (Right Arm)</p>													
		7714L	4529	4804	5017	5339	5792	5956	6355	7113	7477	8185	9142	10335
		7714R	4529	4804	5017	5339	5792	5956	6355	7113	7477	8185	9142	10335
			OVERALL DIMENSIONS			SEAT DIMENSIONS			BACK DIMENSIONS					
			W	D	H	W	D	H	W	H				
			54.5	29.5	41.5	48	19	18	36	24				
			RTA 00											

OS Curve - Two Seater - High Back w/One Arm
 COM Yardage: 6.5
 Freight Class: 300
 Product Weight (lbs.): 88
 Cubic Feet Per Carton: 54

For Power/USB module please see electrical placement chart. Includes ganging hardware (1 side).

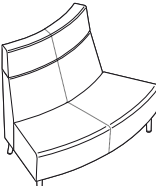
DESCRIPTION	FEATURES	MODEL#	STANDARD TEXTILE GRADES											
			1	2	3	4	5	6	7	8	9	10	11	12
 <p>7714NA</p>														
		7714NA	4099	4351	4549	4844	5263	5416	5783	6484	6822	7472	8356	9459
			OVERALL DIMENSIONS			SEAT DIMENSIONS			BACK DIMENSIONS					
			W	D	H	W	D	H	W	H				
			54	29.5	41.5	48	19	18	36	24				
			RTA 00											

Armless OS Curve - Two Seater - High Back
 COM Yardage: 6
 Freight Class: 300
 Product Weight (lbs.): 78
 Cubic Feet Per Carton: 54

For Power/USB module please see electrical placement chart. Includes ganging hardware (2 sides).

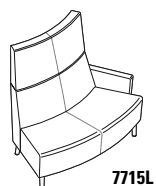
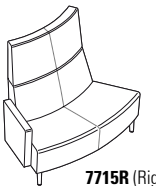
DESCRIPTION	FEATURES	MODEL#	STANDARD TEXTILE GRADES											
			1	2	3	4	5	6	7	8	9	10	11	12
 <p>7715L (Left Arm)</p>	 <p>7715R (Right Arm)</p>													
		7715L	4944	5238	5468	5816	6304	6481	6908	7727	8119	8880	9910	11199
		7715R	4944	5238	5468	5816	6304	6481	6908	7727	8119	8880	9910	11199
			OVERALL DIMENSIONS			SEAT DIMENSIONS			BACK DIMENSIONS					
			W	D	H	W	D	H	W	H				
			54.5	29.5	47	48	19	18	36	29				
			RTA 00											

OS Curve - Two Seater - Extended Back w/One Arm
 COM Yardage: 7
 Freight Class: 300
 Product Weight (lbs.): 93
 Cubic Feet Per Carton: 62.75

For Power/USB module please see electrical placement chart. Includes ganging hardware (1 side).

DESCRIPTION FEATURES MODEL# STANDARD TEXTILE GRADES

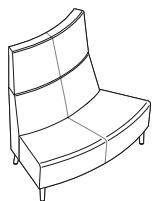

Armless OS Curve - Two Seater - Ext. High Back
 COM Yardage: 6.75
 Freight Class: 300
 Product Weight (lbs.): 83
 Cubic Feet Per Carton: 62.75

For Power/USB module please see electrical placement chart. Includes ganging hardware (2 sides).

MODEL#	1	2	3	4	5	6	7	8	9	10	11	12
7715NA	4506	4787	5012	5343	5815	5985	6398	7189	7568	8301	9294	10536

OVERALL DIMENSIONS			SEAT DIMENSIONS			BACK DIMENSIONS	
W	D	H	W	D	H	W	H
54	29.5	47	48	19	18	36	28

RTA 00

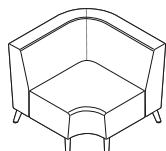

Armless Corner Unit - Standard Back
 COM Yardage: 5.5
 Freight Class: 300
 Product Weight (lbs.): 75
 Cubic Feet Per Carton: 49

For Power/USB module please see electrical placement chart. Includes ganging hardware (2 sides).

MODEL#	1	2	3	4	5	6	7	8	9	10	11	12
7716	4199	4431	4614	4882	5270	5406	5743	6388	6695	7293	8104	9113

OVERALL DIMENSIONS			SEAT DIMENSIONS			BACK DIMENSIONS	
W	D	H	W	D	H	W	H
38	38	32	24	19	18	24	14

RTA 00

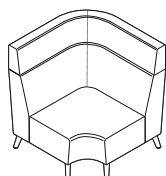

Armless Corner Unit - High Back
 COM Yardage: 7.75
 Freight Class: 300
 Product Weight (lbs.): 82
 Cubic Feet Per Carton: 49

For Power/USB module please see electrical placement chart. Includes ganging hardware (2 sides).

MODEL#	1	2	3	4	5	6	7	8	9	10	11	12
7717	5319	5641	5897	6281	6824	7018	7491	8398	8833	9673	10815	12238

OVERALL DIMENSIONS			SEAT DIMENSIONS			BACK DIMENSIONS	
W	D	H	W	D	H	W	H
38	38	41.5	24	19	18	24	24

RTA 00

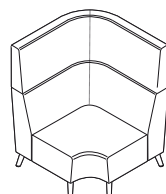

Armless Corner Unit - Extended Back
 COM Yardage: 8.5
 Freight Class: 300
 Product Weight (lbs.): 88
 Cubic Feet Per Carton: 49

For Power/USB module please see electrical placement chart. Includes ganging hardware (2 sides).

MODEL#	1	2	3	4	5	6	7	8	9	10	11	12
7718	5633	5987	6266	6686	7280	7495	8015	9007	9486	10408	11661	13222

OVERALL DIMENSIONS			SEAT DIMENSIONS			BACK DIMENSIONS	
W	D	H	W	D	H	W	H
38	38	47	24	19	18	24	29

RTA 00

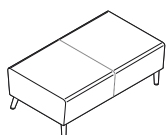

Two Seater Bench
 COM Yardage: 2.25
 Freight Class: 300
 Product Weight (lbs.): 41
 Cubic Feet Per Carton: 21.25

For Power/USB module please see electrical placement chart. Includes ganging hardware (2 sides).

MODEL#	1	2	3	4	5	6	7	8	9	10	11	12
7725	2148	2247	2322	2430	2588	2646	2784	3047	3172	3418	3749	4161

OVERALL DIMENSIONS			SEAT DIMENSIONS			BACK DIMENSIONS	
W	D	H	W	D	H	W	H
48.5	28	17.5					

RTA 00

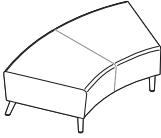
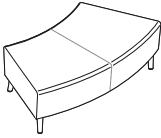
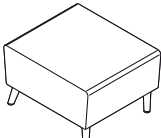
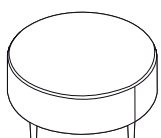
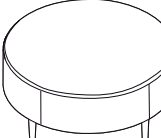
DESCRIPTION	FEATURES	MODEL#	STANDARD TEXTILE GRADES														
			1	2	3	4	5	6	7	8	9	10	11	12			
 <p>IS Curve - Two Seater Bench COM Yardage: 3 Freight Class: 300 Product Weight (lbs.): 41 Cubic Feet Per Carton: 21.25</p>	<p>For Power/USB module please see electrical placement chart. Includes ganging hardware (2 sides).</p>	7726	2918	3048	3146	3293	3502	3579	3764	4114	4282	4608	5050	5602			
		OVERALL DIMENSIONS			SEAT DIMENSIONS			BACK DIMENSIONS									
		W	D	H	W	D	H	W	H								
			54	28	17.5												
			RTA 00														
 <p>OS Curve - Two Seater Bench COM Yardage: 3 Freight Class: 300 Product Weight (lbs.): 41 Cubic Feet Per Carton: 21.25</p>	<p>For Power/USB module please see electrical placement chart. Includes ganging hardware (2 sides).</p>	7727	2918	3048	3146	3293	3502	3579	3764	4114	4282	4608	5050	5602			
		OVERALL DIMENSIONS			SEAT DIMENSIONS			BACK DIMENSIONS									
		W	D	H	W	D	H	W	H								
			54	28	17.5												
			RTA 00														
 <p>Square Single Seater Bench COM Yardage: 1.75 Freight Class: 250 Product Weight (lbs.): 30 Cubic Feet Per Carton: 9.25</p>	<p>For Power/USB module please see electrical placement chart. Includes ganging hardware (2 sides).</p>	7728	1469	1545	1602	1689	1810	1857	1962	2169	2266	2455	2714	3034			
		OVERALL DIMENSIONS			SEAT DIMENSIONS			BACK DIMENSIONS									
		W	D	H	W	D	H	W	H								
			24.5	28	17.5												
			RTA 00														
 <p>36" Dia. - Round Bench COM Yardage: 3 Freight Class: 250 Product Weight (lbs.): 46 Cubic Feet Per Carton: 18.25</p>	<p>No Power/USB module. No ganging hardware.</p>	7729	2156	2286	2384	2533	2743	2820	3003	3352	3521	3846	4288	4840			
		OVERALL DIMENSIONS			SEAT DIMENSIONS			BACK DIMENSIONS									
		W	D	H	W	D	H	W	H								
			36	36	17.5												
			RTA 00														
 <p>42" Dia. - Round Bench COM Yardage: 3.25 Freight Class: 250 Product Weight (lbs.): 50 Cubic Feet Per Carton: 22</p>	<p>No Power/USB module. No ganging hardware.</p>	7730	2481	2618	2726	2889	3112	3194	3393	3776	3957	4309	4787	5385			
		OVERALL DIMENSIONS			SEAT DIMENSIONS			BACK DIMENSIONS									
		W	D	H	W	D	H	W	H								
			42	42	17.5												
			RTA 00														

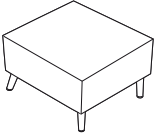
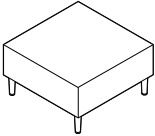
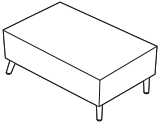
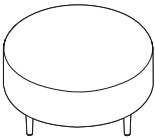
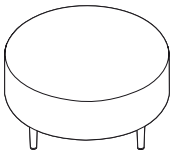
DESCRIPTION	FEATURES	MODEL#	STANDARD TEXTILE GRADES												
			1	2	3	4	5	6	7	8	9	10	11	12	
 <p>30" Square Laminate Coffee Table COM Yardage: N/A Freight Class: 150 Product Weight (lbs.): 61 Cubic Feet Per Carton: 11.5</p>	<p>For Power/USB module please see electrical placement chart. No ganging hardware.</p>	7731	1372												
		OVERALL DIMENSIONS			SEAT DIMENSIONS			BACK DIMENSIONS							
		W	D	H	W	D	H	W	H						
		30	30	17											
			RTA 00												
 <p>36" Square Laminate Coffee Table COM Yardage: N/A Freight Class: 150 Product Weight (lbs.): 85 Cubic Feet Per Carton: 16.5</p>	<p>For Power/USB module please see electrical placement chart. No ganging hardware.</p>	7732	1559												
		OVERALL DIMENSIONS			SEAT DIMENSIONS			BACK DIMENSIONS							
		W	D	H	W	D	H	W	H						
		36	36	17											
			RTA 00												
 <p>Rectangular Laminate Coffee Table COM Yardage: N/A Freight Class: 150 Product Weight (lbs.): 55 Cubic Feet Per Carton: 11.5</p>	<p>For Power/USB module please see electrical placement chart. No ganging hardware.</p>	7733	1378												
		OVERALL DIMENSIONS			SEAT DIMENSIONS			BACK DIMENSIONS							
		W	D	H	W	D	H	W	H						
		40	20	17											
			RTA 00												
 <p>36" Dia. - Round Laminate Coffee Table COM Yardage: N/A Freight Class: 250 Product Weight (lbs.): 63 Cubic Feet Per Carton: 16.5</p>	<p>For Power/USB module please see electrical placement chart. No ganging hardware.</p>	7734	1701												
		OVERALL DIMENSIONS			SEAT DIMENSIONS			BACK DIMENSIONS							
		W	D	H	W	D	H	W	H						
		36	36	17											
			RTA 00												
 <p>42" Dia. - Round Laminate Coffee Table COM Yardage: N/A Freight Class: 250 Product Weight (lbs.): 85 Cubic Feet Per Carton: 22</p>	<p>For Power/USB module please see electrical placement chart. No ganging hardware.</p>	7735	1859												
		OVERALL DIMENSIONS			SEAT DIMENSIONS			BACK DIMENSIONS							
		W	D	H	W	D	H	W	H						
		42	42	17											
			RTA 00												

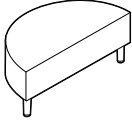
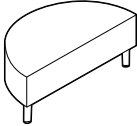
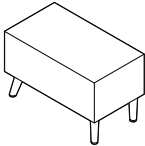
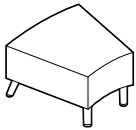
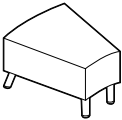
DESCRIPTION	FEATURES	MODEL#	STANDARD TEXTILE GRADES														
			1	2	3	4	5	6	7	8	9	10	11	12			
 <p>36" Half Round Laminate Coffee Table COM Yardage: N/A Freight Class: 150 Product Weight (lbs.): 37 Cubic Feet Per Carton: 8.5</p>	<p>For Power/USB module please see electrical placement chart. No ganging hardware.</p>	7736	1206														
			OVERALL DIMENSIONS			SEAT DIMENSIONS			BACK DIMENSIONS								
			W	D	H	W	D	H	W	H							
			36	18	17												
			RTA 00														
 <p>42" Half Round Laminate Coffee Table COM Yardage: N/A Freight Class: 150 Product Weight (lbs.): 48 Cubic Feet Per Carton: 11.5</p>	<p>For Power/USB module please see electrical placement chart. No ganging hardware.</p>	7737	1461														
			OVERALL DIMENSIONS			SEAT DIMENSIONS			BACK DIMENSIONS								
			W	D	H	W	D	H	W	H							
			42	21	17												
			RTA 00														
 <p>Rectangular Laminate End Table COM Yardage: N/A Freight Class: 125 Product Weight (lbs.): 34 Cubic Feet Per Carton: 5.5</p>	<p>For Power/USB module please see electrical placement chart. Includes ganging hardware (2 sides).</p>	7738	1381														
			OVERALL DIMENSIONS			SEAT DIMENSIONS			BACK DIMENSIONS								
			W	D	H	W	D	H	W	H							
			15	27.25	17												
			RTA 00														
 <p>IS Curve Wide Wedge Laminate End Table COM Yardage: N/A Freight Class: 150 Product Weight (lbs.): 50 Cubic Feet Per Carton: 9.5</p>	<p>For Power/USB module please see electrical placement chart. Includes ganging hardware (2 sides).</p>	7739	1824														
			OVERALL DIMENSIONS			SEAT DIMENSIONS			BACK DIMENSIONS								
			W	D	H	W	D	H	W	H							
			27.25	27.25	17												
			RTA 00														
 <p>IS Curve Narrow Wedge Laminate End Table COM Yardage: N/A Freight Class: 150 Product Weight (lbs.): 34 Cubic Feet Per Carton: 6.5</p>	<p>For Power/USB module please see electrical placement chart. Includes ganging hardware (2 sides).</p>	7740	1477														
			OVERALL DIMENSIONS			SEAT DIMENSIONS			BACK DIMENSIONS								
			W	D	H	W	D	H	W	H							
			18.25	27.25	17												
			RTA 00														

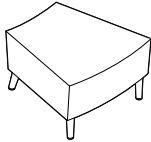
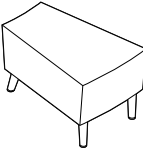
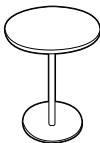
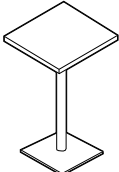
DESCRIPTION	FEATURES	MODEL#	STANDARD TEXTILE GRADES											
			1	2	3	4	5	6	7	8	9	10	11	12
 <p>OS Curve - Wide Wedge Laminate End Table COM Yardage: N/A Freight Class: 150 Product Weight (lbs.): 50 Cubic Feet Per Carton: 9.5</p>	For Power/USB module please see electrical placement chart. Includes ganging hardware (2 sides).	7741	1824											
			OVERALL DIMENSIONS W D H			SEAT DIMENSIONS W D H			BACK DIMENSIONS W H					
			27.25 27.25 17											
			RTA 00											
 <p>OS Curve - Narrow Wedge Laminate End Table COM Yardage: N/A Freight Class: 150 Product Weight (lbs.): 34 Cubic Feet Per Carton: 6.5</p>	For Power/USB module please see electrical placement chart. Includes ganging hardware (2 sides).	7742	1477											
			OVERALL DIMENSIONS W D H			SEAT DIMENSIONS W D H			BACK DIMENSIONS W H					
			18.25 27.25 17											
			RTA 00											
 <p>18" Dia. Round Laminate Laptop Table COM Yardage: N/A Freight Class: 150 Product Weight (lbs.): 32 Cubic Feet Per Carton: 6</p>	No Power/USB module. No ganging hardware.	7743	836											
			OVERALL DIMENSIONS W D H			SEAT DIMENSIONS W D H			BACK DIMENSIONS W H					
			18 18 25.25											
			RTA 00											
 <p>16" Square Laminate Laptop Table COM Yardage: N/A Freight Class: 125 Product Weight (lbs.): 36 Cubic Feet Per Carton: 6</p>	No Power/USB module. No ganging hardware.	7745	855											
			OVERALL DIMENSIONS W D H			SEAT DIMENSIONS W D H			BACK DIMENSIONS W H					
			16 16 25.25											
			RTA 00											

LOUNGE

RIVER™ PERSONAL HARBOR



Sample Layout

ELECTRICAL PLACEMENT

Locations available on left side J1 (black) or W1 (white), right side J3 (black) or W3 (white) or both sides J1/J3 (black) or W1/W3 (white).

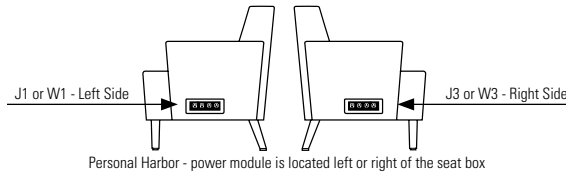

RIVER™ PERSONAL HARBOR R

STANDARD FEATURES

- River Personal Harbor is a line extension of the popular River modular seating series. For modular series see River price book pages.
- The freestanding soft seating models are available with standard height, high and extended high backs.
- The unique tapered legs (swaged legs) are made of welded steel, heavy duty construction, with each leg bolted directly to the frame. The extremely robust construction insures trouble free performance in any environment. All units have the same leg height of 6.5". The leg height makes it easier to clean under the product.
- Each leg is standard with adjustable black nylon leveling glides and are non-marking. Wood legs and casters are not available.
- All cushions are fixed and non-removable (cushions will not migrate). Perimeter seams feature a decorative single stitch detail, which makes seams lay flat and adds extra seam strength.
- Seating frames are heavy duty with interlocking plywood, puzzle box construction, made for rugged active environments. Seats are high density with highly resilient foam and are equipped with a synthetic rubberized webbing suspension system for extra comfort.
- Front edge of face of the seat, angles slightly inward, so feet have freedom of movement and shoe heels don't rub on the seat. This inward slanting matches the inward angles of the back. Benches and connecting end tables also reflect the inward angles on the front and back faces, so all units coordinate in visual appearance.
- High Traffic (**HT**) units are rated at 350 lbs. active load per seat and 24/7 use. These units have the same puzzle box frame construction except that the framing wood is 1" thick, rotary cut, birch plywood and all arms, seat and back cushions are made with Ultracell Foam.
- High Traffic (**HT**) models are recommend to be specified in textiles that meet or exceed 100,000 double rubs for added abrasion performance.

- Check textile availability prior to specifying upholstery material. Leather not available on River Personal Harbor.

OPTIONAL FEATURES

- Seating units can be specified with Power/USB terminals, which includes two power outlets, two double USB terminals and a black 60" three-prong power cord. Each Power/USB module is set in predetermined locations, as shown in the electrical illustrations below. Electrical units must be factory installed.
- To add a Power/USB module: From the electrical illustrations below, please specify **J1, W1, J2, W2, J3, W4, J4, W4, J6 or W6** after the product model number. Please note on seating units, if both right and left locations are required, add both **J1/J3 or W1/W3** to the model number. Add \$997 for each module/location required.
- Power/USB modules are available with either Jet Black (**J**) face plate with black Power/USB receptacles or with a White (**W**) face plate with white Power/USB receptacles.
- **Leg finish**

(CHM) Chrome	(TBL) Black
(TDW) Designer White	(TFO) Fog
(TFR) Frost	(TIV) Cloud
(TKA) Kalua	(TLA) Latte
(TMO) Mocha	(TNE) Nevada
(TOA) Toast	(TSH) Shadow
(TSN) Sand	(TTU) Tungsten
- If more than one fabric or a fabric/vinyl combination is required, please fill out a "Seating Multiple Textile" form, specifying each fabric location. Please contact Customer Care for more information.

DESCRIPTION	FEATURES	MODEL#	STANDARD TEXTILE GRADES											
-------------	----------	--------	-------------------------	--	--	--	--	--	--	--	--	--	--	--

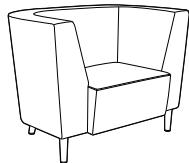

Personal Harbor - Standard Back
 COM Yardage: 5.5
 Freight Class: 150
 Product Weight (lbs.): 50
 Cubic Feet Per Carton: 9.5

For Power/USB module please see electrical placement chart. Freestanding unit only.

	1	2	3	4	5	6	7	8	9	10	11	12
7746	\$4079	\$4318	\$4507	\$4792	\$5194	\$5385	\$5749	\$6329	\$6777	\$7275	\$8301	\$9395

OVERALL DIMENSIONS			SEAT DIMENSIONS			BACK DIMENSIONS	
W	D	H	W	D	H	W	H
45	29.5	32	24	19	18	27	14

RTA 00

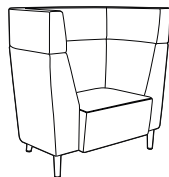

Personal Harbor - High Back
 COM Yardage: 7.09
 Freight Class: 150
 Product Weight (lbs.): 86
 Cubic Feet Per Carton: 9.5

For Power/USB module please see electrical placement chart. Freestanding unit only.

	1	2	3	4	5	6	7	8	9	10	11	12
7747	\$5734	\$6070	\$6336	\$6736	\$7303	\$7569	\$8082	\$8903	\$9534	\$10234	\$11682	\$13222

OVERALL DIMENSIONS			SEAT DIMENSIONS			BACK DIMENSIONS	
W	D	H	W	D	H	W	H
45	29.5	41.5	24	19	18	27	24

RTA 00

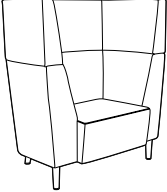
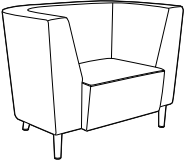
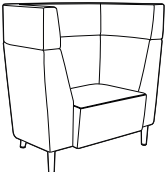
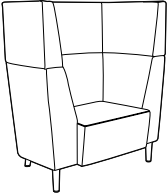

DESCRIPTION	FEATURES	MODEL#	STANDARD TEXTILE GRADES													
			1	2	3	4	5	6	7	8	9	10	11	12		
 <p>Personal Harbor - Extended Back COM Yardage: 8.5 Freight Class: 150 Product Weight (lbs.): 102 Cubic Feet Per Carton: 9.5</p>	<p>For Power/USB module please see electrical placement chart. Freestanding unit only.</p>	7748	\$6451	\$6819	\$7111	\$7552	\$8171	\$8464	\$9028	\$9926	\$10619	\$11389	\$12972	\$14662		
			OVERALL DIMENSIONS			SEAT DIMENSIONS			BACK DIMENSIONS							
			W	D	H	W	D	H	W	H						
			45	29.5	47	24	19	18	27	29						
			RTA 00													
 <p>Personal Harbor - Standard Back COM Yardage: 5.5 Freight Class: 150 Product Weight (lbs.): 50 Cubic Feet Per Carton: 9.5</p>	<p>High Traffic model For Power/USB module please see electrical placement chart. Freestanding unit only.</p>	7786	\$4659	\$4899	\$5087	\$5372	\$5774	\$5965	\$6330	\$6912	\$7360	\$7857	\$8884	\$9978		
			OVERALL DIMENSIONS			SEAT DIMENSIONS			BACK DIMENSIONS							
			W	D	H	W	D	H	W	H						
			45	29.5	32	24	19	18	27	14						
			RTA 00													
 <p>Personal Harbor - High Back COM Yardage: 7.09 Freight Class: 150 Product Weight (lbs.): 86 Cubic Feet Per Carton: 9.5</p>	<p>High Traffic model For Power/USB module please see electrical placement chart. Freestanding unit only.</p>	7787	\$6482	\$6818	\$7084	\$7485	\$8051	\$8318	\$8831	\$9652	\$10282	\$10983	\$12430	\$13968		
			OVERALL DIMENSIONS			SEAT DIMENSIONS			BACK DIMENSIONS							
			W	D	H	W	D	H	W	H						
			45	29.5	41.5	24	19	18	27	24						
			RTA 00													
 <p>Personal Harbor - Extended Back COM Yardage: 8.5 Freight Class: 150 Product Weight (lbs.): 102 Cubic Feet Per Carton: 9.5</p>	<p>High Traffic model For Power/USB module please see electrical placement chart. Freestanding unit only.</p>	7788	\$7031	\$7400	\$7692	\$8132	\$8752	\$9047	\$9608	\$10507	\$11202	\$11970	\$13554	\$15245		
			OVERALL DIMENSIONS			SEAT DIMENSIONS			BACK DIMENSIONS							
			W	D	H	W	D	H	W	H						
			45	29.5	47	24	19	18	27	29						
			RTA 00													

LOUNGE

RIVER+ SEATING



Lounge Chair, High Back model R27802



120 Corner, Standard Back model R27824S



Loop arm R2770

River+ Benches and Tables



For River+ benches, please see page 363
For River+ tables, please see page 368

EXAMPLE RIVER+ SEATING ORDER CODE:

R27802	-CE90	-FOG	-	-S6	-
Model number	Back, arm and seat textile	Connector finish	Shelf finish	Leg Selection	Counterweight
-CHM	-SSB				
Leg finish	Bottom selection				

Additional Options specify at end of order code.	SPECIFY CODE
Additional weight See each model for amount of added weight and upcharge.	CW
Sealed back seams Upcharges vary, see model.	SBS
Sealed seat seams Upcharges vary, see model.	SSS
Power unit finish Jet Black White	J W
Power/USB unit position (see electrical placement images, not available on corner units) Front left Front right Side left Side right Center back (models with shelf only)	\$698 per unit F1 F2 S1 S2 CB
Tamperproof fasteners Upcharges vary, see model.	TP
Moisture barrier Upcharges vary, see model.	MB
Accessory hook finish (for models with shelf) Night (BLK) Fog (FOG) Latte (LAB)	NHK FHK LHK

STANDARD FEATURES

- A modular series that is composed of straight, curved and corner sections.
- Models with the same seat height can be ganged on ends with no upholstered arms. Ganging hardware is standard on armless ends of models (factory installed) and swivels out of the way when not in use.
- Seating frames are constructed of heavy duty plywood, and are made for active environments. Seats are high density with highly resilient foam.
- River+ seating is rated for an active weight up to 600 lbs. per seat and 24/7 use.
- For 24/7 use and/or heavy duty application use, Global's Heavy Duty warranty is only on models specified with performance textiles, rated for 150,000 double rubs or more.
- A clean-out gap is created by seat-to-back connector brackets available in three finishes.
- The standard, 6.5" tapered legs are made of welded steel. Front legs of River+ lounge models are straight. Back legs are angled.
- Models with a shelf are only available with 6.5" high legs. Back legs on these models are standard with (E6) EXTENDED legs.
- Legs include Black nylon, non-marking, height adjustable glides.
- Upholstery options include fabric or vinyl. Leather upholstery is not available.
- All units are shipped fully assembled.
- Arms on upholstered arm models are factory installed and not removable.
- Modular, aluminum loop arms are sold separately and available with or without nylon armcaps. These relocatable arms are field installed at any seat to back connector location.
- A 10" deep, 1" thick shelf is available on the back of select corner, curved, two and three seat models in many thermally fused laminate finishes with matching edge.
- Shelf supports are aluminum with accessory hook in three finishes. Weight capacity: Shelf - 50lbs per seat; Hook - 20lbs each.
- Back shelf heights align with the model's back height. See shelf heights diagrams for details.
- Check textile availability prior to specifying upholstery material.
- The series is available to specify with two textiles, one for the seat cushion and one for the back, arms and front rail (see model image).
- For pricing, start with the base price and add both back/arms graded textile upcharge and the seat graded textile upcharge.
- The blended textile matrix does not apply to this series.

OPTIONAL FEATURES

- Optional 6.5" floor mount legs (F6) are available. Shelf back models are available with EXTENDED floor mount legs (F6).
- Optional 8" (S8) and 8" floor mount legs (F8) are available on models without shelves. Seat heights change to 19" high. Upcharges vary.
- To match back legs of shelf-back models with models without shelf, select (C6) leg with counterweight. Upcharges vary.
- Up to two power units are available on seating models, except 90 and 120 corner units. Add \$698 upcharge per unit.
- Each power unit includes one AC outlet and two USB-A, 10 watt charging ports. Location options include front or side. Back power location option available on models with back shelf (except corners). See electrical placement diagrams.
- Power units are available in either Jet Black (J) or White (W) with 120", three-prong matching cords.
- Tamperproof fasteners can be requested for a higher level of safety. Please specify (TP) - see each model for upcharge. Ganging brackets are not included when Tamper Proof (TP) option is selected.
- Sealed seams are available only for approved coated textiles. Specify (SSS) for sealed seat seams or (SBS) for sealed back and arm seams. Contact customer care

RIVER+ SEATING R

for details. See models for upcharge.

- To reduce ease of movement, counterweights can be added to any model. Specify (CW). See individual model for weight and upcharge.
- Underside of seat is standard with black lining (SB).
- For improved housekeeping and infection control practices, the underside of the seat can be finished with black vinyl and sealed to prevent penetration of liquids. Specify (SP) - see each model for upcharge.
- Steel bottom option provides tamperproof protection (includes tamperproof screws). Specify (BS). Upcharges vary. Note: electrical option and ganging are not available with steel bottom.
- Add option codes in the following order:
 - **Model number**
Specify model number.
 - **Back/Arm Textile**
Specify textile code. See model grade upcharges.
 - **Seat Textile**
Specify textile code. See model grade upcharges.
 - **Seat to back connector finish**
(NGT) Night (BLK). No upcharge.
(FOG) Fog. No upcharge.
(LAB) Latte. No upcharge.
 - **Back shelf finish** (for "S" models with shelf)
See colors shown on website.
 - **Accessory hook finish** (for "S" models with shelf)
(NHK) Night (BLK)
(FHK) Fog (FOG)
(LHK) Latte (LAB)
 - **Leg selection** (models without shelf):
(S6) Standard seat height (17.5"), 6.5" leg w/adjustable glides. No upcharge.
(S8) High seat (19"), 8" leg w/adjustable glides. No upcharge.
(F6) Standard seat height (17.5"), 6.5" leg w/floor mount. Add \$106 for straight units; \$132 for curved, corner units.
(F8) High seat (19"), 8" leg w/floor mount. Add \$106 for straight units; \$132 for curved, corner units.
 - **Leg selection** (For "S" models with shelf):
(E6) Standard seat height (17.5"), 6.5" EXTENDED leg with adjustable glides.
(C6) Standard seat height (17.5"), 6.5" leg, includes counterweight. Matches S6 leg. Upcharges vary, see model.
(F6) Standard seat height (17.5"), 6.5" EXTENDED leg w/floor mount. Add \$106 for straight unit; \$132 for curved, corner units.
 - **Leg finish**

(CHM) Chrome	(TBL) Black
(TDW) Designer White	(TFO) Fog
(TFR) Frost	(TIV) Cloud
(TKA) Kalua	(TLA) Latte
(TMO) Mocha	(TNE) Nevada
(TOA) Toast	(TSH) Shadow
(TSN) Sand	(TTU) Tungsten
 - **Additional weight**
(CU) No counterweight.
(CW) Counterweight. Upcharges vary, see model.
 - **Bottom selection**
(SSB) Standard seat bottom
(SP) Vinyl sealed bottom with staple strip. Upcharges vary, see model.*
(BS) Steel bottom. Upcharges vary, see model.**
 - **Sealed back and arm seams**
(SBS) Sealed back seams. Upcharges vary, see model.
 - **Sealed seat seams**
(SSS) Sealed seat seams. Upcharges vary, see model.
 - **Moisture barrier**
(MB) Moisture Barrier. Upcharges vary, see model.
 - **Power/USB unit position. Add \$698 per unit.**
(NP) No power (no upcharge)
(F1) Front left (F2) Front right
(S1) Side left (S2) Side right
(CB) Center back (models with shelf only)
 - **Power unit finish**
(J) Jet Black (W) White
 - **Tamperproof fasteners**
(TP) Tamperproof fasteners. Upcharges vary, see model.

*linking hardware is lowered to clear the staple strip.
Units will only gang with other units with sealed bottom.
**cannot be combined with linking hardware or power units

SHELF HEIGHTS

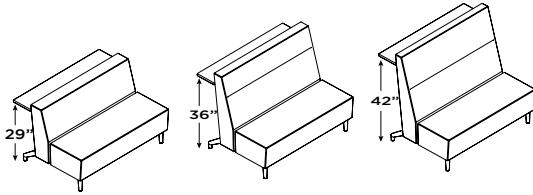

Standard height

High back

Extended high back

DIMENSIONS

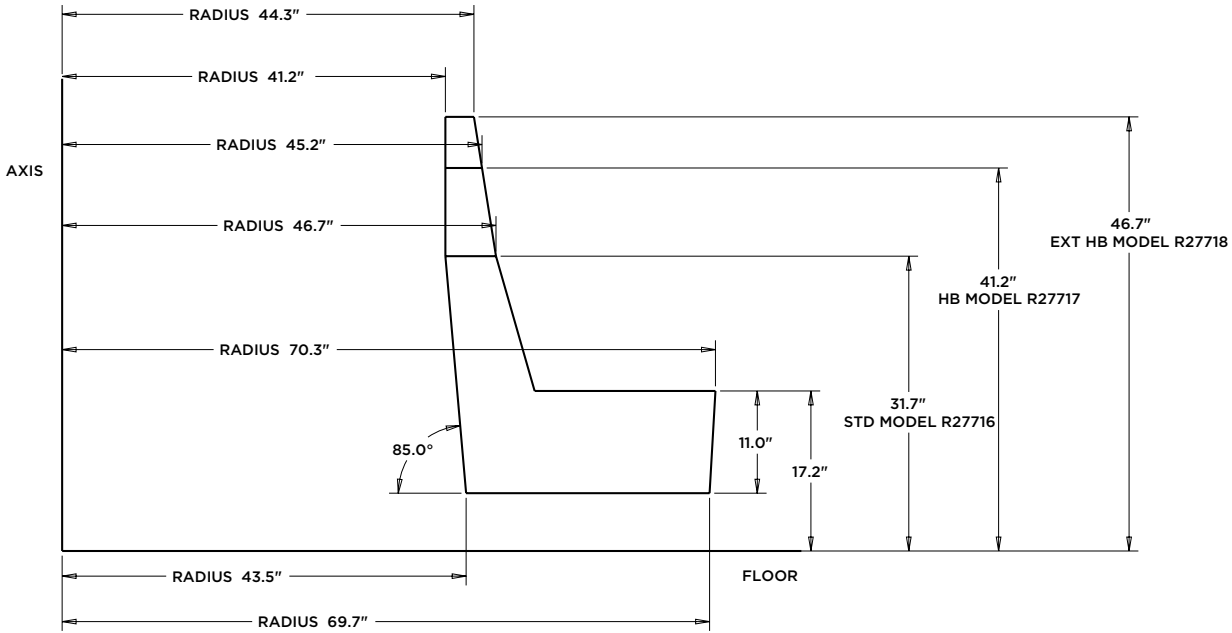



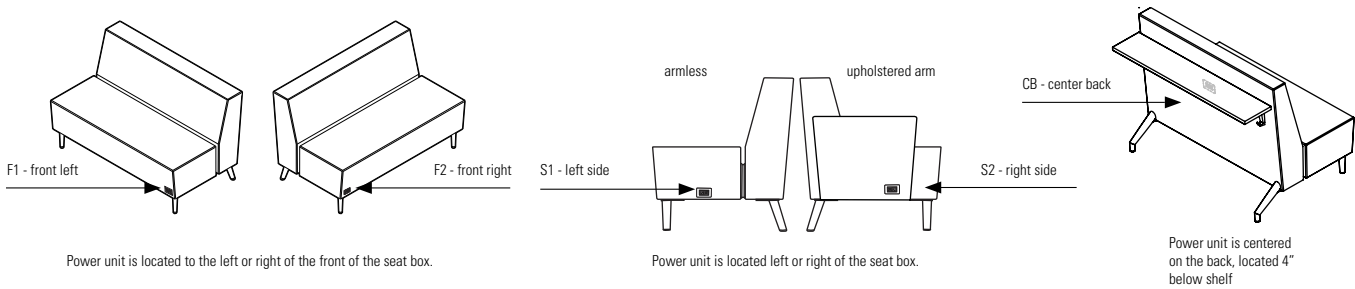

ELECTRICAL PLACEMENT















Power unit is located to the left or right of the front of the seat box.









Power unit is located left or right of the seat box.





Power unit is centered on the back, located 4" below shelf









DESCRIPTION	MODEL#/ FEATURES	STANDARD TEXTILE GRADES													
		1/COM	2	3	4	5	6	7	8	9	10	11	12		
 <p>R27801</p> <p>Lounge Chair - Standard Back COM Yardage: Back: 2; Seat: 1.75 Freight class: 250 Product weight (lbs.): 61 Cubic feet per carton: 19.75</p>	R27801	Base Price:	\$2178												
	Back upcharge:	+0	+\$68	+\$121	+\$199	+\$309	+\$355	+\$450	+\$600	+\$712	+\$834	+\$1089	+\$1357		
	Seat upcharge:	+0	+\$60	+\$106	+\$175	+\$271	+\$311	+\$394	+\$525	+\$623	+\$731	+\$953	+\$1188		
	For power/USB unit, see electrical placement chart. Includes ganging hardware (2 sides). Add \$69 for (SSS), \$74 (SBS) Add \$667 for 36 lbs. (CW) Add \$109 for (SP) or \$513 for (BS) Add \$43 for (TP) Add \$134 for (MB)		OVERALL DIMENSIONS			SEAT DIMENSIONS			BACK DIMENSIONS						
			W	D	H	W	D	H	W	H					
			26	30	32	26	19	18	26	14					
			RTA 00	1 per carton											
	 <p>R27801B</p> <p>Lounge Chair - Standard Back COM Yardage: Back: 4; Seat: 1.75 Freight class: 250 Product weight (lbs.): 82 Cubic feet per carton: 24.5</p>	R27801B	Base Price:	\$2956											
		Back/Arm upcharge:	+0	+\$136	+\$241	+\$397	+\$617	+\$709	+\$899	+\$1199	+\$1423	+\$1667	+\$2178	+\$2714	
		Seat upcharge:	+0	+\$60	+\$106	+\$175	+\$271	+\$311	+\$394	+\$525	+\$623	+\$731	+\$953	+\$1188	
For power/USB unit, see electrical placement chart. Ganging not available. Add \$69 for (SSS), \$130 (SBS) Add \$667 for 36 lbs. (CW) Add \$109 for (SP) or \$513 for (BS) Add \$43 for (TP) Add \$134 for (MB)		OVERALL DIMENSIONS			SEAT DIMENSIONS			BACK DIMENSIONS							
		W	D	H	W	D	H	W	H						
		33	30	32	26	19	18	26	14						
		RTA 00	1 per carton												
 <p>R27801L R27801R</p> <p>Lounge Chair - Standard Back COM Yardage: Back: 3; Seat: 1.75 Freight class: 250 Product weight (lbs.): 72 Cubic feet per carton: 24.5</p>		R27801L	Base Price:	\$2568											
		R27801R	Base Price:	\$2568											
		Back/Arm upcharge:	+0	+\$102	+\$181	+\$298	+\$463	+\$532	+\$675	+\$899	+\$1067	+\$1251	+\$1634	+\$2036	
	Seat upcharge:	+0	+\$60	+\$106	+\$175	+\$271	+\$311	+\$394	+\$525	+\$623	+\$731	+\$953	+\$1188		
	For power/USB unit, see electrical placement chart. Includes ganging hardware (1 side). Add \$69 for (SSS), \$102 (SBS) Add \$667 for 36 lbs. (CW) Add \$109 for (SP) or \$513 for (BS) Add \$43 for (TP) Add \$134 for (MB)		OVERALL DIMENSIONS			SEAT DIMENSIONS			BACK DIMENSIONS						
			W	D	H	W	D	H	W	H					
			29.5	30	32	26	19	18	26	14					
			RTA 00	1 per carton											
	 <p>R27802</p> <p>Lounge Chair - High Back COM Yardage: Back: 2.75; Seat: 1.75 Freight class: 250 Product weight: 71 Cubic feet per carton: 24.75</p>	R27802	Base Price:	\$2554											
		Back upcharge:	+0	+\$93	+\$166	+\$274	+\$425	+\$488	+\$619	+\$824	+\$978	+\$1147	+\$1498	+\$1867	
Seat upcharge:		+0	+\$60	+\$106	+\$175	+\$271	+\$311	+\$394	+\$525	+\$623	+\$731	+\$953	+\$1188		
For power/USB unit, see electrical placement chart. Includes ganging hardware (2 sides). Add \$69 for (SSS), \$105 for (SBS) Add \$667 for 36 lbs. (CW) Add \$109 for (SP) or \$513 for (BS) Add \$43 for (TP) Add \$134 for (MB)		OVERALL DIMENSIONS			SEAT DIMENSIONS			BACK DIMENSIONS							
		W	D	H	W	D	H	W	H						
		26	30.5	41.5	26	19	18	26	23.5						
		RTA 00	1 per carton												
 <p>R27802B</p> <p>Lounge Chair - High Back COM Yardage: Back: 4.75; Seat: 1.75 Freight class: 250 Product weight: 88.5 Cubic feet per carton: 31.25</p>		R27802B	Base Price:	\$3330											
		Back/Arm upcharge:	+0	+\$161	+\$286	+\$472	+\$733	+\$842	+\$1068	+\$1424	+\$1690	+\$1981	+\$2586	+\$3224	
		Seat upcharge:	+0	+\$60	+\$106	+\$175	+\$271	+\$311	+\$394	+\$525	+\$623	+\$731	+\$953	+\$1188	
	For power/USB unit, see electrical placement chart. Ganging not available. Add \$69 for (SSS), \$160 for (SBS) Add \$667 for 36 lbs. (CW) Add \$109 for (SP) or \$513 for (BS) Add \$43 for (TP) Add \$134 for (MB)		OVERALL DIMENSIONS			SEAT DIMENSIONS			BACK DIMENSIONS						
			W	D	H	W	D	H	W	H					
			33	30.5	41.5	26	19	18	26	23.5					
			RTA 00	1 per carton											

DESCRIPTION	MODEL#/ FEATURES	STANDARD TEXTILE GRADES											
		1/COM	2	3	4	5	6	7	8	9	10	11	12
 <p>R27804</p> <p>Two Seater - Standard Back COM Yardage: Back: 2.75; Seat: 2 Freight class: 250 Product weight: 113 133 shelf model Cubic feet per carton: 37.5 51shelf model</p>	<p>R27804S</p> <p>Base Price: \$3394</p> <p>Base Price: \$4159</p> <p>Back upcharge: +0</p> <p>Seat upcharge: +0</p> <p>Shelf: 52W 10D 1H</p> <p>For power/USB unit, see electrical placement chart. Includes ganging hardware (2 sides). Add \$102 for (SSS), \$126 for (SBS) Add \$1330 for 72 lbs. (CW), (C6) Add \$207 for (SP) or \$816 for (BS) Add \$43 for (TP) Add \$266 for (MB)</p>												
		OVERALL DIMENSIONS			SEAT DIMENSIONS			BACK DIMENSIONS					
		W	D	H	W	D	H	W	H				
		52	30	32	52	19	18	52	14				
		RTA 00	1 per carton										
 <p>R27804B</p> <p>Two Seater - Standard Back COM Yardage: Back: 4.75; Seat: 2 Freight class: 250 Product weight: 133 154 shelf model Cubic feet per carton: 42.5 57.5 shelf model</p>	<p>R27804SB</p> <p>Base Price: \$4171</p> <p>Base Price: \$4937</p> <p>Back/Arm upcharge: +0</p> <p>Seat upcharge: +0</p> <p>Shelf: 52W 10D 1H</p> <p>For power/USB unit, see electrical placement chart. Ganging not available. Add \$102 for (SSS), \$181 for (SBS) Add \$1330 for 72 lbs. (CW), (C6) Add \$207 for (SP) or \$816 for (BS) Add \$43 for (TP) Add \$266 for (MB)</p>												
		OVERALL DIMENSIONS			SEAT DIMENSIONS			BACK DIMENSIONS					
		W	D	H	W	D	H	W	H				
		59	30	32	52	19	18	52	14				
		RTA 00	1 per carton										
 <p>R27804L</p> <p>Two Seater - Standard Back COM Yardage: Back: 3.75; Seat: 2 Freight class: 250 Product weight: 123 Cubic feet per carton: 42.5</p>	<p>R27804R</p> <p>Base Price: \$3782</p> <p>Base Price: \$3782</p> <p>Back/Arm upcharge: +0</p> <p>Seat upcharge: +0</p> <p>Shelf: 52W 10D 1H</p> <p>For power/USB unit, see electrical placement chart. Includes ganging hardware (1 side). Add \$102 for (SSS), \$153 for (SBS) Add \$1330 for 72 lbs. (CW), (C6) Add \$207 for (SP) or \$816 for (BS) Add \$43 for (TP) Add \$266 for (MB)</p>												
		OVERALL DIMENSIONS			SEAT DIMENSIONS			BACK DIMENSIONS					
		W	D	H	W	D	H	W	H				
		55.5	30	32	52	19	18	52	14				
		RTA 00	1 per carton										
 <p>R27804SL</p> <p>Two Seater - Standard Back COM Yardage: Back: 3.75; Seat: 2 Freight class: 250 Product weight: 144 Cubic feet per carton: 57.5</p>	<p>R27804SR</p> <p>Base Price: \$4549</p> <p>Base Price: \$4549</p> <p>Back/Arm upcharge: +0</p> <p>Seat upcharge: +0</p> <p>Shelf: 52W 10D 1H</p> <p>For power/USB unit, see electrical placement chart. Includes ganging hardware (1 side). Add \$102 for (SSS), \$153 for (SBS) Add \$1330 for 72 lbs. (CW), (C6) Add \$207 for (SP) or \$816 for (BS) Add \$43 for (TP) Add \$266 for (MB)</p>												
		OVERALL DIMENSIONS			SEAT DIMENSIONS			BACK DIMENSIONS					
		W	D	H	W	D	H	W	H				
		55.5	40.5	32	52	19	18	52	14				
		RTA 00	1 per carton										





DESCRIPTION		MODEL#/ FEATURES	STANDARD TEXTILE GRADES											
			1/COM	2	3	4	5	6	7	8	9	10	11	12
 <p>R27805</p> <p>Two Seater - High Back COM Yardage: Back: 3.50; Seat: 2 Freight class: 250 Product weight: 138 139 shelf model Cubic feet per carton: 47.25 64.75 shelf model</p>	 <p>R27805S</p> <p>For power/USB unit, see electrical placement chart. Includes ganging hardware (1 sides) Add \$102 for (SSS), \$166 for (SBS) Add \$1330 for 72 lbs. (CW), (C6) Add \$207 for (SP) or \$816 for (BS) Add \$43 for (TP) Add \$266 for (MB)</p>	<p>R27805 Base Price: \$4130</p> <p>R27805S Base Price: \$4894</p> <p>Back upcharge: +0 +\$119 +\$211 +\$348 +\$540 +\$621 +\$788 +\$1049 +\$1245 +\$1460 +\$1906 +\$2375</p> <p>Seat upcharge: +0 +\$68 +\$121 +\$199 +\$309 +\$355 +\$450 +\$600 +\$712 +\$834 +\$1089 +\$1357</p> <p>Shelf: 52W 10D 1H</p>												
		<p>OVERALL DIMENSIONS</p> <p>W D H</p> <p>52 30.5 41.5</p> <p>SEAT DIMENSIONS</p> <p>W D H</p> <p>52 19 18</p> <p>BACK DIMENSIONS</p> <p>W H</p> <p>52 23.5</p> <p>RTA 00 1 per carton</p>												
 <p>R27805B</p> <p>Two Seater - High Back COM Yardage: Back: 5.50; Seat: 2 Freight class: 250 Product weight: 138 159 shelf model Cubic feet per carton: 54 73 shelf model</p>	 <p>R27805SB</p> <p>For power/USB unit, see electrical placement chart. Ganging not available. Add \$102 for (SSS), \$221 for (SBS) Add \$1330 for 72 lbs. (CW), (C6) Add \$207 for (SP) or \$816 for (BS) Add \$43 for (TP) Add \$266 for (MB)</p>	<p>R27805B Base Price: \$4907</p> <p>R27805SB Base Price: \$5672</p> <p>Back/Arm upcharge: +0 +\$186 +\$332 +\$546 +\$848 +\$975 +\$1237 +\$1648 +\$1956 +\$2293 +\$2995 +\$3732</p> <p>Seat upcharge: +0 +\$68 +\$121 +\$199 +\$309 +\$355 +\$450 +\$600 +\$712 +\$834 +\$1089 +\$1357</p> <p>Shelf: 52W 10D 1H</p>												
		<p>OVERALL DIMENSIONS</p> <p>W D H</p> <p>59 30.5 41.5</p> <p>SEAT DIMENSIONS</p> <p>W D H</p> <p>52 19 18</p> <p>BACK DIMENSIONS</p> <p>W H</p> <p>52 23.5</p> <p>RTA 00 1 per carton</p>												
 <p>R27805L</p> <p>Two Seater - High Back COM Yardage: Back: 4.50; Seat: 2 Freight class: 250 Product weight: 128 Cubic feet per carton: 54</p>	 <p>R27805R</p> <p>For power/USB unit, see electrical placement chart. Includes ganging hardware (1 side). Add \$102 for (SSS), \$221 for (SBS) Add \$1330 for 72 lbs. (CW), (C6) Add \$207 for (SP) or \$816 for (BS) Add \$43 for (TP) Add \$266 for (MB)</p>	<p>R27805L Base Price: \$4518</p> <p>R27805R Base Price: \$4518</p> <p>Back/Arm upcharge: +0 +\$152 +\$272 +\$447 +\$694 +\$798 +\$1012 +\$1349 +\$1601 +\$1876 +\$2450 +\$3054</p> <p>Seat upcharge: +0 +\$68 +\$121 +\$199 +\$309 +\$355 +\$450 +\$600 +\$712 +\$834 +\$1089 +\$1357</p> <p>Shelf: 52W 10D 1H</p>												
		<p>OVERALL DIMENSIONS</p> <p>W D H</p> <p>55.5 30.5 41.5</p> <p>SEAT DIMENSIONS</p> <p>W D H</p> <p>52 19 18</p> <p>BACK DIMENSIONS</p> <p>W H</p> <p>52 23.5</p> <p>RTA 00 1 per carton</p>												
 <p>R27805SL</p> <p>Two Seater - High Back COM Yardage: Back: 4.50; Seat: 2 Freight class: 250 Product weight: 149 Cubic feet per carton: 73</p>	 <p>R27805SR</p> <p>For power/USB unit, see electrical placement chart. Includes ganging hardware (1 side). Add \$102 for (SSS), \$221 for (SBS) Add \$1330 for 72 lbs. (CW), (C6) Add \$207 for (SP) or \$816 for (BS) Add \$43 for (TP) Add \$266 for (MB)</p>	<p>R27805SL Base Price: \$5283</p> <p>R27805SR Base Price: \$5283</p> <p>Back/Arm upcharge: +0 +\$152 +\$272 +\$447 +\$694 +\$798 +\$1012 +\$1349 +\$1601 +\$1876 +\$2450 +\$3054</p> <p>Seat upcharge: +0 +\$68 +\$121 +\$199 +\$309 +\$355 +\$450 +\$600 +\$712 +\$834 +\$1089 +\$1357</p> <p>Shelf: 52W 10D 1H</p>												
		<p>OVERALL DIMENSIONS</p> <p>W D H</p> <p>55.5 41 41.5</p> <p>SEAT DIMENSIONS</p> <p>W D H</p> <p>52 19 18</p> <p>BACK DIMENSIONS</p> <p>W H</p> <p>52 23.5</p> <p>RTA 00 1 per carton</p>												

DESCRIPTION		MODEL#/ FEATURES	STANDARD TEXTILE GRADES											
			1/COM	2	3	4	5	6	7	8	9	10	11	12
		R27807 Base Price:	\$5321											
		R27807S Base Price:	\$6333											
		Back upcharge:	+0	+\$152	+\$272	+\$447	+\$694	+\$798	+\$1012	+\$1349	+\$1601	+\$1876	+\$2450	+\$3054
		Seat upcharge:	+0	+\$119	+\$211	+\$348	+\$540	+\$621	+\$788	+\$1049	+\$1245	+\$1460	+\$1906	+\$2375
			Shelf: 52W 10D 1H											
			OVERALL DIMENSIONS			SEAT DIMENSIONS			BACK DIMENSIONS					
			W	D	H	W	D	H	W	H				
			78	30	32	78	19	18	78	14				
			RTA 00		1 per carton									
<p>R27807</p> <p>Three Seater - Standard Back COM Yardage: Back: 4.50; Seat: 3.50 Freight class: 250 Product weight: 152 173 shelf model Cubic feet per carton: 55.5 173 shelf model</p>		<p>R27807S</p> <p>For power/USB unit, see electrical placement chart. Includes ganging hardware (2 sides). Add \$124 for (SSS), \$146 for (SBS) Add \$1330 for 72 lbs. (CW), (C6) Add \$311 for (SP) or \$1122 for (BS) Add \$43 for (TP) Add \$396 for (MB)</p>												
		R27807B Base Price:	\$6099											
		R27807SB Base Price:	\$7111											
		Back/Arm upcharge:	+0	+\$220	+\$392	+\$645	+\$1002	+\$1153	+\$1462	+\$1948	+\$2312	+\$2710	+\$3539	+\$4410
		Seat upcharge:	+0	+\$119	+\$211	+\$348	+\$540	+\$621	+\$788	+\$1049	+\$1245	+\$1460	+\$1906	+\$2375
			Shelf: 52W 10D 1H											
			OVERALL DIMENSIONS			SEAT DIMENSIONS			BACK DIMENSIONS					
			W	D	H	W	D	H	W	H				
			85	30	32	78	19	18	78	14				
			RTA 00		1 per carton									
<p>R27807B</p> <p>Three Seater - Standard Back COM Yardage: Back: 6.50; Seat: 3.50 Freight class: 250 Product weight: 170 193 shelf model Cubic feet per carton: 60.5 79.75 shelf model</p>		<p>R27807SB</p> <p>For power/USB unit, see electrical placement chart. Ganging not available. Add \$124 for (SSS), \$200 for (SBS) Add \$1330 for 72 lbs. (CW), (C6) Add \$311 for (SP) or \$1122 for (BS) Add \$43 for (TP) Add \$396 for (MB)</p>												
		R27807L Base Price:	\$5710											
		R27807R Base Price:	\$5710											
		Back/Arm upcharge:	+0	+\$186	+\$332	+\$546	+\$848	+\$975	+\$1237	+\$1648	+\$1956	+\$2293	+\$2995	+\$3732
		Seat upcharge:	+0	+\$119	+\$211	+\$348	+\$540	+\$621	+\$788	+\$1049	+\$1245	+\$1460	+\$1906	+\$2375
			Shelf: 52W 10D 1H											
			OVERALL DIMENSIONS			SEAT DIMENSIONS			BACK DIMENSIONS					
			W	D	H	W	D	H	W	H				
			81.5	30	32	78	19	18	78	14				
			RTA 00		1 per carton									
<p>R27807L</p> <p>Three Seater - Standard Back COM Yardage: Back: 5.50; Seat: 3.50 Freight class: 250 Product weight: 160 Cubic feet per carton: 60.5</p>		<p>R27807R</p> <p>For power/USB unit, see electrical placement chart. Includes ganging hardware (2 sides). Add \$124 for (SSS), \$174 for (SBS) Add \$1330 for 72 lbs. (CW), (C6) Add \$311 for (SP) or \$1122 for (BS) Add \$43 for (TP) Add \$396 for (MB)</p>												
		R27807SL Base Price:	\$6722											
		R27807SR Base Price:	\$6722											
		Back/Arm upcharge:	+0	+\$186	+\$332	+\$546	+\$848	+\$975	+\$1237	+\$1648	+\$1956	+\$2293	+\$2995	+\$3732
		Seat upcharge:	+0	+\$119	+\$211	+\$348	+\$540	+\$621	+\$788	+\$1049	+\$1245	+\$1460	+\$1906	+\$2375
			Shelf: 52W 10D 1H											
			OVERALL DIMENSIONS			SEAT DIMENSIONS			BACK DIMENSIONS					
			W	D	H	W	D	H	W	H				
			81.5	40.5	32	78	19	18	78	14				
			RTA 00		1 per carton									
<p>R27807SL</p> <p>Three Seater - Standard Back COM Yardage: Back: 5.50; Seat: 3.50 Freight class: 250 Product weight: 183 Cubic feet per carton: 79.75</p>		<p>R27807SR</p> <p>For power/USB unit, see electrical placement chart. Includes ganging hardware (2 sides). Add \$124 for (SSS), \$174 for (SBS) Add \$1330 for 72 lbs. (CW), (C6) Add \$311 for (SP) or \$1122 for (BS) Add \$43 for (TP) Add \$396 for (MB)</p>												

DESCRIPTION	MODEL#/ FEATURES	STANDARD TEXTILE GRADES																																							
		1/COM	2	3	4	5	6	7	8	9	10	11	12																												
 <p>R27808 R27808S</p> <p>Three Seater - High Back COM Yardage: Back: 5.75; Seat: 3.50 Freight class: 250 Product weight: 177 201 shelf model Cubic feet per carton: 69.75 95.5 shelf model</p>	<p>R27808 Base Price: \$6206</p> <p>R27808S Base Price: \$7219</p> <p>Back upcharge: +0</p> <p>Seat upcharge: +0</p>	\$6206																																							
	<p>Back upcharge: +\$195</p> <p>Seat upcharge: +\$347</p> <p> +\$571</p> <p> +\$887</p> <p> +\$1020+\$1293</p> <p> +\$1723</p> <p> +\$2045</p> <p> +\$2397</p> <p> +\$3131</p> <p> +\$3902</p> <p>Shelf: 52W 10D 1H</p>	+\$195	+\$347	+\$571	+\$887	+\$1020+\$1293	+\$1723	+\$2045	+\$2397	+\$3131	+\$3902																														
	<p>For power/USB unit, see electrical placement chart. Includes ganging hardware (2 sides). Add \$124 for (SSS), \$195 for (SBS) Add \$1330 for 72 lbs. (CW), (C6) Add \$311 for (SP) or \$1122 for (BS) Add \$43 for (TP) Add \$396 for (MB)</p>	<table border="1"> <thead> <tr> <th colspan="3">OVERALL DIMENSIONS</th> <th colspan="3">SEAT DIMENSIONS</th> <th colspan="2">BACK DIMENSIONS</th> </tr> <tr> <th>W</th> <th>D</th> <th>H</th> <th>W</th> <th>D</th> <th>H</th> <th>W</th> <th>H</th> </tr> </thead> <tbody> <tr> <td>78</td> <td>30.5</td> <td>41.5</td> <td>78</td> <td>19</td> <td>18</td> <td>78</td> <td>23.5</td> </tr> <tr> <td colspan="2">RTA 00</td> <td colspan="6">1 per carton</td> </tr> </tbody> </table>	OVERALL DIMENSIONS			SEAT DIMENSIONS			BACK DIMENSIONS		W	D	H	W	D	H	W	H	78	30.5	41.5	78	19	18	78	23.5	RTA 00		1 per carton												
OVERALL DIMENSIONS			SEAT DIMENSIONS			BACK DIMENSIONS																																			
W	D	H	W	D	H	W	H																																		
78	30.5	41.5	78	19	18	78	23.5																																		
RTA 00		1 per carton																																							
 <p>R27808B R27808SB</p> <p>Three Seater - High Back COM Yardage: Back: 7.75; Seat: 3.50 Freight class: 250 Product weight: 190.5 221.5 shelf model Cubic feet per carton: 69.75 101.5 shelf model</p>	<p>R27808B Base Price: \$6985</p> <p>R27808SB Base Price: \$7997</p> <p>Back/Arm upcharge: +0</p> <p>Seat upcharge: +0</p>	\$6985																																							
	<p>Back/Arm upcharge: +\$262</p> <p>Seat upcharge: +\$467</p> <p> +\$770</p> <p> +\$1195</p> <p> +\$1374+\$1742</p> <p> +\$2323</p> <p> +\$2756</p> <p> +\$3231</p> <p> +\$4219</p> <p> +\$5259</p> <p>Shelf: 52W 10D 1H</p>	+\$262	+\$467	+\$770	+\$1195	+\$1374+\$1742	+\$2323	+\$2756	+\$3231	+\$4219	+\$5259																														
	<p>For power/USB unit, see electrical placement chart. Ganging not available. Add \$124 for (SSS), \$251 for (SBS) Add \$1330 for 72 lbs. (CW), (C6) Add \$311 for (SP) or \$1122 for (BS) Add \$43 for (TP) Add \$396 for (MB)</p>	<table border="1"> <thead> <tr> <th colspan="3">OVERALL DIMENSIONS</th> <th colspan="3">SEAT DIMENSIONS</th> <th colspan="2">BACK DIMENSIONS</th> </tr> <tr> <th>W</th> <th>D</th> <th>H</th> <th>W</th> <th>D</th> <th>H</th> <th>W</th> <th>H</th> </tr> </thead> <tbody> <tr> <td>85</td> <td>30.5</td> <td>41.5</td> <td>78</td> <td>19</td> <td>18</td> <td>78</td> <td>23.5</td> </tr> <tr> <td colspan="2">RTA 00</td> <td colspan="6">1 per carton</td> </tr> </tbody> </table>	OVERALL DIMENSIONS			SEAT DIMENSIONS			BACK DIMENSIONS		W	D	H	W	D	H	W	H	85	30.5	41.5	78	19	18	78	23.5	RTA 00		1 per carton												
OVERALL DIMENSIONS			SEAT DIMENSIONS			BACK DIMENSIONS																																			
W	D	H	W	D	H	W	H																																		
85	30.5	41.5	78	19	18	78	23.5																																		
RTA 00		1 per carton																																							
 <p>R27808L R27808R</p> <p>Three Seater - High Back COM Yardage: Back: 6.75; Seat: 3.50 Freight class: 250 Product weight: 180.5 Cubic feet per carton: 76.75</p>	<p>R27808L Base Price: \$6594</p> <p>R27808R Base Price: \$6594</p> <p>Back/Arm upcharge: +0</p> <p>Seat upcharge: +0</p>	\$6594																																							
	<p>Back/Arm upcharge: +\$228</p> <p>Seat upcharge: +\$407</p> <p> +\$670</p> <p> +\$1041</p> <p> +\$1197+\$1518</p> <p> +\$2023</p> <p> +\$2401</p> <p> +\$2814</p> <p> +\$3675</p> <p> +\$4580</p>	+\$228	+\$407	+\$670	+\$1041	+\$1197+\$1518	+\$2023	+\$2401	+\$2814	+\$3675	+\$4580																														
	<p>For power/USB unit, see electrical placement chart. Includes ganging hardware (2 sides). Add \$124 for (SSS), \$251 for (SBS) Add \$1330 for 72 lbs. (CW), (C6) Add \$311 for (SP) or \$1122 for (BS) Add \$43 for (TP) Add \$396 for (MB)</p>	<table border="1"> <thead> <tr> <th colspan="3">OVERALL DIMENSIONS</th> <th colspan="3">SEAT DIMENSIONS</th> <th colspan="2">BACK DIMENSIONS</th> </tr> <tr> <th>W</th> <th>D</th> <th>H</th> <th>W</th> <th>D</th> <th>H</th> <th>W</th> <th>H</th> </tr> </thead> <tbody> <tr> <td>81.5</td> <td>30.5</td> <td>41.5</td> <td>78</td> <td>19</td> <td>18</td> <td>78</td> <td>23.5</td> </tr> <tr> <td colspan="2">RTA 00</td> <td colspan="6">1 per carton</td> </tr> </tbody> </table>	OVERALL DIMENSIONS			SEAT DIMENSIONS			BACK DIMENSIONS		W	D	H	W	D	H	W	H	81.5	30.5	41.5	78	19	18	78	23.5	RTA 00		1 per carton												
OVERALL DIMENSIONS			SEAT DIMENSIONS			BACK DIMENSIONS																																			
W	D	H	W	D	H	W	H																																		
81.5	30.5	41.5	78	19	18	78	23.5																																		
RTA 00		1 per carton																																							
 <p>R27808SL R27808SR</p> <p>Three Seater - High Back COM Yardage: Back: 6.75; Seat: 3.50 Freight class: 250 Product weight: 211.5 Cubic feet per carton: 101.5</p>	<p>R27808SL Base Price: \$7608</p> <p>R27808SR Base Price: \$7608</p> <p>Back/Arm upcharge: +0</p> <p>Seat upcharge: +0</p>	\$7608																																							
	<p>Back/Arm upcharge: +\$228</p> <p>Seat upcharge: +\$407</p> <p> +\$670</p> <p> +\$1041</p> <p> +\$1197+\$1518</p> <p> +\$2023</p> <p> +\$2401</p> <p> +\$2814</p> <p> +\$3675</p> <p> +\$4580</p> <p>Shelf: 52W 10D 1H</p>	+\$228	+\$407	+\$670	+\$1041	+\$1197+\$1518	+\$2023	+\$2401	+\$2814	+\$3675	+\$4580																														
	<p>For power/USB unit, see electrical placement chart. Includes ganging hardware (2 sides). Add \$124 for (SSS), \$251 for (SBS) Add \$1330 for 72 lbs. (CW), (C6) Add \$311 for (SP) or \$1122 for (BS) Add \$43 for (TP) Add \$396 for (MB)</p>	<table border="1"> <thead> <tr> <th colspan="3">OVERALL DIMENSIONS</th> <th colspan="3">SEAT DIMENSIONS</th> <th colspan="2">BACK DIMENSIONS</th> </tr> <tr> <th>W</th> <th>D</th> <th>H</th> <th>W</th> <th>D</th> <th>H</th> <th>W</th> <th>H</th> </tr> </thead> <tbody> <tr> <td>81.5</td> <td>41</td> <td>41.5</td> <td>78</td> <td>19</td> <td>18</td> <td>78</td> <td>23.5</td> </tr> <tr> <td colspan="2">RTA 00</td> <td colspan="6">1 per carton</td> </tr> </tbody> </table>	OVERALL DIMENSIONS			SEAT DIMENSIONS			BACK DIMENSIONS		W	D	H	W	D	H	W	H	81.5	41	41.5	78	19	18	78	23.5	RTA 00		1 per carton												
OVERALL DIMENSIONS			SEAT DIMENSIONS			BACK DIMENSIONS																																			
W	D	H	W	D	H	W	H																																		
81.5	41	41.5	78	19	18	78	23.5																																		
RTA 00		1 per carton																																							

DESCRIPTION		MODEL#/ FEATURES		STANDARD TEXTILE GRADES													
				1/COM	2	3	4	5	6	7	8	9	10	11	12		
		R27809 Base Price: \$6732 R27809S Base Price: \$7744 Back upcharge: +0 Seat upcharge: +0	For power/USB unit, see electrical placement chart. Includes ganging hardware (2 sides). Add \$124 for (SSS), \$207 for (SBS) Add \$1330 for 72 lbs. (CW), (C6) Add \$311 for (SP) or \$1122 for (BS) Add \$43 for (TP) Add \$396 for (MB)	1/COM	2	3	4	5	6	7	8	9	10	11	12		
				+\$220 +\$119	+\$392 +\$211	+\$645 +\$348	+\$1002 +\$540	+\$1153 +\$621	+\$1462 +\$788	+\$1948 +\$1049	+\$2312 +\$1245	+\$2710 +\$1460	+\$3539 +\$1906	+\$4410 +\$2375	OVERALL DIMENSIONS W D H		SEAT DIMENSIONS W D H
Three Seater - Extended Back COM Yardage: Back: 6.50; Seat: 3.50 Freight class: 250 Product weight: 165 198 shelf model Cubic feet per carton: 79.25 108.5 shelf model				78	31	47	78	19	18	78	29	RTA 00		1 per carton			
		R27809B Base Price: \$7509 R27809SB Base Price: \$8521 Back/Arm upcharge: +0 Seat upcharge: +0	For power/USB unit, see electrical placement chart. Ganging not available. Add \$124 for (SSS), \$262 for (SBS) Add \$1330 for 72 lbs. (CW), (C6) Add \$311 for (SP) or \$1122 for (BS) Add \$43 for (TP) Add \$396 for (MB)	1/COM	2	3	4	5	6	7	8	9	10	11	12		
				+\$287 +\$119	+\$512 +\$211	+\$843 +\$348	+\$1310 +\$540	+\$1507 +\$621	+\$1911 +\$788	+\$2547 +\$1049	+\$3023 +\$1245	+\$3543 +\$1460	+\$4628 +\$1906	+\$5767 +\$2375	OVERALL DIMENSIONS W D H		SEAT DIMENSIONS W D H
Three Seater - Extended Back COM Yardage: Back: 7.50; Seat: 3.50 Freight class: 250 Product weight: 190 220 shelf model Cubic feet per carton: 86.25 114 shelf model				85	31	47	78	19	18	78	29	RTA 00		1 per carton			
		R27809L Base Price: \$7121 R27809R Base Price: \$7121 Back/Arm upcharge: +0 Seat upcharge: +0	For power/USB unit, see electrical placement chart. Includes ganging hardware (1 side). Add \$124 for (SSS), \$235 for (SBS) Add \$1330 for 72 lbs. (CW), (C6) Add \$311 for (SP) or \$1122 for (BS) Add \$43 for (TP) Add \$396 for (MB)	1/COM	2	3	4	5	6	7	8	9	10	11	12		
				+\$254 +\$119	+\$452 +\$211	+\$744 +\$348	+\$1156 +\$540	+\$1330 +\$621	+\$1686 +\$788	+\$2248 +\$1049	+\$2668 +\$1245	+\$3126 +\$1460	+\$4083 +\$1906	+\$5089 +\$2375	OVERALL DIMENSIONS W D H		SEAT DIMENSIONS W D H
Three Seater - Extended Back COM Yardage: Back: 7.50; Seat: 3.50 Freight class: 250 Product weight: 180 Cubic feet per carton: 86.25				81.5	31	47	78	19	18	78	29	RTA 00		1 per carton			
		R27809SL Base Price: \$8132 R27809SR Base Price: \$8132 Back/Arm upcharge: +0 Seat upcharge: +0	For power/USB unit, see electrical placement chart. Includes ganging hardware (1 side). Add \$124 for (SSS), \$235 for (SBS) Add \$1330 for 72 lbs. (CW), (C6) Add \$311 for (SP) or \$1122 for (BS) Add \$43 for (TP) Add \$396 for (MB)	1/COM	2	3	4	5	6	7	8	9	10	11	12		
				+\$254 +\$119	+\$452 +\$211	+\$744 +\$348	+\$1156 +\$540	+\$1330 +\$621	+\$1686 +\$788	+\$2248 +\$1049	+\$2668 +\$1245	+\$3126 +\$1460	+\$4083 +\$1906	+\$5089 +\$2375	OVERALL DIMENSIONS W D H		SEAT DIMENSIONS W D H
Three Seater - Extended Back COM Yardage: Back: 7.50; Seat: 3.50 Freight class: 250 Product weight: 210 Cubic feet per carton: 114				81.5	41.5	47	78	19	18	78	29	RTA 00		1 per carton			

Shelf: 52W 10D 1H

DESCRIPTION	MODEL#/ FEATURES	STANDARD TEXTILE GRADES												
		1/COM	2	3	4	5	6	7	8	9	10	11	12	
 <p>R27810</p> <p>Bariatric Lounge Chair - Standard Back COM Yardage: Back: 2.25; Seat: 2 Freight class: 250 Product weight: 90 Cubic feet per carton: 28.75</p>	R27810	Base Price:	\$3324											
		Back upcharge:	+0	+\$76	+\$137	+\$224	+\$348	+\$399	+\$507	+\$675	+\$801	+\$938	+\$1225	+\$1527
		Seat upcharge:	+0	+\$68	+\$121	+\$199	+\$309	+\$355	+\$450	+\$600	+\$712	+\$834	+\$1089	+\$1357
		For power/USB unit, see electrical placement chart. Includes ganging hardware (2 sides). Add \$74 for (SSS), \$91 for (SBS) Add \$667 for 36 lbs. (CW) Add \$146 for (SP) or \$716 for (BS) Add \$43 for (TP) Add \$199 for (MB)												
				OVERALL DIMENSIONS			SEAT DIMENSIONS			BACK DIMENSIONS				
				W	D	H	W	D	H	W	H			
				39	30	32	39	19	18		39	14		
				RTA 00			1 per carton							
 <p>R27810B</p> <p>Bariatric Lounge Chair - Standard Back COM Yardage: Back: 4.25; Seat: 2 Freight class: 250 Product weight: 108 Cubic feet per carton: 33</p>	R27810B	Base Price:	\$4100											
		Back/Arm upcharge:	+0	+\$144	+\$257	+\$422	+\$656	+\$754	+\$956	+\$1274	+\$1512	+\$1772	+\$2314	+\$2884
		Seat upcharge:	+0	+\$68	+\$121	+\$199	+\$309	+\$355	+\$450	+\$600	+\$712	+\$834	+\$1089	+\$1357
		For power/USB unit, see electrical placement chart. Ganging not available. Add \$74 for (SSS), \$147 for (SBS) Add \$667 for 36 lbs. (CW) Add \$146 for (SP) or \$716 for (BS) Add \$43 for (TP) Add \$199 for (MB)												
				OVERALL DIMENSIONS			SEAT DIMENSIONS			BACK DIMENSIONS				
				W	D	H	W	D	H	W	H			
				46	30	32	39	19	18		39	14		
				RTA 00			1 per carton							
 <p>R27810L</p> <p>Bariatric Lounge Chair - Standard Back COM Yardage: Back: 3.25; Seat: 2 Freight class: 250 Product weight: 98 Cubic feet per carton: 33</p>	R27810L	Base Price:	\$3712											
	R27810R	Base Price:	\$3712											
		Back/Arm upcharge:	+0	+\$110	+\$197	+\$323	+\$502	+\$577	+\$732	+\$974	+\$1157	+\$1355	+\$1770	+\$2205
		Seat upcharge:	+0	+\$68	+\$121	+\$199	+\$309	+\$355	+\$450	+\$600	+\$712	+\$834	+\$1089	+\$1357
		For power/USB unit, see electrical placement chart. Includes ganging hardware (1 side). Add \$74 for (SSS), \$119 for (SBS) Add \$667 for 36 lbs. (CW) Add \$146 for (SP) or \$716 for (BS) Add \$43 for (TP) Add \$199 for (MB)												
				OVERALL DIMENSIONS			SEAT DIMENSIONS			BACK DIMENSIONS				
				W	D	H	W	D	H	W	H			
				42.5	30	32	39	19	18		39	14		
				RTA 00			1 per carton							
 <p>R27811</p> <p>Bariatric Lounge Chair - High Back COM Yardage: Back: 2.75; Seat: 2 Freight class: 250 Product weight: 98 Cubic feet per carton: 36</p>	R27811	Base Price:	\$3697											
		Back upcharge:	+0	+\$93	+\$166	+\$274	+\$425	+\$488	+\$619	+\$824	+\$978	+\$1147	+\$1498	+\$4580
		Seat upcharge:	+0	+\$119	+\$121	+\$199	+\$309	+\$355	+\$450	+\$600	+\$712	+\$834	+\$1089	+\$1357
		For power/USB unit, see electrical placement chart. Includes ganging hardware (2 sides). Add \$74 for (SSS), \$117 for (SBS) Add \$667 for 36 lbs. (CW), (CG) Add \$146 for (SP) or \$716 for (BS) Add \$43 for (TP) Add \$199 for (MB)												
				OVERALL DIMENSIONS			SEAT DIMENSIONS			BACK DIMENSIONS				
				W	D	H	W	D	H	W	H			
				39	30.5	41.5	39	19	18		39	23.5		
				RTA 00			1 per carton							

DESCRIPTION MODEL#/ FEATURES STANDARD TEXTILE GRADES



R27811B

Bariatric Lounge Chair - High Back

COM Yardage: Back: 4.75; Seat: 2
Freight class: 250
Product weight: 117.5
Cubic feet per carton: 42.25

R27811B Base Price:

\$4473

Back/Arm upcharge:

+0 +\$161 +\$286 +\$472 +\$733 +\$842 +\$1068 +\$1424 +\$1690 +\$1981 +\$2586 +\$3224

Seat upcharge:

+0 +\$68 +\$121 +\$199 +\$309 +\$355 +\$450 +\$600 +\$712 +\$834 +\$1089 +\$1357

For power/USB unit, see electrical placement chart.
Ganging not available.

Add \$74 for (SSS), \$171 for (SBS)
Add \$667 for 36 lbs. (CW), (C6)
Add \$146 for (SP) or \$716 for (BS)
Add \$43 for (TP)
Add \$199 for (MB)

OVERALL DIMENSIONS

W D H

46 30.5 41.5

SEAT DIMENSIONS

W D H

39 19 18

BACK DIMENSIONS

W H

39 23.5

RTA 00 1 per carton



R27811L

Bariatric Lounge Chair - High Back

COM Yardage: Back: 3.75; Seat: 2
Freight class: 250
Product weight: 107.5
Cubic feet per carton: 42.25



R27811R

R27811L Base Price:

\$4085

R27811R Base Price:

\$4085

Back/Arm upcharge:

+0 +\$127 +\$226 +\$373 +\$579 +\$665 +\$843 +\$1124 +\$1334 +\$1564 +\$2042 +\$2545

Seat upcharge:

+0 +\$68 +\$121 +\$199 +\$309 +\$355 +\$450 +\$600 +\$712 +\$834 +\$1089 +\$1357

For power/USB unit, see electrical placement chart.
Includes ganging hardware (1 side).

Add \$74 for (SSS), \$145 for (SBS)
Add \$667 for 36 lbs. (CW), (C6)
Add \$146 for (SP) or \$716 for (BS)
Add \$43 for (TP)
Add \$199 for (MB)

OVERALL DIMENSIONS

W D H

42.5 30.5 41.5

SEAT DIMENSIONS

W D H

39 19 18

BACK DIMENSIONS

W H

39 23.5

RTA 00 1 per carton



R27812

Bariatric Lounge Chair - Extended Back

COM Yardage: Back: 3.25; Seat: 2
Freight class: 250
Product weight: 115
Cubic feet per carton: 41

R27812 Base Price:

\$3913

Back upcharge:

+0 +\$110 +\$197 +\$323 +\$502 +\$577 +\$732 +\$974 +\$1157 +\$1355 +\$1770 +\$2205

Seat upcharge:

+0 +\$68 +\$121 +\$199 +\$309 +\$355 +\$450 +\$600 +\$712 +\$834 +\$1089 +\$1357

For power/USB unit, see electrical placement chart.
Includes ganging hardware (2 sides).

Add \$74 for (SSS), \$126 for (SBS)
Add \$667 for 36 lbs. (CW), (C6)
Add \$146 for (SP) or \$716 for (BS)
Add \$43 for (TP)
Add \$199 for (MB)

OVERALL DIMENSIONS

W D H

39 31 47

SEAT DIMENSIONS

W D H

39 19 18

BACK DIMENSIONS

W H

39 29

RTA 00 1 per carton



R27812B

Bariatric Lounge Chair - Extended Back

COM Yardage: Back: 5.25; Seat: 2
Freight class: 250
Product weight: 132.5
Cubic feet per carton: 47.25

R27812B Base Price:

\$4691

Back/Arm upcharge:

+0 +\$178 +\$317 +\$522 +\$810 +\$931 +\$1181 +\$1574 +\$1868 +\$2189 +\$2858 +\$3562

Seat upcharge:

+0 +\$68 +\$121 +\$199 +\$309 +\$355 +\$450 +\$600 +\$712 +\$834 +\$1089 +\$1357

For power/USB unit, see electrical placement chart.
Ganging not available.

Add \$74 for (SSS), \$181 for (SBS)
Add \$667 for 36 lbs. (CW), (C6)
Add \$146 for (SP) or \$716 for (BS)
Add \$43 for (TP)
Add \$199 for (MB)

OVERALL DIMENSIONS

W D H

46 31 47

SEAT DIMENSIONS

W D H





39 19 18





BACK DIMENSIONS





W H





39 29









RTA 00 1 per carton





DESCRIPTION		MODEL#/ FEATURES		STANDARD TEXTILE GRADES																																							
				1/COM	2	3	4	5	6	7	8	9	10	11	12																												
	<p>R27812L</p> <p>Bariatric Lounge Chair - Extended Back COM Yardage: Back: 4.25; Seat: 2 Freight class: 250 Product weight: 122.5 Cubic feet per carton: 47.25</p>	<p>R27812R</p> <p>For power/USB unit, see electrical placement chart. Includes ganging hardware (1 side). Add \$74 for (SSS), \$153 for (SBS) Add \$667 for 36 lbs. (CW), (C6) Add \$146 for (SP) or \$716 for (BS) Add \$43 for (TP) Add \$199 for (MB)</p>	<p>Base Price: \$4304 Base Price: \$4304</p> <p>Back/Arm upcharge: +0 Seat upcharge: +0</p>	<table border="1"> <tr> <td>1/COM</td><td>2</td><td>3</td><td>4</td><td>5</td><td>6</td><td>7</td><td>8</td><td>9</td><td>10</td><td>11</td><td>12</td> </tr> <tr> <td></td><td></td><td></td><td></td><td></td><td></td><td></td><td></td><td></td><td></td><td></td><td></td><td></td><td></td><td></td><td></td> </tr> </table>												1/COM	2	3	4	5	6	7	8	9	10	11	12																
				1/COM	2	3	4	5	6	7	8	9	10	11	12																												
				<p>OVERALL DIMENSIONS</p> <p>W D H</p>			<p>SEAT DIMENSIONS</p> <p>W D H</p>			<p>BACK DIMENSIONS</p> <p>W H</p>																																	
				42.5	31	47	39	19	18	39	29																																
				<p>RTA 00</p>		1 per carton																																					
	<p>R27815</p> <p>Inside Curve Two Seater - Standard Back COM Yardage: Back: 3; Seat: 2 Freight class: 250 Product weight: 93 119 shelf model Cubic feet per carton: 42.75 63.5 shelf model</p>	<p>R27815S</p> <p>For power/USB unit, see electrical placement chart. Includes ganging hardware (2 sides). Add \$91 for (SSS), \$126 for (SBS) Add \$1330 for 72 lbs. (CW), (C6) Add \$184 for (SP) or \$816 for (BS) Add \$43 for (TP) Add \$266 for (MB)</p>	<p>Base Price: \$3582 Base Price: \$4692</p> <p>Back upcharge: +0 Seat upcharge: +0</p>	<table border="1"> <tr> <td>1/COM</td><td>2</td><td>3</td><td>4</td><td>5</td><td>6</td><td>7</td><td>8</td><td>9</td><td>10</td><td>11</td><td>12</td> </tr> <tr> <td></td><td></td><td></td><td></td><td></td><td></td><td></td><td></td><td></td><td></td><td></td><td></td><td></td><td></td><td></td><td></td> </tr> </table>												1/COM	2	3	4	5	6	7	8	9	10	11	12																
				1/COM	2	3	4	5	6	7	8	9	10	11	12																												
				<p>OVERALL DIMENSIONS</p> <p>W D H</p>			<p>SEAT DIMENSIONS</p> <p>W D H</p>			<p>BACK DIMENSIONS</p> <p>W H</p>																																	
				50.5	30	32	42	19	18	51	14																																
				<p>RTA 00</p>		1 per carton																																					
Shelf: 52W 10D 1H																																											
	<p>R27815L</p> <p>Inside Curve Two Seater - Standard Back COM Yardage: Back: 4; Seat: 2 Freight class: 250 Product weight: 102 Cubic feet per carton: 43.5</p>	<p>R27815R</p> <p>For power/USB unit, see electrical placement chart. Includes ganging hardware (1 side). Add \$91 for (SSS), \$153 for (SBS) Add \$1330 for 72 lbs. (CW), (C6) Add \$184 for (SP) or \$816 for (BS) Add \$43 for (TP) Add \$266 for (MB)</p>	<p>Base Price: \$3972 Base Price: \$3972</p> <p>Back/Arm upcharge: +0 Seat upcharge: +0</p>	<table border="1"> <tr> <td>1/COM</td><td>2</td><td>3</td><td>4</td><td>5</td><td>6</td><td>7</td><td>8</td><td>9</td><td>10</td><td>11</td><td>12</td> </tr> <tr> <td></td><td></td><td></td><td></td><td></td><td></td><td></td><td></td><td></td><td></td><td></td><td></td><td></td><td></td><td></td><td></td> </tr> </table>												1/COM	2	3	4	5	6	7	8	9	10	11	12																
				1/COM	2	3	4	5	6	7	8	9	10	11	12																												
				<p>OVERALL DIMENSIONS</p> <p>W D H</p>			<p>SEAT DIMENSIONS</p> <p>W D H</p>			<p>BACK DIMENSIONS</p> <p>W H</p>																																	
				54	30	32	42	19	18	51	14																																
				<p>RTA 00</p>		1 per carton																																					
	<p>R27815SL</p> <p>Inside Curve Two Seater - Standard Back COM Yardage: Back: 4; Seat: 2 Freight class: 250 Product weight: 102 128 shelf model Cubic feet per carton: 43.5 65 shelf model</p>	<p>R27815SR</p> <p>For power/USB unit, see electrical placement chart. Includes ganging hardware (1 side). Add \$91 for (SSS), \$153 for (SBS) Add \$1330 for 72 lbs. (CW), (C6) Add \$184 for (SP) or \$816 for (BS) Add \$43 for (TP) Add \$266 for (MB)</p>	<p>Base Price: \$5081 Base Price: \$5081</p> <p>Back/Arm upcharge: +0 Seat upcharge: +0</p>	<table border="1"> <tr> <td>1/COM</td><td>2</td><td>3</td><td>4</td><td>5</td><td>6</td><td>7</td><td>8</td><td>9</td><td>10</td><td>11</td><td>12</td> </tr> <tr> <td></td><td></td><td></td><td></td><td></td><td></td><td></td><td></td><td></td><td></td><td></td><td></td><td></td><td></td><td></td><td></td> </tr> </table>												1/COM	2	3	4	5	6	7	8	9	10	11	12																
				1/COM	2	3	4	5	6	7	8	9	10	11	12																												
				<p>OVERALL DIMENSIONS</p> <p>W D H</p>			<p>SEAT DIMENSIONS</p> <p>W D H</p>			<p>BACK DIMENSIONS</p> <p>W H</p>																																	
				61.5	40.5	32	42	19	18	51	14																																
				<p>RTA 00</p>		1 per carton																																					
Shelf: 52W 10D 1H																																											

DESCRIPTION		MODEL#/ FEATURES		STANDARD TEXTILE GRADES																																	
				1/COM	2	3	4	5	6	7	8	9	10	11	12																						
 <p>R27816</p> <p>Inside Curve Two Seater - High Back COM Yardage: Back: 3.50; Seat: 2 Freight class: 300 Product weight: 106 132 shelf model Cubic feet per carton: 53.75 79.75 shelf model</p>	<p>R27816S</p> <p>For power/USB unit, see electrical placement chart. Includes ganging hardware (2 sides). Add \$91 for (SSS), \$166 for (SBS) Add \$1330 for 72 lbs. (CW), (C6) Add \$184 for (SP) or \$816 for (BS) Add \$43 for (TP) Add \$266 for (MB)</p>	<p>R27816 Base Price: \$4663</p> <p>R27816S Base Price: \$5704</p> <p>Back upcharge: +0</p> <p>Seat upcharge: +0</p>	<p>\$4663</p> <p>\$5704</p> <p>+0</p> <p>+0</p>																																		
		<p>Shelf: 52W 10D 1H</p> <table border="1"> <thead> <tr> <th colspan="3">OVERALL DIMENSIONS</th> <th colspan="3">SEAT DIMENSIONS</th> <th colspan="2">BACK DIMENSIONS</th> </tr> <tr> <th>W</th> <th>D</th> <th>H</th> <th>W</th> <th>D</th> <th>H</th> <th>W</th> <th>H</th> </tr> </thead> <tbody> <tr> <td>51</td> <td>30.5</td> <td>41.5</td> <td>42</td> <td>19</td> <td>18</td> <td>51</td> <td>23.5</td> </tr> </tbody> </table> <p>RTA 00 1 per carton</p>				OVERALL DIMENSIONS			SEAT DIMENSIONS			BACK DIMENSIONS		W	D	H	W	D	H	W	H	51	30.5	41.5	42	19	18	51	23.5								
OVERALL DIMENSIONS			SEAT DIMENSIONS			BACK DIMENSIONS																															
W	D	H	W	D	H	W	H																														
51	30.5	41.5	42	19	18	51	23.5																														
 <p>R27816L</p> <p>Inside Curve Two Seater - High Back COM Yardage: Back: 4.50; Seat: 2 Freight class: 250 Product weight: 115 Cubic feet per carton: 55.5</p>	<p>R27816SR</p> <p>For power/USB unit, see electrical placement chart. Includes ganging hardware (1 side). Add \$91 for (SSS), \$194 for (SBS) Add \$1330 for 72 lbs. (CW), (C6) Add \$184 for (SP) or \$816 for (BS) Add \$43 for (TP) Add \$266 for (MB)</p>	<p>R27816L Base Price: \$5052</p> <p>R27816SR Base Price: \$5052</p> <p>Back/Arm upcharge: +0</p> <p>Seat upcharge: +0</p>	<p>\$5052</p> <p>\$5052</p> <p>+0</p> <p>+0</p>																																		
		<p>Shelf: 52W 10D 1H</p> <table border="1"> <thead> <tr> <th colspan="3">OVERALL DIMENSIONS</th> <th colspan="3">SEAT DIMENSIONS</th> <th colspan="2">BACK DIMENSIONS</th> </tr> <tr> <th>W</th> <th>D</th> <th>H</th> <th>W</th> <th>D</th> <th>H</th> <th>W</th> <th>H</th> </tr> </thead> <tbody> <tr> <td>54.5</td> <td>30.5</td> <td>41.5</td> <td>42</td> <td>19</td> <td>18</td> <td>51</td> <td>23.5</td> </tr> </tbody> </table> <p>RTA 00 1 per carton</p>				OVERALL DIMENSIONS			SEAT DIMENSIONS			BACK DIMENSIONS		W	D	H	W	D	H	W	H	54.5	30.5	41.5	42	19	18	51	23.5								
OVERALL DIMENSIONS			SEAT DIMENSIONS			BACK DIMENSIONS																															
W	D	H	W	D	H	W	H																														
54.5	30.5	41.5	42	19	18	51	23.5																														
 <p>R27816SL</p> <p>Inside Curve Two Seater - High Back COM Yardage: Back: 4.50; Seat: 2 Freight class: 250 Product weight: 141.5 Cubic feet per carton: 82.5</p>	<p>R27816SR</p> <p>For power/USB unit, see electrical placement chart. Includes ganging hardware (1 side). Add \$91 for (SSS), \$194 for (SBS) Add \$1330 for 72 lbs. (CW), (C6) Add \$184 for (SP) or \$816 for (BS) Add \$43 for (TP) Add \$266 for (MB)</p>	<p>R27816SL Base Price: \$6093</p> <p>R27816SR Base Price: \$6093</p> <p>Back/Arm upcharge: +0</p> <p>Seat upcharge: +0</p>	<p>\$6093</p> <p>\$6093</p> <p>+0</p> <p>+0</p>																																		
		<p>Shelf: 52W 10D 1H</p> <table border="1"> <thead> <tr> <th colspan="3">OVERALL DIMENSIONS</th> <th colspan="3">SEAT DIMENSIONS</th> <th colspan="2">BACK DIMENSIONS</th> </tr> <tr> <th>W</th> <th>D</th> <th>H</th> <th>W</th> <th>D</th> <th>H</th> <th>W</th> <th>H</th> </tr> </thead> <tbody> <tr> <td>62</td> <td>41</td> <td>41.5</td> <td>42</td> <td>19</td> <td>18</td> <td>51</td> <td>23.5</td> </tr> </tbody> </table> <p>RTA 00 1 per carton</p>				OVERALL DIMENSIONS			SEAT DIMENSIONS			BACK DIMENSIONS		W	D	H	W	D	H	W	H	62	41	41.5	42	19	18	51	23.5								
OVERALL DIMENSIONS			SEAT DIMENSIONS			BACK DIMENSIONS																															
W	D	H	W	D	H	W	H																														
62	41	41.5	42	19	18	51	23.5																														
 <p>R27817</p> <p>Inside Curve Two Seater - Extended Back COM Yardage: Back: 4; Seat: 2 Freight class: 300 Product weight: 118 139 shelf model Cubic feet per carton: 61 90.5 shelf model</p>	<p>R27817S</p> <p>For power/USB unit, see electrical placement chart. Includes ganging hardware (2 sides). Add \$91 for (SSS), \$178 for (SBS) Add \$1330 for 72 lbs. (CW), (C6) Add \$184 for (SP) or \$816 for (BS) Add \$43 for (TP) Add \$266 for (MB)</p>	<p>R27817 Base Price: \$4939</p> <p>R27817S Base Price: \$5981</p> <p>Back upcharge: +0</p> <p>Seat upcharge: +0</p>	<p>\$4939</p> <p>\$5981</p> <p>+0</p> <p>+0</p>																																		
		<p>Shelf: 52W 10D 1H</p> <table border="1"> <thead> <tr> <th colspan="3">OVERALL DIMENSIONS</th> <th colspan="3">SEAT DIMENSIONS</th> <th colspan="2">BACK DIMENSIONS</th> </tr> <tr> <th>W</th> <th>D</th> <th>H</th> <th>W</th> <th>D</th> <th>H</th> <th>W</th> <th>H</th> </tr> </thead> <tbody> <tr> <td>51.5</td> <td>31</td> <td>47</td> <td>42</td> <td>19</td> <td>18</td> <td>51</td> <td>29</td> </tr> </tbody> </table> <p>RTA 00 1 per carton</p>				OVERALL DIMENSIONS			SEAT DIMENSIONS			BACK DIMENSIONS		W	D	H	W	D	H	W	H	51.5	31	47	42	19	18	51	29								
OVERALL DIMENSIONS			SEAT DIMENSIONS			BACK DIMENSIONS																															
W	D	H	W	D	H	W	H																														
51.5	31	47	42	19	18	51	29																														

DESCRIPTION		MODEL#/ FEATURES		STANDARD TEXTILE GRADES																																																																																																																						
				1/COM	2	3	4	5	6	7	8	9	10	11	12																																																																																																											
	<p>R27817L</p> <p>Inside Curve Two Seater - Extended Back COM Yardage: Back: 5; Seat: 2 Freight class: 300 Product weight: 122 Cubic feet per carton: 62.25</p>	<p>R27817R</p> <p>For power/USB unit, see electrical placement chart. Includes ganging hardware (1 side). Add \$91 for (SSS), \$206 for (SBS) Add \$1330 for 72 lbs. (CW), (C6) Add \$184 for (SP) or \$816 for (BS) Add \$43 for (TP) Add \$266 for (MB)</p>	<p>Base Price: \$5327</p> <p>Base Price: \$5327</p> <p>Back/Arm upcharge: +0</p> <p>Seat upcharge: +0</p>	<table border="1"> <tr> <td>1/COM</td><td>2</td><td>3</td><td>4</td><td>5</td><td>6</td><td>7</td><td>8</td><td>9</td><td>10</td><td>11</td><td>12</td> </tr> <tr> <td></td><td></td><td></td><td></td><td></td><td></td><td></td><td></td><td></td><td></td><td></td><td></td><td></td><td></td><td></td><td></td> </tr> <tr> <td colspan="3">OVERALL DIMENSIONS</td> <td colspan="3">SEAT DIMENSIONS</td> <td colspan="3">BACK DIMENSIONS</td> <td colspan="6"></td> </tr> <tr> <td>W</td><td>D</td><td>H</td> <td>W</td><td>D</td><td>H</td> <td>W</td><td>H</td> <td colspan="8"></td> </tr> <tr> <td>54</td><td>31</td><td>47</td> <td>42</td><td>19</td><td>18</td> <td>51</td><td>29</td> <td colspan="8"></td> </tr> <tr> <td colspan="4"></td> <td colspan="12"> <table border="1"> <tr> <td>RTA 00</td> <td colspan="15">1 per carton</td> </tr> </table> </td> </tr> </table>												1/COM	2	3	4	5	6	7	8	9	10	11	12																	OVERALL DIMENSIONS			SEAT DIMENSIONS			BACK DIMENSIONS									W	D	H	W	D	H	W	H									54	31	47	42	19	18	51	29													<table border="1"> <tr> <td>RTA 00</td> <td colspan="15">1 per carton</td> </tr> </table>												RTA 00	1 per carton														
				1/COM	2	3	4	5	6	7	8	9	10	11	12																																																																																																											
OVERALL DIMENSIONS			SEAT DIMENSIONS			BACK DIMENSIONS																																																																																																																				
W	D	H	W	D	H	W	H																																																																																																																			
54	31	47	42	19	18	51	29																																																																																																																			
				<table border="1"> <tr> <td>RTA 00</td> <td colspan="15">1 per carton</td> </tr> </table>												RTA 00	1 per carton																																																																																																									
RTA 00	1 per carton																																																																																																																									
	<p>R27817SL</p> <p>Inside Curve Two Seater - Extended Back COM Yardage: Back: 5; Seat: 2 Freight class: 300 Product weight: 149 Cubic feet per carton: 92.75</p>	<p>R27817SR</p> <p>For power/USB unit, see electrical placement chart. Includes ganging hardware (1 side). Add \$91 for (SSS), \$206 for (SBS) Add \$1330 for 72 lbs. (CW), (C6) Add \$184 for (SP) or \$816 for (BS) Add \$43 for (TP) Add \$266 for (MB)</p>	<p>Base Price: \$6371</p> <p>Base Price: \$6371</p> <p>Back/Arm upcharge: +0</p> <p>Seat upcharge: +0</p>	<table border="1"> <tr> <td>1/COM</td><td>2</td><td>3</td><td>4</td><td>5</td><td>6</td><td>7</td><td>8</td><td>9</td><td>10</td><td>11</td><td>12</td> </tr> <tr> <td></td><td></td><td></td><td></td><td></td><td></td><td></td><td></td><td></td><td></td><td></td><td></td><td></td><td></td><td></td><td></td> </tr> <tr> <td colspan="3">OVERALL DIMENSIONS</td> <td colspan="3">SEAT DIMENSIONS</td> <td colspan="3">BACK DIMENSIONS</td> <td colspan="6"></td> </tr> <tr> <td>W</td><td>D</td><td>H</td> <td>W</td><td>D</td><td>H</td> <td>W</td><td>H</td> <td colspan="8"></td> </tr> <tr> <td>62.5</td><td>41.5</td><td>47</td> <td>42</td><td>19</td><td>18</td> <td>51</td><td>29</td> <td colspan="8"></td> </tr> <tr> <td colspan="4"></td> <td colspan="12"> <table border="1"> <tr> <td>RTA 00</td> <td colspan="15">1 per carton</td> </tr> </table> </td> </tr> </table>												1/COM	2	3	4	5	6	7	8	9	10	11	12																	OVERALL DIMENSIONS			SEAT DIMENSIONS			BACK DIMENSIONS									W	D	H	W	D	H	W	H									62.5	41.5	47	42	19	18	51	29													<table border="1"> <tr> <td>RTA 00</td> <td colspan="15">1 per carton</td> </tr> </table>												RTA 00	1 per carton														
				1/COM	2	3	4	5	6	7	8	9	10	11	12																																																																																																											
OVERALL DIMENSIONS			SEAT DIMENSIONS			BACK DIMENSIONS																																																																																																																				
W	D	H	W	D	H	W	H																																																																																																																			
62.5	41.5	47	42	19	18	51	29																																																																																																																			
				<table border="1"> <tr> <td>RTA 00</td> <td colspan="15">1 per carton</td> </tr> </table>												RTA 00	1 per carton																																																																																																									
RTA 00	1 per carton																																																																																																																									
	<p>R27818L</p> <p>Outside Curve Two Seater - Standard Back COM Yardage: Back: 2.25; Seat: 2 Freight class: 4.25 Product weight: 93 107 shelf model Cubic feet per carton: 42.75 63.5 shelf model</p>	<p>R27818S</p> <p>For power/USB unit, see electrical placement chart. Includes ganging hardware (2 sides). Add \$99 for (SSS), \$110 for (SBS) Add \$1330 for 72 lbs. (CW), (C6) Add \$184 for (SP) or \$919 for (BS) Add \$43 for (TP) Add \$266 for (MB)</p>	<p>Base Price: \$3494</p> <p>Base Price: \$4537</p> <p>Back upcharge: +0</p> <p>Seat upcharge: +0</p>	<table border="1"> <tr> <td>1/COM</td><td>2</td><td>3</td><td>4</td><td>5</td><td>6</td><td>7</td><td>8</td><td>9</td><td>10</td><td>11</td><td>12</td> </tr> <tr> <td></td><td></td><td></td><td></td><td></td><td></td><td></td><td></td><td></td><td></td><td></td><td></td><td></td><td></td><td></td><td></td> </tr> <tr> <td colspan="3">OVERALL DIMENSIONS</td> <td colspan="3">SEAT DIMENSIONS</td> <td colspan="3">BACK DIMENSIONS</td> <td colspan="6"></td> </tr> <tr> <td>W</td><td>D</td><td>H</td> <td>W</td><td>D</td><td>H</td> <td>W</td><td>H</td> <td colspan="8"></td> </tr> <tr> <td>50</td><td>30</td><td>32</td> <td>50</td><td>19</td><td>18</td> <td>36</td><td>14</td> <td colspan="8"></td> </tr> <tr> <td colspan="4"></td> <td colspan="12"> <table border="1"> <tr> <td>RTA 00</td> <td colspan="15">1 per carton</td> </tr> </table> </td> </tr> </table>												1/COM	2	3	4	5	6	7	8	9	10	11	12																	OVERALL DIMENSIONS			SEAT DIMENSIONS			BACK DIMENSIONS									W	D	H	W	D	H	W	H									50	30	32	50	19	18	36	14													<table border="1"> <tr> <td>RTA 00</td> <td colspan="15">1 per carton</td> </tr> </table>												RTA 00	1 per carton														
				1/COM	2	3	4	5	6	7	8	9	10	11	12																																																																																																											
OVERALL DIMENSIONS			SEAT DIMENSIONS			BACK DIMENSIONS																																																																																																																				
W	D	H	W	D	H	W	H																																																																																																																			
50	30	32	50	19	18	36	14																																																																																																																			
				<table border="1"> <tr> <td>RTA 00</td> <td colspan="15">1 per carton</td> </tr> </table>												RTA 00	1 per carton																																																																																																									
RTA 00	1 per carton																																																																																																																									
	<p>R27818L</p> <p>Outside Curve Two Seater - Standard Back COM Yardage: Back: 3.25; Seat: 2 Freight class: 5.25 Product weight: 102 Cubic feet per carton: 43.5</p>	<p>R27818R</p> <p>For power/USB unit, see electrical placement chart. Includes ganging hardware (1 side). Add \$99 for (SSS), \$138 for (SBS) Add \$1330 for 72 lbs. (CW), (C6) Add \$184 for (SP) or \$919 for (BS) Add \$43 for (TP) Add \$266 for (MB)</p>	<p>Base Price: \$3882</p> <p>Base Price: \$3882</p> <p>Back/Arm upcharge: +0</p> <p>Seat upcharge: +0</p>	<table border="1"> <tr> <td>1/COM</td><td>2</td><td>3</td><td>4</td><td>5</td><td>6</td><td>7</td><td>8</td><td>9</td><td>10</td><td>11</td><td>12</td> </tr> <tr> <td></td><td></td><td></td><td></td><td></td><td></td><td></td><td></td><td></td><td></td><td></td><td></td><td></td><td></td><td></td><td></td> </tr> <tr> <td colspan="3">OVERALL DIMENSIONS</td> <td colspan="3">SEAT DIMENSIONS</td> <td colspan="3">BACK DIMENSIONS</td> <td colspan="6"></td> </tr> <tr> <td>W</td><td>D</td><td>H</td> <td>W</td><td>D</td><td>H</td> <td>W</td><td>H</td> <td colspan="8"></td> </tr> <tr> <td>53.5</td><td>30</td><td>32</td> <td>50</td><td>19</td><td>18</td> <td>36</td><td>14</td> <td colspan="8"></td> </tr> <tr> <td colspan="4"></td> <td colspan="12"> <table border="1"> <tr> <td>RTA 00</td> <td colspan="15">1 per carton</td> </tr> </table> </td> </tr> </table>												1/COM	2	3	4	5	6	7	8	9	10	11	12																	OVERALL DIMENSIONS			SEAT DIMENSIONS			BACK DIMENSIONS									W	D	H	W	D	H	W	H									53.5	30	32	50	19	18	36	14													<table border="1"> <tr> <td>RTA 00</td> <td colspan="15">1 per carton</td> </tr> </table>												RTA 00	1 per carton														
				1/COM	2	3	4	5	6	7	8	9	10	11	12																																																																																																											
OVERALL DIMENSIONS			SEAT DIMENSIONS			BACK DIMENSIONS																																																																																																																				
W	D	H	W	D	H	W	H																																																																																																																			
53.5	30	32	50	19	18	36	14																																																																																																																			
				<table border="1"> <tr> <td>RTA 00</td> <td colspan="15">1 per carton</td> </tr> </table>												RTA 00	1 per carton																																																																																																									
RTA 00	1 per carton																																																																																																																									

DESCRIPTION	MODEL#/ FEATURES	STANDARD TEXTILE GRADES												
		1/COM	2	3	4	5	6	7	8	9	10	11	12	
 <p>R27819</p> <p>Outside Curve Two Seater - High Back COM Yardage: Back 3.25; Seat: 2 Freight class: 300 Product weight: 101 115 shelf model Cubic feet per carton: 53.75 79.75 shelf model</p>	<p>R27819S</p> <p>For power/USB unit, see electrical placement chart. Includes ganging hardware (2 sides). Add \$99 for (SSS), \$143 for (SBS) Add \$1330 for 72 lbs. (CW), (C6) Add \$184 for (SP) or \$919 for (BS) Add \$43 for (TP) Add \$266 for (MB)</p>	Base Price:	\$4159											
		Base Price:	\$5204											
		Back upcharge:	+0	+\$110	+\$197	+\$323	+\$502	+\$577	+\$732	+\$974	+\$1157	+\$1355	+\$1770	+\$2205
		Seat upcharge:	+0	+\$68	+\$121	+\$199	+\$309	+\$355	+\$450	+\$600	+\$712	+\$834	+\$1089	+\$1357
		Shelf: 52W 10D 1H												
		OVERALL DIMENSIONS			SEAT DIMENSIONS			BACK DIMENSIONS						
		W	D	H	W	D	H	W	H					
		50	30.5	41.5	50	19	18	32	23.5					
		RTA 00 1 per carton												
 <p>R27819L</p> <p>Outside Curve Two Seater - High Back COM Yardage: Back 4.25; Seat: 2 Freight class: 300 Product weight: 110 Cubic feet per carton: 55.5</p>	<p>R27819R</p> <p>For power/USB unit, see electrical placement chart. Includes ganging hardware (1 side). Add \$99 for (SSS), \$170 for (SBS) Add \$1330 for 72 lbs. (CW), (C6) Add \$184 for (SP) or \$919 for (BS) Add \$43 for (TP) Add \$266 for (MB)</p>	Base Price:	\$4549											
		Base Price:	\$4549											
		Back/Arm upcharge:	+0	+\$144	+\$257	+\$422	+\$656	+\$754	+\$956	+\$1274	+\$1512	+\$1772	+\$2314	+\$2884
		Seat upcharge:	+0	+\$68	+\$121	+\$199	+\$309	+\$355	+\$450	+\$600	+\$712	+\$834	+\$1089	+\$1357
		Shelf: 52W 10D 1H												
		OVERALL DIMENSIONS			SEAT DIMENSIONS			BACK DIMENSIONS						
		W	D	H	W	D	H	W	H					
		53.5	30.5	41.5	50	19	18	32	23.5					
		RTA 00 1 per carton												
 <p>R27820</p> <p>Outside Curve Two Seater - Extended Back COM Yardage: Back 4.25; Seat: 2 Freight class: 300 Product weight: 109 120 shelf Cubic feet per carton: 61 90.5 shelf</p>	<p>R27820S</p> <p>For power/USB unit, see electrical placement chart. Includes ganging hardware (2 sides). Add \$99 for (SSS), \$152 for (SBS) Add \$1330 for 72 lbs. (CW), (C6) Add \$184 for (SP) or \$919 for (BS) Add \$43 for (TP) Add \$266 for (MB)</p>	Base Price:	\$4581											
		Base Price:	\$5539											
		Back upcharge:	+0	+\$144	+\$257	+\$422	+\$656	+\$754	+\$956	+\$1274	+\$1512	+\$1772	+\$2314	+\$2884
		Seat upcharge:	+0	+\$68	+\$121	+\$199	+\$309	+\$355	+\$450	+\$600	+\$712	+\$834	+\$1089	+\$1357
		Shelf: 52W 10D 1H												
		OVERALL DIMENSIONS			SEAT DIMENSIONS			BACK DIMENSIONS						
		W	D	H	W	D	H	W	H					
		50	31	47	50	19	18	28	29					
		RTA 00 1 per carton												
 <p>R27820L</p> <p>Outside Curve Two Seater - Extended Back COM Yardage: Back 5.25; Seat: 2 Freight class: 300 Product weight: 113 Cubic feet per carton: 62.25</p>	<p>R27820R</p> <p>For power/USB unit, see electrical placement chart. Includes ganging hardware (1 side). Add \$99 for (SSS), \$180 for (SBS) Add \$1330 for 72 lbs. (CW), (C6) Add \$184 for (SP) or \$919 for (BS) Add \$43 for (TP) Add \$266 for (MB)</p>	Base Price:	\$4970											
		Base Price:	\$4970											
		Back/Arm upcharge:	+0	+\$178	+\$317	+\$522	+\$810	+\$931	+\$1181	+\$1574	+\$1868	+\$2189	+\$2858	+\$3562
		Seat upcharge:	+0	+\$68	+\$121	+\$199	+\$309	+\$355	+\$450	+\$600	+\$712	+\$834	+\$1089	+\$1357
		Shelf: 52W 10D 1H												
		OVERALL DIMENSIONS			SEAT DIMENSIONS			BACK DIMENSIONS						
		W	D	H	W	D	H	W	H					
		53.5	31	47	50	19	18	28	29					
		RTA 00 1 per carton												

DESCRIPTION		MODEL#/ FEATURES		STANDARD TEXTILE GRADES												
				1/COM	2	3	4	5	6	7	8	9	10	11	12	
		R27821	Base Price:	\$4620												
		R27821S	Base Price:	\$6084												
			Back upcharge:	+0	+\$136	+\$241	+\$397	+\$617	+\$709	+\$899	+\$1199	+\$1423	+\$1667	+\$2178	+\$2714	
			Seat upcharge:	+0	+\$68	+\$121	+\$199	+\$309	+\$355	+\$450	+\$600	+\$712	+\$834	+\$1089	+\$1357	
			Shelf: 52W 10D 1H													
			OVERALL DIMENSIONS			SEAT DIMENSIONS			BACK DIMENSIONS							
			W	D	H	W	D	H	W	D	H	W	H			
			37.5	37.5	32	24	19	18	24	14						
			RTA 00		1 per carton											
90 Corner - Standard Back			No power/USB unit. Includes ganging hardware (2 sides). Add \$71 for (SSS), \$137 for (SBS) Add \$1330 for 72 lbs. (CW), (C6) Add \$184 for (SP) or \$919 for (BS) Add \$43 for (TP) Add \$266 for (MB)													
COM Yardage: Back 4; Seat: 2 Freight class: 250 Product weight: 105 137 shelf Cubic feet per carton: 35.5 63 shelf																
		R27822	Base Price:	\$5502												
		R27822S	Base Price:	\$6963												
			Back upcharge:	+0	+\$195	+\$347	+\$571	+\$887	+\$1020	+\$1293	+\$1723	+\$2045	+\$2397	+\$3131	+\$3902	
			Seat upcharge:	+0	+\$68	+\$121	+\$199	+\$309	+\$355	+\$450	+\$600	+\$712	+\$834	+\$1089	+\$1357	
			Shelf: 52W 10D 1H													
			OVERALL DIMENSIONS			SEAT DIMENSIONS			BACK DIMENSIONS							
			W	D	H	W	D	H	W	D	H	W	H			
			38.5	38.5	41.5	24	19	18	24	23.5						
			RTA 00		1 per carton											
90 Corner - High Back			No power/USB unit. Includes ganging hardware (2 sides). Add \$71 for (SSS), \$182 for (SBS) Add \$1330 for 72 lbs. (CW), (C6) Add \$184 for (SP) or \$919 for (BS) Add \$43 for (TP) Add \$266 for (MB)													
COM Yardage: Back 5.75; Seat: 2 Freight class: 250 Product weight: 119 154 shelf Cubic feet per carton: 44.5 79.24 shelf																
		R27823	Base Price:	\$6051												
		R27823S	Base Price:	\$7514												
			Back upcharge:	+0	+\$211	+\$377	+\$621	+\$964	+\$1108	+\$1406	+\$1873	+\$2223	+\$2605	+\$3403	+\$2884	
			Seat upcharge:	+0	+\$68	+\$121	+\$199	+\$309	+\$355	+\$450	+\$600	+\$712	+\$834	+\$1089	+\$1357	
			Shelf: 52W 10D 1H													
			OVERALL DIMENSIONS			SEAT DIMENSIONS			BACK DIMENSIONS							
			W	D	H	W	D	H	W	D	H	W	H			
			39	39	47	24	19	18	24	29						
			RTA 00		1 per carton											
90 Corner - Extended Back			No power/USB unit. Includes ganging hardware (2 sides). Add \$71 for (SSS), \$189 for (SBS) Add \$1330 for 36 lbs. (CW), (C6) Add \$184 for (SP) or \$919 for (BS) Add \$43 for (TP) Add \$266 for (MB)													
COM Yardage: Back 6.25; Seat: 2 Freight class: 250 Product weight: 128 160 shelf Cubic feet per carton: 50.5 90 shelf																
		R27824	Base Price:	\$4783												
		R27824S	Base Price:	\$6248												
			Back upcharge:	+0	+\$136	+\$241	+\$397	+\$617	+\$709	+\$899	+\$1199	+\$1423	+\$1667	+\$2178	+\$2714	
			Seat upcharge:	+0	+\$68	+\$121	+\$199	+\$309	+\$355	+\$450	+\$600	+\$712	+\$834	+\$1089	+\$1357	
			Shelf: 52W 10D 1H													
			OVERALL DIMENSIONS			SEAT DIMENSIONS			BACK DIMENSIONS							
			W	D	H	W	D	H	W	D	H	W	H			
			52.5	30	32	52	19	18	52	14						
			RTA 00		1 per carton											
120 Corner - Standard Back			No power/USB unit. Includes ganging hardware (2 sides). Add \$94 for (SSS), \$133 for (SBS) Add \$1330 for 36 lbs. (CW), (C6) Add \$228 for (SP) or \$1018 for (BS) Add \$43 for (TP) Add \$266 for (MB)													
COM Yardage: Back 4; Seat: 2 Freight class: 250 Product weight: 109 138 shelf Cubic feet per carton: 48.25 68.5 shelf																

DESCRIPTION		MODEL#/ FEATURES		STANDARD TEXTILE GRADES													
				1/COM	2	3	4	5	6	7	8	9	10	11	12		
	<p>R27825</p> <p>R27825S</p>	<p>Base Price: \$5596</p> <p>Base Price: \$7062</p> <p>Back upcharge: +0</p> <p>Seat upcharge: +0</p>	<p>Shelf: 52W 10D 1H</p>														
				<p>No power/USB unit. Includes ganging hardware (2 sides). Add \$94 for (SSS), \$174 for (SBS) Add \$1330 for 36 lbs. (CW), (C6) Add \$228 for (SP) or \$1018 for (BS) Add \$43 for (TP) Add \$266 for (MB)</p>													
<p>120 Corner - High Back COM Yardage: Back 5.75; Seat: 2 Freight class: 300 Product weight: 118 144 shelf Cubic feet per carton: 60.5 86 shelf</p>				<p>OVERALL DIMENSIONS</p> <p>W D H</p>			<p>SEAT DIMENSIONS</p> <p>W D H</p>			<p>BACK DIMENSIONS</p> <p>W H</p>							
				53.5	30.5	41.5	41	21	18	51	23.5						
				<p>RTA 00</p>		<p>1 per carton</p>											
	<p>R27826</p> <p>R27826S</p>	<p>Base Price: \$6072</p> <p>Base Price: \$7534</p> <p>Back upcharge: +0</p> <p>Seat upcharge: +0</p>	<p>Shelf: 52W 10D 1H</p>														
				<p>No power/USB unit. Includes ganging hardware (2 sides). Add \$94 for (SSS), \$185 for (SBS) Add \$1330 for 36 lbs. (CW), (C6) Add \$228 for (SP) or \$1018 for (BS) Add \$43 for (TP) Add \$266 for (MB)</p>													
<p>120 Corner - Extended Back COM Yardage: Back 6.25; Seat: 2 Freight class: 300 Product weight: 123 144 shelf Cubic feet per carton: 68.75 97.75 shelf</p>				<p>OVERALL DIMENSIONS</p> <p>W D H</p>			<p>SEAT DIMENSIONS</p> <p>W D H</p>			<p>BACK DIMENSIONS</p> <p>W H</p>							
				54	31.5	47	41	21	18	51	29						
				<p>RTA 00</p>		<p>1 per carton</p>											
	<p>R2770</p>	<p>Attachment hardware included. Polished Aluminum arms sold separately (1 pc).</p> <p>Armcap finish options: (NGT) Night, (FOG) Fog, (LAB) Latte</p>	<p>List price</p> <p>\$351</p>														
				<p>OVERALL DIMENSIONS</p> <p>W D H</p>												<p>SEAT DIMENSIONS</p> <p>W D H</p>	
<p>Loop Arm COM Yardage: N/A Freight class: 92.5 Product weight (lbs.): 6.3 Cubic feet per carton: 0.6</p>				2.5	14	19.5	-	-	-	-	-						
				<p>RTA 1</p>		<p>FedEx UPS 1 per carton</p>											
	<p>R2771</p>	<p>Attachment hardware included. Polished Aluminum arms sold separately (1 pc).</p> <p>Armcap finish options: (NGT) Night, (FOG) Fog, (LAB) Latte</p>	<p>List price</p> <p>\$399</p>														
				<p>OVERALL DIMENSIONS</p> <p>W D H</p>												<p>SEAT DIMENSIONS</p> <p>W D H</p>	
<p>Loop Arm w/Armcap COM Yardage: N/A Freight class: 92.5 Product weight (lbs.): 6.61 Cubic feet per carton: 0.6</p>				2.5	14	19.5	-	-	-	-	-						
				<p>RTA 1</p>		<p>FedEx UPS 1 per carton</p>											

LOUNGE

RIVER+ BENCHES



Two Seater Bench
model R27832



Y Bench
model R27842



42" Round Bench
model R27845



Inside Curve Boomerang Bench
model R27840

River+ Seating, Tables



For River+ seating, please see page 345
For River+ tables, please see page 368

EXAMPLE RIVER+ BENCH ORDER CODE:

R27832	-CE90	-S6	-AS	-CH	-	-SP
Model number	Textile	Leg selection	Leg angle	Leg finish	Additional weight	Bottom selection

-	-	-F1	-W
Sealed Seams	Moisture barrier	Power/USB position	Power finish

Additional Options specify at end of order code.	SPECIFY CODE
Tamperproof fasteners Upcharges vary, see model.	TP
Moisture barrier Upcharges vary, see model.	MB

*linking hardware is lowered to clear the staple strip.
Units will only gang with other units with sealed bottom.
**cannot be combined with linking hardware or power units

ELECTRICAL PLACEMENT

Straight benches

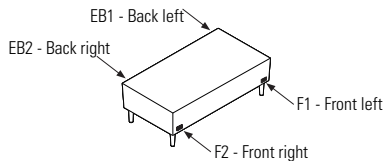

Y bench

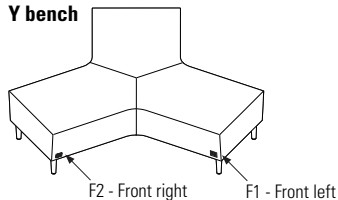

Curved benches

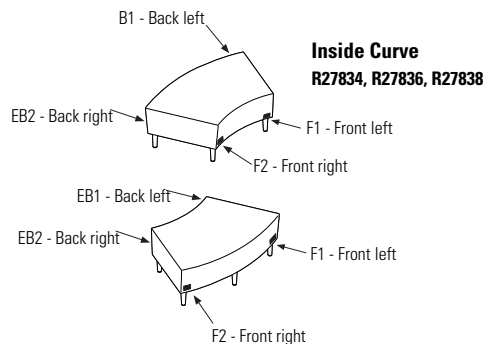

Boomerang benches

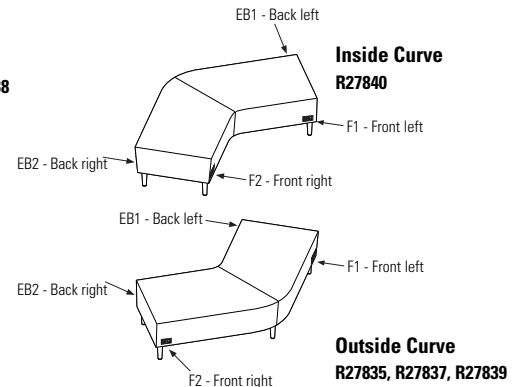

STANDARD FEATURES

- A modular series that is composed of straight, and curved sections, as well as freestanding units.
- Linking units can be used together in any combination to create a wide variety of layouts. Ganging hardware is standard and is factory installed. Ganging hardware swivels out of the way when not in use.
- The standard, 6.5" tapered legs are made of welded steel.
- Legs are straight (vertical) as standard. Linking models are optionally available with angled back legs to match River+ seating units.
- Legs include Black nylon, non-marking, height adjustable glides.
- River+ is rated for an active weight up to 600 lbs. per seat and 24/7 use.
- For 24/7 use and/or heavy duty application use, Global's Heavy Duty warranty is applicable on models specified with performance textiles, rated for 150,000 double rubs.
- Check textile availability prior to specifying upholstery material. Leather not available on River+ series.
- All units are shipped fully assembled.

OPTIONAL FEATURES



- Legs are available in 3" and 8" heights with no upcharge. All heights are available with fixed-to-floor option. Please specify. Add \$106. Fastening hardware not included.
- Steel bottom provides tamperproof protection (includes tamperproof screws). Specify **(BS)** - see each model for upcharge.**
- Up to two power units are available on straight, Y, curved and boomerang benches.
- Each power unit includes one AC outlet and two USB-a,10-watt charging ports.
- Power location options include front or back. See electrical placement diagrams. Electrical units must be factory installed. Add \$661 per unit.
- Power units are available in either Jet Black **(J)** or White **(W)** with 120", three-prong matching cords.
- To add sealed seams to your product, specify **(SLS)** - see each model for upcharge.
- To match leg angles with lounge seating, straight front and angled back 6.5" or 8" legs are available on straight, curved, corner, and boomerang units. Specify **(SA)**. No upcharge.
- Products can be weighted to reduce the ease of movement. For additional weight options, specify **(CW)** - see each model for available additional weight and upcharge.
- The underside of the seat can be finished with PVC (vinyl) and sealed to prevent penetration of liquids. Specify **(SP)** - see each model for upcharge.*

Please add option codes in the following order:

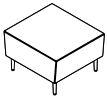
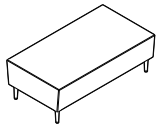
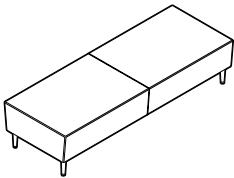
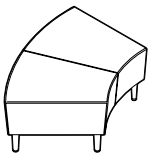
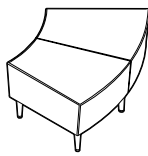

- **Model number**
R27831 to R27833 Straight benches
R27834 to R27835 Curved benches
R27836 to R27839 Corner benches
R27840 to R27841 Boomerang benches
R27842 Y bench
R27843 to R27846 Round non-linking benches
R27847 to R27850 Square non-linking benches
- **Textile**
Specify textile code.
- **Leg selection**
(S6) Standard seat height (17.5"), 6.5" leg w/ adjustable glides. No upcharge.
(S3) Low seat (14"), 3" leg w/adjustable glides. No upcharge.
(S8) High seat (19"), 8" leg w/adjustable glides. No upcharge.
(F6) Standard seat height (17.5"), 6.5" leg, fixed to floor. Add \$106.
(F3) Low seat (14"), 3" leg, fixed to floor. Add \$106.
(F8) High seat (19"), 8" leg, fixed to floor. Add \$106.
- **Leg angle**
(AST) Straight legs. No upcharge.
(SA) Straight front legs, angled back legs (available only for 6.5" and 8" high legs on straight, curved, corner and boomerang units). No upcharge.
- **Leg finish**
(CHM) Chrome
(TDW) Designer White
(TFR) Frost
(TLA) Latte
(TNE) Nevada
(TSH) Shadow
(TTU) Tungsten
(TBL) Black
(TFO) Fog
(TIV) Cloud
(TMO) Mocha
(TOA) Toast
(TSN) Sand
- **Additional weight**
(CW) Additional weight. Upcharges vary, see model.
- **Bottom selection**
(SSB) Standard bottom.
(SP) Vinyl sealed bottom w/staple strip. Upcharges vary, see model.*
(BS) Steel bottom. Upcharges vary, see model.**
- **Sealed seams**
(SLS) Sealed seams. Upcharges vary, see model.
- **Moisture barrier**
(MB) Upcharges vary, see model.
- **Power/USB unit position** (straight, curved, boomerang and Y benches only, as shown below). Add \$661 per unit.
(NP) No power (no upcharge)
(F1) Front left
(F2) Front right
(EB1) Back left
(EB2) Back right
- **Power unit finish**
(J) Jet Black
(W) White
- **Tamperproof fasteners**
(TP) Upcharges vary, see model.

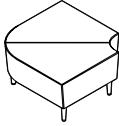
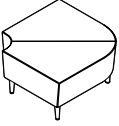
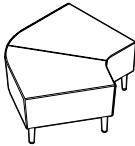
DESCRIPTION	FEATURES	MODEL#	STANDARD TEXTILE GRADES											
			1	2	3	4	5	6	7	8	9	10	11	12
 <p>Single Seater Bench COM Yardage: 1.75 Freight class: 1.75 Product weight: 48 Cubic feet per carton: 10.5</p>	<p>For power/USB unit, see electrical placement chart.</p> <p>Includes ganging hardware (2 sides).</p> <p>Add \$73 for (SLS) Add \$106 for (F6, F3, or F8) Add \$667 for 36 lbs. (CW) Add \$85 for (SP) or \$388 for (BS) Add \$43 for (TP) Add \$134 for (MB)</p>	<p>R27831</p>	1469	1529	1575	1644	1740	1780	1863	1994	2092	2200	2422	2657
			<p>OVERALL DIMENSIONS</p> <p>W D H</p>			<p>SEAT DIMENSIONS</p> <p>W D H</p>			<p>BACK DIMENSIONS</p> <p>W H</p>					
			26	28.5	17.5	-	-	-	-	-	-			
			<p>RTA 00</p>			1 per carton								
 <p>Two Seater Bench COM Yardage: 2.75 Freight class: 2.50 Product weight: 65 Cubic feet per carton: 20.5</p>	<p>For power/USB unit, see electrical placement chart.</p> <p>Includes ganging hardware (2 sides).</p> <p>Add \$89 for (SLS) Add \$106 for (F6, F3, or F8) Add \$1330 for 72 lbs. (CW) Add \$132 for (SP) or \$641 for (BS) Add \$43 for (TP) Add \$266 for (MB)</p>	<p>R27832</p>	2148	2241	2314	2422	2573	2636	2767	2972	3126	3295	3646	4015
			<p>OVERALL DIMENSIONS</p> <p>W D H</p>			<p>SEAT DIMENSIONS</p> <p>W D H</p>			<p>BACK DIMENSIONS</p> <p>W H</p>					
			52	28.5	17.5	-	-	-	-	-	-			
			<p>RTA 00</p>			1 per carton								
 <p>Three Seater Bench COM Yardage: 4.5 Freight class: 4.5 Product weight: 103 Cubic feet per carton: 30.25</p>	<p>For power/USB unit, see electrical placement chart.</p> <p>Includes ganging hardware (2 sides).</p> <p>Add \$130 for (SLS) Add \$106 for (F6, F3, or F8) Add \$1330 for 72 lbs. (CW) Add \$184 for (SP) or \$816 for (BS) Add \$43 for (TP) Add \$396 for (MB)</p>	<p>R27833</p>	3379	3531	3651	3826	4073	4177	4391	4728	4980	5255	5829	6433
			<p>OVERALL DIMENSIONS</p> <p>W D H</p>			<p>SEAT DIMENSIONS</p> <p>W D H</p>			<p>BACK DIMENSIONS</p> <p>W H</p>					
			78	28.5	17.5	-	-	-	-	-	-			
			<p>RTA 00</p>			1 per carton								
 <p>Inside Curve Two Seater Bench COM Yardage: 3 Freight class: 2.50 Product weight: 60 Cubic feet per carton: 22.75</p>	<p>For power/USB unit, see electrical placement chart.</p> <p>Includes ganging hardware (2 sides).</p> <p>Add \$80 for (SLS) Add \$106 for (F6, F3, or F8) Add \$1332 for 72 lbs. (CW) Add \$132 for (SP) or \$513 for (BS) Add \$52 for (TP) Add \$266 for (MB)</p>	<p>R27834</p>	2918	3020	3099	3216	3381	3450	3593	3817	3985	4169	4552	4954
			<p>OVERALL DIMENSIONS</p> <p>W D H</p>			<p>SEAT DIMENSIONS</p> <p>W D H</p>			<p>BACK DIMENSIONS</p> <p>W H</p>					
			50	30.5	17.5	-	-	-	-	-	-			
			<p>RTA 00</p>			1 per carton								
 <p>Outside Curve Two Seater Bench COM Yardage: 3 Freight class: 2.50 Product weight: 60 Cubic feet per carton: 22.75</p>	<p>For power/USB unit, see electrical placement chart.</p> <p>Includes ganging hardware (2 sides).</p> <p>Add \$80 for (SLS) Add \$106 for (F6, F3, or F8) Add \$1333 for 72 lbs. (CW) Add \$132 for (SP) or \$513 for (BS) Add \$52 for (TP) Add \$266 for (MB)</p>	<p>R27835</p>	2918	3020	3099	3216	3381	3450	3593	3817	3985	4169	4552	4954
			<p>OVERALL DIMENSIONS</p> <p>W D H</p>			<p>SEAT DIMENSIONS</p> <p>W D H</p>			<p>BACK DIMENSIONS</p> <p>W H</p>					
			50	30.5	17.5	-	-	-	-	-	-			
			<p>RTA 00</p>			1 per carton								

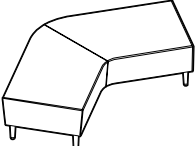
Options: **(SLS)** Sealed seams
(F6, F3, F8) Floor mount legs
(CW) Counterweight
(SP) Vinyl sealed bottom
(BS) Steel bottom
(TP) Tamperproof
(MB) Moisture barrier

DESCRIPTION	FEATURES	MODEL#	STANDARD TEXTILE GRADES												
			1	2	3	4	5	6	7	8	9	10	11	12	
 <p>90° Inside Curve Corner Bench COM Yardage: 3.25 Freight class: 250 Product weight: 60 Cubic feet per carton: 17.25</p>	<p>For power/USB unit, see electrical placement chart.</p> <p>Includes ganging hardware (2 sides).</p> <p>Add \$80 for (SLS) Add \$106 for (F6, F3, or F8) Add \$667 for 36 lbs. (CW) Add \$153 for (SP) or \$597 for (BS) Add \$52 for (TP) Add \$266 for (MB)</p>	R27836	2910	3020	3107	3233	3412	3487	3642	3884	4067	4265	4680	5115	
		OVERALL DIMENSIONS			SEAT DIMENSIONS			BACK DIMENSIONS							
		W	D	H	W	D	H	W	H						
		36.5	36.5	17.5	-	-	-	-	-						
			RTA 00	1 per carton											
 <p>90° Outside Curve Corner Bench COM Yardage: 3.25 Freight class: 250 Product weight: 60 Cubic feet per carton: 17.25</p>	<p>For power/USB unit, see electrical placement chart.</p> <p>Includes ganging hardware (2 sides).</p> <p>Add \$80 for (SLS) Add \$106 for (F6, F3, or F8) Add \$668 for 36 lbs. (CW) Add \$153 for (SP) or \$597 for (BS) Add \$52 for (TP) Add \$266 for (MB)</p>	R27837	2910	3020	3107	3233	3412	3487	3642	3884	4067	4265	4680	5115	
		OVERALL DIMENSIONS			SEAT DIMENSIONS			BACK DIMENSIONS							
		W	D	H	W	D	H	W	H						
		36.5	36.5	17.5	-	-	-	-	-						
			RTA 00	1 per carton											
 <p>120° Inside Curve Corner Bench COM Yardage: 3.5 Freight class: 250 Product weight: 57 Cubic feet per carton: 26.75</p>	<p>For power/USB unit, see electrical placement chart.</p> <p>Includes ganging hardware (2 sides).</p> <p>Add \$84 for (SLS) Add \$106 for (F6, F3, or F8) Add \$669 for 36 lbs. (CW) Add \$146 for (SP) or \$656 for (BS) Add \$52 for (TP) Add \$266 for (MB)</p>	R27838	2910	3029	3121	3258	3450	3531	3698	3959	4155	4370	4816	5285	
		OVERALL DIMENSIONS			SEAT DIMENSIONS			BACK DIMENSIONS							
		W	D	H	W	D	H	W	H						
		36.5	51.5	17.5	-	-	-	-	-						
			RTA 00	1 per carton											
 <p>120° Outside Curve Corner Bench COM Yardage: 3.5 Freight class: 250 Product weight: 57 Cubic feet per carton: 26.75</p>	<p>For power/USB unit, see electrical placement chart.</p> <p>Includes ganging hardware (2 sides).</p> <p>Add \$84 for (SLS) Add \$106 for (F6, F3, or F8) Add \$671 for 36 lbs. (CW) Add \$146 for (SP) or \$656 for (BS) Add \$52 for (TP) Add \$266 for (MB)</p>	R27839	2910	3029	3121	3258	3450	3531	3698	3959	4155	4370	4816	5285	
		OVERALL DIMENSIONS			SEAT DIMENSIONS			BACK DIMENSIONS							
		W	D	H	W	D	H	W	H						
		36.5	51.5	17.5	-	-	-	-	-						
			RTA 00	1 per carton											
 <p>Inside Curve Boomerang Bench COM Yardage: 5.25 Freight class: 250 Product weight: 126 Cubic feet per carton: 47.75</p>	<p>For power/USB unit, see electrical placement chart.</p> <p>Includes ganging hardware (2 sides).</p> <p>Add \$124 for (SLS) Add \$106 for (F6, F3, or F8) Add \$1330 for 72 lbs. (CW) Add \$214 for (SP) or \$1153 for (BS) Add \$52 for (TP) Add \$396 for (MB)</p>	R27840	4501	4679	4818	5023	5311	5432	5682	6075	6369	6690	7359	8063	
		OVERALL DIMENSIONS			SEAT DIMENSIONS			BACK DIMENSIONS							
		W	D	H	W	D	H	W	H						
		82	45	17.5	-	-	-	-	-						
			RTA 00	1 per carton											

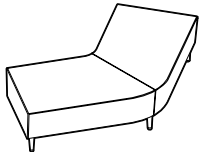
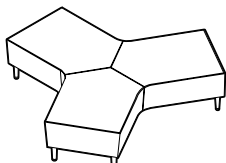
Options: **(SLS)** Sealed seams
(F6, F3, F8) Floor mount legs
(CW) Counterweight
(SP) Vinyl sealed bottom
(BS) Steel bottom
(TP) Tamperproof
(MB) Moisture barrier

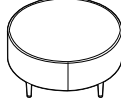
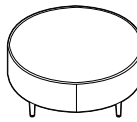
DESCRIPTION	FEATURES	MODEL#	STANDARD TEXTILE GRADES											
			1	2	3	4	5	6	7	8	9	10	11	12
 <p>Outside Curve Boomerang Bench COM Yardage: 5.25 Freight class: 250 Product weight: 126 Cubic feet per carton: 47.75</p>	<p>For power/USB unit, see electrical placement chart.</p> <p>Includes ganging hardware (2 sides).</p> <p>Add \$124 for (SLS) Add \$106 for (F6, F3, or F8) Add \$1330 for 72 lbs. (CW) Add \$214 for (SP) or \$1153 for (BS) Add \$52 for (TP) Add \$396 for (MB)</p>	<p>R27841</p>	4501	4679	4818	5023	5311	5432	5682	6075	6369	6690	7359	8063
			OVERALL DIMENSIONS			SEAT DIMENSIONS			BACK DIMENSIONS					
			W	D	H	W	D	H	W	H				
			82	45	17.5	-	-	-	-	-				
			RTA 00	1 per carton										
 <p>Y Bench COM Yardage: 8 Freight class: 250 Product weight: 203 Cubic feet per carton: 101.2</p>	<p>For power/USB unit, see electrical placement chart.</p> <p>Includes ganging hardware (2 sides).</p> <p>Add \$206 for (SLS) Add \$106 for (F6, F3, or F8) Add \$997 for 54 lbs. (CW) Add \$320 for (SP) or \$1429 for (BS) Add \$73 for (TP) Add \$529 for (MB)</p>	<p>R27842</p>	7248	7519	7730	8042	8481	8666	9046	9645	10093	10582	11604	12675
			OVERALL DIMENSIONS			SEAT DIMENSIONS			BACK DIMENSIONS					
			W	D	H	W	D	H	W	H				
			82	70	17.5	-	-	-	-	-				
			RTA 00	1 per carton										
 <p>18" Dia. Round Bench COM Yardage: 1 Freight class: 150 Product weight: 25 Cubic feet per carton: 4.7</p>	<p>No power/USB unit.</p> <p>Freestanding unit only.</p> <p>Add \$49 for (SLS) Add \$106 for (F6, F3, or F8) Not available (CW) Add \$124 for (SP), (BS) not available Add \$43 for (TP) Add \$134 for (MB)</p>	<p>R27843</p>	900	934	961	1000	1055	1078	1125	1200	1256	1317	1445	1579
			OVERALL DIMENSIONS			SEAT DIMENSIONS			BACK DIMENSIONS					
			W	D	H	W	D	H	W	H				
			18	18	17.5	-	-	-	-	-				
			RTA 00	1 per carton										
 <p>36" Dia. Round Bench COM Yardage: 3.25 Freight class: 250 Product weight: 50 Cubic feet per carton: 18.25</p>	<p>No power/USB unit.</p> <p>Freestanding unit only.</p> <p>Add \$73 for (SLS) Add \$106 for (F6, F3, or F8) Add \$667 for 36 lbs. (CW) Add \$193 for (SP) or \$656 for (BS) Add \$43 for (TP) Add \$134 for (MB)</p>	<p>R27844</p>	2156	2266	2353	2479	2658	2733	2888	3130	3313	3511	3926	4361
			OVERALL DIMENSIONS			SEAT DIMENSIONS			BACK DIMENSIONS					
			W	D	H	W	D	H	W	H				
			36	36	17.5	-	-	-	-	-				
			RTA 00	1 per carton										
 <p>42" Dia. Round Bench COM Yardage: 3.5 Freight class: 250 Product weight: 55 Cubic feet per carton: 23</p>	<p>No power/USB unit.</p> <p>Freestanding unit only.</p> <p>Add \$80 for (SLS) Add \$106 for (F6, F3, or F8) Add \$1330 for 72 lbs. (CW) Add \$214 for (SP) or \$724 for (BS) Add \$43 for (TP) Add \$266 for (MB)</p>	<p>R27845</p>	2481	2600	2692	2829	3021	3102	3269	3530	3726	3941	4387	4856
			OVERALL DIMENSIONS			SEAT DIMENSIONS			BACK DIMENSIONS					
			W	D	H	W	D	H	W	H				
			42	42	17.5	-	-	-	-	-				
			RTA 00	1 per carton										

Options: (SLS) Sealed seams
(F6, F3, F8) Floor mount legs
(CW) Counterweight
(SP) Vinyl sealed bottom
(BS) Steel bottom
(TP) Tamperproof
(MB) Moisture barrier

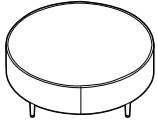
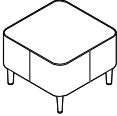
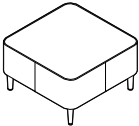
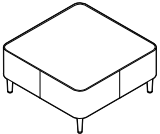
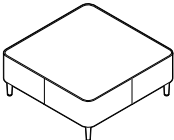
DESCRIPTION	FEATURES	MODEL#	STANDARD TEXTILE GRADES													
			1	2	3	4	5	6	7	8	9	10	11	12		
 <p>48" Dia. Round Bench COM Yardage: 3.75 Freight class: 250 Product weight: 65 Cubic feet per carton: 30</p>	No power/USB unit. Freestanding unit only. Add \$89 for (SLS) Add \$106 for (F6, F3, or F8) Add \$1330 for 72 lbs. (CW) Add \$237 for (SP) or \$770 for (BS) Add \$43 for (TP) Add \$396 for (MB)	R27846	2797	2924	3023	3170	3376	3462	3640	3921	4131	4361	4839	5342		
		OVERALL DIMENSIONS			SEAT DIMENSIONS			BACK DIMENSIONS								
		W	D	H	W	D	H	W	H							
		48	48	17.5	-	-	-	-	-							
			RTA 00	1 per carton												
 <p>24" Square Bench COM Yardage: 1.5 Freight class: 250 Product weight: 30 Cubic feet per carton: 8</p>	No power/USB unit. Freestanding unit only. Add \$64 for (SLS) Add \$106 for (F6, F3, or F8) Add \$667 for 36 lbs. (CW) Add \$132 for (SP) or \$297 for (BS) Add \$43 for (TP) Add \$134 for (MB)	R27847	1230	1281	1321	1379	1462	1496	1568	1680	1764	1856	2047	2249		
		OVERALL DIMENSIONS			SEAT DIMENSIONS			BACK DIMENSIONS								
		W	D	H	W	D	H	W	H							
		24	24	17.5	-	-	-	-	-							
			RTA 00	1 per carton												
 <p>30" Square Bench COM Yardage: 2.75 Freight class: 250 Product weight: 40 Cubic feet per carton: 12.25</p>	No power/USB unit. Freestanding unit only. Add \$73 for (SLS) Add \$106 for (F6, F3, or F8) Add \$667 for 36 lbs. (CW) Add \$184 for (SP) or \$196 for (BS) Add \$43 for (TP) Add \$134 for (MB)	R27848	1623	1716	1789	1897	2048	2111	2242	2447	2601	2770	3121	3490		
		OVERALL DIMENSIONS			SEAT DIMENSIONS			BACK DIMENSIONS								
		W	D	H	W	D	H	W	H							
		30	30	17.5	-	-	-	-	-							
			RTA 00	1 per carton												
 <p>36" Square Bench COM Yardage: 3 Freight class: 250 Product weight: 50 Cubic feet per carton: 18.25</p>	No power/USB unit. Freestanding unit only. Add \$80 for (SLS) Add \$106 for (F6, F3, or F8) Add \$1330 for 72 lbs. (CW) Add \$198 for (SP) or \$483 for (BS) Add \$43 for (TP) Add \$266 for (MB)	R27849	2023	2125	2204	2321	2486	2555	2698	2922	3090	3274	3657	4059		
		OVERALL DIMENSIONS			SEAT DIMENSIONS			BACK DIMENSIONS								
		W	D	H	W	D	H	W	H							
		36	36	17.5	-	-	-	-	-							
			RTA 00	1 per carton												
 <p>42" Square Bench COM Yardage: 3.25 Freight class: 250 Product weight: 60 Cubic feet per carton: 23</p>	No power/USB unit. Freestanding unit only. Add \$91 for (SLS) Add \$106 for (F6, F3, or F8) Add \$1330 for 72 lbs. (CW) Add \$220 for (SP) or \$673 for (BS) Add \$43 for (TP) Add \$396 for (MB)	R27850	2458	2568	2655	2781	2960	3035	3190	3432	3615	3813	4228	4663		
		OVERALL DIMENSIONS			SEAT DIMENSIONS			BACK DIMENSIONS								
		W	D	H	W	D	H	W	H							
		42	42	17.5	-	-	-	-	-							
			RTA 00	1 per carton												

Options: **(SLS)** Sealed seams
(F6, F3, F8) Floor mount legs
(CW) Counterweight
(SP) Vinyl sealed bottom
(BS) Steel bottom
(TP) Tamperproof
(MB) Moisture barrier

RIVER+ TABLES

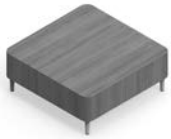

42" Square Coffee Table
model R27858



Outside Curve End Table
model R27864



18" Dia. Round Laptop Table
model 7743

River+ Seating and Benches



For River+ seating, please see page 345
For River+ benches, please see page 363

STANDARD FEATURES

- A modular series that is composed of straight and curved sections, as well as freestanding units.
- Linking units can be used together in any combination with River+ seating and bench units to create a wide variety of layouts. Ganging hardware is standard and is factory installed. Ganging hardware swivels out of the way when not in use.
- Front and back faces of end (linking) tables angles slightly inwards. This inward slant matches the inward angles of River seating so all units coordinate in visual appearance.
- The standard 6.5", welded steel legs are straight (vertical) as standard. Linking models are optionally available with an angled back leg to visually align with River+ seating units.
- Legs include Black nylon, non-marking, height adjustable glides.
- Tables are made with high pressure laminate. Custom high pressure laminate finishes will be considered upon request.
- Laptop tables have 1" thick laminate tops.
- Laptop table painted metal base finishes are available in Black and Tungsten only.

OPTIONAL FEATURES

- Legs of coffee and end (linking) tables are available in 3" (**S3**) and 8" (**S8**) heights. All leg heights are available with fixed-to-floor (**F3**) and (**F8**) options. Add \$106.
- To match adjacent lounge seating, straight front and angled back 6.5" or 8" legs are available on linking/end tables. Specify (**SA**). No upcharge.
- Power units are available on all tables except laptop tables. Each unit includes one AC outlet and two USB-a,10 watt charging ports. Add \$661 upcharge per unit.
- Power location options include top, front or end. See electrical placement diagrams. Electrical units must be factory installed.
- Power units are available in either Jet Black (**J**) or White (**W**) with 120", three-prong matching cords.
- Most products can be weighted to reduce the ease of movement. For additional weight options, specify (**CW**). See each model for available additional weight and upcharge.

Please add option codes in the following order:

- **Model number**
R27855 to R27858 Square coffee tables
R27859 Rectangular coffee table
R27860 to R27861 Round coffee tables
R27862 to R27864 Linking/end tables
7443 and 7745 Freestanding tables
- **Laminate finishes**
(ACJ) Absolute Acajou **(ASN)** Asian Night
(AWC) Avant Cherry **(AWH)** Avant Honey
(BLK) Black **(BRC)** Brushed Cobalt
(BZD) Blizzard **(CGY)** Custom Grey
(CMB) Clear Maple **(DES)** Dark Espresso
(DWT) Designer White **(FAS)** Fashionista
(FCL) First Class
(NBL) Noce Biondo **(NGL)** Noce Grigio
(NEL) Noce Leggero **(NML)** Noce Medio
(QTM) Quartered Mahogany
(SBY) Sheer Beauty **(SDT)** Stonedust
(SOG) Storm Grey **(WCR)** Winter Cherry
(WHC) White Chocolate **(WHE)** Walnut Heights
(colors shown on website)
- **Leg selection**
(S6) Standard height (6.5") w/adjustable glides. No upcharge.
(S3) Low (3") w/adjustable glides. No upcharge.
(S8) High (8") w/adjustable glides. No upcharge.
(F6) Standard height (6.5"), fixed to floor. Add \$106.
(F3) Low (3"), fixed to floor. Add \$106.
(F8) High (8"), fixed to floor. Add \$106.
- **Leg angle** (linking/end tables only)
(AST) Straight legs. No upcharge.
(SA) Straight front legs, angled back legs. No upcharge.
- **Leg finish**
(CHM) Chrome **(TBL)** Black
(TDW) Designer White **(TFO)** Fog
(TFR) Frost **(TIV)** Cloud
(TLA) Latte **(TMO)** Mocha
(TNE) Nevada **(TOA)** Toast
(TSH) Shadow **(TSN)** Sand
(TTU) Tungsten
- **Additional weight**
(CW) Additional weight. Upcharges vary, see model.
- **Power/USB unit position** (coffee and linking/end tables only, as shown below).
Add \$661 per unit.
(NP) No power (no upcharge)
(LE1) Left end (coffee table only)
(LE2) Right end (coffee table only)
(F3) Front center (coffee table only)
(T1) Top
- **Power unit finish**
(J) Jet Black
(W) White
- **(TP) Tamperproof fasteners.** Add \$169.

EXAMPLE RIVER+ TABLE ORDER CODE:

R27858	-ACJ	-S6	-AS	-CM	-	-T1	-W	-
Model number	Laminate	Leg selection	Leg angle	Leg finish	Additional weight	Power/USB	Power finish	Fasteners

ELECTRICAL PLACEMENT

Coffee Tables

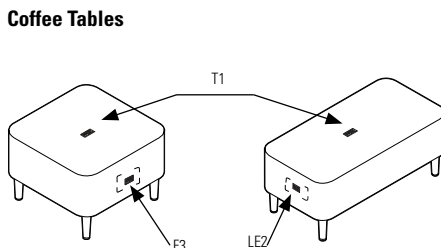

Linking Tables

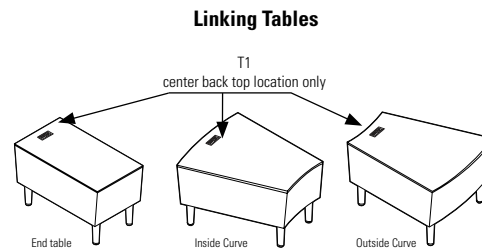

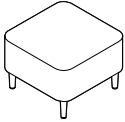
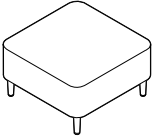
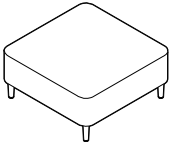
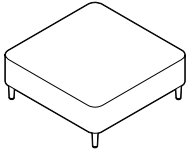
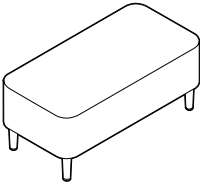
DESCRIPTION	FEATURES	MODEL#	STANDARD TEXTILE GRADES							
 <p>24" Square Coffee Table COM: N/A Freight class: 250 Product weight: 40 Cubic feet per carton: 10.7</p>	<p>For power/USB unit, see electrical placement chart.</p> <p>Freestanding unit only. Add \$511 for 36 lbs. (CW)</p>	<p>R27855</p>	List price							
			1566							
			OVERALL DIMENSIONS			SEAT DIMENSIONS			BACK DIMENSIONS	
			W	D	H	W	D	H	W	H
24	24	17	-	-	-	-	-			
<p>RTA 00 1 per carton</p>										
 <p>30" Square Coffee Table COM: N/A Freight class: 250 Product weight: 53 Cubic feet per carton: 15.3</p>	<p>For power/USB unit, see electrical placement chart.</p> <p>Freestanding unit only. Add \$383 for 27 lbs. (CW)</p>	<p>R27856</p>	List price							
			1649							
			OVERALL DIMENSIONS			SEAT DIMENSIONS			BACK DIMENSIONS	
			W	D	H	W	D	H	W	H
30	30	17	-	-	-	-	-			
<p>RTA 00 1 per carton</p>										
 <p>36" Square Coffee Table COM: N/A Freight class: 250 Product weight: 75 Cubic feet per carton: 20.6</p>	<p>For power/USB unit, see electrical placement chart.</p> <p>Freestanding unit only. No counterweight.</p>	<p>R27857</p>	List price							
			1890							
			OVERALL DIMENSIONS			SEAT DIMENSIONS			BACK DIMENSIONS	
			W	D	H	W	D	H	W	H
36	36	17	-	-	-	-	-			
<p>RTA 00 1 per carton</p>										
 <p>42" Square Coffee Table COM: N/A Freight class: 150 Product weight: 115 Cubic feet per carton: 26.7</p>	<p>For power/USB unit, see electrical placement chart.</p> <p>Freestanding unit only. No counterweight.</p>	<p>R27858</p>	List price							
			2101							
			OVERALL DIMENSIONS			SEAT DIMENSIONS			BACK DIMENSIONS	
			W	D	H	W	D	H	W	H
42	42	17	-	-	-	-	-			
<p>RTA 00 1 per carton</p>										
 <p>Rectangular Coffee Table COM: N/A Freight class: 250 Product weight: 55 Cubic feet per carton: 14.2</p>	<p>For power/USB unit, see electrical placement chart.</p> <p>Freestanding unit only. Add 256 for 18 lbs. (CW)</p>	<p>R27859</p>	List price							
			1716							
			OVERALL DIMENSIONS			SEAT DIMENSIONS			BACK DIMENSIONS	
			W	D	H	W	D	H	W	H
40	20	17	-	-	-	-	-			
<p>RTA 00 1 per carton</p>										

Options: (CW) Counterweight

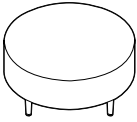
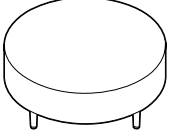
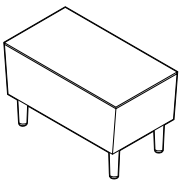
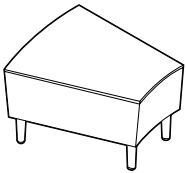
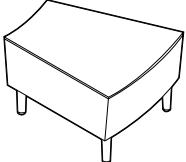
DESCRIPTION	FEATURES	MODEL#	STANDARD TEXTILE GRADES							
 <p>36" Dia. Round Coffee Table COM: N/A Freight class: 150 Product weight: 63 Cubic feet per carton: 15.3</p>	<p>For power/USB unit, see electrical placement chart.</p> <p>Freestanding unit only. Add \$256 for 18 lbs. (CW)</p>	<p>List price</p> <p>R27860 2033</p>								
			OVERALL DIMENSIONS		SEAT DIMENSIONS			BACK DIMENSIONS		
			W	D	H	W	D	H	W	H
			36	36	17	-	-	-	-	-
			RTA 00	1 per carton						
 <p>42" Dia. Round Coffee Table COM: N/A Freight class: 150 Product weight: 85 Cubic feet per carton: 20.6</p>	<p>For power/USB unit, see electrical placement chart.</p> <p>Freestanding unit only. No counterweight.</p>	<p>List price</p> <p>R27861 2230</p>								
			OVERALL DIMENSIONS		SEAT DIMENSIONS			BACK DIMENSIONS		
			W	D	H	W	D	H	W	H
			42	42	17	-	-	-	-	-
			RTA 00	1 per carton						
 <p>Rectangular End Table COM: N/A Freight class: 300 Product weight: 40 Cubic feet per carton: 20.6</p>	<p>For power/USB unit, see electrical placement chart.</p> <p>Includes ganging hardware (2 sides). Add \$511 for 36 lbs. (CW)</p>	<p>List price</p> <p>R27862 1665</p>								
			OVERALL DIMENSIONS		SEAT DIMENSIONS			BACK DIMENSIONS		
			W	D	H	W	D	H	W	H
			28	15	17	-	-	-	-	-
			RTA 00	1 per carton						
 <p>Inside Curve End Table COM: N/A Freight class: 250 Product weight: 47 Cubic feet per carton: 13.3</p>	<p>For power/USB unit, see electrical placement chart.</p> <p>Includes ganging hardware (2 sides). Add \$511 for 36 lbs. (CW)</p>	<p>List price</p> <p>R27863 2188</p>								
			OVERALL DIMENSIONS		SEAT DIMENSIONS			BACK DIMENSIONS		
			W	D	H	W	D	H	W	H
			28	17	17	-	-	-	-	-
			RTA 00	1 per carton						
 <p>Outside Curve End Table COM: N/A Freight class: 250 Product weight: 47 Cubic feet per carton: 13.3</p>	<p>For power/USB unit, see electrical placement chart.</p> <p>Includes ganging hardware (2 sides). Add \$511 for 36 lbs. (CW)</p>	<p>List price</p> <p>R27864 2188</p>								
			OVERALL DIMENSIONS		SEAT DIMENSIONS			BACK DIMENSIONS		
			W	D	H	W	D	H	W	H
			28	17	17	-	-	-	-	-
			RTA 00	1 per carton						

Options: **(CW)** Counterweight

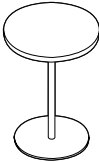
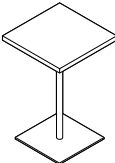
DESCRIPTION	FEATURES	MODEL#	STANDARD TEXTILE GRADES						
 <p>18" Dia. Round Laptop Table COM: N/A Freight class: 150 Product weight: 32 Cubic feet per carton: 6</p>	No power/USB unit.	List price							
		7743	836						
		OVERALL DIMENSIONS			SEAT DIMENSIONS			BACK DIMENSIONS	
		W	D	H	W	D	H	W	H
		18	18	25.25	-	-	-	-	-
		RTA 00	1 per carton						
 <p>16" Square Laptop Table COM: N/A Freight class: 125 Product weight: 36 Cubic feet per carton: 6</p>	No power/USB unit.	List price							
		7745	855						
		OVERALL DIMENSIONS			SEAT DIMENSIONS			BACK DIMENSIONS	
		W	D	H	W	D	H	W	H
		16	16	25.25	-	-	-	-	-
		RTA 00	1 per carton						

SIRENA™



models 3371 Lounge Chairs, 3373 Two Seat Sofa, 3400 Coffee Table, and 3402 End Table



model 3371



model 3372CRTL

STANDARD FEATURES

- Modern club style seating includes: lounge chair, two and three seat sofas.
- Complete with Modern tables for reception areas, meeting rooms, and private office use.
- Lounge seating distinctive round style feet are finished in Black Only.
- All models have fixed, non-removable seat cushions with arm height at 25" in the front.
- Casters are available on lounge chairs only. **C1M** casters are standard.
- Please note leather models offer additional stitch details.
- Check textile availability prior to specifying upholstery material.
- When ordering models with tablet, specify for left hand or for right hand tablet. See models below.
- Laminate Tops, are 1.5" thick.
- Table legs are 1.5" steel tubing, tapered toward the bottom to 7/8", equipped with self-leveling, pivoting steel glides.



OPTIONAL FEATURES

- Laminate tables, tablets and bookshelves are offered in the following laminate finishes: Absolute Acajou (**ACJ**), Asian Night (**ASN**), Avant Cherry (**AWC**), Avant Honey (**AWH**), Blizzard (**BZD**), Clear Maple (**CMB**), Custom Grey (**CGY**), Dark Espresso (**DES**), Designer White (**DWT**), Fashionista (**FAS**), First Class (**FCL**), Noce Biondo (**NBL**), Noce Grigio (**NGL**), Noce Leggero (**NEL**), Noce Medio (**NML**), Quartered Mahogany (**QTM**), Sheer Beauty (**SBY**), Stonedust (**SDT**), Walnut Heights (**WHE**), White Chocolate (**WHC**) and Winter Cherry (**WCR**). Please Specify.
- Table legs are available in Tungsten (**TU**), Shadow (**TSH**), Black (**TBL**) at no upcharge. Not available in Chrome.

STITCH DETAIL WHEN UPHOLSTERED IN ALL LEATHER - ILLUSTRATIONS BELOW

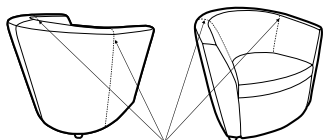

Lounge Chair

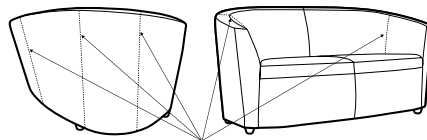

Two and Three Seater Sofas

DESCRIPTION FEATURES MODEL# STANDARD TEXTILE GRADES



Lounge Chair Fabric
COM Yardage: 4.25
Freight Class: 250
Product Weight (lbs.): 52
Cubic Feet Per Carton: 19.25

	1	2	3	4	5	6	7	8	9	10	11	12
3371	-	1826	1956	2140	2407	2505	2737	3174	3390	3795	4358	5054

OVERALL DIMENSIONS			SEAT DIMENSIONS			BACK DIMENSIONS	
W	D	H	W	D	H	W	H
30.5	29.5	28.5	20	20	17.5	19	11.5

RTA 00











Lounge Chair w/Casters
COM Yardage: 4.25
Freight Class: 250
Product Weight (lbs.): 52
Cubic Feet Per Carton: 19.25

	1	2	3	4	5	6	7	8	9	10	11	12
3371C	-	1964	2101	2296	2576	2680	2923	3380	3609	4033	4621	5351

OVERALL DIMENSIONS			SEAT DIMENSIONS			BACK DIMENSIONS	
W	D	H	W	D	H	W	H
30.5	29.5	29.5	20	20	17.5	19	11.5

RTA 00

DESCRIPTION	FEATURES	MODEL#	STANDARD TEXTILE GRADES											
			1	2	3	4	5	6	7	8	9	10	11	12
 3371LTL	 3371RTL	3371LTL 3371RTL	-	2635	2768	2967	3244	3348	3591	4050	4279	4700	5292	6022
			OVERALL DIMENSIONS W D H			SEAT DIMENSIONS W D H			BACK DIMENSIONS W H					
Lounge Chair w/Laminate Tablet COM Yardage: 4.25 Freight Class: 250 Product Weight (lbs.): 58 Cubic Feet Per Carton: 19.25			<div style="text-align: center;">RTA 00</div>											
 3371CLTL	 3371CRTL	3371CLTL 3371CRTL	-	2786	2922	3118	3395	3499	3745	4199	4430	4851	5443	6173
			OVERALL DIMENSIONS W D H			SEAT DIMENSIONS W D H			BACK DIMENSIONS W H					
Lounge Chair w/Casters & Laminate Tablet COM Yardage: 4.25 Freight Class: 250 Product Weight (lbs.): 62 Cubic Feet Per Carton: 19.25			<div style="text-align: center;">RTA 00</div>											
		3372	-	2431	2561	2745	3012	3110	3342	3779	3995	4400	4963	5659
	OVERALL DIMENSIONS W D H			SEAT DIMENSIONS W D H			BACK DIMENSIONS W H							
Lounge Chair w/Laminate Book Shelf COM Yardage: 4.25 Freight Class: 250 Product Weight (lbs.): 55 Cubic Feet Per Carton: 19.25			<div style="text-align: center;">RTA 00</div>											
		3372C	-	2665	2795	2979	3246	3344	3576	4013	4229	4634	5197	5893
	OVERALL DIMENSIONS W D H			SEAT DIMENSIONS W D H			BACK DIMENSIONS W H							
Lounge Chair w/Casters & Laminate Book Shelf COM Yardage: 4.25 Freight Class: 250 Product Weight (lbs.): 55 Cubic Feet Per Carton: 19.25			<div style="text-align: center;">RTA 00</div>											
 3372LTL	 3372RTL	3372LTL 3372RTL	-	3170	3300	3484	3751	3849	4081	4518	4734	5139	5702	6398
			OVERALL DIMENSIONS W D H			SEAT DIMENSIONS W D H			BACK DIMENSIONS W H					
Lounge Chair w/Laminate Tablet/Book Shelf COM Yardage: 4.25 Freight Class: 250 Product Weight (lbs.): 66 Cubic Feet Per Carton: 19.25			<div style="text-align: center;">RTA 00</div>											

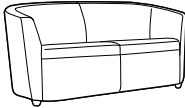
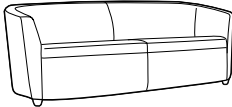
DESCRIPTION	FEATURES	MODEL#	STANDARD TEXTILE GRADES											
			1	2	3	4	5	6	7	8	9	10	11	12
 3372CLTL	 3372CRTL	3372CLTL 3372CRTL	-	3326	3456	3640	3907	4005	4237	4674	4890	5296	5858	6554
			OVERALL DIMENSIONS W D H			SEAT DIMENSIONS W D H			BACK DIMENSIONS W H					
Lounge Chair w/ Casters & Laminate Tablet/Book Shelf COM Yardage: 4.25 Freight Class: 250 Product Weight (lbs.): 66 Cubic Feet Per Carton: 19.25			32.5	29.5	28.5	20	20	17.5	19	11.5				
			RTA 00											
		3373	-	3426	3636	3945	4380	4544	4927	5641	6002	6670	7594	8736
	OVERALL DIMENSIONS W D H			SEAT DIMENSIONS W D H			BACK DIMENSIONS W H							
Two Seat Sofa COM Yardage: 7 Freight Class: 300 Product Weight (lbs.): 92 Cubic Feet Per Carton: 48			62	29.5	28.5	53	20	17.5	53	11.5				
			RTA 00											
		3374	-	4119	4349	4689	5172	5357	5777	6571	6970	7706	8731	9996
	OVERALL DIMENSIONS W D H			SEAT DIMENSIONS W D H			BACK DIMENSIONS W H							
Three Seat Sofa COM Yardage: 7.75 Freight Class: 300 Product Weight (lbs.): 107 Cubic Feet Per Carton: 55.5			81.5	29.5	28.5	72.5	20	17.5	72.5	11.5				
			RTA 00											

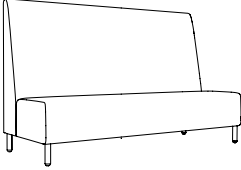
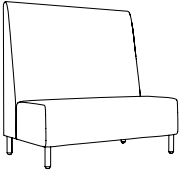
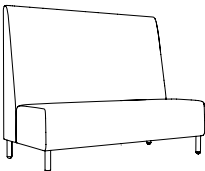
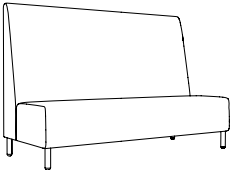
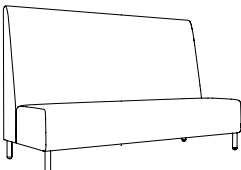
DESCRIPTION	FEATURES	MODEL#	STANDARD TEXTILE GRADES											
			1	2	3	4	5	6	7	8	9	10	11	12
 <p>78"W Three Seater Banquette, Closed Back COM Yardage: 10 Freight Class: 250 Product weight (lbs): 163 Cubic Feet Per Carton: 79.75</p>		8506-78	4413	4779	5063	5485	6077	6328	6841	7650	8254	8914	10293	11740
	OVERALL DIMENSIONS			SEAT DIMENSIONS			BACK DIMENSIONS							
	W	D	H	W	D	H	W	H						
	78	28	48	78	19	18	78	30						
			RTA 00		1 per carton									
 <p>48"W Two Seater Banquette, Open Back COM Yardage: 5 Freight Class: 250 Product weight (lbs): 105 Cubic Feet Per Carton: 50.75</p>		8507-48	2981	3164	3306	3517	3814	3939	4196	4600	4902	5232	5922	6646
	OVERALL DIMENSIONS			SEAT DIMENSIONS			BACK DIMENSIONS							
	W	D	H	W	D	H	W	H						
	48	28	48	48	19	18	48	30						
			RTA 00		1 per carton									
 <p>60"W Two Seater Banquette, Open Back COM Yardage: 6 Freight Class: 250 Product weight (lbs): 127 Cubic Feet Per Carton: 62.75</p>		8507-60	3394	3614	3786	4038	4394	4543	4853	5337	5700	6096	6922	7792
	OVERALL DIMENSIONS			SEAT DIMENSIONS			BACK DIMENSIONS							
	W	D	H	W	D	H	W	H						
	60	28	48	60	19	18	60	30						
			RTA 00		1 per carton									
 <p>72"W Three Seater Banquette, Open Back COM Yardage: 7 Freight Class: 250 Product weight (lbs): 153 Cubic Feet Per Carton: 75</p>		8507-72	3805	4061	4260	4556	4970	5146	5505	6072	6494	6957	7921	8935
	OVERALL DIMENSIONS			SEAT DIMENSIONS			BACK DIMENSIONS							
	W	D	H	W	D	H	W	H						
	72	28	48	72	19	18	72	30						
			RTA 00		1 per carton									
 <p>78"W Three Seater Banquette, Open Back COM Yardage: 8 Freight Class: 250 Product weight (lbs): 163 Cubic Feet Per Carton: 79.75</p>		8507-78	4179	4472	4701	5037	5511	5711	6123	6768	7253	7781	8884	10042
	OVERALL DIMENSIONS			SEAT DIMENSIONS			BACK DIMENSIONS							
	W	D	H	W	D	H	W	H						
	78	28	48	78	19	18	78	30						
			RTA 00		1 per carton									

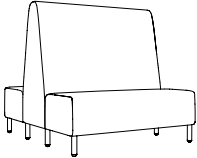
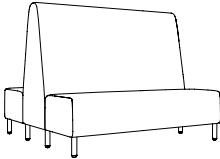
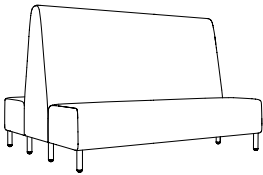
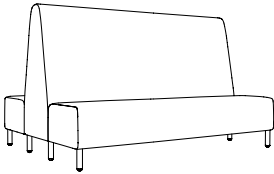
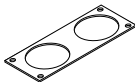
DESCRIPTION	FEATURES	MODEL#	STANDARD TEXTILE GRADES											
			1	2	3	4	5	6	7	8	9	10	11	12
 <p>48\" W Four Seater Banquette, Double Back COM Yardage: 9 Freight Class: 300 Product weight (lbs): 163 Cubic Feet Per Carton: 89.75</p>	optional (KD) packaging (no upcharge)	8508-48	5749	6079	6336	6715	7249	7472	7935	8662	9207	9802	11041	12345
			OVERALL DIMENSIONS			SEAT DIMENSIONS			BACK DIMENSIONS					
			W	D	H	W	D	H	W	H				
			48	55	48	48	19	18	48	30				
			RTA 00		1 per carton									
 <p>60\" W Four Seater Banquette, Double Back COM Yardage: 10 Freight Class: 300 Product weight (lbs): 198 Cubic Feet Per Carton: 111</p>	optional (KD) packaging (no upcharge)	8508-60	6661	7027	7311	7733	8325	8576	9089	9898	10502	11162	12541	13988
			OVERALL DIMENSIONS			SEAT DIMENSIONS			BACK DIMENSIONS					
			W	D	H	W	D	H	W	H				
			60	55	48	60	19	18	60	30				
			RTA 00		1 per carton									
 <p>72\" W Six Seater Banquette, Double Back COM Yardage: 11 Freight Class: 300 Product weight (lbs): 242 Cubic Feet Per Carton: 132.5</p>	optional (KD) packaging (no upcharge)	8508-72	7909	8311	8626	9089	9741	10015	10581	11469	12135	12862	14378	15970
			OVERALL DIMENSIONS			SEAT DIMENSIONS			BACK DIMENSIONS					
			W	D	H	W	D	H	W	H				
			72	55	48	72	19	18	72	30				
			RTA 00		1 per carton									
 <p>78\" W Six Seater Banquette, Double Back COM Yardage: 12 Freight Class: 300 Product weight (lbs): 255 Cubic Feet Per Carton: 141.7</p>	optional (KD) packaging (no upcharge)	8508-78	8838	9276	9619	10126	10837	11136	11752	12722	13448	14241	15894	17632
			OVERALL DIMENSIONS			SEAT DIMENSIONS			BACK DIMENSIONS					
			W	D	H	W	D	H	W	H				
			78	55	48	78	19	18	78	30				
			RTA 00		1 per carton									
 <p>Ganging Bracket Kit COM Yardage: n/a Freight Class: 70 Product weight (lbs): 0.5 Cubic Feet Per Carton: 0.1</p>	Includes two brackets	8509	List price											
			98											
			OVERALL DIMENSIONS			SEAT DIMENSIONS			BACK DIMENSIONS					
			W	D	H	W	D	H	W	H				
2.5	6	0.25	-	-	-	-	-							
			RTA 00		1 per carton									

VITROLA



Vitrola is offered in two back heights, standard lounge and high back lounge, along with two and three seat sofa models.



Matching ottoman and accent pillow to complete the offering.

STANDARD FEATURES

- Classic soft seating upholstery design with swooping arms.
- Available in standard Lounge, High Back Lounge along with Two and Three Seat Sofa models.
- Matching Ottoman and Accent Pillow complete the offering.
- Fully upholstered with piping details at the bottom of frame.
- Seat cushions are fixed or sewn tight.
- Standard in tapered maple wood legs. Standard in tapered maple wood legs. Legs are equipped with White non-marking glides as standard. Suitable for both carpet and hard surface flooring.
- Back upholstery is continuous without seams. In the event the textile cannot be railroaded, stitch lines will be required (one for 2 seater and two for 3 seater).
- All models ship fully assembled.
- Check textile availability prior to specifying upholstery material.

OPTION CODES





Please add option codes in the following order:

- **Model number**
8271 Lounge Chair
8272 Two Seat Sofa
8273 Three Seat Sofa
8274 Ottoman
8275 High Back Lounge Chair
8276 Accent Pillow
- **Fabric**
Specify fabric code.
- **Wood Legs**
(AAM) Absolute
(BKM) Black
(ACM) Cherry
(EOM) English Oak
(ECM) Espresso Café
(HGM) Grey
(AHM) Honey
(TMM) Mahogany
(AVM) Maple
(MWM) Medium Walnut
(NLW) Natural Walnut
(ASM) Night
(NBM) Noce Biondo
(NGM) Noce Grigio
(NEM) Noce Leggero
(NMM) Noce Medio
(SKM) Shaker Cherry
(TFM) Fruitwood
(TWM) Walnut
(WTM) WC Cream
(WHM) White
(WCM) Winter Cherry
(colors shown on website).

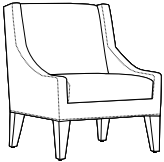
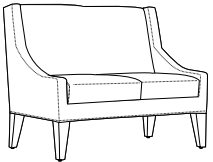
EXAMPLE OF ORDER CODE:

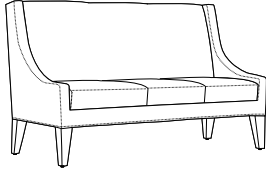
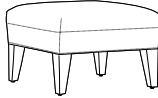
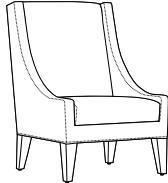
8271	WA50	HGM
Model Number	Fabric	Wood Legs

DESCRIPTION	FEATURES	MODEL#	STANDARD TEXTILE GRADES											
			1	2	3	4	5	6	7	8	9	10	11	12
 <p>Lounge Chair COM Yardage: 5.25 Freight Class: 150 Product Weight (lbs.): 90 Cubic Feet Per Carton: 20.25</p>		8271	\$1691	\$1895	\$2053	\$2290	\$2629	\$2791	\$3096	\$3585	\$3962	\$4380	\$5242	\$6163
			OVERALL DIMENSIONS			SEAT DIMENSIONS			BACK DIMENSIONS					
			W	D	H	W	D	H	W	H				
			28	31	34	22	21	17.5	22	18				
		RTA 00												
 <p>Two Seat Sofa COM Yardage: 7.25 Freight Class: 250 Product Weight (lbs.): 107 Cubic Feet Per Carton: 36.5</p>		8272	\$2774	\$3096	\$3349	\$3731	\$4274	\$4529	\$5020	\$5802	\$6404	\$7075	\$8457	\$9927
			OVERALL DIMENSIONS			SEAT DIMENSIONS			BACK DIMENSIONS					
			W	D	H	W	D	H	W	H				
			51	31	34	44	21	17.5	44	18				
		RTA 00												

DESCRIPTION	FEATURES	MODEL#	STANDARD TEXTILE GRADES											
			1	2	3	4	5	6	7	8	9	10	11	12
 <p>Three Seat Sofa COM Yardage: 9.25 Freight Class: 250 Product Weight (lbs.): 140 Cubic Feet Per Carton: 51.75</p>		8273	\$3608	\$4090	\$4473	\$5045	\$5858	\$6238	\$6976	\$8149	\$9052	\$10059	\$12130	\$14336
			OVERALL DIMENSIONS			SEAT DIMENSIONS			BACK DIMENSIONS					
			W	D	H	W	D	H	W	H				
			74.25	31	34	66	21	17.5	66	18				
			RTA 00											
 <p>Ottoman COM Yardage: 1.75 Freight Class: 250 Product Weight (lbs.): 20 Cubic Feet Per Carton: 8</p>		8274	\$972	\$1078	\$1157	\$1277	\$1445	\$1526	\$1679	\$1924	\$2112	\$2321	\$2754	\$3213
			OVERALL DIMENSIONS			SEAT DIMENSIONS			BACK DIMENSIONS					
			W	D	H	W	D	H	W	H				
			24	24	17	-	-	-	-	-				
			RTA 00											
 <p>High Back Lounge Chair COM Yardage: 6.25 Freight Class: 250 Product Weight (lbs.): 96 Cubic Feet Per Carton: 28.25</p>		8275	\$2035	\$2259	\$2433	\$2696	\$3068	\$3242	\$3581	\$4119	\$4534	\$4994	\$5944	\$6955
			OVERALL DIMENSIONS			SEAT DIMENSIONS			BACK DIMENSIONS					
			W	D	H	W	D	H	W	H				
			28	31	42	22	21	17.5	22	26				
			RTA 00											
 <p>Accent Pillow COM Yardage: 0.75 Freight Class: 150 Product Weight (lbs.): 4 Cubic Feet Per Carton: 1</p>		8276	\$202	\$230	\$252	\$282	\$327	\$348	\$387	\$451	\$500	\$555	\$668	\$786
			OVERALL DIMENSIONS			SEAT DIMENSIONS			BACK DIMENSIONS					
			W	D	H	W	D	H	W	H				
			23	6	8	-	-	-	-	-				
			RTA 00											
						 			1 per carton					

WIND™



models 3361 Lounge chair & 3362 Two seat sofa, with 3357 Coffee table.

ADDITIONAL STITCH DETAIL - ILLUSTRATIONS BELOW

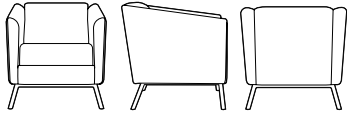

Standard Detailing - when upholstered in FABRIC or VINYL

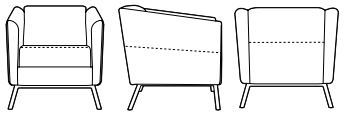

Additional Detailing - when upholstered in GENUINE LEATHER



Contrasting Textile Application



For Wind tables, see page 382

STANDARD FEATURES

- The Wind and Wind Linear series are compact, contemporary designed seating offering a raised, modern version of the traditional lounge chair; scaled down for smaller spaces.
- Wind is comprised of freestanding lounge chairs and tables.
- Wind Linear (see page 384 includes ganging seating and tables.
- Metal leg models (3361, 3362 and 3363) are available in plated and painted finishes noted.
- Wood leg models (3431, 3432 and 3433) are available in standard Global wood finishes.
- Wind tables are available with metal legs only.
- Metal legs are standard with Black glides and offer non-marking glides at no upcharge.
- Wood legs are standard with nonmarking glides and offer a variety of glide types for various flooring types. See list for types and upcharges.
- Casters are not available for Wind.
- Available with fabric, coated textile and leather upholstery; check approved textiles prior to ordering.
- The series is available with contrasting fabrics. Specify arms, back and front rail separate from seat cushion, see model image.
- For pricing, start with the base price and add both back/arms graded textile upcharge and the seat graded textile upcharge.
- For leather upholstery, note additional stitch details on seat and outside arm and back panels.
- Wind is covered under Global's Limited Lifetime Warranty.
- Wind seating has a 300 lb capacity.

Add option codes in the following order:





- **Model Number**
Specify model number.
3431 to 3433 Wood leg seating
3361 to 3363 Metal leg seating
- **Back and Arm Textile** (includes front rail)
Specify textile code.
- **Seat Textile**
Specify textile code.
- **Leg Finish** (metal legs)

(TBL) Black	(TBZ) Buzz Blue
(TCC) Cactus	(TCR) Carrot
(TDJ) Dijon	(TDW) Designer White
(TEG) Eggplant	(TFO) Fog
(TFR) Frost	(TIN) Ink
(TIV) Cloud	(TKA) Kalua
(TLA) Latte	(TMO) Mocha
(TOA) Toast	(TNE) Nevada
(TSH) Shadow	(TSN) Sand
(TSR) Scarlet	(TTU) Tungsten
- **Leg Finish** (wood legs)

(AAM) Absolute	(BKM) Black
(ACM) Cherry	(EOM) English Oak
(ECM) Espresso Cafe	(TFM) Fruitwood
(HGM) Grey	(AHM) Honey
(TMM) Mahogany	(AVM) Maple
(NLW) Natural Walnut	(MWM) Medium Walnut
(ASM) Night	(NBM) Noce Biondo
(NGM) Noce Grigio	(NEM) Noce Leggero
(NMM) Noce Medio	(SKM) Shaker Cherry
(TWM) Walnut	(WTM) WC Cream
(WHM) White	(WCM) Winter Cherry
- **Glide Type (metal legs)**
 - (GL) Black Glide for most surfaces (standard).
 - (NM) Non-Marking Glide for most surfaces. No upcharge.
- **Glide Type (wood legs)**
 - (NM) Non-marking glides for most surfaces (standard).
 - (SG) Steel cushioned glides for carpeted surfaces.. Add \$36
 - (RG) Rubber non-slip glides for most hard floor surfaces. Add \$36
 - (FG) Felt glides for most hard floor surfaces. Add \$36

DESCRIPTION	FEATURES	MODEL#	STANDARD TEXTILE GRADES													
			1	2	3	4	5	6	7	8	9	10	11	12		
 <p>Lounge Chair, Wood Legs COM Yardage: Back: 3.5; Seat: 1 Freight Class: 250 Product Weight (lbs.): 59 Cubic Feet Per Carton: 16.5</p>	3431	Base Price:	\$2950													
		Back/Arm upcharge:	+0	+0	\$93	\$229	\$421	\$503	\$669	\$931	\$1127	\$1341	\$1788	\$2257		
		Seat upcharge:	+0	+0	\$27	\$66	\$121	\$144	\$191	\$266	\$322	\$383	\$511	\$645		
		OVERALL DIMENSIONS														
		W	D	H	W	D	H	W	D	H	W	H				
		27.5	29	28.5	19.5	19	17	19			12					

RTA 00

DESCRIPTION	FEATURES	MODEL#	STANDARD TEXTILE GRADES													
			1	2	3	4	5	6	7	8	9	10	11	12		
 <p>Two Seat Sofa, Wood Legs COM Yardage: Back: 5 ; Seat: 1.75 Freight Class: 250 Product Weight (lbs.): 98 Cubic Feet Per Carton: 30</p>	3432	Base Price:	\$3833													
		Back/Arm upcharge:	+0	+0	\$132	\$328	\$602	\$718	\$955	\$1330	\$1609	\$1915	\$2554	\$3224		
		Seat upcharge:	+0	+0	\$47	\$115	\$211	\$252	\$335	\$466	\$564	\$671	\$894	\$1129		
			OVERALL DIMENSIONS			SEAT DIMENSIONS			BACK DIMENSIONS							
			W	D	H	W	D	H	W	H						
		54.5	29	28.5	46.5	19	17	46.5	12							
		RTA 00														
 <p>Three Seat Sofa, Wood Legs COM Yardage: Back: 6 ; Seat: 3 Freight Class: 250 Product Weight (lbs.): 129 Cubic Feet Per Carton: 42.5</p>	3433	Base Price:	\$4713													
		Back/Arm upcharge:	+0	+0	\$159	\$393	\$722	\$861	\$1146	\$1596	\$1931	\$2298	\$3064	\$3868		
		Seat upcharge:	+0	+0	\$80	\$197	\$361	\$431	\$573	\$798	\$966	\$1149	\$1532	\$1934		
			OVERALL DIMENSIONS			SEAT DIMENSIONS			BACK DIMENSIONS							
			W	D	H	W	D	H	W	H						
		78	29	28.5	70.5	19	17	70.5	12							
		RTA 00														
 <p>Lounge Chair, Metal Legs COM Yardage: Back: 2.75 ; Seat: 1.75 Freight Class: 250 Product Weight (lbs.): 62 Cubic Feet Per Carton: 16.5</p>	3361	Base Price:	\$2687													
		Back/Arm upcharge:	+0	+0	\$73	\$181	\$332	\$395	\$526	\$732	\$886	\$1054	\$1405	\$1774		
		Seat upcharge:	+0	+0	\$47	\$115	\$211	\$252	\$335	\$466	\$564	\$671	\$894	\$1129		
			OVERALL DIMENSIONS			SEAT DIMENSIONS			BACK DIMENSIONS							
			W	D	H	W	D	H	W	H						
		27.5	29	28.5	19.5	19	17	19	12							
		RTA 00														
 <p>Two Seat Sofa, Metal Legs COM Yardage: Back: 3.5 ; Seat: 3.25 Freight Class: 250 Product Weight (lbs.): 102 Cubic Feet Per Carton: 250</p>	3362	Base Price:	\$3570													
		Back/Arm upcharge:	+0	+0	\$93	\$229	\$421	\$503	\$669	\$931	\$1127	\$1341	\$1788	\$2257		
		Seat upcharge:	+0	+0	\$87	\$214	\$392	\$467	\$622	\$865	\$1047	\$1245	\$1660	\$2096		
			OVERALL DIMENSIONS			SEAT DIMENSIONS			BACK DIMENSIONS							
			W	D	H	W	D	H	W	H						
		54.5	29	28.5	46.5	19	17	46.5	12							
		RTA 00														
 <p>Three Seat Sofa, Metal Legs COM Yardage: Back: 4.5 ; Seat: 4.5 Freight Class: 250 Product Weight (lbs.): 135 Cubic Feet Per Carton: 250</p>	3363	Base Price:	\$4449													
		Back/Arm upcharge:	+0	+0	\$120	\$295	\$542	\$646	\$860	\$1197	\$1449	\$1724	\$2298	\$2902		
		Seat upcharge:	+0	+0	\$120	\$295	\$542	\$646	\$860	\$1197	\$1449	\$1724	\$2298	\$2902		
			OVERALL DIMENSIONS			SEAT DIMENSIONS			BACK DIMENSIONS							
			W	D	H	W	D	H	W	H						
		78	29	28.5	70.5	19	17	70.5	12							
		RTA 00														

WIND™ TABLES



models 3361 Lounge chair & 3362 Two seat sofa, with 3357 Coffee table.





For Wind seating, see page 380

STANDARD FEATURES

- Wind tables compliment the modern decor of many environments, pairing naturally with Wind and Wind Linear lounge seating and other contemporary seating, such as Kate, Erin, and Marche.
- Metal Legs are available in plated and painted finishes noted.
- Table tops are standard with Thermally Fused Laminate (LPL). High Pressure Laminate (HPL) surface is available at a 20% upcharge.

Add option codes in the following order:

- **Model Number**
Specify model number.
3366 to 3371 Metal leg tables
- **Laminate Tops (LPL)**
(**ACJ**) Absolute Acajou (**ASN**) Asian Night
(**AWC**) Avant Cherry (**AWH**) Avant Honey
(**BLK**) Black (**BRC**) Brushed Cobalt
(**BZD**) Blizzard (**CGY**) Custom Grey
(**CMB**) Clear Maple (**DES**) Dark Espresso
(**DWT**) Designer White (**FAS**) Fashionista
(**FCL**) First Class (**NBL**) Noce Biondo
(**NGL**) Noce Grigio (**NEL**) Noce Leggero
(**NML**) Noce Medio
(**QTM**) Quartered Mahogany
(**SBY**) Sheer Beauty (**SDT**) Stonedust
(**SOG**) Storm Grey (**WHE**) Walnut Heights
(**WHC**) White Chocolate (**WCR**) Winter Cherry
- **Leg Finish** (metal legs)
(**TBL**) Black (**TBZ**) Buzz Blue
(**TCC**) Cactus (**TCR**) Carrot
(**TDJ**) Dijon (**TDW**) Designer White
(**TEG**) Eggplant (**TFO**) Fog
(**TFR**) Frost (**TIN**) Ink
(**TIV**) Cloud (**TKA**) Kalua
(**TLA**) Latte (**TMO**) Mocha
(**TOA**) Toast (**TNE**) Nevada
(**TSH**) Shadow (**TSN**) Sand
(**TSR**) Scarlet (**TTU**) Tungsten
Metallics:
(**CHM**) Chrome. No upcharge.
(**BCH**) Brushed Chrome. Add \$224
- **Glide Type**
(**GL**) Black Glide for most surfaces (standard).
(**NM**) Non-Marking Glide for most surfaces. No upcharge.

DESCRIPTION	FEATURES	MODEL#	STANDARD TEXTILE GRADES													
			1	2	3	4	5	6	7	8	9	10	11	12		
 End Table COM Yardage: N/A Freight Class: 250 Product Weight (lbs.): 36 Cubic Feet Per Carton: 11.5	3366 List Price: \$985 Laminate Top															
		OVERALL DIMENSIONS W D H			SEAT DIMENSIONS W D H			BACK DIMENSIONS W H								
		24	24	17	-	-	-	-	-							
		RTA 00														
 Rectangular Coffee Table COM Yardage: N/A Freight Class: 250 Product Weight (lbs.): 52 Cubic Feet Per Carton: 16	3367 List Price: \$1302 Laminate Top															
		OVERALL DIMENSIONS W D H			SEAT DIMENSIONS W D H			BACK DIMENSIONS W H								
		48	20	15	-	-	-	-	-							
		RTA 00														

DESCRIPTION	FEATURES	MODEL#	STANDARD TEXTILE GRADES														
			1	2	3	4	5	6	7	8	9	10	11	12			
	3368 Laminate Top	List Price: \$1762															
Square Coffee Table COM Yardage: N/A Freight Class: Z50 Product Weight (lbs.): 66 Cubic Feet Per Carton: 22			OVERALL DIMENSIONS			SEAT DIMENSIONS			BACK DIMENSIONS								
			W	D	H	W	D	H	W	H							
			36	36	15	-	-	-	-	-							
			RTA 00														

DESCRIPTION	FEATURES	MODEL#	STANDARD TEXTILE GRADES														
			1	2	3	4	5	6	7	8	9	10	11	12			
	3870 Laminate Top	List Price: \$1077															
Round Table COM Yardage: N/A Freight Class: Z50 Product Weight (lbs.): 35 Cubic Feet Per Carton: 11.5			OVERALL DIMENSIONS			SEAT DIMENSIONS			BACK DIMENSIONS								
			W	D	H	W	D	H	W	H							
			24	24	17	-	-	-	-	-							
			RTA 00 FedEx ups														

DESCRIPTION	FEATURES	MODEL#	STANDARD TEXTILE GRADES														
			1	2	3	4	5	6	7	8	9	10	11	12			
	3871 Laminate Top	List Price: \$1584															
Round Coffee Table COM Yardage: N/A Freight Class: Z50 Product Weight (lbs.): 57 Cubic Feet Per Carton: 22			OVERALL DIMENSIONS			SEAT DIMENSIONS			BACK DIMENSIONS								
			W	D	H	W	D	H	W	H							
			36	36	15	-	-	-	-	-							
			RTA 00														

WIND™ LINEAR



models 3363R and 3363L with 3882 bridge table, 3360 table attaching bracket kit and two 3380 coffee tables



Contrasting Textile Application



For Wind Linear tables, see page 389

STANDARD FEATURES

- Wind Linear is an extension of the Wind lounge series with an emphasis on expansive, clean lines.
- Wind Linear tables complement the modern decor of many offices.
- This modular furniture series includes single arm and armless sofas and benches for use as freestanding or ganged seating. See ganging features below.
- Metal Leg models (3361L/R/NA, 3363L/R/NA, 3361B and 3363B) are available in plated and painted finishes noted.
- Wood Leg models (3431L/R/NA, 3433L/R/NA, 3434B and 3435B) are available in standard Global wood finishes, noted.
- Casters are not available on Wind Linear.
- Wind Linear tables are available with metal legs.
- A variety of glide types are available. Use glide chart for recommended glide use on various flooring types.
- Available with fabric, coated textile and leather upholstery; check approved textiles prior to ordering.
- The series is available with contrasting fabrics. Specify arms, back and front rail separate from seat cushion, see model image.
- For pricing, start with the base price and add both back/arms graded textile upcharge and the seat graded textile upcharge.
- For leather upholstery, note additional stitch details on seat and outside arm and back panels.
- Wind is covered under Global's Limited Lifetime Warranty.
- Wind Linear seating has a 300 lb capacity.

GANGING FEATURES

- Metal or wood leg seating gang to table 'bridges' and metal leg corner tables in-between seating units at armless ends. A table attaching bracket kit (3360) is required, specified separately and field installed. See Wind Linear Tables for details.
- Wood Leg seating models (only) offer a (GBS) ganging seat-to-seat option to gang seating together at armless ends (without tables). Option must be selected at the time of the order, the ganging bracket is factory installed and cannot be field installed. See above for ganging with tables.
- Benches and ottomans do not gang to seating models.

Add option codes in the following order:

- **Model Number**
Specify model number.
3361 to 3363 Metal leg seating
3431 to 3435 Wood leg seating
- **Back and Arm Textile** (includes front rail)
Specify textile code.
- **Seat Textile**
Specify textile code.
- **Leg Finish** (metal legs)

(TBL) Black	(TBZ) Buzz Blue
(TCC) Cactus	(TCR) Carrot
(TDJ) Dijon	(TDW) Designer White
(TEG) Eggplant	(TFO) Fog
(TFR) Frost	(TIN) Ink
(TIV) Cloud	(TKA) Kalua
(TLA) Latte	(TMO) Mocha
(TOA) Toast	(TSH) Shadow
(TSN) Sand	(TSR) Scarlet

Metallics:
(CHM) Chrome. No upcharge.
(BCH) Brushed Chrome. Add \$165 for single seaters. Add \$257 for three seat sofas. Add \$165 for ottoman. Add \$224 for bench.
- **Leg Finish** (wood legs)

(AAM) Absolute	(BKM) Black
(ACM) Cherry	(EOM) English Oak
(ECM) Espresso Cafe	(TFM) Fruitwood
(HGM) Grey	(AHM) Honey
(TMM) Mahogany	(AVM) Maple
(NLW) Natural Walnut	(MWM) Medium Walnut
(ASM) Night	(NBM) Noce Biondo
(NGM) Noce Grigio	(NEM) Noce Leggero
(NMM) Noce Medio	(SKM) Shaker Cherry
(TWM) Walnut	(WTM) WC Cream
(WHM) White	(WCM) Winter Cherry
- **Glide Type** (metal legs)

(GL) Black Glide for most surfaces (standard)
(NM) Non-Marking Glide for most surfaces. No upcharge.
- **Glide Type** (wood legs)

(NM) Non-marking glides for most surfaces (standard).
(SG) Steel cushioned glides for carpeted surfaces. Add \$36
(RG) Rubber non-slip glides for most hard floor surfaces. Add \$36
(FG) Felt glides for most hard floor surfaces. Add \$36
- **Ganging** (wood leg seating - for ganging seat to seat)

(NG) No ganging (Standard)
(GS) Ganging seat to seat. Add \$48

SAMPLE LAYOUTS

Layout A



Qty	Model Number	Description	Dimensions	List Price
1	3361R	Single Seater - Right Arm	39.5 x 29 x 28.5	2844
1	3361L	Single Seater - Left Arm	39.5 x 29 x 28.5	2844
1	3363NA	Single Sofa - Armless	72 x 29 x 28.5	3788
1	3881R	Bridge Corner Table - Right	25 x 25 x 12	1839
1	3881L	Bridge Corner Table - Left	25 x 25 x 12	1839
2	3360	Table Bracket Kit - 1 Kit per table		204 x 2

SAMPLE LAYOUT TOTAL IN STANDARD BLACK FRAME \$12,852

Layout B

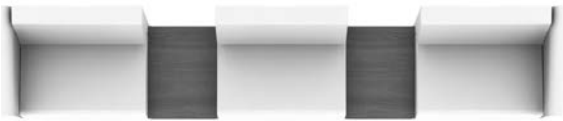

Qty	Model Number	Description	Dimensions	List Price
1	3361R	Single Seater - Right Arm	39.5 x 29 x 28.5	2844
1	3361L	Single Seater - Left Arm	39.5 x 29 x 28.5	2844
1	3361NA	Single Seater - Armless	36.5 x 29 x 28.5	2514
2	3882	Bridge End Table	25 x 20 x 12	1005 x 2
2	3360	Table Bracket Kit - 1 Kit per table		204 x 2

SAMPLE LAYOUT TOTAL IN STANDARD BLACK FRAME \$10,062

DESCRIPTION	FEATURES	MODEL#	STANDARD TEXTILE GRADES											
			1	2	3	4	5	6	7	8	9	10	11	12

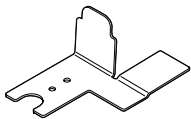

3360 List Price: \$204

OVERALL DIMENSIONS			SEAT DIMENSIONS			BACK DIMENSIONS		
W	D	H	W	D	H	W	H	

-	-	-	-	-	-	-	-
---	---	---	---	---	---	---	---



Table Bracket Kit
 COM Yardage: N/A
 Freight Class: 70
 Product Weight (lbs.): 1.5
 Cubic Feet Per Carton: 0.03 (1 Kit per carton)

Includes 4 brackets and hardware.
 Use with models 3381R, 3381L, 3436R, 3436L, 3882 and 3884



3361R 3361L





3361R/3361L	Base Price:	1	2	3	4	5	6	7	8	9	10	11	12
	\$2844												
	Back/Arm upcharge:	+0	+0	\$67	\$164	\$301	\$359	\$478	\$665	\$805	\$958	\$1277	\$1613
	Seat upcharge:	+0	+0	\$61	\$148	\$272	\$323	\$431	\$599	\$725	\$862	\$1149	\$1451

OVERALL DIMENSIONS			SEAT DIMENSIONS			BACK DIMENSIONS		
W	D	H	W	D	H	W	H	

39.5	29	28.5	36	19	17	36	12
------	----	------	----	----	----	----	----









Single Seater - w/ Left or Right Arm, Metal Legs
 COM Yardage: Back: 2.5 ; Seat: 2.25
 Freight Class: 250
 Product Weight (lbs.): 72
 Cubic Feet Per Carton: 28.5

DESCRIPTION	FEATURES	MODEL#		STANDARD TEXTILE GRADES										
		1	2	3	4	5	6	7	8	9	10	11	12	
 <p>Single Seater - Armless, Metal Legs COM Yardage: Back: 1.5; Seat: 1.75 Freight Class: 250 Product Weight (lbs.): 58 Cubic Feet Per Carton: 28.5</p>	<p>3361NA Base Price: \$2514 Back/Arm upcharge: Seat upcharge:</p>													
		+0	+0	\$41	\$99	\$181	\$216	\$287	\$399	\$484	\$575	\$766	\$968	
		+0	+0	\$47	\$115	\$211	\$252	\$335	\$466	\$564	\$671	\$894	\$1129	
		OVERALL DIMENSIONS			SEAT DIMENSIONS			BACK DIMENSIONS						
		W	D	H	W	D	H	W	H					
		36.5	29	28.5	36.5	19	17	36.5	12					
		RTA 00												
 <p>Three Seat Sofa - w/ Left or Right Arm, Metal Legs COM Yardage: Back: 3.5; Seat: 4.25 Freight Class: 250 Product Weight (lbs.): 120 Cubic Feet Per Carton: 41</p>	<p>3363R/3363L Base Price: \$4257 Back/Arm upcharge: Seat upcharge:</p>													
		+0	+0	\$93	\$229	\$421	\$503	\$669	\$931	\$1127	\$1341	\$1788	\$2257	
		+0	+0	\$113	\$279	\$512	\$610	\$813	\$1130	\$1369	\$1628	\$2171	\$2740	
		OVERALL DIMENSIONS			SEAT DIMENSIONS			BACK DIMENSIONS						
		W	D	H	W	D	H	W	H					
		75	29	28.5	17	19	17	71	12					
		RTA 00												
 <p>Three Seat Sofa - Armless, Metal Legs COM Yardage: Back: 2.25; Seat: 4.25 Freight Class: 250 Product Weight (lbs.): 111 Cubic Feet Per Carton: 39.25</p>	<p>3363NA Base Price: \$3788 Back/Arm upcharge: Seat upcharge:</p>													
		+0	+0	\$61	\$148	\$272	\$323	\$431	\$599	\$725	\$862	\$1149	\$1451	
		+0	+0	\$113	\$279	\$512	\$610	\$813	\$1130	\$1369	\$1628	\$2171	\$2740	
		OVERALL DIMENSIONS			SEAT DIMENSIONS			BACK DIMENSIONS						
		W	D	H	W	D	H	W	H					
		72	29	28.5	72	19	17	72	12					
		RTA 00												
 <p>Ottoman, Metal Legs COM Yardage: 1.75 Freight Class: 150 Product Weight (lbs.): 50 Cubic Feet Per Carton: 12.5</p>	<p>3361B List Price: -</p>	\$1869	\$1916	\$1984	\$2080	\$2121	\$2204	\$2335	\$2433	\$2540	\$2763	\$2998		
		OVERALL DIMENSIONS			SEAT DIMENSIONS			BACK DIMENSIONS						
				W	D	H	W	D	H	W	H			
				35.5	20.5	17.5								
		RTA 00												
 <p>Bench, Metal Legs COM Yardage: 3.5 Freight Class: 150 Product Weight (lbs.): 80 Cubic Feet Per Carton: 18.75</p>	<p>3363B List Price: -</p>	\$2876	\$2969	\$3105	\$3297	\$3379	\$3545	\$3807	\$4003	\$4217	\$4664	\$5133		
		OVERALL DIMENSIONS			SEAT DIMENSIONS			BACK DIMENSIONS						
				W	D	H	W	D	H	W	H			
				72	20.5	17.5								
		RTA 00												

LOUNGE

WIND LINEAR W

DESCRIPTION	FEATURES	MODEL#	STANDARD TEXTILE GRADES													
			1	2	3	4	5	6	7	8	9	10	11	12		
	3431R/3431L Base Price: \$3107 Back/Arm upcharge: Seat upcharge:															
3431R 3431L Single Seater - w/ Left or Right Arm, Wood Legs COM Yardage: Back: 1.75 ; Seat: 3 Freight Class: 250 Product Weight (lbs.): 70 Cubic Feet Per Carton: 28.5	Specify (GBS) option for ganging seat-to-to seat. Add \$No Match!		OVERALL DIMENSIONS			SEAT DIMENSIONS			BACK DIMENSIONS							
			W	D	H	W	D	H	W	H						
			39.5	29	28.5	36	19	17	36	12						
			RTA 00													
	3431NA Base Price: \$2777 Back/Arm upcharge: Seat upcharge:															
3431NA Single Seater - Armless, Wood Legs COM Yardage: Back: 1.55 ; Seat: 1.7 Freight Class: 300 Product Weight (lbs.): 56 Cubic Feet Per Carton: 28.5	Specify (GBS) option for ganging seat-to-to seat. Add \$No Match!		OVERALL DIMENSIONS			SEAT DIMENSIONS			BACK DIMENSIONS							
			W	D	H	W	D	H	W	H						
			36.5	29	28.5	36.5	19	17	36.5	12						
			RTA 00													
	3433R/3433L Base Price: \$4521 Back/Arm upcharge: Seat upcharge:															
3433R 3433L Three Seat Sofa w/ Left or Right Arm, Wood Legs COM Yardage: Back: 4.5 ; Seat: 3.25 Freight Class: 250 Product Weight (lbs.): 111 Cubic Feet Per Carton: 41	Specify (GBS) option for ganging seat-to-to seat. Add \$No Match!		OVERALL DIMENSIONS			SEAT DIMENSIONS			BACK DIMENSIONS							
			W	D	H	W	D	H	W	H						
			75	29	28.5	71	19	17	71	12						
			RTA 00													
	3433NA Base Price: \$4052 Back/Arm upcharge: Seat upcharge:															
3433NA Three Seat Sofa - Armless, Wood Legs COM Yardage: Back: 3.5 ; Seat: 3 Freight Class: 250 Product Weight (lbs.): 105 Cubic Feet Per Carton: 39.25	Specify (GBS) option for ganging seat-to-to seat. Add \$No Match!		OVERALL DIMENSIONS			SEAT DIMENSIONS			BACK DIMENSIONS							
			W	D	H	W	D	H	W	H						
			72	29	28.5	72	19	17	72	12						
			RTA 00													
	3434B List Price: -															
3434B Ottoman, Wood Legs COM Yardage: 1.75 Freight Class: 250 Product Weight (lbs.): 48 Cubic Feet Per Carton: 12.5	Specify (GBS) option for ganging seat-to-to seat. Add \$No Match!		OVERALL DIMENSIONS			SEAT DIMENSIONS			BACK DIMENSIONS							
			W	D	H	W	D	H	W	H						
			35.5	20.5	17.5											
			RTA 00													

DESCRIPTION	FEATURES	MODEL#			STANDARD TEXTILE GRADES									
		1	2	3	4	5	6	7	8	9	10	11	12	
 <p>Bench, Wood Legs COM Yardage: 3.5 Freight Class: 150 Product Weight (lbs.): 76 Cubic Feet Per Carton: 18.75</p>	<p>List Price:</p> <p>Specify (GBS) option for ganging seat-to-to seat. Add \$No Match!</p>	3435B	\$3140	\$3233	\$3369	\$3561	\$3643	\$3809	\$4071	\$4267	\$4481	\$4928	\$5397	
		OVERALL DIMENSIONS			SEAT DIMENSIONS			BACK DIMENSIONS						
		W	D	H	W	D	H	W	H					
		72	20.5	17.5										
		RTA 00												

DESCRIPTION	FEATURES	MODEL#			STANDARD TEXTILE GRADES									
		1	2	3	4	5	6	7	8	9	10	11	12	
<p>Bolster Cushion COM Yardage: 1 Freight Class: 70 Product Weight (lbs.): 1.5 Cubic Feet Per Carton: 1.3</p>	<p>1 Loose Cushion.</p>	3885	-	\$263	\$290	\$329	\$384	\$407	\$454	\$529	\$585	\$646	\$774	\$908
		OVERALL DIMENSIONS			SEAT DIMENSIONS			BACK DIMENSIONS						
		W	D	H	W	D	H	W	H					
		16	5	7										
		RTA 00												

WIND™ LINEAR TABLES



models 3363R and 3363L with 3882 bridge table, 3360 table attaching bracket kit and two 3380 coffee tables



For Wind Linear seating, see page 384

STANDARD FEATURES



- Wind Linear is an extension of the Wind lounge series with an emphasis on expansive, clean lines of seating and tables.
- Tables are available with metal legs.
- Table tops are standard with Thermally Fused Laminate (LPL)
- A variety of table 'bridges' are designed to mount between seating (at armless ends), or between benches or ottomans. See Ganging Features below.
- A variety of glide types are available. Use glide chart for recommended glide use on various flooring types.

GANGING FEATURES





- Corner bridge tables and bridge end tables, models 3881R/L, 3882, 3883 and 3436R/L mount between chairs and sofa units only at armless ends. Specify Table Attaching Bracket Kit 3360 separately. (Not usable with bench or ottoman models.)
- Bridge tables (model 3884) mount between ottoman models 3434B and 3361B and/or bench models 3435B and 3363B. Specify Table Attaching Bracket Kit 3360 separately.

Add option codes in the following order:

- **Model Number**
Specify model number.
- **Laminate Tops (LPL)**
(**ACJ**) Absolute Acajou (**ASN**) Asian Night
(**AWC**) Avant Cherry (**AWH**) Avant Honey
(**BLK**) Black (**BRC**) Brushed Cobalt
(**BZD**) Blizzard (**CGY**) Custom Grey
(**CMB**) Clear Maple (**DES**) Dark Espresso
(**DWT**) Designer White (**FAS**) Fashionista
(**FCL**) First Class (**NBL**) Noce Biondo
(**NGL**) Noce Grigio (**NEL**) Noce Leggero
(**NML**) Noce Medio
(**QTM**) Quartered Mahogany
(**SBY**) Sheer Beauty (**SDT**) Stonedust
(**SOG**) Storm Grey (**WHE**) Walnut Heights
(**WHC**) White Chocolate (**WCR**) Winter Cherry
- **Leg Finish** (metal legs)
(**TBL**) Black (**TBZ**) Buzz Blue
(**TCC**) Cactus (**TCR**) Carrot
(**TDJ**) Dijon (**TDW**) Designer White
(**TEG**) Eggplant (**TFO**) Fog
(**TFR**) Frost (**TIN**) Ink
(**TIV**) Cloud (**TKA**) Kalua
(**TLA**) Latte (**TMO**) Mocha
(**TOA**) Toast (**TNE**) Nevada
(**TSH**) Shadow (**TSN**) Sand
(**TSR**) Scarlet (**TTU**) Tungsten
Metallics:
(**CHM**) Chrome. No upcharge.
(**BCH**) Brushed Chrome. Add \$224
- **Glide Type**
(**GL**) Black Glide for most surfaces (standard).
(**NM**) Non-Marking Glide for most surfaces. No upcharge.

DESCRIPTION	FEATURES	MODEL#	STANDARD TEXTILE GRADES											
			1	2	3	4	5	6	7	8	9	10	11	12
 Side Table - Rectangular, Metal Legs COM Yardage: N/A Freight Class: 250 Product Weight (lbs.): 38 Cubic Feet Per Carton: 11.5	3878 Laminate Top Freestanding	List Price: \$1408 RTA 00	OVERALL DIMENSIONS			SEAT DIMENSIONS			BACK DIMENSIONS					
			W	D	H	W	D	H	W	H				
			20	25	16	-	-	-	-	-				
 Side Table - 25" Square, Metal Legs COM Yardage: N/A Freight Class: 250 Product Weight (lbs.): 40 Cubic Feet Per Carton: 11.5	3879 Laminate Top Freestanding	List Price: \$1536 RTA 00	OVERALL DIMENSIONS			SEAT DIMENSIONS			BACK DIMENSIONS					
			W	D	H	W	D	H	W	H				
			25	25	16	-	-	-	-	-				



DESCRIPTION	FEATURES	MODEL#	STANDARD TEXTILE GRADES												
			1	2	3	4	5	6	7	8	9	10	11	12	
 <p>Coffee Table - 54", Metal Legs COM Yardage: N/A Freight Class: 250 Product Weight (lbs.): 36 Cubic Feet Per Carton: 11.5</p>	<p>3880 List Price: \$1713 Laminate Top</p>														
		OVERALL DIMENSIONS			SEAT DIMENSIONS			BACK DIMENSIONS							
		W	D	H	W	D	H	W	H						
		54	20	15	-	-	-	-	-						
			RTA 00												
 <p>3881R 3881L</p> <p>Bridge Corner Table, Metal Legs COM Yardage: N/A Freight Class: 250 Product Weight (lbs.): 33 Cubic Feet Per Carton: 11.5</p>	<p>3881R/3881L List Price: \$1839 Laminate Top</p>														
		OVERALL DIMENSIONS			SEAT DIMENSIONS			BACK DIMENSIONS							
		W	D	H	W	D	H	W	H						
		25	25	12											
			RTA 00												
 <p>Bridge End Table COM Yardage: N/A Freight Class: 125 Product Weight (lbs.): 25 Cubic Feet Per Carton: 3.4</p>	<p>3882 List Price: \$1005 Laminate Top</p>														
		OVERALL DIMENSIONS			SEAT DIMENSIONS			BACK DIMENSIONS							
		W	D	H	W	D	H	W	H						
		20	25	5	-	-	-	-	-						
			RTA 00												
 <p>Low Side Table, Metal Legs COM Yardage: N/A Freight Class: 250 Product Weight (lbs.): 32 Cubic Feet Per Carton: 11.5</p>	<p>3883 List Price: \$1394 Laminate Top</p>														
		OVERALL DIMENSIONS			SEAT DIMENSIONS			BACK DIMENSIONS							
		W	D	H	W	D	H	W	H						
		20	25	12	-	-	-	-	-						
			RTA 00												
 <p>Bridge Table - 20" Square COM Yardage: N/A Freight Class: 125 Product Weight (lbs.): 23 Cubic Feet Per Carton: 3.4</p>	<p>3884 List Price: \$935 Laminate Top</p>														
		OVERALL DIMENSIONS			SEAT DIMENSIONS			BACK DIMENSIONS							
		W	D	H	W	D	H	W	H						
		20	20	5	-	-	-	-	-						
			RTA 00												

