

# lounge

Ballara .....	266	Jeo .....	332	Sirena .....	392
Braden .....	278	Kate .....	335	Venture .....	396
Bridges II Collaborative Seating .....	281	Lux .....	336	Vitrola .....	399
calidon tables .....	292	ML .....	338	Wind .....	401
Camino .....	295	ML Park .....	340	Wind Linear .....	403
Citi .....	300	Prairie .....	341		
Citi Square .....	305	River .....	342		
Drift .....	314	River+ .....	360		

BALLARA™



model 9751

model 9751NA & 9757L

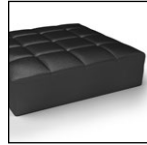

**Quilted Seat Option**  
See optional features for more details.



model 9752NA Two Seat Sofa, 9755 Corner Table, 9751NA Lounge Chair, 9757L Left Tablet

**STANDARD FEATURES**

- An all inclusive, modular series which includes seating, storage, power, tables and tablets.
- Fulfill many space planning scenarios including corner, in-line, open concept as well as traditional reception.
- Furniture pieces, seating or tables can be used as stand alone items or linked together with ganging brackets to create infinite configurations.
- Four high back (banquette) models available in two different heights (42" or 48") and two sizes (two-seat or three-seat armless sofas).
- Banquettes are available as table back models (TB) which are equipped with an 8" laminate back table shelf.
- Tablets can be mounted outside or between seats to accommodate various work and collaborative settings. Tablets have a 14" round surface and come with a 2-point locking mechanism for easy handling and stability.
- Fixed cushions are accented by a metal base and frame.
- Tables features durable and matching 3mm edges.
- Power modules include one power outlet and two USB ports and can be mounted under any seat or table. Wire management is included.
- All models are standard with Black polypropylene foot glides.
- Check textile availability prior to specifying upholstery material.

**OPTIONAL FEATURES**

- Quilted Seat (Q) is available. Backless stools, add \$107 each. Single seat models, add \$212. Two seater sofa, add \$417. Three seater sofa, add \$626.
- **Seating and Table Frame Finish:** All chair frames, table frames, tablet metal components, ganging brackets and power modules are available in the following finishes  
(TBL) Black  
(TDW) Designer White  
(TTU) Tungsten  
(CHM) Chrome. **Upcharge varies.**  
(BCH) Brushed Chrome. **Upcharge varies.**  
Please Specify.

- Brushed Chrome (BCH) and Chrome (CHM) are available at an upcharge. Add \$225 for counter height and bar height stools. Add \$242 for single seat lounge chairs. Add \$321 for two seat sofas. Add \$401 for three seat sofas. Add \$242 for storage/end tables. Add \$321 for storage/coffee tables. Add \$124 for tablets. Add \$31 for ganging brackets. Add \$24 for power modules.
- **Table Tops**  
Corner tables, storage tables and tablets are offered in the following High Pressure Laminate finishes:  
(ACJ) Absolute Acajou (ASN) Asian Night  
(AWC) Avant Cherry (AWH) Avant Honey  
(BLK) Black (BRC) Brushed Cobalt  
(CMB) Clear Maple (DES) Dark Espresso  
(DWT) Designer White (FAS) Fashionista  
(FCL) First Class  
(NBL) Noce Biondo (NGL) Noce Grigio  
(NEL) Noce Leggero (NML) Noce Medio  
(QTM) Quartered Mahogany  
(SBY) Sheer Beauty (SOG) Storm Grey  
(WHE) Walnut Heights (WHC) White Chocolate  
(WCR) Winter Cherry

**SAMPLE LAYOUTS**

**Layout A**



Qty	Model Number	Description	Dimensions	List Price
1	9751L	Lounge Chair - Left Arm	28.5 x 29.5 x 30	2110
1	9751R	Lounge Chair - Right Arm	28.5 x 29.5 x 30	2110
1	9755	Corner Table	27.25 x 27.25 x 16.5	840
2	9759	Ganging Bracket	1 x 0.75 x 10	25 x 2

**SAMPLE LAYOUT TOTAL IN STANDARD FRAME FINISHES**

**\$5,110**

**SAMPLE LAYOUT TOTAL IN OPTIONAL FRAME FINISHES**

**\$5,898**

## SAMPLE LAYOUTS

**Layout B**



Qty	Model Number	Description	Dimensions	List Price
1	<b>9751L</b>	Lounge Chair - Left Arm	28.5 x 29.5 x 30	2110
1	<b>9751R</b>	Lounge Chair - Right Arm	28.5 x 29.5 x 30	2110
1	<b>9755</b>	Corner Table	27.25 x 27.25 x 16.5	840
2	<b>9759</b>	Ganging Bracket	1 x 0.75 x 10	25 x 2

**SAMPLE LAYOUT TOTAL IN STANDARD BLACK FRAME \$5,110**  
**SAMPLE LAYOUT TOTAL IN OPTIONAL FRAME FINISHES \$5,898**

**Layout C**



Qty	Model Number	Description	Dimensions	List Price
1	<b>9751L</b>	Lounge Chair - Left Arm	28.5 x 29.5 x 30	2110
1	<b>9751R</b>	Lounge Chair - Right Arm	28.5 x 29.5 x 30	2110
1	<b>9751NA</b>	Lounge Chair - No Arms	27.5 x 29.5 x 30	1749
2	<b>9755</b>	Corner Table	27.25 x 27.25 x 16.5	840 x 2
4	<b>9759</b>	Ganging Bracket	1 x 0.75 x 10	25 x 4

**SAMPLE LAYOUT TOTAL IN STANDARD BLACK FRAME \$7,749**  
**SAMPLE LAYOUT TOTAL IN OPTIONAL FRAME FINISHES \$9,083**

**Layout D**



Qty	Model Number	Description	Dimensions	List Price
1	<b>9751L</b>	Lounge Chair - Left Arm	28.5 x 29.5 x 30	2110
1	<b>9751R</b>	Lounge Chair - Right Arm	28.5 x 29.5 x 30	2110
1	<b>9751NA</b>	Lounge Chair - Armless	27.5 x 29.5 x 30	1749
2	<b>9755</b>	Corner Table	27.25 x 27.25 x 16.5	840 x 2
1	<b>9757L</b>	Left Tablet	14 x 14 x 17.25	646
1	<b>9758R</b>	Right Tablet	14 x 14 x 17.25	646
4	<b>9759</b>	Ganging Bracket	1 x 0.75 x 10	25 x 4

**SAMPLE LAYOUT TOTAL IN STANDARD BLACK FRAME \$9041**  
**SAMPLE LAYOUT TOTAL IN OPTIONAL FRAME FINISHES \$10,623**

**Layout E**



Qty	Model Number	Description	Dimensions	List Price
1	<b>9752L-OB</b>	Two Seat Sofa Open Back - Left Arm	55 x 29.5 x 30	3437
1	<b>9752NA</b>	Two Seat Sofa - Armless	54 x 29.5 x 30	3157
1	<b>9754</b>	Storage Table	27.25 x 27.25 x 16.5	1333
1	<b>9755</b>	Corner Table	27.25 x 27.25 x 16.5	840
1	<b>9757R</b>	Right Tablet	14 x 14 x 17.25	646
2	<b>9759</b>	Ganging Bracket	1 x 0.75 x 10	25 x 2

**SAMPLE LAYOUT TOTAL IN STANDARD BLACK FRAME \$9463**  
**SAMPLE LAYOUT TOTAL IN OPTIONAL FRAME FINISHES \$11,060**

## SAMPLE LAYOUTS

Layout F

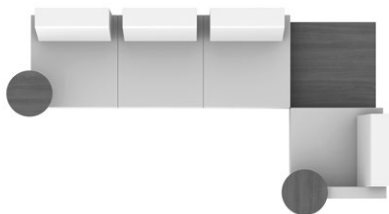

Qty	Model Number	Description	Dimensions	List Price
1	<b>9753NA-OB</b>	Three Seat Sofa Open Back - Armless	80.5 x 29.5 x 30	4426
1	<b>9751L</b>	Lounge Chair - Left Arm	28.5 x 29.5 x 30	2110
1	<b>9755</b>	Corner Table	27.25 x 27.25 x 16.5	840
1	<b>9757L</b>	Left Tablet	14 x 14 x 17.25	646
1	<b>9758R</b>	Right Tablet	14 x 14 x 17.25	646
2	<b>9759</b>	Ganging Bracket	1 x 0.75 x 10	25 x 2

**SAMPLE LAYOUT TOTAL IN STANDARD FRAME FINISHES**

**\$8,718**

**SAMPLE LAYOUT TOTAL IN OPTIONAL FRAME FINISHES**

**\$9,913**

Layout G



Qty	Model Number	Description	Dimensions	List Price
1	<b>9753NA-OB</b>	Three Seat Sofa Open Back - Armless	80.5 x 29.5 x 30	4426
1	<b>9751</b>	Lounge Chair	29.5 x 29.5 x 30	2467
1	<b>9755</b>	Corner Table	27.25 x 27.25 x 16.5	840
1	<b>9757L</b>	Left Tablet	14 x 14 x 17.25	646
1	<b>9759</b>	Ganging Bracket	1 x 0.75 x 10	25 x 1

**SAMPLE LAYOUT TOTAL IN STANDARD FRAME FINISHES**

**\$8,404**

**SAMPLE LAYOUT TOTAL IN OPTIONAL FRAME FINISHES**

**\$9,444**

Layout H



Qty	Model Number	Description	Dimensions	List Price
1	<b>9751L</b>	Lounge Chair - Left Arm	28.5 x 29.5 x 30	2110
1	<b>9751R</b>	Lounge Chair - Right Arm	28.5 x 29.5 x 30	2110
1	<b>9751NA</b>	Lounge Chair - No Arms	27.5 x 29.5 x 30	1749
2	<b>9755</b>	Corner Table	27.25 x 27.25 x 16.5	840 x 2
4	<b>9759</b>	Ganging Bracket	1 x 0.75 x 10	25 x 4

**SAMPLE LAYOUT TOTAL IN STANDARD FRAME FINISHES**

**\$7,749**

**SAMPLE LAYOUT TOTAL IN OPTIONAL FRAME FINISHES**

**\$9,083**

Layout I

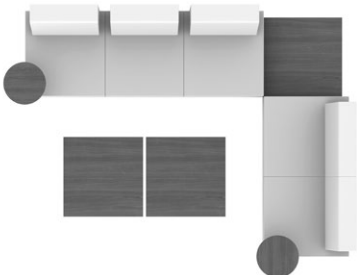

Qty	Model Number	Description	Dimensions	List Price
1	<b>9753NA-OB</b>	Three Seat Sofa Open Back - Armless	80.5 x 29.5 x 30	4426
1	<b>9752NA</b>	Two Seat Sofa - Armless	54 x 29.5 x 30	3157
2	<b>9754</b>	Storage Table	27.25 x 27.25 x 16.5	1333 x 2
1	<b>9755</b>	Corner Table	27.25 x 27.25 x 16.5	840
1	<b>9757L</b>	Left Tablet	14 x 14 x 17.25	646
1	<b>9758R</b>	Right Tablet	14 x 14 x 17.25	646
2	<b>9759</b>	Ganging Bracket	1 x 0.75 x 10	25 x 2

**SAMPLE LAYOUT TOTAL IN STANDARD FRAME FINISHES**

**\$12,431**

**SAMPLE LAYOUT TOTAL IN OPTIONAL FRAME FINISHES**

**\$14,189**

**SAMPLE LAYOUTS**

**Layout J**

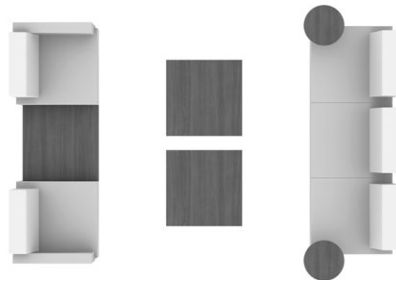

Qty	Model Number	Description	Dimensions	List Price
1	<b>9753NA-OB</b>	Three Seat Sofa Open Back - Armless	80.5 x 29.5 x 30	4426
1	<b>9751L</b>	Lounge Chair - Left Arm	28.5 x 29.5 x 30	2110
1	<b>9751R</b>	Lounge Chair - Right Arm	28.5 x 29.5 x 30	2110
2	<b>9754</b>	Storage Table	27.25 x 27.25 x 16.5	1333 x2
1	<b>9755</b>	Corner Table	27.25 x 27.25 x 16.5	840
1	<b>9757L</b>	Left Tablet	14 x 14 x 17.25	646
1	<b>9758R</b>	Right Tablet	14 x 14 x 17.25	646
2	<b>9759</b>	Ganging Bracket	1 x 0.75 x 10	25 x 2

**SAMPLE LAYOUT TOTAL IN STANDARD FRAME FINISHES \$13,494**  
**SAMPLE LAYOUT TOTAL IN OPTIONAL FRAME FINISHES \$15,415**

**Layout K**



Qty	Model Number	Description	Dimensions	List Price
2	<b>9753NA-OB</b>	Three Seat Sofa Open Back - Armless	80.5 x 29.5 x 30	4426 x 2
2	<b>9755</b>	Corner Table	27.25 x 27.25 x 16.5	840 x 2
2	<b>9759</b>	Ganging Bracket	1 x 0.75 x 10	25 x 2

**SAMPLE LAYOUT TOTAL IN STANDARD FRAME FINISHES \$10,582**  
**SAMPLE LAYOUT TOTAL IN OPTIONAL FRAME FINISHES \$11,930**

**Layout L**



Qty	Model Number	Description	Dimensions	List Price
1	<b>9752NA</b>	Two Seat Sofa - Armless	54 x 29.5 x 30	3157
1	<b>9751L</b>	Lounge Chair - Left Arm	28.5 x 29.5 x 30	2110
1	<b>9751R</b>	Lounge Chair - Right Arm	28.5 x 29.5 x 30	2110
2	<b>9755</b>	Corner Table	27.25 x 27.25 x 16.5	840 x 2
4	<b>9759</b>	Ganging Bracket	1 x 0.75 x 10	25 x 4

**SAMPLE LAYOUT TOTAL IN STANDARD FRAME FINISHES \$9,157**  
**SAMPLE LAYOUT TOTAL IN OPTIONAL FRAME FINISHES \$10,570**

**Layout M**



Qty	Model Number	Description	Dimensions	List Price
1	<b>9753NA-OB</b>	Three Seat Sofa Open Back - Armless	80.5 x 29.5 x 30	4426
1	<b>9752L-OB</b>	Two Seat Sofa Open Back - Left Arm	55 x 29.5 x 30	3437
1	<b>9752NA</b>	Two Seat Sofa - Armless	54 x 29.5 x 30	3157
2	<b>9755</b>	Corner Table	27.25 x 27.25 x 16.5	840 x 2
1	<b>9754</b>	Storage Table	27.25 x 27.25 x 16.5	1333
1	<b>9758R</b>	Right Tablet	14 x 14 x 17.25	646
4	<b>9759</b>	Ganging Bracket	1 x 0.75 x 10	25 x 4

**SAMPLE LAYOUT TOTAL IN STANDARD FRAME FINISHES \$14,779**  
**SAMPLE LAYOUT TOTAL IN OPTIONAL FRAME FINISHES \$16,796**

**SAMPLE LAYOUTS**

**Layout N**



Qty	Model Number	Description	Dimensions	List Price
1	<b>9753NA-OB</b>	Three Seat Sofa Open Back - Armless	80.5 x 29.5 x 30	4426
1	<b>9751L</b>	Lounge Chair - Left Arm	28.5 x 29.5 x 30	2110
1	<b>9751R</b>	Lounge Chair - Right Arm	28.5 x 29.5 x 30	2110
2	<b>9755</b>	Corner Table	27.25 x 27.25 x 16.5	840 x 2
4	<b>9759</b>	Ganging Bracket	1 x 0.75 x 10	25 x 4

**SAMPLE LAYOUT TOTAL IN STANDARD FRAME FINISHES \$10,426**  
**SAMPLE LAYOUT TOTAL IN OPTIONAL FRAME FINISHES \$11,919**

**Layout O**

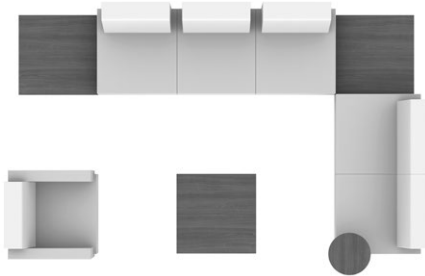

Qty	Model Number	Description	Dimensions	List Price
1	<b>9753NA-OB</b>	Three Seat Sofa Open Back - Armless	80.5 x 29.5 x 30	4426
1	<b>9752NA</b>	Two Seat Sofa - Armless	54 x 29.5 x 30	3157
1	<b>9751</b>	Lounge Chair	29.5 x 29.5 x 30	2467
1	<b>9754</b>	Storage Table	27.25 x 27.25 x 16.5	1333
2	<b>9755</b>	Corner Table	27.25 x 27.25 x 16.5	840 x 2
1	<b>9757L</b>	Left Tablet	14 x 14 x 17.25	646
3	<b>9759</b>	Ganging Bracket	1 x 0.75 x 10	25 x 3

**SAMPLE LAYOUT TOTAL IN STANDARD FRAME FINISHES \$13,784**  
**SAMPLE LAYOUT TOTAL IN OPTIONAL FRAME FINISHES \$15,691**

**Layout P**

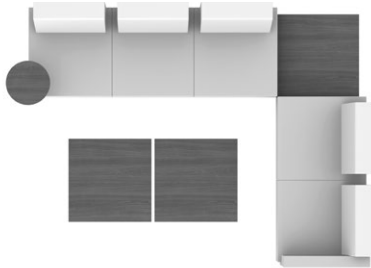

Qty	Model Number	Description	Dimensions	List Price
1	<b>9753NA-OB</b>	Three Seat Sofa Open Back - Armless	80.5 x 29.5 x 30	4426
1	<b>9752L-OB</b>	Two Seat Sofa Open Back - Left Arm	55 x 29.5 x 30	3437
2	<b>9754</b>	Storage Table	27.25 x 27.25 x 16.5	1333 x 2
1	<b>9755</b>	Corner Table	27.25 x 27.25 x 16.5	840
1	<b>9758R</b>	Right Tablet	14 x 14 x 17.25	646
2	<b>9759</b>	Ganging Bracket	1 x 0.75 x 10	25 x 2

**SAMPLE LAYOUT TOTAL IN STANDARD FRAME FINISHES \$12,065**  
**SAMPLE LAYOUT TOTAL IN OPTIONAL FRAME FINISHES \$13,699**



**Lounge Chair**  
 COM Yardage: 4.25  
 Freight Class: 250  
 Product Weight (lbs.): 71  
 Cubic Feet Per Carton: 21.5

	1	2	3	4	5	6	7	8	9	10	11	12
<b>9751</b>	2467	2604	2709	2870	3093	3175	3373	3749	3930	4282	4756	5348

OVERALL DIMENSIONS			SEAT DIMENSIONS			BACK DIMENSIONS	
W	D	H	W	D	H	W	H
30.5	31	30	24	20.5	18.5	22	12.5

**RTA 00**



**9751R**



**9751L**





**Lounge Chair - One Arm**  
 COM Yardage: 3.25  
 Freight Class: 250  
 Product Weight (lbs.): 61  
 Cubic Feet Per Carton: 20



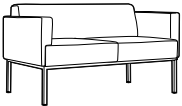

Ganging clip required for sectional use

	1	2	3	4	5	6	7	8	9	10	11	12
<b>9751R</b>	2110	2223	2312	2445	2634	2724	2895	3168	3378	3611	4605	5120
<b>9751L</b>												

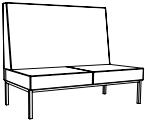

OVERALL DIMENSIONS			SEAT DIMENSIONS			BACK DIMENSIONS	
W	D	H	W	D	H	W	H
28.5	31	30	24	20.5	18.5	22	12.5

**RTA 00**

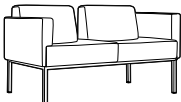

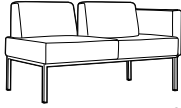

DESCRIPTION	FEATURES	MODEL#	STANDARD TEXTILE GRADES											
			1	2	3	4	5	6	7	8	9	10	11	12
 <p><b>Lounge Chair - Armless</b> COM Yardage: 2.25 Freight Class: 250 Product Weight (lbs.): 51 Cubic Feet Per Carton: 18.75</p>	Ganging clip required for sectional use	9751NA	1749	1832	1893	1986	2118	2180	2300	2490	2638	2802	3138	3498
			<b>OVERALL DIMENSIONS</b>			<b>SEAT DIMENSIONS</b>			<b>BACK DIMENSIONS</b>					
			<b>W</b>	<b>D</b>	<b>H</b>	<b>W</b>	<b>D</b>	<b>H</b>	<b>W</b>	<b>H</b>				
			26.5	31	30	24	20.5	18.5	22	12.5				
			<b>RTA 00</b>											
 <p><b>Corner Unit</b> COM Yardage: 3 Freight Class: 250 Product Weight (lbs.): 72 Cubic Feet Per Carton: 18.5</p>	Ganging clip required for sectional use	9764	2268	2387	2477	2617	2816	2887	3061	3390	3549	3855	4271	4790
			<b>OVERALL DIMENSIONS</b>			<b>SEAT DIMENSIONS</b>			<b>BACK DIMENSIONS</b>					
			<b>W</b>	<b>D</b>	<b>H</b>	<b>W</b>	<b>D</b>	<b>H</b>	<b>W</b>	<b>H</b>				
			28.5	28.5	30	22	20.5	18.5	22	12.5				
			<b>RTA 00</b>											
 <p><b>Two Seat Sofa</b> COM Yardage: 6.25 Freight Class: 250 Product Weight (lbs.): 111 Cubic Feet Per Carton: 37.5</p>		9752	3883	4088	4247	4486	4823	4944	5241	5806	6077	6601	7315	8207
			<b>OVERALL DIMENSIONS</b>			<b>SEAT DIMENSIONS</b>			<b>BACK DIMENSIONS</b>					
			<b>W</b>	<b>D</b>	<b>H</b>	<b>W</b>	<b>D</b>	<b>H</b>	<b>W</b>	<b>H</b>				
			56	31	30	48	20.5	18.5	44	12.5				
			<b>RTA 00</b>											
 <p><b>Two Seat Sofa - One Arm</b> COM Yardage: 5 Freight Class: 250 Product Weight (lbs.): 101 Cubic Feet Per Carton: 36.25</p>	Ganging clip required for sectional use	9752R 9752L	3476	3644	3779	3978	4257	4359	4607	5076	5305	5741	6336	7076
			<b>OVERALL DIMENSIONS</b>			<b>SEAT DIMENSIONS</b>			<b>BACK DIMENSIONS</b>					
			<b>W</b>	<b>D</b>	<b>H</b>	<b>W</b>	<b>D</b>	<b>H</b>	<b>W</b>	<b>H</b>				
			54	31	30	48	20.5	18.5	44	12.5				
			<b>RTA 00</b>											
 <p><b>Two Seat Sofa - Armless</b> COM Yardage: 4 Freight Class: 250 Product Weight (lbs.): 91 Cubic Feet Per Carton: 35.5</p>	Ganging clip required for sectional use	9752NA	3157	3295	3400	3561	3787	3868	4066	4442	4622	4973	5449	6041
			<b>OVERALL DIMENSIONS</b>			<b>SEAT DIMENSIONS</b>			<b>BACK DIMENSIONS</b>					
			<b>W</b>	<b>D</b>	<b>H</b>	<b>W</b>	<b>D</b>	<b>H</b>	<b>W</b>	<b>H</b>				
			52	31	30	48	20.5	18.5	44	12.5				
			<b>RTA 00</b>											

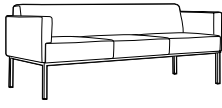
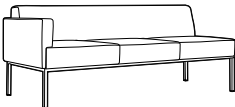
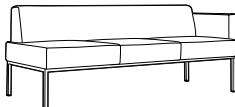
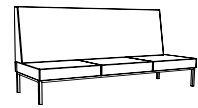

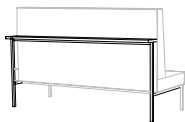
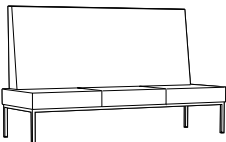
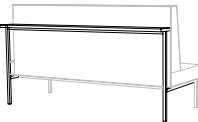
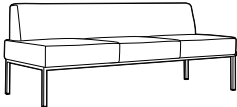
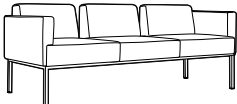
DESCRIPTION	FEATURES	MODEL#	STANDARD TEXTILE GRADES											
			1	2	3	4	5	6	7	8	9	10	11	12
 <p><b>Two Seat Sofa - 42" High Back</b> COM Yardage: 8 Freight Class: 250 Product Weight (lbs.): 120 Cubic Feet Per Carton: 48.5</p>	Ganging clip required for sectional use	9752NAHB42	2865	3143	3363	3692	4157	4377	4802	5475	5996	6573	7763	9030
			<b>OVERALL DIMENSIONS</b>			<b>SEAT DIMENSIONS</b>			<b>BACK DIMENSIONS</b>					
			<b>W</b>	<b>D</b>	<b>H</b>	<b>W</b>	<b>D</b>	<b>H</b>	<b>W</b>	<b>H</b>				
			52	31	42	48	20.5	18.5	44	24.5				
			<b>RTA 00</b>											
 <p><b>Two Seat Sofa - 42" High Back w/36" H Table Shelf</b> COM Yardage: 6 Freight Class: 250 Product Weight (lbs.): 111 Cubic Feet Per Carton: 35.25</p>	Ganging clip required for sectional use	9752NAHB42TB	4030	4238	4402	4646	4993	5155	5469	5969	6356	6784	7667	8608
			<b>OVERALL DIMENSIONS</b>			<b>SEAT DIMENSIONS</b>			<b>BACK DIMENSIONS</b>					
			<b>W</b>	<b>D</b>	<b>H</b>	<b>W</b>	<b>D</b>	<b>H</b>	<b>W</b>	<b>H</b>				
			52	41	42	48	20.5	18.5	44	24.5				
			<b>RTA 00</b>											
 <p><b>Two Seat Sofa - 48" High Back</b> COM Yardage: 6 Freight Class: 250 Product Weight (lbs.): 130 Cubic Feet Per Carton: 35.25</p>	Ganging clip required for sectional use	9752NAHB48	\$2964	\$3268	\$3508	\$3868	\$4376	\$4618	\$5080	\$5818	\$6387	\$7019	\$8320	\$9707
			<b>OVERALL DIMENSIONS</b>			<b>SEAT DIMENSIONS</b>			<b>BACK DIMENSIONS</b>					
			<b>W</b>	<b>D</b>	<b>H</b>	<b>W</b>	<b>D</b>	<b>H</b>	<b>W</b>	<b>H</b>				
			52	31	48	48	20.5	18.5	44	30.5				
			<b>RTA 00</b>											
 <p><b>Two Seat Sofa - 48" High Back w/42" H Table Shelf</b> COM Yardage: 8.75 Freight Class: 250 Product Weight (lbs.): 145 Cubic Feet Per Carton: 71.25</p>	Ganging clip required for sectional use	9752NAHB48TB	\$4129	\$4336	\$4500	\$4744	\$5091	\$5253	\$5567	\$6067	\$6453	\$6882	\$7764	\$8704
			<b>OVERALL DIMENSIONS</b>			<b>SEAT DIMENSIONS</b>			<b>BACK DIMENSIONS</b>					
			<b>W</b>	<b>D</b>	<b>H</b>	<b>W</b>	<b>D</b>	<b>H</b>	<b>W</b>	<b>H</b>				
			52	41	48	48	20.5	18.5	44	30.5				
			<b>RTA 00</b>											
 <p><b>Two Seat Sofa - Open Back</b> COM Yardage: 6.25 Freight Class: 250 Product Weight (lbs.): 111 Cubic Feet Per Carton: 35.25</p>		9752-OB	3840	4042	4201	4440	4779	4899	5194	5760	6032	6557	7271	8159
			<b>OVERALL DIMENSIONS</b>			<b>SEAT DIMENSIONS</b>			<b>BACK DIMENSIONS</b>					
			<b>W</b>	<b>D</b>	<b>H</b>	<b>W</b>	<b>D</b>	<b>H</b>	<b>W</b>	<b>H</b>				
			56	29.5	30	54	20.5	18.5	48	12.5				
			<b>RTA 00</b>											

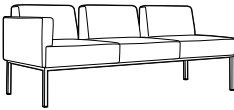
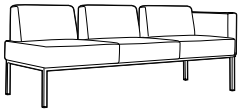
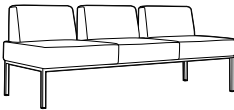



DESCRIPTION	FEATURES	MODEL#	STANDARD TEXTILE GRADES											
			1	2	3	4	5	6	7	8	9	10	11	12
 <p><b>9752R-OB</b></p> <p><b>Two Seat Sofa - Open Back - One Arm</b> COM Yardage: 5.25 Freight Class: 250 Product Weight (lbs.): 101 Cubic Feet Per Carton: 36.25</p>	 <p><b>9752L-OB</b></p> <p>Ganging clip required for sectional use</p>	<p><b>9752R-OB</b></p> <p><b>9752L-OB</b></p>	3437	3605	3738	3938	4219	4321	4568	5038	5265	5702	6297	5702
			<p><b>OVERALL DIMENSIONS</b></p> <p>W D H</p>			<p><b>SEAT DIMENSIONS</b></p> <p>W D H</p>			<p><b>BACK DIMENSIONS</b></p> <p>W H</p>					
			54	31	30	48	20.5	18.5			44	12.5		
			<b>RTA 00</b>											
 <p><b>9752NA-OB</b></p> <p><b>Two Seat Sofa - Open Back - Armless</b> COM Yardage: 4.25 Freight Class: 250 Product Weight (lbs.): 91 Cubic Feet Per Carton: 35.5</p>			3115	3252	3358	3518	3744	3823	4022	4400	4580	4930	5404	5996
	<p><b>OVERALL DIMENSIONS</b></p> <p>W D H</p>			<p><b>SEAT DIMENSIONS</b></p> <p>W D H</p>			<p><b>BACK DIMENSIONS</b></p> <p>W H</p>							
			52	31	30	48	20.5	18.5			44	12.5		
			<b>RTA 00</b>											
 <p><b>9753</b></p> <p><b>Three Seat Sofa</b> COM Yardage: 9.5 Freight Class: 250 Product Weight (lbs.): 153 Cubic Feet Per Carton: 54.5</p>			5194	5512	5766	6146	6687	6941	7429	8208	8810	9477	10852	12318
	<p><b>OVERALL DIMENSIONS</b></p> <p>W D H</p>			<p><b>SEAT DIMENSIONS</b></p> <p>W D H</p>			<p><b>BACK DIMENSIONS</b></p> <p>W H</p>							
			82.5	31	30	76.5	20.5	18.5			66	12.5		
			<b>RTA 00</b>											
 <p><b>9753R</b></p> <p><b>Three Seat Sofa - One Arm</b> COM Yardage: 8.25 Freight Class: 250 Product Weight (lbs.): 143 Cubic Feet Per Carton: 54.5</p>	 <p><b>9753L</b></p> <p>Ganging clip required for sectional use</p>	<p><b>9753R</b></p> <p><b>9753L</b></p>	4854	5133	5356	5685	6156	6375	6801	7480	8005	8585	9783	11059
			<p><b>OVERALL DIMENSIONS</b></p> <p>W D H</p>			<p><b>SEAT DIMENSIONS</b></p> <p>W D H</p>			<p><b>BACK DIMENSIONS</b></p> <p>W H</p>					
			81.5	31	30	80.5	20.5	18.5			74	12.5		
			<b>RTA 00</b>											
 <p><b>9753NAHB42</b></p> <p><b>Three Seat Sofa - 42" High Back</b> COM Yardage: 12.25 Freight Class: 300 Product Weight (lbs.): 143 Cubic Feet Per Carton: 72.50</p>			\$4316	\$4730	\$5057	\$5552	\$6252	\$6580	\$7214	\$8224	\$9004	\$9868	\$11651	\$13554
	<p><b>OVERALL DIMENSIONS</b></p> <p>W D H</p>			<p><b>SEAT DIMENSIONS</b></p> <p>W D H</p>			<p><b>BACK DIMENSIONS</b></p> <p>W H</p>							
			80.5	31	42	74	20.5	18.5			74	24.5		
			<b>RTA 00</b>											



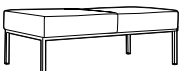
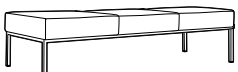

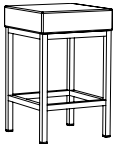
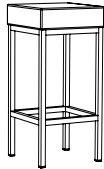

DESCRIPTION	FEATURES	MODEL#	STANDARD TEXTILE GRADES											
			1	2	3	4	5	6	7	8	9	10	11	12
 <p><b>Three Seat Sofa - 42" High Back w/36" H Table Shelf</b>                      Ganging clip required for sectional use                      COM Yardage: 9                      Freight Class: 300                      Product Weight (lbs.): 158                      Cubic Feet Per Carton: 93.50</p>		9753NAHB42TB	5676	5978	6216	6576	7085	7325	7785	8521	9087	9717	11015	12398
			OVERALL DIMENSIONS			SEAT DIMENSIONS			BACK DIMENSIONS					
			W	D	H	W	D	H	W	H				
			80.5	41	42	74	20.5	18.5	74	24.5				
			<b>RTA 00</b>											
 <p><b>Three Seat Sofa - 48" High Back</b>                      Ganging clip required for sectional use                      COM Yardage: 13.25                      Freight Class: 250                      Product Weight (lbs.): 168                      Cubic Feet Per Carton: 82.25</p>		9753NAHB48	4593	5042	5397	5932	6688	7044	7729	8821	9665	10600	12528	14585
			OVERALL DIMENSIONS			SEAT DIMENSIONS			BACK DIMENSIONS					
			W	D	H	W	D	H	W	H				
			80.5	31	48	74	20.5	18.5	74	30.5				
			<b>RTA 00</b>											
 <p><b>Three Seat Sofa - 48" High Back w/42" H Table Shelf</b>                      Ganging clip required for sectional use                      COM Yardage: 9                      Freight Class: 300                      Product Weight (lbs.): 158                      Cubic Feet Per Carton: 106</p>		9753NAHB48TB	5953	6313	6555	6918	7435	7679	8146	8893	9469	10106	11423	12826
			OVERALL DIMENSIONS			SEAT DIMENSIONS			BACK DIMENSIONS					
			W	D	H	W	D	H	W	H				
			80.5	41	48	74	20.5	18.5	74	30.5				
			<b>RTA 00</b>											
 <p><b>Three Seat Sofa - Armless</b>                      Ganging clip required for sectional use                      COM Yardage: 7                      Freight Class: 250                      Product Weight (lbs.): 133                      Cubic Feet Per Carton: 51.5</p>		9753NA	4471	4708	4896	5177	5577	5764	6127	6706	7151	7645	8664	9751
			OVERALL DIMENSIONS			SEAT DIMENSIONS			BACK DIMENSIONS					
			W	D	H	W	D	H	W	H				
			80.5	31	30	80.5	20.5	18.5	74	12.5				
			<b>RTA 00</b>											
 <p><b>Three Seat Sofa - Open Back</b>                      Ganging clip required for sectional use                      COM Yardage: 8                      Freight Class: 250                      Product Weight (lbs.): 153                      Cubic Feet Per Carton: 54.5</p>		9753-OB	5157	5423	5638	5957	6407	6568	6964	7718	8081	8780	9731	10914
			OVERALL DIMENSIONS			SEAT DIMENSIONS			BACK DIMENSIONS					
			W	D	H	W	D	H	W	H				
			82.5	31	30	80.5	20.5	18.5	74	12.5				
			<b>RTA 00</b>											

DESCRIPTION	FEATURES	MODEL#	STANDARD TEXTILE GRADES											
			1	2	3	4	5	6	7	8	9	10	11	12
 <p><b>9753R-OB</b></p> <p><b>Three Seat Sofa - Open Back - One Arm</b> COM Yardage: 7 Freight Class: 250 Product Weight (lbs.): 143 Cubic Feet Per Carton: 54.5</p>	 <p><b>9753L-OB</b></p> <p>Ganging clip required for sectional use</p>	<p><b>9753R-OB</b> 4810 5046 5232 5510 5905 6046 6392 7053 7371 7981 8813 9851</p> <p><b>9753L-OB</b></p>	<b>OVERALL DIMENSIONS</b>			<b>SEAT DIMENSIONS</b>			<b>BACK DIMENSIONS</b>					
			<b>W</b>	<b>D</b>	<b>H</b>	<b>W</b>	<b>D</b>	<b>H</b>	<b>W</b>	<b>H</b>				
			81.5	31	30	80.5	20.5	17.5	74	12.5				
			<b>RTA 00</b>											
 <p><b>9753NA-OB</b></p> <p><b>Three Seat Sofa - Open Back - Armless</b> COM Yardage: 6.25 Freight Class: 250 Product Weight (lbs.): 133 Cubic Feet Per Carton: 51.5</p>	<p>Ganging clip required for sectional use</p>	<p><b>9753NA-OB</b> 4426 4631 4790 5029 5366 5487 5784 6349 6622 7144 7859 8750</p>	<b>OVERALL DIMENSIONS</b>			<b>SEAT DIMENSIONS</b>			<b>BACK DIMENSIONS</b>					
			<b>W</b>	<b>D</b>	<b>H</b>	<b>W</b>	<b>D</b>	<b>H</b>	<b>W</b>	<b>H</b>				
			80.5	31	30	80.5	20.5	17.5	74	12.5				
			<b>RTA 00</b>											
 <p><b>9754</b></p> <p><b>Storage Table</b> COM Yardage: N/A Freight Class: 125 Product Weight (lbs.): 65 Cubic Feet Per Carton: 11.5</p>	<p>Ganging clip required for sectional use</p>	<p><b>9754</b> 1333 - - - - - - - - - - - -</p>	<b>OVERALL DIMENSIONS</b>			<b>SEAT DIMENSIONS</b>			<b>BACK DIMENSIONS</b>					
			<b>W</b>	<b>D</b>	<b>H</b>	<b>W</b>	<b>D</b>	<b>H</b>	<b>W</b>	<b>H</b>				
			27.25	27.25	16.5	-	-	-	-	-	-	-	-	
			<b>RTA 00</b>											
 <p><b>9755</b></p> <p><b>Corner Table</b> COM Yardage: N/A Freight Class: 150 Product Weight (lbs.): 40 Cubic Feet Per Carton: 8</p>	<p>Ganging clip required for sectional use</p>	<p><b>9755</b> 840 - - - - - - - - - - - -</p>	<b>OVERALL DIMENSIONS</b>			<b>SEAT DIMENSIONS</b>			<b>BACK DIMENSIONS</b>					
			<b>W</b>	<b>D</b>	<b>H</b>	<b>W</b>	<b>D</b>	<b>H</b>	<b>W</b>	<b>H</b>				
			27.25	27.25	12.5	-	-	-	-	-	-	-	-	
			<b>RTA 00</b>											
 <p><b>9759</b></p> <p><b>Ganging Bracket</b> COM Yardage: N/A Freight Class: 70 Product Weight (lbs.): .052 Cubic Feet Per Carton: 0.02</p>	<p>Only one set is needed per connection.</p>	<p><b>9759</b> 25 - - - - - - - - - - - -</p>	<b>OVERALL DIMENSIONS</b>			<b>SEAT DIMENSIONS</b>			<b>BACK DIMENSIONS</b>					
			<b>W</b>	<b>D</b>	<b>H</b>	<b>W</b>	<b>D</b>	<b>H</b>	<b>W</b>	<b>H</b>				
			1	0.75	10	-	-	-	-	-	-	-	-	
			<b>RTA 00</b>											
			FedEx 											

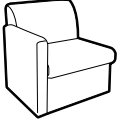
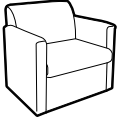
DESCRIPTION	FEATURES	MODEL#	STANDARD TEXTILE GRADES												
			1	2	3	4	5	6	7	8	9	10	11	12	
 <p><b>Tablet</b> COM Yardage: N/A Freight Class: 150 Product Weight (lbs.): 12 Cubic Feet Per Carton: 2.5</p>	Mounts underneath of seating.	9757L	646	-	-	-	-	-	-	-	-	-	-	-	-
		9758R	-	-	-	-	-	-	-	-	-	-	-	-	-
		<b>OVERALL DIMENSIONS</b>			<b>SEAT DIMENSIONS</b>			<b>BACK DIMENSIONS</b>							
		W	D	H	W	D	H	W	H						
			14	17.25	14	-	-	-	-	-	-	-	-	-	-
			<b>RTA 1</b>			<b>FedEx</b>			<b>UPS</b>						
 <p><b>Power Module</b> COM Yardage: N/A Freight Class: 125 Product Weight (lbs.): 3 Cubic Feet Per Carton: 0.5</p>	Mounts underneath of seating or tables.	9760	\$407	-	-	-	-	-	-	-	-	-	-	-	-
		10 Ft. power cord													
		<b>OVERALL DIMENSIONS</b>			<b>SEAT DIMENSIONS</b>			<b>BACK DIMENSIONS</b>							
		W	D	H	W	D	H	W	H						
			6	2.75	2.75	-	-	-	-	-	-	-	-	-	-
			<b>RTA 00</b>			<b>FedEx</b>			<b>UPS</b>						
 <p><b>One Seat Bench</b> COM Yardage: 2 Freight Class: 250 Product Weight (lbs.): 37 Cubic Feet Per Carton: 10.75</p>	Ganging clip required for sectional use	9761	1309	1379	1433	1514	1628	1683	1786	1953	2082	2223	2517	2828	
		<b>OVERALL DIMENSIONS</b>			<b>SEAT DIMENSIONS</b>			<b>BACK DIMENSIONS</b>							
		W	D	H	W	D	H	W	H						
					27.5	28.5	17.5	-	-	-	-	-	-	-	-
			<b>RTA 00</b>												
 <p><b>Two Seat Bench</b> COM Yardage: 4 Freight Class: 250 Product Weight (lbs.): 57 Cubic Feet Per Carton: 21.25</p>	Ganging clip required for sectional use	9762	2329	2467	2575	2738	2970	3079	3287	3620	3878	4164	4752	5379	
		<b>OVERALL DIMENSIONS</b>			<b>SEAT DIMENSIONS</b>			<b>BACK DIMENSIONS</b>							
		W	D	H	W	D	H	W	H						
					54	28.5	17.5	-	-	-	-	-	-	-	-
			<b>RTA 00</b>												
 <p><b>Three Seat Bench</b> COM Yardage: 6 Freight Class: 250 Product Weight (lbs.): 80 Cubic Feet Per Carton: 29.5</p>	Ganging clip required for sectional use	9763	3296	3501	3660	3901	4244	4405	4713	5206	5585	6009	6878	7808	
		<b>OVERALL DIMENSIONS</b>			<b>SEAT DIMENSIONS</b>			<b>BACK DIMENSIONS</b>							
		W	D	H	W	D	H	W	H						
					80.5	28.5	17.5	-	-	-	-	-	-	-	-
			<b>RTA 00</b>												

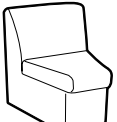
DESCRIPTION	FEATURES	MODEL#	STANDARD TEXTILE GRADES												
			1	2	3	4	5	6	7	8	9	10	11	12	
 <p><b>Coffee Storage Table (2 Seat Length)</b> COM Yardage: N/A Freight Class: 150 Product Weight (lbs.): 112 Cubic Feet Per Carton: 20.5</p>	Ganging clip required for sectional use	9765	2430	-	-	-	-	-	-	-	-	-	-	-	-
		<b>OVERALL DIMENSIONS</b>			<b>SEAT DIMENSIONS</b>			<b>BACK DIMENSIONS</b>							
		W	D	H	W	D	H	W	H						
		53.75	27.25	16.5	-	-	-	-	-						
			<b>RTA 00</b>												
 <p><b>Coffee Table (2 Seat Length)</b> COM Yardage: N/A Freight Class: 150 Product Weight (lbs.): 68 Cubic Feet Per Carton: 17.75</p>		9766	1572	-	-	-	-	-	-	-	-	-	-	-	-
	<b>OVERALL DIMENSIONS</b>			<b>SEAT DIMENSIONS</b>			<b>BACK DIMENSIONS</b>								
	W	D	H	W	D	H	W	H							
	54	27.5	13	-	-	-	-	-							
			<b>RTA 00</b>												
 <p><b>24" Stool</b> COM Yardage: 0.75 Freight Class: 150 Product Weight (lbs.): 22 Cubic Feet Per Carton: 4.75</p>		9769S24	\$858	\$885	\$905	\$934	\$977	\$997	\$1036	\$1096	\$1143	\$1195	\$1303	\$1419	
	<b>OVERALL DIMENSIONS</b>			<b>SEAT DIMENSIONS</b>			<b>BACK DIMENSIONS</b>								
	W	D	H	W	D	H	W	H							
	15	15	24	15	15	3	-	-							
			<b>RTA 00</b>												
 <p><b>30" Stool</b> COM Yardage: .50 Freight Class: 150 Product Weight (lbs.): 23 Cubic Feet Per Carton: 5.5</p>		9769S30	\$935	\$962	\$982	\$1011	\$1053	\$1073	\$1110	\$1170	\$1216	\$1268	\$1372	\$1485	
	<b>OVERALL DIMENSIONS</b>			<b>SEAT DIMENSIONS</b>			<b>BACK DIMENSIONS</b>								
	W	D	H	W	D	H	W	H							
	15	15	30	15	15	30	-	-							
			<b>RTA 00</b>												

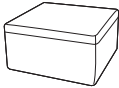
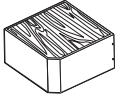

DESCRIPTION	FEATURES	MODEL#	STANDARD TEXTILE GRADES											
			1	2	3	4	5	6	7	8	9	10	11	12
 <p><b>Single Seater - Right Arm</b> COM Yardage: 3.75 Freight Class: 250 Product Weight (lbs.): 45 Cubic Feet Per Carton: 16.5</p>		<b>7870R</b>	921	1071	1187	1365	1613	1701	1920	2335	2536	2919	3444	4098
			<b>OVERALL DIMENSIONS</b>			<b>SEAT DIMENSIONS</b>			<b>BACK DIMENSIONS</b>					
			<b>W</b>	<b>D</b>	<b>H</b>	<b>W</b>	<b>D</b>	<b>H</b>	<b>W</b>	<b>H</b>				
			27	27.5	30	24	19.5	16.5	24	13.5				
			<b>RTA 00</b>											
 <p><b>Single Seater - with Arms</b> COM Yardage: 4.75 Freight Class: 250 Product Weight (lbs.): 52 Cubic Feet Per Carton: 16.5</p>		<b>7871</b>	1136	1308	1445	1647	1936	2039	2290	2776	3006	3453	4062	4817
			<b>OVERALL DIMENSIONS</b>			<b>SEAT DIMENSIONS</b>			<b>BACK DIMENSIONS</b>					
			<b>W</b>	<b>D</b>	<b>H</b>	<b>W</b>	<b>D</b>	<b>H</b>	<b>W</b>	<b>H</b>				
			30	27.5	30	24	19.5	16.5	24	13.5				
			<b>RTA 00</b>											
 <p><b>Corner Unit</b> COM Yardage: 2.75 Freight Class: 300 Product Weight (lbs.): 31 Cubic Feet Per Carton: 16.5</p>		<b>7872</b>	746	859	944	1073	1253	1322	1479	1785	1929	2213	2597	3076
			<b>OVERALL DIMENSIONS</b>			<b>SEAT DIMENSIONS</b>			<b>BACK DIMENSIONS</b>					
			<b>W</b>	<b>D</b>	<b>H</b>	<b>W</b>	<b>D</b>	<b>H</b>	<b>W</b>	<b>H</b>				
			24	27.5	30	20	19.5	16.5	15	13.5				
			<b>RTA 00</b>											
 <p><b>Corner Unit</b> COM Yardage: 2.75 Freight Class: 300 Product Weight (lbs.): 31 Cubic Feet Per Carton: 16.5</p>		<b>7873</b>	746	859	944	1073	1253	1322	1479	1785	1929	2213	2597	3076
			<b>OVERALL DIMENSIONS</b>			<b>SEAT DIMENSIONS</b>			<b>BACK DIMENSIONS</b>					
			<b>W</b>	<b>D</b>	<b>H</b>	<b>W</b>	<b>D</b>	<b>H</b>	<b>W</b>	<b>H</b>				
			24	27.5	30	16	19.5	16.5	21.5	13.5				
			<b>RTA 00</b>											
 <p><b>Table - 24" Square</b> w/Upholstered Sides COM Yardage: 1.75 Freight Class: 125 Product Weight (lbs.): 38 Cubic Feet Per Carton: 6.25</p>		<b>7874</b>	610	682	736	817	933	977	1077	1271	1363	1544	1788	2093
			<b>OVERALL DIMENSIONS</b>			<b>SEAT DIMENSIONS</b>			<b>BACK DIMENSIONS</b>					
			<b>W</b>	<b>D</b>	<b>H</b>	<b>W</b>	<b>D</b>	<b>H</b>	<b>W</b>	<b>H</b>				
			24	24	14.5	-	-	-	-	-				
			<b>RTA 00</b>											
			 											

DESCRIPTION	FEATURES	MODEL#	STANDARD TEXTILE GRADES											
			1	2	3	4	5	6	7	8	9	10	11	12
 <p><b>Foot Stool/Single Bench - 24" Square</b>                      COM Yardage: 1.75                      Freight Class: 125                      Product Weight (lbs.): 38                      Cubic Feet Per Carton: 6.25</p>		<b>7874FS</b>	695	781	845	945	1084	1133	1256	1488	1599	1815	2109	2474
			<b>OVERALL DIMENSIONS</b>			<b>SEAT DIMENSIONS</b>			<b>BACK DIMENSIONS</b>					
			<b>W</b>	<b>D</b>	<b>H</b>	<b>W</b>	<b>D</b>	<b>H</b>	<b>W</b>	<b>H</b>				
			24	24	17.5	-	-	-	-	-				
			<b>RTA 00</b>											
 <p><b>Corner Table - 17" Square w/Upholstered Sides</b>                      COM Yardage: 1.75                      Freight Class: 125                      Product Weight (lbs.): 38                      Cubic Feet Per Carton: 6.25</p>		<b>7880</b>	831	901	955	1035	1146	1198	1299	1463	1587	1726	2012	2316
			<b>OVERALL DIMENSIONS</b>			<b>SEAT DIMENSIONS</b>			<b>BACK DIMENSIONS</b>					
			<b>W</b>	<b>D</b>	<b>H</b>	<b>W</b>	<b>D</b>	<b>H</b>	<b>W</b>	<b>H</b>				
			24	24	14.5	-	-	-	-	-				
			<b>RTA 00</b>											



BRIDGES II COLLABORATIVE SEATING



model BRTSE2424B



model BRTSE6060B



model BRTS2448F

STANDARD FEATURES

- For all Bridges II components, please see the Bridges II section of the Desking Price Book.
- Bridges collaborative seating collection consists of seating, privacy screens, tables, tablets and power.
- It is a versatile modular furniture series which can be configured into many space planning scenarios, including corner, in-line, open concept, traditional reception, as well as secluded seating with high privacy partitions.
- Furniture pieces can be used as stand alone items or can be mechanically linked together to form a variety of seating configurations.
- Seat and backrest can be integrated with Bridges tables.
- Corner tables and in-line 6" table modules double as power delivery centers.
- Dedicated seat backrests feature dual USB charging port.
- Some in line 6" table modules are furnished with grommets to support tablets.
- Legs are available in standard Bridges metal painted finishes and anodized aluminum finish.
- Bridges Collaborative Seating upholstery features a single stitch, thick white thread around the edges. The white, wide stitch along with crisp corners are part of its distinctive personality.
- In order to achieve crisp edges and to minimize "pillow" effect caused by taut fabric, the upholstery material has been applied deliberately loose, which may over time, produce puckering of the upholstery surface material. This can be easily corrected by stretching the fabric by hand or during vacuuming.
- Freestanding 17"h table. Central partition divides space under top surface into two 11" deep compartments.

- In order to efficiently utilize fabric yield, all 60" seats and backs feature a seam in the middle. The double stitch seam is sewn with a thin thread, closely matching the upholstery material in color.
- Some complicated fabric patterns prevent pattern matching and will be upholstered without the seam at the discretion of the factory.
- Should you require no middle seam by cutting into the roll, please specify "NO SEAM" at time of your order.
- Check textile availability prior to specifying upholstery material.

OPTIONAL FEATURES

- Optional Anodized Aluminum Leg on all models. Add \$74.
- Models BRTS2406BT and BRTS2406BPT include 9.5" x 14.5" swivel tablet. If top is specified in high pressure laminate, tablet will also be manufactured in high pressure laminate.
- Bridges II tables and tablets are offered in the following laminate finishes: Absolute Acajou (ACJ), Asian Night (ASN), Avant Cherry (AWC), Avant Honey (AWH), Black (BLK), Brushed Cobalt (BRC), Clear Maple (CMB), Custom Grey (CGY), Dark Espresso (DES), Designer White (DWT), Fashionista (FAS), First Class (FCL), Noce Biondo (NBL), Noce Grigio (NGL), Noce Leggero (NEL), Noce Medio (NML), Quartered Mahogany (QTM), Sheer Beauty (SBY) Storm Grey (SOG), Walnut Heights (WHE), White Chocolate (WHC) and Winter Cherry (WCR). Please Specify.

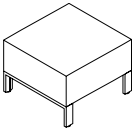
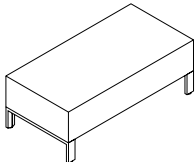
DESCRIPTION	FEATURES	MODEL#	STANDARD TEXTILE GRADES											
			1	2	3	4	5	6	7	8	9	10	11	12
 <p><b>Lounge Seat - 24"</b> COM Yardage: 1.25 Freight Class: 150 Product Weight (lbs.): 22.70 Cubic Feet Per Carton: 5.57</p>		<b>BRTSE24NB</b>	787	863	863	911	979	1010	1072	1170	1246	1330	1501	1686
			<b>OVERALL DIMENSIONS</b>			<b>SEAT DIMENSIONS</b>			<b>BACK DIMENSIONS</b>					
			<b>W</b>	<b>D</b>	<b>H</b>	<b>W</b>	<b>D</b>	<b>H</b>	<b>W</b>	<b>H</b>				
			24	24	17	-	-	-	-	-				
		<b>RTA 00</b>												
 <p><b>Lounge Seat - 48"</b> COM Yardage: 2 Freight Class: 250 Product Weight (lbs.): 36.90 Cubic Feet Per Carton: 11.33</p>		<b>BRTSE48NB</b>	1433	1553	1553	1630	1737	1789	1888	2045	2164	2300	2577	2870
			<b>OVERALL DIMENSIONS</b>			<b>SEAT DIMENSIONS</b>			<b>BACK DIMENSIONS</b>					
			<b>W</b>	<b>D</b>	<b>H</b>	<b>W</b>	<b>D</b>	<b>H</b>	<b>W</b>	<b>H</b>				
			24	48	17	-	-	-	-	-				
		<b>RTA 00</b>												

DESCRIPTION	FEATURES	MODEL#	STANDARD TEXTILE GRADES											
			1	2	3	4	5	6	7	8	9	10	11	12

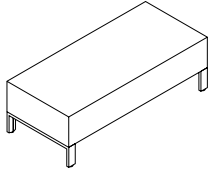

**Lounge Seat - 60"**  
 COM Yardage: 2  
 Freight Class: 250  
 Product Weight (lbs.): 47  
 Cubic Feet Per Carton: 14.17

<b>BRTSE60NB</b>	1659	1743	1807	1901	2039	2101	2225	2421	2572	2741	3084	3454
------------------	------	------	------	------	------	------	------	------	------	------	------	------

OVERALL DIMENSIONS			SEAT DIMENSIONS			BACK DIMENSIONS	
W	D	H	W	D	H	W	H
24	60	17	-	-	-	-	-

**RTA 00**

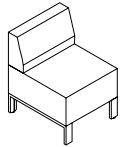

**Lounge Seat, Full Backrest - 24"**  
 COM Yardage: 2.25  
 Freight Class: 250  
 Product Weight (lbs.): 33  
 Cubic Feet Per Carton: 9.57

<b>BRTSE2424B</b>	1239	1373	1373	1458	1580	1638	1749	1925	2061	2213	2525	2855
-------------------	------	------	------	------	------	------	------	------	------	------	------	------

OVERALL DIMENSIONS			SEAT DIMENSIONS			BACK DIMENSIONS	
W	D	H	W	D	H	W	H
24	24	29	-	-	-	-	-

**RTA 00**

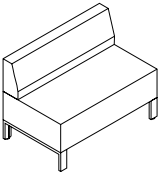

**Lounge Seat, Full Backrest - 48"**  
 COM Yardage: 3.5  
 Freight Class: 250  
 Product Weight (lbs.): 55.50  
 Cubic Feet Per Carton: 19.33

<b>BRTSE4848B</b>	2286	2491	2491	2625	2817	2905	3076	3350	3562	3797	4282	4797
-------------------	------	------	------	------	------	------	------	------	------	------	------	------

OVERALL DIMENSIONS			SEAT DIMENSIONS			BACK DIMENSIONS	
W	D	H	W	D	H	W	H
24	48	29	-	-	-	-	-

**RTA 00**

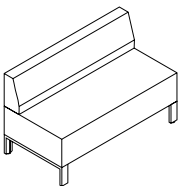

**Lounge Seat, Full Backrest - 60"**  
 COM Yardage: 4.5  
 Freight Class: 250  
 Product Weight (lbs.): 70  
 Cubic Feet Per Carton: 24.17

<b>BRTSE6060B</b>	2649	2912	2912	3084	3327	3443	3666	4018	4288	4590	5214	5878
-------------------	------	------	------	------	------	------	------	------	------	------	------	------

OVERALL DIMENSIONS			SEAT DIMENSIONS			BACK DIMENSIONS	
W	D	H	W	D	H	W	H
24	60	29	-	-	-	-	-

**RTA 00**

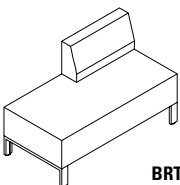

**BRTSE2448BR**

**Lounge Seat, 24" Offset Backrest**  
 COM Yardage: 3  
 Freight Class: 250  
 Product Weight (lbs.): 46.1  
 Cubic Feet Per Carton: 19.33

<b>BRTSE2448BR</b>	1884	2063	2063	2175	2339	2416	2563	2800	2980	3179	3596	4038
--------------------	------	------	------	------	------	------	------	------	------	------	------	------

<b>BRTSE2448BL</b>	1884	2063	2063	2175	2339	2416	2563	2800	2980	3179	3596	4038
--------------------	------	------	------	------	------	------	------	------	------	------	------	------

OVERALL DIMENSIONS			SEAT DIMENSIONS			BACK DIMENSIONS	
W	D	H	W	D	H	W	H
24	48	29	-	-	-	-	-

**RTA 00**

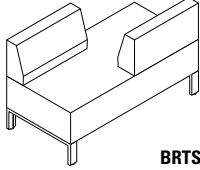
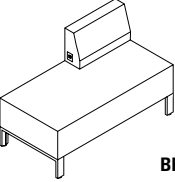
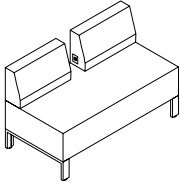
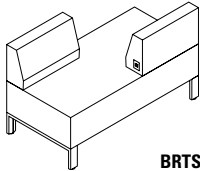
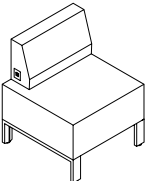
DESCRIPTION	FEATURES	MODEL#	STANDARD TEXTILE GRADES											
 <p><b>BRTSE2448BODR</b></p> <p><b>Lounge Seat, Two 24" Offset Backrests</b>                      COM Yardage: 4                      Freight Class: 250                      Product Weight (lbs.): 46.5                      Cubic Feet Per Carton: 19.33</p>			1	2	3	4	5	6	7	8	9	10	11	12
		<b>BRTSE2448BODR</b>	2336	2570	2570	2724	2940	3043	3241	3554	3794	4065	4618	5206
		<b>BRTSE2448BODL</b>	2336	2468	2570	2724	2940	3043	3241	3554	3794	4065	4618	5206
			<b>OVERALL DIMENSIONS</b>			<b>SEAT DIMENSIONS</b>			<b>BACK DIMENSIONS</b>					
			<b>W</b>	<b>D</b>	<b>H</b>	<b>W</b>	<b>D</b>	<b>H</b>	<b>W</b>	<b>H</b>				
			24	48	29	-	-	-	-	-				
			<b>RTA 00</b>											
 <p><b>BRTSE2148EBR</b></p> <p><b>Lounge Seat, 21" USB Backrest</b>                      COM Yardage: 3                      Freight Class: 250                      Product Weight (lbs.): 33                      Cubic Feet Per Carton: 9.67</p>			1	2	3	4	5	6	7	8	9	10	11	12
		<b>BRTSE2148EBR</b>	2184	2287	2363	2475	2639	2716	2863	3100	3280	3479	3896	4338
		<b>BRTSE2148EBL</b>	2184	2287	2363	2475	2639	2716	2863	3100	3280	3479	3896	4338
			<b>OVERALL DIMENSIONS</b>			<b>SEAT DIMENSIONS</b>			<b>BACK DIMENSIONS</b>					
			<b>W</b>	<b>D</b>	<b>H</b>	<b>W</b>	<b>D</b>	<b>H</b>	<b>W</b>	<b>H</b>				
			24	48	29	-	-	-	-	-				
			<b>RTA 00</b>											
 <p><b>BRTSE2148E2B</b></p> <p><b>Lounge Seat, Two 21" USB Backrests</b>                      COM Yardage: 4                      Freight Class: 250                      Product Weight (lbs.): 57                      Cubic Feet Per Carton: 19.33</p>			1	2	3	4	5	6	7	8	9	10	11	12
		<b>BRTSE2148E2B</b>	2934	3066	3165	3319	3536	3641	3838	4151	4392	4660	5213	5803
			<b>OVERALL DIMENSIONS</b>			<b>SEAT DIMENSIONS</b>			<b>BACK DIMENSIONS</b>					
			<b>W</b>	<b>D</b>	<b>H</b>	<b>W</b>	<b>D</b>	<b>H</b>	<b>W</b>	<b>H</b>				
			24	48	29	-	-	-	-	-				
			<b>RTA 00</b>											
 <p><b>BRTSE2148EBODR</b></p> <p><b>Lounge Seat, Two Offset USB Backrests</b>                      COM Yardage: 4                      Freight Class: 250                      Product Weight (lbs.): 57                      Cubic Feet Per Carton: 19.33</p>			1	2	3	4	5	6	7	8	9	10	11	12
		<b>BRTSE2148EBODR</b>	2934	3066	3165	3319	3536	3641	3838	4151	4392	4660	5213	5803
		<b>BRTSE2148EBODL</b>	2934	3066	3165	3319	3536	3641	3838	4151	4392	4660	5213	5803
			<b>OVERALL DIMENSIONS</b>			<b>SEAT DIMENSIONS</b>			<b>BACK DIMENSIONS</b>					
			<b>W</b>	<b>D</b>	<b>H</b>	<b>H</b>	<b>W</b>	<b>D</b>	<b>H</b>	<b>WH</b>				
			24	48	29	-	-	-	-	-				
			<b>RTA 00</b>											
 <p><b>BRTSE2124EBR</b></p> <p><b>Lounge Seat, 21" USB Backrest</b>                      COM Yardage: 2.25                      Freight Class: 250                      Product Weight (lbs.): 46.10                      Cubic Feet Per Carton: 19.33</p>			1	2	3	4	5	6	7	8	9	10	11	12
		<b>BRTSE2124EBR</b>	2934	1614	1673	1757	1879	1939	2049	2225	2360	2512	2824	3154
		<b>BRTSE2124EBL</b>	1538	1614	1673	1757	1879	1939	2049	2225	2360	2512	2824	3154
			<b>OVERALL DIMENSIONS</b>			<b>SEAT DIMENSIONS</b>			<b>BACK DIMENSIONS</b>					
			<b>W</b>	<b>D</b>	<b>H</b>	<b>W</b>	<b>D</b>	<b>H</b>	<b>W</b>	<b>H</b>				
			24	24	29	-	-	-	-	-				
			<b>RTA 00</b>											

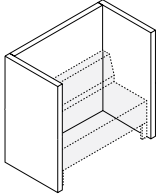
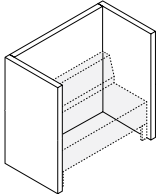
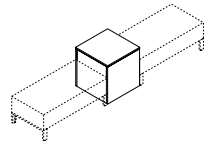
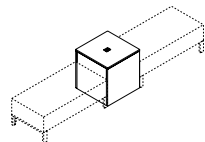
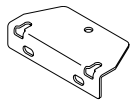

DESCRIPTION	FEATURES	MODEL#	STANDARD TEXTILE GRADES												
			1	2	3	4	5	6	7	8	9	10	11	12	
 <p><b>Seat Privacy Partitions - 24"</b> COM Yardage: Freight Class: 300 Product Weight (lbs.): 32 Cubic Feet Per Carton: 24.08</p>	<p>Fully 3 - Part Kit  Seating not included. Panel textiles only.</p>	<b>BRTPP2424L2</b>	2199	-	-	-	-	-	-	-	-	-	-	-	
		<b>OVERALL DIMENSIONS</b>			<b>SEAT DIMENSIONS</b>			<b>BACK DIMENSIONS</b>							
		<b>W</b>	<b>D</b>	<b>H</b>	<b>W</b>	<b>D</b>	<b>H</b>	<b>W</b>	<b>H</b>						
		53	28.7	50	-	-	-	-	-						
			<b>RTA 00</b>												
 <p><b>Seat Privacy Partitions - 48"</b> COM Yardage: Freight Class: 400 Product Weight (lbs.): 41 Cubic Feet Per Carton: 44.01</p>	<p>Fully 3 - Part Kit Seating not included.</p>	<b>BRTPP2448L2</b>	2813	-	-	-	-	-	-	-	-	-	-	-	
		<b>OVERALL DIMENSIONS</b>			<b>SEAT DIMENSIONS</b>			<b>BACK DIMENSIONS</b>							
		<b>W</b>	<b>D</b>	<b>H</b>	<b>W</b>	<b>D</b>	<b>H</b>	<b>W</b>	<b>H</b>						
		53	28.7	50	-	-	-	-	-						
			<b>RTA 00</b>												
 <p><b>Square Table Block - No Power</b> COM Yardage: N/A Freight Class: 250 Product Weight (lbs.): 32 Cubic Feet Per Carton: 12.04</p>	<p>Freestanding Table. Seating not included. Includes 2 brackets and screws</p>	<b>BRTS2424B</b>	619	-	-	-	-	-	-	-	-	-	-	-	
		<b>OVERALL DIMENSIONS</b>			<b>SEAT DIMENSIONS</b>			<b>BACK DIMENSIONS</b>							
		<b>W</b>	<b>D</b>	<b>H</b>	<b>W</b>	<b>D</b>	<b>H</b>	<b>W</b>	<b>H</b>						
		24	24	25	-	-	-	-	-						
			<b>RTA 00</b>												
 <p><b>Square Table Block w/ Center Power</b> COM Yardage: N/A Freight Class: 125 Product Weight (lbs.): 59.30 Cubic Feet Per Carton: 8.33</p>	<p>Freestanding Table. Seating not included. Includes 2 brackets and screws</p>	<b>BRTS2424BP</b>	619	-	-	-	-	-	-	-	-	-	-	-	
		<b>OVERALL DIMENSIONS</b>			<b>SEAT DIMENSIONS</b>			<b>BACK DIMENSIONS</b>							
		<b>W</b>	<b>D</b>	<b>H</b>	<b>W</b>	<b>D</b>	<b>H</b>	<b>W</b>	<b>H</b>						
		24	24	25	-	-	-	-	-						
			<b>RTA 00</b>												
 <p><b>Square Table Block Ganging Bracket Kit</b> COM Yardage: N/A Freight Class: 70 Product Weight (lbs.): 0.05 Cubic Feet Per Carton: 0.01</p>	<p>Includes 2 brackets and screws. Black Only.</p>	<b>BRTSTBG</b>	47	-	-	-	-	-	-	-	-	-	-	-	
		<b>OVERALL DIMENSIONS</b>			<b>SEAT DIMENSIONS</b>			<b>BACK DIMENSIONS</b>							
		<b>W</b>	<b>D</b>	<b>H</b>	<b>W</b>	<b>D</b>	<b>H</b>	<b>W</b>	<b>H</b>						
		2.5	5	1.1	-	-	-	-	-						
			<b>RTA 00</b>												

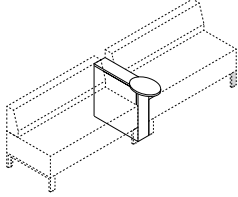

DESCRIPTION	FEATURES	MODEL#	STANDARD TEXTILE GRADES													
			1	2	3	4	5	6	7	8	9	10	11	12		
 <p><b>Inline 6" Table Block w/ Front Power &amp; Tablet Arm</b>                      COM Yardage: N/A                      Freight Class: 92.50                      Product Weight (lbs.): 24.30                      Cubic Feet Per Carton: 2.08</p>	<p>Must use with seating.                      Seating not included.                      Includes 2 brackets and screws</p>	<p><b>BRTS2406BPT</b></p>	1627	-	-	-	-	-	-	-	-	-	-	-		
			OVERALL DIMENSIONS			SEAT DIMENSIONS			BACK DIMENSIONS							
			W	D	H	W	D	H	W	H						
24	6	25	-	-	-	-	-									
			<b>RTA 00</b>													

CALIDON



GC36305  
Wood Lounge Single Seat, Open Arms



GC36301  
Wood Guest Single Seat, Open Arms



GC36308  
Wood Lounge Single Seat, Closed Arms



For Calidon tables, see page 292

EXAMPLE CALIDON ORDER CODE:

GC36308	PU75	AAM	NBS
Model #	Textile	Frame Finish	Sealed Back Seams
NSS	NB	NM	SRT
Sealed Seat Seams	Moisture Barrier	Glides	Power

STANDARD FEATURES

- Calidon series consists of wood frame guest, lounge, bariatric and bench seating in addition to fully upholstered lounge seating. Freestanding and tandem/bridge tables also available to complement the line.
- Calidon is designed for the rigors of high use environments. Lounge units include metal frame supports.
- The seating in this series is available to specify with two textiles, one for the seat cushion and one for the back and arms (see model image).
- For pricing, start with the base price and add both back/arms graded textile upcharge and the seat graded textile upcharge.
- Frame design features a wall saver leg to prevent back contact and damage to walls.
- All guest and lounge chairs feature a clean out between seat and back, replaceable seat cushions and tall legs for ease of cleaning.
- For added comfort, seats are standard with high density Ultracell foam.
- Active weight capacity up to 400 lbs/seat for standard seating; up to 600 lbs for bariatric seating.
- For healthcare textiles, visit the website at [globalfurnituregroup.com](http://globalfurnituregroup.com).
- Textiles with a minimum of 100,000 double rubs must be specified to meet Global's 24/7 warranty coverage.
- Can be upholstered in standard Global textiles if Healthcare 24/7 warranty compliance is not required.
- For alternate textile applications, contact Global specials. The Blended Textile matrix does not apply to this series.
- Tandem table models connect to guest seating only. See Calidon tables.
- No seating or bench models gang together.
- Shipped fully assembled.

OPTIONAL FEATURES

- All guest and lounge models can be specified with or without armcaps. Urethane armcaps are available on Wood arm guest and lounge chairs. Solid surface armcaps are available on all chair models. Armcaps are field replaceable, securely fastened with metal-to-metal connectors. Armcaps cannot be retrofitted in the field on units with no existing armcaps.
- Fully upholstered lounge chairs can be specified with a tamperproof Black power/USB unit, which includes one AC outlet, two 10 watt USB ports, and a 10 ft long power cord. Power is factory installed and must be specified at time of order. Add **\$237** each. Power locations vary by model. See power location diagram.
- For moisture barrier on seat, specify **(MB)**. Upcharges vary, see model.
- To add sealed seams, specify **(SBS)** for seat back and arms and/or **(SSS)** for seat. Upcharges vary, see model.
- A tamperproof power unit is available to specify in various locations on closed arm lounge models only. See diagrams.

SUGGESTED APPLICATIONS

- Guest seating
- Lobby/Lounge
- Treatment/Exam rooms



Please add option codes in the following order:



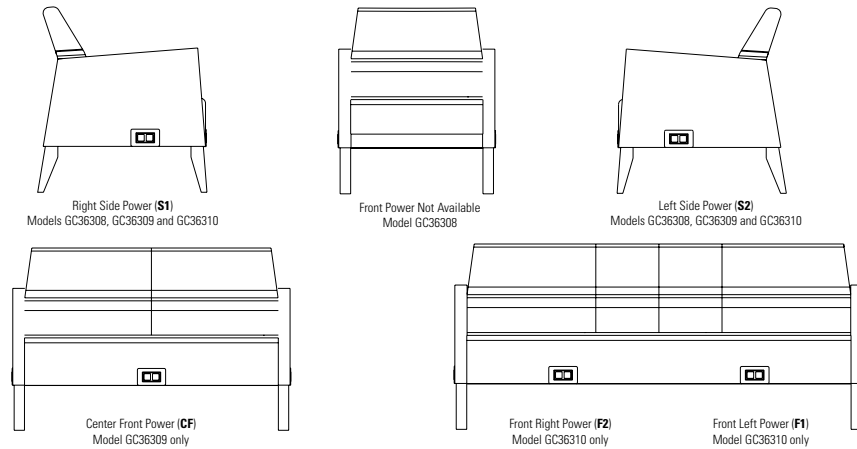

- **Model number**  
See models.  
For Calidon tables, refer to calidon tables 292
- **Back/Arm Textile**  
Specify textile code. See model grade upcharges.
- **Seat Textile**  
Specify textile code. See model grade upcharges.
- **Armcaps option**  
**(FNA)** No armcaps  
**(FAC)** With armcaps. Upcharges vary, see model.
- **Frame finish**  
**(AAM)** Absolute  
**(CJM)** Charcoal Java  
**(ACM)** Cherry  
**(EMM)** Empire Mahogany  
**(EOM)** English Oak  
**(ECM)** Espresso Cafe  
**(TFM)** Fruitwood  
**(HGM)** Grey  
**(HOM)** Harvest Oak  
**(AHM)** Honey  
**(JOM)** Jet Onyx  
**(LHM)** Light Honey  
**(TMM)** Mahogany  
**(AVM)** Maple  
**(MWM)** Medium Walnut  
**(ASM)** Night  
**(NBM)** Noce Biondo  
**(NGM)** Noce Grigio  
**(NEM)** Noce Leggero  
**(NMM)** Noce Medio  
**(SBM)** Sandy Beach  
**(SKM)** Shaker Cherry  
**(SOM)** Silver Oak  
**(TWM)** Walnut  
**(WTM)** WC Cream  
**(WHM)** White  
**(WCM)** Winter Cherry
- **Armcaps finish**  
**(SSU)** Urethane (for wood arm models of guest and lounge seating with FAC specified).  
Urethane finishes (upcharges vary, see model):  
**(BLK)** Black  
**(J52)** Mocha  
**(KAL)** Kalua  
**(SHW)** Shadow  
**(LAB)** Latte  
**(TOA)** Toast  
**(CO)** Solid Surface (for all wood and fully upholstered arm models with FAC specified). Solid Surface Finishes:  
Grade 1: (Upcharges vary, see model)  
**(SWH)** Designer White  
Grade 2: (Upcharges vary, see model)  
**(SBT)** Beige Tempest  
**(SBX)** Black Onyx Mirage  
**(SMG)** Milk Glass Spectra  
**(SFW)** Frosty White Mirage  
**(SHS)** Hot Stone  
**(SNM)** Northern Melange
- **Sealed Back Seams** (Contact Customer Care for approved textiles.)  
**(NBS)** No sealed back seams  
**(SBS)** Sealed back seams. Upcharges vary, see model.
- **Sealed Seat Seams** (Contact Customer Care for approved textiles.)  
**(NSS)** No sealed seat seams  
**(SSS)** Sealed seat seams. Upcharges vary, see model.
- **Glides**  
**(NM)** Non-marking  
**(NS)** Non-slip  
Guest single seat, bariatric and lounge chairs, add \$29.  
Guest two seater, Add \$44.  
Guest three seater, add \$56.
- **Moisture Barrier** (seat only) (Not available with Sealed Seams)  
**(NB)** No moisture barrier  
**(MB)** Moisture barrier. Upcharges vary, see model.
- **Power/USB unit position** (lounge models only). Add **\$237**.  
**(NPM)** No power  
**(TPM)** Tamperproof power unit  
**(J)** Black  
**(SRT)** Side right  
**(SLT)** Side left  
**(FLT)** Front left (three seater only)  
**(FRT)** Front right (three seater only)  
**(CRF)** Center front (two seater only)  
**(SLR)** Side left and right. Add **\$472**.  
**(FLR)** Front left and right. Add **\$472**.







## POWER LOCATION DIAGRAM



DESCRIPTION	MODEL#/ FEATURES	STANDARD TEXTILE GRADES											
		1/COM	2	3	4	5	6	7	8	9	10	11	12
 <p><b>Wood Guest Single Seat</b> COM Yardage: Back: 0.9; Seat: 1 Freight Class: 250 Product Weight (lbs.): 38 Cubic Feet Per Carton: 16.5</p>	<p><b>GC36301</b> Base Price:</p> <p>Back upcharge:</p> <p>Seat upcharge:</p> <p>Active weight 400 lbs.</p>	\$1195											
		+0	+\$29	+\$52	+\$85	+\$132	+\$152	+\$192	+\$256	+\$304	+\$356	+\$465	+\$579
		+0	+\$32	+\$57	+\$94	+\$146	+\$168	+\$213	+\$284	+\$337	+\$395	+\$516	+\$643
		<b>OVERALL DIMENSIONS</b>			<b>SEAT DIMENSIONS</b>			<b>BACK DIMENSIONS</b>					
		W	D	H	W	D	H	W	H				
	23.5	26.5	34.5	21.5	18	18	21.5	16.5					
 <p><b>Wood Guest Two Seater, Full Center Arm</b> COM Yardage: Back: 1.8; Seat: 2 Freight Class: 250 Product Weight (lbs.): 68 Cubic Feet Per Carton: 31.75</p>	<p><b>GC36302</b> Base Price:</p> <p>Back upcharge:</p> <p>Seat upcharge:</p> <p>Active weight 400 lbs./seat</p>	\$2211											
		+0	+\$58	+\$103	+\$170	+\$263	+\$303	+\$384	+\$512	+\$607	+\$711	+\$929	+\$1158
		+0	+\$64	+\$114	+\$188	+\$292	+\$336	+\$426	+\$568	+\$674	+\$790	+\$1032	+\$1286
		<b>OVERALL DIMENSIONS</b>			<b>SEAT DIMENSIONS</b>			<b>BACK DIMENSIONS</b>					
		W	D	H	W	D	H	W	H				
	46	26.5	34.5	21.5	18	18	21.5	16.5					
 <p><b>Wood Guest Three Seater, Full Center Arms</b> COM Yardage: Back: 2.7; Seat: 3 Freight Class: 250 Product Weight (lbs.): 101 Cubic Feet Per Carton: 47.5</p>	<p><b>GC36303</b> Base Price:</p> <p>Back upcharge:</p> <p>Seat upcharge:</p> <p>Active weight 400 lbs./seat</p>	\$3255											
		+0	+\$87	+\$154	+\$254	+\$395	+\$454	+\$576	+\$767	+\$910	+\$1067	+\$1394	+\$1737
		+0	+\$96	+\$171	+\$282	+\$438	+\$504	+\$639	+\$852	+\$1011	+\$1185	+\$1548	+\$1929
		<b>OVERALL DIMENSIONS</b>			<b>SEAT DIMENSIONS</b>			<b>BACK DIMENSIONS</b>					
		W	D	H	W	D	H	W	H				
	68	26.5	34.5	21.5	18	18	21.5	16.5					

DESCRIPTION	MODEL#/ FEATURES	STANDARD TEXTILE GRADES											
		1/COM	2	3	4	5	6	7	8	9	10	11	12
 <p><b>Wood Guest Bariatric Chair,</b> COM Yardage: Back: 1.25; Seat: 1.25 Freight Class: 250 Product Weight (lbs.): 55 Cubic Feet Per Carton: 22.25</p>	<b>GC36304</b> Base Price:	\$1827											
	Back upcharge:	<b>+0</b>	<b>+\$40</b>	<b>+\$72</b>	<b>+\$118</b>	<b>+\$183</b>	<b>+\$210</b>	<b>+\$267</b>	<b>+\$355</b>	<b>+\$422</b>	<b>+\$494</b>	<b>+\$645</b>	<b>+\$804</b>
	Seat upcharge:	<b>+0</b>	<b>+\$40</b>	<b>+\$72</b>	<b>+\$118</b>	<b>+\$183</b>	<b>+\$210</b>	<b>+\$267</b>	<b>+\$355</b>	<b>+\$422</b>	<b>+\$494</b>	<b>+\$645</b>	<b>+\$804</b>
	Active weight 600 lbs.	<b>OVERALL DIMENSIONS</b>			<b>SEAT DIMENSIONS</b>			<b>BACK DIMENSIONS</b>					
		<b>W</b>	<b>D</b>	<b>H</b>	<b>W</b>	<b>D</b>	<b>H</b>	<b>W</b>	<b>H</b>				
	32.75	26.5	34.5				31	18	18	30.5	16.5		
 <p><b>Wood Lounge Single Seat</b> COM Yardage: Back: 1.25; Seat: 1.25 Freight Class: 250 Product Weight (lbs.): 49 Cubic Feet Per Carton: 18.25</p>	<b>GC36305</b> Base Price:	\$1670											
	Back upcharge:	<b>+0</b>	<b>+\$40</b>	<b>+\$72</b>	<b>+\$118</b>	<b>+\$183</b>	<b>+\$210</b>	<b>+\$267</b>	<b>+\$355</b>	<b>+\$422</b>	<b>+\$494</b>	<b>+\$645</b>	<b>+\$804</b>
	Seat upcharge:	<b>+0</b>	<b>+\$40</b>	<b>+\$72</b>	<b>+\$118</b>	<b>+\$183</b>	<b>+\$210</b>	<b>+\$267</b>	<b>+\$355</b>	<b>+\$422</b>	<b>+\$494</b>	<b>+\$645</b>	<b>+\$804</b>
	Active weight 400 lbs.	<b>OVERALL DIMENSIONS</b>			<b>SEAT DIMENSIONS</b>			<b>BACK DIMENSIONS</b>					
		<b>W</b>	<b>D</b>	<b>H</b>	<b>W</b>	<b>D</b>	<b>H</b>	<b>W</b>	<b>H</b>				
	25.75	29.5	32.5				24	21	16	23.5	16.5		
 <p><b>Wood Lounge Two Seater</b> COM Yardage: Back: 1.75; Seat: 2.25 Freight Class: 250 Product Weight (lbs.): 77 Cubic Feet Per Carton: 32.75</p>	<b>GC36306</b> Base Price:	\$2348											
	Back upcharge:	<b>+0</b>	<b>+\$56</b>	<b>+\$100</b>	<b>+\$165</b>	<b>+\$256</b>	<b>+\$294</b>	<b>+\$373</b>	<b>+\$497</b>	<b>+\$590</b>	<b>+\$692</b>	<b>+\$903</b>	<b>+\$1126</b>
	Seat upcharge:	<b>+0</b>	<b>+\$72</b>	<b>+\$129</b>	<b>+\$212</b>	<b>+\$329</b>	<b>+\$378</b>	<b>+\$480</b>	<b>+\$639</b>	<b>+\$759</b>	<b>+\$889</b>	<b>+\$1161</b>	<b>+\$1447</b>
	Active weight 400 lbs./seat	<b>OVERALL DIMENSIONS</b>			<b>SEAT DIMENSIONS</b>			<b>BACK DIMENSIONS</b>					
		<b>W</b>	<b>D</b>	<b>H</b>	<b>W</b>	<b>D</b>	<b>H</b>	<b>W</b>	<b>H</b>				
	47.5	29.5	32.5				45	21	16	44.5	16.5		
 <p><b>Wood Lounge Three Seater,</b> COM Yardage: Back: 2.5; Seat: 2.75 Freight Class: 250 Product Weight (lbs.): 109 Cubic Feet Per Carton: 50.75</p>	<b>GC36307</b> Base Price:	\$2936											
	Back upcharge:	<b>+0</b>	<b>+\$80</b>	<b>+\$143</b>	<b>+\$235</b>	<b>+\$365</b>	<b>+\$420</b>	<b>+\$533</b>	<b>+\$710</b>	<b>+\$843</b>	<b>+\$988</b>	<b>+\$1290</b>	<b>+\$1608</b>
	Seat upcharge:	<b>+0</b>	<b>+\$88</b>	<b>+\$157</b>	<b>+\$259</b>	<b>+\$402</b>	<b>+\$462</b>	<b>+\$586</b>	<b>+\$781</b>	<b>+\$927</b>	<b>+\$1087</b>	<b>+\$1419</b>	<b>+\$1769</b>
	Active weight 400 lbs./seat	<b>OVERALL DIMENSIONS</b>			<b>SEAT DIMENSIONS</b>			<b>BACK DIMENSIONS</b>					
		<b>W</b>	<b>D</b>	<b>H</b>	<b>W</b>	<b>D</b>	<b>H</b>	<b>W</b>	<b>H</b>				
	70.5	29.5	32.5				68	21	16	67.5	16.5		
 <p><b>Fully Upholstered Wood Lounge Single Seat</b> COM Yardage: Back/Arm: 2.75; Seat: 1.25 Freight Class: 250 Product Weight (lbs.): 58 Cubic Feet Per Carton: 18.75</p>	<b>GC36308</b> Base Price:	\$1893											
	Back/Arm upcharge:	<b>+0</b>	<b>+\$88</b>	<b>+\$157</b>	<b>+\$259</b>	<b>+\$402</b>	<b>+\$462</b>	<b>+\$586</b>	<b>+\$781</b>	<b>+\$927</b>	<b>+\$1087</b>	<b>+\$1419</b>	<b>+\$1769</b>
	Seat upcharge:	<b>+0</b>	<b>+\$40</b>	<b>+\$72</b>	<b>+\$118</b>	<b>+\$183</b>	<b>+\$210</b>	<b>+\$267</b>	<b>+\$355</b>	<b>+\$422</b>	<b>+\$494</b>	<b>+\$645</b>	<b>+\$804</b>
	Active weight 400 lbs.	<b>OVERALL DIMENSIONS</b>			<b>SEAT DIMENSIONS</b>			<b>BACK DIMENSIONS</b>					
		<b>W</b>	<b>D</b>	<b>H</b>	<b>W</b>	<b>D</b>	<b>H</b>	<b>W</b>	<b>H</b>				
	27.5	29.5	33.5				24	21	16	23.5	17.5		

DESCRIPTION	MODEL#/ FEATURES	STANDARD TEXTILE GRADES															
		1/COM	2	3	4	5	6	7	8	9	10	11	12				
 <p><b>Fully Upholstered Wood Lounge Two Seater</b> COM Yardage: Back/Arm: 3.5; Seat: 2.25 Freight Class: 250 Product Weight (lbs.): 89 Cubic Feet Per Carton: 33.75</p>	<b>GC36309</b> Base Price:	\$2545															
	Back/Arm upcharge:	+0	+\$112	+\$200	+\$329	+\$511	+\$588	+\$746	+\$994	+\$1180	+\$1383	+\$1806	+\$2251				
	Seat upcharge:	+0	+\$72	+\$129	+\$212	+\$329	+\$378	+\$480	+\$639	+\$759	+\$889	+\$1161	+\$1447				
	Active weight 400 lbs./seat																
		<b>OVERALL DIMENSIONS</b>	<b>SEAT DIMENSIONS</b>	<b>BACK DIMENSIONS</b>													
	W D H	W D H	W H														
	49.5 29.5 33.5	44.5 18 16	45.5 17.5														
	Add \$403 for (CO) Grade 1 armcaps Add \$431 for (CO) Grade 2 armcaps Add \$250 for (MB) Add \$52 for (SSS), \$160 for (SBS) Power/USB unit available.																
 <p><b>Fully Upholstered Wood Lounge Three Seater</b> COM Yardage: Back/Arm: 4.25; Seat: 2.75 Freight Class: 250 Product Weight (lbs.): 123 Cubic Feet Per Carton: 52</p>	<b>GC36310</b> Base Price:	\$3196															
	Back/Arm upcharge:	+0	+\$136	+\$243	+\$400	+\$621	+\$714	+\$906	+\$1207	+\$1433	+\$1679	+\$2193	+\$2733				
	Seat upcharge:	+0	+\$88	+\$157	+\$259	+\$402	+\$462	+\$586	+\$781	+\$927	+\$1087	+\$1419	+\$1769				
	Active weight 400 lbs./seat																
		<b>OVERALL DIMENSIONS</b>	<b>SEAT DIMENSIONS</b>	<b>BACK DIMENSIONS</b>													
	W D H	W D H	W H														
	71.5 29.5 33.5	66.5 18 16	67.5 17.5														
	Add \$403 for (CO) Grade 1 armcaps Add \$431 for (CO) Grade 2 armcaps Add \$373 for (MB) Add \$86 for (SSS), \$179 for (SBS) Power/USB unit available.																
 <p><b>Single Seat Bench</b> COM Yardage: 1 Freight Class: 150 Product Weight (lbs.): 41 Cubic Feet Per Carton: 10</p>	<b>GC36311</b> Base Price:	\$1279															
	Seat upcharge:	+0	+\$32	+\$57	+\$94	+\$146	+\$168	+\$213	+\$284	+\$337	+\$395	+\$516	+\$643				
	Active weight 400 lbs.																
		<b>OVERALL DIMENSIONS</b>	<b>SEAT DIMENSIONS</b>	<b>BACK DIMENSIONS</b>													
		W D H	W D H	W H													
	24 28 18	24 26.75 18															
	Add \$126 for (MB) Add \$31 for (SSS)																
 <p><b>Two Seat Bench</b> COM Yardage: 2 Freight Class: 250 Product Weight (lbs.): 61 Cubic Feet Per Carton: 18.75</p>	<b>GC36312</b> Base Price:	\$2023															
	Seat upcharge:	+0	+\$64	+\$114	+\$188	+\$292	+\$336	+\$426	+\$568	+\$674	+\$790	+\$1032	+\$1286				
	Active weight 400 lbs./seat																
		<b>OVERALL DIMENSIONS</b>	<b>SEAT DIMENSIONS</b>	<b>BACK DIMENSIONS</b>													
		W D H	W D H	W H													
	48 28 18	48 26.75 18															
	Add \$250 for (MB) Add \$61 for (SSS)																
 <p><b>Three Seat Bench</b> COM Yardage: 3 Freight Class: 250 Product Weight (lbs.): 97 Cubic Feet Per Carton: 27.75</p>	<b>GC36313</b> Base Price:	\$2414															
	Seat upcharge:	+0	+\$96	+\$171	+\$282	+\$438	+\$504	+\$639	+\$852	+\$1011	+\$1185	+\$1548	+\$1929				
	Active weight 400 lbs./seat																
		<b>OVERALL DIMENSIONS</b>	<b>SEAT DIMENSIONS</b>	<b>BACK DIMENSIONS</b>													
		W D H	W D H	W H													
	72 28 18	72 26.75 18															
	Add \$373 for (MB) Add \$89 for (SSS)																

CALIDON TABLES



Square end table - 22"  
GC36314



Rectangular Coffee Table  
GC36317



Tandem Side Table, Right  
GC36319R

EXAMPLE CALIDON TABLE ORDER CODE:

GC36319R	-HP	-ACJ	-CNT
Model #	Top material	Laminated finish	Power

TABLE TOP FINISHES:

Thermally fused laminate (LP):

- Absolute Acajou (ACJ)
- Asian Night (ASN)
- Avant Cherry (AWC)
- Avant Honey (AWH)
- Black (BLK)
- Brushed Cobalt (BRC)
- Clear Maple (CMB)
- Dark Espresso (DES)
- Designer White (DWT)
- Fashionista (FAS)
- First Class (FCL)
- Noce Biondo (NBL)
- Noce Grigio (NGL)
- Noce Leggero (NEL)
- Noce Medio (NML)
- Quartered Mahogany (QTM)
- Sheer Beauty (SBY)
- Walnut Heights (WHE)
- White Chocolate (WHC)
- Winter Cherry (WCR)

High pressure laminate (HP):

- Absolute Acajou (ACJ)
- Asian Night (ASN)
- Avant Cherry (AWC)
- Avant Honey (AWH)
- Black (BLK)
- Brushed Cobalt (BRC)
- Clear Maple (CMB)
- Dark Espresso (DES)
- Designer White (DWT)
- Fashionista (FAS)
- First Class (FCL)
- Noce Biondo (NBL)
- Noce Grigio (NGL)
- Noce Leggero (NEL)
- Noce Medio (NML)
- Quartered Mahogany (QTM)
- Sheer Beauty (SBY)
- Walnut Heights (WHE)
- White Chocolate (WHC)
- Winter Cherry (WCR)

Solid Surface (CO):

- Grade 1:  
(SWH) Designer White
- Grade 2:  
(SBT) Beige Tempest  
(SBX) Black Onyx Mirage  
(SMG) Milk Glass Spectra  
(SFW) Frosty White Mirage  
(SHS) Hot Stone  
(SNM) Northern Melange

TABLE STANDARD FEATURES

- A variety of wood leg tables are available. The wood legs/frames are specifiable in the same wood seating finishes.
- Table tops are 1" thick, available in thermally fused laminate (LP), high pressure laminate (HP), and Corian® solid surface (CO). Upcharges vary, see model for pricing. For detailed solid surface material information, please reference WilsonArt's Solid Surface collection.
- Laminate top tables include color coordinating vinyl edge band.
- Tandem/bridge table models (GC36318 to GC36321) connect to guest seating only and include ganging brackets.
- Tandem tables are specified left or right, as seated.

TABLE OPTIONAL FEATURES

- A tamperproof tabletop power unit may be specified on laminate top, tandem and square end tables only. Specify **CNT**. Add **\$358**. The power unit is located centered 1.5" from the edge of the surface. See power location diagrams for reference.

SUGGESTED APPLICATIONS

- Lounge/Lobby
- Patient rooms
- Resident rooms
- Private office

Please add option codes in the following order:

- **Table model number**  
GC36314 to GC36317 Freestanding tables  
GC36318 to GC36321 Tandem/bridge tables  
For Calidon seating, refer to page 289.
- **Top Material (tables)**  
(LP) Thermally fused laminate. Specify finish - See LP finishes.  
(HP) High pressure laminate. Upcharges vary - see model. Specify finish - see HP finishes.  
(CO) Solid surface. Upcharges vary - see model. Specify finish - see CO finishes and grades.
- **Leg finish**  
(AAM) Absolute (MWM) Medium Walnut  
(CJM) Charcoal Java (ASM) Night  
(ACM) Cherry (NBM) Noce Biondo  
(EMM) Empire Mahogany (NGM) Noce Grigio  
(EOM) English Oak (NEM) Noce Leggero  
(ECM) Espresso Cafe (NMM) Noce Medio  
(TFM) Fruitwood (SBM) Sandy Beach  
(HGM) Grey (SKM) Shaker Cherry  
(HOM) Harvest Oak (SOM) Silver Oak  
(AHM) Honey (TWM) Walnut  
(JOM) Jet Onyx (WTM) WC Cream  
(LHM) Light Honey (WHM) White  
(TMM) Mahogany (WCM) Winter Cherry  
(AVM) Maple
- **Power/USB unit position** (tandem and square side tables with laminate tops only).  
(NPM) No power  
(CNT) Center top power. Jet Black. Add **\$358**.  
(RBP) Right back top power. Jet Black. Add **\$358**.  
(LBP) Left back top power. Jet Black. Add **\$358**.

POWER LOCATION DIAGRAM

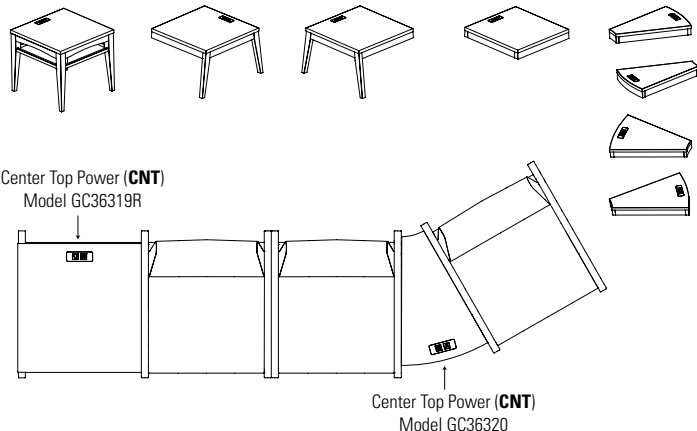

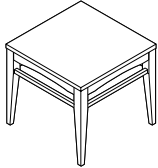
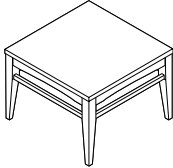
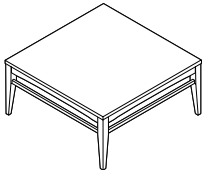
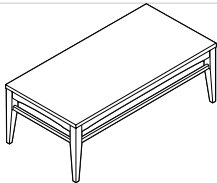
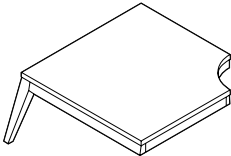
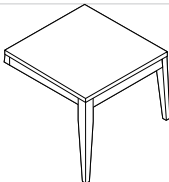
TABLES	MODEL#	DIMENSIONS	FREIGHT CLASS	WT./LBS.	CUBIC FT.	LIST PRICE
 <p><b>Square End Table - 22"</b></p>	GC36314	22 x 22 x 20.25	150	36	7.75	<b>\$826</b>
						<ul style="list-style-type: none"> <li>• Pricing shown for a thermally fused laminate top (LP).</li> <li>• For a high pressure laminate top (HP), add <b>\$65</b>.</li> <li>• For a solid surface top (CO), add <b>\$1071</b> for Grade 1 and add <b>\$1315</b> for Grade 2</li> </ul> <p>Coordinating edge on laminate surfaces with solid wood frame and legs. 1 per carton. Power/USB unit can be specified in the surface of laminate top tables (CNT). Add <b>\$358</b>.</p>
 <p><b>Square Coffee Table - 24"</b></p>	GC36315	24 x 24 x 17.25	250	37	9.5	<b>\$857</b>
						<ul style="list-style-type: none"> <li>• Pricing shown for a thermally fused laminate top (LP).</li> <li>• For a high pressure laminate top (HP), add <b>\$65</b>.</li> <li>• For a solid surface top (CO), add <b>\$1300</b> for Grade 1 and add <b>\$1605</b> for Grade 2</li> </ul> <p>Coordinating edge on laminate surfaces with solid wood frame and legs. 1 per carton.</p>
 <p><b>Square Coffee Table - 36"</b></p>	GC36316	36 x 36 x 17.25	250	65	18.25	<b>\$1025</b>
						<ul style="list-style-type: none"> <li>• Pricing shown for a thermally fused laminate top (LP).</li> <li>• For a high pressure laminate top (HP), add <b>\$140</b>.</li> <li>• For a solid surface top (CO), add <b>\$2979</b> for Grade 1 and add <b>\$3589</b> for Grade 2</li> </ul> <p>Coordinating edge on laminate surfaces with solid wood frame and legs. 1 per carton.</p>
 <p><b>Rectangular Coffee Table</b></p>	GC36317	24 x 48 x 17.25	250	56	16.5	<b>\$1123</b>
						<ul style="list-style-type: none"> <li>• Pricing shown for a thermally fused laminate top (LP).</li> <li>• For a high pressure laminate top (HP), add <b>\$127</b>.</li> <li>• For a solid surface top (CO), add <b>\$2481</b> for Grade 1 and add <b>\$2894</b> for Grade 2.</li> </ul> <p>Coordinating edge on laminate surfaces with solid wood frame and legs. 1 per carton.</p>
 <p><b>Corner Table, 90°</b></p>	GC36318	31.25 x 31.25 x 15.75	250	46	14.5	<b>\$1025</b>
						<ul style="list-style-type: none"> <li>• Pricing shown for a thermally fused laminate top (LP).</li> <li>• For a high pressure laminate top (HP), add <b>\$104</b>.</li> <li>• For a solid surface top (CO), add <b>\$2576</b> for Grade 1 and add <b>\$3079</b> for Grade 2.</li> </ul> <p>Coordinating edge on laminate surfaces with solid wood frame and legs. Must be connected between two guest chairs. Includes two sets of U-channel connectors and hardware. 1 per carton. Power/USB unit can be specified in the surface of laminate top tables (RBP) or (LBP). Add <b>\$358</b>. See power location diagram for placement.</p>
 <p><b>Tandem Side Table, Left</b></p>	GC36319L	26.5 x 22.25 x 15.75	250	20	6.75	<b>\$715</b>
						<ul style="list-style-type: none"> <li>• Pricing shown for a thermally fused laminate top (LP).</li> <li>• For a high pressure laminate top (HP), add <b>\$65</b>.</li> <li>• For a solid surface top (CO), add <b>\$1089</b> for Grade 1 and add <b>\$1311</b> for Grade 2.</li> </ul> <p>Coordinating edge on laminate surfaces with solid wood frame and legs. Must be connected to a guest chair. Includes one set of U-channel connectors and hardware. 1 per carton. Power/USB unit can be specified in the surface of laminate top tables (CNT). Add <b>\$358</b>.</p>

TABLES	MODEL#	DIMENSIONS	FREIGHT CLASS	WT/LBS.	CUBIC FT.	LIST PRICE
--------	--------	------------	---------------	---------	-----------	------------

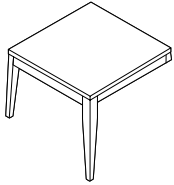

**Tandem Side Table, Right**

GC36319R	26.5 x 22.25 x 15.75	250	20	6.75	<b>\$715</b>
----------	----------------------	-----	----	------	--------------

- Pricing shown for a thermally fused laminate top (LP).
- For a high pressure laminate top (HP), add **\$65**.
- For a solid surface top (CO), add **\$1089** for Grade 1 and add **\$1311** for Grade 2.

Coordinating edge on laminate surfaces with solid wood frame and legs. Must be connected to a guest chair. Includes one set of U-channel connectors and hardware. 1 per carton. Power/USB unit can be specified in the surface of laminate top tables (CNT). Add **\$358**.

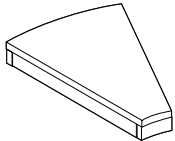

**Corner Table, 30 Degree**

GC36320	22.5 x 15.75 x 3	92.5	16	1.5	<b>\$563</b>
---------	------------------	------	----	-----	--------------

- Pricing shown for a thermally fused laminate top (LP).
- For a high pressure laminate top (HP), add **\$65**.
- For a solid surface top (CO), add **\$910** for Grade 1 and add **\$1093** for Grade 2.

Coordinating edge on laminate surfaces with solid wood frame and legs. Must be connected between two guest chairs. Includes two sets of U-channel connectors and hardware. 1 per carton. Power/USB unit can be specified in the surface of laminate top tables (CNT). Add **\$358**.

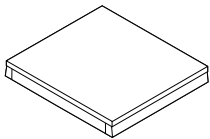

**In-Line Table, Square**

GC36321	21 x 23.5 x 3	92.5	20	1.9	<b>\$597</b>
---------	---------------	------	----	-----	--------------

- Pricing shown for a thermally fused laminate top (LP).
- For a high pressure laminate top (HP), add **\$65**.
- For a solid surface top (CO), add **\$942** for Grade 1 and add **\$1161** for Grade 2.

Coordinating edge on laminate surfaces with solid wood frame and legs. Must be connected between two guest chairs. Includes two sets of U-channel connectors and hardware. 1 per carton. Power/USB unit can be specified in the surface of laminate top tables (CNT). Add **\$358**.

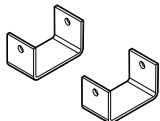

**U-Channel (set of 2)**

GC36322	2.87 x 1.5 x 1.62	70	0.75	0.03	<b>\$48</b>
---------	-------------------	----	------	------	-------------

Includes hardware. 4 sets per carton.

## CAMINO



models shown: 5471-CP Lounge Chair, 5475-W End Table, 5472-CP Two Seat Sofa.



model 5471-CP



model 5475-W





model 5485-W

### STANDARD FEATURES

- A transitional soft seating series composed of one, two and three seat units. The series also offers tables with coordinating details and finishes.
- Frame is a heavy duty, interlocking plywood, puzzle box construction suitable for public environments.
- The soft seating leg system utilizes a continuous visible frame between the front and rear leg. Each leg frame is bolted directly to the sofa frame with large bolts to provide a very durable leg construction.
- Legs are equipped with translucent non marking glides as standard. Suitable for both carpet and hard surface flooring.
- Seating features as standard, decorative double stitch detail, which make seams lay flat and add extra seam strength.
- Cushions are highly resilient foam and seats are equipped with a synthetic rubberized sheet webbing suspension system for extra comfort. Cushions are fixed and non-removable.
- Tables are made with a choice of tops: Genuine Wood tops (**W**) with a reverse beveled edge, Thermally Fused Laminate tops (**LP**) with matching PVC edging or High Pressure Laminate top (**HP**) with matching PVC edging. Custom high pressure laminate finishes will be considered upon requested.
- Regardless of top chosen all tables have wood aprons and a unique tapered leg design.
- Some table assembly required, see RTA code with each item below.
- Measurement shown for weight is for one unit, measurement for volume is per carton.
- Check textile availability prior to specifying upholstery material.

### OPTIONAL FEATURES

- Optional cushions and arms can have tailored piping details.
- For piping made in fabric matching the rest of the upholstery fabric please use **MP** models (matching piping after the model number). This is no upcharge.
- For contrast piping made in a fabric that does not match the rest of the upholstery fabric, you can specify any grade 1 or 2 upholstery material for this purpose, please see model numbers ending in **CP** which reflect the appropriate upcharge.
- For contrast piping in a fabric higher than grade 2, you must ask for a special quotation. Per unit price will vary depending on the number of units being ordered.
- Seating unit and tables come with a choice of wood legs or a polished cast aluminum. The table leg finishes coordinate with the legs on the soft seating units.
- Seating and tables with polished aluminum legs are shown as separate skus.
- Tops finishes coordinate with the laminate finishes for Global Desking and wood seating finishes. Specify laminate finishes from the Adaptabilities or Zira sections of the price list.
- Wood legs for seating are available in select Global wood seating finishes - see seating finishes. Only finishes ending in "**M**" are available for this series.

DESCRIPTION	FEATURES	MODEL#	STANDARD TEXTILE GRADES											
			1	2	3	4	5	6	7	8	9	10	11	12
 <p><b>Lounge Chair w/ Wood Legs</b> COM Yardage: 4 Freight Class: 250 Product Weight (lbs.): 60 Cubic Feet Per Carton: 19.25</p>	No Piping.	<b>5471</b>	2626	2782	2903	3082	3340	3459	3694	4064	4348	4668	5321	6018
		<b>OVERALL DIMENSIONS</b>			<b>SEAT DIMENSIONS</b>			<b>BACK DIMENSIONS</b>						
		<b>W</b>	<b>D</b>	<b>H</b>	<b>W</b>	<b>D</b>	<b>H</b>	<b>W</b>	<b>H</b>					
		29.5	29	30.5	21	19.5	18	20	11.5					
		<b>RTA.00</b>												
 <p><b>Lounge Chair w/ Wood Legs &amp; Piping</b> COM Yardage: 4 Freight Class: 250 Product Weight (lbs.): 60 Cubic Feet Per Carton: 19.25</p>	CP = Contrast Piping MP = Matching Piping	<b>5471-CP</b>	2827	2983	3104	3283	3541	3660	3895	4265	4549	4869	5522	6219
		<b>5471-MP</b>	2626	2782	2903	3082	3340	3459	3694	4064	4348	4668	5321	6018
		<b>OVERALL DIMENSIONS</b>			<b>SEAT DIMENSIONS</b>			<b>BACK DIMENSIONS</b>						
		<b>W</b>	<b>D</b>	<b>H</b>	<b>W</b>	<b>D</b>	<b>H</b>	<b>W</b>	<b>H</b>					
			29.5	29	30.5	21	19.5	18	20	11.5				
		<b>RTA.00</b>												

**DESCRIPTION**                      **FEATURES**                      **MODEL#**                      **STANDARD TEXTILE GRADES**

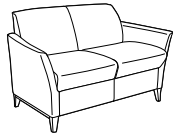

**Two Seat Sofa w/ Wood Legs**  
COM Yardage: 5.75  
Freight Class: 250  
Product Weight (lbs.): 84  
Cubic Feet Per Carton: 36

No Piping.

	1	2	3	4	5	6	7	8	9	10	11	12
--	---	---	---	---	---	---	---	---	---	----	----	----

<b>5472</b>	3721	3943	4115	4375	4744	4916	5252	5785	6194	6652	7591	8596
-------------	------	------	------	------	------	------	------	------	------	------	------	------

OVERALL DIMENSIONS			SEAT DIMENSIONS			BACK DIMENSIONS	
W	D	H	W	D	H	W	H

51	29	30.5	42	19.5	18	41	11.5
----	----	------	----	------	----	----	------

**RTA 00**

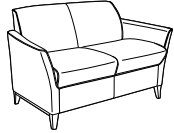

**Two Seat Sofa w/ Wood Legs**  
COM Yardage: 5.75  
Freight Class: 250  
Product Weight (lbs.): 84  
Cubic Feet Per Carton: 36

CP = Contrast Piping  
MP = Matching Piping

	1	2	3	4	5	6	7	8	9	10	11	12
--	---	---	---	---	---	---	---	---	---	----	----	----

<b>5472-CP</b>	3987	4209	4381	4641	5010	5182	5518	6051	6460	6918	7857	8862
----------------	------	------	------	------	------	------	------	------	------	------	------	------

<b>5472-MP</b>	3721	3943	4115	4375	4744	4916	5252	5785	6194	6652	7591	8596
----------------	------	------	------	------	------	------	------	------	------	------	------	------

OVERALL DIMENSIONS			SEAT DIMENSIONS			BACK DIMENSIONS	
W	D	H	W	D	H	W	H

51	29	30.5	42	19.5	18	41	11.5
----	----	------	----	------	----	----	------

**RTA 00**

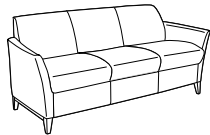

**Three Seat Sofa w/ Wood Legs**  
COM Yardage: 7.5  
Freight Class: 250  
Product Weight (lbs.): 110  
Cubic Feet Per Carton: 50.25

No Piping.

	1	2	3	4	5	6	7	8	9	10	11	12
--	---	---	---	---	---	---	---	---	---	----	----	----

<b>5473</b>	4816	5103	5327	5669	6148	6375	6811	7506	8044	8638	9865	11173
-------------	------	------	------	------	------	------	------	------	------	------	------	-------

OVERALL DIMENSIONS			SEAT DIMENSIONS			BACK DIMENSIONS	
W	D	H	W	D	H	W	H

71	29	30.5	63	19.5	18	62	11.5
----	----	------	----	------	----	----	------

**RTA 00**

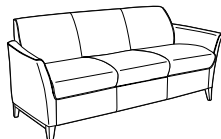

**Three Seat Sofa w/ Wood Legs**  
COM Yardage: 7.5  
Freight Class: 250  
Product Weight (lbs.): 110  
Cubic Feet Per Carton: 50.25

CP = Contrast Piping  
MP = Matching Piping

	1	2	3	4	5	6	7	8	9	10	11	12
--	---	---	---	---	---	---	---	---	---	----	----	----

<b>5473-CP</b>	5147	5433	5659	6000	6479	6706	7143	7837	8375	8969	10196	11504
----------------	------	------	------	------	------	------	------	------	------	------	-------	-------

<b>5473-MP</b>	4816	5103	5327	5669	6148	6375	6811	7506	8044	8638	9865	11173
----------------	------	------	------	------	------	------	------	------	------	------	------	-------

OVERALL DIMENSIONS			SEAT DIMENSIONS			BACK DIMENSIONS	
W	D	H	W	D	H	W	H

71	29	30.5	63	19.5	18	62	11.5
----	----	------	----	------	----	----	------

**RTA 00**

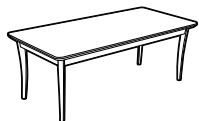

**Coffee Table - 22" x 48" Rectangular w/Wood Legs**  
COM Yardage: N/A  
Freight Class: 92.5  
Product Weight (lbs.): 40  
Cubic Feet Per Carton: 4

	1	2	3	4	5	6	7	8	9	10	11	12
--	---	---	---	---	---	---	---	---	---	----	----	----

<b>5474-LP</b>	2030	-	-	-	-	-	-	-	-	-	-	-
----------------	------	---	---	---	---	---	---	---	---	---	---	---

<b>5474-HP</b>	2177	-	-	-	-	-	-	-	-	-	-	-
----------------	------	---	---	---	---	---	---	---	---	---	---	---

<b>5474-W</b>	2619	-	-	-	-	-	-	-	-	-	-	-
---------------	------	---	---	---	---	---	---	---	---	---	---	---

LP = Laminate Top    HP = High Pressure Laminate Top    W = Wood Top





OVERALL DIMENSIONS			SEAT DIMENSIONS			BACK DIMENSIONS	
W	D	H	W	D	H	W	H



22	48	17.5	-	-	-	-	-
----	----	------	---	---	---	---	---



**RTA 8**



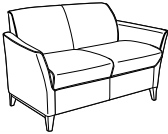
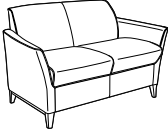
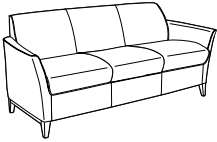
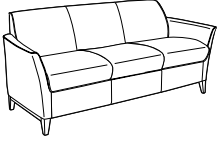

DESCRIPTION	FEATURES	MODEL#	STANDARD TEXTILE GRADES												
			1	2	3	4	5	6	7	8	9	10	11	12	
 <p><b>End Table - 21"x 21" Square w/Wood Legs</b>                      COM Yardage: N/A                      Freight Class: 100                      Product Weight (lbs.): 20                      Cubic Feet Per Carton: 2.1</p>															
	5475-LP	1511	-	-	-	-	-	-	-	-	-	-	-		
	5475-HP	1662	-	-	-	-	-	-	-	-	-	-	-		
	5475-W	1830	-	-	-	-	-	-	-	-	-	-	-		
	LP = Laminate Top HP = High Pressure Laminate Top W = Wood Top														
	<b>OVERALL DIMENSIONS</b>			<b>SEAT DIMENSIONS</b>			<b>BACK DIMENSIONS</b>								
	W D H			W D H			W H								
	21 21 17.5			-			-								
	RTA 8			FedEx			UPS								
	 <p><b>End Table - 24" Round w/Wood Legs</b>                      COM Yardage: N/A                      Freight Class: 92.5                      Product Weight (lbs.): 21                      Cubic Feet Per Carton: 2.1</p>														
5476-LP		1563	-	-	-	-	-	-	-	-	-	-	-		
5476-HP		1716	-	-	-	-	-	-	-	-	-	-	-		
5476-W		1988	-	-	-	-	-	-	-	-	-	-	-		
LP = Laminate Top HP = High Pressure Laminate Top W = Wood Top															
<b>OVERALL DIMENSIONS</b>			<b>SEAT DIMENSIONS</b>			<b>BACK DIMENSIONS</b>									
W D H			W D H			W H									
24 24 17.5			-			-									
RTA 8			FedEx			UPS									
 <p><b>Coffee Table - 32" Round w/Wood Legs</b>                      COM Yardage: N/A                      Freight Class: 125                      Product Weight (lbs.): 35                      Cubic Feet Per Carton: 4.4</p>															
	5477-LP	2361	-	-	-	-	-	-	-	-	-	-	-		
	5477-HP	2510	-	-	-	-	-	-	-	-	-	-	-		
	5477-W	2985	-	-	-	-	-	-	-	-	-	-	-		
	LP = Laminate Top HP = High Pressure Laminate Top W = Wood Top														
	<b>OVERALL DIMENSIONS</b>			<b>SEAT DIMENSIONS</b>			<b>BACK DIMENSIONS</b>								
	W D H			W D H			W H								
	32 32 17.5			-			-								
	RTA 8			FedEx			UPS								
	 <p><b>Lounge Chair w/Aluminum Legs</b>                      COM Yardage: 4                      Freight Class: 250                      Product Weight (lbs.): 62                      Cubic Feet Per Carton: 19.25</p>														
5481		2626	2782	2903	3082	3340	3459	3694	4064	4348	4668	5321	6018		
<b>OVERALL DIMENSIONS</b>			<b>SEAT DIMENSIONS</b>			<b>BACK DIMENSIONS</b>									
W D H			W D H			W H									
29.5 29 30.5			21 19.5 18			20 11.5									
No Piping.															
RTA 00															
 <p><b>Lounge Chair w/Aluminum Legs</b>                      COM Yardage: 4                      Freight Class: 250                      Product Weight (lbs.): 62                      Cubic Feet Per Carton: 19.25</p>															
		5481-CP	2827	2983	3104	3283	3541	3660	3895	4265	4549	4869	5522	6219	
		5481-MP	2626	2782	2903	3082	3340	3459	3694	4064	4348	4668	5321	6018	
	<b>OVERALL DIMENSIONS</b>			<b>SEAT DIMENSIONS</b>			<b>BACK DIMENSIONS</b>								
	W D H			W D H			W H								
	29.5 29 30.5			21 19.5 18			20 11.5								
	CP = Contrast Piping. MP = Matching Piping.														
	RTA 00														

DESCRIPTION	FEATURES	MODEL#	STANDARD TEXTILE GRADES											
			1	2	3	4	5	6	7	8	9	10	11	12
 <p><b>Two Seat Sofa w/ Aluminum Legs</b> COM Yardage: 5.75 Freight Class: 250 Product Weight (lbs.): 86 Cubic Feet Per Carton: 36</p>	No Piping.	<b>5482</b>	3721	3943	4115	4375	4744	4916	5252	5785	6194	6652	7591	8596
			<b>OVERALL DIMENSIONS</b>			<b>SEAT DIMENSIONS</b>			<b>BACK DIMENSIONS</b>					
			<b>W</b>	<b>D</b>	<b>H</b>	<b>W</b>	<b>D</b>	<b>H</b>	<b>W</b>	<b>H</b>				
			51	29	30.5	42	19.5	18	41	11.5				
			<b>RTA 00</b>											
 <p><b>Two Seat Sofa w/ Aluminum Legs</b> COM Yardage: 5.75 Freight Class: 250 Product Weight (lbs.): 86 Cubic Feet Per Carton: 36</p>	CP = Contrast Piping. MP = Matching Piping.	<b>5482-CP</b>	3987	4209	4381	4209	4381	4641	5010	5182	5518	6051	6460	8862
			<b>5482-MP</b>	3721	3943	4115	4375	4744	4916	5252	5785	6194	6652	7591
		<b>OVERALL DIMENSIONS</b>			<b>SEAT DIMENSIONS</b>			<b>BACK DIMENSIONS</b>						
		<b>W</b>	<b>D</b>	<b>H</b>	<b>W</b>	<b>D</b>	<b>H</b>	<b>W</b>	<b>H</b>					
51	29	30.5	42	19.5	18	41	11.5							
			<b>RTA 00</b>											
 <p><b>Three Seat Sofa w/ Aluminum Legs</b> COM Yardage: 7.5 Freight Class: 250 Product Weight (lbs.): 112 Cubic Feet Per Carton: 50.25</p>	No Piping.	<b>5483</b>	4816	5103	5327	5103	6148	6375	6811	7506	8044	8638	9865	11173
			<b>OVERALL DIMENSIONS</b>			<b>SEAT DIMENSIONS</b>			<b>BACK DIMENSIONS</b>					
			<b>W</b>	<b>D</b>	<b>H</b>	<b>W</b>	<b>D</b>	<b>H</b>	<b>W</b>	<b>H</b>				
			71	29	30.5	63	19.5	18	62	11.5				
			<b>RTA 00</b>											
 <p><b>Three Seat Sofa w/Aluminum Legs</b> COM Yardage: 7.5 Freight Class: 250 Product Weight (lbs.): 112 Cubic Feet Per Carton: 50.25</p>	CP = Contrast Piping. MP = Matching Piping.	<b>5483-CP</b>	5147	5434	5659	6000	6479	6706	7143	7837	8375	11504	10196	11504
			<b>5483-MP</b>	4816	5103	5327	5669	6148	6375	6811	7506	8044	8638	9865
		<b>OVERALL DIMENSIONS</b>			<b>SEAT DIMENSIONS</b>			<b>BACK DIMENSIONS</b>						
		<b>W</b>	<b>D</b>	<b>H</b>	<b>W</b>	<b>D</b>	<b>H</b>	<b>W</b>	<b>H</b>					
30.5	29	30.5	63	19.5	18	62	11.5							
			<b>RTA 00</b>											
 <p><b>Coffee Table - 22" x 48" Rectangular w/Aluminum Legs</b> COM Yardage: N/A Freight Class: 92.5 Product Weight (lbs.): 46 Cubic Feet Per Carton: 4</p>		<b>5484-LP</b>	2142	-	-	-	-	-	-	-	-	-	-	
			<b>5484-HP</b>	2291	-	-	-	-	-	-	-	-	-	-
		<b>5484-W</b>	2731	-	-	-	-	-	-	-	-	-	-	
		<b>LP = Laminate Top</b>			<b>HP = High Pressure Laminate Top</b>			<b>W = Wood Top</b>						
<b>OVERALL DIMENSIONS</b>			<b>SEAT DIMENSIONS</b>			<b>BACK DIMENSIONS</b>								
<b>W</b>	<b>D</b>	<b>H</b>	<b>W</b>	<b>D</b>	<b>H</b>	<b>W</b>	<b>H</b>							
22	48	17.5	-	-	-	-	-							
			<b>RTA 6</b>											

DESCRIPTION	FEATURES	MODEL#	STANDARD TEXTILE GRADES												
			1	2	3	4	5	6	7	8	9	10	11	12	
 <p><b>End Table - 21" x 21" Square w/Aluminum Legs</b>                      COM Yardage: N/A                      Freight Class: 85                      Product Weight (lbs.): 26                      Cubic Feet Per Carton: 2.1</p>															
	5485-LP	1623	-	-	-	-	-	-	-	-	-	-	-	-	
	5485-HP	1774	-	-	-	-	-	-	-	-	-	-	-	-	
	5485-W	1942	-	-	-	-	-	-	-	-	-	-	-	-	
	LP = Laminate Top HP = High Pressure Laminate Top W = Wood Top														
	<b>OVERALL DIMENSIONS</b>			<b>SEAT DIMENSIONS</b>			<b>BACK DIMENSIONS</b>								
	W D H			W D H			W H								
	21 21 17.5			-			-								
	RTA 8			FedEx			ups								
	 <p><b>End Table - 24" Round w/Aluminum Legs</b>                      COM Yardage: N/A                      Freight Class: 85                      Product Weight (lbs.): 27                      Cubic Feet Per Carton: 2.1</p>														
5486-LP		1676	-	-	-	-	-	-	-	-	-	-	-	-	
5486-HP		1827	-	-	-	-	-	-	-	-	-	-	-	-	
5486-W		2101	-	-	-	-	-	-	-	-	-	-	-	-	
LP = Laminate Top HP = High Pressure Laminate Top W = Wood Top															
<b>OVERALL DIMENSIONS</b>			<b>SEAT DIMENSIONS</b>			<b>BACK DIMENSIONS</b>									
W D H			W D H			W H									
24 24 17.5			-			-									
RTA 8			FedEx			ups									
 <p><b>Coffee Table - 32" Round w/Aluminum Legs</b>                      COM Yardage: N/A                      Freight Class: 100                      Product Weight (lbs.): 41                      Cubic Feet Per Carton: 4.4</p>															
	5487-LP	2473	-	-	-	-	-	-	-	-	-	-	-	-	
	5487-HP	2623	-	-	-	-	-	-	-	-	-	-	-	-	
	5487-W	3098	-	-	-	-	-	-	-	-	-	-	-	-	
	LP = Laminate Top HP = High Pressure Laminate Top W = Wood Top														
	<b>OVERALL DIMENSIONS</b>			<b>SEAT DIMENSIONS</b>			<b>BACK DIMENSIONS</b>								
	W D H			W D H			W H								
	32 32 17.5			-			-								
	RTA 8														

CITI™



model 7875LTL (BK)



model 7889



Citi Modular Group & Tables - Shown in Tungsten



5" tubular metal leg  
(shown in Tungsten)



5" tapered wood leg  
(shown in Maple)

STANDARD FEATURES

- Fully upholstered contemporary design, complements the timeless decor of many offices. Proportions are compact, 31" deep, and work well in public spaces.
- All models have fixed, non-removable cushions.
- For increased durability with a softer sit, a highly resilient, high density Ultracell foam (UCO option is available. See upcharges.
- Arm height on all models is 25".
- Casters are not available on this series.
- Citi seating and table legs are 5" high tubular metal. Seating also available with wood, tapered, softened square legs.
- Citi table tops are available in either tempered glass or laminate.
- Laminate tablet seating models (TL suffix) are available specified as seated. Specify right (RTL) or left (LTL). For additional tablet arm models, contact CustomerCare for pricing. The tablet is 0.75" thick with thermally fused laminate and measure 12"D x 16.5"W.
- Ganging brackets (7892) are sold separately.
- Ganging brackets are to be used on armless seating if interconnection to another armless seating unit is required. Bench and ottomans only gang to other benches/ottomans, cannot gang with seating units. Brackets come with a template for installation.
- Upholstery options: fabric, vinyl or leather. Starting at grade 5 pricing. Leather models feature a stitch detail across the seat and/or back cushions, if applicable.
- If you would like fabric/vinyl on the shell of the Type text here chair with leather seat and back cushions or other combinations, please complete "Multi Fabric" Form and submit with your order. Multi Fabric grade will apply.

Add option codes in the following order:

- Model Number**  
Specify model number.

- Seat Foam Upgrade** (add option to end of model number)  
(RF) Standard Foam  
(UC) Soft Ultracell foam. For Lounge and corner chairs add \$137; Two Seat Sofas add \$269; Three Seat Sofas add \$403.
- Leg Type** (Lounge only)  
(MTL) Metal Legs  
(WDL) Wood Legs. Add \$315
- Leg Finish:**  
Metal leg finish (lounge and tables):  
(TBL) Black  
(TTU) Tungsten  
(CHM) Chrome. **Add \$110.**  
Wood leg finish (lounge only):  
(AAM) Absolute (BLM) Black  
(ACM) Cherry (EOM) English Oak  
(ECM) Espresso Cafe (TFM) Fruitwood  
(HGM) Gray (AHM) Honey  
(TMM) Mahogany (AVM) Maple  
(MWM) Medium Walnut (NLW) Natural Walnut  
(ASM) Night (NBM) Noce Biondo  
(NGM) Noce Grigio (NEM) Noce Leggero  
(NMM) Noce Medio (SKM) Shaker Cherry  
(TWM) Walnut (WTM) WC Cream  
(WHM) White (WCM) Winter Cherry
- Glide Type** (wood legs)  
(NM) White, non-marking nylon glide for most surfaces  
(SG) Steel cushioned glide for carpeted surfaces. Add \$34.  
(RG) Non-slip rubber glide for most hard floor surfaces. Add \$34.  
(FG) Felt glide for most hard floor surfaces. Add \$34.
- Laminate Finish** (tables and tablets)  
(ACJ) Absolute Acajou (ASN) Asian Night  
(AWC) Avant Cherry (AWH) Avant Honey  
(BLK) Black (BRC) Brushed Cobalt  
(CMB) Clear Maple (DES) Dark Espresso  
(DWT) Designer White (FAS) Fashionista  
(FCL) First Class (NBL) Noce Biondo  
(NEL) Noce Leggero  
(NGL) Noce Grigio (NML) Noce Medio  
(QTM) Quartered Mahogany  
(SBY) Sheer Beauty (SOG) Storm Grey  
(WCR) Winter Cherry  
(WHC) White Chocolate (WHE) Walnut Heights

SAMPLE LAYOUTS

Layout A

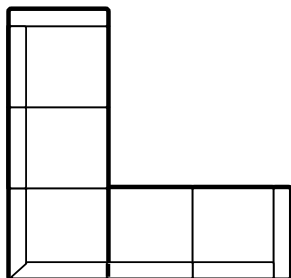





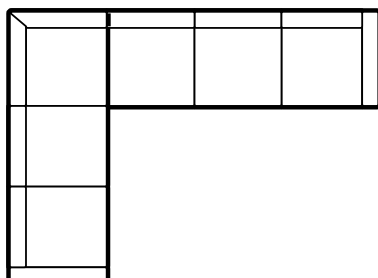

Qty	Model Number	Description	Dimensions	List Price
1	7890LNB	Two Seat Sofa w/Left Arm	48 x 31 x 30.75	2133
1	7862	Corner Seat	37 x 37 x 31	2316
1	7890RNB	Two Seat Sofa w/Right Arm	48 x 31 x 30.75	2133
2	7892	Ganging Bracket	0.5 x 3.87 x 2	32
<b>SAMPLE LAYOUT TOTAL IN STANDARD FEET FINISH</b>				<b>\$6,614</b>

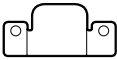

Layout B





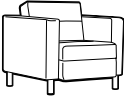

Qty	Model Number	Description	Dimensions	List Price
1	7890RNB	Two Seat Sofa w/Right Arm	48 x 31 x 30.75	2133
1	7862	Corner Seat	37 x 37 x 31	2316
1	7891LNB	Three Seat Sofa w/Left Arm	77 x 31 x 30.75	2850
2	7892	Ganging Bracket	0.5 x 3.87 x 2	32 x 2
<b>SAMPLE LAYOUT TOTAL IN STANDARD FEET FINISH</b>				<b>\$7,363</b>

DESCRIPTION	FEATURES	MODEL#	STANDARD TEXTILE GRADES											
			1	2	3	4	5	6	7	8	9	10	11	12
 <p><b>Ganging Bracket</b> COM Yardage: N/a Freight Class: 70 Product Weight (lbs.): 0.25 Cubic Feet Per Carton: 0.01</p>	<p>Kit includes 2 brackets, 4 screws and a template.</p>	7892	32	-	-	-	-	-	-	-	-	-	-	
		<b>OVERALL DIMENSIONS</b>			<b>SEAT DIMENSIONS</b>			<b>BACK DIMENSIONS</b>						
		<b>W</b>	<b>D</b>	<b>H</b>	<b>W</b>	<b>D</b>	<b>H</b>	<b>W</b>	<b>H</b>					
		-	-	-	-	-	-	-	-					
		  												

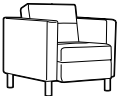
DESCRIPTION	FEATURES	MODEL#	STANDARD TEXTILE GRADES											
			1	2	3	4	5	6	7	8	9	10	11	12
 <p><b>Corner Seat</b> COM Yardage: 6.25 Freight Class: 250 Product Weight (lbs.): 65 Cubic Feet Per Carton: 30.25</p>		7862	-	-	-	-	2316	2487	2810	3390	3722	4257	5069	6036
		<b>OVERALL DIMENSIONS</b>			<b>SEAT DIMENSIONS</b>			<b>BACK DIMENSIONS</b>						
		<b>W</b>	<b>D</b>	<b>H</b>	<b>W</b>	<b>D</b>	<b>H</b>	<b>W</b>	<b>H</b>					
		37	37	30.75	26	26	17.5	26	13.5					
														

DESCRIPTION	FEATURES	MODEL#	STANDARD TEXTILE GRADES											
			1	2	3	4	5	6	7	8	9	10	11	12
 <p><b>Large Lounge Chair - for 6'+ Tall Users</b> COM Yardage: 5.50 Freight Class: 250 Product Weight (lbs.): 70 Cubic Feet Per Carton: 24.25</p>		7864	-	-	-	-	2054	-	-	2998	3291	3762	4476	5328
		<b>OVERALL DIMENSIONS</b>			<b>SEAT DIMENSIONS</b>			<b>BACK DIMENSIONS</b>						
		<b>W</b>	<b>D</b>	<b>H</b>	<b>W</b>	<b>D</b>	<b>H</b>	<b>W</b>	<b>H</b>					
		34	33	30	23	20	19	23	13.5					
														

DESCRIPTION	FEATURES	MODEL#	STANDARD TEXTILE GRADES											
			1	2	3	4	5	6	7	8	9	10	11	12
 <p><b>Lounge Chair</b> COM Yardage: 4.5 Freight Class: 250 Product Weight (lbs.): 67 Cubic Feet Per Carton: 21</p>		7875	-	-	-	-	1517	1646	1885	2318	2562	2958	3559	4278
		<b>OVERALL DIMENSIONS</b>			<b>SEAT DIMENSIONS</b>			<b>BACK DIMENSIONS</b>						
		<b>W</b>	<b>D</b>	<b>H</b>	<b>W</b>	<b>D</b>	<b>H</b>	<b>W</b>	<b>H</b>					
		30	31	30	21	19.5	17.5	21	12.5					
														

DESCRIPTION	FEATURES	MODEL#	STANDARD TEXTILE GRADES											
			1	2	3	4	5	6	7	8	9	10	11	12
  <p><b>Lounge Chair w/Laminate Tablet</b> COM Yardage: 4.5 Freight Class: 250 Product Weight (lbs.): 75 Cubic Feet Per Carton: 22.5</p>		7875LTL 7875RTL	-	-	-	-	2275	2405	2651	3089	3338	3746	4360	5089
		<b>OVERALL DIMENSIONS</b>			<b>SEAT DIMENSIONS</b>			<b>BACK DIMENSIONS</b>						
		<b>W</b>	<b>D</b>	<b>H</b>	<b>W</b>	<b>D</b>	<b>H</b>	<b>W</b>	<b>H</b>					
		31.5	33.5	33.5	21	19.5	17.5	21	12.5					
														

DESCRIPTION	FEATURES	MODEL#	STANDARD TEXTILE GRADES											
			1	2	3	4	5	6	7	8	9	10	11	12



**Lounge Chair - Armless**  
 COM Yardage: 3  
 Freight Class: 250  
 Product Weight (lbs.): 45  
 Cubic Feet Per Carton: 15.5

<b>7895</b>	-	-	-	-	1519	1605	1758	2037	2196	2453	2842	3307
-------------	---	---	---	---	------	------	------	------	------	------	------	------

OVERALL DIMENSIONS			SEAT DIMENSIONS			BACK DIMENSIONS	
W	D	H	W	D	H	W	H
22	31	30.75	21	19.5	17.5	21	14

RTA 00

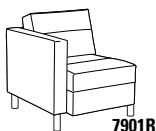

**Lounge Chair - Single Arm**  
 COM Yardage: 4  
 Freight Class: 250  
 Product Weight (lbs.): 65  
 Cubic Feet Per Carton: 21

<b>7901L</b>	-	-	-	-	1829	1939	2143	2467	2715	2995	3568	4176
<b>7901R</b>	-	-	-	-	-	-	-	-	-	-	-	-

OVERALL DIMENSIONS			SEAT DIMENSIONS			BACK DIMENSIONS	
W	D	H	H	W	D	H	WH
26	31	30	22	19.5	17.5	22	12.5

RTA 00

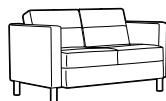

**Two Seat Sofa**  
 COM Yardage: 6.25  
 Freight Class: 250  
 Product Weight (lbs.): 125  
 Cubic Feet Per Carton: 36

<b>7876</b>	-	-	-	-	2046	2225	2554	3150	3494	4044	4881	5880
-------------	---	---	---	---	------	------	------	------	------	------	------	------

OVERALL DIMENSIONS			SEAT DIMENSIONS			BACK DIMENSIONS	
W	D	H	W	D	H	W	H
51.25	31	30	42.5	19.5	17.5	42.5	12.5

RTA 00



**Two Seat Sofa - Armless**  
 COM Yardage: 5  
 Freight Class: 250  
 Product Weight (lbs.): 93  
 Cubic Feet Per Carton: 36

<b>7896</b>	-	-	-	-	1890	2028	2286	2751	3015	3446	4093	4866
-------------	---	---	---	---	------	------	------	------	------	------	------	------

OVERALL DIMENSIONS			SEAT DIMENSIONS			BACK DIMENSIONS	
W	D	H	W	D	H	W	H
43.25	31	30.75	42.5	19.5	17.5	42.5	12.5

RTA 00

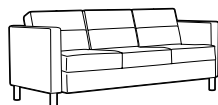





**Three Seat Sofa**  
 COM Yardage: 8.75  
 Freight Class: 250  
 Product Weight (lbs.): 163  
 Cubic Feet Per Carton: 50.25



<b>7877</b>	-	-	-	-	2575	2820	3287	4125	4602	5375	6547	7939
-------------	---	---	---	---	------	------	------	------	------	------	------	------

OVERALL DIMENSIONS			SEAT DIMENSIONS			BACK DIMENSIONS	
W	D	H	W	D	H	W	H
72.5	31	30	63.5	19.5	17.5	63.5	12.5

RTA 00



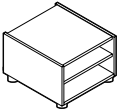

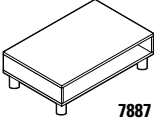

DESCRIPTION	FEATURES	MODEL#	STANDARD TEXTILE GRADES											
			1	2	3	4	5	6	7	8	9	10	11	12
 <p><b>Three Seat Sofa - Armless</b> COM Yardage: 7.25 Freight Class: 250 Product Weight (lbs.): 131 Cubic Feet Per Carton: 50.25</p>		<b>7897</b>	-	-	-	-	2488	2686	3063	3733	4117	4739	5680	6803
			<b>OVERALL DIMENSIONS</b>			<b>SEAT DIMENSIONS</b>			<b>BACK DIMENSIONS</b>					
			<b>W</b>	<b>D</b>	<b>H</b>	<b>W</b>	<b>D</b>	<b>H</b>	<b>W</b>	<b>H</b>				
			64.5	31	30.75	63.5	19.5	17.5	63.5	12.5				
			<b>RTA 00</b>											

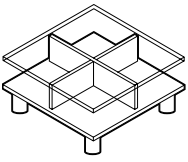
DESCRIPTION	FEATURES	MODEL#	STANDARD TEXTILE GRADES											
			1	2	3	4	5	6	7	8	9	10	11	12
 <p><b>Ottoman</b> COM Yardage: 1.5 Freight Class: 250 Product Weight (lbs.): 27 Cubic Feet Per Carton: 7.5</p>		<b>7879</b>	-	-	-	-	587	632	712	859	942	1080	1283	1526
			<b>OVERALL DIMENSIONS</b>			<b>SEAT DIMENSIONS</b>			<b>BACK DIMENSIONS</b>					
			<b>W</b>	<b>D</b>	<b>H</b>	<b>W</b>	<b>D</b>	<b>H</b>	<b>W</b>	<b>H</b>				
			22	22	17	-	-	17	-	-				
			<b>RTA 00</b>  											

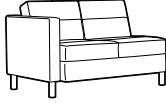
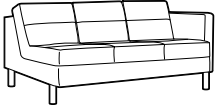
DESCRIPTION	FEATURES	MODEL#	STANDARD TEXTILE GRADES												
			1	2	3	4	5	6	7	8	9	10	11	12	
 <p><b>End Table</b> COM Yardage: N/A Freight Class: 100 Product Weight (lbs.): 53 Cubic Feet Per Carton: 6</p>		<b>7885</b>	827	-	-	-	-	-	-	-	-	-	-	-	
			Laminate												
			<b>7886</b>	1166	-	-	-	-	-	-	-	-	-	-	-
				Glass Top											
			<b>OVERALL DIMENSIONS</b>			<b>SEAT DIMENSIONS</b>			<b>BACK DIMENSIONS</b>						
			<b>W</b>	<b>D</b>	<b>H</b>	<b>W</b>	<b>D</b>	<b>H</b>	<b>W</b>	<b>H</b>					
			20	24	20	-	-	-	-	-					
			<b>RTA 1</b>  												

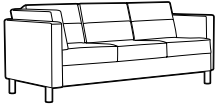
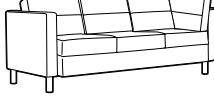
DESCRIPTION	FEATURES	MODEL#	STANDARD TEXTILE GRADES												
			1	2	3	4	5	6	7	8	9	10	11	12	
 <p><b>Coffee Table Rectangular</b> COM Yardage: N.A Freight Class: 100 Product Weight (lbs.): 60 Cubic Feet Per Carton: 6.5</p>		<b>7887</b>	863	-	-	-	-	-	-	-	-	-	-	-	
			Laminate												
			<b>7888</b>	1343	-	-	-	-	-	-	-	-	-	-	-
				Glass Top											
			<b>OVERALL DIMENSIONS</b>			<b>SEAT DIMENSIONS</b>			<b>BACK DIMENSIONS</b>						
			<b>W</b>	<b>D</b>	<b>H</b>	<b>W</b>	<b>D</b>	<b>H</b>	<b>W</b>	<b>H</b>					
			40	20	15	-	-	-	-	-					
			<b>RTA 1</b>												

DESCRIPTION	FEATURES	MODEL#	STANDARD TEXTILE GRADES												
			1	2	3	4	5	6	7	8	9	10	11	12	
 <p><b>Coffee Table Square</b> COM Yardage: N/A Freight Class: 92.5 Product Weight (lbs.): 90 Cubic Feet Per Carton: 8.75</p>		<b>7889</b>	1630	-	-	-	-	-	-	-	-	-	-	-	
			Glass Top												
				<b>OVERALL DIMENSIONS</b>			<b>SEAT DIMENSIONS</b>			<b>BACK DIMENSIONS</b>					
				<b>W</b>	<b>D</b>	<b>H</b>	<b>W</b>	<b>D</b>	<b>H</b>	<b>W</b>	<b>H</b>				
			33	33	15	-	-	-	-	-					
			<b>RTA 1</b>												

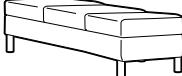
DESCRIPTION	FEATURES	MODEL#	STANDARD TEXTILE GRADES											
			1	2	3	4	5	6	7	8	9	10	11	12
 7890LNB  7890RNB	<p><b>Two Seat Sofa - No Connector</b>                      COM Yardage: 5.25                      Freight Class: 250                      Product Weight (lbs.): 107                      Cubic Feet Per Carton: 36</p> <p>**Intended to be free standing.                      No connecting hardware.</p>	7890LNB	-	-	-	-	2133	2283	2569	3081	3370	3843	4560	5415
		7890RNB	-	-	-	-	2133	2283	2569	3081	3370	3843	4560	5415
			<b>OVERALL DIMENSIONS</b>			<b>SEAT DIMENSIONS</b>			<b>BACK DIMENSIONS</b>					
			<b>W</b>	<b>D</b>	<b>H</b>	<b>W</b>	<b>D</b>	<b>H</b>	<b>W</b>	<b>H</b>				
			0	0	0	42.5	19.5	17.5	42.5	13.25				
			<b>RTA 00</b>											
 7891LNB  7891RNB	<p><b>Three Seat Sofa - No Connector</b>                      COM Yardage: 7.25                      Freight Class: 250                      Product Weight (lbs.): 138                      Cubic Feet Per Carton: 50.25</p> <p>**Intended to be free standing.                      No connecting hardware.</p>	7891LNB	-	-	-	-	2850	3048	3425	4095	4479	5101	6042	7165
		7891RNB	-	-	-	-	2850	3048	3425	4095	4479	5101	6042	7165
			<b>OVERALL DIMENSIONS</b>			<b>SEAT DIMENSIONS</b>			<b>BACK DIMENSIONS</b>					
			<b>W</b>	<b>D</b>	<b>H</b>	<b>W</b>	<b>D</b>	<b>H</b>	<b>W</b>	<b>H</b>				
			0	0	0	63.5	19.5	17.5	63.5	13.25				
			<b>RTA 00</b>											
 7891L-RCNB  7891R-RCNB	<p><b>Three Seat Sofa - No Connector</b>                      COM Yardage: 8.5                      Freight Class: 250                      Product Weight (lbs.): 154                      Cubic Feet Per Carton: 55.5</p> <p>**Intended to be free standing.                      No connecting hardware.</p>	7891L-RCNB	-	-	-	-	3433	3674	4137	4964	5437	6203	7361	8744
		7891R-RCNB	-	-	-	-	3433	3674	4137	4964	5437	6203	7361	8744
			<b>OVERALL DIMENSIONS</b>			<b>SEAT DIMENSIONS</b>			<b>BACK DIMENSIONS</b>					
			<b>W</b>	<b>D</b>	<b>H</b>	<b>W</b>	<b>D</b>	<b>H</b>	<b>W</b>	<b>H</b>				
			0	0	0	60	19.5	17.5	60	13.25				
			<b>RTA 00</b>											
 7893	<p><b>Two Seat Bench</b>                      COM Yardage: 2.25                      Freight Class: 250                      Product Weight (lbs.): 42                      Cubic Feet Per Carton: 11.5</p>	7893	-	-	-	-	1165	1231	1351	1574	1698	1899	2206	2574
		7893	-	-	-	-	1165	1231	1351	1574	1698	1899	2206	2574
			<b>OVERALL DIMENSIONS</b>			<b>SEAT DIMENSIONS</b>			<b>BACK DIMENSIONS</b>					
			<b>W</b>	<b>D</b>	<b>H</b>	<b>W</b>	<b>D</b>	<b>H</b>	<b>W</b>	<b>H</b>				
			43	21.5	17	-	-	17	-	-				
			<b>RTA 00</b>  											
 7894	<p><b>Three Seat Bench</b>                      COM Yardage: 3.75                      Freight Class: 250                      Product Weight (lbs.): 62                      Cubic Feet Per Carton: 16.75</p>	7894	-	-	-	-	1663	1773	1977	2340	2549	2891	3399	4008
		7894	-	-	-	-	1663	1773	1977	2340	2549	2891	3399	4008
			<b>OVERALL DIMENSIONS</b>			<b>SEAT DIMENSIONS</b>			<b>BACK DIMENSIONS</b>					
			<b>W</b>	<b>D</b>	<b>H</b>	<b>W</b>	<b>D</b>	<b>H</b>	<b>W</b>	<b>H</b>				
			64.5	21.5	17	-	-	17	-	-				
			<b>RTA 00</b>											



CITI™ SQUARE



model S7875LT



Sample Layout A - Models shown: S7875UC and S7911



Sample Layout B - Models shown: S7890RUC, S7862UC (2), S7897UC, S7890LUC and S7912

STANDARD FEATURES

- Fully upholstered lounge series with a complete range of sectional components for all applications. Proportions are compact, 31" and 33.5" deep so it works well in public spaces.
- All models have fixed, non-removable cushions.
- Upholstery options: fabric, vinyl and leather. Leather models may feature a horizontal stitch detail across the seat and/or back cushions if applicable.
- The 5 inch high leg frame for seating and occasional tables lightens the look, it is available in Tungsten (S1) as standard or optionally available in Black (S2) Please specify finish, no upcharge added.
- Casters are not available on this series.
- Arm height on all models is 25"
- Tablet arms are made from thermally fused laminate, measure 12"D x 16.5"W 3/4" thick. Available right hand seated (RT), left Hand seated (LT) or both right and left hand (LRT).
- Ganging Brackets are sold separately. Ganging brackets are to be used on armless seating if interconnection to another armless seating unit is required. Bench and ottomans only gang to other benches/ottomans, cannot gang with seating units.
- Brackets come with a template for installation: unless noted otherwise all armless skus are equipped with the steel on steel connectors to receive this bracket.
- Upholstery options: fabric, vinyl and leather. Leather models feature a horizontal stitch detail across the seat and/or back cushions if applicable.
- Check textile availability prior to specifying upholstery material.
- If you would like fabric/vinyl on the shell of the chair with leather seat and back cushions or other combinations, please complete "Multi Fabric" Form and submit with your order. Multi Fabric grade will apply.
- Measurement shown for weight is for one unit. Measurement for volume is per carton.

OPTIONAL FEATURES

- Seating and Table Leg Finishes**  
Metal legs are available in the following finishes:  
(TBL) Black (TBZ) Buzz Blue  
(TCC) Cactus (TCR) Carrot  
(TDJ) Dijon (TDW) Designer White  
(TEG) Eggplant (TFO) Fog

- (TFR) Frost (TIV) Cloud (TLA) Latte (TOA) Toast (TSH) Shadow (TSR) Scarlet (CHM) Chrome. Add \$205 (ACO) Antique Copper. Add \$458 for corner units. Add \$342 for single seat units. Add \$558 for two seat units. Add \$558 for three seat units. Add \$669 for four seat units. (BCH) Brushed Chrome. Add \$300 for corner units. Add \$215 for single seat units. Add \$329 for two seat units. Add \$329 for three seat units. Add \$389 for four seat units. (SBR) Satin Brass. Add \$458 for corner units. Add \$342 for single seat units. Add \$558 for two seat units. Add \$558 for three seat units. Add \$669 for four seat units.
- (TIN) Ink (TKA) Kalua (TMO) Mocha (TNE) Nevada (TSN) Sand (TTU) Tungsten
- Laminate Tables and Tablet arms are made with high pressure laminate and are offered in the following finishes: Absolute Acajou (ACJ), Asian Night (ASN), Avant Cherry (AWC), Avant Honey (AWH), Black (BLK), Brushed Cobalt (BRC), Clear Maple (CMB), Dark Espresso (DES), Designer White (DWT), Fashionista (FAS), First Class (FCL), Noce Biondo (NBL), Noce Grigio (NGL), Noce Leggero (NEL), Noce Medio (NML), Quartered Mahogany (QTM), Sheer Beauty (SBY), Walnut Heights (WHE), White Chocolate (WHC) and Winter Cherry (WCR). Please Specify. Custom high pressure laminate finishes will be considered upon request.
- For high resilient, high density Ultracell foam on seat, specify (UC) after the model number. One Seater, add \$137. Two Seater, add \$269. Three Seater, add \$403, and Four Seater, add \$536
- Power/USB modules are available in the Citi Square tables. Each module includes a double power outlet and two USB terminals. It is equipped with a 6' long three-prong power cord with standard three prong plug. The Power monuments are available in Jet Black (J1) or White (W1). Add \$945 per unit. Please see Electrical Placement below for predetermined locations.

ELECTRICAL PLACEMENT

Coffee/End Tables: Predetermined Location is on the end/side of the unit J1 (black) or W1 (white).

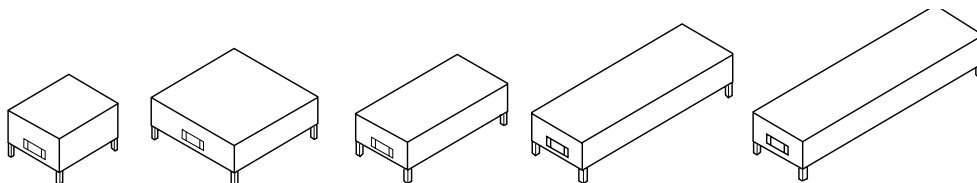

	1	2	3	4	5	6	7	8	9	10	11	12
7892	32	-	-	-	-	-	-	-	-	-	-	-



**Ganging Bracket**  
COM Yardage: N/A  
Freight Class: 70  
Product Weight (lbs.): 00.25  
Cubic Feet Per Carton: 00.01

Two brackets included.  
Only one set is needed per connection.

OVERALL DIMENSIONS			SEAT DIMENSIONS			BACK DIMENSIONS	
W	D	H	W	D	H	W	H
0.5	3.87	2	-	-	-	-	-

DESCRIPTION	FEATURES	MODEL#	STANDARD TEXTILE GRADES											
			1	2	3	4	5	6	7	8	9	10	11	12

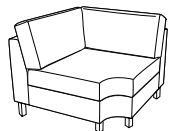

**Linking Corner Unit**  
 COM Yardage: 6.25  
 Freight Class: 250  
 Product Weight (lbs.): 75  
 Cubic Feet Per Carton: 30.25

No ganging hardware  
 Armless side(s) can be equipped  
 with ganging brackets, model 7892.

<b>S7862</b>	-	-	-	-	2588	2783	3145	3725	4169	4665	5689	6778
--------------	---	---	---	---	------	------	------	------	------	------	------	------

OVERALL DIMENSIONS			SEAT DIMENSIONS			BACK DIMENSIONS	
W	D	H	W	D	H	W	H
37	37	31	26	26	17.5	26	13.5

RTA 00

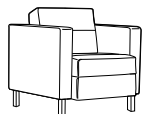

**Single Seat w/Arms**  
 COM Yardage: 4.5  
 Freight Class: 250  
 Product Weight (lbs.): 81  
 Cubic Feet Per Carton: 21

Free standing unit only.

<b>S7875</b>	-	-	-	-	1829	1969	2232	2648	2970	3329	4064	4847
--------------	---	---	---	---	------	------	------	------	------	------	------	------

OVERALL DIMENSIONS			SEAT DIMENSIONS			BACK DIMENSIONS	
W	D	H	W	D	H	W	H
30	31	30	21	19.5	17.5	21	12.5

RTA 00



S7875RT

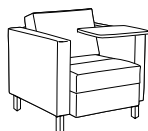

S7875LT

**Single Seat w/Arms & Laminate Tablet**  
 COM Yardage: 4.5  
 Freight Class: 250  
 Product Weight (lbs.): 89  
 Cubic Feet Per Carton: 22.5

Free standing unit only.  
 Tablets are Right Hand Seated (RT)  
 or Left Hand Seated (LT).

<b>S7875RT</b>	-	-	-	-	2448	2588	2851	3267	3587	3948	4683	5466
<b>S7875LT</b>	-	-	-	-	2448	2588	2851	3267	3587	3948	4683	5466

OVERALL DIMENSIONS			SEAT DIMENSIONS			BACK DIMENSIONS	
W	D	H	W	D	H	W	H
31.5	33.5	30	21	19.5	17.5	21	12.5

RTA 00

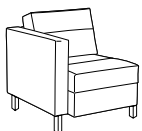

S7901R



S7901L

**Single Seat w/One Arm**  
 COM Yardage: 4  
 Freight Class: 250  
 Product Weight (lbs.): 65  
 Cubic Feet Per Carton: 21

No ganging hardware.  
 Armless side can be equipped  
 with ganging brackets, model 7892.  
 Arms are Right Hand Seated (RT)  
 or Left Hand Seated (LT).

<b>S7901R</b>	-	-	-	-	1829	1939	2143	2467	2715	2995	3568	4176
<b>S7901L</b>	-	-	-	-	1829	1939	2143	2467	2715	2995	3568	4176

OVERALL DIMENSIONS			SEAT DIMENSIONS			BACK DIMENSIONS	
W	D	H	W	D	H	W	H
26	31	30.75	21	19.5	17.5	21	12.5

RTA 00



S7901RRT



S7901LLT



**Single Seat w/One Arm & Laminate Tablet**  
 COM Yardage: 4  
 Freight Class: 250  
 Product Weight (lbs.): 73  
 Cubic Feet Per Carton: 22.5



No ganging hardware.  
 Armless side(s) can be equipped  
 with ganging brackets, model 7892.  
 Tablets are Arms are Right Hand Seated (RT)  
 or Left Hand Seated (LT).

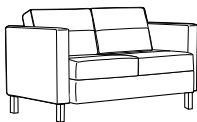
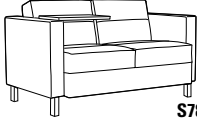
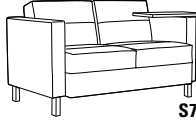
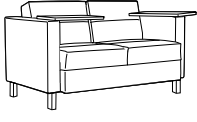
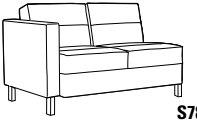

<b>S7901RRT</b>	-	-	-	-	2448	2762	1783	3086	3334	3614	4187	4795
<b>S7901LLT</b>	-	-	-	-	2448	2558	2762	3086	3334	3614	4187	4795

OVERALL DIMENSIONS			SEAT DIMENSIONS			BACK DIMENSIONS	
W	D	H	W	D	H	W	H
27.5	31	30.75	21	19.5	17.5	21	12.5

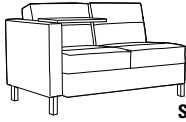
RTA 00

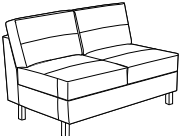
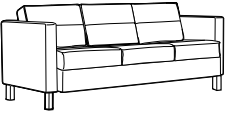
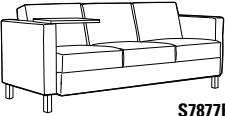
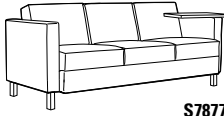
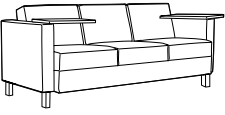
DESCRIPTION	FEATURES	MODEL#	STANDARD TEXTILE GRADES												
			1	2	3	4	5	6	7	8	9	10	11	12	
 <b>Armless Single Seat</b> COM Yardage: 3 Freight Class: 2250 Product Weight (lbs.): 45 Cubic Feet Per Carton: 15.5	No ganging hardware. Armless side(s) can be equipped with ganging brackets, model 7892.	<b>S7895</b>	-	-	-	-	1829	1923	2096	2377	2590	2830	3320	3844	
		<b>OVERALL DIMENSIONS</b>			<b>SEAT DIMENSIONS</b>			<b>BACK DIMENSIONS</b>							
		<b>W</b>	<b>D</b>	<b>H</b>	<b>W</b>	<b>D</b>	<b>H</b>	<b>W</b>	<b>H</b>						
		22	31	30.75	21	18.5	17.5	21	12.5						
			<b>RTA 00</b>												
 <b>Two Seater w/Arms</b> COM Yardage: 6.25 Freight Class: 250 Product Weight (lbs.): 122 Cubic Feet Per Carton: 36	Free standing unit only.	<b>S7876</b>	-	-	-	-	2588	2783	3145	3725	4169	4665	5689	6778	
		<b>OVERALL DIMENSIONS</b>			<b>SEAT DIMENSIONS</b>			<b>BACK DIMENSIONS</b>							
		<b>W</b>	<b>D</b>	<b>H</b>	<b>W</b>	<b>D</b>	<b>H</b>	<b>W</b>	<b>H</b>						
		51.25	31	30	42.5	19.5	17.5	42.5	12.5						
			<b>RTA 00</b>												
  <b>Two Seater w/Arms &amp; Laminate Tablet</b> COM Yardage: 6.25 Freight Class: 250 Product Weight (lbs.): 130 Cubic Feet Per Carton: 41.25	Free standing unit only. Tablets are Right Hand Seated (RT) or Left Hand Seated (LT).	<b>S7876RT</b>	-	-	-	-	3208	3401	3765	4342	4789	5285	6309	7398	
		<b>S7876LT</b>	-	-	-	-	3208	3401	3765	4342	4789	5285	6309	7398	
		<b>OVERALL DIMENSIONS</b>			<b>SEAT DIMENSIONS</b>			<b>BACK DIMENSIONS</b>							
		<b>W</b>	<b>D</b>	<b>H</b>	<b>W</b>	<b>D</b>	<b>H</b>	<b>W</b>	<b>H</b>						
52.75	33.5	30	42.5	19.5	17.5	42.5	12.5								
			<b>RTA 00</b>												
 <b>Two Seater w/Arms &amp; Laminate Tablets</b> COM Yardage: 6.25 Freight Class: 250 Product Weight (lbs.): 138 Cubic Feet Per Carton: 41.25	Free standing unit only. With both Left and Right Tablets.	<b>S7876LRT</b>	-	-	-	-	3829	4022	4386	4963	5410	5906	6930	8019	
		<b>OVERALL DIMENSIONS</b>			<b>SEAT DIMENSIONS</b>			<b>BACK DIMENSIONS</b>							
		<b>W</b>	<b>D</b>	<b>H</b>	<b>W</b>	<b>D</b>	<b>H</b>	<b>W</b>	<b>H</b>						
		54.25	33.5	30	42.5	19.5	17.5	42.5	12.5						
			<b>RTA 00</b>												
  <b>Two Seater w/One Arm</b> COM Yardage: 5.25 Freight Class: 250 Product Weight (lbs.): 106 Cubic Feet Per Carton: 36	No ganging hardware. Armless side can be equipped with ganging brackets, model 7892. Arms are Right Hand Seated (RT) or Left Hand Seated (LT).	<b>S7890R</b>	-	-	-	-	2403	2565	2870	3357	3732	4151	5007	5924	
		<b>S7890L</b>	-	-	-	-	2403	2565	2870	3357	3732	4151	5007	5924	
		<b>OVERALL DIMENSIONS</b>			<b>SEAT DIMENSIONS</b>			<b>BACK DIMENSIONS</b>							
		<b>W</b>	<b>D</b>	<b>H</b>	<b>W</b>	<b>D</b>	<b>H</b>	<b>W</b>	<b>H</b>						
47.25	31	30.75	42.5	19.5	17.5	42.5	13.25								
			<b>RTA 00</b>												

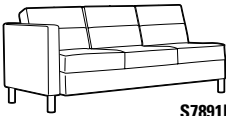
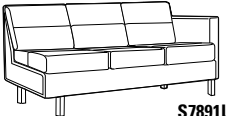
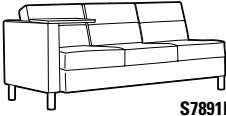
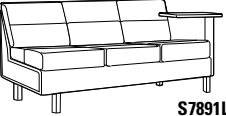
DESCRIPTION	FEATURES	MODEL#	STANDARD TEXTILE GRADES											
			1	2	3	4	5	6	7	8	9	10	11	12
 <p><b>S7890RRT</b></p>	 <p><b>S7890LLT</b></p>	<p><b>S7890RRT</b></p> <p><b>S7890LLT</b></p>	-	-	-	-	3022	3184	3489	3976	4351	4769	5626	6542
			-	-	-	-	3022	3184	3489	3976	4351	4769	5626	6542
<p><b>Two Seater w/One Arm and Laminate Tablet</b>                      COM Yardage: 5.25                      Freight Class: 250                      Product Weight (lbs.): 114                      Cubic Feet Per Carton: 41.25</p>			<p>No ganging hardware.                      Armless side(s) can be equipped with ganging brackets, model 7892.                      Tablets are Arms are Right Hand Seated (RT) or Left Hand Seated (LT).</p>			48.75	33.5	30.75	42.5	19.5	17.5	42.5	13.25	
			<b>RTA 00</b>											
 <p><b>S7896</b></p>		<p><b>S7896</b></p>	-	-	-	-	2403	2559	2848	3313	3671	4069	4886	5756
			-	-	-	-	2403	2559	2848	3313	3671	4069	4886	5756
<p><b>Armless Two Seater</b>                      COM Yardage: 5                      Freight Class: 250                      Product Weight (lbs.): 43.25                      Cubic Feet Per Carton: 36</p>			<p>No ganging hardware.                      Armless side(s) can be equipped with ganging brackets, model 7892.</p>			43.25	31	30.75	42.5	19.5	17.5	42.5	13.25	
			<b>RTA 00</b>											
 <p><b>S7877</b></p>		<p><b>S7877</b></p>	-	-	-	-	3351	3618	4128	4941	5564	6260	7689	9216
			-	-	-	-	3351	3618	4128	4941	5564	6260	7689	9216
<p><b>Three Seater w/Arms</b>                      COM Yardage: 8.75                      Freight Class: 250                      Product Weight (lbs.): 163                      Cubic Feet Per Carton: 50.25</p>			<p>Free standing unit only.</p>			72.5	31	30	63.5	19.5	17.5	63.5	12.5	
			<b>RTA 00</b>											
 <p><b>S7877RT</b></p>	 <p><b>S7877LT</b></p>	<p><b>S7877RT</b></p> <p><b>S7877LT</b></p>	-	-	-	-	3969	4235	4746	5559	6182	6878	8307	9834
			-	-	-	-	3969	4235	4746	5559	6182	6878	8307	9834
<p><b>Three Seater w/Arms and Laminate Tablet</b>                      COM Yardage: 8.75                      Freight Class: 250                      Product Weight (lbs.): 171                      Cubic Feet Per Carton: 55.5</p>			<p>Free standing unit only.                      Tablets are Right Hand Seated (RT) or Left Hand Seated (LT).</p>			74	33.5	30	63.5	19.5	17.5	63.5	12.5	
			<b>RTA 00</b>											
 <p><b>S7877LRT</b></p>		<p><b>S7877LRT</b></p>	-	-	-	-	4588	4854	5365	6178	6801	7497	8926	10453
			-	-	-	-	4588	4854	5365	6178	6801	7497	8926	10453
<p><b>Three Seater w/Arms and Laminate Tablets</b>                      COM Yardage: 8.75                      Freight Class: 250                      Product Weight (lbs.): 250                      Cubic Feet Per Carton: 55.5</p>			<p>Free standing unit only.                      With both Left and Right Tablets.</p>			75.5	33.5	30	63.5	19.5	17.5	63.5	12.5	
			<b>RTA 00</b>											

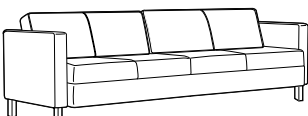
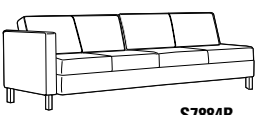
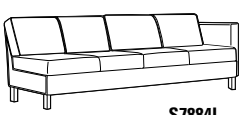
DESCRIPTION	FEATURES	MODEL#	STANDARD TEXTILE GRADES											
			1	2	3	4	5	6	7	8	9	10	11	12
 <p><b>S7891R</b></p> <p><b>Three Seater w/One Arm</b>                      COM Yardage: 7.25                      Freight Class: 250                      Product Weight (lbs.): 147                      Cubic Feet Per Carton: 50.25</p>	 <p><b>S7891L</b></p> <p>No ganging hardware.                      Armless side can be equipped with ganging brackets, model 7892.                      Arms are Right Hand Seated (RT) or Left Hand Seated (LT).</p>	<b>S7891R</b>	-	-	-	-	3245	3468	3889	4564	5081	5656	6842	8105
		<b>S7891L</b>	-	-	-	-	3245	3468	3889	4564	5081	5656	6842	8105
<b>OVERALL DIMENSIONS</b>			<b>SEAT DIMENSIONS</b>			<b>BACK DIMENSIONS</b>								
W D H			W D H			W H								
68.5 31 30.75			63.5 19.5 17.5			63.5 13.25								
<b>RTA 00</b>														
 <p><b>S7891RRT</b></p> <p><b>Three Seater w/One Arm and Laminate Tablet</b>                      COM Yardage: 7.25                      Freight Class: 250                      Product Weight (lbs.): 155                      Cubic Feet Per Carton: 55.25</p>	 <p><b>S7891LLT</b></p> <p>No ganging hardware.                      Armless side(s) can be equipped with ganging brackets, model 7892.                      Tablets are Arms are Right Hand Seated (RT) or Left Hand Seated (LT).</p>	<b>S7891RRT</b>	-	-	-	-	3864	4087	4507	5183	5700	6275	7461	8724
		<b>S7891LLT</b>	-	-	-	-	3864	4087	4507	5183	5700	6275	7461	8724
<b>OVERALL DIMENSIONS</b>			<b>SEAT DIMENSIONS</b>			<b>BACK DIMENSIONS</b>								
W D H			W D H			W H								
70 33.5 30.75			63.5 19.5 17.5			63.5 13.25								
<b>RTA 00</b>														
 <p><b>S7897</b></p> <p><b>Armless Three Seater</b>                      COM Yardage: 7.25                      Freight Class: 250                      Product Weight (lbs.): 131                      Cubic Feet Per Carton: 50.25</p>	<p>No ganging hardware.                      Armless side(s) can be equipped with ganging brackets, model 7892.</p>	<b>S7897</b>	-	-	-	-	3245	3468	3889	4564	5081	5656	6842	8105
		<b>S7897</b>	-	-	-	-	3245	3468	3889	4564	5081	5656	6842	8105
<b>OVERALL DIMENSIONS</b>			<b>SEAT DIMENSIONS</b>			<b>BACK DIMENSIONS</b>								
W D H			W D H			W H								
64.5 31 30.75			63.5 19.5 17.5			63.5 13.25								
<b>RTA 00</b>														
 <p><b>S7884</b></p> <p><b>Four Seater w/Arms</b>                      COM Yardage: 10.25                      Freight Class: 250                      Product Weight (lbs.): 204                      Cubic Feet Per Carton: 69</p>	<p>Free standing unit only.</p>	<b>S7884</b>	-	-	-	-	4929	5243	5839	6789	7520	8335	10010	11798
		<b>S7884</b>	-	-	-	-	4929	5243	5839	6789	7520	8335	10010	11798
<b>OVERALL DIMENSIONS</b>			<b>SEAT DIMENSIONS</b>			<b>BACK DIMENSIONS</b>								
W D H			W D H			W H								
93.5 31 30			84 19.5 17.5			84 12.5								
<b>RTA 00</b>														
 <p><b>S7884R</b></p> <p><b>Four Seater w/One Arm</b>                      COM Yardage: 9.5                      Freight Class: 250                      Product Weight (lbs.): 188                      Cubic Feet Per Carton: 69</p>	 <p><b>S7884L</b></p> <p>No ganging hardware.                      Armless side can be equipped with ganging brackets, model 7892.                      Arms are Right Hand Seated (RT) or Left Hand Seated (LT).</p>	<b>S7884R</b>	-	-	-	-	4823	5112	5666	6545	7225	7980	9532	11189
		<b>S7884L</b>	-	-	-	-	4823	5112	5666	6545	7225	7980	9532	11189
<b>OVERALL DIMENSIONS</b>			<b>SEAT DIMENSIONS</b>			<b>BACK DIMENSIONS</b>								
W D H			W D H			W H								
89.5 31 30.75			84 19.5 17.5			84 12.5								
<b>RTA 00</b>														

DESCRIPTION FEATURES MODEL# STANDARD TEXTILE GRADES

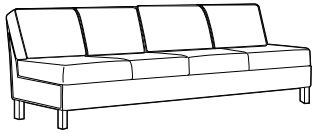

**Armless Four Seater**  
 COM Yardage: 8.75  
 Freight Class: 250  
 Product Weight (lbs.): 172  
 Cubic Feet Per Carton: 61.5

No ganging hardware.  
 Armless side(s) can be equipped with ganging brackets, model 7892.

MODEL#	1	2	3	4	5	6	7	8	9	10	11	12
<b>S7884NA</b>	-	-	-	-	4823	5089	5600	6413	7036	7732	9161	10688

OVERALL DIMENSIONS			SEAT DIMENSIONS			BACK DIMENSIONS	
W	D	H	W	D	H	W	H
85.5	31	30.75	84	19.5	17.5	84	12.5

RTA 00

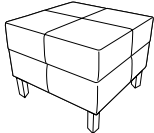

**Square Ottoman**  
 COM Yardage: 1.5  
 Freight Class: 250  
 Product Weight (lbs.): 27  
 Cubic Feet Per Carton: 7.5

No ganging hardware.  
 Side(s) can be equipped with ganging brackets, model 7892.  
 Does not gang to seating units.

MODEL#	1	2	3	4	5	6	7	8	9	10	11	12
<b>S7879</b>	-	-	-	-	759	807	896	1036	1144	1262	1508	1768

OVERALL DIMENSIONS			SEAT DIMENSIONS			BACK DIMENSIONS	
W	D	H	W	D	H	W	H
22	22	17	-	-	17	-	-

RTA 00

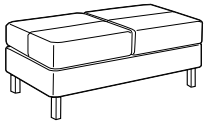

**Two Seater Bench**  
 COM Yardage: 2.25  
 Freight Class: 250  
 Product Weight (lbs.): 42  
 Cubic Feet Per Carton: 11.5

No ganging hardware.  
 Side(s) can be equipped with ganging brackets, model 7892.  
 Does not gang to seating units.

MODEL#	1	2	3	4	5	6	7	8	9	10	11	12
<b>S7893</b>	-	-	-	-	1458	1530	1663	1870	2033	2210	2577	2970

OVERALL DIMENSIONS			SEAT DIMENSIONS			BACK DIMENSIONS	
W	D	H	W	D	H	W	H
43	21.5	17	-	-	17	-	-

RTA 00

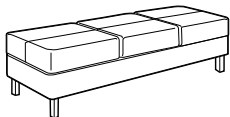

**Three Seater Bench**  
 COM Yardage: 3.75  
 Freight Class: 250  
 Product Weight (lbs.): 62  
 Cubic Feet Per Carton: 16.75

No ganging hardware.  
 Side(s) can be equipped with ganging brackets, model 7892.  
 Does not gang to seating units.

MODEL#	1	2	3	4	5	6	7	8	9	10	11	12
<b>S7894</b>	-	-	-	-	2076	2194	2412	2759	3027	3325	3937	4591

OVERALL DIMENSIONS			SEAT DIMENSIONS			BACK DIMENSIONS	
W	D	H	W	D	H	W	H
64.5	21.5	17	-	-	17	-	-

RTA 00

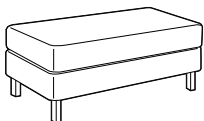

**Two Seater Bench - Single Cushion**  
 COM Yardage: 2.25  
 Freight Class: 250  
 Product Weight (lbs.): 42  
 Cubic Feet Per Carton: 11.5

No ganging hardware.  
 Side(s) can be equipped with ganging brackets, model 7892.  
 Does not gang to seating units.

MODEL#	1	2	3	4	5	6	7	8	9	10	11	12
<b>S7905</b>	-	-	-	-	1146	1218	1351	1558	1717	1898	2265	2658

OVERALL DIMENSIONS			SEAT DIMENSIONS			BACK DIMENSIONS	
W	D	H	W	D	H	W	H
43	21.5	17	-	-	17	-	-

RTA 00

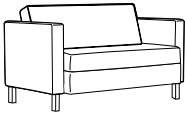
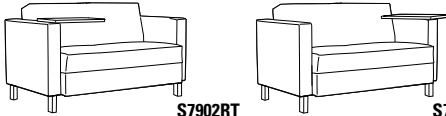
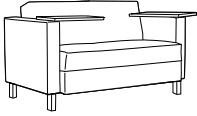
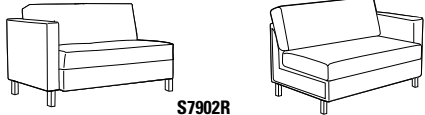
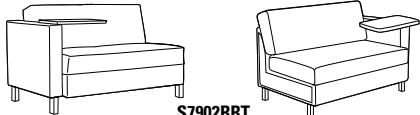
DESCRIPTION	FEATURES	MODEL#	STANDARD TEXTILE GRADES											
			1	2	3	4	5	6	7	8	9	10	11	12
 <p><b>Two Seater w/Arms - Single Cushion</b> COM Yardage: 6.5 Freight Class: 250 Product Weight (lbs.): 122 Cubic Feet Per Carton: 36</p>	Free standing unit only.	<b>S7902</b>	-	-	-	-	2588	2783	3145	3725	4169	4665	5689	6778
		<b>OVERALL DIMENSIONS</b>			<b>SEAT DIMENSIONS</b>			<b>BACK DIMENSIONS</b>						
		<b>W</b>	<b>D</b>	<b>H</b>	<b>W</b>	<b>D</b>	<b>H</b>	<b>W</b>	<b>H</b>					
		51.25	31	30	42.5	19.5	17.5	42.5	12.5					
			<b>RTA 00</b>											
 <p><b>S7902RT</b>      <b>S7902LT</b></p> <p><b>Two Seater w/Arms &amp; Lam. Tablet - Single Cushion</b> COM Yardage: 5.25 Freight Class: 250 Product Weight (lbs.): 114 Cubic Feet Per Carton: 36</p>	Free standing unit only. Tablets are Right Hand Seated (RT) or Left Hand Seated (LT).	<b>S7902RT</b>	-	-	-	-	3208	2543	2543	4389	2543	5371	6432	7566
		<b>S7902LT</b>	-	-	-	-	3208	2543	2543	4389	2543	5371	6432	7566
		<b>OVERALL DIMENSIONS</b>			<b>SEAT DIMENSIONS</b>			<b>BACK DIMENSIONS</b>						
		<b>W</b>	<b>D</b>	<b>H</b>	<b>W</b>	<b>D</b>	<b>H</b>	<b>W</b>	<b>H</b>					
48.75	33.5	30.75	42.5	19.5	17.5	42.5	13.25							
			<b>RTA 00</b>											
 <p><b>Two Seater w/Arms &amp; Lam. Tablets - Single Cushion</b> COM Yardage: 6.5 Freight Class: 250 Product Weight (lbs.): 127 Cubic Feet Per Carton: 41.25</p>	Free standing unit only. With both Left and Right Tablets.	<b>S7902LRT</b>	-	-	-	-	3829	4028	4409	5010	5475	5992	7053	8187
		<b>OVERALL DIMENSIONS</b>			<b>SEAT DIMENSIONS</b>			<b>BACK DIMENSIONS</b>						
		<b>W</b>	<b>D</b>	<b>H</b>	<b>W</b>	<b>D</b>	<b>H</b>	<b>W</b>	<b>H</b>					
		54.25	33.5	30	42.5	19.5	17.5	42.5	12.5					
			<b>RTA 00</b>											
 <p><b>S7902R</b>      <b>S7902L</b></p> <p><b>Two Seater w/One Arm - Single Cushion</b> COM Yardage: 5.25 Freight Class: 250 Product Weight (lbs.): 114 Cubic Feet Per Carton: 36</p>	No ganging hardware. Armless side can be equipped with ganging brackets, model 7892. Arms are Right Hand Seated (RT) or Left Hand Seated (LT).	<b>S7902R</b>	-	-	-	-	2403	2565	2870	3357	3732	4151	5007	5924
		<b>S7902L</b>	-	-	-	-	2403	2565	2870	3357	3732	4151	5007	5924
		<b>OVERALL DIMENSIONS</b>			<b>SEAT DIMENSIONS</b>			<b>BACK DIMENSIONS</b>						
		<b>W</b>	<b>D</b>	<b>H</b>	<b>W</b>	<b>D</b>	<b>H</b>	<b>W</b>	<b>H</b>					
47.25	31	30.75	42.5	19.5	17.5	42.5	13.25							
			<b>RTA 00</b>											
 <p><b>S7902RRT</b>      <b>S902LLT</b></p> <p><b>Two Seater w/One Arm &amp; Lam. Tablet - Single Cushion</b> COM Yardage: 5.25 Freight Class: 250 Product Weight (lbs.): 114 Cubic Feet Per Carton: 36</p>	Free standing unit only. Tablets are Right Hand Seated (RT) or Left Hand Seated (LT).	<b>S7902RRT</b>	-	-	-	-	3022	3184	3489	3976	4351	4769	5626	6542
		<b>S902LLT</b>	-	-	-	-	3022	3184	3489	3976	4351	4769	5626	6542
		<b>OVERALL DIMENSIONS</b>			<b>SEAT DIMENSIONS</b>			<b>BACK DIMENSIONS</b>						
		<b>W</b>	<b>D</b>	<b>H</b>	<b>W</b>	<b>D</b>	<b>H</b>	<b>W</b>	<b>H</b>					
48.75	33.5	30.75	42.5	19.5	17.5	42.5	13.25							
			<b>RTA 00</b>											

DESCRIPTION	FEATURES	MODEL#	STANDARD TEXTILE GRADES											
			1	2	3	4	5	6	7	8	9	10	11	12

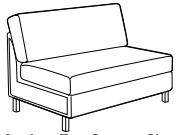

**Armless Two Seater - Single Cushion**  
 COM Yardage: 6.5  
 Freight Class: 250  
 Product Weight (lbs.): 90  
 Cubic Feet Per Carton: 36

No ganging hardware.  
 Armless side(s) can be equipped with ganging brackets, model 7892.

<b>S7902NA</b>	-	-	-	-	2403	2543	2806	3222	3544	3903	4638	5421
----------------	---	---	---	---	------	------	------	------	------	------	------	------

OVERALL DIMENSIONS			SEAT DIMENSIONS			BACK DIMENSIONS	
W	D	H	W	D	H	W	H
43.25	31	30.75	42.5	19.5	17.5	42.5	13.25

RTA 00

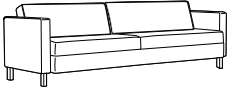

**Four Seater w/Arms - Duo Cushion**  
 COM Yardage: 10.25  
 Freight Class: 250  
 Product Weight (lbs.): 204  
 Cubic Feet Per Carton: 69

Free standing unit only.

<b>S7904</b>	-	-	-	-	4929	5243	5839	6789	7520	8335	10010	11798
--------------	---	---	---	---	------	------	------	------	------	------	-------	-------

OVERALL DIMENSIONS			SEAT DIMENSIONS			BACK DIMENSIONS	
W	D	H	W	D	H	W	H
93.5	31	30	84	19.5	17.5	84	12.5

RTA 00

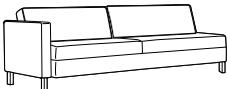

S7904R

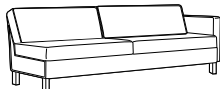

S7904L

**Four Seater w/One Arm - Duo Cushion**  
 COM Yardage: 9.5  
 Freight Class: 250  
 Product Weight (lbs.): 188  
 Cubic Feet Per Carton: 61.5

No ganging hardware.  
 Armless side can be equipped with ganging brackets, model 7892.  
 Arms are Right Hand Seated (RT) or Left Hand Seated (LT) .

<b>S7904R</b>	-	-	-	-	4823	5112	5666	6545	7225	7980	9532	11189
<b>S7904L</b>	-	-	-	-	4823	5112	5666	6545	7225	7980	9532	11189

OVERALL DIMENSIONS			SEAT DIMENSIONS			BACK DIMENSIONS	
W	D	H	W	D	H	W	H
89.5	31	30.75	84	19.5	17.5	84	12.5

RTA 00

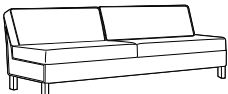

**Armless Four Seater - Single Cushion**  
 COM Yardage: 8.75  
 Freight Class: 250  
 Product Weight (lbs.): 172  
 Cubic Feet Per Carton: 61.5

No ganging hardware.  
 Armless side(s) can be equipped with ganging brackets, model 7892.

<b>S7904NA</b>	-	-	-	-	4823	5089	5600	6413	7036	7732	9161	10688
----------------	---	---	---	---	------	------	------	------	------	------	------	-------

OVERALL DIMENSIONS			SEAT DIMENSIONS			BACK DIMENSIONS	
W	D	H	W	D	H	W	H
85.5	31	30.75	84	19.5	17.5	84	12.5

RTA 00

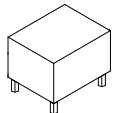

**Cube End Table**  
 COM Yardage: N/A  
 Freight Class: 100  
 Product Weight (lbs.): 51  
 Cubic Feet Per Carton: 5.5

Free standing unit only.  
 No ganging hardware.  
 For Power/USB module please see electrical placement chart.

<b>S7911</b>	1915	-	-	-	-	-	-	-	-	-	-	-
--------------	------	---	---	---	---	---	---	---	---	---	---	---

OVERALL DIMENSIONS			SEAT DIMENSIONS			BACK DIMENSIONS	
W	D	H	W	D	H	W	H
20	24	16	-	-	-	-	-

RTA 00

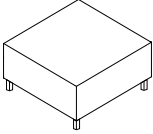
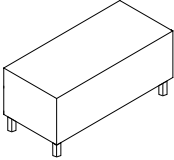
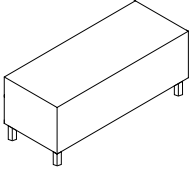
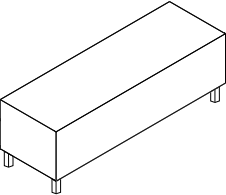

DESCRIPTION	FEATURES	MODEL#	STANDARD TEXTILE GRADES													
			1	2	3	4	5	6	7	8	9	10	11	12		
 <p><b>Cube Square Coffee Table</b> COM Yardage: N/A Freight Class: 100 Product Weight (lbs.): 86 Cubic Feet Per Carton: 10.75</p>	<p>Free standing unit only. No ganging hardware. For Power/USB module please see electrical placement chart.</p>	<p><b>S7912</b></p>	2433	-	-	-	-	-	-	-	-	-	-	-		
			<p><b>OVERALL DIMENSIONS</b></p>			<p><b>SEAT DIMENSIONS</b></p>			<p><b>BACK DIMENSIONS</b></p>							
			W	D	H	W	D	H	W	H						
			33	33	14	-	-	-	-	-						
			<p><b>RTA 00</b></p>													
 <p><b>Cube 40" Coffee Table</b> COM Yardage: N/A Freight Class: 100 Product Weight (lbs.): 66 Cubic Feet Per Carton: 8</p>	<p>Free standing unit only. No ganging hardware. For Power/USB module please see electrical placement chart.</p>	<p><b>S7913</b></p>	2303	-	-	-	-	-	-	-	-	-	-			
			<p><b>OVERALL DIMENSIONS</b></p>			<p><b>SEAT DIMENSIONS</b></p>			<p><b>BACK DIMENSIONS</b></p>							
			W	D	H	W	D	H	W	H						
			40	20	14	-	-	-	-	-						
			<p><b>RTA 00</b></p>													
 <p><b>Cube Extended 60" Coffee Table</b> COM Yardage: N/A Freight Class: 125 Product Weight (lbs.): 93 Cubic Feet Per Carton: 12</p>	<p>Free standing unit only. No ganging hardware. For Power/USB module please see electrical placement chart.</p>	<p><b>S7915</b></p>	3008	-	-	-	-	-	-	-	-	-	-			
			<p><b>OVERALL DIMENSIONS</b></p>			<p><b>SEAT DIMENSIONS</b></p>			<p><b>BACK DIMENSIONS</b></p>							
			W	D	H	W	D	H	W	H						
			60	20	14	-	-	-	-	-						
			<p><b>RTA 00</b></p>													
 <p><b>Cube Extended 72" Coffee Table</b> COM Yardage: N/A Freight Class: 125 Product Weight (lbs.): 107 Cubic Feet Per Carton: 14.25</p>	<p>Free standing unit only. No ganging hardware. For Power/USB module please see electrical placement chart.</p>	<p><b>S7916</b></p>	3078	-	-	-	-	-	-	-	-	-	-			
			<p><b>OVERALL DIMENSIONS</b></p>			<p><b>SEAT DIMENSIONS</b></p>			<p><b>BACK DIMENSIONS</b></p>							
			W	D	H	W	D	H	W	H						
			72	20	14	-	-	-	-	-						
			<p><b>RTA 00</b></p>													

DRIFT



Wood Base model 8030  
Side Chair w/4 Leg



Side Chair, Sled Base  
Arm Patches model 8023P



Chrome Base model 8034  
Low Back Lounge Chair



Wood Base model 8037  
Mid Back Lounge Chair



Ottoman model 8026



Wood Base model 8052  
Counter Stool



For Drift tables, see page page 327

EXAMPLE OF TABLE ORDER CODE:

8030P	WA50	WA50	R11	NM	AAM
Model Number	Back/Arm Textile	Seat Textile	Patch Textile	Seat Height	Base Finish

NM	NBS	NSS	NB
Glide Type	Sealed Back Seams	Sealed Seat Seams	Moisture Barrier

5-Star Base Mechanism

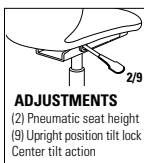

**ADJUSTMENTS**  
(2) Pneumatic seat height  
(9) Upright position tilt lock  
Center tilt action

**Ergonomic features:**  
B, C, S, U



**Flip Forward Seat**  
"F" suffix models

STANDARD FEATURES





- Drift's soft seat and contoured back and arms provide the perfect balance of style and comfort. Side chairs are available in six base types: sled, wood 4-leg, wood 4-prong swivel, chrome 4-prong swivel, high 4-star swivel and 5-star base on casters.
- Lounge chairs are available in four base types: sled, wood 4-leg, wood 4-star swivel and Chrome 4-prong swivel.
- Counter and bar height stools are available with three base types: sled, wood 4-leg, and Chrome 4-star swivel.
- Wood bases are made from Beechwood and are available in all standard wood finishes.
- Wood base seating models are standard with White non-marking polycarbonate glides. See Glide Type for additional glide options.
- Sled bases are standard in painted metal or Chrome finish. See Frame Finish for upcharges.
- Sled base models are standard with clear polycarbonate glides. See Glide Type for additional glide options.
- Chrome swivel bases are available in polished Chrome only. Lounge models with Chrome swivel bases swivel 360deg, available in swivel or self-centering swivel.
- Lounge seating is available with 17" seat height with a classic lounge angle or 18" seat height with a reduced back angle for ease of sitting and standing.
- Side chairs with 5-star base and casters swivel 360 degrees, are height adjustable with 4" range and include a tilting mechanism with upright tilt lock. Base is Polished Aluminum with C114 Carpet or C114R hard floor, dual wheel casters. See upcharges.
- Ottomans have a weighted bottom to maintain upright position. Specify Top and Side textile separately. Glides are White, non-marking.
- For increased durability on side and lounge seating, P and PH suffix models are available with arm and head patches. These high touch areas are covered in Global's Release vinyl. Specify Release color.
- For ease of cleaning, Side and Lounge Chair models with "F" suffix have flip-forward seats. Material under seat matches seat textile selection. (Stools and side chairs with high 4- star and 5-star bases have fixed seat cushions only.)
- Sealed seams are available on chair backs and/ or seats (with upcharge). For sealed seams on Ottoman, specify Ottoman (8026S), available only in sealed seam approved textiles.
- A moisture barrier may be added to seat cushions only (with upcharge). Not available with sealed seams.
- Upholstery options: fabric, vinyl, or leather.
- All Drift seating is assembled using tamper proof screws.
- Drift seating is available to specify with two textiles, one for the seat cushion and one for the back and arms (see model image).
- For pricing, start with the base price and add both back/arms graded textile upcharge and the seat graded textile upcharge.
- The Blended Textile matrix does not apply to this series.
- Drift seating is designed for 300lb capacity.
- Shipped fully assembled.
- See finishes section in Price List for solid wood/ laminate coordination chart.





Add option codes in the following order:





- **Model Number**  
Specify model number.
- **Back/Arm Textile**  
Specify textile code. See model grade upcharges.
- **Seat Textile**  
Specify textile code. See model grade upcharges.
- **Arm and Head Patch Textile** (For P and PH suffix models)  
Release Vinyl only





- **Seat Height** (lounge models only):  
(S17) 17" Seat height  
(S18) 18" Seat height
- **Base Finish** (wood base models)  
(AAM) Absolute (BKM) Black  
(ACM) Cherry (EOM) English Oak  
(ECM) Espresso Cafe (TFM) Fruitwood  
(HGM) Grey (AHM) Honey  
(TMM) Mahogany (AVM) Maple  
(NLW) Natural Walnut (MVM) Medium Walnut  
(ASM) Night (NBM) Noce Biondo  
(NGM) Noce Grigio (NEM) Noce Leggero  
(NMM) Noce Medio (SKM) Shaker Cherry  
(TWM) Walnut (WTM) WC Cream  
(WHM) White (WCM) Winter Cherry
- **Base Finish** (sled base models)  
(TBL) Black (TBZ) Buzz Blue  
(TCC) Cactus (TCR) Carrot  
(TDJ) Dijon (TDW) Designer White  
(TEG) Eggplant (TFO) Fog  
(TFR) Frost (TIN) Ink  
(TIV) Cloud (TKA) Kalua  
(TLA) Latte (TOA) Toast  
(TNE) Nevada (TSH) Shadow  
(TSN) Sand (TSR) Scarlet  
(TTU) Tungsten  
Metallics: Side/Lounge Counter Bar  
(CHM) Chrome. Add \$42 \$84 \$84
- **Base Finish** (5-star base only)  
(A7) Polish Aluminum
- **Cylinder Selection** (Chrome swivel lounge models):  
(DSC) Swivel cylinder  
(DAC) Self-centering cylinder
- **Glide Type** (wood base seating)  
(NM) White, non-marking nylon for most hard floor surfaces (standard)  
(SG) Steel cushioned glides for carpeted surfaces. Add \$34  
(RG) Non-slip, rubber glides for most hard floor surfaces. Add \$34  
(FG) Felt glides for most hard floor surfaces. Add \$34
- **Glide Type** (sled base seating)  
(CG) Clear, polycarbonate glide for most surfaces (standard)  
(XG) No glide for carpeted surfaces  
(FG) Felt glide for most hard surfaces. Add \$31  
(SG) Steel cushioned glide for carpeted surfaces. Add \$34  
(RG) Non-slip rubber glide for most hard surfaces. Add \$34
- **Glide Type** (High, 4-Star base side chairs)  
(NM) White Polyethylene non-marking glide for most surfaces  
(FG) Felt Glide for most hard floor surfaces. Add \$34
- **Caster Type** (5-star base side chairs)  
(DC) 2" Caster for carpeted surfaces  
(RC) 2" Caster for hard floor surfaces. Add \$50
- **Sealed Back Seams** (contact customer care for approved textiles)  
(NBS) No sealed back seam  
(SBS) Sealed back seams. See model for upcharge.
- **Sealed Seat Seams** (contact customer care for approved textiles)  
(NSS) No sealed seat seams  
(SSS) Sealed seat seams. See model for upcharge.
- **Moisture Barrier** (not available with sealed seams)  
(NB) No moisture barrier  
(MB) Moisture barrier (seat only). Add \$101







DESCRIPTION	MODEL#/ FEATURES	STANDARD TEXTILE GRADES																					
		1/COM	2	3	4	5	6	7	8	9	10	11	12										
 <p><b>Side Chairs, 4 Leg Wood Base, Arm Patches</b>                      COM Yardage: Back/Arms: 1.25; Seat: .75                      COM Yardage "F" Model: Back/Arms: 1.25; Seat 1                      Freight Class: 250                      Product Weight (lbs.): 28                      Cubic Feet Per Carton: 13.25</p>	<b>8030P</b>	Base Price:	\$1647																				
		Back/Arm upcharge:	<b>+0</b>	<b>+40</b>	<b>+72</b>	<b>+118</b>	<b>+183</b>	<b>+210</b>	<b>+267</b>	<b>+355</b>	<b>+422</b>	<b>+494</b>	<b>+645</b>	<b>+804</b>									
		Seat upcharge:	<b>+0</b>	<b>+24</b>	<b>+43</b>	<b>+71</b>	<b>+110</b>	<b>+126</b>	<b>+160</b>	<b>+213</b>	<b>+253</b>	<b>+297</b>	<b>+387</b>	<b>+483</b>									
	<b>8030PF</b>	Base Price:	\$1892																				
		Back/Arm upcharge:	<b>+0</b>	<b>+40</b>	<b>+72</b>	<b>+118</b>	<b>+183</b>	<b>+210</b>	<b>+267</b>	<b>+355</b>	<b>+422</b>	<b>+494</b>	<b>+645</b>	<b>+804</b>									
		Seat upcharge:	<b>+0</b>	<b>+32</b>	<b>+57</b>	<b>+94</b>	<b>+146</b>	<b>+168</b>	<b>+213</b>	<b>+284</b>	<b>+337</b>	<b>+395</b>	<b>+516</b>	<b>+643</b>									
		<b>OVERALL DIMENSIONS</b>	<b>W</b>	<b>D</b>	<b>H</b>	<b>SEAT DIMENSIONS</b>			<b>W</b>	<b>D</b>	<b>H</b>	<b>BACK DIMENSIONS</b>		<b>W</b>	<b>H</b>								
		"F" model = Flip Forward Seat for ease of cleaning	24.5	23	31	18	17.5	18	15	13													
		Add \$54 for (SBS) Add \$27 for (SSS); \$44 (F model)																					
 <p><b>Side Chair, Wood Swivel Base</b>                      COM Yardage: Back/Arms: 1.25; Seat: .75                      COM Yardage "F" Model: Back/Arms: 1.25; Seat 1                      Freight Class: 300                      Product Weight (lbs.): 31                      Cubic Feet Per Carton: 15.75</p>	<b>8031</b>	Base Price:	\$1883																				
		Back/Arm upcharge:	<b>+0</b>	<b>+40</b>	<b>+72</b>	<b>+118</b>	<b>+183</b>	<b>+210</b>	<b>+267</b>	<b>+355</b>	<b>+422</b>	<b>+494</b>	<b>+645</b>	<b>+804</b>									
		Seat upcharge:	<b>+0</b>	<b>+24</b>	<b>+43</b>	<b>+71</b>	<b>+110</b>	<b>+126</b>	<b>+160</b>	<b>+213</b>	<b>+253</b>	<b>+297</b>	<b>+387</b>	<b>+483</b>									
	<b>8031F</b>	Base Price:	\$2128																				
		Back/Arm upcharge:	<b>+0</b>	<b>+40</b>	<b>+72</b>	<b>+118</b>	<b>+183</b>	<b>+210</b>	<b>+267</b>	<b>+355</b>	<b>+422</b>	<b>+494</b>	<b>+645</b>	<b>+804</b>									
		Seat upcharge:	<b>+0</b>	<b>+32</b>	<b>+57</b>	<b>+94</b>	<b>+146</b>	<b>+168</b>	<b>+213</b>	<b>+284</b>	<b>+337</b>	<b>+395</b>	<b>+516</b>	<b>+643</b>									
		<b>OVERALL DIMENSIONS</b>	<b>W</b>	<b>D</b>	<b>H</b>	<b>SEAT DIMENSIONS</b>			<b>W</b>	<b>D</b>	<b>H</b>	<b>BACK DIMENSIONS</b>		<b>W</b>	<b>H</b>								
		"F" model = Flip Forward Seat for ease of cleaning	24.5	23	31	18	17.5	18	15	13													
		Add \$36 for (SBS) Add \$27 for (SSS); \$44 (F model)																					
 <p><b>Side Chair, Wood Swivel Base, Arm Patches</b>                      COM Yardage: Back/Arms: 1.25; Seat: .75                      COM Yardage "F" Model: Back/Arms: 1.25; Seat 1                      Freight Class: 250                      Product Weight (lbs.): 33                      Cubic Feet Per Carton: 13.25</p>	<b>8031P</b>	Base Price:	\$1908																				
		Back/Arm upcharge:	<b>+0</b>	<b>+40</b>	<b>+72</b>	<b>+118</b>	<b>+183</b>	<b>+210</b>	<b>+267</b>	<b>+355</b>	<b>+422</b>	<b>+494</b>	<b>+645</b>	<b>+804</b>									
		Seat upcharge:	<b>+0</b>	<b>+24</b>	<b>+43</b>	<b>+71</b>	<b>+110</b>	<b>+126</b>	<b>+160</b>	<b>+213</b>	<b>+253</b>	<b>+297</b>	<b>+387</b>	<b>+483</b>									
	<b>8031PF</b>	Base Price:	\$2153																				
		Back/Arm upcharge:	<b>+0</b>	<b>+40</b>	<b>+72</b>	<b>+118</b>	<b>+183</b>	<b>+210</b>	<b>+267</b>	<b>+355</b>	<b>+422</b>	<b>+494</b>	<b>+645</b>	<b>+804</b>									
		Seat upcharge:	<b>+0</b>	<b>+32</b>	<b>+57</b>	<b>+94</b>	<b>+146</b>	<b>+168</b>	<b>+213</b>	<b>+284</b>	<b>+337</b>	<b>+395</b>	<b>+516</b>	<b>+643</b>									
		<b>OVERALL DIMENSIONS</b>	<b>W</b>	<b>D</b>	<b>H</b>	<b>SEAT DIMENSIONS</b>			<b>W</b>	<b>D</b>	<b>H</b>	<b>BACK DIMENSIONS</b>		<b>W</b>	<b>H</b>								
		"F" model = Flip Forward Seat for ease of cleaning	24.5	23	31	18	17.5	18	15	13													
		Add \$54 for (SBS) Add \$27 for (SSS); \$44 (F model)																					
 <p><b>Side Chair, Chrome Swivel Base</b>                      COM Yardage: Back/Arms: 1.25; Seat: .75                      COM Yardage "F" Model: Back/Arms: 1.25; Seat 1                      Freight Class: 300                      Product Weight (lbs.): 31                      Cubic Feet Per Carton: 15.75</p>	<b>8032</b>	Base Price:	\$1927																				
		Back/Arm upcharge:	<b>+0</b>	<b>+40</b>	<b>+72</b>	<b>+118</b>	<b>+183</b>	<b>+210</b>	<b>+267</b>	<b>+355</b>	<b>+422</b>	<b>+494</b>	<b>+645</b>	<b>+804</b>									
		Seat upcharge:	<b>+0</b>	<b>+24</b>	<b>+43</b>	<b>+71</b>	<b>+110</b>	<b>+126</b>	<b>+160</b>	<b>+213</b>	<b>+253</b>	<b>+297</b>	<b>+387</b>	<b>+483</b>									
	<b>8032F</b>	Base Price:	\$2172																				
		Back/Arm upcharge:	<b>+0</b>	<b>+32</b>	<b>+57</b>	<b>+94</b>	<b>+146</b>	<b>+168</b>	<b>+213</b>	<b>+284</b>	<b>+337</b>	<b>+395</b>	<b>+516</b>	<b>+643</b>									
		Seat upcharge:	<b>+0</b>	<b>+40</b>	<b>+72</b>	<b>+118</b>	<b>+183</b>	<b>+210</b>	<b>+267</b>	<b>+355</b>	<b>+422</b>	<b>+494</b>	<b>+645</b>	<b>+804</b>									
		<b>OVERALL DIMENSIONS</b>	<b>W</b>	<b>D</b>	<b>H</b>	<b>SEAT DIMENSIONS</b>			<b>W</b>	<b>D</b>	<b>H</b>	<b>BACK DIMENSIONS</b>		<b>W</b>	<b>H</b>								
		"F" model = Flip Forward Seat for ease of cleaning	24.5	23	31	18	17.5	18	15	13													
		Add \$36 for (SBS) Add \$27 for (SSS); \$44 (F model)																					





DESCRIPTION	MODEL#/ FEATURES	STANDARD TEXTILE GRADES													
		1/COM	2	3	4	5	6	7	8	9	10	11	12		
 <p><b>Side Chair, Chrome Swivel Base, Arm Patches</b> COM Yardage: Back/Arms: 1.25; Seat: .75 COM Yardage "F" Model: Back/Arms: 1.25; Seat: 1 Freight Class: 250 Product Weight (lbs.): 33 Cubic Feet Per Carton: 13.25</p>	<b>8032P</b>	Base Price:	\$1952												
	Back/Arm upcharge:	<b>+0</b>	<b>+24</b>	<b>+43</b>	<b>+71</b>	<b>+110</b>	<b>+126</b>	<b>+160</b>	<b>+213</b>	<b>+253</b>	<b>+297</b>	<b>+387</b>	<b>+483</b>		
	Seat upcharge:	<b>+0</b>	<b>+40</b>	<b>+72</b>	<b>+118</b>	<b>+183</b>	<b>+210</b>	<b>+267</b>	<b>+355</b>	<b>+422</b>	<b>+494</b>	<b>+645</b>	<b>+804</b>		
	<b>8032PF</b>	Base Price:	\$2196												
	Back/Arm upcharge:	<b>+0</b>	<b>+40</b>	<b>+72</b>	<b>+118</b>	<b>+183</b>	<b>+210</b>	<b>+267</b>	<b>+355</b>	<b>+422</b>	<b>+494</b>	<b>+645</b>	<b>+804</b>		
	Seat upcharge:	<b>+0</b>	<b>+32</b>	<b>+57</b>	<b>+94</b>	<b>+146</b>	<b>+168</b>	<b>+213</b>	<b>+284</b>	<b>+337</b>	<b>+395</b>	<b>+516</b>	<b>+643</b>		
	<b>OVERALL DIMENSIONS</b>		<b>W</b>	<b>D</b>	<b>H</b>	<b>SEAT DIMENSIONS</b>			<b>W</b>	<b>D</b>	<b>H</b>	<b>BACK DIMENSIONS</b>		<b>W</b>	<b>H</b>
			24.5	23	31	18	17.5	18	15	13					
	"F" model = Flip Forward Seat for ease of cleaning														
	Add \$54 for (SBS) Add \$27 for (SSS); \$44 (F model)		<b>RTA 00</b> 1 per carton												
 <p><b>Side Chair, High 4 Star Swivel Base</b> COM Yardage: Back/Arms: 1.25; Seat: .75 Freight Class: 300 Product Weight (lbs.): 31 Cubic Feet Per Carton: 15.75</p>	<b>8021</b>	Base Price:	\$1894												
	Back/Arm upcharge:	<b>+0</b>	<b>+40</b>	<b>+72</b>	<b>+118</b>	<b>+183</b>	<b>+210</b>	<b>+267</b>	<b>+355</b>	<b>+422</b>	<b>+494</b>	<b>+645</b>	<b>+804</b>		
	Seat upcharge:	<b>+0</b>	<b>+24</b>	<b>+43</b>	<b>+71</b>	<b>+110</b>	<b>+126</b>	<b>+160</b>	<b>+213</b>	<b>+253</b>	<b>+297</b>	<b>+387</b>	<b>+483</b>		
	<b>OVERALL DIMENSIONS</b>		<b>W</b>	<b>D</b>	<b>H</b>	<b>SEAT DIMENSIONS</b>			<b>W</b>	<b>D</b>	<b>H</b>	<b>BACK DIMENSIONS</b>		<b>W</b>	<b>H</b>
			24.5	23	32	18	17.5	18.5	15	13					
	Fixed seat cushion only.														
	Add \$36 for (SBS) Add \$27 for (SSS)		<b>RTA 00</b> 1 per carton												
	 <p><b>Side Chair, High 4 Star Swivel Base, Arm Patches</b> COM Yardage: Back/Arms: 1.25; Seat: .75 Freight Class: 250 Product Weight (lbs.): 35.5 Cubic Feet Per Carton: 13.25</p>	<b>8021P</b>	Base Price:	\$1919											
		Back/Arm upcharge:	<b>+0</b>	<b>+40</b>	<b>+72</b>	<b>+118</b>	<b>+183</b>	<b>+210</b>	<b>+267</b>	<b>+355</b>	<b>+422</b>	<b>+494</b>	<b>+645</b>	<b>+804</b>	
		Seat upcharge:	<b>+0</b>	<b>+24</b>	<b>+43</b>	<b>+71</b>	<b>+110</b>	<b>+126</b>	<b>+160</b>	<b>+213</b>	<b>+253</b>	<b>+297</b>	<b>+387</b>	<b>+483</b>	
<b>OVERALL DIMENSIONS</b>		<b>W</b>	<b>D</b>	<b>H</b>	<b>SEAT DIMENSIONS</b>			<b>W</b>	<b>D</b>	<b>H</b>	<b>BACK DIMENSIONS</b>		<b>W</b>	<b>H</b>	
		24.5	23	32	18	17.5	18.5	15	13						
Fixed seat cushion only.															
Add \$354 for (SBS) Add \$27 for (SSS)		<b>RTA 00</b> 1 per carton													
 <p><b>Side Chair, Swivel Tilt, 5 Star Base and Casters</b> COM Yardage: Back/Arms: 1.25; Seat: .75 Freight Class: 300 Product Weight (lbs.): 31 Cubic Feet Per Carton: 15.75</p>		<b>8022</b>	Base Price:	\$2065											
		Back/Arm upcharge:	<b>+0</b>	<b>+40</b>	<b>+72</b>	<b>+118</b>	<b>+183</b>	<b>+210</b>	<b>+267</b>	<b>+355</b>	<b>+422</b>	<b>+494</b>	<b>+645</b>	<b>+804</b>	
		Seat upcharge:	<b>+0</b>	<b>+24</b>	<b>+43</b>	<b>+71</b>	<b>+110</b>	<b>+126</b>	<b>+160</b>	<b>+213</b>	<b>+253</b>	<b>+297</b>	<b>+387</b>	<b>+483</b>	
	<b>OVERALL DIMENSIONS</b>		<b>W</b>	<b>D</b>	<b>H</b>	<b>SEAT DIMENSIONS</b>			<b>W</b>	<b>D</b>	<b>H</b>	<b>BACK DIMENSIONS</b>		<b>W</b>	<b>H</b>
			24.5	23	32.5	18	17.5	15	15	13					
	Tilting mechanism with tilt lock. Fixed seat cushion only.														
	Add \$36 for (SBS) Add \$27 for (SSS)		<b>RTA 00</b> 1 per carton												





DESCRIPTION	MODEL#/ FEATURES	STANDARD TEXTILE GRADES												
		1/COM	2	3	4	5	6	7	8	9	10	11	12	
 <p><b>Side Chair, Swivel Tilt, 5 Star Base, Arm Patches and Casters</b> COM Yardage: Back/Arms: 1.25; Seat: .75 Freight Class: 250 Product Weight (lbs.): 37.5 Cubic Feet Per Carton: 15.75</p>	<b>8022P</b> Base Price: \$2090 Back/Arm upcharge: +0 Seat upcharge: +0													
	Tilting mechanism with tilt lock. Fixed seat cushion only.	24.5	23	32.5	18	17.5	15	15	13					
	Add \$54 for (SBS) Add \$27 for (SSS)													
		<b>RTA 00</b>	1 per carton											
 <p><b>Low Back Lounge Chair, Sled Base</b> COM Yardage: Back/Arms: 2.25; Seat: 1 COM Yardage "F" Model: Back/Arms: 2.25; Seat: 1.25 Freight Class: 250 Product Weight (lbs.): 52 Cubic Feet Per Carton: 19.25</p>	<b>8024</b> Base Price: \$2191 Back/Arm upcharge: +0 Seat upcharge: +0													
	"F" model = Flip Forward Seat for ease of cleaning	29	30	33	21.5	20	17	21	16					
	Add \$75 for (SBS) Add \$32 for (SSS); \$48 (F model)													
		<b>RTA 00</b>	1 per carton											
 <p><b>Low Back Lounge Chair, Sled Base, Arm Patches</b> COM Yardage: Back/Arms: 2.25; Seat: 1 COM Yardage "F" Model: Back/Arms: 2.25; Seat: 1.25 Freight Class: 250 Product Weight (lbs.): 52 Cubic Feet Per Carton: 19.25</p>	<b>8024P</b> Base Price: \$2216 Back/Arm upcharge: +0 Seat upcharge: +0													
	"F" model = Flip Forward Seat for ease of cleaning	29	30	33	21.5	20	17	21	16					
	Add \$39 for (SBS) Add \$32 for (SSS); \$48 (F model)													
		<b>RTA 00</b>	1 per carton											
 <p><b>Low Back Lounge Chair, 4 Leg Wood Base</b> COM Yardage: Back/Arms: 2.25; Seat: 1 COM Yardage "F" Model: Back/Arms: 2.75; Seat: 1.25 Freight Class: 250 Product Weight (lbs.): 53.5 Cubic Feet Per Carton: 19</p>	<b>8025</b> Base Price: \$2884 Back/Arm upcharge: +0 Seat upcharge: +0													
	"F" model = Flip Forward Seat for ease of cleaning	29	30	33	21.5	20	17	21	16					
	Add \$75 for (SBS) Add \$32 for (SSS); \$48 (F model)													
		<b>RTA 00</b>	1 per carton											
 <p><b>Low Back Lounge Chair, 4 Leg Wood Base</b> COM Yardage: Back/Arms: 2.25; Seat: 1 COM Yardage "F" Model: Back/Arms: 2.75; Seat: 1.25 Freight Class: 250 Product Weight (lbs.): 53.5 Cubic Feet Per Carton: 19</p>	<b>8025F</b> Base Price: \$3135 Back/Arm upcharge: +0 Seat upcharge: +0													
	"F" model = Flip Forward Seat for ease of cleaning	29	30	33	21.5	20	17	21	16					
	Add \$75 for (SBS) Add \$32 for (SSS); \$48 (F model)													
		<b>RTA 00</b>	1 per carton											





DESCRIPTION	MODEL#/ FEATURES	STANDARD TEXTILE GRADES													
		1/COM	2	3	4	5	6	7	8	9	10	11	12		
 <p><b>Low Back Lounge Chair, 4 Leg Wood Base, Arm Patches</b>                      COM Yardage: Back/Arms: 2.25; Seat: 1                      COM Yardage "F" Model: Back/Arms: 2.75; Seat: 1.25                      Freight Class: 250                      Product Weight (lbs.): 53.5                      Cubic Feet Per Carton: 19</p>	<b>8025P</b>	Base Price:	\$2909												
	Back/Arm upcharge:	<b>+0</b>	<b>+72</b>	<b>+129</b>	<b>+212</b>	<b>+329</b>	<b>+378</b>	<b>+480</b>	<b>+639</b>	<b>+759</b>	<b>+889</b>	<b>+1161</b>	<b>+1447</b>		
	Seat upcharge:	<b>+0</b>	<b>+32</b>	<b>+57</b>	<b>+94</b>	<b>+146</b>	<b>+168</b>	<b>+213</b>	<b>+284</b>	<b>+337</b>	<b>+395</b>	<b>+516</b>	<b>+643</b>		
	<b>8025PF</b>	Base Price:	\$3160												
	Back/Arm upcharge:	<b>+0</b>	<b>+88</b>	<b>+157</b>	<b>+259</b>	<b>+402</b>	<b>+462</b>	<b>+586</b>	<b>+781</b>	<b>+927</b>	<b>+1087</b>	<b>+1419</b>	<b>+1769</b>		
	Seat upcharge:	<b>+0</b>	<b>+40</b>	<b>+72</b>	<b>+118</b>	<b>+183</b>	<b>+210</b>	<b>+267</b>	<b>+355</b>	<b>+422</b>	<b>+494</b>	<b>+645</b>	<b>+804</b>		
	<b>OVERALL DIMENSIONS</b>		<b>W</b>	<b>D</b>	<b>H</b>	<b>SEAT DIMENSIONS</b>			<b>W</b>	<b>D</b>	<b>H</b>	<b>BACK DIMENSIONS</b>		<b>W</b>	<b>H</b>
			29	30	33	21.5	20	17	21	16					
	"F" model = Flip Forward Seat for ease of cleaning  Add \$93 for (SBS) Add \$32 for (SSS); \$48 (F model)					<b>RTA 00</b>	1 per carton								
	 <p><b>Low Back Lounge Chair, Wood Swivel Base</b>                      COM Yardage: Back: 2.25; Seat: 1                      COM Yardage "F" Model: Back/Arms: 2.75; Seat: 1.25                      Freight Class: 250                      Product Weight (lbs.): 53                      Cubic Feet Per Carton: 19</p>	<b>8033</b>	Base Price:	\$2640											
Back/Arm upcharge:		<b>+0</b>	<b>+72</b>	<b>+129</b>	<b>+212</b>	<b>+329</b>	<b>+378</b>	<b>+480</b>	<b>+639</b>	<b>+759</b>	<b>+889</b>	<b>+1161</b>	<b>+1447</b>		
Seat upcharge:		<b>+0</b>	<b>+32</b>	<b>+57</b>	<b>+94</b>	<b>+146</b>	<b>+168</b>	<b>+213</b>	<b>+284</b>	<b>+337</b>	<b>+395</b>	<b>+516</b>	<b>+643</b>		
<b>8033F</b>		Base Price:	\$2891												
Back/Arm upcharge:		<b>+0</b>	<b>+88</b>	<b>+157</b>	<b>+259</b>	<b>+402</b>	<b>+462</b>	<b>+586</b>	<b>+781</b>	<b>+927</b>	<b>+1087</b>	<b>+1419</b>	<b>+1769</b>		
Seat upcharge:		<b>+0</b>	<b>+40</b>	<b>+72</b>	<b>+118</b>	<b>+183</b>	<b>+210</b>	<b>+267</b>	<b>+355</b>	<b>+422</b>	<b>+494</b>	<b>+645</b>	<b>+804</b>		
<b>OVERALL DIMENSIONS</b>		<b>W</b>	<b>D</b>	<b>H</b>	<b>SEAT DIMENSIONS</b>			<b>W</b>	<b>D</b>	<b>H</b>	<b>BACK DIMENSIONS</b>		<b>W</b>	<b>H</b>	
		29	30	33	21.5	20	17	21	16						
"F" model = Flip Forward Seat for ease of cleaning  Add \$75 for (SBS) Add \$32 for (SSS); \$48 (F model)					<b>RTA 00</b>	per carton									
 <p><b>Low Back Lounge Chair, Wood Swivel Base, Arm Patches</b>                      COM Yardage: Back: 2.25; Seat: 1                      COM Yardage "F" Model: Back/Arms: 2.75; Seat: 1.25                      Freight Class: 250                      Product Weight (lbs.): 53                      Cubic Feet Per Carton: 19</p>		<b>8033P</b>	Base Price:	\$2665											
	Back/Arm upcharge:	<b>+0</b>	<b>+72</b>	<b>+129</b>	<b>+212</b>	<b>+329</b>	<b>+378</b>	<b>+480</b>	<b>+639</b>	<b>+759</b>	<b>+889</b>	<b>+1161</b>	<b>+1447</b>		
	Seat upcharge:	<b>+0</b>	<b>+32</b>	<b>+57</b>	<b>+94</b>	<b>+146</b>	<b>+168</b>	<b>+213</b>	<b>+284</b>	<b>+337</b>	<b>+395</b>	<b>+516</b>	<b>+643</b>		
	<b>8033PF</b>	Base Price:	\$2917												
	Back/Arm upcharge:	<b>+0</b>	<b>+88</b>	<b>+157</b>	<b>+259</b>	<b>+402</b>	<b>+462</b>	<b>+586</b>	<b>+781</b>	<b>+927</b>	<b>+1087</b>	<b>+1419</b>	<b>+1769</b>		
	Seat upcharge:	<b>+0</b>	<b>+40</b>	<b>+72</b>	<b>+118</b>	<b>+183</b>	<b>+210</b>	<b>+267</b>	<b>+355</b>	<b>+422</b>	<b>+494</b>	<b>+645</b>	<b>+804</b>		
	<b>OVERALL DIMENSIONS</b>		<b>W</b>	<b>D</b>	<b>H</b>	<b>SEAT DIMENSIONS</b>			<b>W</b>	<b>D</b>	<b>H</b>	<b>BACK DIMENSIONS</b>		<b>W</b>	<b>H</b>
			29	30	33	21.5	20	17	21	16					
	"F" model = Flip Forward Seat for ease of cleaning  Add \$93 for (SBS) Add \$32 for (SSS); \$48 (F model)					<b>RTA 00</b>	per carton								
	 <p><b>Low Back Lounge Chair, Chrome Swivel Base</b>                      COM Yardage: Back: 2.25; Seat: 1                      COM Yardage "F" Model: Back/Arms: 2.75; Seat: 1.25                      Freight Class: 250                      Product Weight (lbs.): 59                      Cubic Feet Per Carton: 19.25</p>	<b>8034</b>	Base Price:	\$2652											
Back/Arm upcharge:		<b>+0</b>	<b>+72</b>	<b>+129</b>	<b>+212</b>	<b>+329</b>	<b>+378</b>	<b>+480</b>	<b>+639</b>	<b>+759</b>	<b>+889</b>	<b>+1161</b>	<b>+1447</b>		
Seat upcharge:		<b>+0</b>	<b>+32</b>	<b>+57</b>	<b>+94</b>	<b>+146</b>	<b>+168</b>	<b>+213</b>	<b>+284</b>	<b>+337</b>	<b>+395</b>	<b>+516</b>	<b>+643</b>		
<b>8034F</b>		Base Price:	\$2903												
Back/Arm upcharge:		<b>+0</b>	<b>+88</b>	<b>+129</b>	<b>+259</b>	<b>+402</b>	<b>+462</b>	<b>+586</b>	<b>+781</b>	<b>+927</b>	<b>+1087</b>	<b>+1419</b>	<b>+1769</b>		
Seat upcharge:		<b>+0</b>	<b>+40</b>	<b>+72</b>	<b>+118</b>	<b>+183</b>	<b>+210</b>	<b>+267</b>	<b>+355</b>	<b>+422</b>	<b>+494</b>	<b>+645</b>	<b>+804</b>		
<b>OVERALL DIMENSIONS</b>		<b>W</b>	<b>D</b>	<b>H</b>	<b>SEAT DIMENSIONS</b>			<b>W</b>	<b>D</b>	<b>H</b>	<b>BACK DIMENSIONS</b>		<b>W</b>	<b>H</b>	
		29	30	33	21.5	20	17	21	16						
"F" model = Flip Forward Seat for ease of cleaning  Add \$75 for (SBS) Add \$32 for (SSS); \$48 (F model)					<b>RTA 00</b>	1 per carton									





DESCRIPTION	MODEL#/ FEATURES	STANDARD TEXTILE GRADES												
		1/COM	2	3	4	5	6	7	8	9	10	11	12	
 <p><b>Low Back Lounge Chair, Chrome Swivel Base, Arm Patches</b> COM Yardage: Back: 2.25; Seat: 1 COM Yardage "F" Model: Back/Arms: 2.75; Seat: 1.25 Freight Class: 250 Product Weight (lbs.): 59 Cubic Feet Per Carton: 19.25</p>	<b>8034P</b>	Base Price:	\$2677											
		Back/Arm upcharge:	+0	+72	+129	+212	+329	+378	+480	+639	+759	+889	+1161	+1447
		Seat upcharge:	+0	+32	+57	+94	+146	+168	+213	+284	+337	+395	+516	+643
	<b>8034PF</b>	Base Price:	\$2928											
		Back/Arm upcharge:	+0	+88	+157	+259	+402	+462	+586	+781	+927	+1087	+1419	+1769
		Seat upcharge:	+0	+40	+72	+118	+183	+210	+267	+355	+422	+494	+645	+804
			<b>OVERALL DIMENSIONS</b>											
			<b>W</b>	<b>D</b>	<b>H</b>	<b>W</b>	<b>D</b>	<b>H</b>	<b>W</b>	<b>D</b>	<b>H</b>	<b>W</b>	<b>H</b>	
			29	30	33	21.5	20	17	21	16				
		"F" model = Flip Forward Seat for ease of cleaning												
	Add \$93 for (SBS)													
	Add \$32 for (SSS); \$48 (F model)													
					<b>RTA 00</b>				1 per carton					
 <p><b>Mid Back Lounge Chair, Sled Base</b> COM Yardage: Back: 2.5; Seat: 1 COM Yardage "F" Model: Back/Arms: 3; Seat: 1.25 Freight Class: 250 Product Weight (lbs.): 52 Cubic Feet Per Carton: 25.5</p>	<b>8016</b>	Base Price:	\$2437											
		Back/Arm upcharge:	+0	+80	+143	+235	+365	+420	+533	+710	+843	+988	+1290	+1608
		Seat upcharge:	+0	+32	+57	+94	+146	+168	+213	+284	+337	+395	+516	+643
	<b>8016F</b>	Base Price:	\$2688											
		Back/Arm upcharge:	+0	+96	+171	+282	+438	+504	+639	+852	+1011	+1185	+1548	+1929
		Seat upcharge:	+0	+40	+72	+118	+183	+210	+267	+355	+422	+494	+645	+804
			<b>OVERALL DIMENSIONS</b>											
			<b>W</b>	<b>D</b>	<b>H</b>	<b>W</b>	<b>D</b>	<b>H</b>	<b>W</b>	<b>D</b>	<b>H</b>	<b>W</b>	<b>H</b>	
			29	31.5	38.5	21.5	20	17	21	21.5				
		"F" model = Flip Forward Seat for ease of cleaning												
	Add \$81 for (SBS)													
	Add \$32 for (SSS); \$48 (F model)													
					<b>RTA 00</b>				1 per carton					
 <p><b>Mid Back Lounge Chair, Sled Base, Arm Patches</b> COM Yardage: Back: 2.5; Seat: 1 COM Yardage "F" Model: Back/Arms: 3; Seat: 1.25 Freight Class: 250 Product Weight (lbs.): 52 Cubic Feet Per Carton: 25.5</p>	<b>8016P</b>	Base Price:	\$2462											
		Back/Arm upcharge:	+0	+80	+143	+235	+365	+420	+533	+710	+843	+988	+1290	+1608
		Seat upcharge:	+0	+32	+57	+94	+146	+168	+213	+284	+337	+395	+516	+643
	<b>8016PF</b>	Base Price:	\$2713											
		Back/Arm upcharge:	+0	+96	+171	+282	+438	+504	+639	+852	+1011	+1185	+1548	+1929
		Seat upcharge:	+0	+40	+72	+94	+183	+210	+267	+355	+422	+494	+645	+804
			<b>OVERALL DIMENSIONS</b>											
			<b>W</b>	<b>D</b>	<b>H</b>	<b>W</b>	<b>D</b>	<b>H</b>	<b>W</b>	<b>D</b>	<b>H</b>	<b>W</b>	<b>H</b>	
			29	31.5	38.5	21.5	20	17	21	21.5				
		"F" model = Flip Forward Seat for ease of cleaning												
	Add \$99 for (SBS)													
	Add \$32 for (SSS); \$48 (F model)													
					<b>RTA 00</b>				1 per carton					
 <p><b>Mid Back Lounge Chair, 4 Leg Wood Base</b> COM Yardage: Back: 2.5; Seat: 1 COM Yardage "F" Model: Back/Arms: 3; Seat: 1.25 Freight Class: 250 Product Weight (lbs.): 53.5 Cubic Feet Per Carton: 25.5</p>	<b>8027</b>	Base Price:	\$3120											
		Back/Arm upcharge:	+0	+80	+143	+235	+365	+420	+533	+710	+843	+988	+1290	+1608
		Seat upcharge:	+0	+32	+57	+94	+146	+168	+213	+284	+337	+395	+516	+643
	<b>8027F</b>	Base Price:	\$3371											
		Back/Arm upcharge:	+0	+96	+171	+282	+438	+504	+639	+852	+1011	+1185	+1548	+1929
		Seat upcharge:	+0	+40	+72	+118	+183	+210	+267	+355	+422	+494	+645	+804
			<b>OVERALL DIMENSIONS</b>											
			<b>W</b>	<b>D</b>	<b>H</b>	<b>W</b>	<b>D</b>	<b>H</b>	<b>W</b>	<b>D</b>	<b>H</b>	<b>W</b>	<b>H</b>	
			29	31.5	38.5	21.5	20	17	21	21.5				
		"F" model = Flip Forward Seat for ease of cleaning												
	Add \$81 for (SBS)													
	Add \$32 for (SSS); \$48 (F model)													
					<b>RTA 00</b>				1 per carton					









DESCRIPTION	MODEL#/ FEATURES	STANDARD TEXTILE GRADES												
		1/COM	2	3	4	5	6	7	8	9	10	11	12	
 <p><b>Mid Back Lounge Chair, 4 Leg Wood Base, Arm Patches</b>                      COM Yardage: Back: 2.5; Seat: 1                      COM Yardage "F" Model: Back/Arms: 3; Seat: 1.25                      Freight Class: 250                      Product Weight (lbs.): 53.5                      Cubic Feet Per Carton: 25.5</p>	<b>8027P</b>	Base Price:	\$3145											
		Back/Arm upcharge:	<b>+0</b>	<b>+80</b>	<b>+143</b>	<b>+235</b>	<b>+365</b>	<b>+420</b>	<b>+533</b>	<b>+710</b>	<b>+843</b>	<b>+988</b>	<b>+1290</b>	<b>+1608</b>
		Seat upcharge:	<b>+0</b>	<b>+32</b>	<b>+57</b>	<b>+94</b>	<b>+146</b>	<b>+168</b>	<b>+213</b>	<b>+284</b>	<b>+337</b>	<b>+395</b>	<b>+516</b>	<b>+643</b>
	<b>8027PF</b>	Base Price:	\$3396											
		Back/Arm upcharge:	<b>+0</b>	<b>+96</b>	<b>+171</b>	<b>+282</b>	<b>+438</b>	<b>+504</b>	<b>+639</b>	<b>+852</b>	<b>+1011</b>	<b>+1185</b>	<b>+1548</b>	<b>+1929</b>
		Seat upcharge:	<b>+0</b>	<b>+40</b>	<b>+72</b>	<b>+118</b>	<b>+183</b>	<b>+210</b>	<b>+267</b>	<b>+355</b>	<b>+422</b>	<b>+494</b>	<b>+645</b>	<b>+804</b>
		<b>OVERALL DIMENSIONS</b>			<b>SEAT DIMENSIONS</b>			<b>BACK DIMENSIONS</b>						
			<b>W</b>	<b>D</b>	<b>H</b>	<b>W</b>	<b>D</b>	<b>H</b>	<b>W</b>	<b>H</b>				
			29	31.5	38.5	21.5	20	17	21	21.5				
		"F" model = Flip Forward Seat for ease of cleaning												
	Add \$99 for (SBS) Add \$32 for (SSS); \$48 (F model)													
 <p><b>Mid Back Lounge Chair, Wood Swivel Base</b>                      COM Yardage: Back: 2.5; Seat: 1                      COM Yardage "F" Model: Back/Arms: 3; Seat: 1.25                      Freight Class: 250                      Product Weight (lbs.): 54                      Cubic Feet Per Carton: 25.5</p>	<b>8035</b>	Base Price:	\$2745											
		Back/Arm upcharge:	<b>+0</b>	<b>+80</b>	<b>+143</b>	<b>+235</b>	<b>+365</b>	<b>+420</b>	<b>+533</b>	<b>+710</b>	<b>+843</b>	<b>+988</b>	<b>+1290</b>	<b>+1608</b>
		Seat upcharge:	<b>+0</b>	<b>+32</b>	<b>+57</b>	<b>+94</b>	<b>+146</b>	<b>+168</b>	<b>+213</b>	<b>+284</b>	<b>+337</b>	<b>+395</b>	<b>+516</b>	<b>+643</b>
	<b>8035F</b>	Base Price:	\$2996											
		Back/Arm upcharge:	<b>+0</b>	<b>+96</b>	<b>+171</b>	<b>+282</b>	<b>+438</b>	<b>+504</b>	<b>+639</b>	<b>+852</b>	<b>+1011</b>	<b>+1185</b>	<b>+1548</b>	<b>+1929</b>
		Seat upcharge:	<b>+0</b>	<b>+40</b>	<b>+72</b>	<b>+118</b>	<b>+183</b>	<b>+210</b>	<b>+267</b>	<b>+355</b>	<b>+422</b>	<b>+494</b>	<b>+645</b>	<b>+804</b>
		<b>OVERALL DIMENSIONS</b>			<b>SEAT DIMENSIONS</b>			<b>BACK DIMENSIONS</b>						
			<b>W</b>	<b>D</b>	<b>H</b>	<b>W</b>	<b>D</b>	<b>H</b>	<b>W</b>	<b>H</b>				
			29	31.5	38.5	21.5	20	17	21	21.5				
		"F" model = Flip Forward Seat for ease of cleaning												
	Add \$81 for (SBS) Add \$32 for (SSS); \$48 (F model)													
 <p><b>Mid Back Lounge Chair, Wood Swivel Base, Arm Patches</b>                      COM Yardage: Back: 2.5; Seat: 1                      COM Yardage "F" Model: Back/Arms: 3; Seat: 1.25                      Freight Class: 250                      Product Weight (lbs.): 54                      Cubic Feet Per Carton: 25.5</p>	<b>8035P</b>	Base Price:	\$2770											
		Back/Arm upcharge:	<b>+0</b>	<b>+80</b>	<b>+143</b>	<b>+235</b>	<b>+365</b>	<b>+420</b>	<b>+533</b>	<b>+710</b>	<b>+843</b>	<b>+988</b>	<b>+1290</b>	<b>+1608</b>
		Seat upcharge:	<b>+0</b>	<b>+32</b>	<b>+57</b>	<b>+94</b>	<b>+146</b>	<b>+168</b>	<b>+213</b>	<b>+284</b>	<b>+337</b>	<b>+395</b>	<b>+516</b>	<b>+643</b>
	<b>8035PF</b>	Base Price:	\$3021											
		Back/Arm upcharge:	<b>+0</b>	<b>+96</b>	<b>+171</b>	<b>+282</b>	<b>+438</b>	<b>+504</b>	<b>+639</b>	<b>+852</b>	<b>+1011</b>	<b>+1185</b>	<b>+1548</b>	<b>+1929</b>
		Seat upcharge:	<b>+0</b>	<b>+40</b>	<b>+72</b>	<b>+118</b>	<b>+183</b>	<b>+210</b>	<b>+267</b>	<b>+355</b>	<b>+422</b>	<b>+494</b>	<b>+645</b>	<b>+804</b>
		<b>OVERALL DIMENSIONS</b>			<b>SEAT DIMENSIONS</b>			<b>BACK DIMENSIONS</b>						
			<b>W</b>	<b>D</b>	<b>H</b>	<b>W</b>	<b>D</b>	<b>H</b>	<b>W</b>	<b>H</b>				
			29	31.5	38.5	21.5	20	17	21	21.5				
		"F" model = Flip Forward Seat for ease of cleaning												
	Add \$99 for (SBS) Add \$32 for (SSS); \$48 (F model)													
 <p><b>Mid Back Lounge Chair, Chrome Swivel Base</b>                      COM Yardage: Back: 2.5; Seat: 1                      COM Yardage "F" Model: Back/Arms: 3; Seat: 1.25                      Freight Class: 250                      Product Weight (lbs.): 60                      Cubic Feet Per Carton: 25.5</p>	<b>8036</b>	Base Price:	\$2762											
		Back/Arm upcharge:	<b>+0</b>	<b>+80</b>	<b>+143</b>	<b>+235</b>	<b>+365</b>	<b>+420</b>	<b>+533</b>	<b>+710</b>	<b>+843</b>	<b>+988</b>	<b>+1290</b>	<b>+1608</b>
		Seat upcharge:	<b>+0</b>	<b>+32</b>	<b>+57</b>	<b>+94</b>	<b>+146</b>	<b>+168</b>	<b>+213</b>	<b>+284</b>	<b>+337</b>	<b>+395</b>	<b>+516</b>	<b>+643</b>
	<b>8036F</b>	Base Price:	\$3013											
		Back/Arm upcharge:	<b>+0</b>	<b>+96</b>	<b>+171</b>	<b>+282</b>	<b>+438</b>	<b>+504</b>	<b>+639</b>	<b>+852</b>	<b>+1011</b>	<b>+1185</b>	<b>+1548</b>	<b>+1929</b>
		Seat upcharge:	<b>+0</b>	<b>+40</b>	<b>+72</b>	<b>+118</b>	<b>+183</b>	<b>+210</b>	<b>+267</b>	<b>+355</b>	<b>+422</b>	<b>+494</b>	<b>+645</b>	<b>+804</b>
		<b>OVERALL DIMENSIONS</b>			<b>SEAT DIMENSIONS</b>			<b>BACK DIMENSIONS</b>						
			<b>W</b>	<b>D</b>	<b>H</b>	<b>W</b>	<b>D</b>	<b>H</b>	<b>W</b>	<b>H</b>				
			29	31.5	38.5	21.5	20	17	21	21.5				
		"F" model = Flip Forward Seat for ease of cleaning												
	Add \$81 for (SBS) Add \$32 for (SSS); \$48 (F model)													

DESCRIPTION	MODEL#/ FEATURES	STANDARD TEXTILE GRADES											
		1/COM	2	3	4	5	6	7	8	9	10	11	12
 <p><b>Mid Back Lounge Chair, Chrome Swivel Base, Arm Patches</b> COM Yardage: Back: 2.5; Seat: 1 COM Yardage "F" Model: Back/Arms: 3; Seat: 1.25 Freight Class: 250 Product Weight (lbs.): 60 Cubic Feet Per Carton: 25.5</p>	<p><b>8036P</b> Base Price: \$2787 Back/Arm upcharge: +0 Seat upcharge: +0</p>	+80	+143	+235	+365	+420	+533	+710	+843	+988	+1290	+1608	
	<p><b>8036PF</b> Base Price: \$3038 Back/Arm upcharge: +0 Seat upcharge: +0</p>	+96	+171	+282	+438	+504	+639	+852	+1011	+1185	+1548	+1929	
	<b>OVERALL DIMENSIONS</b>			<b>SEAT DIMENSIONS</b>			<b>BACK DIMENSIONS</b>						
	W D H			W D H			W H						
	29 31.5 38.5			21.5 20 17			21 21.5						
	"F" model = Flip Forward Seat for ease of cleaning			1 per carton									
	Add \$99 for (SBS) Add \$32 for (SSS); \$48 (F model)			RTA 00									
	 <p><b>High Back Lounge Chair, Sled Base</b> COM Yardage: Back: 2.75; Seat: 1 COM Yardage "F" Model: Back/Arms: 3.25; Seat: 1.25 Freight Class: 300 Product Weight (lbs.): 56 Cubic Feet Per Carton: 28.25</p>	<p><b>8028</b> Base Price: \$2778 Back/Arm upcharge: +0 Seat upcharge: +0</p>	+88	+157	+259	+402	+462	+586	+781	+927	+1087	+1419	+1769
		<p><b>8028F</b> Base Price: \$3029 Back/Arm upcharge: +0 Seat upcharge: +0</p>	+104	+186	+306	+475	+546	+693	+923	+1096	+1284	+1677	+2090
		<b>OVERALL DIMENSIONS</b>			<b>SEAT DIMENSIONS</b>			<b>BACK DIMENSIONS</b>					
W D H			W D H			W H							
29 31.5 44.5			21.5 20 17			21 27.5							
"F" model = Flip Forward Seat for ease of cleaning			1 per carton										
Add \$84 for (SBS) Add \$32 for (SSS); \$48 (F model)			RTA 00										
 <p><b>High Back Lounge Chair, Sled Base, Arm Patches</b> COM Yardage: Back: 2.75; Seat: 1 COM Yardage "F" Model: Back/Arms: 3.25; Seat: 1.25 Freight Class: 300 Product Weight (lbs.): 56 Cubic Feet Per Carton: 28.25</p>		<p><b>8028P</b> Base Price: \$2829 Back/Arm upcharge: +0 Seat upcharge: +0</p>	+88	+157	+259	+402	+462	+586	+781	+927	+1087	+1419	+1769
		<p><b>8028PF</b> Base Price: \$3080 Back/Arm upcharge: +0 Seat upcharge: +0</p>	+104	+186	+306	+475	+546	+693	+923	+1096	+1284	+1677	+2090
		<b>OVERALL DIMENSIONS</b>			<b>SEAT DIMENSIONS</b>			<b>BACK DIMENSIONS</b>					
	W D H			W D H			W H						
	29 31.5 44.5			21.5 20 17			21 27.5						
	"F" model = Flip Forward Seat for ease of cleaning			1 per carton									
	Add \$102 for (SBS) Add \$32 for (SSS); \$48 (F model)			RTA 00									
	 <p><b>High Back Lounge Chair, Sled Base, Arm and Head Patches</b> COM Yardage: Back: 2.75; Seat: 1 COM Yardage "F" Model: Back/Arms: 3.25; Seat: 1.25 Freight Class: 300 Product Weight (lbs.): 56 Cubic Feet Per Carton: 28.25</p>	<p><b>8028PH</b> Base Price: \$2879 Back/Arm upcharge: +0 Seat upcharge: +0</p>	+88	+157	+259	+402	+462	+586	+781	+927	+1087	+1419	+1769
		<p><b>8028PHF</b> Base Price: \$3130 Back/Arm upcharge: +0 Seat upcharge: +0</p>	+104	+186	+306	+475	+546	+693	+923	+1096	+1284	+1677	+2090
		<b>OVERALL DIMENSIONS</b>			<b>SEAT DIMENSIONS</b>			<b>BACK DIMENSIONS</b>					
W D H			W D H			W H							
29 31.5 44.5			21.5 20 17			21 27.5							
"F" model = Flip Forward Seat for ease of cleaning			1 per carton										
Add \$123 for (SBS) Add \$32 for (SSS); \$48 (F model)			RTA 00										

DESCRIPTION	MODEL#/ FEATURES	STANDARD TEXTILE GRADES												
		1/COM	2	3	4	5	6	7	8	9	10	11	12	
	<b>8029</b> Base Price:	\$3477												
	Back/Arm upcharge:	+0	+88	+157	+259	+402	+462	+586	+781	+927	+1087	+1419	+1769	
	Seat upcharge:	+0	+32	+57	+94	+146	+168	+213	+284	+337	+395	+516	+643	
	<b>8029F</b> Base Price:	\$3728												
	Back/Arm upcharge:	+0	+104	+186	+306	+475	+546	+693	+923	+1096	+1284	+1677	+2090	
	Seat upcharge:	+0	+40	+72	+118	+183	+210	+267	+355	+422	+494	+645	+804	
	<b>OVERALL DIMENSIONS</b>													
	W D H		29	31.5	44.5		21.5	20	17		21		27.5	
	"F" model = Flip Forward Seat for ease of cleaning													
	Add \$84 for (SBS) Add \$32 for (SSS); \$48 (F model)					<b>RTA 00</b>								1 per carton
	<b>8029P</b> Base Price:	\$3527												
	Back/Arm upcharge:	+0	+88	+157	+259	+402	+462	+586	+781	+927	+1087	+1419	+1769	
	Seat upcharge:	+0	+32	+57	+94	+146	+168	+213	+284	+337	+395	+516	+643	
	<b>8029PF</b> Base Price:	\$3778												
	Back/Arm upcharge:	+0	+104	+186	+306	+475	+546	+693	+923	+1096	+1284	+1677	+2090	
	Seat upcharge:	+0	+40	+72	+118	+183	+210	+267	+355	+422	+494	+645	+804	
	<b>OVERALL DIMENSIONS</b>													
	W D H		29	31.5	44.5		21.5	20	17		21		27.5	
	"F" model = Flip Forward Seat for ease of cleaning													
	Add \$102 for (SBS) Add \$32 for (SSS); \$48 (F model)					<b>RTA 00</b>								1 per carton
	<b>8029PH</b> Base Price:	\$3577												
	Back/Arm upcharge:	+0	+88	+157	+259	+402	+462	+586	+781	+927	+1087	+1419	+1769	
	Seat upcharge:	+0	+32	+57	+94	+146	+168	+213	+284	+337	+395	+516	+643	
	<b>8029PHF</b> Base Price:	\$3828												
	Back/Arm upcharge:	+0	+104	+186	+306	+475	+546	+693	+923	+1096	+1284	+1677	+2090	
	Seat upcharge:	+0	+40	+72	+118	+183	+210	+267	+355	+422	+494	+645	+804	
	<b>OVERALL DIMENSIONS</b>													
	W D H		29	31.5	44.5		21.5	20	17		21		27.5	
	"F" model = Flip Forward Seat for ease of cleaning													
	Add \$123 for (SBS) Add \$32 for (SSS); \$48 (F model)					<b>RTA 00</b>								1 per carton
	<b>8037</b> Base Price:	\$3000												
	Back/Arm upcharge:	+0	+88	+157	+259	+402	+462	+586	+781	+927	+1087	+1419	+1769	
	Seat upcharge:	+0	+32	+57	+94	+146	+168	+213	+284	+337	+395	+516	+643	
	<b>8037F</b> Base Price:	\$3251												
	Back/Arm upcharge:	+0	+104	+186	+306	+475	+546	+693	+923	+1096	+1284	+1677	+2090	
	Seat upcharge:	+0	+40	+72	+118	+183	+210	+267	+355	+422	+494	+645	+804	
	<b>OVERALL DIMENSIONS</b>													
	W D H		29	31.5	44.5		21.5	20	17		21		27.5	
	"F" model = Flip Forward Seat for ease of cleaning													
	Add \$84 for (SBS) Add \$32 for (SSS); \$48 (F model)					<b>RTA 00</b>								1 per carton

DESCRIPTION	MODEL#/ FEATURES	STANDARD TEXTILE GRADES											
		1/COM	2	3	4	5	6	7	8	9	10	11	12
	<b>8037P</b> Base Price:	\$3050											
	Back/Arm upcharge:	+0	+88	+157	+259	+402	+462	+586	+781	+927	+1087	+1419	+1769
	Seat upcharge:	+0	+32	+57	+94	+146	+168	+213	+284	+337	+395	+516	+643
	<b>8037PF</b> Base Price:	\$3301											
	Back/Arm upcharge:	+0	+104	+186	+306	+475	+546	+693	+923	+1096	+1284	+1677	+2090
	Seat upcharge:	+0	+40	+72	+118	+183	+210	+267	+355	+422	+494	+645	+804
	<b>OVERALL DIMENSIONS</b>			<b>SEAT DIMENSIONS</b>			<b>BACK DIMENSIONS</b>						
	W D H			W D H			W H						
	29 31.5 44.5			21.5 20 17			21 27.5						
	<p><b>High Back Lounge Chair, Wood Swivel Base, Arm Patches</b>                      COM Yardage: Back: 2.75; Seat: 1                      COM Yardage "F" Model: Back/Arms: 3.25; Seat: 1.25                      Freight Class: 250                      Product Weight (lbs.): 57                      Cubic Feet Per Carton: 28.25</p>		<p>"F" model = Flip Forward                      Seat for ease of cleaning</p> <p>Add \$102 for (SBS)                      Add \$32 for (SSS); \$48 (F model)</p>		<p><b>RTA 00</b></p>		1 per carton						
	<b>8037PH</b> Base Price:	\$3100											
	Back/Arm upcharge:	+0	+88	+157	+259	+402	+462	+586	+781	+927	+1087	+1419	+1769
	Seat upcharge:	+0	+32	+57	+94	+146	+168	+213	+284	+337	+395	+516	+643
	<b>8037PHF</b> Base Price:	\$3352											
	Back/Arm upcharge:	+0	+104	+186	+306	+475	+546	+693	+923	+1096	+1284	+1677	+2090
	Seat upcharge:	+0	+40	+72	+118	+183	+210	+267	+355	+422	+494	+645	+804
	<b>OVERALL DIMENSIONS</b>			<b>SEAT DIMENSIONS</b>			<b>BACK DIMENSIONS</b>						
	W D H			W D H			W H						
	29 31.5 44.5			21.5 20 17			21 27.5						
	<p><b>High Back Lounge Chair, Wood Swivel Base, Arm and Head Patches</b>                      COM Yardage: Back: 2.75; Seat: 1                      COM Yardage "F" Model: Back/Arms: 3.25; Seat: 1.25                      Freight Class: 250                      Product Weight (lbs.): 57                      Cubic Feet Per Carton: 28.25</p>		<p>"F" model = Flip Forward                      Seat for ease of cleaning</p> <p>Add \$132 for (SBS)                      Add \$32 for (SSS); \$48 (F model)</p>		<p><b>RTA 00</b></p>		1 per carton						
	<b>8038</b> Base Price:	\$3017											
	Back/Arm upcharge:	+0	+88	+157	+259	+402	+462	+586	+781	+927	+1087	+1419	+1769
	Seat upcharge:	+0	+32	+57	+94	+146	+168	+213	+284	+337	+395	+516	+643
	<b>8038F</b> Base Price:	\$3269											
	Back/Arm upcharge:	+0	+104	+186	+306	+475	+546	+693	+923	+1096	+1284	+1677	+2090
	Seat upcharge:	+0	+40	+72	+118	+183	+210	+267	+355	+422	+494	+645	+804
	<b>OVERALL DIMENSIONS</b>			<b>SEAT DIMENSIONS</b>			<b>BACK DIMENSIONS</b>						
	W D H			W D H			W H						
	29 31.5 44.5			21.5 20 17			21 27.5						
	<p><b>High Back Lounge Chair, Chrome Swivel Base</b>                      COM Yardage: Back: 2.75; Seat: 1                      COM Yardage "F" Model: Back/Arms: 3.25; Seat: 1.25                      Freight Class: 250                      Product Weight (lbs.): 63                      Cubic Feet Per Carton: 28.25</p>		<p>"F" model = Flip Forward                      Seat for ease of cleaning</p> <p>Add \$84 for (SBS)                      Add \$32 for (SSS); \$48 (F model)</p>		<p><b>RTA 00</b></p>		1 per carton 1 per carton						
	<b>8038P</b> Base Price:	\$3068											
	Back/Arm upcharge:	+0	+88	+157	+259	+402	+462	+586	+781	+927	+1087	+1419	+1769
	Seat upcharge:	+0	+32	+57	+94	+146	+168	+213	+284	+337	+395	+516	+643
	<b>8038PF</b> Base Price:	\$3319											
	Back/Arm upcharge:	+0	+104	+186	+306	+475	+546	+693	+923	+1096	+1284	+1677	+2090
	Seat upcharge:	+0	+40	+72	+118	+183	+210	+267	+355	+422	+494	+645	+804
	<b>OVERALL DIMENSIONS</b>			<b>SEAT DIMENSIONS</b>			<b>BACK DIMENSIONS</b>						
	W D H			W D H			W H						
	29 31.5 44.5			21.5 20 17			21 27.5						
	<p><b>High Back Lounge Chair, Chrome Swivel Base, Arm Patches</b>                      COM Yardage: Back: 2.75; Seat: 1                      COM Yardage "F" Model: Back/Arms: 3.25; Seat: 1.25                      Freight Class: 250                      Product Weight (lbs.): 63                      Cubic Feet Per Carton: 28.25</p>		<p>"F" model = Flip Forward                      Seat for ease of cleaning</p> <p>Add \$102 for (SBS)                      Add \$32 for (SSS); \$48 (F model)</p>		<p><b>RTA 00</b></p>		1 per carton 1 per carton						

DESCRIPTION	MODEL#/ FEATURES	STANDARD TEXTILE GRADES												
		1/COM	2	3	4	5	6	7	8	9	10	11	12	
 <p><b>High Back Lounge Chair, Chrome Swivel Base, Arm and Head Patches</b>                      COM Yardage: Back: 2.75; Seat: 1                      COM Yardage "F" Model: Back/Arms: 3.25; Seat: 1.25                      Freight Class: 250                      Product Weight (lbs.): 63                      Cubic Feet Per Carton: 28.25</p>	<b>8038PH</b> Base Price:	\$3118												
	Back/Arm upcharge:	<b>+0</b>	<b>+88</b>	<b>+157</b>	<b>+59</b>	<b>+402</b>	<b>+462</b>	<b>+586</b>	<b>+781</b>	<b>+927</b>	<b>+1087</b>	<b>+1419</b>	<b>+1769</b>	
	Seat upcharge:	<b>+0</b>	<b>+32</b>	<b>+57</b>	<b>+94</b>	<b>+146</b>	<b>+168</b>	<b>+213</b>	<b>+284</b>	<b>+337</b>	<b>+395</b>	<b>+516</b>	<b>+643</b>	
	<b>8038PHF</b> Base Price:	\$3369												
	Back/Arm upcharge:	<b>+0</b>	<b>+104</b>	<b>+186</b>	<b>+306</b>	<b>+475</b>	<b>+546</b>	<b>+693</b>	<b>+923</b>	<b>+1096</b>	<b>+1284</b>	<b>+1677</b>	<b>+2090</b>	
	Seat upcharge:	<b>+0</b>	<b>+40</b>	<b>+72</b>	<b>+118</b>	<b>+183</b>	<b>+210</b>	<b>+267</b>	<b>+355</b>	<b>+422</b>	<b>+494</b>	<b>+645</b>	<b>+804</b>	
	<b>OVERALL DIMENSIONS</b>		<b>W</b>	<b>D</b>	<b>H</b>	<b>SEAT DIMENSIONS</b>			<b>BACK DIMENSIONS</b>		<b>W</b>	<b>H</b>		
			29	31.5	44.5	21.5	20	17	21	27.5				
	"F" model = Flip Forward Seat for ease of cleaning  Add \$123 for (SBS) Add \$32 for (SSS); \$48 (F model)					<b>RTA 00</b>			1 per carton					
	 <p><b>Counter Stool, Sled Base</b>                      COM Yardage: Back: 1; Seat: 1                      Freight Class: 250                      Product Weight (lbs.): 32                      Cubic Feet Per Carton: 9</p>	<b>8051</b> Base Price:	\$1269											
Back/Arm upcharge:		<b>+0</b>	<b>+32</b>	<b>+57</b>	<b>+94</b>	<b>+146</b>	<b>+168</b>	<b>+213</b>	<b>+284</b>	<b>+337</b>	<b>+395</b>	<b>+516</b>	<b>+643</b>	
Seat upcharge:		<b>+0</b>	<b>+16</b>	<b>+29</b>	<b>+47</b>	<b>+73</b>	<b>+84</b>	<b>+107</b>	<b>+142</b>	<b>+169</b>	<b>+198</b>	<b>+258</b>	<b>+322</b>	
<b>OVERALL DIMENSIONS</b>		<b>W</b>	<b>D</b>	<b>H</b>	<b>SEAT DIMENSIONS</b>			<b>BACK DIMENSIONS</b>		<b>W</b>	<b>H</b>			
		19.25	19	35	15.5	15.75	24.75	12.5	10					
Add \$32 for (SBS) Add \$20 for (SSS)					<b>RTA 00</b>			1 per carton						
 <p><b>Counter Stool, Wood Base</b>                      COM Yardage: Back: 1; Seat: 1                      Freight Class: 250                      Product Weight (lbs.): 28</p>		<b>8052</b> Base Price:	\$1988											
		Back/Arm upcharge:	<b>+0</b>	<b>+32</b>	<b>+57</b>	<b>+94</b>	<b>+146</b>	<b>+168</b>	<b>+213</b>	<b>+284</b>	<b>+337</b>	<b>+395</b>	<b>+516</b>	<b>+643</b>
		Seat upcharge:	<b>+0</b>	<b>+16</b>	<b>+29</b>	<b>+47</b>	<b>+73</b>	<b>+84</b>	<b>+107</b>	<b>+142</b>	<b>+169</b>	<b>+198</b>	<b>+258</b>	<b>+322</b>
		<b>OVERALL DIMENSIONS</b>		<b>W</b>	<b>D</b>	<b>H</b>	<b>SEAT DIMENSIONS</b>			<b>BACK DIMENSIONS</b>		<b>W</b>	<b>H</b>	
			19.25	19	35	15.5	15.75	24.75	12.5	10				
	Add \$32 for (SBS) Add \$20 for (SSS)					<b>RTA 00</b>		<b>FedEx</b>	<b>ups</b>	1 per carton				
	 <p><b>Counter Stool, Chrome Swivel Base</b>                      COM Yardage: Back: 1; Seat: 1                      Freight Class: 250                      Product Weight (lbs.): 43                      Cubic Feet Per Carton: 11.5</p>	<b>8053</b> Base Price:	\$2419											
		Back/Arm upcharge:	<b>+0</b>	<b>+32</b>	<b>+57</b>	<b>+94</b>	<b>+146</b>	<b>+168</b>	<b>+213</b>	<b>+284</b>	<b>+337</b>	<b>+395</b>	<b>+516</b>	<b>+643</b>
		Seat upcharge:	<b>+0</b>	<b>+16</b>	<b>+29</b>	<b>+47</b>	<b>+73</b>	<b>+84</b>	<b>+107</b>	<b>+142</b>	<b>+169</b>	<b>+198</b>	<b>+258</b>	<b>+322</b>
		<b>OVERALL DIMENSIONS</b>		<b>W</b>	<b>D</b>	<b>H</b>	<b>SEAT DIMENSIONS</b>			<b>BACK DIMENSIONS</b>		<b>W</b>	<b>H</b>	
		19.25	20	34.5	15.5	15.75	24.75	12.5	10					
Add \$32 for (SBS) Add \$20 for (SSS)					<b>RTA 00</b>			1 per carton						
 <p><b>Bar Stool, Sled Base</b>                      COM Yardage: Back: 1; Seat: 1                      Freight Class: 250                      Product Weight (lbs.): 34.5                      Cubic Feet Per Carton: 11</p>		<b>8054</b> Base Price:	\$1366											
		Back/Arm upcharge:	<b>+0</b>	<b>+32</b>	<b>+57</b>	<b>+94</b>	<b>+146</b>	<b>+168</b>	<b>+213</b>	<b>+284</b>	<b>+337</b>	<b>+395</b>	<b>+516</b>	<b>+643</b>
		Seat upcharge:	<b>+0</b>	<b>+16</b>	<b>+29</b>	<b>+47</b>	<b>+73</b>	<b>+84</b>	<b>+107</b>	<b>+142</b>	<b>+169</b>	<b>+198</b>	<b>+258</b>	<b>+322</b>
		<b>OVERALL DIMENSIONS</b>		<b>W</b>	<b>D</b>	<b>H</b>	<b>SEAT DIMENSIONS</b>			<b>BACK DIMENSIONS</b>		<b>W</b>	<b>H</b>	
			19.25	20	40.25	15.5	15.75	30.25	12.5	10				
	Add \$32 for (SBS) Add \$20 for (SSS)					<b>RTA 00</b>			1 per carton					

DESCRIPTION	MODEL#/ FEATURES	STANDARD TEXTILE GRADES												
		1/COM	2	3	4	5	6	7	8	9	10	11	12	
 <p><b>Bar Stool, Wood Base</b> COM Yardage: Back: 1; Seat: .5 Freight Class: 250 Product Weight (lbs.): 30 Cubic Feet Per Carton: 11</p>	8055	Base Price:	\$2084											
		Back/Arm upcharge:	+0	+32	+57	+94	+146	+168	+213	+284	+337	+395	+516	+643
		Seat upcharge:	+0	+16	+29	+47	+73	+84	+107	+142	+169	+198	+258	+322
		<b>OVERALL DIMENSIONS</b>												
		<b>W D H</b>	19.25	20	40	15.5	15.75	30	12.5	10				
		Add \$32 for (SBS)												
		Add \$20 for (SSS)												
					<b>RTA 00</b>	<b>FedEx</b>								
													1 per carton	

 <p><b>Bar Stool, Chrome Swivel Base</b> COM Yardage: Back: 1; Seat: .5 Freight Class: 250 Product Weight (lbs.): 45.5 Cubic Feet Per Carton: 13.25</p>	8056	Base Price:	\$2514											
		Back/Arm upcharge:	+0	+32	+57	+94	+146	+168	+213	+284	+337	+395	+516	+643
		Seat upcharge:	+0	+16	+29	+47	+73	+84	+107	+142	+169	+198	+258	+322
		<b>OVERALL DIMENSIONS</b>												
		<b>W D H</b>	19.25	20	40	15.5	15.75	30	12.5	10				
		Add \$32 for (SBS)												
		Add \$20 for (SSS)												
					<b>RTA 00</b>									
													1 per carton	

DRIFT TABLES



model 8041R2616C  
26"W x 16"H Round Table,  
Laminate Surface, Flat Edge,  
Chrome Base



model 8042SQ2816I  
28"W x 16"H Square Table,  
Laminate Surface, Flat Edge,  
Sled Base



Model 8042SQ2816W  
28"W x 16"H Square Table,  
Laminate Surface, Flat Edge  
Wood Base



For Drift seating, see page 314

EXAMPLE OF TABLE ORDER CODE:

8041R2616I	TFL	ACJ	TBL	CG
Model Number	Surface Type	Top HPL Finish	Base Finish (Sled Base)	Glide Type (Sled Base)

STANDARD FEATURES

- Tables are available in three shapes, multiple sizes, two edge styles, three top materials and three base types including: sled, wood and polished Chrome bases.
- Table bases are fixed and do not swivel.
- Wood bases are made from beechwood and are available in all standard wood finishes.
- Sled bases are standard in painted metal.
- Chrome base tables are available in polished Chrome only.
- All table tops are available with flat edge. High pressure laminate (HPL) and solid surface top tables are also available with knife edge.
- Laminate flat edge tops are available in either (TFL) 1" thick thermally fused laminate with 2mm edgeband or (HPL) 1-1/16" thick high pressure laminate with 2mm edgeband, with upcharge.
- Laminate knife edge tops are 1-3/16" thick with 2.5mm edgeband, available in high pressure laminate (HPL) only.
- Solid surface tabletops are 1.25" thick, available on models with flat or knife edge. For detailed material information, please reference WilsonArt's Solid Surface collection.
- Wood and Chrome bases are equipped with White non-marking polycarbonate glides suitable for most hard and carpeted floor surfaces.
- Sled bases are available with clear polycarbonate glides, standard.
- Wood and sled bases may be specified with a variety of optional glide types to suit various flooring materials. (See Glide Types for additional glide options and upcharges.)
- Tables are shipped fully assembled.

Add option codes in the following order:

- **Model Number**  
Specify model number
- **Surface Type** (Laminate, Flat Edge Tables)  
(TFL) Thermally fused laminate  
(HPL) High pressure laminate
- **Top Finish** (TFL or HPL laminate, flat edge tables and HPL laminate knife edge tables only)  
HPL upcharges apply -see model  
(ACJ) Absolute Acajou (ASN) Asian Night  
(AWC) Avant Cherry (AWH) Avant Honey  
(BLK) Black (BRC) Brushed Cobalt  
(CMB) Clear Maple (DES) Dark Espresso  
(DWT) Designer White (FAS) Fashionista  
(FCL) First Class (NBL) Noce Biondo  
(NGL) Noce Grigio (NEL) Noce Leggero  
(NML) Noce Medio  
(QTM) Quartered Mahogany  
(SBY) Sheer Beauty (SOG) Storm Grey  
(WHE) Walnut Heights (WHC) White Chocolate  
(WCR) Winter Cherry
- **Top Finish** (solid surface, flat and knife edge tables)  
Grade 1  
(SWH) Designer White  
Grade 2, Upcharge applicable, see models.  
(SBT) Beige Tempest  
(SBX) Black Onyx Mirage  
(SMG) Milk Glass Spectra  
(SFW) Frosty White Mirage  
(SHS) Hot Stone  
(SNM) Northern Melange
- **Base finish** (sled base models only)  
Paint finishes:  
(TBL) Black (TTU) Tungsten  
(TSH) Shadow (TDW) Designer White  
(TNE) Nevada (TLA) Latte  
(TKA) Kalua (TMO) Mocha  
(TOA) Toast (TFO) Fog  
(TIV) Cloud (TSN) Sand  
(TFR) Frost (TDJ) Dijon  
(TCR) Carrot (TSR) Scarlet  
(TCC) Cactus (TBZ) Buzz Blue  
(TEG) Eggplant (TIN) Ink  
  
Metallic finish:  
(CHM) Chrome. Add \$42
- **Base Finish** (Chrome base only)  
(CHM) Chrome
- **Glide Type** (sled base)  
(CG) Clear, polycarbonate glide for most floor surfaces (standard)  
(XG) No glide for carpeted surfaces, no charge  
(SG) Steel cushioned glide for carpeted surface. Add \$34  
(RG) Rubber, non-slip glide for most hard floor surfaces. Add \$34  
(FG) Felt glide for most hard floor surfaces. Add \$34
- **Glide Type** (wood base)  
(NM) White non-marking nylon glide for most surfaces (standard)  
(SG) Steel cushioned glides for carpeted surfaces. Add \$34.  
(RG) Non-slip rubber glides for most hard floor surfaces. Add \$34.  
(FG) Felt glides for most hard floor surfaces. Add \$34.

ROUND LAPTOP TABLES FOR OFFSET BASE



Round Table with Sled Base

MODEL#	DIMENSIONS	FREIGHT CLASS	WT/LBS.	CUBIC FT.	LIST PRICE	HP ADD	GR. 2 ADD
--------	------------	---------------	---------	-----------	------------	--------	-----------

D x W x H

**Laminate, flat edge (TFL laminate)**

8041R2616I	26 x 26 x 16	250	35	10.25	<b>\$561</b>	<b>\$98</b>	n/a
8041R3016I	30 x 30 x 16	250	44	13	<b>\$591</b>	<b>\$115</b>	n/a
8041R2120I	21 x 21 x 20	250	29	8.75	<b>\$587</b>	<b>\$97</b>	n/a

**Laminate, knife edge (HPL laminate)**

8041R2616IK	26 x 26 x 16	250	35	10.25	<b>\$1199</b>	n/a	n/a
8041R3016IK	30 x 30 x 16	250	44	13	<b>\$1284</b>	n/a	n/a
8041R2120IK	21 x 21 x 20	250	29	8.75	<b>\$996</b>	n/a	n/a

**Solid surface, flat edge**

8041R2616ISF	26 x 26 x 16	150	48	10.25	<b>\$2343</b>	n/a	<b>\$158</b>
8041R3016ISF	30 x 30 x 16	150	61	13	<b>\$2522</b>	n/a	<b>\$218</b>
8041R2120ISF	21 x 21 x 20	150	37.5	8.75	<b>\$2204</b>	n/a	<b>\$109</b>

**Solid surface, knife edge**

8041R2616ISK	26 x 26 x 16	150	48	10.25	<b>\$2397</b>	n/a	<b>\$169</b>
8041R3016ISK	30 x 30 x 16	150	61	13	<b>\$2603</b>	n/a	<b>\$234</b>
8041R2120ISK	21 x 21 x 20	150	37.5	8.75	<b>\$2302</b>	n/a	<b>\$115</b>

Finished height will vary depending on material top. Shipped fully assembled in 1 carton.



Square Table with Sled Base

**Laminate, flat edge (TFL laminate)**

8042SQ2216I	22 x 22 x 16	150	34	8	<b>\$561</b>	<b>\$98</b>	n/a
8042SQ2816I	28 x 28 x 16	250	44	11.75	<b>\$591</b>	<b>\$115</b>	n/a
8042SQ1920I	19 x 19 x 20	250	29	7.75	<b>\$568</b>	<b>\$88</b>	n/a

**Laminate, knife edge (HPL laminate)**

8042SQ2216IK	22 x 22 x 16	150	34	8	<b>\$996</b>	n/a	n/a
8042SQ2816IK	28 x 28 x 16	250	44	11.75	<b>\$1248</b>	n/a	n/a
8042SQ1920IK	19 x 19 x 20	250	29	7.75	<b>\$955</b>	n/a	n/a

**Solid surface, flat edge**

8042SQ2216ISF	22 x 22 x 16	150	39.5	8	<b>\$2065</b>	n/a	<b>\$136</b>
8042SQ2816ISF	28 x 28 x 16	150	62.5	11.75	<b>\$2365</b>	n/a	<b>\$218</b>
8042SQ1920ISF	19 x 19 x 20	150	38	7.75	<b>\$1976</b>	n/a	<b>\$164</b>

**Solid surface, knife edge**

8042SQ2216ISK	22 x 22 x 16	150	39.5	8	<b>\$2397</b>	n/a	<b>\$164</b>
8042SQ2816ISK	28 x 28 x 16	150	62.5	11.75	<b>\$2819</b>	n/a	<b>\$245</b>
8042SQ1920ISK	19 x 19 x 20	150	38	7.75	<b>\$2302</b>	n/a	<b>\$120</b>

Finished height will vary depending on material top. Shipped fully assembled in 1 carton.



ROUND LAPTOP TABLES FOR OFFSET BASE

MODEL# DIMENSIONS FREIGHT CLASS WT/LBS. CUBIC FT. LIST PRICE HP ADD GR. 2 ADD

D x W x H

Laminate, flat edge (TFL laminate)

80430V2616I	26 x 22 x 16	150	36.5	8.75	\$561	\$98	n/a
80430V3116I	31 x 26 x 16	250	46	11.75	\$591	\$115	n/a
80430V2220I	22 x 18 x 20	250	34	10.75	\$587	\$97	n/a

Laminate, knife edge (HPL laminate)

80430V2616IK	26 x 22 x 16	150	36.5	8.75	\$1199	n/a	n/a
80430V3116IK	31 x 26 x 16	250	46	11.75	\$1365	n/a	n/a
80430V2220IK	22 x 18 x 20	250	34	10.75	\$1113	n/a	n/a

Solid surface, flat edge

80430V2616ISF	26 x 22 x 16	150	42	8.75	\$2343	n/a	\$158
80430V3116ISF	31 x 26 x 16	150	60	11.75	\$2522	n/a	\$218
80430V2220ISF	22 x 18 x 20	250	38	10.75	\$2204	n/a	\$109

Solid surface, knife edge

80430V2616ISK	26 x 22 x 16	150	42	8.75	\$2397	n/a	\$169
80430V3116ISK	31 x 26 x 16	150	60	11.75	\$2603	n/a	\$234
80430V2220ISK	22 x 18 x 20	250	38	10.75	\$2302	n/a	\$115

Finished height will vary depending on material top. Shipped fully assembled in 1 carton.



Oval Table with Sled Base

Laminate, flat edge (TFL laminate)

8041R2616C	26 x 26 x 16	250	38	10.75	\$1058	\$98	n/a
8041R3016C	30 x 30 x 16	250	45	13	\$1088	\$115	n/a

Laminate, knife edge (HPL laminate)

8041R2616CK	26 x 26 x 16	250	38	10.75	\$1696	n/a	n/a
8041R3016CK	30 x 30 x 16	250	45	13	\$1782	n/a	n/a

Solid surface, flat edge

8041R2616CSF	26 x 26 x 16	150	51	10.75	\$2840	n/a	\$158
8041R3016CSF	30 x 30 x 16	150	62.5	13	\$3019	n/a	\$218

Solid surface, knife edge

8041R2616CSK	26 x 26 x 16	150	51	10.75	\$2894	n/a	\$169
8041R3016CSK	30 x 30 x 16	250	31.25	13	\$3101	n/a	\$234

Finished height will vary depending on material top. Shipped fully assembled in 1 carton.



Round Table with Polished Chrome Base

Laminate, flat edge (TFL laminate)

8041R2616W	26 x 26 x 16	250	32	10.75	\$1204	\$98	n/a
8041R3016W	30 x 30 x 16	250	40	13	\$1234	\$115	n/a

Laminate, knife edge (HPL laminate)

8041R2616WK	26 x 26 x 16	250	32	10.75	\$1842	n/a	n/a
8041R3016WK	30 x 30 x 16	250	40	13	\$1927	n/a	n/a

Solid surface, flat edge

8041R2616WSF	26 x 26 x 16	150	45.5	10.75	\$2985	n/a	\$158
8041R3016WSF	30 x 30 x 16	150	57.5	13	\$3165	n/a	\$218

Solid surface, knife edge

8041R2616WSK	26 x 26 x 16	150	45.5	10.75	\$3040	n/a	\$169
8041R3016WSK	30 x 30 x 16	150	57.5	13	\$3246	n/a	\$234

Finished height will vary depending on material top. Shipped fully assembled in 1 carton.



Round Table with Wood Base



ROUND LAPTOP TABLES FOR OFFSET BASE



Square Table with Polished Chrome Base

MODEL#	DIMENSIONS	FREIGHT CLASS	WT/LBS.	CUBIC FT.	LIST PRICE	HP ADD	GR. 2 ADD
<b>D x W x H</b>							
<b>Laminate, flat edge (TFL laminate)</b>							
8042SQ2216C	22.75 x 22.75 x 16	150	36	7.75	<b>\$1058</b>	<b>\$98</b>	n/a
8042SQ2816C	28.5 x 28.5 x 16	250	45	11.5	<b>\$1088</b>	<b>\$115</b>	n/a
<b>Laminate, knife edge (HPL laminate)</b>							
8042SQ2216CK	22.75 x 22.75 x 16	150	36	7.75	<b>\$1493</b>	n/a	n/a
8042SQ2816CK	28.5 x 28.5 x 16	250	45	11.5	<b>\$1588</b>	n/a	n/a
<b>Solid surface, flat edge</b>							
8042SQ2216CSF	22.75 x 22.75 x 16	150	41	7.75	<b>\$2563</b>	n/a	<b>\$136</b>
8042SQ2816CSF	28.5 x 28.5 x 16	150	57.5	11.5	<b>\$2862</b>	n/a	<b>\$218</b>
<b>Solid surface, knife edge</b>							
8042SQ2216CSK	22.75 x 22.75 x 16	150	41	7.75	<b>\$2894</b>	n/a	<b>\$164</b>
8042SQ2816CSK	28.5 x 28.5 x 16	150	57.5	11.5	<b>\$3316</b>	n/a	<b>\$245</b>

Finished height will vary depending on material top. Shipped fully assembled in 1 carton.



Square Table with Wood Base

<b>Laminate, flat edge (HPL laminate)</b>							
8042SQ2216W	22.75 x 22.75 x 16	250	30	7.75	<b>\$1204</b>	<b>\$98</b>	n/a
8042SQ2816W	28.5 x 28.5 x 16	250	39	11.5	<b>\$1234</b>	<b>\$115</b>	n/a
<b>Laminate, knife edge (HPL laminate)</b>							
8042SQ2216WK	22.75 x 22.75 x 16	250	30	7.75	<b>\$1639</b>	n/a	n/a
8042SQ2816WK	28.5 x 28.5 x 16	250	39	11.5	<b>\$1734</b>	n/a	n/a
<b>Solid surface, flat edge</b>							
8042SQ2216WSF	22.75 x 22.75 x 16	150	36	7.75	<b>\$2708</b>	n/a	<b>\$136</b>
8042SQ2816WSF	28.5 x 28.5 x 16	150	59	11.5	<b>\$3008</b>	n/a	<b>\$218</b>
<b>Solid surface, knife edge</b>							
8042SQ2216WSK	22.75 x 22.75 x 16	150	36	7.75	<b>\$3040</b>	n/a	<b>\$164</b>
8042SQ2816WSK	28.5 x 28.5 x 16	150	59	11.5	<b>\$3462</b>	n/a	<b>\$245</b>

Finished height will vary depending on material top. Shipped fully assembled in 1 carton.

ROUND LAPTOP TABLES FOR OFFSET BASE

MODEL# DIMENSIONS FREIGHT CLASS WT/LBS. CUBIC FT. LIST PRICE HP ADD GR. 2 ADD

D x W x H



Oval Table with Polished Chrome Base

Laminate, flat edge

80430V2616C	26 x 22 x 16	150	38	9.25	<b>\$1058</b>	<b>\$98</b>	n/a
80430V3116C	31 x 26 x 16	250	44	11.75	<b>\$1088</b>	<b>\$115</b>	n/a

Laminate, knife edge

80430V2616CK	26 x 22 x 16	150	38	9.25	<b>\$1696</b>	n/a	n/a
80430V3116CK	31 x 26 x 16	250	44	11.75	<b>\$1862</b>	n/a	n/a

Solid surface, flat edge

80430V2616CSF	26 x 22 x 16	150	49.5	9.25	<b>\$2840</b>	n/a	<b>\$158</b>
80430V3116CSF	31 x 26 x 16	150	61.5	11.75	<b>\$3019</b>	n/a	<b>\$218</b>

Solid surface, knife edge

80430V2616CSK	26 x 22 x 16	150	49.5	9.25	<b>\$2894</b>	n/a	<b>\$169</b>
80430V3116CSK	31 x 26 x 16	150	61.5	11.75	<b>\$3101</b>	n/a	<b>\$234</b>

Finished height will vary depending on material top. Shipped fully assembled in 1 carton.



Oval Table with Wood Base

Laminate, flat edge

80430V2616W	26 x 22 x 16	250	32	9.25	<b>\$1204</b>	<b>\$98</b>	n/a
80430V3116W	31 x 26 x 16	250	39	11.75	<b>\$1234</b>	<b>\$115</b>	n/a

Laminate, knife edge

80430V2616WK	26 x 22 x 16	250	32	9.25	<b>\$1842</b>	n/a	n/a
80430V3116WK	31 x 26 x 16	250	39	11.75	<b>\$2008</b>	n/a	n/a

Solid surface, flat edge

80430V2616WSF	26 x 22 x 16	150	44.5	9.25	<b>\$2985</b>	n/a	<b>\$158</b>
80430V3116WSF	31 x 26 x 16	150	56.5	11.75	<b>\$3165</b>	n/a	<b>\$218</b>

Solid surface, knife edge

80430V2616WSK	26 x 22 x 16	150	44.5	9.25	<b>\$3040</b>	n/a	<b>\$169</b>
80430V3116WSK	31 x 26 x 16	150	56.5	11.75	<b>\$3246</b>	n/a	<b>\$234</b>

Finished height will vary depending on material top. Shipped fully assembled in 1 carton.

JEO



model 8434



model 8433-4



Optional Quilted Stitch Back (Q).



model 8435-2224



model 8436-1530



Optional 5 prong base with glides (G).

STANDARD FEATURES

- Jeo is a contemporary, retro - inspired series with versatility for a variety of workplace applications.
- The tailored box styling functions well in lounge, conferencing, collaboration and side/guest environments.
- Three seating models: swivel tilter with a 5 prong caster base, a swivel self-centering return with a stationary round pedestal base or a matching four legged Arm Chair.
- Model 8433-4 is standard with a five prong Black nylon base with carpet casters (C1).
- Model 8437 is standard with Black four-legged frame.
- Jeo also offers two styles of matching pedestal base occasional tables with a round or square laminate top, available in two height sizes --- 15" and 22" high.
- Upholstery options: fabric, vinyl, leather or a combination of two or more materials. The upholstery surfaces are seamed together with tailored double stitch detailing.
- Check textile availability prior to specifying upholstery material.

OPTIONAL FEATURES

- Chairs are available with an Optional Quilted Stitch back. Please specify (Q). Add \$212.
- Model 8433-4 has an optional five prong Aluminum base. specify (AL). Add \$63.
- Optional 5 prong Aluminum base with hard glides. Please specify (C7).
- Optional soft casters are available on the 5 prong base. Please specify (C9R) . Add \$72.
- Model 8434 round pedestal base available in Chrome (CHM) or Brushed Chrome (BCH). Please specify.
- Model 8437 has optional Chrome (CHM) or Brushed Chrome (BCH) four-legged frame.
- Occasional tables are available in the following laminate finishes to coordinate with Global Desking and wood seating: Absolute Acajou (ACJ), Asian Night (ASN), Avant Cherry (AWC), Avant Honey (AWH), Black (BLK), Brushed Cobalt (BRC), Clear Maple (CMB), Dark Espresso (DES), Designer White (DWT), Fashionista (FAS), First Class (FCL), Noce Biondo (NBL), Noce Grigio (NGL), Noce Leggero (NEL), Noce Medio (NML), Quartered Mahogany (QTM), Sheer Beauty (SBY), Walnut Heights (WHE), White Chocolate (WHC), and Winter Cherry (WCR). Please Specify.

DESCRIPTION	FEATURES	MODEL#	STANDARD TEXTILE GRADES											
			1	2	3	4	5	6	7	8	9	10	11	12



Self-Centering Lounge Chair on Pedestal Base

COM Yardage: 2.75  
 Freight Class: 250  
 Product Weight (lbs.): 50  
 Cubic Feet Per Carton: 22

Ergonomic Features:  
 C

8434	2345	2435	2505	2609	2757	2809	2938	3184	3305	3532	3843	4229
------	------	------	------	------	------	------	------	------	------	------	------	------

OVERALL DIMENSIONS			SEAT DIMENSIONS			BACK DIMENSIONS	
W	D	H	W	D	H	W	H

26	25	30-32.5	20	19	16.5-19	20	15
----	----	---------	----	----	---------	----	----



Swivel Tilter Chair

COM Yardage: 2.75  
 Freight Class: 250  
 Product Weight (lbs.): 50  
 Cubic Feet Per Carton: 22

Ergonomic Features:  
 A, B, C, S

8433-4	1591	1703	1788	1918	2101	2187	2353	2616	2822	3048	3515	4013
--------	------	------	------	------	------	------	------	------	------	------	------	------

OVERALL DIMENSIONS			SEAT DIMENSIONS			BACK DIMENSIONS	
W	D	H	W	D	H	W	H

26	25	30-32.5	20	19	16.5-19	20	15
----	----	---------	----	----	---------	----	----





Arm Chair



COM Yardage: 2.75  
 Freight Class: 250  
 Product Weight (lbs.): 50  
 Cubic Feet Per Carton: 22

8437	1549	1649	1724	1838	1997	2074	2219	2451	2629	2827	3238	3673
------	------	------	------	------	------	------	------	------	------	------	------	------

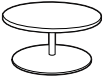
OVERALL DIMENSIONS			SEAT DIMENSIONS			BACK DIMENSIONS	
W	D	H	W	D	H	W	H

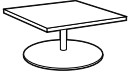
26	25	34	20	19	18	20	15
----	----	----	----	----	----	----	----

DESCRIPTION	FEATURES	MODEL#	STANDARD TEXTILE GRADES																		
			1	2	3	4	5	6	7	8	9	10	11	12							
 <p><b>15" H Round End Table - 24" Dia. Top on Pedestal Base</b>                      COM Yardage: n/a                      Freight Class: 150                      Product Weight (lbs.): 44                      Cubic Feet Per Carton: 10</p>		<b>8435-1524</b>	1442																		
					<b>OVERALL DIMENSIONS</b>			<b>SEAT DIMENSIONS</b>			<b>BACK DIMENSIONS</b>										
					<b>W</b>	<b>Dia.</b>	<b>H</b>	<b>W</b>	<b>D</b>	<b>H</b>	<b>W</b>	<b>H</b>									
					24		15														
							FedEx		ups												
 <p><b>15" H Round Coffee Table - 30" Dia. Top on Pedestal Base</b>                      COM Yardage: n/a                      Freight Class: 150                      Product Weight (lbs.): 44                      Cubic Feet Per Carton: 10</p>		<b>8435-1530</b>	1683																		
					<b>OVERALL DIMENSIONS</b>			<b>SEAT DIMENSIONS</b>			<b>BACK DIMENSIONS</b>										
					<b>W</b>	<b>Dia.</b>	<b>H</b>	<b>W</b>	<b>D</b>	<b>H</b>	<b>W</b>	<b>H</b>									
					30		15														
 <p><b>22" H Round End Table - 24" Dia. Top on Pedestal Base</b>                      COM Yardage: n/a                      Freight Class: 150                      Product Weight (lbs.): 44                      Cubic Feet Per Carton: 10</p>		<b>8435-2224</b>	1579																		
					<b>OVERALL DIMENSIONS</b>			<b>SEAT DIMENSIONS</b>			<b>BACK DIMENSIONS</b>										
					<b>W</b>	<b>Dia.</b>	<b>H</b>	<b>W</b>	<b>D</b>	<b>H</b>	<b>W</b>	<b>H</b>									
					24		22														
							FedEx		ups												
 <p><b>22" H Round Coffee Table - 30" Dia. Top on Pedestal Base</b>                      COM Yardage: n/a                      Freight Class: 150                      Product Weight (lbs.): 44                      Cubic Feet Per Carton: 10</p>		<b>8435-2230</b>	1819																		
					<b>OVERALL DIMENSIONS</b>			<b>SEAT DIMENSIONS</b>			<b>BACK DIMENSIONS</b>										
					<b>W</b>	<b>Dia.</b>	<b>H</b>	<b>W</b>	<b>D</b>	<b>H</b>	<b>W</b>	<b>H</b>									
					30		22														
 <p><b>15" H Square End Table - 24" Top on Pedestal Base</b>                      COM Yardage: n/a                      Freight Class: 150                      Product Weight (lbs.): 44                      Cubic Feet Per Carton: 10</p>		<b>8436-1524</b>	1442																		
					<b>OVERALL DIMENSIONS</b>			<b>SEAT DIMENSIONS</b>			<b>BACK DIMENSIONS</b>										
					<b>W</b>	<b>D</b>	<b>H</b>	<b>W</b>	<b>D</b>	<b>H</b>	<b>W</b>	<b>H</b>									
					24	24	15														

DESCRIPTION	FEATURES	MODEL#	STANDARD TEXTILE GRADES														
			1	2	3	4	5	6	7	8	9	10	11	12			
 <p><b>15" H Square End Coffee - 30" Top on Pedestal Base</b>                      COM Yardage: n/a                      Freight Class: 150                      Product Weight (lbs.): 44                      Cubic Feet Per Carton: 10</p>		<b>8436-1530</b>	1683														
 <p><b>22" H Square End Table - 24" Top on Pedestal Base</b>                      COM Yardage: n/a                      Freight Class: 150                      Product Weight (lbs.): 44                      Cubic Feet Per Carton: 10</p>		<b>8436-2224</b>	1579														
 <p><b>22" H Square End Coffee - 30" Top on Pedestal Base</b>                      COM Yardage: n/a                      Freight Class: 150                      Product Weight (lbs.): 44                      Cubic Feet Per Carton: 10</p>		<b>8436-2230</b>	1819														

KATE®



model 2811-4





model 2811-8

STANDARD FEATURES

- A contemporary, yet retro series featuring sculpted seat and back cushions.
- Fully upholstered closed arms offer a unique style and function in the workplace.
- Models are standard with a five legged Polished Aluminum base.
- C10 casters are standard.
- Check textile availability prior to specifying upholstery material.

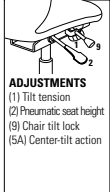
OPTIONAL FEATURES

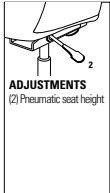
- An optional Black injection molded base is available at no upcharge, please specify (BK).
- There are no caster options for this series. C7 glides can be specified at no upcharge.
- For hard surface flooring please specify C10R. Add \$66.
- For fully assembled in box, specify SU. Add \$76.

DESCRIPTION	FEATURES	MODEL#	STANDARD TEXTILE GRADES																								
			1	2	3	4	5	6	7	8	9	10	11	12													
 <p><b>MB Tilter</b> COM Yardage: 3.75 Freight Class: 250 Product Weight (lbs.): 47 Cubic Feet Per Carton: 15.75</p>	 <p><b>ADJUSTMENTS</b> (1) Tilt tension (2) Pneumatic seat height (9) Chair tilt lock (5A) Center-tilt action</p>	<p>Ergonomic Features: A, B, C, N</p>	<table border="1"> <tr> <td>2811-4</td> <td>\$1412</td> <td>\$1549</td> <td>\$1660</td> <td>\$1824</td> <td>\$2055</td> <td>\$2141</td> <td>\$2342</td> <td>\$2732</td> <td>\$2918</td> <td>\$3277</td> <td>\$3767</td> <td>\$4374</td> </tr> </table>												2811-4	\$1412	\$1549	\$1660	\$1824	\$2055	\$2141	\$2342	\$2732	\$2918	\$3277	\$3767	\$4374
			2811-4	\$1412	\$1549	\$1660	\$1824	\$2055	\$2141	\$2342	\$2732	\$2918	\$3277	\$3767	\$4374												
			<p><b>OVERALL DIMENSIONS</b></p> <table border="1"> <tr> <th>W</th> <th>D</th> <th>H</th> </tr> <tr> <td>26</td> <td>24.5</td> <td>33</td> </tr> </table>			W	D	H	26	24.5	33	<p><b>SEAT DIMENSIONS</b></p> <table border="1"> <tr> <th>W</th> <th>D</th> <th>H</th> </tr> <tr> <td>17.5</td> <td>18</td> <td>17.5-21.50</td> </tr> </table>			W	D	H	17.5	18	17.5-21.50	<p><b>BACK DIMENSIONS</b></p> <table border="1"> <tr> <th>W</th> <th>H</th> </tr> <tr> <td>19</td> <td>15.5</td> </tr> </table>			W	H	19	15.5
			W	D	H																						
26	24.5	33																									
W	D	H																									
17.5	18	17.5-21.50																									
W	H																										
19	15.5																										
<p>RTA 00</p>																											
<p>RTA 00</p>																											
 <p><b>MB Swivel</b> COM Yardage: 3.75 Freight Class: 250 Product Weight (lbs.): 43 Cubic Feet Per Carton: 15.75</p>	 <p><b>ADJUSTMENTS</b> (2) Pneumatic seat height</p>	<p>Ergonomic Features: C, N</p>	<table border="1"> <tr> <td>2811-8</td> <td>\$1362</td> <td>\$1504</td> <td>\$1615</td> <td>\$1776</td> <td>\$2008</td> <td>\$2094</td> <td>\$2296</td> <td>\$2685</td> <td>\$2871</td> <td>\$3229</td> <td>\$3719</td> <td>\$4327</td> </tr> </table>												2811-8	\$1362	\$1504	\$1615	\$1776	\$2008	\$2094	\$2296	\$2685	\$2871	\$3229	\$3719	\$4327
			2811-8	\$1362	\$1504	\$1615	\$1776	\$2008	\$2094	\$2296	\$2685	\$2871	\$3229	\$3719	\$4327												
			<p><b>OVERALL DIMENSIONS</b></p> <table border="1"> <tr> <th>W</th> <th>D</th> <th>H</th> </tr> <tr> <td>26</td> <td>24.5</td> <td>33</td> </tr> </table>			W	D	H	26	24.5	33	<p><b>SEAT DIMENSIONS</b></p> <table border="1"> <tr> <th>W</th> <th>D</th> <th>H</th> </tr> <tr> <td>17.5</td> <td>18</td> <td>17.5-21.50</td> </tr> </table>			W	D	H	17.5	18	17.5-21.50	<p><b>BACK DIMENSIONS</b></p> <table border="1"> <tr> <th>W</th> <th>H</th> </tr> <tr> <td>19</td> <td>15.5</td> </tr> </table>			W	H	19	15.5
			W	D	H																						
26	24.5	33																									
W	D	H																									
17.5	18	17.5-21.50																									
W	H																										
19	15.5																										
<p>RTA 00</p>																											
<p>RTA 00</p>																											
 <p><b>Armchair</b> COM Yardage: 3.75 Freight Class: 250 Product Weight (lbs.): 42 Cubic Feet Per Carton: 15.75</p>		<p>Ergonomic Features: N</p>	<table border="1"> <tr> <td>2813</td> <td>\$1543</td> <td>\$1676</td> <td>\$1782</td> <td>\$1937</td> <td>\$2158</td> <td>\$2237</td> <td>\$2431</td> <td>\$2801</td> <td>\$2979</td> <td>\$3322</td> <td>\$3787</td> <td>\$4367</td> </tr> </table>												2813	\$1543	\$1676	\$1782	\$1937	\$2158	\$2237	\$2431	\$2801	\$2979	\$3322	\$3787	\$4367
			2813	\$1543	\$1676	\$1782	\$1937	\$2158	\$2237	\$2431	\$2801	\$2979	\$3322	\$3787	\$4367												
			<p><b>OVERALL DIMENSIONS</b></p> <table border="1"> <tr> <th>W</th> <th>D</th> <th>H</th> </tr> <tr> <td>26.5</td> <td>26.5</td> <td>33.5</td> </tr> </table>			W	D	H	26.5	26.5	33.5	<p><b>SEAT DIMENSIONS</b></p> <table border="1"> <tr> <th>W</th> <th>D</th> <th>H</th> </tr> <tr> <td>17.5</td> <td>18</td> <td>18</td> </tr> </table>			W	D	H	17.5	18	18	<p><b>BACK DIMENSIONS</b></p> <table border="1"> <tr> <th>W</th> <th>H</th> </tr> <tr> <td>19</td> <td>15.5</td> </tr> </table>			W	H	19	15.5
			W	D	H																						
26.5	26.5	33.5																									
W	D	H																									
17.5	18	18																									
W	H																										
19	15.5																										
<p>RTA 00</p>																											
<p>RTA 00</p>																											
 <p><b>Ottoman</b> COM Yardage: 1.5 Freight Class: 250 Product Weight (lbs.): 22 Cubic Feet Per Carton: 6</p>		<p>Ergonomic Features: N</p>	<table border="1"> <tr> <td>2814</td> <td>\$966</td> <td>\$1024</td> <td>\$1065</td> <td>\$1126</td> <td>\$1214</td> <td>\$1247</td> <td>\$1324</td> <td>\$1472</td> <td>\$1544</td> <td>\$1680</td> <td>\$1867</td> <td>\$2098</td> </tr> </table>												2814	\$966	\$1024	\$1065	\$1126	\$1214	\$1247	\$1324	\$1472	\$1544	\$1680	\$1867	\$2098
			2814	\$966	\$1024	\$1065	\$1126	\$1214	\$1247	\$1324	\$1472	\$1544	\$1680	\$1867	\$2098												
			<p><b>OVERALL DIMENSIONS</b></p> <table border="1"> <tr> <th>W</th> <th>D</th> <th>H</th> </tr> <tr> <td>23.5</td> <td>18.75</td> <td>17.75</td> </tr> </table>			W	D	H	23.5	18.75	17.75	<p><b>SEAT DIMENSIONS</b></p> <table border="1"> <tr> <th>W</th> <th>D</th> <th>H</th> </tr> <tr> <td>20.5</td> <td>18.5</td> <td>17-22</td> </tr> </table>			W	D	H	20.5	18.5	17-22	<p><b>BACK DIMENSIONS</b></p> <table border="1"> <tr> <th>W</th> <th>H</th> </tr> <tr> <td>20</td> <td>21</td> </tr> </table>			W	H	20	21
			W	D	H																						
23.5	18.75	17.75																									
W	D	H																									
20.5	18.5	17-22																									
W	H																										
20	21																										
<p>RTA 00</p>																											
<p>FedEx UPS</p>																											

LUX



model LX2426AC



model LX8033S

STANDARD FEATURES

- Contemporary styling featuring luxurious cushioning.
- Sofa cushions are removable.
- Fully upholstered. Wood legs with non marking clear glides.
- Cylindrical bolsters included with lounge chair models. One bolster on single seat lounge chair and two bolsters on two-seat and three-seat sofas.
- This item may require a longer lead time. Please contact your Global sales representative for further information.
- Check textile availability prior to specifying upholstery material.

OPTIONAL FEATURES

- Wood frames are available in Absolute (AAM), Black (BKM), Cherry (ACM), English Oak (EOM), Espresso Cafe (ECM), Fruitwood (TFM), Gray (HGM), Honey (AHM), Mahogany (TMM), Maple (AVM), Medium Walnut (MWM), Night (ASM), Natural Walnut (NLW), Noce Biondo (NBM), Noce Grigio (NGM), Noce Leggero (NEM), Noce Medio (NMM), Shaker Cherry (SKM), Walnut (TWM), WC Cream (WTM), White (WHM) and Winter Cherry (WCM). Please Specify. Genuine maple faced veneers and solids are used.

DESCRIPTION	FEATURES	MODEL#	STANDARD TEXTILE GRADES											
-------------	----------	--------	-------------------------	--	--	--	--	--	--	--	--	--	--	--



**Side Chair**  
COM Yardage: 3  
Freight Class: 150  
Product Weight (lbs.): 36  
Cubic Feet Per Carton: 17.75

	1	2	3	4	5	6	7	8	9	10	11	12
<b>LX2226SC</b>	1089	1203	1249	1321	1420	1453	1540	1704	1784	1938	2145	2405

OVERALL DIMENSIONS			SEAT DIMENSIONS			BACK DIMENSIONS	
W	D	H	W	D	H	W	H
25	27.75	36	19	19.5	19.5	19	18

RTA 00



**Armchair**  
COM Yardage: 3  
Freight Class: 250  
Product Weight (lbs.): 40  
Cubic Feet Per Carton: 17.75

	1	2	3	4	5	6	7	8	9	10	11	12
<b>LX2426AC</b>	1414	1533	1626	1763	1959	2051	2229	2513	2731	2973	3472	4005

OVERALL DIMENSIONS			SEAT DIMENSIONS			BACK DIMENSIONS	
W	D	H	W	D	H	W	H
26	27.75	36	19	19.5	19.5	19	18

RTA 00



**Lounge Chair**  
COM Yardage: 8.50  
Freight Class: 250  
Product Weight (lbs.): 77  
Cubic Feet Per Carton: 30.25

	1	2	3	4	5	6	7	8	9	10	11	12
<b>LX3433CH</b>	2754	3050	3286	3640	4142	4380	4832	5558	6118	6739	8017	9381

OVERALL DIMENSIONS			SEAT DIMENSIONS			BACK DIMENSIONS	
W	D	H	W	D	H	W	H
35	34	33	-	-	-	-	-

RTA 00



**Ottoman**  
COM Yardage: 2.5  
Freight Class: 250  
Product Weight (lbs.): 48  
Cubic Feet Per Carton: 18.25

	1	2	3	4	5	6	7	8	9	10	11	12
<b>LX3636OTT</b>	2630	2843	2908	3006	3151	3197	3324	3559	3673	3890	4189	4559

OVERALL DIMENSIONS			SEAT DIMENSIONS			BACK DIMENSIONS	
W	D	H	W	D	H	W	H
36	36	16	-	-	-	-	-

RTA 00

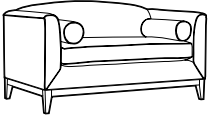
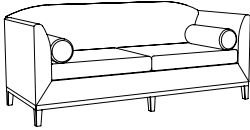

DESCRIPTION	FEATURES	MODEL#	STANDARD TEXTILE GRADES												
			1	2	3	4	5	6	7	8	9	10	11	12	
 <p><b>Two Seat Sofa</b> w/Cylindrical bolsters. COM Yardage: 12 Freight Class: 250 Product Weight (lbs.): 105 Cubic Feet Per Carton: 50.25</p>		<b>LX6033S</b>	2843	3260	3594	4092	4800	5132	5775	6797	7585	8461	10263	12187	
		<b>OVERALL DIMENSIONS</b>			<b>SEAT DIMENSIONS</b>			<b>BACK DIMENSIONS</b>							
		<b>W</b>	<b>D</b>	<b>H</b>	<b>W</b>	<b>D</b>	<b>H</b>	<b>W</b>	<b>H</b>						
		61	34	33	20	18.5	18.5	20	16						
			<b>RTA 00</b>												
 <p><b>Three Seat Sofa</b> w/Cylindrical bolsters. COM Yardage: 14.75 Freight Class: 300 Product Weight (lbs.): 125 Cubic Feet Per Carton: 66.25</p>		<b>LX8033S</b>	4092	4756	5126	5687	6474	6758	7449	8769	9403	10628	12290	14365	
		<b>OVERALL DIMENSIONS</b>			<b>SEAT DIMENSIONS</b>			<b>BACK DIMENSIONS</b>							
		<b>W</b>	<b>D</b>	<b>H</b>	<b>W</b>	<b>D</b>	<b>H</b>	<b>W</b>	<b>H</b>						
		81	34	33	20	18.5	18.5	20	16						
			<b>RTA 00</b>												

ML™



model ML2630

**STANDARD FEATURES**

- Modern seating with a distinctive retro design.
- Features a steel tube frame, legs and arms.
- Fully upholstered continuous seat and back cushions.
- Standard with non marring, Black glides.
- Check textile availability prior to specifying upholstery material.

**OPTIONAL FEATURES**

- Available in five frame finish options. Please specify Chrome (**CHM**), Brushed Chrome (**BCH**), Black (**TBL**), Designer White (**TDW**) or Tungsten (**TTU**). No upcharge applies. Please specify.

DESCRIPTION	FEATURES	MODEL#	STANDARD TEXTILE GRADES											
-------------	----------	--------	-------------------------	--	--	--	--	--	--	--	--	--	--	--



**Counter Height Stool - 24" Seat Height**

COM Yardage: 1  
 Freight Class: 250  
 Product Weight (lbs.): 22  
 Cubic Feet Per Carton: 5.75

	1	2	3	4	5	6	7	8	9	10	11	12
<b>ML171724</b>	1581	1604	1618	1644	1673	1688	1718	1764	1799	1840	1922	2009

OVERALL DIMENSIONS			SEAT DIMENSIONS			BACK DIMENSIONS	
W	D	H	W	D	H	W	H
18	19	24	17	16	23	-	-

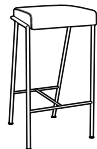

**Bar Height Stool - 30" Seat Height**

COM Yardage: 1  
 Freight Class: 250  
 Product Weight (lbs.): 23  
 Cubic Feet Per Carton: 8

	1	2	3	4	5	6	7	8	9	10	11	12
<b>ML171730</b>	1631	1652	1666	1689	1717	1729	1754	1802	1827	1872	1934	2012

OVERALL DIMENSIONS			SEAT DIMENSIONS			BACK DIMENSIONS	
W	D	H	W	D	H	W	H
18	20.5	30	17	16	29	-	-



**Bar Height Stool - 33" Seat Height**

COM Yardage: 1  
 Freight Class: 250  
 Product Weight (lbs.): 24  
 Cubic Feet Per Carton: 9

	1	2	3	4	5	6	7	8	9	10	11	12
<b>ML171733</b>	1663	1762	1777	1796	1823	1834	1860	1905	1928	1972	2031	2106

OVERALL DIMENSIONS			SEAT DIMENSIONS			BACK DIMENSIONS	
W	D	H	W	D	H	W	H
18	21.5	33	17	16	32	-	-





**Ottoman**

COM Yardage: 1.25  
 Freight Class: 150  
 Product Weight (lbs.): 28  
 Cubic Feet Per Carton: 5.75

	1	2	3	4	5	6	7	8	9	10	11	12
<b>ML2121</b>	1122	1212	1239	1279	1336	1356	1404	1499	1545	1630	1751	1899

OVERALL DIMENSIONS			SEAT DIMENSIONS			BACK DIMENSIONS	
W	D	H	W	D	H	W	H
21	21	17	-	-	-	-	-



DESCRIPTION	FEATURES	MODEL#	STANDARD TEXTILE GRADES											
			1	2	3	4	5	6	7	8	9	10	11	12
 <p><b>Dining Chair</b> COM Yardage: 1.75 Freight Class: 250 Product Weight (lbs.): 33 Cubic Feet Per Carton: 14.75</p>		<b>ML2326</b>	1317	1450	1503	1582	1695	1735	1835	2023	2113	2288	2526	2824
			<b>OVERALL DIMENSIONS</b>			<b>SEAT DIMENSIONS</b>			<b>BACK DIMENSIONS</b>					
			<b>W</b>	<b>D</b>	<b>H</b>	<b>W</b>	<b>D</b>	<b>H</b>	<b>W</b>	<b>H</b>				
			23.25	29.5	29.75	20	18.5	18.5	20	16				
			<b>RTA 00</b>											
 <p><b>Lounge Chair</b> COM Yardage: 2.5 Freight Class: 250 Product Weight (lbs.): 54 Cubic Feet Per Carton: 21.25</p>		<b>ML2630</b>	1976	2158	2224	2323	2462	2513	2639	2875	2986	3206	3503	3873
			<b>OVERALL DIMENSIONS</b>			<b>SEAT DIMENSIONS</b>			<b>BACK DIMENSIONS</b>					
			<b>W</b>	<b>D</b>	<b>H</b>	<b>W</b>	<b>D</b>	<b>H</b>	<b>W</b>	<b>H</b>				
			26	34.5	35	23	20	18.5	18.5	20.5				
			<b>RTA 00</b>											

ML PARK



model ML4634CH



model ML8634

STANDARD FEATURES

- Armless modern lounge seating with a distinctive retro design.
- Features beautiful aluminum legs with Black glides.
- Fully upholstered continuous seat and back cushions with distinctive seams.
- Check textile availability prior to specifying upholstery material.

OPTIONAL FEATURES

- Optional fixed back cushion (FC) is available on lounge models with upcharge. Please specify. Model ML4634, add \$182. Model ML6634, add \$241. Model ML8634, add \$299.
- Available in five leg finish options. Specify: Black (TBL), Brushed Aluminum (BAL), Designer White (TDW), Polished Aluminum (ALU) or Tungsten (TTU). No upcharge applies.

DESCRIPTION	FEATURES	MODEL#	STANDARD TEXTILE GRADES											
			1	2	3	4	5	6	7	8	9	10	11	12

ML2634	2177	2230	2271	2333	2420	2462	2541	2667	2763	2872	3095	3331
--------	------	------	------	------	------	------	------	------	------	------	------	------



Ottoman

COM Yardage: 1.50  
 Freight Class: 150  
 Product Weight (lbs.): 28  
 Cubic Feet Per Carton: 5.75

OVERALL DIMENSIONS	SEAT DIMENSIONS			BACK DIMENSIONS	
	W	D	H	W	H

21	26.75	18.25	26.75	-	20	-	-
----	-------	-------	-------	---	----	---	---

RTA 00

DESCRIPTION	FEATURES	MODEL#	STANDARD TEXTILE GRADES											
			1	2	3	4	5	6	7	8	9	10	11	12

ML4634	3731	3964	4144	4414	4802	4980	5329	5886	6314	6790	7771	8818
--------	------	------	------	------	------	------	------	------	------	------	------	------



Lounge Chair

COM Yardage: 7.25  
 Freight Class: 250  
 Product Weight (lbs.): 54  
 Cubic Feet Per Carton: 21.25

OVERALL DIMENSIONS	SEAT DIMENSIONS			BACK DIMENSIONS	
	W	D	H	W	H

26	34.5	35	42.75	22	19	27	13
----	------	----	-------	----	----	----	----

RTA 00

DESCRIPTION	FEATURES	MODEL#	STANDARD TEXTILE GRADES											
			1	2	3	4	5	6	7	8	9	10	11	12

ML6634	4028	4491	4701	5022	5471	5636	6028	6781	7145	7843	8797	9981
--------	------	------	------	------	------	------	------	------	------	------	------	------

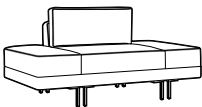

Two Seat Sofa

COM Yardage: 7.50  
 Freight Class: 250  
 Product Weight (lbs.): 132  
 Cubic Feet Per Carton: 52

OVERALL DIMENSIONS	SEAT DIMENSIONS			BACK DIMENSIONS	
	W	D	H	W	H

66	36	32	66	22	19	27	13
----	----	----	----	----	----	----	----

RTA 00

DESCRIPTION	FEATURES	MODEL#	STANDARD TEXTILE GRADES											
			1	2	3	4	5	6	7	8	9	10	11	12

ML8634	5314	5937	6229	6666	7288	7511	8051	9088	9587	10549	11856	13488
--------	------	------	------	------	------	------	------	------	------	-------	-------	-------

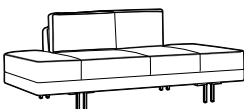

Three Seat Sofa

COM Yardage: 11  
 Freight Class: 250  
 Product Weight (lbs.): 132  
 Cubic Feet Per Carton: 52

OVERALL DIMENSIONS	SEAT DIMENSIONS			BACK DIMENSIONS	
	W	D	H	W	H

66	36	32	86	22	19	52	13
----	----	----	----	----	----	----	----

RTA 00

## PRAIRIE™



model 3481



model 3482

### STANDARD FEATURES

- Featuring, gently barrel shaped arms that provide an attractive appearance.
- Fully upholstered. Tapered wood skirt and legs.
- Series includes lounge chair, two seat and three seat sofa.
- Check textile availability prior to specifying upholstery material.

### OPTIONAL FEATURES

- Tapered wood legs are available in Absolute (AAM), Black (BKM), Cherry (ACM), Espresso Cafe (ECM), English Oak (EOM), Fruitwood (TFM), Gray (HGM), Honey (AHM), Mahogany (TMM), Maple (AVM), Medium Walnut (MWVM), Natural Walnut (NLW), Night (ASM), Noce Biondo (NBM), Noce Grigio (NGM), Noce Leggero (NEM), Noce Medio (NMM), Shaker Cherry (SKM), Walnut (TWM), WC Cream (WTM), White (WHM) and Winter Cherry (WCM). Please specify. Genuine maple faced veneers and solids are used.

### STITCH DETAIL WHEN UPHOLSTERED IN ALL LEATHER - ILLUSTRATIONS BELOW

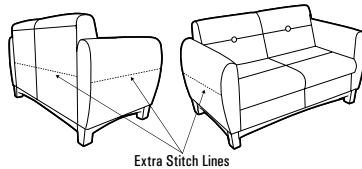

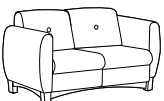
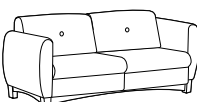
DESCRIPTION	FEATURES	MODEL#	STANDARD TEXTILE GRADES											
			1	2	3	4	5	6	7	8	9	10	11	12
 <b>Lounge Chair</b> COM Yardage: 4.25 Freight Class: 150 Product Weight (lbs.): 80 Cubic Feet Per Carton: 19.25		<b>3481</b>	2129	2313	2457	2671	2977	3085	3348	3855	4103	4570	5212	6008
			<b>OVERALL DIMENSIONS</b>			<b>SEAT DIMENSIONS</b>			<b>BACK DIMENSIONS</b>					
			<b>W</b>	<b>D</b>	<b>H</b>	<b>W</b>	<b>D</b>	<b>H</b>	<b>W</b>	<b>H</b>				
			32	29	30.5	21	19	16	21	14.5				
			<b>RTA 00</b>											
 <b>Two Seat Sofa</b> COM Yardage: 6.25 Freight Class: 250 Product Weight (lbs.): 106 Cubic Feet Per Carton: 41.25		<b>3482</b>	3021	3258	3443	3720	4119	4258	4602	5262	5576	6191	7022	8061
			<b>OVERALL DIMENSIONS</b>			<b>SEAT DIMENSIONS</b>			<b>BACK DIMENSIONS</b>					
			<b>W</b>	<b>D</b>	<b>H</b>	<b>W</b>	<b>D</b>	<b>H</b>	<b>W</b>	<b>H</b>				
			52.5	29	30.5	42	19	16	42	14.5				
			<b>RTA 00</b>											
 <b>Three Seat Sofa</b> COM Yardage: 9.5 Freight Class: 250 Product Weight (lbs.): 150 Cubic Feet Per Carton: 55.5		<b>3483</b>	3798	4127	4388	4780	5337	5599	6103	6907	7528	8216	9635	11148
			<b>OVERALL DIMENSIONS</b>			<b>SEAT DIMENSIONS</b>			<b>BACK DIMENSIONS</b>					
			<b>W</b>	<b>D</b>	<b>H</b>	<b>W</b>	<b>D</b>	<b>H</b>	<b>W</b>	<b>H</b>				
			73.5	29	30.5	63.5	19	16	63.5	14.5				
			<b>RTA 00</b>											

RIVER™



Sample Layout



Sample Layout

STANDARD FEATURES

- A modular seating series that is composed of modular linking units in straight, curved and corner units. Soft seating models are available with standard height, high and extended high backs. All linking units can be used together in any combination to create a wide variety of layouts.
- The unique tapered legs (swaged legs) are made of welded steel, heavy duty construction, with each leg bolted directly to the frame. The extremely robust construction insures trouble free performance in any environment. All units except for the Laptop Tables have the same leg height of 6.5". The leg height makes it easier to clean under the product.
- Each leg is standard with adjustable black nylon leveling glides and are non-marking. Wood legs and casters are not available.
- All cushions are fixed and non-removable (cushions will not migrate). Perimeter seams feature a decorative single stitch detail, which makes seams lay flat and adds extra seam strength.
- Seating frames are heavy duty with interlocking plywood, puzzle box construction, made for rugged active environments. Seats are high density with highly resilient foam and are equipped with a synthetic rubberized webbing suspension system for extra comfort.
- Front edge or face of the seat, angles slightly inward, so feet have freedom of movement and shoe heels don't rub on the seat. This inward slanting matches the inward angles of the back. Benches and connecting end tables also reflect the inward angles on the front and back faces, so all units coordinate in visual appearance.
- For use in high traffic applications as well as 24/7 environments or for models with 600 lb. standard weight capacity, clean out space between seat and back and /or modular arms, please see the River-series.
- Most units can be ganged together with a quick connect, disconnect feature. Ganging hardware is standard and is factory installed. Ganging hardware swivels out of sight when not in use.

OPTIONAL FEATURES

- Most tables and seating units can be specified with Power/USB terminals, which includes two power outlets, two double USB terminals and a black 60" three-prong power cord. Each Power/USB module is set in predetermined locations, as shown in the electrical illustrations below. Electrical units must be factory installed.
- To add a Power/USB module: From the electrical illustrations below, please specify **J1, W1, J2, W2, J3, W4, J4, W4, J6 or W6** after the product model number. Please note on seating units, if both right and left locations are required, add both **J1/J3 or W1/W3** to the model number. Add \$945 for each module/location required.
- Power/USB modules are available with either Jet Black (**J**) face plate with black Power/USB receptacles or with a White (**W**) face plate with white Power/USB receptacles.
- Tables are made with high pressure laminate and are offered in the following finishes: Absolute Acajou (**ACJ**), Asian Night (**ASN**), Avant Cherry (**AWC**), Avant Honey (**AWH**), Clear Maple (**CMB**), Dark Espresso (**DES**), Designer White (**DWT**), Fashionista (**FAS**), First Class (**FCL**), Noce Biondo (**NBL**), Noce Grigio (**NGL**), Noce Leggero (**NEL**), Noce Medio (**NML**), Quartered Mahogany (**QTM**), Sheer Beauty (**SBY**), Walnut Heights (**WHE**), White Chocolate (**WHC**) and Winter Cherry (**WCR**). Please Specify. Custom High Pressure laminate finishes will be considered upon request.
- **Seating and Table Leg Finish**  

<b>(CHM)</b> Chrome	<b>(TBL)</b> Black
<b>(TDW)</b> Designer White	<b>(TFO)</b> Fog
<b>(TFR)</b> Frost	<b>(TIV)</b> Cloud
<b>(TLA)</b> Latte	<b>(TMO)</b> Mocha
<b>(TNE)</b> Nevada	<b>(TOA)</b> Toast
<b>(TSH)</b> Shadow	<b>(TSN)</b> Sand
<b>(TTU)</b> Tungsten	<b>(TKA)</b> Kalua
- Check textile availability prior to specifying upholstery material. Leather not available on River series.
- If more than one fabric or a fabric/vinyl combination is required, please fill out a "Seating Multiple Textile" form, specifying each fabric location. Please contact Customer Care for more information.

ELECTRICAL PLACEMENT

Soft Seating

Locations available on left side J1 (black) or W1 (white), right side J3 (black), or W3 (white) or both sides J1/J3 (black) or W1/W3 (white).

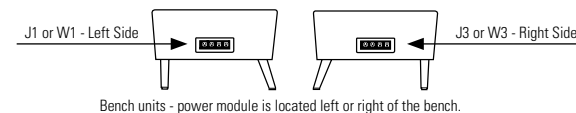
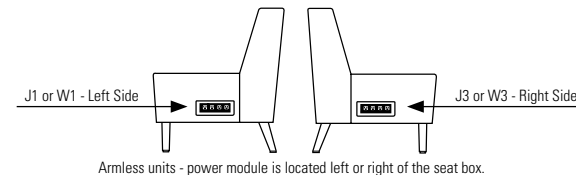
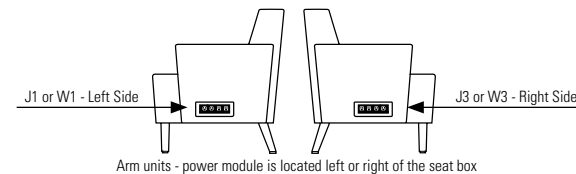

Coffee/End Tables

Primary location is on the top of the unit, centered J2 (black) or W2 (white). Secondary Location is end/side of the unit J1 (black) or W1 (white).

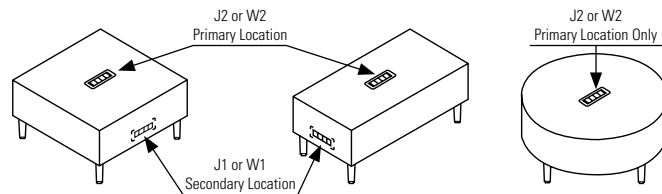

Primary location is on the top rear/edge of the unit J4 (black) or W4 (white). Secondary Location is the back side of the unit J6 (black) or W6 (white).

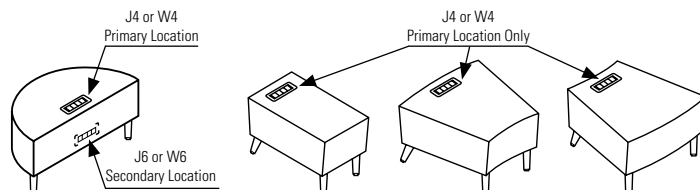

## SAMPLE LAYOUTS

**RVR101 (Layout 1)**

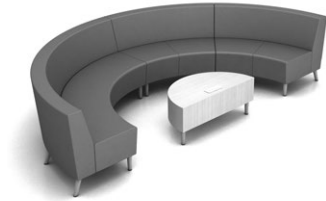

Qty	Model Number	Description	Dimensions	List Price
4	<b>7710NA</b>	Armless IS Curve - Two Seat - Standard Back	55 x 29.5 x 32	3258 x 4
1	<b>7737W6</b>	42" Half Round Laminate Coffee Table w/ W6 Rear Power/USB Module	42 x 21 x 17 upcharge	1384 945

**SAMPLE LAYOUT TOTAL (Starting at Grade 1) \$15,361**

**RVR102 (Layout 2)**



Qty	Model Number	Description	Dimensions	List Price
8	<b>7714NA</b>	Armless OS Curve - Two Seater - High Back	54 x 29.5 x 41.5	3885 x 8

**SAMPLE LAYOUT TOTAL (Starting at Grade 1) \$31,080**

**RVR103 (Layout 3)**

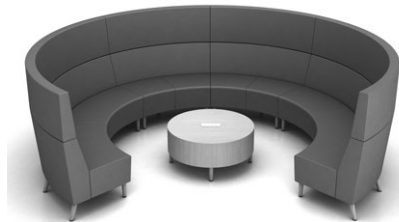

Qty	Model Number	Description	Dimensions	List Price
6	<b>7712NA</b>	Armless IS Curve - Two Seater - Extended Back	55 x 29.5 x 47	4553 x 6
1	<b>7734W2</b>	36" Dia - Round Laminate Coffee Table w/ W2 Center Power/USB Module	36 x 36 x 17 upcharge	1612 945

**SAMPLE LAYOUT TOTAL (Starting at Grade 1) \$29,875**

**RVR104 (Layout 4)**



Qty	Model Number	Description	Dimensions	List Price
2	<b>7712NA</b>	Armless IS Curve - Two Seater - Extended Back	55 x 29.5 x 47	4553 x 2
2	<b>7712NAW3</b>	Armless IS Curve - Two Seater - Extended Back w/ W3 Right Power/USB Module	55 x 29.5 x 47 upcharge	4553 x 2 825 x 2
2	<b>7726</b>	IS Curve - Two Seater Bench	54 x 28 x 17.5	2765 x 2
1	<b>7734</b>	36" Dia - Round Laminate Coffee Table	36 x 36 x 17	1612

**SAMPLE LAYOUT TOTAL (Starting at Grade 1) \$27,244**

**RVR105 (Layout 5)**



Qty	Model Number	Description	Dimensions	List Price
3	<b>7711NA</b>	Armless IS Curve - Two Seater - High Back	55 x 29.5 x 41.5	4137 x 3
3	<b>7712NAW3</b>	Armless IS Curve - Two Seater - Extended Back w/ W3 Right Power/USB Module	55 x 29.5 x 47 upcharge	4553 x 3 825 x 2
1	<b>7738</b>	Rectangular Laminate End Table	15 x 27.25 x 17	1309
2	<b>7743</b>	18" Dia. Round Laminate Laptop Table	18 x 18 x 25.25	792 x 2

**SAMPLE LAYOUT TOTAL (Starting at Grade 1) \$30,853**

SAMPLE LAYOUTS

RVR106 (Layout 6)



Qty	Model Number	Description	Dimensions	List Price
1	<b>7709R</b>	Three Seater - Extended Back w/Right Arm	75 x 29.5 x 47	6199
1	<b>7709L</b>	Three Seater - Extended Back w/Left Arm	75 x 29.5 x 47	6199
1	<b>7718</b>	Armless Corner Unit - Extended Back	38 x 38 x 47	5339
1	<b>7732W2</b>	36" Square Laminate Coffee Table w/ W2 Center Power/USB Module	36 x 36 x 17 upcharge	1477 945

**SAMPLE LAYOUT TOTAL (Starting at Grade 1) \$20,159**

RVR107 (Layout 7)



Qty	Model Number	Description	Dimensions	List Price
1	<b>7704NA</b>	Armless Two Seater - Standard. Back	75x 29.5 x 47	2820
2	<b>7716</b>	Armless Corner Unit - Standard. Back	75 x 29.5 x 47	3980 x 2
1	<b>7725</b>	Two Seater Bench	75x 29.5 x 47	2036
1	<b>7728</b>	Square Single Seater Bench	75 x 29.5 x 17.5	1392
1	<b>7731</b>	30" Square Laminate Coffee Table	75 x 30 x 47	1300

**SAMPLE LAYOUT TOTAL (Starting at Grade 1) \$15,508**

RVR108 (Layout 8)



Qty	Model Number	Description	Dimensions	List Price
2	<b>7708NAW3</b>	Armless Three Seater - High Back w/ W3 Right Power/USB Module	75 x 29.5 x 41.5 upcharge	5345 x 2 945 x 2
2	<b>7708NAW1</b>	Armless Three Seater - High Back w/ W1 Left Power/USB Module	72.5 x 29.5 x 41.5 upcharge	5345 x 2 945 x 2
2	<b>7745</b>	16" Square Laminate Laptop Table	16 x 16 x 25.25	810 x 2

**SAMPLE LAYOUT TOTAL (Starting at Grade 1) \$26,780**

RVR109 (Layout 9)



Qty	Model Number	Description	Dimensions	List Price
2	<b>7702</b>	Lounge Chair - High Back w/Arms	29.5 x 29.5 x 41.5	3016 x 2
1	<b>7708NAW1</b>	Armless Three Seater - High Back w/ W1 Left Power/USB Module	72.5 x 29.5 x 41.5 upcharge	5345 945
1	<b>7708NAW3</b>	Armless Three Seater - High Back w/ W3 Right Power/USB Module	72.5 x 29.5 x 41.5 upcharge	5345 945
1	<b>7733</b>	Rectangular Laminate Coffee Table	40 x 20 x 17	1306

**SAMPLE LAYOUT TOTAL (Starting at Grade 1) \$19,918**

RVR110 (Layout 10)



Qty	Model Number	Description	Dimensions	List Price
1	<b>7705NAW3</b>	Armless Two Seater - High Back w/ W3 Right Power/USB Module	48.5 x 29.5 x 41.5 upcharge	3456 945
1	<b>7705NAW1</b>	Armless Two Seater - High Back w/ W1 Left Power/USB Module	48.5 x 29.5 x 41.5 upcharge	3456 945
1	<b>7708NA</b>	Armless Three Seater - High Back	72.5 x 29.5 x 41.5	5345
1	<b>7708NAW3</b>	Armless Three Seater - High Back w/ W3 Right Power/USB Module	72.5 x 29.5 x 41.5 upcharge	5345 945
1	<b>7708NAW1</b>	Armless Three Seater - High Back w/ W1 Left Power/USB Module	72.5 x 29.5 x 41.5 upcharge	5345 945
2	<b>7717</b>	Armless Corner Unit - High Back	38 x 38 x 41.5	5041 x 2
3	<b>7745</b>	16" Square Laminate Laptop Table	16 x 16 x 25.25	810 x 3

**SAMPLE LAYOUT TOTAL (Starting at Grade 1) \$39,239**



DESCRIPTION	FEATURES	MODEL#	STANDARD TEXTILE GRADES		
<b>RVR111 (Layout 11)</b>					
	Qty	Model Number	Description	Dimensions	List Price
	2	<b>7701NA</b>	Armless One Seater - Standard Back	24.5 x 29.5x 32	1807 x 2
	4	<b>7710NA</b>	Armless IS Curve - Two Seat - Standard Back	55 x 29.5 x 32	3258 x 4
	2	<b>7743</b>	18" Dia. Round Laminate Laptop Table	18 x 18 x 25.25	792 x 2
<b>SAMPLE LAYOUT TOTAL (Starting at Grade 1)</b>					<b>\$18,230</b>

<b>RVR112 (Layout 12)</b>					
	Qty	Model Number	Description	Dimensions	List Price
	2	<b>7711NA</b>	Armless IS Curve - Two Seater - High Back	55 x 29.5 x 41.5	4137 x 2
	6	<b>7712NA</b>	Armless IS Curve - Two Seater - Extended Back	55 x 29.5 x 47	4553 x 6
	1	<b>7709NA</b>	Armless Three Seater - Extended Back	72.5 x 29.5 x 47	5786
	2	<b>7734</b>	36"Dia - Round Laminate Coffee Table	36 x 36 x 17	1612 x 2
<b>SAMPLE LAYOUT TOTAL (Starting at Grade 1)</b>					<b>\$44,602</b>

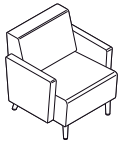

**Lounge Chair - Standard Back w/Arms**  
 COM Yardage: 4  
 Freight Class: 250  
 Product Weight (lbs.): 57  
 Cubic Feet Per Carton: 22.5

For Power/USB module please see electrical placement chart. No ganging hardware.

	1	2	3	4	5	6	7	8	9	10	11	12
<b>7701</b>	2631	2790	2916	3103	3368	3463	3695	4138	4351	4761	5321	6018

OVERALL DIMENSIONS			SEAT DIMENSIONS			BACK DIMENSIONS	
W	D	H	W	D	H	W	H
29.5	29.5	32	24	19	18	24	14

RTA 00

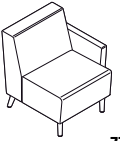

**7701L** (Left Arm)

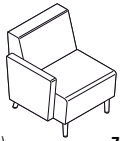

**7701R** (Right Arm)

**Lounge Chair - Standard w/One Arm**  
 COM Yardage: 3.25  
 Freight Class: 250  
 Product Weight (lbs.): 47  
 Cubic Feet Per Carton: 22.5

For Power/USB module please see electrical placement chart. Includes ganging hardware (1 side).

	1	2	3	4	5	6	7	8	9	10	11	12
<b>7701L</b>	2225	2357	2459	2612	2825	2905	3092	3453	3625	3960	4414	4981
<b>7701R</b>	2225	2357	2459	2612	2825	2905	3092	3453	3625	3960	4414	4981

OVERALL DIMENSIONS			SEAT DIMENSIONS			BACK DIMENSIONS	
W	D	H	W	D	H	W	H
27	29.5	32	24	19	18	24	14

RTA 00

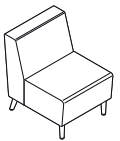





**Armless Lounge Chair - Standard Back**  
 COM Yardage: 2.5  
 Freight Class: 300  
 Product Weight (lbs.): 37  
 Cubic Feet Per Carton: 22.5

For Power/USB module please see electrical placement chart. Includes ganging hardware (2 sides).

	1	2	3	4	5	6	7	8	9	10	11	12
<b>7701NA</b>	1807	1910	1987	2104	2271	2331	2477	2751	2886	3142	3492	3928

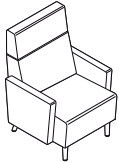
OVERALL DIMENSIONS			SEAT DIMENSIONS			BACK DIMENSIONS	
W	D	H	W	D	H	W	H
24.5	29.5	32	24	19	18	24	14

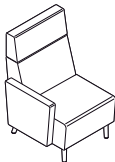
RTA 00

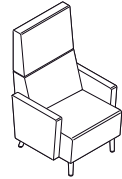
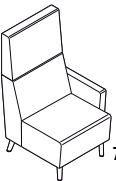
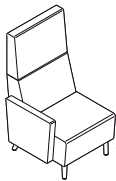
DESCRIPTION	FEATURES	MODEL#	STANDARD TEXTILE GRADES											
			1	2	3	4	5	6	7	8	9	10	11	12
 <p><b>Lounge Chair - High Back w/Arms</b> COM Yardage: 4.5 Freight Class: 250 Product Weight (lbs.): 61 Cubic Feet Per Carton: 28.25</p>	<p>For Power/USB module please see electrical placement chart. No ganging hardware.</p>	<b>7702</b>	3016	3196	3337	3548	3846	3955	4213	4712	4953	5416	6044	6827
		<b>OVERALL DIMENSIONS</b>			<b>SEAT DIMENSIONS</b>			<b>BACK DIMENSIONS</b>						
		<b>W</b>	<b>D</b>	<b>H</b>	<b>W</b>	<b>D</b>	<b>H</b>	<b>W</b>	<b>H</b>					
		29.5	29.5	41.5	24	19	18	24	24					
			<b>RTA 00</b>											
  <p><b>7702L (Left Arm)</b>      <b>7702R (Right Arm)</b></p> <p><b>Lounge Chair - High Back w/One Arm</b> COM Yardage: 4.5 Freight Class: 250 Product Weight (lbs.): 61 Cubic Feet Per Carton: 28.25</p>	<p>For Power/USB module please see electrical placement chart. Includes ganging hardware (1 side).</p>	<b>7702L</b>	2609	2761	2876	3054	3302	3390	3608	4023	4224	4609	5133	5787
		<b>7702R</b>	2609	2761	2876	3054	3302	3390	3608	4023	4224	4609	5133	5787
		<b>OVERALL DIMENSIONS</b>			<b>SEAT DIMENSIONS</b>			<b>BACK DIMENSIONS</b>						
		<b>W</b>	<b>D</b>	<b>H</b>	<b>W</b>	<b>D</b>	<b>H</b>	<b>W</b>	<b>H</b>					
			29.5	29.5	41.5	24	19	18	24	24				
			<b>RTA 00</b>											
 <p><b>Armless Lounge Chair - High Back</b> COM Yardage: 3 Freight Class: 300 Product Weight (lbs.): 41 Cubic Feet Per Carton: 28.25</p>	<p>For Power/USB module please see electrical placement chart. Includes ganging hardware (2 sides).</p>	<b>7702NA</b>	2193	2316	2408	2548	2746	2818	2994	3326	3485	3794	4213	4737
		<b>OVERALL DIMENSIONS</b>			<b>SEAT DIMENSIONS</b>			<b>BACK DIMENSIONS</b>						
		<b>W</b>	<b>D</b>	<b>H</b>	<b>W</b>	<b>D</b>	<b>H</b>	<b>W</b>	<b>H</b>					
		24.5	29.5	41.5	24	19	18	24	24					
			<b>RTA 00</b>											
 <p><b>Lounge Chair - Extended Back w/Arms</b> COM Yardage: 4.75 Freight Class: 250 Product Weight (lbs.): 68 Cubic Feet Per Carton: 32.75</p>	<p>For Power/USB module please see electrical placement chart. No ganging hardware.</p>	<b>7703</b>	3494	3681	3831	4054	4369	4483	4758	5284	5538	6026	6688	7516
		<b>OVERALL DIMENSIONS</b>			<b>SEAT DIMENSIONS</b>			<b>BACK DIMENSIONS</b>						
		<b>W</b>	<b>D</b>	<b>H</b>	<b>W</b>	<b>D</b>	<b>H</b>	<b>W</b>	<b>H</b>					
		29.5	29.5	47	24	19	18	24	29					
			<b>RTA 00</b>											
  <p><b>7703L (Left Arm)</b>      <b>7703R (Right Arm)</b></p> <p><b>Lounge Chair - Extended Back w/One Arm</b> COM Yardage: 4 Freight Class: 300 Product Weight (lbs.): 58 Cubic Feet Per Carton: 32.75</p>	<p>For Power/USB module please see electrical placement chart. Includes ganging hardware (1 side).</p>	<b>7703L</b>	3088	3247	3373	3560	3823	3919	4149	4594	4808	5218	5777	6475
		<b>7703R</b>	3088	3247	3373	3560	3823	3919	4149	4594	4808	5218	5777	6475
		<b>OVERALL DIMENSIONS</b>			<b>SEAT DIMENSIONS</b>			<b>BACK DIMENSIONS</b>						
		<b>W</b>	<b>D</b>	<b>H</b>	<b>W</b>	<b>D</b>	<b>H</b>	<b>W</b>	<b>H</b>					
			29.5	29.5	47	24	19	18	24	29				
			<b>RTA 00</b>											

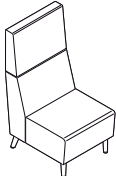
DESCRIPTION	FEATURES	MODEL#	STANDARD TEXTILE GRADES													
			1	2	3	4	5	6	7	8	9	10	11	12		
 <p><b>Armless Lounge Chair - Extended Back</b>                      COM Yardage: 3.25                      Freight Class: 300                      Product Weight (lbs.): 48                      Cubic Feet Per Carton: 32.75</p>	For Power/USB module please see electrical placement chart. Includes ganging hardware (2 sides).	<b>7703NA</b>	2672	2802	2905	3058	3272	3350	3539	3899	4071	4406	4859	5425		
		<b>OVERALL DIMENSIONS</b>			<b>SEAT DIMENSIONS</b>			<b>BACK DIMENSIONS</b>								
		<b>W</b>	<b>D</b>	<b>H</b>	<b>W</b>	<b>D</b>	<b>H</b>	<b>W</b>	<b>H</b>							
		24.5	29.5	47	24	19	18	24	29							
			<b>RTA 00</b>													

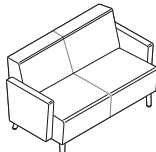
DESCRIPTION	FEATURES	MODEL#	STANDARD TEXTILE GRADES													
			1	2	3	4	5	6	7	8	9	10	11	12		
 <p><b>Two Seater - Standard Back w/Arms</b>                      COM Yardage: 5.5                      Freight Class: 250                      Product Weight (lbs.): 95                      Cubic Feet Per Carton: 39</p>	For Power/USB module please see electrical placement chart. No ganging hardware.	<b>7704</b>	3636	3854	4025	4281	4647	4778	5098	5709	5998	6564	7332	8290		
		<b>OVERALL DIMENSIONS</b>			<b>SEAT DIMENSIONS</b>			<b>BACK DIMENSIONS</b>								
		<b>W</b>	<b>D</b>	<b>H</b>	<b>W</b>	<b>D</b>	<b>H</b>	<b>W</b>	<b>H</b>							
		53.5	29.5	32	48	19	18	48	14							
			<b>RTA 00</b>													

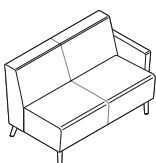
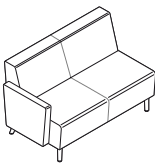
DESCRIPTION	FEATURES	MODEL#	STANDARD TEXTILE GRADES													
			1	2	3	4	5	6	7	8	9	10	11	12		
 <p><b>7704L (Left Arm)</b></p>  <p><b>7704R (Right Arm)</b></p> <p><b>Two Seater - Standard Back w/One Arm</b>                      COM Yardage: 4.75                      Freight Class: 300                      Product Weight (lbs.): 85                      Cubic Feet Per Carton: 39</p>	For Power/USB module please see electrical placement chart. Includes ganging hardware (1 side).	<b>7704L</b>	3235	3424	3574	3796	4112	4225	4501	5026	5280	5768	6432	7260		
		<b>7704R</b>	3235	3424	3574	3796	4112	4225	4501	5026	5280	5768	6432	7260		
		<b>OVERALL DIMENSIONS</b>			<b>SEAT DIMENSIONS</b>			<b>BACK DIMENSIONS</b>								
		<b>W</b>	<b>D</b>	<b>H</b>	<b>W</b>	<b>D</b>	<b>H</b>	<b>W</b>	<b>H</b>							
			<b>RTA 00</b>													

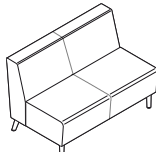
DESCRIPTION	FEATURES	MODEL#	STANDARD TEXTILE GRADES													
			1	2	3	4	5	6	7	8	9	10	11	12		
 <p><b>Armless Two Seater - Standard Back</b>                      COM Yardage: 4.25                      Freight Class: 300                      Product Weight (lbs.): 75                      Cubic Feet Per Carton: 39</p>	For Power/USB module please see electrical placement chart. Includes ganging hardware (2 sides).	<b>7704NA</b>	2820	2991	3125	3324	3605	3705	3952	4422	4650	5086	5681	6421		
		<b>OVERALL DIMENSIONS</b>			<b>SEAT DIMENSIONS</b>			<b>BACK DIMENSIONS</b>								
		<b>W</b>	<b>D</b>	<b>H</b>	<b>W</b>	<b>D</b>	<b>H</b>	<b>W</b>	<b>H</b>							
		48.5	29.5	32	48	19	18	48	14							
			<b>RTA 00</b>													

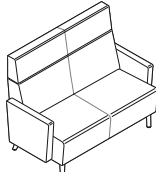
DESCRIPTION	FEATURES	MODEL#	STANDARD TEXTILE GRADES													
			1	2	3	4	5	6	7	8	9	10	11	12		
 <p><b>Two Seater - High Back w/Arms</b>                      COM Yardage: 6.5                      Freight Class: 300                      Product Weight (lbs.): 97                      Cubic Feet Per Carton: 54</p>	For Power/USB module please see electrical placement chart. No ganging hardware.	<b>7705</b>	4279	4538	4740	5046	5474	5629	6009	6728	7073	7742	8650	9781		
		<b>OVERALL DIMENSIONS</b>			<b>SEAT DIMENSIONS</b>			<b>BACK DIMENSIONS</b>								
		<b>W</b>	<b>D</b>	<b>H</b>	<b>W</b>	<b>D</b>	<b>H</b>	<b>W</b>	<b>H</b>							
		53.5	29.5	41.5	48	19	18	48	24							
			<b>RTA 00</b>													

DESCRIPTION FEATURES MODEL# STANDARD TEXTILE GRADES



7705L (Left Arm)

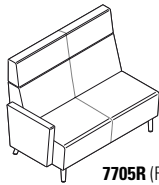

7705R (Right Arm)

**Two Seater - High Back w/One Arm**  
 COM Yardage: 5.75  
 Freight Class: 300  
 Product Weight (lbs.): 87  
 Cubic Feet Per Carton: 54

For Power/USB module please see electrical placement chart. Includes ganging hardware (1 side).

	1	2	3	4	5	6	7	8	9	10	11	12
<b>7705L</b>	3871	4098	4278	4546	4929	5065	5400	6036	6343	6933	7737	8740
<b>7705R</b>	3871	4098	4278	4546	4929	5065	5400	6036	6343	6933	7737	8740

OVERALL DIMENSIONS			SEAT DIMENSIONS			BACK DIMENSIONS	
W	D	H	W	D	H	W	H
51	29.5	41.5	48	19	18	48	24

RTA 00

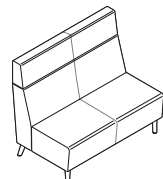

**Armless Two Seater - High Back**  
 COM Yardage: 5.25  
 Freight Class: 300  
 Product Weight (lbs.): 77  
 Cubic Feet Per Carton: 54

For Power/USB module please see electrical placement chart. Includes ganging hardware (2 sides).

	1	2	3	4	5	6	7	8	9	10	11	12
<b>7705NA</b>	3456	3664	3829	4076	4422	4549	4853	5434	5715	6253	6986	7902

OVERALL DIMENSIONS			SEAT DIMENSIONS			BACK DIMENSIONS	
W	D	H	W	D	H	W	H
48.5	29.5	41.5	48	19	18	48	24

RTA 00

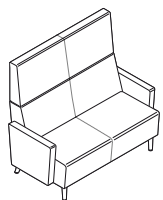

**Two Seater - Extended Back w/Arms**  
 COM Yardage: 7  
 Freight Class: 300  
 Product Weight (lbs.): 107  
 Cubic Feet Per Carton: 56.75

For Power/USB module please see electrical placement chart. No ganging hardware.

	1	2	3	4	5	6	7	8	9	10	11	12
<b>7706</b>	4516	4794	5012	5341	5805	5973	6376	7152	7525	8246	9222	10440

OVERALL DIMENSIONS			SEAT DIMENSIONS			BACK DIMENSIONS	
W	D	H	W	D	H	W	H
53.5	29.5	47	48	19	18	48	29

RTA 00



7706L (Left Arm)

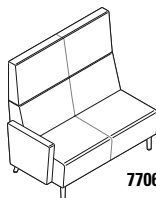

7706R (Right Arm)

**Two Seater - Extended Back w/One Arm**  
 COM Yardage: 6.25  
 Freight Class: 300  
 Product Weight (lbs.): 97  
 Cubic Feet Per Carton: 56.75

For Power/USB module please see electrical placement chart. Includes ganging hardware (1 side).

	1	2	3	4	5	6	7	8	9	10	11	12
<b>7706L</b>	4108	4356	4551	4843	5258	5404	5768	6462	6793	7438	8311	9398
<b>7706R</b>	4108	4356	4551	4843	5258	5404	5768	6462	6793	7438	8311	9398

OVERALL DIMENSIONS			SEAT DIMENSIONS			BACK DIMENSIONS	
W	D	H	W	D	H	W	H
51	29.5	47	48	19	18	48	29

RTA 00

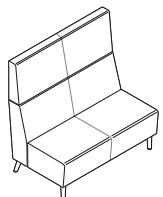



**Armless Two Seater - Extended Back**  
 COM Yardage: 5.75  
 Freight Class: 300  
 Product Weight (lbs.): 87  
 Cubic Feet Per Carton: 56.75

For Power/USB module please see electrical placement chart. Includes ganging hardware (2 sides).

	1	2	3	4	5	6	7	8	9	10	11	12
<b>7706NA</b>	3690	3918	4098	4367	4749	4885	5220	5856	6163	6753	7557	8560

OVERALL DIMENSIONS			SEAT DIMENSIONS			BACK DIMENSIONS	
W	D	H	W	D	H	W	H
48.5	29.5	47	48	19	18	48	29

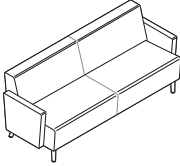
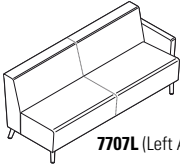
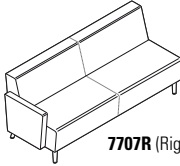
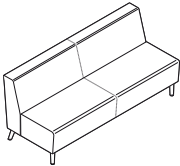
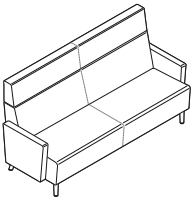
RTA 00

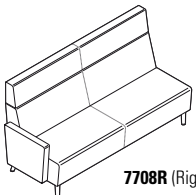
DESCRIPTION	FEATURES	MODEL#	STANDARD TEXTILE GRADES											
			1	2	3	4	5	6	7	8	9	10	11	12
 <p><b>Three Seater - Standard Back w/Arms</b> COM Yardage: 8.25 Freight Class: 250 Product Weight (lbs.): 139 Cubic Feet Per Carton: 55.5</p>	<p>For Power/USB module please see electrical placement chart. No ganging hardware.</p>	<b>7707</b>	5406	5729	5990	6375	6922	7117	7596	8511	8951	9800	10952	12388
		<b>OVERALL DIMENSIONS</b>			<b>SEAT DIMENSIONS</b>			<b>BACK DIMENSIONS</b>						
		<b>W</b>	<b>D</b>	<b>H</b>	<b>W</b>	<b>D</b>	<b>H</b>	<b>W</b>	<b>H</b>					
			<b>RTA 00</b>											
 <p><b>7707L (Left Arm)</b></p>  <p><b>7707R (Right Arm)</b></p> <p><b>Three Seater - Standard Back w/One Arm</b> COM Yardage: 7.75 Freight Class: 250 Product Weight (lbs.): 129 Cubic Feet Per Carton: 55.5</p>	<p>For Power/USB module please see electrical placement chart. Includes ganging hardware (1 side).</p>	<b>7707L</b>	5001	5306	5548	5911	6424	6611	7059	7916	8330	9127	10209	11559
		<b>7707R</b>	5001	5306	5548	5911	6424	6611	7059	7916	8330	9127	10209	11559
		<b>OVERALL DIMENSIONS</b>			<b>SEAT DIMENSIONS</b>			<b>BACK DIMENSIONS</b>						
<b>W</b>	<b>D</b>	<b>H</b>	<b>W</b>	<b>D</b>	<b>H</b>	<b>W</b>	<b>H</b>							
			<b>RTA 00</b>											
 <p><b>Armless Three Seater - Standard Back</b> COM Yardage: 7 Freight Class: 250 Product Weight (lbs.): 119 Cubic Feet Per Carton: 55.5</p>	<p>For Power/USB module please see electrical placement chart. Includes ganging hardware (2 sides).</p>	<b>7707NA</b>	4584	4863	5080	5410	5874	6040	6445	7221	7594	8314	9291	10512
		<b>OVERALL DIMENSIONS</b>			<b>SEAT DIMENSIONS</b>			<b>BACK DIMENSIONS</b>						
		<b>W</b>	<b>D</b>	<b>H</b>	<b>W</b>	<b>D</b>	<b>H</b>	<b>W</b>	<b>H</b>					
			<b>RTA 00</b>											
 <p><b>Three Seater - High Back w/Arms</b> COM Yardage: 10.5 Freight Class: 250 Product Weight (lbs.): 148 Cubic Feet Per Carton: 69.75</p>	<p>For Power/USB module please see electrical placement chart. No ganging hardware.</p>	<b>7708</b>	6162	6575	6902	7395	8089	8341	8948	10112	10673	11750	13219	15047
		<b>OVERALL DIMENSIONS</b>			<b>SEAT DIMENSIONS</b>			<b>BACK DIMENSIONS</b>						
		<b>W</b>	<b>D</b>	<b>H</b>	<b>W</b>	<b>D</b>	<b>H</b>	<b>W</b>	<b>H</b>					
			<b>RTA 00</b>											
 <p><b>7708L (Left Arm)</b></p>  <p><b>7708R (Right Arm)</b></p> <p><b>Three Seater - High Back w/One Arm</b> COM Yardage: 9.75 Freight Class: 300 Product Weight (lbs.): 139 Cubic Feet Per Carton: 69.75</p>	<p>For Power/USB module please see electrical placement chart. Includes ganging hardware (1 side).</p>	<b>7708L</b>	5761	6146	6451	6905	7551	7785	8349	9429	9949	10951	12314	14013
		<b>7708R</b>	5761	6146	6451	6905	7551	7785	8349	9429	9949	10951	12314	14013
		<b>OVERALL DIMENSIONS</b>			<b>SEAT DIMENSIONS</b>			<b>BACK DIMENSIONS</b>						
<b>W</b>	<b>D</b>	<b>H</b>	<b>W</b>	<b>D</b>	<b>H</b>	<b>W</b>	<b>H</b>							
			<b>RTA 00</b>											

DESCRIPTION FEATURES MODEL# STANDARD TEXTILE GRADES

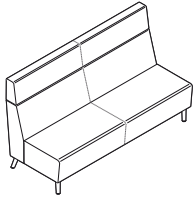

**Armless Three Seater - High Back**  
 COM Yardage: 9.25  
 Freight Class: 300  
 Product Weight (lbs.): 126  
 Cubic Feet Per Carton: 69.75

For Power/USB module please see electrical placement chart. Includes ganging hardware (2 sides).

MODEL#	1	2	3	4	5	6	7	8	9	10	11	12
7708NA	5345	5712	5999	6433	7046	7268	7801	8828	9322	10271	11563	13175

OVERALL DIMENSIONS			SEAT DIMENSIONS			BACK DIMENSIONS	
W	D	H	W	D	H	W	H
72.5	29.5	41.5	72	19	18	72	24

RTA 00

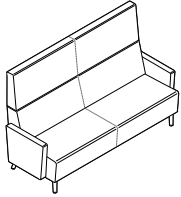

**Three Seater - Extended Back w/Arms**  
 COM Yardage: 11  
 Freight Class: 300  
 Product Weight (lbs.): 144  
 Cubic Feet Per Carton: 78.75

For Power/USB module please see electrical placement chart. No ganging hardware.

MODEL#	1	2	3	4	5	6	7	8	9	10	11	12
7709	6610	7044	7386	7902	8632	8893	9532	10749	11335	12467	14004	15919

OVERALL DIMENSIONS			SEAT DIMENSIONS			BACK DIMENSIONS	
W	D	H	W	D	H	W	H
77.5	29.5	47	72	19	18	72	29

RTA 00



7709L (Left Arm)

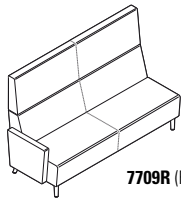

7709R (Right Arm)

**Three Seater - Extended Back w/One Arm**  
 COM Yardage: 10.5  
 Freight Class: 300  
 Product Weight (lbs.): 134  
 Cubic Feet Per Carton: 78.75

For Power/USB module please see electrical placement chart. Includes ganging hardware (1 side).

MODEL#	1	2	3	4	5	6	7	8	9	10	11	12
7709L	6199	6613	6939	7432	8128	8378	8988	10149	10707	11787	13254	15082
7709R	6199	6613	6939	7432	8128	8378	8988	10149	10707	11787	13254	15082

OVERALL DIMENSIONS			SEAT DIMENSIONS			BACK DIMENSIONS	
W	D	H	W	D	H	W	H
75	29.5	47	72	19	18	72	29

RTA 00

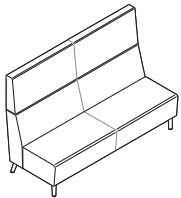

**Armless Three Seater - Extended Back**  
 COM Yardage: 9.75  
 Freight Class: 300  
 Product Weight (lbs.): 124  
 Cubic Feet Per Carton: 78.75

For Power/USB module please see electrical placement chart. Includes ganging hardware (2 sides).

MODEL#	1	2	3	4	5	6	7	8	9	10	11	12
7709NA	5786	6171	6476	6930	7576	7810	8373	9454	9974	10976	12340	14038

OVERALL DIMENSIONS			SEAT DIMENSIONS			BACK DIMENSIONS	
W	D	H	W	D	H	W	H
72.5	29.5	47	72	19	18	72	29

RTA 00

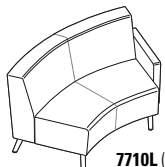

7710L (Left Arm)

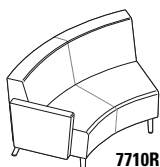

7710R (Right Arm)

**IS Curve - Two Seater - Standard Back w/One Arm**  
 COM Yardage: 5.25  
 Freight Class: 250  
 Product Weight (lbs.): 88  
 Cubic Feet Per Carton: 43



For Power/USB module please see electrical placement chart. Includes ganging hardware (1 side).

MODEL#	1	2	3	4	5	6	7	8	9	10	11	12
7710L	3676	3888	4049	4296	4644	4769	5074	5654	5936	6473	7206	8122
7710R	3676	3888	4049	4296	4644	4769	5074	5654	5936	6473	7206	8122

OVERALL DIMENSIONS			SEAT DIMENSIONS			BACK DIMENSIONS	
W	D	H	W	D	H	W	H
57	29.5	32	42	19	18	51	14

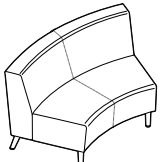
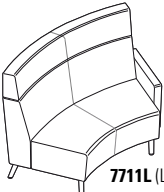
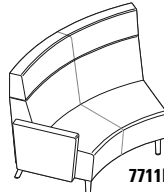
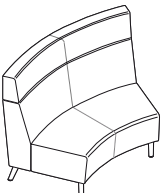
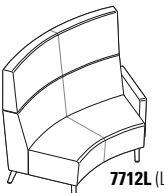
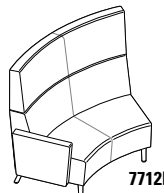
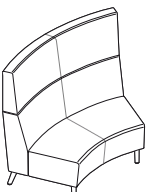
RTA 00

DESCRIPTION	FEATURES	MODEL#	STANDARD TEXTILE GRADES													
			1	2	3	4	5	6	7	8	9	10	11	12		
 <p><b>Armless IS Curve - Two Seat - Standard Back</b>                      COM Yardage: 4.5                      Freight Class: 300                      Product Weight (lbs.): 78                      Cubic Feet Per Carton: 43</p>	<p>For Power/USB module please see electrical placement chart. Includes ganging hardware (2 sides).</p>	<b>7710NA</b>	3258	3437	3576	3789	4088	4195	4455	4954	5194	5656	6286	7068		
		<b>OVERALL DIMENSIONS</b>			<b>SEAT DIMENSIONS</b>			<b>BACK DIMENSIONS</b>								
		<b>W</b>	<b>D</b>	<b>H</b>	<b>W</b>	<b>D</b>	<b>H</b>	<b>W</b>	<b>H</b>							
		55	29.5	32	42	19	18	51	14							
		<b>RTA 00</b>														
 <p><b>7711L (Left Arm)</b></p>  <p><b>7711R (Right Arm)</b></p> <p><b>IS Curve - Two Seater - High Back w/One Arm</b>                      COM Yardage: 6.5                      Freight Class: 300                      Product Weight (lbs.): 94                      Cubic Feet Per Carton: 54</p>	<p>For Power/USB module please see electrical placement chart. Includes ganging hardware (1 side).</p>	<b>7711L</b>	4553	4811	5014	5318	5748	5902	6279	7000	7346	8015	8921	10055		
		<b>7711R</b>	4553	4811	5014	5318	5748	5902	6279	7000	7346	8015	8921	10055		
		<b>OVERALL DIMENSIONS</b>			<b>SEAT DIMENSIONS</b>			<b>BACK DIMENSIONS</b>								
		<b>W</b>	<b>D</b>	<b>H</b>	<b>W</b>	<b>D</b>	<b>H</b>	<b>W</b>	<b>H</b>							
			57	29.5	41.5	42	19	18	51	24						
		<b>RTA 00</b>														
 <p><b>Armless IS Curve - Two Seater - High Back</b>                      COM Yardage: 6                      Freight Class: 300                      Product Weight (lbs.): 84                      Cubic Feet Per Carton: 54</p>	<p>For Power/USB module please see electrical placement chart. Includes ganging hardware (2 sides).</p>	<b>7711NA</b>	4137	4376	4565	4845	5241	5386	5734	6400	6718	7334	8172	9218		
		<b>OVERALL DIMENSIONS</b>			<b>SEAT DIMENSIONS</b>			<b>BACK DIMENSIONS</b>								
		<b>W</b>	<b>D</b>	<b>H</b>	<b>W</b>	<b>D</b>	<b>H</b>	<b>W</b>	<b>H</b>							
		55	29.5	41.5	42	19	18	51	24							
		<b>RTA 00</b>														
 <p><b>7712L (Left Arm)</b></p>  <p><b>7712R (Right Arm)</b></p> <p><b>IS Curve - Two Seater - Extended Back w/One Arm</b>                      COM Yardage: 7                      Freight Class: 300                      Product Weight (lbs.): 99                      Cubic Feet Per Carton: 62.75</p>	<p>For Power/USB module please see electrical placement chart. Includes ganging hardware (1 side).</p>	<b>7712L</b>	4967	5244	5462	5790	6255	6421	6826	7603	7975	8696	9673	10891		
		<b>7712R</b>	4967	5244	5462	5790	6255	6421	6826	7603	7975	8696	9673	10891		
		<b>OVERALL DIMENSIONS</b>			<b>SEAT DIMENSIONS</b>			<b>BACK DIMENSIONS</b>								
		<b>W</b>	<b>D</b>	<b>H</b>	<b>W</b>	<b>D</b>	<b>H</b>	<b>W</b>	<b>H</b>							
			57	29.5	47	42	19	18	51	29						
		<b>RTA 00</b>														
 <p><b>Armless IS Curve - Two Seater - Extended Back</b>                      COM Yardage: 6.75                      Freight Class: 29.5                      Product Weight (lbs.): 89                      Cubic Feet Per Carton: 6.75</p>	<p>For Power/USB module please see electrical placement chart. Includes ganging hardware (2 sides).</p>	<b>7712NA</b>	4553	4819	5030	5346	5793	5954	6346	7095	7455	8150	9091	10266		
		<b>OVERALL DIMENSIONS</b>			<b>SEAT DIMENSIONS</b>			<b>BACK DIMENSIONS</b>								
		<b>W</b>	<b>D</b>	<b>H</b>	<b>W</b>	<b>D</b>	<b>H</b>	<b>W</b>	<b>H</b>							
		55	29.5	47	42	19	18	51	29							
		<b>RTA 00</b>														

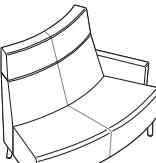
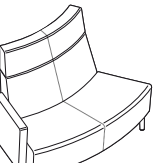
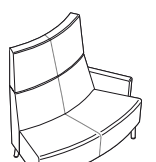
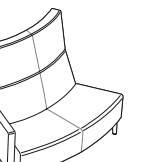
DESCRIPTION	FEATURES	MODEL#	STANDARD TEXTILE GRADES																																																													
			1	2	3	4	5	6	7	8	9	10	11	12																																																		
 <p><b>7713L</b> (Left Arm)</p>	 <p><b>7713R</b> (Right Arm)</p>																																																															
		<p><b>OS Curve - Two Seater - Standard Back w/One Arm</b>                      COM Yardage: 5.25                      Freight Class: 300                      Product Weight (lbs.): 82                      Cubic Feet Per Carton: 43</p>	<p>For Power/USB module please see electrical placement chart. Includes ganging hardware (1 side).</p>	<table border="1"> <thead> <tr> <th colspan="3">OVERALL DIMENSIONS</th> <th colspan="3">SEAT DIMENSIONS</th> <th colspan="3">BACK DIMENSIONS</th> </tr> <tr> <th>W</th> <th>D</th> <th>H</th> <th>W</th> <th>D</th> <th>H</th> <th>W</th> <th>H</th> </tr> </thead> <tbody> <tr> <td>54.5</td> <td>29.5</td> <td>32</td> <td>48</td> <td>19</td> <td>18</td> <td>36</td> <td>14</td> </tr> </tbody> </table>	OVERALL DIMENSIONS			SEAT DIMENSIONS			BACK DIMENSIONS			W	D	H	W	D	H	W	H	54.5	29.5	32	48	19	18	36	14																																			
OVERALL DIMENSIONS			SEAT DIMENSIONS			BACK DIMENSIONS																																																										
W	D	H	W	D	H	W	H																																																									
54.5	29.5	32	48	19	18	36	14																																																									
			<table border="1"> <thead> <tr> <th colspan="12">STANDARD TEXTILE GRADES</th> </tr> <tr> <th>1</th> <th>2</th> <th>3</th> <th>4</th> <th>5</th> <th>6</th> <th>7</th> <th>8</th> <th>9</th> <th>10</th> <th>11</th> <th>12</th> </tr> </thead> <tbody> <tr> <td><b>7713L</b></td> <td>3676</td> <td>3888</td> <td>4049</td> <td>4296</td> <td>4644</td> <td>4769</td> <td>5074</td> <td>5654</td> <td>5936</td> <td>6473</td> <td>7206</td> <td>8122</td> </tr> <tr> <td><b>7713R</b></td> <td>3676</td> <td>3888</td> <td>4049</td> <td>4296</td> <td>4644</td> <td>4769</td> <td>5074</td> <td>5654</td> <td>5936</td> <td>6473</td> <td>7206</td> <td>8122</td> </tr> </tbody> </table>												STANDARD TEXTILE GRADES												1	2	3	4	5	6	7	8	9	10	11	12	<b>7713L</b>	3676	3888	4049	4296	4644	4769	5074	5654	5936	6473	7206	8122	<b>7713R</b>	3676	3888	4049	4296	4644	4769	5074	5654	5936	6473	7206	8122
STANDARD TEXTILE GRADES																																																																
1	2	3	4	5	6	7	8	9	10	11	12																																																					
<b>7713L</b>	3676	3888	4049	4296	4644	4769	5074	5654	5936	6473	7206	8122																																																				
<b>7713R</b>	3676	3888	4049	4296	4644	4769	5074	5654	5936	6473	7206	8122																																																				
			<table border="1"> <thead> <tr> <th colspan="12">STANDARD TEXTILE GRADES</th> </tr> <tr> <th>1</th> <th>2</th> <th>3</th> <th>4</th> <th>5</th> <th>6</th> <th>7</th> <th>8</th> <th>9</th> <th>10</th> <th>11</th> <th>12</th> </tr> </thead> <tbody> <tr> <td><b>7713NA</b></td> <td>3258</td> <td>3437</td> <td>3576</td> <td>3790</td> <td>4088</td> <td>4195</td> <td>4455</td> <td>4954</td> <td>5194</td> <td>5656</td> <td>6286</td> <td>7068</td> </tr> </tbody> </table>												STANDARD TEXTILE GRADES												1	2	3	4	5	6	7	8	9	10	11	12	<b>7713NA</b>	3258	3437	3576	3790	4088	4195	4455	4954	5194	5656	6286	7068													
STANDARD TEXTILE GRADES																																																																
1	2	3	4	5	6	7	8	9	10	11	12																																																					
<b>7713NA</b>	3258	3437	3576	3790	4088	4195	4455	4954	5194	5656	6286	7068																																																				
			<table border="1"> <thead> <tr> <th colspan="3">OVERALL DIMENSIONS</th> <th colspan="3">SEAT DIMENSIONS</th> <th colspan="3">BACK DIMENSIONS</th> </tr> <tr> <th>W</th> <th>D</th> <th>H</th> <th>W</th> <th>D</th> <th>H</th> <th>W</th> <th>H</th> </tr> </thead> <tbody> <tr> <td>54</td> <td>29.5</td> <td>32</td> <td>48</td> <td>19</td> <td>18</td> <td>36</td> <td>14</td> </tr> </tbody> </table>												OVERALL DIMENSIONS			SEAT DIMENSIONS			BACK DIMENSIONS			W	D	H	W	D	H	W	H	54	29.5	32	48	19	18	36	14																									
OVERALL DIMENSIONS			SEAT DIMENSIONS			BACK DIMENSIONS																																																										
W	D	H	W	D	H	W	H																																																									
54	29.5	32	48	19	18	36	14																																																									
			<table border="1"> <thead> <tr> <th colspan="12">STANDARD TEXTILE GRADES</th> </tr> <tr> <th>1</th> <th>2</th> <th>3</th> <th>4</th> <th>5</th> <th>6</th> <th>7</th> <th>8</th> <th>9</th> <th>10</th> <th>11</th> <th>12</th> </tr> </thead> <tbody> <tr> <td><b>7713NA</b></td> <td>3258</td> <td>3437</td> <td>3576</td> <td>3790</td> <td>4088</td> <td>4195</td> <td>4455</td> <td>4954</td> <td>5194</td> <td>5656</td> <td>6286</td> <td>7068</td> </tr> </tbody> </table>												STANDARD TEXTILE GRADES												1	2	3	4	5	6	7	8	9	10	11	12	<b>7713NA</b>	3258	3437	3576	3790	4088	4195	4455	4954	5194	5656	6286	7068													
STANDARD TEXTILE GRADES																																																																
1	2	3	4	5	6	7	8	9	10	11	12																																																					
<b>7713NA</b>	3258	3437	3576	3790	4088	4195	4455	4954	5194	5656	6286	7068																																																				
 <p><b>7714L</b> (Left Arm)</p>	 <p><b>7714R</b> (Right Arm)</p>																																																															
		<p><b>OS Curve - Two Seater - High Back w/One Arm</b>                      COM Yardage: 6.5                      Freight Class: 300                      Product Weight (lbs.): 88                      Cubic Feet Per Carton: 54</p>	<p>For Power/USB module please see electrical placement chart. Includes ganging hardware (1 side).</p>	<table border="1"> <thead> <tr> <th colspan="3">OVERALL DIMENSIONS</th> <th colspan="3">SEAT DIMENSIONS</th> <th colspan="3">BACK DIMENSIONS</th> </tr> <tr> <th>W</th> <th>D</th> <th>H</th> <th>W</th> <th>D</th> <th>H</th> <th>W</th> <th>H</th> </tr> </thead> <tbody> <tr> <td>54.5</td> <td>29.5</td> <td>41.5</td> <td>48</td> <td>19</td> <td>18</td> <td>36</td> <td>24</td> </tr> </tbody> </table>	OVERALL DIMENSIONS			SEAT DIMENSIONS			BACK DIMENSIONS			W	D	H	W	D	H	W	H	54.5	29.5	41.5	48	19	18	36	24																																			
OVERALL DIMENSIONS			SEAT DIMENSIONS			BACK DIMENSIONS																																																										
W	D	H	W	D	H	W	H																																																									
54.5	29.5	41.5	48	19	18	36	24																																																									
			<table border="1"> <thead> <tr> <th colspan="12">STANDARD TEXTILE GRADES</th> </tr> <tr> <th>1</th> <th>2</th> <th>3</th> <th>4</th> <th>5</th> <th>6</th> <th>7</th> <th>8</th> <th>9</th> <th>10</th> <th>11</th> <th>12</th> </tr> </thead> <tbody> <tr> <td><b>7714L</b></td> <td>4292</td> <td>4552</td> <td>4754</td> <td>5059</td> <td>5489</td> <td>5644</td> <td>6022</td> <td>6741</td> <td>7086</td> <td>7757</td> <td>8664</td> <td>9795</td> </tr> <tr> <td><b>7714R</b></td> <td>4292</td> <td>4552</td> <td>4754</td> <td>5059</td> <td>5489</td> <td>5644</td> <td>6022</td> <td>6741</td> <td>7086</td> <td>7757</td> <td>8664</td> <td>9795</td> </tr> </tbody> </table>												STANDARD TEXTILE GRADES												1	2	3	4	5	6	7	8	9	10	11	12	<b>7714L</b>	4292	4552	4754	5059	5489	5644	6022	6741	7086	7757	8664	9795	<b>7714R</b>	4292	4552	4754	5059	5489	5644	6022	6741	7086	7757	8664	9795
STANDARD TEXTILE GRADES																																																																
1	2	3	4	5	6	7	8	9	10	11	12																																																					
<b>7714L</b>	4292	4552	4754	5059	5489	5644	6022	6741	7086	7757	8664	9795																																																				
<b>7714R</b>	4292	4552	4754	5059	5489	5644	6022	6741	7086	7757	8664	9795																																																				
			<table border="1"> <thead> <tr> <th colspan="12">STANDARD TEXTILE GRADES</th> </tr> <tr> <th>1</th> <th>2</th> <th>3</th> <th>4</th> <th>5</th> <th>6</th> <th>7</th> <th>8</th> <th>9</th> <th>10</th> <th>11</th> <th>12</th> </tr> </thead> <tbody> <tr> <td><b>7714NA</b></td> <td>3885</td> <td>4123</td> <td>4311</td> <td>4591</td> <td>4988</td> <td>5133</td> <td>5481</td> <td>6145</td> <td>6466</td> <td>7082</td> <td>7920</td> <td>8965</td> </tr> </tbody> </table>												STANDARD TEXTILE GRADES												1	2	3	4	5	6	7	8	9	10	11	12	<b>7714NA</b>	3885	4123	4311	4591	4988	5133	5481	6145	6466	7082	7920	8965													
STANDARD TEXTILE GRADES																																																																
1	2	3	4	5	6	7	8	9	10	11	12																																																					
<b>7714NA</b>	3885	4123	4311	4591	4988	5133	5481	6145	6466	7082	7920	8965																																																				
			<table border="1"> <thead> <tr> <th colspan="3">OVERALL DIMENSIONS</th> <th colspan="3">SEAT DIMENSIONS</th> <th colspan="3">BACK DIMENSIONS</th> </tr> <tr> <th>W</th> <th>D</th> <th>H</th> <th>W</th> <th>D</th> <th>H</th> <th>W</th> <th>H</th> </tr> </thead> <tbody> <tr> <td>54</td> <td>29.5</td> <td>41.5</td> <td>48</td> <td>19</td> <td>18</td> <td>36</td> <td>24</td> </tr> </tbody> </table>												OVERALL DIMENSIONS			SEAT DIMENSIONS			BACK DIMENSIONS			W	D	H	W	D	H	W	H	54	29.5	41.5	48	19	18	36	24																									
OVERALL DIMENSIONS			SEAT DIMENSIONS			BACK DIMENSIONS																																																										
W	D	H	W	D	H	W	H																																																									
54	29.5	41.5	48	19	18	36	24																																																									
			<table border="1"> <thead> <tr> <th colspan="12">STANDARD TEXTILE GRADES</th> </tr> <tr> <th>1</th> <th>2</th> <th>3</th> <th>4</th> <th>5</th> <th>6</th> <th>7</th> <th>8</th> <th>9</th> <th>10</th> <th>11</th> <th>12</th> </tr> </thead> <tbody> <tr> <td><b>7714NA</b></td> <td>3885</td> <td>4123</td> <td>4311</td> <td>4591</td> <td>4988</td> <td>5133</td> <td>5481</td> <td>6145</td> <td>6466</td> <td>7082</td> <td>7920</td> <td>8965</td> </tr> </tbody> </table>												STANDARD TEXTILE GRADES												1	2	3	4	5	6	7	8	9	10	11	12	<b>7714NA</b>	3885	4123	4311	4591	4988	5133	5481	6145	6466	7082	7920	8965													
STANDARD TEXTILE GRADES																																																																
1	2	3	4	5	6	7	8	9	10	11	12																																																					
<b>7714NA</b>	3885	4123	4311	4591	4988	5133	5481	6145	6466	7082	7920	8965																																																				
 <p><b>7715L</b> (Left Arm)</p>	 <p><b>7715R</b> (Right Arm)</p>																																																															
		<p><b>OS Curve - Two Seater - Extended Back w/One Arm</b>                      COM Yardage: 7                      Freight Class: 300                      Product Weight (lbs.): 93                      Cubic Feet Per Carton: 62.75</p>	<p>For Power/USB module please see electrical placement chart. Includes ganging hardware (1 side).</p>	<table border="1"> <thead> <tr> <th colspan="3">OVERALL DIMENSIONS</th> <th colspan="3">SEAT DIMENSIONS</th> <th colspan="3">BACK DIMENSIONS</th> </tr> <tr> <th>W</th> <th>D</th> <th>H</th> <th>W</th> <th>D</th> <th>H</th> <th>W</th> <th>H</th> </tr> </thead> <tbody> <tr> <td>54.5</td> <td>29.5</td> <td>47</td> <td>48</td> <td>19</td> <td>18</td> <td>36</td> <td>29</td> </tr> </tbody> </table>	OVERALL DIMENSIONS			SEAT DIMENSIONS			BACK DIMENSIONS			W	D	H	W	D	H	W	H	54.5	29.5	47	48	19	18	36	29																																			
OVERALL DIMENSIONS			SEAT DIMENSIONS			BACK DIMENSIONS																																																										
W	D	H	W	D	H	W	H																																																									
54.5	29.5	47	48	19	18	36	29																																																									
			<table border="1"> <thead> <tr> <th colspan="12">STANDARD TEXTILE GRADES</th> </tr> <tr> <th>1</th> <th>2</th> <th>3</th> <th>4</th> <th>5</th> <th>6</th> <th>7</th> <th>8</th> <th>9</th> <th>10</th> <th>11</th> <th>12</th> </tr> </thead> <tbody> <tr> <td><b>7715L</b></td> <td>4686</td> <td>4964</td> <td>5182</td> <td>5512</td> <td>5975</td> <td>6142</td> <td>6547</td> <td>7323</td> <td>7695</td> <td>8416</td> <td>9393</td> <td>10614</td> </tr> <tr> <td><b>7715R</b></td> <td>4686</td> <td>4964</td> <td>5182</td> <td>5512</td> <td>5975</td> <td>6142</td> <td>6547</td> <td>7323</td> <td>7695</td> <td>8416</td> <td>9393</td> <td>10614</td> </tr> </tbody> </table>												STANDARD TEXTILE GRADES												1	2	3	4	5	6	7	8	9	10	11	12	<b>7715L</b>	4686	4964	5182	5512	5975	6142	6547	7323	7695	8416	9393	10614	<b>7715R</b>	4686	4964	5182	5512	5975	6142	6547	7323	7695	8416	9393	10614
STANDARD TEXTILE GRADES																																																																
1	2	3	4	5	6	7	8	9	10	11	12																																																					
<b>7715L</b>	4686	4964	5182	5512	5975	6142	6547	7323	7695	8416	9393	10614																																																				
<b>7715R</b>	4686	4964	5182	5512	5975	6142	6547	7323	7695	8416	9393	10614																																																				
			<table border="1"> <thead> <tr> <th colspan="12">STANDARD TEXTILE GRADES</th> </tr> <tr> <th>1</th> <th>2</th> <th>3</th> <th>4</th> <th>5</th> <th>6</th> <th>7</th> <th>8</th> <th>9</th> <th>10</th> <th>11</th> <th>12</th> </tr> </thead> <tbody> <tr> <td><b>7715NA</b></td> <td>4292</td> <td>4552</td> <td>4754</td> <td>5059</td> <td>5489</td> <td>5644</td> <td>6022</td> <td>6741</td> <td>7086</td> <td>7757</td> <td>8664</td> <td>9795</td> </tr> </tbody> </table>												STANDARD TEXTILE GRADES												1	2	3	4	5	6	7	8	9	10	11	12	<b>7715NA</b>	4292	4552	4754	5059	5489	5644	6022	6741	7086	7757	8664	9795													
STANDARD TEXTILE GRADES																																																																
1	2	3	4	5	6	7	8	9	10	11	12																																																					
<b>7715NA</b>	4292	4552	4754	5059	5489	5644	6022	6741	7086	7757	8664	9795																																																				
			<table border="1"> <thead> <tr> <th colspan="3">OVERALL DIMENSIONS</th> <th colspan="3">SEAT DIMENSIONS</th> <th colspan="3">BACK DIMENSIONS</th> </tr> <tr> <th>W</th> <th>D</th> <th>H</th> <th>W</th> <th>D</th> <th>H</th> <th>W</th> <th>H</th> </tr> </thead> <tbody> <tr> <td>54.5</td> <td>29.5</td> <td>47</td> <td>48</td> <td>19</td> <td>18</td> <td>36</td> <td>29</td> </tr> </tbody> </table>												OVERALL DIMENSIONS			SEAT DIMENSIONS			BACK DIMENSIONS			W	D	H	W	D	H	W	H	54.5	29.5	47	48	19	18	36	29																									
OVERALL DIMENSIONS			SEAT DIMENSIONS			BACK DIMENSIONS																																																										
W	D	H	W	D	H	W	H																																																									
54.5	29.5	47	48	19	18	36	29																																																									
			<table border="1"> <thead> <tr> <th colspan="12">STANDARD TEXTILE GRADES</th> </tr> <tr> <th>1</th> <th>2</th> <th>3</th> <th>4</th> <th>5</th> <th>6</th> <th>7</th> <th>8</th> <th>9</th> <th>10</th> <th>11</th> <th>12</th> </tr> </thead> <tbody> <tr> <td><b>7715NA</b></td> <td>4292</td> <td>4552</td> <td>4754</td> <td>5059</td> <td>5489</td> <td>5644</td> <td>6022</td> <td>6741</td> <td>7086</td> <td>7757</td> <td>8664</td> <td>9795</td> </tr> </tbody> </table>												STANDARD TEXTILE GRADES												1	2	3	4	5	6	7	8	9	10	11	12	<b>7715NA</b>	4292	4552	4754	5059	5489	5644	6022	6741	7086	7757	8664	9795													
STANDARD TEXTILE GRADES																																																																
1	2	3	4	5	6	7	8	9	10	11	12																																																					
<b>7715NA</b>	4292	4552	4754	5059	5489	5644	6022	6741	7086	7757	8664	9795																																																				

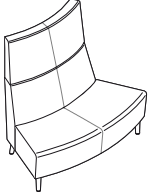
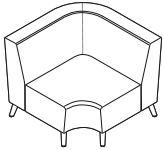
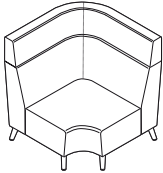
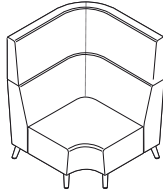
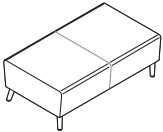

DESCRIPTION	FEATURES	MODEL#	STANDARD TEXTILE GRADES												
			1	2	3	4	5	6	7	8	9	10	11	12	
 <p><b>Armless OS Curve - Two Seater - Ext. High Back</b>                      COM Yardage: 6.75                      Freight Class: 300                      Product Weight (lbs.): 83                      Cubic Feet Per Carton: 62.75</p>	<p>For Power/USB module please see electrical placement chart.                      Includes ganging hardware (2 sides).</p>	<b>7715NA</b>	4271	4537	4750	5064	5511	5672	6064	6814	7173	7868	8809	9986	
		<b>OVERALL DIMENSIONS</b>			<b>SEAT DIMENSIONS</b>			<b>BACK DIMENSIONS</b>							
		<b>W</b>	<b>D</b>	<b>H</b>	<b>W</b>	<b>D</b>	<b>H</b>	<b>W</b>	<b>H</b>						
		54	29.5	47	48	19	18	36	28						
			<b>RTA 00</b>												
 <p><b>Armless Corner Unit - Standard Back</b>                      COM Yardage: 5.5                      Freight Class: 300                      Product Weight (lbs.): 75                      Cubic Feet Per Carton: 49</p>	<p>For Power/USB module please see electrical placement chart.                      Includes ganging hardware (2 sides).</p>	<b>7716</b>	3980	4199	4373	4627	4995	5124	5443	6054	6345	6912	7681	8637	
		<b>OVERALL DIMENSIONS</b>			<b>SEAT DIMENSIONS</b>			<b>BACK DIMENSIONS</b>							
		<b>W</b>	<b>D</b>	<b>H</b>	<b>W</b>	<b>D</b>	<b>H</b>	<b>W</b>	<b>H</b>						
		38	38	32	24	19	18	24	14						
			<b>RTA 00</b>												
 <p><b>Armless Corner Unit - High Back</b>                      COM Yardage: 7.75                      Freight Class: 300                      Product Weight (lbs.): 82                      Cubic Feet Per Carton: 49</p>	<p>For Power/USB module please see electrical placement chart.                      Includes ganging hardware (2 sides).</p>	<b>7717</b>	5041	5346	5588	5952	6467	6651	7099	7959	8371	9168	10250	11599	
		<b>OVERALL DIMENSIONS</b>			<b>SEAT DIMENSIONS</b>			<b>BACK DIMENSIONS</b>							
		<b>W</b>	<b>D</b>	<b>H</b>	<b>W</b>	<b>D</b>	<b>H</b>	<b>W</b>	<b>H</b>						
		38	38	41.5	24	19	18	24	24						
			<b>RTA 00</b>												
 <p><b>Armless Corner Unit - Extended Back</b>                      COM Yardage: 8.5                      Freight Class: 300                      Product Weight (lbs.): 88                      Cubic Feet Per Carton: 49</p>	<p>For Power/USB module please see electrical placement chart.                      Includes ganging hardware (2 sides).</p>	<b>7718</b>	5339	5674	5939	6337	6900	7103	7596	8537	8991	9865	11052	12532	
		<b>OVERALL DIMENSIONS</b>			<b>SEAT DIMENSIONS</b>			<b>BACK DIMENSIONS</b>							
		<b>W</b>	<b>D</b>	<b>H</b>	<b>W</b>	<b>D</b>	<b>H</b>	<b>W</b>	<b>H</b>						
		38	38	47	24	19	18	24	29						
			<b>RTA 00</b>												
 <p><b>Two Seater Bench</b>                      COM Yardage: 2.25                      Freight Class: 300                      Product Weight (lbs.): 41                      Cubic Feet Per Carton: 21.25</p>	<p>For Power/USB module please see electrical placement chart.                      Includes ganging hardware (2 sides).</p>	<b>7725</b>	2036	2129	2200	2303	2453	2508	2638	2888	3006	3239	3553	3944	
		<b>OVERALL DIMENSIONS</b>			<b>SEAT DIMENSIONS</b>			<b>BACK DIMENSIONS</b>							
		<b>W</b>	<b>D</b>	<b>H</b>	<b>W</b>	<b>D</b>	<b>H</b>	<b>W</b>	<b>H</b>						
		48.5	28	17.5											
			<b>RTA 00</b>												

DESCRIPTION FEATURES MODEL# STANDARD TEXTILE GRADES

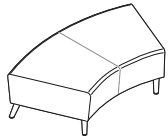

**IS Curve - Two Seater Bench**  
 COM Yardage: 3  
 Freight Class: 300  
 Product Weight (lbs.): 41  
 Cubic Feet Per Carton: 21.25

For Power/USB module please see electrical placement chart. Includes ganging hardware (2 sides).

MODEL#	1	2	3	4	5	6	7	8	9	10	11	12
7726	2765	2888	2981	3120	3318	3391	3566	3898	4057	4366	4785	5309

OVERALL DIMENSIONS			SEAT DIMENSIONS			BACK DIMENSIONS	
W	D	H	W	D	H	W	H

54 28 17.5

RTA 00

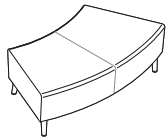

**OS Curve - Two Seater Bench**  
 COM Yardage: 3  
 Freight Class: 300  
 Product Weight (lbs.): 41  
 Cubic Feet Per Carton: 21.25

For Power/USB module please see electrical placement chart. Includes ganging hardware (2 sides).

MODEL#	1	2	3	4	5	6	7	8	9	10	11	12
7727	2765	2888	2981	3120	3318	3391	3566	3898	4057	4366	4785	5309

OVERALL DIMENSIONS			SEAT DIMENSIONS			BACK DIMENSIONS	
W	D	H	W	D	H	W	H

54 28 17.5

RTA 00

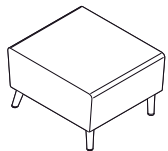

**Square Single Seater Bench**  
 COM Yardage: 1.75  
 Freight Class: 250  
 Product Weight (lbs.): 30  
 Cubic Feet Per Carton: 9.25

For Power/USB module please see electrical placement chart. Includes ganging hardware (2 sides).

MODEL#	1	2	3	4	5	6	7	8	9	10	11	12
7728	1392	1464	1518	1600	1715	1759	1859	2055	2147	2326	2572	2875

OVERALL DIMENSIONS			SEAT DIMENSIONS			BACK DIMENSIONS	
W	D	H	W	D	H	W	H

24.5 28 17.5

RTA 00

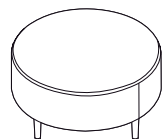

**36" Dia. - Round Bench**  
 COM Yardage: 3  
 Freight Class: 250  
 Product Weight (lbs.): 46  
 Cubic Feet Per Carton: 18.25

No Power/USB module. No ganging hardware.

MODEL#	1	2	3	4	5	6	7	8	9	10	11	12
7729	2043	2166	2259	2400	2599	2672	2845	3176	3336	3644	4063	4587

OVERALL DIMENSIONS			SEAT DIMENSIONS			BACK DIMENSIONS	
W	D	H	W	D	H	W	H

36 36 17.5

RTA 00

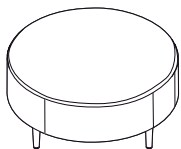

**42" Dia. - Round Bench**  
 COM Yardage: 3.25  
 Freight Class: 250  
 Product Weight (lbs.): 50  
 Cubic Feet Per Carton: 22

No Power/USB module. No ganging hardware.

MODEL#	1	2	3	4	5	6	7	8	9	10	11	12
7730	2351	2480	2583	2737	2949	3026	3215	3578	3750	4083	4536	5103

OVERALL DIMENSIONS			SEAT DIMENSIONS			BACK DIMENSIONS	
W	D	H	W	D	H	W	H

42 42 17.5

RTA 00

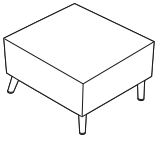
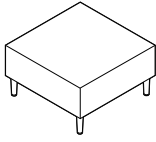
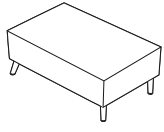
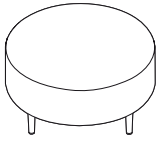
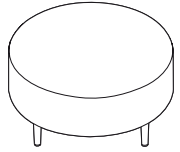
DESCRIPTION	FEATURES	MODEL#	STANDARD TEXTILE GRADES														
			1	2	3	4	5	6	7	8	9	10	11	12			
 <p><b>30" Square Laminate Coffee Table</b> COM Yardage: N/A Freight Class: 150 Product Weight (lbs.): 61 Cubic Feet Per Carton: 11.5</p>	<p>For Power/USB module please see electrical placement chart. No ganging hardware.</p>	7731	1300														
			OVERALL DIMENSIONS			SEAT DIMENSIONS			BACK DIMENSIONS								
			W	D	H	W	D	H	W	H							
			30	30	17												
			RTA 00														
 <p><b>36" Square Laminate Coffee Table</b> COM Yardage: N/A Freight Class: 150 Product Weight (lbs.): 85 Cubic Feet Per Carton: 16.5</p>	<p>For Power/USB module please see electrical placement chart. No ganging hardware.</p>	7732	1477														
			OVERALL DIMENSIONS			SEAT DIMENSIONS			BACK DIMENSIONS								
			W	D	H	W	D	H	W	H							
			36	36	17												
			RTA 00														
 <p><b>Rectangular Laminate Coffee Table</b> COM Yardage: N/A Freight Class: 150 Product Weight (lbs.): 55 Cubic Feet Per Carton: 11.5</p>	<p>For Power/USB module please see electrical placement chart. No ganging hardware.</p>	7733	1306														
			OVERALL DIMENSIONS			SEAT DIMENSIONS			BACK DIMENSIONS								
			W	D	H	W	D	H	W	H							
			40	20	17												
			RTA 00														
 <p><b>36" Dia. - Round Laminate Coffee Table</b> COM Yardage: N/A Freight Class: 250 Product Weight (lbs.): 63 Cubic Feet Per Carton: 16.5</p>	<p>For Power/USB module please see electrical placement chart. No ganging hardware.</p>	7734	1612														
			OVERALL DIMENSIONS			SEAT DIMENSIONS			BACK DIMENSIONS								
			W	D	H	W	D	H	W	H							
			36	36	17												
			RTA 00														
 <p><b>42" Dia. - Round Laminate Coffee Table</b> COM Yardage: N/A Freight Class: 250 Product Weight (lbs.): 85 Cubic Feet Per Carton: 22</p>	<p>For Power/USB module please see electrical placement chart. No ganging hardware.</p>	7735	1762														
			OVERALL DIMENSIONS			SEAT DIMENSIONS			BACK DIMENSIONS								
			W	D	H	W	D	H	W	H							
			42	42	17												
			RTA 00														

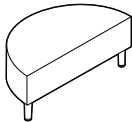
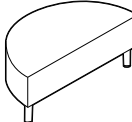
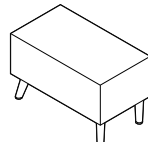
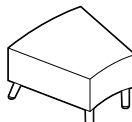
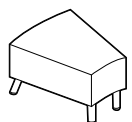
DESCRIPTION	FEATURES	MODEL#	STANDARD TEXTILE GRADES														
			1	2	3	4	5	6	7	8	9	10	11	12			
 <p><b>36" Half Round Laminate Coffee Table</b> COM Yardage: N/A Freight Class: 150 Product Weight (lbs.): 37 Cubic Feet Per Carton: 8.5</p>	<p>For Power/USB module please see electrical placement chart. No ganging hardware.</p>	7736	1143														
			OVERALL DIMENSIONS			SEAT DIMENSIONS			BACK DIMENSIONS								
			W	D	H	W	D	H	W	H							
			36	18	17												
			RTA 00														
 <p><b>42" Half Round Laminate Coffee Table</b> COM Yardage: N/A Freight Class: 150 Product Weight (lbs.): 48 Cubic Feet Per Carton: 11.5</p>	<p>For Power/USB module please see electrical placement chart. No ganging hardware.</p>	7737	1384														
			OVERALL DIMENSIONS			SEAT DIMENSIONS			BACK DIMENSIONS								
			W	D	H	W	D	H	W	H							
			42	21	17												
			RTA 00														
 <p><b>Rectangular Laminate End Table</b> COM Yardage: N/A Freight Class: 125 Product Weight (lbs.): 34 Cubic Feet Per Carton: 5.5</p>	<p>For Power/USB module please see electrical placement chart. Includes ganging hardware (2 sides).</p>	7738	1309														
			OVERALL DIMENSIONS			SEAT DIMENSIONS			BACK DIMENSIONS								
			W	D	H	W	D	H	W	H							
			15	27.25	17												
			RTA 00														
 <p><b>IS Curve Wide Wedge Laminate End Table</b> COM Yardage: N/A Freight Class: 150 Product Weight (lbs.): 50 Cubic Feet Per Carton: 9.5</p>	<p>For Power/USB module please see electrical placement chart. Includes ganging hardware (2 sides).</p>	7739	1728														
			OVERALL DIMENSIONS			SEAT DIMENSIONS			BACK DIMENSIONS								
			W	D	H	W	D	H	W	H							
			27.25	27.25	17												
			RTA 00														
 <p><b>IS Curve Narrow Wedge Laminate End Table</b> COM Yardage: N/A Freight Class: 150 Product Weight (lbs.): 34 Cubic Feet Per Carton: 6.5</p>	<p>For Power/USB module please see electrical placement chart. Includes ganging hardware (2 sides).</p>	7740	1400														
			OVERALL DIMENSIONS			SEAT DIMENSIONS			BACK DIMENSIONS								
			W	D	H	W	D	H	W	H							
			18.25	27.25	17												
			RTA 00														

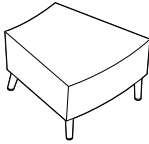
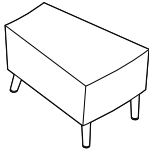
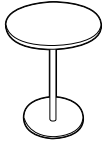
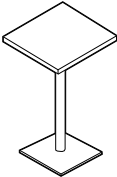
DESCRIPTION	FEATURES	MODEL#	STANDARD TEXTILE GRADES														
			1	2	3	4	5	6	7	8	9	10	11	12			
 <p><b>OS Curve - Wide Wedge Laminate End Table</b>                      COM Yardage: N/A                      Freight Class: 150                      Product Weight (lbs.): 50                      Cubic Feet Per Carton: 9.5</p>	For Power/USB module please see electrical placement chart. Includes ganging hardware (2 sides).	7741	1728														
		<b>OVERALL DIMENSIONS</b>			<b>SEAT DIMENSIONS</b>			<b>BACK DIMENSIONS</b>									
		W	D	H	W	D	H	W	H								
		27.25	27.25	17													
			<b>RTA 00</b>														
 <p><b>OS Curve - Narrow Wedge Laminate End Table</b>                      COM Yardage: N/A                      Freight Class: 150                      Product Weight (lbs.): 34                      Cubic Feet Per Carton: 6.5</p>	For Power/USB module please see electrical placement chart. Includes ganging hardware (2 sides).	7742	1400														
		<b>OVERALL DIMENSIONS</b>			<b>SEAT DIMENSIONS</b>			<b>BACK DIMENSIONS</b>									
		W	D	H	W	D	H	W	H								
		18.25	27.25	17													
			<b>RTA 00</b>														
 <p><b>18" Dia. Round Laminate Laptop Table</b>                      COM Yardage: N/A                      Freight Class: 150                      Product Weight (lbs.): 32                      Cubic Feet Per Carton: 6</p>	No Power/USB module. No ganging hardware.	7743	792														
		<b>OVERALL DIMENSIONS</b>			<b>SEAT DIMENSIONS</b>			<b>BACK DIMENSIONS</b>									
		W	D	H	W	D	H	W	H								
		18	18	25.25													
			<b>RTA 00</b>														
 <p><b>16" Square Laminate Laptop Table</b>                      COM Yardage: N/A                      Freight Class: 125                      Product Weight (lbs.): 36                      Cubic Feet Per Carton: 6</p>	No Power/USB module. No ganging hardware.	7745	810														
		<b>OVERALL DIMENSIONS</b>			<b>SEAT DIMENSIONS</b>			<b>BACK DIMENSIONS</b>									
		W	D	H	W	D	H	W	H								
		16	16	25.25													
			<b>RTA 00</b>														

# RIVER™ PERSONAL HARBOR



Sample Layout

### ELECTRICAL PLACEMENT

Locations available on left side J1 (black) or W1 (white), right side J3 (black) or W3 (white) or both sides J1/J3 (black) or W1/W3 (white).

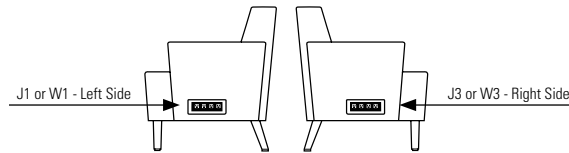

Personal Harbor - power module is located left or right of the seat box

# RIVER™ PERSONAL HARBOR

### STANDARD FEATURES

- River Personal Harbor is a line extension of the popular River modular seating series. For modular series see River price book pages.
- The freestanding soft seating models are available with standard height, high and extended high backs.
- The unique tapered legs (swaged legs) are made of welded steel, heavy duty construction, with each leg bolted directly to the frame. The extremely robust construction insures trouble free performance in any environment. All units have the same leg height of 6.5". The leg height makes it easier to clean under the product.
- Each leg is standard with adjustable black nylon leveling glides and are non-marking. Wood legs and casters are not available.
- All cushions are fixed and non-removable (cushions will not migrate). Perimeter seams feature a decorative single stitch detail, which makes seams lay flat and adds extra seam strength.
- Seating frames are heavy duty with interlocking plywood, puzzle box construction, made for rugged active environments. Seats are high density with highly resilient foam and are equipped with a synthetic rubberized webbing suspension system for extra comfort.
- Front edge or face of the seat, angles slightly inward, so feet have freedom of movement and shoe heels don't rub on the seat. This inward slanting matches the inward angles of the back. Benches and connecting end tables also reflect the inward angles on the front and back faces, so all units coordinate in visual appearance.
- High Traffic (HT) units are rated at 350 lbs. active load per seat and 24/7 use. These units have the same puzzle box frame construction except that the framing wood is 1" thick, rotary cut, birch plywood and all arms, seat and back cushions are made with Ultracell Foam.
- High Traffic (HT) models are recommend to be specified in textiles that meet or exceed 100,000 double rubs for added abrasion performance.

- Check textile availability prior to specifying upholstery material. Leather not available on River Personal Harbor.

### OPTIONAL FEATURES

- Seating units can be specified with Power/USB terminals, which includes two power outlets, two double USB terminals and a black 60" three-prong power cord. Each Power/USB module is set in predetermined locations, as shown in the electrical illustrations below. Electrical units must be factory installed.
- To add a Power/USB module: From the electrical illustrations below, please specify **J1, W1, J2, W2, J3, W4, J4, W4, J6** or **W6** after the product model number. Please note on seating units, if both right and left locations are required, add both **J1/J3** or **W1/W3** to the model number. Add \$945 for each module/location required.
- Power/USB modules are available with either Jet Black (**J**) face plate with black Power/USB receptacles or with a White (**W**) face plate with white Power/USB receptacles.
- **Leg finish**  
**(CHM)** Chrome **(TBL)** Black  
**(TDW)** Designer White **(TFO)** Fog  
**(TFR)** Frost **(TIV)** Cloud  
**(TKA)** Kalua **(TLA)** Latte  
**(TMO)** Mocha **(TNE)** Nevada  
**(TOA)** Toast **(TSH)** Shadow  
**(TSN)** Sand **(TTU)** Tungsten
- If more than one fabric or a fabric/vinyl combination is required, please fill out a "Seating Multiple Textile" form, specifying each fabric location. Please contact Customer Care for more information.

### DESCRIPTION

### FEATURES

### MODEL#

### STANDARD TEXTILE GRADES

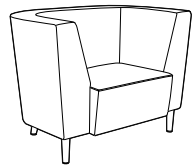

**Personal Harbor - Standard Back**  
 COM Yardage: 5.5  
 Freight Class: 150  
 Product Weight (lbs.): 50  
 Cubic Feet Per Carton: 9.5

For Power/USB module please see electrical placement chart. Freestanding unit only.

MODEL#	1	2	3	4	5	6	7	8	9	10	11	12
<b>7746</b>	\$3866	\$4092	\$4271	\$4541	\$4922	\$5103	\$5448	\$5998	\$6423	\$6895	\$7867	\$8904

### OVERALL DIMENSIONS

### SEAT DIMENSIONS

### BACK DIMENSIONS

### W D H

### W D H

### W H

45	29.5	32	24	19	18	27	14
----	------	----	----	----	----	----	----

RTA 00

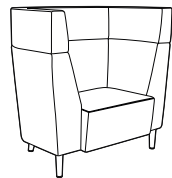

**Personal Harbor - High Back**  
 COM Yardage: 7.09  
 Freight Class: 150  
 Product Weight (lbs.): 86  
 Cubic Feet Per Carton: 9.5

For Power/USB module please see electrical placement chart. Freestanding unit only.

MODEL#	1	2	3	4	5	6	7	8	9	10	11	12
<b>7747</b>	\$5435	\$5753	\$6005	\$6384	\$6922	\$7174	\$7660	\$8438	\$9036	\$9700	\$11072	\$12532

### OVERALL DIMENSIONS

### SEAT DIMENSIONS

### BACK DIMENSIONS

### W D H

### W D H

### W H

45	29.5	41.5	24	19	18	27	24
----	------	------	----	----	----	----	----

RTA 00

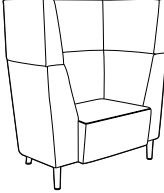
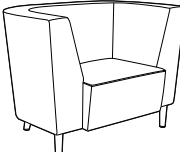
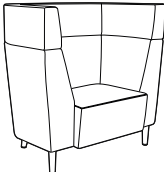
DESCRIPTION	FEATURES	MODEL#	STANDARD TEXTILE GRADES												
			1	2	3	4	5	6	7	8	9	10	11	12	
 <p><b>Personal Harbor - Extended Back</b> COM Yardage: 8.5 Freight Class: 150 Product Weight (lbs.): 102 Cubic Feet Per Carton: 9.5</p>	<p>For Power/USB module please see electrical placement chart. Freestanding unit only.</p>	7748	\$6114	\$6462	\$6739	\$7157	\$7744	\$8022	\$8556	\$9407	\$10064	\$10794	\$12295	\$13896	
			<b>OVERALL DIMENSIONS</b>			<b>SEAT DIMENSIONS</b>			<b>BACK DIMENSIONS</b>						
			<b>W</b>	<b>D</b>	<b>H</b>	<b>W</b>	<b>D</b>	<b>H</b>	<b>W</b>	<b>H</b>					
			45	29.5	47	24	19	18	27	29					
			<b>RTA 00</b>												
 <p><b>Personal Harbor - Standard Back</b> COM Yardage: 5.5 Freight Class: 150 Product Weight (lbs.): 50 Cubic Feet Per Carton: 9.5</p>	<p><b>High Traffic model</b> For Power/USB module please see electrical placement chart. Freestanding unit only.</p>	7786	\$4416	\$4643	\$4821	\$5091	\$5472	\$5653	\$5999	\$6551	\$6976	\$7447	\$8420	\$9457	
			<b>OVERALL DIMENSIONS</b>			<b>SEAT DIMENSIONS</b>			<b>BACK DIMENSIONS</b>						
			<b>W</b>	<b>D</b>	<b>H</b>	<b>W</b>	<b>D</b>	<b>H</b>	<b>W</b>	<b>H</b>					
			45	29.5	32	24	19	18	27	14					
			<b>RTA 00</b>												
 <p><b>Personal Harbor - High Back</b> COM Yardage: 7.09 Freight Class: 150 Product Weight (lbs.): 86 Cubic Feet Per Carton: 9.5</p>	<p><b>High Traffic model</b> For Power/USB module please see electrical placement chart. Freestanding unit only.</p>	7787	\$6144	\$6462	\$6714	\$7094	\$7631	\$7884	\$8370	\$9148	\$9745	\$10410	\$11781	\$13239	
			<b>OVERALL DIMENSIONS</b>			<b>SEAT DIMENSIONS</b>			<b>BACK DIMENSIONS</b>						
			<b>W</b>	<b>D</b>	<b>H</b>	<b>W</b>	<b>D</b>	<b>H</b>	<b>W</b>	<b>H</b>					
			45	29.5	41.5	24	19	18	27	24					
			<b>RTA 00</b>												
 <p><b>Personal Harbor - Extended Back</b> COM Yardage: 8.5 Freight Class: 150 Product Weight (lbs.): 102 Cubic Feet Per Carton: 9.5</p>	<p><b>High Traffic model</b> For Power/USB module please see electrical placement chart. Freestanding unit only.</p>	7788	\$6664	\$7013	\$7290	\$7707	\$8295	\$8574	\$9106	\$9958	\$10617	\$11345	\$12846	\$14449	
			<b>OVERALL DIMENSIONS</b>			<b>SEAT DIMENSIONS</b>			<b>BACK DIMENSIONS</b>						
			<b>W</b>	<b>D</b>	<b>H</b>	<b>W</b>	<b>D</b>	<b>H</b>	<b>W</b>	<b>H</b>					
			45	29.5	47	24	19	18	27	29					
			<b>RTA 00</b>												

# R RIVER+ SEATING

## RIVER+ SEATING



Lounge Chair, High Back  
model R27802



120 Corner, Standard Back  
model R27824S



Loop arm  
R2770

## River+ Benches, Tables & Media Hearths



For River+ benches, please see page 379  
For River+ media hearths, please see page 388  
For River+ tables, please see page 384

## EXAMPLE RIVER+ SEATING ORDER CODE:

R27802	-CE90	-FOG	-	-S6	-
Model number	Back, arm and seat textile	Connector finish	Shelf finish	Leg Selection	Counterweight

-CHM	-SSB
Leg finish	Bottom selection

Additional Options specify at end of order code.	SPECIFY CODE
<b>Additional weight</b> See each model for amount of added weight and upcharge.	<b>CW</b>
<b>Sealed back seams</b> Upcharges vary, see model.	<b>SBS</b>
<b>Sealed seat seams</b> Upcharges vary, see model.	<b>SSS</b>
<b>Power unit finish</b> Jet Black White	<b>J</b> <b>W</b>
<b>Power/USB unit position</b> (see electrical placement images, not available on corner units) Front left Front right Side left Side right Center back (models with shelf only)	\$661 per unit <b>F1</b> <b>F2</b> <b>S1</b> <b>S2</b> <b>CB</b>
<b>Tamperproof fasteners</b> Upcharges vary, see model.	<b>TP</b>
<b>Moisture barrier</b> Upcharges vary, see model.	<b>MB</b>
<b>Accessory hook finish</b> (for models with shelf) Night (BLK) Fog (FOG) Latte (LAB)	<b>NHK</b> <b>FHK</b> <b>LHK</b>

\*linking hardware is lowered to clear the staple strip.  
Units will only gang with other units with sealed bottom.  
\*\*cannot be combined with linking hardware or power units

## STANDARD FEATURES

- A modular series that is composed of straight, curved and corner sections.
- Models with the same seat height can be ganged on ends with no upholstered arms. Ganging hardware is standard on armless ends of models (factory installed) and swivels out of the way when not in use.
- Seating frames are constructed of heavy duty plywood, and are made for active environments. Seats are high density with highly resilient foam.
- River+ seating is rated for an active weight up to 600 lbs. per seat and 24/7 use.
- For 24/7 use and/or heavy duty application use, Global's Heavy Duty warranty is only on models specified with performance textiles, rated for 150,000 double rubs or more.
- A clean-out gap is created by seat-to-back connector brackets available in three finishes.
- The standard, 6.5" tapered legs are made of welded steel. Front legs of River+ lounge models are straight. Back legs are angled.
- Models with a shelf are only available with 6.5" high legs. Back legs on these models are standard with (E6) EXTENDED legs.
- Legs include Black nylon, non-marking, height adjustable glides.
- Upholstery options include fabric or vinyl. Leather upholstery is not available.
- All units are shipped fully assembled.
- Arms on upholstered arm models are factory installed and not removable.
- Modular, aluminum loop arms are sold separately and available with or without nylon armcaps. These relocatable arms are field installed at any seat to back connector location.
- A 10" deep, 1" thick shelf is available on the back of corner, curved, two and three seat models in many thermally fused laminate finishes with matching edge.
- Shelf supports are aluminum with accessory hook in three finishes. Weight capacity: Shelf - 50lbs per seat; Hook - 20lbs each.
- Back shelf heights align with the model's back height. See shelf heights diagrams for details.
- Check textile availability prior to specifying upholstery material.
- The series is available to specify with two textiles, one for the seat cushion and one for the back, arms and front rail (see model image).
- For pricing, start with the base price and add both back/arms graded textile upcharge and the seat graded textile upcharge.
- The blended textile matrix does not apply to this series.

## OPTIONAL FEATURES

- Optional 6.5" floor mount legs (F6) are available. Shelf back models are available with EXTENDED floor mount legs (F6).
- Optional 8" (S8) and 8" floor mount legs (F8) are available on models without shelves. Seat heights change to 19" high. Upcharges vary.
- To match back legs of shelf-back models with models without shelf, select (C6) leg with counterweight. Upcharges vary.
- Up to two power units are available on seating models, except 90 and 120 corner units. Add \$661 upcharge per unit.
- Each power unit includes one AC outlet and two USB-A, 10 watt charging ports. Location options include front or side. Back power location option available on models with back shelf (except corners). See electrical placement diagrams.
- Power units are available in either Jet Black (J) or White (W) with 120", three-prong matching cords.
- Sealed seams are available only for approved coated textiles. Specify (SSS) for sealed seat seams or (SBS) for sealed back and arm seams. Contact customer care for details. See models for upcharge.
- To reduce ease of movement, counterweights can be added to any model. Specify (CW). See individual model for weight and upcharge.

# LOUNGE

- For improved housekeeping and infection control practices, the underside of the seat can be finished with black vinyl and sealed to prevent penetration of liquids. Specify (SP) - see each model for upcharge.
- Steel bottom option provides tamperproof protection (includes tamperproof screws). Specify (BS). Upcharges vary. Note: electrical option and ganging are not available with steel bottom.

Add option codes in the following order:

- Model number**  
Specify model number.
- Back/Arm Textile**  
Specify textile code. See model grade upcharges.
- Seat Textile**  
Specify textile code. See model grade upcharges.
- Seat to back connector finish (NGT)** Night (BLK). No upcharge.  
**(FOG)** Fog. No upcharge.  
**(LAB)** Latte. No upcharge.
- Back shelf finish** (for "S" models with shelf)  
See colors shown on website.
- Accessory hook finish** (for "S" models with shelf)  
**(NHK)** Night (BLK)  
**(FHK)** Fog (FOG)  
**(LHK)** Latte (LAB)
- Leg selection** (models without shelf):  
**(S6)** Standard seat height (17.5"), 6.5" leg w/adjustable glides. No upcharge.  
**(S8)** High seat (19"), 8" leg w/adjustable glides. No upcharge.  
**(F6)** Standard seat height (17.5"), 6.5" leg w/floor mount. Add \$100 for straight units; \$125 for curved, corner units.  
**(F8)** High seat (19"), 8" leg w/floor mount. Add \$100 for straight units; \$125 for curved, corner units.
- Leg selection** (for "S" models with shelf):  
**(E6)** Standard seat height (17.5"), 6.5" EXTENDED leg with adjustable glides.  
**(C6)** Standard seat height (17.5"), 6.5" leg, includes counterweight. Matches S6 leg. Upcharges vary, see model.  
**(F6)** Standard seat height (17.5"), 6.5" EXTENDED leg w/floor mount. Add \$100 for straight unit; \$125 for curved, corner units.
- Leg finish**  
**(CHM)** Chrome **(TBL)** Black  
**(TDW)** Designer White **(TFO)** Fog  
**(TFR)** Frost **(TIV)** Cloud  
**(TKA)** Kalua **(TLA)** Latte  
**(TMO)** Mocha **(TNE)** Nevada  
**(TOA)** Toast **(TSH)** Shadow  
**(TSN)** Sand **(TTU)** Tungsten
- Additional weight**  
**(CU)** No counterweight.  
**(CW)** Counterweight. Upcharges vary, see model.
- Bottom selection**  
**(SSB)** Standard seat bottom  
**(SP)** Vinyl sealed bottom with staple strip. Upcharges vary, see model.\*  
**(BS)** Steel bottom. Upcharges vary, see model.\*\*
- Sealed back and arm seams**  
**(SBS)** Sealed back seams. Upcharges vary, see model.
- Sealed seat seams**  
**(SSS)** Sealed seat seams. Upcharges vary, see model.
- Moisture barrier**  
**(MB)** Moisture Barrier. Upcharges vary, see model.
- Power/USB unit position. Add \$661 per unit.**  
**(NP)** No power (no upcharge)  
**(F1)** Front left **(F2)** Front right  
**(S1)** Side left **(S2)** Side right  
**(CB)** Center back (models with shelf only)
- Power unit finish**  
**(J)** Jet Black **(W)** White
- Tamperproof fasteners**  
**(TP)** Tamperproof fasteners. Upcharges vary, see model.



SHELF HEIGHTS

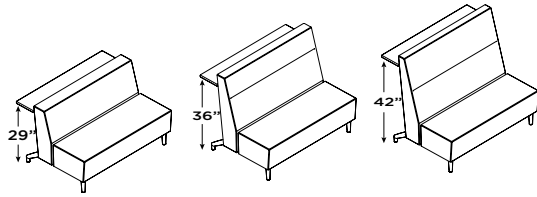

Standard height

High back

Extended high back

DIMENSIONS

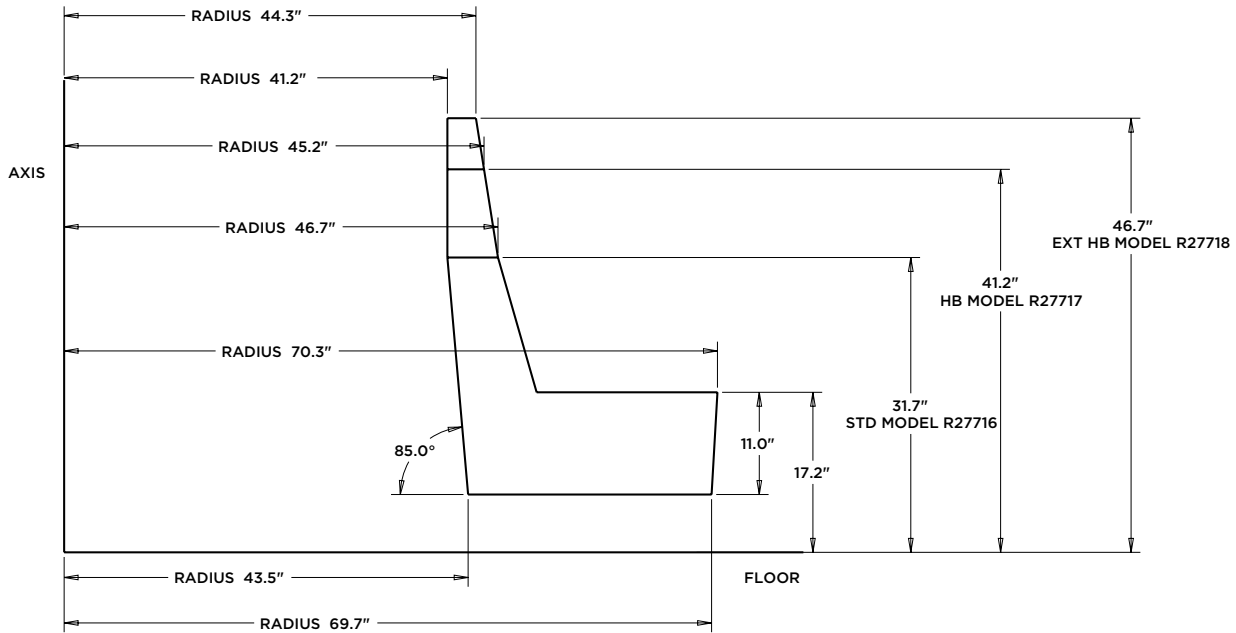

ELECTRICAL PLACEMENT

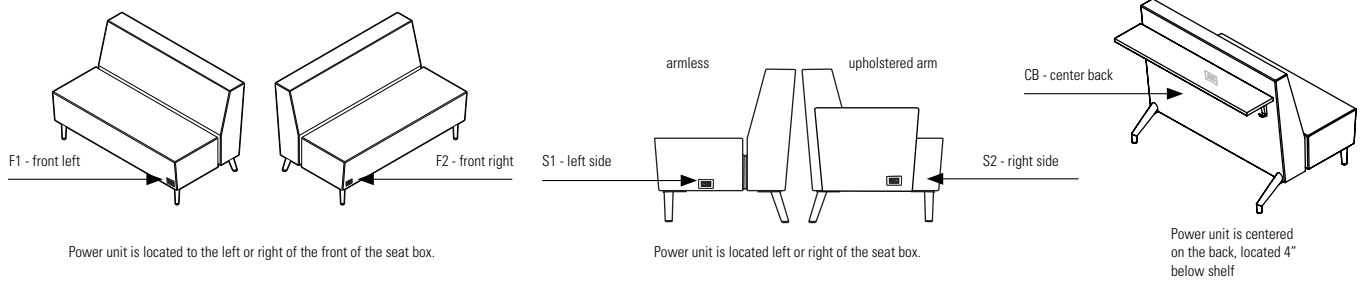

Power unit is located to the left or right of the front of the seat box.

Power unit is located left or right of the seat box.

Power unit is centered on the back, located 4" below shelf

DESCRIPTION MODEL#/ FEATURES STANDARD TEXTILE GRADES



R27801

**Lounge Chair - Standard Back**  
COM Yardage: Back: 2; Seat: 1.75  
Freight class: 250  
Product weight (lbs.): 61  
Cubic feet per carton: 19.75

**R27801** Base Price:  
Back upcharge:  
Seat upcharge:

For power/USB unit, see electrical placement chart. Includes ganging hardware (2 sides). Add \$65 for (SSS), \$70 (SBS) Add \$632 for 36 lbs. (CW) Add \$103 for (SP) or \$486 for (BS) Add \$40 for (TP) Add \$127 for (MB)

1/COM	2	3	4	5	6	7	8	9	10	11	12	
<b>\$2064</b>												
	<b>+0</b>	<b>+\$64</b>	<b>+\$114</b>	<b>+\$188</b>	<b>+\$292</b>	<b>+\$336</b>	<b>+\$426</b>	<b>+\$568</b>	<b>+\$674</b>	<b>+\$790</b>	<b>+\$1032</b>	<b>+\$1286</b>
	<b>+0</b>	<b>+\$56</b>	<b>+\$100</b>	<b>+\$165</b>	<b>+\$256</b>	<b>+\$294</b>	<b>+\$373</b>	<b>+\$497</b>	<b>+\$590</b>	<b>+\$692</b>	<b>+\$903</b>	<b>+\$1126</b>
OVERALL DIMENSIONS			SEAT DIMENSIONS			BACK DIMENSIONS						
W	D	H	W	D	H	W	H					
26	30	32	26	19	18	26	14					
<b>RTA 00</b> 1 per carton												



R27801B

**Lounge Chair - Standard Back**  
COM Yardage: Back: 4; Seat: 1.75  
Freight class: 250  
Product weight (lbs.): 82  
Cubic feet per carton: 24.5

**R27801B** Base Price:  
Back/Arm upcharge:  
Seat upcharge:

For power/USB unit, see electrical placement chart. Ganging not available. Add \$65 for (SSS), \$123 (SBS) Add \$632 for 36 lbs. (CW) Add \$103 for (SP) or \$486 for (BS) Add \$40 for (TP) Add \$127 for (MB)

1/COM	2	3	4	5	6	7	8	9	10	11	12	
<b>\$2801</b>												
	<b>+0</b>	<b>+\$128</b>	<b>+\$228</b>	<b>+\$376</b>	<b>+\$584</b>	<b>+\$672</b>	<b>+\$852</b>	<b>+\$1136</b>	<b>+\$1348</b>	<b>+\$1580</b>	<b>+\$2064</b>	<b>+\$2572</b>
	<b>+0</b>	<b>+\$56</b>	<b>+\$100</b>	<b>+\$165</b>	<b>+\$256</b>	<b>+\$294</b>	<b>+\$373</b>	<b>+\$497</b>	<b>+\$590</b>	<b>+\$692</b>	<b>+\$903</b>	<b>+\$1126</b>
OVERALL DIMENSIONS			SEAT DIMENSIONS			BACK DIMENSIONS						
W	D	H	W	D	H	W	H					
33	30	32	26	19	18	26	14					
<b>RTA 00</b> 1 per carton												



R27801L

R27801R

**Lounge Chair - Standard Back**  
COM Yardage: Back: 3; Seat: 1.75  
Freight class: 250  
Product weight (lbs.): 72  
Cubic feet per carton: 24.5

**R27801L** Base Price:  
**R27801R** Base Price:  
Back/Arm upcharge:  
Seat upcharge:

For power/USB unit, see electrical placement chart. Includes ganging hardware (1 side). Add \$65 for (SSS), \$96 (SBS) Add \$632 for 36 lbs. (CW) Add \$103 for (SP) or \$486 for (BS) Add \$40 for (TP) Add \$127 for (MB)

1/COM	2	3	4	5	6	7	8	9	10	11	12	
<b>\$2434</b>												
	<b>+0</b>	<b>+\$96</b>	<b>+\$171</b>	<b>+\$282</b>	<b>+\$438</b>	<b>+\$504</b>	<b>+\$639</b>	<b>+\$852</b>	<b>+\$1011</b>	<b>+\$1185</b>	<b>+\$1548</b>	<b>+\$1929</b>
	<b>+0</b>	<b>+\$56</b>	<b>+\$100</b>	<b>+\$165</b>	<b>+\$256</b>	<b>+\$294</b>	<b>+\$373</b>	<b>+\$497</b>	<b>+\$590</b>	<b>+\$692</b>	<b>+\$903</b>	<b>+\$1126</b>
OVERALL DIMENSIONS			SEAT DIMENSIONS			BACK DIMENSIONS						
W	D	H	W	D	H	W	H					
29.5	30	32	26	19	18	26	14					
<b>RTA 00</b> 1 per carton												



R27802

**Lounge Chair - High Back**  
COM Yardage: Back: 2.75; Seat: 1.75  
Freight class: 250  
Product weight: 71  
Cubic feet per carton: 24.75

**R27802** Base Price:  
Back upcharge:  
Seat upcharge:

For power/USB unit, see electrical placement chart. Includes ganging hardware (2 sides). Add \$65 for (SSS), \$99 for (SBS) Add \$632 for 36 lbs. (CW) Add \$103 for (SP) or \$486 for (BS) Add \$40 for (TP) Add \$127 for (MB)

1/COM	2	3	4	5	6	7	8	9	10	11	12	
<b>\$2420</b>												
	<b>+0</b>	<b>+\$88</b>	<b>+\$157</b>	<b>+\$259</b>	<b>+\$402</b>	<b>+\$462</b>	<b>+\$586</b>	<b>+\$781</b>	<b>+\$927</b>	<b>+\$1087</b>	<b>+\$1419</b>	<b>+\$1769</b>
	<b>+0</b>	<b>+\$56</b>	<b>+\$100</b>	<b>+\$165</b>	<b>+\$256</b>	<b>+\$294</b>	<b>+\$373</b>	<b>+\$497</b>	<b>+\$590</b>	<b>+\$692</b>	<b>+\$903</b>	<b>+\$1126</b>
OVERALL DIMENSIONS			SEAT DIMENSIONS			BACK DIMENSIONS						
W	D	H	W	D	H	W	H					
26	30.5	41.5	26	19	18	26	23.5					
<b>RTA 00</b> 1 per carton												



R27802B

**Lounge Chair - High Back**  
COM Yardage: Back: 4.75; Seat: 1.75  
Freight class: 250  
Product weight: 88.5  
Cubic feet per carton: 31.25

**R27802B** Base Price:  
Back/Arm upcharge:  
Seat upcharge:

For power/USB unit, see electrical placement chart. Ganging not available. Add \$65 for (SSS), \$151 for (SBS) Add \$632 for 36 lbs. (CW) Add \$103 for (SP) or \$486 for (BS) Add \$40 for (TP) Add \$127 for (MB)

1/COM	2	3	4	5	6	7	8	9	10	11	12	
<b>\$3156</b>												
	<b>+0</b>	<b>+\$152</b>	<b>+\$271</b>	<b>+\$447</b>	<b>+\$694</b>	<b>+\$798</b>	<b>+\$1012</b>	<b>+\$1349</b>	<b>+\$1601</b>	<b>+\$1877</b>	<b>+\$2451</b>	<b>+\$3055</b>
	<b>+0</b>	<b>+\$56</b>	<b>+\$100</b>	<b>+\$165</b>	<b>+\$256</b>	<b>+\$294</b>	<b>+\$373</b>	<b>+\$497</b>	<b>+\$590</b>	<b>+\$692</b>	<b>+\$903</b>	<b>+\$1126</b>
OVERALL DIMENSIONS			SEAT DIMENSIONS			BACK DIMENSIONS						
W	D	H	W	D	H	W	H					
33	30.5	41.5	26	19	18	26	23.5					
<b>RTA 00</b> 1 per carton												

DESCRIPTION MODEL#/ FEATURES STANDARD TEXTILE GRADES



R27802L R27802R

**Lounge Chair - High Back**  
COM Yardage: Back: 3.75; Seat: 1.75  
Freight class: 250  
Product weight: 78.5  
Cubic feet per carton: 31.25

**R27802L** Base Price: **\$2788**  
**R27802R** Base Price: **\$2788**  
Back/Arm upcharge: **+0**  
Seat upcharge: **+0**  
For power/USB unit, see electrical placement chart.  
Includes ganging hardware (1 side).  
Add \$65 for (SSS), \$125 (SBS)  
Add \$632 for 36 lbs. (CW)  
Add \$103 for (SP) or \$486 for (BS)  
Add \$40 for (TP)  
Add \$127 for (MB)

1/COM	2	3	4	5	6	7	8	9	10	11	12
<b>OVERALL DIMENSIONS</b>			<b>SEAT DIMENSIONS</b>			<b>BACK DIMENSIONS</b>					
<b>W</b>	<b>D</b>	<b>H</b>	<b>W</b>	<b>D</b>	<b>H</b>	<b>W</b>	<b>D</b>	<b>H</b>	<b>W</b>	<b>H</b>	
29.5	30.5	41.5	26	19	18	26			23.5		
<b>RTA 00</b> 1 per carton											



R27803

**Lounge Chair - Extended Back**  
COM Yardage: Back: 3; Seat: 1.75  
Freight class: 250  
Product weight: 81  
Cubic feet per carton: 28

**R27803** Base Price: **\$2877**  
Back upcharge: **+0**  
Seat upcharge: **+0**  
For power/USB unit, see electrical placement chart.  
Includes ganging hardware (2 sides).  
Add \$65 for (SSS), \$105 for (SBS)  
Add \$632 for 36 lbs. (CW)  
Add \$103 for (SP) or \$486 for (BS)  
Add \$40 for (TP)  
Add \$127 for (MB)

1/COM	2	3	4	5	6	7	8	9	10	11	12
<b>OVERALL DIMENSIONS</b>			<b>SEAT DIMENSIONS</b>			<b>BACK DIMENSIONS</b>					
<b>W</b>	<b>D</b>	<b>H</b>	<b>W</b>	<b>D</b>	<b>H</b>	<b>W</b>	<b>D</b>	<b>H</b>	<b>W</b>	<b>H</b>	
26	31	47	26	19	18	26			29		
<b>RTA 00</b> 1 per carton											



R27803B

**Lounge Chair - Extended Back**  
COM Yardage: Back: 5; Seat: 1.75  
Freight class: 250  
Product weight (lbs.): 101.5  
Cubic feet per carton: 35

**R27803B** Base Price: **\$3614**  
Back/Arm upcharge: **+0**  
Seat upcharge: **+0**  
For power/USB unit, see electrical placement chart.  
Ganging not available.  
Add \$65 for (SSS), \$158 (SBS)  
Add \$632 for 36 lbs. (CW)  
Add \$103 for (SP) or \$486 for (BS)  
Add \$40 for (TP)  
Add \$127 for (MB)

1/COM	2	3	4	5	6	7	8	9	10	11	12
<b>OVERALL DIMENSIONS</b>			<b>SEAT DIMENSIONS</b>			<b>BACK DIMENSIONS</b>					
<b>W</b>	<b>D</b>	<b>H</b>	<b>W</b>	<b>D</b>	<b>H</b>	<b>W</b>	<b>D</b>	<b>H</b>	<b>W</b>	<b>H</b>	
33	31	47	26	19	18	26			29		
<b>RTA 00</b> 1 per carton											





R27803L R27803R

**Lounge Chair - Extended Back**  
COM Yardage: Back: 4; Seat: 1.75  
Freight class: 250  
Product weight (lbs.): 91.5  
Cubic feet per carton: 35

**R27803L** Base Price: **\$3246**  
**R27803R** Base Price: **\$3246**  
Back/Arm upcharge: **+0**  
Seat upcharge: **+0**  
For power/USB unit, see electrical placement chart.  
Includes ganging hardware (1 side).  
Add \$65 for (SSS), \$131 (SBS)  
Add \$632 for 36 lbs. (CW)  
Add \$103 for (SP) or \$486 for (BS)  
Add \$40 for (TP)  
Add \$127 for (MB)





1/COM	2	3	4	5	6	7	8	9	10	11	12
<b>OVERALL DIMENSIONS</b>			<b>SEAT DIMENSIONS</b>			<b>BACK DIMENSIONS</b>					
<b>W</b>	<b>D</b>	<b>H</b>	<b>W</b>	<b>D</b>	<b>H</b>	<b>W</b>	<b>D</b>	<b>H</b>	<b>W</b>	<b>H</b>	
29.5	31	47	26	19	18	26			29		
<b>RTA 00</b> 1 per carton											

DESCRIPTION	MODEL#/ FEATURES	STANDARD TEXTILE GRADES												
		1/COM	2	3	4	5	6	7	8	9	10	11	12	
 <p><b>R27804</b></p> <p><b>Two Seater - Standard Back</b> COM Yardage: Back: 2.75; Seat: 2 Freight class: 250 Product weight: 113   133 shelf model Cubic feet per carton: 37.5   51shelf model</p>	<p><b>R27804</b></p> <p>For power/USB unit, see electrical placement chart. Includes ganging hardware (2 sides). Add \$96 for (SSS), \$119 for (SBS) Add \$1260 for 72 lbs. (CW), (C6) Add \$196 for (SP) or \$773 for (BS) Add \$40 for (TP) Add \$252 for (MB)</p>	Base Price:	<b>\$3217</b>											
		Base Price:	<b>\$3942</b>											
		Back upcharge:	<b>+0</b>	<b>+\$88</b>	<b>+\$157</b>	<b>+\$259</b>	<b>+\$402</b>	<b>+\$462</b>	<b>+\$586</b>	<b>+\$781</b>	<b>+\$927</b>	<b>+\$1087</b>	<b>+\$1419</b>	<b>+\$1769</b>
		Seat upcharge:	<b>+0</b>	<b>+\$64</b>	<b>+\$114</b>	<b>+\$188</b>	<b>+\$292</b>	<b>+\$336</b>	<b>+\$426</b>	<b>+\$568</b>	<b>+\$674</b>	<b>+\$790</b>	<b>+\$1032</b>	<b>+\$1286</b>
		Shelf: 52W 10D 1H												
		<b>OVERALL DIMENSIONS</b>	<b>W</b>	<b>D</b>	<b>H</b>	<b>SEAT DIMENSIONS</b>			<b>BACK DIMENSIONS</b>					
			52	30	32	52	19	18	52	14				
		<b>RTA 00</b>	1 per carton											

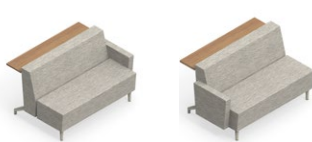
DESCRIPTION	MODEL#/ FEATURES	STANDARD TEXTILE GRADES												
		1/COM	2	3	4	5	6	7	8	9	10	11	12	
 <p><b>R27804B</b></p> <p><b>Two Seater - Standard Back</b> COM Yardage: Back: 4.75; Seat: 2 Freight class: 250 Product weight: 133   154 shelf model Cubic feet per carton: 42.5   57.5 shelf model</p>	<p><b>R27804B</b></p> <p>For power/USB unit, see electrical placement chart. Ganging not available. Add \$96 for (SSS), \$171 for (SBS) Add \$1260 for 72 lbs. (CW), (C6) Add \$196 for (SP) or \$773 for (BS) Add \$40 for (TP) Add \$252 for (MB)</p>	Base Price:	<b>\$3953</b>											
		Base Price:	<b>\$4679</b>											
		Back/Arm upcharge:	<b>+0</b>	<b>+\$152</b>	<b>+\$271</b>	<b>+\$447</b>	<b>+\$694</b>	<b>+\$798</b>	<b>+\$1012</b>	<b>+\$1349</b>	<b>+\$1601</b>	<b>+\$1877</b>	<b>+\$2451</b>	<b>+\$3055</b>
		Seat upcharge:	<b>+0</b>	<b>+\$64</b>	<b>+\$114</b>	<b>+\$188</b>	<b>+\$292</b>	<b>+\$336</b>	<b>+\$426</b>	<b>+\$568</b>	<b>+\$674</b>	<b>+\$790</b>	<b>+\$1032</b>	<b>+\$1286</b>
		Shelf: 52W 10D 1H												
		<b>OVERALL DIMENSIONS</b>	<b>W</b>	<b>D</b>	<b>H</b>	<b>SEAT DIMENSIONS</b>			<b>BACK DIMENSIONS</b>					
			59	30	32	52	19	18	52	14				
		<b>RTA 00</b>	1 per carton											

DESCRIPTION	MODEL#/ FEATURES	STANDARD TEXTILE GRADES												
		1/COM	2	3	4	5	6	7	8	9	10	11	12	
 <p><b>R27804L</b></p> <p><b>Two Seater - Standard Back</b> COM Yardage: Back: 3.75; Seat: 2 Freight class: 250 Product weight: 123 Cubic feet per carton: 42.5</p>	<p><b>R27804L</b></p> <p>For power/USB unit, see electrical placement chart. Includes ganging hardware (1 side). Add \$96 for (SSS), \$145 for (SBS) Add \$1260 for 72 lbs. (CW), (C6) Add \$196 for (SP) or \$773 for (BS) Add \$40 for (TP) Add \$252 for (MB)</p>	Base Price:	<b>\$3584</b>											
		Base Price:	<b>\$3584</b>											
		Back/Arm upcharge:	<b>+0</b>	<b>+\$120</b>	<b>+\$214</b>	<b>+\$353</b>	<b>+\$548</b>	<b>+\$630</b>	<b>+\$799</b>	<b>+\$1065</b>	<b>+\$1264</b>	<b>+\$1482</b>	<b>+\$1935</b>	<b>+\$2412</b>
		Seat upcharge:	<b>+0</b>	<b>+\$64</b>	<b>+\$114</b>	<b>+\$188</b>	<b>+\$292</b>	<b>+\$336</b>	<b>+\$426</b>	<b>+\$568</b>	<b>+\$674</b>	<b>+\$790</b>	<b>+\$1032</b>	<b>+\$1286</b>
		Shelf: 52W 10D 1H												
		<b>OVERALL DIMENSIONS</b>	<b>W</b>	<b>D</b>	<b>H</b>	<b>SEAT DIMENSIONS</b>			<b>BACK DIMENSIONS</b>					
			55.5	30	32	52	19	18	52	14				
		<b>RTA 00</b>	1 per carton											

DESCRIPTION	MODEL#/ FEATURES	STANDARD TEXTILE GRADES												
		1/COM	2	3	4	5	6	7	8	9	10	11	12	
 <p><b>R27804SL</b></p> <p><b>Two Seater - Standard Back</b> COM Yardage: Back: 3.75; Seat: 2 Freight class: 250 Product weight: 144 Cubic feet per carton: 57.5</p>	<p><b>R27804SL</b></p> <p>For power/USB unit, see electrical placement chart. Includes ganging hardware (1 side). Add \$96 for (SSS), \$145 for (SBS) Add \$1260 for 72 lbs. (CW), (C6) Add \$196 for (SP) or \$773 for (BS) Add \$40 for (TP) Add \$252 for (MB)</p>	Base Price:	<b>\$4311</b>											
		Base Price:	<b>\$4311</b>											
		Back/Arm upcharge:	<b>+0</b>	<b>+\$120</b>	<b>+\$214</b>	<b>+\$353</b>	<b>+\$548</b>	<b>+\$630</b>	<b>+\$799</b>	<b>+\$1065</b>	<b>+\$1264</b>	<b>+\$1482</b>	<b>+\$1935</b>	<b>+\$2412</b>
		Seat upcharge:	<b>+0</b>	<b>+\$64</b>	<b>+\$114</b>	<b>+\$188</b>	<b>+\$292</b>	<b>+\$336</b>	<b>+\$426</b>	<b>+\$568</b>	<b>+\$674</b>	<b>+\$790</b>	<b>+\$1032</b>	<b>+\$1286</b>
		Shelf: 52W 10D 1H												
		<b>OVERALL DIMENSIONS</b>	<b>W</b>	<b>D</b>	<b>H</b>	<b>SEAT DIMENSIONS</b>			<b>BACK DIMENSIONS</b>					
			55.5	40.5	32	52	19	18	52	14				
		<b>RTA 00</b>	1 per carton											

DESCRIPTION	MODEL#/ FEATURES	STANDARD TEXTILE GRADES												
		1/COM	2	3	4	5	6	7	8	9	10	11	12	
 <p><b>R27805</b></p> <p><b>Two Seater - High Back</b> COM Yardage: Back: 3.50; Seat: 2 Freight class: 250 Product weight: 138   139 shelf model Cubic feet per carton: 47.25   64.75 shelf model</p>	<p><b>R27805S</b></p> <p>For power/USB unit, see electrical placement chart. Includes ganging hardware (1 sides) Add \$96 for (SSS), \$157for (SBS) Add \$1260 for 72 lbs. (CW), (C6) Add \$196 for (SP) or \$773 for (BS) Add \$40 for (TP) Add \$252 for (MB)</p>	Base Price:	\$3914											
		Back Price:	\$4638											
		Back upcharge:	+0	+\$112	+\$200	+\$329	+\$511	+\$588	+\$746	+\$994	+\$1180	+\$1383	+\$1806	+\$2251
		Seat upcharge:	+0	+\$64	+\$114	+\$188	+\$292	+\$336	+\$426	+\$568	+\$674	+\$790	+\$1032	+\$1286
		Shelf: 52W 10D 1H												
		OVERALL DIMENSIONS			SEAT DIMENSIONS			BACK DIMENSIONS						
		W	D	H	W	D	H	W	H					
		52	30.5	41.5	52	19	18	52	23.5					
		RTA 00		1 per carton										
 <p><b>R27805B</b></p> <p><b>Two Seater - High Back</b> COM Yardage: Back: 5.50; Seat: 2 Freight class: 250 Product weight: 138   159 shelf model Cubic feet per carton: 54   73 shelf model</p>	<p><b>R27805SB</b></p> <p>For power/USB unit, see electrical placement chart. Ganging not available. Add \$96 for (SSS), \$209 for (SBS) Add \$1260 for 72 lbs. (CW), (C6) Add \$196 for (SP) or \$773 for (BS) Add \$40 for (TP) Add \$252 for (MB)</p>	Base Price:	\$4651											
		Back Price:	\$5376											
		Back/Arm upcharge:	+0	+\$176	+\$314	+\$517	+\$803	+\$924	+\$1172	+\$1562	+\$1854	+\$2173	+\$2838	+\$3537
		Seat upcharge:	+0	+\$64	+\$114	+\$188	+\$292	+\$336	+\$426	+\$568	+\$674	+\$790	+\$1032	+\$1286
		Shelf: 52W 10D 1H												
		OVERALL DIMENSIONS			SEAT DIMENSIONS			BACK DIMENSIONS						
		W	D	H	W	D	H	W	H					
		59	30.5	41.5	52	19	18	52	23.5					
		RTA 00		1 per carton										
 <p><b>R27805L</b></p> <p><b>Two Seater - High Back</b> COM Yardage: Back: 4.50; Seat: 2 Freight class: 250 Product weight: 128 Cubic feet per carton: 54</p>	<p><b>R27805R</b></p> <p>For power/USB unit, see electrical placement chart. Includes ganging hardware (1 side). Add \$96 for (SSS), \$209 for (SBS) Add \$1260 for 72 lbs. (CW), (C6) Add \$196 for (SP) or \$773 for (BS) Add \$40 for (TP) Add \$252 for (MB)</p>	Base Price:	\$4282											
		Back Price:	\$4282											
		Back/Arm upcharge:	+0	+\$144	+\$257	+\$423	+\$657	+\$756	+\$959	+\$1278	+\$1517	+\$1778	+\$2322	+\$2894
		Seat upcharge:	+0	+\$64	+\$114	+\$188	+\$292	+\$336	+\$426	+\$568	+\$674	+\$790	+\$1032	+\$1286
		Shelf: 52W 10D 1H												
		OVERALL DIMENSIONS			SEAT DIMENSIONS			BACK DIMENSIONS						
		W	D	H	W	D	H	W	H					
		55.5	30.5	41.5	52	19	18	52	23.5					
		RTA 00		1 per carton										
 <p><b>R27805SL</b></p> <p><b>Two Seater - High Back</b> COM Yardage: Back: 4.50; Seat: 2 Freight class: 250 Product weight: 149 Cubic feet per carton: 73</p>	<p><b>R27805SR</b></p> <p>For power/USB unit, see electrical placement chart. Includes ganging hardware (1 side). Add \$96 for (SSS), \$209 for (SBS) Add \$1260 for 72 lbs. (CW), (C6) Add \$196 for (SP) or \$773 for (BS) Add \$40 for (TP) Add \$252 for (MB)</p>	Base Price:	\$5007											
		Back Price:	\$5007											
		Back/Arm upcharge:	+0	+\$144	+\$257	+\$423	+\$657	+\$756	+\$959	+\$1278	+\$1517	+\$1778	+\$2322	+\$2894
		Seat upcharge:	+0	+\$64	+\$114	+\$188	+\$292	+\$336	+\$426	+\$568	+\$674	+\$790	+\$1032	+\$1286
		Shelf: 52W 10D 1H												
		OVERALL DIMENSIONS			SEAT DIMENSIONS			BACK DIMENSIONS						
		W	D	H	W	D	H	W	H					
		55.5	41	41.5	52	19	18	52	23.5					
		RTA 00		1 per carton										



DESCRIPTION MODEL#/ FEATURES STANDARD TEXTILE GRADES



R27806

R27806S

**Two Seater - Extended Back**  
COM Yardage: Back: 3.50; Seat: 2  
Freight class: 250  
Product weight: 131 | 152 shelf model  
Cubic feet per carton: 53.75 | 72.75 shelf model

**R27806** Base Price:  
**R27806S** Base Price:  
Back upcharge:  
Seat upcharge:

1/COM	2	3	4	5	6	7	8	9	10	11	12
\$4455											
\$5182											
+0	+\$112	+\$200	+\$329	+\$511	+\$588	+\$746	+\$994	+\$1180	+\$1383	+\$1806	+\$2251
+0	+\$64	+\$114	+\$188	+\$292	+\$336	+\$426	+\$568	+\$674	+\$790	+\$1032	+\$1286

Shelf: 52W 10D 1H

OVERALL DIMENSIONS			SEAT DIMENSIONS			BACK DIMENSIONS					
W	D	H	W	D	H	W	H				
52	31	47	52	19	18	52	29				
RTA 00			1 per carton								



R27806B

R27806SB

**Two Seater - Extended Back**  
COM Yardage: Back: 6 Seat: 2  
Freight class: 250  
Product weight: 151 | 172 shelf model  
Cubic feet per carton: 60.5 | 82 shelf model

**R27806B** Base Price:  
**R27806SB** Base Price:  
Back/Arm upcharge:  
Seat upcharge:

1/COM	2	3	4	5	6	7	8	9	10	11	12
\$5193											
\$5918											
+0	+\$192	+\$342	+\$564	+\$876	+\$1008	+\$1278	+\$1704	+\$2022	+\$2370	+\$3096	+\$3858
+0	+\$64	+\$114	+\$188	+\$292	+\$336	+\$426	+\$568	+\$674	+\$790	+\$1032	+\$1286

Shelf: 52W 10D 1H

OVERALL DIMENSIONS			SEAT DIMENSIONS			BACK DIMENSIONS					
W	D	H	W	D	H	W	H				
59	31	47	52	19	18	52	29				
RTA 00			1 per carton								



R27806L

R27806R

**Two Seater - Extended Back**  
COM Yardage: Back: 5; Seat: 2  
Freight class: 250  
Product weight: 141  
Cubic feet per carton: 60.5

**R27806L** Base Price:  
**R27806R** Base Price:  
Back/Arm upcharge:  
Seat upcharge:

1/COM	2	3	4	5	6	7	8	9	10	11	12
\$4824											
\$5551											
+0	+\$160	+\$285	+\$470	+\$730	+\$840	+\$1065	+\$1420	+\$1685	+\$1975	+\$2580	+\$3215
+0	+\$64	+\$114	+\$188	+\$292	+\$336	+\$426	+\$568	+\$674	+\$790	+\$1032	+\$1286

Shelf: 52W 10D 1H

OVERALL DIMENSIONS			SEAT DIMENSIONS			BACK DIMENSIONS					
W	D	H	W	D	H	W	H				
55.5	31	47	52	19	18	52	29				
RTA 00			1 per carton								



R27806SL

R27806SR





**Two Seater - Extended Back**  
COM Yardage: Back: 5; Seat: 2  
Freight class: 250  
Product weight: 162  
Cubic feet per carton: 82

**R27806SL** Base Price:  
**R27806SR** Base Price:  
Back/Arm upcharge:  
Seat upcharge:

1/COM	2	3	4	5	6	7	8	9	10	11	12
\$5551											
\$5551											
+0	+\$160	+\$285	+\$470	+\$730	+\$840	+\$1065	+\$1420	+\$1685	+\$1975	+\$2580	+\$3215
+0	+\$64	+\$114	+\$188	+\$292	+\$336	+\$426	+\$568	+\$674	+\$790	+\$1032	+\$1286

Shelf: 52W 10D 1H

OVERALL DIMENSIONS			SEAT DIMENSIONS			BACK DIMENSIONS					
W	D	H	W	D	H	W	H				
55.5	41.5	47	52	19	18	52	29				
RTA 00			1 per carton								

DESCRIPTION		MODEL#/ FEATURES		STANDARD TEXTILE GRADES																																		
				1/COM	2	3	4	5	6	7	8	9	10	11	12																							
	<p><b>R27807</b></p> <p><b>R27807S</b></p>	<p>Base Price: <b>\$5043</b></p> <p>Base Price: <b>\$6002</b></p> <p>Back upcharge: <b>+0</b></p> <p>Seat upcharge: <b>+0</b></p>	<p>Shelf: 52W 10D 1H</p> <table border="1"> <thead> <tr> <th colspan="3">OVERALL DIMENSIONS</th> <th colspan="3">SEAT DIMENSIONS</th> <th colspan="2">BACK DIMENSIONS</th> </tr> <tr> <th>W</th> <th>D</th> <th>H</th> <th>W</th> <th>D</th> <th>H</th> <th>W</th> <th>H</th> </tr> </thead> <tbody> <tr> <td>78</td> <td>30</td> <td>32</td> <td>78</td> <td>19</td> <td>18</td> <td>78</td> <td>14</td> </tr> </tbody> </table>												OVERALL DIMENSIONS			SEAT DIMENSIONS			BACK DIMENSIONS		W	D	H	W	D	H	W	H	78	30	32	78	19	18	78	14
			OVERALL DIMENSIONS			SEAT DIMENSIONS			BACK DIMENSIONS																													
W	D	H	W	D	H	W	H																															
78	30	32	78	19	18	78	14																															
<p><b>Three Seater - Standard Back</b> COM Yardage: Back: 4.50; Seat: 3.50 Freight class: 250 Product weight: 152   173 shelf model Cubic feet per carton: 55.5   173 shelf model</p>		<p>For power/USB unit, see electrical placement chart. Includes ganging hardware (2 sides). Add \$117 for (SSS), \$138 for (SBS) Add \$1260 for 72 lbs. (CW), (C6) Add \$294 for (SP) or \$1063 for (BS) Add \$40 for (TP) Add \$375 for (MB)</p>																																				
	<p><b>R27807B</b></p> <p><b>R27807SB</b></p>	<p>Base Price: <b>\$5781</b></p> <p>Base Price: <b>\$6740</b></p> <p>Back/Arm upcharge: <b>+0</b></p> <p>Seat upcharge: <b>+0</b></p>	<p>Shelf: 52W 10D 1H</p> <table border="1"> <thead> <tr> <th colspan="3">OVERALL DIMENSIONS</th> <th colspan="3">SEAT DIMENSIONS</th> <th colspan="2">BACK DIMENSIONS</th> </tr> <tr> <th>W</th> <th>D</th> <th>H</th> <th>W</th> <th>D</th> <th>H</th> <th>W</th> <th>H</th> </tr> </thead> <tbody> <tr> <td>85</td> <td>30</td> <td>32</td> <td>78</td> <td>19</td> <td>18</td> <td>78</td> <td>14</td> </tr> </tbody> </table>												OVERALL DIMENSIONS			SEAT DIMENSIONS			BACK DIMENSIONS		W	D	H	W	D	H	W	H	85	30	32	78	19	18	78	14
			OVERALL DIMENSIONS			SEAT DIMENSIONS			BACK DIMENSIONS																													
W	D	H	W	D	H	W	H																															
85	30	32	78	19	18	78	14																															
<p><b>Three Seater - Standard Back</b> COM Yardage: Back: 6.50; Seat: 3.50 Freight class: 250 Product weight: 170   193 shelf model Cubic feet per carton: 60.5   79.75 shelf model</p>		<p>For power/USB unit, see electrical placement chart. Ganging not available. Add \$117 for (SSS), \$189 for (SBS) Add \$1260 for 72 lbs. (CW), (C6) Add \$294 for (SP) or \$1063 for (BS) Add \$40 for (TP) Add \$375 for (MB)</p>																																				
	<p><b>R27807L</b></p> <p><b>R27807R</b></p>	<p>Base Price: <b>\$5412</b></p> <p>Base Price: <b>\$5412</b></p> <p>Back/Arm upcharge: <b>+0</b></p> <p>Seat upcharge: <b>+0</b></p>	<p>Shelf: 52W 10D 1H</p> <table border="1"> <thead> <tr> <th colspan="3">OVERALL DIMENSIONS</th> <th colspan="3">SEAT DIMENSIONS</th> <th colspan="2">BACK DIMENSIONS</th> </tr> <tr> <th>W</th> <th>D</th> <th>H</th> <th>W</th> <th>D</th> <th>H</th> <th>W</th> <th>H</th> </tr> </thead> <tbody> <tr> <td>81.5</td> <td>30</td> <td>32</td> <td>78</td> <td>19</td> <td>18</td> <td>78</td> <td>14</td> </tr> </tbody> </table>												OVERALL DIMENSIONS			SEAT DIMENSIONS			BACK DIMENSIONS		W	D	H	W	D	H	W	H	81.5	30	32	78	19	18	78	14
			OVERALL DIMENSIONS			SEAT DIMENSIONS			BACK DIMENSIONS																													
W	D	H	W	D	H	W	H																															
81.5	30	32	78	19	18	78	14																															
<p><b>Three Seater - Standard Back</b> COM Yardage: Back: 5.50; Seat: 3.50 Freight class: 250 Product weight: 160 Cubic feet per carton: 60.5</p>		<p>For power/USB unit, see electrical placement chart. Includes ganging hardware (2 sides). Add \$117 for (SSS), \$164 for (SBS) Add \$1260 for 72 lbs. (CW), (C6) Add \$294 for (SP) or \$1063 for (BS) Add \$40 for (TP) Add \$375 for (MB)</p>																																				
	<p><b>R27807SL</b></p> <p><b>R27807SR</b></p>	<p>Base Price: <b>\$6371</b></p> <p>Base Price: <b>\$6371</b></p> <p>Back/Arm upcharge: <b>+0</b></p> <p>Seat upcharge: <b>+0</b></p>	<p>Shelf: 52W 10D 1H</p> <table border="1"> <thead> <tr> <th colspan="3">OVERALL DIMENSIONS</th> <th colspan="3">SEAT DIMENSIONS</th> <th colspan="2">BACK DIMENSIONS</th> </tr> <tr> <th>W</th> <th>D</th> <th>H</th> <th>W</th> <th>D</th> <th>H</th> <th>W</th> <th>H</th> </tr> </thead> <tbody> <tr> <td>81.5</td> <td>40.5</td> <td>32</td> <td>78</td> <td>19</td> <td>18</td> <td>78</td> <td>14</td> </tr> </tbody> </table>												OVERALL DIMENSIONS			SEAT DIMENSIONS			BACK DIMENSIONS		W	D	H	W	D	H	W	H	81.5	40.5	32	78	19	18	78	14
			OVERALL DIMENSIONS			SEAT DIMENSIONS			BACK DIMENSIONS																													
W	D	H	W	D	H	W	H																															
81.5	40.5	32	78	19	18	78	14																															
<p><b>Three Seater - Standard Back</b> COM Yardage: Back: 5.50; Seat: 3.50 Freight class: 250 Product weight: 183 Cubic feet per carton: 79.75</p>		<p>For power/USB unit, see electrical placement chart. Includes ganging hardware (2 sides). Add \$117 for (SSS), \$164 for (SBS) Add \$1260 for 72 lbs. (CW), (C6) Add \$294 for (SP) or \$1063 for (BS) Add \$40 for (TP) Add \$375 for (MB)</p>																																				





DESCRIPTION	MODEL#/ FEATURES	STANDARD TEXTILE GRADES												
		1/COM	2	3	4	5	6	7	8	9	10	11	12	
 <p><b>R27808</b></p> <p><b>Three Seater - High Back</b> COM Yardage: Back: 5.75; Seat: 3.50 Freight class: 250 Product weight: 177   201 shelf model Cubic feet per carton: 69.75   95.5 shelf model</p>	<p><b>R27808S</b></p> <p>For power/USB unit, see electrical placement chart. Includes ganging hardware (2 sides). Add \$117 for (SSS), \$184 for (SBS) Add \$1260 for 72 lbs. (CW), (C6) Add \$294 for (SP) or \$1063 for (BS) Add \$40 for (TP) Add \$375 for (MB)</p>	Base Price:	\$5882											
		Base Price:	\$6842											
		Back upcharge:	+0	+\$184	+\$328	+\$541	+\$840	+\$966	+\$1225	+\$1633	+\$1938	+\$2272	+\$2967	+\$3698
		Seat upcharge:	+0	+\$112	+\$200	+\$329	+\$511	+\$588	+\$746	+\$994	+\$1180	+\$1383	+\$1806	+\$2251
		Shelf: 52W 10D 1H												
		OVERALL DIMENSIONS			SEAT DIMENSIONS			BACK DIMENSIONS						
		W	D	H	W	D	H	W	D	H				
		78	30.5	41.5	78	19	18	78				23.5		
		RTA 00		1 per carton										

DESCRIPTION	MODEL#/ FEATURES	STANDARD TEXTILE GRADES												
		1/COM	2	3	4	5	6	7	8	9	10	11	12	
 <p><b>R27808B</b></p> <p><b>Three Seater - High Back</b> COM Yardage: Back: 7.75; Seat: 3.50 Freight class: 250 Product weight: 190.5   221.5 shelf model Cubic feet per carton: 69.75   101.5 shelf model</p>	<p><b>R27808SB</b></p> <p>For power/USB unit, see electrical placement chart. Ganging not available. Add \$117 for (SSS), \$237 for (SBS) Add \$1260 for 72 lbs. (CW), (C6) Add \$294 for (SP) or \$1063 for (BS) Add \$40 for (TP) Add \$375 for (MB)</p>	Base Price:	\$6620											
		Base Price:	\$7580											
		Back/Arm upcharge:	+0	+\$248	+\$442	+\$729	+\$1132	+\$1302	+\$1651	+\$2201	+\$2612	+\$3062	+\$3999	+\$4984
		Seat upcharge:	+0	+\$112	+\$200	+\$329	+\$511	+\$588	+\$746	+\$994	+\$1180	+\$1383	+\$1806	+\$2251
		Shelf: 52W 10D 1H												
		OVERALL DIMENSIONS			SEAT DIMENSIONS			BACK DIMENSIONS						
		W	D	H	W	D	H	W	D	H				
		85	30.5	41.5	78	19	18	78				23.5		
		RTA 00		1 per carton										

DESCRIPTION	MODEL#/ FEATURES	STANDARD TEXTILE GRADES												
		1/COM	2	3	4	5	6	7	8	9	10	11	12	
 <p><b>R27808L</b></p> <p><b>Three Seater - High Back</b> COM Yardage: Back: 6.75; Seat: 3.50 Freight class: 250 Product weight: 180.5 Cubic feet per carton: 76.75</p>	<p><b>R27808R</b></p> <p>For power/USB unit, see electrical placement chart. Includes ganging hardware (2 sides). Add \$117 for (SSS), \$237 for (SBS) Add \$1260 for 72 lbs. (CW), (C6) Add \$294 for (SP) or \$1063 for (BS) Add \$40 for (TP) Add \$375 for (MB)</p>	Base Price:	\$6250											
		Base Price:	\$6250											
		Back/Arm upcharge:	+0	+\$216	+\$385	+\$635	+\$986	+\$1134	+\$1438	+\$1917	+\$2275	+\$2667	+\$3483	+\$4341
		Seat upcharge:	+0	+\$112	+\$200	+\$329	+\$511	+\$588	+\$746	+\$994	+\$1180	+\$1383	+\$1806	+\$2251
		Shelf: 52W 10D 1H												
		OVERALL DIMENSIONS			SEAT DIMENSIONS			BACK DIMENSIONS						
		W	D	H	W	D	H	W	D	H				
		81.5	30.5	41.5	78	19	18	78				23.5		
		RTA 00		1 per carton										

DESCRIPTION	MODEL#/ FEATURES	STANDARD TEXTILE GRADES												
		1/COM	2	3	4	5	6	7	8	9	10	11	12	
 <p><b>R27808SL</b></p> <p><b>Three Seater - High Back</b> COM Yardage: Back: 6.75; Seat: 3.50 Freight class: 250 Product weight: 211.5 Cubic feet per carton: 101.5</p>	<p><b>R27808SR</b></p> <p>For power/USB unit, see electrical placement chart. Includes ganging hardware (2 sides). Add \$117 for (SSS), \$237 for (SBS) Add \$1260 for 72 lbs. (CW), (C6) Add \$294 for (SP) or \$1063 for (BS) Add \$40 for (TP) Add \$375 for (MB)</p>	Base Price:	\$7211											
		Base Price:	\$7211											
		Back/Arm upcharge:	+0	+\$216	+\$385	+\$635	+\$986	+\$1134	+\$1438	+\$1917	+\$2275	+\$2667	+\$3483	+\$4341
		Seat upcharge:	+0	+\$112	+\$200	+\$329	+\$511	+\$588	+\$746	+\$994	+\$1180	+\$1383	+\$1806	+\$2251
		Shelf: 52W 10D 1H												
		OVERALL DIMENSIONS			SEAT DIMENSIONS			BACK DIMENSIONS						
		W	D	H	W	D	H	W	D	H				
		81.5	41	41.5	78	19	18	78				23.5		
		RTA 00		1 per carton										



DESCRIPTION	MODEL#/ FEATURES	STANDARD TEXTILE GRADES												
		1/COM	2	3	4	5	6	7	8	9	10	11	12	
 <p><b>R27809</b>                      <b>R27809S</b></p> <p><b>Three Seater - Extended Back</b> COM Yardage: Back: 6.50; Seat: 3.50 Freight class: 250 Product weight: 165   198 shelf model Cubic feet per carton: 79.25   108.5 shelf model</p>	<p><b>R27809</b>      Base Price:      <b>\$6381</b></p> <p><b>R27809S</b>      Base Price:      <b>\$7340</b></p> <p>Back upcharge:      <b>+0</b></p> <p>Seat upcharge:      <b>+0</b></p> <p>For power/USB unit, see electrical placement chart. Includes ganging hardware (2 sides). Add \$117 for (SSS), \$196 for (SBS) Add \$1260 for 72 lbs. (CW), (C6) Add \$294 for (SP) or \$1063 for (BS) Add \$40 for (TP) Add \$375 for (MB)</p>	<p><b>\$6381</b></p> <p><b>\$7340</b></p> <p><b>+0</b>      <b>+\$208</b>      <b>+\$371</b>      <b>+\$611</b>      <b>+\$949</b>      <b>+\$1092+\$1385</b>      <b>+\$1846</b>      <b>+\$2191</b>      <b>+\$2568</b>      <b>+\$3354</b>      <b>+\$4180</b></p> <p><b>+0</b>      <b>+\$112</b>      <b>+\$200</b>      <b>+\$329</b>      <b>+\$511</b>      <b>+\$588</b>      <b>+\$746</b>      <b>+\$994</b>      <b>+\$1180</b>      <b>+\$1383</b>      <b>+\$1806</b>      <b>+\$2251</b></p>	<p><b>OVERALL DIMENSIONS</b></p> <p>W      D      H</p>			<p><b>SEAT DIMENSIONS</b></p> <p>W      D      H</p>			<p><b>BACK DIMENSIONS</b></p> <p>W      H</p>					
				78	31	47	78	19	18	78	29			
			<p><b>RTA 00</b>      1 per carton</p>											
 <p><b>R27809B</b>                      <b>R27809SB</b></p> <p><b>Three Seater - Extended Back</b> COM Yardage: Back: 7.50; Seat: 3.50 Freight class: 250 Product weight: 190   220 shelf model Cubic feet per carton: 86.25   114 shelf model</p>	<p><b>R27809B</b>      Base Price:      <b>\$7117</b></p> <p><b>R27809SB</b>      Base Price:      <b>\$8076</b></p> <p>Back/Arm upcharge:      <b>+0</b></p> <p>Seat upcharge:      <b>+0</b></p> <p>For power/USB unit, see electrical placement chart. Ganging not available. Add \$117 for (SSS), \$248 for (SBS) Add \$1260 for 72 lbs. (CW), (C6) Add \$294 for (SP) or \$1063 for (BS) Add \$40 for (TP) Add \$375 for (MB)</p>	<p><b>\$7117</b></p> <p><b>\$8076</b></p> <p><b>+0</b>      <b>+\$272</b>      <b>+\$485</b>      <b>+\$799</b>      <b>+\$1241</b>      <b>+\$1428+\$1811</b>      <b>+\$2414</b>      <b>+\$2865</b>      <b>+\$3358</b>      <b>+\$4386</b>      <b>+\$5466</b></p> <p><b>+0</b>      <b>+\$112</b>      <b>+\$200</b>      <b>+\$329</b>      <b>+\$511</b>      <b>+\$588</b>      <b>+\$746</b>      <b>+\$994</b>      <b>+\$1180</b>      <b>+\$1383</b>      <b>+\$1806</b>      <b>+\$2251</b></p>	<p><b>OVERALL DIMENSIONS</b></p> <p>W      D      H</p>			<p><b>SEAT DIMENSIONS</b></p> <p>W      D      H</p>			<p><b>BACK DIMENSIONS</b></p> <p>W      H</p>					
				85	31	47	78	19	18	78	29			
			<p><b>RTA 00</b>      1 per carton</p>											
 <p><b>R27809L</b>                      <b>R27809R</b></p> <p><b>Three Seater - Extended Back</b> COM Yardage: Back: 7.50; Seat: 3.50 Freight class: 250 Product weight: 180 Cubic feet per carton: 86.25</p>	<p><b>R27809L</b>      Base Price:      <b>\$6749</b></p> <p><b>R27809R</b>      Base Price:      <b>\$6749</b></p> <p>Back/Arm upcharge:      <b>+0</b></p> <p>Seat upcharge:      <b>+0</b></p> <p>For power/USB unit, see electrical placement chart. Includes ganging hardware (1 side). Add \$117 for (SSS), \$222 for (SBS) Add \$1260 for 72 lbs. (CW), (C6) Add \$294 for (SP) or \$1063 for (BS) Add \$40 for (TP) Add \$375 for (MB)</p>	<p><b>\$6749</b></p> <p><b>\$6749</b></p> <p><b>+0</b>      <b>+\$240</b>      <b>+\$428</b>      <b>+\$705</b>      <b>+\$1095</b>      <b>+\$1260+\$1598</b>      <b>+\$2130</b>      <b>+\$2528</b>      <b>+\$2963</b>      <b>+\$3870</b>      <b>+\$4823</b></p> <p><b>+0</b>      <b>+\$112</b>      <b>+\$200</b>      <b>+\$329</b>      <b>+\$511</b>      <b>+\$588</b>      <b>+\$746</b>      <b>+\$994</b>      <b>+\$1180</b>      <b>+\$1383</b>      <b>+\$1806</b>      <b>+\$2251</b></p>	<p><b>OVERALL DIMENSIONS</b></p> <p>W      D      H</p>			<p><b>SEAT DIMENSIONS</b></p> <p>W      D      H</p>			<p><b>BACK DIMENSIONS</b></p> <p>W      H</p>					
				81.5	31	47	78	19	18	78	29			
			<p><b>RTA 00</b>      1 per carton</p>											
 <p><b>R27809SL</b>                      <b>R27809SR</b></p> <p><b>Three Seater - Extended Back</b> COM Yardage: Back: 7.50; Seat: 3.50 Freight class: 250 Product weight: 210 Cubic feet per carton: 114</p>	<p><b>R27809SL</b>      Base Price:      <b>\$7708</b></p> <p><b>R27809SR</b>      Base Price:      <b>\$7708</b></p> <p>Back/Arm upcharge:      <b>+0</b></p> <p>Seat upcharge:      <b>+0</b></p> <p>For power/USB unit, see electrical placement chart. Includes ganging hardware (1 side). Add \$117 for (SSS), \$222 for (SBS) Add \$1260 for 72 lbs. (CW), (C6) Add \$294 for (SP) or \$1063 for (BS) Add \$40 for (TP) Add \$375 for (MB)</p>	<p><b>\$7708</b></p> <p><b>\$7708</b></p> <p><b>+0</b>      <b>+\$240</b>      <b>+\$428</b>      <b>+\$705</b>      <b>+\$1095</b>      <b>+\$1260+\$1598</b>      <b>+\$2130</b>      <b>+\$2528</b>      <b>+\$2963</b>      <b>+\$3870</b>      <b>+\$4823</b></p> <p><b>+0</b>      <b>+\$112</b>      <b>+\$200</b>      <b>+\$329</b>      <b>+\$511</b>      <b>+\$588</b>      <b>+\$746</b>      <b>+\$994</b>      <b>+\$1180</b>      <b>+\$1383</b>      <b>+\$1806</b>      <b>+\$2251</b></p>	<p><b>OVERALL DIMENSIONS</b></p> <p>W      D      H</p>			<p><b>SEAT DIMENSIONS</b></p> <p>W      D      H</p>			<p><b>BACK DIMENSIONS</b></p> <p>W      H</p>					
				81.5	41.5	47	78	19	18	78	29			
			<p><b>RTA 00</b>      1 per carton</p>											
			<p>Shelf: 52W 10D 1H</p>											

DESCRIPTION MODEL#/ FEATURES STANDARD TEXTILE GRADES



R27810

**Bariatric Lounge Chair - Standard Back**  
COM Yardage: Back: 2.25; Seat: 2  
Freight class: 250  
Product weight: 90  
Cubic feet per carton: 28.75

**R27810** Base Price:  
Back upcharge:  
Seat upcharge:

1/COM	2	3	4	5	6	7	8	9	10	11	12
<b>\$3150</b>											
<b>+0</b>	<b>+\$72</b>	<b>+\$129</b>	<b>+\$212</b>	<b>+\$329</b>	<b>+\$378</b>	<b>+\$480</b>	<b>+\$639</b>	<b>+\$759</b>	<b>+\$889</b>	<b>+\$1161</b>	<b>+\$1447</b>
<b>+0</b>	<b>+\$64</b>	<b>+\$114</b>	<b>+\$188</b>	<b>+\$292</b>	<b>+\$336</b>	<b>+\$426</b>	<b>+\$568</b>	<b>+\$674</b>	<b>+\$790</b>	<b>+\$1032</b>	<b>+\$1286</b>

For power/USB unit, see electrical placement chart. Includes ganging hardware (2 sides).  
Add \$70 for (SSS), \$86 for (SBS)  
Add \$632 for 36 lbs. (CW)  
Add \$138 for (SP) or \$678 for (BS)  
Add \$40 for (TP)  
Add \$188 for (MB)

OVERALL DIMENSIONS			SEAT DIMENSIONS			BACK DIMENSIONS	
W	D	H	W	D	H	W	H
39	30	32	39	19	18	39	14
<b>RTA 00</b>			1 per carton				



R27810B

**Bariatric Lounge Chair - Standard Back**  
COM Yardage: Back: 4.25; Seat: 2  
Freight class: 250  
Product weight: 108  
Cubic feet per carton: 33

**R27810B** Base Price:  
Back/Arm upcharge:  
Seat upcharge:

1/COM	2	3	4	5	6	7	8	9	10	11	12
<b>\$3886</b>											
<b>+0</b>	<b>+\$136</b>	<b>+\$243</b>	<b>+\$400</b>	<b>+\$621</b>	<b>+\$714</b>	<b>+\$906</b>	<b>+\$1207</b>	<b>+\$1433</b>	<b>+\$1679</b>	<b>+\$2193</b>	<b>+\$2733</b>
<b>+0</b>	<b>+\$64</b>	<b>+\$114</b>	<b>+\$188</b>	<b>+\$292</b>	<b>+\$336</b>	<b>+\$426</b>	<b>+\$568</b>	<b>+\$674</b>	<b>+\$790</b>	<b>+\$1032</b>	<b>+\$1286</b>

For power/USB unit, see electrical placement chart. Ganging not available.  
Add \$70 for (SSS), \$139 for (SBS)  
Add \$632 for 36 lbs. (CW)  
Add \$138 for (SP) or \$678 for (BS)  
Add \$40 for (TP)  
Add \$188 for (MB)

OVERALL DIMENSIONS			SEAT DIMENSIONS			BACK DIMENSIONS	
W	D	H	W	D	H	W	H
46	30	32	39	19	18	39	14
<b>RTA 00</b>			1 per carton				



R27810L

R27810R

**Bariatric Lounge Chair - Standard Back**  
COM Yardage: Back: 3.25; Seat: 2  
Freight class: 250  
Product weight: 98  
Cubic feet per carton: 33

**R27810L** Base Price:  
**R27810R** Base Price:  
Back/Arm upcharge:  
Seat upcharge:

1/COM	2	3	4	5	6	7	8	9	10	11	12
<b>\$3518</b>											
<b>+0</b>	<b>+\$104</b>	<b>+\$186</b>	<b>+\$306</b>	<b>+\$475</b>	<b>+\$546</b>	<b>+\$693</b>	<b>+\$923</b>	<b>+\$1096</b>	<b>+\$1284</b>	<b>+\$1677</b>	<b>+\$2090</b>
<b>+0</b>	<b>+\$64</b>	<b>+\$114</b>	<b>+\$188</b>	<b>+\$292</b>	<b>+\$336</b>	<b>+\$426</b>	<b>+\$568</b>	<b>+\$674</b>	<b>+\$790</b>	<b>+\$1032</b>	<b>+\$1286</b>

For power/USB unit, see electrical placement chart. Includes ganging hardware (1 side).  
Add \$70 for (SSS), \$112 for (SBS)  
Add \$632 for 36 lbs. (CW)  
Add \$138 for (SP) or \$678 for (BS)  
Add \$40 for (TP)  
Add \$188 for (MB)

OVERALL DIMENSIONS			SEAT DIMENSIONS			BACK DIMENSIONS	
W	D	H	W	D	H	W	H
42.5	30	32	39	19	18	39	14
<b>RTA 00</b>			1 per carton				



R27811

**Bariatric Lounge Chair - High Back**  
COM Yardage: Back: 2.75; Seat: 2  
Freight class: 250  
Product weight: 98  
Cubic feet per carton: 36





**R27811** Base Price:  
Back upcharge:  
Seat upcharge:

1/COM	2	3	4	5	6	7	8	9	10	11	12
<b>\$3504</b>											
<b>+0</b>	<b>+\$88</b>	<b>+\$157</b>	<b>+\$259</b>	<b>+\$402</b>	<b>+\$462</b>	<b>+\$586</b>	<b>+\$781</b>	<b>+\$927</b>	<b>+\$1087</b>	<b>+\$1419</b>	<b>+\$4341</b>
<b>+0</b>	<b>+\$112</b>	<b>+\$114</b>	<b>+\$188</b>	<b>+\$292</b>	<b>+\$336</b>	<b>+\$426</b>	<b>+\$568</b>	<b>+\$674</b>	<b>+\$790</b>	<b>+\$1032</b>	<b>+\$1286</b>

For power/USB unit, see electrical placement chart. Includes ganging hardware (2 sides).  
Add \$70 for (SSS), \$110 for (SBS)  
Add \$632 for 36 lbs. (CW), (C6)  
Add \$138 for (SP) or \$678 for (BS)  
Add \$40 for (TP)  
Add \$188 for (MB)

OVERALL DIMENSIONS			SEAT DIMENSIONS			BACK DIMENSIONS	
W	D	H	W	D	H	W	H
39	30.5	41.5	39	19	18	39	23.5
<b>RTA 00</b>			1 per carton				







DESCRIPTION	MODEL#/ FEATURES	STANDARD TEXTILE GRADES													
		1/COM	2	3	4	5	6	7	8	9	10	11	12		
 <p><b>R27811B</b></p> <p><b>Bariatric Lounge Chair - High Back</b>                      COM Yardage: Back: 4.75; Seat: 2                      Freight class: 250                      Product weight: 117.5                      Cubic feet per carton: 42.25</p>	<b>R27811B</b>	Base Price:	<b>\$4239</b>												
	Back/Arm upcharge:	<b>+0</b>	<b>+\$152</b>	<b>+\$271</b>	<b>+\$447</b>	<b>+\$694</b>	<b>+\$798</b>	<b>+\$1012</b>	<b>+\$1349</b>	<b>+\$1601</b>	<b>+\$1877</b>	<b>+\$2451</b>	<b>+\$3055</b>		
	Seat upcharge:	<b>+0</b>	<b>+\$64</b>	<b>+\$114</b>	<b>+\$188</b>	<b>+\$292</b>	<b>+\$336</b>	<b>+\$426</b>	<b>+\$568</b>	<b>+\$674</b>	<b>+\$790</b>	<b>+\$1032</b>	<b>+\$1286</b>		
	For power/USB unit, see electrical placement chart. Ganging not available.				<b>OVERALL DIMENSIONS</b>			<b>SEAT DIMENSIONS</b>			<b>BACK DIMENSIONS</b>				
	Add \$70 for (SSS), \$162 for (SBS) Add \$632 for 36 lbs. (CW), (C6) Add \$138 for (SP) or \$678 for (BS) Add \$40 for (TP) Add \$188 for (MB)		W	D	H	W	D	H	W	H					
			46	30.5	41.5	39	19	18	39	23.5					
			<b>RTA 00</b>		1 per carton										
	 <p><b>R27811L</b>      <b>R27811R</b></p> <p><b>Bariatric Lounge Chair - High Back</b>                      COM Yardage: Back: 3.75; Seat: 2                      Freight class: 250                      Product weight: 107.5                      Cubic feet per carton: 42.25</p>	<b>R27811L</b>	Base Price:	<b>\$3872</b>											
		<b>R27811R</b>	Base Price:	<b>\$3872</b>											
		Back/Arm upcharge:	<b>+0</b>	<b>+\$120</b>	<b>+\$214</b>	<b>+\$353</b>	<b>+\$548</b>	<b>+\$630</b>	<b>+\$799</b>	<b>+\$1065</b>	<b>+\$1264</b>	<b>+\$1482</b>	<b>+\$1935</b>	<b>+\$2412</b>	
Seat upcharge:		<b>+0</b>	<b>+\$64</b>	<b>+\$114</b>	<b>+\$188</b>	<b>+\$292</b>	<b>+\$336</b>	<b>+\$426</b>	<b>+\$568</b>	<b>+\$674</b>	<b>+\$790</b>	<b>+\$1032</b>	<b>+\$1286</b>		
For power/USB unit, see electrical placement chart. Includes ganging hardware (1 side). Add \$70 for (SSS), \$137 for (SBS) Add \$632 for 36 lbs. (CW), (C6) Add \$138 for (SP) or \$678 for (BS) Add \$40 for (TP) Add \$188 for (MB)				<b>OVERALL DIMENSIONS</b>			<b>SEAT DIMENSIONS</b>			<b>BACK DIMENSIONS</b>					
		W	D	H	W	D	H	W	H						
		42.5	30.5	41.5	39	19	18	39	23.5						
		<b>RTA 00</b>		1 per carton											
 <p><b>R27812</b></p> <p><b>Bariatric Lounge Chair - Extended Back</b>                      COM Yardage: Back: 3.25; Seat: 2                      Freight class: 250                      Product weight: 115                      Cubic feet per carton: 41</p>		<b>R27812</b>	Base Price:	<b>\$3709</b>											
		Back upcharge:	<b>+0</b>	<b>+\$104</b>	<b>+\$186</b>	<b>+\$306</b>	<b>+\$475</b>	<b>+\$546</b>	<b>+\$693</b>	<b>+\$923</b>	<b>+\$1096</b>	<b>+\$1284</b>	<b>+\$1677</b>	<b>+\$2090</b>	
	Seat upcharge:	<b>+0</b>	<b>+\$64</b>	<b>+\$114</b>	<b>+\$188</b>	<b>+\$292</b>	<b>+\$336</b>	<b>+\$426</b>	<b>+\$568</b>	<b>+\$674</b>	<b>+\$790</b>	<b>+\$1032</b>	<b>+\$1286</b>		
	For power/USB unit, see electrical placement chart. Includes ganging hardware (2 sides). Add \$70 for (SSS), \$119 for (SBS) Add \$632 for 36 lbs. (CW), (C6) Add \$138 for (SP) or \$678 for (BS) Add \$40 for (TP) Add \$188 for (MB)				<b>OVERALL DIMENSIONS</b>			<b>SEAT DIMENSIONS</b>			<b>BACK DIMENSIONS</b>				
			W	D	H	W	D	H	W	H					
			39	31	47	39	19	18	39	29					
			<b>RTA 00</b>		1 per carton										
	 <p><b>R27812B</b></p> <p><b>Bariatric Lounge Chair - Extended Back</b>                      COM Yardage: Back: 5.25; Seat: 2                      Freight class: 250                      Product weight: 132.5                      Cubic feet per carton: 47.25</p>	<b>R27812B</b>	Base Price:	<b>\$4446</b>											
		Back/Arm upcharge:	<b>+0</b>	<b>+\$168</b>	<b>+\$300</b>	<b>+\$494</b>	<b>+\$767</b>	<b>+\$882</b>	<b>+\$1119</b>	<b>+\$1491</b>	<b>+\$1770</b>	<b>+\$2074</b>	<b>+\$2709</b>	<b>+\$3376</b>	
		Seat upcharge:	<b>+0</b>	<b>+\$64</b>	<b>+\$114</b>	<b>+\$188</b>	<b>+\$292</b>	<b>+\$336</b>	<b>+\$426</b>	<b>+\$568</b>	<b>+\$674</b>	<b>+\$790</b>	<b>+\$1032</b>	<b>+\$1286</b>	
For power/USB unit, see electrical placement chart. Ganging not available. Add \$70 for (SSS), \$171 for (SBS) Add \$632 for 36 lbs. (CW), (C6) Add \$138 for (SP) or \$678 for (BS) Add \$40 for (TP) Add \$188 for (MB)				<b>OVERALL DIMENSIONS</b>			<b>SEAT DIMENSIONS</b>			<b>BACK DIMENSIONS</b>					
		W	D	H	W	D	H	W	H						
		46	31	47	39	19	18	39	29						
		<b>RTA 00</b>		1 per carton											









DESCRIPTION	MODEL#/ FEATURES	STANDARD TEXTILE GRADES												
		1/COM	2	3	4	5	6	7	8	9	10	11	12	
 <p><b>R27812L</b></p> <p><b>Bariatric Lounge Chair - Extended Back</b> COM Yardage: Back: 4.25; Seat: 2 Freight class: 250 Product weight: 122.5 Cubic feet per carton: 47.25</p>	<p><b>R27812R</b></p> <p>For power/USB unit, see electrical placement chart. Includes ganging hardware (1 side). Add \$70 for (SSS), \$145 for (SBS) Add \$632 for 36 lbs. (CW), (C6) Add \$138 for (SP) or \$678 for (BS) Add \$40 for (TP) Add \$188 for (MB)</p>	Base Price:	\$4079											
		Back/Arm upcharge:	+0	+\$136	+\$243	+\$400	+\$621	+\$714	+\$906	+\$1207	+\$1433	+\$1679	+\$2193	+\$2733
		Seat upcharge:	+0	+\$64	+\$114	+\$188	+\$292	+\$336	+\$426	+\$568	+\$674	+\$790	+\$1032	+\$1286
		<b>OVERALL DIMENSIONS</b>	<b>W</b>	<b>D</b>	<b>H</b>	<b>SEAT DIMENSIONS</b>			<b>BACK DIMENSIONS</b>					
			42.5	31	47	39	19	18	39	29				
			<b>RTA 00</b>		1 per carton									





DESCRIPTION	MODEL#/ FEATURES	STANDARD TEXTILE GRADES												
		1/COM	2	3	4	5	6	7	8	9	10	11	12	
 <p><b>R27815</b></p> <p><b>Inside Curve Two Seater - Standard Back</b> COM Yardage: Back: 3; Seat: 2 Freight class: 250 Product weight: 93   119 shelf model Cubic feet per carton: 42.75   63.5 shelf model</p>	<p><b>R27815S</b></p> <p>For power/USB unit, see electrical placement chart. Includes ganging hardware (2 sides). Add \$86 for (SSS), \$119 for (SBS) Add \$1260 for 72 lbs. (CW), (C6) Add \$174 for (SP) or \$773 for (BS) Add \$40 for (TP) Add \$252 for (MB)</p>	Base Price:	\$3395											
		Back upcharge:	+0	+\$96	+\$171	+\$282	+\$438	+\$504	+\$639	+\$852	+\$1011	+\$1185	+\$1548	+\$1929
		Seat upcharge:	+0	+\$64	+\$114	+\$188	+\$292	+\$336	+\$426	+\$568	+\$674	+\$790	+\$1032	+\$1286
			Shelf: 52W 10D 1H											
		<b>OVERALL DIMENSIONS</b>	<b>W</b>	<b>D</b>	<b>H</b>	<b>SEAT DIMENSIONS</b>			<b>BACK DIMENSIONS</b>					
			50.5	30	32	42	19	18	51	14				
			<b>RTA 00</b>		1 per carton									





DESCRIPTION	MODEL#/ FEATURES	STANDARD TEXTILE GRADES												
		1/COM	2	3	4	5	6	7	8	9	10	11	12	
 <p><b>R27815L</b></p> <p><b>Inside Curve Two Seater - Standard Back</b> COM Yardage: Back: 4; Seat: 2 Freight class: 250 Product weight: 102 Cubic feet per carton: 43.5</p>	<p><b>R27815R</b></p> <p>For power/USB unit, see electrical placement chart. Includes ganging hardware (1 side). Add \$86 for (SSS), \$145 for (SBS) Add \$1260 for 72 lbs. (CW), (C6) Add \$174 for (SP) or \$773 for (BS) Add \$40 for (TP) Add \$252 for (MB)</p>	Base Price:	\$3764											
		Back/Arm upcharge:	+0	+\$128	+\$228	+\$376	+\$584	+\$672	+\$852	+\$1136	+\$1348	+\$1580	+\$2064	+\$2572
		Seat upcharge:	+0	+\$64	+\$114	+\$188	+\$292	+\$336	+\$426	+\$568	+\$674	+\$790	+\$1032	+\$1286
		<b>OVERALL DIMENSIONS</b>	<b>W</b>	<b>D</b>	<b>H</b>	<b>SEAT DIMENSIONS</b>			<b>BACK DIMENSIONS</b>					
			54	30	32	42	19	18	51	14				
			<b>RTA 00</b>		1 per carton									

DESCRIPTION	MODEL#/ FEATURES	STANDARD TEXTILE GRADES												
		1/COM	2	3	4	5	6	7	8	9	10	11	12	
 <p><b>R27815SL</b></p> <p><b>Inside Curve Two Seater - Standard Back</b> COM Yardage: Back: 4; Seat: 2 Freight class: 250 Product weight: 102   128 shelf model Cubic feet per carton: 43.5   65 shelf model</p>	<p><b>R27815SR</b></p> <p>For power/USB unit, see electrical placement chart. Includes ganging hardware (1 side). Add \$86 for (SSS), \$145 for (SBS) Add \$1260 for 72 lbs. (CW), (C6) Add \$174 for (SP) or \$773 for (BS) Add \$40 for (TP) Add \$252 for (MB)</p>	Base Price:	\$4816											
		Back/Arm upcharge:	+0	+\$128	+\$228	+\$376	+\$584	+\$672	+\$852	+\$1136	+\$1348	+\$1580	+\$2064	+\$2572
		Seat upcharge:	+0	+\$64	+\$114	+\$188	+\$292	+\$336	+\$426	+\$568	+\$674	+\$790	+\$1032	+\$1286
			Shelf: 52W 10D 1H											
		<b>OVERALL DIMENSIONS</b>	<b>W</b>	<b>D</b>	<b>H</b>	<b>SEAT DIMENSIONS</b>			<b>BACK DIMENSIONS</b>					
			61.5	40.5	32	42	19	18	51	14				
			<b>RTA 00</b>		1 per carton									





DESCRIPTION	MODEL#/ FEATURES	STANDARD TEXTILE GRADES												
		1/COM	2	3	4	5	6	7	8	9	10	11	12	
 <p><b>R27816</b></p> <p><b>Inside Curve Two Seater - High Back</b> COM Yardage: Back: 3.50; Seat: 2 Freight class: 300 Product weight: 106   132 shelf model Cubic feet per carton: 53.75   79.75 shelf model</p>	<p><b>R27816S</b></p> <p>For power/USB unit, see electrical placement chart. Includes ganging hardware (2 sides). Add \$86 for (SSS), \$157 for (SBS) Add \$1260 for 72 lbs. (CW), (C6) Add \$174 for (SP) or \$773 for (BS) Add \$40 for (TP) Add \$252 for (MB)</p>	Base Price:	<b>\$4419</b>											
		Back Price:	<b>\$5406</b>											
		Back upcharge:	<b>+0</b>	<b>+\$112</b>	<b>+\$200</b>	<b>+\$329</b>	<b>+\$511</b>	<b>+\$588</b>	<b>+\$746</b>	<b>+\$994</b>	<b>+\$1180</b>	<b>+\$1383</b>	<b>+\$1806</b>	<b>+\$2251</b>
		Seat upcharge:	<b>+0</b>	<b>+\$64</b>	<b>+\$114</b>	<b>+\$188</b>	<b>+\$292</b>	<b>+\$336</b>	<b>+\$426</b>	<b>+\$568</b>	<b>+\$674</b>	<b>+\$790</b>	<b>+\$1032</b>	<b>+\$1286</b>
		Shelf: 52W 10D 1H												
		<b>OVERALL DIMENSIONS</b>	<b>W</b>	<b>D</b>	<b>H</b>	<b>SEAT DIMENSIONS</b>			<b>BACK DIMENSIONS</b>					
			51	30.5	41.5	42	19	18	51	23.5				
		<b>RTA 00</b>	1 per carton											
 <p><b>R27816L</b></p> <p><b>Inside Curve Two Seater - High Back</b> COM Yardage: Back: 4.50; Seat: 2 Freight class: 250 Product weight: 115 Cubic feet per carton: 55.5</p>	<p><b>R27816SR</b></p> <p>For power/USB unit, see electrical placement chart. Includes ganging hardware (1 side). Add \$86 for (SSS), \$183 for (SBS) Add \$1260 for 72 lbs. (CW), (C6) Add \$174 for (SP) or \$773 for (BS) Add \$40 for (TP) Add \$252 for (MB)</p>	Base Price:	<b>\$4788</b>											
		Back Price:	<b>\$4788</b>											
		Back/Arm upcharge:	<b>+0</b>	<b>+\$144</b>	<b>+\$257</b>	<b>+\$423</b>	<b>+\$657</b>	<b>+\$756</b>	<b>+\$959</b>	<b>+\$1278</b>	<b>+\$1517</b>	<b>+\$1778</b>	<b>+\$2322</b>	<b>+\$2894</b>
		Seat upcharge:	<b>+0</b>	<b>+\$64</b>	<b>+\$114</b>	<b>+\$188</b>	<b>+\$292</b>	<b>+\$336</b>	<b>+\$426</b>	<b>+\$568</b>	<b>+\$674</b>	<b>+\$790</b>	<b>+\$1032</b>	<b>+\$1286</b>
		Shelf: 52W 10D 1H												
		<b>OVERALL DIMENSIONS</b>	<b>W</b>	<b>D</b>	<b>H</b>	<b>SEAT DIMENSIONS</b>			<b>BACK DIMENSIONS</b>					
			54.5	30.5	41.5	42	19	18	51	23.5				
		<b>RTA 00</b>	1 per carton											
 <p><b>R27816SL</b></p> <p><b>Inside Curve Two Seater - High Back</b> COM Yardage: Back: 4.50; Seat: 2 Freight class: 250 Product weight: 141.5 Cubic feet per carton: 82.5</p>	<p><b>R27816SR</b></p> <p>For power/USB unit, see electrical placement chart. Includes ganging hardware (1 side). Add \$86 for (SSS), \$183 for (SBS) Add \$1260 for 72 lbs. (CW), (C6) Add \$174 for (SP) or \$773 for (BS) Add \$40 for (TP) Add \$252 for (MB)</p>	Base Price:	<b>\$5775</b>											
		Back Price:	<b>\$5775</b>											
		Back/Arm upcharge:	<b>+0</b>	<b>+\$144</b>	<b>+\$257</b>	<b>+\$423</b>	<b>+\$657</b>	<b>+\$756</b>	<b>+\$959</b>	<b>+\$1278</b>	<b>+\$1517</b>	<b>+\$1778</b>	<b>+\$2322</b>	<b>+\$2894</b>
		Seat upcharge:	<b>+0</b>	<b>+\$64</b>	<b>+\$114</b>	<b>+\$188</b>	<b>+\$292</b>	<b>+\$336</b>	<b>+\$426</b>	<b>+\$568</b>	<b>+\$674</b>	<b>+\$790</b>	<b>+\$1032</b>	<b>+\$1286</b>
		Shelf: 52W 10D 1H												
		<b>OVERALL DIMENSIONS</b>	<b>W</b>	<b>D</b>	<b>H</b>	<b>SEAT DIMENSIONS</b>			<b>BACK DIMENSIONS</b>					
			62	41	41.5	42	19	18	51	23.5				
		<b>RTA 00</b>	1 per carton											
 <p><b>R27817</b></p> <p><b>Inside Curve Two Seater - Extended Back</b> COM Yardage: Back: 4; Seat: 2 Freight class: 300 Product weight: 118   139 shelf model Cubic feet per carton: 61   90.5 shelf model</p>	<p><b>R27817S</b></p> <p>For power/USB unit, see electrical placement chart. Includes ganging hardware (2 sides). Add \$86 for (SSS), \$168 for (SBS) Add \$1260 for 72 lbs. (CW), (C6) Add \$174 for (SP) or \$773 for (BS) Add \$40 for (TP) Add \$252 for (MB)</p>	Base Price:	<b>\$4681</b>											
		Back Price:	<b>\$5669</b>											
		Back upcharge:	<b>+0</b>	<b>+\$128</b>	<b>+\$228</b>	<b>+\$376</b>	<b>+\$584</b>	<b>+\$672</b>	<b>+\$852</b>	<b>+\$1136</b>	<b>+\$1348</b>	<b>+\$1580</b>	<b>+\$2064</b>	<b>+\$2572</b>
		Seat upcharge:	<b>+0</b>	<b>+\$64</b>	<b>+\$114</b>	<b>+\$188</b>	<b>+\$292</b>	<b>+\$336</b>	<b>+\$426</b>	<b>+\$568</b>	<b>+\$674</b>	<b>+\$790</b>	<b>+\$1032</b>	<b>+\$1286</b>
		Shelf: 52W 10D 1H												
		<b>OVERALL DIMENSIONS</b>	<b>W</b>	<b>D</b>	<b>H</b>	<b>SEAT DIMENSIONS</b>			<b>BACK DIMENSIONS</b>					
			51.5	31	47	42	19	18	51	29				
		<b>RTA 00</b>	1 per carton											

DESCRIPTION		MODEL#/ FEATURES		STANDARD TEXTILE GRADES																							
				1/COM	2	3	4	5	6	7	8	9	10	11	12												
		<b>R27817L</b>	Base Price:	<b>\$5049</b>																							
		<b>R27817R</b>	Base Price:	<b>\$5049</b>																							
			Back/Arm upcharge:	<b>+0</b>	<b>+\$160</b>	<b>+\$285</b>	<b>+\$470</b>	<b>+\$730</b>	<b>+\$840</b>	<b>+\$1065</b>	<b>+\$1420</b>	<b>+\$1685</b>	<b>+\$1975</b>	<b>+\$2580</b>	<b>+\$3215</b>												
			Seat upcharge:	<b>+0</b>	<b>+\$64</b>	<b>+\$114</b>	<b>+\$188</b>	<b>+\$292</b>	<b>+\$336</b>	<b>+\$426</b>	<b>+\$568</b>	<b>+\$674</b>	<b>+\$790</b>	<b>+\$1032</b>	<b>+\$1286</b>												
<p><b>R27817L</b></p> <p><b>Inside Curve Two Seater - Extended Back</b> COM Yardage: Back: 5; Seat: 2 Freight class: 300 Product weight: 122 Cubic feet per carton: 62.25</p>		<p><b>R27817R</b></p> <p>For power/USB unit, see electrical placement chart. Includes ganging hardware (1 side). Add \$86 for (SSS), \$195 for (SBS) Add \$1260 for 72 lbs. (CW), (C6) Add \$174 for (SP) or \$773 for (BS) Add \$40 for (TP) Add \$252 for (MB)</p>	<table border="1"> <thead> <tr> <th colspan="3">OVERALL DIMENSIONS</th> <th colspan="3">SEAT DIMENSIONS</th> <th colspan="2">BACK DIMENSIONS</th> </tr> <tr> <th>W</th> <th>D</th> <th>H</th> <th>W</th> <th>D</th> <th>H</th> <th>W</th> <th>H</th> </tr> </thead> <tbody> <tr> <td>54</td> <td>31</td> <td>47</td> <td>42</td> <td>19</td> <td>18</td> <td>51</td> <td>29</td> </tr> </tbody> </table> <p><b>RTA 00</b> 1 per carton</p>	OVERALL DIMENSIONS			SEAT DIMENSIONS			BACK DIMENSIONS		W	D	H	W	D	H	W	H	54	31	47	42	19	18	51	29
OVERALL DIMENSIONS			SEAT DIMENSIONS			BACK DIMENSIONS																					
W	D	H	W	D	H	W	H																				
54	31	47	42	19	18	51	29																				
		<b>R27817SL</b>	Base Price:	<b>\$6038</b>																							
		<b>R27817SR</b>	Base Price:	<b>\$6038</b>																							
			Back/Arm upcharge:	<b>+0</b>	<b>+\$160</b>	<b>+\$285</b>	<b>+\$470</b>	<b>+\$730</b>	<b>+\$840</b>	<b>+\$1065</b>	<b>+\$1420</b>	<b>+\$1685</b>	<b>+\$1975</b>	<b>+\$2580</b>	<b>+\$3215</b>												
			Seat upcharge:	<b>+0</b>	<b>+\$64</b>	<b>+\$114</b>	<b>+\$188</b>	<b>+\$292</b>	<b>+\$336</b>	<b>+\$426</b>	<b>+\$568</b>	<b>+\$674</b>	<b>+\$790</b>	<b>+\$1032</b>	<b>+\$1286</b>												
<p><b>R27817SL</b></p> <p><b>Inside Curve Two Seater - Extended Back</b> COM Yardage: Back: 5; Seat: 2 Freight class: 300 Product weight: 149 Cubic feet per carton: 92.75</p>		<p><b>R27817SR</b></p> <p>For power/USB unit, see electrical placement chart. Includes ganging hardware (1 side). Add \$86 for (SSS), \$195 for (SBS) Add \$1260 for 72 lbs. (CW), (C6) Add \$174 for (SP) or \$773 for (BS) Add \$40 for (TP) Add \$252 for (MB)</p>	<p>Shelf: 52W 10D 1H</p> <table border="1"> <thead> <tr> <th colspan="3">OVERALL DIMENSIONS</th> <th colspan="3">SEAT DIMENSIONS</th> <th colspan="2">BACK DIMENSIONS</th> </tr> <tr> <th>W</th> <th>D</th> <th>H</th> <th>W</th> <th>D</th> <th>H</th> <th>W</th> <th>H</th> </tr> </thead> <tbody> <tr> <td>62.5</td> <td>41.5</td> <td>47</td> <td>42</td> <td>19</td> <td>18</td> <td>51</td> <td>29</td> </tr> </tbody> </table> <p><b>RTA 00</b> 1 per carton</p>	OVERALL DIMENSIONS			SEAT DIMENSIONS			BACK DIMENSIONS		W	D	H	W	D	H	W	H	62.5	41.5	47	42	19	18	51	29
OVERALL DIMENSIONS			SEAT DIMENSIONS			BACK DIMENSIONS																					
W	D	H	W	D	H	W	H																				
62.5	41.5	47	42	19	18	51	29																				
		<b>R27818</b>	Base Price:	<b>\$3311</b>																							
		<b>R27818S</b>	Base Price:	<b>\$4300</b>																							
			Back upcharge:	<b>+0</b>	<b>+\$72</b>	<b>+\$129</b>	<b>+\$212</b>	<b>+\$329</b>	<b>+\$378</b>	<b>+\$480</b>	<b>+\$639</b>	<b>+\$759</b>	<b>+\$889</b>	<b>+\$1161</b>	<b>+\$1447</b>												
			Seat upcharge:	<b>+0</b>	<b>+\$64</b>	<b>+\$114</b>	<b>+\$188</b>	<b>+\$292</b>	<b>+\$336</b>	<b>+\$426</b>	<b>+\$568</b>	<b>+\$674</b>	<b>+\$790</b>	<b>+\$1032</b>	<b>+\$1286</b>												
<p><b>R27818</b></p> <p><b>Outside Curve Two Seater - Standard Back</b> COM Yardage: Back: 2.25; Seat: 2 Freight class: 4.25 Product weight: 93   107 shelf model Cubic feet per carton: 42.75   63.5 shelf model</p>		<p><b>R27818S</b></p> <p>For power/USB unit, see electrical placement chart. Includes ganging hardware (2 sides). Add \$93 for (SSS), \$104 for (SBS) Add \$1260 for 72 lbs. (CW), (C6) Add \$174 for (SP) or \$871 for (BS) Add \$40 for (TP) Add \$252 for (MB)</p>	<p>Shelf: 52W 10D 1H</p> <table border="1"> <thead> <tr> <th colspan="3">OVERALL DIMENSIONS</th> <th colspan="3">SEAT DIMENSIONS</th> <th colspan="2">BACK DIMENSIONS</th> </tr> <tr> <th>W</th> <th>D</th> <th>H</th> <th>W</th> <th>D</th> <th>H</th> <th>W</th> <th>H</th> </tr> </thead> <tbody> <tr> <td>50</td> <td>30</td> <td>32</td> <td>50</td> <td>19</td> <td>18</td> <td>36</td> <td>14</td> </tr> </tbody> </table> <p><b>RTA 00</b> 1 per carton</p>	OVERALL DIMENSIONS			SEAT DIMENSIONS			BACK DIMENSIONS		W	D	H	W	D	H	W	H	50	30	32	50	19	18	36	14
OVERALL DIMENSIONS			SEAT DIMENSIONS			BACK DIMENSIONS																					
W	D	H	W	D	H	W	H																				
50	30	32	50	19	18	36	14																				
		<b>R27818L</b>	Base Price:	<b>\$3679</b>																							
		<b>R27818R</b>	Base Price:	<b>\$3679</b>																							
			Back/Arm upcharge:	<b>+0</b>	<b>+\$104</b>	<b>+\$186</b>	<b>+\$306</b>	<b>+\$475</b>	<b>+\$546</b>	<b>+\$693</b>	<b>+\$923</b>	<b>+\$1096</b>	<b>+\$1284</b>	<b>+\$1677</b>	<b>+\$2090</b>												
			Seat upcharge:	<b>+0</b>	<b>+\$64</b>	<b>+\$114</b>	<b>+\$188</b>	<b>+\$292</b>	<b>+\$336</b>	<b>+\$426</b>	<b>+\$568</b>	<b>+\$674</b>	<b>+\$790</b>	<b>+\$1032</b>	<b>+\$1286</b>												
<p><b>R27818L</b></p> <p><b>Outside Curve Two Seater - Standard Back</b> COM Yardage: Back: 3.25; Seat: 2 Freight class: 5.25 Product weight: 102 Cubic feet per carton: 43.5</p>		<p><b>R27818R</b></p> <p>For power/USB unit, see electrical placement chart. Includes ganging hardware (1 side). Add \$93 for (SSS), \$130 for (SBS) Add \$1260 for 72 lbs. (CW), (C6) Add \$174 for (SP) or \$871 for (BS) Add \$40 for (TP) Add \$252 for (MB)</p>	<table border="1"> <thead> <tr> <th colspan="3">OVERALL DIMENSIONS</th> <th colspan="3">SEAT DIMENSIONS</th> <th colspan="2">BACK DIMENSIONS</th> </tr> <tr> <th>W</th> <th>D</th> <th>H</th> <th>W</th> <th>D</th> <th>H</th> <th>W</th> <th>H</th> </tr> </thead> <tbody> <tr> <td>53.5</td> <td>30</td> <td>32</td> <td>50</td> <td>19</td> <td>18</td> <td>36</td> <td>14</td> </tr> </tbody> </table> <p><b>RTA 00</b> 1 per carton</p>	OVERALL DIMENSIONS			SEAT DIMENSIONS			BACK DIMENSIONS		W	D	H	W	D	H	W	H	53.5	30	32	50	19	18	36	14
OVERALL DIMENSIONS			SEAT DIMENSIONS			BACK DIMENSIONS																					
W	D	H	W	D	H	W	H																				
53.5	30	32	50	19	18	36	14																				

DESCRIPTION	MODEL#/ FEATURES	STANDARD TEXTILE GRADES																																																																																			
		1/COM	2	3	4	5	6	7	8	9	10	11	12																																																																								
 <p><b>R27818SL</b></p> <p><b>Outside Curve Two Seater - Standard Back</b> COM Yardage: Back 3.25; Seat: 2 Freight class: 5.25 Product weight: 116 Cubic feet per carton: 65</p>	<p><b>R27818SL</b> Base Price: <b>\$4668</b> <b>R27818SR</b> Base Price: <b>\$4668</b></p> <p>Back/Arm upcharge: <b>+0</b> Seat upcharge: <b>+0</b></p> <p>Shelf: 52W 10D 1H</p> <p>For power/USB unit, see electrical placement chart. Includes ganging hardware (1 side). Add \$93 for (SSS), \$130 for (SBS) Add \$1260 for 72 lbs. (CW), (C6) Add \$174 for (SP) or \$871 for (BS) Add \$40 for (TP) Add \$252 for (MB)</p>	<table border="1"> <thead> <tr> <th colspan="3">OVERALL DIMENSIONS</th> <th colspan="3">SEAT DIMENSIONS</th> <th colspan="2">BACK DIMENSIONS</th> </tr> <tr> <th>W</th> <th>D</th> <th>H</th> <th>W</th> <th>D</th> <th>H</th> <th>W</th> <th>H</th> </tr> </thead> <tbody> <tr> <td>53.5</td> <td>40.5</td> <td>32</td> <td>50</td> <td>19</td> <td>18</td> <td>36</td> <td>14</td> </tr> </tbody> </table>			OVERALL DIMENSIONS			SEAT DIMENSIONS			BACK DIMENSIONS		W	D	H	W	D	H	W	H	53.5	40.5	32	50	19	18	36	14	<table border="1"> <thead> <tr> <th colspan="3">OVERALL DIMENSIONS</th> <th colspan="3">SEAT DIMENSIONS</th> <th colspan="2">BACK DIMENSIONS</th> </tr> <tr> <th>W</th> <th>D</th> <th>H</th> <th>W</th> <th>D</th> <th>H</th> <th>W</th> <th>H</th> </tr> </thead> <tbody> <tr> <td>53.5</td> <td>40.5</td> <td>32</td> <td>50</td> <td>19</td> <td>18</td> <td>36</td> <td>14</td> </tr> </tbody> </table>			OVERALL DIMENSIONS			SEAT DIMENSIONS			BACK DIMENSIONS		W	D	H	W	D	H	W	H	53.5	40.5	32	50	19	18	36	14	<table border="1"> <thead> <tr> <th colspan="3">OVERALL DIMENSIONS</th> <th colspan="3">SEAT DIMENSIONS</th> <th colspan="2">BACK DIMENSIONS</th> </tr> <tr> <th>W</th> <th>D</th> <th>H</th> <th>W</th> <th>D</th> <th>H</th> <th>W</th> <th>H</th> </tr> </thead> <tbody> <tr> <td>53.5</td> <td>40.5</td> <td>32</td> <td>50</td> <td>19</td> <td>18</td> <td>36</td> <td>14</td> </tr> </tbody> </table>			OVERALL DIMENSIONS			SEAT DIMENSIONS			BACK DIMENSIONS		W	D	H	W	D	H	W	H	53.5	40.5	32	50	19	18	36	14	<p><b>RTA 00</b> 1 per carton</p>		
		OVERALL DIMENSIONS			SEAT DIMENSIONS			BACK DIMENSIONS																																																																													
W	D	H	W	D	H	W	H																																																																														
53.5	40.5	32	50	19	18	36	14																																																																														
OVERALL DIMENSIONS			SEAT DIMENSIONS			BACK DIMENSIONS																																																																															
W	D	H	W	D	H	W	H																																																																														
53.5	40.5	32	50	19	18	36	14																																																																														
OVERALL DIMENSIONS			SEAT DIMENSIONS			BACK DIMENSIONS																																																																															
W	D	H	W	D	H	W	H																																																																														
53.5	40.5	32	50	19	18	36	14																																																																														
 <p><b>R27819</b></p> <p><b>Outside Curve Two Seater - High Back</b> COM Yardage: Back 3.25; Seat: 2 Freight class: 300 Product weight: 101   115 shelf model Cubic feet per carton: 53.75   79.75 shelf model</p>	<p><b>R27819</b> Base Price: <b>\$3942</b> <b>R27819S</b> Base Price: <b>\$4932</b></p> <p>Back upcharge: <b>+0</b> Seat upcharge: <b>+0</b></p> <p>Shelf: 52W 10D 1H</p> <p>For power/USB unit, see electrical placement chart. Includes ganging hardware (2 sides). Add \$93 for (SSS), \$135 for (SBS) Add \$1260 for 72 lbs. (CW), (C6) Add \$174 for (SP) or \$871 for (BS) Add \$40 for (TP) Add \$252 for (MB)</p>	<table border="1"> <thead> <tr> <th colspan="3">OVERALL DIMENSIONS</th> <th colspan="3">SEAT DIMENSIONS</th> <th colspan="2">BACK DIMENSIONS</th> </tr> <tr> <th>W</th> <th>D</th> <th>H</th> <th>W</th> <th>D</th> <th>H</th> <th>W</th> <th>H</th> </tr> </thead> <tbody> <tr> <td>50</td> <td>30.5</td> <td>41.5</td> <td>50</td> <td>19</td> <td>18</td> <td>32</td> <td>23.5</td> </tr> </tbody> </table>			OVERALL DIMENSIONS			SEAT DIMENSIONS			BACK DIMENSIONS		W	D	H	W	D	H	W	H	50	30.5	41.5	50	19	18	32	23.5	<table border="1"> <thead> <tr> <th colspan="3">OVERALL DIMENSIONS</th> <th colspan="3">SEAT DIMENSIONS</th> <th colspan="2">BACK DIMENSIONS</th> </tr> <tr> <th>W</th> <th>D</th> <th>H</th> <th>W</th> <th>D</th> <th>H</th> <th>W</th> <th>H</th> </tr> </thead> <tbody> <tr> <td>50</td> <td>30.5</td> <td>41.5</td> <td>50</td> <td>19</td> <td>18</td> <td>32</td> <td>23.5</td> </tr> </tbody> </table>			OVERALL DIMENSIONS			SEAT DIMENSIONS			BACK DIMENSIONS		W	D	H	W	D	H	W	H	50	30.5	41.5	50	19	18	32	23.5	<table border="1"> <thead> <tr> <th colspan="3">OVERALL DIMENSIONS</th> <th colspan="3">SEAT DIMENSIONS</th> <th colspan="2">BACK DIMENSIONS</th> </tr> <tr> <th>W</th> <th>D</th> <th>H</th> <th>W</th> <th>D</th> <th>H</th> <th>W</th> <th>H</th> </tr> </thead> <tbody> <tr> <td>50</td> <td>30.5</td> <td>41.5</td> <td>50</td> <td>19</td> <td>18</td> <td>32</td> <td>23.5</td> </tr> </tbody> </table>			OVERALL DIMENSIONS			SEAT DIMENSIONS			BACK DIMENSIONS		W	D	H	W	D	H	W	H	50	30.5	41.5	50	19	18	32	23.5	<p><b>RTA 00</b> 1 per carton</p>		
		OVERALL DIMENSIONS			SEAT DIMENSIONS			BACK DIMENSIONS																																																																													
W	D	H	W	D	H	W	H																																																																														
50	30.5	41.5	50	19	18	32	23.5																																																																														
OVERALL DIMENSIONS			SEAT DIMENSIONS			BACK DIMENSIONS																																																																															
W	D	H	W	D	H	W	H																																																																														
50	30.5	41.5	50	19	18	32	23.5																																																																														
OVERALL DIMENSIONS			SEAT DIMENSIONS			BACK DIMENSIONS																																																																															
W	D	H	W	D	H	W	H																																																																														
50	30.5	41.5	50	19	18	32	23.5																																																																														
 <p><b>R27819L</b></p> <p><b>Outside Curve Two Seater - High Back</b> COM Yardage: Back 4.25; Seat: 2 Freight class: 300 Product weight: 110 Cubic feet per carton: 55.5</p>	<p><b>R27819L</b> Base Price: <b>\$4311</b> <b>R27819R</b> Base Price: <b>\$4311</b></p> <p>Back/Arm upcharge: <b>+0</b> Seat upcharge: <b>+0</b></p> <p>Shelf: 52W 10D 1H</p> <p>For power/USB unit, see electrical placement chart. Includes ganging hardware (1 side). Add \$93 for (SSS), \$161 for (SBS) Add \$1260 for 72 lbs. (CW), (C6) Add \$174 for (SP) or \$871 for (BS) Add \$40 for (TP) Add \$252 for (MB)</p>	<table border="1"> <thead> <tr> <th colspan="3">OVERALL DIMENSIONS</th> <th colspan="3">SEAT DIMENSIONS</th> <th colspan="2">BACK DIMENSIONS</th> </tr> <tr> <th>W</th> <th>D</th> <th>H</th> <th>W</th> <th>D</th> <th>H</th> <th>W</th> <th>H</th> </tr> </thead> <tbody> <tr> <td>53.5</td> <td>30.5</td> <td>41.5</td> <td>50</td> <td>19</td> <td>18</td> <td>32</td> <td>23.5</td> </tr> </tbody> </table>			OVERALL DIMENSIONS			SEAT DIMENSIONS			BACK DIMENSIONS		W	D	H	W	D	H	W	H	53.5	30.5	41.5	50	19	18	32	23.5	<table border="1"> <thead> <tr> <th colspan="3">OVERALL DIMENSIONS</th> <th colspan="3">SEAT DIMENSIONS</th> <th colspan="2">BACK DIMENSIONS</th> </tr> <tr> <th>W</th> <th>D</th> <th>H</th> <th>W</th> <th>D</th> <th>H</th> <th>W</th> <th>H</th> </tr> </thead> <tbody> <tr> <td>53.5</td> <td>30.5</td> <td>41.5</td> <td>50</td> <td>19</td> <td>18</td> <td>32</td> <td>23.5</td> </tr> </tbody> </table>			OVERALL DIMENSIONS			SEAT DIMENSIONS			BACK DIMENSIONS		W	D	H	W	D	H	W	H	53.5	30.5	41.5	50	19	18	32	23.5	<table border="1"> <thead> <tr> <th colspan="3">OVERALL DIMENSIONS</th> <th colspan="3">SEAT DIMENSIONS</th> <th colspan="2">BACK DIMENSIONS</th> </tr> <tr> <th>W</th> <th>D</th> <th>H</th> <th>W</th> <th>D</th> <th>H</th> <th>W</th> <th>H</th> </tr> </thead> <tbody> <tr> <td>53.5</td> <td>30.5</td> <td>41.5</td> <td>50</td> <td>19</td> <td>18</td> <td>32</td> <td>23.5</td> </tr> </tbody> </table>			OVERALL DIMENSIONS			SEAT DIMENSIONS			BACK DIMENSIONS		W	D	H	W	D	H	W	H	53.5	30.5	41.5	50	19	18	32	23.5	<p><b>RTA 00</b> 1 per carton</p>		
		OVERALL DIMENSIONS			SEAT DIMENSIONS			BACK DIMENSIONS																																																																													
W	D	H	W	D	H	W	H																																																																														
53.5	30.5	41.5	50	19	18	32	23.5																																																																														
OVERALL DIMENSIONS			SEAT DIMENSIONS			BACK DIMENSIONS																																																																															
W	D	H	W	D	H	W	H																																																																														
53.5	30.5	41.5	50	19	18	32	23.5																																																																														
OVERALL DIMENSIONS			SEAT DIMENSIONS			BACK DIMENSIONS																																																																															
W	D	H	W	D	H	W	H																																																																														
53.5	30.5	41.5	50	19	18	32	23.5																																																																														
 <p><b>R27819SL</b></p> <p><b>Outside Curve Two Seater - High Back</b> COM Yardage: Back 4.25; Seat: 2 Freight class: 300 Product weight: 124.5 Cubic feet per carton: 82.5</p>	<p><b>R27819SL</b> Base Price: <b>\$5300</b> <b>R27819SR</b> Base Price: <b>\$5300</b></p> <p>Back/Arm upcharge: <b>+0</b> Seat upcharge: <b>+0</b></p> <p>Shelf: 52W 10D 1H</p> <p>For power/USB unit, see electrical placement chart. Includes ganging hardware (1 side). Add \$93 for (SSS), \$161 for (SBS) Add \$1260 for 72 lbs. (CW), (C6) Add \$174 for (SP) or \$871 for (BS) Add \$40 for (TP) Add \$252 for (MB)</p>	<table border="1"> <thead> <tr> <th colspan="3">OVERALL DIMENSIONS</th> <th colspan="3">SEAT DIMENSIONS</th> <th colspan="2">BACK DIMENSIONS</th> </tr> <tr> <th>W</th> <th>D</th> <th>H</th> <th>W</th> <th>D</th> <th>H</th> <th>W</th> <th>H</th> </tr> </thead> <tbody> <tr> <td>53.5</td> <td>41</td> <td>41.5</td> <td>50</td> <td>19</td> <td>18</td> <td>32</td> <td>23.5</td> </tr> </tbody> </table>			OVERALL DIMENSIONS			SEAT DIMENSIONS			BACK DIMENSIONS		W	D	H	W	D	H	W	H	53.5	41	41.5	50	19	18	32	23.5	<table border="1"> <thead> <tr> <th colspan="3">OVERALL DIMENSIONS</th> <th colspan="3">SEAT DIMENSIONS</th> <th colspan="2">BACK DIMENSIONS</th> </tr> <tr> <th>W</th> <th>D</th> <th>H</th> <th>W</th> <th>D</th> <th>H</th> <th>W</th> <th>H</th> </tr> </thead> <tbody> <tr> <td>53.5</td> <td>41</td> <td>41.5</td> <td>50</td> <td>19</td> <td>18</td> <td>32</td> <td>23.5</td> </tr> </tbody> </table>			OVERALL DIMENSIONS			SEAT DIMENSIONS			BACK DIMENSIONS		W	D	H	W	D	H	W	H	53.5	41	41.5	50	19	18	32	23.5	<table border="1"> <thead> <tr> <th colspan="3">OVERALL DIMENSIONS</th> <th colspan="3">SEAT DIMENSIONS</th> <th colspan="2">BACK DIMENSIONS</th> </tr> <tr> <th>W</th> <th>D</th> <th>H</th> <th>W</th> <th>D</th> <th>H</th> <th>W</th> <th>H</th> </tr> </thead> <tbody> <tr> <td>53.5</td> <td>41</td> <td>41.5</td> <td>50</td> <td>19</td> <td>18</td> <td>32</td> <td>23.5</td> </tr> </tbody> </table>			OVERALL DIMENSIONS			SEAT DIMENSIONS			BACK DIMENSIONS		W	D	H	W	D	H	W	H	53.5	41	41.5	50	19	18	32	23.5	<p><b>RTA 00</b> 1 per carton</p>		
		OVERALL DIMENSIONS			SEAT DIMENSIONS			BACK DIMENSIONS																																																																													
W	D	H	W	D	H	W	H																																																																														
53.5	41	41.5	50	19	18	32	23.5																																																																														
OVERALL DIMENSIONS			SEAT DIMENSIONS			BACK DIMENSIONS																																																																															
W	D	H	W	D	H	W	H																																																																														
53.5	41	41.5	50	19	18	32	23.5																																																																														
OVERALL DIMENSIONS			SEAT DIMENSIONS			BACK DIMENSIONS																																																																															
W	D	H	W	D	H	W	H																																																																														
53.5	41	41.5	50	19	18	32	23.5																																																																														

DESCRIPTION		MODEL#/ FEATURES		STANDARD TEXTILE GRADES												
				1/COM	2	3	4	5	6	7	8	9	10	11	12	
	<p><b>R27820</b></p> <p><b>Outside Curve Two Seater - Extended Back</b> COM Yardage: Back 4.25; Seat: 2 Freight class: 300 Product weight: 109   120 shelf Cubic feet per carton: 61   90.5 shelf</p>	<p><b>R27820S</b></p> <p>For power/USB unit, see electrical placement chart. Includes ganging hardware (2 sides). Add \$93 for (SSS), \$144 for (SBS) Add \$1260 for 72 lbs. (CW), (C6) Add \$174 for (SP) or \$871 for (BS) Add \$40 for (TP) Add \$252 for (MB)</p>	<p>Base Price: <b>\$4342</b></p> <p>Base Price: <b>\$5250</b></p> <p>Back upcharge: <b>+0</b></p> <p>Seat upcharge: <b>+0</b></p>													
				Shelf: 52W 10D 1H												
				OVERALL DIMENSIONS			SEAT DIMENSIONS			BACK DIMENSIONS						
				W	D	H	W	D	H	W	H					
				50	31	47	50	19	18	28	29					
				RTA 00		1 per carton										
	<p><b>R27820L</b></p> <p><b>Outside Curve Two Seater - Extended Back</b> COM Yardage: Back 5.25; Seat: 2 Freight class: 300 Product weight: 113 Cubic feet per carton: 62.25</p>	<p><b>R27820R</b></p> <p>For power/USB unit, see electrical placement chart. Includes ganging hardware (1 side). Add \$93 for (SSS), \$170 for (SBS) Add \$1260 for 72 lbs. (CW), (C6) Add \$174 for (SP) or \$871 for (BS) Add \$40 for (TP) Add \$252 for (MB)</p>	<p>Base Price: <b>\$4710</b></p> <p>Base Price: <b>\$4710</b></p> <p>Back/Arm upcharge: <b>+0</b></p> <p>Seat upcharge: <b>+0</b></p>													
				Shelf: 52W 10D 1H												
				OVERALL DIMENSIONS			SEAT DIMENSIONS			BACK DIMENSIONS						
				W	D	H	W	D	H	W	H					
				53.5	31	47	50	19	18	28	29					
				RTA 00		1 per carton										
	<p><b>R27820SL</b></p> <p><b>Outside Curve Two Seater - Extended Back</b> COM Yardage: Back 5.25; Seat: 2 Freight class: 300 Product weight: 113   130 shelf Cubic feet per carton: 62.25   92.75 shelf</p>	<p><b>R27820SR</b></p> <p>For power/USB unit, see electrical placement chart. Includes ganging hardware (1 side). Add \$93 for (SSS), \$170 for (SBS) Add \$1260 for 72 lbs. (CW), (C6) Add \$174 for (SP) or \$871 for (BS) Add \$40 for (TP) Add \$252 for (MB)</p>	<p>Base Price: <b>\$5620</b></p> <p>Base Price: <b>\$5620</b></p> <p>Back/Arm upcharge: <b>+0</b></p> <p>Seat upcharge: <b>+0</b></p>													
				Shelf: 52W 10D 1H												
				OVERALL DIMENSIONS			SEAT DIMENSIONS			BACK DIMENSIONS						
				W	D	H	W	D	H	W	H					
				53.5	41.5	47	50	19	18	28	29					
				RTA 00		1 per carton										
	<p><b>R27821</b></p> <p><b>90 Corner - Standard Back</b> COM Yardage: Back 4; Seat: 2 Freight class: 250 Product weight: 105   137 shelf Cubic feet per carton: 35.5   63 shelf</p>	<p><b>R27821S</b></p> <p>No power/USB unit. Includes ganging hardware (2 sides). Add \$67 for (SSS), \$129 for (SBS) Add \$1260 for 72 lbs. (CW), (C6) Add \$174 for (SP) or \$871 for (BS) Add \$40 for (TP) Add \$252 for (MB)</p>	<p>Base Price: <b>\$4379</b></p> <p>Base Price: <b>\$5766</b></p> <p>Back upcharge: <b>+0</b></p> <p>Seat upcharge: <b>+0</b></p>													
				Shelf: 52W 10D 1H												
				OVERALL DIMENSIONS			SEAT DIMENSIONS			BACK DIMENSIONS						
				W	D	H	W	D	H	W	H					
				37.5	37.5	32	24	19	18	24	14					
				RTA 00		1 per carton										



DESCRIPTION	MODEL#/ FEATURES	STANDARD TEXTILE GRADES												
		1/COM	2	3	4	5	6	7	8	9	10	11	12	
 <p><b>R27822</b></p> <p><b>90 Corner - High Back</b> COM Yardage: Back 5.75; Seat: 2 Freight class: 250 Product weight: 119   154 shelf Cubic feet per carton: 44.5   79.24 shelf</p>	<p><b>R27822S</b></p> <p>No power/USB unit. Includes ganging hardware (2 sides). Add \$67 for (SSS), \$172 for (SBS) Add \$1260 for 72 lbs. (CW), (C6) Add \$174 for (SP) or \$871 for (BS) Add \$40 for (TP) Add \$252 for (MB)</p>	Base Price:	\$5215											
		Base Price:	\$6600											
		Back upcharge:	+0	+\$184	+\$328	+\$541	+\$840	+\$966	+\$1225	+\$1633	+\$1938	+\$2272	+\$2967	+\$3698
		Seat upcharge:	+0	+\$64	+\$114	+\$188	+\$292	+\$336	+\$426	+\$568	+\$674	+\$790	+\$1032	+\$1286
		Shelf: 52W 10D 1H												
		OVERALL DIMENSIONS			SEAT DIMENSIONS			BACK DIMENSIONS						
		W	D	H	W	D	H	W	H					
		38.5	38.5	41.5	24	19	18	24	23.5					
		RTA 00		1 per carton										
 <p><b>R27823</b></p> <p><b>90 Corner - Extended Back</b> COM Yardage: Back 6.25; Seat: 2 Freight class: 250 Product weight: 128   160 shelf Cubic feet per carton: 50.5   90 shelf</p>	<p><b>R27823S</b></p> <p>No power/USB unit. Includes ganging hardware (2 sides). Add \$67 for (SSS), \$179 for (SBS) Add \$1260 for 36 lbs. (CW), (C6) Add \$174 for (SP) or \$871 for (BS) Add \$40 for (TP) Add \$252 for (MB)</p>	Base Price:	\$5735											
		Base Price:	\$7122											
		Back upcharge:	+0	+\$200	+\$357	+\$588	+\$913	+\$1050	+\$1332	+\$1775	+\$2107	+\$2469	+\$3225	+\$2733
		Seat upcharge:	+0	+\$64	+\$114	+\$188	+\$292	+\$336	+\$426	+\$568	+\$674	+\$790	+\$1032	+\$1286
		Shelf: 52W 10D 1H												
		OVERALL DIMENSIONS			SEAT DIMENSIONS			BACK DIMENSIONS						
		W	D	H	W	D	H	W	H					
		39	39	47	24	19	18	24	29					
		RTA 00		1 per carton										
 <p><b>R27824</b></p> <p><b>120 Corner - Standard Back</b> COM Yardage: Back 4; Seat: 2 Freight class: 250 Product weight: 109   138 shelf Cubic feet per carton: 48.25   68.5 shelf</p>	<p><b>R27824S</b></p> <p>No power/USB unit. Includes ganging hardware (2 sides). Add \$89 for (SSS), \$126 for (SBS) Add \$1260 for 36 lbs. (CW), (C6) Add \$216 for (SP) or \$964 for (BS) Add \$40 for (TP) Add \$252 for (MB)</p>	Base Price:	\$4533											
		Base Price:	\$5922											
		Back upcharge:	+0	+\$128	+\$228	+\$376	+\$584	+\$672	+\$852	+\$1136	+\$1348	+\$1580	+\$2064	+\$2572
		Seat upcharge:	+0	+\$64	+\$114	+\$188	+\$292	+\$336	+\$426	+\$568	+\$674	+\$790	+\$1032	+\$1286
		Shelf: 52W 10D 1H												
		OVERALL DIMENSIONS			SEAT DIMENSIONS			BACK DIMENSIONS						
		W	D	H	W	D	H	W	H					
		52.5	30	32	52	19	18	52	14					
		RTA 00		1 per carton										
 <p><b>R27825</b></p> <p><b>120 Corner - High Back</b> COM Yardage: Back 5.75; Seat: 2 Freight class: 300 Product weight: 118   144 shelf Cubic feet per carton: 60.5   86 shelf</p>	<p><b>R27825S</b></p> <p>No power/USB unit. Includes ganging hardware (2 sides). Add \$89 for (SSS), \$164 for (SBS) Add \$1260 for 36 lbs. (CW), (C6) Add \$216 for (SP) or \$964 for (BS) Add \$40 for (TP) Add \$252 for (MB)</p>	Base Price:	\$5304											
		Base Price:	\$6693											
		Back upcharge:	+0	+\$184	+\$328	+\$541	+\$840	+\$966	+\$1225	+\$1633	+\$1938	+\$2272	+\$2967	+\$3698
		Seat upcharge:	+0	+\$64	+\$114	+\$188	+\$292	+\$336	+\$426	+\$568	+\$674	+\$790	+\$1032	+\$1286
		Shelf: 52W 10D 1H												
		OVERALL DIMENSIONS			SEAT DIMENSIONS			BACK DIMENSIONS						
		W	D	H	W	D	H	W	H					
		53.5	30.5	41.5	41	21	18	51	23.5					
		RTA 00		1 per carton										

DESCRIPTION MODEL#/ FEATURES STANDARD TEXTILE GRADES



R27826

R27826S

**120 Corner - Extended Back**  
COM Yardage: Back 6.25; Seat: 2  
Freight class: 300  
Product weight: 123 | 144 shelf  
Cubic feet per carton: 68.75 | 97.75 shelf

No power/USB unit.  
Includes ganging hardware (2 sides).  
Add \$89 for (SSS), \$175 for (SBS)  
Add \$1260 for 36 lbs. (CW), (C6)  
Add \$216 for (SP) or \$964 for (BS)  
Add \$40 for (TP)  
Add \$252 for (MB)

1/COM	2	3	4	5	6	7	8	9	10	11	12		
<b>R27826</b>	Base Price: <b>\$5755</b>												
<b>R27826S</b>	Base Price: <b>\$7141</b>												
	Back upcharge:	<b>+0</b>	<b>+\$200</b>	<b>+\$357</b>	<b>+\$588</b>	<b>+\$913</b>	<b>+\$1050</b>	<b>+\$1332</b>	<b>+\$1775</b>	<b>+\$2107</b>	<b>+\$2469</b>	<b>+\$3225</b>	<b>+\$4019</b>
	Seat upcharge:	<b>+0</b>	<b>+\$64</b>	<b>+\$114</b>	<b>+\$188</b>	<b>+\$292</b>	<b>+\$336</b>	<b>+\$426</b>	<b>+\$568</b>	<b>+\$674</b>	<b>+\$790</b>	<b>+\$1032</b>	<b>+\$1286</b>
Shelf: 52W 10D 1H													

OVERALL DIMENSIONS			SEAT DIMENSIONS			BACK DIMENSIONS	
W	D	H	W	D	H	W	H
54	31.5	47	41	21	18	51	29
<b>RTA 00</b>			1 per carton				



**Loop Arm**  
COM Yardage: N/A  
Freight class: 92.5  
Product weight (lbs.): 6.3  
Cubic feet per carton: 0.6

Attachment hardware included.  
Polished Aluminum arms sold separately (1 pc).  
Armpcap finish options: (NGT) Night, (FOG) Fog, (LAB) Latte

List price							
<b>R2770</b>	\$332						
OVERALL DIMENSIONS			SEAT DIMENSIONS			BACK DIMENSIONS	
W	D	H	W	D	H	W	H
2.5	14	19.5	-	-	-	-	-
<b>RTA 1</b>			FedEx  1 per carton				



**Loop Arm w/Armpcap**  
COM Yardage: N/A  
Freight class: 92.5  
Product weight (lbs.): 6.61  
Cubic feet per carton: 0.6

Attachment hardware included.  
Polished Aluminum arms sold separately (1 pc).  
Armpcap finish options: (NGT) Night, (FOG) Fog, (LAB) Latte

List price							
<b>R2771</b>	\$378						
OVERALL DIMENSIONS			SEAT DIMENSIONS			BACK DIMENSIONS	
W	D	H	W	D	H	W	H
2.5	14	19.5	-	-	-	-	-
<b>RTA 1</b>			FedEx  1 per carton				

# LOUNGE

## RIVER+ BENCHES

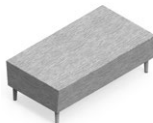

Two Seater Bench  
model R27832



Y Bench  
model R27842



42" Round Bench  
model R27845

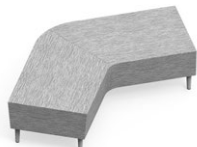

Inside Curve Boomerang Bench  
model R27840

### River+ Seating, Tables & Media Hearths

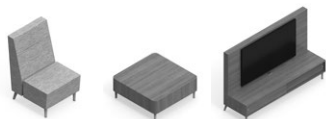

For River+ seating, please see page 360  
For River+ tables, please see page 384  
For River+ media hearths, please see page 388

### EXAMPLE RIVER+ BENCH ORDER CODE:

R27832	-CE90	-S6	-AS	-CH	-	-SP
Model number	Textile	Leg selection	Leg angle	Leg finish	Additional weight	Bottom selection

-	-	-F1	-W
Sealed Seams	Moisture barrier	Power/USB position	Power finish

Additional Options specify at end of order code.	SPECIFY CODE
Tamperproof fasteners Upcharges vary, see model.	TP
Moisture barrier Upcharges vary, see model.	MB

\*linking hardware is lowered to clear the staple strip.  
Units will only gang with other units with sealed bottom.  
\*\*cannot be combined with linking hardware or power units

### ELECTRICAL PLACEMENT

#### Straight benches

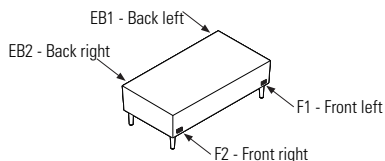

#### Y bench

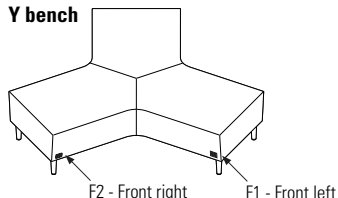

#### Curved benches

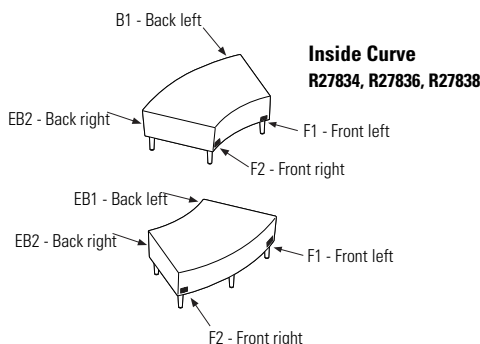

#### Boomerang benches

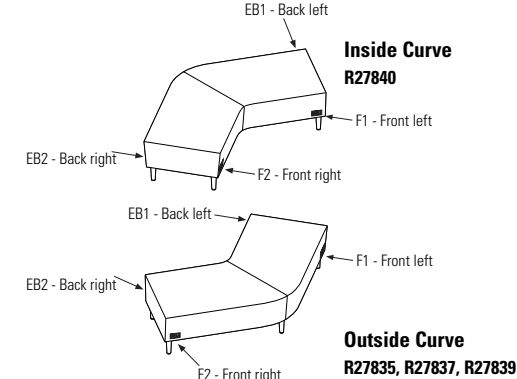

### STANDARD FEATURES

- A modular series that is composed of straight, and curved sections, as well as freestanding units.
- Linking units can be used together in any combination to create a wide variety of layouts. Ganging hardware is standard and is factory installed. Ganging hardware swivels out of the way when not in use.
- The standard, 6.5" tapered legs are made of welded steel.
- Legs are straight (vertical) as standard. Linking models are optionally available with angled back legs to match River+ seating units.
- Legs include Black nylon, non-marking, height adjustable glides.
- River+ is rated for an active weight up to 600 lbs. per seat and 24/7 use.
- For 24/7 use and/or heavy duty application use, Global's Heavy Duty warranty is applicable on models specified with performance textiles, rated for 150,000 double rubs.
- Check textile availability prior to specifying upholstery material. Leather not available on River+ series.
- All units are shipped fully assembled.

### OPTIONAL FEATURES

- Legs are available in 3" and 8" heights with no upcharge. All heights are available with fixed-to-floor option. Please specify. Add \$100. Fastening hardware not included.
- Steel bottom provides tamperproof protection (includes tamperproof screws). Specify (BS) - see each model for upcharge.\*\*
- Up to two power units are available on straight, Y, curved and boomerang benches.
- Each power unit includes one AC outlet and two USB-a, 10-watt charging ports.
- Power location options include front or back. See electrical placement diagrams. Electrical units must be factory installed. Add \$661 per unit.
- Power units are available in either Jet Black (J) or White (W) with 120", three-prong matching cords.
- To add sealed seams to your product, specify (SLS) - see each model for upcharge.
- To match leg angles with lounge seating, straight front and angled back 6.5" or 8" legs are available on straight, curved, corner, and boomerang units. Specify (SA). No upcharge.
- Products can be weighted to reduce the ease of movement. For additional weight options, specify (CW) - see each model for available additional weight and upcharge.
- The underside of the seat can be finished with PVC (vinyl) and sealed to prevent penetration of liquids. Specify (SP) - see each model for upcharge.\*

# RIVER+ BENCHES R

Please add option codes in the following order:

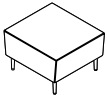
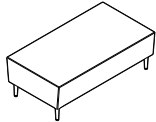
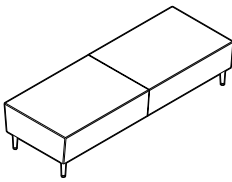
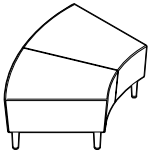
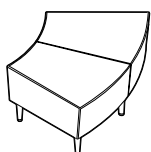

- Model number**  
R27831 to R27833 Straight benches  
R27834 to R27835 Curved benches  
R27836 to R27839 Corner benches  
R27840 to R27841 Boomerang benches  
R27842 Y bench  
R27843 to R27846 Round non-linking benches  
R27847 to R27850 Square non-linking benches
- Textile**  
Specify textile code.
- Leg selection**  
(S6) Standard seat height (17.5"), 6.5" leg w/ adjustable glides. No upcharge.  
(S3) Low seat (14"), 3" leg w/adjustable glides. No upcharge.  
(S8) High seat (19"), 8" leg w/adjustable glides. No upcharge.  
(F6) Standard seat height (17.5"), 6.5" leg, fixed to floor. Add \$100.  
(F3) Low seat (14"), 3" leg, fixed to floor. Add \$100.  
(F8) High seat (19"), 8" leg, fixed to floor. Add \$100.
- Leg angle**  
(AST) Straight legs. No upcharge.  
(SA) Straight front legs, angled back legs (available only for 6.5" and 8" high legs on straight, curved, corner and boomerang units). No upcharge.
- Leg finish**  
(CHM) Chrome (TBL) Black  
(TDW) Designer White (TFO) Fog  
(TFR) Frost (TIV) Cloud  
(TLA) Latte (TMO) Mocha  
(TNE) Nevada (TOA) Toast  
(TSH) Shadow (TSN) Sand  
(TTU) Tungsten
- Additional weight**  
(CW) Additional weight. Upcharges vary, see model.
- Bottom selection**  
(SSB) Standard bottom.  
(SP) Vinyl sealed bottom w/staple strip. Upcharges vary, see model.\*  
(BS) Steel bottom. Upcharges vary, see model.\*\*
- Sealed seams**  
(SLS) Sealed seams. Upcharges vary, see model.
- Moisture barrier**  
(MB) Upcharges vary, see model.
- Power/USB unit position** (straight, curved, boomerang and Y benches only, as shown below). Add \$661 per unit.  
(NP) No power (no upcharge)  
(F1) Front left  
(F2) Front right  
(EB1) Back left  
(EB2) Back right
- Power unit finish**  
(J) Jet Black  
(W) White
- Tamperproof fasteners**  
(TP) Upcharges vary, see model.

DESCRIPTION	FEATURES	MODEL#	STANDARD TEXTILE GRADES											
			1	2	3	4	5	6	7	8	9	10	11	12
 <p><b>Single Seater Bench</b> COM Yardage: 1.75 Freight class: 1.75 Product weight: 48 Cubic feet per carton: 10.5</p>	<p>For power/USB unit, see electrical placement chart.</p> <p>Includes ganging hardware (2 sides).</p> <p>Add \$69 for (SLS) Add \$100 for (F6, F3, or F8) Add \$632 for 36 lbs. (CW) Add \$80 for (SP) or \$367 for (BS) Add \$40 for (TP) Add \$127 for (MB)</p>	<p><b>R27831</b></p>	1392	1448	1492	1557	1648	1686	1765	1889	1982	2084	2295	2518
			<p><b>OVERALL DIMENSIONS</b></p> <p>W D H</p>			<p><b>SEAT DIMENSIONS</b></p> <p>W D H</p>			<p><b>BACK DIMENSIONS</b></p> <p>W H</p>					
			26	28.5	17.5	-	-	-	-	-	-	-	-	-
			<p><b>RTA 00</b> 1 per carton</p>											
 <p><b>Two Seater Bench</b> COM Yardage: 2.75 Freight class: 250 Product weight: 65 Cubic feet per carton: 20.5</p>	<p>For power/USB unit, see electrical placement chart.</p> <p>Includes ganging hardware (2 sides).</p> <p>Add \$84 for (SLS) Add \$100 for (F6, F3, or F8) Add \$1260 for 72 lbs. (CW) Add \$125 for (SP) or \$607 for (BS) Add \$40 for (TP) Add \$252 for (MB)</p>	<p><b>R27832</b></p>	2036	2124	2193	2295	2438	2498	2622	2817	2963	3123	3455	3805
			<p><b>OVERALL DIMENSIONS</b></p> <p>W D H</p>			<p><b>SEAT DIMENSIONS</b></p> <p>W D H</p>			<p><b>BACK DIMENSIONS</b></p> <p>W H</p>					
			52	28.5	17.5	-	-	-	-	-	-	-	-	-
			<p><b>RTA 00</b> 1 per carton</p>											
 <p><b>Three Seater Bench</b> COM Yardage: 4.5 Freight class: 4.5 Product weight: 103 Cubic feet per carton: 30.25</p>	<p>For power/USB unit, see electrical placement chart.</p> <p>Includes ganging hardware (2 sides).</p> <p>Add \$123 for (SLS) Add \$100 for (F6, F3, or F8) Add \$1260 for 72 lbs. (CW) Add \$174 for (SP) or \$773 for (BS) Add \$40 for (TP) Add \$375 for (MB)</p>	<p><b>R27833</b></p>	3202	3346	3459	3625	3859	3958	4161	4480	4719	4980	5524	6096
			<p><b>OVERALL DIMENSIONS</b></p> <p>W D H</p>			<p><b>SEAT DIMENSIONS</b></p> <p>W D H</p>			<p><b>BACK DIMENSIONS</b></p> <p>W H</p>					
			78	28.5	17.5	-	-	-	-	-	-	-	-	-
			<p><b>RTA 00</b> 1 per carton</p>											
 <p><b>Inside Curve Two Seater Bench</b> COM Yardage: 3 Freight class: 250 Product weight: 60 Cubic feet per carton: 22.75</p>	<p>For power/USB unit, see electrical placement chart.</p> <p>Includes ganging hardware (2 sides).</p> <p>Add \$75 for (SLS) Add \$100 for (F6, F3, or F8) Add \$1262 for 72 lbs. (CW) Add \$125 for (SP) or \$486 for (BS) Add \$49 for (TP) Add \$252 for (MB)</p>	<p><b>R27834</b></p>	2765	2861	2936	3047	3203	3269	3404	3617	3776	3950	4313	4694
			<p><b>OVERALL DIMENSIONS</b></p> <p>W D H</p>			<p><b>SEAT DIMENSIONS</b></p> <p>W D H</p>			<p><b>BACK DIMENSIONS</b></p> <p>W H</p>					
			50	30.5	17.5	-	-	-	-	-	-	-	-	-
			<p><b>RTA 00</b> 1 per carton</p>											
 <p><b>Outside Curve Two Seater Bench</b> COM Yardage: 3 Freight class: 250 Product weight: 60 Cubic feet per carton: 22.75</p>	<p>For power/USB unit, see electrical placement chart.</p> <p>Includes ganging hardware (2 sides).</p> <p>Add \$75 for (SLS) Add \$100 for (F6, F3, or F8) Add \$1263 for 72 lbs. (CW) Add \$125 for (SP) or \$486 for (BS) Add \$49 for (TP) Add \$252 for (MB)</p>	<p><b>R27835</b></p>	2765	2861	2936	3047	3203	3269	3404	3617	3776	3950	4313	4694
			<p><b>OVERALL DIMENSIONS</b></p> <p>W D H</p>			<p><b>SEAT DIMENSIONS</b></p> <p>W D H</p>			<p><b>BACK DIMENSIONS</b></p> <p>W H</p>					
			50	30.5	17.5	-	-	-	-	-	-	-	-	-
			<p><b>RTA 00</b> 1 per carton</p>											

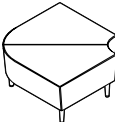
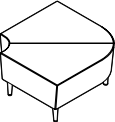
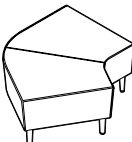
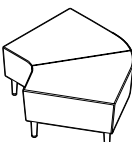
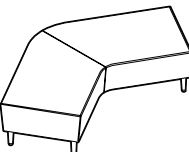
Options: (SLS) Sealed seams  
(F6, F3, F8) Floor mount legs  
(CW) Counterweight  
(SP) Vinyl sealed bottom  
(BS) Steel bottom  
(TP) Tamperproof  
(MB) Moisture barrier

DESCRIPTION	FEATURES	MODEL#	STANDARD TEXTILE GRADES													
			1	2	3	4	5	6	7	8	9	10	11	12		
 <p><b>90° Inside Curve Corner Bench</b> COM Yardage: 3.25 Freight class: 250 Product weight: 60 Cubic feet per carton: 17.25</p>	<p>For power/USB unit, see electrical placement chart.</p> <p>Includes ganging hardware (2 sides).</p> <p>Add \$75 for <b>(SLS)</b> Add \$100 for <b>(F6, F3, or F8)</b> Add \$632 for 36 lbs. <b>(CW)</b> Add \$145 for <b>(SP)</b> or \$565 for <b>(BS)</b> Add \$49 for <b>(TP)</b> Add \$252 for <b>(MB)</b></p>	<b>R27836</b>	2758	2862	2944	3064	3233	3304	3451	3681	3854	4042	4435	4848		
		<b>OVERALL DIMENSIONS</b>			<b>SEAT DIMENSIONS</b>			<b>BACK DIMENSIONS</b>								
		<b>W</b>	<b>D</b>	<b>H</b>	<b>W</b>	<b>D</b>	<b>H</b>	<b>W</b>	<b>H</b>							
		36.5	36.5	17.5	-	-	-	-	-							
			<b>RTA 00</b>	1 per carton												
 <p><b>90° Outside Curve Corner Bench</b> COM Yardage: 3.25 Freight class: 250 Product weight: 60 Cubic feet per carton: 17.25</p>	<p>For power/USB unit, see electrical placement chart.</p> <p>Includes ganging hardware (2 sides).</p> <p>Add \$75 for <b>(SLS)</b> Add \$100 for <b>(F6, F3, or F8)</b> Add \$633 for 36 lbs. <b>(CW)</b> Add \$145 for <b>(SP)</b> or \$565 for <b>(BS)</b> Add \$49 for <b>(TP)</b> Add \$252 for <b>(MB)</b></p>	<b>R27837</b>	2758	2862	2944	3064	3233	3304	3451	3681	3854	4042	4435	4848		
		<b>OVERALL DIMENSIONS</b>			<b>SEAT DIMENSIONS</b>			<b>BACK DIMENSIONS</b>								
		<b>W</b>	<b>D</b>	<b>H</b>	<b>W</b>	<b>D</b>	<b>H</b>	<b>W</b>	<b>H</b>							
		36.5	36.5	17.5	-	-	-	-	-							
			<b>RTA 00</b>	1 per carton												
 <p><b>120° Inside Curve Corner Bench</b> COM Yardage: 3.5 Freight class: 250 Product weight: 57 Cubic feet per carton: 26.75</p>	<p>For power/USB unit, see electrical placement chart.</p> <p>Includes ganging hardware (2 sides).</p> <p>Add \$79 for <b>(SLS)</b> Add \$100 for <b>(F6, F3, or F8)</b> Add \$634 for 36 lbs. <b>(CW)</b> Add \$138 for <b>(SP)</b> or \$621 for <b>(BS)</b> Add \$49 for <b>(TP)</b> Add \$252 for <b>(MB)</b></p>	<b>R27838</b>	2758	2870	2958	3087	3269	3346	3504	3752	3938	4141	4564	5009		
		<b>OVERALL DIMENSIONS</b>			<b>SEAT DIMENSIONS</b>			<b>BACK DIMENSIONS</b>								
		<b>W</b>	<b>D</b>	<b>H</b>	<b>W</b>	<b>D</b>	<b>H</b>	<b>W</b>	<b>H</b>							
		36.5	51.5	17.5	-	-	-	-	-							
			<b>RTA 00</b>	1 per carton												
 <p><b>120° Outside Curve Corner Bench</b> COM Yardage: 3.5 Freight class: 250 Product weight: 57 Cubic feet per carton: 26.75</p>	<p>For power/USB unit, see electrical placement chart.</p> <p>Includes ganging hardware (2 sides).</p> <p>Add \$79 for <b>(SLS)</b> Add \$100 for <b>(F6, F3, or F8)</b> Add \$636 for 36 lbs. <b>(CW)</b> Add \$138 for <b>(SP)</b> or \$621 for <b>(BS)</b> Add \$49 for <b>(TP)</b> Add \$252 for <b>(MB)</b></p>	<b>R27839</b>	2758	2870	2958	3087	3269	3346	3504	3752	3938	4141	4564	5009		
		<b>OVERALL DIMENSIONS</b>			<b>SEAT DIMENSIONS</b>			<b>BACK DIMENSIONS</b>								
		<b>W</b>	<b>D</b>	<b>H</b>	<b>W</b>	<b>D</b>	<b>H</b>	<b>W</b>	<b>H</b>							
		36.5	51.5	17.5	-	-	-	-	-							
			<b>RTA 00</b>	1 per carton												
 <p><b>Inside Curve Boomerang Bench</b> COM Yardage: 5.25 Freight class: 250 Product weight: 126 Cubic feet per carton: 47.75</p>	<p>For power/USB unit, see electrical placement chart.</p> <p>Includes ganging hardware (2 sides).</p> <p>Add \$117 for <b>(SLS)</b> Add \$100 for <b>(F6, F3, or F8)</b> Add \$1260 for 72 lbs. <b>(CW)</b> Add \$202 for <b>(SP)</b> or \$1092 for <b>(BS)</b> Add \$49 for <b>(TP)</b> Add \$375 for <b>(MB)</b></p>	<b>R27840</b>	4266	4434	4566	4760	5033	5148	5385	5757	6036	6340	6975	7642		
		<b>OVERALL DIMENSIONS</b>			<b>SEAT DIMENSIONS</b>			<b>BACK DIMENSIONS</b>								
		<b>W</b>	<b>D</b>	<b>H</b>	<b>W</b>	<b>D</b>	<b>H</b>	<b>W</b>	<b>H</b>							
		82	45	17.5	-	-	-	-	-							
			<b>RTA 00</b>	1 per carton												

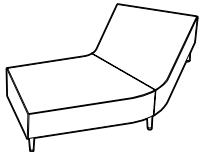
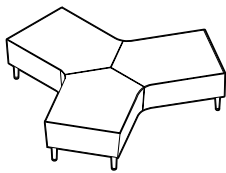
Options: **(SLS)** Sealed seams  
**(F6, F3, F8)** Floor mount legs  
**(CW)** Counterweight  
**(SP)** Vinyl sealed bottom  
**(BS)** Steel bottom  
**(TP)** Tamperproof  
**(MB)** Moisture barrier

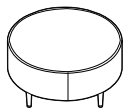
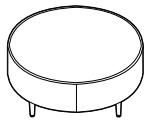
DESCRIPTION	FEATURES	MODEL#	STANDARD TEXTILE GRADES											
			1	2	3	4	5	6	7	8	9	10	11	12
 <p><b>Outside Curve Boomerang Bench</b> COM Yardage: 5.25 Freight class: 250 Product weight: 126 Cubic feet per carton: 47.75</p>	<p>For power/USB unit, see electrical placement chart.</p> <p>Includes ganging hardware (2 sides).</p> <p>Add \$117 for (SLS) Add \$100 for (F6, F3, or F8) Add \$1260 for 72 lbs. (CW) Add \$202 for (SP) or \$1092 for (BS) Add \$49 for (TP) Add \$375 for (MB)</p>	R27841	4266	4434	4566	4760	5033	5148	5385	5757	6036	6340	6975	7642
			<b>OVERALL DIMENSIONS</b>			<b>SEAT DIMENSIONS</b>			<b>BACK DIMENSIONS</b>					
			<b>W</b>	<b>D</b>	<b>H</b>	<b>W</b>	<b>D</b>	<b>H</b>	<b>W</b>	<b>H</b>				
			82	45	17.5	-	-	-	-	-				
			RTA 00			1 per carton								
 <p><b>Y Bench</b> COM Yardage: 8 Freight class: 250 Product weight: 203 Cubic feet per carton: 101.2</p>	<p>For power/USB unit, see electrical placement chart.</p> <p>Includes ganging hardware (2 sides).</p> <p>Add \$195 for (SLS) Add \$100 for (F6, F3, or F8) Add \$945 for 54 lbs. (CW) Add \$303 for (SP) or \$1354 for (BS) Add \$69 for (TP) Add \$501 for (MB)</p>	R27842	6870	7126	7326	7622	8038	8214	8574	9142	9566	10030	10998	12014
			<b>OVERALL DIMENSIONS</b>			<b>SEAT DIMENSIONS</b>			<b>BACK DIMENSIONS</b>					
			<b>W</b>	<b>D</b>	<b>H</b>	<b>W</b>	<b>D</b>	<b>H</b>	<b>W</b>	<b>H</b>				
			82	70	17.5	-	-	-	-	-				
			RTA 00			1 per carton								
 <p><b>18" Dia. Round Bench</b> COM Yardage: 1 Freight class: 150 Product weight: 25 Cubic feet per carton: 4.7</p>	<p>No power/USB unit.</p> <p>Freestanding unit only.</p> <p>Add \$46 for (SLS) Add \$100 for (F6, F3, or F8) Not available (CW) Add \$117 for (SP), (BS) not available Add \$40 for (TP) Add \$127 for (MB)</p>	R27843	853	885	910	947	999	1021	1066	1137	1190	1248	1369	1496
			<b>OVERALL DIMENSIONS</b>			<b>SEAT DIMENSIONS</b>			<b>BACK DIMENSIONS</b>					
			<b>W</b>	<b>D</b>	<b>H</b>	<b>W</b>	<b>D</b>	<b>H</b>	<b>W</b>	<b>H</b>				
			18	18	17.5	-	-	-	-	-				
			RTA 00			1 per carton								
 <p><b>36" Dia. Round Bench</b> COM Yardage: 3.25 Freight class: 250 Product weight: 50 Cubic feet per carton: 18.25</p>	<p>No power/USB unit.</p> <p>Freestanding unit only.</p> <p>Add \$69 for (SLS) Add \$100 for (F6, F3, or F8) Add \$632 for 36 lbs. (CW) Add \$182 for (SP) or \$621 for (BS) Add \$40 for (TP) Add \$127 for (MB)</p>	R27844	2043	2147	2229	2349	2518	2589	2736	2966	3139	3327	3720	4133
			<b>OVERALL DIMENSIONS</b>			<b>SEAT DIMENSIONS</b>			<b>BACK DIMENSIONS</b>					
			<b>W</b>	<b>D</b>	<b>H</b>	<b>W</b>	<b>D</b>	<b>H</b>	<b>W</b>	<b>H</b>				
			36	36	17.5	-	-	-	-	-				
			RTA 00			1 per carton								
 <p><b>42" Dia. Round Bench</b> COM Yardage: 3.5 Freight class: 250 Product weight: 55 Cubic feet per carton: 23</p>	<p>No power/USB unit.</p> <p>Freestanding unit only.</p> <p>Add \$75 for (SLS) Add \$100 for (F6, F3, or F8) Add \$1260 for 72 lbs. (CW) Add \$202 for (SP) or \$686 for (BS) Add \$40 for (TP) Add \$252 for (MB)</p>	R27845	2351	2463	2551	2680	2862	2939	3097	3345	3531	3734	4157	4602
			<b>OVERALL DIMENSIONS</b>			<b>SEAT DIMENSIONS</b>			<b>BACK DIMENSIONS</b>					
			<b>W</b>	<b>D</b>	<b>H</b>	<b>W</b>	<b>D</b>	<b>H</b>	<b>W</b>	<b>H</b>				
			42	42	17.5	-	-	-	-	-				
			RTA 00			1 per carton								

Options: (SLS) Sealed seams  
(F6, F3, F8) Floor mount legs  
(CW) Counterweight  
(SP) Vinyl sealed bottom  
(BS) Steel bottom  
(TP) Tamperproof  
(MB) Moisture barrier

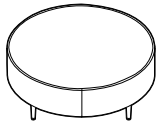
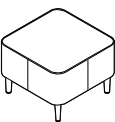
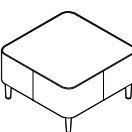
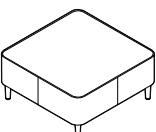
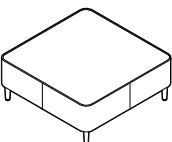
DESCRIPTION	FEATURES	MODEL#	STANDARD TEXTILE GRADES													
			1	2	3	4	5	6	7	8	9	10	11	12		
 <p><b>48" Dia. Round Bench</b> COM Yardage: 3.75 Freight class: 250 Product weight: 65 Cubic feet per carton: 30</p>	No power/USB unit.  Freestanding unit only.  Add \$84 for <b>(SLS)</b> Add \$100 for <b>(F6, F3, or F8)</b> Add \$1260 for 72 lbs. <b>(CW)</b> Add \$224 for <b>(SP)</b> or \$729 for <b>(BS)</b> Add \$40 for <b>(TP)</b> Add \$375 for <b>(MB)</b>	<b>R27846</b>	2651	2771	2865	3004	3199	3281	3450	3716	3915	4133	4586	5063		
		<b>OVERALL DIMENSIONS</b>			<b>SEAT DIMENSIONS</b>			<b>BACK DIMENSIONS</b>								
		<b>W</b>	<b>D</b>	<b>H</b>	<b>W</b>	<b>D</b>	<b>H</b>	<b>W</b>	<b>H</b>							
		48	48	17.5	-	-	-	-	-							
		<b>RTA 00</b>	1 per carton													
 <p><b>24" Square Bench</b> COM Yardage: 1.5 Freight class: 250 Product weight: 30 Cubic feet per carton: 8</p>	No power/USB unit.  Freestanding unit only.  Add \$60 for <b>(SLS)</b> Add \$100 for <b>(F6, F3, or F8)</b> Add \$632 for 36 lbs. <b>(CW)</b> Add \$125 for <b>(SP)</b> or \$281 for <b>(BS)</b> Add \$40 for <b>(TP)</b> Add \$127 for <b>(MB)</b>	<b>R27847</b>	1165	1213	1251	1306	1384	1417	1485	1591	1671	1758	1939	2130		
		<b>OVERALL DIMENSIONS</b>			<b>SEAT DIMENSIONS</b>			<b>BACK DIMENSIONS</b>								
		<b>W</b>	<b>D</b>	<b>H</b>	<b>W</b>	<b>D</b>	<b>H</b>	<b>W</b>	<b>H</b>							
		24	24	17.5	-	-	-	-	-							
		<b>RTA 00</b>	1 per carton													
 <p><b>30" Square Bench</b> COM Yardage: 2.75 Freight class: 250 Product weight: 40 Cubic feet per carton: 12.25</p>	No power/USB unit.  Freestanding unit only.  Add \$69 for <b>(SLS)</b> Add \$100 for <b>(F6, F3, or F8)</b> Add \$632 for 36 lbs. <b>(CW)</b> Add \$174 for <b>(SP)</b> or \$196 for <b>(BS)</b> Add \$40 for <b>(TP)</b> Add \$127 for <b>(MB)</b>	<b>R27848</b>	1538	1626	1695	1797	1940	2000	2124	2319	2465	2625	2957	3307		
		<b>OVERALL DIMENSIONS</b>			<b>SEAT DIMENSIONS</b>			<b>BACK DIMENSIONS</b>								
		<b>W</b>	<b>D</b>	<b>H</b>	<b>W</b>	<b>D</b>	<b>H</b>	<b>W</b>	<b>H</b>							
		30	30	17.5	-	-	-	-	-							
		<b>RTA 00</b>	1 per carton													
 <p><b>36" Square Bench</b> COM Yardage: 3 Freight class: 250 Product weight: 50 Cubic feet per carton: 18.25</p>	No power/USB unit.  Freestanding unit only.  Add \$75 for <b>(SLS)</b> Add \$100 for <b>(F6, F3, or F8)</b> Add \$1260 for 72 lbs. <b>(CW)</b> Add \$187 for <b>(SP)</b> or \$457 for <b>(BS)</b> Add \$40 for <b>(TP)</b> Add \$252 for <b>(MB)</b>	<b>R27849</b>	1917	2013	2088	2199	2355	2421	2556	2769	2928	3102	3465	3846		
		<b>OVERALL DIMENSIONS</b>			<b>SEAT DIMENSIONS</b>			<b>BACK DIMENSIONS</b>								
		<b>W</b>	<b>D</b>	<b>H</b>	<b>W</b>	<b>D</b>	<b>H</b>	<b>W</b>	<b>H</b>							
		36	36	17.5	-	-	-	-	-							
		<b>RTA 00</b>	1 per carton													
 <p><b>42" Square Bench</b> COM Yardage: 3.25 Freight class: 250 Product weight: 60 Cubic feet per carton: 23</p>	No power/USB unit.  Freestanding unit only.  Add \$86 for <b>(SLS)</b> Add \$100 for <b>(F6, F3, or F8)</b> Add \$1260 for 72 lbs. <b>(CW)</b> Add \$208 for <b>(SP)</b> or \$637 for <b>(BS)</b> Add \$40 for <b>(TP)</b> Add \$375 for <b>(MB)</b>	<b>R27850</b>	2329	2433	2515	2635	2804	2875	3022	3252	3425	3613	4006	4419		
		<b>OVERALL DIMENSIONS</b>			<b>SEAT DIMENSIONS</b>			<b>BACK DIMENSIONS</b>								
		<b>W</b>	<b>D</b>	<b>H</b>	<b>W</b>	<b>D</b>	<b>H</b>	<b>W</b>	<b>H</b>							
		42	42	17.5	-	-	-	-	-							
		<b>RTA 00</b>	1 per carton													

Options: **(SLS)** Sealed seams  
**(F6, F3, F8)** Floor mount legs  
**(CW)** Counterweight  
**(SP)** Vinyl sealed bottom  
**(BS)** Steel bottom  
**(TP)** Tamperproof  
**(MB)** Moisture barrier

## RIVER+ TABLES

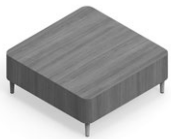

42" Square Coffee Table  
model R27858



Outside Curve End Table  
model R27864



18" Dia. Round Laptop Table  
model 7743

### River+ Seating, Benches & Media Hearths



For River+ seating, please see page 360

For River+ benches, please see page 379

For River+ media hearths, please see page 388

### STANDARD FEATURES

- A modular series that is composed of straight and curved sections, as well as freestanding units.
- Linking units can be used together in any combination with River+ seating and bench units to create a wide variety of layouts. Ganging hardware is standard and is factory installed. Ganging hardware swivels out of the way when not in use.
- Front and back faces of end (linking) tables angles slightly inwards. This inward slant matches the inward angles of River seating so all units coordinate in visual appearance.
- The standard 6.5", welded steel legs are straight (vertical) as standard. Linking models are optionally available with an angled back leg to visually align with River+ seating units.
- Legs include Black nylon, non-marking, height adjustable glides.
- Tables are made with high pressure laminate. Custom high pressure laminate finishes will be considered upon request.
- Laptop tables have 1" thick laminate tops.
- Laptop table painted metal base finishes are available in Black and Tungsten only.

### OPTIONAL FEATURES

- Legs of coffee and end (linking) tables are available in 3" (**S3**) and 8" (**S8**) heights. All leg heights are available with fixed-to-floor (**F3**) and (**F8**) options. Add \$100.
- To match adjacent lounge seating, straight front and angled back 6.5" or 8" legs are available on linking/end tables. Specify (**SA**). No upcharge.
- Power units are available on all tables except laptop tables. Each unit includes one AC outlet and two USB-a,10 watt charging ports. Add \$661 upcharge per unit.
- Power location options include top, front or end. See electrical placement diagrams. Electrical units must be factory installed.
- Power units are available in either Jet Black (**J**) or White (**W**) with 120", three-prong matching cords.
- Most products can be weighted to reduce the ease of movement. For additional weight options, specify (**CW**). See each model for available additional weight and upcharge.

Please add option codes in the following order:

- **Model number**  
**R27855 to R27858** Square coffee tables  
**R27859** Rectangular coffee table  
**R27860 to R27861** Round coffee tables  
**R27862 to R27864** Linking/end tables  
**7443 and 7745** Freestanding tables
- **Laminate finishes**  
**(ACJ)** Absolute Acajou    **(ASN)** Asian Night  
**(AWC)** Avant Cherry    **(AWH)** Avant Honey  
**(BLK)** Black    **(BRC)** Brushed Cobalt  
**(CMB)** Clear Maple    **(DES)** Dark Espresso  
**(DWT)** Designer White    **(FAS)** Fashionista  
**(FCL)** First Class  
**(NBL)** Noce Biondo    **(NGL)** Noce Grigio  
**(NEL)** Noce Leggero    **(NML)** Noce Medio  
**(QTM)** Quartered Mahogany  
**(SBY)** Sheer Beauty    **(SOG)** Storm Grey  
**(WCR)** Winter Cherry    **(WHC)** White Chocolate  
**(WHE)** Walnut Heights  
(colors shown on website)
- **Leg selection**  
**(S6)** Standard height (6.5") w/adjustable glides. No upcharge.  
**(S3)** Low (3") w/adjustable glides. No upcharge.  
**(S8)** High (8") w/adjustable glides. No upcharge.  
**(F6)** Standard height (6.5"), fixed to floor. Add \$100.  
**(F3)** Low (3"), fixed to floor. Add \$100.  
**(F8)** High (8"), fixed to floor. Add \$100.
- **Leg angle** (linking/end tables only)  
**(AST)** Straight legs. No upcharge.  
**(SA)** Straight front legs, angled back legs. No upcharge.
- **Leg finish**  
**(CHM)** Chrome    **(TBL)** Black  
**(TDW)** Designer White    **(TFO)** Fog  
**(TFR)** Frost    **(TIV)** Cloud  
**(TLA)** Latte    **(TMO)** Mocha  
**(TNE)** Nevada    **(TOA)** Toast  
**(TSH)** Shadow    **(TSN)** Sand  
**(TTU)** Tungsten
- **Additional weight**  
**(CW)** Additional weight. Upcharges vary, see model.
- **Power/USB unit position** (coffee and linking/end tables only, as shown below). Add \$661 per unit.  
**(NP)** No power (no upcharge)  
**(LE1)** Left end (coffee table only)  
**(LE2)** Right end (coffee table only)  
**(F3)** Front center (coffee table only)  
**(T1)** Top
- **Power unit finish**  
**(J)** Jet Black  
**(W)** White
- **(TP) Tamperproof fasteners.** Add \$160.

### EXAMPLE RIVER+ TABLE ORDER CODE:

R27858	-ACJ	-S6	-AS	-CM	-	-T1	-W	-
Model number	Laminate	Leg selection	Leg angle	Leg finish	Additional weight	Power/USB	Power finish	Fasteners

### ELECTRICAL PLACEMENT

#### Coffee Tables

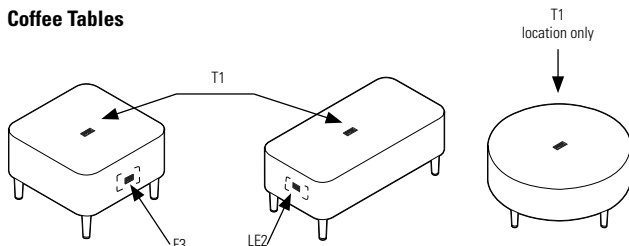

#### Linking Tables

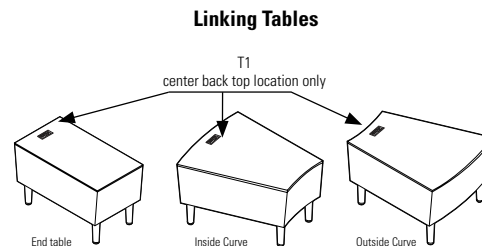

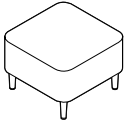
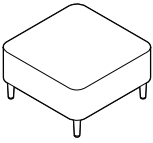
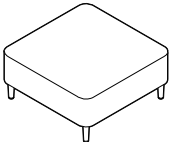
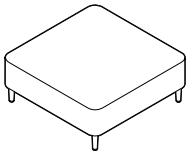
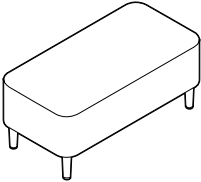

DESCRIPTION	FEATURES	MODEL#	STANDARD TEXTILE GRADES																							
 <p><b>24" Square Coffee Table</b> COM: N/A Freight class: 250 Product weight: 40 Cubic feet per carton: 10.7</p>	<p>For power/USB unit, see electrical placement chart.</p> <p>Freestanding unit only. Add \$511 for 36 lbs. (CW)</p>	List price																								
		R27855	1484																							
		<table border="1"> <thead> <tr> <th colspan="3">OVERALL DIMENSIONS</th> <th colspan="3">SEAT DIMENSIONS</th> <th colspan="2">BACK DIMENSIONS</th> </tr> <tr> <th>W</th> <th>D</th> <th>H</th> <th>W</th> <th>D</th> <th>H</th> <th>W</th> <th>H</th> </tr> </thead> <tbody> <tr> <td>24</td> <td>24</td> <td>17</td> <td>-</td> <td>-</td> <td>-</td> <td>-</td> <td>-</td> </tr> </tbody> </table>			OVERALL DIMENSIONS			SEAT DIMENSIONS			BACK DIMENSIONS		W	D	H	W	D	H	W	H	24	24	17	-	-	-
OVERALL DIMENSIONS			SEAT DIMENSIONS			BACK DIMENSIONS																				
W	D	H	W	D	H	W	H																			
24	24	17	-	-	-	-	-																			
 <p><b>30" Square Coffee Table</b> COM: N/A Freight class: 250 Product weight: 53 Cubic feet per carton: 15.3</p>	<p>For power/USB unit, see electrical placement chart.</p> <p>Freestanding unit only. Add \$383 for 27 lbs. (CW)</p>	List price																								
		R27856	1563																							
		<table border="1"> <thead> <tr> <th colspan="3">OVERALL DIMENSIONS</th> <th colspan="3">SEAT DIMENSIONS</th> <th colspan="2">BACK DIMENSIONS</th> </tr> <tr> <th>W</th> <th>D</th> <th>H</th> <th>W</th> <th>D</th> <th>H</th> <th>W</th> <th>H</th> </tr> </thead> <tbody> <tr> <td>30</td> <td>30</td> <td>17</td> <td>-</td> <td>-</td> <td>-</td> <td>-</td> <td>-</td> </tr> </tbody> </table>			OVERALL DIMENSIONS			SEAT DIMENSIONS			BACK DIMENSIONS		W	D	H	W	D	H	W	H	30	30	17	-	-	-
OVERALL DIMENSIONS			SEAT DIMENSIONS			BACK DIMENSIONS																				
W	D	H	W	D	H	W	H																			
30	30	17	-	-	-	-	-																			
 <p><b>36" Square Coffee Table</b> COM: N/A Freight class: 250 Product weight: 75 Cubic feet per carton: 20.6</p>	<p>For power/USB unit, see electrical placement chart.</p> <p>Freestanding unit only. No counterweight.</p>	List price																								
		R27857	1791																							
		<table border="1"> <thead> <tr> <th colspan="3">OVERALL DIMENSIONS</th> <th colspan="3">SEAT DIMENSIONS</th> <th colspan="2">BACK DIMENSIONS</th> </tr> <tr> <th>W</th> <th>D</th> <th>H</th> <th>W</th> <th>D</th> <th>H</th> <th>W</th> <th>H</th> </tr> </thead> <tbody> <tr> <td>36</td> <td>36</td> <td>17</td> <td>-</td> <td>-</td> <td>-</td> <td>-</td> <td>-</td> </tr> </tbody> </table>			OVERALL DIMENSIONS			SEAT DIMENSIONS			BACK DIMENSIONS		W	D	H	W	D	H	W	H	36	36	17	-	-	-
OVERALL DIMENSIONS			SEAT DIMENSIONS			BACK DIMENSIONS																				
W	D	H	W	D	H	W	H																			
36	36	17	-	-	-	-	-																			
 <p><b>42" Square Coffee Table</b> COM: N/A Freight class: 150 Product weight: 115 Cubic feet per carton: 26.7</p>	<p>For power/USB unit, see electrical placement chart.</p> <p>Freestanding unit only. No counterweight.</p>	List price																								
		R27858	1991																							
		<table border="1"> <thead> <tr> <th colspan="3">OVERALL DIMENSIONS</th> <th colspan="3">SEAT DIMENSIONS</th> <th colspan="2">BACK DIMENSIONS</th> </tr> <tr> <th>W</th> <th>D</th> <th>H</th> <th>W</th> <th>D</th> <th>H</th> <th>W</th> <th>H</th> </tr> </thead> <tbody> <tr> <td>42</td> <td>42</td> <td>17</td> <td>-</td> <td>-</td> <td>-</td> <td>-</td> <td>-</td> </tr> </tbody> </table>			OVERALL DIMENSIONS			SEAT DIMENSIONS			BACK DIMENSIONS		W	D	H	W	D	H	W	H	42	42	17	-	-	-
OVERALL DIMENSIONS			SEAT DIMENSIONS			BACK DIMENSIONS																				
W	D	H	W	D	H	W	H																			
42	42	17	-	-	-	-	-																			
 <p><b>Rectangular Coffee Table</b> COM: N/A Freight class: 250 Product weight: 55 Cubic feet per carton: 14.2</p>	<p>For power/USB unit, see electrical placement chart.</p> <p>Freestanding unit only. Add 256 for 18 lbs. (CW)</p>	List price																								
		R27859	1626																							
		<table border="1"> <thead> <tr> <th colspan="3">OVERALL DIMENSIONS</th> <th colspan="3">SEAT DIMENSIONS</th> <th colspan="2">BACK DIMENSIONS</th> </tr> <tr> <th>W</th> <th>D</th> <th>H</th> <th>W</th> <th>D</th> <th>H</th> <th>W</th> <th>H</th> </tr> </thead> <tbody> <tr> <td>40</td> <td>20</td> <td>17</td> <td>-</td> <td>-</td> <td>-</td> <td>-</td> <td>-</td> </tr> </tbody> </table>			OVERALL DIMENSIONS			SEAT DIMENSIONS			BACK DIMENSIONS		W	D	H	W	D	H	W	H	40	20	17	-	-	-
OVERALL DIMENSIONS			SEAT DIMENSIONS			BACK DIMENSIONS																				
W	D	H	W	D	H	W	H																			
40	20	17	-	-	-	-	-																			

Options: (CW) Counterweight

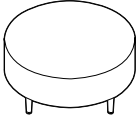
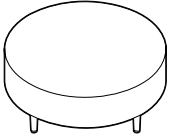
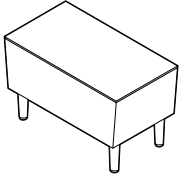
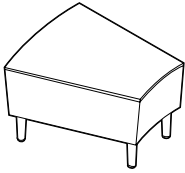
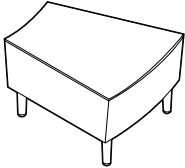
DESCRIPTION	FEATURES	MODEL#	STANDARD TEXTILE GRADES																												
 <p><b>36" Dia. Round Coffee Table</b> COM: N/A Freight class: 150 Product weight: 63 Cubic feet per carton: 15.3</p>	<p>For power/USB unit, see electrical placement chart.</p> <p>Freestanding unit only. Add \$256 for 18 lbs. (CW)</p>	List price																													
		<b>R27860</b>	1927																												
		<table border="1"> <thead> <tr> <th colspan="3">OVERALL DIMENSIONS</th> <th colspan="3">SEAT DIMENSIONS</th> <th colspan="2">BACK DIMENSIONS</th> </tr> <tr> <th>W</th> <th>D</th> <th>H</th> <th>W</th> <th>D</th> <th>H</th> <th>W</th> <th>H</th> </tr> </thead> <tbody> <tr> <td>36</td> <td>36</td> <td>17</td> <td>-</td> <td>-</td> <td>-</td> <td>-</td> <td>-</td> </tr> </tbody> </table>		OVERALL DIMENSIONS			SEAT DIMENSIONS			BACK DIMENSIONS		W	D	H	W	D	H	W	H	36	36	17	-	-	-	-	-	<table border="1"> <thead> <tr> <th colspan="2">RTA 00</th> </tr> </thead> <tbody> <tr> <td colspan="2">1 per carton</td> </tr> </tbody> </table>		RTA 00	
OVERALL DIMENSIONS			SEAT DIMENSIONS			BACK DIMENSIONS																									
W	D	H	W	D	H	W	H																								
36	36	17	-	-	-	-	-																								
RTA 00																															
1 per carton																															
 <p><b>42" Dia. Round Coffee Table</b> COM: N/A Freight class: 150 Product weight: 85 Cubic feet per carton: 20.6</p>	<p>For power/USB unit, see electrical placement chart.</p> <p>Freestanding unit only. No counterweight.</p>	List price																													
		<b>R27861</b>	2113																												
		<table border="1"> <thead> <tr> <th colspan="3">OVERALL DIMENSIONS</th> <th colspan="3">SEAT DIMENSIONS</th> <th colspan="2">BACK DIMENSIONS</th> </tr> <tr> <th>W</th> <th>D</th> <th>H</th> <th>W</th> <th>D</th> <th>H</th> <th>W</th> <th>H</th> </tr> </thead> <tbody> <tr> <td>42</td> <td>42</td> <td>17</td> <td>-</td> <td>-</td> <td>-</td> <td>-</td> <td>-</td> </tr> </tbody> </table>		OVERALL DIMENSIONS			SEAT DIMENSIONS			BACK DIMENSIONS		W	D	H	W	D	H	W	H	42	42	17	-	-	-	-	-	<table border="1"> <thead> <tr> <th colspan="2">RTA 00</th> </tr> </thead> <tbody> <tr> <td colspan="2">1 per carton</td> </tr> </tbody> </table>		RTA 00	
OVERALL DIMENSIONS			SEAT DIMENSIONS			BACK DIMENSIONS																									
W	D	H	W	D	H	W	H																								
42	42	17	-	-	-	-	-																								
RTA 00																															
1 per carton																															
 <p><b>Rectangular End Table</b> COM: N/A Freight class: 300 Product weight: 40 Cubic feet per carton: 20.6</p>	<p>For power/USB unit, see electrical placement chart.</p> <p>Includes ganging hardware (2 sides). Add \$511 for 36 lbs. (CW)</p>	List price																													
		<b>R27862</b>	1578																												
		<table border="1"> <thead> <tr> <th colspan="3">OVERALL DIMENSIONS</th> <th colspan="3">SEAT DIMENSIONS</th> <th colspan="2">BACK DIMENSIONS</th> </tr> <tr> <th>W</th> <th>D</th> <th>H</th> <th>W</th> <th>D</th> <th>H</th> <th>W</th> <th>H</th> </tr> </thead> <tbody> <tr> <td>28</td> <td>15</td> <td>17</td> <td>-</td> <td>-</td> <td>-</td> <td>-</td> <td>-</td> </tr> </tbody> </table>		OVERALL DIMENSIONS			SEAT DIMENSIONS			BACK DIMENSIONS		W	D	H	W	D	H	W	H	28	15	17	-	-	-	-	-	<table border="1"> <thead> <tr> <th colspan="2">RTA 00</th> </tr> </thead> <tbody> <tr> <td colspan="2">1 per carton</td> </tr> </tbody> </table>		RTA 00	
OVERALL DIMENSIONS			SEAT DIMENSIONS			BACK DIMENSIONS																									
W	D	H	W	D	H	W	H																								
28	15	17	-	-	-	-	-																								
RTA 00																															
1 per carton																															
 <p><b>Inside Curve End Table</b> COM: N/A Freight class: 250 Product weight: 47 Cubic feet per carton: 13.3</p>	<p>For power/USB unit, see electrical placement chart.</p> <p>Includes ganging hardware (2 sides). Add \$511 for 36 lbs. (CW)</p>	List price																													
		<b>R27863</b>	2073																												
		<table border="1"> <thead> <tr> <th colspan="3">OVERALL DIMENSIONS</th> <th colspan="3">SEAT DIMENSIONS</th> <th colspan="2">BACK DIMENSIONS</th> </tr> <tr> <th>W</th> <th>D</th> <th>H</th> <th>W</th> <th>D</th> <th>H</th> <th>W</th> <th>H</th> </tr> </thead> <tbody> <tr> <td>28</td> <td>17</td> <td>17</td> <td>-</td> <td>-</td> <td>-</td> <td>-</td> <td>-</td> </tr> </tbody> </table>		OVERALL DIMENSIONS			SEAT DIMENSIONS			BACK DIMENSIONS		W	D	H	W	D	H	W	H	28	17	17	-	-	-	-	-	<table border="1"> <thead> <tr> <th colspan="2">RTA 00</th> </tr> </thead> <tbody> <tr> <td colspan="2">1 per carton</td> </tr> </tbody> </table>		RTA 00	
OVERALL DIMENSIONS			SEAT DIMENSIONS			BACK DIMENSIONS																									
W	D	H	W	D	H	W	H																								
28	17	17	-	-	-	-	-																								
RTA 00																															
1 per carton																															
 <p><b>Outside Curve End Table</b> COM: N/A Freight class: 250 Product weight: 47 Cubic feet per carton: 13.3</p>	<p>For power/USB unit, see electrical placement chart.</p> <p>Includes ganging hardware (2 sides). Add \$511 for 36 lbs. (CW)</p>	List price																													
		<b>R27864</b>	2073																												
		<table border="1"> <thead> <tr> <th colspan="3">OVERALL DIMENSIONS</th> <th colspan="3">SEAT DIMENSIONS</th> <th colspan="2">BACK DIMENSIONS</th> </tr> <tr> <th>W</th> <th>D</th> <th>H</th> <th>W</th> <th>D</th> <th>H</th> <th>W</th> <th>H</th> </tr> </thead> <tbody> <tr> <td>28</td> <td>17</td> <td>17</td> <td>-</td> <td>-</td> <td>-</td> <td>-</td> <td>-</td> </tr> </tbody> </table>		OVERALL DIMENSIONS			SEAT DIMENSIONS			BACK DIMENSIONS		W	D	H	W	D	H	W	H	28	17	17	-	-	-	-	-	<table border="1"> <thead> <tr> <th colspan="2">RTA 00</th> </tr> </thead> <tbody> <tr> <td colspan="2">1 per carton</td> </tr> </tbody> </table>		RTA 00	
OVERALL DIMENSIONS			SEAT DIMENSIONS			BACK DIMENSIONS																									
W	D	H	W	D	H	W	H																								
28	17	17	-	-	-	-	-																								
RTA 00																															
1 per carton																															

Options: (CW) Counterweight

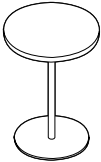
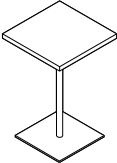
DESCRIPTION	FEATURES	MODEL#	STANDARD TEXTILE GRADES						
 <p><b>18" Dia. Round Laptop Table</b>                      COM: N/A                      Freight class: 150                      Product weight: 32                      Cubic feet per carton: 6</p>	No power/USB unit.	List price							
		<b>7743</b>	792						
		OVERALL DIMENSIONS			SEAT DIMENSIONS			BACK DIMENSIONS	
		W	D	H	W	D	H	W	H
18	18	25.25	-	-	-	-	-		
		<b>RTA 00</b>	1 per carton						
 <p><b>16" Square Laptop Table</b>                      COM: N/A                      Freight class: 125                      Product weight: 36                      Cubic feet per carton: 6</p>	No power/USB unit.	List price							
		<b>7745</b>	810						
		OVERALL DIMENSIONS			SEAT DIMENSIONS			BACK DIMENSIONS	
		W	D	H	W	D	H	W	H
16	16	25.25	-	-	-	-	-		
		<b>RTA 00</b>	1 per carton						

## RIVER+ MEDIA HEARTH



Media Hearth with Sliding Laminate Doors - 84" model R27877

### River+ Seating, Tables & Benches

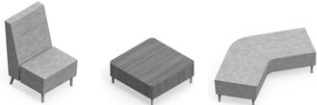

For River+ seating, please see page 360  
 For River+ tables, please see page 384.  
 For River+ benches, please see page 379

### STANDARD FEATURES

- A fully finished media center with features and finishes that coordinate with River+ seating, benches and tables. The fully finished back supports ease of planning.
- The 6.5" legs match River+ tapered legs. Legs are straight on the front and angled on the back.
- Legs include Black nylon, non-marking, height adjustable glides.
- Two hidden grommets are standard on the unit. One grommet is centered on the back panel, behind the monitor location. The other is beneath the unit, allowing cables to route from the monitor, through the unit, to the floor.
- Models are available with open shelving or closed, with sliding laminate or glass doors.
- Monitors, mounts and power are not included.
- See Suggested Maximum Monitor Diagonal Sizes chart for recommended maximum dimensions.
- To mount flatscreen or monitor to media hearth, use fixed mounting hardware only; not for use with articulating or extendable arm mounting hardware. Combined weight of mounting hardware and monitor or flatscreen not to exceed 75 lbs.
- Media hearths are made with thermally fused laminates. Specify from the many finishes listed. Custom, high pressure laminate finishes will be considered upon request.

### OPTIONAL FEATURES

- An optional user access grommet is available for the top of the storage shelf, allowing cable routing for user access. Specify center grommet (GP2). Add \$96.
- Optional 6.5" floor mount legs are available. Add \$100. Mounting hardware not included.

Please add option codes in the following order:

- **Model number**  
**R27870 to R27874** Media hearth with open shelf.  
**R27875 to R27879** Media hearth with sliding laminate doors.  
**R27880 to R27884** Media hearth with sliding glass doors.
- **Laminate finishes**  
**(ACJ)** Absolute Acajou **(ASN)** Asian Night  
**(AWC)** Avant Cherry **(AWH)** Avant Honey  
**(BLK)** Black **(BRC)** Brushed Cobalt  
**(CMB)** Clear Maple **(DES)** Dark Espresso  
**(DWT)** Designer White **(FAS)** Fashionista  
**(FCL)** First Class  
**(NBL)** Noce Biondo **(NGL)** Noce Grigio  
**(NEL)** Noce Leggero **(NML)** Noce Medio  
**(QTM)** Quartered Mahogany  
**(SBY)** Sheer Beauty **(SOG)** Storm Grey  
**(WCR)** Winter Cherry **(WHC)** White Chocolate  
**(WHE)** Walnut Heights  
 (colors shown on website)
- **Leg selection**  
**(S6)** Standard height (6.5") w/adjustable glides. No upcharge.  
**(F6)** Standard height (6.5"), floor mount. Add \$100.
- **Leg finish**  
**(CHM)** Chrome **(TBL)** Black  
**(TDW)** Designer White **(TFO)** Fog  
**(TFR)** Frost **(TIV)** Cloud  
**(TLA)** Latte **(TMO)** Mocha  
**(TNE)** Nevada **(TOA)** Toast  
**(TSH)** Shadow **(TSN)** Sand  
**(TTU)** Tungsten
- **Grommet**  
**(GP2)** Center grommet. Add \$96..

### EXAMPLE RIVER+ MEDIA HEARTH ORDER CODE:

R27870	-ACJ	-S6	-CH	-
Model number	Laminate finish	Leg selection	Leg finish	Grommet

SUGGESTED MAXIMUM MONITOR DIAGONAL SIZES			
(measurements to be verified by end user)			
Model	Width	Overall usable area	Monitor diagonal dim.
R27870, R27875, R27880	60"	60 W x 37 H	60"
R27871, R27876, R27881	72"	72 W x 37 H	65"
R27872, R27877, R27882	84"	84 W x 37 H	65"
R27873, R27878, R27883	96"	96 W x 37 H	65"
R27874, R27879, R27884	96"	96 W x 37 H	2 x 50"

### GROMMET PLACEMENT

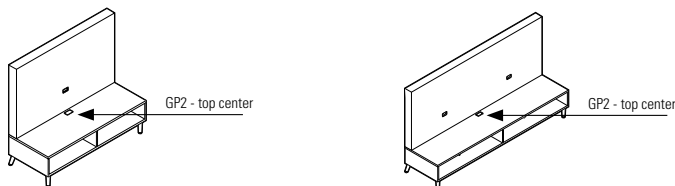

\*Optional grommet is always located in the center of the top of the storage shelf (near the vertical surface).

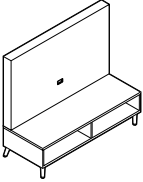
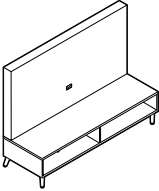
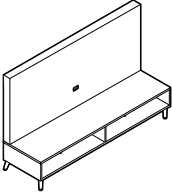
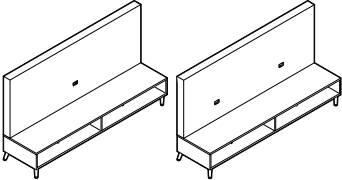
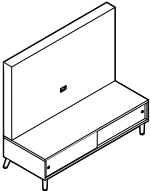
DESCRIPTION	FEATURES	MODEL#	STANDARD TEXTILE GRADES								
 <p><b>Media Hearth with Open Shelf - 60"</b>                      COM: N/A                      Freight class: 150                      Product weight: 170.5                      Cubic feet per carton: 14.37</p>			List price								
		<b>R27870</b>	4047								
				OVERALL DIMENSIONS			SEAT DIMENSIONS			BACK DIMENSIONS	
				W	D	H	W	D	H	W	H
			60	24	54	-	-	-	-	-	
				<b>RTA 1</b>		2 cartons					
 <p><b>Media Hearth with Open Shelf - 72"</b>                      COM: N/A                      Freight class: 150                      Product weight: 189                      Cubic feet per carton: 17.15</p>			List price								
		<b>R27871</b>	4177								
				OVERALL DIMENSIONS			SEAT DIMENSIONS			BACK DIMENSIONS	
				W	D	H	W	D	H	W	H
			72	24	54	-	-	-	-	-	
				<b>RTA 1</b>		2 cartons					
 <p><b>Media Hearth with Open Shelf - 84"</b>                      COM: N/A                      Freight class: 150                      Product weight: 209                      Cubic feet per carton: 19.94</p>			List price								
		<b>R27872</b>	4478								
				OVERALL DIMENSIONS			SEAT DIMENSIONS			BACK DIMENSIONS	
				W	D	H	W	D	H	W	H
			84	24	54	-	-	-	-	-	
				<b>RTA 1</b>		2 cartons					
 <p><b>Media Hearth with Open Shelf - 96"</b>                      COM: N/A                      Freight class: 150                      Product weight: 231.5                      Cubic feet per carton: 22.72</p>			List price								
		<b>R27873</b>	4676								
		<b>R27874</b>	4761								
			Dual Monitor								
			OVERALL DIMENSIONS			SEAT DIMENSIONS			BACK DIMENSIONS		
			W	D	H	W	D	H	W	H	
			96	24	54	-	-	-	-	-	
				<b>RTA 1</b>		2 cartons					
 <p><b>Media Hearth with Sliding Laminate Doors - 60"</b>                      COM: N/A                      Freight class: 150                      Product weight: 170.5                      Cubic feet per carton: 14.37</p>			List price								
		<b>R27875</b>	5247								
				OVERALL DIMENSIONS			SEAT DIMENSIONS			BACK DIMENSIONS	
				W	D	H	W	D	H	W	H
			60	24	54	-	-	-	-	-	
				<b>RTA 1</b>		2 cartons					

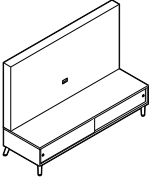
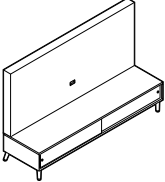
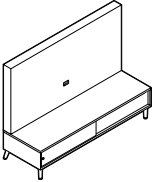
DESCRIPTION	FEATURES	MODEL#	STANDARD TEXTILE GRADES								
 <p><b>Media Hearth with Sliding Laminate Doors - 72"</b>                      COM: N/A                      Freight class: 150                      Product weight: 189                      Cubic feet per carton: 17.15</p>			List price								
		<b>R27876</b>	5528								
				<b>OVERALL DIMENSIONS</b>			<b>SEAT DIMENSIONS</b>			<b>BACK DIMENSIONS</b>	
				<b>W</b>	<b>D</b>	<b>H</b>	<b>W</b>	<b>D</b>	<b>H</b>	<b>W</b>	<b>H</b>
			72	24	54	-	-	-	-	-	
				<b>RTA 1</b>	2 cartons						
 <p><b>Media Hearth with Sliding Laminate Doors - 84"</b>                      COM: N/A                      Freight class: 150                      Product weight: 209                      Cubic feet per carton: 19.94</p>			List price								
		<b>R27877</b>	5838								
				<b>OVERALL DIMENSIONS</b>			<b>SEAT DIMENSIONS</b>			<b>BACK DIMENSIONS</b>	
				<b>W</b>	<b>D</b>	<b>H</b>	<b>W</b>	<b>D</b>	<b>H</b>	<b>W</b>	<b>H</b>
			84	24	54	-	-	-	-	-	
				<b>RTA 1</b>	2 cartons						
 <p><b>Media Hearth with Sliding Laminate Doors - 96"</b>                      COM: N/A                      Freight class: 150                      Product weight: 231.5                      Cubic feet per carton: 22.72</p>			List price								
		<b>R27878</b>	6047								
		<b>R27879</b>	6123	Dual Monitor							
				<b>OVERALL DIMENSIONS</b>			<b>SEAT DIMENSIONS</b>			<b>BACK DIMENSIONS</b>	
			<b>W</b>	<b>D</b>	<b>H</b>	<b>W</b>	<b>D</b>	<b>H</b>	<b>W</b>	<b>H</b>	
			96	24	54	-	-	-	-	-	
				<b>RTA 1</b>	2 cartons						
 <p><b>Media Hearth with Sliding Glass Doors - 60"</b>                      COM: N/A                      Freight class: 150                      Product weight: 170.5                      Cubic feet per carton: 14.37</p>			List price								
		<b>R27880</b>	5575								
				<b>OVERALL DIMENSIONS</b>			<b>SEAT DIMENSIONS</b>			<b>BACK DIMENSIONS</b>	
				<b>W</b>	<b>D</b>	<b>H</b>	<b>W</b>	<b>D</b>	<b>H</b>	<b>W</b>	<b>H</b>
			60	24	54	-	-	-	-	-	
				<b>RTA 1</b>	2 cartons						
 <p><b>Media Hearth with Sliding Glass Doors - 72"</b>                      COM: N/A                      Freight class: 150                      Product weight: 189                      Cubic feet per carton: 17.15</p>			List price								
		<b>R27881</b>	5852								
				<b>OVERALL DIMENSIONS</b>			<b>SEAT DIMENSIONS</b>			<b>BACK DIMENSIONS</b>	
				<b>W</b>	<b>D</b>	<b>H</b>	<b>W</b>	<b>D</b>	<b>H</b>	<b>W</b>	<b>H</b>
			72	24	54	-	-	-	-	-	
				<b>RTA 1</b>	2 cartons						

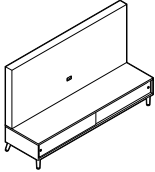
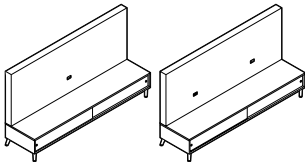
DESCRIPTION	FEATURES	MODEL#	STANDARD TEXTILE GRADES							
 <p><b>Media Hearth with Sliding Glass Doors - 84"</b>                      COM: N/A                      Freight class: 150                      Product weight: 209                      Cubic feet per carton: 19.94</p>			List price							
		<b>R27882</b>	6186							
				<b>OVERALL DIMENSIONS</b>		<b>SEAT DIMENSIONS</b>			<b>BACK DIMENSIONS</b>	
				<b>W</b>	<b>D</b>	<b>H</b>	<b>W</b>	<b>D</b>	<b>H</b>	<b>W</b>
			84	24	54	-	-	-	-	-
						<b>RTA 1</b>		2 cartons		
 <p><b>Media Hearth with Sliding Glass Doors - 96"</b>                      COM: N/A                      Freight class: 150                      Product weight: 231.5                      Cubic feet per carton: 22.72</p>			List price							
		<b>R27883</b>	6571							
		<b>R27884</b>	6647	Dual Monitor						
				<b>OVERALL DIMENSIONS</b>		<b>SEAT DIMENSIONS</b>			<b>BACK DIMENSIONS</b>	
			<b>W</b>	<b>D</b>	<b>H</b>	<b>W</b>	<b>D</b>	<b>H</b>	<b>W</b>	<b>H</b>
			96	24	54	-	-	-	-	-
						<b>RTA 1</b>		2 cartons		

SIRENA™



models 3371 Lounge Chairs, 3373 Two Seat Sofa, 3400 Coffee Table, and 3402 End Table



model 3371



model 3372CRTL

STANDARD FEATURES

- Modern club style seating includes: lounge chair, two and three seat sofas.
- Complete with Modern tables for reception areas, meeting rooms, and private office use.
- Lounge seating distinctive round style feet are finished in Black Only.
- All models have fixed, non-removable seat cushions with arm height at 25" in the front.
- Casters are available on lounge chairs only. **C1M** casters are standard.
- Please note leather models offer additional stitch details.
- Check textile availability prior to specifying upholstery material.
- When ordering models with tablet, specify for left hand or for right hand tablet. See models below.
- Laminate Tops, are 1.5" thick.
- Table legs are 1.5" steel tubing, tapered toward the bottom to 7/8", equipped with self-leveling, pivoting steel glides.



OPTIONAL FEATURES

- Laminate tables, tablets and bookshelves are offered in the following laminate finishes: Absolute Acajou (**ACJ**), Asian Night (**ASN**), Avant Cherry (**AWC**), Avant Honey (**AWH**), Clear Maple (**CMB**), Dark Espresso (**DES**), Designer White (**DWT**), Fashionista (**FAS**), First Class (**FCL**), Noce Biondo (**NBL**), Noce Grigio (**NGL**), Noce Leggero (**NEL**), Noce Medio (**NML**), Quartered Mahogany (**QTM**), Sheer Beauty (**SBY**), Walnut Heights (**WHE**), White Chocolate (**WHC**) and Winter Cherry (**WCR**). Please Specify.
- Table legs are available in Tungsten (**TTU**), Shadow (**TSH**), Black (**TBL**) at no upcharge. Not available in Chrome.

STITCH DETAIL WHEN UPHOLSTERED IN ALL LEATHER - ILLUSTRATIONS BELOW

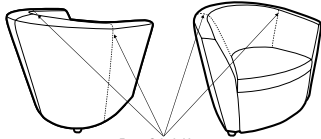

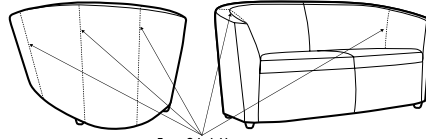

Extra Stitch Lines

Lounge Chair











Extra Stitch Lines

Two and Three Seater Sofas

DESCRIPTION	FEATURES	MODEL#	STANDARD TEXTILE GRADES											
			1	2	3	4	5	6	7	8	9	10	11	12
 <p><b>Lounge Chair</b> Fabric COM Yardage: 4.25 Freight Class: 250 Product Weight (lbs.): 52 Cubic Feet Per Carton: 19.25</p>		<b>3371</b>	-	1730	1853	2027	2280	2373	2593	3007	3212	3596	4130	4789
			<b>OVERALL DIMENSIONS</b>			<b>SEAT DIMENSIONS</b>			<b>BACK DIMENSIONS</b>					
			<b>W</b>	<b>D</b>	<b>H</b>	<b>W</b>	<b>D</b>	<b>H</b>	<b>W</b>	<b>H</b>				
			30.5	29.5	28.5	20	20	17.5	19	11.5				
		<b>RTA 00</b>												
 <p><b>Lounge Chair w/Casters</b> COM Yardage: 4.25 Freight Class: 250 Product Weight (lbs.): 52 Cubic Feet Per Carton: 19.25</p>		<b>3371C</b>	-	1861	1990	2175	2441	2539	2770	3203	3420	3822	4379	5071
			<b>OVERALL DIMENSIONS</b>			<b>SEAT DIMENSIONS</b>			<b>BACK DIMENSIONS</b>					
			<b>W</b>	<b>D</b>	<b>H</b>	<b>W</b>	<b>D</b>	<b>H</b>	<b>W</b>	<b>H</b>				
			30.5	29.5	29.5	20	20	17.5	19	11.5				
		<b>RTA 00</b>												



DESCRIPTION	FEATURES	MODEL#	STANDARD TEXTILE GRADES											
			1	2	3	4	5	6	7	8	9	10	11	12
 <b>3371LTL</b>	 <b>3371RTL</b>	<b>3371LTL</b> 3371RTL	-	2497	2623	2811	3074	3172	3403	3838	4055	4454	5015	5707
			<b>OVERALL DIMENSIONS</b> W D H			<b>SEAT DIMENSIONS</b> W D H			<b>BACK DIMENSIONS</b> W H					
Lounge Chair w/Laminate Tablet COM Yardage: 4.25 Freight Class: 250 Product Weight (lbs.): 58 Cubic Feet Per Carton: 19.25			<b>RTA 00</b>											
 <b>3371CLTL</b>	 <b>3371CRTL</b>	<b>3371CLTL</b> 3371CRTL	-	2640	2768	2954	3217	3315	3549	3979	4198	4597	5158	5850
			<b>OVERALL DIMENSIONS</b> W D H			<b>SEAT DIMENSIONS</b> W D H			<b>BACK DIMENSIONS</b> W H					
Lounge Chair w/Casters & Laminate Tablet COM Yardage: 4.25 Freight Class: 250 Product Weight (lbs.): 62 Cubic Feet Per Carton: 19.25			<b>RTA 00</b>											
		<b>3372</b>	-	2304	2427	2601	2854	2947	3167	3581	3786	4170	4704	5363
	<b>OVERALL DIMENSIONS</b> W D H			<b>SEAT DIMENSIONS</b> W D H			<b>BACK DIMENSIONS</b> W H							
Lounge Chair w/Laminate Book Shelf COM Yardage: 4.25 Freight Class: 250 Product Weight (lbs.): 55 Cubic Feet Per Carton: 19.25			<b>RTA 00</b>											
		<b>3372C</b>	-	2526	2649	2823	3076	3169	3389	3803	4008	4392	4926	5585
	<b>OVERALL DIMENSIONS</b> W D H			<b>SEAT DIMENSIONS</b> W D H			<b>BACK DIMENSIONS</b> W H							
Lounge Chair w/Casters & Laminate Book Shelf COM Yardage: 4.25 Freight Class: 250 Product Weight (lbs.): 55 Cubic Feet Per Carton: 19.25			<b>RTA 00</b>											
 <b>3372LTL</b>	 <b>3372RTL</b>	<b>3372LTL</b> 3372RTL	-	3004	3127	3301	3554	3647	3867	4281	4486	4870	5404	6063
			<b>OVERALL DIMENSIONS</b> W D H			<b>SEAT DIMENSIONS</b> W D H			<b>BACK DIMENSIONS</b> W H					
Lounge Chair w/Laminate Tablet/Book Shelf COM Yardage: 4.25 Freight Class: 250 Product Weight (lbs.): 66 Cubic Feet Per Carton: 19.25			<b>RTA 00</b>											

DESCRIPTION FEATURES MODEL# STANDARD TEXTILE GRADES



3372CLTL



3372CRTL

**Lounge Chair w/ Casters & Laminate Table/Book Shelf**  
 COM Yardage: 4.25  
 Freight Class: 250  
 Product Weight (lbs.): 66  
 Cubic Feet Per Carton: 19.25

	1	2	3	4	5	6	7	8	9	10	11	12
<b>3372CLTL</b>	-	3152	3275	3449	3702	3795	4015	4429	4634	5019	5552	6211
3372CRTL												

OVERALL DIMENSIONS			SEAT DIMENSIONS			BACK DIMENSIONS	
W	D	H	W	D	H	W	H
32.5	29.5	28.5	20	20	17.5	19	11.5

RTA 00

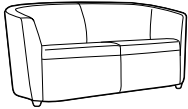

**Two Seat Sofa**  
 COM Yardage: 7  
 Freight Class: 300  
 Product Weight (lbs.): 92  
 Cubic Feet Per Carton: 48

	1	2	3	4	5	6	7	8	9	10	11	12
<b>3373</b>	-	3247	3446	3738	4151	4306	4669	5346	5688	6321	7197	8280

OVERALL DIMENSIONS			SEAT DIMENSIONS			BACK DIMENSIONS	
W	D	H	W	D	H	W	H
62	29.5	28.5	53	20	17.5	53	11.5

RTA 00

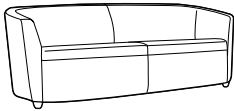

**Three Seat Sofa**  
 COM Yardage: 7.75  
 Freight Class: 300  
 Product Weight (lbs.): 107  
 Cubic Feet Per Carton: 55.5

	1	2	3	4	5	6	7	8	9	10	11	12
<b>3374</b>	-	3904	4122	4444	4902	5077	5475	6228	6606	7304	8275	9474

OVERALL DIMENSIONS			SEAT DIMENSIONS			BACK DIMENSIONS	
W	D	H	W	D	H	W	H
81.5	29.5	28.5	72.5	20	17.5	72.5	11.5

RTA 00

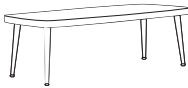

**Coffee Table - 48" Laminate Top**  
 COM Yardage: N/A  
 Freight Class: 250  
 Product Weight (lbs.): 52  
 Cubic Feet Per Carton: 17.25

	1	2	3	4	5	6	7	8	9	10	11	12
<b>3400</b>	1856	-	-	-	-	-	-	-	-	-	-	-

OVERALL DIMENSIONS			SEAT DIMENSIONS			BACK DIMENSIONS	
W	D	H	W	D	H	W	H
48	22	14.5	-	-	-	-	-

RTA 00



**Coffee Table - 56" Laminate Top**  
 COM Yardage: N/A  
 Freight Class: 175  
 Product Weight (lbs.): 60  
 Cubic Feet Per Carton: 19

	1	2	3	4	5	6	7	8	9	10	11	12
<b>3401</b>	2052	-	-	-	-	-	-	-	-	-	-	-

OVERALL DIMENSIONS			SEAT DIMENSIONS			BACK DIMENSIONS	
W	D	H	W	D	H	W	H
56	22	15	-	-	-	-	-

RTA 00

DESCRIPTION	FEATURES	MODEL#	STANDARD TEXTILE GRADES													
			1	2	3	4	5	6	7	8	9	10	11	12		
		3402	1489	-	-	-	-	-	-	-	-	-	-	-	-	-



**End Table - Laminate Top**  
 COM Yardage: N/A  
 Freight Class: 250  
 Product Weight (lbs.): 26  
 Cubic Feet Per Carton: 7.75

OVERALL DIMENSIONS			SEAT DIMENSIONS			BACK DIMENSIONS	
W	D	H	W	D	H	W	H
17	22	14.5	-	-	-	-	-



VENTURE



48"W Two Seater Banquette model 8506-48



78"W Three Seater Banquette model 8506-78



60"W Four Seater Banquette, Double Back model 8508-60

EXAMPLE VENTURE ORDER CODE:

8506-48	EL58	TBL
Model #	Textile	Leg Finish

STANDARD FEATURES

- Venture is a solid and durable banquette seating series.
- Banquettes are available with or without fully upholstered backs. Open back banquettes are intended to be placed against walls or in other layouts where the back will not be visible.
- Heavy duty frame has plywood construction suitable for public environments. For 24/7 use environments, must use approved textiles with 100,000 double-rubs and above.
- Cushions are made with highly resilient foam and seats are equipped with a synthetic rubberized webbing suspension system for extra comfort.
- Cushions are fixed and non-removable.
- Ganging bracket kit (8509) gangs single back models 'back to back'. Standard in Black. Contains two brackets
- Legs are metal painted and Chrome with Black glides, suitable for carpet and hard surface flooring. Closed back models are fully upholstered for use in open settings and to support reconfiguration.
- Open back models are available for use against walls or for ganging back to back. They and have a Black outer back protective dust cover.

- Partial assembly (KD) packaging is optional on Double Back models to allow the unit to fit through standard doors. Assembly instructions are included.
- Check textile availability prior to specifying upholstery material.

**Note:** Double-sided models (8508-48 to 8508-78) measure 55" deep, 48" high and weigh over 100 lbs. They may require coordination for special handling and accommodation through doorway and elevators.

OPTIONAL FEATURES:

Add option codes in the following order

- **Model Number**
- **Back and seat textile**  
Specify textile code.
- **Leg Finish.** No upcharge  
(CHM) Chrome  
(TBL) Black  
(TLA) Latte  
(TTU) Tungsten
- **Package options.** No upcharge  
Available on Double Back models.  
(ST) Standard Fully assembled  
(KD) Knocked Down

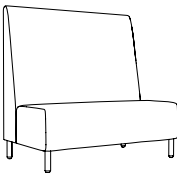
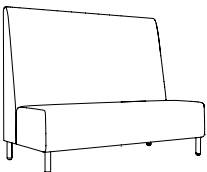
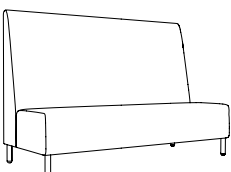
DESCRIPTION	FEATURES	MODEL #	STANDARD TEXTILE GRADES											
			1	2	3	4	5	6	7	8	9	10	11	12
 <b>48"W Two Seater Banquette, Closed Back</b> COM Yardage: 6.75 Freight Class: 300 Product weight (lbs): 104 Cubic Feet Per Carton: 50.75		<b>8506-48</b>	3002	3237	3419	3688	4068	4228	4557	5074	5461	5883	6765	7691
 <b>60"W Two Seater Banquette, Closed Back</b> COM Yardage: 8 Freight Class: 250 Product weight (lbs): 127 Cubic Feet Per Carton: 62.75		<b>8506-60</b>	3579	3856	4072	4392	4841	5031	5420	6033	6491	6992	8038	9135
 <b>72"W Three Seater Banquette, Closed Back</b> COM Yardage: 9 Freight Class: 250 Product weight (lbs): 153 Cubic Feet Per Carton: 75		<b>8506-72</b>	3813	4125	4368	4727	5233	5446	5884	6574	7089	7653	8829	10063

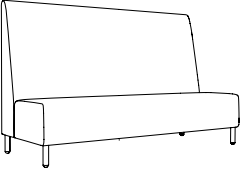
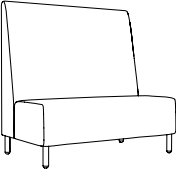
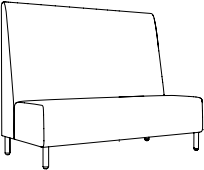
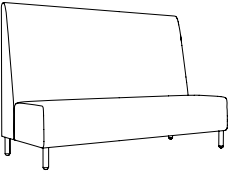
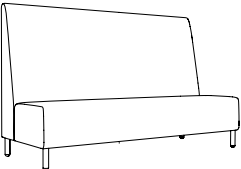
DESCRIPTION	FEATURES	MODEL#	STANDARD TEXTILE GRADES											
			1	2	3	4	5	6	7	8	9	10	11	12
 <p><b>78"W Three Seater Banquette, Closed Back</b>                      COM Yardage: 10                      Freight Class: 250                      Product weight (lbs): 163                      Cubic Feet Per Carton: 79.75</p>		8506-78	4182	4528	4798	5198	5759	5997	6483	7250	7822	8448	9755	11127
	<b>OVERALL DIMENSIONS</b>			<b>SEAT DIMENSIONS</b>			<b>BACK DIMENSIONS</b>							
	<b>W</b>	<b>D</b>	<b>H</b>	<b>W</b>	<b>D</b>	<b>H</b>	<b>W</b>	<b>H</b>						
	78	28	48	78	19	18	78	30						
			<b>RTA 00</b>			1 per carton								
 <p><b>48"W Two Seater Banquette, Open Back</b>                      COM Yardage: 5                      Freight Class: 250                      Product weight (lbs): 105                      Cubic Feet Per Carton: 50.75</p>		8507-48	2825	2998	3133	3333	3614	3733	3976	4359	4645	4958	5612	6298
	<b>OVERALL DIMENSIONS</b>			<b>SEAT DIMENSIONS</b>			<b>BACK DIMENSIONS</b>							
	<b>W</b>	<b>D</b>	<b>H</b>	<b>W</b>	<b>D</b>	<b>H</b>	<b>W</b>	<b>H</b>						
	48	28	48	48	19	18	48	30						
			<b>RTA 00</b>			1 per carton								
 <p><b>60"W Two Seater Banquette, Open Back</b>                      COM Yardage: 6                      Freight Class: 250                      Product weight (lbs): 127                      Cubic Feet Per Carton: 62.75</p>		8507-60	3217	3425	3588	3827	4164	4306	4599	5058	5402	5778	6561	7385
	<b>OVERALL DIMENSIONS</b>			<b>SEAT DIMENSIONS</b>			<b>BACK DIMENSIONS</b>							
	<b>W</b>	<b>D</b>	<b>H</b>	<b>W</b>	<b>D</b>	<b>H</b>	<b>W</b>	<b>H</b>						
	60	28	48	60	19	18	60	30						
			<b>RTA 00</b>			1 per carton								
 <p><b>72"W Three Seater Banquette, Open Back</b>                      COM Yardage: 7                      Freight Class: 250                      Product weight (lbs): 153                      Cubic Feet Per Carton: 75</p>		8507-72	3606	3848	4037	4317	4710	4877	5217	5754	6154	6593	7507	8468
	<b>OVERALL DIMENSIONS</b>			<b>SEAT DIMENSIONS</b>			<b>BACK DIMENSIONS</b>							
	<b>W</b>	<b>D</b>	<b>H</b>	<b>W</b>	<b>D</b>	<b>H</b>	<b>W</b>	<b>H</b>						
	72	28	48	72	19	18	72	30						
			<b>RTA 00</b>			1 per carton								
 <p><b>78"W Three Seater Banquette, Open Back</b>                      COM Yardage: 8                      Freight Class: 250                      Product weight (lbs): 163                      Cubic Feet Per Carton: 79.75</p>		8507-78	3961	4238	4455	4774	5223	5413	5803	6415	6874	7375	8420	9518
	<b>OVERALL DIMENSIONS</b>			<b>SEAT DIMENSIONS</b>			<b>BACK DIMENSIONS</b>							
	<b>W</b>	<b>D</b>	<b>H</b>	<b>W</b>	<b>D</b>	<b>H</b>	<b>W</b>	<b>H</b>						
	78	28	48	78	19	18	78	30						
			<b>RTA 00</b>			1 per carton								

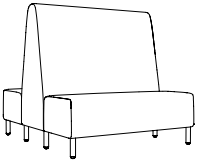
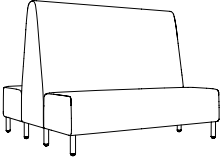
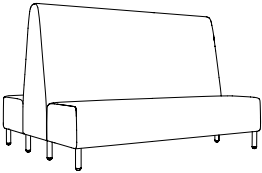
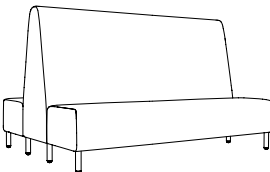
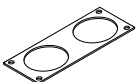
DESCRIPTION	FEATURES	MODEL#	STANDARD TEXTILE GRADES											
			1	2	3	4	5	6	7	8	9	10	11	12
 <p><b>48"W Four Seater Banquette, Double Back</b>                      COM Yardage: 9                      Freight Class: 300                      Product weight (lbs): 163                      Cubic Feet Per Carton: 89.75</p>	optional (KD) packaging (no upcharge)	<b>8508-48</b>	5449	5761	6005	6364	6870	7082	7521	8210	8726	9290	10465	11701
			<b>OVERALL DIMENSIONS</b> W D H			<b>SEAT DIMENSIONS</b> W D H			<b>BACK DIMENSIONS</b> W H					
			48	55	48	48	19	18	48	30				
			<b>RTA 00</b>			1 per carton								
 <p><b>60"W Four Seater Banquette, Double Back</b>                      COM Yardage: 10                      Freight Class: 300                      Product weight (lbs): 198                      Cubic Feet Per Carton: 111</p>	optional (KD) packaging (no upcharge)	<b>8508-60</b>	6313	6659	6929	7329	7890	8128	8614	9381	9953	10579	11886	13258
			<b>OVERALL DIMENSIONS</b> W D H			<b>SEAT DIMENSIONS</b> W D H			<b>BACK DIMENSIONS</b> W H					
			60	55	48	60	19	18	60	30				
			<b>RTA 00</b>			1 per carton								
 <p><b>72"W Six Seater Banquette, Double Back</b>                      COM Yardage: 11                      Freight Class: 300                      Product weight (lbs): 242                      Cubic Feet Per Carton: 132.5</p>	optional (KD) packaging (no upcharge)	<b>8508-72</b>	7496	7877	8175	8614	9232	9492	10028	10870	11501	12190	13627	15136
			<b>OVERALL DIMENSIONS</b> W D H			<b>SEAT DIMENSIONS</b> W D H			<b>BACK DIMENSIONS</b> W H					
			72	55	48	72	19	18	72	30				
			<b>RTA 00</b>			1 per carton								
 <p><b>78"W Six Seater Banquette, Double Back</b>                      COM Yardage: 12                      Freight Class: 300                      Product weight (lbs): 255                      Cubic Feet Per Carton: 141.7</p>	optional (KD) packaging (no upcharge)	<b>8508-78</b>	8377	8792	9117	9597	10271	10555	11139	12058	12746	13498	15065	16712
			<b>OVERALL DIMENSIONS</b> W D H			<b>SEAT DIMENSIONS</b> W D H			<b>BACK DIMENSIONS</b> W H					
			78	55	48	78	19	18	78	30				
			<b>RTA 00</b>			1 per carton								
 <p><b>Ganging Bracket Kit</b>                      COM Yardage: n/a                      Freight Class: 70                      Product weight (lbs): 0.5                      Cubic Feet Per Carton: 0.1</p>	Includes two brackets	<b>8509</b>	List price											
			2.5	6	0.25	-	-	-	-	-				
			<b>RTA 00</b>			1 per carton								

VITROLA



Vitrola is offered in two back heights, standard lounge and high back lounge, along with two and three seat sofa models.



Matching ottoman and accent pillow to complete the offering.

STANDARD FEATURES

- Classic soft seating upholstery design with swooping arms.
- Available in standard Lounge, High Back Lounge along with Two and Three Seat Sofa models.
- Matching Ottoman and Accent Pillow complete the offering.
- Fully upholstered with piping details at the bottom of frame.
- Seat cushions are fixed or sewn tight.
- Standard in tapered maple wood legs. Standard in tapered maple wood legs. Legs are equipped with White non-marking glides as standard. Suitable for both carpet and hard surface flooring.
- Back upholstery is continuous without seams. In the event the textile cannot be railroaded, stitch lines will be required (one for 2 seater and two for 3 seater).
- All models ship fully assembled.
- Check textile availability prior to specifying upholstery material.

OPTION CODES

Please add option codes in the following order:

- **Model number**  
**8271** Lounge Chair  
**8272** Two Seat Sofa  
**8273** Three Seat Sofa  
**8274** Ottoman  
**8275** High Back Lounge Chair  
**8276** Accent Pillow
- **Fabric**  
Specify fabric code.
- **Wood Legs**  
**(AA)** Absolute **(AAM)**  
**(BM)** Black **(BKM)**  
**(CM)** Cherry **(ACM)**  
**(EO)** English Oak **(EOM)**  
**(EC)** Espresso Café **(ECM)**  
**(HG)** Grey **(HGM)**  
**(HO)** Honey **(AHM)**  
**(TM)** Mahogany **(TMM)**  
**(VM)** Maple **(AVM)**  
**(MM)** Medium Walnut **(MWM)**  
**(NL)** Natural Walnut **(NLW)**  
**(SN)** Night **(ASM)**  
**(BI)** Noce Biondo **(NBM)**  
**(GI)** Noce Grigio **(NGM)**  
**(EI)** Noce Leggero **(NEM)**  
**(MI)** Noce Medio **(NMM)**  
**(SK)** Shaker Cherry **(SKM)**  
**(TF)** Fruitwood **(TFM)**  
**(TW)** Walnut **(TWM)**  
**(WC)** WC Cream **(WTM)**  
**(WH)** White **(WHM)**  
**(WE)** Winter Cherry **(WCM)**  
(colors shown on website).

EXAMPLE OF ORDER CODE:

8271	WA50	HG
Model Number	Fabric	Wood Legs

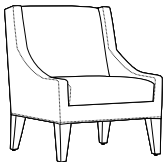
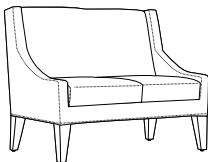
DESCRIPTION	FEATURES	MODEL#	STANDARD TEXTILE GRADES											
			1	2	3	4	5	6	7	8	9	10	11	12
 <p><b>Lounge Chair</b>  COM Yardage: 5.25  Freight Class: 150  Product Weight (lbs.): 90  Cubic Feet Per Carton: 20.25</p>		<b>8271</b>	\$1602	\$1795	\$1945	\$2169	\$2491	\$2644	\$2933	\$3397	\$3754	\$4150	\$4967	\$5840
			<b>OVERALL DIMENSIONS</b>			<b>SEAT DIMENSIONS</b>			<b>BACK DIMENSIONS</b>					
			<b>W</b>	<b>D</b>	<b>H</b>	<b>W</b>	<b>D</b>	<b>H</b>	<b>W</b>	<b>H</b>				
			28	31	34	22	21	17.5	22	18				
			<b>RTA 00</b>											
 <p><b>Two Seat Sofa</b>  COM Yardage: 7.25  Freight Class: 250  Product Weight (lbs.): 107  Cubic Feet Per Carton: 36.5</p>		<b>8272</b>	\$2629	\$2934	\$3174	\$3536	\$4050	\$4292	\$4757	\$5499	\$6069	\$6705	\$8015	\$9409
			<b>OVERALL DIMENSIONS</b>			<b>SEAT DIMENSIONS</b>			<b>BACK DIMENSIONS</b>					
			<b>W</b>	<b>D</b>	<b>H</b>	<b>W</b>	<b>D</b>	<b>H</b>	<b>W</b>	<b>H</b>				
			51	31	34	44	21	17.5	44	18				
			<b>RTA 00</b>											





WIND™



models 3361 Lounge chair & 3362 Two seat sofa, with 3357 Coffee table.

ADDITIONAL STITCH DETAIL - ILLUSTRATIONS BELOW

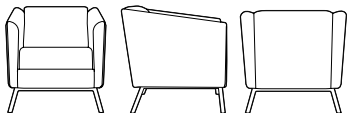

Standard Detailing - when upholstered in FABRIC or VINYL

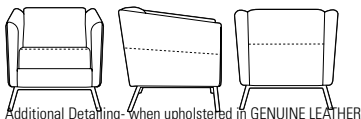

Additional Detailing - when upholstered in GENUINE LEATHER

STANDARD FEATURES

- Compact, contemporary design includes a raised modern version of the traditional lounge chair that is scaled down for smaller spaces.
- Chair and table legs is standard in Chrome.
- There are no caster options for the Wind series.
- Wind tables complement the modern decor of many office environments.
- Check textile availability prior to specifying upholstery material.

OPTIONAL FEATURES



Seating and Table Frame Finish

- (CHM) Chrome (TBL) Black (TBZ) Buzz Blue (TCC) Cactus (TCR) Carrot (TDJ) Dijon (TDW) Designer White (TEG) Eggplant (TFO) Fog (TFR) Frost (TIN) Ink (TIV) Cloud (TKA) Kalua (TLA) Latte (TMO) Mocha (TOA) Toast (TNE) Nevada (TSH) Shadow (TSN) Sand (TSR) Scarlet (TTU) Tungsten (ACO) Antique Chrome. Add \$331 for lounge chair. Add \$414 for two seat sofa. Add \$485 for three seat sofa. Add \$162 for tables.
- (BCH) Brushed Chrome. Add \$156 for lounge chair. Add \$189 for two seat sofa. Add \$212 for three seat sofa. Add \$108 for tables.
- (SBR) Satin Brass. Add \$331 for lounge chair. Add \$414 for two seat sofa. Add \$485 for three seat

sofa. Add \$162 for tables.

Table Tops

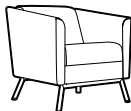
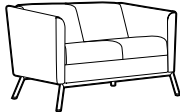
- Table tops are available in the following laminate finishes:
  - (ACJ) Absolute Acajou (ASN) Asian Night (AWC) Avant Cherry (AWH) Avant Honey (BLK) Black (BRC) Brushed Cobalt (CMB) Clear Maple (DES) Dark Espresso (DWT) Designer White (FAS) Fashionista (FCL) First Class (NBL) Noce Biondo (NGL) Noce Grigio (NEL) Noce Leggero (NML) Noce Medio (QTM) Quartered Mahogany (SBY) Sheer Beauty (SOG) Storm Grey (WHE) Walnut Heights (WHC) White Chocolate (WCR) Winter Cherry
- Table tops (models 3366, 3367, 3368, 3870, and 3871) are available in high pressure laminate at a 20% upcharge. Please specify (HPL) in addition to the finish.

DESCRIPTION	FEATURES	MODEL#	STANDARD TEXTILE GRADES											
			1	2	3	4	5	6	7	8	9	10	11	12
 <p><b>Lounge Chair</b> COM Yardage: 4.5 Freight Class: 250 Product Weight (lbs.): 62 Cubic Feet Per Carton: 16.5</p>		3361	-	2546	2679	2873	3146	3247	3488	3939	4166	4582	5164	5883
			<b>OVERALL DIMENSIONS</b>			<b>SEAT DIMENSIONS</b>			<b>BACK DIMENSIONS</b>					
			<b>W</b>	<b>D</b>	<b>H</b>	<b>W</b>	<b>D</b>	<b>H</b>	<b>W</b>	<b>H</b>				
			27.5	29	28.5	19.5	19	17	19	12				
			<b>RTA 00</b>											
 <p><b>Two Seat Sofa</b> COM Yardage: 6.75 Freight Class: 250 Product Weight (lbs.): 102 Cubic Feet Per Carton: 30</p>		3362	-	3383	3582	3868	4278	4436	4793	5470	5806	6434	7308	8384
			<b>OVERALL DIMENSIONS</b>			<b>SEAT DIMENSIONS</b>			<b>BACK DIMENSIONS</b>					
			<b>W</b>	<b>D</b>	<b>H</b>	<b>W</b>	<b>D</b>	<b>H</b>	<b>W</b>	<b>H</b>				
			54.5	29	28.5	46.5	19	17	46.5	12				
			<b>RTA 00</b>											
 <p><b>Three Seat Sofa</b> COM Yardage: 9 Freight Class: 250 Product Weight (lbs.): 135 Cubic Feet Per Carton: 42.5</p>		3363	-	4217	4471	4847	5375	5577	6043	6916	7355	8165	9292	10689
			<b>OVERALL DIMENSIONS</b>			<b>SEAT DIMENSIONS</b>			<b>BACK DIMENSIONS</b>					
			<b>W</b>	<b>D</b>	<b>H</b>	<b>W</b>	<b>D</b>	<b>H</b>	<b>W</b>	<b>H</b>				
			78	29	28.5	70.5	19	17	70.5	12				
			<b>RTA 00</b>											

DESCRIPTION FEATURES MODEL# STANDARD TEXTILE GRADES



**End Table**  
COM Yardage: N/A  
Freight Class: 250  
Product Weight (lbs.): 36  
Cubic Feet Per Carton: 11.5

MODEL#	STANDARD TEXTILE GRADES											
	1	2	3	4	5	6	7	8	9	10	11	12
3366	933	-	-	-	-	-	-	-	-	-	-	-
Laminate Top												
OVERALL DIMENSIONS			SEAT DIMENSIONS			BACK DIMENSIONS						
W	D	H	W	D	H	W	H					
24	24	17	-	-	-	-	-					
<b>RTA 00</b>												



**Rectangular Coffee Table**  
COM Yardage: N/A  
Freight Class: 250  
Product Weight (lbs.): 52  
Cubic Feet Per Carton: 16

MODEL#	STANDARD TEXTILE GRADES											
	1	2	3	4	5	6	7	8	9	10	11	12
3367	1234	-	-	-	-	-	-	-	-	-	-	-
Laminate Top												
OVERALL DIMENSIONS			SEAT DIMENSIONS			BACK DIMENSIONS						
W	D	H	W	D	H	W	H					
48	20	15	-	-	-	-	-					
<b>RTA 00</b>												





**Square Coffee Table**  
COM Yardage: N/A  
Freight Class: 250  
Product Weight (lbs.): 66  
Cubic Feet Per Carton: 22

MODEL#	STANDARD TEXTILE GRADES											
	1	2	3	4	5	6	7	8	9	10	11	12
3368	1670	-	-	-	-	-	-	-	-	-	-	-
Laminate Top												
OVERALL DIMENSIONS			SEAT DIMENSIONS			BACK DIMENSIONS						
W	D	H	W	D	H	W	H					
36	36	15	-	-	-	-	-					
<b>RTA 00</b>												



**Round Table**  
COM Yardage: N/A  
Freight Class: 250  
Product Weight (lbs.): 35  
Cubic Feet Per Carton: 11.5

MODEL#	STANDARD TEXTILE GRADES											
	1	2	3	4	5	6	7	8	9	10	11	12
3870	1020	-	-	-	-	-	-	-	-	-	-	-
Laminate Top												
OVERALL DIMENSIONS			SEAT DIMENSIONS			BACK DIMENSIONS						
W	D	H	W	D	H	W	H					
24	24	17	-	-	-	-	-					
<b>RTA 00</b>  												



**Round Coffee Table**  
COM Yardage: N/A  
Freight Class: 250  
Product Weight (lbs.): 57  
Cubic Feet Per Carton: 22

MODEL#	STANDARD TEXTILE GRADES											
	1	2	3	4	5	6	7	8	9	10	11	12
3871	1501	-	-	-	-	-	-	-	-	-	-	-
Laminate Top												
OVERALL DIMENSIONS			SEAT DIMENSIONS			BACK DIMENSIONS						
W	D	H	W	D	H	W	H					
36	36	15	-	-	-	-	-					
<b>RTA 00</b>												

# LOUNGE

WIND™ LINEAR



models 3363R and 3363L with 3882 bridge table, 3360 table attaching bracket kit and two 3380 coffee tables

# WIND™ LINEAR W

## STANDARD FEATURES

- Wind Linear is an extension of the Wind lounge series with an emphasis on expansive, clean lines. Wind Linear tables complement the modern decor of many offices.
- This modular furniture series includes single arm and armless sofas, benches, bridges and tables
- Seating and freestanding tables can be used as stand-alone products. Seating units can be linked together using bridge tables to create infinite configurations. Note: an upholstered seat unit cannot be linked with another upholstered seat unit.
- Chair and table legs are standard in Chrome.
- There are no caster options for the Wind Linear series.
- Table 'bridges' can mount outside or in-between seats to accommodate various work and collaborative settings. Requires table attaching bracket kit (3360).
- Please note Bridge End Table (model 3882) is only to be used with Chairs and/or Sofa models. Not usable with Bench or Ottoman Models.
- Please note Bridge Table (model 3884) is only to be used with Bench models 3361B and/or Ottoman models 3363B.
- Check textile availability prior to specifying upholstery material.

## OPTIONAL FEATURES

- Wind Linear table models are offered in laminate finishes to coordinate with Global casegoods and wood seating.
- **Table Tops**  
Table tops are available in the following laminate finishes:  

(ACJ) Absolute Acajou	(ASN) Asian Night
(AWC) Avant Cherry	(AWH) Avant Honey
(BLK) Black	(BRC) Brushed Cobalt
(CMB) Clear Maple	(DES) Dark Espresso
(DWT) Designer White	(FAS) Fashionista
(FCL) First Class	
(NBL) Noce Biondo	(NGL) Noce Grigio
(NEL) Noce Leggero	(NML) Noce Medio
(QTM) Quartered Mahogany	
(SBY) Sheer Beauty	(SOG) Storm Grey
(WHE) Walnut Heights	(WHC) White Chocolate
(WCR) Winter Cherry	
- Table tops are not available in high pressure laminate.
- Chair and Table legs are available in Tungsten (TUN), Charcoal (CHR) and Black (BLK) finishes at no up charge.

## SAMPLE LAYOUTS

### Layout A



Qty	Model Number	Description	Dimensions	List Price
1	<b>3361R</b>	Single Seater - Right Arm	39.5 x 29 x 28.5	2695
1	<b>3361L</b>	Single Seater - Left Arm	39.5 x 29 x 28.5	2695
1	<b>3363NA</b>	Single Sofa - Armless	72 x 29 x 28.5	3590
1	<b>3881R</b>	Bridge Corner Table - Right	25 x 25 x 12	1743
1	<b>3881L</b>	Bridge Corner Table - Left	25 x 25 x 12	1743
2	<b>3360</b>	Table Bracket Kit - 1 Kit per table		193 x 2

**SAMPLE LAYOUT TOTAL IN STANDARD BLACK FRAME**

**\$12,852**

### Layout B



Qty	Model Number	Description	Dimensions	List Price
1	<b>3361R</b>	Single Seater - Right Arm	39.5 x 29 x 28.5	2695
1	<b>3361L</b>	Single Seater - Left Arm	39.5 x 29 x 28.5	2695
1	<b>3361NA</b>	Single Seater - Armless	36.5 x 29 x 28.5	2382
2	<b>3882</b>	Bridge End Table	25 x 20 x 12	952 x 2
2	<b>3360</b>	Table Bracket Kit - 1 Kit per table		193 x 2

**SAMPLE LAYOUT TOTAL IN STANDARD BLACK FRAME**

**\$10,062**

## DESCRIPTION

## FEATURES

## MODEL#

## STANDARD TEXTILE GRADES

	1	2	3	4	5	6	7	8	9	10	11	12
<b>3360</b>	193	-	-	-	-	-	-	-	-	-	-	-

## OVERALL DIMENSIONS

## SEAT DIMENSIONS

## BACK DIMENSIONS

W	D	H	W	D	H	W	H
-	-	-	-	-	-	-	-

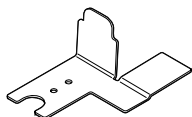



### Table Bracket Kit

COM Yardage: N/A  
Freight Class: 70  
Product Weight (lbs.): 1.5  
Cubic Feet Per Carton: 0.03 ( 1 Kit per carton)







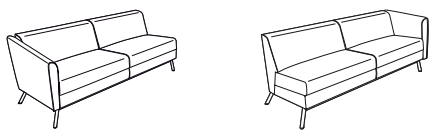
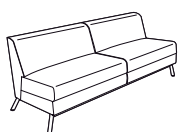

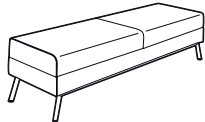
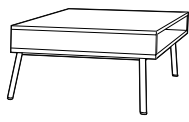
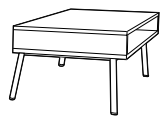
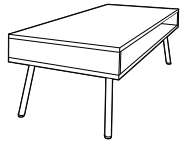
Includes 4 brackets and hardware.  
Use with models 3381R, 3381L, & 3382.

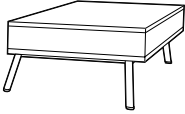
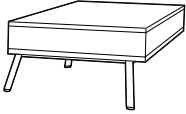
RTA 00

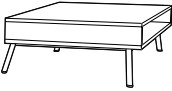
FedEx UPS

DESCRIPTION	FEATURES	MODEL#	STANDARD TEXTILE GRADES											
			1	2	3	4	5	6	7	8	9	10	11	12
 <p><b>3361R</b>      <b>3361L</b></p> <p><b>Single Seater - w/ Left or Right Arm</b>                      COM Yardage: 4.75                      Freight Class: 250                      Product Weight (lbs.): 72                      Cubic Feet Per Carton: 28.5</p>														
	<p><b>3361R</b>      <b>3361L</b></p> <p>-      2695   2832   3030   3310   3415   3659   4121   4351   4782   5377   6114</p>													
			<b>OVERALL DIMENSIONS</b>			<b>SEAT DIMENSIONS</b>			<b>BACK DIMENSIONS</b>					
			<b>W</b>	<b>D</b>	<b>H</b>	<b>W</b>	<b>D</b>	<b>H</b>	<b>W</b>	<b>H</b>				
			39.5	29	28.5	36	19	17	36	12				
			<b>RTA 00</b>											
 <p><b>3361NA</b></p> <p><b>Single Seater - Armless</b>                      COM Yardage: 3.25                      Freight Class: 250                      Product Weight (lbs.): 58                      Cubic Feet Per Carton: 28.5</p>														
	<p><b>3361NA</b></p> <p>-      2382   2476   2614   2805   2877   3045   3360   3515   3811   4221   4720</p>													
			<b>OVERALL DIMENSIONS</b>			<b>SEAT DIMENSIONS</b>			<b>BACK DIMENSIONS</b>					
			<b>W</b>	<b>D</b>	<b>H</b>	<b>W</b>	<b>D</b>	<b>H</b>	<b>W</b>	<b>H</b>				
			36.5	29	28.5	36.5	19	17.5	36.5	12				
			<b>RTA 00</b>											
 <p><b>3363R</b>      <b>3363L</b></p> <p><b>Single Sofa - w/ Left or Right Arm</b>                      COM Yardage: 7.75                      Freight Class: 250                      Product Weight (lbs.): 120                      Cubic Feet Per Carton: 41</p>														
	<p><b>3363R</b>      <b>3363L</b></p> <p>-      4035   4254   4578   5034   5208   5607   6360   6738   7436   8407   9610</p>													
			<b>OVERALL DIMENSIONS</b>			<b>SEAT DIMENSIONS</b>			<b>BACK DIMENSIONS</b>					
			<b>W</b>	<b>D</b>	<b>H</b>	<b>W</b>	<b>D</b>	<b>H</b>	<b>W</b>	<b>H</b>				
			75	29	28.5	71	19	17	71	12				
			<b>RTA 00</b>											
 <p><b>3363NA</b></p> <p><b>Single Sofa - Armless</b>                      COM Yardage: 6.5                      Freight Class: 250                      Product Weight (lbs.): 111                      Cubic Feet Per Carton: 39.25</p>														
	<p><b>3363NA</b></p> <p>-      3590   3774   4045   4426   4574   4910   5539   5856   6444   7258   8264</p>													
			<b>OVERALL DIMENSIONS</b>			<b>SEAT DIMENSIONS</b>			<b>BACK DIMENSIONS</b>					
			<b>W</b>	<b>D</b>	<b>H</b>	<b>W</b>	<b>D</b>	<b>H</b>	<b>W</b>	<b>H</b>				
			72	29	28.5	72	19	17	72	12				
			<b>RTA 00</b>											

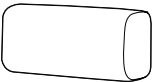
DESCRIPTION	FEATURES	MODEL#	STANDARD TEXTILE GRADES												
			1	2	3	4	5	6	7	8	9	10	11	12	
 <p><b>Ottoman</b> COM Yardage: 1.75 Freight Class: 150 Product Weight (lbs.): 50 Cubic Feet Per Carton: 12.5</p>		<b>3361B</b>	-	1771	1823	1897	2004	2052	2147	2301	2417	2548	2818	3104	
			<b>OVERALL DIMENSIONS</b>			<b>SEAT DIMENSIONS</b>			<b>BACK DIMENSIONS</b>						
			<b>W</b>	<b>D</b>	<b>H</b>	<b>W</b>	<b>D</b>	<b>H</b>	<b>W</b>	<b>H</b>					
			35.5	20.5	17.5	-	-	-	-	-					
			<b>RTA 00</b>												
 <p><b>Bench</b> COM Yardage: 3.5 Freight Class: 150 Product Weight (lbs.): 80 Cubic Feet Per Carton: 18.75</p>		<b>3363B</b>	-	2726	2852	2949	3095	3303	3373	3556	3900	4067	4386	4820	
			<b>OVERALL DIMENSIONS</b>			<b>SEAT DIMENSIONS</b>			<b>BACK DIMENSIONS</b>						
			<b>W</b>	<b>D</b>	<b>H</b>	<b>W</b>	<b>D</b>	<b>H</b>	<b>W</b>	<b>H</b>					
			72	20.5	17.5	-	-	-	-	-					
			<b>RTA 00</b>												
 <p><b>Side Table - Rectangular</b> COM Yardage: N/A Freight Class: 250 Product Weight (lbs.): 38 Cubic Feet Per Carton: 11.5</p>	Freestanding.	<b>3878</b>	1334	-	-	-	-	-	-	-	-	-	-	-	
				<b>OVERALL DIMENSIONS</b>			<b>SEAT DIMENSIONS</b>			<b>BACK DIMENSIONS</b>					
				<b>W</b>	<b>D</b>	<b>H</b>	<b>W</b>	<b>D</b>	<b>H</b>	<b>W</b>	<b>H</b>				
				20	25	16	-	-	-	-	-				
			<b>RTA 00</b>												
 <p><b>Side Table - 25" Square</b> COM Yardage: N/A Freight Class: 250 Product Weight (lbs.): 40 Cubic Feet Per Carton: 11.5</p>	Freestanding.	<b>3879</b>	1455	-	-	-	-	-	-	-	-	-	-	-	
				<b>OVERALL DIMENSIONS</b>			<b>SEAT DIMENSIONS</b>			<b>BACK DIMENSIONS</b>					
				<b>W</b>	<b>D</b>	<b>H</b>	<b>W</b>	<b>D</b>	<b>H</b>	<b>W</b>	<b>H</b>				
				25	25	16	-	-	-	-	-				
			<b>RTA 00</b>												
 <p><b>Coffee Table - 54"</b> COM Yardage: N/A Freight Class: 250 Product Weight (lbs.): 52 Cubic Feet Per Carton: 16</p>	Freestanding.	<b>3880</b>	1623	-	-	-	-	-	-	-	-	-	-	-	
				<b>OVERALL DIMENSIONS</b>			<b>SEAT DIMENSIONS</b>			<b>BACK DIMENSIONS</b>					
				<b>W</b>	<b>D</b>	<b>H</b>	<b>W</b>	<b>D</b>	<b>H</b>	<b>W</b>	<b>H</b>				
				20	54	15	-	-	-	-	-				
			<b>RTA 00</b>												

DESCRIPTION	FEATURES	MODEL#	STANDARD TEXTILE GRADES											
			1	2	3	4	5	6	7	8	9	10	11	12
 <p><b>3881R</b></p> <p><b>Bridge Corner Table</b> COM Yardage: - Freight Class: 250 Product Weight (lbs.): 33 Cubic Feet Per Carton: 11.5</p>	 <p><b>3881L</b></p> <p>Require Bracket Kit (3360).</p>	<p><b>3881R</b> 1743</p> <p><b>3881L</b></p>												
			<p><b>OVERALL DIMENSIONS</b></p> <p><b>W D H</b></p> <p>25 25 12</p>			<p><b>SEAT DIMENSIONS</b></p> <p><b>W D H</b></p> <p>- - -</p>			<p><b>BACK DIMENSIONS</b></p> <p><b>W H</b></p> <p>- -</p>					
			<p><b>RTA 00</b></p>											
 <p><b>3882</b></p> <p><b>Bridge End Table</b> COM Yardage: N/A Freight Class: 250 Product Weight (lbs.): 25 Cubic Feet Per Carton: 3.4</p>	<p>Require Bracket Kit (3360). To be used with Chair and Sofa models. Not usable with Bench or Ottoman Models</p>	<p><b>3882</b> 952</p>												
			<p><b>OVERALL DIMENSIONS</b></p> <p><b>W D H</b></p> <p>20 25 5</p>			<p><b>SEAT DIMENSIONS</b></p> <p><b>W D H</b></p> <p>- - -</p>			<p><b>BACK DIMENSIONS</b></p> <p><b>W H</b></p> <p>- -</p>					
			<p><b>RTA 00</b></p>											
 <p><b>3883</b></p> <p><b>Low Side Table</b> COM Yardage: N/A Freight Class: 250 Product Weight (lbs.): 32 Cubic Feet Per Carton: 11.5</p>	<p>Freestanding.</p>	<p><b>3883</b> 1321</p>												
			<p><b>OVERALL DIMENSIONS</b></p> <p><b>W D H</b></p> <p>20 25 12</p>			<p><b>SEAT DIMENSIONS</b></p> <p><b>W D H</b></p> <p>- - -</p>			<p><b>BACK DIMENSIONS</b></p> <p><b>W H</b></p> <p>- -</p>					
			<p><b>RTA 00</b></p>											
 <p><b>3884</b></p> <p><b>Bridge Table - 20" Square</b> COM Yardage: N/A Freight Class: 125 Product Weight (lbs.): 23 Cubic Feet Per Carton: 3.4</p>	<p>Require Bracket Kit (3360). To be used with models 3361B and/or 3363B.</p>	<p><b>3884</b> 886</p>												
			<p><b>OVERALL DIMENSIONS</b></p> <p><b>W D H</b></p> <p>20 20 5</p>			<p><b>SEAT DIMENSIONS</b></p> <p><b>W D H</b></p> <p>- - -</p>			<p><b>BACK DIMENSIONS</b></p> <p><b>W H</b></p> <p>- -</p>					
			<p><b>RTA 00</b>  </p>											
 <p><b>3885</b></p> <p><b>Bolster Cushion</b> COM Yardage: 1 Freight Class: 70 Product Weight (lbs.): 1.5 Cubic Feet Per Carton: 1.3</p>	<p>1 Loose Cushion.</p>	<p><b>3885</b> - 249 282 322 381 406 456 554 602 692 816 972</p>												
			<p><b>OVERALL DIMENSIONS</b></p> <p><b>W D H</b></p> <p>16 5 7</p>			<p><b>SEAT DIMENSIONS</b></p> <p><b>W D H</b></p> <p>- - -</p>			<p><b>BACK DIMENSIONS</b></p> <p><b>W H</b></p> <p>- -</p>					
			<p><b>RTA 00</b>  </p>											



