

think global

THE GLOBAL EDGE

ERGONOMICS IN THE TOTAL OFFICE

- One stop shopping for a full range of office furniture.
- Seating, desks, tables, files, modular furniture, panels and accessories.
- Ergonomics, competitive pricing and built-in value.

STRENGTH AND STABILITY

- Established in 1966.
- One of North America's largest office furniture manufacturers.
- Manufacturing and showrooms worldwide.

QUICK SHIP - INSTOCK

- Thousands of products available in a 2 day quickship program.
- Hundreds of products in stock for immediate delivery.

STRONG LOCAL REPRESENTATION

- Service and expert advice where you are, when you need it!

MANUFACTURING CAPABILITY

- Vertical integration ensures "start to finish" control.
- Ongoing research and investment in new, innovative production technology.

QUALITY ASSURANCE

- Quality Assurance Program is qualified by C.G.S.B. ISO9001 standards.
- On-site furniture testing facility.
- Product and components are tested to meet or exceed ANSI/BIFMA standards.

ENVIRONMENTAL COMMITMENT

- Continuous development of "earth friendly" programs.
- One of the first molded foam manufacturers to create ozone friendly, CFC and HFC-free process.
- Seat and back pans are made from recyclable plastics and wood waste, enabling little waste and cost effective products.

SYMBOL IDENTIFICATION

Each seating product with an RTA code identifies the assembly requirements.

RTA 00 FULLY ASSEMBLED

RTA 1 SIMPLE ASSEMBLY (No Tools Required)

Parts to Install:

- Casters
- Base
- Pneumatic Cylinder/Cover can

RTA 2 MODEST ASSEMBLY (Tools Supplied, if necessary)

Parts to Install:

- Casters
- Base
- Pneumatic Cylinder/Cover can
- Back

RTA 4 MODERATE ASSEMBLY (Tools Supplied)

Parts to Install:

- Casters
- Base
- Pneumatic Cylinder/Cover can
- Back
- Armrest

RTA 8 FULL ASSEMBLY (Tools Supplied)

Parts to Install:

- Casters
- Base
- Pneumatic Cylinder/Cover can
- Back
- Armrest
- Mechanism



Global's Certified Products are in compliance with the stringent emission guidelines set by the GREENGUARD Environmental Institute and include all Upholstered Seating. To obtain a GREENGUARD or GREENGUARD Gold Certificate for any product, please go to the Environmental Commitment section on our website www.globalfurnituregroup.com and click on "GREENGUARD".



level™ certification, based on the ANSI/BIFMA e3-2012 furniture sustainability standard, sets furniture manufacturers on a path toward greater sustainability over time. Based on environmental and social criteria set forth in the standard, a product's entire supply chain is assessed.

Certification assessment includes an evaluation of specific corporate policies and guidelines and an assessment of associated company manufacturing facilities. Products must meet quantifiable milestones of environmental and social performance at every step of development.

The quantitative assessment addresses four categories: material use, energy and atmosphere impacts, human and ecosystem health and social responsibility.

Manufacturers earn points in each of the four categories. The level™ brand and its numeric rating of 1, 2 or 3 indicate what threshold of certification a product has achieved. level™ 3 is the highest rating.



All products with this designation are suitable for FedEx and UPS shipment throughout the United States.

TABLE OF CONTENTS

A

Academic Task	441
Arno	25
Arturo	26
Aspen	27
Auburn	29

B

Bakhita	135
Ballara	272
Beach	138
Beam Seating	139
Braden	284
Bridges II Collaborative Seating	287

C

Calidon	295
Camino	301
Caprice	149
Chap	151
Citi	306
Citi Square.....	311
Comet	153
Concorde	30

D

Diplomat	32
Drift	320
Duet	157
Duet tables	174

E

Enterprise	33
Erin	177

F

Factor.....	37
File Buddy	181
Flap	182

G

G1	39
G20	41
Global Accord	42
Goal	46
Graham	48
Granada	49
Granada Deluxe	54
Granada Deluxe TS	421
Graphic	58

I

Industrial Seating	443
Industrial Wipe Down	448
Islands	184

J

Jeo.....	338
----------	-----

K

Kate	341
------------	-----

L

Layne	185
Lite	187
Loover	60
Luray	64
Lux.....	342

M

Malaga	67
Malaga TS	421
Marche	192
Mayne	194
Mirage	68
ML	344
ML Park	344
Moda Four-Legged	195
Moda Stacking	196

N

Noetic.....	69
Novello	74

O

ObusForme Comfort + XL78

P

Popcorn198

Prairie347

Prefer84

R

Rambler348

Rebound203

River351

River Personal Harbor367

River+369

Robust427

Roma86

Roma Nester208

S

Sas210

Saxon428

Sidero212

Sirena397

Solar90

Solo92

Sonic216

Sora94

Spritz96

Spritz multi-purpose232

Spyker235

Stream236

Supra101

Supra X103

Synopsis106

T

Tamiri109

Traditional111

Triumph115

Truform116

Twilight248

Tye119

V

Venture401

Vion122

Vion guest251

Vitrola404

W

Weev130

Willow256

Wind406

Wind Linear410

Z

Zoma270

REFERENCES/PROGRAMS

Seating by Category Types 4-11

Suggested Applications by Series 12-13

Ergonomic Features and Benefits 15

Mechanism Adjustments 16

How to Order Seating 17

Act Performance Symbols 18

Fast 19

Heavy Duty/24 Hour 420

How to select armrests 432

Arm selections 433

Caster selections 436

Cylinder chart 438

Duet + Popcorn glide selections 439

Specialty seating 441

Textiles + Finishes 454















COM Authorization Form 461

Terms/Conditions/Warranty 464

SEATING BY CATEGORY TYPE



















Task

 Arno.....25	 Luray64	 Stream.....98
 Aspen27	 Malaga67	 Supra101
 Duet.....135	 Noetic.....69	 Supra X103
 Enterprise33	 Novello74	 Synopsis106
 Factor37	 ObusForme Comfort + XL78	 Tamiri109
 G139	 Popcorn198	 Triumph115
 G2041	 Prefer84	 Truform116
 Goal46	 Roma86	 Tye119
 Graham48	 Solar90	 Vion122
 Granada49	 Solo92	 Weev130
 Granada Deluxe54	 Sonic216	
 Graphic58	 Sora94	
 Loover60	 Spritz96	

SEATING BY CATEGORY TYPE

Conference/Management

























 Arno25	 Kate.....341	 Solar90
 Arturo26	 Luray64	 Solo92
 Diplomat32	 Mirage68	 Supra101
 Enterprise33	 Roma86	 Synopsis106
 Global Accord42		 Tamiri109
 Graphic58		 Traditional111
 Jeo338		

SEATING BY CATEGORY TYPE

Executive















	Arno25		Enterprise.....33		
	Arturo26		Global Accord42		Synopsis.....106
	Auburn29		Luray64		Tamiri109
	Concorde30		Mirage68		Traditional111
	Diplomat.....32				

Height Adjustable Stools

	Aspen27		Loover60		Spritz96
	Duet.....157		Malaga67		Stream.....98
	Factor37		Noetic.....69		Supra X.....103
	G1 Ergo Select39		Novello74		Synopsis106
	Global Accord42		ObusForme Comfort + XL78		Truform116
	Goal46		Prefer84		Tye119
	Granada49		Roma86		Vion122
	Granada Deluxe54		Solar90		Weev130
	Graphic58				



Stacking







 Bakhita135	 Popcorn198	 Spyker235
 Comet153	 Rebound203	 Stream236
 Duet157	 Sas210	 Vion guest251
 Flap182	 Sidero212	 Willow256
 Moda196	 Sonic216	 Zoma270

Guest (Metal)

 Arno25	 Factor179	 Sas210
 Caprice149	 Jeo338	 Sidero212
 Comet153	 Kate341	 Sonic216
 Diplomat156	 Lite187	 Stream236
 Drift320	 Marche192	 Twilight248
 Enterprise33	 Popcorn198	 Vion guest251
 Erin177	 Rebound203	 Willow256

SEATING BY CATEGORY TYPE















Guest (Wood)

 Beach138	 Drift.....320	 Layne185
 Chap151	 Islands184	 Mayne194















Nesting

 Roma Nester208	 Spritz Nester232
--	--

Tandem/Beam/Pedestal

 Duet (Beam)144	 Sidero (Beam)146	 Synopsis (Pedestal).....106
 Duet (Pedestal).....157	 Sonic (Beam)146	 Vion (Beam)147
 Global Accord (Pedestal).....42	 Sonic (Pedestal).....216	 Vion (Pedestal).....122
 Luray (Pedestal).....64	 Spritz (Pedestal).....232	Beam Seating139
 Novello (Pedestal).....74	 Stream (Pedestal).....236	
 Popcorn (Beam)145		

Stools

 Diplomat156	 ML.....344	 Sonic216
 Duet157	 Popcorn198	 Stream236
 Drift.....320	 Rebound203	 Twilight248
 File Buddy181	 Sas210	 Vion guest251
 Marche192	 Sidero212	 Willow.....256



LOUNGE SEATING

Ballara.....272	Kate.....341	River+369
Braden.....284	Lux.....342	Sirena.....397
Bridges II Collaborative Seating...287	ML.....344	Venture.....401
Camino.....301	ML Park346	Vitrola.....404
Citi.....306	Prairie.....347	Wind.....406
Drift.....320	Rambler.....348	Wind Linear.....410
Jeo338	River351	

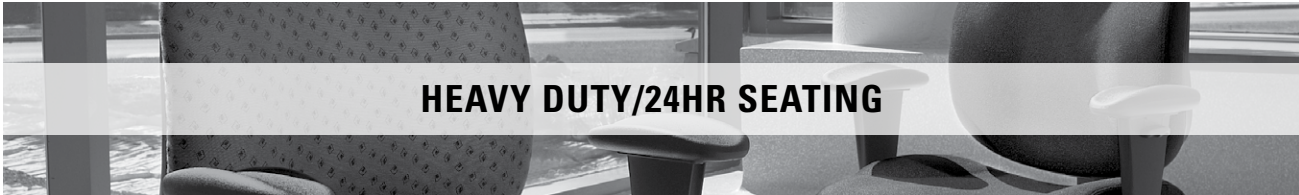

HEAVY DUTY/24HR SEATING

Concorde Executive 24HR424	Malaga TS421	Saxon428
G1 Ergo Select TS425	ObusForme Comfort TS422	Truform TS423
Granada TS420	Robust427	Vion TS429
Granada Deluxe TS421		

SEATING BY CATEGORY TYPE



EDUCATION

Classroom

Academic Task441	Popcorn198	Spritz Nester232
Duet157	Rebound203	Supra X103
Duet tables174	Roma Nester208	Vion122
Graphic58	Sidero212	Willow256
Novello74	Sonic216	

Work + Task

Factor37	Noetic69	Sora94
G139	Novello74	Spritz96
Granada49	ObusForme Comfort + XL78	Supra X103
Graphic58	Prefer84	Truform116
Loover60	Roma86	Vion122

SEATING BY CATEGORY TYPE

Guest

Caprice149	Rebound203	Vion guest251
Duet157	Roma Nester208	Willow.....256
Graphic58	Sidero212	Zoma270
Islands184	Sonic216	

Lecture Hall

Duet (Beam)144	Sidero (Beam)146	Vion (Beam)147
Popcorn (Beam)145	Sonic (Beam)146	

Lab Seating + Stools

Caprice149	Novello74	Spritz96
Duet157	Sidero212	Supra X103
Graphic58	Sonic216	Vion122

Cafeteria

Bakhita135	Popcorn198	Spyker235
Duet157	Rebound203	Willow.....256
Sas210	Sonic216	

SEATING BY CATEGORY TYPE



EDUCATION

Lounge

Ballara.....272	Citi Square.....311	Sirena.....397
Citi.....306	River.....351	Wind Linear.....410
Drift.....320	River+.....369	

Stacking & Nesting

Bakhita.....135	Roma Nester.....208	Spritz Nester.....232
Duet.....157	Sas.....210	Spyker.....235
Popcorn.....198	Sidero.....212	Stream.....236
Rebound.....203	Sonic.....216	Zoma.....270

SUGGESTED APPLICATIONS BY SERIES

SERIES	SUGGESTED APPLICATION	ACADEMIC SEATING	CAFETERIA SEATING	CONFERENCE ROOM SEATING	ERGONOMIC AND TASK	EXECUTIVE TASK SEATING	HEAVY DUTY SEATING	HOSPITALITY SEATING	GUEST SEATING	LOUNGE/RECEPTION SEATING	MANAGEMENT SEATING	MEETING ROOM SEATING	MULTI PURPOSE SEATING	PUBLIC SEATING	STACKING SEATING	STOODLS	TABLET SEATING	TECHNICAL SEATING	WOOD GUEST SEATING
ARNO			•					•		•	•								
ARTURO			•							•									
ASPEN				•	•					•	•								
AUBURN			•							•									
BAKHITA	•	•										•		•					
BALLARA							•		•							•			
BEACH							•	•	•			•	•						•
BEAM SEATING	•	•					•	•											
BRADEN									•										
BRIDGES II COLLAB. SEATING							•	•	•				•						
CAMINO							•	•	•										
CAPRICE		•						•				•				•			
CHAP							•	•	•										•
CITI & CITI SQUARE								•	•				•				•		
COMET		•						•	•		•	•							
CONCORDE					•	•													
DIPLOMAT			•					•		•	•					•			•
DUET	•	•	•	•					•		•	•	•	•	•	•	•		
ENTERPRISE			•	•				•		•	•								
FACTOR			•	•							•					•			
FILE BUDDY													•			•			
G1 ERGO SELECT			•	•	•					•							•		
G20			•	•	•					•	•								
GLOBAL ACCORD			•							•	•		•			•			
GOAL	•			•															•
GRAHAM				•															
GRANADA & GRANADA DELUXE	•			•		•		•								•		•	
GRAPHIC			•								•						•		
ISLANDS							•	•	•										•
JEO								•	•				•						
KATE			•					•											
LAYNE							•	•											•
LITE	•	•					•	•	•			•							
LOOVER			•	•				•		•									
LURAY			•	•						•			•						
LUX								•	•										
MALAGA	•			•		•		•								•			
MARCHE							•	•			•					•			

SUGGESTED APPLICATIONS BY SERIES

SERIES	SUGGESTED APPLICATION	ACADEMIC SEATING	CAFETERIA SEATING	CONFERENCE ROOM SEATING	ERGONOMIC AND TASK	EXECUTIVE TASK SEATING	HEAVY DUTY SEATING	HOSPITALITY SEATING	GUEST SEATING	LOUNGE/RECEPTION SEATING	MANAGEMENT SEATING	MEETING ROOM SEATING	MULTI PURPOSE SEATING	PUBLIC SEATING	STACKING SEATING	STOODLS	TABLET SEATING	TECHNICAL SEATING	WOOD GUEST SEATING
MAYNE								•	•										•
MIRAGE																			
ML			•					•	•	•						•			
ML PARK			•					•	•	•						•			
MODA			•						•						•				
NOVELLO	•			•	•			•			•	•	•			•			
OBUSFORME COMFORT				•	•					•									
POPCORN			•	•					•	•	•	•	•						
PRAIRIE									•										
RIVER								•	•	•			•						
ROBUST							•			•									
ROMA			•	•	•						•	•	•			•			
ROMA NESTER												•	•						
SAS			•					•	•					•	•				•
SAXON							•												
SIDERO			•					•	•			•		•	•				
SIRENA								•	•								•		
SOLAR				•	•			•											
SOLO				•					•	•									
SONIC			•	•				•	•	•	•	•	•	•	•	•	•		
SPRITZ	•	•		•				•	•	•	•	•	•	•	•				
SPYKER			•									•		•					
STREAM	•	•		•				•	•	•	•	•	•	•	•	•	•		
SUPRA				•				•		•									
SUPRA X	•			•													•		
SYNOPSIS				•	•			•		•	•					•			
TAMIRI				•				•		•									
TRADITIONAL								•	•	•									
TRIMPH					•					•									
TRIFORM				•		•				•									
TWILIGHT			•					•			•	•				•			
TYE				•	•			•			•								
VENTURE								•	•				•						
VION				•	•	•	•	•	•	•			•	•	•				
VITROLA								•		•			•						
WEEV				•	•					•						•			
WIND & WIND LINEAR									•										
ZOMA			•					•	•	•	•	•		•					

ERGONOMIC FEATURES & BENEFITS

EACH GLOBAL CHAIR IS BUILT WITH FEATURES THAT ARE ERGONOMICALLY DESIGNED TO PROMOTE GOOD POSTURE AND PROVIDE MAXIMUM COMFORT. WHILE FULLY SUPPORTING YOUR BODY, THESE FEATURES SHOULD ALSO ALLOW YOU TO ADJUST YOUR CHAIR TO FIT YOU.



A TENSION ADJUSTMENT

Increase or decrease to match body weight. Allows you to rock comfortably, without heavy pushing, reducing muscle fatigue.



B CHAIR TILT LOCK

Lock the tilt movement in position(s) to accommodate your working posture. Allows you to lock your chair in a comfortable and supportive position. (Can be either single position or infinite style).



C SEAT HEIGHT

Raise or lower to allow your feet to rest flat on the floor. Avoids pressure under your thighs, easing blood flow.



D BACK HEIGHT

Raise or lower to position lumbar support in your lumbar area. Reduces likelihood of back pain.



E SEAT DEPTH

Change the depth of the seat to accommodate the length of your thighs. Keeps your back in contact with the backrest while avoiding pressure behind your knees.



F FORWARD SEAT ANGLE

Allows chair to tilt forward changing the angle of your thighs in relation to the floor. Helps reduce disc pressure during forward leaning tasks.



G BACK ANGLE

Adjust to change the angle of your torso in relation to your thighs. Helps reduce disc pressure and relaxes your back muscles.



H ARM HEIGHT

Raise or lower to support your forearms. Reduces muscular effort in neck and shoulders, minimizing risk of pain.



J KNEE-TILT MOVEMENT

Chair tilt pivot point is toward the front of the seat. Stability is maintained as the user reclines, keeping their feet on the floor and maintaining the same torso to thigh angle.



L SYNCHRO-TILT MOVEMENT

The seat pivots at the center point, while the backrest reclines at a faster rate than the seat, increasing the angle between the user's torso and thighs. Enhances comfort and encourages dynamic body movement.



M WATERFALL SEAT EDGE

Reduces pressure at the back of the knee, contributing to good blood flow.



N CONTOURED CUSHION

Supports the body effectively, allowing you to sit longer without discomfort.



P VIBRATING SEAT & BACK

Soothing effect contributes to your relaxation during work breaks.



Q WIDTH ADJUSTABLE ARMS

Allows outward movement of armrests to match shoulder breadth. Ensures armrests properly support forearms, reducing muscular efforts in neck and shoulders.



R ARM ROTATION

Rotate armcaps to support your forearms in various positions. Reduces muscular effort in neck and shoulders minimizing risk of pain.

Top View



S CENTER TILT

Chair tilts at the center point of the seat allowing you to recline while maintaining the same torso to thigh angle. When your feet are well supported, blood flow is enhanced.



U SOFT DESCENT PNEUMATIC LIFT

Gently and gradually lowering the seat helps you easily select proper seat height without causing a jerking motion.



V LUMBAR DEPTH ADJUSTMENT

Increase or decrease curvature of the back to match the profile of your lower back. Enhances comfort and support in the lower lumbar area.

MAXIMIZING YOUR ERGONOMIC SEATING

- Always select a chair that is designed for the type of work you perform and make certain the chair is comfortable for the length of time spent using it.
- Ensure that the seat and back cushions are contoured to fit your body, which will help eliminate pressure points.
- An ergonomically designed chair should allow changing positions easily.
- As you work, reposition yourself throughout the day to reduce strain and stress on specific muscle groups. If you change job functions, adjust your chair to fit the new task.
- Proper ergonomic seating should help eliminate many of the work related injuries that result from poor posture and poorly designed chairs.

TASK (-6)



ADJUSTMENTS

- (2) Pneumatic seat height
- (8) Manual seat depth
- Back height **
- Swivel

POSTURE TASK (-7)

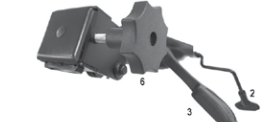

ADJUSTMENTS

- (2) Pneumatic seat height
- (3) Back angle
- (6) Back height **
- Seat depth *
- Swivel

TILTER (-4)

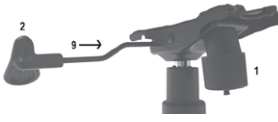

ADJUSTMENTS

- (2) Pneumatic seat height
- (9) Chair tilt lock *
- Center-tilt action
- Swivel

KNEE-TILTER (-2)

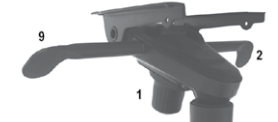

ADJUSTMENTS

- (1) Tilt tension
- (2) Pneumatic seat height
- (9) Chair tilt-lock *
- Back height **
- Knee-tilt action
- Swivel
- Optional sliding seat depth adjustment (MD)

MULTI-TILTER (-3)



ADJUSTMENTS

- (1) Tilt tension
- (2) Pneumatic seat height
- (3) Back angle adjustment
- (9) Infinite position seat tilt lock
- (7) Forward tilt lock *
- (8) Sliding seat depth adjustment (MD)
- Back height **
- Center-tilt action
- Swivel

SYNCHRO-TILTER (-0, -8)



ADJUSTMENTS

- (1) Tilt tension
- (2) Pneumatic seat height
- (3) Back angle adjustment
- (8) Sliding seat depth adjustment (MD)
- (9) Chair tilt lock Synchro-tilt action
- Anti-kickback *
- Back height **
- Swivel

POSTURE-TILTER *



ADJUSTMENTS

- (1) Tilt tension
- (2) Pneumatic seat height
- (8) Sliding seat depth adjustment (MD)
- (9) Infinite position seat tilt lock
- Back height **
- Swivel

OPERATOR (-5)



ADJUSTMENTS

- (2) Pneumatic seat height
- (3) Back angle *(Free Float/lock)
- (4) Seat angle *(Free Float/lock)
- (4) Seat angle / Back angle
- Back height **
- Free floating seat and back *
- With single lever operator mechanism, seat and back angle are controlled using lever 4 *
- Swivel

NOTES

- * Selected models only.
- ** RATCHET back height adjustment on selected models.
- *** Mechanisms shown are generic depictions and may differ from one chair to another.

HOW TO ORDER SEATING



5451-3

MODEL NUMBER

+



MD

MECHANISM OPTION

+



BK

FRAME FINISH

+



AX27

FABRIC CODE

FABRIC CHAIR EXAMPLE

If there are any options for the chair they would be inserted between the Model Number with Arm Style and Frame Finish. For example (see above):

5451-3 BK AX27

This would be the **Truform Medium Back Multi-Tilter** with standard Height Adjustable Arms and Multi-Tilter. Black Frame **BK** and Oxygen fabric in Axis, Noir **AX27**, complete the chair.

CHAIR SAFETY TIPS

Common sense guidelines to ensure that your Global chair will provide many years of comfort and service in a safe and productive environment:

- Always read and follow assembly instructions. Make sure that all of the pieces of your Global chair are installed in the proper order to ensure structural integrity.
- Ensure that chair casters are fully inserted into the base of the unit.
- Inspect your chair for loose or worn parts at least once a year.
- Always keep the base of your chair completely on the floor.
- Most Global chairs are equipped with casters for use on carpeted surfaces. Other flooring surfaces may require different casters.
- Speak to your Global Sales Representative or refer to the Casters Section of this Price Book for appropriate custom selections.
- Many Global office chairs are equipped with tilt tension controls on the seating mechanism. The tension control compensates for different body weights and postures. Always ensure that the control is properly adjusted for a smooth and controlled tilt motion. Your Global Sales Representative can demonstrate the proper use of all the adjustments on your office chair.
- Do not stand on your Global chair or sit on the arms of your chair.
- Do not put electrical appliances on chairs. Even fire retardant fabrics can be damaged when exposed to direct heat or flame.
- Choose the right chair for your work environment. Global offers a full line of Intensive Use, Multi-Shift and Specialized chairs for environments with demanding health or safety requirements. Your Global Sales Representative is trained to help you make the right choice for your workplace.

THE ASSOCIATION FOR CONTRACT TEXTILES (ACT) HAS DEVELOPED THE FOLLOWING PERFORMANCE GUIDELINES TO MAKE FABRIC SPECIFICATION EASIER. THE FIVE SYMBOLS GIVE ARCHITECTS, DESIGNERS AND END USERS A VAST AMOUNT OF PERFORMANCE INFORMATION IN A SUCCINCT, VISUAL WAY. THIS CHART LISTS THE REQUIRED TESTS THAT CORRESPOND TO SPECIFIC END USES. AN EXPLANATION OF THE SYMBOL ALSO APPEARS.

FIRE RETARDANCY



Flammability testing determines a fabric's performance and resistance to burning.

APPLICATION

Upholstery
Panels and upholstered walls

PASSES

California bulletin 117, section E.
ASTM E 84-03 Class A or Class 1 (unadhered method).

COLOR FASTNESS TO WET & DRY CROCKING



Color fastness to wet & dry crocking refers to the rubbing off of color from the fabric onto clothing, hands or other materials and can occur under wet or dry conditions.

APPLICATION

Upholstery
Panels and upholstered walls

PASSES

AATCC 8-2001 Dry crocking. Class 4 minimum.
Wet crocking, Class 3 minimum.
AATCC 8-2001 E 84 (unadhered method).

COLOR FASTNESS TO LIGHT



Color fastness to light is the degree to which fabric will retain its color when exposed to light.

APPLICATION

Upholstery
Panels and upholstered walls

PASSES

AATCC option 2-2003 or AATCC - option 3-2003.
Class 4 minimum of 40 hours.
AATCC option 2-2003 or AATCC - option 3-2003.
Class 4 minimum of 40 hours.

PHYSICAL PROPERTIES



Three physical property tests include: 1 - Brush pill test to determine a fabric's pilling (the formation of fuzzy galls of fiber on the surface of a fabric). 2 - Breaking/tensile strength is the ability of a fabric to withstand tension without breaking or tearing. 3 - Seam slippage is the pulling apart of fabrics at the seams.

APPLICATION

Upholstery
Panels and upholstered walls

PASSES

Brush pill ASTM D3511-02, 3 minimum.
Breaking strength ASTM D5034-95 (2001) 50 lbs. minimum in warp & weft.
Seam slippage ASTM D4034 25 lbs. minimum in warp & weft.
Breaking strength ASTM D5034-95 (2001) (grab test).
35 lbs. minimum in warp & weft.

ABRASION



Abrasion is the ability of a fabric to withstand damage from wear and rubbing. There is a general contract specification as well as a heavy duty specification.

APPLICATION

General contract upholstery
Heavy duty upholstery

PASSES

ASTM D4157-02 (#10 cotton duck) 15,000 double rubs, Wyzenbeek method.
ASTM D4966-98 (12 KPA pressure) 20,000 double rubs, Martindale method.
ASTM D4157-02 (#10 cotton duck) 30,000 double rubs, Wyzenbeek method.
ASTM D4966-98 (12 KPA pressure) 40,000 double rubs, Martindale method.

fast5

Global's fast5 quick ship program offers many of our bestselling models upholstered in your choice of our most popular textiles.

- 20+ Series, 150+ Models, 200+ Textiles to customize your order
- No special order forms required

Global's fast production and shipping make it simple to order and ideal for tight deadlines!

Color it your way

GRADE 1

Carrera 100% Polyester
 CE84 Zest
 CE86 Slate
 CE88 Aspen
 CE90 Flannel
 CE92 Chili
 CE95 Ink
 CE97 Java

CE85 Savannah
 CE87 Rainforest
 CE89 Dune
 CE91 Azure
 CE93 Jute
 CE96 Sangria
 CE98 Charcoal

Fusion 90% Virgin Polyester / 10% Post-Consumer Recycled Polyester

FU71 Tangerine
 FU73 Moss
 FU75 Aqua
 FU77 Granite
 FU79 Cadet
 FU81 Graphite
 FU83 Cobalt
 FU85 Carbon

FU72 Fresh
 FU74 Tomato
 FU76 Sandstone
 FU78 Poppy
 FU80 Oasis
 FU82 Viola
 FU84 Flax

Illusion 100% Virgin Polyester

I01 Cappuccino
 I03 Tropic
 I05 Hemp
 I07 Maui
 I09 Smoke
 I11 Fiji
 I13 Ebony

I02 Paprika
 I04 Wicker
 I06 Cayenne
 I08 Dusk
 I10 Currant
 I12 Ozone

Jenny 100% Polyester

JN01 Midnite
 JN03 Slate
 JN08 Admiral
 JN25 Silver Lining
 JN27 Sunflower
 JN29 Harvest
 JN31 Berry
 JN33 Roast

JN02 Ebony
 JN07 Vermilion
 JN11 Charcoal
 JN26 Oatmeal
 JN28 Cascade
 JN30 Melon
 JN32 Green Grass

Quilt 100% Polyester

QL10 Black
 QL14 Navy
 QL19 Silver
 QL21 Dune
 QL23 Cadet
 QL25 Daisy
 QL27 Punch
 QL29 Cocoa

QL11 Charcoal Grey
 QL16 Wine
 QL20 Feather
 QL22 Meadow
 QL24 Geranium
 QL26 Quest
 QL28 Tangerine

Trak 100% Recycled Polyester

TK40 Taupe
 TK42 Latte
 TK44 Silver
 TK46 Teal
 TK48 Steel
 TK50 Midnight Sky
 TK52 Carbon

TK41 Mustard
 TK43 Cement
 TK45 Copper
 TK47 Apple
 TK49 Merlot
 TK51 Mocha

Urban 62% Recycled Polyester / 32% Polyester

UR10 Red Rose
 UR12 Blue Bayou
 UR14 Sandcastle
 UR16 Boardwalk
 UR18 Brown Ridge
 UR20 Granite Rock
 UR22 Black Coal

UR11 Ocean Blue
 UR13 Green Grass
 UR15 Beach Day
 UR17 Earth
 UR19 White Sand
 UR21 Gravel Road

Wavelength 100% Virgin Polyester

WV01 Lime
 WV03 Stone
 WV05 Mykonos
 WV07 Mesa
 WV09 Cancun
 WV11 Moonrock
 WV13 Corfu
 WV14 Panther

WV02 Mint
 WV04 Flame
 WV06 Savannah
 WV08 Plasma
 WV10 Quartz
 WV12 Rubine
 WV14 Bluejey

Imprint 100% Post-Consumer Polyester

IM70 Almond
 IM72 Sand
 IM74 Candy Apple
 IM76 Navy
 IM78 Celery
 IM80 Walnut
 IM82 Graphite
 IM84 Licorice

IM71 Cork
 IM73 Currie
 IM75 Ocean
 IM77 Green Tea
 IM79 Oregano
 IM81 Paprika
 IM83 Slate

Luxhide 100% Vinyl Face / Bonded Leather Backing

BL20 Black
 BL23 Saddle
 BL26 Burgundy
 BL28 White
 BL34 Light Grey

BL22 Parchment
 BL24 Dark Brown
 BL27 Charcoal

Release 100% Vinyl Face

RL11 White
 RL13 Stone
 RL15 Orange
 RL17 Tuscan
 RL19 Yellow
 RL22 Brave Red
 RL24 Cajun
 RL26 Olive
 RL28 Summer's Dream
 RL31 Green
 RL33 Black
 RL35 Thunder Grey
 RL37 Dark Chocolate

RL12 Chalk
 RL14 Taupe
 RL16 Country
 RL18 Cottage
 RL21 Red Barn
 RL23 Gypsy Red
 RL25 Vineyard
 RL27 Bonsai
 RL29 Calico
 RL32 Blue
 RL34 Cool Grey
 RL36 Navy
 RL38 Espresso

GRADE 10

Prescott Leather

PC02 Zinc
 PC05 Soul White
 PC14 Avana
 PC41 Antique
 PC57 Chestnut
 PC80 Indigo
 PC86 Santorini
 PC97 Smoke
 PD03 Black Ink

PC04 Papyrus
 PC10 Caffè Latte
 PC18 Swamp
 PC54 Antipol
 PC79 Oceania
 PC81 Deep
 PC96 Turtledove
 PD02 Grayshadow

Elevate 80% Post-Consumer Recycled Polyester / 20% Rayon

EL51 Halo
 EL53 Safari
 EL55 Margarita
 EL57 Mist
 EL59 Wasabi
 EL61 Mica
 EL63 Scuba
 EL65 Onyx

EL52 Dove
 EL54 Sunglow
 EL56 Fiji
 EL58 Blaze
 EL60 Mystic
 EL62 Cherry
 EL64 Lapis

Etch 80% Post-Consumer Recycled Polyester / 20% Rayon

ET81 Drift
 ET83 Calypso
 ET85 Crisp
 ET87 Nickel
 ET89 Nutmeg
 ET91 Magnet
 ET93 Espresso
 ET95 Anthracite

ET82 Citron
 ET84 Mandarin
 ET86 Iris
 ET88 Paprika
 ET90 Marine
 ET92 Infrared
 ET94 Indigo























Textiles are subject to change, please confirm current selection.

TERMS AND CONDITIONS

- All product series have MAXIMUM order quantities which can be fulfilled within the fast5 program. These are noted with each series' Specs + Options. For greater quantities, please contact CustomerCare for lead time and terms.
- Orders that exceed maximum unit quantities will receive standard lead times.
- Orders must clearly note "fast5" and be submitted as a separate purchase order. Global cannot mix fast5 and standard delivery or InStock products on the same purchase order.
- Purchase orders containing products from fast5 and fast10 programs will automatically receive fast10 lead time and shipping. Purchase order should be noted "fast10".

- Certain models, noted on the series' Specs + Options, are multi-packed and must be ordered in quantities accordingly. Package unit quantities cannot be changed.
- Program is limited to exact models, model options and textiles within series listed.
- Program is limited to exact textile pattern colorways listed in the fast5 program. Use the Textile Search Tool to confirm desired textile is approved for use on the selected series.
- Orders must be clean with correct model numbers, options, textiles, correct pricing, etc. to apply.
- Orders cannot be changed or canceled after order acknowledgment.

- Current Global list pricing applies at the time of order. fast5 orders may be shipped FedEx, UPS or via alternate carriers. Global reserves the right to ship "best way".
- fast5 products will be manufactured to your orders' specifications in 5 business days or less and ship immediately thereafter.
- Orders will ship to the dealer or commercial end-user directly. Delivery charges may apply for special handling, services, etc. Please consult your Territory Manager or CustomerCare Representative.
- Dealer must be in good standing and account within terms for order(s) to be processed without delay.
- fast5 program is available in the 48 contiguous United States.

Series	Model Numbers	Series	Model Numbers	Series	Model Numbers
Aspen 	(maximum 20) 2851-3 2853-3	Luray 	(maximum 20) 6461 6462	Sonic 	Plastic (maximum 100) 6508 6508MB 6513 6513MB 6558 6558CS 6573 6573MB 6577 6577MB
	Comet 		(maximum 50) 2171WS 2172WS		Noetic 
Duet 	Plastic (maximum 100) 6620 6621	Popcorn 	Plastic (maximum 100) 6710 6711	Sora 	(maximum 20) 6941 6942
	Upholstered (maximum 50) 6622 6627 6623 6628 6624		Factor 		(maximum 50) 6712 6713 6715
G1 Ergo Select 	(maximum 50) 7331 7332	Prefer 	(maximum 20) 8458 8459	Synopsis 	Nester (maximum 50) 6764C 6465C
	Global Accord 		(maximum 50) 2670-2 2676-2 2670-4 2676-4 2671-2 2677-2 2671-4 2677-4 2672-6 2678-6		Rebound 
Goal 	(maximum 50) 2235-6 2237-5 2236-6 2237-6 2237-3 2239-6	Roma 	(maximum 50) 1890 1903 1896 1906 1897 1907 1901 1908 1902	Truform 	(maximum 50) 5450-3 5458-6 5451-3 TS5450-3 5457-6 TS5451-3
	Granada 		(maximum 50) 3212 3254 3278		Sidero 
Loover 	(maximum 50) 2661-0 2662-0 2661-3 2662-3 2661-4 2662-4 2661-8 2662-8	Solar 	(maximum 50) 8456 8457 8456NA 8457NA 8456S 8457S 8456SNA 8457SNA	Vion 	Mesh (maximum 50) 6321-0 6322-4 6321-3 6322-8 6321-4 6327-6 6321-8 6328-6 6322-0 TS6321-3 6322-3 TS6322-3
	Solo 		(maximum 50) 5228		Upholstered (maximum 50) 6331-0 6332-0 6331-3 6332-3 6331-4 6332-4 6331-8 6332-8

fast10

Global's fast10 quick ship program offers many of our bestselling models upholstered in your choice of our most popular textiles.

- 5 Series, 25+ Models, 200+ Textiles to customize your order
- No special order forms required

Global's fast production and shipping make it simple to order and ideal for tight deadlines!

Color it your way

GRADE 1

Carrera 100% Polyester	
CE84 Zest	CE85 Savannah
CE86 Slate	CE87 Rainforest
CE88 Aspen	CE89 Dune
CE90 Flannel	CE91 Azure
CE92 Chili	CE93 Jute
CE95 Ink	CE96 Sangria
CE97 Java	CE98 Charcoal

Fusion 90% Virgin Polyester / 10% Post-Consumer Recycled Polyester

FU71 Tangerine	FU72 Fresh
FU73 Moss	FU74 Tomato
FU75 Aqua	FU76 Sandstone
FU77 Granite	FU78 Poppy
FU79 Cadet	FU80 Oasis
FU81 Graphite	FU82 Viola
FU83 Cobalt	FU84 Flax
FU85 Carbon	

Illusion 100% Virgin Polyester

I101 Cappuccino	I102 Paprika
I103 Tropic	I104 Wicker
I105 Hemp	I106 Cayenne
I107 Maui	I108 Dusk
I109 Smoke	I110 Currant
I111 Fiji	I112 Ozone
I113 Ebony	

Jenny 100% Polyester

JN01 Midnite	JN02 Ebony
JN03 Slate	JN07 Vermilion
JN08 Admiral	JN11 Charcoal
JN25 Silver Lining	JN26 Oatmeal
JN27 Sunflower	JN28 Cascade
JN29 Harvest	JN30 Melon
JN31 Berry	JN32 Green Grass
JN33 Roast	

Quilt 100% Polyester

QL10 Black	QL11 Charcoal Grey
QL14 Navy	QL16 Wine
QL19 Silver	QL20 Feather
QL21 Dune	QL22 Meadow
QL23 Cadet	QL24 Geranium
QL25 Daisy	QL26 Quest
QL27 Punch	QL28 Tangerine
QL29 Cocoa	

Trak 100% Recycled Polyester

TK40 Taupe	TK41 Mustard
TK42 Latte	TK43 Cement
TK44 Silver	TK45 Copper
TK46 Teal	TK47 Apple
TK48 Steel	TK49 Merlot
TK50 Midnight Sky	TK51 Mocha
TK52 Carbon	

Urban 62% Recycled Polyester / 32% Polyester

UR10 Red Rose	UR11 Ocean Blue
UR12 Blue Bayou	UR13 Green Grass
UR14 Sandcastle	UR15 Beach Day
UR16 Boardwalk	UR17 Earth
UR18 Brown Ridge	UR19 White Sand
UR20 Granite Rock	UR21 Gravel Road
UR22 Black Coal	

Wavelength 100% Virgin Polyester

WV01 Lime	WV02 Mint
WV03 Stone	WV04 Flame
WV05 Mykonos	WV06 Savannah
WV07 Mesa	WV08 Plasma
WV09 Cancun	WV10 Quartz
WV11 Moonrock	WV12 Rubine
WV13 Corfu	WV14 Bluejay
WV14 Panther	

GRADE 2

Allante Free 100% Vinyl Face / 100% Polyester Backing

A01F Illusion	A02F Bright White
A03F White Crush	A04F Ivory
A05F Ice	A06F Bleached Sand
A07F Taupe Fawn	A08F Warm Smoke
A09F Autumn Rain	A10F Cookie
A11F Sierra Brick	A12F Gibraltar
A13F Chateau Grey	A14F Garden Green
A15F Oasis Green	A16F Ink Black
A17F Purple Impulse	A18F Italian Rose
A19F Mountain Sky	A20F Old Navy
A21F Galaxy	A22F Red Truffle
A23F Chocolate Sundae	A24F Province Blue
A25F Eclipse	

Elevate 80% Post-Consumer Recycled Polyester / 20% Rayon

EL51 Halo	EL52 Dove
EL53 Safari	EL54 Sunglow
EL55 Margarita	EL56 Fiji
EL57 Mist	EL58 Blaze
EL59 Wasabi	EL60 Mystic
EL61 Mica	EL62 Cherry
EL63 Scuba	EL64 Lapis
EL65 Onyx	

Etch 80% Post-Consumer Recycled Polyester / 20% Rayon

ET81 Drift	ET82 Citron
ET83 Calypso	ET84 Mandarin
ET85 Crisp	ET86 Iris
ET87 Nickel	ET88 Paprika
ET89 Nutmeg	ET90 Marine
ET91 Magnet	ET92 Infrared
ET93 Espresso	ET94 Indigo
ET95 Anthracite	

Imprint 100% Post-Consumer Polyester

IM70 Almond	IM71 Cork
IM72 Sand	IM73 Currie
IM74 Candy Apple	IM75 Ocean
IM76 Navy	IM77 Green Tea
IM78 Celery	IM79 Oregano
IM80 Walnut	IM81 Paprika
IM82 Graphite	IM83 Slate
IM84 Licorice	

Luxhide 100% Vinyl Face / Bonded Leather Backing

BL20 Black	BL22 Parchment
BL23 Saddle	BL24 Dark Brown
BL26 Burgundy	BL27 Charcoal
BL28 White	
BL34 Light Grey	

Release 100% Vinyl Face

RL11 White	RL12 Chalk
RL13 Stone	RL14 Taupe
RL15 Orange	RL16 Country
RL17 Tuscan	RL18 Cottage
RL19 Yellow	RL21 Red Barn
RL22 Brave Red	RL23 Gypsy Red
RL24 Cajun	RL25 Vineyard
RL26 Olive	RL27 Bonsai
RL28 Summer's Dream	RL29 Calico
RL31 Green	RL32 Blue
RL33 Black	RL34 Cool Grey
RL35 Thunder Grey	RL36 Navy
RL37 Dark Chocolate	RL38 Espresso

GRADE 10

Prescott Leather	
PC02 Zinc	PC04 Papyrus
PC05 Soul White	PC10 Caffè Latte
PC14 Avana	PC18 Swamp
PC41 Antique	PC54 Antipol
PC57 Chestnut	PC79 Oceania
PC80 Indigo	PC81 Deep
PC86 Santorini	PC96 Turtledove
PC97 Smoke	PD02 Grayshadow
PD03 Black Ink	

Textiles are subject to change, please confirm current selection.

TERMS AND CONDITIONS

- All models have MAXIMUM quantity of 10 pieces, noted on each sheet, which can be fulfilled within the fast10 program. These are noted next to each series' Specs + Options. For greater quantities, please contact CustomerCare for lead times and terms.
- Orders that exceed maximum unit quantities will receive standard lead times.
- Orders must clearly note "fast10" and be submitted as a separate purchase order. Global cannot mix "fast10" and standard delivery or InStock products on the same purchase order.
- Purchase orders containing products from fast5 and fast10 programs will automatically receive fast10 lead time and shipping. Purchase order should be noted "fast10".
- Program is limited to exact models, model options and textiles within series listed.
- Program is limited to exact textile pattern colorways listed in the fast10 program. Use the Textile Search Tool to confirm desired textile is approved for use on the selected series.
- Orders must be clean with correct model numbers, options, textiles, correct pricing, etc. to apply.
- Orders cannot be changed or canceled after order acknowledgment.
- Current Global list pricing applies at the time of order.
- fast10 models are not available for FEDEX or UPS shipping. Global reserves the right to ship "best way".
- fast10 products will be manufactured to your orders' specifications in 10 business days or less and be consolidated for shipping immediately thereafter.
- Orders will ship to the dealer or commercial end-user directly. Delivery charges may apply for special handling, services, etc. Please consult your Territory Manager or CustomerCare Representative.
- Dealer must be in good standing and account within terms for order(s) to be processed without delay.
- fast10 Program is available in the 48 contiguous United States.

Series	Model Numbers	Series	Model Numbers	Series	Model Numbers
Citi 	(maximum 10)	Wind 	(maximum 10)	Drift 	(maximum 10)
	7864		3361		8016
	7875		3362		8021
	7876		3363		8022
	7877				8023
	7879				8024
	7885		8026		
			8030		
			8032		
			8033		
			8034		
			8035		
			8036		
<hr/> Citi Square		<hr/> sirena			
	(maximum 10)		(maximum 10)		
	S7875		3371		
	S7876				
	S7877				
	S7877				
	S7911				