

# think global

## THE GLOBAL EDGE

### ERGONOMICS IN THE TOTAL OFFICE

- One stop shopping for a full range of office furniture.
- Seating, desks, tables, files, modular furniture, panels and accessories.
- Ergonomics, competitive pricing and built-in value.

### STRENGTH AND STABILITY

- Established in 1966.
- One of North America's largest office furniture manufacturers.
- Manufacturing and showrooms worldwide.

### QUICK SHIP - INSTOCK

- Thousands of products available in a 2 day quickship program.
- Hundreds of products in stock for immediate delivery.

### STRONG LOCAL REPRESENTATION

- Service and expert advice where you are, when you need it!

### MANUFACTURING CAPABILITY

- Vertical integration ensures "start to finish" control.
- Ongoing research and investment in new, innovative production technology.

### QUALITY ASSURANCE

- Quality Assurance Program is qualified by C.G.S.B. ISO9001 standards.
- On-site furniture testing facility.
- Product and components are tested to meet or exceed ANSI/BIFMA standards.

### ENVIRONMENTAL COMMITMENT

- Continuous development of "earth friendly" programs.
- One of the first molded foam manufacturers to create ozone friendly, CFC and HFC-free process.
- Seat and back pans are made from recyclable plastics and wood waste, enabling little waste and cost effective products.

## SYMBOL IDENTIFICATION

Each seating product with an RTA code identifies the assembly requirements.

**RTA 00** FULLY ASSEMBLED

**RTA 1** SIMPLE ASSEMBLY (No Tools Required)

Parts to Install:

- Casters
- Base
- Pneumatic Cylinder/Cover can

**RTA 2** MODEST ASSEMBLY (Tools Supplied, if necessary)

Parts to Install:

- Casters
- Base
- Pneumatic Cylinder/Cover can
- Back

**RTA 4** MODERATE ASSEMBLY (Tools Supplied)

Parts to Install:

- Casters
- Base
- Pneumatic Cylinder/Cover can
- Back
- Armrest

**RTA 8** FULL ASSEMBLY (Tools Supplied)

Parts to Install:

- Casters
- Base
- Pneumatic Cylinder/Cover can
- Back
- Armrest
- Mechanism



Global's Certified Products are in compliance with the stringent emission guidelines set by the GREENGUARD Environmental Institute and include all Upholstered Seating. To obtain a GREENGUARD or GREENGUARD Gold Certificate for any product, please go to the Environmental Commitment section on our website [www.globalfurnituregroup.com](http://www.globalfurnituregroup.com) and click on "GREENGUARD".



level™ certification, based on the ANSI/BIFMA e3-2012 furniture sustainability standard, sets furniture manufacturers on a path toward greater sustainability over time. Based on environmental and social criteria set forth in the standard, a product's entire supply chain is assessed.

Certification assessment includes an evaluation of specific corporate policies and guidelines and an assessment of associated company manufacturing facilities. Products must meet quantifiable milestones of environmental and social performance at every step of development.

The quantitative assessment addresses four categories: material use, energy and atmosphere impacts, human and ecosystem health and social responsibility.

Manufacturers earn points in each of the four categories. The level™ brand and its numeric rating of 1, 2 or 3 indicate what threshold of certification a product has achieved. level™ 3 is the highest rating.



All products with this designation are suitable for FedEx and UPS shipment throughout the United States.

# TABLE OF CONTENTS

## A

Academic Task .....	439
Arno .....	25
Arturo .....	26
Aspen .....	27
Auburn .....	29

## B

Bakhita .....	135
Ballara .....	270
Beach .....	138
Beam Seating .....	139
Braden .....	282
Bridges II Collaborative Seating .....	285

## C

Calidon .....	293
Camino .....	299
Caprice .....	149
Chap .....	151
Citi .....	304
Citi Square.....	309
Comet .....	153
Concorde .....	30

## D

Diplomat .....	32
Drift .....	318
Duet .....	157
Duet tables .....	174

## E

Enterprise .....	33
Erin .....	177

## F

Factor .....	37
File Buddy .....	179
Flap .....	180

## G

G1 .....	39
G20 .....	41
Global Accord .....	42
Goal .....	46
Graham .....	48
Granada .....	49
Granada Deluxe .....	54
Granada Deluxe TS .....	419
Graphic .....	58

## I

Industrial Seating .....	441
Industrial Wipe Down .....	446
Islands .....	182

## J

Jeo.....	336
----------	-----

## K

Kate .....	339
------------	-----

## L

Layne .....	183
Lite .....	185
Loover .....	60
Luray .....	64
Lux.....	340

## M

Malaga .....	67
Malaga TS .....	419
Marche .....	190
Mayne .....	192
Mirage .....	68
ML .....	342
ML Park .....	342
Moda Four-Legged .....	193
Moda Stacking .....	194

## N

Noetic.....	69
Novello .....	74

## O

ObusForme Comfort + XL .....78

## P

Popcorn .....196

Prairie .....345

Prefer .....84

## R

Rebound .....201

River .....346

River Personal Harbor .....362

River+ .....364

Robust .....425

Roma .....86

Roma Nester .....206

## S

Sas .....208

Saxon .....426

Sidero .....210

Sirena .....396

Solar .....90

Solo .....92

Sonic .....214

Sora .....94

Spritz .....96

Spritz multi-purpose .....230

Spyker .....233

Stream .....234

Supra .....101

Supra X .....103

Synopsis .....106

## T

Tamiri .....109

Traditional .....111

Triumph .....115

Truform .....116

Twilight .....246

Tye .....119

## V

Venture .....400

Vion .....122

Vion guest .....249

Vitrola .....403

## W

Weev .....130

Willow .....254

Wind .....405

Wind Linear .....409

## Z

Zoma .....268

## REFERENCES/PROGRAMS

Seating by Category Types ..... 4-11

Suggested Applications by Series ..... 12-13

Ergonomic Features and Benefits ..... 15

Mechanism Adjustments ..... 16

How to Order Seating ..... 17

Act Performance Symbols ..... 18

Fast5 ..... 19

Heavy Duty/24 Hour ..... 418

How to select armrests ..... 430

Arm selections ..... 431

Caster selections ..... 434

Cylinder chart ..... 436

Duet + Popcorn glide selections ..... 437

Specialty seating ..... 439

Textiles + Finishes ..... 452





COM Authorization Form ..... 459

Terms/Conditions/Warranty ..... 462

# SEATING BY CATEGORY TYPE



















## Task

 Arno.....25	 Luray .....64	 Stream.....98
 Aspen .....27	 Malaga .....67	 Supra .....101
 Duet.....135	 Noetic.....69	 Supra X .....103
 Enterprise .....33	 Novello .....74	 Synopsis .....106
 Factor .....37	 ObusForme Comfort + XL .....78	 Tamiri .....109
 G1 .....39	 Popcorn .....196	 Triumph .....115
 G20 .....41	 Prefer .....84	 Truform .....116
 Goal .....46	 Roma .....86	 Tye .....119
 Graham .....48	 Solar .....90	 Vion .....122
 Granada .....49	 Solo .....92	 Weev .....130
 Granada Deluxe .....54	 Sonic .....214	
 Graphic .....58	 Sora .....94	
 Loover .....60	 Spritz .....96	

# SEATING BY CATEGORY TYPE

## Conference/Management

























 Arno .....25	 Kate.....339	 Solar .....90
 Arturo .....26	 Luray .....64	 Solo .....92
 Diplomat .....32	 Mirage .....68	 Supra .....101
 Enterprise .....33	 Roma .....86	 Synopsis .....106
 Global Accord .....42		 Tamiri .....109
 Graphic .....58		 Traditional .....111
 Jeo .....336		

# SEATING BY CATEGORY TYPE

## Executive















 Arno .....25	 Enterprise.....33	
 Arturo .....26	 Global Accord .....42	 Synopsis.....106
 Auburn .....29	 Luray .....64	 Tamiri .....109
 Concorde .....30	 Mirage .....68	 Traditional .....111
 Diplomat.....32		

## Height Adjustable Stools





















 Aspen .....27	 Loover .....60	 Spritz .....96
 Duet.....157	 Malaga .....67	 Stream.....98
 Factor .....37	 Noetic.....69	 Supra X.....103
 G1 Ergo Select .....39	 Novello .....74	 Synopsis .....106
 Global Accord .....42	 ObusForme Comfort + XL .....78	 Truform .....116
 Goal .....46	 Prefer .....84	 Tye .....119
 Granada .....49	 Roma .....86	 Vion .....122
 Granada Deluxe .....54	 Solar .....90	 Weev .....130
 Graphic .....58		



**Stacking**







 Bakhita .....135	 Popcorn .....196	 Spyker .....233
 Comet .....153	 Rebound .....201	 Stream .....234
 Duet .....157	 Sas .....208	 Vion guest .....249
 Flap .....180	 Sidero .....210	 Willow .....254
 Moda .....194	 Sonic .....214	 Zoma .....268

**Guest (Metal)**

 Arno .....25	 Jeo .....336	 Sidero .....210
 Caprice .....149	 Kate .....339	 Sonic .....214
 Comet .....153	 Lite .....185	 Stream .....234
 Diplomat .....156	 Marche .....190	 Twilight .....246
 Drift .....318	 Popcorn .....196	 Vion guest .....249
 Enterprise .....33	 Rebound .....201	 Willow .....254
 Erin .....177	 Sas .....208	

# SEATING BY CATEGORY TYPE















## Guest (Wood)

 Beach .....138	 Drift.....318	 Layne .....183
 Chap .....151	 Islands .....182	 Mayne .....192















## Nesting

 Roma Nester .....206	 Spritz Nester .....230
--	--

## Tandem/Beam/Pedestal

 Duet (Beam) .....144	 Roma (Pedestal).....86	 Synopsis (Pedestal).....106
 Duet (Pedestal).....157	 Sidero (Beam) .....146	 Vion (Beam) .....147
 Global Accord (Pedestal).....42	 Sonic (Beam) .....146	 Vion (Pedestal).....122
 Luray (Pedestal).....64	 Sonic (Pedestal).....214	Beam Seating .....139
 Novello (Pedestal).....74	 Spritz (Pedestal).....230	
 Popcorn (Beam) .....145	 Stream (Pedestal).....234	

## Stools

 Diplomat .....156	 ML.....342	 Sonic .....214
 Duet .....157	 Popcorn .....196	 Stream .....234
 Drift.....318	 Rebound .....201	 Twilight .....246
 File Buddy .....179	 Sas .....208	 Vion guest .....249
 Marche .....190	 Sidero .....210	 Willow.....254





**LOUNGE SEATING**

Ballara.....270	Kate.....339	Sirena.....396
Braden.....282	Lux.....340	Venture.....400
Bridges II Collaborative Seating...285	ML.....342	Vitrola.....403
Camino.....299	ML Park.....344	Wind.....405
Citi.....304	Prairie.....345	
Drift.....318	River.....346	
Jeo.....336	River+.....364	

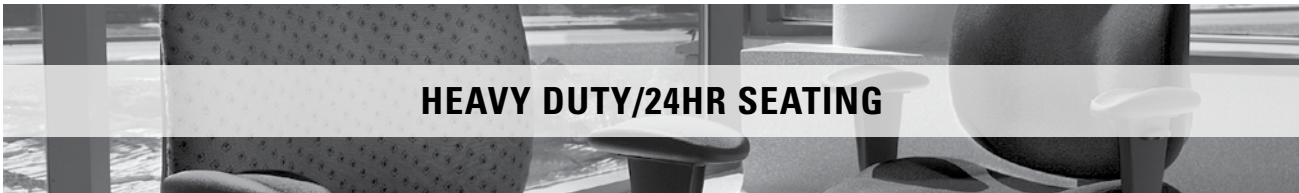

**HEAVY DUTY/24HR SEATING**

Concorde Executive 24HR.....422	Malaga TS.....419	Saxon.....426
G1 Ergo Select TS.....423	ObusForme Comfort TS.....420	Truform TS.....421
Granada TS.....418	Robust.....425	Vion TS.....427
Granada Deluxe TS.....419		

# SEATING BY CATEGORY TYPE



## EDUCATION

### Classroom

Academic Task .....439	Popcorn .....196	Spritz Nester .....230
Duet .....157	Rebound .....201	Supra X .....103
Duet tables .....174	Roma Nester .....206	Vion .....122
Graphic .....58	Sidero .....210	Willow .....254
Novello .....74	Sonic .....214	

### Work + Task

Factor .....37	Noetic .....69	Sora .....94
G1 .....39	Novello .....74	Spritz .....96
Granada .....49	ObusForme Comfort + XL .....78	Supra X .....103
Graphic .....58	Prefer .....84	Truform .....116
Loover .....60	Roma .....86	Vion .....122

# SEATING BY CATEGORY TYPE

## Guest

Caprice .....149	Rebound .....201	Vion guest .....249
Duet .....157	Roma Nester .....206	Willow.....254
Graphic .....58	Sidero .....210	Zoma .....268
Islands .....182	Sonic .....214	

## Lecture Hall

Duet (Beam) .....144	Sidero (Beam) .....146	Vion (Beam) .....147
Popcorn (Beam) .....145	Sonic (Beam) .....146	

## Lab Seating + Stools

Caprice .....149	Novello .....74	Spritz .....96
Duet .....157	Sidero .....210	Supra X .....103
Graphic .....58	Sonic .....214	Vion .....122

## Cafeteria

Bakhita .....135	Popcorn .....196	Spyker .....233
Duet .....157	Rebound .....201	Willow.....254
Sas .....208	Sonic .....214	

# SEATING BY CATEGORY TYPE



## EDUCATION

### Lounge

Ballara.....270	Citi Square.....309	Sirena.....396
Citi.....304	River.....346	Wind Linear.....409
Drift.....318	River+.....364	

### Stacking & Nesting

Bakhita.....135	Roma Nester.....206	Spritz Nester.....230
Duet.....157	Sas.....208	Spyker.....233
Popcorn.....196	Sidero.....210	Stream.....234
Rebound.....201	Sonic.....214	Zoma.....268

# SUGGESTED APPLICATIONS BY SERIES

SERIES	SUGGESTED APPLICATION	ACADEMIC SEATING	CAFETERIA SEATING	CONFERENCE ROOM SEATING	ERGONOMIC AND TASK	EXECUTIVE TASK SEATING	HEAVY DUTY SEATING	HOSPITALITY SEATING	GUEST SEATING	LOUNGE/RECEPTION SEATING	MANAGEMENT SEATING	MEETING ROOM SEATING	MULTI PURPOSE SEATING	PUBLIC SEATING	STACKING SEATING	STOODLS	TABLET SEATING	TECHNICAL SEATING	WOOD GUEST SEATING
ARNO			•					•		•	•								
ARTURO			•							•									
ASPEN				•	•					•	•								
AUBURN			•							•									
BAKHITA	•	•										•		•					
BALLARA							•		•							•			
BEACH							•	•	•			•	•						•
BEAM SEATING	•	•					•	•											
BRADEN									•										
BRIDGES II COLLAB. SEATING							•	•	•				•						
CAMINO							•	•	•										
CAPRICE		•						•				•				•			
CHAP							•	•	•										•
CITI & CITI SQUARE								•	•				•				•		
COMET		•						•	•		•	•							
CONCORDE					•	•													
DIPLOMAT			•					•		•	•					•			•
DUET	•	•	•	•					•		•	•	•	•	•	•	•		
ENTERPRISE			•	•				•		•	•								
FACTOR			•	•							•					•			
FILE BUDDY													•			•			
G1 ERGO SELECT			•	•	•					•							•		
G20			•	•	•					•	•								
GLOBAL ACCORD			•							•	•		•			•			
GOAL	•			•															•
GRAHAM				•															
GRANADA & GRANADA DELUXE	•			•		•		•								•		•	
GRAPHIC			•								•						•		
ISLANDS							•	•	•										•
JEO								•	•				•						
KATE			•					•											
LAYNE							•	•											•
LITE	•	•					•	•	•			•							
LOOVER			•	•				•		•									
LURAY			•	•						•			•						
LUX								•	•										
MALAGA	•			•		•		•								•			
MARCHE							•	•			•					•			

# SUGGESTED APPLICATIONS BY SERIES

SERIES	SUGGESTED APPLICATION	ACADEMIC SEATING	CAFETERIA SEATING	CONFERENCE ROOM SEATING	ERGONOMIC AND TASK	EXECUTIVE TASK SEATING	HEAVY DUTY SEATING	HOSPITALITY SEATING	GUEST SEATING	LOUNGE/RECEPTION SEATING	MANAGEMENT SEATING	MEETING ROOM SEATING	MULTI PURPOSE SEATING	PUBLIC SEATING	STACKING SEATING	STOODLS	TABLET SEATING	TECHNICAL SEATING	WOOD GUEST SEATING
MAYNE								•	•										•
MIRAGE																			
ML			•					•	•	•						•			
ML PARK			•					•	•	•						•			
MODA			•						•						•				
NOVELLO	•			•	•			•			•	•	•			•			
OBUSFORME COMFORT				•	•					•									
POPCORN			•	•					•	•	•	•	•						
PRAIRIE									•										
RIVER								•	•	•			•						
ROBUST							•			•									
ROMA			•	•	•						•	•	•			•			
ROMA NESTER												•	•						
SAS			•					•	•					•	•				•
SAXON							•												
SIDERO			•					•	•			•		•	•				
SIRENA								•	•								•		
SOLAR				•	•			•											
SOLO				•					•		•								
SONIC			•	•					•	•	•	•	•	•	•	•	•		
SPRITZ	•	•		•					•	•		•	•	•	•				
SPYKER			•									•		•					
STREAM	•	•		•				•	•		•	•	•	•	•	•	•		
SUPRA				•				•		•									
SUPRA X	•			•													•		
SYNOPSIS				•	•			•		•	•					•			
TAMIRI				•				•		•									
TRADITIONAL								•	•	•									
TRIUMPH					•					•									
TRUFORM				•		•				•									
TWILIGHT			•					•			•	•				•			
TYE				•	•				•		•								
VENTURE								•	•				•						
VION				•	•	•	•	•	•	•			•	•	•				
VITROLA								•		•			•						
WEEV				•	•						•								
WIND & WIND LINEAR									•										
ZOMA			•					•	•		•	•	•		•				

# ERGONOMIC FEATURES & BENEFITS

EACH GLOBAL CHAIR IS BUILT WITH FEATURES THAT ARE ERGONOMICALLY DESIGNED TO PROMOTE GOOD POSTURE AND PROVIDE MAXIMUM COMFORT. WHILE FULLY SUPPORTING YOUR BODY, THESE FEATURES SHOULD ALSO ALLOW YOU TO ADJUST YOUR CHAIR TO FIT YOU.



## A TENSION ADJUSTMENT

Increase or decrease to match body weight. Allows you to rock comfortably, without heavy pushing, reducing muscle fatigue.



## B CHAIR TILT LOCK

Lock the tilt movement in position(s) to accommodate your working posture. Allows you to lock your chair in a comfortable and supportive position. (Can be either single position or infinite style).



## C SEAT HEIGHT

Raise or lower to allow your feet to rest flat on the floor. Avoids pressure under your thighs, easing blood flow.



## D BACK HEIGHT

Raise or lower to position lumbar support in your lumbar area. Reduces likelihood of back pain.



## E SEAT DEPTH

Change the depth of the seat to accommodate the length of your thighs. Keeps your back in contact with the backrest while avoiding pressure behind your knees.



## F FORWARD SEAT ANGLE

Allows chair to tilt forward changing the angle of your thighs in relation to the floor. Helps reduce disc pressure during forward leaning tasks.



## G BACK ANGLE

Adjust to change the angle of your torso in relation to your thighs. Helps reduce disc pressure and relaxes your back muscles.



## H ARM HEIGHT

Raise or lower to support your forearms. Reduces muscular effort in neck and shoulders, minimizing risk of pain.



## J KNEE-TILT MOVEMENT

Chair tilt pivot point is toward the front of the seat. Stability is maintained as the user reclines, keeping their feet on the floor and maintaining the same torso to thigh angle.



## L SYNCHRO-TILT MOVEMENT

The seat pivots at the center point, while the backrest reclines at a faster rate than the seat, increasing the angle between the user's torso and thighs. Enhances comfort and encourages dynamic body movement.



## M WATERFALL SEAT EDGE

Reduces pressure at the back of the knee, contributing to good blood flow.



## N CONTOURED CUSHION

Supports the body effectively, allowing you to sit longer without discomfort.



## P VIBRATING SEAT & BACK

Soothing effect contributes to your relaxation during work breaks.



## Q WIDTH ADJUSTABLE ARMS

Allows outward movement of armrests to match shoulder breadth. Ensures armrests properly support forearms, reducing muscular efforts in neck and shoulders.



## R ARM ROTATION

Rotate armcaps to support your forearms in various positions. Reduces muscular effort in neck and shoulders minimizing risk of pain.



## S CENTER TILT

Chair tilts at the center point of the seat allowing you to recline while maintaining the same torso to thigh angle. When your feet are well supported, blood flow is enhanced.



## U SOFT DESCENT PNEUMATIC LIFT

Gently and gradually lowering the seat helps you easily select proper seat height without causing a jerking motion.



## V LUMBAR DEPTH ADJUSTMENT

Increase or decrease curvature of the back to match the profile of your lower back. Enhances comfort and support in the lower lumbar area.

## MAXIMIZING YOUR ERGONOMIC SEATING

- Always select a chair that is designed for the type of work you perform and make certain the chair is comfortable for the length of time spent using it.
- Ensure that the seat and back cushions are contoured to fit your body, which will help eliminate pressure points.
- An ergonomically designed chair should allow changing positions easily.
- As you work, reposition yourself throughout the day to reduce strain and stress on specific muscle groups. If you change job functions, adjust your chair to fit the new task.
- Proper ergonomic seating should help eliminate many of the work related injuries that result from poor posture and poorly designed chairs.

**TASK (-6)**



**ADJUSTMENTS**

- (2) Pneumatic seat height
- (8) Manual seat depth
- Back height \*\*
- Swivel

**POSTURE TASK (-7)**

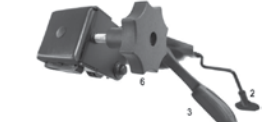

**ADJUSTMENTS**

- (2) Pneumatic seat height
- (3) Back angle
- (6) Back height \*\*
- Seat depth \*
- Swivel

**TILTER (-4)**

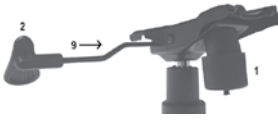

**ADJUSTMENTS**

- (2) Pneumatic seat height
- (9) Chair tilt lock \*
- Center-tilt action
- Swivel

**KNEE-TILTER (-2)**



**ADJUSTMENTS**

- (1) Tilt tension
- (2) Pneumatic seat height
- (9) Chair tilt-lock \*
- Back height \*\*
- Knee-tilt action
- Swivel
- Optional sliding seat depth adjustment (MD)

**MULTI-TILTER (-3)**



**ADJUSTMENTS**

- (1) Tilt tension
- (2) Pneumatic seat height
- (3) Back angle adjustment
- (9) Infinite position seat tilt lock
- (7) Forward tilt lock \*
- (8) Sliding seat depth adjustment (MD)
- Back height \*\*
- Center-tilt action
- Swivel

**SYNCHRO-TILTER (-0, -8)**



**ADJUSTMENTS**

- (1) Tilt tension
- (2) Pneumatic seat height
- (3) Back angle adjustment
- (8) Sliding seat depth adjustment (MD)
- (9) Chair tilt lock Synchro-tilt action
- Anti-kickback \*
- Back height \*\*
- Swivel

**POSTURE-TILTER \***



**ADJUSTMENTS**

- (1) Tilt tension
- (2) Pneumatic seat height
- (8) Sliding seat depth adjustment (MD)
- (9) Infinite position seat tilt lock
- Back height \*\*
- Swivel

**OPERATOR (-5)**



**ADJUSTMENTS**

- (2) Pneumatic seat height
- (3) Back angle \*(Free Float/lock)
- (4) Seat angle \*(Free Float/lock)
- (4) Seat angle / Back angle
- Back height \*\*
- Free floating seat and back \*
- With single lever operator mechanism, seat and back angle are controlled using lever 4 \*
- Swivel

**NOTES**

- \* Selected models only.
- \*\* RATCHET back height adjustment on selected models.
- \*\*\* Mechanisms shown are generic depictions and may differ from one chair to another.



## HOW TO ORDER SEATING



**5451-3**

MODEL NUMBER

+



**MD**

MECHANISM OPTION

+



**BK**

FRAME FINISH

+



**AX27**

FABRIC CODE

### FABRIC CHAIR EXAMPLE

If there are any options for the chair they would be inserted between the Model Number with Arm Style and Frame Finish. For example (see above):

#### 5451-3 BK AX27

This would be the **Truform Medium Back Multi-Tilter** with standard Height Adjustable Arms and Multi-Tilter. Black Frame **BK** and Oxygen fabric in Axis, Noir **AX27**, complete the chair.

### CHAIR SAFETY TIPS

**Common sense guidelines to ensure that your Global chair will provide many years of comfort and service in a safe and productive environment:**

- Always read and follow assembly instructions. Make sure that all of the pieces of your Global chair are installed in the proper order to ensure structural integrity.
- Ensure that chair casters are fully inserted into the base of the unit.
- Inspect your chair for loose or worn parts at least once a year.
- Always keep the base of your chair completely on the floor.
- Most Global chairs are equipped with casters for use on carpeted surfaces. Other flooring surfaces may require different casters.
- Speak to your Global Sales Representative or refer to the Casters Section of this Price Book for appropriate custom selections.
- Many Global office chairs are equipped with tilt tension controls on the seating mechanism. The tension control compensates for different body weights and postures. Always ensure that the control is properly adjusted for a smooth and controlled tilt motion. Your Global Sales Representative can demonstrate the proper use of all the adjustments on your office chair.
- Do not stand on your Global chair or sit on the arms of your chair.
- Do not put electrical appliances on chairs. Even fire retardant fabrics can be damaged when exposed to direct heat or flame.
- Choose the right chair for your work environment. Global offers a full line of Intensive Use, Multi-Shift and Specialized chairs for environments with demanding health or safety requirements. Your Global Sales Representative is trained to help you make the right choice for your workplace.

THE ASSOCIATION FOR CONTRACT TEXTILES (ACT) HAS DEVELOPED THE FOLLOWING PERFORMANCE GUIDELINES TO MAKE FABRIC SPECIFICATION EASIER. THE FIVE SYMBOLS GIVE ARCHITECTS, DESIGNERS AND END USERS A VAST AMOUNT OF PERFORMANCE INFORMATION IN A SUCCINCT, VISUAL WAY. THIS CHART LISTS THE REQUIRED TESTS THAT CORRESPOND TO SPECIFIC END USES. AN EXPLANATION OF THE SYMBOL ALSO APPEARS.

## FIRE RETARDANCY



Flammability testing determines a fabric's performance and resistance to burning.

### APPLICATION

Upholstery  
Panels and upholstered walls

### PASSES

California bulletin 117, section E.  
ASTM E 84-03 Class A or Class 1 (unadhered method).

## COLOR FASTNESS TO WET & DRY CROCKING



Color fastness to wet & dry crocking refers to the rubbing off of color from the fabric onto clothing, hands or other materials and can occur under wet or dry conditions.

### APPLICATION

Upholstery  
Panels and upholstered walls

### PASSES

AATCC 8-2001 Dry crocking. Class 4 minimum.  
Wet crocking, Class 3 minimum.  
AATCC 8-2001 E 84 (unadhered method).

## COLOR FASTNESS TO LIGHT



Color fastness to light is the degree to which fabric will retain its color when exposed to light.

### APPLICATION

Upholstery  
Panels and upholstered walls

### PASSES

AATCC option 2-2003 or AATCC - option 3-2003.  
Class 4 minimum of 40 hours.  
AATCC option 2-2003 or AATCC - option 3-2003.  
Class 4 minimum of 40 hours.

## PHYSICAL PROPERTIES



Three physical property tests include: 1 - Brush pill test to determine a fabric's pilling (the formation of fuzzy galls of fiber on the surface of a fabric). 2 - Breaking/tensile strength is the ability of a fabric to withstand tension without breaking or tearing. 3 - Seam slippage is the pulling apart of fabrics at the seams.

### APPLICATION

Upholstery  
Panels and upholstered walls

### PASSES

Brush pill ASTM D3511-02, 3 minimum.  
Breaking strength ASTM D5034-95 (2001) 50 lbs. minimum in warp & weft.  
Seam slippage ASTM D4034 25 lbs. minimum in warp & weft.  
Breaking strength ASTM D5034-95 (2001) (grab test).  
35 lbs. minimum in warp & weft.

## ABRASION



Abrasion is the ability of a fabric to withstand damage from wear and rubbing. There is a general contract specification as well as a heavy duty specification.

### APPLICATION

General contract upholstery  
Heavy duty upholstery

### PASSES

ASTM D4157-02 (#10 cotton duck) 15,000 double rubs, Wyzenbeek method.  
ASTM D4966-98 (12 KPA pressure) 20,000 double rubs, Martindale method.  
ASTM D4157-02 (#10 cotton duck) 30,000 double rubs, Wyzenbeek method.  
ASTM D4966-98 (12 KPA pressure) 40,000 double rubs, Martindale method.

# fast5

Global's fast5 quick ship program offers many of our bestselling models upholstered in your choice of our most popular textiles.

- 20+ Series, 150+ Models, 200+ Textiles to customize your order
- No special order forms required

Global's fast production and shipping make it simple to order and ideal for tight deadlines!

## Color it your way

### GRADE 1

Carrera 100% Polyester	
CE84 Zest	CE85 Savannah
CE86 Slate	CE87 Rainforest
CE88 Aspen	CE89 Dune
CE90 Flannel	CE91 Azure
CE92 Chili	CE93 Jute
CE95 Ink	CE96 Sangria
CE97 Java	CE98 Charcoal

### Fusion 90% Virgin Polyester / 10% Post-Consumer Recycled Polyester

FU71 Tangerine	FU72 Fresh
FU73 Moss	FU74 Tomato
FU75 Aqua	FU76 Sandstone
FU77 Granite	FU78 Poppy
FU79 Cadet	FU80 Oasis
FU81 Graphite	FU82 Viola
FU83 Cobalt	FU84 Flax
FU85 Carbon	

### Illusion 100% Virgin Polyester

II01 Cappuccino	II02 Paprika
II03 Tropic	II04 Wicker
II05 Hemp	II06 Cayenne
II07 Maui	II08 Dusk
II09 Smoke	II10 Currant
II11 Fiji	II12 Ozone
II13 Ebony	

### Jenny 100% Polyester

JN01 Midnite	JN02 Ebony
JN03 Slate	JN07 Vermilion
JN08 Admiral	JN11 Charcoal
JN25 Silver Lining	JN26 Oatmeal
JN27 Sunflower	JN28 Cascade
JN29 Harvest	JN30 Melon
JN31 Berry	JN32 Green Grass
JN33 Roast	

### Quilt 100% Polyester

QL10 Black	QL11 Charcoal Grey
QL14 Navy	QL16 Wine
QL19 Silver	QL20 Feather
QL21 Dune	QL22 Meadow
QL23 Cadet	QL24 Geranium
QL25 Daisy	QL26 Quest
QL27 Punch	QL28 Tangerine
QL29 Cocoa	

### Trak 100% Recycled Polyester

TK40 Taupe	TK41 Mustard
TK42 Latte	TK43 Cement
TK44 Silver	TK45 Copper
TK46 Teal	TK47 Apple
TK48 Steel	TK49 Merlot
TK50 Midnight Sky	TK51 Mocha
TK52 Carbon	

### Urban 62% Recycled Polyester / 32% Polyester

UR10 Red Rose	UR11 Ocean Blue
UR12 Blue Bayou	UR13 Green Grass
UR14 Sandcastle	UR15 Beach Day
UR16 Boardwalk	UR17 Earth
UR18 Brown Ridge	UR19 White Sand
UR20 Granite Rock	UR21 Gravel Road
UR22 Black Coal	

### Wavelength 100% Virgin Polyester

WV01 Lime	WV02 Mint
WV03 Stone	WV04 Flame
WV05 Mykonos	WV06 Savannah
WV07 Mesa	WV08 Plasma
WV09 Cancun	WV10 Quartz
WV11 Moonrock	WV12 Rubine
WV13 Corfu	WV14 Bluejey
WV14 Panther	

### GRADE 2

Atlante Flee 100% Vinyl Face / 100% Polyester Backing	
A01F Illusion	A02F Bright White
A03F White Crush	A04F Ivory
A05F Ice	A06F Bleached Sand
A07F Taupe Fawn	A08F Warm Smoke
A09F Autumn Rain	A10F Cookie
A11F Sierra Brick	A12F Gibraltar
A13F Chateau Grey	A14F Garden Green
A15F Oasis Green	A16F Ink Black
A17F Purple Impulse	A18F Italian Rose
A19F Mountain Sky	A20F Old Navy
A21F Galaxy	A22F Red Truffle
A23F Chocolate Sundae	A24F Provence Blue
A25F Eclipse	

### Elevate 80% Post-Consumer Recycled Polyester / 20% Rayon

EL51 Halo	EL52 Dove
EL53 Safari	EL54 Sunglow
EL55 Margarita	EL56 Fiji
EL57 Mist	EL58 Blaze
EL59 Wasabi	EL60 Mystic
EL61 Mica	EL62 Cherry
EL63 Scuba	EL64 Lapis
EL65 Onyx	

### Etch 80% Post-Consumer Recycled Polyester / 20% Rayon

ET81 Drift	ET82 Citron
ET83 Calypso	ET84 Mandarin
ET85 Crisp	ET86 Iris
ET87 Nickel	ET88 Paprika
ET89 Nutmeg	ET90 Marine
ET91 Magnet	ET92 Infrared
ET93 Espresso	ET94 Indigo
ET95 Anthracite	

### Imprint 100% Post-Consumer Polyester

IM70 Almond	IM71 Cork
IM72 Sand	IM73 Currie
IM74 Candy Apple	IM75 Ocean
IM76 Navy	IM77 Green Tea
IM78 Celery	IM79 Oregano
IM80 Walnut	IM81 Paprika
IM82 Graphite	IM83 Slate
IM84 Licorice	

### Luxhide 100% Vinyl Face / Bonded Leather Backing

BL20 Black	BL22 Parchment
BL23 Saddle	BL24 Dark Brown
BL26 Burgundy	BL27 Charcoal
BL28 White	
BL34 Light Grey	

### Release 100% Vinyl Face

RL11 White	RL12 Chalk
RL13 Stone	RL14 Taupe
RL15 Orange	RL16 Country
RL17 Tuscan	RL18 Cottage
RL19 Yellow	RL21 Red Barn
RL22 Brave Red	RL23 Gypsy Red
RL24 Cajun	RL25 Vineyard
RL26 Olive	RL27 Bonsai
RL28 Summer's Dream	RL29 Calico
RL31 Green	RL32 Blue
RL33 Black	RL34 Cool Grey
RL35 Thunder Grey	RL36 Navy
RL37 Dark Chocolate	RL38 Espresso





















### GRADE 10

Prescott Leather	
PC02 Zinc	PC04 Papyrus
PC05 Soul White	PC10 Caffè Latte
PC14 Avana	PC18 Swamp
PC41 Antique	PC54 Antipol
PC57 Chestnut	PC79 Oceania
PC80 Indigo	PC81 Deep
PC86 Santorini	PC96 Turtledove
PC97 Smoke	PD02 Grayshadow
PD03 Black Ink	

Textiles are subject to change, please confirm current selection.

## TERMS AND CONDITIONS

- All product series have MAXIMUM order quantities which can be fulfilled within the fast5 program. These are noted with each series' Specs + Options. For greater quantities, please contact CustomerCare for lead time and terms.
- Orders that exceed maximum unit quantities will receive standard lead times.
- Orders must clearly note "fast5" and be submitted as a separate purchase order. Global cannot mix fast5 and standard delivery or InStock products on the same purchase order.
- Purchase orders containing products from fast5 and fast10 programs will automatically receive fast10 lead time and shipping. Purchase order should be noted "fast10".
- Certain models, noted on the series' Specs + Options, are multi-packed and must be ordered in quantities accordingly. Package unit quantities cannot be changed.
- Program is limited to exact models, model options and textiles within series listed.
- Program is limited to exact textile pattern colorways listed in the fast5 program. Use the Textile Search Tool to confirm desired textile is approved for use on the selected series.
- Orders must be clean with correct model numbers, options, textiles, correct pricing, etc. to apply.
- Orders cannot be changed or canceled after order acknowledgment.
- Current Global list pricing applies at the time of order. fast5 orders may be shipped FedEx, UPS or via alternate carriers. Global reserves the right to ship "best way".
- fast5 products will be manufactured to your orders' specifications in 5 business days or less and ship immediately thereafter.
- Orders will ship to the dealer or commercial end-user directly. Delivery charges may apply for special handling, services, etc. Please consult your Territory Manager or CustomerCare Representative.
- Dealer must be in good standing and account within terms for order(s) to be processed without delay.
- fast5 program is available in the 48 contiguous United States.

Series	Model Numbers	Series	Model Numbers	Series	Model Numbers	
<b>Aspen</b> 	(maximum 20) 2851-3 2853-3	<b>Luray</b> 	(maximum 20) 6461 6462	<b>Sonic</b> 	Plastic (maximum 100) 6508 6508MB 6513 6513MB 6558 6558CS 6573 6573MB 6577 6577MB	
	<b>Comet</b> 		(maximum 50) 2171WS 2172WS		<b>Popcorn</b> 	Plastic (maximum 100) 6710 6711  Upholstered (maximum 50) 6712 6713 6715
<b>Duet</b> 	Plastic (maximum 100) 6620 6621  Upholstered (maximum 50) 6622 6627 6623 6628 6624	<b>Prefer</b> 	(maximum 20) 8458 8459	<b>Sora</b> 	(maximum 20) 6941 6942	
	<b>Factor</b> 		(maximum 50) 5540 5541 5540NA 5541NA		<b>Rebound</b> 	Plastic (maximum 100) R5NPPG R5APPG R5NPPC R5APPC  Upholstered (maximum 50) R5NPUG R5APUG R5NPUC R5APUC
<b>G1 Ergo Select</b> 	(maximum 50) 7331 7332	<b>Roma</b> 	(maximum 50) 1890 1903 1896 1906 1897 1907 1901 1908 1902	<b>Synopsis</b> 	(maximum 50) 5080-0 5081-3 5080-3 5090-4 5081-0 5091-4	
	<b>Global Accord</b> 		(maximum 50) 2670-2 2676-2 2670-4 2676-4 2671-2 2677-2 2671-4 2677-4 2672-6 2678-6		Nester (maximum 50) 1898 1900 1899	<b>Sidero</b> 
<b>Goal</b> 	(maximum 50) 2235-6 2237-5 2236-6 2237-6 2237-3 2239-6	<b>Solar</b> 	(maximum 50) 8456 8457 8456NA 8457NA 8456S 8457S 8456SNA 8457SNA	<b>Triumph</b> 	(maximum 20) 3650-3 3651-3 3650-8 3651-8	
	<b>Granada</b> 		(maximum 50) 3212 3254 3278		<b>Solo</b> 	(maximum 50) 5228
<b>Loover</b> 	(maximum 50) 2661-0 2662-0 2661-3 2662-3 2661-4 2662-4 2661-8 2662-8				Upholstered (maximum 50) 6331-0 6332-0 6331-3 6332-3 6331-4 6332-4 6331-8 6332-8	
					Guest (maximum 50) 6324 6325 6324C 6325C	

# fast10

Global's fast10 quick ship program offers many of our bestselling models upholstered in your choice of our most popular textiles.

- 5 Series, 25+ Models, 200+ Textiles to customize your order
- No special order forms required

Global's fast production and shipping make it simple to order and ideal for tight deadlines!

## Color it your way

### GRADE 1

Carrera 100% Polyester	
CE84 Zest	CE85 Savannah
CE86 Slate	CE87 Rainforest
CE88 Aspen	CE89 Dune
CE90 Flannel	CE91 Azure
CE92 Chili	CE93 Jute
CE95 Ink	CE96 Sangria
CE97 Java	CE98 Charcoal

### Fusion 90% Virgin Polyester / 10% Post-Consumer Recycled Polyester

FU71 Tangerine	FU72 Fresh
FU73 Moss	FU74 Tomato
FU75 Aqua	FU76 Sandstone
FU77 Granite	FU78 Poppy
FU79 Cadet	FU80 Oasis
FU81 Graphite	FU82 Viola
FU83 Cobalt	FU84 Flax
FU85 Carbon	

### Illusion 100% Virgin Polyester

I101 Cappuccino	I102 Paprika
I103 Tropic	I104 Wicker
I105 Hemp	I106 Cayenne
I107 Maui	I108 Dusk
I109 Smoke	I110 Currant
I111 Fiji	I112 Ozone
I113 Ebony	

### Jenny 100% Polyester

JN01 Midnite	JN02 Ebony
JN03 Slate	JN07 Vermilion
JN08 Admiral	JN11 Charcoal
JN25 Silver Lining	JN26 Oatmeal
JN27 Sunflower	JN28 Cascade
JN29 Harvest	JN30 Melon
JN31 Berry	JN32 Green Grass
JN33 Roast	

### Quilt 100% Polyester

QL10 Black	QL11 Charcoal Grey
QL14 Navy	QL16 Wine
QL19 Silver	QL20 Feather
QL21 Dune	QL22 Meadow
QL23 Cadet	QL24 Geranium
QL25 Daisy	QL26 Quest
QL27 Punch	QL28 Tangerine
QL29 Cocoa	

### Trak 100% Recycled Polyester

TK40 Taupe	TK41 Mustard
TK42 Latte	TK43 Cement
TK44 Silver	TK45 Copper
TK46 Teal	TK47 Apple
TK48 Steel	TK49 Merlot
TK50 Midnight Sky	TK51 Mocha
TK52 Carbon	

### Urban 62% Recycled Polyester / 32% Polyester

UR10 Red Rose	UR11 Ocean Blue
UR12 Blue Bayou	UR13 Green Grass
UR14 Sandcastle	UR15 Beach Day
UR16 Boardwalk	UR17 Earth
UR18 Brown Ridge	UR19 White Sand
UR20 Granite Rock	UR21 Gravel Road
UR22 Black Coal	

### Wavelength 100% Virgin Polyester

WV01 Lime	WV02 Mint
WV03 Stone	WV04 Flame
WV05 Mykonos	WV06 Savannah
WV07 Mesa	WV08 Plasma
WV09 Cancun	WV10 Quartz
WV11 Moonrock	WV12 Rubine
WV13 Corfu	WV14 Bluejay
WV14 Panther	

### GRADE 2

#### Allante Free 100% Vinyl Face / 100% Polyester Backing

A01F Illusion	A02F Bright White
A03F White Crush	A04F Ivory
A05F Ice	A06F Bleached Sand
A07F Taupe Fawn	A08F Warm Smoke
A09F Autumn Rain	A10F Cookie
A11F Sierra Brick	A12F Gibraltar
A13F Chateau Grey	A14F Garden Green
A15F Oasis Green	A16F Ink Black
A17F Purple Impulse	A18F Italian Rose
A19F Mountain Sky	A20F Old Navy
A21F Galaxy	A22F Red Truffle
A23F Chocolate Sundae	A24F Province Blue
A25F Eclipse	

#### Elevate 80% Post-Consumer Recycled Polyester / 20% Rayon

EL51 Halo	EL52 Dove
EL53 Safari	EL54 Sunglow
EL55 Margarita	EL56 Fiji
EL57 Mist	EL58 Blaze
EL59 Wasabi	EL60 Mystic
EL61 Mica	EL62 Cherry
EL63 Scuba	EL64 Lapis
EL65 Onyx	

#### Etch 80% Post-Consumer Recycled Polyester / 20% Rayon

ET81 Drift	ET82 Citron
ET83 Calypso	ET84 Mandarin
ET85 Crisp	ET86 Iris
ET87 Nickel	ET88 Paprika
ET89 Nutmeg	ET90 Marine
ET91 Magnet	ET92 Infrared
ET93 Espresso	ET94 Indigo
ET95 Anthracite	

### Imprint 100% Post-Consumer Polyester

IM70 Almond	IM71 Cork
IM72 Sand	IM73 Currie
IM74 Candy Apple	IM75 Ocean
IM76 Navy	IM77 Green Tea
IM78 Celery	IM79 Oregano
IM80 Walnut	IM81 Paprika
IM82 Graphite	IM83 Slate
IM84 Licorice	

### Luxhide 100% Vinyl Face / Bonded Leather Backing

BL20 Black	BL22 Parchment
BL23 Saddle	BL24 Dark Brown
BL26 Burgundy	BL27 Charcoal
BL28 White	
BL34 Light Grey	

### Release 100% Vinyl Face

RL11 White	RL12 Chalk
RL13 Stone	RL14 Taupe
RL15 Orange	RL16 Country
RL17 Tuscan	RL18 Cottage
RL19 Yellow	RL21 Red Barn
RL22 Brave Red	RL23 Gypsy Red
RL24 Cajun	RL25 Vineyard
RL26 Olive	RL27 Bonsai
RL28 Summer's Dream	RL29 Calico
RL31 Green	RL32 Blue
RL33 Black	RL34 Cool Grey
RL35 Thunder Grey	RL36 Navy
RL37 Dark Chocolate	RL38 Espresso

### GRADE 10

PC02 Zinc	PC04 Papyrus
PC05 Soul White	PC10 Caffè Latte
PC14 Avana	PC18 Swamp
PC41 Antique	PC54 Antipol
PC57 Chestnut	PC79 Oceania
PC80 Indigo	PC81 Deep
PC86 Santorini	PC86 Turtledove
PC97 Smoke	PD02 Grayshadow
PD03 Black Ink	

Textiles are subject to change, please confirm current selection.

## TERMS AND CONDITIONS

- All models have MAXIMUM quantity of 10 pieces, noted on each sheet, which can be fulfilled within the fast10 program. These are noted next to each series' Specs + Options. For greater quantities, please contact CustomerCare for lead times and terms.
- Orders that exceed maximum unit quantities will receive standard lead times.
- Orders must clearly note "fast10" and be submitted as a separate purchase order. Global cannot mix "fast10" and standard delivery or InStock products on the same purchase order.
- Purchase orders containing products from fast5 and fast10 programs will automatically receive fast10 lead time and shipping. Purchase order should be noted "fast10".
- Program is limited to exact models, model options and textiles within series listed.
- Program is limited to exact textile pattern colorways listed in the fast10 program. Use the Textile Search Tool to confirm desired textile is approved for use on the selected series.
- Orders must be clean with correct model numbers, options, textiles, correct pricing, etc. to apply.
- Orders cannot be changed or canceled after order acknowledgment.
- Current Global list pricing applies at the time of order.
- fast10 models are not available for FEDEX or UPS shipping. Global reserves the right to ship "best way".
- fast10 products will be manufactured to your orders' specifications in 10 business days or less and be consolidated for shipping immediately thereafter.
- Orders will ship to the dealer or commercial end-user directly. Delivery charges may apply for special handling, services, etc. Please consult your Territory Manager or CustomerCare Representative.
- Dealer must be in good standing and account within terms for order(s) to be processed without delay.
- fast10 Program is available in the 48 contiguous United States.

Series	Model Numbers	Series	Model Numbers	Series	Model Numbers
<b>Citi</b> 	(maximum 10)	<b>Wind</b> 	(maximum 10)	<b>Drift</b> 	(maximum 10)
	7864		3361		8016
	7875		3362		8021
	7876		3363		8022
	7877				8023
	7879				8024
	7885		8026		
			8030		
			8032		
			8033		
			8034		
			8035		
			8036		
<hr/> <b>Citi Square</b>		<hr/> <b>sirena</b>			
	(maximum 10)		(maximum 10)		
	S7875		3371		
	S7876				
	S7877				
	S7877				
	S7911				