

think global

THE GLOBAL EDGE

ERGONOMICS IN THE TOTAL OFFICE

- One stop shopping for a full range of office furniture.
- Seating, desks, tables, files, modular furniture, panels and accessories.
- Ergonomics, competitive pricing and built-in value.

STRENGTH AND STABILITY

- Established in 1966.
- One of North America's largest office furniture manufacturers.
- Manufacturing and showrooms worldwide.

QUICK SHIP - INSTOCK

- Thousands of products available in a 2 day quickship program.
- Hundreds of products in stock for immediate delivery.

STRONG LOCAL REPRESENTATION

- Service and expert advice where you are, when you need it!

MANUFACTURING CAPABILITY

- Vertical integration ensures "start to finish" control.
- Ongoing research and investment in new, innovative production technology.

QUALITY ASSURANCE

- Quality Assurance Program is qualified by C.G.S.B. ISO9001 standards.
- On-site furniture testing facility.
- Product and components are tested to meet or exceed ANSI/BIFMA standards.

ENVIRONMENTAL COMMITMENT

- Continuous development of "earth friendly" programs.
- One of the first molded foam manufacturers to create ozone friendly, CFC and HFC-free process.
- Seat and back pans are made from recyclable plastics and wood waste, enabling little waste and cost effective products.

SYMBOL IDENTIFICATION

Each seating product with an RTA code identifies the assembly requirements.

RTA 00 FULLY ASSEMBLED

RTA 1 SIMPLE ASSEMBLY (No Tools Required)

Parts to Install:

- Casters
- Base
- Pneumatic Cylinder/Cover can

RTA 2 MODEST ASSEMBLY (Tools Supplied, if necessary)

Parts to Install:

- Casters
- Base
- Pneumatic Cylinder/Cover can
- Back

RTA 4 MODERATE ASSEMBLY (Tools Supplied)

Parts to Install:

- Casters
- Base
- Pneumatic Cylinder/Cover can
- Back
- Armrest

RTA 8 FULL ASSEMBLY (Tools Supplied)

Parts to Install:

- Casters
- Base
- Pneumatic Cylinder/Cover can
- Back
- Armrest
- Mechanism



Global's Certified Products are in compliance with the stringent emission guidelines set by the GREENGUARD Environmental Institute and include all Upholstered Seating. To obtain a GREENGUARD or GREENGUARD Gold Certificate for any product, please go to the Environmental Commitment section on our website www.globalfurnituregroup.com and click on "GREENGUARD".



level™ certification, based on the ANSI/BIFMA e3-2012 furniture sustainability standard, sets furniture manufacturers on a path toward greater sustainability over time. Based on environmental and social criteria set forth in the standard, a product's entire supply chain is assessed.

Certification assessment includes an evaluation of specific corporate policies and guidelines and an assessment of associated company manufacturing facilities. Products must meet quantifiable milestones of environmental and social performance at every step of development.

The quantitative assessment addresses four categories: material use, energy and atmosphere impacts, human and ecosystem health and social responsibility.

Manufacturers earn points in each of the four categories. The level™ brand and its numeric rating of 1, 2 or 3 indicate what threshold of certification a product has achieved. level™ 3 is the highest rating.



All products with this designation are suitable for FedEx and UPS shipment throughout the United States.

TABLE OF CONTENTS

| | | | | |
|---|--|-------------------------------|--|--------------------------------|
| A | | E | | K |
| Arno25 | | Enterprise32 | | Kate317 |
| Arturo26 | | Erin169 | | |
| Aspen27 | | F | | L |
| Auburn28 | | Factor.....36 | | Layne177 |
| B | | File Buddy173 | | Lite179 |
| Bakhita134 | | Flap174 | | Loover62 |
| Ballara258 | | G | | Luray66 |
| Beach137 | | G138 | | Lux318 |
| Beam Seating138 | | G2040 | | |
| Braden265 | | Global Accord41 | | M |
| Bridges II Collaborative Seating267 | | Goal44 | | Malaga68 |
| C | | Graham46 | | Malaga TS395 |
| Calidon275 | | Granada47 | | Marche184 |
| Camino281 | | Granada Deluxe52 | | Mayne186 |
| Caprice148 | | Granada Deluxe TS395 | | Mirage69 |
| Chap150 | | Graphic56 | | ML320 |
| Citi284 | | I | | ML Park320 |
| Citi Square.....289 | | Include.....59 | | Moda Four-Legged187 |
| Comet152 | | Industrial Seating417 | | Moda Stacking188 |
| Concorde29 | | Industrial Wipe Down422 | | |
| D | | Islands176 | | N |
| Diplomat31 | | J | | Noetic.....70 |
| Drift298 | | Jeo.....316 | | Novello75 |
| Duet156 | | | | O |
| Duet tables166 | | | | ObusForme Comfort + XL79 |

TABLE OF CONTENTS

P

| | |
|---------------|-----|
| Popcorn | 190 |
| Prairie | 323 |
| Prefer | 86 |

Q

| | |
|-------------|----|
| Quora | 88 |
|-------------|----|

R

| | |
|-----------------------------|-----|
| Rambler | 324 |
| Rebound | 195 |
| River | 327 |
| River Personal Harbor | 343 |
| River+ | 345 |
| Robust | 401 |
| Roma | 89 |
| Roma Nester | 200 |

S

| | |
|----------------------------|-----|
| Sas | 202 |
| Saxon | 402 |
| Sidero | 204 |
| Sirena | 372 |
| Solar | 93 |
| Solo | 95 |
| Sonic | 208 |
| Sora | 97 |
| Spritz | 99 |
| Spritz multi-purpose | 220 |
| Spyker | 223 |
| Stream | 224 |
| Supra | 104 |
| Supra X | 106 |
| Synopsis | 109 |

T

| | |
|-------------------|-----|
| Traditional | 112 |
| Triumph | 115 |
| Truform | 116 |
| Twilight | 233 |
| Tye | 119 |

V

| | |
|------------------|-----|
| Venture | 375 |
| Vion | 122 |
| Vion guest | 236 |
| Vitrola | 378 |

W

| | |
|-------------------|-----|
| Weev | 130 |
| Willow | 241 |
| Wind | 380 |
| Wind Linear | 384 |

Z

| | |
|------------|-----|
| Zoma | 255 |
|------------|-----|

















REFERENCES/PROGRAMS

| | |
|---|-------|
| Seating by Category Types | 4-11 |
| Suggested Applications by Series | 12-13 |
| Ergonomic Features and Benefits | 15 |
| Mechanism Adjustments | 16 |
| How to Order Seating | 17 |
| Act Performance Symbols | 18 |
| Fast | 19 |
| Heavy Duty/24 Hour | 394 |
| How to select armrests | 406 |
| Arm selections | 407 |
| Caster selections | 410 |
| Cylinder chart | 412 |
| Duet + Popcorn glide selections 1 | 414 |
| Specialty seating | 417 |
| Textiles + Finishes | 432 |
| COM Authorization Form | 439 |
| Terms/Conditions/Warranty | 428 |

SEATING BY CATEGORY TYPE



Task

| | | |
|--|--|---|
|  Arno.....25 |  Luray66 |  Stream.....101 |
|  Aspen27 |  Malaga68 |  Supra104 |
|  Duet.....134 |  Noetic.....70 |  Supra X106 |
|  Enterprise32 |  Novello75 |  Synopsis109 |
|  Factor36 |  ObusForme Comfort + XL79 |  Triumph115 |
|  G138 |  Popcorn190 |  Truform116 |
|  G2040 | |  Tye119 |
|  Goal44 |  Prefer86 |  Vion122 |
|  Graham46 |  Roma89 |  Weev130 |
|  Granada47 |  Solar93 | |
|  Granada Deluxe52 |  Solo95 | |
|  Graphic56 |  Sonic208 | |
|  Loover62 |  Sora97 | |
| |  Spritz99 | |

Conference/Management



Arno25



Arturo26



Diplomat31



Enterprise32



Global Accord41



Graphic56



Include.....59



Jeo316



Kate.....317



Luray66



Mirage69



Roma89



Solar93



Solo95



Supra104













Synopsis109



























Traditional112

SEATING BY CATEGORY TYPE

Executive















| | | |
|--|---|--|
|  Arno25 |  Enterprise.....32 |  Synopsis.....109 |
|  Arturo26 |  Global Accord41 |  Traditional112 |
|  Auburn28 |  Luray66 | |
|  Concorde29 |  Mirage69 | |
|  Diplomat.....31 | | |

Height Adjustable Stools

| | | |
|--|--|---|
|  Duet.....156 |  Loover62 |  Spritz99 |
|  Factor36 |  Malaga68 |  Stream.....101 |
|  G1 Ergo Select38 |  Noetic.....70 |  Supra X.....106 |
|  Global Accord41 |  Novello75 |  Synopsis109 |
|  Goal44 |  ObusForme Comfort + XL79 |  Truform116 |
|  Granada47 |  Prefer86 |  Tye119 |
|  Granada Deluxe52 |  Roma89 |  Vion122 |
|  Graphic56 |  Solar93 |  Weev130 |



Stacking





| | | |
|--|--|---|
|  Bakhita134 |  Popcorn190 |  Spyker223 |
|  Comet152 |  Rebound195 |  Stream224 |
|  Duet156 |  Sas202 |  Vion guest236 |
|  Flap174 |  Sidero204 |  Willow241 |
|  Moda188 |  Sonic208 |  Zoma255 |

Guest (Metal)

| | | |
|--|--|---|
|  Arno25 |  Factor171 |  Sas202 |
|  Caprice148 |  Jeo316 |  Sidero204 |
|  Comet152 |  Kate317 |  Sonic208 |
|  Diplomat155 |  Lite179 |  Stream224 |
|  Drift298 |  Marche184 |  Twilight233 |
|  Enterprise32 |  Popcorn190 |  Vion guest236 |
|  Erin169 |  Rebound195 |  Willow241 |

SEATING BY CATEGORY TYPE













Guest (Wood)

| | | |
|--|--|--|
|  Beach137 |  Drift.....298 |  Layne177 |
|  Chap150 |  Islands176 |  Mayne186 |















Nesting

| | |
|--|--|
|  Roma Nester200 |  Spritz Nester220 |
|--|--|

Tandem/Beam/Pedestal

| | | |
|--|--|---|
|  Duet (Beam)143 |  Sidero (Beam)145 |  Synopsis (Pedestal).....109 |
|  Duet (Pedestal).....156 |  Sonic (Beam)145 |  Vion (Beam)146 |
|  Global Accord (Pedestal).....41 |  Sonic (Pedestal).....208 |  Vion (Pedestal).....122 |
|  Luray (Pedestal).....66 | | Beam Seating138 |
|  Novello (Pedestal).....75 | | |
|  Popcorn (Beam)144 | | |

Stools

| | | |
|---|--|---|
|  Diplomat155 |  ML.....320 |  Sonic208 |
|  Duet156 |  Popcorn190 |  Stream224 |
|  Drift.....298 |  Rebound195 |  Twilight233 |
|  File Buddy173 |  Sas202 |  Vion guest236 |
|  Marche184 |  Sidero204 |  Willow.....241 |



LOUNGE SEATING

| | | |
|--|------------------|---------------------|
| Ballara.....258 | Kate.....317 | Sirena.....372 |
| Braden.....284 | ML.....320 | Venture.....375 |
| Bridges II Collaborative Seating...267 | ML Park322 | Vitrola.....378 |
| Camino.....281 | Prairie.....323 | Wind.....380 |
| Citi.....284 | Rambler.....324 | Wind Linear.....384 |
| Drift.....298 | River.....327 | |
| Jeo.....316 | River+.....345 | |

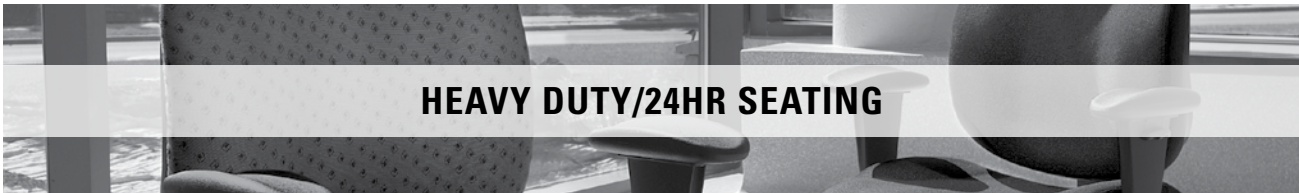

HEAVY DUTY/24HR SEATING

| | | |
|----------------------------------|-------------------------------|---------------------|
| Concorde Executive 24HR398 | Malaga TS395 | Saxon402 |
| G1 Ergo Select TS399 | ObusForme Comfort TS396 | Truform TS397 |
| Granada TS394 | Robust401 | Vion TS403 |
| Granada Deluxe TS395 | | |

SEATING BY CATEGORY TYPE



EDUCATION

Classroom

| | | | | | |
|-------------------|-----|---------------------|-----|---------------|-----|
| Duet | 156 | Rebound | 195 | Supra X | 106 |
| Duet tables | 166 | Roma Nester | 200 | Vion | 122 |
| Graphic | 56 | Sidero | 204 | Willow..... | 241 |
| Novello | 75 | Sonic | 208 | | |
| Popcorn | 190 | Spritz Nester | 220 | | |

Work + Task

| | | | | | |
|---------------|----|------------------------------|----|---------------|-----|
| Factor | 36 | Noetic..... | 70 | Sora | 97 |
| G1 | 38 | Novello | 75 | Spritz | 99 |
| Granada | 47 | ObusForme Comfort + XL | 79 | Supra X | 106 |
| Graphic | 56 | Prefer | 86 | Truform | 116 |
| Loover | 62 | Roma | 89 | Vion | 122 |

SEATING BY CATEGORY TYPE

Guest

| | | |
|------------------|----------------------|---------------------|
| Caprice148 | Rebound195 | Vion guest236 |
| Duet156 | Roma Nester200 | Willow.....241 |
| Graphic56 | Sidero204 | Zoma255 |
| Islands176 | Sonic208 | |

Lecture Hall

| | | |
|-------------------------|------------------------|----------------------|
| Duet (Beam)143 | Sidero (Beam)145 | Vion (Beam)146 |
| Popcorn (Beam)144 | Sonic (Beam)145 | |

Lab Seating + Stools

| | | |
|------------------|-----------------|------------------|
| Caprice148 | Novello75 | Spritz99 |
| Duet156 | Sidero204 | Supra X106 |
| Graphic56 | Sonic208 | Vion122 |

Cafeteria

| | | |
|------------------|------------------|-----------------|
| Bakhita134 | Popcorn190 | Spyker223 |
| Duet156 | Rebound195 | Willow.....241 |
| Sas202 | Sonic208 | |

SEATING BY CATEGORY TYPE



EDUCATION

Lounge

| | | |
|-----------------|----------------------|---------------------|
| Ballara.....258 | Citi Square289 | Sirena.....372 |
| Citi.....284 | River.....327 | Wind Linear.....384 |
| Drift.....298 | River+345 | |

Stacking & Nesting

| | | |
|------------------|----------------------|------------------------|
| Bakhita134 | Roma Nester200 | Spritz Nester220 |
| Duet156 | Sas202 | Spyker223 |
| Popcorn190 | Sidero204 | Stream224 |
| Rebound.....195 | Sonic208 | Zoma255 |

SUGGESTED APPLICATIONS BY SERIES

| SERIES | SUGGESTED APPLICATION | ACADEMIC SEATING | CAFETERIA SEATING | CONFERENCE ROOM SEATING | ERGONOMIC AND TASK | EXECUTIVE TASK SEATING | HEAVY DUTY SEATING | HOSPITALITY SEATING | GUEST SEATING | LOUNGE/RECEPTION SEATING | MANAGEMENT SEATING | MEETING ROOM SEATING | MULTI PURPOSE SEATING | PUBLIC SEATING | STACKING SEATING | STOODLS | TABLET SEATING | TECHNICAL SEATING | WOOD GUEST SEATING |
|----------------------------|-----------------------|------------------|-------------------|-------------------------|--------------------|------------------------|--------------------|---------------------|---------------|--------------------------|--------------------|----------------------|-----------------------|----------------|------------------|---------|----------------|-------------------|--------------------|
| ARNO | | | • | | | | | • | | • | • | | | | | | | | |
| ARTURO | | | • | | | | | | | • | | | | | | | | | |
| ASPEN | | | | • | • | | | | | • | • | | | | | | | | |
| AUBURN | | | • | | | | | | | • | | | | | | | | | |
| BAKHITA | • | • | | | | | | | | | | • | | • | | | | | |
| BALLARA | | | | | | | • | | • | | | | | | | • | | | |
| BEACH | | | | | | | • | • | • | | | • | • | | | | | | • |
| BEAM SEATING | • | • | | | | | • | • | | | | | | | | | | | |
| BRADEN | | | | | | | | | • | | | | | | | | | | |
| BRIDGES II COLLAB. SEATING | | | | | | | • | • | • | | | | • | | | | | | |
| CAMINO | | | | | | | • | • | • | | | | | | | | | | |
| CAPRICE | | • | | | | | | • | | | | • | | | | • | | | |
| CHAP | | | | | | | • | • | • | | | | | | | | | | • |
| CITI & CITI SQUARE | | | | | | | | • | • | | | | • | | | | • | | |
| COMET | | • | | | | | | • | • | | • | • | | | | | | | |
| CONCORDE | | | | | • | • | | | | | | | | | | | | | |
| DIPLOMAT | | | • | | | | | • | | • | • | | | | | • | | | • |
| DUET | • | • | • | • | | | | | • | | • | • | • | • | • | • | • | | |
| ENTERPRISE | | | • | • | | | | • | | • | • | | | | | | | | |
| FACTOR | | | • | • | | | | | | | • | | | | | • | | | |
| FILE BUDDY | | | | | | | | | | | | | • | | | • | | | |
| G1 ERGO SELECT | | | • | • | • | | | | | • | | | | | | | • | | |
| G20 | | | • | • | • | | | | | • | • | | | | | | | | |
| GLOBAL ACCORD | | | • | | | | | | | • | • | | • | | | • | | | |
| GOAL | • | | | • | | | | | | | | | | | | | | | • |
| GRAHAM | | | | • | | | | | | | | | | | | | | | |
| GRANADA & GRANADA DELUXE | • | | | • | | • | | • | | | | | | | | • | | • | |
| GRAPHIC | | | • | | | | | | | | • | | | | | • | | | |
| ISLANDS | | | | | | | • | • | • | | | | | | | | | | • |
| JEO | | | | | | | | • | • | | | | • | | | | | | |
| KATE | | | • | | | | | • | | | | | | | | | | | |
| LAYNE | | | | | | | • | • | | | | | | | | | | | • |
| LITE | • | • | | | | | • | • | • | | | • | | | | | | | |
| LOOVER | | | • | • | | | | • | | • | | | | | | | | | |
| LURAY | | | • | • | | | | | | • | | | • | | | | | | |
| MALAGA | • | | | • | | • | | • | | | | | | | | • | | | |
| MARCHE | | | | | | | • | • | | | • | | | | | • | | | |

SUGGESTED APPLICATIONS BY SERIES

| SERIES | SUGGESTED APPLICATION | ACADEMIC SEATING | CAFETERIA SEATING | CONFERENCE ROOM SEATING | ERGONOMIC AND TASK | EXECUTIVE TASK SEATING | HEAVY DUTY SEATING | HOSPITALITY SEATING | GUEST SEATING | LOUNGE/RECEPTION SEATING | MANAGEMENT SEATING | MEETING ROOM SEATING | MULTI PURPOSE SEATING | PUBLIC SEATING | STACKING SEATING | STOODLS | TABLET SEATING | TECHNICAL SEATING | WOOD GUEST SEATING |
|--------------------|-----------------------|------------------|-------------------|-------------------------|--------------------|------------------------|--------------------|---------------------|---------------|--------------------------|--------------------|----------------------|-----------------------|----------------|------------------|---------|----------------|-------------------|--------------------|
| MAYNE | | | | | | | | • | • | | | | | | | | | | • |
| MIRAGE | | | | | | | | | | | | | | | | | | | |
| ML | | | • | | | | | • | • | • | | | | | | | | | • |
| ML PARK | | | • | | | | | • | • | • | | | | | | | | | |
| MODA | | | • | | | | | | • | | | | | | | | | | |
| NOVELLO | • | | | • | • | | | • | | | • | • | • | | | | | | • |
| OBUSFORME COMFORT | | | | • | • | | | | | • | | | | | | | | | |
| POPCORN | | | • | • | | | | | • | • | • | • | • | | | | | | |
| PRAIRIE | | | | | | | | | • | | | | | | | | | | |
| RIVER | | | | | | | | • | • | • | | | • | | | | | | |
| ROBUST | | | | | | | • | | | • | | | | | | | | | |
| ROMA | | | • | • | • | | | | | | • | • | • | | | | | | • |
| ROMA NESTER | | | | | | | | | | | | • | • | | | | | | |
| SAS | | | • | | | | | • | • | | | | | | | | | | • |
| SAXON | | | | | | | • | | | | | | | | | | | | |
| SIDERO | | | • | | | | | • | • | | | • | | | | | | | • |
| SIRENA | | | | | | | | • | • | | | | | | | | | | • |
| SOLAR | | | | • | • | | | • | | | | | | | | | | | |
| SOLO | | | | • | | | | | • | | • | | | | | | | | |
| SONIC | | | • | | • | | | | • | • | • | • | • | • | • | • | • | | |
| SPRITZ | • | • | | • | | | | | • | • | • | • | • | • | • | • | | | |
| SPYKER | | | • | | | | | | | | | • | | | • | | | | |
| STREAM | • | • | | • | | | | • | • | • | • | • | • | • | • | • | • | | |
| SUPRA | | | | • | | | | • | | • | | | | | | | | | |
| SUPRA X | • | | | | • | | | | | | | | | | | | | | • |
| SYNOPSIS | | | | • | • | | | | • | • | | | | | | | | | • |
| TRADITIONAL | | | | | | | | • | • | • | | | | | | | | | |
| TRIUMPH | | | | | • | | | | | • | | | | | | | | | |
| TRUFORM | | | | • | | • | | | | • | | | | | | | | | • |
| TWILIGHT | | | • | | | | | • | | | • | • | | | | | | | • |
| TYE | | | | • | • | | | • | | | • | | | | | | | | • |
| VENTURE | | | | | | | | • | | • | | | • | | | | | | |
| VION | | | | • | • | • | • | • | | • | | | • | • | • | | | | |
| VITROLA | | | | | | | | • | | • | | | • | | | | | | |
| WEEV | | | | • | • | | | | | • | | | | | | | | | • |
| WIND & WIND LINEAR | | | | | | | | | • | | | | | | | | | | |
| ZOMA | | | • | | | | | • | • | • | • | • | | | • | | | | |

ERGONOMIC FEATURES & BENEFITS

EACH GLOBAL CHAIR IS BUILT WITH FEATURES THAT ARE ERGONOMICALLY DESIGNED TO PROMOTE GOOD POSTURE AND PROVIDE MAXIMUM COMFORT. WHILE FULLY SUPPORTING YOUR BODY, THESE FEATURES SHOULD ALSO ALLOW YOU TO ADJUST YOUR CHAIR TO FIT YOU.



A TENSION ADJUSTMENT

Increase or decrease to match body weight. Allows you to rock comfortably, without heavy pushing, reducing muscle fatigue.



B CHAIR TILT LOCK

Lock the tilt movement in position(s) to accommodate your working posture. Allows you to lock your chair in a comfortable and supportive position. (Can be either single position or infinite style).



C SEAT HEIGHT

Raise or lower to allow your feet to rest flat on the floor. Avoids pressure under your thighs, easing blood flow.



D BACK HEIGHT

Raise or lower to position lumbar support in your lumbar area. Reduces likelihood of back pain.



E SEAT DEPTH

Change the depth of the seat to accommodate the length of your thighs. Keeps your back in contact with the backrest while avoiding pressure behind your knees.



F FORWARD SEAT ANGLE

Allows chair to tilt forward changing the angle of your thighs in relation to the floor. Helps reduce disc pressure during forward leaning tasks.



G BACK ANGLE

Adjust to change the angle of your torso in relation to your thighs. Helps reduce disc pressure and relaxes your back muscles.



H ARM HEIGHT

Raise or lower to support your forearms. Reduces muscular effort in neck and shoulders, minimizing risk of pain.



J KNEE-TILT MOVEMENT

Chair tilt pivot point is toward the front of the seat. Stability is maintained as the user reclines, keeping their feet on the floor and maintaining the same torso to thigh angle.



L SYNCHRO-TILT MOVEMENT

The seat pivots at the center point, while the backrest reclines at a faster rate than the seat, increasing the angle between the user's torso and thighs. Enhances comfort and encourages dynamic body movement.



M WATERFALL SEAT EDGE

Reduces pressure at the back of the knee, contributing to good blood flow.



N CONTOURED CUSHION

Supports the body effectively, allowing you to sit longer without discomfort.



P VIBRATING SEAT & BACK

Soothing effect contributes to your relaxation during work breaks.



Q WIDTH ADJUSTABLE ARMS

Allows outward movement of armrests to match shoulder breadth. Ensures armrests properly support forearms, reducing muscular efforts in neck and shoulders.



Top View

R ARM ROTATION

Rotate armcaps to support your forearms in various positions. Reduces muscular effort in neck and shoulders minimizing risk of pain.



S CENTER TILT

Chair tilts at the center point of the seat allowing you to recline while maintaining the same torso to thigh angle. When your feet are well supported, blood flow is enhanced.



U SOFT DESCENT PNEUMATIC LIFT

Gently and gradually lowering the seat helps you easily select proper seat height without causing a jerking motion.



V LUMBAR DEPTH ADJUSTMENT

Increase or decrease curvature of the back to match the profile of your lower back. Enhances comfort and support in the lower lumbar area.

MAXIMIZING YOUR ERGONOMIC SEATING

- Always select a chair that is designed for the type of work you perform and make certain the chair is comfortable for the length of time spent using it.
- Ensure that the seat and back cushions are contoured to fit your body, which will help eliminate pressure points.
- An ergonomically designed chair should allow changing positions easily.
- As you work, reposition yourself throughout the day to reduce strain and stress on specific muscle groups. If you change job functions, adjust your chair to fit the new task.
- Proper ergonomic seating should help eliminate many of the work related injuries that result from poor posture and poorly designed chairs.

TASK (-6)



ADJUSTMENTS

- (2) Pneumatic seat height
- (8) Manual seat depth
- Back height **
- Swivel

POSTURE TASK (-7)

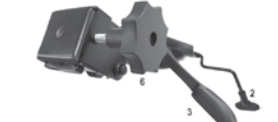

ADJUSTMENTS

- (2) Pneumatic seat height
- (3) Back angle
- (6) Back height **
- Seat depth *
- Swivel

TILTER (-4)

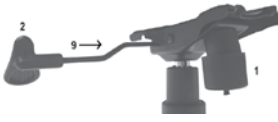

ADJUSTMENTS

- (2) Pneumatic seat height
- (9) Chair tilt lock *
- Center-tilt action
- Swivel

KNEE-TILTER (-2)



ADJUSTMENTS

- (1) Tilt tension
- (2) Pneumatic seat height
- (9) Chair tilt-lock *
- Back height **
- Knee-tilt action
- Swivel
- Optional sliding seat depth adjustment (MD)

MULTI-TILTER (-3)



ADJUSTMENTS

- (1) Tilt tension
- (2) Pneumatic seat height
- (3) Back angle adjustment
- (9) Infinite position seat tilt lock
- (7) Forward tilt lock *
- (8) Sliding seat depth adjustment (MD)
- Back height **
- Center-tilt action
- Swivel

SYNCHRO-TILTER (-0, -8)



ADJUSTMENTS

- (1) Tilt tension
- (2) Pneumatic seat height
- (3) Back angle adjustment
- (8) Sliding seat depth adjustment (MD)
- (9) Chair tilt lock Synchro-tilt action
- Anti-kickback *
- Back height **
- Swivel

POSTURE-TILTER *



ADJUSTMENTS

- (1) Tilt tension
- (2) Pneumatic seat height
- (8) Sliding seat depth adjustment (MD)
- (9) Infinite position seat tilt lock
- Back height **
- Swivel

OPERATOR (-5)



ADJUSTMENTS

- (2) Pneumatic seat height
- (3) Back angle *(Free Float/lock)
- (4) Seat angle *(Free Float/lock)
- (4) Seat angle / Back angle
- Back height **
- Free floating seat and back *
- With single lever operator mechanism, seat and back angle are controlled using lever 4 *
- Swivel

NOTES

- * Selected models only.
- ** RATCHET back height adjustment on selected models.
- *** Mechanisms shown are generic depictions and may differ from one chair to another.

HOW TO ORDER SEATING



5451-3

MODEL NUMBER

+



MD

MECHANISM OPTION

+



BK

FRAME FINISH

+



AX27

FABRIC CODE

FABRIC CHAIR EXAMPLE

If there are any options for the chair they would be inserted between the Model Number with Arm Style and Frame Finish. For example (see above):

5451-3 BK AX27

This would be the **Truform Medium Back Multi-Tilter** with standard Height Adjustable Arms and Multi-Tilter. Black Frame **BK** and Oxygen fabric in Axis, Noir **AX27**, complete the chair.

CHAIR SAFETY TIPS

Common sense guidelines to ensure that your Global chair will provide many years of comfort and service in a safe and productive environment:

- Always read and follow assembly instructions. Make sure that all of the pieces of your Global chair are installed in the proper order to ensure structural integrity.
- Ensure that chair casters are fully inserted into the base of the unit.
- Inspect your chair for loose or worn parts at least once a year.
- Always keep the base of your chair completely on the floor.
- Most Global chairs are equipped with casters for use on carpeted surfaces. Other flooring surfaces may require different casters.
- Speak to your Global Sales Representative or refer to the Casters Section of this Price Book for appropriate custom selections.
- Many Global office chairs are equipped with tilt tension controls on the seating mechanism. The tension control compensates for different body weights and postures. Always ensure that the control is properly adjusted for a smooth and controlled tilt motion. Your Global Sales Representative can demonstrate the proper use of all the adjustments on your office chair.
- Do not stand on your Global chair or sit on the arms of your chair.
- Do not put electrical appliances on chairs. Even fire retardant fabrics can be damaged when exposed to direct heat or flame.
- Choose the right chair for your work environment. Global offers a full line of Intensive Use, Multi-Shift and Specialized chairs for environments with demanding health or safety requirements. Your Global Sales Representative is trained to help you make the right choice for your workplace.

THE ASSOCIATION FOR CONTRACT TEXTILES (ACT) HAS DEVELOPED THE FOLLOWING PERFORMANCE GUIDELINES TO MAKE FABRIC SPECIFICATION EASIER. THE FIVE SYMBOLS GIVE ARCHITECTS, DESIGNERS AND END USERS A VAST AMOUNT OF PERFORMANCE INFORMATION IN A SUCCINCT, VISUAL WAY. THIS CHART LISTS THE REQUIRED TESTS THAT CORRESPOND TO SPECIFIC END USES. AN EXPLANATION OF THE SYMBOL ALSO APPEARS.

FIRE RETARDANCY



Flammability testing determines a fabric's performance and resistance to burning.

APPLICATION

Upholstery
Panels and upholstered walls

PASSES

California bulletin 117, section E.
ASTM E 84-03 Class A or Class 1 (unadhered method).

COLOR FASTNESS TO WET & DRY CROCKING



Color fastness to wet & dry crocking refers to the rubbing off of color from the fabric onto clothing, hands or other materials and can occur under wet or dry conditions.

APPLICATION

Upholstery
Panels and upholstered walls

PASSES

AATCC 8-2001 Dry crocking. Class 4 minimum.
Wet crocking, Class 3 minimum.
AATCC 8-2001 E 84 (unadhered method).

COLOR FASTNESS TO LIGHT



Color fastness to light is the degree to which fabric will retain its color when exposed to light.

APPLICATION

Upholstery
Panels and upholstered walls

PASSES

AATCC option 2-2003 or AATCC - option 3-2003.
Class 4 minimum of 40 hours.
AATCC option 2-2003 or AATCC - option 3-2003.
Class 4 minimum of 40 hours.

PHYSICAL PROPERTIES



Three physical property tests include: 1 - Brush pill test to determine a fabric's pilling (the formation of fuzzy galls of fiber on the surface of a fabric). 2 - Breaking/tensile strength is the ability of a fabric to withstand tension without breaking or tearing. 3 - Seam slippage is the pulling apart of fabrics at the seams.

APPLICATION

Upholstery
Panels and upholstered walls

PASSES

Brush pill ASTM D3511-02, 3 minimum.
Breaking strength ASTM D5034-95 (2001) 50 lbs. minimum in warp & weft.
Seam slippage ASTM D4034 25 lbs. minimum in warp & weft.
Breaking strength ASTM D5034-95 (2001) (grab test).
35 lbs. minimum in warp & weft.

ABRASION



Abrasion is the ability of a fabric to withstand damage from wear and rubbing. There is a general contract specification as well as a heavy duty specification.

APPLICATION

General contract upholstery
Heavy duty upholstery

PASSES

ASTM D4157-02 (#10 cotton duck) 15,000 double rubs, Wyzenbeek method.
ASTM D4966-98 (12 KPA pressure) 20,000 double rubs, Martindale method.
ASTM D4157-02 (#10 cotton duck) 30,000 double rubs, Wyzenbeek method.
ASTM D4966-98 (12 KPA pressure) 40,000 double rubs, Martindale method.

fast5

Global's fast5 quick ship program offers many of our bestselling models upholstered in your choice of our most popular textiles.

- 20+ Series, 150+ Models, 200+ Textiles to customize your order
- No special order forms required

Global's fast production and shipping make it simple to order and ideal for tight deadlines!





















Color it your way

| | | | |
|--|---|--|--|
| <p>GRADE 1</p> <p>Carrera 100% Polyester</p> <p>CE84 Zest CE85 Savannah</p> <p>CE86 Slate CE87 Rainforest</p> <p>CE88 Aspen CE89 Dune</p> <p>CE90 Flannel CE91 Azure</p> <p>CE92 Chili CE93 Jute</p> <p>CE95 Ink CE96 Sangria</p> <p>CE97 Java CE98 Charcoal</p> | <p>Quilt 100% Polyester</p> <p>QL10 Black</p> <p>QL14 Navy</p> <p>QL19 Silver</p> <p>QL21 Dune</p> <p>QL23 Cadet</p> <p>QL25 Daisy</p> <p>QL27 Punch</p> <p>QL29 Cocoa</p> | <p>QL11 Charcoal Grey</p> <p>QL16 Wine</p> <p>QL20 Feather</p> <p>QL22 Meadow</p> <p>QL24 Geranium</p> <p>QL26 Quest</p> <p>QL28 Tangerine</p> | <p>Essence 73.5% Post-Consumer Recycled Biodegradable Polyester</p> <p>26.5% Biodegradable Polyester</p> <p>EE05 Sand Dollar EE06 Canyon</p> <p>EE07 Morning Mist EE08 Agate</p> <p>EE09 Dark Shadow EE10 Raven</p> <p>EE11 Bumblebee EE12 Sky Blue</p> <p>EE13 Harbour EE14 Iris</p> <p>EE15 Rose Quartz EE16 Terracotta</p> <p>EE17 Sea Glass EE18 Pine</p> <p>EE19 Cabernet</p> |
| <p>EMerge 81% Post-Consumer Recycled Biodegradable Polyester</p> <p>19% Pre-Consumer Recycled Biodegradable Polyester</p> <p>EM10 Parchment EM11 Citrine</p> <p>EM12 Terra Rose EM13 Clay</p> <p>EM14 Carise EM15 Squid Ink</p> <p>EM16 Emerald EM17 Aloe</p> <p>EM18 Cobalt EM19 Atmosphere</p> <p>EM20 Cloud EM21 Smoke</p> <p>EM22 Featherstone EM23 Graphite</p> <p>EM24 Evening</p> | <p>Trak 100% Recycled Polyester</p> <p>TK40 Taupe</p> <p>TK42 Latte</p> <p>TK44 Silver</p> <p>TK46 Teal</p> <p>TK48 Steel</p> <p>TK50 Midnight Sky</p> <p>TK52 Carbon</p> | <p>TK41 Mustard</p> <p>TK43 Cement</p> <p>TK45 Copper</p> <p>TK47 Apple</p> <p>TK49 Merlot</p> <p>TK51 Mocha</p> | <p>Etch 80% Post-Consumer Recycled Polyester/ 20% Rayon</p> <p>ET81 Drift ET82 Citron</p> <p>ET83 Calypso ET84 Mandarin</p> <p>ET85 Crisp ET86 Iris</p> <p>ET87 Nickel ET88 Paprika</p> <p>ET89 Nutmeg ET90 Marine</p> <p>ET91 Magnet ET92 Infrared</p> <p>ET93 Espresso ET94 Indigo</p> <p>ET95 Anthracite</p> |
| <p>Fusion Polyester</p> <p>FU71 Tangerine FU72 Fresh</p> <p>FU73 Moss FU74 Tomato</p> <p>FU75 Aqua FU76 Sandstone</p> <p>FU77 Granite FU78 Poppy</p> <p>FU79 Cadet FU80 Oasis</p> <p>FU81 Graphite FU82 Viola</p> <p>FU83 Cobalt FU84 Flax</p> <p>FU85 Carbon</p> | <p>Urban 62% Recycled Polyester / 32% Polyester</p> <p>UR11 Ocean Blue UR12 Blue Bayou</p> <p>UR13 Green Grass UR18 Brown Ridge</p> <p>UR19 White Sand UR20 Granite Rock</p> <p>UR21 Gravel Road UR22 Black Coal</p> | <p>Wavelength 100% Virgin Polyester</p> <p>WV01 Lime WV02 Mint</p> <p>WV03 Stone WV04 Flame</p> <p>WV05 Mykonos WV06 Savannah</p> <p>WV07 Mesa WV08 Plasma</p> <p>WV09 Cancun WV10 Quartz</p> <p>WV11 Moonrock WV12 Rubine</p> <p>WV13 Corfu WV14 Bluejay</p> | <p>Imprint 100% Post-Consumer Polyester</p> <p>IM70 Almond IM71 Cork</p> <p>IM72 Sand IM73 Currie</p> <p>IM74 Candy Apple IM75 Ocean</p> <p>IM76 Navy IM77 Green Tea</p> <p>IM78 Celery IM79 Oregano</p> <p>IM80 Walnut IM81 Paprika</p> <p>IM82 Graphite IM83 Slate</p> <p>IM84 Licorice</p> |
| <p>Illusion 100% Virgin Polyester</p> <p>I101 Cappuccino I102 Paprika</p> <p>I103 Tropic I104 Wicker</p> <p>I105 Hemp I106 Cayenne</p> <p>I107 Maui I108 Dusk</p> <p>I109 Smoke I110 Currant</p> <p>I111 Fiji I112 Ozone</p> <p>I113 Ebony</p> | <p>GRADE 2</p> <p>Allante FRee 100% Vinyl Face / 100% Polyester Backing</p> <p>A01F Illusion A02F Bright White</p> <p>A03F White Crush A04F Ivory</p> <p>A05F Ice A06F Bleached Sand</p> <p>A07F Taupe Fawn A08F Warm Smoke</p> <p>A09F Autumn Rain A10F Cookie</p> <p>A11F Sierra Brick A12F Gibraltar</p> <p>A13F Chateau Grey A14F Garden Green</p> <p>A15F Oasis Green A16F Ink Black</p> <p>A17F Purple Impulse A18F Italian Rose</p> <p>A19F Mountain Sky A20F Old Navy</p> <p>A21F Galaxy A22F Red Truffle</p> <p>A23F Chocolate Sundae A24F Provence Blue</p> <p>A25F Eclipse</p> | <p>Elevate 80% Post-Consumer Recycled Polyester/ 20% Rayon</p> <p>EL51 Halo EL52 Dove</p> <p>EL53 Safari EL54 Sunglow</p> <p>EL55 Margarita EL56 Fiji</p> <p>EL57 Mist EL58 Blaze</p> <p>EL59 Wasabi EL60 Mystic</p> <p>EL61 Mica EL62 Cherry</p> <p>EL63 Scuba EL64 Lapis</p> <p>EL65 Onyx</p> | <p>Page 52.99% Polyester / 47.01% Olefin</p> <p>PG35 Flax PG36 Charcoal</p> <p>PG37 Pearl PG38 Pewter</p> <p>PG39 Deepness PG40 Moss</p> <p>PG41 Lawn PG42 Steel</p> <p>PG44 Navy PG45 Ocean</p> <p>PG46 Pomegranate PG47 Blush</p> <p>PG48 Nile</p> |
| <p>Jenny 100% Polyester</p> <p>JN01 Midnite JN02 Ebony</p> <p>JN03 Slate JN07 Vermilion</p> <p>JN08 Admiral JN11 Charcoal</p> <p>JN25 Silver Lining JN26 Oatmeal</p> <p>JN27 Sunflower JN28 Cascade</p> <p>JN29 Harvest JN30 Melon</p> <p>JN31 Berry JN32 Green Grass</p> <p>JN33 Roast</p> | <p>LuxPlus Vinyl (PVC) Coated Fabric Face / Polyester Backing</p> <p>L01P Black L02P Parchment</p> <p>L03P Saddle L04P Dark Brown</p> <p>L05P Burgundy L06P Charcoal</p> <p>L07P White L09P Light Grey</p> | <p>Release 100% Vinyl Face</p> <p>RL11 White RL12 Chalk</p> <p>RL13 Stone RL14 Taupe</p> <p>RL15 Orange RL16 Country</p> <p>RL17 Tuscan RL18 Cottage</p> <p>RL19 Yellow RL21 Red Barn</p> <p>RL22 Brave Red RL23 Gypsy Red</p> <p>RL24 Cajun RL25 Vineyard</p> <p>RL26 Olive RL27 Bonsai</p> <p>RL28 Summer's Dream RL29 Calico</p> <p>RL31 Green RL32 Blue</p> <p>RL33 Black RL34 Cool Grey</p> <p>RL35 Thunder Grey RL36 Navy</p> <p>RL37 Dark Chocolate RL38 Espresso</p> | <p>GRADE 10</p> <p>Prescott Leather</p> <p>PC02 Zinc PC04 Papyrus</p> <p>PC05 Soul White PC10 Caffe Latte</p> <p>PC14 Avana PC18 Swamp</p> <p>PC41 Antique PC54 Antilop</p> <p>PC57 Chestnut PC79 Oceania</p> <p>PC80 Indigo PC81 Deep</p> <p>PC86 Santorini PC96 Turtledove</p> <p>PC97 Smoke PDO2 Grayshadow</p> <p>PDO3 Black Ink</p> |

Textiles are subject to change, please confirm current selection.

TERMS AND CONDITIONS

- All product series have MAXIMUM order quantities which can be fulfilled within the fast5 program. These are noted with each series' Specs + Options. For greater quantities, please contact CustomerCare for lead time and terms.
- Orders that exceed maximum unit quantities will receive standard lead times.
- Orders must clearly note "fast5" and be submitted as a separate purchase order. Global cannot mix fast5 and standard delivery or InStock products on the same purchase order.
- Purchase orders containing products from fast5 and fast10 programs will automatically receive fast10 lead time and shipping. Purchase order should be noted "fast10".
- Certain models, noted on the series' Specs + Options, are multi-packed and must be ordered in quantities accordingly. Packaged unit quantities cannot be changed.
- Program is limited to exact models, model options and textiles within series listed.
- Program is limited to exact textile pattern colorways listed in the fast5 program. Use the Textile Search Tool to confirm desired textile is approved for use on the selected series.
- Orders must be clean with correct model numbers, options, textiles, correct pricing, etc. to apply.
- Orders cannot be changed or canceled after order acknowledgment.
- Current Global list pricing applies at the time of order. fast5 orders may be shipped FedEx, UPS or via alternate carriers. Global reserves the right to ship "best way".
- fast5 products will be manufactured to your orders' specifications in 5 business days or less and ship immediately thereafter.
- Orders will ship to the dealer or commercial end-user directly. Delivery charges may apply for special handling, services, etc. Please consult your Territory Manager or CustomerCare Representative.
- Dealer must be in good standing and account within terms for order(s) to be processed without delay.
- fast5 program is available in the 48 contiguous United States.

| Series | Model Numbers | Series | Model Numbers | Series | Model Numbers |
|---|---|---|---|--|--|
| Aspen  | (maximum 20) 2851-3 2853-3 | Luray  | (maximum 20) 6461 6462 | Sonic  | Plastic (maximum 100) 6508 6508MB 6513 6513MB 6558 6558CS 6573 6573MB 6577 6577MB |
| | Comet  | | (maximum 50) 2171WS 2172WS | | Noetic  |
| Duet  | Plastic (maximum 100) 6620 6621 | Popcorn  | Plastic (maximum 100) 6710 6711 | Sora  | |
| | Upholstered (maximum 50) 6622 6627 6623 6628 6624 | | Factor  | | Upholstered (maximum 50) 6712 6713 6715 |
| G1 Ergo Select  | (maximum 50) 7331 7332 | Prefer  | | (maximum 20) 8458 8459 | Nester (maximum 50) 6764C 6465C |
| | Global Accord  | | (maximum 50) 2670-2 2676-2 2670-4 2676-4 2671-2 2677-2 2671-4 2677-4 2672-6 2678-6 | Rebound  | |
| Goal  | | (maximum 50) 2235-6 2237-5 2236-6 2237-6 2237-3 2239-6 | Roma  | | (maximum 50) 1890 1903 1896 1906 1897 1907 1901 1908 1902 |
| | Granada  | (maximum 50) 3212 3254 3278 | | Sidero  | (maximum 50) 6900 6901 6900C 6901C 2125C |
| Include  | | (maximum 50) IN30NMB IN30NHB IN30AMB IN30AHB | Solar  | | (maximum 50) 8456 8457 8456NA 8457NA 8456S 8457S 8456SNA 8457SNA |
| | Loover  | (maximum 50) 2661-0 2662-0 2661-3 2662-3 2661-4 2662-4 2661-8 2662-8 | | Solo  | (maximum 50) 5228 |

fast10

Global's fast10 quick ship program offers many of our bestselling models upholstered in your choice of our most popular textiles.

- 5 Series, 25+ Models, 200+ Textiles to customize your order
- No special order forms required

Global's fast production and shipping make it simple to order and ideal for tight deadlines!

Color it your way

| | | |
|--|--|---|
| <p>GRADE 1</p> <p>Carrera 100% Polyester</p> <p>CE84 Zest CE85 Savannah CE86 Slate CE87 Rainforest CE88 Aspen CE89 Dune CE90 Flannel CE91 Azure CE92 Chili CE93 Jute CE95 Ink CE96 Sangria CE97 Java CE98 Charcoal</p> | <p>Quilt 100% Polyester</p> <p>QL10 Black QL11 Charcoal Grey QL14 Navy QL16 Wine QL19 Silver QL20 Feather QL21 Dune QL22 Meadow QL23 Cadet QL24 Geranium QL25 Daisy QL26 Quest QL27 Punch QL28 Tangerine QL29 Cocoa</p> | <p>Essence 73.5% Post-Consumer Recycled Biodegradable Polyester 26.5% Biodegradable Polyester</p> <p>EE05 Sand Dollar EE06 Canyon EE07 Morning Mist EE08 Agate EE09 Dark Shadow EE10 Raven EE11 Bumblebee EE12 Sky Blue EE13 Harbour EE14 Iris EE15 Rose Quartz EE16 Terracotta EE17 Sea Glass EE18 Pine EE19 Cabernet</p> |
| <p>Emerge 81% Post-Consumer Recycled Biodegradable Polyester 19% Pre-Consumer Recycled Biodegradable Polyester</p> <p>EM10 Parchment EM11 Citrine EM12 Terra Rose EM13 Clay EM14 Cerise EM15 Squid Ink EM16 Emerald EM17 Aloe EM18 Cobalt EM19 Atmosphere EM20 Cloud EM21 Smoke EM22 Featherstone EM23 Graphite EM24 Evening</p> | <p>Trak 100% Recycled Polyester</p> <p>TK40 Taupe TK41 Mustard TK42 Latte TK43 Cement TK44 Silver TK45 Copper TK46 Teal TK47 Apple TK48 Steel TK49 Merlot TK50 Midnight Sky TK51 Mocha TK52 Carbon</p> | <p>Etch 80% Post-Consumer Recycled Polyester/ 20% Rayon</p> <p>ET81 Drift ET82 Citron ET83 Calypso ET84 Mandarin ET85 Crisp ET86 Iris ET87 Nickel ET88 Paprika ET89 Nutmeg ET90 Marine ET91 Magnet ET92 Infrared ET93 Espresso ET94 Indigo ET95 Anthracite</p> |
| <p>Fusion 90% Virgin Polyester / 10% Post-Consumer Recycled Polyester</p> <p>FU71 Tangerine FU72 Fresh FU73 Moss FU74 Tomato FU75 Aqua FU76 Sandstone FU77 Granite FU78 Poppy FU79 Cadet FU80 Oasis FU81 Graphite FU82 Viola FU83 Cobalt FU84 Flax FU85 Carbon</p> | <p>Urban 62% Recycled Polyester / 32% Polyester</p> <p>UR11 Ocean Blue UR12 Blue Bayou UR13 Green Grass UR18 Brown Ridge UR19 White Sand UR20 Granite Rock UR21 Gravel Road UR22 Black Coal</p> | <p>Imprint 100% Post-Consumer Polyester</p> <p>IM70 Almond IM71 Cork IM72 Sand IM73 Currie IM74 Candy Apple IM75 Ocean IM76 Navy IM77 Green Tea IM78 Celery IM79 Oregano IM80 Walnut IM81 Paprika IM82 Graphite IM83 Slate IM84 Licorice</p> |
| <p>Illusion 100% Virgin Polyester</p> <p>II01 Cappuccino II02 Paprika II03 Tropic II04 Wicker II05 Hemp II06 Cayenne II07 Maui II08 Dusk II09 Smoke II10 Currant II11 Fiji II12 Ozone II13 Ebony</p> | <p>Wavelength 100% Virgin Polyester</p> <p>WW01 Lime WW02 Mint WW03 Stone WW04 Flame WW05 Mykonos WW06 Savannah WW07 Mesa WW08 Plasma WW09 Cancun WW10 Quartz WW11 Moonrock WW12 Rubine WW13 Corfu WW14 Bluejay</p> | <p>Page 52.99% Polyester / 47.01% Olefin</p> <p>PG35 Flax PG36 Charcoal PG37 Pearl PG38 Pewter PG39 Deepness PG40 Moss PG41 Lawn PG42 Steel PG44 Navy PG45 Ocean PG46 Pomegranate PG47 Blush PG48 Nile</p> |
| <p>Jenny 100% Polyester</p> <p>JN01 Midnite JN02 Ebony JN03 Slate JN07 Vermilion JN08 Admiral JN11 Charcoal JN25 Silver Lining JN26 Oatmeal JN27 Sunflower JN28 Cascade JN29 Harvest JN30 Melon JN31 Berry JN32 Green Grass JN33 Roast</p> | <p>GRADE 2</p> <p>Allante fFree 100% Vinyl Face / 100% Polyester Backing</p> <p>A01F Illusion A02F Bright White A03F White Crush A04F Ivory A05F Ice A06F Bleached Sand A07F Taupe Fawn A08F Warm Smoke A09F Autumn Rain A10F Cookie A11F Sierra Brick A12F Gibraltar A13F Chateau Grey A14F Garden Green A15F Oasis Green A16F Ink Black A17F Purple Impulse A18F Italian Rose A19F Mountain Sky A20F Old Navy A21F Galaxy A22F Red Truffle A23F Chocolate Sundae A24F Provence Blue A25F Eclipse</p> | <p>Release 100% Vinyl Face</p> <p>RL11 White RL12 Chalk RL13 Stone RL14 Taupe RL15 Orange RL16 Country RL17 Tuscan RL18 Cottage RL19 Yellow RL21 Red Barn RL22 Brave Red RL23 Gypsy Red RL24 Cajun RL25 Vineyard RL26 Olive RL26 Gypsy Red RL28 Summer's Dream RL29 Calico RL31 Green RL32 Blue RL33 Black RL34 Cool Grey RL35 Thunder Grey RL36 Navy RL37 Dark Chocolate RL38 Espresso</p> |
| <p>LuxPlus Vinyl (PVC) Coated Fabric Face / Polyester Backing</p> <p>LO1P Black LO2P Parchment LO3P Saddle LO4P Dark Brown LO5P Burgundy LO6P Charcoal LO7P White LO9P Light Grey</p> | <p>Elevate 80% Post-Consumer Recycled Polyester/ 20% Rayon</p> <p>EL51 Halo EL52 Dove EL53 Safari EL54 Sunglow EL55 Margarita EL56 Fiji EL57 Mist EL58 Blaze EL59 Wasabi EL60 Mystic EL61 Mica EL62 Cherry EL63 Scuba EL64 Lapis EL65 Onyx</p> | <p>GRADE 10</p> <p>Prescott Leather</p> <p>PC02 Zinc PC04 Papyrus PC05 Soul White PC10 Caffe Latte PC14 Avana PC18 Swamp PC41 Antique PC54 Antipol PC57 Chestnut PC79 Oceania PC80 Indigo PC81 Deep PC86 Santorini PC96 Turtledove PC97 Smoke P002 Grayshadow P003 Black Ink</p> |

Textiles are subject to change, please confirm current selection.

TERMS AND CONDITIONS

- All models have MAXIMUM quantity of 10 pieces, noted on each sheet, which can be fulfilled within the fast10 program. These are noted next to each series' Specs + Options. For greater quantities, please contact CustomerCare for lead times and terms.
- Orders that exceed maximum unit quantities will receive standard lead times.
- Orders must clearly note "fast10" and be submitted as a separate purchase order. Global cannot mix "fast10" and standard delivery or InStock products on the same purchase order.
- Purchase orders containing products from fast5 and fast10 programs will automatically receive fast10 lead time and shipping. Purchase order should be noted "fast10".
- Program is limited to exact models, model options and textiles within series listed.
- Program is limited to exact textile pattern colorways listed in the fast10 program. Use the Textile Search Tool to confirm desired textile is approved for use on the selected series.
- Orders must be clean with correct model numbers, options, textiles, correct pricing, etc. to apply.
- Orders cannot be changed or canceled after order acknowledgment.
- Current Global list pricing applies at the time of order.
- fast10 models are not available for FEDEX or UPS shipping. Global reserves the right to ship "best way".
- fast10 products will be manufactured to your orders' specifications in 10 business days or less and be consolidated for shipping immediately thereafter.
- Orders will ship to the dealer or commercial end-user directly. Delivery charges may apply for special handling, services, etc. Please consult your Territory Manager or CustomerCare Representative.
- Dealer must be in good standing and account within terms for order(s) to be processed without delay.
- fast10 Program is available in the 48 contiguous United States.

| Series | Model Numbers | Series | Model Numbers | Series | Model Numbers |
|--|---------------|--|---------------|---|---------------|
| Citi  | (maximum 10) | Wind  | (maximum 10) | Drift  | (maximum 10) |
| | 7864 | | 3361 | | 8016 |
| | 7875 | | 3362 | | 8021 |
| | 7876 | | 3363 | | 8022 |
| | 7877 | | | | 8023 |
| | 7879 | | | | 8024 |
| | 7885 | | 8026 | | |
| | | | 8030 | | |
| | | | 8032 | | |
| | | | 8033 | | |
| | | | 8034 | | |
| | | | 8035 | | |
| | | | 8036 | | |
| <hr/> Citi Square | | <hr/> sirena | | | |
| | (maximum 10) | | (maximum 10) | | |
|  | S7875 |  | 3371 | | |
| | S7876 | | | | |
| | S7877 | | | | |
| | S7877 | | | | |
| | S7911 | | | | |