

T TABLE POWER + TECHNOLOGY SOLUTIONS™ - NOTES

- Global is pleased to offer a range of sophisticated electrical and technology options for training and conference tables.
- Worksurface cut-outs for units must be specified separately, please see appropriate product note pages for details.
- Daisy chaining is generally defined as having multiple power units connect to one another from a single electrical infeed source.
- The daisy-chain units below utilize a 4-wire, 2 circuit system (when hardwired by a licensed electrician to a building power source) or can run a single circuit (when utilizing the 42AP1-72 plug and play infeed).
- The following maximums are to National Electric Code (NEC) – some local codes vary from NEC code – it is the customer's responsibility to follow all applicable local codes and guidelines.

Product	Max units per circuit
Villa I	8 units per circuit
Villa II	4 units per circuit
Villa USB	8 units per circuit
Oasis Mini A	3 units per circuit
Oasis Mini B	3 units per circuit

Electrical System

4-2 Wiring Schematic
 4-Wire Shared Neutral
 Complies with National Electric Code
 UL Listed
 All circuits rated for 20 AMP

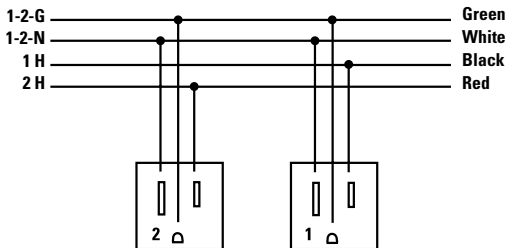

VILLA I, VILLA II AND VILLA USB DETAILS

- Each Villa unit is available two ways. Corded units includes three-prong plugs to connect directly into a standard outlet. DaisyLink kits can be specified separately to daisy-chain multiple units off of a single infeed. Infeeds are specified separately.
- Villa I units include two power outlets and either two knockouts or two data ports included, **all accessible at the surface**.
- Villa II units include two power outlets and either two knockouts for data or two data ports included accessible at the surface. Another two power outlets are **accessible below the surface**.
- Villa USB includes two power outlets, two 2.1 AMP charging USB ports and either two data knockouts or two data ports included, **all accessible at the surface**.

OASIS MINI DETAILS

- Each Oasis Mini (except for Chicago Mini Oasis) is available two ways. Corded units includes three-prong plugs to connect directly into a standard outlet. DaisyLink units must have interconnecting cords specified separately to daisy-chain multiple units off of a single infeed. Infeeds are specified separately.
- Oasis Mini A units includes six power outlets and two telecom plate knockouts
- Oasis Mini B units includes four power outlets and three telecom plate knockouts
- Oasis Mini USB units include six power outlets, two 2.1 AMP charging USB ports and one telecom plate knockouts

TELECOM PLATE DETAILS

- Telecom plates are for use on Oasis Mini units only, providing a means to provide different types of telephone, data and audio visual connections to the worksurface. For every telecom plate knockout on a Oasis Mini unit, please specify one telecom plate. If telecom plates are not required, it is recommended blank telecom plates are specified - see page 484 for details.

EXAMPLE LAYOUTS - TRAINING TABLES

- Single Power Block Kits Available on training tables 36" – 72" (**must specify V2 cut-out on table**):
- Each single block kit includes 1 Power Block and 1 Grommet Cover, 1 Female/Female Interconnecting Cable and 1 Female/Male Interconnecting Cable. Cable clamps for management of these cables are also included.

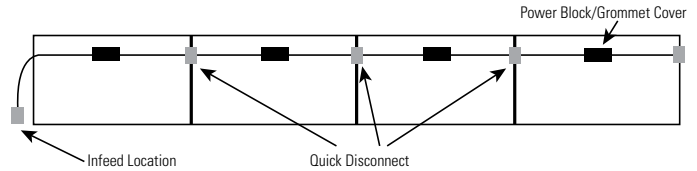

- Double Power Block Kits Available on 60", 66" and 72" (must specify V1 and V3 cut-out on table):
- Each double block kit includes 2 Power Blocks and 2 Grommet Covers, 2 Female/Female Interconnecting Cable and 1 Female/Male Interconnecting Cable. Cable clamps for management of these cables are also included.

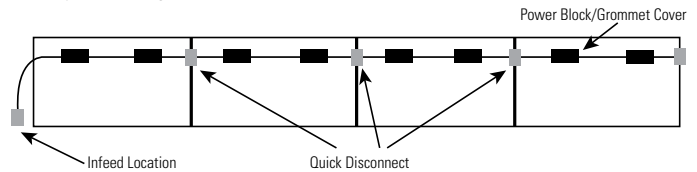

VILLA CUT-OUTS

- Optional Villa cut-out available in standard worksurface locations (left, center or right) **for Rectangular Tables**. Order as: **V1, V2 or V3**. **Add \$96 for each cut-out**.
- Villa cut-outs may be placed at non-standard locations. Please contact customer service.

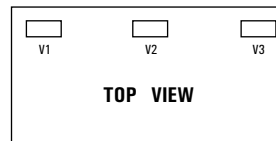

OASIS MINI CUT-OUTS

- Optional Oasis Mini cut-out available in standard worksurface locations (left, center or right) **for Rectangular Tables**. Order as: **M1, M2 or M3**. **Add \$96 for each cut-out**.
- Oasis Mini cut-outs may be placed at non-standard locations. Please contact customer care.
- **Oasis Mini is only available on Zira Boardroom Tables**

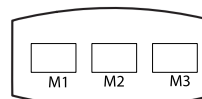

VILLA I, CENTER POSITION- DAISYLINK KITS

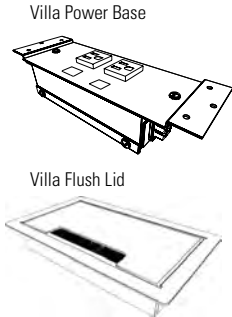

Data Knockouts, No Data Ports

MODEL#	DIMENSIONS	FREIGHT CLASS	WT./LBS.	CUBIC FT.	LIST PRICE
D x W x H					
VIF-41-DKO_72SK	--	70	9	.45	\$496
VIF-41-DKO_66SK	--	70	9	.45	\$496
VIF-41-DKO_60SK	--	70	9	.45	\$496
VIF-41-DKO_54K	--	70	9	.45	\$496
VIF-41-DKO_48K	--	70	9	.45	\$496
VIF-41-DKO_42K	--	70	9	.45	\$496
VIF-41-DKO_36K	--	70	9	.45	\$496

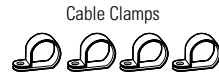
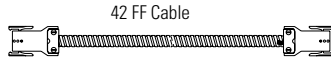

Includes **one power block** with **two power receptacles** and two knockouts for data, grommet cover, one female/female interconnecting cable, one female/male interconnecting cable and four cable clamps. **V2 cut-out must be specified on training table** (see product notes section for more details and cut-out upcharge). **Power Infeed required and sold separate** (see page 485). For multiple circuit configurations, please contact customer service. UL listed: UL 183 and CSA Certified.

- Replace _ with **B** for **Black**
- Replace _ with **S** for **Silver Pearl**
- Villa DaisyLink kits are not recommended for use on 2gether tables or Zira Boardroom Tables

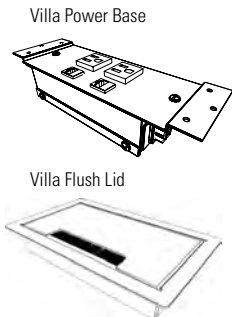

Data Knockouts, Data Ports Included

VIF-41-D-_72SK	--	70	9	.45	\$648
VIF-41-D-_66SK	--	70	9	.45	\$648
VIF-41-D-_60SK	--	70	9	.45	\$648
VIF-41-D-_54K	--	70	9	.45	\$648
VIF-41-D-_48K	--	70	9	.45	\$648
VIF-41-D-_42K	--	70	9	.45	\$648
VIF-41-D-_36K	--	70	9	.45	\$648

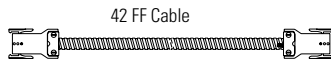

Includes **one power block** with **two power receptacles** and **two RJ45** Cat 6 Data, grommet cover, one female/female interconnecting cable, one female/male interconnecting cable and four cable clamps. **V2 cut-out must be specified on training table** (see product notes section for more details and cut-out upcharge). **Power Infeed required and sold separate** (see page 485). For multiple circuit configurations, please contact customer service. UL listed: UL 183 and CSA Certified.

- Replace _ with **B** for **Black**
- Replace _ with **S** for **Silver Pearl**
- Villa DaisyLink kits are not recommended for use on 2gether tables or Zira Boardroom Tables

Required Specifications

Finish
Power Infeed
Cut-out location

T TABLE POWER + TECHNOLOGY SOLUTIONS

VILLA I, CENTER POSITION- DAISYLINK KITS

MODEL# DIMENSIONS FREIGHT CLASS WT/LBS. CUBIC FT. LIST PRICE

D x W x H

VIF-41-UDKO_-36K	--	70	10	.45	\$679
VIF-41-UDKO_-42K	--	70	10	.45	\$679
VIF-41-UDKO_-48K	--	70	10	.45	\$679
VIF-41-UDKO_-54K	--	70	10	.45	\$679
VIF-41-UDKO_60SK	--	70	10	.45	\$679
VIF-41-UDKO_66SK	--	70	10	.45	\$679
VIF-41-UDKO_72SK	--	70	10	.45	\$679

Villa Power Base

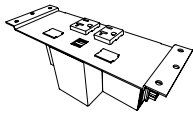

Villa Flush Lid

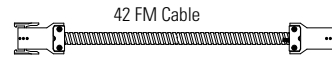

Cable Clamps



Villa I USB Data Knockouts, No Data Ports

Includes **one power block with two power receptacles, two 2.1 AMP USB charging ports** and two knockouts for data, grommet cover, one female/female interconnecting cable, one female/male interconnecting cable and four cable clamps. **V2 cut-out must be specified on training table** (see product notes section for more details and cut-out upcharge). **Power Infeed required and sold separate** (see page 485). For multiple circuit configurations, please contact customer service.

UL listed: UL 183 and CSA Certified.

- Replace _ with **B** for **Black**
- Replace _ with **S** for **Silver Pearl**
- Villa DaisyLink kits are not recommended for use on 2gether tables or Zira Boardroom Tables
- Not compatible with Terina tables or Junction wire managers (JNECxx)

VIF-41-UD_-36K	--	70	10	.45	\$831
VIF-41-UD_-42K	--	70	10	.45	\$831
VIF-41-UD_-48K	--	70	10	.45	\$831
VIF-41-UD_-54K	--	70	10	.45	\$831
VIF-41-UD_60SK	--	70	10	.45	\$831
VIF-41-UD_66SK	--	70	10	.45	\$831
VIF-41-UD_72SK	--	70	10	.45	\$831

Villa Power Base

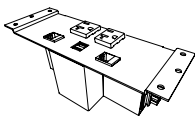

Villa Flush Lid



Villa I USB Data Knockouts, Data Ports Included

Includes **one power block with two power receptacles, two 2.1 AMP USB charging ports** and two RJ45 Cat 6 for data, grommet cover, one female/female interconnecting cable, one female/male interconnecting cable and four cable clamps. **V2 cut-out must be specified on training table** (see product notes section for more details and cut-out upcharge). **Power Infeed required and sold separate** (see page 485). For multiple circuit configurations, please contact customer service.

UL listed: UL 183 and CSA Certified.

- Replace _ with **B** for **Black**
- Replace _ with **S** for **Silver Pearl**
- Villa DaisyLink kits are not recommended for use on 2gether tables or Zira Boardroom Tables
- Not compatible with Terina tables or Junction wire managers (JNECxx)

Required Specifications

Finish
Power Infeed
Cutout location

VILLA II, CENTER POSITION - DAISYLINK KITS

Villa II Power Base

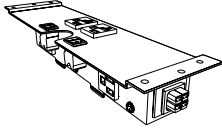

Villa II Flush Lid



Data Knockouts, No Data Ports

MODEL#	DIMENSIONS	FREIGHT CLASS	WT/LBS.	CUBIC FT.	LIST PRICE
--------	------------	---------------	---------	-----------	------------

D x W x H

VIF2-41-DKO_72SK	--	65	12	.45	\$585
VIF2-41-DKO_66SK	--	65	12	.45	\$585
VIF2-41-DKO_60SK	--	65	12	.45	\$585
VIF2-41-DKO_54K	--	65	12	.45	\$585
VIF2-41-DKO_48K	--	65	12	.45	\$585
VIF2-41-DKO_42K	--	65	12	.45	\$585
VIF2-41-DKO_36K	--	65	12	.45	\$585

42 FF Cable



42 FM Cable



Cable Clamps



Includes **one power block** with **four power receptacles** (two worksurface accessible, two below worksurface) and two knockouts for data, grommet cover, one female/female interconnecting cable, one female/male interconnecting cable and four cable clamps. **V2 cut-out must be specified on training table** (see product notes section for more details and cut-out upcharge). **Power Infeed required and sold separate** (see page 485). For multiple circuit configurations, please contact customer service. UL listed: UL 183 and CSA Certified.

- Replace _ with **B** for **Black**
- Replace _ with **S** for **Silver Pearl**
- Villa DaisyLink kits are not recommended for use on 2gether tables or Zira Boardroom Tables

Villa II Power Base

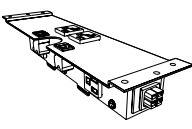

Villa II Flush Lid



Data Knockouts, Data Ports Included

VIF2-41-D_72SK	--	65	12	.45	\$740
VIF2-41-D_66SK	--	65	12	.45	\$740
VIF2-41-D_60SK	--	65	12	.45	\$740
VIF2-41-D_54K	--	65	12	.45	\$740
VIF2-41-D_48K	--	65	12	.45	\$740
VIF2-41-D_42K	--	65	12	.45	\$740
VIF2-41-D_36K	--	65	12	.45	\$740

42 FF Cable



42 FM Cable



Cable Clamps



Includes **one power block** with **four power receptacles** (two worksurface accessible, two below worksurface) and **two RJ45 Cat 6 Data**, grommet cover, one female/female interconnecting cable, one female/male interconnecting cable and four cable clamps. **V2 cut-out must be specified on training table** (see product notes section for more details and cut-out upcharge). **Power Infeed required and sold separate** (see page 485). For multiple circuit configurations, please contact customer service. UL listed: UL 183 and CSA Certified.

- Replace _ with **B** for **Black**
- Replace _ with **S** for **Silver Pearl**
- Villa DaisyLink kits are not recommended for use on 2gether tables or Zira Boardroom Tables

Required Specifications

Finish
Power Infeed
Cutout location

T TABLE POWER + TECHNOLOGY SOLUTIONS

VILLA I, LEFT & RIGHT POSITION - DAISYLINK KITS MODEL# DIMENSIONS FREIGHT CLASS WT/LBS. CUBIC FT. LIST PRICE

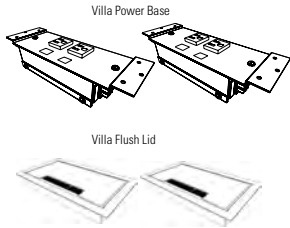

Data Knockouts, No Data Ports

MODEL#	D x W x H	FREIGHT CLASS	WT/LBS.	CUBIC FT.	LIST PRICE
GL-VIF41KO_72DK	--	60	18	.23	\$924
GL-VIF41KO_66DK	--	60	18	.23	\$924
GL-VIF41KO_60DK	--	60	18	.23	\$924

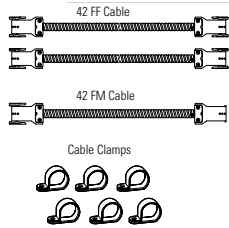

Includes **two power blocks** with **two power receptacles** and two knockouts for data in each block, two grommet covers, two female/female interconnecting cables, one female/male interconnecting cable and 6 cable clamps. **V1 & V3 cut-outs must be specified on training table** (see product notes section for more details and cut-out upcharge). **Power Infeed required and sold separate** (see page 485). For multiple circuit configurations, please contact customer service. UL listed: UL 183 and CSA Certified.

- Replace _ with **B** for **Black**
- Replace _ with **S** for **Silver Pearl**
- Villa DaisyLink kits are not recommended for use on 2gether tables or Zira Boardroom Tables

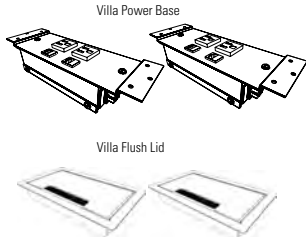

Data Knockouts, Data Ports Included

GL-VIF41D_72DK	--	60	18	.23	\$955
GL-VIF41D_66DK	--	60	18	.23	\$955
GL-VIF41D_60DK	--	60	18	.23	\$955

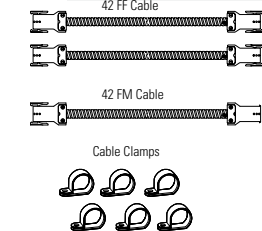

Includes **two power blocks** with **two power receptacles** and **two RJ45** Cat 6 data in each block, two grommet covers, two female/female interconnecting cables, one female/male interconnecting cable and 6 cable clamps. **V1 & V3 cut-outs must be specified on training table** (see product notes section for more details and cut-out upcharge). **Power Infeed required and sold separate** (see page 485). For multiple circuit configurations, please contact customer service. UL listed: UL 183 and CSA Certified.

- Replace _ with **B** for **Black**
- Replace _ with **S** for **Silver Pearl**
- Villa DaisyLink kits are not recommended for use on 2gether tables or Zira Boardroom tables

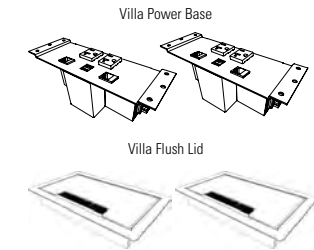

Villa I USB

GL-VIF41UKO_72DK	--	60	23	.23	\$1294
GL-VIF41UKO_66DK	--	60	23	.23	\$1294
GL-VIF41UKO_60DK	--	60	23	.23	\$1294

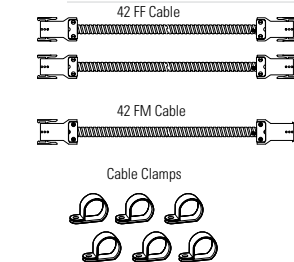

Includes **two power blocks** with **two power receptacles**, **two 2.1 AMP USB charging ports** and two knockouts for data, grommet cover, two female/female interconnecting cables, one female/male interconnecting cable and four cable clamps. **V1 & V3 cut-outs must be specified on training table** (see product notes section for more details and cut-out upcharge). **Power Infeed required and sold separate** (see page 485). For multiple circuit configurations, please contact customer service. UL listed: UL 183 and CSA Certified.

- Replace _ with **B** for **Black**
- Replace _ with **S** for **Silver Pearl**
- Villa DaisyLink kits are not recommended for use on 2gether tables or Zira Boardroom Tables
- Not compatible with Terina tables or Junction wire managers (JNECxx)

Required Specifications

- Finish
- Power infeed
- Cut-out location

VILLA II, LEFT & RIGHT POSITION - DAISYLINK KITS **MODEL#** **DIMENSIONS** **FREIGHT CLASS** **WT/LBS.** **CUBIC FT.** **LIST PRICE**

D x W x H

GLVIF241KO_72DK	--	60	22	.23	\$986
GLVIF241KO_66DK	--	60	22	.23	\$986
GLVIF241KO_60DK	--	60	22	.23	\$986

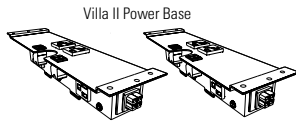

Villa II Power Base



Villa Flush Lid

Data Knockouts, No Data Ports

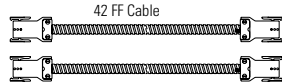

42 FF Cable



42 FM Cable

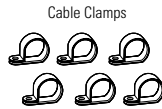

Cable Clamps

Includes **two power blocks** with **four power receptacles** (two worksurface accessible, two below worksurface) and two knockouts for data in each block, two grommet covers, two female/female interconnecting cables, one female/male interconnecting cable and 6 cable clamps. **V1 & V3 cut-outs must be specified on training table** (see product notes section for more details and cut-out upcharge). **Power Infeed required and sold separate** (see page 485). For multiple circuit configurations, please contact customer service. UL listed: UL 183 and CSA Certified.

- Replace _ with **B** for **Black**
- Replace _ with **S** for **Silver Pearl**
- Villa DaisyLink kits are not recommended for use on 2gether tables or Zira Boardroom Tables

GL-VIF241D_72DK	--	60	22	.23	\$1294
GL-VIF241D_66DK	--	60	22	.23	\$1294
GL-VIF241D_60DK	--	60	22	.23	\$1294

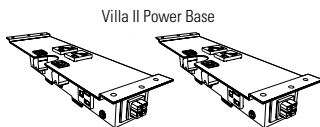

Villa II Power Base

Villa Flush Lid

Data Knockouts, Data Ports Included

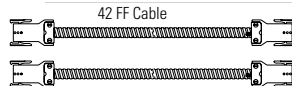

42 FF Cable



42 FM Cable

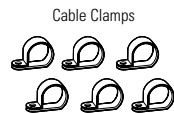

Cable Clamps

Includes **two power blocks** with **four power receptacles** (two worksurface accessible, two below worksurface) and **two RJ45 Cat 6** data in each block, two grommet covers, two female/female interconnecting cables, one female/male interconnecting cable and 6 cable clamps. **V1 & V3 cut-outs must be specified on training table** (see product notes section for more details and cut-out upcharge). **Power Infeed required and sold separate** (see page 485). For multiple circuit configurations, please contact customer service. UL listed: UL 183 and CSA Certified.

- Replace _ with **B** for **Black**
- Replace _ with **S** for **Silver Pearl**
- Villa DaisyLink kits are not recommended for use on 2gether tables or Zira Boardroom Tables

Required Specifications

- Finish
- Power Infeed
- Cut-out location

T TABLE POWER + TECHNOLOGY SOLUTIONS

VILLA I - CORDED UNITS

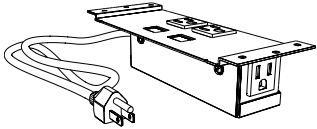

Data Knockouts, No Data Ports

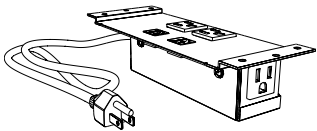

Data Knockouts, Data Ports Included

MODEL#	DIMENSIONS D x W x H	FREIGHT CLASS	WT/LBS.	CUBIC FT.	LIST PRICE
VIL-C-DKO-_-108	3.25 x 8.75 x 2.25	100	4	.45	\$249
VIL-C-DKO-_-72	3.25 x 8.75 x 2.25	100	4	.45	\$249

Villa I with 3-prong plug. Includes **two power receptacles** and two knockouts for data. A third convenience receptacle is provided below the worksurface. **V1, V2 or V3 cut-out(s) must be specified on training table** (see product notes section for more details and cut-out upcharge). **Grommet cover is required and sold separate** (see page 481). UL listed: UL 962A and CUL listed.

- Replace _ with **B** for **Black**
- Replace _ with **S** for **Silver Pearl**
- Compatible with Zira Collaborative tables
- -108 models include a 108" long cord. -72 models include a 72" long cord.

VIL-C-D-_-108	3.25 x 8.75 x 2.25	100	4	.45	\$402
VIL-C-D-_-72	3.25 x 8.75 x 2.25	100	4	.45	\$402

Villa I with 3-prong plug. Includes **two power receptacles** and **two RJ45** Cat 6 data. A third convenience receptacle is provided below the worksurface. **V1, V2 or V3 cut-out(s) must be specified on training table** (see product notes section for more details and cut-out upcharge). **Grommet cover is required and sold separate** (see page 481). UL listed: UL 962A and CUL listed.

- Replace _ with **B** for **Black**
- Replace _ with **S** for **Silver Pearl**
- Compatible with Zira Collaborative tables

VILLA II - CORDED UNITS

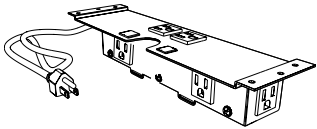

Data Knockouts, No Data Ports

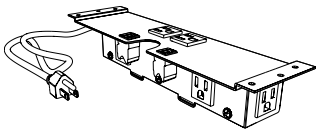

Data Knockouts, Data Ports Included

MODEL#	DIMENSIONS	FREIGHT CLASS	WT/LBS.	CUBIC FT.	LIST PRICE
VIL2-C2-DKO_-108	3.25 x 11 x 2.25	85	6	.45	\$340
VIL2-C2-DKO_-72	3.25 x 11 x 2.25	85	6	.45	\$340

Villa II with 3-prong plug. Includes **four power receptacles** (two worksurface accessible, two below worksurface) and two knockouts for data. A fifth convenience receptacle is provided below the worksurface. **V1, V2 or V3 cut-out(s) must be specified on training table** (see product notes section for more details and cut-out upcharge). **Grommet cover is required and sold separate** (see below). UL listed: UL 962A and CUL listed.

- Replace _ with **B** for **Black**
- Replace _ with **S** for **Silver Pearl**
- Not compatible with Zira Collaborative tables

VIL2-C2-D-_-108	3.25 x 11 x 2.25	85	6	.45	\$496
VIL2-C2-D-_-72	3.25 x 11 x 2.25	85	6	.45	\$496

Villa II with 3-prong plug. Includes **four power receptacles** (two worksurface accessible, two below worksurface) and **two RJ45** Cat 6 data. A fifth convenience receptacle is provided below the worksurface. **V1, V2 or V3 cut-out(s) must be specified on training table** (see product notes section for more details and cut-out upcharge). **Grommet cover is required and sold separate** (see below). UL listed: UL 962A and CUL listed.

- Replace _ with **B** for **Black**
- Replace _ with **S** for **Silver Pearl**
- Not compatible with Zira Collaborative tables

Required Specifications

Finish
Power Infeed
Cutout location

VILLA DAISYLINK

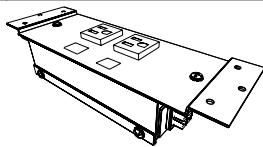

Villa I, DaisyLink

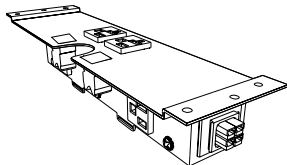

Villa II, DaisyLink

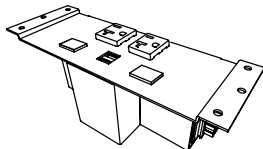

Villa USB, DaisyLink

MODEL#	DIMENSIONS	FREIGHT CLASS	WT/LBS.	CUBIC FT.	LIST PRICE
--------	------------	---------------	---------	-----------	------------

D x W x H

VIL-4-1-DKO-__	--	100	4	.45	\$218
----------------	----	-----	---	-----	--------------

Villa I for use in hardwire or DaisyLink applications. Includes **two power receptacles** and **two knockouts for data in each block**. **V1, V2 or V3 cut-out(s) must be specified on table** (see product notes section for more details and cut-out upcharge). **Power infeed required and sold separate** (see page 485). *Please see our **Daisy-Chain guide** on page 486 for appropriate cable lengths and important notes.* **Grommet cover is required and sold separate** (see page 481). UL listed: UL 183 and CSA Certified.

- Replace __ with **B** for **Black** or **S** for **Silver Pearl**
- Villa DaisyLink kits are not recommended for use on 2gether tables.
- Not compatible with Zira Collaborative tables.
- Intended for use on Zira Boardroom tables, Kadin and Swap tables

VIL2-4-1-DKO-__	--	85	6	.45	\$310
-----------------	----	----	---	-----	--------------

Villa II for use in hardwire or DaisyLink applications. Includes **four power receptacles (two worksurface accessible, two below worksurface)** and **two knockouts for data in each block**. **V1, V2 or V3 cut-out(s) must be specified on table** (see product notes section for more details and cut-out upcharge). **Power infeed and connecting cables sold separate** (see page 485). *Please see our **Daisy-Chain guide** on page 486 for appropriate cable lengths and important notes.* **Grommet cover is required and sold separate** (see page 481). UL listed: UL 183 and CSA Certified.

- Replace __ with **B** for **Black** or **S** for **Silver Pearl**
- Villa DaisyLink kits are not recommended for use on 2gether tables.
- Not compatible with Zira Collaborative tables.
- Intended for use on Zira Boardroom tables, Kadin and Swap tables

VIL-4-1-U-DKO-__	--	85	6	.45	\$402
------------------	----	----	---	-----	--------------

Villa USB for use in hardwire or DaisyLink applications. Includes **two power receptacles, two 2.1 AMB USB charging ports, and two knockouts for data in each block**. **V1, V2 or V3 cut-out(s) must be specified on table** (see product notes section for more details and cut-out upcharge). **Power infeed and connecting cables sold separate** (see page 485). *Please see our **Daisy-Chain guide** on page 486 for appropriate cable lengths and important notes.* **Grommet cover is required and sold separate** (see page 481). UL listed: UL 183 and CSA Certified.

- Replace __ with **B** for **Black** or **S** for **Silver Pearl**
- Villa DaisyLink kits are not recommended for use on 2gether tables
- Not compatible with Zira Collaborative tables, Terina tables or Junction wire managers (JNECxx)
- Intended for use on Zira Boardroom tables, Kadin and Swap tables

VILLA GROMMET COVERS

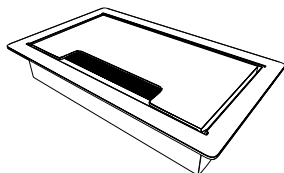

Villa Grommet Cover

MODEL#	DIMENSIONS	FREIGHT CLASS	WT/LBS.	CUBIC FT.	LIST PRICE
--------	------------	---------------	---------	-----------	------------

VIL-GROM-F-__	3.5 x 5.75 x .94	70	1	.08	\$126
---------------	------------------	----	---	-----	--------------

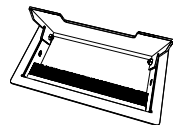

Powder coated flush metal grommet to be used with Villa I and Villa II **corded** series power blocks. Cut-outs in tables must be specified separately. **V1, V2 or V3 cut-out(s) must be specified on training table** (see product notes section for more details and cut-out upcharge). **Grommet cover remains open while in use.**

- **Cannot be used with PMSPDM.**
- Replace __ with **B** for **Black** or **S** for **Silver Pearl**

Required Specifications

Finish
Power Infeed
Cutout location

T TABLE POWER + TECHNOLOGY SOLUTIONS

OASIS MINI

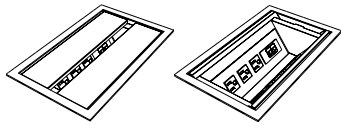

Oasis Mini A, Corded

MODEL#	DIMENSIONS D x W x H	FREIGHT CLASS	WT./LBS.	CUBIC FT.	LIST PRICE
OAM-A-PC-__	15 x 9 x 5.25	92.5	16	1.53	\$1826

Mini Oasis A unit. 15" Trough with six power receptacles, two telecom plate cut-outs (**telecom plates sold separate**, see page 484) and two 108" 3-prong plugs. **M1, M2 or M3 cut-out(s) must be specified on conference table** (see product notes section for more details and cut-out upcharge). Cut-out dimensions: 14.12" x 8.25". UL Listed: UL 962A.

- **Cannot be daisy-chained.**
- Replace _ with **B** for **Black**
- Replace _ with **S** for **Silver Pearl**

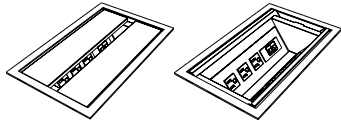

Oasis Mini A, DaisyLink Version

OAM-A-PC-4-1-__	15 x 9 x 5.25	92.5	16	1.53	\$2091

For hardwire and daisy chain applications. Mini Oasis A unit. 15" Trough with six power receptacles, two telecom plate cut-outs (**telecom plates sold separate**, see page 484). **Power infeed sold separate** (see page 485). **M1, M2 or M3 cut-out(s) must be specified on conference table** (see product notes section for more details and cut-out upcharge). For multiple circuit configurations, please contact customer service. *Please see our **Daisy-Chain guide** on page 486 for appropriate cable lengths and important notes.* UL Listed: UL 183.

- Replace _ with **B** for **Black**
- Replace _ with **S** for **Silver Pearl**

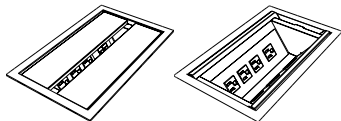

Oasis Mini B, Corded

OAM-B-PC-__	15 x 9 x 5.25	92.5	16	1.53	\$1826

Mini Oasis B unit. 15" Trough with four power receptacles, three telecom plate cut-outs (**telecom plates sold separate**, see page 484) and one 108" 3-prong plug. **M1, M2 or M3 cut-out(s) must be specified on conference table** (see product notes section for more details and cut-out upcharge). UL Listed: UL 962A.

- **Cannot be daisy-chained.**
- Replace _ with **B** for **Black**
- Replace _ with **S** for **Silver Pearl**

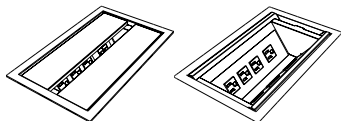

Oasis Mini B, DaisyLink Version

OAM-B-PC-4-1-__	15 x 9 x 5.25	92.5	16	1.53	\$2091

For hardwire and daisy chain applications. Mini Oasis B unit. 15" Trough with four power receptacles, three telecom plate cut-outs (**telecom plates sold separate**, see page 484). **Power infeed sold separate** (see page 485). **M1, M2 or M3 cut-out(s) must be specified on conference table** (see product notes section for more details and cut-out upcharge). For multiple circuit configurations, please contact customer service. *Please see our **Daisy-Chain guide** on page 486 for appropriate cable lengths and important notes.* UL Listed: UL 183.

- Replace _ with **B** for **Black**
- Replace _ with **S** for **Silver Pearl**

Required Specifications

Finish
Power Infeed
Cut-out location

OASIS MINI

MODEL#	DIMENSIONS	FREIGHT CLASS	WT/LBS.	CUBIC FT.	LIST PRICE
--------	------------	---------------	---------	-----------	------------

D x W x H

OAM-U-PC-__	15 x 9 x 5.25	92.5	16	1.53	\$2044
-------------	---------------	------	----	------	--------

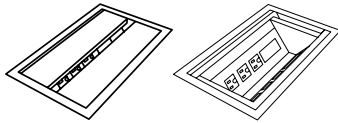

Oasis Mini USB, Corded



Mini Oasis USB unit. 15" trough with six power receptacles, two 2.1 AMP USB charging ports and one telecom plate cut-out (**telecom plates sold separate**, see page 484) and two 108" 3-prong plugs. **M1, M2 or M3 cut-out(s) must be specified on conference table** (see product notes section for more details and cut-out upcharge). UL Listed: UL 962A.

- **Cannot be daisy-chained.**
- Replace _ with **B** for **Black**
- Replace _ with **S** for **Silver Pearl**

OAM-U-PC-4-1-__	15 x 9 x 5.25	92.5	16	1.53	\$2307
-----------------	---------------	------	----	------	--------

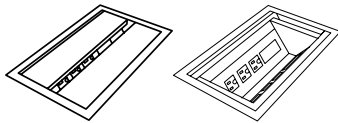

Oasis Mini USB, DaisyLink Version

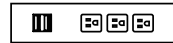

For hardwire and daisy chain applications. Mini Oasis USB unit. 15" trough with six power receptacles, two 2.1 AMP USB charging ports and one telecom plate cut-out (**telecom plates sold separate**, see page 484). **Power infeed sold separate** (see page 485). **M1, M2 or M3 cut-out(s) must be specified on conference table** (see product notes section for more details and cut-out upcharge). For multiple circuit configurations, please contact customer service. *Please see our **Daisy-Chain guide** on page 486 for appropriate cable lengths and important notes.* UL Listed: UL 183.

- Replace _ with **B** for **Black**
- Replace _ with **S** for **Silver Pearl**

GL-OAMPD_P72HW	15 x 9 x 5.25	92.5	16	1.53	\$2490
----------------	---------------	------	----	------	--------

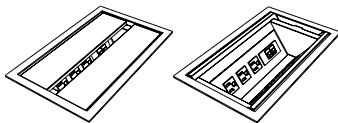

Oasis Mini, Chicago Code

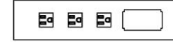
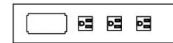

Mini Oasis for Chicago code includes electrical trough with (2) separate hardwire inserts. Each insert includes (3) simplex outlets and (1) telecom plate cut-out (**telecom plates sold separate**, see page 484). **M1, M2 or M3 cut-out(s) must be specified on conference table** (see product notes section for more details and cut-out upcharge). Each component is UL Listed: UL 962A.

- **Cannot be daisy-chained.**
- Replace _ with **B** for **Black**
- Replace _ with **S** for **Silver Pearl**

Required Specifications

Finish
Power Infeed
Cut-out location

T TABLE POWER + TECHNOLOGY SOLUTIONS

TOP TELECOM PLATES

D x W x H





NOT COMPATIBLE WITH VILLA UNITS

TOP TELECOM PLATE	MODEL	CONFIGURATION	LIST PRICE
	A-__-A-B	Telecom plate with RJ11 Cat 3 Phone and RJ45 Cat 6 Data	\$108
	A-__-B-B	(2) RJ45 Cat 6 Connectors	\$141
	A-__-B-B-B	(3) RJ45 Cat 6 Connectors	\$206
	A-__-B-B-B-B	(4) RJ45 Cat 6 Connectors	\$274
	A-__-B-C51-L	RJ45 Cat 6 Data, Mini-Stereo Inline and 15 pin HD VGA Female/Female with 72" patch cord attached.	\$244
	A-__-B-B-C51	(2) RJ45 Cat 6 Data and (1) 15 pin HD VGA Female/Female with 72" patch cord attached.	\$254
	A-__-A-B-102	RJ11 Cat 3 phone, RJ45 Cat 6 Data and USB with 72" patch cord attached.	\$244
	A-__-B	RJ45 Cat 6 Data	\$76
	A-__-C51-L	Mini Stereo Inline and 15 pin HD VGA Female/Female with 72" patch cord attached.	\$191
	A-__-CRDMINDER	Cordminder Plate - 2 5/8" holes and 1 7/8" holes	\$43
	A-__-C45-C51-L	HDMI Female/Female with 36" patch cord attached. Mini Stereo Inline and 15 Pin HD VGA Female/Female with 72" patch cord attached.	\$333

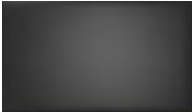

Required Specifications

- Finish
- Power Infeed
- Cut-out location

TOP TELECOM PLATES

		D x W x H				
TOP TELECOM PLATE	MODEL	CONFIGURATION				LIST PRICE
	A-__-C45	HDMI Female/Female with 36" patch cord attached.				\$164
	A-__-A-B-B	(1) RJ11 Cat 3 Phone and (2) RJ45 Cat 6 data.				\$178
	A-__	Blank telecom plate				\$27
	A-__-102	USB with 72" patch cord attached.				\$76
	A-__-C51	15 pin HD VGA Female/Female with 72" patch cord attached.				\$123
<ul style="list-style-type: none"> • Replace __ with BL for Black • Replace __ with GR for Grey 						

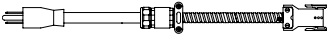
POWER INFEEDS

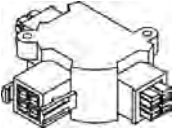
	42AP1-72	--	--	--	--	\$245
Plug and Play Infeed	Single Circuit 20 AMP Power Infeed with 72" 3-prong plug. Provides single power entry from floor or wall mounted standard power supply. Connects to Oasis Mini or Villa units that require a separate infeed. UL Listed: UL 1286.					
	42SB2-108	--	--	--	--	\$203
Multi-Circuit Hardwire Power Infeed	42SB2-72	--	--	--	--	\$158
	42SB2-36	--	--	--	--	\$115
Multi-Circuit Hardwire Infeed (up to 20 AMPS per circuit), two circuits. Provides single power entry from floor or wall located building power supply. Connects to Oasis Mini or Villa units that require a power infeed. TO BE HARDWIRED BY A LICENSED ELECTRICIAN. UL Listed: UL 183.						
	DAISY-T	--	70	1	1	\$187
3 Way Power Splitter	Daisy-T power manager includes two male and one female connection. For use in splitting a power source two ways. UL Listed: UL 183.					

Required Specifications

Finish
Power Infeed
Cut-out location

T TABLE POWER + TECHNOLOGY SOLUTIONS

TOP TELECOM PLATES



Interconnecting Cables

	D x W x H
42FF-__	
Female/Female	
42FM-__	
Female/Male	

UL Listed: UL 183 and CSA Certified. For appropriate quantity and sizes, please refer to the chart on the next page.

Interconnecting Cables - Common Cable Lengths (in inches)

Female/Female				Female/Male	
42FF-27	\$116	42FF-97	\$216	42FM-12	\$104
42FF-38	\$129	42FF-98	\$216	42FM-27	\$121
42FF-41	\$133	42FF-100	\$205	42FM-38	\$134
42FF-50	\$145	42FF-101	\$208	42FM-41	\$139
42FF-53	\$149	42FF-103	\$208	42FM-50	\$151
42FF-63	\$159	42FF-110	\$219	42FM-63	\$167
42FF-65	\$163	42FF-113	\$225	42FM-75	\$181
42FF-75	\$175			42FM-82	\$190
42FF-76	\$176			42FM-85	\$164
42FF-77	\$177			42FM-86	\$195
42FF-82	\$184			42FM-97	\$216
42FF-85	\$187			42FM-98	\$216
42FF-86	\$188			42FM-100	\$230
42FF-89	\$193			42FM-110	\$230

DRAWING 1A - OASIS MINI A & OASIS MINI USB

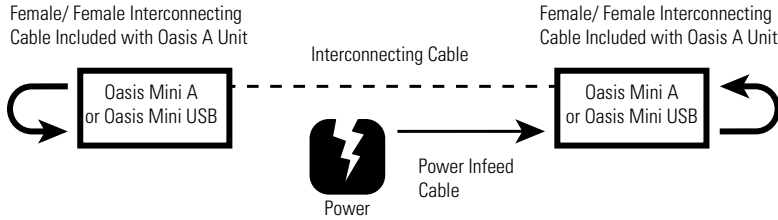

DRAWING 1B - OASIS MINI B

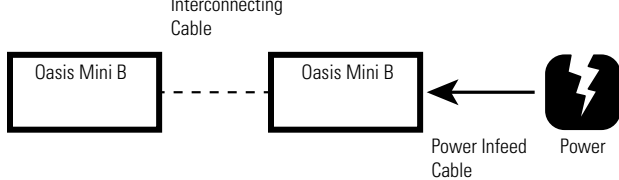

DRAWING 2A - OASIS MINI A & OASIS MINI USB

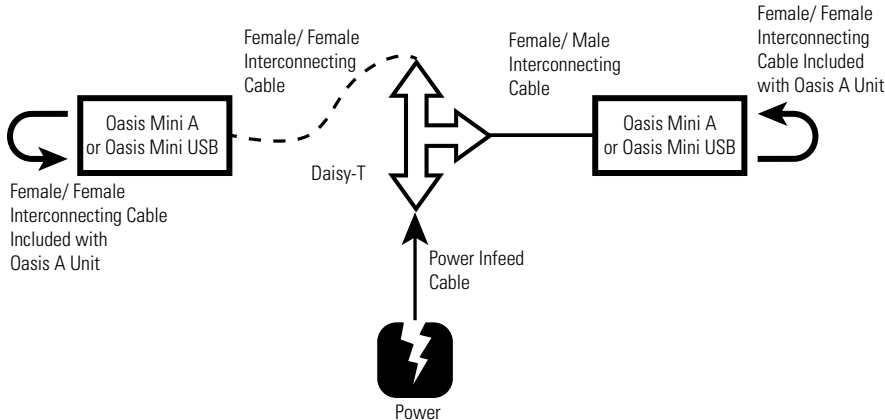

DRAWING 2B - OASIS MINI B

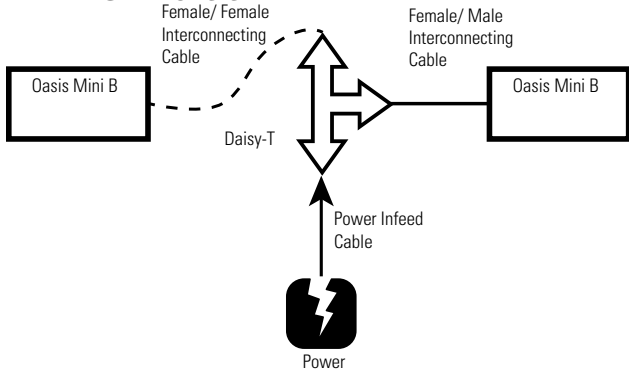

DRAWING 3 - OASIS MINI A & OASIS MINI USB

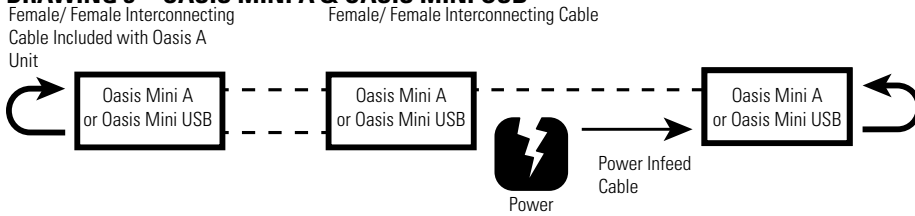

DRAWING 4 - OASIS MINI A & OASIS MINI USB

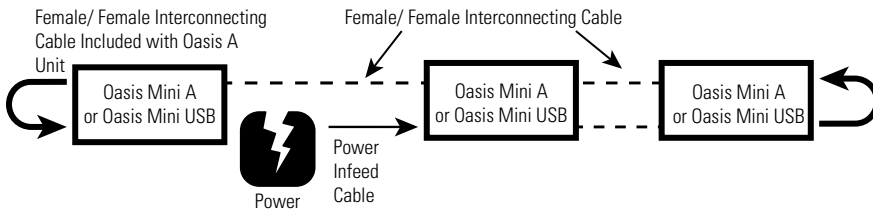

DRAWING 5 - OASIS MINI B

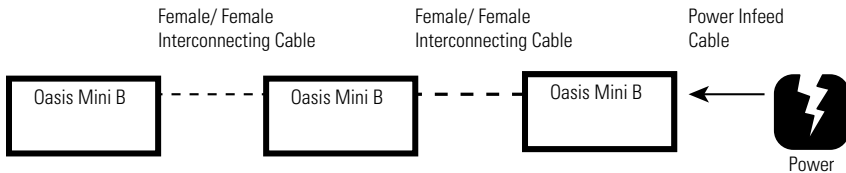

DRAWING 6 - OASIS MINI B

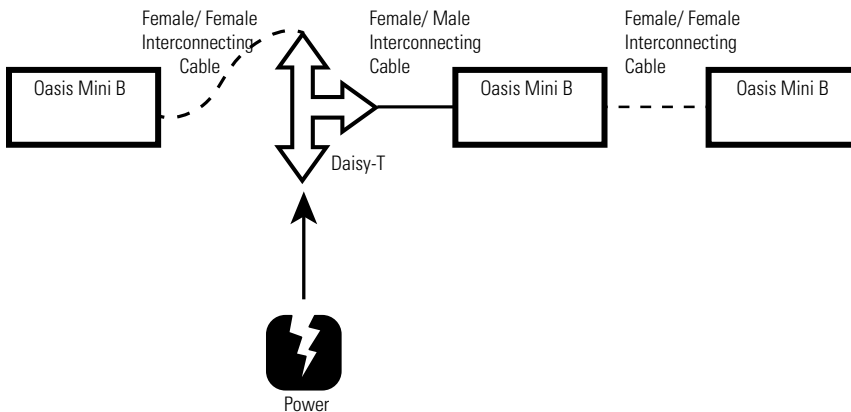

OASIS MINI A, B & USB CABLE LENGTHS NEEDED FOR DAISY-CHAINING

Model #	Villa DaisyLink, Oasis Mini USB Oasis Mini A Oasis Mini B	Villa DaisyLink, Oasis Mini USB Oasis Mini A Oasis Mini B	Oasis Mini USB Oasis Mini A	Oasis Mini USB Oasis Mini A	Villa DaisyLink or Oasis Mini B	Villa DaisyLink or Oasis Mini B
Cut-out Positions	V1, V3, M1, M3	V1, V3, M1, M3	M1, M2 & M3	M1, M2 & M3	V1, V2, V3, M1, M2, M3	V1, V2, V3, M1, M2, M3
Infeed Position	Left or Right	Center	Left or Right	Center	Left or Right	Center
Reference	Drawing 1A/1B	Drawing 2A/2B	Drawing 3	Drawing 4	Drawing 5	Drawing 6
Z4896BE Z4896RTE Z4896REE Z4896BW	(1) 42FF-53 SPECIFY INFEED	(1) 42FF-27 (1) 42FM-27 (1) DAISY-T SPECIFY INFEED	N/A	N/A	N/A	N/A
Z48120BE Z48120RTE Z48120REE Z48120BW	(1) 42FF-76 SPECIFY INFEED	(1) 42FF-38 (1) 42FM-38 (1) DAISY-T SPECIFY INFEED	(3) 42FF-41 SPECIFY INFEED	(3) 42FF-41 SPECIFY INFEED	(2) 42FF-41 SPECIFY INFEED	(2) 42FF-41 (1) 42FM-12 (1) DAISY-T SPECIFY INFEED
Z48144BE Z48144RTE Z48144REE Z48144BW	(1) 42FF-100 SPECIFY INFEED	(1) 42FF-50 (1) 42FM-50 (1) DAISY-T SPECIFY INFEED	(3) 42FF-53 SPECIFY INFEED	(3) 42FF-53 SPECIFY INFEED	(2) 42FF-53 SPECIFY INFEED	(2) 42FF-53 (1) 42FM-12 (1) DAISY-T SPECIFY INFEED
Z48168BE Z48168RTE Z48168REE Z48168BW	(1) 42FF-63 (1) 42FM-63 SPECIFY INFEED	1) 42FF-63 (1) 42FM-63 (1) DAISY-T SPECIFY INFEED	(3) 42FF-65 SPECIFY INFEED	(3) 42FF-65 SPECIFY INFEED	(2) 42FF-65 SPECIFY INFEED	(2) 42FF-65 (1) 42FM-12 (1) DAISY-T SPECIFY INFEED
Z48192BE Z48192RTE Z48192REE Z48192BW	(1) 42FF-75 (1) 42FM-75 SPECIFY INFEED	1) 42FF-75 (1) 42FM-75 (1) DAISY-T SPECIFY INFEED	(3) 42FF-77 SPECIFY INFEED	(3) 42FF-77 SPECIFY INFEED	(2) 42FF-77 SPECIFY INFEED	(2) 42FF-77 (1) 42FM-12 (1) DAISY-T SPECIFY INFEED
Z48216BE Z48216RTE Z48216REE Z48216BW	(1) 42FF-86 (1) 42FM-86 SPECIFY INFEED	1) 42FF-85 (1) 42FM-85 (1) DAISY-T SPECIFY INFEED	(3) 42FF-89 SPECIFY INFEED	(3) 42FF-89 SPECIFY INFEED	(2) 42FF-89 SPECIFY INFEED	(2) 42FF-89 (1) 42FM-12 (1) DAISY-T SPECIFY INFEED
Z48240BE Z48240RTE Z48240REE Z48240BW	(1) 42FF-98 (1) 42FM-98 SPECIFY INFEED	1) 42FF-97 (1) 42FM-97 (1) DAISY-T SPECIFY INFEED	(3) 42FF-101 SPECIFY INFEED	(3) 42FF-101 SPECIFY INFEED	(2) 42FF-101 SPECIFY INFEED	(2) 42FF-101 (1) 42FM-12 (1) DAISY-T SPECIFY INFEED
Z48264BE Z48264RTE Z48264REE Z48264BW	(1) 42FF-110 (1) 42FM-110 SPECIFY INFEED	(1) 42FF-110 (1) 42FM-110 (1) DAISY-T SPECIFY INFEED	(3) 42FF-113 SPECIFY INFEED	(3) 42FF-113 SPECIFY INFEED	(2) 42FF-113 SPECIFY INFEED	(2) 42FF-113 (1) 42FM-12 (1) DAISY-T SPECIFY INFEED
Z48288BE Z48288RTE Z48288REE Z48288BW	(1) 42FF-82 (2) 42FM-82 SPECIFY INFEED	(2) 42FF-41 (2) 42FM-41 (1) DAISY-T SPECIFY INFEED	(3) 42FF-63 (3) 42FM-63 SPECIFY INFEED	(3) 42FF-63 (3) 42FM-63 SPECIFY INFEED	(2) 42FF-63 (2) 42FM-63 SPECIFY INFEED	(2) 42FF-63 (2) 42FM-63 (1) DAISY-T SPECIFY INFEED

tables and accessories

café, meeting and conference

Boardroom.....	492	Kadin.....	642
Collaborative Spaces.....	545	Swap.....	651

training

2gether.....	490	Edventure.....	591
Bungee.....	513	FreeFit.....	599
Bungee SL.....	530	Junction.....	635
Connectables.....	572	Terina.....	696
Duet.....	588	Zook.....	700

reception and occasional

Citi.....	712	River+ tables.....	721
Drift tables.....	716	Sirena tables.....	724
Lite Lift II.....	720	Wind.....	725
Occasional tables.....	714	Work tables.....	726



GENERAL INFORMATION

- 2gether is a series of multi-purpose flip-top tables for collaboration, classroom, training and conference applications.
- “Easy Touch” mechanism allows you to flip the tables up or down with maximum ease
- Adjustable leveling casters provide smooth mobility
- Offset “Y” sculpted legs allow for parallel space-saving table nesting, to minimize footprint required for storage
- Optional modesty panels with integrated wire troughs are available
- Grommets are available on 24” deep worksurfaces
- Available sizes: 18”D x 60”W, 24”D x 60”W and 72”W
- Shipped easy to assemble. Each component is packaged individually; legs are shipped 1 per carton.
- For environmental certifications, please visit globalfurnituregroup.com

WORKSURFACES

- 1” thick tops are constructed of 45 lb. density particleboard with high performance thermally fused laminate

CONSTRUCTION

- “Easy touch” lever located at both sides of table for flip-top operation from either side
- Global’s preferred matching edge
- Tops are pre-drilled with threaded steel inserts
- Tops 60” and 72” wide feature a built-in support bar
- 14.25” high optional articulating modesty panel attaches to underside of flip-top
- Bumpers on legs and undercarriage prevent tables from being damaged while nested
- Grommets optional on 24” deep tops only
- Champagne base finish
- Products specified with the high pressure laminate option are finished on the underside of the surface with a kraft paper backing.

LAMINATE FINISHES

ACJ	Absolute Acajou	FCL	First Class
ASN	Asian Night	NBL	Noce Biondo
AWC	Avant Cherry	NGL	Noce Grigio
AWH	Avant Honey	NEL	Noce Leggero
BLK	Black	NML	Noce Medio
BZD	Blizzard	QTM	Quartered Mahogany
BRC	Brushed Cobalt	SBY	Sheer Beauty
CMB	Clear Maple	SOG	Storm Grey
CGY	Custom Grey	SDT	Stonedust
DES	Dark Espresso	WHE	Walnut Heights
DWT	Designer White	WHC	White Chocolate
FAS	Fashionista	WCR	Winter Cherry

GANGING PLATES

- Ganging plates are available for ganging adjoining tables together.
- Ganging plates are black epoxy coated steel plates with two thumbscrews

GROMMETS

- Available only on 24” deep worksurfaces
- Additional grommets available in standard worksurface locations (left, center or right). Order as: **AG1, AG2 or AG3. Add \$96**
- Grommet hole dimensions are 3 ¼” wide x 1 7/8” deep.

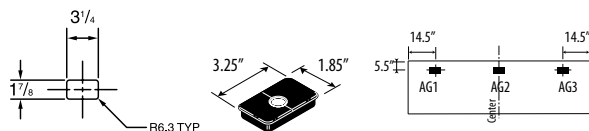

- Grommets may be placed at non-standard locations. Order as: **AGS - Add \$96** A drawing must be supplied with vertical and horizontal dimensions to the center of the cut-out (as in drawing above). Please refer to CUSTOM GROMMET LOCATION FORM in the back reference section.

POWER BLOCK

- Available only on 24” deep worksurfaces
- A Power Block is a rectangular worksurface power/data module with one electrical duplex receptacle and two data (RJ45) receptacles. 9’ black cord included. Power Block dimensions are 3 ½” deep x 6 ½” wide x 2 ¾” high.
- A Power Block (model **PMSPDM**) may be ordered for **24” Deep Tables** in place of standard grommets.
- To purchase a Power Block, you must specify both the Power Block cut-out location and the Power Block model #. Order Power Block as **PMSPDM, Add \$330**. Power Blocks are available in standard worksurface locations (left, center or right). Order as **E1, E2 or E3. Add \$96**.

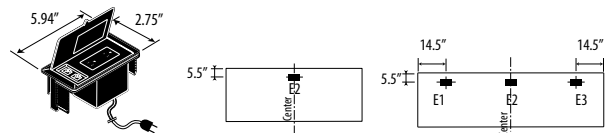

For 48”w units

For 60” and 72”w units.

Power Block **PMSPDM, Add \$330** Specify location **E1, E2 or E3, Add \$96**

VILLA CUT-OUTS

- Available only on 24” deep worksurfaces
- A Villa Power Block is available for daisy-chaining or corded for use on individual tables (see page 475 for Villa details). Villa Power Block dimensions vary by model. Villa cutout dimensions are 3” deep x 5 ¼” wide.
- Villa DaisyLink **kits** are not for use on 2gether tables.
- A Villa cutout may be ordered for 24” Deep Tables. Order as **V1, V2 or V3, Add \$96 for each cutout**.
- Order Villa Power Block and Villa Grommet Cover separately, see page 475 for pricing and details

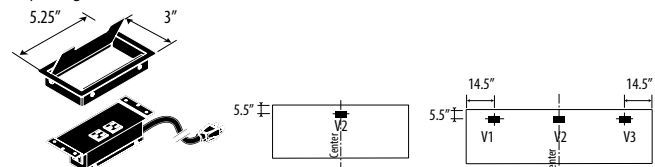

For 48”w units

For 60” and 72”w units.

MODPOWER DAISY CHAIN SOLUTION

- Add flexible power and USB charging to 2gether tables. Connect up to four units with a single corded infeed with NEMA plug.
- ModPower units are sold separately, refer to Productivity Solutions page 465.
- Begin run with a starter unit which includes a corded infeed. Add additional middle or end units as required. Middle and end units are equipped with connecting cables.
- To be used with rectangular tables **IT2460RX** and **IT2472RX** only.
- On-surface modules clamp on or screw mount to the table tops.
- In-surface modules require table top cut-outs for mounting. Specify cut-out option:
 - **MPS** for a single cut-out to accommodate one ModPower in-surface unit (cut-out will be centered on the approach side). **Add \$96**
 - **MPD** for two cut-outs in the left and right positions, 15” from ends to center of unit on approach side. **Add \$192**.

RECTANGULAR TOP **MODEL#** **DIMENSIONS** **FREIGHT CLASS** **WT/LBS.** **CUBIC FT.** **LIST PRICE** **HP ADD**

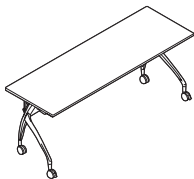

Rectangular Table - Flip-Top

	D x W x H						
IT2472RX	24 x 72 x 29	92.5	97.20	8.68	\$2237	\$274	
IT2460RX	24 x 60 x 29	92.5	86	7.68	\$2092	\$242	
IT1860RX	18 x 60 x 29	92.5	75	6.98	\$2014	\$214	

Flip-top table on four adjustable leveling casters, two locking. Easy-touch lever located at both ends of the table allows for activation on either side of the table; offset Y leg accommodates in-line nesting for space-saving storage. Nested dimensions: first 18D tables: 22.2" + 5.6" per additional table nested; first 24D tables: 25.1" + 5.6" per additional table nested. . Wire management channel included. Champagne finish leg. Black/dark grey casters. Optional articulating modesty panel available. Shipped easy to assemble in 3 cartons.

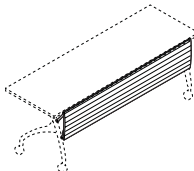

Modesty Panel

IT72MP	2.75 x 63 x 14.25	125	13.20	2	\$328		
IT60MP	2.75 x 51 x 14.25	125	11.40	1.60	\$302		

Articulating modesty for use with flip-top 2gether tables. Champagne finish.

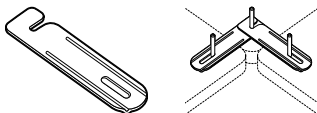

Ganging Connector

CNGFP	5 x 2.5 x 1.13	70	.20	.10	\$69		
-------	----------------	----	-----	-----	-------------	--	--

Black epoxy coated 13 gauge steel with 2 thumbscrews included. Used to connect tabletops together for additional stability or for connecting freestanding tops together. Holes with steel inserts are located in the corner of all tops to accommodate this plate. **Sold individually.**

Required Specifications
Top Finish

Accessories
Modesty Panel

B BOARDROOM TABLES



Sturdy and economically priced, Global boardroom tables are excellent choices. All tables are made from thermally fused, high performance laminate and are easy to maintain.

Choose from four attractive table edges: Bullnose, T-mold, Self-edge, or Built-up Self-edge. Available in a variety of colors, all edge options are durable and wear-resistant.

Table tops are offered in five shapes - rectangular, racetrack, boat-shaped, square and round, and a variety of bases including slab, drum and arch. Add to this an impressive variety of laminate finishes that may be mixed and matched and you'll find Global can satisfy any and every business need.

From small meeting rooms to large boardrooms, from traditional to contemporary, Global's incredible range of table components, shapes, sizes and colors will enhance any office decor.

Features and Benefits

- One-piece tops can be cut to 2 pieces for an upcharge
- Tables 96" to 144" in length special ordered with two piece tops must have a third base
- All tops are premarked as to base location
- All tops are 1 1/8" thick - a 1 3/4" built-up self edge is available on all models
- Tops and bases boxed as appropriate
- Custom finish laminate tables available as special order
- Bullnose edges available in Black or Grey
- T-Mold edge available in Black, Grey or coordinating laminate finish.
- Self-edge and built-up self edge available in same color as laminate finish.
- All edges available on all tables

GENERAL INFORMATION

- All tables are 29" high
- Tops are thermally fused laminate with 45 lb. density particle board core.
- Multiple base styles available in thermally fused laminate or metal.
- Tables 144" or less are standard in one piece. All tops over 144" are standard in two pieces.
- Five top shapes: rectangular, racetrack, boat, square and round and four edge options: self edge, bullnose, T-mold or built-up self edge.
- For environmental certifications, please visit globalfurnituregroup.com

CONSTRUCTION

- All tables are 29" high. Tops are made of 45 lb. density particle board covered on both sides with high performance, thermally fused laminate. Table width is nominal.
- All tables with cross bases use Blum fasteners
- Round and square tops up to 60" dia. are 1" thick; all other tops are 1.125" thick.
- Tops with BU edge have a 1.75" built-up self edge.
- Tops are crated and bases boxed or crated as appropriate
- Table tops of 144" or less in length are standard as one piece. 1 piece tops can be cut to 2 piece tops, **Add \$289**; however, an additional base will be required. Tables 96" to 144" in length special ordered with 2 piece tops **must** have a third base.
- All tops are **PRE-MARKED** as to base location, and the slot and hook assembly method (on selected tables) allows for easy installation.
- All racetrack, boat and rectangular tables 144" and under are standard with two drum, slab, arch, 2-legged, or tubular bases and are priced accordingly. For 3 bases, **Add \$506** list per table for a drum, and **add \$333** list per table for the slab. Arch base tables will require a special 3" thick slab at a list price of **\$448** per table. **Add \$430** list per table for 2-legged base, and **add \$448** list per table for tubular.
- Custom size tables are priced at next size table price, not to exceed width or length. Example: 44" x 108" would be priced at the 48" x 120" price. Contact Customer Care for pricing of tables over 48" in width. Custom tables **less** than the smallest size must be quoted.
- Products specified with the high pressure laminate option are finished on the underside of the surface with a kraft paper backing.

EDGE OPTIONS

- Self, built-up, bullnose and T-mold edges are available on all models. Corners of rectangular, square and boat shaped tables ordered with T-mold or bullnose will be rounded.
- **Bullnose** edge is available in Black (BK) or Grey (GR) only.
- **T-mold** edge is available in Black (BK), Grey (GR) or coordinating laminate finish (ME)
- **Self edge and built-up** edges are same color as laminate finish.

METAL BASE FINISHES

- Available on all round and square GCARxx, GTCRxx, GCRRx, GCASxx, GTCSxx, and GCRSxx tables.

Paint finishes

TBL	Black	TIN	Ink
TBZ	Buzz Blue	TKA	Kalua
TCC	Cactus	TLA	Latte
TCR	Carrot	TMO	Mocha
TIV	Cloud	TNE	Nevada
TDW	Designer White	TSN	Sand
TDJ	Dijon	TSR	Scarlet
TEG	Eggplant	TSH	Shadow
TFO	Fog	TOA	Toast
TFR	Frost	TTU	Tungsten

Plated finishes - upcharge applies

CHM	Polished Chrome	BCH	Brushed Chrome
ACO	Antique Copper	SBR	Satin Brass

LAMINATE FINISHES

ACJ	Absolute Acajou	FCL	First Class
ASN	Asian Night	NBL	Noce Biondo
AWC	Avant Cherry	NGL	Noce Grigio
AWH	Avant Honey	NEL	Noce Leggero
BLK	Black	NML	Noce Medio
BZD	Blizzard	QTM	Quartered Mahogany
BRC	Brushed Cobalt	SBY	Sheer Beauty
CMB	Clear Maple	SOG	Storm Grey
CGY	Custom Grey	SDT	Stonedust
DES	Dark Espresso	WHE	Walnut Heights
DWT	Designer White	WCH	White Chocolate
FAS	Fashionista	WCR	Winter Cherry

- Fashionista (FAS), First Class (FCL), Sheer Beauty (SBY) + White Chocolate (WCH) not available on 10 & 12 foot tables. Must be cut in two pieces and specify third base.
- Fashionista (FAS), First Class (FCL), Sheer Beauty (SBY) + White Chocolate (WCH) not available on 20', 22' & 24' tables. Tables must be quoted to be in three pieces with appropriate bases. Please contact Customer Care.
- The above laminate finishes are available in **High Pressure**. Upcharge varies by model.
- Tables in woodgrain finishes over 12' in length will not have a perfect match of grain at the center where the two halves meet.
- All tables with Drum Bases & Pedestal require approx. 125 lb. of sand in each base for adequate stability. Sand is not included with Drum Bases.
- If other than a Global standard laminate finish is preferred, contact your customer care Representative. Information needed includes the name of the laminate manufacturer, color name, number and model of table. You will then be given a quote for this special order.

BASE SIZE CHART (Table width is nominal)

Round or Square Tops:

Top	Slab	Drum	Arch	Cross	4 Leg	Trumpet	4 Tube
36"	n/a	n/a	n/a	n/a	32"	24"	30"
42"	n/a	18"	n/a	30"	32"	24"	30"
48"	n/a	24"	n/a	30"	32"	n/a	30"
60"	n/a	30"	n/a	36"	n/a	n/a	n/a

Rectangular, Boat or Racetrack Tops:

Top	Slab	Drum	Arch	Cross	2 Leg	Trumpet	2/3 Tube
36" x 72"	24"	18"	24"	n/a	32"	n/a	30"
48" x 96"	28"	18"	28"	n/a	32"	n/a	30"
48" x 120"	28"	24"	28"	n/a	32"	n/a	30"
48" x 144"	28"	24"	28"	n/a	32"	n/a	30"

GROMMETS

- Grommets available in standard table top locations (left, center or right). Order as: **AG1, AG2 or AG3. Add \$96.**
- Grommet hole dimensions are 3 1/4" wide x 1 7/8" deep.

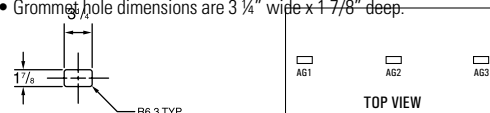

- Actual grommet locations will vary according to base selection.

POWER BLOCK

- A Power Block (model **PMSpdm**) may be ordered on all worksurfaces.
- A Power Block is a rectangular worksurface power/data module with one electrical duplex receptacle and two data (RJ45) receptacles. 9' black cord included. Power Block dimensions are 3 1/2" deep x 6 1/2" wide x 2 3/4" high.
- Actual Power Block locations vary according to base selection. The locations will be left (AG1, E1), center (AG2, E2), and right (AG3, E3). **Example:** 8' table with drum base does not have a modesty panel, so the grommet (AG2) and power block (E2) can be perfectly centered in the table. An 8' table with a slab base has the modesty panel, so the grommet (AG2) and power block (E2) will be offset alongside the modesty panel.

B BOARDROOM TABLES

- To purchase a Power Block, you must specify both the Power Block cut-out location and the Power Block model #. Order Power Block as **PMSPPM, Add \$330**. Power Blocks are available in standard worksurface locations (left, center or right). Order as **E1, E2 or E3. Add \$96**.

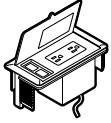

Power Block **PMSPPM - Add \$330** Specify location **E1, E2 or E3 - Add \$96**

TABLE NOTES - ESTIMATED CAPACITY

- Use the following for determining the size of a round table and the number of chairs needed for a conference area. All estimates are based on an average chair width of 23" with a 4" clearance between chairs. Adjust accordingly for a different chair size.

Top Size	Round	Square	Rectangular	Boat	Racetrack	Elliptical
30x30	3	3	N/A	N/A	N/A	N/A
36x36	4	4	N/A	N/A	N/A	N/A
42x42	4	4	N/A	N/A	N/A	N/A
48x48	4	4	N/A	N/A	N/A	N/A
60x60	5	6	N/A	N/A	N/A	N/A
30x60	N/A	N/A	4-6	4-6	4-6	4
36x72	N/A	N/A	4-6	4-6	4-6	4
44x84	N/A	N/A	6-8	6-8	6-8	6
48x96	N/A	N/A	6-8	6-8	6-8	6
48x120	N/A	N/A	8-10	8-10	8-10	8
48x144	N/A	N/A	10-12	10-12	10-12	10
48x168	N/A	N/A	12-14	12-14	12-14	12
48x192	N/A	N/A	14-16	14-16	14-16	14
48x216	N/A	N/A	16-18	16-18	16-18	16
48x240	N/A	N/A	18-20	18-20	18-20	18
48x264	N/A	N/A	20-22	20-22	20-22	20
48x288	N/A	N/A	22-24	22-24	22-24	22

BASE OPTIONS

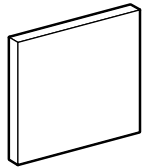

slab

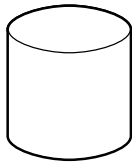

drum

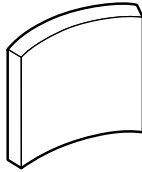

arch

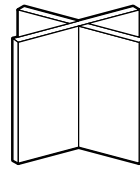

cross

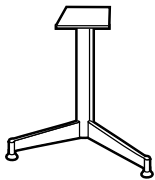

2-leg



4-leg

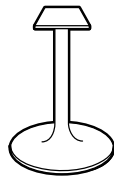

trumpet

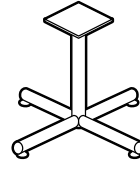

tube

EDGE OPTIONS

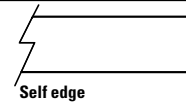

Self edge

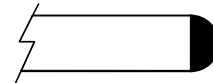

Bullnose

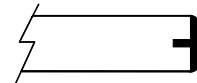

T-mold

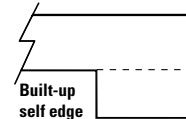

Built-up self edge

TABLE TOP STYLES

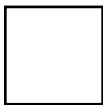

Square

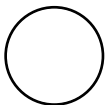

Round



Racetrack

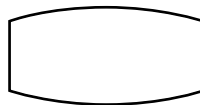

Boat

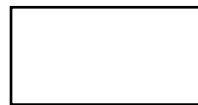

Rectangular

ROUND TOP - DRUM BASE

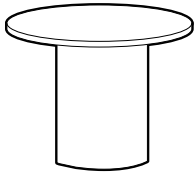

	MODEL#	DIMENSIONS	FRT. CLASS	WT./LBS.	CUBIC FT.	LIST PRICE	HP ADD		
		D x W x H							
self edge	G42CZ	42 x 42 x 29	92.5	89	8.50	\$915		\$461	
bullnose edge	G42CZBN	42 x 42 x 29	92.5	86	8.50	\$915		\$461	
T-mold edge	G42CZTM	42 x 42 x 29	92.5	90	8.50	\$915		\$461	
built-up self edge	G42CZBU	42 x 42 x 29	92.5	96	9.40	\$1016		\$510	
self edge	G48CZ	48 x 48 x 29	125	106	13.60	\$1059		\$532	
bullnose edge	G48CZBN	48 x 48 x 29	100	117	13.60	\$1059		\$532	
T-mold edge	G48CZTM	48 x 48 x 29	100	121	13.60	\$1059		\$532	
built-up self edge	G48CZBU	48 x 48 x 29	100	133	14.90	\$1180		\$591	
self edge	G60CZ	60 x 60 x 29	100	171	21	\$1327		\$665	
bullnose edge	G60CZBN	60 x 60 x 29	100	171	21	\$1327		\$665	
T-mold edge	G60CZTM	60 x 60 x 29	100	171	21	\$1327		\$665	
built-up self edge	G60CZBU	60 x 60 x 29	125	174	23.20	\$1560		\$781	

• All Drum Bases require approx. 125 lb. of sand in each base for adequate stability. Sand is not included.

ROUND TOP - CROSS BASE

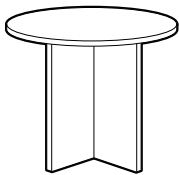

self edge	G42CH	42 x 42 x 29	70	97	5	\$852		\$428	
bullnose edge	G42CHBN	42 x 42 x 29	70	94	5	\$852		\$428	
T-mold edge	G42CHTM	42 x 42 x 29	70	98	5	\$852		\$428	
built-up self edge	G42CHBU	42 x 42 x 29	70	104	5.70	\$915		\$461	
self edge	G48CH	48 x 48 x 29	70	101	6	\$992		\$496	
bullnose edge	G48CHBN	48 x 48 x 29	70	112	6	\$992		\$496	
T-mold edge	G48CHTM	48 x 48 x 29	70	116	6	\$992		\$496	
built-up self edge	G48CHBU	48 x 48 x 29	70	128	6.60	\$1138		\$571	
self edge	G60CH	60 x 60 x 29	70	174	9	\$1271		\$637	
bullnose edge	G60CHBN	60 x 60 x 29	125	64	9	\$1271		\$637	
T-mold edge	G60CHTM	60 x 60 x 29	125	64	9	\$1271		\$637	
built-up self edge	G60CHBU	60 x 60 x 29	70	190	9.70	\$1497		\$751	

ROUND TOP - 4 LEG BASE



	MODEL#	DIMENSIONS	FRT. CLASS	WT./LBS.	CUBIC FT.	LIST PRICE	HP ADD	CHM/BCH	ACO/SBR
self edge	GCAR36	36 x 36 x 29	250	48	13	\$617	\$309	\$92	\$332
bullnose edge	GCAR36BN	36 x 36 x 29	150	55	13	\$617	\$309	\$92	\$332
T-mold edge	GCAR36TM	36 x 36 x 29	250	48	13	\$617	\$309	\$92	\$332
built-up self edge	GCAR36BU	36 x 36 x 29	150	68	13	\$686	\$346	\$92	\$332
self edge	GCAR42	42 x 42 x 29	150	59	14	\$736	\$369	\$92	\$332
bullnose edge	GCAR42BN	42 x 42 x 29	150	68	14	\$736	\$369	\$92	\$332
T-mold edge	GCAR42TM	42 x 42 x 29	150	61	14	\$736	\$369	\$92	\$332
built-up self edge	GCAR42BU	42 x 42 x 29	150	78	14	\$813	\$408	\$92	\$332
self edge	GCAR48	48 x 48 x 29	150	72	15	\$863	\$434	\$92	\$332
bullnose edge	GCAR48BN	48 x 48 x 29	150	83	15	\$863	\$434	\$92	\$332
T-mold edge	GCAR48TM	48 x 48 x 29	150	87	15	\$863	\$434	\$92	\$332
built-up self edge	GCAR48BU	48 x 48 x 29	125	99	15	\$958	\$482	\$92	\$332

Required Specifications

Top finish
Base finish
Edge color, if applicable

B BOARDROOM TABLES

ROUND TOP - TRUMPET BASE

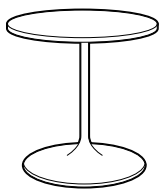

	MODEL#	DIMENSIONS	FRT. CLASS	WT./LBS.	CUBIC FT.	LIST PRICE	HP ADD	BCH/CHM	ACO/SBR
D x W x H									
self edge	GTCR36	36 x 36 x 29	250	54	19	\$863	\$434	\$89	\$363
bullnose edge	GTCR36BN	36 x 36 x 29	250	61	18	\$863	\$434	\$89	\$363
T-mold edge	GTCR36TM	36 x 36 x 29	250	54	18	\$863	\$434	\$89	\$363
built-up self edge	GTCR36BU	36 x 36 x 29	150	74	18	\$958	\$482	\$89	\$363
self edge	GTCR42	42 x 42 x 29	150	77	19	\$968	\$486	\$89	\$363
bullnose edge	GTCR42BN	42 x 42 x 29	250	74	19	\$968	\$486	\$89	\$363
T-mold edge	GTCR42TM	42 x 42 x 29	150	78	19	\$968	\$486	\$89	\$363
built-up self edge	GTCR42BU	42 x 42 x 29	150	84	19	\$1078	\$542	\$89	\$363

ROUND TOP - TUBULAR BASE



	MODEL#	DIMENSIONS	FRT. CLASS	WT./LBS.	CUBIC FT.	LIST PRICE	HP ADD	BCH/CHM	ACO/SBR
self edge	GCRR36	36 x 36 x 29	250	50	18	\$744	\$373	\$92	\$398
bullnose edge	GCRR36BN	36 x 36 x 29	250	57	19	\$744	\$373	\$92	\$398
T-mold edge	GCRR36TM	36 x 36 x 29	250	50	19	\$744	\$373	\$92	\$398
built-up self edge	GCRR36BU	36 x 36 x 29	250	70	19	\$830	\$415	\$92	\$398
self edge	GCRR42	42 x 42 x 29	250	61	19	\$863	\$434	\$92	\$398
bullnose edge	GCRR42BN	42 x 42 x 29	250	70	19	\$863	\$434	\$92	\$398
T-mold edge	GCRR42TM	42 x 42 x 29	250	63	19	\$863	\$434	\$92	\$398
built-up self edge	GCRR42BU	42 x 42 x 29	150	80	19	\$958	\$482	\$92	\$398
self edge	GCRR48	48 x 48 x 29	250	74	20	\$992	\$496	\$92	\$398
bullnose edge	GCRR48BN	48 x 48 x 29	150	85	20	\$992	\$496	\$92	\$398
T-mold edge	GCRR48TM	48 x 48 x 29	150	89	20	\$992	\$496	\$92	\$398
built-up self edge	GCRR48BU	48 x 48 x 29	150	101	20	\$1099	\$551	\$92	\$398

SQUARE TOP - DRUM BASE

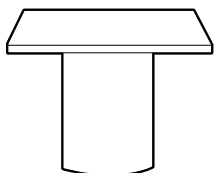

						LIST PRICE	HP ADD
self edge	G42SZ	42 x 42 x 29	100	89	9	\$915	\$461
bullnose edge	G42SZBN	42 x 42 x 29	100	89	9	\$915	\$461
T-mold edge	G42SZTM	42 x 42 x 29	100	89	9	\$915	\$461
built-up self edge	G42SZBU	42 x 42 x 29	92.5	106	9.40	\$1016	\$510
self edge	G48SZ	48 x 48 x 29	100	121	13.40	\$1059	\$532
bullnose edge	G48SZBN	48 x 48 x 29	100	121	13.40	\$1059	\$532
T-mold edge	G48SZTM	48 x 48 x 29	100	121	13.60	\$1059	\$532
built-up self edge	G48SZBU	48 x 48 x 29	100	133	14.90	\$1180	\$591
self edge	G60SZ	60 x 60 x 29	100	171	21	\$1327	\$665
bullnose edge	G60SZBN	60 x 60 x 29	100	171	21	\$1327	\$665
T-mold edge	G60SZTM	60 x 60 x 29	100	171	21	\$1327	\$665
built-up self edge	G60SZBU	60 x 60 x 29	125	174	23.20	\$1560	\$781

• All Drum Bases require approx. 125 lb. of sand in each base for adequate stability. Sand is not included.

SQUARE TOP - CROSS BASE

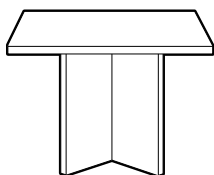

						LIST PRICE	HP ADD
self edge	G42SH	42 x 42 x 29	70	97	5	\$852	\$428
bullnose edge	G42SHBN	42 x 42 x 29	70	97	5	\$852	\$428
T-mold edge	G42SHTM	42 x 42 x 29	70	97	5	\$852	\$428
built-up self edge	G42SHBU	42 x 42 x 29	70	114	5.70	\$915	\$461
self edge	G48SH	48 x 48 x 29	70	116	6	\$992	\$496
bullnose edge	G48SHBN	48 x 48 x 29	70	116	6	\$992	\$496
T-mold edge	G48SHTM	48 x 48 x 29	70	116	6	\$992	\$496
built-up self edge	G48SHBU	48 x 48 x 29	70	122	6.40	\$1138	\$571
self edge	G60SH	60 x 60 x 29	125	64	9	\$1271	\$637
bullnose edge	G60SHBN	60 x 60 x 29	125	64	9	\$1271	\$637
T-mold edge	G60SHTM	60 x 60 x 29	125	64	9	\$1271	\$637
built-up self edge	G60SHBU	60 x 60 x 29	125	64	9.70	\$1497	\$751

Required Specifications

Top finish
Base finish
Edge color, if applicable

Optional Specifications

HP laminate

SQUARE TOP - 4 LEG BASE



	MODEL#	DIMENSIONS	FRT. CLASS	WT./LBS.	CUBIC FT.	LIST PRICE	HP ADD	BCH/CHM	ACO/SBR	
D x W x H										
self edge	GCAS36	36 x 36 x 29	150	63	13	\$617	\$309	\$92	\$332	
bullnose edge	GCAS36BN	36 x 36 x 29	150	63	13	\$617	\$309	\$92	\$332	
T-mold edge	GCAS36TM	36 x 36 x 29	150	63	13	\$617	\$309	\$92	\$332	
built-up self edge	GCAS36BU	36 x 36 x 29	150	67	13	\$686	\$346	\$92	\$332	
self edge	GCAS42	42 x 42 x 29	150	71	14	\$736	\$369	\$92	\$332	
bullnose edge	GCAS42BN	42 x 42 x 29	150	78	14	\$736	\$369	\$92	\$332	
T-mold edge	GCAS42TM	42 x 42 x 29	150	78	14	\$736	\$369	\$92	\$332	
built-up self edge	GCAS42BU	42 x 42 x 29	125	86	14	\$813	\$408	\$92	\$332	

SQUARE TOP - TRUMPET BASE



self edge	GTCS36	36 x 36 x 29	250	69	18	\$863	\$434	\$89	\$363
bullnose edge	GTCS36BN	36 x 36 x 29	250	69	18	\$863	\$434	\$89	\$363
T-mold edge	GTCS36TM	36 x 36 x 29	250	69	18	\$863	\$434	\$89	\$363
built-up self edge	GTCS36BU	36 x 36 x 29	150	76	18	\$958	\$482	\$89	\$363
self edge	GTCS42	42 x 42 x 29	150	77	19	\$968	\$486	\$89	\$363
bullnose edge	GTCS42BN	42 x 42 x 29	150	77	19	\$968	\$486	\$89	\$363
T-mold edge	GTCS42TM	42 x 42 x 29	150	77	19	\$968	\$486	\$89	\$363
built-up self edge	GTCS42BU	42 x 42 x 29	150	84	19	\$1078	\$542	\$89	\$363

SQUARE TOP - TUBULAR BASE



self edge	GCRS36	36 x 36 x 29	250	65	18	\$744	\$373	\$92	\$398
bullnose edge	GCRS36BN	36 x 36 x 29	250	65	18	\$744	\$373	\$92	\$398
T-mold edge	GCRS36TM	36 x 36 x 29	250	65	18	\$744	\$373	\$92	\$398
built-up self edge	GCRS36BU	36 x 36 x 29	250	69	18	\$830	\$415	\$92	\$398
self edge	GCRS42	42 x 42 x 29	250	73	19	\$863	\$434	\$92	\$398
bullnose edge	GCRS42BN	42 x 42 x 29	150	80	19	\$863	\$434	\$92	\$398
T-mold edge	GCRS42TM	42 x 42 x 29	150	80	19	\$863	\$434	\$92	\$398
built-up self edge	GCRS42BU	42 x 42 x 29	150	88	19	\$958	\$482	\$92	\$398

Required Specifications

Top finish
Base finish
Edge color, if applicable

Optional Specifications

HP laminate

B BOARDROOM TABLES

RECTANGULAR TOP - SLAB BASE

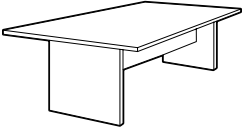

		MODEL#	DIMENSIONS	FREIGHT CLASS	WT/LBS.	CUBIC FT.	LIST PRICE	HP ADD
		D x W x H						
5 foot	self edge	GCT5RX	30 x 60 x 29	70	131	6	\$1074	\$538
	bullnose edge	GCT5RXBN	30 x 60 x 60	70	131	6	\$1074	\$538
	T-mold edge	GCT5RXTM	30 x 60 x 29	70	131	6	\$1074	\$538
	built-up self edge	GCT5RXBU	30 x 60 x 29	70	134	7	\$1187	\$594
6 foot	self edge	GCT6RX	36 x 72 x 29	70	174	11.38	\$1203	\$603
	bullnose edge	GCT6RXBN	36 x 72 x 29	70	174	11.38	\$1203	\$603
	T-mold edge	GCT6RXTM	36 x 72 x 29	70	174	11.38	\$1203	\$603
	built-up self edge	GCT6RXBU	36 x 72 x 29	85	177	13.32	\$1341	\$672
7 foot	self edge	GCT7RX	44 x 84 x 29	85	199	14.94	\$1549	\$776
	bullnose edge	GCT7RXBN	44 x 84 x 29	85	199	14.94	\$1549	\$776
	T-mold edge	GCT7RXTM	44 x 84 x 84	85	199	14.94	\$1549	\$776
	built-up self edge	GCT7RXBU	44 x 84 x 84	92.5	203	17.93	\$1748	\$875
8 foot	self edge	GCT8WRX	48 x 96 x 29	70	218	11.29	\$1549	\$776
	bullnose edge	GCT8WRXBN	48 x 96 x 29	70	218	11.29	\$1549	\$776
	T-mold edge	GCT8WRXTM	48 x 96 x 29	70	218	11.29	\$1549	\$776
	built-up self edge	GCT8WRXBU	48 x 96 x 29	70	249	13.53	\$1748	\$875
10 foot	self edge	GCT10WRX2	48 x 120 x 29	70	272	13.53	\$1795	\$900
	bullnose edge	GCT10WRX2BN	48 x 120 x 29	70	272	13.53	\$1795	\$900
	T-mold edge	GCT10WRX2TM	48 x 120 x 29	70	272	13.53	\$1795	\$900
	built-up self edge	GCT10WRX2BU	48 x 120 x 29	70	291	16.20	\$2124	\$1062
12 foot	self edge	GCT12WRX2	48 x 144 x 29	70	309	15.54	\$2105	\$1055
	bullnose edge	GCT12WRX2BN	48 x 144 x 29	70	309	15.54	\$2105	\$1055
	T-mold edge	GCT12WRX2TM	48 x 144 x 29	70	309	15.54	\$2105	\$1055
	built-up self edge	GCT12WRX2BU	48 x 144 x 29	70	348	18.77	\$2472	\$1237
14 foot	self edge	GCT14WRX2	48 x 168 x 29	70	419	22.50	\$3044	\$1524
	bullnose edge	GCT14WRX2BN	48 x 168 x 29	70	419	22.50	\$3044	\$1524
	T-mold edge	GCT14WRX2TM	48 x 168 x 29	65	419	18	\$3044	\$1524
	built-up self edge	GCT14WRX2BU	48 x 168 x 29	70	425	20	\$3398	\$1701
16 foot	self edge	GCT16WRX2	48 x 192 x 29	70	460	22.72	\$3172	\$1588
	bullnose edge	GCT16WRX2BN	48 x 192 x 29	70	460	22.72	\$3172	\$1588
	T-mold edge	GCT16WRX2TM	48 x 192 x 29	70	460	22.70	\$3172	\$1588
	built-up self edge	GCT16WRX2BU	48 x 192 x 29	70	466	27.20	\$3542	\$1772
18 foot	self edge	GCT18WRX2	48 x 216 x 29	70	521	24.60	\$3948	\$1976
	bullnose edge	GCT18WRX2BN	48 x 216 x 29	70	521	24.60	\$3948	\$1976
	T-mold edge	GCT18WRX2TM	48 x 216 x 29	70	521	24.60	\$3948	\$1976
	built-up self edge	GCT18WRX2BU	48 x 216 x 29	70	528	29.80	\$4425	\$2216
20 foot	self edge	GCT20WRX2	48 x 240 x 29	70	572	26.60	\$4011	\$2007
	bullnose edge	GCT20WRX2BN	48 x 240 x 29	70	572	26.60	\$4011	\$2007
	T-mold edge	GCT20WRX2TM	48 x 240 x 29	70	572	26.60	\$4011	\$2007
	built-up self edge	GCT20WRX2BU	48 x 240 x 29	70	580	32.50	\$4489	\$2246
22 foot	self edge	GCT22WRX2	48 x 264 x 29	70	612	28.90	\$4655	\$2328
	bullnose edge	GCT22WRX2BN	48 x 264 x 29	70	612	28.90	\$4655	\$2328
	T-mold edge	GCT22WRX2TM	48 x 264 x 29	70	612	28.90	\$4655	\$2328
	built-up self edge	GCT22WRX2BU	48 x 264 x 29	70	620	35.10	\$5141	\$2572
24 foot	self edge	GCT24WRX2	48 x 288 x 29	70	673	31.20	\$4786	\$2396
	bullnose edge	GCT24WRX2BN	48 x 288 x 29	70	673	31.20	\$4786	\$2396
	T-mold edge	GCT24WRX2TM	48 x 288 x 29	70	673	31.20	\$4786	\$2396
	built-up self edge	GCT24WRX2BU	48 x 288 x 29	70	682	37.70	\$5295	\$2650

- All tops over 144" are standard in two pieces. Woodgrain laminate finishes will NOT align where the two tops join.
- All tops 168", 192", 216" and 240" are SHIPPED WITH 3 SLAB BASES.
- All tops 264" and 288" are SHIPPED WITH 4 SLAB BASES.

Required Specifications

Top finish
Base finish
Edge color, if applicable

Optional Specifications

Grommet
HP laminate

Accessories

Power Block

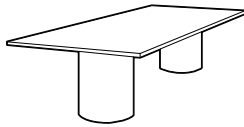
RECTANGULAR TOP - DRUM BASE

		MODEL#	DIMENSIONS	FREIGHT CLASS	WT./LBS.	CUBIC FT.	LIST PRICE	HP ADD
			D x W x H					
6 foot	self edge	GCT6RZ	36 x 72 x 29	100	154	17.50	\$1626	\$814
	bullnose edge	GCT6RZBN	36 x 72 x 29	100	167	17.50	\$1626	\$814
	T-mold edge	GCT6RZTM	36 x 72 x 29	100	167	17.50	\$1626	\$814
	built-up self edge	GCT6RZBU	36 x 72 x 29	100	177	18.80	\$1819	\$911
7 foot	self edge	GCT7RZ	44 x 84 x 29	125	196	29.04	\$1883	\$943
	bullnose edge	GCT7RZBN	44 x 84 x 29	125	196	29.04	\$1883	\$943
	T-mold edge	GCT7RZTM	44 x 84 x 29	125	196	29.04	\$1883	\$943
	built-up self edge	GCT7RZBU	44 x 84 x 29	125	199	31.66	\$2075	\$1039
8 foot	self edge	GCT8WRZ	48 x 96 x 29	125	219	31.82	\$1883	\$943
	bullnose edge	GCT8WRZBN	48 x 96 x 29	125	219	31.82	\$1883	\$943
	T-mold edge	GCT8WRZTM	48 x 96 x 29	125	219	31.82	\$1883	\$943
	built-up self edge	GCT8WRZBU	48 x 96 x 29	125	250	35.18	\$2075	\$1039
10 foot	self edge	GCT10WRZ2	48 x 120 x 29	100	295	33	\$2206	\$1104
	bullnose edge	GCT10WRZ2BN	48 x 120 x 29	100	295	33	\$2206	\$1104
	T-mold edge	GCT10WRZ2TM	48 x 120 x 29	100	295	33.02	\$2206	\$1104
	built-up self edge	GCT10WRZ2BU	48 x 120 x 29	100	314	35.72	\$2432	\$1217
12 foot	self edge	GCT12WRZ2	48 x 144 x 29	100	328	35.10	\$2466	\$1234
	bullnose edge	GCT12WRZ2BN	48 x 144 x 29	100	328	35.10	\$2466	\$1234
	T-mold edge	GCT12WRZ2TM	48 x 144 x 29	250	97	35.10	\$2466	\$1234
	built-up self edge	GCT12WRZ2BU	48 x 144 x 29	250	367	96	\$2737	\$1371
14 foot	self edge	GCT14WRZ2	48 x 168 x 29	92.5	441	39	\$3304	\$1654
	bullnose edge	GCT14WRZ2BN	48 x 168 x 29	92.5	441	39	\$3304	\$1654
	T-mold edge	GCT14WRZ2TM	48 x 168 x 29	92.5	441	39	\$3304	\$1654
	built-up self edge	GCT14WRZ2BU	48 x 168 x 29	92.5	447	42	\$3664	\$1834
16 foot	self edge	GCT16WRZ2	48 x 192 x 29	92.5	482	42.50	\$3433	\$1718
	bullnose edge	GCT16WRZ2BN	48 x 192 x 29	92.5	482	42.50	\$3433	\$1718
	T-mold edge	GCT16WRZ2TM	48 x 192 x 29	92.5	482	42.50	\$3433	\$1718
	built-up self edge	GCT16WRZ2BU	48 x 192 x 29	92.5	488	47	\$3788	\$1897
18 foot	self edge	GCT18WRZ2	48 x 216 x 29	100	523	54.40	\$4464	\$2233
	bullnose edge	GCT18WRZ2BN	48 x 216 x 29	100	523	54.40	\$4464	\$2233
	T-mold edge	GCT18WRZ2TM	48 x 216 x 29	100	523	54.40	\$4464	\$2233
	built-up self edge	GCT18WRZ2BU	48 x 216 x 29	100	550	59	\$5018	\$2511
20 foot	self edge	GCT20WRZ2	48 x 240 x 29	100	564	66.20	\$4529	\$2266
	bullnose edge	GCT20WRZ2BN	48 x 240 x 29	100	564	66.20	\$4529	\$2266
	T-mold edge	GCT20WRZ2TM	48 x 240 x 29	100	564	66.20	\$4529	\$2266
	built-up self edge	GCT20WRZ2BU	48 x 240 x 29	100	572	70.60	\$5084	\$2545
22 foot	self edge	GCT22WRZ2	48 x 264 x 29	100	604	68.20	\$5044	\$2523
	bullnose edge	GCT22WRZ2BN	48 x 264 x 29	100	604	68.20	\$5044	\$2523
	T-mold edge	GCT22WRZ2TM	48 x 264 x 29	100	604	68.20	\$5044	\$2523
	built-up self edge	GCT22WRZ2BU	48 x 264 x 29	100	612	73.68	\$5635	\$2819
24 foot	self edge	GCT24WRZ2	48 x 288 x 29	100	646	70.20	\$5175	\$2590
	bullnose edge	GCT24WRZ2BN	48 x 288 x 29	100	646	70.20	\$5175	\$2590
	T-mold edge	GCT24WRZ2TM	48 x 288 x 29	100	646	70.20	\$5175	\$2590
	built-up self edge	GCT24WRZ2BU	48 x 288 x 29	100	655	76.80	\$5756	\$2880

- All Drum Bases require approx. 125 lb. of sand in each base for adequate stability. Sand is not included.
- All tops over 144" are standard in two pieces. Woodgrain laminate finishes will NOT align where the two tops join.
- All tops 168", 192" and 216" are SHIPPED WITH 3 DRUM BASES.
- All tops 240", 264" and 288" are SHIPPED WITH 4 DRUM BASES.

Required Specifications

Top finish
Base finish
Edge color, if applicable

Optional Specifications

Grommet
HP laminate

Accessories

Power Block

B BOARDROOM TABLES

RECTANGULAR TOP - ARCH BASE

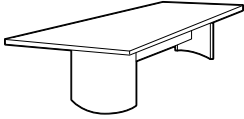

	MODEL#	DIMENSIONS	FREIGHT CLASS	WT/LBS.	CUBIC FT.	LIST PRICE	HP ADD
D x W x H							
5 foot	self edge	GCT5RA	30 x 60 x 29	85	131	9	\$1430 \$717
	bullnose edge	GCT5RABN	30 x 60 x 29	85	131	9	\$1430 \$717
	T-mold edge	GCT5RATM	30 x 60 x 29	85	131	9	\$1430 \$717
	built-up self edge	GCT5RABU	30 x 60 x 29	85	134	10	\$1625 \$814
6 foot	self edge	GCT6RA	36 x 72 x 29	125	157	24.64	\$1496 \$750
	bullnose edge	GCT6RABN	36 x 72 x 29	125	157	24.64	\$1496 \$750
	T-mold edge	GCT6RATM	36 x 72 x 29	70	157	8.24	\$1496 \$750
	built-up self edge	GCT6RABU	36 x 72 x 29	100	167	17.96	\$1777 \$889
7 foot	self edge	GCT7RA	44 x 84 x 29	92.5	203	19.43	\$1820 \$912
	bullnose edge	GCT7RABN	44 x 84 x 29	92.5	203	19.43	\$1820 \$912
	T-mold edge	GCT7RATM	44 x 84 x 29	92.5	203	19.43	\$1820 \$912
	built-up self edge	GCT7RABU	44 x 84 x 29	100	206	20.90	\$2060 \$1033
8 foot	self edge	GCT8WRA	48 x 96 x 29	100	220	22.40	\$1820 \$912
	bullnose edge	GCT8WRABN	48 x 96 x 29	100	220	22.40	\$1820 \$912
	T-mold edge	GCT8WRATM	48 x 96 x 29	100	220	22.40	\$1820 \$912
	built-up self edge	GCT8WRABU	48 x 96 x 29	92.5	251	23.89	\$2060 \$1033
10 foot	self edge	GCT10WRA	48 x 120 x 29	70	274	16.95	\$2076 \$1041
	bullnose edge	GCT10WRABN	48 x 120 x 29	70	274	16.95	\$2076 \$1041
	T-mold edge	GCT10WRATM	48 x 120 x 29	70	274	16.95	\$2076 \$1041
	built-up self edge	GCT10WRABU	48 x 120 x 29	70	293	18.92	\$2448 \$1227
12 foot	self edge	GCT12WRA	48 x 144 x 29	70	311	19.94	\$2400 \$1201
	bullnose edge	GCT12WRABN	48 x 144 x 29	70	311	19.94	\$2400 \$1201
	T-mold edge	GCT12WRATM	48 x 144 x 29	70	311	19.94	\$2400 \$1201
	built-up self edge	GCT12WRABU	48 x 144 x 29	70	350	21.92	\$2801 \$1402
14 foot	self edge	GCT14WRA	48 x 168 x 29	70	423	26	\$3692 \$1848
	bullnose edge	GCT14WRABN	48 x 168 x 29	70	423	26	\$3692 \$1848
	T-mold edge	GCT14WRATM	48 x 168 x 29	70	423	26	\$3692 \$1848
	built-up self edge	GCT14WRABU	48 x 168 x 29	70	429	28	\$4114 \$2058
16 foot	self edge	GCT16WRA	48 x 192 x 29	70	474	30	\$3884 \$1944
	bullnose edge	GCT16WRABN	48 x 192 x 29	70	474	30	\$3884 \$1944
	T-mold edge	GCT16WRATM	48 x 192 x 29	70	474	30	\$3884 \$1944
	built-up self edge	GCT16WRABU	48 x 192 x 29	70	480	32	\$4342 \$2173
18 foot	self edge	GCT18WRA	48 x 216 x 29	70	525	31.92	\$4786 \$2396
	bullnose edge	GCT18WRABN	48 x 216 x 29	70	525	31.92	\$4786 \$2396
	T-mold edge	GCT18WRATM	48 x 216 x 29	70	525	31.92	\$4786 \$2396
	built-up self edge	GCT18WRABU	48 x 216 x 29	70	532	33.89	\$5349 \$2676
20 foot	self edge	GCT20WRA	48 x 240 x 29	70	576	33.89	\$4855 \$2428
	bullnose edge	GCT20WRABN	48 x 240 x 29	70	576	33.89	\$4855 \$2428
	T-mold edge	GCT20WRATM	48 x 240 x 29	70	576	33.89	\$4855 \$2428
	built-up self edge	GCT20WRABU	48 x 240 x 29	70	584	35.93	\$5399 \$2702
22 foot	self edge	GCT22WRA	48 x 264 x 29	70	626	36.89	\$5427 \$2716
	bullnose edge	GCT22WRABN	48 x 264 x 29	70	626	36.89	\$5427 \$2716
	T-mold edge	GCT22WRATM	48 x 264 x 29	70	626	36.89	\$5427 \$2716
	built-up self edge	GCT22WRABU	48 x 264 x 29	70	634	37.90	\$6068 \$3036
24 foot	self edge	GCT24WRA	48 x 288 x 29	70	678	40	\$5558 \$2780
	bullnose edge	GCT24WRABN	48 x 288 x 29	70	678	40	\$5558 \$2780
	T-mold edge	GCT24WRATM	48 x 288 x 29	70	678	40	\$5558 \$2780
	built-up self edge	GCT24WRABU	48 x 288 x 29	70	687	42	\$6193 \$3099

- All tops over 144" are standard in two pieces. Woodgrain laminate finishes will NOT align where the two tops join.
- All tops 168", 192", 216" and 240" are SHIPPED WITH 2 ARCH BASES AND 1 SLAB BASE.
- All tops 264" and 288" are SHIPPED WITH 2 ARCH BASES AND 2 SLAB BASES.

Required Specifications

Top finish
Base finish
Edge color, if applicable

Optional Specifications

Grommet
HP laminate

Accessories

Power Block

RECTANGULAR TOP - 2 LEG BASE		MODEL#	DIMENSIONS	FREIGHT CLASS	WT./LBS.	CUBIC FT.	LIST PRICE	HP ADD
		D x W x H						
5 foot	self edge	GCT5R	30 x 60 x 29	125	88	13	\$1263	\$634
	bullnose edge	GCT5RBN	30 x 60 x 29	125	88	13	\$1263	\$634
	T-mold edge	GCT5RTM	30 x 60 x 29	125	88	13	\$1263	\$634
	built-up self edge	GCT5RBU	30 x 60 x 29	125	91	14	\$1410	\$708
6 foot	self edge	GCT6R	36 x 72 x 29	125	115	15	\$1407	\$705
	bullnose edge	GCT6RBN	36 x 72 x 29	92.5	152	15	\$1407	\$705
	T-mold edge	GCT6RTM	36 x 72 x 29	92.5	152	15	\$1407	\$705
	built-up self edge	GCT6RBU	36 x 72 x 29	92.5	162	16	\$1562	\$782
7 foot	self edge	GCT7R	44 x 84 x 29	100	155	17	\$1626	\$814
	bullnose edge	GCT7RBN	44 x 84 x 29	100	155	17	\$1626	\$814
	T-mold edge	GCT7RTM	44 x 84 x 29	100	155	17	\$1626	\$814
	built-up self edge	GCT7RBU	44 x 84 x 29	100	158	19.02	\$1821	\$912
8 foot	self edge	GCT8WR	48 x 96 x 29	92.5	194	19.04	\$1626	\$814
	bullnose edge	GCT8WRBN	48 x 96 x 29	100	180	19.02	\$1626	\$814
	T-mold edge	GCT8WRM	48 x 96 x 29	100	180	19.02	\$1626	\$814
	built-up self edge	GCT8WRBU	48 x 96 x 29	92.5	211	21	\$1821	\$912
10 foot	self edge	GCT10WR	48 x 120 x 29	92.5	214	20.93	\$2258	\$1131
	bullnose edge	GCT10WRBN	48 x 120 x 29	92.5	237	21	\$2258	\$1131
	T-mold edge	GCT10WRM	48 x 120 x 29	92.5	237	21	\$2258	\$1131
	built-up self edge	GCT10WRBU	48 x 120 x 29	125	256	34.37	\$2526	\$1264
12 foot	self edge	GCT12WR	48 x 144 x 29	92.5	270	23	\$2541	\$1272
	bullnose edge	GCT12WRBN	48 x 144 x 29	85	270	21	\$2541	\$1272
	T-mold edge	GCT12WRM	48 x 144 x 29	92.5	270	22.90	\$2541	\$1272
	built-up self edge	GCT12WRBU	48 x 144 x 29	85	309	24.91	\$2830	\$1419
14 foot	self edge	GCT14WR	48 x 168 x 29	100	326	34	\$2914	\$1460
	bullnose edge	GCT14WRBN	48 x 168 x 29	100	326	34	\$2914	\$1460
	T-mold edge	GCT14WRM	48 x 168 x 29	100	326	34	\$2914	\$1460
	built-up self edge	GCT14WRBU	48 x 168 x 29	100	332	38	\$3220	\$1612
16 foot	self edge	GCT16WR	48 x 192 x 29	100	367	38	\$3044	\$1524
	bullnose edge	GCT16WRBN	48 x 192 x 29	100	367	38	\$3044	\$1524
	T-mold edge	GCT16WRM	48 x 192 x 29	100	367	38	\$3044	\$1524
	built-up self edge	GCT16WRBU	48 x 192 x 29	100	373	40	\$3297	\$1651
18 foot	self edge	GCT18WR	48 x 216 x 29	92.5	408	40	\$3627	\$1816
	bullnose edge	GCT18WRBN	48 x 216 x 29	92.5	408	40	\$3627	\$1816
	T-mold edge	GCT18WRM	48 x 216 x 29	92.5	408	40	\$3627	\$1816
	built-up self edge	GCT18WRBU	48 x 216 x 29	100	416	42	\$4044	\$2025
20 foot	self edge	GCT20WR	48 x 240 x 29	92.5	449	42	\$3756	\$1880
	bullnose edge	GCT20WRBN	48 x 240 x 29	92.5	449	42	\$3756	\$1880
	T-mold edge	GCT20WRM	48 x 240 x 29	92.5	449	42	\$3756	\$1880
	built-up self edge	GCT20WRBU	48 x 240 x 29	92.5	457	44	\$4167	\$2086
22 foot	self edge	GCT22WR	48 x 264 x 29	92.5	489	44	\$4140	\$2073
	bullnose edge	GCT22WRBN	48 x 264 x 29	92.5	489	44	\$4140	\$2073
	T-mold edge	GCT22WRM	48 x 264 x 29	92.5	489	44	\$4140	\$2073
	built-up self edge	GCT22WRBU	48 x 264 x 29	92.5	497	46	\$4662	\$2332
24 foot	self edge	GCT24WR	48 x 288 x 29	92.5	531	46	\$4268	\$2135
	bullnose edge	GCT24WRBN	48 x 288 x 29	92.5	531	46	\$4268	\$2135
	T-mold edge	GCT24WRM	48 x 288 x 29	92.5	531	46	\$4268	\$2135
	built-up self edge	GCT24WRBU	48 x 288 x 29	92.5	540	48	\$4772	\$2387



- All tops over 144" are standard in two pieces. Woodgrain laminate finishes will NOT align where the two tops join.
- All tops 120", 144", and 168" are SHIPPED WITH 3 LEG BASES.
- All tops 192" are SHIPPED WITH 4 LEG BASES.
- All tops 216", 240", 264" and 288" are SHIPPED WITH 6 LEG BASES.

Required Specifications	Optional Specifications	Accessories
Top finish	Grommet	Power Block
Base finish	HP laminate	
Edge color, if applicable		

B BOARDROOM TABLES

RECTANGULAR TOP - TUBULAR BASE

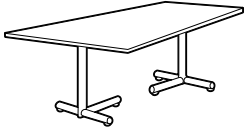

	MODEL#	DIMENSIONS	FREIGHT CLASS	WT/LBS.	CUBIC FT.	LIST PRICE	HP ADD
D x W x H							
5 foot	self edge	GCR5R	30 x 60 x 29	150	94	21	\$1303 \$654
	bullnose edge	GCR5RBN	30 x 60 x 29	150	94	21	\$1303 \$654
	T-mold edge	GCR5RTM	30 x 60 x 29	150	94	21	\$1303 \$654
	built-up self edge	GCR5RBU	30 x 60 x 29	150	97	23	\$1454 \$731
6 foot	self edge	GCR6R	36 x 72 x 29	150	107	23	\$1447 \$725
	bullnose edge	GCR6RBN	36 x 72 x 29	150	107	23	\$1447 \$725
	T-mold edge	GCR6RTM	36 x 72 x 29	150	107	23	\$1447 \$725
	built-up self edge	GCR6RBU	36 x 72 x 29	150	117	25	\$1610 \$806
7 foot	self edge	GCR7R	44 x 84 x 29	125	161	25	\$1667 \$834
	bullnose edge	GCR7RBN	44 x 84 x 29	125	161	25	\$1667 \$834
	T-mold edge	GCR7RTM	44 x 84 x 29	125	161	25	\$1667 \$834
	built-up self edge	GCR7RBU	44 x 84 x 29	125	164	27	\$1865 \$933
8 foot	self edge	GCR8WR	48 x 96 x 29	125	177	27	\$1667 \$834
	bullnose edge	GCR8WRBN	48 x 96 x 29	125	177	27	\$1667 \$834
	T-mold edge	GCR8WRTM	48 x 96 x 29	125	177	27	\$1667 \$834
	built-up self edge	GCR8WRBU	48 x 96 x 29	125	208	29	\$1865 \$933
10 foot	self edge	GCR10WR	48 x 120 x 29	125	221	28.92	\$2281 \$1142
	bullnose edge	GCR10WRBN	48 x 120 x 29	125	221	28.92	\$2281 \$1142
	T-mold edge	GCR10WRTM	48 x 120 x 29	125	221	29	\$2281 \$1142
	built-up self edge	GCR10WRBU	48 x 120 x 29	125	239	32	\$2560 \$1281
12 foot	self edge	GCR12WR	48 x 144 x 29	100	270	30.96	\$2570 \$1287
	bullnose edge	GCR12WRBN	48 x 144 x 29	100	270	30.96	\$2570 \$1287
	T-mold edge	GCR12WRTM	48 x 144 x 29	100	270	30.96	\$2570 \$1287
	built-up self edge	GCR12WRBU	48 x 144 x 29	100	293	33.89	\$2869 \$1436
14 foot	self edge	GCR14WR	48 x 168 x 29	125	330	50	\$2952 \$1479
	bullnose edge	GCR14WRBN	48 x 168 x 29	125	330	50	\$2952 \$1479
	T-mold edge	GCR14WRTM	48 x 168 x 29	125	330	50	\$2952 \$1479
	built-up self edge	GCR14WRBU	48 x 168 x 29	125	336	54	\$3260 \$1631
16 foot	self edge	GCR16WR	48 x 192 x 29	125	371	54	\$3082 \$1542
	bullnose edge	GCR16WRBN	48 x 192 x 29	125	371	54	\$3082 \$1542
	T-mold edge	GCR16WRTM	48 x 192 x 29	125	371	54	\$3082 \$1542
	built-up self edge	GCR16WRBU	48 x 192 x 29	125	377	58	\$3384 \$1695
18 foot	self edge	GCR18WR	48 x 216 x 29	125	412	56	\$3651 \$1827
	bullnose edge	GCR18WRBN	48 x 216 x 29	125	412	56	\$3651 \$1827
	T-mold edge	GCR18WRTM	48 x 216 x 29	125	412	56	\$3651 \$1827
	built-up self edge	GCR18WRBU	48 x 216 x 29	125	419	60	\$4077 \$2042
20 foot	self edge	GCR20WR	48 x 240 x 29	125	453	58	\$3780 \$1894
	bullnose edge	GCR20WRBN	48 x 240 x 29	125	453	58	\$3780 \$1894
	T-mold edge	GCR20WRTM	48 x 240 x 29	125	453	58	\$3780 \$1894
	built-up self edge	GCR20WRBU	48 x 240 x 29	125	461	62	\$4214 \$2108
22 foot	self edge	GCR22WR	48 x 264 x 29	100	493	60	\$4206 \$2104
	bullnose edge	GCR22WRBN	48 x 264 x 29	100	493	60	\$4206 \$2104
	T-mold edge	GCR22WRTM	48 x 264 x 29	100	493	60	\$4206 \$2104
	built-up self edge	GCR22WRBU	48 x 264 x 29	125	501	64	\$4697 \$2352
24 foot	self edge	GCR24WR	48 x 288 x 29	100	535	62	\$4338 \$2171
	bullnose edge	GCR24WRBN	48 x 288 x 29	100	535	62	\$4338 \$2171
	T-mold edge	GCR24WRTM	48 x 288 x 29	100	535	62	\$4338 \$2171
	built-up self edge	GCR24WRBU	48 x 288 x 29	100	544	66	\$4821 \$2413

- All tops over 144" are standard in two pieces. Woodgrain laminate finishes will NOT align where the two tops join.
- All tops 120", 144", and 168" are SHIPPED WITH 3 TUBULAR BASES.
- All tops 192" are SHIPPED WITH 4 TUBULAR BASES.
- All tops 216", 240", 264" and 288" are SHIPPED WITH 6 TUBULAR BASES.

Required Specifications

Top finish
Base finish
Edge color, if applicable

Optional Specifications

Grommet
HP laminate

Accessories

Power Block

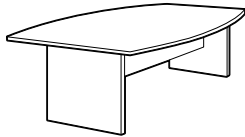
BOAT TOP - SLAB BASE

	MODEL#	DIMENSIONS	FREIGHT CLASS	WT./LBS.	CUBIC FT.	LIST PRICE	HP ADD
		D x W x H					
5 foot	self edge	GCT5BX	30 x 60 x 29	70	131	6	\$1074 \$538
	bullnose edge	GCT5BXBN	30 x 60 x 29	70	131	6	\$1074 \$538
	T-mold edge	GCT5BXTM	30 x 60 x 29	70	131	7	\$1074 \$538
	built-up self edge	GCT5BXBU	30 x 60 x 29	125	114	17	\$1187 \$594
6 foot	self edge	GCT6BX	36 x 72 x 29	70	138	7.60	\$1203 \$603
	bullnose edge	GCT6BXBN	36 x 72 x 29	70	138	7.60	\$1203 \$603
	T-mold edge	GCT6BXTM	36 x 72 x 29	70	147	7.60	\$1203 \$603
	built-up self edge	GCT6BXBU	36 x 72 x 29	70	157	8.90	\$1341 \$672
7 foot	self edge	GCT7BX	44 x 84 x 29	70	199	9.94	\$1549 \$776
	bullnose edge	GCT7BXBN	44 x 84 x 29	70	199	9.94	\$1549 \$776
	T-mold edge	GCT7BXTM	44 x 84 x 29	70	199	9.94	\$1549 \$776
	built-up self edge	GCT7BXBU	44 x 84 x 29	70	203	11.95	\$1748 \$875
8 foot	self edge	GCT8WBX	48 x 96 x 29	70	218	11.29	\$1549 \$776
	bullnose edge	GCT8WBXBN	48 x 96 x 29	70	218	11.29	\$1549 \$776
	T-mold edge	GCT8WBXTM	48 x 96 x 29	70	218	11.29	\$1549 \$776
	built-up self edge	GCT8WBXBU	48 x 96 x 29	70	218	13.53	\$1748 \$875
10 foot	self edge	GCT10WBX2	48 x 120 x 29	70	249	13.53	\$1795 \$900
	bullnose edge	GCT10WBX2BN	48 x 120 x 29	70	249	13.53	\$1795 \$900
	T-mold edge	GCT10WBX2TM	48 x 120 x 29	70	249	13.53	\$1795 \$900
	built-up self edge	GCT10WBX2BU	48 x 120 x 29	70	294	16.20	\$2124 \$1062
12 foot	self edge	GCT12WBX2	48 x 144 x 29	70	308	15.54	\$2105 \$1055
	bullnose edge	GCT12WBX2BN	48 x 144 x 29	70	308	15.54	\$2105 \$1055
	T-mold edge	GCT12WBX2TM	48 x 144 x 29	70	308	15.54	\$2105 \$1055
	built-up self edge	GCT12WBX2BU	48 x 144 x 29	70	338	18.83	\$2472 \$1237
14 foot	self edge	GCT14WBX2	48 x 168 x 29	65	419	18	\$3044 \$1524
	bullnose edge	GCT14WBX2BN	48 x 168 x 29	65	419	18	\$3044 \$1524
	T-mold edge	GCT14WBX2TM	48 x 168 x 29	65	419	18	\$3044 \$1524
	built-up self edge	GCT14WBX2BU	48 x 168 x 29	65	425	16	\$3398 \$1701
16 foot	self edge	GCT16WBX2	48 x 192 x 29	70	460	22.70	\$3172 \$1588
	bullnose edge	GCT16WBX2BN	48 x 192 x 29	70	460	22.70	\$3172 \$1588
	T-mold edge	GCT16WBX2TM	48 x 192 x 29	70	460	22.70	\$3172 \$1588
	built-up self edge	GCT16WBX2BU	48 x 192 x 29	70	466	27.20	\$3542 \$1772
18 foot	self edge	GCT18WBX2	48 x 216 x 29	70	521	24.60	\$3948 \$1976
	bullnose edge	GCT18WBX2BN	48 x 216 x 29	70	521	24.60	\$3948 \$1976
	T-mold edge	GCT18WBX2TM	48 x 216 x 29	70	521	24.60	\$3948 \$1976
	built-up self edge	GCT18WBX2BU	48 x 216 x 29	70	528	29.80	\$4425 \$2216
20 foot	self edge	GCT20WBX2	48 x 240 x 29	70	572	26.60	\$4011 \$2007
	bullnose edge	GCT20WBX2BN	48 x 240 x 29	70	572	26.60	\$4011 \$2007
	T-mold edge	GCT20WBX2TM	48 x 240 x 29	70	572	26.60	\$4011 \$2007
	built-up self edge	GCT20WBX2BU	48 x 240 x 29	70	580	32.50	\$4489 \$2246
22 foot	self edge	GCT22WBX2	48 x 264 x 29	70	612	28.90	\$4655 \$2328
	bullnose edge	GCT22WBX2BN	48 x 264 x 29	70	612	28.90	\$4655 \$2328
	T-mold edge	GCT22WBX2TM	48 x 264 x 29	70	612	28.90	\$4655 \$2328
	built-up self edge	GCT22WBX2BU	48 x 264 x 29	70	620	35.10	\$5141 \$2572
24 foot	self edge	GCT24WBX2	48 x 288 x 29	70	673	31.20	\$4786 \$2396
	bullnose edge	GCT24WBX2BN	48 x 288 x 29	70	673	31.20	\$4786 \$2396
	T-mold edge	GCT24WBX2TM	48 x 288 x 29	70	673	31.20	\$4786 \$2396
	built-up self edge	GCT24WBX2BU	48 x 288 x 29	70	682	37.70	\$5295 \$2650

- All tops over 144" are standard in two pieces. Woodgrain laminate finishes will NOT align where the two tops join.
- All tops 168", 192", 216" and 240" are SHIPPED WITH 3 SLAB BASES.
- All tops 264" and 288" are SHIPPED WITH 4 SLAB BASES.

Required Specifications

Top finish
Base finish
Edge color, if applicable

Optional Specifications

Grommet
HP laminate

Accessories

Power Block

B BOARDROOM TABLES

BOAT TOP - DRUM BASE

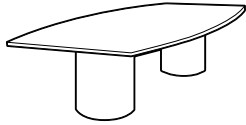

		MODEL#	DIMENSIONS	FREIGHT CLASS	WT/LBS.	CUBIC FT.	LIST PRICE	HP ADD
			D x W x H					
6 foot	self edge	GCT6BZ	36 x 72 x 29	100	162	17.50	\$1626	\$814
	bullnose edge	GCT6BZBN	36 x 72 x 29	100	153	17.50	\$1626	\$814
	T-mold edge	GCT6BZTM	36 x 72 x 29	100	162	17.50	\$1626	\$814
	built-up self edge	GCT6BZBU	36 x 72 x 29	100	172	18.90	\$1819	\$911
7 foot	self edge	GCT7BZ	44 x 84 x 29	92.5	196	19.40	\$1846	\$925
	bullnose edge	GCT7BZBN	44 x 84 x 29	92.5	196	19.40	\$1846	\$925
	T-mold edge	GCT7BZTM	44 x 84 x 29	92.5	196	19.40	\$1846	\$925
	built-up self edge	GCT7BZBU	44 x 84 x 29	100	199	21.20	\$2075	\$1039
8 foot	self edge	GCT8WBZ	48 x 96 x 29	92.5	219	21.20	\$1883	\$943
	bullnose edge	GCT8WBZBN	48 x 96 x 29	92.5	219	21.20	\$1883	\$943
	T-mold edge	GCT8WBZTM	48 x 96 x 29	92.5	219	21.20	\$1883	\$943
	built-up self edge	GCT8WBZBU	48 x 96 x 29	92.5	250	23.50	\$2075	\$1039
10 foot	self edge	GCT10WBZ2	48 x 120 x 29	100	272	33.30	\$2206	\$1104
	bullnose edge	GCT10WBZ2BN	48 x 120 x 29	100	272	33.30	\$2206	\$1104
	T-mold edge	GCT10WBZ2TM	48 x 120 x 29	100	272	33.22	\$2206	\$1104
	built-up self edge	GCT10WBZ2BU	48 x 120 x 29	100	317	35.70	\$2432	\$1217
12 foot	self edge	GCT12WBZ2	48 x 144 x 29	100	327	35.30	\$2466	\$1234
	bullnose edge	GCT12WBZ2BN	48 x 144 x 29	100	327	35.30	\$2466	\$1234
	T-mold edge	GCT12WBZ2TM	48 x 144 x 29	100	327	35.30	\$2466	\$1234
	built-up self edge	GCT12WBZ2BU	48 x 144 x 29	100	357	38.40	\$2737	\$1371
14 foot	self edge	GCT14WBZ2	48 x 168 x 29	92.5	441	39	\$3304	\$1654
	bullnose edge	GCT14WBZ2BN	48 x 168 x 29	92.5	441	39	\$3304	\$1654
	T-mold edge	GCT14WBZ2TM	48 x 168 x 29	92.5	441	39	\$3304	\$1654
	built-up self edge	GCT14WBZ2BU	48 x 168 x 29	92.5	447	42	\$3664	\$1834
16 foot	self edge	GCT16WBZ2	48 x 192 x 29	92.5	482	42.52	\$3433	\$1718
	bullnose edge	GCT16WBZ2BN	48 x 192 x 29	92.5	482	42.52	\$3433	\$1718
	T-mold edge	GCT16WBZ2TM	48 x 192 x 29	92.5	482	42.52	\$3433	\$1718
	built-up self edge	GCT16WBZ2BU	48 x 192 x 29	92.5	488	47	\$3788	\$1897
18 foot	self edge	GCT18WBZ2	48 x 216 x 29	100	523	54.40	\$4464	\$2233
	bullnose edge	GCT18WBZ2BN	48 x 216 x 29	100	523	54.40	\$4464	\$2233
	T-mold edge	GCT18WBZ2TM	48 x 216 x 29	100	523	54.40	\$4464	\$2233
	built-up self edge	GCT18WBZ2BU	48 x 216 x 29	100	550	59	\$5018	\$2511
20 foot	self edge	GCT20WBZ2	48 x 240 x 29	100	564	66.20	\$4529	\$2266
	bullnose edge	GCT20WBZ2BN	48 x 240 x 29	100	564	66.20	\$4529	\$2266
	T-mold edge	GCT20WBZ2TM	48 x 240 x 29	100	564	66.20	\$4529	\$2266
	built-up self edge	GCT20WBZ2BU	48 x 240 x 29	100	572	70.60	\$5084	\$2545
22 foot	self edge	GCT22WBZ2	48 x 264 x 29	100	604	68.20	\$5044	\$2523
	bullnose edge	GCT22WBZ2BN	48 x 264 x 29	100	604	68.20	\$5044	\$2523
	T-mold edge	GCT22WBZ2TM	48 x 264 x 29	100	604	68.20	\$5044	\$2523
	built-up self edge	GCT22WBZ2BU	48 x 264 x 29	100	612	73.68	\$5635	\$2819
24 foot	self edge	GCT24WBZ2	48 x 288 x 29	100	646	70.20	\$5175	\$2590
	bullnose edge	GCT24WBZ2BN	48 x 288 x 29	100	646	70.20	\$5175	\$2590
	T-mold edge	GCT24WBZ2TM	48 x 288 x 29	100	646	70.20	\$5175	\$2590
	built-up self edge	GCT24WBZ2BU	48 x 288 x 29	100	655	76.80	\$5756	\$2880

- All Drum Bases require approx. 125 lb. of sand in each base for adequate stability. Sand is not included.
- All tops over 144" are standard in two pieces. Woodgrain laminate finishes will NOT align where the two tops join.
- All tops 168", 192" and 216" are SHIPPED WITH 3 DRUM BASES.
- All tops 240", 264" and 288" are SHIPPED WITH 4 DRUM BASES.

Required Specifications

Top finish
Base finish
Edge color, if applicable

Optional Specifications

Grommet
HP laminate

Accessories

Power Block

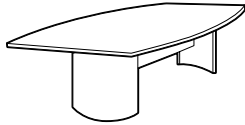
BOAT TOP - ARCH BASE

	MODEL#	DIMENSIONS	FREIGHT CLASS	WT./LBS.	CUBIC FT.	LIST PRICE	HP ADD
		D x W x H					
5 foot	self edge	GCT5BA	30 x 60 x 29	85	131	9	\$1430 \$717
	bullnose edge	GCT5BABN	30 x 60 x 29	85	131	9	\$1430 \$717
	T-mold edge	GCT5BATM	30 x 60 x 29	85	131	9	\$1430 \$717
	built-up self edge	GCT5BABU	30 x 60 x 29	85	134	10	\$1625 \$814
6 foot	self edge	GCT6BA	36 x 72 x 29	85	152	11	\$1496 \$750
	bullnose edge	GCT6BABN	36 x 72 x 29	85	152	11	\$1496 \$750
	T-mold edge	GCT6BATM	36 x 72 x 29	85	152	11	\$1496 \$750
	built-up self edge	GCT6BABU	36 x 72 x 29	85	162	12	\$1777 \$889
7 foot	self edge	GCT7BA	44 x 84 x 29	70	203	12.96	\$1820 \$912
	bullnose edge	GCT7BABN	44 x 84 x 29	70	203	12.96	\$1820 \$912
	T-mold edge	GCT7BATM	44 x 84 x 29	70	203	12.96	\$1820 \$912
	built-up self edge	GCT7BABU	44 x 84 x 29	85	206	13.98	\$2060 \$1033
8 foot	self edge	GCT8WBA	48 x 96 x 29	70	228	14.97	\$1820 \$912
	bullnose edge	GCT8WBABN	48 x 96 x 29	85	220	14.97	\$1820 \$912
	T-mold edge	GCT8WBATM	48 x 96 x 29	85	220	14.97	\$1820 \$912
	built-up self edge	GCT8WBABU	48 x 96 x 29	85	220	15.96	\$2060 \$1033
10 foot	self edge	GCT10WBA	48 x 120 x 29	85	251	16.96	\$2076 \$1041
	bullnose edge	GCT10WBABN	48 x 120 x 29	85	251	16.95	\$2076 \$1041
	T-mold edge	GCT10WBATM	48 x 120 x 29	85	251	16.95	\$2076 \$1041
	built-up self edge	GCT10WBABU	48 x 120 x 29	70	296	18.92	\$2448 \$1227
12 foot	self edge	GCT12WBA	48 x 144 x 29	70	306	20	\$2400 \$1201
	bullnose edge	GCT12WBABN	48 x 144 x 29	70	310	19.94	\$2400 \$1201
	T-mold edge	GCT12WBATM	48 x 144 x 29	70	310	19.94	\$2400 \$1201
	built-up self edge	GCT12WBABU	48 x 144 x 29	70	340	21.89	\$2801 \$1402
14 foot	self edge	GCT14WBA	48 x 168 x 29	70	423	25.93	\$3692 \$1848
	bullnose edge	GCT14WBABN	48 x 168 x 29	70	423	25.93	\$3692 \$1848
	T-mold edge	GCT14WBATM	48 x 168 x 29	70	423	25.93	\$3692 \$1848
	built-up self edge	GCT14WBABU	48 x 168 x 29	70	429	27.90	\$4114 \$2058
16 foot	self edge	GCT16WBA	48 x 192 x 29	70	474	29.94	\$3884 \$1944
	bullnose edge	GCT16WBABN	48 x 192 x 29	70	474	29.94	\$3884 \$1944
	T-mold edge	GCT16WBATM	48 x 192 x 29	70	474	29.94	\$3884 \$1944
	built-up self edge	GCT16WBABU	48 x 192 x 29	70	480	31.92	\$4342 \$2173
18 foot	self edge	GCT18WBA	48 x 216 x 29	70	525	31.92	\$4786 \$2396
	bullnose edge	GCT18WBABN	48 x 216 x 29	70	525	31.92	\$4786 \$2396
	T-mold edge	GCT18WBATM	48 x 216 x 29	70	525	31.92	\$4786 \$2396
	built-up self edge	GCT18WBABU	48 x 216 x 29	70	532	33.89	\$5349 \$2676
20 foot	self edge	GCT20WBA	48 x 240 x 29	70	576	33.89	\$4855 \$2428
	bullnose edge	GCT20WBABN	48 x 240 x 29	70	576	33.89	\$4855 \$2428
	T-mold edge	GCT20WBATM	48 x 240 x 29	70	576	33.89	\$4855 \$2428
	built-up self edge	GCT20WBABU	48 x 240 x 29	70	584	35.93	\$5399 \$2702
22 foot	self edge	GCT22WBA	48 x 264 x 29	70	626	36.89	\$5427 \$2716
	bullnose edge	GCT22WBABN	48 x 264 x 29	70	626	36.89	\$5427 \$2716
	T-mold edge	GCT22WBATM	48 x 264 x 29	70	626	36.89	\$5427 \$2716
	built-up self edge	GCT22WBABU	48 x 264 x 29	70	634	37.90	\$6068 \$3036
24 foot	self edge	GCT24WBA	48 x 288 x 29	70	678	40	\$5558 \$2780
	bullnose edge	GCT24WBABN	48 x 288 x 29	70	678	40	\$5558 \$2780
	T-mold edge	GCT24WBATM	48 x 288 x 29	70	678	40	\$5558 \$2780
	built-up self edge	GCT24WBABU	48 x 288 x 29	65	687	25.10	\$6193 \$3099

- All tops over 144" are standard in two pieces. Woodgrain laminate finishes will NOT align where the two tops join.
- All tops 168", 192", 216" and 240" are SHIPPED WITH 2 ARCH BASES AND 1 SLAB BASE.
- All tops 264" and 288" are SHIPPED WITH 2 ARCH BASES AND 2 SLAB BASES.

Required Specifications

Top finish
Base finish
Edge color, if applicable

Optional Specifications

Grommet
HP laminate

Accessories

Power Block

B BOARDROOM TABLES

BOAT TOP - 2 LEG BASE



	MODEL#	DIMENSIONS	FREIGHT CLASS	WT/LBS.	CUBIC FT.	LIST PRICE	HP ADD
D x W x H							
5 foot	self edge	GCT5B	30 x 60 x 29	125	88	13	\$1263 \$634
	bullnose edge	GCT5BBN	30 x 60 x 29	125	88	13	\$1263 \$634
	T-mold edge	GCT5BTM	30 x 60 x 29	125	88	13	\$1263 \$634
	built-up self edge	GCT5BBU	30 x 60 x 29	125	91	14	\$1410 \$708
6 foot	self edge	GCT6B	36 x 72 x 29	100	123	15	\$1407 \$705
	bullnose edge	GCT6BBN	36 x 72 x 29	125	114	15	\$1407 \$705
	T-mold edge	GCT6BTM	36 x 72 x 29	100	123	15	\$1407 \$705
	built-up self edge	GCT6BBU	36 x 72 x 29	100	133	16	\$1562 \$782
7 foot	self edge	GCT7B	44 x 84 x 29	100	155	16.98	\$1626 \$814
	bullnose edge	GCT7BBN	44 x 84 x 29	100	155	16.98	\$1626 \$814
	T-mold edge	GCT7BTM	44 x 84 x 29	100	155	16.98	\$1626 \$814
	built-up self edge	GCT7BBU	44 x 84 x 29	100	158	18.98	\$1821 \$912
8 foot	self edge	GCT8WB	48 x 96 x 29	100	188	19	\$1626 \$814
	bullnose edge	GCT8WBBN	48 x 96 x 29	100	180	19	\$1626 \$814
	T-mold edge	GCT8WBTM	48 x 96 x 29	100	180	18.98	\$1626 \$814
	built-up self edge	GCT8WBBU	48 x 96 x 29	100	180	21	\$1821 \$912
10 foot	self edge	GCT10WB	48 x 120 x 29	92.5	214	21	\$2258 \$1131
	bullnose edge	GCT10WBBN	48 x 120 x 29	92.5	214	20.98	\$2258 \$1131
	T-mold edge	GCT10WBTM	48 x 120 x 29	92.5	214	20.93	\$2258 \$1131
	built-up self edge	GCT10WBBU	48 x 120 x 29	92.5	259	22.93	\$2526 \$1264
12 foot	self edge	GCT12WB	48 x 144 x 29	92.5	265	22.80	\$2541 \$1272
	bullnose edge	GCT12WBBN	48 x 144 x 29	92.5	269	22.69	\$2541 \$1272
	T-mold edge	GCT12WBTM	48 x 144 x 29	92.5	269	22.69	\$2541 \$1272
	built-up self edge	GCT12WBBU	48 x 144 x 29	92.5	299	25.69	\$2832 \$1419
14 foot	self edge	GCT14WB	48 x 168 x 29	100	326	34	\$2914 \$1460
	bullnose edge	GCT14WBBN	48 x 168 x 29	100	326	34	\$2914 \$1460
	T-mold edge	GCT14WBTM	48 x 168 x 29	100	326	34	\$2914 \$1460
	built-up self edge	GCT14WBBU	48 x 168 x 29	100	332	38	\$3220 \$1612
16 foot	self edge	GCT16WB	48 x 192 x 29	100	367	38	\$3044 \$1524
	bullnose edge	GCT16WBBN	48 x 192 x 29	100	367	38	\$3044 \$1524
	T-mold edge	GCT16WBTM	48 x 192 x 29	100	367	38	\$3044 \$1524
	built-up self edge	GCT16WBBU	48 x 192 x 29	100	373	40	\$3297 \$1651
18 foot	self edge	GCT18WB	48 x 216 x 29	92.5	408	40	\$3627 \$1816
	bullnose edge	GCT18WBBN	48 x 216 x 29	92.5	408	40	\$3627 \$1816
	T-mold edge	GCT18WBTM	48 x 216 x 29	92.5	408	40	\$3627 \$1815
	built-up self edge	GCT18WBBU	48 x 216 x 29	100	416	42	\$4044 \$2025
20 foot	self edge	GCT20WB	48 x 240 x 29	92.5	449	42	\$3756 \$1880
	bullnose edge	GCT20WBBN	48 x 240 x 29	92.5	449	42	\$3756 \$1880
	T-mold edge	GCT20WBTM	48 x 240 x 29	92.5	449	42	\$3756 \$1880
	built-up self edge	GCT20WBBU	48 x 240 x 29	92.5	457	44	\$4167 \$2086
22 foot	self edge	GCT22WB	48 x 264 x 29	92.5	489	44	\$4140 \$2073
	bullnose edge	GCT22WBBN	48 x 264 x 29	92.5	489	44	\$4140 \$2073
	T-mold edge	GCT22WBTM	48 x 264 x 29	92.5	489	44	\$4140 \$2073
	built-up self edge	GCT22WBBU	48 x 264 x 29	92.5	497	46	\$4662 \$2332
24 foot	self edge	GCT24WB	48 x 288 x 29	92.5	531	46	\$4268 \$2135
	bullnose edge	GCT24WBBN	48 x 288 x 29	92.5	531	46	\$4268 \$2135
	T-mold edge	GCT24WBTM	48 x 288 x 29	92.5	531	46	\$4268 \$2135
	built-up self edge	GCT24WBBU	48 x 288 x 29	92.5	540	48	\$4772 \$2387

- All tops over 144" are standard in two pieces. Woodgrain laminate finishes will NOT align where the two tops join.
- All tops 120", 144", and 168" are SHIPPED WITH 3 LEG BASES.
- All tops 192" are SHIPPED WITH 4 LEG BASES.
- All tops 216", 240", 264" and 288" are SHIPPED WITH 6 LEG BASES.

Required Specifications

Top finish
Base finish
Edge color, if applicable

Optional Specifications

Grommet
HP laminate

Accessories

Power Block

BOAT TOP - TUBULAR BASE

	MODEL#	DIMENSIONS	FREIGHT CLASS	WT/LBS.	CUBIC FT.	LIST PRICE	HP ADD
		D x W x H					
5 foot	self edge	GCR5B	30 x 60 x 29	150	94	21	\$1303 \$654
	bullnose edge	GCR5BBN	30 x 60 x 29	150	94	21	\$1303 \$654
	T-mold edge	GCR5BTM	30 x 60 x 29	150	94	21	\$1303 \$654
	built-up self edge	GCR5BBU	30 x 60 x 29	150	97	23	\$1454 \$731
6 foot	self edge	GCR6B	36 x 72 x 29	150	107	23	\$1447 \$725
	bullnose edge	GCR6BBN	36 x 72 x 29	150	107	23	\$1447 \$725
	T-mold edge	GCR6BTM	36 x 72 x 29	150	107	23	\$1447 \$725
	built-up self edge	GCR6BBU	36 x 72 x 29	150	117	25	\$1610 \$806
7 foot	self edge	GCR7B	44 x 84 x 29	125	161	25	\$1667 \$834
	bullnose edge	GCR7BBN	44 x 84 x 29	125	161	25	\$1667 \$834
	T-mold edge	GCR7BTM	44 x 84 x 29	125	161	25	\$1667 \$834
	built-up self edge	GCR7BBU	44 x 84 x 29	150	164	29	\$1865 \$933
8 foot	self edge	GCR8WB	48 x 96 x 29	125	184	27	\$1667 \$834
	bullnose edge	GCR8WBBN	48 x 96 x 29	125	177	27	\$1667 \$834
	T-mold edge	GCR8WBTM	48 x 96 x 29	125	177	27	\$1667 \$834
	built-up self edge	GCR8WBBU	48 x 96 x 29	125	208	29	\$1865 \$933
10 foot	self edge	GCR10WB	48 x 120 x 29	125	221	29	\$2281 \$1142
	bullnose edge	GCR10WBBN	48 x 120 x 29	125	221	29	\$2281 \$1142
	T-mold edge	GCR10WBTM	48 x 120 x 29	125	221	29	\$2281 \$1142
	built-up self edge	GCR10WBBU	48 x 120 x 29	125	239	32	\$2560 \$1436
12 foot	self edge	GCR12WB	48 x 144 x 29	100	270	31	\$2570 \$1287
	bullnose edge	GCR12WBBN	48 x 144 x 29	100	270	31	\$2570 \$1287
	T-mold edge	GCR12WBTM	48 x 144 x 29	100	270	30.78	\$2570 \$1287
	built-up self edge	GCR12WBBU	48 x 144 x 29	100	293	34	\$2869 \$1436
14 foot	self edge	GCR14WB	48 x 168 x 29	125	330	50	\$2952 \$1479
	bullnose edge	GCR14WBBN	48 x 168 x 29	125	330	50	\$2952 \$1479
	T-mold edge	GCR14WBTM	48 x 168 x 29	125	330	50	\$2952 \$1479
	built-up self edge	GCR14WBBU	48 x 168 x 29	125	336	54	\$3260 \$1631
16 foot	self edge	GCR16WB	48 x 192 x 29	125	371	54	\$3082 \$1542
	bullnose edge	GCR16WBBN	48 x 192 x 29	125	371	54	\$3082 \$1542
	T-mold edge	GCR16WBTM	48 x 192 x 29	125	371	54	\$3082 \$1542
	built-up self edge	GCR16WBBU	48 x 192 x 29	125	377	58	\$3384 \$1695
18 foot	self edge	GCR18WB	48 x 216 x 29	125	412	56	\$3651 \$1827
	bullnose edge	GCR18WBBN	48 x 216 x 29	125	412	56	\$3651 \$1827
	T-mold edge	GCR18WBTM	48 x 216 x 29	125	412	56	\$3651 \$1827
	built-up self edge	GCR18WBBU	48 x 216 x 29	125	419	60	\$4077 \$2042
20 foot	self edge	GCR20WB	48 x 240 x 29	125	453	58	\$3780 \$1894
	bullnose edge	GCR20WBBN	48 x 240 x 29	125	453	58	\$3780 \$1894
	T-mold edge	GCR20WBTM	48 x 240 x 29	125	453	58	\$3780 \$1894
	built-up self edge	GCR20WBBU	48 x 240 x 29	125	461	62	\$4214 \$2108
22 foot	self edge	GCR22WB	48 x 264 x 29	100	493	60	\$4206 \$2104
	bullnose edge	GCR22WBBN	48 x 264 x 29	100	493	60	\$4206 \$2104
	T-mold edge	GCR22WBTM	48 x 264 x 29	100	493	60	\$4206 \$2104
	built-up self edge	GCR22WBBU	48 x 264 x 29	125	501	64	\$4697 \$2352
24 foot	self edge	GCR24WB	48 x 288 x 29	100	535	62	\$4338 \$2171
	bullnose edge	GCR24WBBN	48 x 288 x 29	100	535	62	\$4338 \$2171
	T-mold edge	GCR24WBTM	48 x 288 x 29	100	535	62	\$4338 \$2171
	built-up self edge	GCR24WBBU	48 x 288 x 29	100	544	66	\$4821 \$2413

- All tops over 144" are standard in two pieces. Woodgrain laminate finishes will NOT align where the two tops join.
- All tops 120", 144", and 168" are SHIPPED WITH 3 TUBULAR BASES.
- All tops 192" are SHIPPED WITH 4 TUBULAR BASES.
- All tops 216", 240", 264" and 288" are SHIPPED WITH 6 TUBULAR BASES.

Required Specifications

Top finish
Base finish
Edge color, if applicable

Optional Specifications

Grommet
HP laminate

Accessories

Power Block

B BOARDROOM TABLES

RACETRACK TOP - SLAB BASE

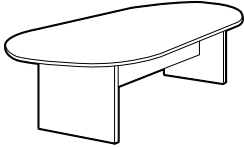

	MODEL#	DIMENSIONS	FREIGHT CLASS	WT/LBS.	CUBIC FT.	LIST PRICE	HP ADD
D x W x H							
5 foot	self edge	GRT5X	30 x 60 x 29	70	131	6	\$1074 \$538
	bullnose edge	GRT5XBN	30 x 60 x 29	70	131	6	\$1074 \$538
	T-mold edge	GRT5XTM	30 x 60 x 29	70	131	6	\$1074 \$538
	built-up self edge	GRT5XBU	30 x 60 x 29	70	134	7	\$1187 \$594
6 foot	self edge	GRT6X	36 x 72 x 29	70	135	7.60	\$1203 \$603
	bullnose edge	GRT6XBN	36 x 72 x 29	70	143	7.60	\$1203 \$603
	T-mold edge	GRT6XTM	36 x 72 x 29	70	143	7.60	\$1203 \$603
	built-up self edge	GRT6XBU	36 x 72 x 29	70	160	8.90	\$1341 \$672
7 foot	self edge	GRT7X	44 x 84 x 29	70	199	9.94	\$1549 \$776
	bullnose edge	GRT7XBN	44 x 84 x 29	70	199	9.97	\$1549 \$776
	T-mold edge	GRT7XTM	44 x 84 x 29	70	199	9.94	\$1549 \$776
	built-up self edge	GRT7XBU	44 x 84 x 29	70	203	11.95	\$1748 \$875
8 foot	self edge	GRT8WX	48 x 96 x 29	70	216	11.29	\$1549 \$776
	bullnose edge	GRT8WXBN	48 x 96 x 29	70	218	11.29	\$1549 \$776
	T-mold edge	GRT8WXTM	48 x 96 x 29	70	216	11.29	\$1549 \$776
	built-up self edge	GRT8WXBU	48 x 96 x 29	70	242	13.53	\$1748 \$875
10 foot	self edge	GRT10WX2	48 x 120 x 29	70	280	13.53	\$1795 \$900
	bullnose edge	GRT10WX2BN	48 x 120 x 29	70	266	13.53	\$1795 \$900
	T-mold edge	GRT10WX2TM	48 x 120 x 29	70	256	13.53	\$1795 \$900
	built-up self edge	GRT10WX2BU	48 x 120 x 29	70	289	16.20	\$2124 \$1062
12 foot	self edge	GRT12WX2	48 x 144 x 29	70	210	12.54	\$2105 \$1055
	bullnose edge	GRT12WX2BN	48 x 144 x 29	65	307	12.54	\$2105 \$1055
	T-mold edge	GRT12WX2TM	48 x 144 x 29	65	307	12.54	\$2105 \$1055
	built-up self edge	GRT12WX2BU	48 x 144 x 29	70	340	18.83	\$2472 \$1237
14 foot	self edge	GRT14WX2	48 x 168 x 29	65	419	18	\$3044 \$1524
	bullnose edge	GRT14WX2BN	48 x 168 x 29	65	419	18	\$3044 \$1524
	T-mold edge	GRT14WX2TM	48 x 168 x 29	65	419	18	\$3044 \$1524
	built-up self edge	GRT14WX2BU	48 x 168 x 29	70	425	20	\$3398 \$1701
16 foot	self edge	GRT16WX2	48 x 192 x 29	70	460	22.70	\$3172 \$1588
	bullnose edge	GRT16WX2BN	48 x 192 x 29	70	460	22.70	\$3172 \$1588
	T-mold edge	GRT16WX2TM	48 x 192 x 29	70	460	22.70	\$3172 \$1588
	built-up self edge	GRT16WX2BU	48 x 192 x 29	70	466	27.20	\$3542 \$1772
18 foot	self edge	GRT18WX2	48 x 216 x 29	70	521	24.60	\$3948 \$1976
	bullnose edge	GRT18WX2BN	48 x 216 x 29	70	521	24.60	\$3948 \$1976
	T-mold edge	GRT18WX2TM	48 x 216 x 29	70	521	24.60	\$3948 \$1976
	built-up self edge	GRT18WX2BU	48 x 216 x 29	70	528	29.80	\$4425 \$2216
20 foot	self edge	GRT20WX2	48 x 240 x 29	70	572	26.60	\$4011 \$2007
	bullnose edge	GRT20WX2BN	48 x 240 x 29	70	572	26.60	\$4011 \$2007
	T-mold edge	GRT20WX2TM	48 x 240 x 29	70	572	26.60	\$4011 \$2007
	built-up self edge	GRT20WX2BU	48 x 240 x 29	70	580	32.50	\$4489 \$2246
22 foot	self edge	GRT22WX2	48 x 264 x 29	70	612	28.90	\$4655 \$2328
	bullnose edge	GRT22WX2BN	48 x 264 x 29	70	612	28.90	\$4655 \$2328
	T-mold edge	GRT22WX2TM	48 x 264 x 29	70	612	28.90	\$4655 \$2328
	built-up self edge	GRT22WX2BU	48 x 264 x 29	70	620	35.10	\$5141 \$2572
24 foot	self edge	GRT24WX2	48 x 288 x 29	70	673	31.20	\$4786 \$2396
	bullnose edge	GRT24WX2BN	48 x 288 x 29	70	673	31.20	\$4786 \$2396
	T-mold edge	GRT24WX2TM	48 x 288 x 29	70	673	31.20	\$4786 \$2396
	built-up self edge	GRT24WX2BU	48 x 288 x 29	70	682	37.70	\$5295 \$2650

- All tops over 144" are standard in two pieces. Woodgrain laminate finishes will NOT align where the two tops join.
- All tops 168", 192", 216" and 240" are SHIPPED WITH 3 SLAB BASES.
- All tops 264" and 288" are SHIPPED WITH 4 SLAB BASES.

Required Specifications

Top finish
Base finish
Edge color, if applicable

Optional Specifications

Grommet
HP laminate

Accessories

Power Block

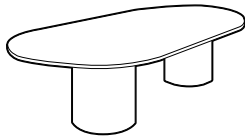
RACETRACK TOP - DRUM BASE

	MODEL#	DIMENSIONS	FREIGHT CLASS	WT./LBS.	CUBIC FT.	LIST PRICE	HP ADD
		D x W x H					
6 foot	self edge	GRT6Z	36 x 72 x 29	100	150	17.50	\$1626 \$814
	bullnose edge	GRT6ZBN	36 x 72 x 29	100	158	17.50	\$1626 \$814
	T-mold edge	GRT6ZTM	36 x 72 x 29	100	158	17.50	\$1626 \$814
	built-up self edge	GRT6ZBU	36 x 72 x 29	100	175	18.80	\$1819 \$911
7 foot	self edge	GRT7Z	44 x 84 x 29	92.5	196	19.40	\$1883 \$943
	bullnose edge	GRT7ZBN	44 x 84 x 29	92.5	196	19.40	\$1883 \$943
	T-mold edge	GRT7ZTM	44 x 84 x 29	92.5	196	19.40	\$1883 \$943
	built-up self edge	GRT7ZBU	44 x 84 x 29	100	199	21.20	\$2075 \$1039
8 foot	self edge	GRT8WZ	48 x 96 x 29	92.5	217	21.26	\$1883 \$943
	bullnose edge	GRT8WZBN	48 x 96 x 29	92.5	219	21.26	\$1883 \$943
	T-mold edge	GRT8WZTM	48 x 96 x 29	92.5	217	21.26	\$1883 \$943
	built-up self edge	GRT8WZBU	48 x 96 x 29	92.5	243	23.50	\$2075 \$942
10 foot	self edge	GRT10WZ2	48 x 120 x 29	100	313	33.14	\$2206 \$1104
	bullnose edge	GRT10WZ2BN	48 x 120 x 29	100	289	33.14	\$2206 \$1104
	T-mold edge	GRT10WZ2TM	48 x 120 x 29	100	279	33.14	\$2206 \$1104
	built-up self edge	GRT10WZ2BU	48 x 120 x 29	100	312	35.70	\$2432 \$1217
12 foot	self edge	GRT12WZ2	48 x 144 x 29	100	329	35.14	\$2466 \$1234
	bullnose edge	GRT12WZ2BN	48 x 144 x 29	150	326	58.70	\$2466 \$1234
	T-mold edge	GRT12WZ2TM	48 x 144 x 29	100	326	35.14	\$2466 \$1234
	built-up self edge	GRT12WZ2BU	48 x 144 x 29	100	359	38.32	\$2737 \$1234
14 foot	self edge	GRT14WZ2	48 x 168 x 29	92.5	478	44.44	\$3304 \$1654
	bullnose edge	GRT14WZ2BN	48 x 168 x 29	92.5	441	39	\$3304 \$1654
	T-mold edge	GRT14WZ2TM	48 x 168 x 29	92.5	441	39	\$3304 \$1654
	built-up self edge	GRT14WZ2BU	48 x 168 x 29	92.5	447	42	\$3664 \$1834
16 foot	self edge	GRT16WZ2	48 x 192 x 29	92.5	478	42.50	\$3433 \$1718
	bullnose edge	GRT16WZ2BN	48 x 192 x 29	92.5	482	42.50	\$3433 \$1718
	T-mold edge	GRT16WZ2TM	48 x 192 x 29	92.5	482	42.50	\$3433 \$1718
	built-up self edge	GRT16WZ2BU	48 x 192 x 29	92.5	488	47	\$3788 \$1897
18 foot	self edge	GRT18WZ2	48 x 216 x 29	100	523	54.40	\$4464 \$2233
	bullnose edge	GRT18WZ2BN	48 x 216 x 29	100	523	54	\$4464 \$2233
	T-mold edge	GRT18WZ2TM	48 x 216 x 29	100	523	54.40	\$4464 \$2233
	built-up self edge	GRT18WZ2BU	48 x 216 x 29	100	550	59	\$5018 \$2511
20 foot	self edge	GRT20WZ2	48 x 240 x 29	100	564	66.20	\$4529 \$2266
	bullnose edge	GRT20WZ2BN	48 x 240 x 29	100	564	66.20	\$4529 \$2266
	T-mold edge	GRT20WZ2TM	48 x 240 x 29	100	564	66.20	\$4529 \$2266
	built-up self edge	GRT20WZ2BU	48 x 240 x 29	100	572	70.60	\$5084 \$2545
22 foot	self edge	GRT22WZ2	48 x 264 x 29	100	604	68.20	\$5044 \$2523
	bullnose edge	GRT22WZ2BN	48 x 264 x 29	100	604	68.20	\$5044 \$2523
	T-mold edge	GRT22WZ2TM	48 x 264 x 29	100	604	68.20	\$5044 \$2523
	built-up self edge	GRT22WZ2BU	48 x 264 x 29	100	612	73.70	\$5635 \$2819
24 foot	self edge	GRT24WZ2	48 x 288 x 29	100	646	70.20	\$5175 \$2590
	bullnose edge	GRT24WZ2BN	48 x 288 x 29	100	646	70.20	\$5175 \$2590
	T-mold edge	GRT24WZ2TM	48 x 288 x 29	100	646	70.20	\$5175 \$2590
	built-up self edge	GRT24WZ2BU	48 x 288 x 29	100	655	76.80	\$5756 \$2880

- All Drum Bases require approx. 125 lb. of sand in each base for adequate stability. Sand is not included.
- All tops over 144" are standard in two pieces. Woodgrain laminate finishes will NOT align where the two tops join.
- All tops 168", 192" and 216" are SHIPPED WITH 3 DRUM BASES.
- All tops 240", 264" and 288" are SHIPPED WITH 4 DRUM BASES.

Required Specifications

Top finish
Base finish
Edge color, if applicable

Optional Specifications

Grommet
HP laminate

Accessories

Power Block

B BOARDROOM TABLES

RACETRACK TOP - ARCH BASE

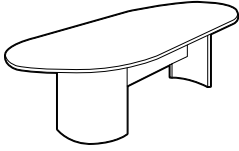

	MODEL#	DIMENSIONS	FREIGHT CLASS	WT/LBS.	CUBIC FT.	LIST PRICE	HP ADD
D x W x H							
5 foot	self edge	GRT5A	30 x 60 x 29	85	131	9	\$1430 \$717
	bullnose edge	GRT5ABN	30 x 60 x 29	85	131	9	\$1430 \$717
	T-mold edge	GRT5ATM	30 x 60 x 29	85	131	9	\$1430 \$717
	built-up self edge	GRT5ABU	30 x 60 x 29	85	134	10	\$1625 \$814
6 foot	self edge	GRT6A	36 x 72 x 29	85	140	11	\$1496 \$750
	bullnose edge	GRT6ABN	36 x 72 x 29	85	148	11	\$1496 \$750
	T-mold edge	GRT6ATM	36 x 72 x 29	85	148	11	\$1496 \$750
	built-up self edge	GRT6ABU	36 x 72 x 29	85	165	12	\$1777 \$889
7 foot	self edge	GRT7A	44 x 84 x 29	70	203	12.93	\$1820 \$912
	bullnose edge	GRT7ABN	44 x 84 x 29	70	203	12.93	\$1820 \$912
	T-mold edge	GRT7ATM	44 x 84 x 29	70	203	12.93	\$1820 \$912
	built-up self edge	GRT7ABU	44 x 84 x 29	85	206	13.95	\$2060 \$1033
8 foot	self edge	GRT8WA	48 x 96 x 29	85	218	14.94	\$1820 \$912
	bullnose edge	GRT8WABN	48 x 96 x 29	92.5	236	22.40	\$1820 \$912
	T-mold edge	GRT8WATM	48 x 96 x 29	85	218	14.94	\$1820 \$912
	built-up self edge	GRT8WABU	48 x 96 x 29	70	244	15.93	\$2060 \$1033
10 foot	self edge	GRT10WA	48 x 120 x 29	70	268	16.95	\$2076 \$1041
	bullnose edge	GRT10WABN	48 x 120 x 29	70	268	16.95	\$2076 \$1041
	T-mold edge	GRT10WATM	48 x 120 x 29	70	268	16.95	\$2076 \$1041
	built-up self edge	GRT10WABU	48 x 120 x 29	70	291	18.92	\$2448 \$1227
12 foot	self edge	GRT12WA	48 x 144 x 29	85	309	24.94	\$2400 \$1201
	bullnose edge	GRT12WABN	48 x 144 x 29	65	309	11.98	\$2400 \$1201
	T-mold edge	GRT12WATM	48 x 144 x 29	100	309	33.29	\$2400 \$1201
	built-up self edge	GRT12WABU	48 x 144 x 29	70	342	21.95	\$2801 \$1402
14 foot	self edge	GRT14WA	48 x 168 x 29	70	423	26	\$3692 \$1848
	bullnose edge	GRT14WABN	48 x 168 x 29	70	423	26	\$3692 \$1848
	T-mold edge	GRT14WATM	48 x 168 x 29	70	423	26	\$3692 \$1848
	built-up self edge	GRT14WABU	48 x 168 x 29	70	429	28	\$4114 \$2058
16 foot	self edge	GRT16WA	48 x 192 x 29	70	474	30	\$3884 \$1944
	bullnose edge	GRT16WABN	48 x 192 x 29	70	474	29.94	\$3884 \$1944
	T-mold edge	GRT16WATM	48 x 192 x 29	70	474	29.94	\$3884 \$1944
	built-up self edge	GRT16WABU	48 x 192 x 29	70	480	31.92	\$4342 \$2173
18 foot	self edge	GRT18WA	48 x 216 x 29	70	525	31.92	\$4786 \$2396
	bullnose edge	GRT18WABN	48 x 216 x 29	70	525	31.92	\$4786 \$2396
	T-mold edge	GRT18WATM	48 x 216 x 29	70	525	31.92	\$4786 \$2396
	built-up self edge	GRT18WABU	48 x 216 x 29	70	532	33.89	\$5349 \$2676
20 foot	self edge	GRT20WA	48 x 240 x 29	70	576	33.89	\$4855 \$2428
	bullnose edge	GRT20WABN	48 x 240 x 29	70	576	33.89	\$4855 \$2428
	T-mold edge	GRT20WATM	48 x 240 x 29	70	576	33.89	\$4855 \$2428
	built-up self edge	GRT20WABU	48 x 240 x 29	70	584	35.93	\$5399 \$2702
22 foot	self edge	GRT22WA	48 x 264 x 29	70	626	36.89	\$5427 \$2716
	bullnose edge	GRT22WABN	48 x 264 x 29	70	626	36.89	\$5427 \$2716
	T-mold edge	GRT22WATM	48 x 264 x 29	70	626	36.89	\$5427 \$2716
	built-up self edge	GRT22WABU	48 x 264 x 29	70	634	37.90	\$6068 \$3036
24 foot	self edge	GRT24WA	48 x 288 x 29	70	678	39.88	\$5558 \$2780
	bullnose edge	GRT24WABN	48 x 288 x 29	70	678	39.88	\$5558 \$2780
	T-mold edge	GRT24WATM	48 x 288 x 29	70	678	39.88	\$5558 \$2780
	built-up self edge	GRT24WABU	48 x 288 x 29	70	687	41.92	\$6193 \$3099

- All tops over 144" are standard in two pieces. Woodgrain laminate finishes will NOT align where the two tops join.
- All tops 168", 192", 216" and 240" are SHIPPED WITH 2 ARCH BASES AND 1 SLAB BASE.
- All tops 264" and 288" are SHIPPED WITH 2 ARCH BASES AND 2 SLAB BASES.

Required Specifications

Top finish
Base finish
Edge color, if applicable

Optional Specifications

Grommet
HP laminate

Accessories

Power Block

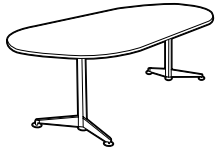
RACETRACK TOP - 2 LEG BASE

	MODEL#	DIMENSIONS	FREIGHT CLASS	WT/LBS.	CUBIC FT.	LIST PRICE	HP ADD
		D x W x H					
5 foot	self edge	GRT5	30 x 60 x 29	125	88	13	\$1263 \$634
	bullnose edge	GRT5BN	30 x 60 x 29	125	88	13	\$1263 \$634
	T-mold edge	GRT5TM	30 x 60 x 29	125	88	13	\$1263 \$634
	built-up self edge	GRT5BU	30 x 60 x 29	125	91	14	\$1410 \$708
6 foot	self edge	GRT6	36 x 72 x 29	125	111	15	\$1407 \$705
	bullnose edge	GRT6BN	36 x 72 x 29	125	119	15	\$1407 \$705
	T-mold edge	GRT6TM	36 x 72 x 29	125	119	15	\$1407 \$705
	built-up self edge	GRT6BU	36 x 72 x 29	100	136	16	\$1562 \$782
7 foot	self edge	GRT7	44 x 84 x 29	100	155	17	\$1626 \$814
	bullnose edge	GRT7BN	44 x 84 x 29	100	155	17	\$1626 \$814
	T-mold edge	GRT7TM	44 x 84 x 29	100	155	17	\$1626 \$814
	built-up self edge	GRT7BU	44 x 84 x 29	100	158	19	\$1821 \$912
8 foot	self edge	GRT8W	48 x 96 x 29	100	178	19	\$1626 \$814
	bullnose edge	GRT8WBN	48 x 96 x 29	100	180	19	\$1626 \$814
	T-mold edge	GRT8WTM	48 x 96 x 29	100	178	19	\$1626 \$814
	built-up self edge	GRT8WBU	48 x 96 x 29	100	204	21	\$1821 \$912
10 foot	self edge	GRT10W	48 x 120 x 29	300	39	21	\$2258 \$1131
	bullnose edge	GRT10WBN	48 x 120 x 29	92.5	231	21	\$2258 \$1131
	T-mold edge	GRT10WTM	48 x 120 x 29	92.5	221	21	\$2258 \$1131
	built-up self edge	GRT10WBU	48 x 120 x 29	92.5	254	23	\$2526 \$1264
12 foot	self edge	GRT12W	48 x 144 x 29	92.5	271	23	\$2541 \$1272
	bullnose edge	GRT12WBN	48 x 144 x 29	92.5	268	23	\$2541 \$1272
	T-mold edge	GRT12WTM	48 x 144 x 29	92.5	268	23	\$2541 \$1272
	built-up self edge	GRT12WBU	48 x 144 x 29	92.5	301	25.90	\$2832 \$1419
14 foot	self edge	GRT14W	48 x 168 x 29	100	326	34	\$2914 \$1460
	bullnose edge	GRT14WBN	48 x 168 x 29	100	326	34	\$2914 \$1460
	T-mold edge	GRT14WTM	48 x 168 x 29	100	326	34	\$2914 \$1460
	built-up self edge	GRT14WBU	48 x 168 x 29	100	332	38	\$3220 \$1612
16 foot	self edge	GRT16W	48 x 192 x 29	100	367	38	\$3044 \$1524
	bullnose edge	GRT16WBN	48 x 192 x 29	100	367	38	\$3044 \$1524
	T-mold edge	GRT16WTM	48 x 192 x 29	100	367	38	\$3044 \$1524
	built-up self edge	GRT16WBU	48 x 192 x 29	100	368	40	\$3297 \$1651
18 foot	self edge	GRT18W	48 x 216 x 29	92.5	408	40	\$3627 \$1816
	bullnose edge	GRT18WBN	48 x 216 x 29	92.5	408	40	\$3627 \$1816
	T-mold edge	GRT18WTM	48 x 216 x 29	92.5	408	40	\$3627 \$1816
	built-up self edge	GRT18WBU	48 x 216 x 29	100	416	42	\$4044 \$2025
20 foot	self edge	GRT20W	48 x 240 x 29	92.5	449	42	\$3756 \$1880
	bullnose edge	GRT20WBN	48 x 240 x 29	92.5	449	42	\$3756 \$1880
	T-mold edge	GRT20WTM	48 x 240 x 29	92.5	449	42	\$3756 \$1880
	built-up self edge	GRT20WBU	48 x 240 x 29	92.5	457	44	\$4167 \$2086
22 foot	self edge	GRT22W	48 x 264 x 29	92.5	489	44	\$4140 \$2073
	bullnose edge	GRT22WBN	48 x 264 x 29	92.5	489	44	\$4140 \$2073
	T-mold edge	GRT22WTM	48 x 264 x 29	92.5	489	44	\$4140 \$2073
	built-up self edge	GRT22WBU	48 x 264 x 29	92.5	497	46	\$4662 \$2332
24 foot	self edge	GRT24W	48 x 288 x 29	92.5	531	46	\$4268 \$2135
	bullnose edge	GRT24WBN	48 x 288 x 29	92.5	531	46	\$4268 \$2135
	T-mold edge	GRT24WTM	48 x 288 x 29	92.5	531	46	\$4268 \$2135
	built-up self edge	GRT24WBU	48 x 288 x 29	92.5	540	48	\$4772 \$2387

- All tops over 144" are standard in two pieces. Woodgrain laminate finishes will NOT align where the two tops join.
- All tops 120", 144", and 168" are SHIPPED WITH 3 LEG BASES.
- All tops 192" are SHIPPED WITH 4 LEG BASES.
- All tops 216", 240", 264" and 288" are SHIPPED WITH 6 LEG BASES.

Required Specifications

Top finish
Base finish
Edge color, if applicable

Optional Specifications

Grommet
HP laminate

Accessories

Power Block

B BOARDROOM TABLES

RACETRACK TOP - TUBULAR BASE

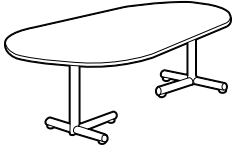

		MODEL#	DIMENSIONS	FREIGHT CLASS	WT/LBS.	CUBIC FT.	LIST PRICE	HP ADD
		D x W x H						
5 foot	self edge	GRT5R	30 x 60 x 29	150	94	21	\$1303	\$654
	bullnose edge	GRT5RBN	30 x 60 x 29	150	94	21	\$1303	\$654
	T-mold edge	GRT5RTM	30 x 60 x 29	150	94	21	\$1303	\$654
	built-up self edge	GRT5RBU	30 x 60 x 29	150	97	23	\$1454	\$731
6 foot	self edge	GRT6R	36 x 72 x 29	150	107	23	\$1447	\$725
	bullnose edge	GRT6RBN	36 x 72 x 29	150	107	23	\$1447	\$725
	T-mold edge	GRT6RTM	36 x 72 x 29	150	107	23	\$1447	\$725
	built-up self edge	GRT6RBU	36 x 72 x 29	150	117	25	\$1610	\$806
7 foot	self edge	GRT7R	44 x 84 x 29	125	161	25	\$1667	\$834
	bullnose edge	GRT7RBN	44 x 84 x 29	125	161	25	\$1667	\$834
	T-mold edge	GRT7RTM	44 x 84 x 29	125	161	25	\$1667	\$834
	built-up self edge	GRT7RBU	44 x 84 x 29	125	164	27	\$1865	\$933
8 foot	self edge	GRT8WR	48 x 96 x 29	125	175	27	\$1667	\$834
	bullnose edge	GRT8WRBN	48 x 96 x 29	125	177	27	\$1667	\$834
	T-mold edge	GRT8WRM	48 x 96 x 29	125	175	27	\$1667	\$834
	built-up self edge	GRT8WRBU	48 x 96 x 29	125	176	29	\$1865	\$933
10 foot	self edge	GRT10WR	48 x 120 x 29	125	221	29	\$2281	\$1142
	bullnose edge	GRT10WRBN	48 x 120 x 29	125	221	29	\$2281	\$1142
	T-mold edge	GRT10WRM	48 x 120 x 29	125	221	29	\$2281	\$1142
	built-up self edge	GRT10WRBU	48 x 120 x 29	125	239	32	\$2560	\$1281
12 foot	self edge	GRT12WR	48 x 144 x 29	100	270	31	\$2570	\$1287
	bullnose edge	GRT12WRBN	48 x 144 x 29	100	270	31	\$2570	\$1287
	T-mold edge	GRT12WRM	48 x 144 x 29	100	270	30.9	\$2570	\$1287
	built-up self edge	GRT12WRBU	48 x 144 x 29	100	301	34	\$2869	\$1436
14 foot	self edge	GRT14WR	48 x 168 x 29	125	330	50	\$2952	\$1479
	bullnose edge	GRT14WRBN	48 x 168 x 29	125	330	50	\$2952	\$1479
	T-mold edge	GRT14WRM	48 x 168 x 29	125	330	50	\$2952	\$1479
	built-up self edge	GRT14WRBU	48 x 168 x 29	125	326	54	\$3260	\$1631
16 foot	self edge	GRT16WR	48 x 192 x 29	125	371	54	\$3082	\$1542
	bullnose edge	GRT16WRBN	48 x 192 x 29	125	371	54	\$3082	\$1542
	T-mold edge	GRT16WRM	48 x 192 x 29	125	371	54	\$3082	\$1542
	built-up self edge	GRT16WRBU	48 x 192 x 29	125	377	58	\$3384	\$1695
18 foot	self edge	GRT18WR	48 x 216 x 29	125	412	56	\$3651	\$1827
	bullnose edge	GRT18WRBN	48 x 216 x 29	125	412	56	\$3651	\$1827
	T-mold edge	GRT18WRM	48 x 216 x 29	125	412	56	\$3651	\$1827
	built-up self edge	GRT18WRBU	48 x 216 x 29	125	419	60	\$4077	\$2042
20 foot	self edge	GRT20WR	48 x 240 x 29	125	453	58	\$3780	\$1894
	bullnose edge	GRT20WRBN	48 x 240 x 29	125	453	58	\$3780	\$1894
	T-mold edge	GRT20WRM	48 x 240 x 29	125	453	58	\$3780	\$1894
	built-up self edge	GRT20WRBU	48 x 240 x 29	125	461	62	\$4214	\$2108
22 foot	self edge	GRT22WR	48 x 264 x 29	100	493	60	\$4206	\$2104
	bullnose edge	GRT22WRBN	48 x 264 x 29	100	493	60	\$4206	\$2104
	T-mold edge	GRT22WRM	48 x 264 x 29	100	493	60	\$4206	\$2104
	built-up self edge	GRT22WRBU	48 x 264 x 29	125	501	64	\$4697	\$2352
24 foot	self edge	GRT24WR	48 x 288 x 29	100	535	62	\$4338	\$2171
	bullnose edge	GRT24WRBN	48 x 288 x 29	100	535	62	\$4338	\$2171
	T-mold edge	GRT24WRM	48 x 288 x 29	100	535	62	\$4338	\$2171
	built-up self edge	GRT24WRBU	48 x 288 x 29	100	544	66	\$4821	\$2413

- All tops over 144" are standard in two pieces. Woodgrain laminate finishes will NOT align where the two tops join.
- All tops 120", 144", and 168" are SHIPPED WITH 3 TUBULAR BASES.
- All tops 192" are SHIPPED WITH 4 TUBULAR BASES.
- All tops 216", 240", 264" and 288" are SHIPPED WITH 6 TUBULAR BASES.

Required Specifications

Top finish
Base finish
Edge color, if applicable

Optional Specifications

Grommet
HP laminate

Accessories

Power Block

BUNGEE™ TABLES



Bungee is a series of freestanding tables and accessories designed for classrooms, training rooms, boardrooms and any other multi-functional space that may require frequent configurations. Tables are sold complete with legs and Bungee cords so they may quickly and easily be connected together without searching for tools or worrying about loose parts.

Bungee tables feature rounded corners with a unique “bubble molding” that is engineered to compress under the tension of the Bungee cords. The compressed molding creates a seal that serves to locate and align interconnected tables while also providing a soft and forgiving edge.

Choose from a variety of top shapes and laminate finishes to create your individual style. In addition, most tables offer a choice of tapered legs or spider legs in a Tungsten or Black finish with adjustable levelers or optional casters. Optional modesty panels, grommets, wire management and power blocks further enhance your workspace.



Flip-Top tables can be nested and easily stored by activating the single hand release mechanism from the left or right side.

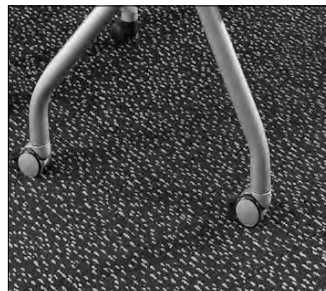

Optional locking casters are available in Tungsten or Black (standard on Flip-Top models).

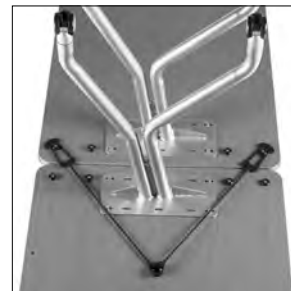

Bungee cords are utilized to quickly and easily reconfigure tables

Features and Benefits

- Bungee tables are complete with Top, Legs and Bungee cords
- Bungee cords provide a fast and easy method of reconfiguring tables without requiring a tool
- Tops are 1” thick and are offered in a variety of shapes and sizes
- Legs are offered in tapered or spider design in a Tungsten or Black finish.
- Levelers on legs are standard.
- Laminate modesty panels and filler modesty inserts help conceal wires and enhance visual appeal
- Wire management tracks neatly contain wires, using two separate channels for data and voice wires
- Optional grommets or power blocks offer technological flexibility
- Models with handles feature a bow handle in Silver or Black Nickel finish
- Metal feet are height adjustable and offered in Black or Tungsten finish
- Boardrooms were never easier to specify - table “sets” and accessories such as AV Cabinets and Credenza Buffets are specified with one model number

B BUNGEE™ TABLES - NOTES

GENERAL INFORMATION

- Bungee is a series of freestanding tables and accessories designed for classrooms, training rooms, boardrooms and any other multifunctional space that requires frequent reconfigurations.
- Bungee tables come complete with a work top, a set of legs and built-in Bungee cord connectors
- Bungee cords allow the movement and reconfiguration of tables without a risk of damage or losing loose parts
- High pressure tops are available in all Bungee laminate finishes at an extended lead time - please see model # for pricing.
- Unique “bubble molding” edging is specially engineered to create a secure seal to align interconnected tables.
- Bungee products have been tested and comply with all mechanical tests.
- For environmental certifications, please visit globalfurnituregroup.com

CONSTRUCTION

- Tops are 1” thick. Modesty panels are 11/16” thick.
- All components are made of 45 lb. commercial density particle board, covered on both sides with high performance, thermally fused laminate.
- Tops 54” and over feature a built-in support bar.
- Products specified with the high pressure laminate option are finished on the underside of the surface with a kraft paper backing.

w

BUNGEE CORDS

- Bungee cords are patented elastic devices designed to provide a rapid, no-tool method of attaching tables of the same depth.
- The elastic nature of cords allows two connected tables to be moved around without risk of damage to the table top or connecting hardware.
- Bungee cords are included with all freestanding tables and carry a lifetime warranty.

EDGE DETAIL

- Bungee comes with a choice of four edge styles (check model for edge availability):



A3 - square corner, standard edge



AR - square corner, bicut edge



AS - square corner, Silver



AB - square corner, Black



BS - rounded corner, Silver



BB - rounded corner, Black

- **BB/BS** - Bungee Bubble Edge: unique “bubble” molding is engineered to compress under the tension of the Bungee cords, creating a seal that serves to locate and align interconnected tables.
- **AB/AS** - Split color PVC edge: edge matches split color aesthetic of the bubble edge, but allows for 90 degree corners and a cleaner look.
- **A3** - Global’s preferred edge. Coordinates well with Adaptabilities and Zira 1” tops.
- **AR** - Bicut edge. Coordinates well with Zira 1” tops.
- **NOTE:** Trapezoid tables can only be specified with Bubble Edge (Rounded Corners).
- **NOTE:** Boardroom Table sets allow for all edge types but **ONLY** with rounded corners (when AS/AB/A3/AR are selected, the table will be produced with rounded corners).

LEGS

- Tables feature two styles of legs - Tapered leg or Spider leg. Legs on fixed tables offer glides or casters. Adjusts 3mm-10mm in height.
- For legs and glides in Tungsten, specify (**TTU**).
- For legs and glides in Black, specify (**TBL**).
- For legs and casters in Tungsten, specify (**TTC**).
- For legs and casters in Black, specify (**TBC**).

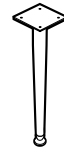

Tapered Leg



Spider Leg

HANDLES

- Metal handles are standard on all drawers and doors. Handles are offered in two finishes: Silver (**HS**) or Black Nickel (**HT**), please specify
- Handle finish will match leg finish.



bow handle, Silver finish (**HS**)



bow handle, Black Nickel finish (**HT**)

FEET

- Metal feet are standard on all cabinets. Feet adjust 3/4” in height.
- Feet are available in Tungsten Finish (**TTU**) or Black Finish (**BLK**).



TTU - Tungsten



BLK - Black Nickel

MODESTY PANELS

- Panels are 9.5” high, recessed 3/4” from the back and inset 7” from the sides.
- Available in all Bungee laminate finishes.
- Edge available in Silver finish (**SI**) or Black finish (**BK**). Please specify.

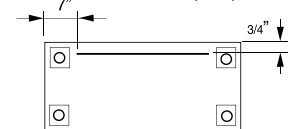
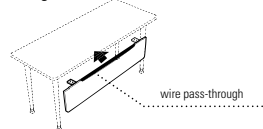

FILLER MODESTY PANELS

- Used to fill the space between two modesty panels when two tables are linked together. Helps conceal wires and enhance visual appeal.
- Reversible - Black on one side, Silver on the other.

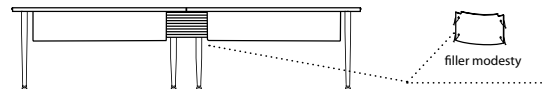

WIRE MANAGEMENT

- Wire management tracks are mounted to the underside of the worksurface. Available in 5” and 22” track lengths.
- 5” track includes one wire clamp; 22” track includes two wire clamps.
- Data and voice wires can be routed separately using two separate channels on each clamp.
- Available in Black only.

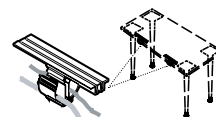

5” Wire Management Track

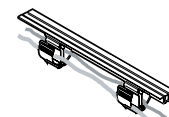

22” Wire Management Track

1. SPECIFY MODEL NUMBER

2. SPECIFY FINISH

LAMINATE FINISHES

ACJ	Absolute Acajou	FCL	First Class
ASN	Asian Night	NBL	Noce Biondo
AWC	Avant Cherry	NGL	Noce Grigio
AWH	Avant Honey	NEL	Noce Leggero
BLK	Black	NML	Noce Medio
BZD	Blizzard	QTM	Quartered Mahogany
BRC	Brushed Cobalt	SBY	Sheer Beauty
CMB	Clear Maple	SOG	Storm Grey
CGY	Custom Grey	SDT	Stonedust
DES	Dark Espresso	WHE	Walnut Heights
DWT	Designer White	WHC	White Chocolate
FAS	Fashionista	WCR	Winter Cherry

Edge:

BB	Bungee bubble edge with Black trim
BS	Bungee bubble edge with Silver trim
AB	Split color edge with Black trim
AS	Split color edge with Silver trim
A3	Matching edge
AR	Matching bicut edge

Legs with Glides:

TBL	Black
TTU	Tungsten

Legs with Casters:

TBC	Black
TTC	Tungsten

Handles:

HS	Silver
HT	Black Nickel

Modesty Panel Edge:

SI	Silver
BK	Black Nickel

Feet:

BLK	Black Nickel	TTU	Tungsten
-----	--------------	-----	----------

3. SPECIFY OPTIONS

GROMMETS

- Optional Grommets available in standard worksurface locations (left, center or right) for **Rectangular Tops 48" and up**. Order as: **AG1, AG2 or AG3 - Add \$96**
- Additional grommets are available in **center position only** for **Rectangular Tops (36", 42" and 48") and Trapezoid Tables**. Order as **AG2 - Add \$96**.
- Grommet hole dimensions are 3 1/4" wide x 1 7/8" deep.
- Grommets may be placed at non-standard locations. Order as: **AGS - Add \$96**. A drawing must be supplied with vertical and horizontal dimensions to the center of the cut-out (as in drawing above). Please refer to CUSTOM GROMMET LOCATION FORM in the back reference section.

Grommet hole dimensions

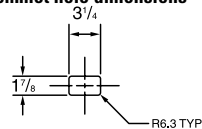

Grommet

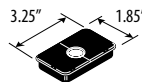

Rectangular Tops

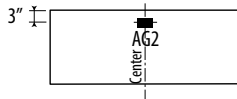

For 36" and 42" wide units

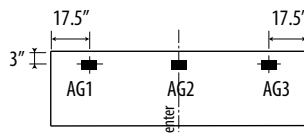

For 48", 60" and 72" wide units

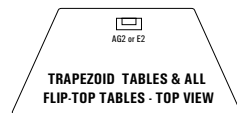

Trapezoid Tables

Grommet Location - AG2...Add \$96

POWER BLOCK

- A Power Block is a rectangular worksurface power/data module with one electrical duplex receptacle and two data (RJ45) receptacles. 9' black cord included. Power Block dimensions are 3 1/2" deep x 6 1/2" wide x 2 3/4" high.
- A Power Block (model **PMSPDM**) may be ordered for **Rectangular Tables 60" and up** in place of standard grommets. Order as **E1, E2 or E3 - Add \$96**.
- Additional Power Blocks are available in **center position only** for **Rectangular Tops (36", 42" and 48") and Trapezoid Tables**. Order as **E2 - Add \$96**.
- To purchase a Power Block, you must specify both the Power Block cut-out location and the Power Block model #. Order Power Block as **PMSPDM, Add \$330**.
- Power Blocks are available in standard worksurface locations (left, center or right). Order as **E1, E2 or E3. Add \$96**.
- See above for examples of placement.**



Power Block **PMSPDM Add \$330**

Rectangular Tops

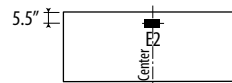

For 36", 42" and 48" wide units

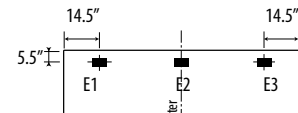

For 60" and 72" wide units

VILLA CUTOUTS

- Optional Villa cutout available in standard worksurface locations (left, center or right) for **Rectangular Tables 60" and up**. Order as: **V1, V2 or V3 - Add \$96 for each cutout**.
- Additional power block cutouts are available in **center position only** for **Rectangular Tops (36", 42" and 48") and Trapezoid Tables**. Order as **V2 - Add \$96**.
- Villa cutouts may be placed at non-standard locations. Please contact customer care.
- To purchase a Villa Power Block, you must specify both the Villa Power Block cutout location and the Power Block model #. Please see page 475 for Villa models.

Rectangular Tops



For 36", 42" and 48" wide units

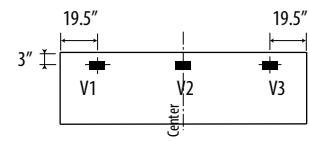

For 60" and 72" wide units

MODPOWER DAISY CHAIN SOLUTION

- Add flexible power and USB charging to Bungee rectangular tables. Connect up to four units with a single corded infeed with NEMA plug.
- ModPower units are sold separately, refer to Productivity Solutions page 465.
- Begin run with a starter unit which includes a corded infeed. Add additional middle or end units as required. Middle and end units are equipped with connecting cables.
- On-surface modules clamp on or screw mount to the table tops.
- In-surface modules require table top cut-outs for mounting. Specify cut-out option:
 - **MPS** for a single cut-out to accommodate one ModPower in-surface unit (cut-out will be centered on the approach side) for **42" to 72" wide non-flip tables and 48" to 72" wide flip tables. Add \$96**
 - **MPD** for two cut-outs in the left and right positions, 18.25" from ends to center of unit on approach side for **60", 66" and 72" wide rectangular tables. Add \$192.**

B BUNGEE™ TABLES

CONNECTING CONDITIONS

- Bungee cords allow for fast and easy reconfiguring of tables whenever needed. Due to the elastic nature of the Bungee cord, two tables connected with Bungee cords can be moved around without risk of damage to the table top or the connecting hardware.
- Connecting tables is simple and intuitive. Tools are not required and there are no loose parts that may be misplaced.
- Bungee cords connect tables of the same depth in all directions.
- Rectangular Tables 48" and longer connect in both Straight and "L" configurations. Rectangular Tables 36" and 42" connect in Straight configurations only.

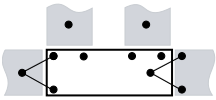
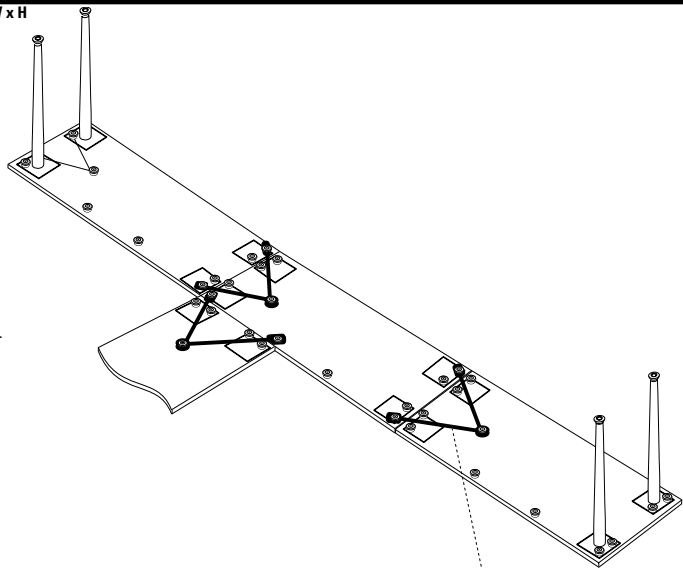

Rectangular Tables

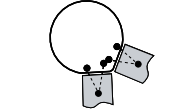

Round Wedge Tables

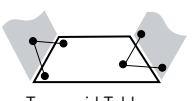

Trapezoid Tables

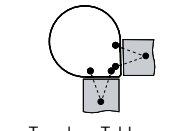

Teardrop Tables

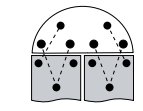

Half Moon Tables

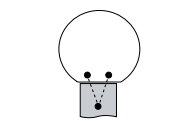

Flat Round Tables

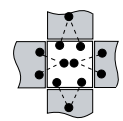

Square Tables



Keystone Tables

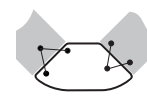

Wedge Tables

SAMPLE TABLE CONFIGURATIONS

- The following table configurations can be created using Bungee Boardroom Table Sets only.

Meeting/Boardroom Table



Meeting/Boardroom Table



Training

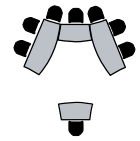

Lecture / AV Presentations

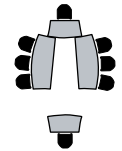

Small Teaming Stations



Large Teaming Stations

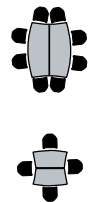

Meeting/Boardroom Table

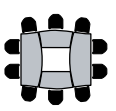

Training

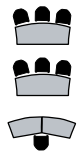

FLIP TOP TABLE NESTING DIAGRAM

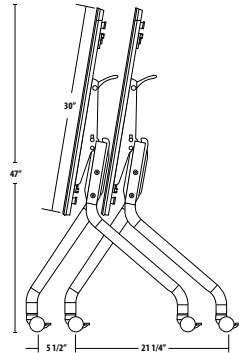
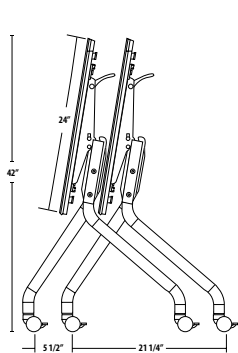

RECTANGULAR TABLES

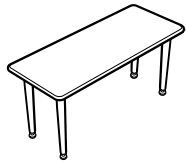
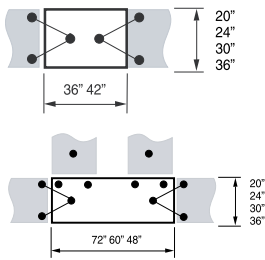

Rectangular Table - Tapered Legs

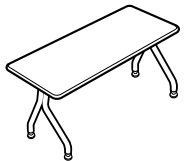
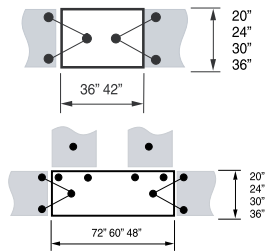

Rectangular Table - Spider Legs

MODEL#	DIMENSIONS D x W x H	FREIGHT CLASS	WT/LBS.	CUBIC FT.	LIST PRICE	HP ADD
B2036REF	20 x 36 x 28.7	92.5	59	5.26	\$874	\$178
B2042REF	20 x 42 x 28.7	92.5	62	5.76	\$906	\$236
B2048REF	20 x 48 x 28.7	92.5	67	6	\$940	\$236
B2060REF	20 x 60 x 28.7	92.5	74	7	\$1064	\$324
B2072REF	20 x 72 x 28.7	92.5	81	7.26	\$1167	\$367
B2436REF	24 x 36 x 28.7	92.5	65	5.76	\$925	\$178
B2442REF	24 x 42 x 28.7	92.5	69	6	\$956	\$236
B2448REF	24 x 48 x 28.7	92.5	72	6.5	\$988	\$236
B2460REF	24 x 60 x 28.7	92.5	82	7.26	\$1141	\$353
B2472REF	24 x 72 x 28.7	92.5	91	8	\$1232	\$548
B3036REF	30 x 36 x 28.7	100	70	7.26	\$913	\$332
B3042REF	30 x 42 x 28.7	92.5	78	7.5	\$956	\$367
B3048REF	30 x 48 x 28.7	92.5	81	7.5	\$982	\$353
B3060REF	30 x 60 x 28.7	92.5	92	8.26	\$1141	\$441
B3072REF	30 x 72 x 28.7	92.5	102	9	\$1250	\$548
B3642REF	36 x 42 x 28.7	150	83	15	\$1048	\$353
B3648REF	36 x 48 x 28.7	92.5	91	8	\$1150	\$334
B3660REF	36 x 60 x 28.7	92.5	103	9	\$1250	\$415
B3672REF	36 x 72 x 28.7	92.5	116	10	\$1397	\$526

Freestanding table includes four tapered legs with levellers and Bungee cords. Each table can be "Bungee-tied" to other tables of the same depth. Shipped RTA (ready to assemble). Modesty panels available, see page 521.

- Tables 48" and longer connect in both Straight and "L" configurations
- Tables 36" and 42" connect in Straight configurations only.
- Available with optional locking casters, specify option "TBC" or "TTC".

B2036RES	20 x 36 x 28.7	100	57	6.76	\$982	\$178
B2042RES	20 x 42 x 28.7	100	60	7.26	\$1015	\$236
B2048RES	20 x 48 x 28.7	100	65	7.5	\$1048	\$236
B2060RES	20 x 60 x 28.7	100	72	8.5	\$1181	\$324
B2072RES	20 x 72 x 28.7	100	79	8.76	\$1290	\$367
B2436RES	24 x 36 x 28.7	100	62	7.26	\$1039	\$178
B2442RES	24 x 42 x 28.7	150	64	15	\$1064	\$236
B2448RES	24 x 48 x 28.7	125	71	10	\$1105	\$236
B2460RES	24 x 60 x 28.7	125	80	10.76	\$1250	\$353
B2472RES	24 x 72 x 28.7	125	89	11.26	\$1354	\$548
B3036RES	30 x 36 x 28.7	125	72	10.26	\$1064	\$332
B3042RES	30 x 42 x 28.7	125	80	10.5	\$1097	\$367
B3048RES	30 x 48 x 28.7	125	83	10.5	\$1132	\$404
B3060RES	30 x 60 x 28.7	100	94	11.26	\$1290	\$404
B3072RES	30 x 72 x 28.7	100	104	12	\$1383	\$549

Freestanding table includes two spider legs with levellers and Bungee cords. Each table can be "Bungee-tied" to other tables of the same depth. Shipped RTA (ready to assemble). Modesty panels available, see page 521.

- Tables 48" and longer connect in both Straight and "L" configurations
- Tables 36" and 42" connect in Straight configurations only.
- Available with optional locking casters, specify option "TBC" or "TTC".

Required Specifications

Top finish
Edge
Leg finish

Optional Specifications

Casters
Grommet
Modesty Panel
High Pressure Laminate

Accessories

Power Block

B BUNGEE™ TABLES

TRAPEZOID TABLES

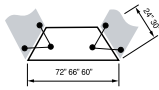

Trapezoid Table - Tapered Legs

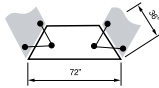
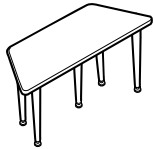

Trapezoid Table - Tapered Legs

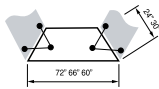
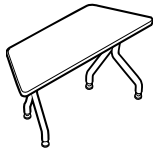

Trapezoid Table - Spider Legs

MODEL#	DIMENSIONS	FREIGHT CLASS	WT./LBS.	CUBIC FT.	LIST PRICE	HP ADD
--------	------------	---------------	----------	-----------	------------	--------

D x W x H

B2460TRF	24 x 60 x 28.7	100	71	7.5	\$1048	\$353
B2466TRF	24 x 66 x 28.7	100	74	8	\$1075	\$548
B2472TRF	24 x 72 x 28.7	100	78	8.26	\$1155	\$548
B3060TRF	30 x 60 x 28.7	100	78	8.5	\$1120	\$404
B3066TRF	30 x 66 x 28.7	100	81	9.5	\$1167	\$548
B3072TRF	30 x 72 x 28.7	100	85	9.5	\$1240	\$548

Freestanding table includes four tapered legs with levelers and Bungee cords. Each table can be "Bungee-tied" to other tables of the same depth. Shipped RTA (ready to assemble). Modesty panels available, see page 521.

- Available with bubble edge (BB or BS) only.

B3672TRF	36 x 72 x 28.7	100	91	10.5	\$1431	\$526
----------	----------------	-----	----	------	---------------	--------------

Freestanding table includes five tapered legs with levelers and Bungee cords. Each table can be "Bungee-tied" to other tables of the same depth. Shipped RTA (ready to assemble). Modesty panels available, see page 521.

- Available with bubble edge (BB or BS) only.
- Available with optional locking casters, specify option "TBC" or "TTC".

B2060TRS	20 x 60 x 28.7	125	67	8.76	\$1132	\$324
B2066TRS	20 x 66 x 28.7	125	68	9	\$1167	\$367
B2072TRS	20 x 72 x 28.7	125	74	9.26	\$1213	\$367

B2460TRS	24 x 60 x 28.7	125	69	9.26	\$1167	\$353
B2466TRS	24 x 66 x 28.7	125	72	9.76	\$1213	\$548
B2472TRS	24 x 72 x 28.7	125	76	10	\$1264	\$548

B3060TRS	30 x 60 x 28.7	125	79	11.5	\$1254	\$404
B3066TRS	30 x 66 x 28.7	125	83	12.5	\$1301	\$548
B3072TRS	30 x 72 x 28.7	125	87	12.5	\$1372	\$548

Freestanding table includes two spider legs with levelers and Bungee cords. Each table can be "Bungee-tied" to other tables of the same depth. Shipped RTA (ready to assemble). Modesty panels available, see page 521.

- Available with bubble edge (BB or BS) only.
- Available with optional locking casters, specify option "TBC" or "TTC".

KEYSTONE TABLES

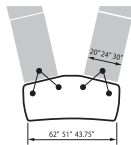
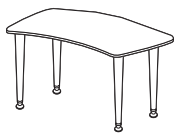

Keystone Table - Tapered Legs

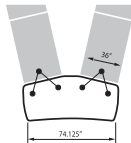
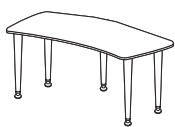

Keystone Table - Tapered Legs

B30KSF	30 x 62 x 28.7	150	69	15.2	\$1112	\$441
B24KSF	24 x 51 x 28.7	150	60	13	\$1029	\$296
B20KSF	20 x 43.75 x 28.7	150	58	13	\$1016	\$236

Freestanding table includes four tapered legs with levelers and Bungee cords. Each table can be "Bungee-tied" to other tables of 24" and 30" depth. Shipped RTA (ready to assemble). Modesty panels or Filler Modestys are NOT available.

B36KSF	36 x 74.13 x 28.7	150	84	16.8	\$1373	\$621
--------	-------------------	-----	----	------	---------------	--------------

Freestanding table includes five tapered legs with levelers and Bungee cords. Each table can be "Bungee-tied" to other tables of 24" and 30" depth. Shipped RTA (ready to assemble). Modesty panels or Filler Modestys are NOT available.

Required Specifications

Top finish
Edge
Leg finish

Optional Specifications

Grommet
Casters
Modesty panel (Trapezoid Tables only)
HP laminate

Accessories

Power block

KEYSTONE TABLES

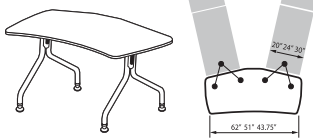

Keystone Table - Spider Legs

MODEL#	DIMENSIONS D x W x H	FREIGHT CLASS	WT/LBS.	CUBIC FT.	LIST PRICE	HP ADD
B30KSS	30 x 62 x 28.7	150	77	15.2	\$1298	\$439
B24KSS	24 x 51 x 28.7	150	66	13	\$1208	\$274
B20KSS	20 x 43.75 x 28.7	150	64	13	\$1187	\$236

Freestanding table includes two spider legs with levelers and Bungee cords. Each table can be "Bungee-tied" to other tables of 24" and 30" depth. Shipped RTA (ready to assemble). Modesty panels or Filler Modestys are NOT available.

- Available with optional locking casters, specify option "TBC" or "TTC".

WEDGE TABLES

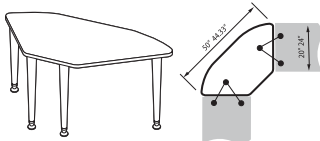

Wedge Table - Tapered Legs

B24WEF	24 x 63 x 28.7	150	54	13.2	\$1076	\$295
B20WEF	20 x 57 x 28.7	150	46	10.2	\$985	\$236

Freestanding table includes four tapered legs with levelers and Bungee cords. Each table can be "Bungee-tied" to other tables of the same depth. Shipped RTA (ready to assemble). Modesty panels are NOT available.

- Available with optional locking casters, specify option "TBC" or "TTC".

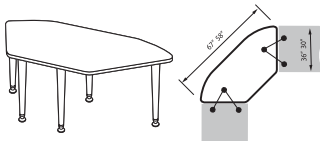

Wedge Table - Tapered Legs

B36WEF	36 x 80 x 28.7	150	84	18.8	\$1465	\$526
B30WEF	30 x 70 x 28.7	150	70	14.4	\$1298	\$367

Freestanding table includes five tapered legs with levelers and Bungee cords. Each table can be "Bungee-tied" to other tables of the same depth. Shipped RTA (ready to assemble). Modesty panels are NOT available.

- Available with optional locking casters, specify option "TBC" or "TTC".

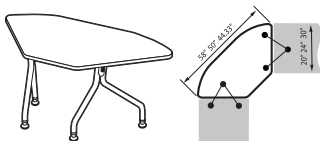

Wedge Table - Spider Legs

B30WES	30 x 70 x 28.7	150	73	14.4	\$1286	\$370
B24WES	24 x 63 x 28.7	150	62	13.2	\$1201	\$295
B20WES	20 x 57 x 28.7	150	52	10.2	\$1112	\$236

Freestanding table includes two spider legs with levelers and Bungee cords. Each table can be "Bungee-tied" to other tables of the same depth. Shipped RTA (ready to assemble). Modesty panels are NOT available.

- Available with optional locking casters, specify option "TBC" or "TTC".

HALF MOON TABLES

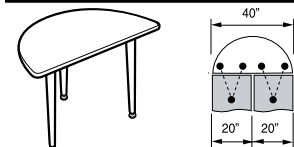

Half Moon Table - Tapered Legs

B2040HMF	20 x 40 x 28.7	100	49	6	\$692	\$236
----------	----------------	-----	----	---	--------------	--------------

Freestanding table includes three tapered legs with levelers and Bungee cords. Each table can be "Bungee-tied" to other tables of the same depth. Shipped RTA (ready to assemble). Modesty panels or Filler Modestys are NOT available.

- Available with optional locking casters, specify option "TBC" or "TTC".

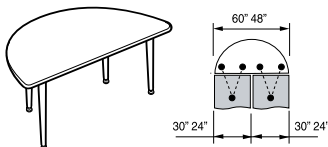

Half Moon Table - Tapered Legs

B2448HMF	24 x 48 x 28.7	100	69	7.76	\$900	\$236
B3060HMF	30 x 60 x 28.7	100	81	8.5	\$956	\$404

Freestanding table includes four tapered legs with levelers and Bungee cords. Each table can be "Bungee-tied" to other tables of the same depth. Shipped RTA (ready to assemble). Modesty panels or Filler Modestys are NOT available.

- Available with optional locking casters, specify option "TBC" or "TTC".

Required Specifications

Top finish
Edge
Leg finish

Optional Specifications

Casters
HP laminate

Accessories

Power Block (position 2 only)

B BUNGEE™ TABLES

HALF MOON TABLES

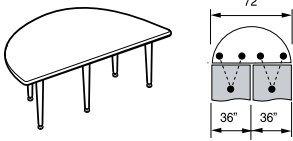

Half Moon Table - Tapered Legs

MODEL#	DIMENSIONS D x W x H	FREIGHT CLASS	WT./LBS.	CUBIC FT.	LIST PRICE	HP ADD
B3672HMF	36 x 72 x 28.7	100	110	11.5	\$1346	\$526

Freestanding table includes five tapered legs with levellers and Bungee cords. Each table can be "Bungee-tied" to other tables of the same depth. Shipped RTA (ready to assemble). Modesty panels or Filler Modestys are NOT available.

- Available with optional locking casters, specify option "TBC" or "TTC".

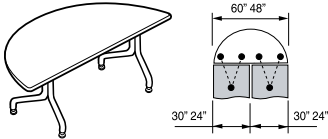

Half Moon Table - Spider Legs

B2448HMS	24 x 48 x 28.7	125	67	9.26	\$1023	\$236
B3060HMS	30 x 60 x 28.7	125	83	11.5	\$1097	\$404

Freestanding table includes two spider legs with levellers and Bungee cords. Each table can be "Bungee-tied" to other tables of the same depth. Shipped RTA (ready to assemble). Modesty panels or Filler Modestys are NOT available.

- Available with optional locking casters, specify option "TBC" or "TTC".

SQUARE TABLES

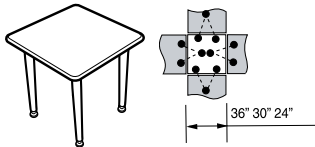

Square Table - Tapered Legs

B2424SQF	24 x 24 x 28.7	92.5	55	4.6	\$856	\$151
B3030SQF	30 x 30 x 28.7	100	65	7.5	\$874	\$223
B3636SQF	36 x 36 x 28.7	100	78	8	\$999	\$265

Freestanding table includes four tapered legs with levellers and Bungee cords. Each table can be "Bungee-tied" to other tables of the same depth. Shipped RTA (ready to assemble). Modesty panels available, see page 521.

- Available with optional locking casters, specify option "TBC" or "TTC".

ROUND WEDGE TABLES

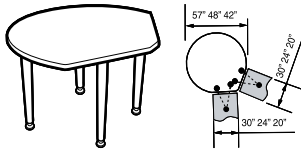

Round Wedge 120° Table

B2042RWF	20 x 42 x 28.7	100	76	8.26	\$956	\$513
B2448RWF	24 x 48 x 28.7	125	85	10.76	\$982	\$513
B3057RWF	30 x 57 x 28.7	100	102	12	\$1167	\$731

Freestanding table includes four tapered legs with levellers and Bungee cords. Each table can be "Bungee-tied" to other tables of the same depth. Shipped RTA (ready to assemble). Modesty panels or Filler Modestys are NOT available.

- Available with bubble edge (BB or BS) only.
- Available with optional locking casters, specify option "TBC" or "TTC".

TEARDROP TABLES

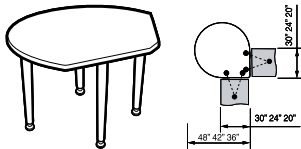

Teardrop 90° Table

B2036TDF	20 x 36 x 28.7	100	71	8	\$900	\$332
B2442TDF	24 x 42 x 28.7	100	81	8.5	\$982	\$513
B3048TDF	30 x 48 x 28.7	100	91	11	\$1079	\$477

Freestanding table includes four tapered legs with levellers and Bungee cords. Each table can be "Bungee-tied" to other tables of the same depth. Shipped RTA (ready to assemble). Modesty panels or Filler Modestys are NOT available.

- Available with bubble edge (BB or BS) only.
- Available with optional locking casters, specify option "TBC" or "TTC".

Required Specifications

Top finish
Edge
Leg finish

Optional Specifications

Casters
High Pressure Laminate

FLAT ROUND TABLES

MODEL# DIMENSIONS FREIGHT CLASS WT/LBS. CUBIC FT. LIST PRICE HP ADD

D x W x H

B2030FRF	20 x 30 x 28.7	100	56	6	\$874	\$296
B2036FRF	20 x 36 x 28.7	100	66	7.26	\$874	\$332
B2436FRF	24 x 36 x 28.7	100	64	7.26	\$874	\$332
B2442FRF	24 x 42 x 28.7	100	76	8.26	\$1039	\$513
B3042FRF	30 x 42 x 28.7	100	74	8	\$1039	\$513
B3048FRF	30 x 48 x 28.7	100	88	11	\$1039	\$469
B3648FRF	36 x 48 x 28.7	125	85	11	\$1150	\$731
B3652FRF	36 x 52 x 28.7	100	93	11	\$1150	\$731

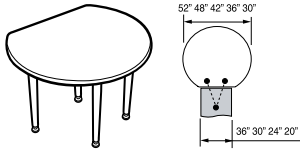

Flat Round Table*

Freestanding table includes four tapered legs with levellers and Bungee cords. Each table can be "Bungee-tied" to other tables of the same depth. Shipped RTA (ready to assemble). Modesty panels or Filler Modestys are NOT available.

- Available with bubble edge (BB or BS) only.
- Available with optional locking casters, specify option "TBC" or "TTC".

MODESTY PANELS

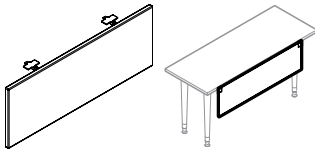

Modesty Panel

BX36QMP	.69 x 21 x 9.6	250	3	1.3	\$114	N/A
BX42QMP	.69 x 27 x 9.6	250	4	1.4	\$120	N/A
BX48QMP	.69 x 33 x 9.6	250	4	1.6	\$127	N/A
BX60QMP	.69 x 45 x 9.6	250	5	2.1	\$138	N/A
BX66QMP	.69 x 51 x 9.6	250	6	2.4	\$144	N/A
BX72QMP	.69 x 57 x 9.6	250	7	2.6	\$151	N/A

For use on **Rectangular** and **Square** Tables. Includes hinged mounting bracket. Available in all Bungee laminate finishes. Edge available in Silver finish (SI) or Black finish (BK).

- Modesty panel model number indicates the width of table to be used on.

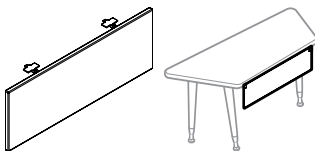

Modesty Panel

BXM60QMP	.69 x 27 x 9.6	300	4	2.1	\$120	N/A
BXM66QMP	.69 x 33 x 9.6	300	4	2.4	\$127	N/A
BXM72QMP	.69 x 39 x 9.6	300	5	2.6	\$132	N/A
BXL60QMP	.69 x 21 x 9.6	300	3	2.1	\$118	N/A
BXL66QMP	.69 x 27 x 9.6	300	4	2.4	\$120	N/A
BXL72QMP	.69 x 33 x 9.6	300	4	2.6	\$127	N/A

For use on **Trapezoid** Tables. Includes hinged mounting bracket. Intended for use on the short side of the table; may be used on long side but leaves a larger gap. Available in all Bungee laminate finishes.

- Modesty panel model number indicates the width of table to be used on.
- Specify **BXM** models for 24" D tables and **BXL** models for 30" D tables.

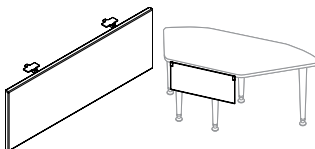

Modesty Panel

BXWQMP	.69 x 27 x 9.6	250	4	1.5	\$120	N/A
--------	----------------	-----	---	-----	--------------	-----

For use on **Wedge** Tables. Includes hinged mounting bracket. Intended for use on the short side of the table. Available in all Bungee laminate finishes. Edge available in Silver finish (SI) or Black finish (BK).

Required Specifications

Top finish
Edge
Leg finish*

Optional Specifications

Casters*
HP laminate*

B BUNGEE™ TABLES

FILLER MODESTY PANELS



Filler Modesty Panel - Straight

MODEL#	DIMENSIONS D x W x H	FREIGHT CLASS	WT/LBS.	CUBIC FT.	LIST PRICE	HP ADD
BSFMS	.25 x 21 x 9	70	1	0.03	\$125	N/A

Used to fill the space between two **square** modesty panels where tables are linked in a straight configuration. Available in Silver (**SI**) or Black (**BK**). Please specify.



Filler Modesty Panel - Straight to Wedge

BSWFM	9 x 19.6 x .25	70	1	1.5	\$135	N/A
-------	----------------	----	---	-----	--------------	-----

Used to fill the space between a straight modesty panel and a wedge table. Use for regular wedge table - tapered legs and flip-top wedge - spider legs. Available in Silver (**SI**) or Black (**BK**). Please specify.

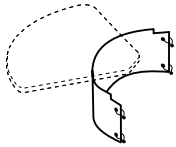

Filler Modesty Panel - Inside Curve

B23IFMS	.06 x 23 x 9	250	3	1.5	\$150	N/A
B29IFMS	.06 x 29 x 9	250	3	1.5	\$150	N/A
B30IFMS	.06 x 30 x 9	70	3	0.15	\$150	N/A

Used to fill the space (inside curve) between two modesty panels where tables are linked at an angle or curve. Use for the inside curve of Round Wedge Tables, Teardrop Tables, or Trapezoid Tables. Available in Silver (**SI**) or Black (**BK**). Please specify.

- Use model **B23IFMS** for Trapezoid Tables inside curve only.
- Use model **B29IFMS** for Teardrop Tables inside curve only.
- Use model **B30IFMS** for Round Wedge Tables inside curve only.

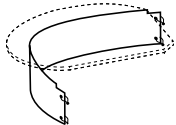

Filler Modesty Panel - Outside Curve

B56S	.06 x 56 x 9	250	4	1.5	\$215	N/A
B62S	.06 x 62 x 9	250	4	1.5	\$233	N/A
B71S	.06 x 71 x 9	250	4	1.5	\$281	N/A

Used to fill the space (outside curve) between two modesty panels where tables are linked at an angle or curve. Use for Teardrop Tables only (**B2036TDF**, **B2442TDF** and **B3048TDF**). Available in Silver (**SI**) or Black (**BK**). Please specify.

- Use model **B56S** for **B2036TDF** Teardrop Tables outside curve only.
- Use model **B62S** for **B2442TDF** Teardrop Tables outside curve only.
- Use model **B71S** for **B3048TDF** Teardrop Tables outside curve only.

Required Specifications

Finish

WIRE MANAGEMENT

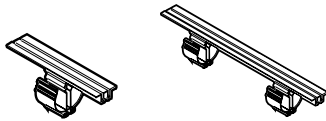

Wire Management - 5" /22" Track

MODEL#	DIMENSIONS D x W x H	FREIGHT CLASS	WT/LBS.	CUBIC FT.	LIST PRICE	HP ADD
BWMS5	2 x 5 x 3.5	70	1	.10	\$17	N/A
BWMD22	2 x 22 x 3.5	70	1	.10	\$24	N/A

Retrofittable track mounts to the underside of worksurface. Includes wire clamp that can route data and voice wires separately. Black only.

- For a 5" track, order model **BWMS5** - includes one wire clamp.
- For a 22" track, order model **BWMD22** - includes two wire clamps.

BOARDROOM TABLE SETS

11 Foot Configurations

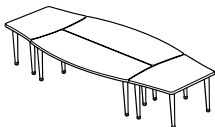

Boardroom Table Set - 11 foot

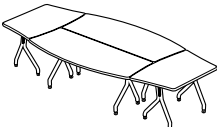

Boardroom Table Set - 11 foot

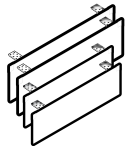

Modesty Panel Set for Boardroom Table

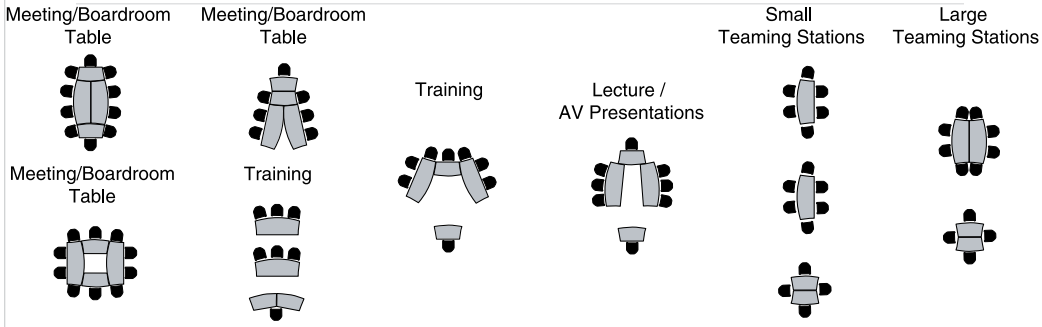

BK132F	60 x 132 x 28.7	70	290	19.25	\$4220	\$1606
--------	-----------------	----	-----	-------	--------	--------

Set includes four freestanding tables with **tapered legs** and Bungee cords for tool free ganging. Leg finish or legs with casters optional, see page 514 . Shipped easy to assemble in 6 cartons. Modesty panel set available, order **BXK132QMP**.

- Due to the unique geometry of the tables, all edge types will feature rounded corners.

BK132S	60 x 132 x 28.7	85	290	22.25	\$4735	\$1606
--------	-----------------	----	-----	-------	--------	--------

Set includes four freestanding tables with **spider legs** and Bungee cords for tool free ganging. Leg finish or legs with casters optional, see page 514 . Shipped easy to assemble in 6 cartons. Modesty panel set available, order **BXK132QMP**.

- Due to the unique geometry of the tables, all edge types will feature rounded corners.

BXK132QMP	.69 x 45 x 9.6	92.5	13	1.10	\$464	N/A
-----------	----------------	------	----	------	-------	-----

For use on **11 foot Boardroom Table Set**. Includes mounting bracket and wire access sweep. Available in all Bungee laminate finishes.

Required Specifications

- Top finish
- Edge
- Leg finish

Optional Specifications

- Casters
- Grommet
- Modesty panel
- HP laminate

B BUNGEE™ TABLES

BOARDROOM TABLE SETS

13/15 Foot Configurations

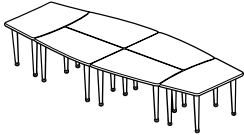

Boardroom Table Set - 13 and 15 foot

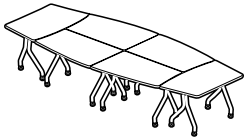

Boardroom Table Set - 13 and 15 foot

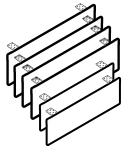

Modesty Panel Set for Boardroom Table

MODEL#	DIMENSIONS D x W x H	FREIGHT CLASS	WT/LBS.	CUBIC FT.	LIST PRICE	HP ADD
Meeting/Boardroom Table	Lecture / AV Presentations	Training			Small Teaming Stations	Large Teaming Stations
Meeting/Boardroom Table	Lecture / AV Presentations	Meeting/Boardroom Table	Training		Small Teaming Stations	
BK156F	60 x 156 x 28.7	85	374	26.25	\$6212	\$2037
BK180F	60 x 180 x 28.7	85	420	29.75	\$6769	\$2327

Set includes six freestanding tables with **tapered legs** and Bungee cords for tool free ganging. Leg finish or legs with casters optional, see page 514 . Shipped easy to assemble in 9 cartons. Modesty panel set available, order **BK156QMP/ BK180QMP**.

- Due to the unique geometry of the tables, all edge types will feature rounded corners.

BK156S	60 x 156 x 28.7	85	374	28.75	\$6409	\$2037
BK180S	60 x 180 x 28.7	85	420	32.50	\$6949	\$2327

Set includes six freestanding tables with **spider legs** and Bungee cords for tool free ganging. Leg finish or legs with casters optional, see page 514 . Shipped easy to assemble in 9 cartons. Modesty panel set available, order **BK156QMP/ BK180QMP**.

- Due to the unique geometry of the tables, all edge types will feature rounded corners.

BXK156QMP	.69 x 33 x 9.6	125	20	2.9	\$785	N/A
BXK180QMP	.69 x 45 x 9.6	125	25	3.2	\$752	N/A

For use on **13 & 15 foot Boardroom Table Set**. Includes mounting bracket and wire access sweep. Available in all Bungee laminate finishes. Edge available in Silver finish (**SI**) or Black finish (**BK**).

- Use model **BXK156QMP** for **BK156F/S** Boardroom Table Set.
- Use model **BXK180QMP** for **BK180F/S** Boardroom Table Set.

Required Specifications

Top finish
Edge
Leg + caster finish

Optional Specifications

Grommet
Modesty panel
HP laminate

Accessories

Power block

RECTANGULAR TABLE - FLIP TOP

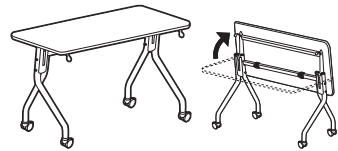
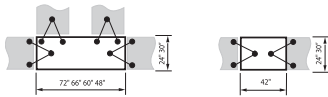

Flip-Top Rectangular Table - Spider Legs

MODEL#	DIMENSIONS	FREIGHT CLASS	WT/LBS.	CUBIC FT.	LIST PRICE	HP ADD
	D x W x H					
BX2442RES	24 x 42 x 29.2	250	66	20.75	\$1554	\$233
BX2448RES	24 x 48 x 29.2	250	72	23.5	\$1575	\$233
BX2460RES	24 x 60 x 29.2	250	84	29	\$1612	\$290
BX2466RES	24 x 66 x 29.2	250	97	31.75	\$1626	\$347
BX2472RES	24 x 72 x 29.2	250	102	34.75	\$1656	\$347
BX3042RES	30 x 42 x 29.2	250	73	25.5	\$1554	\$290
BX3048RES	30 x 48 x 29.2	250	73	28.75	\$1575	\$290
BX3060RES	30 x 60 x 29.2	250	94	35.75	\$1618	\$360
BX3066RES	30 x 66 x 29.2	250	106	39.25	\$1635	\$432
BX3072RES	30 x 72 x 29.2	250	112	42.5	\$1671	\$432

Table features a flip-top worksurface for ease of storage. Single hand release mechanism can be activated from left or right side of the table. Tables can be nested when folded. Each table can be "Bungee-tied" to other tables of the same depth. Folding modesty panels available, see next page.

- **Tables 48" and longer connect in both Straight and "L" configurations**
- **Standard with locking casters**
- **Due to hardware placement, tables placed in back-to-back configurations will not be able to be "Bungee-tied" together.**

TRAPEZOID TABLES - FLIP TOP

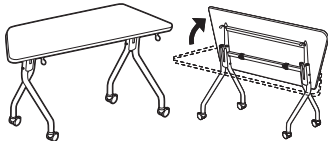
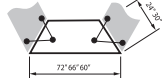

Flip-Top Trapezoid Table - Spider Legs

BX2460TRS	24 x 60 x 29.2	150	112	28	\$1457	\$290
BX2466TRS	24 x 66 x 29.2	250	112	31	\$1481	\$347
BX2472TRS	24 x 72 x 29.2	250	112	33	\$1502	\$347
BX3060TRS	30 x 60 x 29.2	250	112	35.5	\$1489	\$360
BX3066TRS	30 x 66 x 29.2	250	112	39	\$1510	\$432
BX3072TRS	30 x 72 x 29.2	250	112	42.5	\$1532	\$432

Table features a flip-top worksurface for ease of storage. Single hand release mechanism can be activated from left or right side of the table. Tables can be nested when folded. Each table can be "Bungee-tied" to other tables of the same depth. Folding modesty panels available, see next page.

- **Available with bubble edge (BB or BS) only.**
- **Standard with locking casters**

KEYSTONE TABLES - FLIP TOP

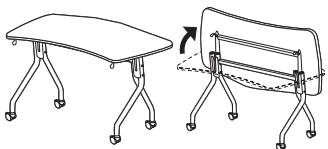

Flip-Top Keystone Table - Spider Legs

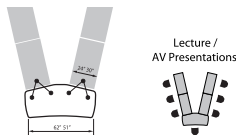

BX24KSS	24 x 51 x 29.2	125	112	16.5	\$1449	\$290
BX30KSS	30 x 62 x 29.2	125	112	16.5	\$1510	\$432

Table features a flip-top worksurface for ease of storage. Single hand release mechanism can be activated from left or right side of the table. Tables can be nested when folded. Each table can be "Bungee-tied" to other tables of the same depth.

- **Modesty panels or Filler Modestys are NOT available.**
- **Standard with locking casters**

Required Specifications

Top finish
Edge
Leg + caster finish

Optional Specifications

Grommet
Modesty panel
HP laminate

Accessories

Power block

B BUNGEE™ TABLES

WEDGE TABLES - FLIP TOP

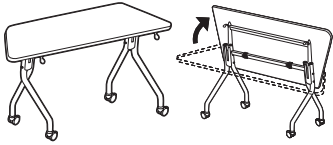

Flip-Top Wedge Table - Spider Legs

MODEL#	DIMENSIONS D x W x H	FREIGHT CLASS	WT/LBS.	CUBIC FT.	LIST PRICE	HP ADD
BX24WES	24 x 63 x 29	60	76	33	\$1825	\$415
BX30WES	30 x 70 x 29.2	250	84	33	\$1855	\$415

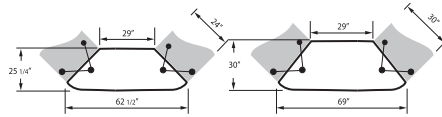
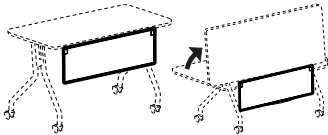

Table features a flip-top worksurface for ease of storage. Single hand release mechanism can be activated from left or right side of the table. Tables can be nested when folded. Each table can be "Bungee-tied" to other tables of the same depth. Folding modesty panels available, see below.

- Standard with locking casters

MODESTY PANELS - FLIP TOP



Modesty Panel

BX36QMP	.69 x 21 x 9.6	250	3	1.3	\$114	N/A
BX42QMP	.69 x 27 x 9.6	250	4	1.4	\$120	N/A
BX48QMP	.69 x 33 x 9.6	250	4	1.6	\$127	N/A
BX60QMP	.69 x 45 x 9.6	250	5	2.1	\$138	N/A
BX66QMP	.69 x 51 x 9.6	250	6	2.4	\$144	N/A
BX72QMP	.69 x 57 x 9.6	250	7	2.6	\$151	N/A

For use on **Flip Top Rectangular Tables**. Includes hinged mounting bracket. Available in all Bungee laminate finishes. Edge available in Silver finish (**SI**) or Black finish (**BK**).

- Modesty panel model number indicates the width of table to be used on.

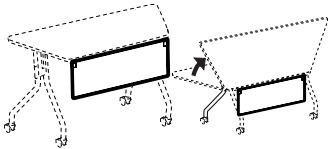

Modesty Panel

BXM60QMP	.69 x 27 x 9.6	300	4	2.1	\$120	N/A
BXM66QMP	.69 x 33 x 9.6	300	4	2.4	\$127	N/A
BXM72QMP	.69 x 39 x 9.6	300	5	2.6	\$132	N/A
BXL60QMP	.69 x 21 x 9.6	300	3	2.1	\$118	N/A
BXL66QMP	.69 x 27 x 9.6	300	4	2.4	\$120	N/A
BXL72QMP	.69 x 33 x 9.6	300	4	2.6	\$127	N/A

For use on **Flip Top Trapezoid Tables**. Includes hinged mounting bracket. Intended for use on the short side of the table; may be used on long side but leaves a larger gap. Available in all Bungee laminate finishes. Edge available in Silver finish (**SI**) or Black finish (**BK**).

- Modesty panel model number indicates the width of table to be used on.
- Specify **BXM** models for 24" D tables and **BXL** models for 30" D tables.

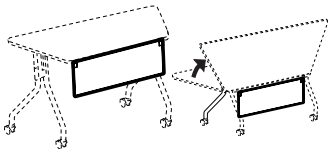

Modesty Panel

BXWQMP	.69 x 27 x 9.6	250	4	1.5	\$120	N/A
--------	----------------	-----	---	-----	--------------	-----

For use on **Flip Top Wedge Tables**. Includes hinged mounting bracket. Intended for use on the short side of the table. Available in all Bungee laminate finishes. Edge available in Silver finish (**SI**) or Black finish (**BK**).

- Modesty panel model number indicates the width of table to be used on.

Required Specifications

Top finish
Edge
Leg + caster finish

Optional Specifications

Grommet
Modesty panel
HP laminate

Accessories

Power block

BOARDROOM TABLE SET - FLIP TOP

MODEL#

DIMENSIONS

FREIGHT CLASS

WT/LBS.

CUBIC FT.

LIST PRICE

HP ADD

D x W x H

4 pc. Configurations

Meeting/Boardroom Table



Meeting/Boardroom Table



Training



Lecture / AV Presentations

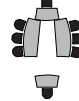

Small Teaming Stations



Large Teaming Stations



Meeting/Boardroom Table



Training



Boardroom Table Set - 4pc. Flip Top

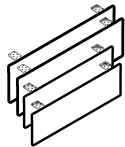

Square Modesty Panel Set for 4pc. Flip Top Table

BXK132S

60 x 132 x 29.2

250

352

151.25

\$5962

\$1641

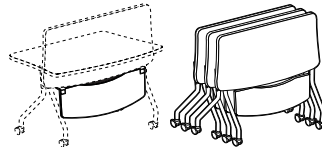

Set includes four freestanding tables with **spider legs** and Bungee cords for tool free ganging. Only legs with casters available, see page 514 for finish choices. All tables feature a flip top worksurface for ease of storage. Single hand release mechanism can be activated from left or right side of table. Tables can be nested when folded. Shipped in 4 cartons. Modesty panel set available, order **BXK132QMP**.

- Due to the unique geometry of the tables, all edge types will feature rounded corners.

BXK132QMP

.69 x 45 x 9.6

150

13

2.5

\$464

N/A

For use on **4 pc. flip top table kits**. Modesty panels flip down for storage. Features black wire access sweep. Available in all Bungee laminate finishes. Edge available in Silver finish (**SI**) or Black finish (**BK**).

Required Specifications

- Top finish
- Edge
- Leg + caster finish

Optional Specifications

- HP laminate

B BUNGEE™ TABLES

MODESTY PANEL SETS

6 pc. Configurations

MODEL#	DIMENSIONS D x W x H	FREIGHT CLASS	WT/LBS.	CUBIC FT.	LIST PRICE	HP ADD

BXK156S	60 x 156 x 29.2	250	452	181.75	\$8826	\$1894
BXK180S	60 x 180 x 29.2	250	507	209.50	\$9040	\$2179



Boardroom Table Set - 6pc. Flip Top

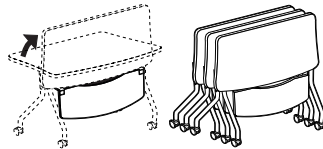

Set includes six freestanding tables with **spider legs** and Bungee cords for tool free ganging. Only legs with casters available, see page 514 for finish choices. All tables feature a flip top worksurface for ease of storage. Single hand release mechanism can be activated from left or right side of table. Tables can be nested when folded. Shipped in 6 cartons. Modesty panel set available, order **BXK156QMP/ BXK180QMP**.

• **Due to the unique geometry of the tables, all edge types will feature rounded corners.**

BXK156QMP	.69 x 33 x 9.6	125	20	2.9	\$785	N/A
BXK180QMP	.69 x 45 x 9.6	125	25	3.2	\$752	N/A

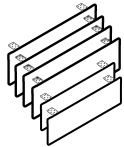

Square Modesty Panel Set for 6 pc. Flip Top Table

For use on **6 pc. flip top table kits**. Modesty panels flip down for storage. Features black wire access sweep. Available in all Bungee laminate finishes. Edge available in Silver finish (**SI**) or Black finish (**BK**).

Required Specifications

Top finish
Edge
Leg + caster finish

Optional Specifications

Grommet

Accessories

Power block

ACCESSORIES

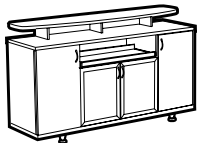

Credenza Buffet

MODEL#	DIMENSIONS D x W x H	FREIGHT CLASS	WT./LBS.	CUBIC FT.	LIST PRICE	HP ADD
B2072BUF	20 x 72 x 42	100	305	37.50	\$3681	\$543

Pull-out shelf. Top transaction shelf is edged with bubble molding. Side storage compartments feature a laminate door and one adjustable shelf each. Center storage features frosted aluminum doors with one adjustable shelf. Leveler feet are standard.

- Some assembly required.

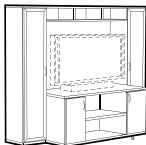

Audio/Visual Cabinet

B249072AV	24 x 90 x 72	92.5	530	52.52	\$6068	\$548
-----------	--------------	------	-----	-------	---------------	--------------

Top pigeon holes and center adjustable shelf accommodate electronic equipment, CDs and other media. Bottom storage compartments feature laminate doors and one adjustable shelf. Side storage towers feature frosted aluminum doors with three adjustable shelves each. Accommodates TVs up to 58" w x 34" h x 24" d.

- Some assembly required.



Lectern

B44LEC	17 x 22 x 44	250	36	12.50	\$925	\$178
--------	--------------	-----	----	-------	--------------	--------------

Features angled stand with pencil ledge. Locking casters. **Specify CS or CK.**

Required Specifications

Top finish
Edge
Leg finish

Optional Specifications

Grommet

Accessories

Power block

B BUNGEE SL™ - NOTES



BUNGEE SL - a completely new product line to complement and coordinate with the Bungee Training Tables series. Bungee SL takes the popular aesthetic of the Bungee series and allows tables to be specified in shared leg and permanent applications - great for training, teaming and academic areas. Bungee SL tops and legs are sold separately, increasing the flexibility of the product in the future and allows for space saving in areas where real estate is a premium.

For greater flexibility, specify **Power and Data Management Troughs** for the BUNGEE SL table series. Add Global's proprietary 4-wire power kits and create inexpensive and versatile training, benching, academic and meeting areas. Front panels are available in Laminate or Aluminum. A center spine version allows for inexpensive double-sided applications.

Features and Benefits

- Tops are 1" thick with a choice of four edges: BB/BS - Bungee bubble edge, AB/AS - split color edge, A3 - matching edge and AR - Bicut edge.
- Legs are offered in Tapered or Spider design in a Tungsten or Black finish. Levelers are standard
- Power and data management troughs are sold separately and are meant to be used on BUNGEE SL only.



Tapered leg with levelers, offered in Tungsten or Black finish.



Optional power and data management troughs for Bungee SL. Center spine shown.



Shared leg, back-to-back tables with center spine trough.

GENERAL INFORMATION

- Introducing **BUNGEE SL** - a completely new product line to complement and coordinate with the top selling Bungee Training Tables series.
- Bungee SL takes the popular aesthetic of the Bungee series and allows tables to be specified in shared leg and permanent applications - great for benching, training, teaming and academic areas.
- Bungee SL tops and legs are sold separately, increasing the flexibility of the product in the future and allows for space saving in areas where real estate is a premium.
- High pressure tops are available in all BUNGEE SL laminates at an extended lead time - please refer to model # for pricing.
- For environmental certifications, please visit globalfurnituregroup.com

CONSTRUCTION

- Tops are 1" thick
- All laminate components are made of 45 lb. density particleboard with high performance thermally fused laminate.
- Tops 60" and over feature a built-in support bar. The support bar is 10" from the **approach** side, and clearance to the bottom of the support bar is 27" from the floor.
- **BUNGEE CORDS ARE NOT INCLUDED AND ARE NOT COMPATIBLE WITH BUNGEE SL TOPS**
- Products specified with the high pressure laminate option are finished on the underside of the surface with a kraft paper backing.

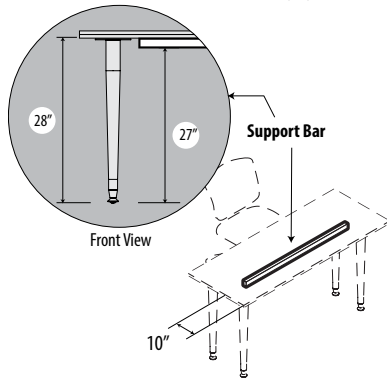

EDGE DETAIL

- Bungee SL comes with a choice of four edge styles:



A3 - square corner, standard edge



AR - square corner, bicut edge



AS - square corner, Silver



AB - square corner, Black



BS - rounded corner, Silver



BB - rounded corner, Black

- **BB/BS** - Bungee Bubble Edge: unique "bubble" molding found on original Bungee
- **AB/AS** - Split color PVC edge: edge matches split color aesthetic of the bubble edge, but allows for 90 degree corners and a cleaner look.
- **A3** - Global's preferred edge. Coordinates well with Adaptabilities and Zira 1" tops.
- **AR** - Bicut edge. Coordinates well with Zira 1" tops.

LEGS

- Two leg styles are available - Tapered and Spider leg. Available in Black (**TBL**) or Tungsten (**TTU**) finish. Levelers are standard; casters are not available for Bungee SL legs. Levelers adjust 3mm - 10mm in height.

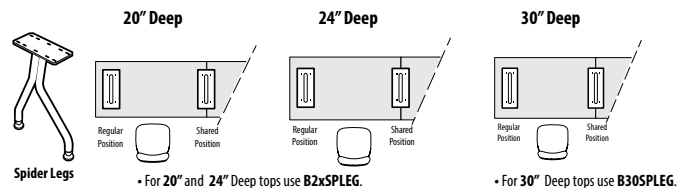

MODESTY PANELS

- See **POWER AND DATA MANAGEMENT TROUGHS** - page 537
- For modesty panels without power and data management, please see **Bungee modesty panels**, found on page 547

WIRE MANAGEMENT / POWER OPTIONS

- **TO UTILIZE BUNGEE SL TO THE FULLEST EXTENT, SPECIFY POWER AND DATA MANAGEMENT TROUGH (SEE PAGE 537).**
- For basic wire management, see details on page 547.

1. SPECIFY MODEL NUMBER

2. SPECIFY FINISH

Laminate Finishes:

ACJ	Absolute Acajou	NBL	Noce Biondo
ASN	Asian Night	NGL	Noce Grigio
AWC	Avant Cherry	NEL	Noce Leggero
AWH	Avant Honey	NML	Noce Medio
BLK	Black	QTM	Quartered Mahogany
BRC	Brushed Cobalt	SBY	Sheer Beauty
BZD	Blizzard	SDT	Stonedust
CMB	Clear Maple	SOG	Storm Grey
CGY	Custom Grey	WHE	Walnut Heights
DES	Dark Espresso	WHC	White Chocolate
DWT	Designer White	WCR	Winter Cherry
FAS	Fashionista		

Edge:

BB	Bungee bubble edge with Black trim
BS	Bungee bubble edge with Silver trim
AB	Split color edge with Black trim
AS	Split color edge with Silver trim
A3	Matching edge
AR	Matching bicut edge

Legs:

TBL	Black
TTU	Tungsten

3. SPECIFY OPTIONS

GROMMETS

- Optional Grommets available in standard worksurface locations (left, center or right) for **rectangular tops 48" and up**. Order as: **AG1, AG2 or AG3 - Add \$96**
- Optional grommets are available in **center position only** for **rectangular tops (36" and 42")**, **keystone**, **half moon** and **wedge tops**. Order as **AG2 - Add \$96**.
- Grommet hole dimensions are 3.25" wide x 1.875" deep.
- Grommets may be placed at non-standard locations. Order as: **AGS - Add \$96**. A drawing must be supplied with vertical and horizontal dimensions to the center of the cut-out (as in drawing below). Please refer to CUSTOM GROMMET LOCATION FORM in the back reference section.

Grommet hole dimensions

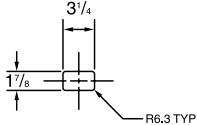

Grommet

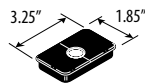

Keystone

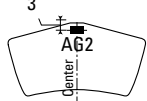

Half Moon

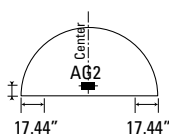

Wedge



Rectangular Tops

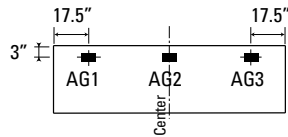
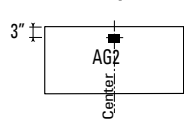

For 36" and 42" wide units

For 48", 60" and 72" wide units

Rectangular Tops

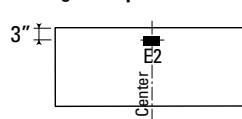

For 36", 42" and 48" wide units

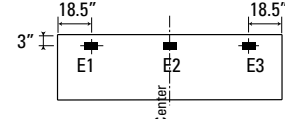

For 60" and 72" wide units

VILLA POWER BLOCK (CORDED VERSION ONLY)

- A Villa power block (corded) is available in four options (see page 544 for Villa Corded details). Villa power block (corded) dimensions vary by model. Villa cutout dimensions are 3"D x 5.25"W.
- A Villa cutout may be ordered for **rectangular tops 48" and up**. Order as: **V1, V2 or V3 - Add \$96 for each cutout**.
- A Villa cutout may be ordered in the **center position only** for **rectangular tops (36" and 42")**, **keystone** and **half moon tops**. Order as: **V2 - Add \$96**.
- Order Villa Power Block and Villa Grommet Cover separately, see page 544 for pricing and details.

Keystone

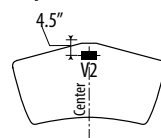

Half Moon

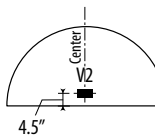

Villa Power Block

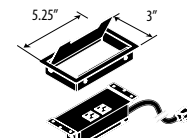

Rectangular Tops

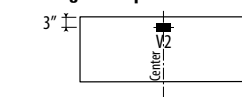

For 36", 42" and 48" wide units

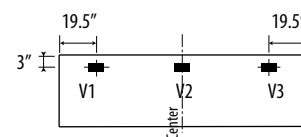

For 60" and 72" wide units

POWER BLOCK

- A Power Block is a rectangular worksurface power/data module with one electrical duplex receptacle and two data (RJ45) receptacles. 9' black cord included. Power block dimensions are 3.5"D x 6.5"W x 2.75"H. Power block cutout dimensions are 2.75"D x 6"W.
- A power block cutout (model **PMSPPDM**) may be ordered for **rectangular tops (48" and up)** in place of standard grommets. Order as **E1, E2 or E3. Add \$96**.
- A power block cutout (model **PMSPPDM**) may be ordered in the **center position only** for **rectangular tops (36" and 42")**, **keystone** and **half moon tops**. Order as **E2. Add \$96**.
- To purchase a power block, you must specify both the power block cut-out location and the power block model #. Order power block separately as **PMSPPDM, Add \$330**.

Keystone

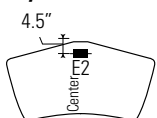

Half Moon

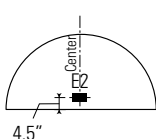

Power Block

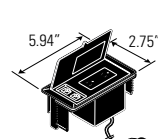

MODPOWER DAISY CHAIN SOLUTION

- Add flexible power and USB charging to Bungee SL rectangular tables. Connect up to four units with a single corded infeed with NEMA plug.
- ModPower units are sold separately, refer to Productivity Solutions page 465.
- Begin run with a starter unit which includes a corded infeed. Add additional middle or end units as required. Middle and end units are equipped with connecting cables.
- On-surface modules clamp on or screw mount to the table tops.
- In-surface modules require table top cut-outs for mounting. Specify cut-out option:
 - **MPS** for a single cut-out to accommodate one ModPower in-surface unit (cut-out will be centered on the approach side) for **42" to 72" wide rectangular tables. Add \$96**
 - **MPD** for two cut-outs in the left and right positions, 18.25" from ends to center of unit on approach side for **60", 66" and 72" wide rectangular tables. Add \$192**.

TOPS WITH SQUARE CORNERS (A3, AR OR AB/AS EDGE)	MODEL#	DIMENSIONS	FREIGHT CLASS	WT/LBS.	CUBIC FT.	LIST PRICE	HP ADD
---	--------	------------	---------------	---------	-----------	------------	--------

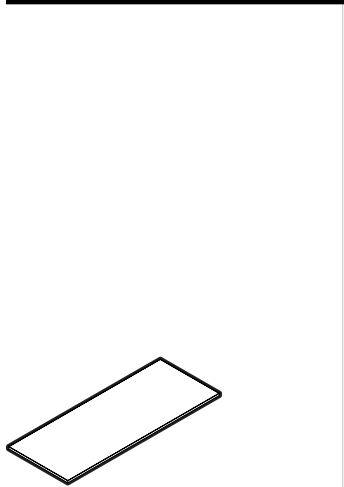

Rectangular Top - Square Corners

	D x W x H						
BS3072REC	30 x 72 x 1	70	60	4	\$575	\$494	
BS3060REC	30 x 60 x 1	70	53	3.4	\$480	\$411	
BS3048REC	30 x 48 x 1	70	46	2.7	\$295	\$331	
BS3042REC	30 x 42 x 1	70	42	2.4	\$287	\$290	
BS3036REC	30 x 36 x 1	70	38	2.1	\$229	\$250	
BS2472REC	24 x 72 x 1	70	51	3.3	\$503	\$396	
BS2460REC	24 x 60 x 1	70	44	2.8	\$439	\$331	
BS2448REC	24 x 48 x 1	70	37	2.3	\$251	\$264	
BS2442REC	24 x 42 x 1	70	33	2	\$237	\$234	
BS2436REC	24 x 36 x 1	70	29	1.8	\$224	\$200	
BS2072REC	20 x 72 x 1	85	43	2.9	\$467	\$331	
BS2060REC	20 x 60 x 1	70	37	2.4	\$396	\$278	
BS2048REC	20 x 48 x 1	70	30	2	\$236	\$234	
BS2042REC	20 x 42 x 1	70	27	1.8	\$218	\$200	
BS2036REC	20 x 36 x 1	70	24	1.5	\$205	\$200	

Rectangular 1" thick worksurface with **Square Corners**. Can accept Tapered (B29TPLEG) or Spider Legs (B2XSPLEG / B30SPLEG) in "end of run" or shared leg positions. Tops 60" and up include a built-in support bar. Shipped RTA (ready to assemble). Compatible with **power and data management troughs** (see page 537) or standard modesty panels (see page 573).

- For worksurfaces to be used as a return, please see Return Tops.
- Legs sold separately.

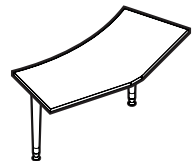

Keystone Top - Square Corners

BS30KSF	30.5 x 62.75 x 28.7	150	37	7.2	\$1112	\$494
BS24KSF	28.75 x 52 x 28.7	150	29	5.6	\$1029	\$361
BS20KSF	27.75 x 44 x 28.7	150	25	4.8	\$1016	\$299

1" thick worksurface with **Square Corners**. Includes (2) Tapered legs. *Not available with Spider Legs*. Connects to other tops of 20", 24" or 30" depths. Shipped RTA (ready to assemble). Modesty panels or filler panels are NOT available.

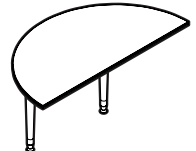

Half Moon Top - Square Corners

BS3060HMF	29.75 x 59.4 x 28.7	150	36	6.6	\$956	\$411
BS2448HMF	24 x 48.2 x 28.7	150	24	4.6	\$900	\$264

1" thick worksurface with **Square Corners**. Includes (2) Tapered legs. *Not available with Spider Legs*. Connects to other tables equaling the same length. Shipped RTA (ready to assemble). Modesty panels or filler panels are NOT available.



90° Wedge Top - Square Corners

BS24WE	26.8 x 26.8 x 1	92.5	15	1.5	\$278	\$234
BS20WE	22.8 x 22.8 x 1	100	10	1.2	\$205	\$200

1" thick worksurface with **Square Corners**. Can accept Tapered (B29TPLEG) or Spider Legs (B2XSPLEG / B30SPLEG) in shared positions only. Shipped RTA (ready to assemble). Accepts filler modesty panels.

- Legs sold separately.

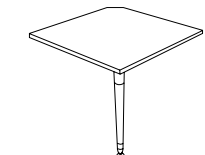

90° Corner - Square Corners

BS30CN	33.2 x 33.2 x 28.7	125	36	2.50	\$624	\$194
--------	--------------------	-----	----	------	-------	-------

Connects to 30" Deep Rectangular Tables. Includes (1) Tapered leg. *Not available with Spider Legs*.

Required Specifications

Top Finish
Top / Edge Detail

Optional Specifications

Grommet
Power/Data Management Troughs -
(Rectangular tops only)
Modesty Panel (Rectangular tops only)

HP Laminate

Accessories

Power Block
Villa Power Block (Corded)

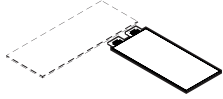

Rectangular Return Tops - Square Corners

MODEL#	DIMENSIONS D x W x H	FREIGHT CLASS	WT./LBS.	CUBIC FT.	LIST PRICE	HP ADD
BS3054RRE	30 x 54 x 1	70	50	3.1	\$314	\$372
BS3048RRE	30 x 48 x 1	70	46	2.7	\$295	\$331
BS3042RRE	30 x 42 x 1	70	42	2.4	\$287	\$290
BS3036RRE	30 x 36 x 1	70	38	2.1	\$229	\$250
BS2454RRE	24 x 54 x 1	70	40	2.5	\$272	\$299
BS2448RRE	24 x 48 x 1	70	37	2.3	\$251	\$264
BS2442RRE	24 x 42 x 1	70	33	2	\$237	\$234
BS2436RRE	24 x 36 x 1	70	29	1.8	\$224	\$200
BS2054RRE	20 x 54 x 1	70	33	2.2	\$258	\$250
BS2048RRE	20 x 48 x 1	70	30	2	\$236	\$223
BS2042RRE	20 x 42 x 1	70	27	1.8	\$218	\$200
BS2036RRE	20 x 36 x 1	70	24	1.5	\$205	\$167

Rectangular 1" thick worksurface with **Square Corners**. Includes two flat brackets to attach to another worksurface on one end. Can accept Tapered (B29TPLEG) or Spider Legs (B2XSPLEG / B30SPLEG) on the other end. 54" tops include a built-in support bar. Shipped RTA (ready to assemble). Compatible with standard modesty panels (see page 555).

- For worksurfaces to be used as a main surface, please see Rectangular Tops.
- Legs sold separately.

TOPS WITH ROUNDED CORNERS (BB/BS EDGES ONLY)



Rectangular Top - Rounded Corners

BB3072REC	30 x 72 x 1	85	59	4	\$737	\$494
BB3060REC	30 x 60 x 1	70	52	3.4	\$616	\$411
BB3048REC	30 x 48 x 1	70	45	2.7	\$375	\$331
BB3042REC	30 x 42 x 1	70	41	2.4	\$367	\$290
BB3036REC	30 x 36 x 1	70	37	2.1	\$296	\$250
BB2472REC	24 x 72 x 1	70	50	3.3	\$646	\$396
BB2460REC	24 x 60 x 1	70	43	2.8	\$562	\$331
BB2448REC	24 x 48 x 1	70	36	2.3	\$319	\$264
BB2442REC	24 x 42 x 1	70	32	2	\$305	\$234
BB2436REC	24 x 36 x 1	70	28	1.8	\$287	\$200
BB2072REC	20 x 72 x 1	85	42	2.9	\$599	\$331
BB2060REC	20 x 60 x 1	70	36	2.4	\$507	\$278
BB2048REC	20 x 48 x 1	85	29	2	\$302	\$234
BB2042REC	20 x 42 x 1	85	26	1.8	\$278	\$200
BB2036REC	20 x 36 x 1	70	23	1.5	\$260	\$200

Rectangular 1" thick worksurface with **Rounded Corners**. Can accept Tapered (B29TPLEG) or Spider Legs (B2XSPLEG / B30SPLEG) in "end of run" or shared leg positions. Tops 60" and up include a built-in support bar. Shipped RTA (ready to assemble). Compatible with **power and data management troughs** (see page 537) or standard modesty panels (see page 555).

- For worksurfaces to be used as a return, please see Return Tops
- Legs sold separately.

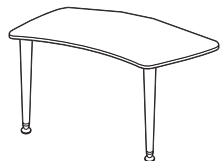

Keystone Top - Rounded Corners

BB30KSF	30.5 x 62.75 x 28.7	150	36	7.2	\$1112	\$494
BB24KSF	28.75 x 52 x 28.7	150	28	5.6	\$1029	\$361
BB20KSF	27.75 x 44 x 28.7	150	24	4.8	\$1016	\$299

1" thick worksurface with **Rounded Corners**. Includes (2) Tapered legs. *Not available with Spider Legs*. Connects to other tops of 20", 24" or 30" depths. Shipped RTA (ready to assemble). Modesty panels or filler panels are NOT available.

Required Specifications

Top Finish
Top / Edge Detail

Optional Specifications

Grommet
Power/Data Management Troughs -
(Rectangular tops only)
Modesty Panel

HP Laminare

Accessories

Power Block
Villa Power Block (Corded)

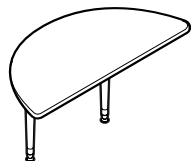

Half Moon Top - Rounded Corners

MODEL#	DIMENSIONS D x W x H	FREIGHT CLASS	WT/LBS.	CUBIC FT.	LIST PRICE	HP ADD
BB3060HMF	29.75 x 59.4 x 28.7	150	35	6.6	\$956	\$411
BB2448HMF	24 x 48.2 x 28.7	150	23	4.6	\$900	\$264

1" thick worksurface with **Rounded Corners**. Includes (2) Tapered legs. *Not available with Spider Legs*. Connects to other tables equaling the same length. Shipped RTA (ready to assemble). Modesty panels or filler panels are NOT available.



90° Wedge Top - Rounded Corners

BB24WE	26.8 x 26.8 x 1	100	14	1.5	\$356	\$234
BB20WE	22.8 x 22.8 x 1	125	9	1.2	\$260	\$200

1" thick worksurface with **Rounded Corners**. Can accept Tapered (B29TPLEG) or Spider Legs (B2XSPLEG / B30SPLEG) in shared positions only. Shipped RTA (ready to assemble). Accepts filler modesty panels.

- Legs sold separately.

BB3054RRE	30 x 54 x 1	70	50	3.06	\$403	\$372
BB3048RRE	30 x 48 x 1	70	46	2.75	\$375	\$331
BB3042RRE	30 x 42 x 1	70	42	2.44	\$367	\$290
BB3036RRE	30 x 36 x 1	70	38	2.13	\$296	\$250

BB2454RRE	24 x 54 x 1	70	40	2.54	\$347	\$299
BB2448RRE	24 x 48 x 1	70	37	2.28	\$319	\$264
BB2442RRE	24 x 42 x 1	70	33	2.03	\$305	\$234
BB2436RRE	24 x 36 x 1	70	29	1.77	\$287	\$200

BB2054RRE	20 x 54 x 1	70	33	2.2	\$329	\$250
BB2048RRE	20 x 48 x 1	70	30	1.97	\$302	\$223
BB2042RRE	20 x 42 x 1	70	27	1.75	\$278	\$200
BB2036RRE	20 x 36 x 1	70	24	1.53	\$260	\$167

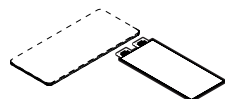

Rectangular Return Tops - Rounded Corners

Rectangular 1" thick worksurface with **Rounded Corners**. Includes two flat brackets to attach to another worksurface on one end. Can accept Tapered (B29TPLEG) or Spider Legs (B2XSPLEG / B30SPLEG) on the other end. 54" tops include a built-in support bar. Shipped RTA (ready to assemble). Compatible with standard modesty panels (see page 573).

- For worksurfaces to be used as a main surface, please see Rectangular Tops
- Legs sold separately.

BB30CN	33.17 x 33.17 x 28.7	125	36	2.50	\$671	\$194
--------	----------------------	-----	----	------	--------------	--------------

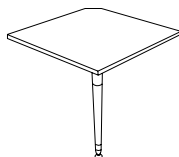

90° Corner - Rounded Corners

Connects to 30" Deep Rectangular Tables. Includes (1) Tapered leg. *Not available with Spider Legs*.

B30SPLEG	25 x 6 x 27.7	150	16	2.9	\$403	
----------	---------------	-----	----	-----	--------------	--



Spider Legs for 30"D Tables

Spider leg with levers. Shipped/sold one per carton. **Tops sold separately.**

- Available in Tungsten (TTU) or Black (TBL). Please specify.
- **To be used with 30"D tops only**

Required Specifications

Top Finish
Top / Edge Detail

Optional Specifications

Grommet
Filler Modesty Panel (Wedge Tops only)
Modesty Panel (Rectangular Return Tops)
HP Laminate

Accessories

Power Block
Villa Power Block (Corded)

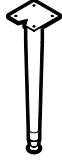
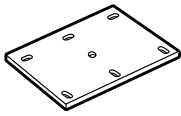
	MODEL#	DIMENSIONS	FREIGHT CLASS	WT/LBS.	CUBIC FT.	LIST PRICE
 <p>Spider Legs for 20" & 24" D Tables</p>	B2XSPLEG	D x W x H 20 x 6 x 27.7	125	14	2.2	\$348
	<p>Spider leg with levellers. Shipped/sold one per carton. Tops sold separately.</p> <ul style="list-style-type: none"> • Available in Tungsten (TTU) or Black (TBL). Please specify. • To be used with 20" & 24" deep tops only 					
 <p>Tapered Leg</p>	B29TPLEG	6 x 6 x 27.7	85	11	0.8	\$165
	<p>Tapered leg with levellers for tables of all depths. Shipped/sold one per carton. Tops sold separately.</p> <ul style="list-style-type: none"> • Available in Tungsten (TTU) or Black (TBL). Please specify. 					
 <p>Flat Bracket</p>	B6PLT	6 x 6 x .25	70	2	0.1	\$57
	<p>To be used as a mending plate for Bungee SL. Black only. Shipped/sold one per pack.</p>					

Required Specifications

Leg Finish

GENERAL INFORMATION

- Power and Data Management Troughs for the **BUNGEE SL** table series. Add Global's proprietary 4-wire power kits and create inexpensive and versatile training, benching, academic and meeting areas.
- Front panels are available in aluminum. A center spine version allows for inexpensive double-sided applications.
- **POWER AND DATA MANAGEMENT TROUGHS** are sold separately and are meant to be used on **BUNGEE SL only**.
- **POWER AND DATA MANAGEMENT TROUGHS** accept Global's 4-wire power kit in addition to numerous data, phone and other multimedia wires.
- Filler modesty panels conceal wiring in spaces not covered by troughs.
- For environmental certifications, please visit globalfurnituregroup.com

FINISHES

LAMINATE:

ACJ Absolute Acajou	FCL First Class
ASN Asian Night	NBL Noce Biondo
AWC Avant Cherry	NGL Noce Grigio
AWH Avant Honey	NEL Noce Leggero
BLK Black	NML Noce Medio
BZD Blizzard	QTM Quartered Mahogany
BRC Brushed Cobalt	SBY Sheer Beauty
CMB Clear Maple	SOG Storm Grey
CGY Custom Grey	SDT Stonedust
DES Dark Espresso	WHE Walnut Heights
DWT Designer White	WHC White Chocolate
FAS Fashionista	WCR Winter Cherry

Aluminum Face Panel, Trough, Filler Panels and End Caps:

Black (BLK) Tungsten (TUN)

LAMINATE FACE PANEL (LFP)

- Laminate face panel (LFP) on the approach side is 11/16" thick. LFP height is 13".
- Rear access panel is 1/4" thick laminate. Rear panel height is 7.25".
- LFP and rear panel swing up to allow wire access and feature a flexible sweep at the top.
- All laminate components are made of 45 lb. commercial density particle board, covered on both sides with high performance, thermally fused laminate.
- The trough portion of the unit is made of a heavy duty aluminum extrusion to allow wire systems (including Global's 4-Wire System) to lie within the bottom.
- **LFP is available in Black (BLK) laminate only.**
- Aluminum trough available in Tungsten (TUN) or Black (BLK) finish, please specify.
- Rear access panel is finished in Black (BLK) laminate.
- End Caps (JBEC) sold separately

side view

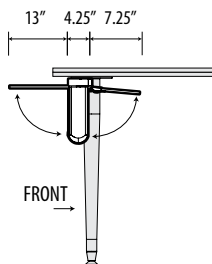

Tops, legs and end caps not included

CENTER SPINE (CS)

- 1/4" thick laminate panels on both sides of the unit. Panel height is 7.25".
- Both panels swing up to allow wire access and feature a flexible sweep at the top.
- All laminate components are made of 45 lb. commercial density particle board, covered on both sides with high performance, thermally fused laminate.
- The trough portion of the unit is made of a heavy duty aluminum extrusion to allow wire systems (like Global's 4-Wire System) to lie within the bottom.
- Aluminum trough available in Tungsten (TUN) or Black (BLK) finish, please specify (rear access panel is finished in Brushed Cobalt (BRC) laminate when TUN is specified, or both access panels are finished in Black (BLK) laminate when BLK is specified).
- End Caps (JBEC) sold separately.



Tops, legs and end caps not included

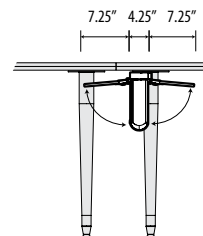

B BUNGEE SL™ POWER/DATA MANAGEMENT TROUGHS - NOTES

FILLER MODESTY PANELS

- Used to fill the space between two power and data management troughs and conceal wiring from the approach side
- Straight Filler allows for use in straight configurations between two rectangular tables with power and data management troughs
- Curved Filler allows for use at curve with 90° wedge tables between two rectangular tables with power and data management troughs
- Available in Silver (SI) or Black (BK) finish. Please specify.

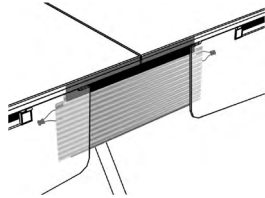

Straight Filler Modesty Panel

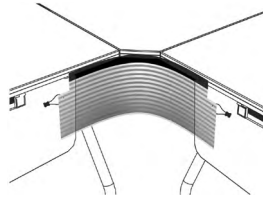

Curved Filler Modesty Panel

END CAPS

- Plastic end caps with decorative insert. Required for beginning and end of runs.
- Cap can be notched in field to allow wire infeed pass through.
- Charcoal finish only.



WIRE MANAGEMENT

- Two wire manager clamps are included within all power and data management troughs.
- Attached to the unit, they can slide from side to side to accommodate wiring systems
- Data, voice, multi-media and power can be routed separately using channels on each wire manager.
- Additional wire manager clamps are available to retrofit.
- Available in black only.

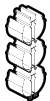

GLOBAL 4-WIRE POWER SYSTEM

- Global's proprietary power system comes with everything you need to power your **BUNGEE SL** layouts. Kits coordinate to the size of the table being used and fit snugly into the bottom of the power and data management trough.
- Single duplex kits come with one duplex – centered on the wiring harness. Duplexes are 6" wide.
- Double duplex kits come with two duplexes – 11" of wiring on each side of the harness allows for flexibility between connections. Duplexes are 6" wide.
- One end of the harness kit features a female connection, while the opposite end features a male connection for a quick and easy connect/disconnect
- Actual kit length is 1" longer than nominal
- Must be hardwired using infeeds (specified separately) by a licensed electrician
- All conduits are enclosed in a black nylon sleeve to reduce visibility
- All duplexes and connectors are plastic. Black only.
- **8 DUPLEXES PER CIRCUIT MAXIMUM** – maximums are to National Electric Code (NEC) – some local codes vary from NEC code – it is the customer's responsibility to follow all applicable local codes and guidelines.

ELECTRICAL SYSTEM

- 4-2 Wiring Schematic
- 4-Wire Shared Neutral
- Complies with National Electric Code
- UL Listed
- All circuits rated for 20 AMP

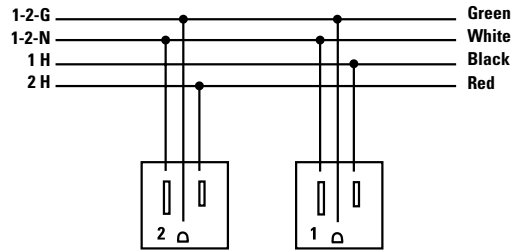

PRODUCT

MAX UNITS PER CIRCUIT

P42S	8 units per circuit
P42D	4 units per circuit

POWER/DATA MANAGEMENT TROUGH PLACEMENT

Single Table - AFP

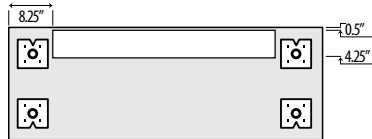

Shared Leg Table - AFP:

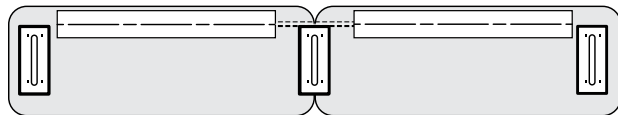
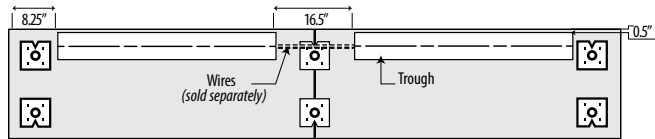

CS

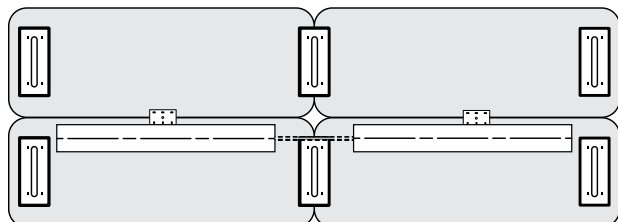
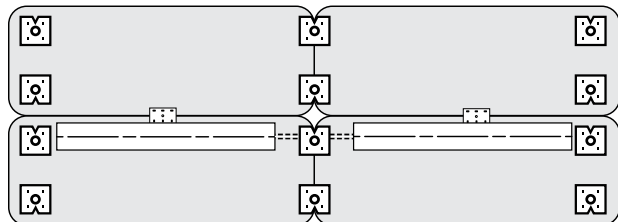
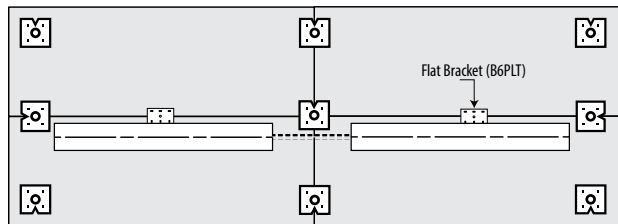

GLOBAL 4-WIRE POWER TO POWER/DATA MANAGEMENT TROUGH:

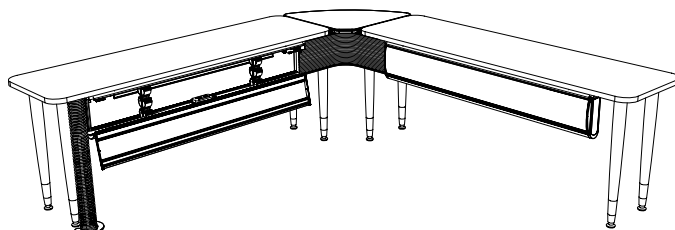

Bungee SL with AFP Power/Data Management Trough - 90° Corner Application

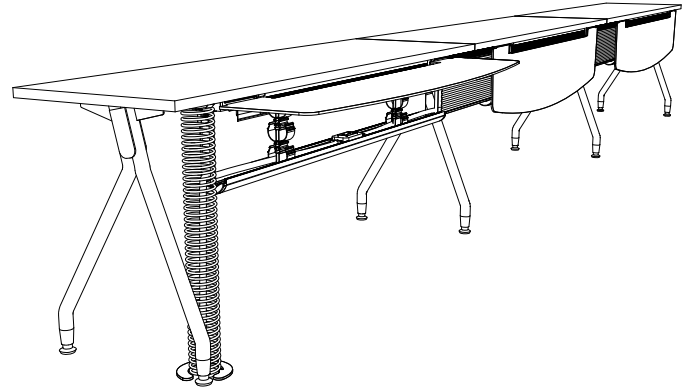

Bungee SL with LFP Power/Data Management Trough - Single Sided Straight Run

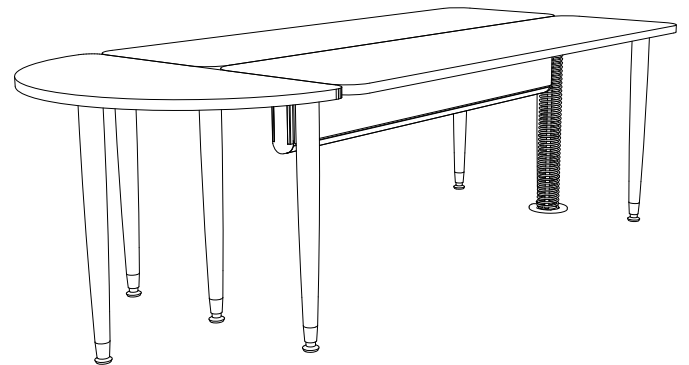

Bungee SL with CS Power/Data Management Trough - Back to Back Application (shown with power snake)

UTILIZING POWER BLOCKS AND GROMMETS WITH POWER/DATA MANAGEMENT TROUGH

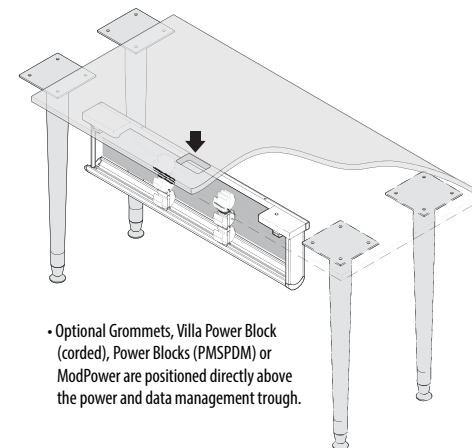

• Optional Grommets, Villa Power Block (corded), Power Blocks (PMSPDM) or ModPower are positioned directly above the power and data management trough.



Grommet



Power Block

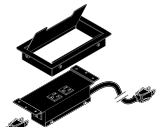

Villa Coded

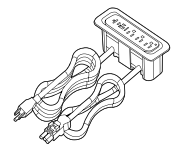

ModPower

B BUNGEE SL™ POWER/DATA MANAGEMENT TROUGHS

MODEL# DIMENSIONS FREIGHT CLASS WT/LBS. CUBIC FT. LIST PRICE

D x W x H

JB72L	4.25 x 55.75 x 10	125	23	2.9	\$857
JB60L	4.25 x 43.75 x 10	125	18	2.3	\$767
JB48L	4.25 x 31.75 x 10	100	14	1.7	\$667
JB42L	4.25 x 25.75 x 10	100	12	1.5	\$618
JB36L	4.25 x 19.75 x 10	100	10	1.2	\$566

Trough w/Laminate Face Panel (LFP)

For use on rectangular Bungee SL surfaces only. Out-facing laminate panel swings up to allow wire access and features flexible sweep at the top. In-facing laminate panel swings up to allow wire access and features flexible sweep at the top. Black wire management clamps included.

- To fill the gap between two power/data management trough (LFP) modules in a straight run, a single filler modesty panel (JBFSFM) is recommended.
- To fill the gap between two power/data management trough (LFP) modules at 90°, a corner filler modesty panel (JBCFM) is recommended.
- Model # corresponds to the size table power/data management trough will fit on (i.e. JB72L will fit a 72" wide table).
- Laminate panels are Black - no finish options available.



JB72C	4.25 x 55.75 x 10	100	19	2.20	\$774
JB60C	4.25 x 43.75 x 10	100	15	1.80	\$729
JB48C	4.25 x 31.75 x 10	100	12	1.30	\$617
JB42C	4.25 x 25.75 x 10	100	10	1.10	\$575
JB36C	4.25 x 19.75 x 10	60	8	.08	\$532

Trough w/Center Spine (CS)

For use on rectangular Bungee SL surfaces only in back-to-back applications only. Two laminate panels swing up to allow wire access and feature flexible sweep at the top. Black wire management clamps included.

- To fill the gap between two power/data management trough (CS) modules in a straight run, two filler modesty panels (JBFSFM) are recommended to conceal wiring from both sides.
- Model # corresponds to the size table power/data management trough will fit on (i.e. JB72C will fit a 72" wide table).
- Laminate panels are Black - no finish options available.

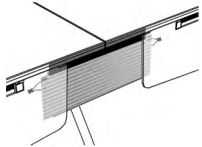

Straight Filler Modesty Panel

Straight filler modesty is used to fill the space between two power/data management trough modules where tables are linked in a straight configuration.

- In center spine applications, two straight filler modesty panels should be specified to cover cabling and wires from both sides.
- Filler modesty panels are reversible with Black (BK) finish on one side and Silver (SI) finish on the opposite side.

JBFSFM	0.25 x 22.5 x 9	70	1.60	.04	\$187
--------	-----------------	----	------	-----	--------------

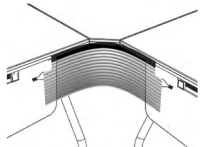

Curved Filler Modesty Panel*

Curved filler modesty is used to fill the space between two power/data management troughs where tables are linked at a 90° curve.

- For interior curves only.
- Filler modesty panels are reversible with Black (BK) finish on one side and Silver (SI) finish on the opposite side.

JBCFM	0.25 x 22.5 x 9	70	1.80	.05	\$223
-------	-----------------	----	------	-----	--------------

Optional Specifications

4-Wire Power System

ACCESSORIES



End Cap

MODEL#	DIMENSIONS	FREIGHT CLASS	WT/LBS.	CUBIC FT.	LIST PRICE
--------	------------	---------------	---------	-----------	------------

	D x W x H				
JBEC	3 x 8 x 1	70	1	.15	\$46

Plastic end cap to be snapped into place at the end of power/data management troughs. To be specified for the beginning and end of runs for a finished look. Charcoal finish only.

- Plastic cap can be notched in the field to allow infeed or data cable pass-through.

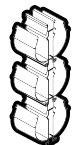

Wire Management Clamp

JBWM2	2.5 x 6 x 1.75	70	1	.01	\$168
-------	----------------	----	---	-----	--------------

Wire management track with double wire clamp - triple height. Can be affixed to the underside of worksurface using double-sided tape (supplied) or retrofit into power/data management trough modules. Black finish only.

- Recommended for use at 90° corners.
- Retrofitting requires disassembly of power/data management trough modules.

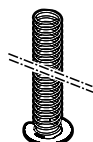

Power Snake

JBPS	4 x 4 x 34	100	2	.25	\$160
------	------------	-----	---	-----	--------------

Attaches to the underside of worksurface with supplied wood screws. Used to organize and channel wires from the power/data management trough down to the floor infeed. Black finish only.

B BUNGEE SL™ POWER/DATA MANAGEMENT TROUGHS

4-WIRE POWER SYSTEM

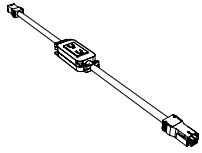

Single Duplex Kit

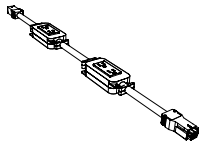

Double Duplex Kit



Power Harness Jumper

MODEL#	DIMENSIONS	FREIGHT CLASS	WT/LBS.	CUBIC FT.	LIST PRICE
--------	------------	---------------	---------	-----------	------------

D x W x H

Circuit 1:

P42S-72-1	73 x 2 x 2	60	3.19	.10	\$195
P42S-60-1	61 x 2 x 2	60	2.82	.09	\$178
P42S-48-1	49 x 2 x 2	60	2.44	.08	\$164
P42S-42-1	43 x 2 x 2	60	2.26	.07	\$156
P42S-36-1	37 x 2 x 2	60	2.07	.06	\$149

Circuit 2:

P42S-72-2	73 x 2 x 2	60	3.19	.10	\$195
P42S-60-2	61 x 2 x 2	60	2.82	.09	\$178
P42S-48-2	49 x 2 x 2	60	2.44	.08	\$164
P42S-42-2	43 x 2 x 2	60	2.26	.07	\$156
P42S-36-2	37 x 2 x 2	60	2.07	.06	\$149

Single Duplex Kit includes one black plastic duplex connected to harnesses. Male connection (IN) on one side with female connection (OUT) on the opposite for easy connect and disconnect. Conduit is wrapped in black nylon sleeve. Actual length is 1" longer than nominal.

- Model # corresponds to the size table power/data management trough will fit on (i.e. P42S-48 will fit a JB48A, JB48L or JB48C module).
- Infeed required for connection to building power. Sold separately (next page).

Circuit 1:

P42D-72-1	2 x 73 x 2	60	3.01	.10	\$226
P42D-60-1	2 x 61 x 2	65	2.63	.09	\$208
P42D-48-1	2 x 49 x 2	65	2.26	.08	\$194
P42D-42-1	2 x 43 x 2	65	2.07	.07	\$187
P42D-36-1	2 x 37 x 2	70	1.88	.06	\$178

Circuit 2:

P42D-72-2	2 x 73 x 2	60	3.01	.10	\$226
P42D-60-2	2 x 61 x 2	65	2.63	.09	\$208
P42D-48-2	2 x 49 x 2	65	2.26	.08	\$194
P42D-42-2	2 x 43 x 2	65	2.07	.07	\$187
P42D-36-2	2 x 37 x 2	70	1.88	.06	\$178

Double Duplex Kit includes two black plastic duplexes connected to harnesses. Male connection (IN) on one side with female connection (OUT) on the opposite for easy connect and disconnect. Conduit is wrapped in black nylon sleeve. Actual length is 1" longer than nominal.

- Both duplexes on the kit will be assigned to the same circuit.
- Model # corresponds to the size table power/data management trough will fit on (i.e. P42D-48 will fit a JB48A, JB48L or JB48C module).
- Infeed required for connection to building power. Sold separately (below).

P42J-72	2 x 73 x 2	60	3	.10	\$176
P42J-60	2 x 61 x 2	60	2.73	.09	\$157
P42J-48	2 x 49 x 2	65	2.35	.08	\$139
P42J-42	2 x 43 x 2	60	2.16	.07	\$129
P42J-36	2 x 37 x 2	70	1.98	.06	\$120
P42J-18	2 x 19 x 2	70	1.41	.04	\$93

Male connection (IN) on one side with female connection (OUT) on the opposite for easy connect and disconnect. Conduit is wrapped in black nylon sleeve. Actual length is 1" longer than nominal.

- Use P42J-18 between two power/data management troughs separated by Bungee SL wedge, keystone or half moon tables
- Use all other sizes to jump between power kits on power/data management troughs that are NOT powered (i.e. use a P42J-60 as a pass-through on a 60" wide non-powered table between POWERED power/data management trough modules).

4-WIRE POWER SYSTEM

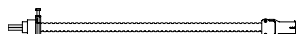

72" Multi-circuit Hardwire Infeed

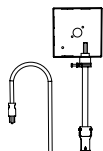

Single-circuit 3-Prong Infeed

MODEL#	DIMENSIONS	FREIGHT CLASS	WT./LBS.	CUBIC FT.	LIST PRICE
--------	------------	---------------	----------	-----------	------------

D x W x H

P42HW-72	1 x 72 x 1	70	6.50	.30	\$193
----------	------------	----	------	-----	--------------

72" Multi-circuit Hardwire Infeed (up to 20 AMPS per circuit), two circuits. Provides single power entry from floor or wall located building power supply. Conduit is wrapped in black nylon sleeve.

- Connects P42S or P42D kits. **Power circuit 1, circuit 2 or a mix.**
- **TO BE HARDWIRED BY LICENSED ELECTRICIAN.** UL listed.
- Where Liquid Tight conduit is required, specify P42HW-72L

P42TP-120	8 x 4 x 2	70	6.10	.30	\$239
P42TP-72	8 x 4 x 4	60	4.50	.15	\$218

Hardwire junction box included (to be mounted on underside of table). Provides single power entry from floor or wall located building power supply. Conduit is wrapped in black nylon sleeve. Allows for quick and easy disconnection from the wall. Available in 72" or 120" overall lengths.

- Connects P42S or P42D kits. **Power circuit 1 only.**
- **TO BE HARDWIRED BY LICENSED ELECTRICIAN.** UL listed.

B BUNGEE SL™ POWER/DATA MANAGEMENT TROUGHS

POWER BLOCK

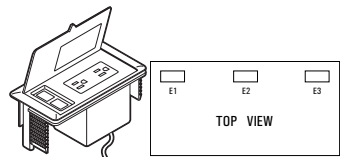

Power/Data Block

MODEL#	DIMENSIONS D x W x H	FREIGHT CLASS	WT./LBS.	CUBIC FT.	LIST PRICE
PMSPDM	3.5 x 6.5 x 2.75	70	2	.10	\$330

Worksurface power and data module. Two power receptacles and two data receptacles. 9' cord. Specify position and **add \$96** for cut-out in worksurface. See diagram E1/E2/E3 for specification location. Black (**BLK**) only.

VILLA I SERIES CORDED UNITS

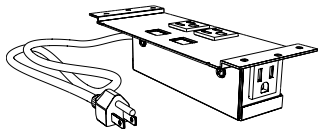

Data Knockouts, No Data Ports

VIL-C-DKO-_-108	3.25 x 8.75 x 2.25	100	4	.45	\$249
VIL-C-DKO-_-72	3.25 x 8.75 x 2.25	100	4	.45	\$249

Villa I with 3-prong plug. Includes **two power receptacles** and two knockouts for data. A third convenience receptacle is provided below the worksurface. **V1, V2 or V3 cutout(s) must be specified on training table** (see product notes section for more details and cutout upcharge). **Grommet cover is required and sold separate** (see below). UL/CUL listed.

- Replace _ with **B** for **Black**
- Replace _ with **S** for **Silver Pearl**

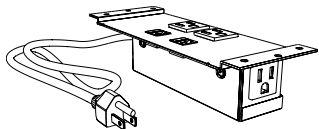

Data Knockouts, Data Ports Included

VIL-C-D-_-108	3.25 x 8.75 x 2.25	100	4	.45	\$402
VIL-C-D-_-72	3.25 x 8.75 x 2.25	100	4	.45	\$402

Villa I with 3-prong plug. Includes **two power receptacles** and **two RJ45 Cat 6** data. A third convenience receptacle is provided below the worksurface. **V1, V2 or V3 cutout(s) must be specified on training table** (see product notes section for more details and cutout upcharge). **Grommet cover is required and sold separate** (see below). UL/CUL listed.

- Replace _ with **B** for **Black**
- Replace _ with **S** for **Silver Pearl**

VILLA GROMMET COVERS

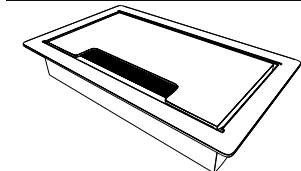

Villa Grommet Cover

VIL-GROM-F-_-	3.5 x 5.75 x .94	70	1	.08	\$126
---------------	------------------	----	---	-----	--------------

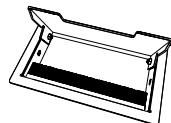

Powder coated flush metal grommet to be used with Villa I **corded** series power blocks. Cutouts in tables must be specified separately. **V1, V2 or V3 cutout(s) must be specified on training table** (see product notes section for more details and cutout upcharge). **Grommet cover remains open while in use.**

- **Cannot be used with PMSPDM.**
- Replace _ with **B** for **Black**
- Replace _ with **S** for **Silver Pearl**

Required Specifications

Face panel and box finish - BLK or TUN



Bring people together. Collaborative Spaces™ fosters teamwork through adaptable environments that can transform at a moment's notice or evolve over time. Optimize existing spaces with individual pieces or create new ones with the full range of mobile team carts, work tables and accessories. Scale up, scale down, create a space for the way you work.

Collaborative Spaces' range of laptop tables can transform any area into a productive workspace. Hospitality carts to support team meetings in relaxed settings, with all the essentials to keep the team fueled up.

Create learning hubs with large workshop and collaboration tables and shelf carts for all the resources they require to get their ideas out into the world. Collaborative Spaces is designed to withstand demanding environments in education.

Features and Benefits

- Tables offered with small (1.5") or large (9") radius corners
- Tables are available with glides or casters
- Media units and power accessories provide means for hybrid collaboration
- Accessories like undersurface bag hooks and trays for bag drops keep items out of the way and off the floor.
- PET felt screens provide privacy and noise reduction while dividing space. PET felt screens clip onto shelf carts with included brackets.
- Laptop shelves and media trays can be added to media carts.
- Wire management accessories at the leg and undersurface hide excess cables.
- Undersurface power modules can be positioned anywhere along the table edge.



Optional recessed power tray



Optional steel mesh tray keeps bags and other personal items off the floor



Cart mounted PET Felt privacy panel

GENERAL INFORMATION

- Collaborative Spaces™ includes a range of products that complement each other.
- Series includes collaboration and workshop tables in three heights: 29", 36" and 42"; occasional tables, laptop tables, team carts, and a variety of accessories.
- Aluminum beams provide strength and rigidity for long term use.
- Combine elements to demark space, absorb ambient noise and afford visual privacy.
- PET felt wire manager hangs from underside of worksurface to organize wires.
- Collaborative Spaces' robust aluminum framework supports high-traffic applications and is 100% recyclable.
- For environmental certifications, please visit globalfurnituregroup.com.

CONSTRUCTION

- All tables are standard in high performance thermally fused laminate. Optional high pressure (HP) laminate available.
- High performance thermally fused laminate tops are 1" thick particle board and have a flat 3mm edge profile on all sides
- High pressure (HP) laminate tops are 1-1/16" thick laminate particle board and have a flat 3mm edge profile on all sides
- Laminate surfaces offer a selection of matching + coordinating edgeband. Specify separately from the surface finish.



- Products specified with the high pressure laminate option are finished on the underside of the surface with a kraft paper backing.
- Grommet location must be specified at the time of order or it will default to a no grommet option.
- Power modules and grommets are not included and must be specified separately.
- Table legs and bases are painted aluminum finish.
- Tables are shipped knocked down and must be assembled on site.
- Corner radius for small radius table tops is 1.5".
- Corner radius for large radius tables tops is 9".
- Top end overhang for large tables is 10.5"
- Worksurface support beams and footrests (where applicable) are centered for tables 18" and 24" deep.
- Worksurface support beams and footrests (where applicable) are 9" from the outside table edges for tables 30" deep.
- Worksurface support beams and footrests (where applicable) are 12" from the outside table edges for tables 36 to 48" deep.
- The top of footrests on café height tables is 8.4" above the floor.
- The top of footrests on bar height tables is 14.4" above the floor.
- Cart shelf load capacities : 120 lbs. for 42" wide (Hospitality Cart), 140 lbs. for 48" wide and 175 lbs. for 60" wide.

HOW TO SPECIFY:

Example: SCTWSL2472:

SC	Spaces Collaborative	<i>Other Options:</i>	C Cafe height table - 36"
W	Work height table - 29"	B	Bar height table - 42"
S	Small radius - 1.5"	L	Large radius - 9"
L	Levelers	C	Casters, available in Black (BLK) or Grey (GRC)
24	Depth		
72	Width		
LP	Low pressure laminate	HP	High pressure laminate

FINISHES

Metal Finishes:

BLK	Black
BZD	Blizzard
CHR	Charcoal
DWT	Designer White
INK	Ink
NEV	Nevada
SIL	Silver
SDT	Stonedust
TPE	Taupe
TUN	Tungsten

Laminate Finishes (thermally fused and high pressure laminates):

ACJ	Absolute Acajou
ASN	Asian Night
AWC	Avant Cherry
AWH	Avant Honey
BLK	Black
BZD	Blizzard
BRC	Brushed Cobalt - Coordinates with TUN edgeband finish
CGY	Custom Grey - Coordinates with SIL edgeband finish
CMB	Clear Maple
DES	Dark Espresso
DWT	Designer White
FAS	Fashionista
FCL	First Class
NBL	Noce Biondo
NGL	Noce Grigio
NEL	Noce Leggero
NML	Noce Medio
QTM	Quartered Mahogany
SBY	Sheer Beauty
SDT	Stonedust
SOG	Storm Grey - Coordinates with CHR edgeband finish
STG	String - Coordinates with NEV edgeband finish
WHC	White Chocolate
WHE	Walnut Heights
WCR	Winter Cherry

Edgeband Finishes:

AAE	Absolute Acajou	NGL	Noce Grigio
ASE	Asian Night	NEL	Noce Leggero
ACE	Avant Cherry	NML	Noce Medio
AHE	Avant Honey	NEV	Nevada (use w/STG)
BLK	Black	QTM	Quartered Mahogany
BRC	Brushed Cobalt	SBY	Sheer Beauty
BZD	Blizzard	SIL	Silver
CHR	Charcoal (use w/SOG)	SDT	Stonedust
CME	Clear Maple	TPE	Taupe
DEE	Dark Espresso	TUN	Tungsten (use w/BRC)
DWE	Designer White	WHE	Walnut Heights
FAS	Fashionista	CBE	White Chocolate
FCL	First Class	WCE	Winter Cherry
NBL	Noce Biondo		

Caster Finish:

BLK	Black
GRC	Grey

PET Felt Colors

BLK	Black
BRI	Brick
DEN	Denim
GPH	Graphite
HVT	Harvest
MTS	Mist
PWT	Pewter
SHR	Shamrock
WHT	White

POWER ACCESSORY CUT-OUT LOCATIONS

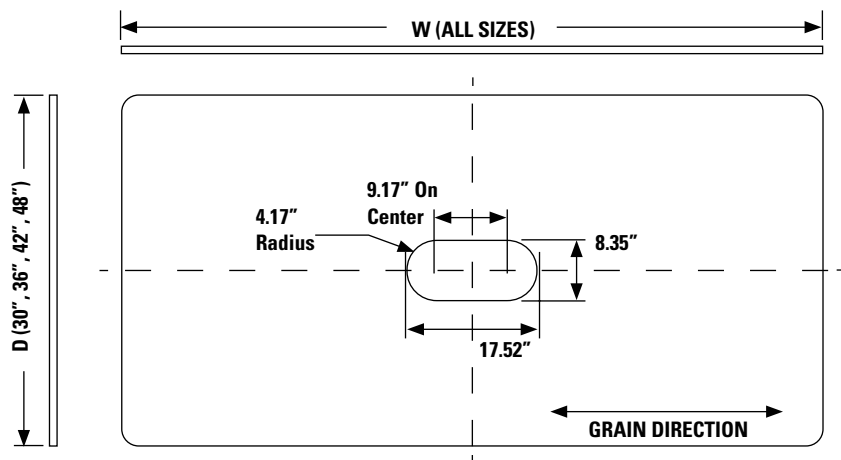

NOTES:

1. **O2, OS** cut-out for SCTAPT + SCTAPR power accessories.
2. Cut-out not available for 18" and 24" deep tables.
3. Cut-out position **O2** available only.
4. These rules apply to both small and large radius table tops. Small radius top shown.

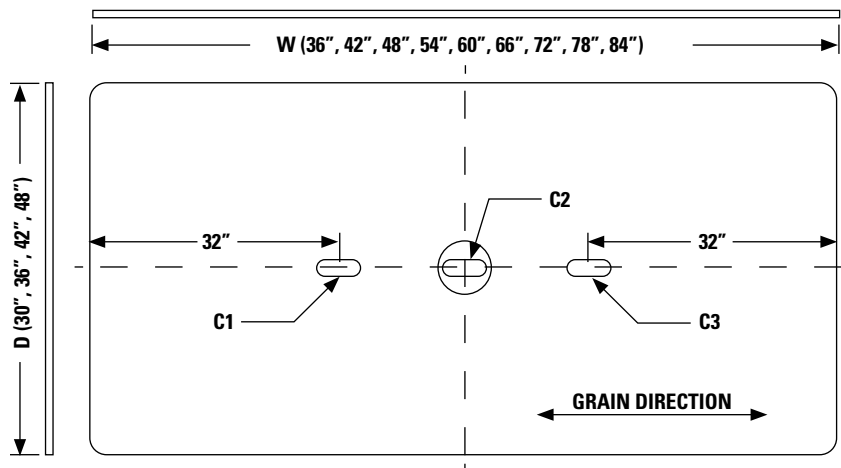

NOTES:

1. **C1, C2, C3, CS** cut-out for SCTAPS + SCTAPR power accessories.
2. Cut-out not available for 18" and 24" deep tables.
3. **C2** cut-outs available on all table widths.
4. **C1** and **C3** cut-outs only available on 90" + 96" w tables.
5. These rules apply to both small and large radius table tops. Small radius top shown.

COLLABORATION TABLES - 29"H

MODEL#	DIMENSIONS	FREIGHT CLASS	WT/LBS.	CUBIC FT.	LIST PRICE	HP ADD
D x W x H						
SCTWD1836	18 x 36 x 29	70	35.54	2.33	\$713	\$84
SCTWD1842	18 x 42 x 29	70	38.52	2.52	\$741	\$102
SCTWD1848	18 x 48 x 29	70	47.05	2.71	\$820	\$116
SCTWD1854	18 x 54 x 29	70	50.88	2.9	\$857	\$130
SCTWD1860	18 x 60 x 29	70	54.7	3.08	\$889	\$195
SCTWD1866	18 x 66 x 29	70	58.52	3.27	\$931	\$218
SCTWD1872	18 x 72 x 29	70	62.34	3.46	\$973	\$236
SCTWD2436	24 x 36 x 29	85	41.51	3.11	\$764	\$116
SCTWD2442	24 x 42 x 29	85	45.49	3.36	\$801	\$135
SCTWD2448	24 x 48 x 29	70	55.02	3.61	\$885	\$153
SCTWD2454	24 x 54 x 29	70	59.83	3.86	\$936	\$171
SCTWD2460	24 x 60 x 29	70	64.65	4.11	\$973	\$254
SCTWD2466	24 x 66 x 29	70	69.46	4.36	\$1024	\$282
SCTWD2472	24 x 72 x 29	70	74.27	4.61	\$1070	\$310
SCTWD3036	30 x 36 x 29	85	47.47	3.89	\$815	\$144
SCTWD3042	30 x 42 x 29	85	52.45	4.2	\$862	\$166
SCTWD3048	30 x 48 x 29	85	62.98	4.51	\$954	\$190
SCTWD3054	30 x 54 x 29	85	68.78	4.83	\$1010	\$213
SCTWD3060	30 x 60 x 29	85	74.59	5.14	\$1056	\$319
SCTWD3066	30 x 66 x 29	85	80.4	5.45	\$1112	\$351
SCTWD3072	30 x 72 x 29	60	86.2	2.76	\$1167	\$384

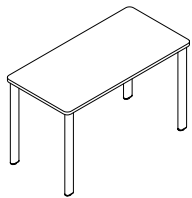

**Core Collaboration Table, 29"H,
Small Radius, Levelers**

Consists of four individual legs and one surface with a small 1.5" radius at each corner.

- Worksurface choice of thermally fused or high pressure laminate with PVC edge.
- Legs are painted extruded aluminum. Levelers have 1" adjustment for leveling.
- Tables from 48" to 72" include a center worksurface support beam.
- Center worksurface support beam eliminates the possibility of a power accessory cut-out.

Required specifications

Laminate finish
Edge finish
Paint finish

Optional specifications

HP laminate

Accessories

Table leg cable organizer,
PET felt modesty panel,
Table mounted bag hook,
Nik power modules, PET felt wire manager

COLLABORATION TABLES - 29"H

MODEL#	DIMENSIONS	FREIGHT CLASS	WT/LBS.	CUBIC FT.	LIST PRICE	HP ADD
D x W x H						
SCTWWSL1836	18 x 36 x 29	70	40.05	2.33	\$1088	\$88
SCTWWSL1842	18 x 42 x 29	70	43.65	2.52	\$1158	\$102
SCTWWSL1848	18 x 48 x 29	70	50.15	2.71	\$1380	\$116
SCTWWSL1854	18 x 54 x 29	70	53.75	2.9	\$1413	\$129
SCTWWSL1860	18 x 60 x 29	70	57.34	3.08	\$1468	\$144
SCTWWSL1866	18 x 66 x 29	70	60.93	3.27	\$1500	\$158
SCTWWSL1872	18 x 72 x 29	70	64.52	3.46	\$1575	\$171
SCTWWSL1878	18 x 78 x 29	70	68.12	3.65	\$1607	\$185
SCTWWSL1884	18 x 84 x 29	70	71.71	3.83	\$1639	\$199
SCTWWSL1890	18 x 90 x 29	70	75.31	4.02	\$1760	\$213
SCTWWSL1896	18 x 96 x 29	70	78.9	4.21	\$1788	\$231
SCTWWSL2436	24 x 36 x 29	85	43.05	3.11	\$1172	\$116
SCTWWSL2442	24 x 42 x 29	85	46.65	3.36	\$1250	\$135
SCTWWSL2448	24 x 48 x 29	85	53.15	3.61	\$1477	\$153
SCTWWSL2454	24 x 54 x 29	85	56.75	3.86	\$1519	\$171
SCTWWSL2460	24 x 60 x 29	85	60.34	4.11	\$1584	\$190
SCTWWSL2466	24 x 66 x 29	85	63.93	4.36	\$1621	\$208
SCTWWSL2472	24 x 72 x 29	85	67.52	4.61	\$1704	\$227
SCTWWSL2478	24 x 78 x 29	85	71.12	4.86	\$1741	\$250
SCTWWSL2484	24 x 84 x 29	85	74.71	5.11	\$1778	\$269
SCTWWSL2490	24 x 90 x 29	85	78.31	5.36	\$1908	\$287
SCTWWSL2496	24 x 96 x 29	85	81.9	5.61	\$1945	\$305
SCTWWSL3036	30 x 36 x 29	92.5	46.05	3.89	\$1408	\$143
SCTWWSL3042	30 x 42 x 29	92.5	49.65	4.2	\$1533	\$167
SCTWWSL3048	30 x 48 x 29	85	56.15	4.51	\$1797	\$190
SCTWWSL3054	30 x 54 x 29	85	59.75	4.83	\$1843	\$213
SCTWWSL3060	30 x 60 x 29	85	63.34	5.14	\$1940	\$241
SCTWWSL3066	30 x 66 x 29	85	66.93	5.45	\$1987	\$263
SCTWWSL3072	30 x 72 x 29	85	70.52	5.76	\$2121	\$287
SCTWWSL3078	30 x 78 x 29	85	74.12	6.08	\$2190	\$310
SCTWWSL3084	30 x 84 x 29	92.5	77.71	6.7	\$2237	\$333
SCTWWSL3090	30 x 90 x 29	85	81.31	6.39	\$2459	\$356
SCTWWSL3096	30 x 96 x 29	85	84.9	7.01	\$2505	\$380

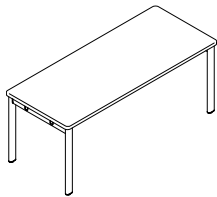

Standard Collaboration Table, 29"H, Small Radius, Levelers

Consists of two leg assemblies, worksurface support beams, and worksurface with a small 1.5" radius at each corner.

- Worksurface choice of thermally fused or high pressure laminate with PVC edge.
- Legs are painted extruded aluminum. Levelers have 1" adjustment for leveling.
- Cut-outs for power modules are limited to specific sizes/configurations, please see "Power Accessory Cut-out Locations".
- 18" and 24" deep tables feature one worksurface support beam.
- 30" deep tables feature two worksurface support beams.

Required specifications

Laminate finish
Edge finish
Paint finish

Optional specifications

HP laminate
Power accessory cut-out

Accessories

Table leg cable organizer,
PET felt modesty panel,
Table mounted bag hook,
Nik power modules, PET felt wire manager

COLLABORATION TABLES - 36" CAFE HEIGHT

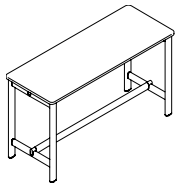

For 18" and 24"D surfaces

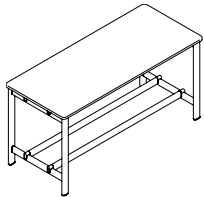

For 30"D tables, 36" to 72"W

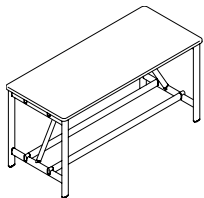

For 30"D tables, 78" to 96"W

Café Height Collaboration Table, 36"H, Small Radius, Levelers

MODEL#	DIMENSIONS D x W x H	FREIGHT CLASS	WT/LBS.	CUBIC FT.	LIST PRICE	HP ADD
SCTCSL1836	18 x 36 x 36	70	50.14	2.33	\$1547	\$88
SCTCSL1842	18 x 42 x 36	70	54.34	2.52	\$1658	\$102
SCTCSL1848	18 x 48 x 36	65	61.46	2.71	\$1880	\$111
SCTCSL1854	18 x 54 x 36	65	65.66	2.9	\$1908	\$130
SCTCSL1860	18 x 60 x 36	65	69.87	3.08	\$1996	\$139
SCTCSL1866	18 x 66 x 36	65	74.07	3.27	\$2024	\$157
SCTCSL1872	18 x 72 x 36	65	78.28	3.46	\$2144	\$171
SCTCSL1878	18 x 78 x 36	65	82.48	3.65	\$2176	\$186
SCTCSL1884	18 x 84 x 36	65	86.69	3.83	\$2204	\$204
SCTCSL1890	18 x 90 x 36	65	90.9	4.02	\$2417	\$213
SCTCSL1896	18 x 96 x 36	65	95.1	4.21	\$2445	\$231
SCTCSL2436	24 x 36 x 36	70	67.83	3.11	\$1658	\$116
SCTCSL2442	24 x 42 x 36	70	74.58	3.36	\$1778	\$135
SCTCSL2448	24 x 48 x 36	65	84.23	3.61	\$2005	\$153
SCTCSL2454	24 x 54 x 36	65	90.98	3.86	\$2042	\$171
SCTCSL2460	24 x 60 x 36	65	97.73	4.11	\$2135	\$190
SCTCSL2466	24 x 66 x 36	65	104.48	4.36	\$2172	\$213
SCTCSL2472	24 x 72 x 36	65	111.23	4.61	\$2301	\$227
SCTCSL2478	24 x 78 x 36	65	117.98	4.86	\$2338	\$250
SCTCSL2484	24 x 84 x 36	65	124.73	5.11	\$2375	\$269
SCTCSL2490	24 x 90 x 36	65	131.48	5.36	\$2593	\$287
SCTCSL2496	24 x 96 x 36	65	138.23	5.61	\$2635	\$301
SCTCSL3036	30 x 36 x 36	70	86.09	3.89	\$2079	\$144
SCTCSL3042	30 x 42 x 36	65	95.44	4.2	\$2288	\$166
SCTCSL3048	30 x 48 x 36	65	107.7	4.51	\$2519	\$194
SCTCSL3054	30 x 54 x 36	65	117.05	4.83	\$2565	\$218
SCTCSL3060	30 x 60 x 36	65	126.41	5.14	\$2718	\$241
SCTCSL3066	30 x 66 x 36	65	135.76	5.45	\$2764	\$264
SCTCSL3072	30 x 72 x 36	65	145.11	5.76	\$2991	\$283
SCTCSL3078	30 x 78 x 36	65	156.91	6.08	\$3209	\$310
SCTCSL3084	30 x 84 x 36	65	166.26	6.7	\$3255	\$333
SCTCSL3090	30 x 90 x 36	65	175.62	6.39	\$3658	\$356
SCTCSL3096	30 x 96 x 36	65	184.97	7.01	\$3704	\$380

Consists of two leg assemblies, worksurface support beam(s), footrest(s), and one worksurface with a small 1.5" radius at each corner.

- Worksurface choice of thermally fused or high pressure laminate with PVC edge.
- Legs are painted extruded aluminum. Levelers have 1" adjustment for leveling.
- Cut-outs for power modules are limited to specific sizes/configurations, please see "Power Accessory Cut-out Locations".
- 18" and 24" deep tables feature one worksurface support beam and one footrest.
- 30" deep tables feature two worksurface support beams and two footrests.
- 30" deep tables 78" wide and greater include a reinforcement cantilever for added stability.

Required specifications

Laminate finish
Edge finish
Paint finish

Optional specifications

HP laminate
Power accessory cut-out

Accessories

Table leg cable organizer,
PET felt modesty panel,
Table mounted bag hook,
Nik power modules, PET felt wire manager

COLLABORATION TABLES - 42" BAR HEIGHT

MODEL#	DIMENSIONS	FREIGHT CLASS	WT/LBS.	CUBIC FT.	LIST PRICE	HP ADD
D x W x H						
SCTBSL1836	18 x 36 x 42	65	70.28	3.11	\$1672	\$83
SCTBSL1842	18 x 42 x 42	65	77.02	3.36	\$1783	\$97
SCTBSL1848	18 x 48 x 42	65	86.68	3.61	\$2000	\$116
SCTBSL1854	18 x 54 x 42	65	93.43	3.86	\$2033	\$130
SCTBSL1860	18 x 60 x 42	65	100.18	4.11	\$2116	\$144
SCTBSL1866	18 x 66 x 42	65	106.93	4.36	\$2149	\$157
SCTBSL1872	18 x 72 x 42	65	113.68	4.61	\$2269	\$171
SCTBSL1878	18 x 78 x 42	65	120.43	4.86	\$2297	\$185
SCTBSL1884	18 x 84 x 42	65	127.18	5.11	\$2329	\$199
SCTBSL1890	18 x 90 x 42	65	133.93	5.36	\$2538	\$212
SCTBSL1896	18 x 96 x 42	65	140.67	5.61	\$2570	\$227
SCTBSL2436	24 x 36 x 42	65	52.58	2.33	\$1783	\$116
SCTBSL2442	24 x 42 x 42	65	56.79	2.52	\$1903	\$130
SCTBSL2448	24 x 48 x 42	65	63.9	2.71	\$2130	\$153
SCTBSL2454	24 x 54 x 42	65	68.11	2.9	\$2167	\$171
SCTBSL2460	24 x 60 x 42	65	72.31	3.08	\$2260	\$190
SCTBSL2466	24 x 66 x 42	65	76.52	3.27	\$2297	\$208
SCTBSL2472	24 x 72 x 42	65	80.72	3.46	\$2422	\$231
SCTBSL2478	24 x 78 x 42	65	84.93	3.65	\$2463	\$246
SCTBSL2484	24 x 84 x 42	65	89.13	3.83	\$2500	\$269
SCTBSL2490	24 x 90 x 42	65	93.34	4.02	\$2718	\$287
SCTBSL2496	24 x 96 x 42	65	97.55	4.21	\$2755	\$306
SCTBSL3036	30 x 36 x 42	65	88.53	3.89	\$2204	\$139
SCTBSL3042	30 x 42 x 42	65	97.89	4.2	\$2408	\$167
SCTBSL3048	30 x 48 x 42	65	110.14	4.51	\$2644	\$190
SCTBSL3054	30 x 54 x 42	65	117.05	4.83	\$2690	\$213
SCTBSL3060	30 x 60 x 42	65	126.41	5.14	\$2843	\$236
SCTBSL3066	30 x 66 x 42	65	135.76	5.45	\$2889	\$260
SCTBSL3072	30 x 72 x 42	65	145.11	5.76	\$3112	\$287
SCTBSL3078	30 x 78 x 42	65	159.35	6.08	\$3334	\$310
SCTBSL3084	30 x 84 x 42	65	168.71	6.7	\$3380	\$333
SCTBSL3090	30 x 90 x 42	65	178.06	6.39	\$3783	\$356
SCTBSL3096	30 x 96 x 42	65	187.41	7.01	\$3829	\$380

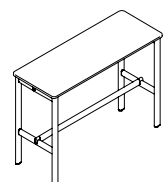

For 18" and 24"D surfaces

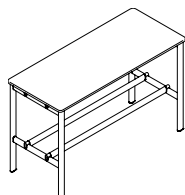

For 30"D tables, 36" to 72"W

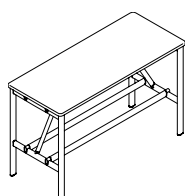

For 30"D tables, 78" to 96"W

Bar Height Collaboration Table, 42"H, Small Radius, Levelers

Consists of two leg assemblies, worksurface support beam(s), footrest(s), and one worksurface with a small 1.5" radius at each corner.

- Worksurface choice of thermally fused or high pressure laminate with PVC edge.
- Legs are painted extruded aluminum. Levelers have 1" adjustment for leveling.
- Cut-outs for power modules are limited to specific sizes/configurations, please see "Power Accessory Cut-out Locations".
- 18" and 24" deep tables feature one worksurface support beam and one footrest.
- 30" deep tables feature two worksurface support beams and two footrests.
- 30" deep tables 78" wide and greater include a reinforcement cantilever for added stability.

Required specifications

Laminate finish
Edge finish
Paint finish

Optional specifications

HP laminate
Power accessory cut-out

Accessories

Table leg cable organizer,
PET felt modesty panel,
Table mounted bag hook,
Nik power modules, PET felt wire manager

WORKSHOP TABLES - 29" H

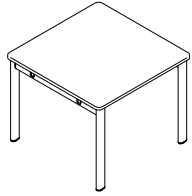

**Workshop Table, 29" H,
Small Radius, Levelers**

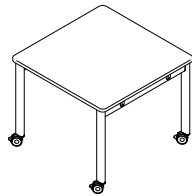

**Workshop Table, 29" H,
Small Radius, Casters***

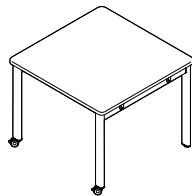

**Workshop Table, 29" H,
Small Radius, Casters/Levelers***

MODEL#	DIMENSIONS	FREIGHT CLASS	WT/LBS.	CUBIC FT.	LIST PRICE	HP ADD
--------	------------	---------------	---------	-----------	------------	--------

D x W x H						
SCTSWSL3636	36 x 36 x 29	70	79.31	4.67	\$1496	\$171
SCTSWSL3642	36 x 42 x 29	70	88.73	5.04	\$1681	\$204
SCTSWSL3648	36 x 48 x 29	70	101.24	5.42	\$1899	\$226
SCTSWSL3654	36 x 54 x 29	70	110.76	5.79	\$1950	\$259
SCTSWSL3660	36 x 60 x 29	70	120.27	6.17	\$2056	\$287
SCTSWSL4242	42 x 42 x 29	70	99.72	5.88	\$1713	\$237
SCTSWSL4248	42 x 48 x 29	70	113.52	6.32	\$1991	\$269
SCTSWSL4254	42 x 54 x 29	70	124.41	6.76	\$2051	\$301
SCTSWSL4260	42 x 60 x 29	70	135.31	7.19	\$2167	\$333
SCTSWSL4848	48 x 48 x 29	70	125.8	7.22	\$2098	\$301
SCTSWSL4854	48 x 54 x 29	70	138.07	7.72	\$2163	\$342
SCTSWSL4860	48 x 60 x 29	70	150.35	8.22	\$2283	\$384

Consists of two leg assemblies, two worksurface support beams, and one worksurface with a small 1.5" radius at each corner.

- Worksurface choice of thermally fused or high pressure laminate with PVC edge.
- Legs are painted extruded aluminum. Levelers have 1" adjustment for leveling.
- Cut-outs for power modules are limited to specific sizes/configurations, please see "Power Accessory Cut-out Locations".

SCTSWSC3636	36 x 36 x 29	70	79.4	4.67	\$1760	\$171
SCTSWSC3642	36 x 42 x 29	70	88.92	5.04	\$1889	\$204
SCTSWSC3648	36 x 48 x 29	70	101.33	5.42	\$2107	\$227
SCTSWSC3654	36 x 54 x 29	70	110.85	5.79	\$2158	\$259
SCTSWSC3660	36 x 60 x 29	70	120.36	6.17	\$2264	\$287

SCTSWSC4242	42 x 42 x 29	70	99.81	5.88	\$1977	\$232
SCTSWSC4248	42 x 48 x 29	70	113.61	6.32	\$2200	\$268
SCTSWSC4254	42 x 54 x 29	70	124.5	6.76	\$2260	\$304
SCTSWSC4260	42 x 60 x 29	70	135.4	7.19	\$2375	\$334
SCTSWSC4848	48 x 48 x 29	70	125.89	7.22	\$2301	\$306
SCTSWSC4854	48 x 54 x 29	70	138.16	7.72	\$2371	\$342
SCTSWSC4860	48 x 60 x 29	70	150.44	8.22	\$2491	\$384

Consists of two leg assemblies, two worksurface support beams, and one worksurface with a small 1.5" radius at each corner.

- Worksurface choice of thermally fused or high pressure laminate with PVC edge.
- Legs are painted extruded aluminum. Casters are lockable, in a choice of two finishes - Black (BLK) or Grey (GRC).
- Cut-outs for power modules are limited to specific sizes/configurations, please see "Power Accessory Cut-out Locations".

SCTSWSX3636	36 x 36 x 29	70	79.36	4.67	\$1625	\$172
SCTSWSX3642	36 x 42 x 29	70	88.87	5.04	\$1760	\$199
SCTSWSX3648	36 x 48 x 29	70	101.29	5.42	\$2005	\$227
SCTSWSX3654	36 x 54 x 29	70	110.8	5.79	\$2056	\$259
SCTSWSX3660	36 x 60 x 29	70	120.31	6.17	\$2163	\$287

SCTSWSX4242	42 x 42 x 29	70	99.77	5.88	\$1848	\$231
SCTSWSX4248	42 x 48 x 29	70	113.56	6.32	\$2098	\$264
SCTSWSX4254	42 x 54 x 29	70	124.46	6.76	\$2158	\$301
SCTSWSX4260	42 x 60 x 29	70	135.36	7.19	\$2269	\$333
SCTSWSX4848	48 x 48 x 29	70	125.71	7.22	\$2200	\$305
SCTSWSX4854	48 x 54 x 29	70	137.99	7.72	\$2269	\$343
SCTSWSX4860	48 x 60 x 29	70	150.27	8.22	\$2389	\$380

Consists of one leg assembly with casters, one leg assembly with levelers, two worksurface support beams, and one worksurface with a small 1.5" radius at each corner.

- Worksurface choice of thermally fused or high pressure laminate with PVC edge.
- Legs are painted extruded aluminum. Casters are lockable, in a choice of two finishes - Black (BLK) or Grey (GRC). Levelers have 1" adjustment for leveling.
- Cut-outs for power modules are limited to specific sizes/configurations, please see "Power Accessory Cut-out Locations".

Required specifications

Laminate finish
Edge finish
Paint finish
Caster finish*

Optional specifications

HP laminate
Grommet option

Accessories

Table leg cable organizer
Table mounted bag hook
Nik power modules
PET felt wire manager

LARGE COLLABORATION TABLES - 29"H **MODEL#** **DIMENSIONS** **FREIGHT CLASS** **WT/LBS.** **CUBIC FT.** **LIST PRICE** **HP ADD**

D x W x H

SCTLWLSL3666	36 x 66 x 29	70	129.78	6.54	\$2112	\$314
SCTLWLSL3672	36 x 72 x 29	70	139.3	6.92	\$2255	\$343
SCTLWLSL3678	36 x 78 x 29	70	148.81	7.29	\$2329	\$371
SCTLWLSL3684	36 x 84 x 29	70	158.32	7.67	\$2380	\$403
SCTLWLSL3690	36 x 90 x 29	70	167.84	8.04	\$2612	\$430
SCTLWLSL3696	36 x 96 x 29	70	177.35	8.42	\$2667	\$458

SCTLWLSL4266	42 x 66 x 29	70	146.21	7.63	\$2227	\$366
SCTLWLSL4272	42 x 72 x 29	70	127.1	8.07	\$2375	\$403
SCTLWLSL4278	42 x 78 x 29	70	168	8.51	\$2459	\$435
SCTLWLSL4284	42 x 84 x 29	70	178.89	8.94	\$2519	\$468
SCTLWLSL4290	42 x 90 x 29	70	189.79	9.38	\$2760	\$500
SCTLWLSL4296	42 x 96 x 29	70	200.68	9.82	\$2820	\$532

SCTLWLSL4866	48 x 66 x 29	70	162.63	8.72	\$2352	\$422
SCTLWLSL4872	48 x 72 x 29	70	174.91	9.22	\$2510	\$458
SCTLWLSL4878	48 x 78 x 29	70	187.18	9.72	\$2598	\$495
SCTLWLSL4884	48 x 84 x 29	70	199.46	10.22	\$2667	\$533
SCTLWLSL4890	48 x 90 x 29	70	211.74	10.72	\$2913	\$574
SCTLWLSL4896	48 x 96 x 29	70	224.01	11.22	\$2982	\$611

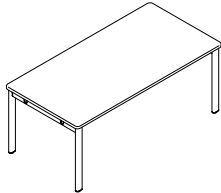

**Large Collaboration Table, 29"H,
Small Radius, Levelers**

Consists of two leg assemblies, two worksurface support beams, and one worksurface with a small 1.5" radius at each corner.

- Worksurface choice of thermally fused or high pressure laminate with PVC edge.
- Legs are painted extruded aluminum. Levelers have 1" adjustment for leveling.
- Cut-outs for power modules are limited to specific sizes/configurations, please see "Power Accessory Cut-out Locations".

SCTLWLL3666	36 x 66 x 29	70	123.52	6.54	\$2056	\$315
SCTLWLL3672	36 x 72 x 29	70	133.03	6.92	\$2112	\$342
SCTLWLL3678	36 x 78 x 29	70	142.55	7.29	\$2218	\$370
SCTLWLL3684	36 x 84 x 29	70	152.06	7.67	\$2269	\$403
SCTLWLL3690	36 x 90 x 29	70	161.57	8.04	\$2413	\$430
SCTLWLL3696	36 x 96 x 29	70	171.09	8.42	\$2487	\$458

SCTLWLL4266	42 x 66 x 29	70	139.94	7.63	\$2172	\$370
SCTLWLL4272	42 x 72 x 29	70	150.84	8.07	\$2232	\$403
SCTLWLL4278	42 x 78 x 29	70	161.73	8.51	\$2348	\$435
SCTLWLL4284	42 x 84 x 29	70	172.63	8.94	\$2408	\$467
SCTLWLL4290	42 x 90 x 29	70	183.52	9.38	\$2556	\$500
SCTLWLL4296	42 x 96 x 29	70	194.42	9.82	\$2616	\$533

SCTLWLL4866	48 x 66 x 29	70	156.37	8.72	\$2297	\$421
SCTLWLL4872	48 x 72 x 29	70	168.64	9.22	\$2366	\$459
SCTLWLL4878	48 x 78 x 29	70	180.92	9.72	\$2487	\$495
SCTLWLL4884	48 x 84 x 29	70	193.2	10.22	\$2556	\$532
SCTLWLL4890	48 x 90 x 29	70	205.48	10.72	\$2713	\$570
SCTLWLL4896	48 x 96 x 29	70	217.75	11.22	\$2801	\$612

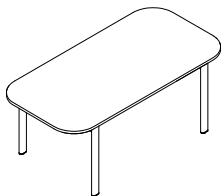

**Large Collaboration Table, 29"H,
Large Radius, Levelers**

Consists of two leg assemblies, two worksurface support beams, and one worksurface with a large 9" radius at each corner with 10.5" overhang on each end.

- Worksurface choice of thermally fused or high pressure laminate with PVC edge.
- Legs are painted extruded aluminum. Levelers have 1" adjustment for leveling.
- Cut-outs for power modules are limited to specific sizes/configurations, please see "Power Accessory Cut-out Locations".
- *Large radius tables are not compatible with SCTAMxx and SCTAMTx Media Units.*

Required specifications

Laminate finish
Edge finish
Paint finish

Optional specifications

HP laminate
Power accessory cut-out

Accessories

Collaboration table media unit,
Table leg cable organizer,
Table mounted bag hook,
Nik power modules, PET felt wire manager

LARGE COLLABORATION TABLES - 29"H

MODEL#	DIMENSIONS D x W x H	FREIGHT CLASS	WT/LBS.	CUBIC FT.	LIST PRICE	HP ADD
SCTLWSC3666	36 x 66 x 29	70	129.87	6.54	\$2320	\$315
SCTLWSC3672	36 x 72 x 29	70	139.39	6.92	\$2463	\$343
SCTLWSC3678	36 x 78 x 29	70	148.9	7.29	\$2538	\$370
SCTLWSC3684	36 x 84 x 29	70	158.41	7.67	\$2588	\$403
SCTLWSC3690	36 x 90 x 29	70	167.93	8.04	\$2820	\$430
SCTLWSC3696	36 x 96 x 29	70	177.44	8.42	\$2875	\$459
SCTLWSC4266	42 x 66 x 29	70	146.3	7.63	\$2436	\$365
SCTLWSC4272	42 x 72 x 29	70	157.19	8.07	\$2584	\$403
SCTLWSC4278	42 x 78 x 29	70	168.09	8.51	\$2667	\$435
SCTLWSC4284	42 x 84 x 29	70	178.98	8.94	\$2727	\$468
SCTLWSC4290	42 x 90 x 29	70	189.88	9.38	\$2968	\$500
SCTLWSC4296	42 x 96 x 29	70	200.77	9.82	\$2792	\$537
SCTLWSC4866	48 x 66 x 29	70	162.72	8.72	\$2561	\$421
SCTLWSC4872	48 x 72 x 29	70	175	9.22	\$2718	\$458
SCTLWSC4878	48 x 78 x 29	70	187.27	9.22	\$2806	\$495
SCTLWSC4884	48 x 84 x 29	70	199.55	10.22	\$2875	\$533
SCTLWSC4890	48 x 90 x 29	70	211.83	10.72	\$3121	\$574
SCTLWSC4896	48 x 96 x 29	70	224.1	11.22	\$3190	\$611

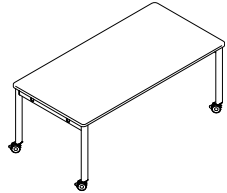

Large Collaboration Table, 29"H, Small Radius, Casters*

Consists of two leg assemblies, two worksurface support beams, and one worksurface with a small 1.5" radius at each corner.

- Worksurface choice of thermally fused or high pressure laminate with PVC edge.
- Legs are painted extruded aluminum. Casters are lockable, in a choice of two finishes - Black (BLK) or Grey (GRC).
- Cut-outs for power modules are limited to specific sizes/configurations, please see "Power Accessory Cut-out Locations".

SCTLWLC3666	36 x 66 x 29	70	123.61	6.54	\$2264	\$315
SCTLWLC3672	36 x 72 x 29	70	133.12	6.92	\$2320	\$343
SCTLWLC3678	36 x 78 x 29	70	142.64	7.29	\$2426	\$371
SCTLWLC3684	36 x 84 x 29	70	152.15	7.67	\$2477	\$403
SCTLWLC3690	36 x 90 x 29	70	161.66	8.04	\$2621	\$430
SCTLWLC3696	36 x 96 x 29	70	171.18	8.42	\$2695	\$458
SCTLWLC4266	42 x 66 x 29	70	140.03	7.63	\$2380	\$370
SCTLWLC4272	42 x 72 x 29	70	150.93	8.07	\$2440	\$403
SCTLWLC4278	42 x 78 x 29	70	161.82	8.51	\$2556	\$435
SCTLWLC4284	42 x 84 x 29	70	172.72	8.94	\$2616	\$468
SCTLWLC4290	42 x 90 x 29	70	183.62	9.38	\$2764	\$500
SCTLWLC4296	42 x 96 x 29	70	194.51	9.82	\$2848	\$532
SCTLWLC4866	48 x 66 x 29	70	156.46	8.72	\$2505	\$421
SCTLWLC4872	48 x 72 x 29	70	168.73	9.22	\$2575	\$458
SCTLWLC4878	48 x 78 x 29	70	181.01	9.72	\$2695	\$495
SCTLWLC4884	48 x 84 x 29	70	193.29	10.22	\$2764	\$533
SCTLWLC4890	48 x 90 x 29	70	205.57	10.72	\$2922	\$569
SCTLWLC4896	48 x 96 x 29	70	217.84	11.22	\$3010	\$611

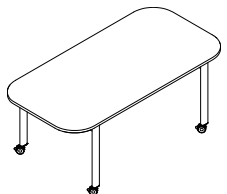

Large Collaboration Table, 29"H, Large Radius, Casters

Consists of two leg assemblies, two worksurface support beams, and one worksurface with a large 9" radius at each corner with 10.5" overhang on each end.

- Worksurface choice of thermally fused or high pressure laminate with PVC edge.
- Legs are painted extruded aluminum. Casters are lockable, in a choice of two finishes - Black (BLK) or Grey (GRC).
- Cut-outs for power modules are limited to specific sizes/configurations, please see "Power Accessory Cut-out Locations".
- Large radius tables are not compatible with SCTAMxx and SCTAMTx Media Units.

Required specifications

Laminate finish
Edge finish
Paint finish
Caster finish

Optional specifications

HP laminate
Grommet option

Accessories

Collaboration table media unit*, Table leg cable organizer, PET felt modesty panel, Table mounted bag hook, Nik power modules, PET felt wire manager

WORKSHOP TABLES - 36"H

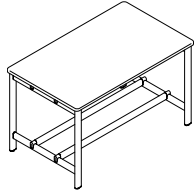

**Café Height Workshop Table, 36"H
Small Radius, Levelers**

MODEL#	DIMENSIONS	FREIGHT CLASS	WT/LBS.	CUBIC FT.	LIST PRICE	HP ADD
D x W x H						
SCTSCSL3636	36 x 36 x 36	70	96.82	5.67	\$2200	\$171
SCTSCSL3642	36 x 42 x 36	70	107.56	6.21	\$2413	\$203
SCTSCSL3648	36 x 48 x 36	70	121.2	6.75	\$2658	\$227
SCTSCSL3654	36 x 54 x 36	70	131.93	7.29	\$2709	\$259
SCTSCSL3660	36 x 60 x 36	70	142.67	7.83	\$2871	\$287
SCTSCSL4242	42 x 42 x 36	70	119.68	7.05	\$2473	\$236
SCTSCSL4248	42 x 48 x 36	70	134.7	7.65	\$2774	\$268
SCTSCSL4254	42 x 54 x 36	70	146.81	8.26	\$2834	\$301
SCTSCSL4260	42 x 60 x 36	70	158.93	8.86	\$3005	\$333
SCTSCSL4848	48 x 48 x 36	70	148.2	8.56	\$2913	\$305
SCTSCSL4854	48 x 54 x 36	70	161.7	9.22	\$2982	\$343
SCTSCSL4860	48 x 60 x 36	70	175.2	9.89	\$3158	\$380

Consists of two leg assemblies, two worksurface support beams, dual footrests and one worksurface with a small 1.5" radius at each corner.

- Worksurface choice of thermally fused or high pressure laminate with PVC edge.
- Legs are painted extruded aluminum. Levelers have 1" adjustment for leveling.
- Cut-outs for power modules are limited to specific sizes/configurations, please see "Power Accessory Cut-out Locations".

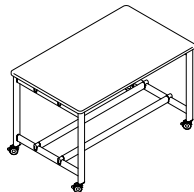

**Café Height Workshop Table, 36"H
Small Radius, Casters***

SCTSCSC3636	36 x 36 x 36	70	96.66	5.67	\$2440	\$172
SCTSCSC3642	36 x 42 x 36	70	107.39	6.21	\$2653	\$199
SCTSCSC3648	36 x 48 x 36	70	107.39	6.21	\$2894	\$231
SCTSCSC3654	36 x 54 x 36	70	131.77	7.29	\$2950	\$254
SCTSCSC3660	36 x 60 x 36	70	142.5	7.83	\$3107	\$287
SCTSCSC4242	42 x 42 x 36	70	119.51	7.05	\$2764	\$232
SCTSCSC4248	42 x 48 x 36	70	134.53	7.65	\$3014	\$264
SCTSCSC4254	42 x 54 x 36	70	146.65	8.26	\$3075	\$300
SCTSCSC4260	42 x 60 x 36	70	158.77	8.86	\$3241	\$334
SCTSCSC4848	48 x 48 x 36	70	148.03	8.56	\$3153	\$306
SCTSCSC4854	48 x 54 x 36	70	161.53	9.22	\$3218	\$347
SCTSCSC4860	48 x 60 x 36	70	175.03	9.89	\$3394	\$384

Consists of two leg assemblies, two worksurface support beams, dual footrests and one worksurface with a small 1.5" radius at each corner.

- Worksurface choice of thermally fused or high pressure laminate with PVC edge.
- Legs are painted extruded aluminum. Casters are lockable, in a choice of two finishes - Black (**BLK**) or Grey (**GRC**).
- Cut-outs for power modules are limited to specific sizes/configurations, please see "Power Accessory Cut-out Locations".

Required specifications

Laminate finish
Edge finish
Paint finish
Caster finish*

Optional specifications

HP laminate
Grommet option

Accessories

Collaboration table media unit, Table leg cable organizer, PET felt modesty panel, Wire mesh storage tray, Table mounted bag hook, Nik power modules, PET felt wire manager

LARGE COLLABORATION TABLES - 36"

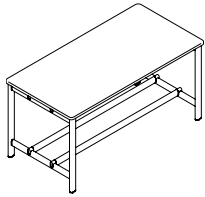

For 66" and 72"W tables

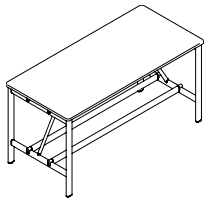

For 78" to 96"W tables

Large Café Height Collaboration Table, 36"H, Small Radius, Levelers*

MODEL#	DIMENSIONS D x W x H	FREIGHT CLASS	WT/LBS.	CUBIC FT.	LIST PRICE	HP ADD
SCTLCSL3666	36 x 66 x 36	70	153.4	8.38	\$2922	\$315
SCTLCSL3672	36 x 72 x 36	70	164.14	8.92	\$3153	\$343
SCTLCSL3678	36 x 78 x 36	70	177.32	9.46	\$3385	\$370
SCTLCSL3684	36 x 84 x 36	70	188.05	10	\$3436	\$402
SCTLCSL3690	36 x 90 x 36	70	198.79	10.54	\$3848	\$426
SCTLCSL3696	36 x 96 x 36	70	209.52	11.08	\$3899	\$458
SCTLCSL4266	42 x 66 x 36	70	171.05	9.47	\$3065	\$366
SCTLCSL4272	42 x 72 x 36	70	183.17	10.07	\$3301	\$403
SCTLCSL4278	42 x 78 x 36	70	197.73	10.67	\$3538	\$435
SCTLCSL4284	42 x 84 x 36	70	209.84	11.28	\$3598	\$467
SCTLCSL4290	42 x 90 x 36	70	221.96	11.88	\$4019	\$500
SCTLCSL4296	42 x 96 x 36	70	234.08	12.49	\$4079	\$533
SCTLCSL4866	48 x 66 x 36	70	188.69	10.56	\$3227	\$417
SCTLCSL4872	48 x 72 x 36	70	202.19	11.22	\$3473	\$458
SCTLCSL4878	48 x 78 x 36	70	218.14	11.89	\$3713	\$496
SCTLCSL4884	48 x 84 x 36	70	231.63	12.56	\$3783	\$532
SCTLCSL4890	48 x 90 x 36	70	245.13	13.22	\$4209	\$569
SCTLCSL4896	48 x 96 x 36	70	258.63	13.89	\$4274	\$611

Consists of two leg assemblies, two worksurface support beams, dual footrests, and one worksurface with a small 1.5" radius at each corner.

- Worksurface choice of thermally fused or high pressure laminate with PVC edge.
- Legs are painted extruded aluminum. Levelers have 1" adjustment for leveling.
- Cut-outs for power modules are limited to specific sizes/configurations, please see "Power Accessory Cut-out Locations".
- Tables 78" wide and greater include a reinforcement cantilever for added stability.

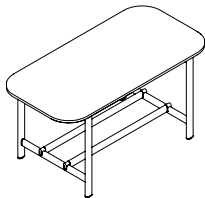

For 66" and 72"W tables

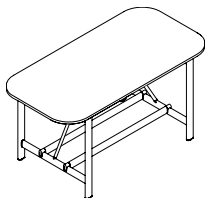

For 78" to 96"W tables

Large Café Height Collaboration Table, 36"H, Large Radius, Levelers

SCTLCLL3666	36 x 66 x 36	70	143.48	8.38	\$2815	\$315
SCTLCLL3672	36 x 72 x 36	70	154.21	8.92	\$2866	\$347
SCTLCLL3678	36 x 78 x 36	70	164.95	9.46	\$3028	\$371
SCTLCLL3684	36 x 84 x 36	70	175.68	10	\$3084	\$398
SCTLCLL3690	36 x 90 x 36	70	186.42	10.54	\$3315	\$426
SCTLCLL3696	36 x 96 x 36	70	199.6	11.08	\$3542	\$458
SCTLCLL4266	42 x 66 x 36	70	161.12	9.47	\$2959	\$366
SCTLCLL4272	42 x 72 x 36	70	173.24	10.07	\$3019	\$398
SCTLCLL4278	42 x 78 x 36	70	185.36	10.67	\$3186	\$430
SCTLCLL4284	42 x 84 x 36	70	197.47	11.28	\$3246	\$467
SCTLCLL4290	42 x 90 x 36	70	209.59	11.88	\$3482	\$505
SCTLCLL4296	42 x 96 x 36	70	224.15	12.49	\$3297	\$537
SCTLCLL4866	48 x 66 x 36	70	178.77	10.56	\$3116	\$422
SCTLCLL4872	48 x 72 x 36	125	688	99	\$3186	\$458
SCTLCLL4878	48 x 78 x 36	125	726	107	\$3362	\$495
SCTLCLL4884	48 x 84 x 36	70	219.26	12.56	\$3426	\$537
SCTLCLL4890	48 x 90 x 36	70	232.76	13.22	\$3676	\$570
SCTLCLL4896	48 x 96 x 36	70	248.71	13.89	\$3917	\$611

Consists of two leg assemblies, two worksurface support beams, dual footrests, and one worksurface with a large 9" radius at each corner with 10.5" overhang on each end.

- Worksurface choice of thermally fused or high pressure laminate with PVC edge.
- Legs are painted extruded aluminum. Levelers have 1" adjustment for leveling.
- Cut-outs for power modules are limited to specific sizes/configurations, please see "Power Accessory Cut-out Locations".
- Tables 78" wide and greater include a reinforcement cantilever for added stability.
- *Large radius tables are not compatible with SCTAMxx and SCTAMTx Media Units.*

Required specifications

Laminate finish
Edge finish
Paint finish

Optional specifications

HP laminate
Power accessory cut-out

Accessories

Collaboration table media unit*, Table leg cable organizer, PET felt modesty panel, Wire mesh storage tray, Table mounted bag hook, Nik power modules, PET felt wire manager

LARGE COLLABORATION TABLES - 36"

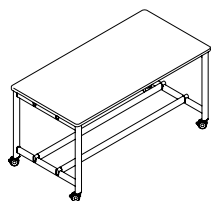

For 66" and 72"W tables

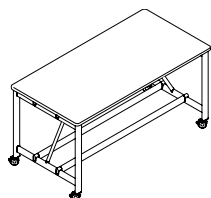

For 78" to 96"W tables

Large Café Height Collaboration Table, 36"H, Small Radius, Casters*

MODEL#	DIMENSIONS	FREIGHT CLASS	WT./LBS.	CUBIC FT.	LIST PRICE	HP ADD
D x W x H						
SCTLCSC3666	36 x 66 x 36	70	153.24	8.38	\$3163	\$314
SCTLCSC3672	36 x 72 x 36	70	163.97	8.92	\$3394	\$343
SCTLCSC3678	36 x 78 x 36	70	177.15	9.46	\$3621	\$370
SCTLCSC3684	36 x 84 x 36	70	187.89	10	\$3676	\$399
SCTLCSC3690	36 x 90 x 36	70	198.62	10.54	\$4084	\$430
SCTLCSC3696	36 x 96 x 36	70	209.36	11.08	\$4139	\$454
SCTLCSC4266	42 x 66 x 36	70	170.88	9.47	\$3301	\$366
SCTLCSC4272	42 x 72 x 36	70	183	10.07	\$3542	\$398
SCTLCSC4278	42 x 78 x 36	70	197.56	10.67	\$3778	\$431
SCTLCSC4284	42 x 84 x 36	70	209.68	11.28	\$3838	\$468
SCTLCSC4290	42 x 90 x 36	70	221.8	11.88	\$4255	\$500
SCTLCSC4296	42 x 96 x 36	70	233.91	12.41	\$4315	\$533
SCTLCSC4866	48 x 66 x 36	70	188.53	10.56	\$3463	\$422
SCTLCSC4872	48 x 72 x 36	70	202.03	11.22	\$3709	\$458
SCTLCSC4878	48 x 78 x 36	70	217.97	11.89	\$3954	\$496
SCTLCSC4884	48 x 84 x 36	70	231.47	12.56	\$4019	\$537
SCTLCSC4890	48 x 90 x 36	70	244.97	13.22	\$4445	\$574
SCTLCSC4896	48 x 96 x 36	70	258.47	13.89	\$4514	\$611

Consists of two leg assemblies, two worksurface support beams, dual footrests, and one worksurface with a small 1.5" radius at each corner.

- Worksurface choice of thermally fused or high pressure laminate with PVC edge.
- Legs are painted extruded aluminum. Casters are lockable, in a choice of two finishes - Black (BLK) or Grey (GRC).
- Cut-outs for power modules are limited to specific sizes/configurations, please see "Power Accessory Cut-out Locations".
- Tables 78" wide and greater include a reinforcement cantilever for added stability.

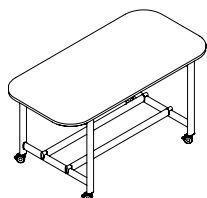

For 66" and 72"W tables

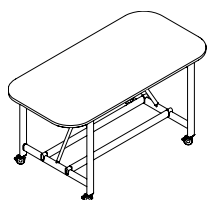

For 78" to 96"W tables

Large Café Height Collaboration Table, 36"H, Large Radius, Casters

SCTLCLC3666	36 x 66 x 36	70	143.31	8.38	\$3051	\$315
SCTLCLC3672	36 x 72 x 36	70	154.05	8.92	\$3107	\$343
SCTLCLC3678	36 x 78 x 36	70	164.78	9.46	\$3264	\$375
SCTLCLC3684	36 x 84 x 36	70	175.52	10	\$3320	\$398
SCTLCLC3690	36 x 90 x 36	70	186.25	10.54	\$3551	\$431
SCTLCLC3696	36 x 96 x 36	70	199.43	11.08	\$3778	\$459
SCTLCLC4266	42 x 66 x 36	70	160.96	9.47	\$3195	\$366
SCTLCLC4272	42 x 72 x 36	70	173.07	10.07	\$3255	\$398
SCTLCLC4278	42 x 78 x 36	70	185.19	10.67	\$3422	\$435
SCTLCLC4284	42 x 84 x 36	70	197.31	11.28	\$3482	\$468
SCTLCLC4290	42 x 90 x 36	70	209.43	11.88	\$3723	\$500
SCTLCLC4296	42 x 96 x 36	70	223.98	12.49	\$3959	\$532
SCTLCLC4866	48 x 66 x 36	70	178.6	10.56	\$3195	\$417
SCTLCLC4872	48 x 72 x 36	70	192.1	11.22	\$3255	\$458
SCTLCLC4878	48 x 78 x 36	70	205.6	11.89	\$3422	\$495
SCTLCLC4884	48 x 84 x 36	70	219.1	12.56	\$3482	\$533
SCTLCLC4890	48 x 90 x 36	70	232.6	13.22	\$3723	\$574
SCTLCLC4896	48 x 96 x 36	70	248.54	12.89	\$4158	\$611

Consists of two leg assemblies, two worksurface support beams, dual footrests, and one worksurface with a large 9" radius at each corner with 10.5" overhang on each end.

- Worksurface choice of thermally fused or high pressure laminate with PVC edge.
- Legs are painted extruded aluminum. Casters are lockable, in a choice of two finishes - Black (BLK) or Grey (GRC).
- Cut-outs for power modules are limited to specific sizes/configurations, please see "Power Accessory Cut-out Locations".
- Tables 78" wide and greater include a reinforcement cantilever for added stability.
- Large radius tables are not compatible with SCTAMxx and SCTAMTxx Media Units.

Required specifications

Laminate finish
Edge finish
Paint finish
Caster finish

Optional specifications

HP laminate
Power accessory cut-out

Accessories

Collaboration table media unit*, Table leg cable organizer, PET felt modesty panel, Wire mesh storage tray, Table mounted bag hook, Nik power modules, PET felt wire manager

LARGE COLLABORATION TABLES - 42"

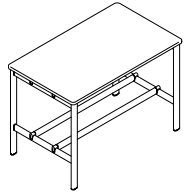

**Bar Height Workshop Table, 42"H
Small Radius, Levelers**

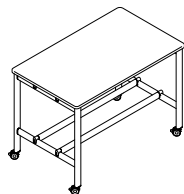

**Bar Height Workshop Table, 42"H
Small Radius, Casters***

MODEL#	DIMENSIONS D x W x H	FREIGHT CLASS	WT/LBS.	CUBIC FT.	LIST PRICE	HP ADD
SCTSBSL3636	36 x 36 x 42	70	99.27	5.67	\$2325	\$171
SCTSBSL3642	36 x 42 x 42	70	110	6.21	\$2538	\$199
SCTSBSL3648	36 x 48 x 42	70	123.64	6.75	\$2778	\$232
SCTSBSL3654	36 x 54 x 42	70	134.38	7.29	\$2834	\$254
SCTSBSL3660	36 x 60 x 42	70	145.11	7.83	\$2991	\$287
SCTSBSL4242	42 x 42 x 42	70	122.12	7.05	\$2649	\$231
SCTSBSL4248	42 x 48 x 42	70	137.14	7.65	\$2899	\$268
SCTSBSL4254	42 x 54 x 42	70	149.26	8.26	\$2959	\$301
SCTSBSL4260	42 x 60 x 42	70	161.38	8.86	\$3125	\$334
SCTSBSL4848	48 x 48 x 42	70	150.64	8.56	\$3038	\$305
SCTSBSL4854	48 x 54 x 42	70	164.14	9.22	\$3107	\$343
SCTSBSL4860	48 x 60 x 42	70	177.64	9.89	\$3278	\$385

Consists of two leg assemblies, two worksurface support beams, dual footrests and one worksurface with a small 1.5" radius at each corner.

- Worksurface choice of thermally fused or high pressure laminate with PVC edge.
- Legs are painted extruded aluminum. Levelers have 1" adjustment for leveling.
- Cut-outs for power modules are limited to specific sizes/configurations, please see "Power Accessory Cut-out Locations".

SCTSBSC3636	36 x 36 x 42	70	99.1	5.67	\$2491	\$172
SCTSBSC3642	36 x 42 x 42	70	109.84	6.21	\$2704	\$199
SCTSBSC3648	36 x 48 x 42	70	123.48	6.75	\$2945	\$231
SCTSBSC3654	36 x 54 x 42	70	134.21	7.29	\$3000	\$255
SCTSBSC3660	36 x 60 x 42	70	144.95	7.83	\$3158	\$287
SCTSBSC4242	42 x 42 x 42	70	121.95	7.05	\$2815	\$232
SCTSBSC4248	42 x 48 x 42	70	136.98	7.65	\$3065	\$264
SCTSBSC4254	42 x 54 x 42	70	149.09	8.26	\$3125	\$301
SCTSBSC4260	42 x 60 x 42	70	161.21	8.86	\$3292	\$333
SCTSBSC4848	48 x 48 x 42	70	150.47	8.56	\$3204	\$306
SCTSBSC4854	48 x 54 x 42	70	163.97	9.22	\$3274	\$342
SCTSBSC4860	48 x 60 x 42	70	177.47	9.89	\$3445	\$384

Consists of two leg assemblies, two worksurface support beams, dual footrests and one worksurface with a small 1.5" radius at each corner.

- Worksurface choice of thermally fused or high pressure laminate with PVC edge.
- Legs are painted extruded aluminum. Casters are lockable, in a choice of two finishes - Black (**BLK**) or Grey (**GRC**).
- Cut-outs for power modules are limited to specific sizes/configurations, please see "Power Accessory Cut-out Locations".

Required specifications

Laminate finish
Edge finish
Paint finish
Caster finish*

Optional specifications

HP laminate
Power accessory cut-out

Accessories

Collaboration table media unit, Table leg cable organizer, PET felt modesty panel, Wire mesh storage tray, Table mounted bag hook, Nik power modules, PET felt wire manager

LARGE COLLABORATION TABLES - 42"

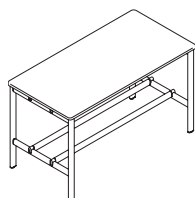

For 66" and 72"W tables

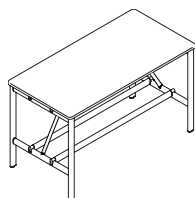

For 78" to 96"W tables

Large Bar Height Collaboration Table, 42"H, Small Radius, Levelers*

MODEL#	DIMENSIONS D x W x H	FREIGHT CLASS	WT/LBS.	CUBIC FT.	LIST PRICE	HP ADD
SCTLBSL3666	36 x 66 x 42	70	155.85	8.38	\$3047	\$315
SCTLBSL3672	36 x 72 x 42	70	166.58	8.92	\$3278	\$343
SCTLBSL3678	36 x 78 x 42	70	179.76	9.46	\$3533	\$370
SCTLBSL3684	36 x 84 x 42	70	190.5	10	\$3584	\$403
SCTLBSL3690	36 x 90 x 42	70	201.23	10.54	\$3996	\$430
SCTLBSL3696	36 x 96 x 42	70	211.97	11.08	\$4047	\$458
SCTLBSL4266	42 x 66 x 42	70	173.49	9.47	\$3186	\$365
SCTLBSL4272	42 x 72 x 42	70	185.61	10.07	\$3426	\$399
SCTLBSL4278	42 x 78 x 42	70	200.17	10.67	\$3690	\$431
SCTLBSL4284	42 x 84 x 42	70	212.29	11.28	\$3750	\$468
SCTLBSL4290	42 x 90 x 42	70	224.41	11.88	\$4167	\$500
SCTLBSL4296	42 x 96 x 42	70	236.52	12.49	\$4227	\$533
SCTLBSL4866	48 x 66 x 42	70	191.14	10.56	\$3348	\$421
SCTLBSL4872	48 x 72 x 42	70	204.64	11.22	\$3593	\$458
SCTLBSL4878	48 x 78 x 42	70	220.58	11.89	\$3866	\$496
SCTLBSL4884	48 x 84 x 42	70	234.08	12.56	\$3931	\$537
SCTLBSL4890	48 x 90 x 42	70	247.58	13.22	\$4357	\$574
SCTLBSL4896	48 x 96 x 42	70	261.08	13.89	\$4426	\$612

Consists of two leg assemblies, two worksurface support beams, dual footrests, and one worksurface with a small 1.5" radius at each corner.

- Worksurface choice of thermally fused or high pressure laminate with PVC edge.
- Legs are painted extruded aluminum. Levelers have 1" adjustment for leveling.
- Cut-outs for power modules are limited to specific sizes/configurations, please see "Power Accessory Cut-out Locations".
- Tables 78" wide and greater include a reinforcement cantilever for added stability.

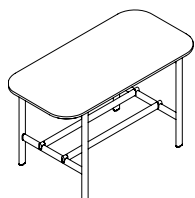

For 66" and 90"W tables

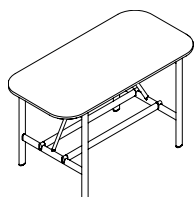

For 96"W tables

Large Bar Height Collaboration Table, 42"H, Large Radius, Levelers

SCTLBLL3666	36 x 66 x 42	70	145.92	8.38	\$2940	\$310
SCTLBLL3672	36 x 72 x 42	70	156.66	8.92	\$2991	\$343
SCTLBLL3678	36 x 78 x 42	70	167.39	9.46	\$3306	\$370
SCTLBLL3684	36 x 84 x 42	70	178.13	10	\$3357	\$245
SCTLBLL3690	36 x 90 x 42	70	188.86	10.54	\$3588	\$278
SCTLBLL3696	36 x 96 x 42	70	202.04	11.08	\$3663	\$458
SCTLBLL4266	42 x 66 x 42	70	163.57	9.47	\$3079	\$366
SCTLBLL4272	42 x 72 x 42	70	175.68	10.07	\$3139	\$399
SCTLBLL4278	42 x 78 x 42	70	187.8	10.67	\$3459	\$282
SCTLBLL4284	42 x 84 x 42	70	199.92	11.28	\$3519	\$315
SCTLBLL4290	42 x 90 x 42	70	212.04	11.88	\$3760	\$347
SCTLBLL4296	42 x 96 x 42	70	226.6	12.49	\$3843	\$537
SCTLBLL4866	48 x 66 x 42	70	181.21	10.56	\$3241	\$417
SCTLBLL4872	48 x 72 x 42	70	194.71	11.22	\$3306	\$458
SCTLBLL4878	48 x 78 x 42	70	208.21	11.89	\$3639	\$338
SCTLBLL4884	48 x 84 x 42	70	221.71	12.56	\$3704	\$380
SCTLBLL4890	48 x 90 x 42	70	235.21	13.22	\$3950	\$421
SCTLBLL4896	48 x 96 x 42	70	251.15	13.89	\$4042	\$611

Consists of two leg assemblies, two worksurface support beams, dual footrests, and one worksurface with a large 9" radius at each corner with 10.5" overhang on each end.

- Worksurface choice of thermally fused or high pressure laminate with PVC edge.
- Legs are painted extruded aluminum. Levelers have 1" adjustment for leveling.
- Cut-outs for power modules are limited to specific sizes/configurations, please see "Power Accessory Cut-out Locations".
- Tables 96" wide and greater include a reinforcement cantilever for added stability.
- Large radius tables are not compatible with SCTAMxx and SCTAMTx Media Units.

Required specifications

Laminate finish
Edge finish
Paint finish

Optional specifications

HP laminate
Power accessory cut-out

Accessories

Collaboration table media unit*, Table leg cable organizer, PET felt modesty panel, Wire mesh storage tray, Table mounted bag hook, Nik power modules, PET felt wire manager

LARGE COLLABORATION TABLES - 42"

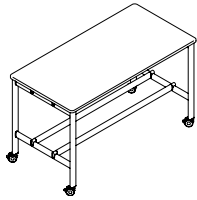

For 66" and 72"W tables

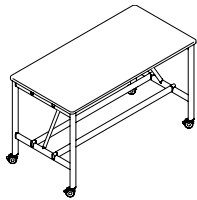

For 78" to 96"W tables

Large Bar Height Collaboration Table, 42"H, Small Radius, Casters*

MODEL#	DIMENSIONS D x W x H	FREIGHT CLASS	WT/LBS.	CUBIC FT.	LIST PRICE	HP ADD
SCTLBSC3666	36 x 66 x 42	70	155.68	8.38	\$3213	\$315
SCTLBSC3672	36 x 72 x 42	70	166.42	8.92	\$3445	\$343
SCTLBSC3678	36 x 78 x 42	70	179.6	9.46	\$3700	\$370
SCTLBSC3684	36 x 84 x 42	70	190.33	10	\$3750	\$403
SCTLBSC3690	36 x 90 x 42	70	201.07	10.54	\$4163	\$430
SCTLBSC3696	36 x 96 x 42	70	211.8	11.08	\$4213	\$459
SCTLBSC4266	42 x 66 x 42	70	173.33	9.47	\$3352	\$366
SCTLBSC4272	42 x 72 x 42	70	185.45	10.07	\$3593	\$398
SCTLBSC4278	42 x 78 x 42	70	200	10.67	\$3857	\$431
SCTLBSC4284	42 x 84 x 42	70	212.12	11.28	\$3917	\$463
SCTLBSC4290	42 x 90 x 42	70	224.24	11.88	\$4334	\$500
SCTLBSC4296	42 x 96 x 42	70	236.36	12.49	\$4394	\$532
SCTLBSC4866	48 x 66 x 42	70	190.97	10.56	\$3514	\$422
SCTLBSC4872	48 x 72 x 42	70	204.47	11.22	\$3760	\$458
SCTLBSC4878	48 x 78 x 42	70	220.41	11.89	\$4033	\$495
SCTLBSC4884	48 x 84 x 42	70	233.91	12.56	\$4098	\$537
SCTLBSC4890	48 x 90 x 42	70	247.41	13.22	\$4524	\$574
SCTLBSC4896	48 x 96 x 42	70	260.91	13.89	\$4593	\$607

Consists of two leg assemblies, two worksurface support beams, dual footrests, and one worksurface with a small 1.5" radius at each corner.

- Worksurface choice of thermally fused or high pressure laminate with PVC edge.
- Legs are painted extruded aluminum. Casters are lockable, in a choice of two finishes - Black (BLK) or Grey (GRC).
- Cut-outs for power modules are limited to specific sizes/configurations, please see "Power Accessory Cut-out Locations".
- Tables 78" wide and greater include a reinforcement cantilever for added stability.

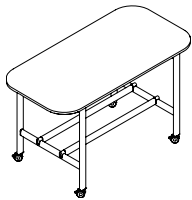

For 66" and 90"W tables

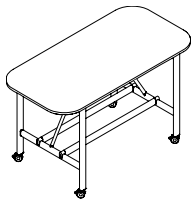

For 96"W tables

Large Bar Height Collaboration Table, 42"H, Large Radius, Casters

SCTLBLC3666	36 x 66 x 42	70	145.75	8.38	\$3102	\$315
SCTLBLC3672	36 x 72 x 42	70	156.49	8.92	\$3158	\$342
SCTLBLC3678	36 x 78 x 42	70	167.23	9.46	\$3315	\$375
SCTLBLC3684	36 x 84 x 42	70	177.96	10	\$3371	\$398
SCTLBLC3690	36 x 90 x 42	70	188.7	10.54	\$3602	\$431
SCTLBLC3696	36 x 96 x 42	70	201.87	11.08	\$3829	\$459
SCTLBLC4266	42 x 66 x 42	70	163.4	9.47	\$3246	\$366
SCTLBLC4272	42 x 72 x 42	70	175.52	10.07	\$3306	\$398
SCTLBLC4278	42 x 78 x 42	70	187.63	10.67	\$3473	\$435
SCTLBLC4284	42 x 84 x 42	70	199.75	11.28	\$3533	\$467
SCTLBLC4290	42 x 90 x 42	70	211.87	11.88	\$3774	\$500
SCTLBLC4296	42 x 96 x 42	70	226.43	12.49	\$4010	\$532
SCTLBLC4866	48 x 66 x 42	70	181.04	10.56	\$3408	\$417
SCTLBLC4872	48 x 72 x 42	70	197.54	11.22	\$3473	\$458
SCTLBLC4878	48 x 78 x 42	70	208.04	11.89	\$3649	\$495
SCTLBLC4884	48 x 84 x 42	70	221.54	12.56	\$3718	\$532
SCTLBLC4890	48 x 90 x 42	70	235.04	13.22	\$3963	\$575
SCTLBLC4896	48 x 96 x 42	70	250.98	13.89	\$4209	\$611

Consists of two leg assemblies, two worksurface support beams, dual footrests, and one worksurface with a large 9" radius at each corner with 10.5" overhang on each end.

- Worksurface choice of thermally fused or high pressure laminate with PVC edge.
- Legs are painted extruded aluminum. Casters are lockable, in a choice of two finishes - Black (BLK) or Grey (GRC).
- Cut-outs for power modules are limited to specific sizes/configurations, please see "Power Accessory Cut-out Locations".
- Tables 96" wide and greater include a reinforcement cantilever for added stability.
- Large radius tables are not compatible with SCTAMxx and SCTAMTx Media Units.

Required specifications

Laminate finish
Edge finish
Paint finish
Caster finish

Optional specifications

HP laminate
Power accessory cut-out

Accessories

Collaboration table media unit*, Table leg cable organizer, PET felt modesty panel, Wire mesh storage tray, Table mounted bag hook, Nik power modules, PET felt wire manager

ACCESSORIES MODEL# DIMENSIONS FREIGHT CLASS WT./LBS. CUBIC FT. LIST PRICE HP ADD

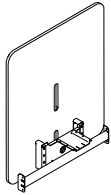

Collaboration Table Media Unit*

	D x W x H						
SCTAM36	11.25 x 36 x 43	150	46.28	10.08	\$907	n/a	
SCTAM42	11.25 x 42 x 43	150	52.5	11.76	\$930	n/a	
SCTAM48	11.25 x 48 x 43	150	58.83	13.44	\$1001	n/a	

Can be affixed to all small radius tables of the same nominal width. User side is thermally fused laminate to accept TV mounts. Side facing away from users features a tackable PET panel affixed to the thermally fused laminate with a 0.5" inset.

- Worksurface available in thermally fused laminate only.
- PET felt available in all standard finishes.
- Brackets and reinforcement bar is painted metal.
- *TV mount not included.*
- Units 36" wide can accept TV's up to 40", not exceeding 50 lbs.
- Units 42" wide can accept TV's up to 43", not exceeding 50 lbs.
- Units 48" wide can accept TV's up to 55", not exceeding 50 lbs.

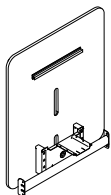

Collaboration Table Media Unit* with TV Mount

SCTAMT36	11.25 x 36 x 43	150	47.58	10.08	\$1141	n/a	
SCTAMT42	11.25 x 42 x 43	150	53.8	11.76	\$1164	n/a	
SCTAMT48	11.25 x 48 x 43	150	60.13	13.44	\$1235	n/a	

Can be affixed to all small radius tables of the same nominal width. User side is thermally fused laminate and includes a TV mount. Side facing away from users features a tackable PET panel affixed to the thermally fused laminate with a 0.5" inset.

- Worksurface available in thermally fused laminate only.
- PET felt backer available in all standard finishes.
- Brackets and reinforcement bar is painted metal.
- Units 36" wide can accept TV's up to 40", not exceeding 50 lbs.
- Units 42" wide can accept TV's up to 43", not exceeding 50 lbs.
- Units 48" wide can accept TV's up to 55", not exceeding 50 lbs.



Table Leg Cable Organizer

SCTAL23	2.21 x 2.965 x 23	70	0.6	0.09	\$41	n/a	
---------	-------------------	----	-----	------	-------------	-----	--

Organizer snaps on to any leg to manage wires vertically. Black only.

Required specifications

- Laminate finish
- Felt finish*
- Paint finish

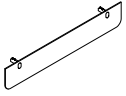
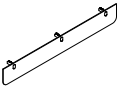
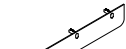
ACCESSORIES	MODEL#	DIMENSIONS	FREIGHT CLASS	WT./LBS.	CUBIC FT.	LIST PRICE	HP ADD
		D x W x H					
	SCTAP36	4.75 x 33 x 11	70	1.78	1	\$92	n/a
	SCTAP42	4.75 x 39 x 11	70	1.99	1.18	\$99	n/a
	SCTAP48	4.75 x 45 x 11	300	2.14	1.36	\$99	n/a
	SCTAP54	4.75 x 51 x 11	300	2.38	1.54	\$104	n/a
	SCTAP60	4.75 x 57 x 11	300	2.53	1.72	\$125	n/a
	SCTAP66	4.75 x 63 x 11	300	2.68	1.9	\$130	n/a
	SCTAP72	4.75 x 69 x 11	300	2.87	2.09	\$135	n/a
	SCTAP78	4.75 x 75 x 11	300	3.05	2.27	\$139	n/a
	SCTAP84	4.75 x 81 x 11	300	3.23	2.45	\$153	n/a
	SCTAP90	4.75 x 87 x 11	300	3.41	2.63	\$167	n/a
	SCTAP96	4.75 x 93 x 11	300	3.59	2.81	\$181	n/a

PET Felt Modesty Panel*

PET felt modesty panel with metal brackets for use on Core, Standard and Workshop tables.

- Specify matching nominal width to table.
- Modesty panels 36" to 54" include two brackets.
- Modesty panels 60" to 90" include three brackets.
- Modesty panels 96" include four brackets.
- PET felt available in standard finishes.

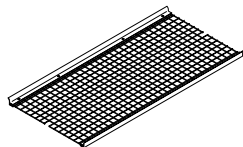

Wire Mesh Storage Tray

SCTAT4848	22 x 42 x 1.6	100	7.85	0.98	\$247	n/a
SCTAT4854	22 x 48 x 1.6	100	8.97	1.1	\$278	n/a
SCTAT4860	22 x 54 x 1.6	100	10.09	1.22	\$315	n/a
SCTAT4866	22 x 60 x 1.6	100	11.19	1.34	\$357	n/a
SCTAT4872	22 x 66 x 1.6	100	12.29	1.47	\$476	n/a
SCTAT4878	22 x 72 x 1.6	100	13.4	1.59	\$489	n/a
SCTAT4884	22 x 78 x 1.6	100	14.52	1.71	\$505	n/a
SCTAT4890	22 x 84 x 1.6	100	15.62	1.83	\$583	n/a
SCTAT4896	22 x 90 x 1.6	100	16.72	1.96	\$600	n/a

Steel storage tray is attached between dual stretchers on tables 48"d x 48"w and larger.

- Specify matching nominal width to table.
- Cannot be combined with SCTAM/SCTAMT media units on tables with casters larger than 78"w.

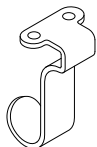
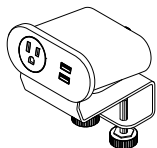

Table-mounted Bag Hook**

SCTAH	0.65 x 1.5 x 3.5	70	0.3	0.01	\$20	n/a
-------	------------------	----	-----	------	-------------	-----

Steel hook for use on Collaborative tables. Specify standard metal paint finish. Maximum capacity of 10 lbs.



Nik Edge/Clamp Mount Power Module

SCTAPEA	2.10 x 6 x 3.7	60	4	0.03	\$570	n/a
SCTAPEB	2.10 x 6 x 3.7	60	4	0.03	\$542	n/a
SCTAPEC	2.10 x 6 x 3.7	60	4	0.03	\$630	n/a
SCTAPED	2.10 x 6 x 3.7	60	4	0.03	\$746	n/a
SCTAPEE	2.10 x 6 x 3.7	60	4	0.03	\$556	n/a

Black with black receptacles, 10ft cord. Specify configuration, last letter of the code represents the following:

- A = 1 AC, 1 USB-A 1.5A charge port, 1 USB-A 2.4A quick charge port
- B = 2 AC
- C = 2 AC, 1 USB-A 1.5A charge port, 1 USB-A 2.4A quick charge port
- D = 1 AC, 1 USB-A 1.5A charge port, 1 USB-A 2.4A quick charge port, 1 60W USB-C charge port
- E = 3 AC

Required specifications

PET felt finish*

Paint finish**

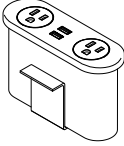
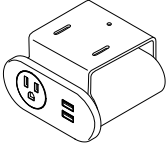
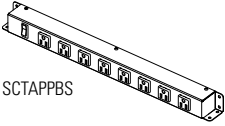
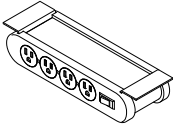
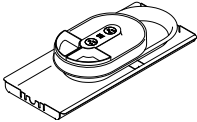
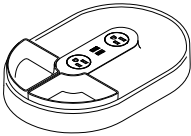
ACCESSORIES	MODEL#	DIMENSIONS D x W x H	FREIGHT CLASS	WT/LBS.	CUBIC FT.	LIST PRICE	HP ADD
 <p>Nik In-Surface Power Module</p>	SCTAPSC	2.10 x 6 x 3.7	60	4	0.03	\$639	n/a
	SCTAPSD	2.10 x 6 x 3.7	60	4	0.03	\$797	n/a
	SCTAPSE	2.10 x 6 x 3.7	60	4	0.03	\$561	n/a
	<p>Black with black receptacles, 10ft cord. Corresponding cut-out option is C1, C2 or C3 (where applicable). Specify configuration, last letter of the code represents the following:</p> <ul style="list-style-type: none"> • C = 2 AC, 1 USB-A 1.5A charge port, 1 USB-A 2.4A quick charge port • D = 1 AC, 1 USB-A 1.5A charge port, 1 USB-A 2.4A quick charge port, 1 60W USB-C charge port • E = 3 AC 						
 <p>Nik Below Surface Power Module</p>	SCTAPBA	2.10 x 6 x 3.7	60	4	0.03	\$445	n/a
	SCTAPBB	2.10 x 6 x 3.7	60	4	0.03	\$403	n/a
	SCTAPBC	2.10 x 6 x 3.7	60	4	0.03	\$473	n/a
	SCTAPBD	2.10 x 6 x 3.7	60	4	0.03	\$584	n/a
	SCTAPBE	2.10 x 6 x 3.7	60	4	0.03	\$413	n/a
<p>Black with black receptacles, 10ft cord. Specify configuration, last letter of the code represents the following:</p> <ul style="list-style-type: none"> • A = 1 AC, 1 USB-A 1.5A charge port, 1 USB-A 2.4A quick charge port • B = 2 AC • C = 2 AC, 1 USB-A 1.5A charge port, 1 USB-A 2.4A quick charge port • D = 1 AC, 1 USB-A 1.5A charge port, 1 USB-A 2.4A quick charge port, 1 60W USB-C charge port • E = 3 AC 							
 <p>SCTAPPBS</p>  <p>SCTAPPBD</p> <p>Below Surface Power Bar</p>	SCTAPPBS	1.95 x 21 x 1.95	60	2.7	0.06	\$343	n/a
	SCTAPPBD	4 x 10.6 x 2.3	60	2.7	0.06	\$843	n/a
<p>Available in black only.</p> <ul style="list-style-type: none"> • Single (SCTAPPBS) includes 8 outlets on a single side • Double (SCTAPPBD) includes 4 outlets on each side of the bar. Built-in circuit breaker. 							
 <p>Collaborative Spaces Power Tray</p>	SCTAPTC	10.51 x 23.26 x 4.53	85	7.73	0.64	\$950	n/a
	SCTAPTD	10.51 x 23.26 x 4.53	85	7.73	0.64	\$1107	n/a
	SCTAPTE	10.51 x 23.26 x 4.53	85	7.73	0.64	\$871	n/a
<p>Black plastic power tray with removable grey accessory trays. Top tray is offset for cable storage underneath. Recessed tray sits 3.7" below surface to keep cables out of sight. 10ft. cord. Corresponding cut-out option is O2 (where applicable). Specify configuration, last letter of the code represents the following:</p> <ul style="list-style-type: none"> • C = 2 AC, 1 USB-A 1.5A charge port, 1 USB-A 2.4A quick charge port • D = 1 AC, 1 USB-A 1.5A charge port, 1 USB-A 2.4A quick charge port, 1 60W USB-C charge port • E = 3 AC 							
 <p>Collaborative Spaces Organizer Tray</p>	SCTAOTC	8.32 x 12.40 x 4.28	70	1.5	0.26	\$709	n/a
	SCTAOTD	8.32 x 12.40 x 4.28	70	1.5	0.26	\$862	n/a
	SCTAOTE	8.32 x 12.40 x 4.28	70	1.5	0.26	\$630	n/a
<p>Black plastic power tray with removable grey accessory trays. 10ft. cord. Corresponding cut-out option is C1, C2 or C3 (where applicable). Specify configuration, last letter of the code represents the following:</p> <ul style="list-style-type: none"> • C = 2 AC, 1 USB-A 1.5A charge port, 1 USB-A 2.4A quick charge port • D = 1 AC, 1 USB-A 1.5A charge port, 1 USB-A 2.4A quick charge port, 1 60W USB-C charge port • E = 3 AC 							

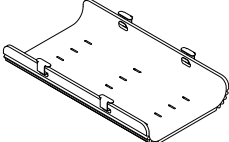
ACCESSORIES	MODEL#	DIMENSIONS	FREIGHT CLASS	WT./LBS.	CUBIC FT.	LIST PRICE	HP ADD
 <p>Collaborative Spaces Recessed Power Tray</p>		D x W x H					
	SCTAPRC	10.51 x 23.26 x 6.4	125	6.06	0.91	\$843	n/a
	SCTAPRD	10.51 x 23.26 x 6.4	125	6.06	0.91	\$996	n/a
	SCTAPRE	10.51 x 23.26 x 6.4	125	6.06	0.91	\$764	n/a
 <p>Collaborative Spaces PET Felt* Wire Manager</p>	SCTACT	26 x 11 x 4	70	1.1	0.66	\$97	n/a

Black plastic power tray. Recessed tray sits 3.7" below surface to keep cables out of sight. 10ft. cord. Corresponding cut-out option is O2 (where applicable). Specify configuration, last letter of the code represents the following:

- C = 2 AC, 1 USB-A 1.5A charge port, 1 USB-A 2.4A quick charge port
- D = 1 AC, 1 USB-A 1.5A charge port, 1 USB-A 2.4A quick charge port, 1 60W USB-C charge port
- E = 3 AC

PET Felt Wire Manager hangs from four brackets under the surface. Includes Black painted metal brackets. PET felt available in standard finishes.

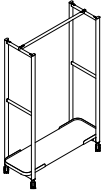
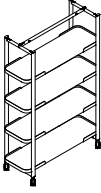
TEAM CARTS	MODEL#	DIMENSIONS	FREIGHT CLASS	WT./LBS.	CUBIC FT.	LIST PRICE	HP ADD
 <p>Coat Rack Cart</p>	SCCR1848	18 x 48 x 72	300	56.82	36.04	\$2202	n/a
	SCCR1860	18 x 60 x 72	300	62.77	45.05	\$2272	n/a
 <p>Shelf Cart*</p>	SCCS1848	18 x 48 x 72	250	123.88	36.04	\$4119	n/a

Cart includes side rails for compatible accessories and a single top rail for hanging coats, jackets, etc.

- Shelf available in thermally fused laminate.
- Painted aluminum frame available in standard paint finishes.
- 48" w cart shelf has a capacity of 140 lbs., evenly distributed.
- 60" w cart shelf has a capacity of 175 lbs., evenly distributed
- Casters are lockable, in a choice of two finishes - Black (**BLK**) or Grey (**GRC**).

Cart includes four fixed shelves with metal trim detail. Vertical rails accept PET privacy panels (sold separately) to create space division within open areas.

- Horizontal top rail accepts compatible accessories.
- Shelf available in thermally fused laminate.
- Painted aluminum frame available in standard paint finishes.
- Each shelf has a capacity of 140 lbs., evenly distributed.
- Casters are lockable, in a choice of two finishes - Black (**BLK**) or Grey (**GRC**).

Required specifications

PET felt finish*
 Laminate finish Edge finish
 Paint finish Caster finish

Accessories

PET privacy panel (*shelf cart only*)
 Accessory cup
 Hook for team cart
 Laptop shelf (*coat rack cart only*)

TEAM CARTS **MODEL#** **DIMENSIONS** **FREIGHT CLASS** **WT./LBS.** **CUBIC FT.** **LIST PRICE** **HP ADD**

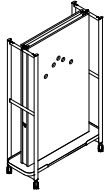

Media Cart

D x W x H

SCCMEP1848	18 x 48 x 72	150	171.42	36.04	\$4257	n/a
SCCMEP1860	18 x 60 x 72	150	214.23	45.05	\$4778	n/a
SCCMNE1848	18 x 48 x 72	150	170.92	36.04	\$4049	n/a
SCCMNE1860	18 x 60 x 72	150	213.73	45.05	\$4569	n/a

Cart includes includes a bottom shelf and thermally fused laminate TV board. Short side panels feature small cut-out for wire pass through and hook for wire management.

- Side rails accept compatible accessories.
- Shelf available in thermally fused laminate.
- Back panel is removable for access to cavity for cable management. Back panel is whiteboard laminate.
- SCCMEP models include a power bar (SCCAMP) mounted internally.
- SCCMNE models do not include any power.
- Units 48" wide can accept TV's up to 55", not exceeding 50lbs.
- Units 60" wide can accept TV's up to 60", not exceeding 50lbs.
- Painted aluminum frame available in standard paint finishes
- Casters are lockable, in a choice of two finishes - Black (**BLK**) or Grey (**GRC**).
- Note: TV mount included. *TV and video conferencing units are not included.*

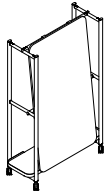

Single-Sided Whiteboard Cart

SCCSW1848	18 x 48 x 72	250	106.37	36.04	\$3647	n/a
SCCSW1860	18 x 60 x 72	150	191.07	45.05	\$4276	n/a

Cart includes one fixed shelf with metal trim detail, accessible from behind whiteboard. Front of vertical whiteboard panel is whiteboard only.

- Side rails accept compatible accessories.
- Back of vertical whiteboard panel is Designer White laminate (DWT) with Designer White edging (DWE).
- Shelf available in thermally fused laminate.
- Painted aluminum frame available in standard paint finishes.
- Casters are lockable, in a choice of two finishes - Black (**BLK**) or Grey (**GRC**).

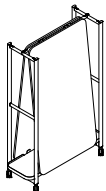

Double-Sided Whiteboard Cart

SCCDW1848	18 x 48 x 72	150	153.96	36.04	\$4918	n/a
SCCDW1860	18 x 60 x 72	150	191.07	45.05	\$6088	n/a

Cart includes one fixed shelf with metal trim detail, accessible from behind whiteboard. Front of vertical whiteboard panels is whiteboard only.

- Side rails accept compatible accessories.
- Back of vertical whiteboard panel is Designer White laminate (DWT) with Designer White edging (DWE).
- Shelf available in thermally fused laminate.
- Painted aluminum frame available in standard paint finishes.
- Casters are lockable, in a choice of two finishes - Black (**BLK**) or Grey (**GRC**).

Required specifications

Laminate finish
Edge finish
Paint finish
Caster finish

Accessories

Concealed power unit (SCCMNExxxx only)
Media tray (SCCMEPxxxx/MNExxxx only)
Accessory cup

Hook for team cart
Laptop shelf

TEAM CARTS

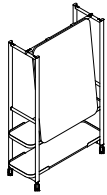

Combo Whiteboard Cart

MODEL#	DIMENSIONS D x W x H	FREIGHT CLASS	WT./LBS.	CUBIC FT.	LIST PRICE	HP ADD
SCCCW1848	18 x 48 x 72	250	115.66	36.04	\$3937	n/a
SCCCW1860	18 x 60 x 72	250	150.33	45.05	\$4524	n/a

Cart includes two fixed shelves with metal trim detail, accessible from behind whiteboard. Bottom shelf is accessible from both sides of cart; top shelf accessible from behind write board. Front of vertical whiteboard panel is whiteboard only.

- Side rails accept compatible accessories.
- Back of vertical whiteboard panel is Designer White laminate (DWT) with Designer White edging (DWE).
- Shelves available in thermally fused laminate.
- Painted aluminum frame available in standard paint finishes.
- 48" w cart shelf has a capacity of 140 lbs., evenly distributed.
- 60" w cart shelf has a capacity of 175 lbs., evenly distributed
- Casters are lockable, in a choice of two finishes - Black (**BLK**) or Grey (**GRC**).

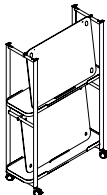

Removable Whiteboard Cart

SCCRW1848	18 x 48 x 72	150	188	42.05	\$6071	n/a
SCCRW1860	18 x 60 x 72	150	245.61	52.56	\$6932	n/a

Cart includes two fixed shelves with spacers for removable whiteboards. Includes five lightweight removable whiteboard panels.

- One whiteboard can be stored at the top and four at the bottom.
- Cart accepts five lightweight removable whiteboard panels maximum.
- Whiteboards feature whiteboard front; back in Designer White laminate (DWT) with Designer White edging (DWE).
- Hanging bracket finish matches the cart frame finish.
- Shelves available in thermally fused laminate.
- Side rails accept compatible accessories.
- Painted aluminum frame available in standard paint finishes.
- Casters are lockable, in a choice of two finishes - Black (**BLK**) or Grey (**GRC**).

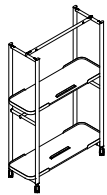

Empty Removable Whiteboard Cart

SCCEW1848	18 x 48 x 72	300	82.31	42.05	\$2973	n/a
SCCEW1860	18 x 60 x 72	250	105.7	52.56	\$3145	n/a

Cart includes two fixed shelves with spacers for removable whiteboards.

- Cart accepts five lightweight removable whiteboard panels maximum.
- One whiteboard can be stored at the top and four at the bottom.
- To order Removable Whiteboard, specify SCCAWB3336 for the 48" wide cart and SCCAWB3348 for the 60" wide cart.
- Hanging bracket finish matches the cart frame finish.
- Shelves available in thermally fused laminate.
- Side rails accept compatible accessories.
- Painted aluminum frame available in standard paint finishes.
- Casters are lockable, in a choice of two finishes - Black (**BLK**) or Grey (**GRC**).

Required specifications

Laminate finish
Edge finish
Paint finish
Caster finish

Accessories

Accessory cup
Hook for team cart
Whiteboard
Laptop shelf

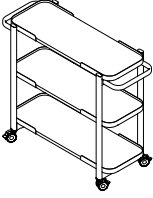
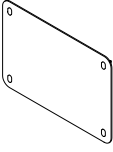
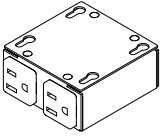
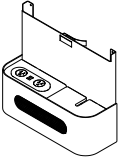
TEAM CARTS	MODEL#	DIMENSIONS	FREIGHT CLASS	WT/LBS.	CUBIC FT.	LIST PRICE	HP ADD
 <p>Hospitality Cart*</p>	D x W x H						
	SCHC2233	22 x 43 x 41	150	81.31	15.39	\$3214	n/a
	SCHC2239	22 x 49 x 41	150	95	17.96	\$3346	n/a
		<p>Cart includes three fixed shelves with metal trim.</p> <ul style="list-style-type: none"> • Surfaces available in thermally fused laminate. • Legs and handles are painted aluminum available in standard paint finishes. • 33" w cart shelf has a capacity of 120 lbs., evenly distributed. • 39" w cart shelf has a capacity of 140 lbs., evenly distributed • Casters are lockable, in a choice of two finishes - Black (BLK) or Grey (GRC). • Note: size is inclusive of handles, shelf sizing is approximately 10" shorter. 					
TEAM CART ACCESSORIES	MODEL#	DIMENSIONS	FREIGHT CLASS	WT/LBS.	CUBIC FT.	LIST PRICE	HP ADD
 <p>Cart Mounted PET Felt Privacy Panels**</p>	SCCAPP3248	0.5 x 48 x 32	85	4.16	0.32	\$271	n/a
	SCCAPP3260	0.5 x 60 x 32	85	5.16	0.4	\$401	n/a
		<p>Lightweight removable PET Felt panels, specify SCCAPP3248 for the 48" w cart and SCCAPP3260 for the 60" w cart.</p> <ul style="list-style-type: none"> • Snaps onto (SCCEWxxxx) vertical rails at various shelf heights to create space division and privacy. • Cover caps painted metal finish should be specified to match the cart finish. • PET felt available in standard finishes. 					
 <p>Concealed Power Unit</p>	SCCAMP	3 x 3 x 1.5	70	0.5	0.01	\$305	n/a
			<p>Provided inside SCCMEPxxxx media units, can be added to SCCNMExxxx in field. Includes two AC outlets. 10ft cord.</p> <ul style="list-style-type: none"> • Compatible with Mobile Media Carts only. • Black (BLK) finish only. 				
 <p>Media Tray**</p>	SCCAMT	5.60 x 14.57 x 13.80	70	12	0.65	\$676	n/a
	SCCAMTPC	5.60 x 14.57 x 13.80	70	12	0.65	\$1315	n/a
	SCCAMTPD	5.60 x 14.57 x 13.80	70	12	0.65	\$1473	n/a
	SCCAMTPE	5.60 x 14.57 x 13.80	70	12	0.65	\$1237	n/a
			<p>Attaches to the front of the SCCMEPxxxx/SCCNMExxxx to provide a wire catch, wireless receiver area and easily accessible power at the front of the media carts</p> <ul style="list-style-type: none"> • Compatible with Mobile Media Carts only. • Tray is painted metal with a PET Felt insert. PET felt available in standard finishes. • SCCAMT is empty and has no power capabilities. • Specify configuration, last letter of the code represents the following • C = 2 AC, 1 USB-A 1.5A charge port, 1 USB-A 2.4A quick charge port • D = 1 AC, 1 USB-A 1.5A charge port, 1 USB-A 2.4A quick charge port, 1 60W USB-C charge port • E = 3 AC 				

Required specifications

- Laminate finish / Edge finish*
- Paint finish*
- Caster finish*
- PET Felt finish**

TEAM CART ACCESSORIES

MODEL# DIMENSIONS FREIGHT CLASS WT/LBS. CUBIC FT. LIST PRICE HP ADD

D x W x H



Accessory Cup

SCCAC	3 x 3 x 1.5	70	0.15	0.02	\$14	n/a
-------	-------------	----	------	------	-------------	-----

Hangs onto any team cart horizontal top or side rail. Black (BLK) finish only.

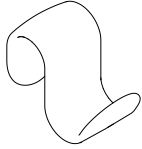

Hook for Team Cart

SCCAH	3 x 3 x 1.5	70	0.1	0.01	\$10	n/a
-------	-------------	----	-----	------	-------------	-----

Hangs onto any team cart horizontal top or side rail. Black (BLK) finish only. Maximum capacity of 10lbs.

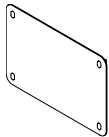

Whiteboard¹

SCCAWB3336	0.50 x 36 x 33	60	17.62	0.34	\$608	n/a
SCCAWB3348	0.50 x 48 x 33	400	23.32	46	\$752	n/a

Lightweight removable whiteboard panels. Specify SCCAWB3336 for the 48" w cart and SCCAWB3348 for the 60" w cart.

- Back of whiteboard is Designer White (DWT) with Designer White edging (DWE).
- Cover caps painted metal finish should be specified to match the cart finish.
- Horizontal and vertical mounting on wall rail(s).

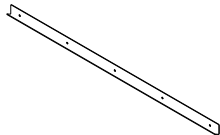

Whiteboard Wall Rail

SCCAWBR36	1 x 36 x 2	70	1.27	0.04	\$62	n/a
SCCAWBR48	1 x 48 x 2	70	1.71	0.05	\$77	n/a
SCCAWBR72	1 x 72 x 2	60	2.54	0.08	\$121	n/a
SCCAWBR96	1 x 96 x 2	60	3.42	0.11	\$149	n/a

Wall rail for whiteboards. Accepts SCCAWBxxxx. Metal extrusion in Black (BLK) only.

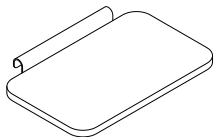

Laptop Shelf*

SCCAL1219	12 x 19 x 3	65	11.07	0.4	\$295	n/a
-----------	-------------	----	-------	-----	--------------	-----

Laminate laptop shelf with dual bracket. Can be flipped vertically to store when cart is not in use.

- Shelf available in thermally fused laminate.
- Bracket included is painted metal finish and should be specified to match the cart finish.

Required specifications

- Laminate finish*
- Edge finish*
- Paint finish*¹

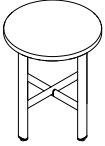
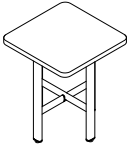
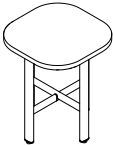
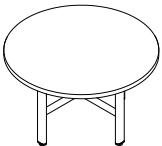
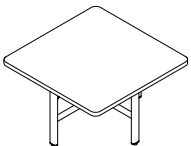
OCCASIONAL TABLES	MODEL#	DIMENSIONS	FREIGHT CLASS	WT/LBS.	CUBIC FT.	LIST PRICE	HP ADD
 <p>Occasional Side Table, Round Top</p>	D x W x H						
	SCOR1818	18 x 18 x 21	150	18.52	3.94	\$667	n/a
	SCOR2424	24 x 24 x 21	250	26.53	7.01	\$785	n/a
<p>Includes leg assembly, cross beams and one worksurface.</p> <ul style="list-style-type: none"> • Surface available in thermally fused laminate. • Legs and cross beam are painted aluminum available in standard paint finishes. 							
 <p>Occasional Side Table, Square Top</p>	D x W x H						
	SCOC1818	18 x 18 x 21	150	21.12	3.94	\$667	n/a
	SCOC2424	24 x 24 x 21	150	31.2	7.01	\$785	n/a
<p>Includes leg assembly, cross beams and one worksurface with a small 1.5" radius at each corner.</p> <ul style="list-style-type: none"> • Surface available in thermally fused laminate. • Legs and cross beam are painted aluminum available in standard paint finishes. 							
 <p>Occasional Side Table, Square Top, Larger Radius</p>	D x W x H						
	SCOCL1818	18 x 18 x 21	150	21.12	3.94	\$667	n/a
	SCOCL2424	24 x 24 x 21	150	31.2	7.01	\$785	n/a
<p>Includes leg assembly, cross beams and one worksurface with a larger 9" radius at each corner.</p> <ul style="list-style-type: none"> • Surface available in thermally fused laminate. • Legs and cross beam are painted aluminum available in standard paint finishes. 							
 <p>Occasional Coffee Table, Round Top</p>	SCOCR2424	24 x 24 x 17	150	25.55	5.67	\$760	n/a
	SCOCR3030	30 x 30 x 17	150	35.76	8.86	\$901	n/a
	SCOCR3636	36 x 36 x 17	250	48.13	12.76	\$1071	n/a
<p>Includes leg assembly, cross beams and one worksurface.</p> <ul style="list-style-type: none"> • Surface available in thermally fused laminate. • Legs and cross beam are painted aluminum available in standard paint finishes. 							
 <p>Occasional Coffee Table, Square Top</p>	D x W x H						
	SCOCS2424	24 x 24 x 17	150	30.22	5.67	\$760	n/a
	SCOCS3030	30 x 30 x 17	150	43.1	8.86	\$901	n/a
<p>Includes leg assembly, cross beams and one worksurface with a small 1.5" radius at each corner.</p> <ul style="list-style-type: none"> • Surface available in thermally fused laminate. • Legs and cross beam are painted aluminum available in standard paint finishes. 							

Required specifications

- Laminate finish
- Edge finish
- Paint finish

OCCASIONAL TABLES

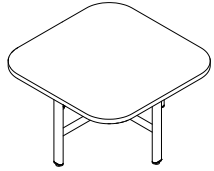

Occasional Coffee Table, Square Top, Larger Radius

MODEL#	DIMENSIONS D x W x H	FREIGHT CLASS	WT/LBS.	CUBIC FT.	LIST PRICE	HP ADD
SCOCSL2424	18 x 18 x 21	150	29.11	5.67	\$760	n/a
SCOCSL3030	24 x 24 x 21	150	41.99	8.86	\$901	n/a

Includes leg assembly, cross beams and one worksurface with a larger 9" radius at each corner.

- Surface available in thermally fused laminate.
- Legs and cross beam are painted aluminum available in standard paint finishes.

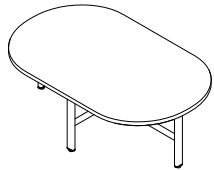

Occasional Coffee Table, Racetrack Top



SCOCC2442	24 x 42 x 17	150	42.78	9.93	\$955	n/a
SCOCC3048	30 x 48 x 17	150	57.13	14.18	\$1137	n/a

Includes leg assembly, cross beams and one racetrack worksurface.

- Surface available in thermally fused laminate.
- Legs and cross beam are painted aluminum available in standard paint finishes.

Required specifications

- Laminate finish
- Edge finish
- Paint finish

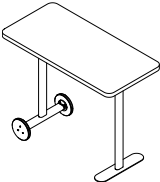
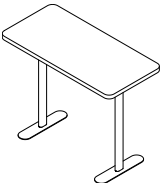
LAPTOP TABLES	MODEL#	DIMENSIONS	FREIGHT CLASS	WT/LBS.	CUBIC FT.	LIST PRICE	HP ADD
 <p>Laptop Table, Racetrack Top, Wheel and Foot Base</p>		D x W x H					
	SCLCC1633	16 x 33 x 26	250	25.6	6.51	\$1181	n/a
 <p>Laptop Table, Racetrack Top, Foot Base</p>							
	SCLCB1633	16 x 33 x 26	250	23.85	6.51	\$713	n/a
 <p>Laptop Table, Rectangular Top, Wheel and Foot Base</p>							
	SCLTC1633	16 x 33 x 26	150	27.64	6.51	\$1181	n/a
 <p>Laptop Table, Rectangular Top, Foot Base</p>							
	SCLTB1633	16 x 33 x 26	250	25.88	6.51	\$713	n/a

Includes leg assembly and two wheels with rubber trim, one leg assembly with a foot, and one racetrack surface.

- Two bag hooks included, one on the exterior of each leg, mounted just under the surface for easy access.
- Each bag hook accepts up to 10 lbs. and is painted to match the legs.
- Legs, beams and hook are painted aluminum available in standard paint finishes.
- Wheel insert is painted to match the legs and beams.
- Surface available in thermally fused laminate.

Includes two leg assemblies with a foot and one racetrack surface.

- Two bag hooks included, one on the exterior of each leg, mounted just under the surface for easy access.
- Each bag hook accepts up to 10 lbs. and is painted to match the legs.
- Legs, beams and hook are painted aluminum available in standard paint finishes.
- Surface available in thermally fused laminate.

Includes leg assembly and two wheels with rubber trim, one leg assembly with a foot, and one rectangular surface with a small 1.5" radius at each corner.

- Two bag hooks included, one on the exterior of each leg, mounted just under the surface for easy access.
- Each bag hook accepts up to 10 lbs. and is painted to match the legs.
- Legs, beams and hooks are painted aluminum available in standard paint finishes.
- Wheel insert is painted to match the legs and beams.
- Surface available in thermally fused laminate.

Includes two leg assemblies with a foot and one rectangular surface with a small 1.5" radius at each corner.

- Two bag hooks included, one on the exterior of each leg, mounted just under the surface for easy access.
- Each bag hook accepts up to 10 lbs. and is painted to match the legs.
- Legs, beams and hook are painted aluminum available in standard paint finishes.
- Surface available in thermally fused laminate.

Required specifications

Laminate finish
Edge finish
Paint finish

Optional specifications

HP laminate
Power accessory cut-out

Accessories

Table leg cable organizer,
PET felt modesty panel,
Table mounted bag hook,
Nik power modules, PET felt wire manager



ConnectTABLES® provides solutions for a variety of day-to-day work environments. Designed as easy-to-use linking or freestanding tables, ConnectTABLES is limited only by your imagination.

Open Conference

Many ConnectTABLES® tops can be assembled to be freestanding. When combined with locking casters and the flip top "T" leg, the result is easy storage and complete portability.

Meeting Rooms

ConnectTABLES® modular units will provide quick and affordable answers for all sizes and shapes of rooms and applications.

Educational and Training Rooms

ConnectTABLES® table tops configure easily into temporary or permanent educational applications.

Features and Benefits

- Optional, easy-to-use thumbscrews allow installation without tools.
- Optional zinc-plated steel ganging hardware connects free standing tops without moving "T" Leg position.
- Optional modesty panel wire management unit available.
- Casters will not affect table height when used in conjunction with or in place of glides.
- Optional Black grommets for convenient wire management can be ordered "factory installed".
- Tops are 1" thick and constructed of 45 lb. density particleboard.
- Optional casters available with or without manual locks provide mobility.
- ConnectTABLES® tops are available in all Global laminate finishes with three leg and two edge color options.



T Leg with leveling glides



Modesty Panel

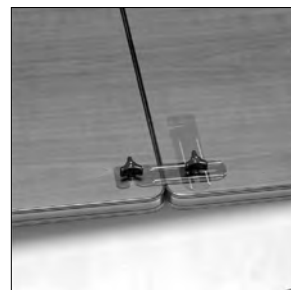

Optional ganging connector

GENERAL INFORMATION

- ConnecTABLES® is an affordable and highly flexible system of modular tables. Designed as easy-to-use linking or freestanding tables, ConnecTABLES adapts to most every requirement: seminar or training room, meeting room, personal workstations, educational, conferencing and team cluster workgroups.
- ConnecTABLES have nine basic top shapes available in various sizes.
- ConnecTABLES edges **do not match** any other Global product in either color or style.
- For environmental certifications, please visit globalfurnituregroup.com.

WORKSURFACES

- Tops are 1" thick, made of 45 lb. density particle board covered on both sides with high performance thermally fused laminate. Optional high pressure laminate tops are 1-1/16" thick.
- Laminate finishes are available in High Pressure. Contact Customer Care for a quote.
- If other than a Global standard laminate finish is preferred, contact Customer Care. Information needed includes the name of the laminate manufacturer, color name, number and model of table. You will then be given a quote for this special order.
- **ConnecTABLES® edges do not match any other Global product in either color or style.**
- Products specified with the high pressure laminate option are finished on the underside of the surface with a kraft paper backing.

CONSTRUCTION

- Some components can stand alone when the "T" base is set in the freestanding position. When the "T" base is in the linking position, all the components can be used in grouping configurations (clusters).
- Optional wire grommets not available on 45° wedge and the 60° triangle.
- Rectangular tops 54" in length and longer are supplied with a 16" gauge steel support channel. Top is pre-drilled for placement.
- Shipped RTA (ready to assemble). Quick and easy to assemble.
- Special width tops are available. Use next size up.
- Adjustable levelers offer up to 1" adjustability.
- Elliptical column cover, glides, casters, thumbscrews and endcaps available in Black only.
- Must specify top, edge, and "T" base color with each order.

LEGS

- "T" leg is coated with environmentally friendly, recyclable paint electrostatically applied epoxy powder coating for a very durable finish in three colors as specified below. Only the bottom horizontal portion of the painted leg is visible.
- Black plastic leveling glides offer 1" adjustability.
- Two black plastic elliptical column caps cover each leg column.
- Casters will not affect table height when used in conjunction with or in place of glides.
- Casters can facilitate mobility in installations which need to be moved frequently.

LAMINATE FINISHES

ACJ	Absolute Acajou	FCL	First Class
ASN	Asian Night	NBL	Noce Biondo
AWC	Avant Cherry	NGL	Noce Grigio
AWH	Avant Honey	NEL	Noce Leggero
BLK	Black	NML	Noce Medio
BZD	Blizzard	QTM	Quartered Mahogany
BRC	Brushed Cobalt	SBY	Sheer Beauty
CMB	Clear Maple	SOG	Storm Grey
CGY	Custom Grey	SDT	Stonedust
DES	Dark Espresso	WHE	Walnut Heights
DWT	Designer White	WHC	White Chocolate
FAS	Fashionista	WCR	Winter Cherry

EDGE COLORS

Black (BK) Grey (GR)

LEG COLORS

Black (TBL) Shadow (TSH)
 Tungsten (TTU) Chrome (CHM) - optional on foot only, upcharge applies

GROMMETS

- Optional Grommets available in standard worksurface locations (left, center or right) **for Rectangular Tables**. Order as: **AG1, AG2 or AG3. Add \$96**
- Grommet hole dimensions are 3 1/4" wide x 1 7/8" deep.

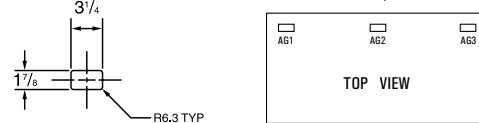

- Grommets may be placed at non-standard locations. Order as: **AGS - Add \$96**. A drawing must be supplied with vertical and horizontal dimensions to the center of the cut-out (as in drawing above). Please refer to CUSTOM GROMMET LOCATION FORM in the back reference section.
- If adding **Cove mini power block** to **AG** cut-out, cannot use with modesties.

POWER BLOCK

- An individually corded power block (model **PMSPDM**) may be ordered on all worksurfaces. Units cannot be daisy chained and cannot be used with modesties.
- Power block is configured with one electrical duplex receptacle and two data (RJ45) receptacles. 9' black cord included. Power block dimensions are 3.5" deep x 6.5" wide x 2.75" high.
- To purchase a power block, you must specify both the power block cut-out location and the power block model #. Order power block as **PMSPDM. Add \$330**. Power Blocks are available in standard worksurface locations (left, center or right). Order as **E1, E2 or E3. Add \$96**.

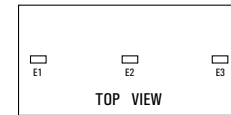

Power Block **PMSPDM, Add \$330**

Specify location **E1, E2 or E3, Add \$96**.

EXAMPLES OF GROMMET AND POWER BLOCK POSITIONS

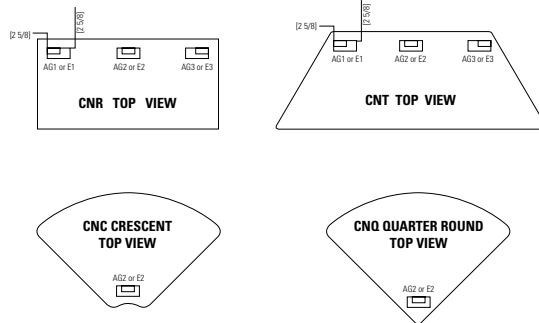

MODPOWER DAISY CHAIN SOLUTION

- Add flexible power and USB charging to ConnecTables rectangular tables. Connect up to four units with a single corded infeed with NEMA plug.
- ModPower units are sold separately, refer to Productivity Solutions page 465.
- Begin run with a starter unit which includes a corded infeed. Add additional middle or end units as required. Middle and end units are equipped with connecting cables.
- On-surface modules clamp on or screw mount to the table tops.
- In-surface modules require table top cut-outs for mounting. Specify cut-out option:
 - **MPS** for a single cut-out to accommodate one ModPower in-surface unit (cut-out will be centered on the approach side) for **30" to 72" wide rectangular tables. Add \$96**
 - **MPD** for two cut-outs in the left and right positions, 18.25" from ends to center of unit on approach side for **60", 66" and 72" wide rectangular tables. Add \$192**.

C CONNECTABLES® - NOTES

VILLA CUTOUTS

- Optional Villa cutout available in standard worksurface locations (left, center or right) for **Rectangular Tables**. Order as: **V1, V2 or V3** - Add \$96 for each cutout.
- Villa cutouts may be placed at non-standard locations. Please contact customer care.

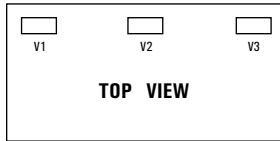

TOP & EDGE OPTIONS

- ConnectTABLES® have nine basic top shapes available in various sizes. All top shapes have a variety of straight or curved edges which are referred to as **Working (W)**, **Connecting (C) or End (E) edges**. Edges can also have a combination of edge types as shown.

*cannot freestand

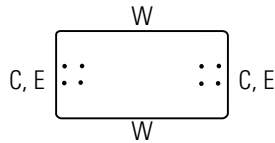

Rectangle

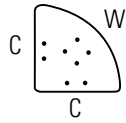

Quarter Round*

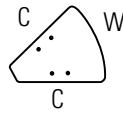

45° Wedge*

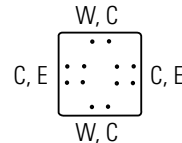

Square

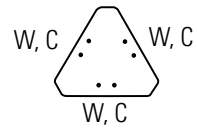

60° Triangle*

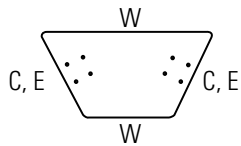

Trapezoid

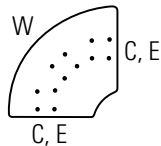

90° Crescent

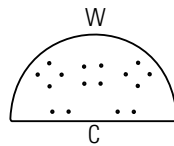

Half Round

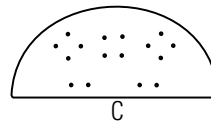

Extended Half Round*

Working Edge (1) - Edges designated with the letter "W" indicate that this is a **working** or sitting edge. These edges can be connected with optional ganging hardware in free-standing applications.

Connecting Edge (2) - Edges designated with the letter "C" indicate that this is a **connecting** edge. These edges can be connected to any other connecting edge of equal width, regardless of the top shape or size.

End Edge (3) - Edges designated with the letter "E" indicate that this is an **end** edge or an edge that can finish a run of tops. If a top has two end edges it can be freestanding. 90° crescent tops can be freestanding if the optional center leg is added.

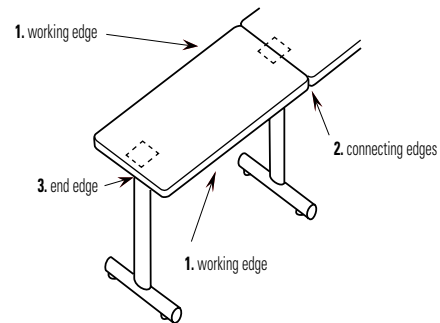

FREESTANDING AND CONNECTING CONDITIONS

Freestanding tables are defined as any one worksurface supported by two or more legs;

connecting tables are defined as more than one work surface supported by a single leg at each point of connection. The rule for determining the quantity of legs of an open configuration is the number of worksurfaces plus one (**See Figure 1**).

On closed configurations, the number of legs is equal to the number of worksurfaces (**See Figure 2**). There are some exceptions, such as when optional third legs are used on quarter round or 90° crescent shapes.

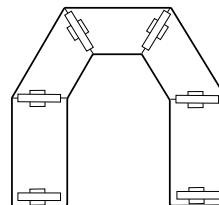

Figure 1. Open Configuration
Number of Surfaces = 5
Number of Legs = 6

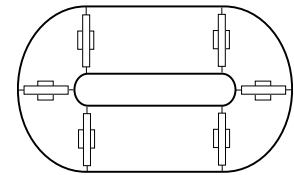

Figure 2. Closed Configuration
Number of Surfaces = 6
Number of Legs = 6

FREESTANDING CONDITIONS

- All square, rectangle and trapezoid shapes are able to act as freestanding tables (**Figure 3**).
- When Trapezoid tops are freestanding, legs must be on the outer left and right sides (**Figure 4**).
- 90° crescent work surfaces have provision for an optional third center leg for additional stability when heavy loads are applied to the outside edge. They can also be used as freestanding tables when a third leg is added (**Figure 5**).
- All freestanding tables can be connected with optional ganging hardware.
- Freestanding tables can be ganged with connected tables in some cases, providing that the number and size of connected tables is easily movable (**Figure 6**).
- **DO NOT DRAG TABLES WHEN RE-CONFIGURING.**

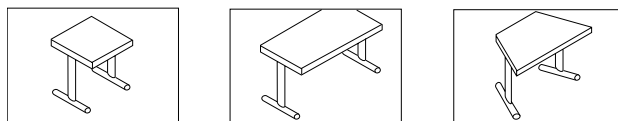
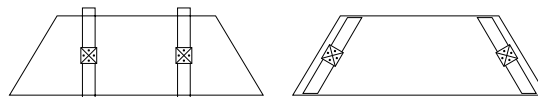

Figure 3 - Freestanding Tables



Incorrect Correct

Figure 4 - Trapezoid Tops

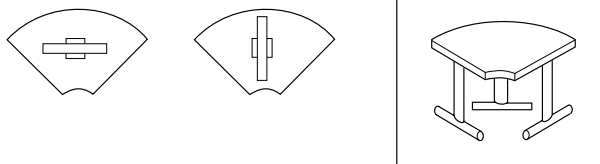

Figure 5 - Adding a Third Leg

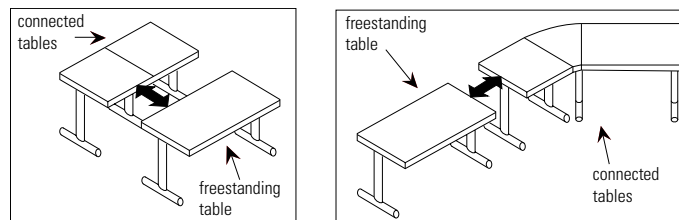

Figure 6 - Ganging with Connected Tables

CONNECTING CONDITIONS

- Any two worksurfaces of equal depth (24"D, 30"D or 36"D) can be connected with one leg, at the connecting or end edges (**Figure 8**).
- Half round work surfaces can be used in the following ways: They must be of equal width when connected to each other (**Figure 7**) or the connecting shapes must be equal to half the width of the connecting half round (**Figure 8**).
- ConnectABLES® is designed with the leg to be fastened parallel to connecting edges, but in some cases you may wish to fasten legs at 90° to connecting edges. This could allow for increased leg or knee clearance, depending on the intended use (**Figure 9**).
- Quarter round and 90° crescent work surfaces have provision for an optional third leg for additional stability when heavy loads are applied to the outside edge. For quarter round work surfaces, it is recommended that configuration "A" be used since the outside end of the center leg in configuration "B" is almost flush with the outside edge of the worksurface. If configuration "B" is installed against a wall or where there will be no traffic flow, then configuration "B" can be used.

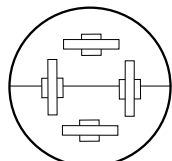

Figure 7

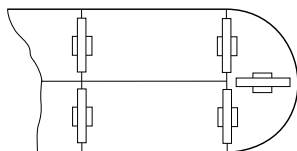

Figure 8

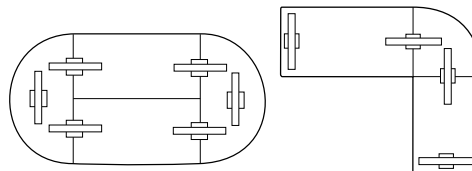
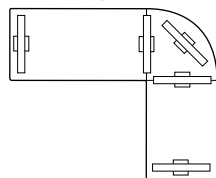
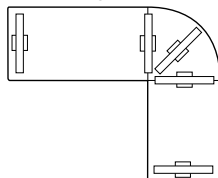

Figure 9 - 90° Leg Connections



Configuration A



Configuration B

C CONNECTABLES® - PUTTING IT ALL TOGETHER

Legs are fastened to worksurfaces utilizing a steel-to-steel connection. Each leg comes equipped with four ¼" x 7/8" machine screws. Screws are inserted through the four oval shaped holes only. Do not use wood screws! When fastening legs to work surfaces, hand thread screws into position to prevent any cross threading. When all screws have been hand threaded, tighten firmly with screwdriver to secure. Optional thumbscrews can be used in place of machine screws. Thumbscrews eliminate the need for a screwdriver, whether assembling or disassembling tables. **Do not use power tools for assembly of legs.**

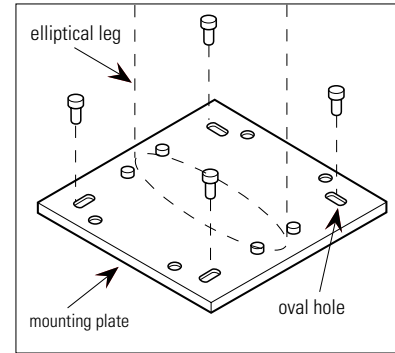

FREESTANDING TABLES

1. Turn work surface upside-down on clean floor. (You may want to use carton from packaging as a protective assembly surface to protect the top from scratching.)
2. Position leg mounting plate holes over threaded steel inserts in top.
3. Fasten each leg to top with four ¼" x 7/8" screws.
4. Turn table right-side up.
5. Level table by adjusting glides.

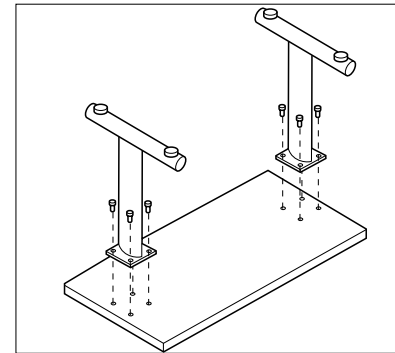

CONNECTING TABLES

1. Determine approximate location of desired configuration in room and turn work surfaces upside-down on floor. (Remember you are working in reverse.)
2. Position leg mounting plate so it is centered over the connecting edge of the first work surface. Fasten leg with two ¼" x 7/8" screws.
3. Repeat step 2 and 3 on the opposite edge of the first work surface.
4. Turn table right-side up.
5. Turn table right-side up and fasten to the previous top from the underside.
6. To add additional work surfaces repeat step 6.
7. When all the tops have been connected, level complete configuration by adjusting glides.

Note: Use the same procedures as above when using optional thumb screws.

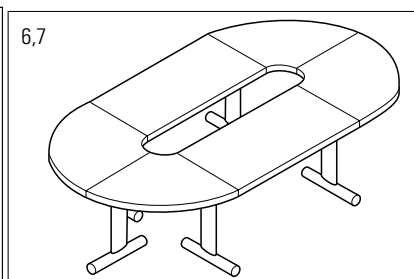
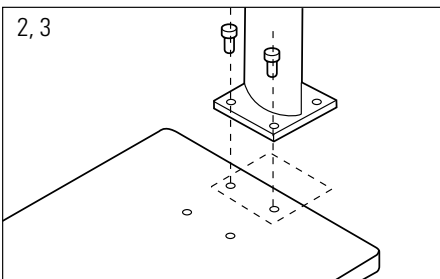
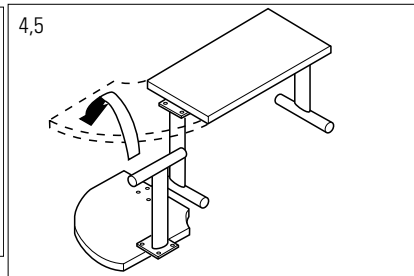
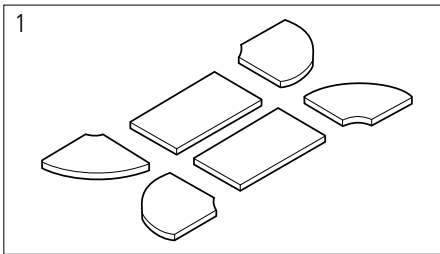

OPTIONAL CASTERS

1. Turn work surface upside-down on floor.
2. Remove existing glide if previously installed.
3. Fasten caster to T-leg by threading caster stem into base of T-leg and secure by tightening lock nut.
4. If casters are used in combination with gliders, level table by adjusting glides.

Note: Casters are available in locking or non-locking styles.

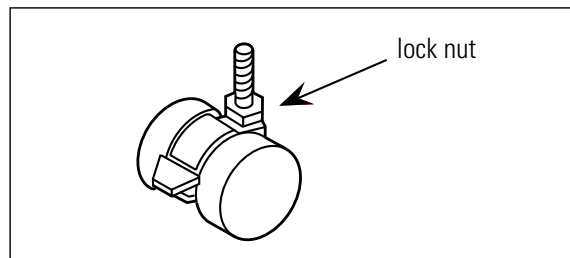
**OPTIONAL GANGING HARDWARE**

1. Optional ganging hardware should be used when quick and frequent reconfigurations are required.
2. Turn work surfaces to be ganged upside-down on floor.
3. Remove ganging hardware from package. Holes with steel inserts are located in the corner of tops.
4. Fasten ganging hardware to each work surface with supplied thumb screws.
5. Projected arm from ganging hardware can pivot out of the way when not in use.

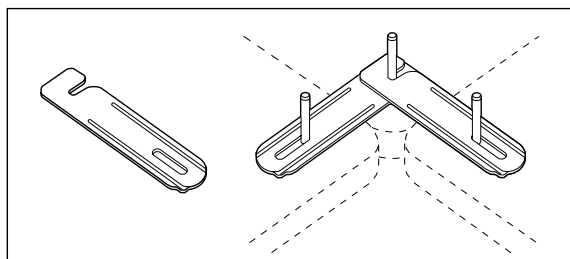

SQUARE TOPS

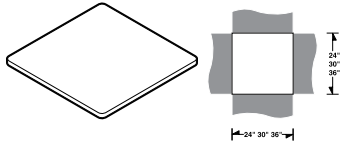

Square Top

MODEL#	DIMENSIONS	FREIGHT CLASS	WT/LB.	CUBIC FT.	LIST PRICE	HP ADD
	D x W x H					
CNS2424	24 x 24 x 1	70	18	1	\$431	\$216
CNS3030	30 x 30 x 1	70	27	1.56	\$525	\$264
CNS3636	36 x 36 x 1	70	39	2	\$563	\$283

T-mold edging. Predrilled with threaded steel inserts for freestanding and linking installations.

RECTANGULAR TOPS

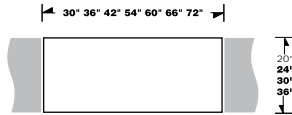

Rectangle Top

MODEL #	DIMENSIONS	FREIGHT CLASS	WT/LB.	CUBIC FT.	LIST PRICE	HP ADD
CNR2030	20 x 30 x 1	70	22	1.25	\$312	\$158
CNR2036	36 x 20 x 1	60	22.5	0.46	\$346	\$174
CNR2042	20 x 42 x 1	70	31	1.75	\$372	\$187
CNR2048	20 x 48 x 1	70	35	2	\$414	\$209
CNRU2054	20 x 54 x 1	60	33.75	0.69	\$513	\$259
CNRU2060	20 x 60 x 1	65	37.5	1.4	\$552	\$278
CNRU2066	20 x 66 x 1	60	41.25	0.84	\$597	\$302
CNRU2072	20 x 72 x 1	60	45	1	\$637	\$319
CNR2430	24 x 30 x 1	70	22	1.25	\$312	\$158
CNR2436	24 x 36 x 1	70	26	1.5	\$346	\$174
CNR2442	24 x 42 x 1	70	31	1.75	\$372	\$187
CNR2448	24 x 48 x 1	70	35	2	\$414	\$209
CNRU2454	24 x 54 x 1	70	42	2.34	\$513	\$259
CNRU2460	24 x 60 x 1	70	47	2.5	\$552	\$278
CNRU2466	24 x 66 x 1	70	52	2.8	\$597	\$302
CNRU2472	24 x 72 x 1	70	57	3	\$637	\$319
CNR3036	30 x 36 x 1	70	33	1.88	\$414	\$209
CNR3042	30 x 42 x 1	70	38	2.19	\$451	\$226
CNR3048	30 x 48 x 1	70	44	2.5	\$477	\$241
CNRU3054	30 x 54 x 1	70	52	2.8	\$590	\$296
CNRU3060	30 x 60 x 1	70	59	3.13	\$634	\$318
CNRU3066	30 x 66 x 1	70	64	3.44	\$677	\$341
CNRU3072	30 x 72 x 1	70	70	3.75	\$721	\$362
CNR3642	36 x 42 x 1	60	52.5	1.6	\$597	\$302
CNR3648	36 x 48 x 1	60	60	1.8	\$653	\$328
CNRU3654	36 x 54 x 1	60	70	2	\$789	\$396
CNRU3660	36 x 60 x 1	60	78	2.2	\$875	\$441
CNRU3666	36 x 66 x 1	60	87	2.4	\$958	\$482
CNRU3672	36 x 72 x 1	60	94	2.6	\$1043	\$524

T-mold edging. Predrilled with threaded steel inserts for freestanding and linking installations. **Tops 54" and longer are standard with a 16 gauge steel support channel.**

TRAPEZOID TOPS

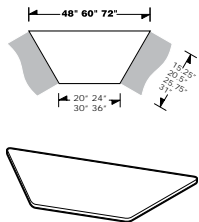

Trapezoid Top

MODEL #	DIMENSIONS	FREIGHT CLASS	WT/LB.	CUBIC FT.	LIST PRICE	HP ADD
CNT2048	17.5 x 48 x 1	60	26.25	0.55	\$435	\$219
CNT2060	17.5 x 60 x 1	65	44	1.85	\$522	\$263
CNT2448	20.5 x 48 x 1	92.5	21	2	\$435	\$219
CNT2460	20.5 x 60 x 1	65	44	1.85	\$522	\$263
CNT3060	25.75 x 60 x 1	92.5	35	3.13	\$571	\$287
CNT3072	25.75 x 72 x 1	60	66	2.2	\$637	\$319
CNT3660	31 x 60 x 1	60	66	2.2	\$814	\$409
CNT3672	31 x 72 x 1	65	79.2	3.5	\$971	\$488

T-mold edging. Predrilled with threaded steel inserts for freestanding and linking installations.

Required Specifications

Top Finish
Edge Finish

Optional Specifications

Grommet

Accessories

Power Block

90° CRESCENT TOPS

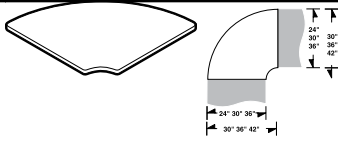

90° Crescent Top

MODEL#	DIMENSIONS	FREIGHT CLASS	WT/LBS.	CUBIC FT.	LIST PRICE	HP ADD
	D x W x H					
CNC2430	30 x 30 x 1	85	20	1.56	\$455	\$228
CNC3036	36 x 36 x 1	85	30	2.25	\$645	\$323
CNC3642	42 x 42 x 1	70	50	3.15	\$885	\$444

T-mold edging. Predrilled with threaded steel inserts for freestanding and linking installations.

- **CNC2430** for use with 24" deep tops
- **CNC3036** for use with 30" deep tops
- **CNC3642** for use with 36" deep tops
- **CNC2430** does not require a center leg

QUARTER ROUND TOPS

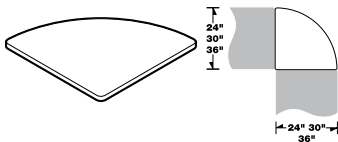

Quarter Round Top

MODEL #	DIMENSIONS	FREIGHT CLASS	WT/LB.	CUBIC FT.	LIST PRICE	HP ADD
CNQ2424	24 x 24 x 1	85	14	1	\$287	\$145
CNQ3030	30 x 30 x 1	85	21	1.56	\$347	\$175
CNQ3636	36 x 36 x 1	60	45	1.3	\$492	\$247

T-mold edging. Predrilled with threaded steel inserts for **linking installations ONLY**.

45° WEDGE TOPS

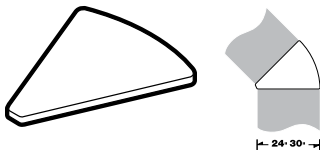

45° Wedge Top

MODEL #	DIMENSIONS	FREIGHT CLASS	WT/LB.	CUBIC FT.	LIST PRICE	HP ADD
CNW2424	24 x 24 x 1	92.5	10	1	\$307	\$156
CNW3030	30 x 30 x 1	100	14	1.56	\$373	\$187

T-mold edging. Predrilled with threaded steel inserts for **linking installations ONLY**.

THREE WAY CONNECTOR TOPS

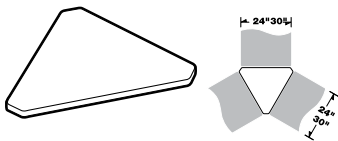

Three Way Connector Top

MODEL #	DIMENSIONS	FREIGHT CLASS	WT/LB.	CUBIC FT.	LIST PRICE	HP ADD
CNY2424	24 x 24 x 1	85	13	1	\$287	\$145
CNY3030	30 x 30 x 1	92.5	18	1.56	\$347	\$175

T-mold edging. Predrilled with threaded steel inserts for **linking installations ONLY**.

HALF ROUND TOPS

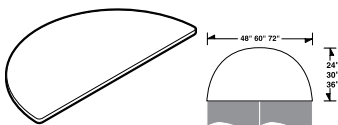

Half Round Top

MODEL #	DIMENSIONS	FREIGHT CLASS	WT/LB.	CUBIC FT.	LIST PRICE	HP ADD
CNHFS2448	24 x 48 x 1	70	36	2	\$438	\$220
CNHFS3060	30 x 60 x 1	70	56	3.13	\$567	\$286
CNHFS3672	36 x 72 x 1	65	81	3.3	\$971	\$488

T-mold edging. Predrilled with threaded steel inserts for freestanding and linking installations.

- *Requires three legs for freestanding*

EXTENDED HALF ROUND TOPS

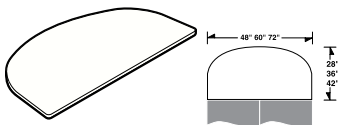

Extended Half Round Top

MODEL #	DIMENSIONS	FREIGHT CLASS	WT/LB.	CUBIC FT.	LIST PRICE	HP ADD
CNHE24	28 x 48 x 1	65	50	1.88	\$536	\$269
CNHE30	36 x 60 x 1	65	75	2.87	\$745	\$375
CNHE36	42 x 72 x 1	65	102	3.88	\$1185	\$594

T-mold edging. Predrilled with threaded steel inserts for **linking installations ONLY**.

Required Specifications

Top Finish
Edge Finish

Optional Specifications

Grommet

Accessories

Power Block

MODESTY PANELS

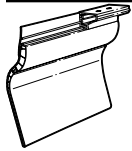

Modesty Panel

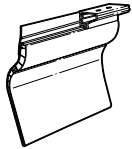

Modesty Panel

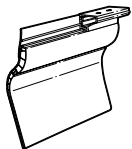

Modesty Panel

MODEL#	DIMENSIONS D x W x H	FREIGHT CLASS	WT./LBS.	CUBIC FT.	LIST PRICE
CNCA2430	2.75 x 35 x 11.75	150	2.8	0.5	\$255
CNCA3036	2.75 x 43 x 11.75	150	3.3	0.6	\$297
CNCA3642	2.75 x 53 x 11.75	150	3.9	0.7	\$389

For use with **CNC crescent tops**. 11 3/4" high, Black plastic, attractive ribbed design. Includes two fold-away installation clips and flexible privacy strips. Connects to predrilled holes in table top.

- *Can not be used when worksurface tops are attached to flip top legs.*

CNOA2424	2.75 x 27 x 11.75	150	2.2	0.4	\$218
CNOA3030	2.75 x 35 x 11.75	150	2.8	0.5	\$255
CNOA3636	2.75 x 44 x 11.75	150	3.3	0.6	\$297

For use with **CNQ quarter round tops**. 11 3/4" high, Black plastic, attractive ribbed design. Includes two fold-away installation clips and flexible privacy strips. Connects to predrilled holes in table top.

- *Can not be used when worksurface tops are attached to flip top legs.*

CNRA2030	2.75 x 29 x 11.75	150	2.8	0.5	\$218
CNRA2036	2.75 x 35 x 11.75	150	3.3	0.6	\$255
CNRA2042	2.75 x 41 x 11.75	150	3.9	0.7	\$297
CNRA2048	2.75 x 47 x 11.75	150	4.4	0.8	\$337
CNRA2054	2.75 x 53 x 11.75	150	5	0.9	\$389
CNRA2060	2.75 x 59 x 11.75	150	5.5	1	\$422
CNRA2066	2.75 x 65 x 11.75	150	6.1	1.1	\$463
CNRA2072	2.75 x 71 x 11.75	150	6.6	1.2	\$505

CNRA2430	2.75 x 29 x 11.75	150	2.8	0.5	\$218
CNRA2436	2.75 x 35 x 11.75	150	3.3	0.6	\$255
CNRA2442	2.75 x 41 x 11.75	150	3.9	0.7	\$297
CNRA2448	2.75 x 47 x 11.75	150	4.4	0.8	\$337
CNRA2454	2.75 x 53 x 11.75	150	5	0.9	\$389
CNRA2460	2.75 x 59 x 11.75	150	5.5	1	\$422
CNRA2466	2.75 x 65 x 11.75	150	6.1	1.1	\$463
CNRA2472	2.75 x 71 x 11.75	150	6.6	1.2	\$505

CNRA3036	2.75 x 35 x 11.75	150	3.3	0.6	\$255
CNRA3042	2.75 x 41 x 11.75	150	3.9	0.7	\$297
CNRA3048	2.75 x 47 x 11.75	150	4.4	0.8	\$337
CNRA3054	2.75 x 53 x 11.75	150	5	0.9	\$389
CNRA3060	2.75 x 59 x 11.75	150	5.5	1	\$422
CNRA3066	2.75 x 65 x 11.75	150	6.1	1.1	\$463
CNRA3072	2.75 x 71 x 11.75	150	6.6	1.2	\$505

CNRA3642	2.75 x 41 x 11.75	150	3.9	0.7	\$297
CNRA3648	2.75 x 47 x 11.75	150	4.4	0.8	\$337
CNRA3654	2.75 x 53 x 11.75	150	5	0.9	\$389
CNRA3660	2.75 x 59 x 11.75	150	5.5	1	\$422
CNRA3666	2.75 x 65 x 11.75	150	6.1	1.1	\$463
CNRA3672	2.75 x 71 x 11.75	150	6.6	1.2	\$505

For use with **CNR/CNRU rectangular tops**. 11 3/4" high, Black plastic, attractive ribbed design. Includes two fold-away installation clips and flexible privacy strips. Connects to predrilled holes in table top.

- *Can not be used when worksurface tops are attached to flip top legs.*

Required Specifications

Top Finish
Edge Finish

Optional Specifications

Grommet

Accessories

Power Block

MODESTY PANELS

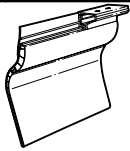

Modesty Panel

MODEL# DIMENSIONS FREIGHT CLASS WT/LBS. CUBIC FT. LIST PRICE

D x W x H

CNSA2424	2.75 x 23 x 11.75	150	2.2	0.4	\$174
CNSA3030	2.75 x 29 x 11.75	150	2.8	0.5	\$218
CNSA3636	2.75 x 35 x 11.75	150	3.3	0.6	\$255

For use with **long side of CNS square tops**. 11 3/4" high, Black plastic, attractive ribbed design. Includes two fold-away installation clips and flexible privacy strips. Connects to predrilled holes in table top.

- *Can not be used when worksurface tops are attached to flip top legs.*

CNTA2048L	20 x 43	150	4.4	0.8	\$297
CNTA2060L	2.750 x 55	150	5.5	1.2	\$389

CNTA2448L	2.75 x 43 x 11.75	150	4.4	0.8	\$297
CNTA2460L	2.75 x 55 x 11.75	150	5.5	1.2	\$389

CNTA3060L	2.75 x 55 x 11.75	150	5.5	1.2	\$389
CNTA3072L	2.75 x 67 x 11.75	150	6.6	1.4	\$463

CNTA3660L	2.75 x 55 x 11.75	150	5.5	1.2	\$389
CNTA3672L	2.75 x 67 x 11.75	150	6.6	1.4	\$463

For use with **long side of CNT trapezoid tops**. 11 3/4" high, Black plastic, attractive ribbed design. Includes two fold-away installation clips and flexible privacy strips. Connects to predrilled holes in table top.

- *Can not be used when worksurface tops are attached to flip top legs.*

CNTA2048S	20 x 24	150	2.2	0.4	\$174
CNTA2060S	20 x 36	150	2.8	0.5	\$255

CNTA2448S	2.75 x 23 x 11.75	150	2.2	0.4	\$174
CNTA2460S	2.75 x 35 x 11.75	150	2.2	0.4	\$255

CNTA3060S	2.75 x 29 x 11.75	150	2.8	0.5	\$218
CNTA3072S	2.75 x 41 x 11.75	150	2.8	0.5	\$297

CNTA3660S	2.75 x 23 x 11.75	150	3.3	0.6	\$174
CNTA3672S	2.75 x 35 x 11.75	150	3.3	0.6	\$255

For use with **short side of CNT trapezoid tops**. 11 3/4" high, Black plastic, attractive ribbed design. Includes two fold-away installation clips and flexible privacy strips. Connects to predrilled holes in table top.

- *Can not be used when worksurface tops are attached to flip top legs.*

CNWA2424	2.75 x 17 x 11.75	150	2.2	0.4	\$135
CNWA3030	2.75 x 22 x 11.75	150	2.8	0.5	\$174

For use with **CNW wedge tops**. 11 3/4" high, Black plastic, attractive ribbed design. Includes two fold-away installation clips and flexible privacy strips. Connects to predrilled holes in table top.

- *Can not be used when worksurface tops are attached to flip top legs.*

CNYA2424	2.75 x 22 x 11.75	150	2.2	0.4	\$164
CNYA3030	2.75 x 27 x 11.75	150	2.8	0.5	\$199

For use with **CNY triangle tops**. 11 3/4" high, Black plastic, attractive ribbed design. Includes two fold-away installation clips and flexible privacy strips. Connects to predrilled holes in table top.

- *Can not be used when worksurface tops are attached to flip top legs.*

Modesty Panel

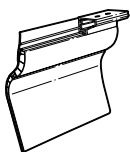

Modesty Panel

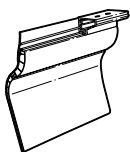

Modesty Panel

Required Specifications

Top Finish
Edge Finish

Optional Specifications

Grommet

Accessories

Power Block

WIRE MANAGEMENT UNITS

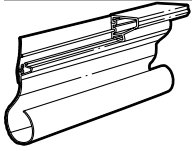

Wire Management Unit

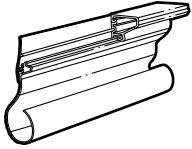

Wire Management Unit

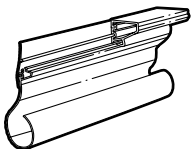

Wire Management Unit

MODEL#	DIMENSIONS D x W x H	FREIGHT CLASS	WT./LBS.	CUBIC FT.	LIST PRICE
CNCB2430	2.75 x 35 x 6	70	1.5	0.5	\$193
CNCB3036	2.75 x 43 x 6	70	1.8	0.6	\$215
CNCB3642	2.75 x 53 x 6	250	2.1	0.7	\$279

For use with **CNC crescent tops**. 6" high, Black plastic, attractive ribbed design. Includes two fold-away installation clips and flexible privacy strips. Connects to predrilled holes in table top. Can be used with or without wire management grommet.

- *Cannot be used when worksurface tops are attached to flip top legs.*

CNQB2424	2.75 x 27 x 6	70	1.2	0.4	\$162
CNQB3030	2.75 x 35 x 6	70	1.5	0.5	\$193
CNQB3636	2.75 x 44 x 6	70	1.8	0.6	\$248

For use with **CNQ quarter round tops**. 6" high, Black plastic, attractive ribbed design. Includes two fold-away installation clips and flexible privacy strips. Connects to predrilled holes in table top. Can be used with or without wire management grommet.

- *Cannot be used when worksurface tops are attached to flip top legs.*

CNRB2030	2.75 x 29 x 6	70	1.5	0.5	\$162
CNRB2036	2.75 x 35 x 6	70	1.8	0.6	\$193
CNRB2042	2.75 x 41 x 6	250	2.1	0.7	\$215
CNRB2048	2.75 x 47 x 6	250	2.4	0.8	\$297
CNRB2054	2.75 x 53 x 6	250	2.7	0.9	\$312
CNRB2060	2.75 x 59 x 6	250	3	1	\$312
CNRB2066	2.75 x 65 x 6	250	3.3	1.1	\$312
CNRB2072	2.75 x 71 x 6	250	3.6	1.2	\$422
CNRB2430	2.75 x 29 x 6	70	1.5	0.5	\$162
CNRB2436	2.75 x 35 x 6	70	1.8	0.6	\$193
CNRB2442	2.75 x 41 x 6	250	2.1	0.7	\$215
CNRB2448	2.75 x 47 x 6	250	2.4	0.8	\$297
CNRB2454	2.75 x 53 x 6	250	2.7	0.9	\$312
CNRB2460	2.75 x 59 x 6	250	3	1	\$312
CNRB2466	2.75 x 65 x 6	250	3.3	1.1	\$312
CNRB2472	2.75 x 71 x 6	250	3.6	1.2	\$422
CNRB3036	2.75 x 35 x 6	70	1.8	0.6	\$193
CNRB3042	2.75 x 41 x 6	250	2.1	0.7	\$215
CNRB3048	2.75 x 47 x 6	250	2.4	0.8	\$248
CNRB3054	2.75 x 53 x 6	250	2.7	0.9	\$279
CNRB3060	2.75 x 59 x 6	250	3	1	\$312
CNRB3066	2.75 x 65 x 6	250	3.3	1.1	\$368
CNRB3072	2.75 x 71 x 6	250	3.6	1.2	\$422
CNRB3642	2.75 x 41 x 6	250	2.1	0.7	\$215
CNRB3648	2.75 x 47 x 6	250	2.4	0.8	\$279
CNRB3654	2.75 x 53 x 6	250	2.7	0.9	\$279
CNRB3660	2.75 x 59 x 6	250	3	1	\$312
CNRB3666	2.75 x 65 x 6	250	3.3	1.1	\$312
CNRB3672	2.75 x 71 x 6	250	3.6	1.2	\$422

For use with **CNR/CNRU rectangular tops**. 6" high, Black plastic, attractive ribbed design. Includes two fold-away installation clips and flexible privacy strips. Connects to predrilled holes in table top. Can be used with or without wire management grommet.

- *Cannot be used when worksurface tops are attached to flip top legs.*

Required Specifications

Top Finish
Edge Finish

Optional Specifications

Grommet

Accessories

Power Block

WIRE MANAGEMENT UNITS

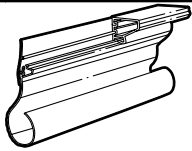

Wire Management Unit

MODEL# DIMENSIONS FREIGHT CLASS WT/LBS. CUBIC FT. LIST PRICE

	D x W x H				
CNSB2424	2.75 x 23 x 6	70	1.8	0.4	\$129
CNSB3030	2.75 x 29 x 6	70	1.5	0.5	\$162
CNSB3636	2.75 x 35 x 6	70	1.8	0.6	\$193

For use with **CNS square tops**. 6" high, Black plastic, attractive ribbed design. Includes two fold-away installation clips and flexible privacy strips. Connects to predrilled holes in table top. Can be used with or without wire management grommet.

- *Cannot be used when worksurface tops are attached to flip top legs.*

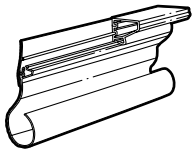

Wire Management Unit

CNTB2048L	0 x 43	250	2.4	0.8	\$215
CNTB2060L	0 x 55	250	3	1	\$279
CNTB2448L	2.75 x 43 x 6	250	2.4	0.8	\$215
CNTB2460L	2.75 x 55 x 6	250	3	1	\$279
CNTB3060L	2.75 x 55 x 6	250	3	1	\$279
CNTB3072L	2.75 x 67 x 6	250	3.6	1.2	\$389
CNTB3660L	2.75 x 55 x 6	250	3	1	\$279
CNTB3672L	2.75 x 67 x 6	250	3.6	1.2	\$389

For use with **long side of CNT trapezoid tops**. 6" high, Black plastic, attractive ribbed design. Includes two fold-away installation clips and flexible privacy strips. Connects to predrilled holes in table top. Can be used with or without wire management grommet.

- *Cannot be used when worksurface tops are attached to flip top legs.*

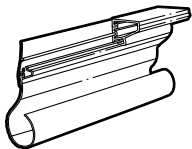

Wire Management Unit

CNTB2048S	0 x 24	70	1.2	0.4	\$129
CNTB2060S	0 x 36	70	1.5	0.5	\$193
CNTB2448S	2.75 x 23 x 6	70	1.2	0.4	\$129
CNTB2460S	2.75 x 35 x 6	70	1.2	0.4	\$193
CNTB3060S	2.75 x 29 x 6	70	1.5	0.5	\$162
CNTB3072S	2.75 x 41 x 6	70	1.5	0.5	\$215
CNTB3660S	2.75 x 23 x 6	70	1.8	0.6	\$129
CNTB3672S	2.75 x 35 x 6	70	1.8	0.6	\$193

For use with **short side of CNT trapezoid tops**. 6" high, Black plastic, attractive ribbed design. Includes two fold-away installation clips and flexible privacy strips. Connects to predrilled holes in table top. Can be used with or without wire management grommet.

- *Can not be used when worksurface tops are attached to flip top legs.*

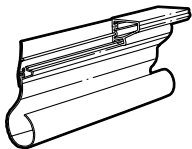

Wire Management Unit

CNWB2424	2.75 x 17 x 6	70	1.2	0.4	\$106
CNWB3030	2.75 x 22 x 6	70	1.5	0.5	\$129

For use with **CNW wedge tops**. 6" high, Black plastic, attractive ribbed design. Includes two fold-away installation clips and flexible privacy strips. Connects to predrilled holes in table top. Can be used with or without wire management grommet.

- *Cannot be used when worksurface tops are attached to flip top legs.*

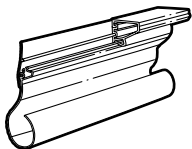

Wire Management Unit

CNYB2424	2.75 x 22 x 6	70	1.2	0.4	\$129
CNYB3030	2.75 x 27 x 6	70	1.5	0.5	\$162

For use with **CNY triangle tops**. 6" high, Black plastic, attractive ribbed design. Includes two fold-away installation clips and flexible privacy strips. Connects to predrilled holes in table top. Can be used with or without wire management grommet.

- *Cannot be used when worksurface tops are attached to flip top legs.*

Required Specifications

Top Finish
Edge Finish

Optional Specifications

Grommet

Accessories

Power Block

MODESTY PANEL WITH WIRE MANAGEMENT

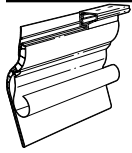

Modesty Panel with Wire Management

MODEL#	DIMENSIONS D x W x H	FREIGHT CLASS	WT./LBS.	CUBIC FT.	LIST PRICE
CNCC2430	2.75 x 35 x 11.75	100	4.3	0.5	\$279
CNCC3036	2.75 x 43 x 11.75	100	5.1	0.6	\$317
CNCC3642	2.75 x 53 x 11.75	100	6	0.7	\$411

For use with **CNC crescent tops**. 11 3/4" high, Black plastic, attractive ribbed design. Includes two fold-away installation clips and flexible privacy strips. Connects to predrilled holes in table top. Can be used with or without wire management grommet.

- *Can not be used when worksurface tops are attached to flip top legs.*

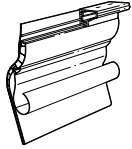

Modesty Panel with Wire Management

CNQC2424	2.75 x 27 x 11.75	100	3.4	0.4	\$233
CNQC3030	2.75 x 35 x 11.75	100	4.3	0.5	\$279
CNQC3636	2.75 x 44 x 11.75	100	5.1	0.6	\$317

For use with **CNC quarter round tops**. 11 3/4" high, Black plastic, attractive ribbed design. Includes two fold-away installation clips and flexible privacy strips. Connects to predrilled holes in table top. Can be used with or without wire management grommet.

- *Can not be used when worksurface tops are attached to flip top legs.*

CNRC2030	2.75 x 29 x 11.75	100	4.3	0.5	\$233
CNRC2036	2.75 x 35 x 11.75	100	5.1	0.6	\$279
CNRC2042	2.75 x 41 x 11.75	100	6	0.7	\$317
CNRC2048	2.75 x 47 x 11.75	100	6.8	0.8	\$369
CNRC2054	2.75 x 53 x 11.75	100	7.7	0.9	\$411
CNRC2060	2.75 x 59 x 11.75	100	8.5	1	\$456
CNRC2066	2.75 x 65 x 11.75	100	9.4	1.1	\$493
CNRC2072	2.75 x 71 x 11.75	100	10.2	1.2	\$522
CNRC2430	2.75 x 29 x 11.75	100	4.3	0.5	\$233
CNRC2436	2.75 x 35 x 11.75	100	5.1	0.6	\$279
CNRC2442	2.75 x 41 x 11.75	100	6	0.7	\$317
CNRC2448	2.75 x 47 x 11.75	100	6.8	0.8	\$369
CNRC2454	2.75 x 53 x 11.75	100	7.7	0.9	\$411
CNRC2460	2.75 x 59 x 11.75	100	8.5	1	\$456
CNRC2466	2.75 x 65 x 11.75	100	9.4	1.1	\$493
CNRC2472	2.75 x 71 x 11.75	100	10.2	1.2	\$522
CNRC3036	2.75 x 35 x 11.75	100	5.1	0.6	\$279
CNRC3042	2.75 x 41 x 11.75	100	6	0.7	\$317
CNRC3048	2.75 x 47 x 11.75	100	6.8	0.8	\$369
CNRC3054	2.75 x 53 x 11.75	100	7.7	0.9	\$411
CNRC3060	2.75 x 59 x 11.75	100	8.5	1	\$456
CNRC3066	2.75 x 65 x 11.75	100	9.4	1.1	\$493
CNRC3072	2.75 x 71 x 11.75	100	10.2	1.2	\$522
CNRC3642	2.75 x 41 x 11.75	100	6	0.7	\$317
CNRC3648	2.75 x 47 x 11.75	100	6.8	0.8	\$369
CNRC3654	2.75 x 53 x 11.75	100	7.7	0.9	\$411
CNRC3660	2.75 x 59 x 11.75	100	8.5	1	\$456
CNRC3666	2.75 x 65 x 11.75	100	9.4	1.1	\$493
CNRC3672	2.75 x 71 x 11.75	100	10.2	1.2	\$522

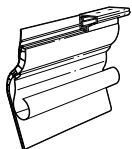

Modesty Panel with Wire Management

For use with **CNR/CNRU rectangular tops**. 11 3/4" high, Black plastic, attractive ribbed design. Includes two fold-away installation clips and flexible privacy strips. Connects to predrilled holes in table top. Can be used with or without wire management grommet.

- *Can not be used when worksurface tops are attached to flip top legs.*

Required Specifications

Top Finish
Leg Finish
Edge Finish

Optional Specifications

Grommet

Accessories

Power Block

MODESTY PANEL WITH WIRE MANAGEMENT

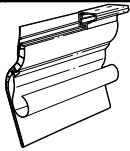

Modesty Panel with Wire Management

MODEL# DIMENSIONS FREIGHT CLASS WT./LBS. CUBIC FT. LIST PRICE

D x W x H

CNSC2424	2.75 x 23 x 11.75	100	3.5	0.4	\$193
CNSC3030	2.75 x 29 x 11.75	100	4.3	0.5	\$233
CNSC3636	2.75 x 35 x 11.75	100	5.1	0.6	\$279

For use with **CNC square tops**. 11 3/4" high, Black plastic, attractive ribbed design. Includes two fold-away installation clips and flexible privacy strips. Connects to predrilled holes in table top. Can be used with or without wire management grommet.

- *Can not be used when worksurface tops are attached to flip top legs.*

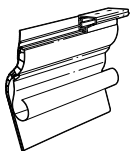

Modesty Panel with Wire Management

CNTC2048L	2.75 x 43 x 11.75	100	6.8	0.8	\$317
CNTC2060L	2.75 x 55 x 11.75	100	8.5	1	\$411
CNTC2448L	2.75 x 43 x 11.75	100	6.8	0.8	\$317
CNTC2460L	2.75 x 55 x 11.75	100	8.5	1	\$411
CNTC3060L	2.75 x 55 x 11.75	100	8.5	1	\$411
CNTC3072L	2.75 x 67 x 11.75	100	10.2	1.2	\$493
CNTC3660L	2.75 x 55 x 11.75	100	8.5	1	\$411
CNTC3672L	2.75 x 67 x 11.75	100	10.2	1.2	\$493

For use with **long side of CNT trapezoid tops**. 11 3/4" high, Black plastic, attractive ribbed design. Includes two fold-away installation clips and flexible privacy strips. Connects to predrilled holes in table top. Can be used with or without wire management grommet.

- *Can not be used when worksurface tops are attached to flip top legs.*

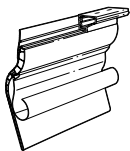

Modesty Panel with Wire Management

CNTC2048S	2.75 x 23 x 11.75	100	3.4	0.4	\$193
CNTC2060S	2.75 x 35 x 11.75	100	3.5	0.5	\$279
CNTC2448S	2.75 x 23 x 11.75	100	3.4	0.4	\$193
CNTC2460S	2.75 x 35 x 11.75	100	3.4	0.4	\$279
CNTC3060S	2.75 x 29 x 11.75	100	4.3	0.5	\$233
CNTC3072S	2.75 x 41 x 11.75	100	4.3	0.5	\$317
CNTC3660S	2.75 x 23 x 11.75	100	5.1	0.6	\$193
CNTC3672S	2.75 x 35 x 11.75	100	5.1	0.6	\$279

For use with **short side of CNT trapezoid tops**. 11 3/4" high, Black plastic, attractive ribbed design. Includes two fold-away installation clips and flexible privacy strips. Connects to predrilled holes in table top. Can be used with or without wire management grommet.

- *Can not be used when worksurface tops are attached to flip top legs.*

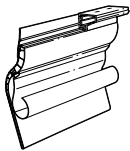

Modesty Panel with Wire Management

CNWC2424	2.75 x 17 x 11.75	100	3.4	0.4	\$158
CNWC3030	2.75 x 22 x 11.75	100	4.3	0.5	\$193

For use with **CNW wedge tops**. 11 3/4" high, Black plastic, attractive ribbed design. Includes two fold-away installation clips and flexible privacy strips. Connects to predrilled holes in table top. Can be used with or without wire management grommet.

- *Can not be used when worksurface tops are attached to flip top legs.*

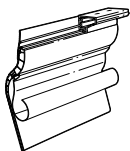

Modesty Panel with Wire Management

CNYC2424	2.75 x 22 x 11.75	100	3.4	0.4	\$193
CNYC3030	2.75 x 27 x 11.75	100	4.3	0.5	\$233

For use with **CNY triangle tops**. 11 3/4" high, Black plastic, attractive ribbed design. Includes two fold-away installation clips and flexible privacy strips. Connects to predrilled holes in table top. Can be used with or without wire management grommet.

- *Can not be used when worksurface tops are attached to flip top legs.*

Required Specifications

Top Finish
Leg Finish
Edge Finish

Optional Specifications

Grommet

Accessories

Power Block

T LEGS

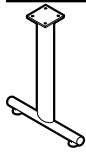

"T" Leg

MODEL#	DIMENSIONS D x W x H	FREIGHT CLASS	WT/LBS.	CUBIC FT.	LIST PRICE
GCNTLEG18	5.25 x 17.1 x 27.63	125	15	2.1	\$294
GCNTLG18P	5.25 x 17.1 x 27.63	100	17	2.1	\$578

18" long with plastic elliptical column cover, leveling glides and end caps. **For assembly with 20" tops.**

- For a single leg, order **GCNTLEG18**.
- For a pair of legs (set of 2), order **GCNTLG18P**.
- Chrome (CHM) is available (on foot only). **Add \$96** list for model GCNTLEG18 and **\$186** list for model GCNTLG18P.

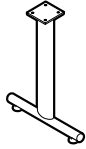

"T" Leg

GCNTLEG24	5.25 x 20.8 x 27.63	150	9	2.1	\$294
GCNTLG24P	5.25 x 20.8 x 27.63	100	17	2.1	\$578

20" long with plastic elliptical column cover, leveling glides and end caps. **For assembly with 24" tops.**

- For a single leg, order **GCNTLEG24**.
- For a pair of legs (set of 2), order **GCNTLG24P**.
- Chrome (CHM) is available (on foot only). **Add \$96** list for model GCNTLEG24 and **\$186** list for model GCNTLG24P.

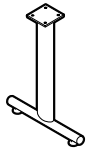

"T" Leg

GCNTLEG30	5.25 x 27.25 x 27.63	250	10	2.6	\$317
GCNTLG30P	5.25 x 27.25 x 27.63	125	19	2.6	\$630

26" long with plastic elliptical column cover, leveling glides and end caps. **For assembly with 30" tops.**

- For a single leg, order **GCNTLEG30**.
- For a pair of legs (set of 2), order **GCNTLG30P**.
- Chrome (CHM) is available (on foot only). **Add \$96** list for model GCNTLEG30 and **\$186** list for model GCNTLG30P.

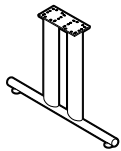

"T" Leg

GCNTLEG36	5.75 x 33.25 x 27.63	150	14	3.3	\$637
GCNTLG36P	5.25 x 33.25 x 27.63	100	27	3.3	\$1262

32" long with double post plastic elliptical column cover, leveling glides and end caps. **For assembly with 36" tops.**

- For a single leg, order **GCNTLEG36**.
- For a pair of legs (set of 2), order **GCNTLG36P**.
- Chrome (CHM) is available (on foot only). **Add \$96** list for model GCNTLEG36 and **\$186** list for model GCNTLG36P.

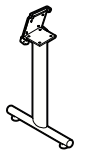

Flip Top "T" Leg

CNTFLEG24	1.75 x 20.8 x 28	150	10	2.4	\$547
-----------	------------------	-----	----	-----	--------------

20" long with plastic elliptical column cover, leveling glides and end caps. **For assembly with 24" deep rectangular and square tops only.** Hinged plate with locking mechanism to lock in open or closed position. Cannot be installed with thumbscrews.

- *Can not be used when modesty panels and wire management are attached to worksurface tops.*
- List Price is per **each leg**.
- Chrome (CHM) is available (on foot only). **Add \$96** list.

Required Specifications

Leg Finish

T LEGS

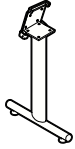

Flip Top "T" Leg

MODEL#	DIMENSIONS	FREIGHT CLASS	WT./LBS.	CUBIC FT.	LIST PRICE
--------	------------	---------------	----------	-----------	------------

D x W x H

CNTFLEG30	1.75 x 27.25 x 28	150	14	3	\$578
-----------	-------------------	-----	----	---	-------

26" long with plastic elliptical column cover, leveling glides and end caps. **For assembly with 30" deep rectangular and square tops only.** Hinged plate with locking mechanism to lock in open or closed position. Cannot be installed with thumbscrews.

- Can not be used when modesty panels and wire management are attached to worksurface tops.
- List Price is per **each leg**.
- Chrome (CHM) is available (on foot only). **Add \$96 list**

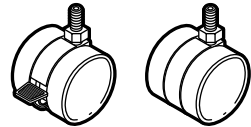

Casters

CNCP	- x - x 1.5	70	0.8	0.05	\$63
------	-------------	----	-----	------	------

Set of (2) 1½" dual wheel casters, one locking. Suggested for hard floor surfaces and industrial carpeting. Casters are fully interchangeable with glides. Black only.

- For use with *ConnecTABLES* units only.
- Casters **DO NOT** affect table height.

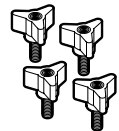

Thumbscrews

CNTS	1.25 x 1.25 x 1.5	70	0.04	0.02	\$40
------	-------------------	----	------	------	------

Triangular thumbscrew with ¾" steel thread. Set of 4. Can be used in place of factory supplied screws to allow installation of "T" legs to tops without tools. Black only.

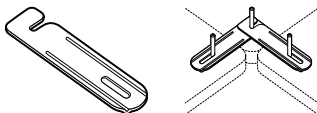

Ganging Connector

CNGFP	5 x 2.5 x 1.13	70	0.2	0.1	\$69
-------	----------------	----	-----	-----	------

Black epoxy coated 13 gauge steel with 2 thumbscrews included. Used to connect tabletops together for additional stability or for connecting freestanding tops together. Holes with steel inserts are located in the corner of all tops to accommodate this plate. **Sold individually.**

Required Specifications

Leg Finish



Duet tables are multi-purpose stacking tables that offer optimum space utilization and flexibility. Their personality and simple design make them ideal for use in any learning or training environment at post-secondary and adult levels. Temporarily and easily convert auditoriums and other spaces into examination and seminar spaces. They can be partnered with stacking chairs such as Duet or Popcorn in matching or complementary colors (stacking chairs can be found in the Multi-Purpose section of the Seating price list).

The one-piece molded top and modesty are gently contoured providing an eased edge with an elegant waterfall transition from top to modesty.

Tops are available in a wide array of colors in 0.5" thick polypropylene. Polypropylene material offers strength and ease of cleaning with a slightly textured surface to offer scratch resistance.

Features and Benefits

- One-piece molded top and modesty are 0.5" thick polypropylene.
- Tables are rated 250 lbs. capacity.
- Surface includes factory installed metal inserts for solid and secure connection to the sled frame.
- 0.5" diameter solid steel rod sled frame.
- Bumpers on the underside for protection when stacking.
- Model with ADA width compliant frame is available.
- Shipped fully assembled.



One-piece top and modesty.



Stacks 5 high on floor or 20 high on dolly.

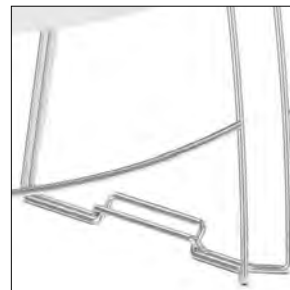

Ganging frame to keep tables evenly aligned.

GENERAL INFORMATION

- Duet tables are multi-purpose stacking tables ideal for auditoriums, seminars or any learning or training environment.
- Lightweight and easy to handle whether stacking for storage or setting up a room.
- Made of durable materials to withstand more demanding environments.
- Shipped fully assembled. Packaged 4 per carton.
- Global products are in compliance with stringent emission guidelines set out by the Greenguard Environmental Institute under the standards for low emitting products and materials. www.greenguard.org.
- Covered by Global's Lifetime Warranty.
- For environmental certifications, please visit globalfurnituregroup.com

WORKSURFACES

- Top and modesty are a one-piece injection molded design in 0.5" thick polypropylene.
- Available in a wide array of colors (see right column "FINISHES") to complement any space or to define sections by color.
- One-piece molded top and modesty are contoured providing an eased user edge, with an elegant waterfall transition from top to modesty.

26"W x 18"D x 9.75"H

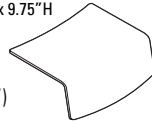

CONSTRUCTION

- Surface includes molded in threaded inserts to provide a secure metal-to-metal connection to the sled frame.
- Bumpers are included on the underside of top and inside modesty to protect surfaces when stacking.

FRAME

- 0.5" diameter solid steel rod sled frame.
- Available in a durable Chrome finish.
- Model with ganging frame keeps tables evenly positioned and aligned. No tools or fasteners required for ganging; the frames simply interlock.
- Model with ADA compliant frame is also available. The frame is 33" wide and the polypropylene top/modesty remain a constant size.
- Tables are standard without glides and are suitable for carpet, rubber or cork flooring.
- Glide options are available (see right column "GLIDES"). Glides must be chosen to best suit flooring type and site conditions. Upcharges apply.

DOLLY

- For space saving storage and transport.
- Constructed from 1.5" x 0.5" steel tubing with heavy duty casters (two locking) and a removable handle.
- Dolly can stack up to 20 tables.
- Stacking height on dolly is up to 68".

FINISHES

BZB	Buzz Blue	FRO	Frost
CCT	Cactus	INK	Ink
CRO	Carrot	LAB	Latte
IVC	Cloud	BLK	Night
DJN	Dijon	SND	Sand
EGP	Eggplant	SAR	Scarlet
FOG	Fog	SHW	Shadow

GLIDES

- CG** Clear polycarbonate (for carpet, rubber or concrete flooring). Height added to table: 0.18". **Add \$18/set.**
- SG** Glides with stainless steel pads (for carpet or rubber flooring). Height added to table: 0.17". **Add \$34/set.**
- FG** Glides with felt pads (for vinyl, cork or laminate flooring). Height added to table: 0.24". **Add \$34/set.**
- RG** Glides with rubber pads (for vinyl, hardwood, laminate, stone or ceramic flooring). Height added to table: 0.16". **Add \$34/set.**

SPECIFICATIONS

- Specifications marked with an * are applicable to only those products which have the * symbol beside the product name.

EXAMPLE DUET TABLE ORDER CODE:

Duet stacking table, polypropylene surface in Latte, clear polycarbonate glides

DTS1828P	-LAB	-CG
Model #	Surface finish	Glides

D DUET™ TABLES

STACKING TABLES

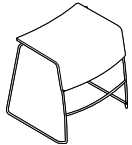

Stacking Table*

MODEL#	DIMENSIONS D x W x H	FREIGHT CLASS	WT./LBS.	CUBIC FT.	LIST PRICE
DTS1828P	25 x 29 x 28	150	26	17.75	\$516

One-piece polypropylene top and modesty with Chrome frame. Shipped fully assembled, 4 per carton.

- Price shown is per table. It is recommended to order in multiples of 4.
- Please be sure to select the appropriate glide (see previous page) for the flooring surface, as scratches could occur.
- Worksurface is 18" D x 28" W

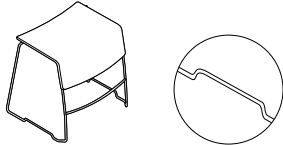

Stacking Table, Ganging Frame*

DTS1828PG	25 x 30.75 x 28	150	26	17.75	\$550
-----------	-----------------	-----	----	-------	--------------

One-piece polypropylene top and modesty with Chrome ganging frame. Shipped fully assembled, 4 per carton.

- Price shown is per table. It is recommended to order in multiples of 4.
- Please be sure to select the appropriate glide (see previous page) for the flooring surface, as scratches could occur.
- Worksurface is 18" D x 28" W

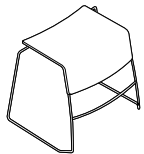

Stacking Table, 32" Wide*

DTA1832P	25 x 33 x 28	150	26	17.75	\$583
----------	--------------	-----	----	-------	--------------

ADA (American with Disabilities Act) compliant. 33" wide. One-piece polypropylene top and modesty with Chrome frame. Underside clearance is 27.1"H (extra height if glides are selected). Stacks up to 5 high on floor only; dolly does not accommodate. Shipped fully assembled, 4 per carton.

- Price shown is per table. It is recommended to order in multiples of 4.
- Please be sure to select the appropriate glide (see previous page) for the flooring surface, as scratches could occur.
- Worksurface is 18" D x 32" W

DOLLY



Dolly

MODEL #	DIMENSIONS	FREIGHT CLASS	WT./LB.	CUBIC FT.	LIST PRICE
DTD20	29.5 x 63 x 38.5	250	50	21	\$749

For use with tables DTS1828P and DTS1828PG. Can stack up to 20 tables. Black only. Removable handle for storage. Shipped fully assembled in 1 carton.

Required Specifications
Finish

Optional Specifications
Grommet

Accessories
Power Block



Edventure is a value series collection that offers a range of teacher desks, student desks and study carrels for more traditional learning environments. Designed to withstand daily rigorous use, traditional style meets modern performance.

Tops are available in a wide array of finishes in 1" thick thermally fused laminate or 1 1/16" high pressure laminate with matching or complementary 2mm PVC edgebanding. Edventure's color palette also includes nine new bold finishes available on select components in high pressure laminate only.

Mobile teacher desks offer versatility with storage options for educators on the move.

Single and connecting study carrels create quiet work areas with optional power and data to stay connected.

Features and Benefits

- Tops are 1" thick thermally fused laminate or 1 1/16" high pressure laminate.
- Tops are constructed of 45 lb. density particle board.
- Matching or complementary 2mm PVC edgebanding.
- Surfaces include factory installed metal inserts for solid and secure leg connections.
- H-leg design on teacher and student desks.
- Teacher's desk includes modesty panel and is available with or without casters.
- Teacher's desk with left or right hand box/box/file pedestal available on casters only.
- Study carrel features curved side panels for seated privacy with a 29"H worksurface.
- Easy to assemble.



H-legs with cross bar.



Mobile teacher desk with modesty panel.



Freestanding and add-on study carrels.

GENERAL INFORMATION

- Edventure series is an affordable collection of teacher desks, student desks and study carrels with personal storage options, that bring a traditional element to the classroom.
- Simple and elegant design respects space requirements to accommodate various teaching styles.
- Edventure series is a high achiever, built to withstand the most demanding environments.
- Shipped easy to assemble.
- For environmental certifications, please visit globalfurnituregroup.com

WORKSURFACES

- Tops are available in 1" thick thermally fused laminate or 1 1/16" thick high pressure laminate.
- Available in an array of finishes in both thermally fused laminate or high pressure laminate.
- Products specified with the high pressure laminate option are finished on the underside of the surface with a kraft paper backing.

CONSTRUCTION

- Top core is made of 45 lb. density particle board.
- Surfaces include factory installed metal inserts for solid and secure leg connections.

EDGE DETAIL

- Global's preferred 2mm PVC edgebanding is standard.
- Edgebanding may be specified in a matching or a complementary finish for tops in standard Global laminates.

LEGS

- H-legs are 28" high and constructed from 2" x 2" square tubing with a 1" x 2" rectangular cross bar and adjustable leveling glides.
- Available in Black (**TBL**), Buzz Blue (**TBZ**), Cactus (**TCC**), Carrot (**TCR**), Cloud (**TIV**), Designer White (**TDW**), Dijon (**TDJ**), Eggplant (**TEG**), Fog (**TFO**), Frost (**TFR**), Ink (**TIN**), Kalua (**TKA**), Latte (**TLA**), Mocha (**TMO**), Nevada (**TNE**), Sand (**TSN**), Scarlet (**TSR**), Shadow (**TSH**), Toast (**TOA**) or Tungsten (**TTU**) painted finishes, Sandtex finish applied.

CASTERS

- Teacher desks are available with locking casters. See models ending in C.
- Casters are 3.5" high overall.

MODESTY PANELS

- 12"H modesty panel is included with teacher desks.
- Available in an array of finishes (see 594) in thermally fused laminate with matching edges only.

SPECIFICATIONS

- Specifications marked with an * are applicable to only those products which have the* symbol beside the product name.

STUDY CARRELS

- The study carrel features a 29" high worksurface and curved side panels for privacy.
- Freestanding (starter) and add-on models are available. Legs and privacy panels are shared between adjoining add-on carrels.
- The back panel is inset to hide connecting fasteners from user's view. The inset back also creates a wire drop for the optional LED task light cord.
- Carrels with an optional shelf are available. See models ending in **S**.
- Optional LED task light is available for carrel with shelf, see page 596
- Optional Cove Daisylink system is available to bring power, USB charging or data to the carrel surface for desktop access, see 598

GROMMETS

- Optional grommets are available in standard worksurface locations (left, center or right) for **teacher desks** and **study carrels**. Order as: **AG1, AG2** or **AG3**. **Add \$96**.
- Grommet hole dimensions are 3.25"W x 1.875"D
 - ENSTxxxx, ENAC2924/3524, ENFC3024/3624 models - **AG2** option only
 - ENFC6024/7224, ENFC5924/7124 models - **AG1 and AG3** option only

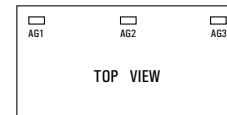
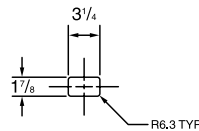

POWER BLOCK

- A power block is a rectangular worksurface power/data module with one electrical duplex receptacle and two data (RJ45) receptacles. 9' Black cord included. Power block dimensions are 6.5"W x 3.5"D x 2.75"H. Units cannot be daisy-chained.
 - ENSTxxxx, ENAC2924/3524, ENFC3024/3624 models - **E2** option only
 - ENFC6024/7224, ENFC5924/7124 models - **E1 and E3** option only

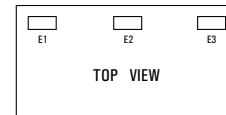
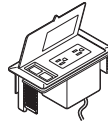

Power block **PMSPDM**. **Add \$330**. Specify location **E1, E2** or **E3**. **Add \$96**.

VILLA CUTOUTS

- Optional Villa cutout available in standard worksurface locations (left, center or right) for Rectangular tables. Order as: **V1, V2 or V3 - Add \$96 for each cutout.**
 - ENSTxxxx, ENAC2924/3524, ENFC3024/3624 models - **V2** option only
 - ENFC6024/7224, ENFC5924/7124 models - **V1 and V3** option only

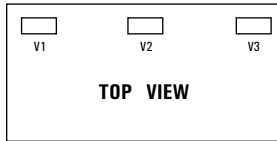
**COVE DAISYLINK COMPONENTS**

- A daisy-chain power solution with a unique “no particular order” feature, making installation or reconfiguration easy.
- Cove Daisylink modules must be ordered separately and are available for study carrels only.
- Specify the cut-out for Cove Daisylink modules when ordering the study carrels; order the Cove kits (modules and jumpers) and infeed separately.
- When **CV** cut-out is specified on 29”, 30”, 35” and 36” study carrels, **one** cut-out in the center position is included. **Add \$96.** When **CV** cut-out is specified on 59”, 60”, 71” and 72” study carrels, **two** cut-outs in the left and right positions are included. **Add \$192.**
- For Cove Daisylink components, see 598
- Maximum of 9 Cove modules per each infeed.

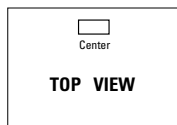

29”, 30”, 35” and 36” study carrels



59”, 60”, 71” and 72” study carrels

MODPOWER DAISY CHAIN SOLUTION

- Add flexible power and USB charging to Edventure study carrels. Connect up to four units with a single corded infeed with NEMA plug.
- ModPower units are sold separately, refer to Productivity Solutions on page 465.
- Begin run with a starter unit which includes a corded infeed. Add additional middle or end units as required. Middle and end units are equipped with connecting cables.
- On-surface modules clamp on or screw mount to the table tops.
- In-surface modules require table top cut-outs for mounting. Specify cut-out option:
 - **MPS** for a single cut-out to accommodate one ModPower in-surface unit (cut-out will be centered on the back edge of surface) for **29” to 72” wide study carrels.** **Add \$96**
 - **MPD** for two cut-outs in the left and right positions, 15” from ends to center of unit on the back edge of surface for **59” to 72” wide study carrels.** **Add \$192.**

FINISHES

Thermally Fused or High Pressure Laminate Tops

ACJ	Absolute Acajou	FCL	First Class
ASN	Asian Night	NBL	Noce Biondo
AWC	Avant Cherry	NGL	Noce Grigio
AWH	Avant Honey	NEL	Noce Leggero
BLK	Black	NML	Noce Medio
BZD	Blizzard	QTM	Quartered Mahogany
BRC	Brushed Cobalt	SBY	Sheer Beauty
CMB	Clear Maple	SOG	Storm Grey
CGY	Custom Grey	SDT	Stonedust
DES	Dark Espresso	WHE	Walnut Heights
DWT	Designer White	WHC	White Chocolate
FAS	Fashionista	WCR	Winter Cherry

Leg finishes

TBL	Black	TIN	Ink
TBZ	Buzz Blue	TKA	Kalua
TCC	Cactus	TLA	Latte
TCR	Carrot	TMO	Mocha
TIV	Cloud	TNE	Nevada
TDW	Designer White	TSN	Sand
TDJ	Dijon	TSR	Scarlet
TEG	Eggplant	TSH	Shadow
TFO	Fog	TOA	Toast
TFR	Frost	TTU	Tungsten

Note: Modesty panel available in thermally fused laminate finishes only. Modesty panel and pedestal edging will match thermally fused laminate finish specified.

2mm Thick Edgebanding

AAE	Absolute Acajou	FCL	First Class
ASE	Asian Night	FOG	Fog
ACE	Avant Cherry	LAB	Latte
AHE	Avant Honey	NBL	Noce Biondo
BLK	Black	NGL	Noce Grigio
BRC	Brushed Cobalt	NEL	Noce Leggero
BZB	Buzz Blue	NML	Noce Medio
BZD	Blizzard	QTM	Quartered Mahogany
CCT	Cactus	SAR	Scarlet
CRO	Carrot	SBY	Sheer Beauty
CME	Clear Maple	SHW	Shadow
CGY	Custom Grey	SDT	Stonedust
DEE	Dark Espresso	SOG	Storm Grey
DWE	Designer White	WHE	Walnut Heights
DJN	Dijon	CBE	White Chocolate
FAS	Fashionista	WCE	Winter Cherry

TO SPECIFY:

1. SPECIFY MODEL NUMBER

2. SPECIFY THE FOLLOWING:

FOR TEACHER AND STUDENT DESKS:

- Top finish
- Optional HP laminate
- Edge finish (top only)
- Modesty finish if applicable
- Pedestal finish if applicable
- Leg finish
- Optional AG grommet or cut-out for PMSPPM, if applicable
- Optional key alike or select number (#100-120) applicable with teacher's desks with pedestals

FOR STUDY CARRELS:

- Top surface finish (shelf, if applicable, will be in the same finish)
- Optional HP laminate
- Edge finish
- Leg finish
- Surround finish (side and back panels)
- Optional cut-out(s) for Cove Daisylink or ModPower components

EXAMPLE ADVENTURE ORDER CODES:

Teacher desk

ENTD7230	-ACJ	-HPL	-AAE	-TTU	-ACJ
Model #	Top finish	High pressure laminate	Edge finish	Leg finish	Modesty panel finish

Study carrel

ENFC3024	-ACJ	-HPL	-AAE	-TTU	-ACJ	-CV
Model #	Top finish	High pressure laminate	Top edge finish	Leg finish	Surround finish	Cut-out for Cove

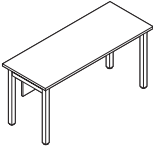
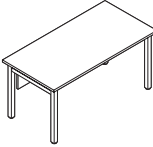
TEACHER DESKS	MODEL#	DIMENSIONS	FREIGHT CLASS	WT/LBS.	CUBIC FT.	LIST PRICE	HP ADD
 <p>Teacher Desk, 24\"</p>	D x W x H						
	ENTD4824	24 x 48 x 29	70	74	4.6	\$1071	\$169
	ENTD5424	24 x 54 x 29	70	80	4.7	\$1084	\$194
	ENTD6024	24 x 60 x 29	70	86	4.9	\$1100	\$207
12\"H modesty panel included. Shipped easy to assemble in 2 cartons.							
 <p>Teacher Desk, 30\"</p>	ENTD6030	30 x 60 x 29	70	96	6.4	\$1170	\$224
	ENTD6630	30 x 66 x 29	70	103	6.6	\$1210	\$273
	ENTD7230	30 x 72 x 29	70	110	6.8	\$1250	\$292
12\"H modesty panel included. Shipped easy to assemble in 2 cartons.							

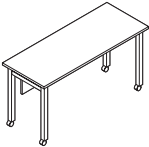
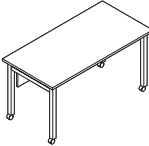
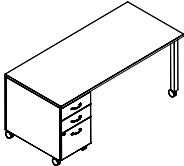
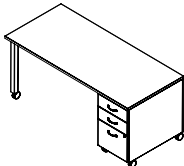
MOBILE TEACHER DESKS	MODEL #	DIMENSIONS	FREIGHT CLASS	WT/LB.	CUBIC FT.	LIST PRICE	HP ADD	
 <p>Mobile Teacher Desk, 24\"</p>	ENTD4824C	24 x 48 x 29	70	75	4.6	\$1242	\$169	
	ENTD5424C	24 x 54 x 29	70	81	4.7	\$1257	\$182	
	ENTD6024C	24 x 60 x 29	70	87	4.9	\$1273	\$196	
12\"H modesty panel included. Shipped easy to assemble in 2 cartons.								
 <p>Mobile Teacher Desk, 30\"</p>	ENTD6030C	30 x 60 x 29	70	98	5.4	\$1343	\$209	
12\"H modesty panel included. Shipped easy to assemble in 2 cartons.								
 <p>Mobile Teacher Desk, BBF - Left*</p>	ET6024BBFLC	24 x 60 x 29	85	155	12.37	\$2385	\$195	
	ET6624BBFLC	24 x 66 x 29	85	161	12.57	\$2428	\$209	
	ET7224BBFLC	24 x 72 x 29	85	167	12.75	\$2474	\$223	
	ET6030BBFLC	30 x 60 x 29	85	193	14.67	\$2521	\$209	
	ET6630BBFLC	30 x 66 x 29	85	201	14.85	\$2565	\$255	
	ET7230BBFLC	30 x 72 x 29	85	210	15.06	\$2610	\$274	
	Inset 12\"H modesty panel and flush left hand locking box/box/file pedestal included. Top box drawer is non-locking. Shipped easy to assemble (BBF pedestal is fully assembled) in 3 cartons.							
	 <p>Mobile Teacher Desk, BBF - Right*</p>	ET6024BBFRC	24 x 60 x 29	85	155	12.37	\$2385	\$195
		ET6624BBFRC	24 x 66 x 29	85	161	12.57	\$2428	\$209
		ET7224BBFRC	24 x 72 x 29	85	167	12.75	\$2474	\$223
ET6030BBFRC		30 x 60 x 29	85	193	14.67	\$2521	\$209	
ET6630BBFRC		30 x 66 x 29	85	201	14.85	\$2565	\$255	
ET7230BBFRC		30 x 72 x 29	85	210	15.06	\$2610	\$274	
Inset 12\"H modesty panel and flush right hand locking box/box/file pedestal included. Top box drawer is non-locking. Shipped easy to assemble (BBF pedestal is fully assembled) in 3 cartons.								

Required specifications

Top finish
 Edge finish
 Leg finish
 Modesty finish
 Pedestal finish*

Optional specifications

HP laminate
 AG grommet or cut-out for PMSPDM*
 Key alike/select key*

STUDENT DESK

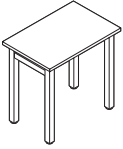

Student Desk**

MODEL#	DIMENSIONS	FREIGHT CLASS	WT/LBS.	CUBIC FT.	LIST PRICE	HP ADD
ENST3020	20 x 30 x 29	85	49	3.9	\$543	\$115

Shipped easy to assemble in 2 cartons.

FREESTANDING OR STARTER STUDY CARRELS

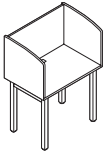

Freestanding/Starter Study Carrel*

MODEL #	DIMENSIONS	FREIGHT CLASS	WT/LB.	CUBIC FT.	LIST PRICE	HP ADD	CUT-OUT ADD
ENFC3024	24 x 30 x 50	70	89	4.44	\$1045	\$119	\$96
ENFC3624	24 x 36 x 50	70	97.5	4.72	\$1091	\$139	\$96
ENFC6024	24 x 60 x 50	70	115	5.8	\$1272	\$207	\$96
ENFC7224	24 x 72 x 50	70	123.5	6.34	\$1359	\$238	\$96

Features a 29" high worksurface with curved side privacy panels. Shown with optional cut-out. Bring power and USB charging to the user with Cove Daisylink components, see 598. Shipped easy to assemble in 2 cartons.

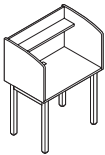

Freestanding/Starter Study Carrel w/Shelf*

ENFC3024S	24 x 30 x 50	70	93	4.44	\$1098	\$138	\$96
ENFC3624S	24 x 36 x 50	70	102.5	4.72	\$1150	\$160	\$96
ENFC6024S	24 x 60 x 50	70	122	5.8	\$1363	\$246	\$96
ENFC7224S	24 x 72 x 50	70	131.5	6.34	\$1465	\$281	\$96

Features a 29" high worksurface with curved side privacy panels. Shown with optional cut-out. Shelf is 6" deep and accepts optional LED task light. Bring power and USB charging to the user with Cove Daisylink components, see 598. Shipped easy to assemble in 2 cartons.

ADD-ON STUDY CARRELS

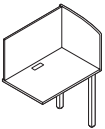

Add-On Study Carrel*

MODEL #	DIMENSIONS	FREIGHT CLASS	WT/LB.	CUBIC FT.	LIST PRICE	HP ADD	CUT-OUT ADD
ENAC2924	24 x 29 x 50	85	63	4.4	\$785	\$119	\$96
ENAC3524	24 x 35 x 50	70	71.5	4.67	\$830	\$139	\$96
ENAC5924	24 x 59 x 50	70	89	5.75	\$1016	\$207	\$96
ENAC7124	24 x 71 x 50	70	97.5	6.3	\$1104	\$238	\$96

Features a 29" high worksurface with curved side privacy panels. Shown with optional cut-out. Bring power and USB charging to the user with Cove Daisylink components, see 598. Shipped easy to assemble in 2 cartons.

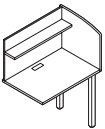

Add-On Study Carrel w/Shelf*

ENAC2924S	24 x 29 x 50	70	67	4.4	\$835	\$138	\$96
ENAC3524S	24 x 35 x 50	70	76.5	4.67	\$888	\$160	\$96
ENAC5924S	24 x 59 x 50	70	96	5.75	\$1110	\$246	\$96
ENAC7124S	24 x 59 x 50	70	105.5	6.3	\$1210	\$281	\$96

Features a 29" high worksurface with curved side privacy panels. Shown with optional cut-out. Shelf is 6" deep and accepts optional LED task light. Bring power and USB charging to the user with Cove Daisylink components, see 598. Clearance from worksurface to shelf is 14". Shipped easy to assemble in 2 cartons.

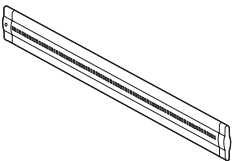

LED Task Light

PLED30	1.5 x 15.5 x .5	150	2	.50	\$494
PLED50	1.5 x 23.5 x .5	150	2	.50	\$569
PLED100	1.5 x 43.5 x .5	125	3	.50	\$660

Energy efficient LED. Ultra slim design. Suitable for mounting on the underside of the shelf of a study carrel. 6' power cord.

Required specifications

Top finish*
Edge finish*
Leg finish*
Surround finish*

Optional specifications

HP laminate*
Cut-out for Cove Daisylink modules*

Accessories

Cove Daisylink modules*
LED task lights*

COVE DAISYLINK COMPONENTS

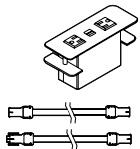

Single Power/USB for 29"/30" Carrels

MODEL#	DIMENSIONS D x W x H	FREIGHT CLASS	WT/LBS.	CUBIC FT.	LIST PRICE
ECV2PU30B	2 x 30 x -	60	4.5	0.5	\$640
ECV2PU30S	2 x 30 x -	60	4.5	0.5	\$640

Cove single desktop module with two power outlets and two 2.1A USB charging ports. Includes four cable clamps, one 14" female/male connecting cable and one 14" female/female connecting cable. Connecting cables will daisy-chain modules between two 30" wide starter carrels, one 30" wide starter carrel and one 29" wide add-on carrel, or two 29" wide add-on carrels. Available in Black **(B)** or Silver **(S)** - indicated by last letter of the model number. Infeed to be ordered separately.

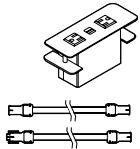

Single Power/USB for 35"/36" Carrels

ECV2PU36B	2 x 36 x -	60	4.6	0.5	\$644
ECV2PU36S	2 x 36 x -	60	4.6	0.5	\$644

Cove single desktop module includes two power outlets and two 2.1A USB charging ports. Includes four cable clamps, one 17" female/male connecting cable and one 17" female/female connecting cable. Connecting cables will daisy-chain modules between two 36" wide starter carrels, one 36" wide starter carrel and one 35" wide add-on carrel, or two 35" wide add-on carrels. Available in Black **(B)** or Silver **(S)** - indicated by last letter of the model number. Infeed to be ordered separately.

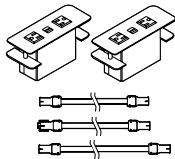

Double Power/USB for 59"/60" Carrels

ECV2PU60B	2 x 60 x -	60	4.6	0.5	\$1182
ECV2PU60S	2 x 60 x -	60	4.6	0.5	\$1182

Cove double desktop modules - each module includes two power outlets and two 2.1A USB charging ports. Includes four cable clamps, one 12" female/male connecting cable, one 12" female/female connecting cable and one 26" female/female interconnecting cable. Connecting cables will daisy-chain modules between two 60" wide starter carrels, one 60" wide starter carrel and one 59" wide add-on carrel, or two 59" wide add-on carrels. Available in Black **(B)** or Silver **(S)** - indicated by last letter of the model number.

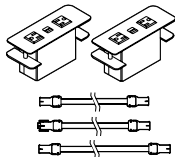

Double Power/USB for 71"/72" Carrels

ECV2PU72B	2 x 72 x -	60	4.6	0.5	\$1202
ECV2PU72S	2 x 72 x -	60	4.6	0.5	\$1202

Cove double desktop modules - each module includes two power outlets and two 2.1A USB charging ports. Includes four cable clamps, one 15" female/male connecting cable, one 15" female/female connecting cable and one 31" female/female interconnecting cable. Connecting cables will daisy-chain modules between two 72" wide starter carrels, one 72" wide starter carrel and one 71" wide add-on carrel, or two 71" wide add-on carrels. Available in Black **(B)** or Silver **(S)** - indicated by last letter of the model number.

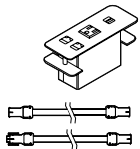

Single Power/Data/USB for 29"/30" Carrels

ECVPUD30B	2 x 30 x -	60	4.6	0.5	\$602
ECVPUD30S	2 x 30 x -	60	4.6	0.5	\$602

Cove single desktop module includes one power outlet, two data knockouts and two 2.1A USB charging ports. Includes four cable clamps, one 14" female/male connecting cable and one 14" female/female connecting cable. Data/telecom options to be ordered separately. Connecting cables will daisy-chain modules between two 30" wide starter carrels, one 30" wide starter carrel and one 29" wide add-on carrel, or two 29" wide add-on carrels. Available in Black **(B)** or Silver **(S)** - indicated by last letter of the model number. Infeed to be ordered separately.

Required specifications

Paint finish, case*
Laminate finish**
Edge finish (ENMST1824 only)
Trim finish (ENLS182 only)

Optional specifications

Key alike*
HP laminate (ENMST1824 only)

COVE DAISYLINK COMPONENTS

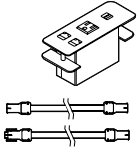

Single Power/Data/USB for 35"/36" Carrels

MODEL#	DIMENSIONS D x W x H	FREIGHT CLASS	WT/LBS.	CUBIC FT.	LIST PRICE
ECVPUD36B	2 x 36 x -	60	4.60	0.5	\$609
ECVPUD36S	2 x 36 x -	60	4.60	0.5	\$609

Cove single desktop module includes one power outlet, two data knockouts and two 2.1A USB charging ports. Includes four cable clamps, one 17" female/male connecting cable and one 17" female/female connecting cable. Data/telecom options to be ordered separately. Connecting cables will daisy-chain modules between two 36" wide starter carrels, one 36" wide starter carrel and one 35" wide add-on carrel, or two 35" wide add-on carrels. Available in Black (B) or Silver (S) - indicated by last letter of the model number. Infeed to be ordered separately.

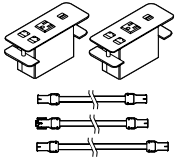

Double Power/Data/USB for 59"/60" Carrels

ECVPUD60B	2 x 60 x -	60	4.6	0.5	\$1112
ECVPUD60S	2 x 60 x -	60	4.6	0.5	\$1112

Cove double desktop modules - each module includes one power outlet, two data knockouts and two 2.1A USB charging ports. Includes four cable clamps, one 12" female/male connecting cable, one 12" female/female connecting cable and one 26" female/female interconnecting cable. Data/telecom options to be ordered separately. Connecting cables will daisy-chain modules between two 60" wide starter carrels, one 60" wide starter carrel and one 59" wide add-on carrel, or two 59" wide add-on carrels. Available in Black (B) or Silver (S) - indicated by last letter of the model number. Infeed to be ordered separately.

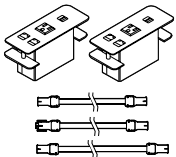

Double Power/Data/USB for 71"/72" Carrels

ECVPUD72B	2 x 72 x -	60	4.6	0.5	\$1123
ECVPUD72S	2 x 72 x -	60	4.6	0.5	\$1123

Cove double desktop modules - each module includes one power outlet, two data knockouts and two 2.1A USB charging ports. Includes four cable clamps, one 15" female/male connecting cable, one 15" female/female connecting cable and one 31" female/female interconnecting cable. Data/telecom options to be ordered separately. Connecting cables will daisy-chain modules between two 72" wide starter carrels, one 72" wide starter carrel and one 71" wide add-on carrel, or two 71" wide add-on carrels. Available in Black (B) or Silver (S) - indicated by last letter of the model number. Infeed to be ordered separately.



Single-Circuit Corded Infeed, 72"

42AP1-72	72"W	70	1	1.80	\$245
----------	------	----	---	------	--------------

72" corded infeed to start a run of Cove Daisylink modules. Maximum of 9 Cove modules per each infeed (Cove double counts as two modules).



Multi-Circuit Power Hardwire Infeed, 72"

42SB2-72	72"W	70	1	1.80	\$158
----------	------	----	---	------	--------------

Hardwire infeed to start a run of Cove Daisylink modules. Maximum of 9 Cove modules per each infeed (Cove double counts as two modules). Certified electrician required for installation.

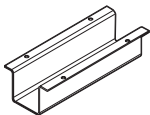

Jumper Guards - Set of 4

ENCVG12	5 x 12 x 3.1	85	14	1.1	\$141
---------	--------------	----	----	-----	--------------

Metal channel to protect jumper connection to Cove Daisylink module. Black only. Mounts directly to the underside of surface.

Required specifications

Top finish*
Edge finish*
Leg finish*
Surround finish*

Optional specifications

HP laminate*
Cut-out for Cove Daisylink modules*

Accessories

Cove Daisylink modules*
LED task lights*



FreeFit offers a universal freestanding design with finish options on bases and surfaces that allow you to easily integrate with existing Global workstation configurations, becoming a part of your workspace. With two concealed motors on each base, FreeFit adjusts at 1.5" per second while emitting just 44db. Select from two table ranges – standard range accommodates most users, while extended range meets BIFMA ergonomics guidelines accommodating an extensive array of user needs.

Features and Benefits

- Tops are 1" thick thermally fused laminate or 1 1/16" high pressure laminate
- Tops are constructed of 45 lb. density particle board
- Worksurfaces are sold separate from the base
- Steel constructed leg tubing, feet and cross bar
- Table frames include expandable width upper cross bars
- Standard up/down handset. Optional digital readout handset.



Add a 3rd leg kit to create an electric height adjustable L station.

GENERAL INFORMATION

- FreeFit Height Adjustable Tables allow for easy movement from sitting to standing and back throughout the day.
- FreeFit offers a universal freestanding design with finish options on the bases and surfaces that allow you to easily integrate with existing Global workstation configurations, becoming a part of your office space.
- Can be used alone or in conjunction with Global desks. Please note Global desks are 1" or 1.5" thick
- For environmental certifications, please visit globalfurnituregroup.com

ORDERING GUIDELINES

CODES

The price list uses a numbering system with meaningful alphanumeric characters to create a simple to understand product number. This makes specifying the product much easier and more accurate.

SPECIFICATION EXAMPLE OF A HEIGHT ADJUSTABLE TABLE:

Ordered as components, please order:

1. BASE

PRODUCT CODE: **FT** - FreeFit
5 - Standard Range Legs
2 - Leg Quantity
SF - Small Frame
24 - Depth

OPTIONS:

Frame Style: **5** - Standard Range Frame 27.5" to 47"
6 - Extended Range Frame 22.5" to 48.5"

Leg Quantity: **1** - 1 leg for return kit
2 - 2 leg table kit
4 - 4 leg table kit

Frame Size: **BF** - Base Frame, for 30" to 42" wide tables
SF - Small Frame, for 48" to 60" wide tables
LF - Large Frame, for 66" to 84" wide tables

Worksurface Depth: **24** - For 23" deep worksurfaces
30 - For 29" and 35" deep worksurfaces

Leg Style: **CL** - C-shaped table leg
TL - T-shaped table leg

Controller Style: **S** - Standard controller
D - Display controller, add \$47 list (\$94 list for back-to-back benching and media tables).

Base Finish: BLK Black
DWT Designer White
TUN Tungsten

2. TOP

PRODUCT CODE: **FTWR2436**

Top: **LP** - Low Pressure laminate, 1" thick
HP - High Pressure laminate, 1-1/16" thick

Top Finish Laminate: Select Color

Top PVC Edge Finish: Select Color

3. ACCESSORIES

PRODUCT CODE: **FTAEC12**

Base Finish: BLK Black
CHR Charcoal
DWT Designer White
FOG Fog
NEV Nevada
SIL Silver
TPE Taupe
TUN Tungsten

CONSTRUCTION

- Table frames feature 3.15" x 1.97" rectangular outer leg with larger tube attached to the foot.
- Open base design with ample room for chair and user's legs
- Flat foot design includes ½" adjustable glides
- Table frames include expandable width upper cross bars.
- Open base design has no lower crossbars.
- All table frames are easy to assemble with few parts.
- Tables are designed so that the paint will never mar on the leg during operation.
- Steel construction of the leg assembly tubing, feet and upper structure assemblies.
- Powder coat finishes for bases are offered in Black (BLK), Charcoal (CHR), Designer White (DWT), Fog (FOG), Nevada (NEV), Silver (SIL), Taupe (TPE) or Tungsten (TUN).
- All standard Global laminate finishes are available.
- Sizes of tops are "nominal." Unless otherwise stated, actual depth is 1" less and actual width is 2" less than "nominal" size.
- All bases lift 350 lbs on two leg tables.
- Operates at 1.5" per second.
- 108" 3-prong power cord
- Standard Range Frame adjusts from 27.5" to 47" including the worksurface.
- Extended Range Frame adjusts from 22.5" to 48.5" including the worksurface.
- Worksurfaces and troughs are sold separate from the base.
- 1" thick tops constructed of 45 lb. density particle board with high performance thermally fused laminate.
- Laminate surfaces offer a selection of matching + coordinating edgeband. Specify separately from the surface finish.
- Products specified with the high pressure laminate option are 1-1/16" thick and finished on the underside of the surface with a kraft paper backing.
- Worksurface sizes are "nominal". Main worksurface sizes are 1" less in depth and 2" less in width.
- Steel constructed leg tubing, feet and cross bar.
- Back-to-back benching kits feature a pad foot with ½" adjustable glides
- Foot on single sided benching is 3.55"W x 1"H (with glides fully recessed).
- **Caution:** to meet BIFMA standards for performance and stability, appropriate base size must be specified with corresponding top sizes identified.
- All products meet or exceed ANSI-BIFMA X5.5-2014 and 7.1 VOC. and CSA-C22.2 No. 6809, CAN/CGSB-44.228-2008.
- **All components** are UL 962 listed.

STANDARD RANGE COLUMNS

The 2-part lifting column is a perfect choice for a wide range of different desk applications in the office.

- Compact design where guide and actuator functions are an integrated unit
- Reinforced column and optimized motor housing design for extra strength and stability
- Max. load 800 N per column
- Max. speed 1.5"/second unloaded
- Standard installation dimension 25.4"
- Standard stroke length 19.7"
- Weight: Approximately 14.3 lbs. per column
- Column dimensions: 1.97" x 3.15" (outer profile) and 1.71" x 2.89" (inner profile)
- Motor housing dimensions: 6.97" x 3.82" x 1.81"
- Low noise level
- No visible gliding pads
- Standard Range Tables have 2-stages and feature an adjustment range of 27.5" – 45.5" (18" travel).

EXTENDED RANGE COLUMNS

The 3-part construction ensures a short installation dimension combined with a long stroke length making the Extended Range Column the optimum choice no matter the height of the person using it. The middle profile of the column moves synchronously so the profiles are always in the same height optimizing the desk design and the stability.

- Compact design where guide and actuator functions are an integrated unit
- Reinforced column and optimized motor housing design for extra strength and stability

- Max. thrust 1200 N per column (12 mm spindle pitch)
- Max. speed 1.5"/second unloaded
- Installation dimension: 22" / 20.4" (BIFMA)
- Stroke length: 25.6" / 26.2" (BIFMA)
- Weight: 17.2 lbs. per column
- Column dimensions: 1.97" x 3.15" (outer profile), 1.71" x 2.89" (middle profile), 1.46" x 2.64" (inner profile)
- Low noise level
- No visible gliding pads



Standard range (2 stage)

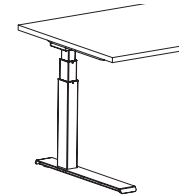

Extended range (3-stage)

FOOT TYPE

- FreeFit offers two foot styles, either a "T" or "C".
- Feet offered in two lengths: 22.75" and 28".
- Foot offers a recessed connection for the column and connects from the bottom with 4 bolts.
- Adjustable glides are standard

DESK MOUNT FRAME

- Can be specified in three lengths:
 - Base Frame (**BF**) for tables 30" - 42" long (nominal dimensions)
 - Short Frame (**SF**) for tables 48" - 60" long (nominal dimensions)
 - Long Frame (**LF**) for tables 66" - 84" long (nominal dimensions)
- All metal parts are Black
- Cantilever length: 21.7"
- Central or off-center placement of columns (T-desk or C-desk)
- Includes all connecting hardware

CONTROL BOX

- Two leg tables come standard with a 200 W Control Box
 - Mains voltage 120 VAC, 60 Hz
 - Ultra-compact; 8.25" long
 - Lightweight control box; weight is approximately 1 lb.
- Three Leg Tables come standard with a 300 W Control Box
 - can be connected up to 4 columns
 - Mains voltage 100-240 VAC, 50-60 Hz (universal)
 - Ultra-compact; 10.5" long
 - Lightweight control box; weight is approximately 1.1 lbs.
- Common features for the (200 W and 300 W):
 - Ultra-low; only 1.5" high
 - Environment: Operation Storage
 - Ambient temperature: 5 to 40 °C -10 to +50 °C
 - Relative humidity: 20 to 80 % at 30 °C 20 to 80 % at 30 °C
 - Atmospheric pressure: 700 to 1060 hPa 700 to 1060 hPa
 - Compact high-power SMPS (Switch Mode Power Supply)
 - Color: Black
 - Protection against overload (EOP), by individual current limitation
 - The control box is designed with a soft start/stop function
 - Autodetection of the number and type of columns connected
 - Cable grooves at the bottom to optimise cable management
 - White plugs for easy recognition when mounting/dismounting
 - PVC-Free™
 - Low standby power consumption – only 0.1 W.
 - Exchangeable standard mains cable

STANDARD HANDSET

- Features Bluetooth® connection, two favorite positions and an LED reminder to prompt users to change position.
- Controller is activated by tilting the desk panel in the same direction as the desk is intended to drive.
- Pulsating orange and green LED lights remind users to change positions.
- Using the integrated Bluetooth® and downloading the Desk Control App, users can also be reminded via notifications on their computer or smart devices.
- Black only. Black cable with RJ45 modular plug. 63" long.
- PVC-Free™, featuring ZERO™. Very low power consumption in standby mode.
- Approved according to EN 60335-1 and UL962

DISPLAY HANDSET

- Features Bluetooth® connection, four favorite positions, a display to guide users, and a light strip to prompt users to change position.
- Controller is activated by tilting the desk panel in the same direction as the desk is intended to drive.
- Display controller features a modern, discreet design with a glossy surface and integrated display to ensure a clean and minimalist design.
- The display provides guidance to users when operating the desk.
- Via pulsating orange and green lights, the light strip reminds users to change positions.
- Using the integrated Bluetooth® and downloading the Desk Control App, users can also be reminded via notifications on their computer or smart devices.
- Black only. Black cable with RJ45 modular plug. 63" long.
- PVC-Free™, featuring ZERO™. Very low power consumption in standby mode.
- Approved according to EN 60335-1 and UL962
- Specify **(D)**, add **\$59** list (**\$117** list for back-to-back benching and media tables).
- A basic handset without Bluetooth® capabilities is available and must be purchased separately, replacing the **S** or **D** handset in the field. See 619 for details and pricing.

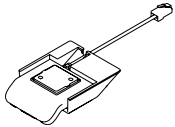

Standard handset (**S**)

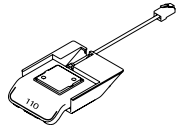

Display handset (**D**)

ANTI-COLLISION SENSOR

- Features enhanced Anti-Collision protection which can limit material damage to a desk or an object if a collision occurs during driving of the desk.
- The sensor is a compact plug-in adapter based on gyroscope-technology, and it detects even slight tilting of the desk when the desk is driving up or down.
- Upon detected tilting, the system stops and drives in the opposite direction to avoid collision and damage to the desk or the object.
- The sensor can detect both hard and soft obstacles.
- The Anti-Collision Sensor is standard on all desks.
- Reacts to angle changes bigger than 0.7° per second
- Just plug it in – no mounting required
- ZERO™ power capable
- PVC-Free™

BATTERY BOX

- A high-performance lithium-Ion battery with a capacity of 2.15 Ah.
- On a full charge the table can cycle from 35 to 45 stroke lengths based upon the range of column selected and load on the table.
- Compact unit for easy handling and installation
- Battery alarm (audio) when charging is needed
- Battery charging indicator (LED light bars) indicating the capacity level
- Thermal switch protection, overcurrent protection
- Color: black
- Battery capacity: 2.15 Ah / 52 Wh
- Nominal voltage: 24 V DC
- Discharge current: 9 A (max)
- Maximum charging voltage: 40 V DC
- Charging current: 0.5 A
- Weight: 1.32 lbs.

USAGE

- Ambient temperature: 41 to 104 °C
- Storage temperature: 32 to 113 °C

Approved according to:

- EN 62133 (Battery safety testing)
- UL 1642 (Lithium cells, standard test)
- UN 38.3 (transportation of Lithium batteries)
- UL 2054 (Household and commercial batteries)
- EN 60335-1 with CBH Advanced

GROMMET WITH ACCESS DOOR OPTIONS FOR FREEFIT BENCHING

- Access door option is specified by first selecting a grommet position left or right of center, use code GL or GR, add \$83 list (see diagram on next page for specific position).
- Access doors are specified separately, using the code + list pricing below.
- Available in Black (**BLK**), Designer White (**DWT**) or Tungsten (**TUN**) paint finishes
- Device holder is only available in white plastic.
- CSA certified power bar includes (3) outlets and (2) charging USB ports (2.1 amp).

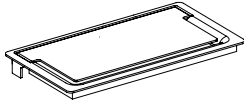

Standard Access Door (**GAADG**). Add **\$90**.

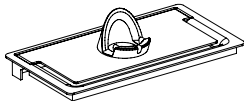

Access Door with Device Holder (**GAADGDH**). Add **\$97**.

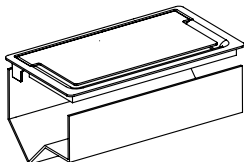

Access Door with Cable Tray (**GAADCT**). Add **\$145**.

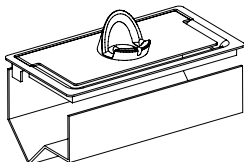

Access Door with Cable Tray & Device Holder (**GAADCTDH**). Add **\$153**.

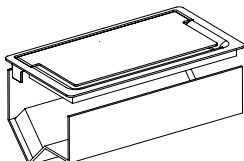

Access Door with Cable Tray & Power Bar (**GAADCTPD**). Add **\$307**.

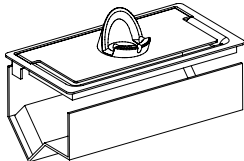

Access Door with Cable Tray, Power Bar & Device Holder (**GAADCTPDDH**). Add **\$316**.

ACCESS DOOR CUT-OUT DIMENSIONS

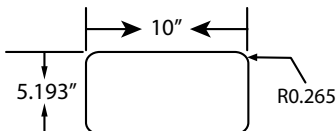

FINISHES

Laminate Top Finishes:

- ACJ Absolute Acajou
- ASN Asian Night
- AWC Avant Cherry
- AWH Avant Honey
- BLK Black - Coordinates with BLK Metal Frame Finish
- BZD Blizzard
- BRC Brushed Cobalt - Coordinates with TUN Metal Frame Finish
- CMB Clear Maple
- CGY Custom Grey
- DES Dark Espresso
- DWT Designer White - Coordinates with DWT Metal Frame Finish
- FAS Fashionista
- FCL First Class
- NBL Noce Biondo
- NGL Noce Grigio
- NEL Noce Leggero
- NML Noce Medio
- QTM Quartered Mahogany
- SBY Sheer Beauty
- SDT Stonedust
- SOG Storm Grey
- STG String
- WHE Walnut Heights
- WHC White Chocolate
- WCR Winter Cherry

Base Finishes

- BLK Black
- CHR Charcoal
- DWT Designer White
- FOG Fog
- NEV Nevada
- SIL Silver
- TPE Taupe
- TUN Tungsten

Edgeband Finishes:

- AAE Absolute Acajou
- ASE Asian Night
- ACE Avant Cherry
- AHE Avant Honey
- BLK Black
- BZD Blizzard
- BRC Brushed Cobalt
- CHR Charcoal (*use w/SOG*)
- CME Clear Maple
- DES Dark Espresso
- DEE Dark Espresso
- DWE Designer White
- FAS Fashionista
- FCL First Class
- NBL Noce Biondo
- NGL Noce Grigio
- NEL Noce Leggero
- NML Noce Medio
- NEV Nevada (*use w/STG*)
- QTM Quartered Mahogany
- SBY Sheer Beauty
- SIL Silver
- SDT Stonedust
- TPE Taupe
- WHE Walnut Heights
- CBE White Chocolate
- WCE Winter Cherry

CUT-OUT LOCATIONS

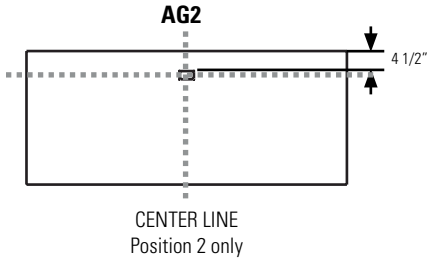

Rectangular Worksurfaces: 46", 52" & 58"
End of Run Table Top: 51"
Rectangular Return/Extension Return Worksurface: All sizes

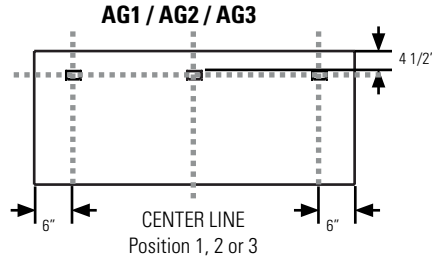

Rectangular Worksurfaces: 64", 70", 76", & 82"
End of Run Table Top: 63"

Access Door grommet in left position (GL)

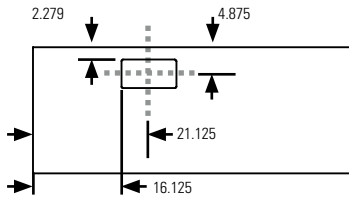

Access Door grommet in right position (GR)

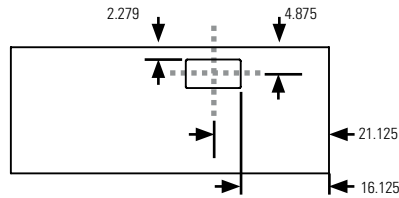

Select one or the other; both options are not available in one surface.

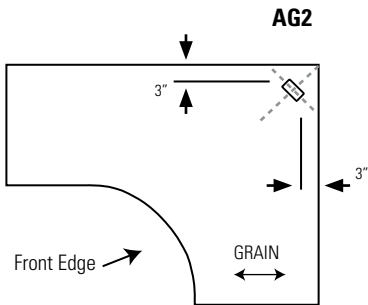

Rectangular Worksurfaces: 46" - 82"
End of Run Table Top: 51" & 63"

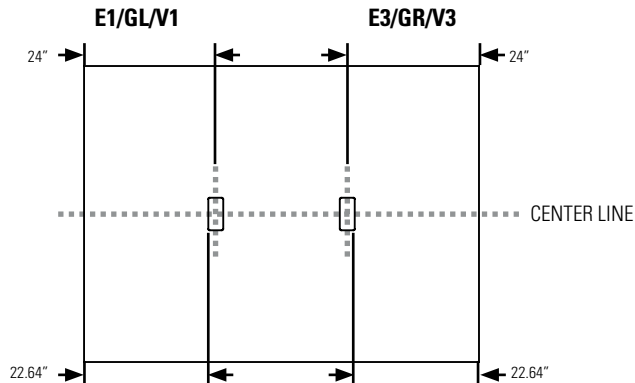

90° Corner Table Tops
Extended 90° Corner Table Tops



Media Table Tops

WORKSURFACES	MODEL#	DIMENSIONS	FREIGHT CLASS	WT/LBS.	CUBIC FT.	LIST PRICE	HP ADD									
 <p>Rectangular Worksurfaces</p>		D x W x H														
	FTWR2328	23 x 28 x 1	70	20	1.16	\$225	\$68									
	FTWR2334	23 x 34 x 1	70	24	1.40	\$249	\$76									
	FTWR2340	23 x 40 x 1	70	28	1.64	\$319	\$104									
	FTWR2346	23 x 46 x 1	70	31	1.84	\$427	\$128									
	FTWR2352	23 x 52 x 1	70	36	2.08	\$457	\$145									
	FTWR2358	23 x 58 x 1	70	40	2.32	\$510	\$162									
	FTWR2364	23 x 64 x 1	70	44	2.56	\$534	\$168									
	FTWR2370	23 x 70 x 1	85	48	3.80	\$577	\$179									
	FTWR2376	23 x 76 x 1	70	52	3.03	\$582	\$185									
	FTWR2382	23 x 82 x 1	70	56	3.27	\$629	\$193									
	FTWR2928	29 x 28 x 1	70	25	1.46	\$261	\$83									
	FTWR2934	29 x 34 x 1	70	30	1.76	\$305	\$96									
	FTWR2940	29 x 40 x 1	70	35	2.06	\$427	\$132									
	FTWR2946	29 x 46 x 1	70	40	2.32	\$509	\$145									
	FTWR2952	29 x 52 x 1	70	45	2.62	\$521	\$145									
	FTWR2958	29 x 58 x 1	70	50	2.92	\$532	\$168									
	FTWR2964	29 x 64 x 1	70	55	3.22	\$555	\$181									
	FTWR2970	29 x 70 x 1	70	60	3.52	\$582	\$186									
	FTWR2976	29 x 76 x 1	70	65	3.83	\$609	\$192									
	FTWR2982	29 x 82 x 1	70	71	4.13	\$677	\$211									
	FTWR3528	35 x 28 x 1	70	30	1.76	\$270	\$86									
	FTWR3534	35 x 34 x 1	70	35	2	\$317	\$99									
	FTWR3540	35 x 40 x 1	70	40	2.50	\$444	\$138									
	FTWR3546	35 x 46 x 1	70	48	2.80	\$578	\$145									
	FTWR3552	35 x 52 x 1	70	54	3.16	\$640	\$164									
	FTWR3558	35 x 58 x 1	70	60	3.52	\$712	\$179									
	FTWR3564	35 x 64 x 1	70	67	3.89	\$776	\$198									
	FTWR3570	35 x 70 x 1	70	73	4.25	\$844	\$213									
	FTWR3576	35 x 76 x 1	70	79	4.62	\$906	\$230									
	FTWR3582	35 x 82 x 1	70	85	4.98	\$976	\$245									
	<p>Rectangular worksurfaces are non-handed and can be interchanged on site. For 23" deep worksurfaces, use FT52xx24 or FT62xx24. For 29" deep worksurfaces, use FT52xx30 or FT62xx30. For 35" deep worksurfaces, use FT52xx30 or FT62xx30.</p> <ul style="list-style-type: none"> • 35" deep worksurfaces cannot be used with Back-to-Back bases. • For back-to-back bases, please use the following chart: <table border="0" style="margin-left: 20px;"> <tr> <td>FTWR(23/29)46, FT54BSF/FT64BSF</td> <td>FTWR(23/29)64, FT54BLF/FT64BLF</td> </tr> <tr> <td>FTWR(23/29)52, FT54BSF/FT64BSF</td> <td>FTWR(23/29)72, FT54BLF/FT64BLF</td> </tr> <tr> <td>FTWR(23/29)58, FT54BSF/FT64BSF</td> <td>FTWR(23/29)76, FT54BLF/FT64BLF</td> </tr> <tr> <td></td> <td>FTWR(23/29)82, FT54BLF/FT64BLF</td> </tr> </table> 								FTWR(23/29)46, FT54BSF/FT64BSF	FTWR(23/29)64, FT54BLF/FT64BLF	FTWR(23/29)52, FT54BSF/FT64BSF	FTWR(23/29)72, FT54BLF/FT64BLF	FTWR(23/29)58, FT54BSF/FT64BSF	FTWR(23/29)76, FT54BLF/FT64BLF		FTWR(23/29)82, FT54BLF/FT64BLF
	FTWR(23/29)46, FT54BSF/FT64BSF	FTWR(23/29)64, FT54BLF/FT64BLF														
	FTWR(23/29)52, FT54BSF/FT64BSF	FTWR(23/29)72, FT54BLF/FT64BLF														
	FTWR(23/29)58, FT54BSF/FT64BSF	FTWR(23/29)76, FT54BLF/FT64BLF														
	FTWR(23/29)82, FT54BLF/FT64BLF															
 <p>Media Table Top</p>	FTWMR5460	54 x 60 x 1	70	96	5.63	\$850	\$328									
	FTWMR5466	54 x 66 x 1	70	106	6.19	\$927	\$360									
	FTWMR5472	54 x 72 x 1	70	115	6.75	\$1004	\$394									
	FTWMR5478	54 x 78 x 1	70	125	7.31	\$1078	\$427									
	FTWMR5484	54 x 84 x 1	70	135	7.88	\$1155	\$459									
	FTWMR5490	54 x 90 x 1	70	144	8.44	\$1235	\$492									
	FTWMR5496	54 x 96 x 1	70	154	9	\$1312	\$524									
	FTWMR6060	60 x 60 x 1	70	107	6.25	\$931	\$366									
	FTWMR6066	60 x 66 x 1	70	118	6.88	\$1018	\$403									
	FTWMR6072	60 x 72 x 1	70	128	7.50	\$1102	\$439									
	FTWMR6078	60 x 78 x 1	70	139	8.13	\$1187	\$473									
	FTWMR6084	60 x 84 x 1	70	150	8.75	\$1271	\$510									
	FTWMR6090	60 x 90 x 1	70	160	9.38	\$1357	\$547									
	FTWMR6096	60 x 96 x 1	70	171	10	\$1440	\$583									
	<p>For tables FTWMR5460 and 6060, use FTM5B2BSF standard range or FTM6B2BSF extended range base. For all other tables, use FTM5B2BLF standard range or FTM6B2BLF extended range base</p>															

Required specifications

Top finish
Edge finish

Optional specifications

HP laminate
Grommet

WORKSURFACES



Rectangular Return Worksurfaces

MODEL#	DIMENSIONS D x W x H	FREIGHT CLASS	WT/LBS.	CUBIC FT.	LIST PRICE	HP ADD
FTWRR2329	23 x 29 x 1	70	20	1.16	\$272	\$68
FTWRR2335	23 x 35 x 1	70	24	1.40	\$368	\$81
FTWRR2341	23 x 41 x 1	70	28	1.64	\$406	\$107
FTWRR2347	23 x 47 x 1	70	32	1.88	\$427	\$128
FTWRR2353	23 x 53 x 1	70	36	2.12	\$457	\$145
FTWRR2359	23 x 59 x 1	70	40	2.36	\$503	\$162
FTWRR2929	29 x 29 x 1	70	25	1.46	\$340	\$84
FTWRR2935	29 x 35 x 1	70	30	1.76	\$503	\$97
FTWRR2941	29 x 41 x 1	70	35	2.06	\$503	\$136
FTWRR2947	29 x 47 x 1	70	40	2.36	\$509	\$145
FTWRR2953	29 x 53 x 1	70	46	2.67	\$521	\$145
FTWRR2959	29 x 59 x 1	70	51	2.97	\$607	\$168

Rectangular return worksurfaces are non-handed and can be interchanged on site. Includes two flat brackets for connection. For use with FT51SR/LR or FT61SR/LR. To determine the appropriate return base, use the following chart:

Main Surface	Return Surface	Return Base
FTWR23xx	FTWRR(23/29)29	FT51/61SR
FTWR23xx	FTWRR(23/29)35	FT51/61SR
FTWR23xx	FTWRR(23/29)41	FT51/61SR
FTWR23xx	FTWRR(23/29)47	FT51/61LR
FTWR23xx	FTWRR(23/29)53	FT51/61LR
FTWR23xx	FTWRR(23/29)59	FT51/61LR
FTWR29xx	FTWRR(23/29)29	FT51/61SR
FTWR29xx	FTWRR(23/29)35	FT51/61SR
FTWR29xx	FTWRR(23/29)41	FT51/61LR
FTWR29xx	FTWRR(23/29)47	FT51/61LR
FTWR29xx	FTWRR(23/29)53	FT51/61LR
FTWR29xx	FTWRR(23/29)59	FT51/61LR

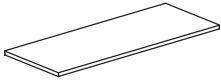

Rectangular End of Run Worksurfaces

FTWR2351	23 x 51 x 1	70	40	2.02	\$498	\$162
FTWR2362	23 x 62 x 1	70	44	2.50	\$523	\$168
FTWR2951	29 x 51 x 1	70	50	2.54	\$523	\$168
FTWR2962	29 x 62 x 1	70	55	3.15	\$535	\$270

Rectangular return worksurfaces are non-handed and can be interchanged on site.

- For 23" deep worksurfaces, use with FT52xx24 or FT62xx24.
- For 29" deep worksurfaces, use with FT52xx30 or FT62xx30.
- For back-to-back bases, please use the following chart:
FTWR(23/29)51, FT52BSF24/30 or FT62BSF24/30
FTWR(23/29)62, FT52BLF24/30 or FT62BLF24/30

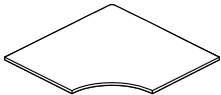

90° Corner Worksurface

FTWCC234023	40 x 40 x 1	60	80	1.5	\$827	\$83
FTWCC234623	46 x 46 x 1	60	95	2	\$851	\$85
FTWCC235223	52 x 52 x 1	70	80	4.69	\$987	\$85
FTWCC235823	58 x 58 x 1	70	100	5.84	\$1263	\$128
FTWCC294029	40 x 40 x 1	60	80	1.5	\$827	\$83
FTWCC294629	46 x 46 x 1	70	63	3.67	\$838	\$86
FTWCC295229	52 x 52 x 1	70	80	4.69	\$987	\$103
FTWCC295829	58 x 58 x 1	70	100	5.84	\$1263	\$128

For tables that connect with 23" deep worksurfaces, use with FT539FS24CL or FT639FS24CL. For tables that connect with 29" deep worksurfaces, use with FT539FS30CL or FT639FS30CL.

Required specifications

Top finish
Edge finish

Optional specifications

HP laminate
Grommet

EXTENDED CORNER WORKSURFACES

MODEL# DIMENSIONS FREIGHT CLASS WT/LBS. CUBIC FT. LIST PRICE HP ADD

D x W x H

FTWEC23584023	58 x 40 x 1	60	115	2.6	\$1114	\$281
FTWEC23644023	64 x 40 x 1	60	127	2.8	\$1238	\$311
FTWEC23704023	70 x 40 x 1	60	138	3.1	\$1353	\$343
FTWEC23764023	76 x 40 x 1	60	150	3.3	\$1445	\$359
FTWEC23824023	82 x 40 x 1	60	162	3.6	\$1533	\$384
FTWEC23584623	58 x 46 x 1	60	115	2.55	\$1164	\$292
FTWEC23644623	64 x 46 x 1	60	127	2.81	\$1294	\$326
FTWEC23704623	70 x 46 x 1	60	138	3.07	\$1415	\$358
FTWEC23764623	76 x 46 x 1	60	150	3.34	\$1510	\$378
FTWEC23824623	82 x 46 x 1	60	162	3.6	\$1602	\$403
FTWEC23585223	58 x 52 x 1	60	130	2.88	\$1198	\$304
FTWEC23645223	64 x 52 x 1	60	143	3.18	\$1333	\$337
FTWEC23705223	70 x 52 x 1	60	156	3.48	\$1457	\$368
FTWEC23765223	76 x 52 x 1	60	170	3.77	\$1555	\$389
FTWEC23825223	82 x 52 x 1	60	183	4.07	\$1648	\$415
FTWEC23645823	64 x 58 x 1	60	160	3.54	\$1372	\$345
FTWEC23705823	70 x 58 x 1	60	174	3.88	\$1501	\$379
FTWEC23765823	76 x 58 x 1	60	189	4.21	\$1602	\$402
FTWEC23825823	82 x 58 x 1	60	204	4.54	\$1698	\$431

FTWEC29584029	58 x 40 x 1	60	115	2.2	\$1159	\$291
FTWEC29644029	64 x 40 x 1	60	127	2.4	\$1290	\$322
FTWEC29704029	70 x 40 x 1	60	138	2.7	\$1407	\$356
FTWEC29764029	76 x 40 x 1	60	150	2.9	\$1502	\$373
FTWEC29824029	82 x 40 x 1	60	162	3.1	\$1593	\$401
FTWEC29584629	58 x 46 x 1	60	115	2.55	\$1212	\$305
FTWEC29644629	64 x 46 x 1	60	127	2.81	\$1346	\$338
FTWEC29704629	70 x 46 x 1	60	138	3.07	\$1471	\$373
FTWEC29764629	76 x 46 x 1	60	150	3.34	\$1570	\$391
FTWEC29824629	82 x 46 x 1	60	152	3.6	\$1665	\$418
FTWEC29585229	58 x 52 x 1	60	130	2.88	\$1248	\$316
FTWEC29645229	64 x 52 x 1	60	143	3.18	\$1385	\$350
FTWEC29705229	70 x 52 x 1	60	156	3.48	\$1516	\$382
FTWEC29765229	76 x 52 x 1	60	170	3.77	\$1616	\$403
FTWEC29825229	82 x 52 x 1	60	183	4.07	\$1716	\$432
FTWEC29645829	64 x 58 x 1	60	160	3.54	\$1427	\$360
FTWEC29705829	70 x 58 x 1	60	174	3.88	\$1562	\$393
FTWEC29765829	76 x 58 x 1	60	189	4.21	\$1665	\$417
FTWEC29825829	82 x 58 x 1	60	204	4.54	\$1766	\$444

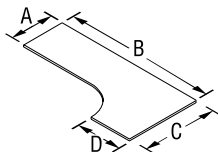

A	B	C	D
DEPTH	WIDTH	LENGTH	DEPTH

Ext. 90° Corner Worksurface, Left

For tables that connect with 23" deep (**A** and **D**) worksurfaces, use with FT539F(S/L)24CL or FT539F(S/L)24CL bases. For tables that connect with 29" deep (**A** and **D**) worksurfaces, use with FT539F(S/L)30CL or FT639F(S/L)30CL bases. Must use with FTWRExxx return surfaces only.

Required specifications

Top finish
Edge finish

Optional specifications

HP laminate
Grommet

MODEL# DIMENSIONS FREIGHT CLASS WT/LBS. CUBIC FT. LIST PRICE HP ADD

D x W x H

FTWEC23405823	58 x 40 x 1	60	115	2.6	\$1114	\$281
FTWEC23406423	64 x 40 x 1	60	127	2.8	\$1238	\$311
FTWEC23407023	70 x 40 x 1	60	138	3.1	\$1353	\$343
FTWEC23407623	76 x 40 x 1	60	150	3.3	\$1445	\$359
FTWEC23408223	82 x 40 x 1	60	162	3.6	\$1533	\$384
FTWEC23465823	58 x 46 x 1	60	115	2.55	\$1164	\$292
FTWEC23466423	64 x 46 x 1	60	127	2.81	\$1294	\$326
FTWEC23467023	70 x 46 x 1	60	138	3.07	\$1415	\$358
FTWEC23467623	76 x 46 x 1	60	150	3.34	\$1510	\$378
FTWEC23468223	82 x 46 x 1	60	162	3.6	\$1602	\$403
FTWEC23525823	58 x 52 x 1	60	130	2.88	\$1198	\$304
FTWEC23526423	64 x 52 x 1	60	143	3.18	\$1333	\$337
FTWEC23527023	70 x 52 x 1	60	156	3.48	\$1457	\$368
FTWEC23527623	76 x 52 x 1	60	170	3.77	\$1555	\$389
FTWEC23528223	82 x 52 x 1	60	183	4.07	\$1648	\$415
FTWEC23586423	64 x 58 x 1	60	160	3.54	\$1372	\$345
FTWEC23587023	70 x 58 x 1	60	174	3.88	\$1501	\$379
FTWEC23587623	76 x 58 x 1	60	189	4.21	\$1602	\$402
FTWEC23588223	82 x 58 x 1	60	204	4.54	\$1698	\$431

FTWEC29405829	58 x 40 x 1	60	115	2.2	\$1159	\$291
FTWEC29406429	64 x 40 x 1	60	127	2.4	\$1290	\$322
FTWEC29407029	70 x 40 x 1	60	138	2.7	\$1407	\$356
FTWEC29407629	76 x 40 x 1	60	127	2.4	\$1502	\$373
FTWEC29408229	82 x 40 x 1	60	162	3.1	\$1593	\$401
FTWEC29465829	58 x 46 x 1	60	115	2.55	\$1212	\$305
FTWEC29466429	64 x 46 x 1	60	127	2.81	\$1346	\$338
FTWEC29467029	70 x 46 x 1	60	138	3.07	\$1471	\$373
FTWEC29467629	76 x 46 x 1	60	150	3.34	\$1570	\$391
FTWEC29468229	82 x 46 x 1	60	162	3.6	\$1665	\$418
FTWEC29525829	58 x 52 x 1	60	130	2.88	\$1248	\$316
FTWEC29526429	64 x 52 x 1	60	143	3.18	\$1385	\$350
FTWEC29527029	70 x 52 x 1	60	156	3.48	\$1516	\$382
FTWEC29527629	76 x 52 x 1	60	170	3.77	\$1616	\$403
FTWEC29528229	82 x 52 x 1	60	183	4.07	\$1716	\$432
FTWEC29586429	64 x 58 x 1	60	160	3.54	\$1427	\$360
FTWEC29587029	70 x 58 x 1	60	174	3.88	\$1562	\$393
FTWEC29587629	76 x 58 x 1	60	189	4.21	\$1665	\$417
FTWEC29588229	82 x 58 x 1	60	204	4.54	\$1766	\$444

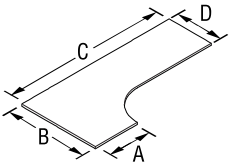

Ext. 90° Corner Worksurface, Right

For tables that connect with 23" deep (A and D) worksurfaces, use with FT539F(S/L)24CL or FT539F(S/L)24CL bases. For tables that connect with 29" deep (A and D) worksurfaces, use with FT539F(S/L)30CL or FT639F(S/L)30CL bases. Must use with FTWRExxxx return surfaces only.

FTWRE2324	23 x 24 x 1	70	16	0.96	\$211	\$68
FTWRE2330	23 x 30 x 1	70	20	1.2	\$229	\$68
FTWRE2336	23 x 36 x 1	70	25	1.44	\$255	\$81
FTWRE2924	29 x 24 x 1	70	21	1.21	\$250	\$74
FTWRE2930	29 x 30 x 1	70	26	1.51	\$266	\$84
FTWRE2936	29 x 36 x 1	70	31	1.81	\$308	\$97

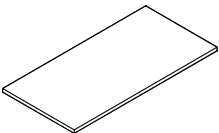

Rectangular Extension**
Return Worksurface

Worksurfaces to be used only with Extended 90° Corner Worksurfaces.

- FTWRE23 to be used with FTWEC23xxxx23
- FTWRE29 to be used with FTWEC29xxxx29

Required specifications

Top finish
Edge finish

Optional specifications

HP laminate
Grommet

BASES

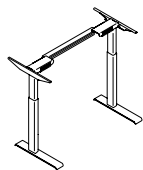

Standard Range Base*

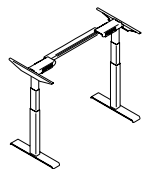

Extended Range Base*

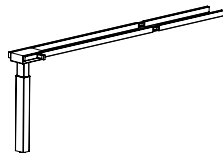

Standard Range Return Kit

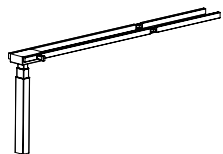

Extended Range Return Kit

MODEL# DIMENSIONS FREIGHT CLASS WT/LBS. CUBIC FT. LIST PRICE

D x W x H

FT52BF24	24 x 30-42 x 27.5-47	60	67	1.47	\$1255
FT52SF24	24 x 48-60 x 27.5-47	60	67	1.47	\$1382
FT52LF24	24 x 66-84 x 27.5-47	60	67	1.47	\$1388
FT52BF30	30-36 x 30-42 x 27.5-47	60	67	1.47	\$1265
FT52SF30	30-36 x 48-60 x 27.5-47	60	67	1.47	\$1392
FT52LF30	30-36 x 66-84 x 27.5-47	60	67	1.47	\$1398

Kit includes one beam, two cantilevers, two standard range columns, and two C or T styled feet. **BF** indicates base frame for 30" to 42" tables. **SF** indicates small frame for 48" to 60" tables. **LF** indicates large frame: 66" to 84" tables. For 23" deep worksurfaces, use 24" leg. For 29" and 35" deep worksurface, use 30" leg. For enhanced collision detection, an Anti Collision Desk Sensor is included with every base. Standard up/down controller with 2 memory positions, reminder settings + Bluetooth capability is standard - specify **(S)**. For a Display controller with height readout, 4 memory positions, reminder settings + Bluetooth capabilities, specify **(D)**, add **\$59** list. Specify paint finish: Black (**BLK**), Charcoal (**CHR**), Designer White (**DWT**), Fog (**FOG**), Nevada (**NEV**), Silver (**SIL**), Taupe (**TPE**), Tungsten (**TUN**). UL Listed: UL 962.

FT62BF24	24 x 30-42 x 22.5-48.5	60	67	1.47	\$1341
FT62SF24	24 x 48-60 x 22.5-48.5	60	67	1.47	\$1473
FT62LF24	24 x 66-84 x 22.5-48.5	60	67	1.47	\$1480
FT62BF30	30-36 x 30-42 x 22.5-48.5	60	67	1.47	\$1351
FT62SF30	30-36 x 48-60 x 22.5-48.5	60	67	1.47	\$1485
FT62LF30	30-36 x 66-84 x 22.5-48.5	60	67	1.47	\$1489

Kit includes one beam, two cantilevers, two extended range columns, and two C or T styled feet. **BF** indicates base frame for 30" to 42" tables. **SF** indicates small frame for 48" to 60" tables. **LF** indicates large frame: 66" to 84" tables. For 23" deep worksurfaces, use 24" leg. For 29" and 35" deep worksurface, use 30" leg. For enhanced collision detection, an Anti Collision Desk Sensor is included with every base. Standard up/down controller with 2 memory positions, reminder settings + Bluetooth capability is standard - specify **(S)**. For a Display controller with height readout, 4 memory positions, reminder settings + Bluetooth capabilities, specify **(D)**, add **\$59** list. Specify paint finish: Black (**BLK**), Charcoal (**CHR**), Designer White (**DWT**), Fog (**FOG**), Nevada (**NEV**), Silver (**SIL**), Taupe (**TPE**), Tungsten (**TUN**). UL Listed: UL 962.

FT51SRNL	-- x 24-48 x 27.5-47	60	61	1.47	\$846
FT51LRNL	-- x 54-72 x 27.5-47	60	61	1.47	\$863

Kit includes one beam, one cantilever, one standard range columns, and one pad foot. See chart on 606 to determine whether SR or LR kit is required. For 23" deep worksurfaces, use 24" return. For 29" and 35" deep worksurface, use 30" return. Specify paint finish: Black (**BLK**), Charcoal (**CHR**), Designer White (**DWT**), Fog (**FOG**), Nevada (**NEV**), Silver (**SIL**), Taupe (**TPE**), Tungsten (**TUN**). UL Listed: UL 962.

- When using the return kit for a 23"d return and a 29"/35" deep desk, a new foot must be ordered separately. See FTFOOT24TL/CL (619) for specification information.

FT61SRNL	-- x 24-48 x 22.5-48.5	60	61	1.47	\$890
FT61LRNL	-- x 54-72 x 22.5-48.5	60	61	1.47	\$908

Kit includes one beam, one cantilever, one standard range columns, and one pad foot. See chart on 606 to determine whether SR or LR kit is required. For 23" deep worksurfaces, use 24" return. For 29" and 35" deep worksurface, use 30" return. Specify paint finish: Black (**BLK**), Charcoal (**CHR**), Designer White (**DWT**), Fog (**FOG**), Nevada (**NEV**), Silver (**SIL**), Taupe (**TPE**), Tungsten (**TUN**). UL Listed: UL 962.

- When using the return kit for a 23"d return and a 29"/35" deep desk, a new foot must be ordered separately. See FTFOOT24TL/CL (619) for specification information.

Required specifications

Base finish
Leg style*

Optional specifications

Digital handset

BASES

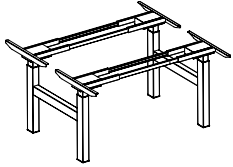

Back-to-Back Standard Range Base

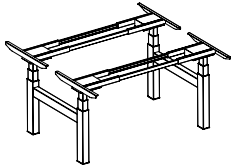

Back-to-Back Extended Range Base

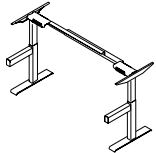

Standard Range Single Frame

MODEL#	DIMENSIONS D x W x H	FREIGHT CLASS	WT/LBS.	CUBIC FT.	LIST PRICE
FT54BSFNL	24 x -- x 27.5-47	60	123	2.94	\$3080
FT54BLFNL	24 x -- x 27.5-47	60	123	2.94	\$3089

Back-to-back height adjustable bases includes four height adjustable columns with pad feet, two sets of cross rails for surface support and two short beams to attach the columns back-to-back. Combine with surfaces & trough kits (sold separately) to create a complete workstation. For 50.5" depth, use two x 23" deep worksurfaces. For 62.5" depth, use two x 29" deep worksurfaces. **30" or larger depth worksurfaces cannot be used with Back to Back bases.** Duplex receptacles are not included, please specify separately. For enhanced collision detection, an Anti Collision Desk Sensor is included with every base. Standard up/down controller with 2 memory positions, reminder settings + Bluetooth capability is standard - specify **(S)**. For a Display controller with height readout, 4 memory positions, reminder settings + Bluetooth capabilities, specify **(D)**, add **\$117** list. Specify paint finish: Black **(BLK)**, Charcoal **(CHR)**, Designer White **(DWT)**, Fog **(FOG)**, Nevada **(NEV)**, Silver **(SIL)**, Taupe **(TPE)**, Tungsten **(TUN)**. UL Listed: UL 962.

FT64BSFNL	10 x -- x 22.5-48.5	60	123	2.94	\$3253
FT64BLFNL	10 x -- x 22.5-48.5	60	123	2.94	\$3264

Back-to-back height adjustable bases includes four height adjustable columns with pad feet, two sets of cross rails for surface support and two short beams to attach the columns back-to-back. Combine with surfaces & trough kits (sold separately) to create a complete workstation. For 50.5" depth, use two x 23" deep worksurfaces. For 62.5" depth, use two x 29" deep worksurfaces. **30" or larger depth worksurfaces cannot be used with Back to Back bases.** Duplex receptacles are not included, please specify separately. For enhanced collision detection, an Anti Collision Desk Sensor is included with every base. Standard up/down controller with 2 memory positions, reminder settings + Bluetooth capability is standard - specify **(S)**. For a Display controller with height readout, 4 memory positions, reminder settings + Bluetooth capabilities, specify **(D)**, add **\$117** list. Specify paint finish: Black **(BLK)**, Charcoal **(CHR)**, Designer White **(DWT)**, Fog **(FOG)**, Nevada **(NEV)**, Silver **(SIL)**, Taupe **(TPE)**, Tungsten **(TUN)**. UL Listed: UL 962.

FT52BSF24	24 x -- x 27.5-47	60	72	1.47	\$1741
FT52BLF24	24 x -- x 27.5-47	60	72	1.47	\$1751
FT52BSF30	30 x -- x 27.5-47	60	72	1.47	\$1806
FT52BLF30	30 x -- x 27.5-47	60	72	1.47	\$1816

Single sided height adjustable bases includes two height adjustable columns with "T" feet, one set of cross rails for surface support and two short beams to attach the columns to a trough kit. Combine with single surfaces & trough kits (sold separately) to create a complete workstation. Use 23" deep worksurfaces with FT52BSF24 + FT52BLF24. Use 29" deep worksurfaces with FT52BSF30 + FT52BLF30. **30" or larger depth worksurfaces cannot be used with benching bases.** Duplex receptacles are not included, please specify separately. For enhanced collision detection, an Anti Collision Desk Sensor is included with every base. Standard up/down controller with 2 memory positions, reminder settings + Bluetooth capability is standard - specify **(S)**. For a Display controller with height readout, 4 memory positions, reminder settings + Bluetooth capabilities, specify **(D)**, add **\$117** list. Specify paint finish: Black **(BLK)**, Charcoal **(CHR)**, Designer White **(DWT)**, Fog **(FOG)**, Nevada **(NEV)**, Silver **(SIL)**, Taupe **(TPE)**, Tungsten **(TUN)**. UL Listed: UL 962.

Required specifications

Base finish
Leg style*

Optional specifications

Digital handset

BASES

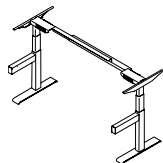

Extended Range Single Frame

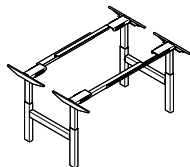

Standard Range Media Table Base

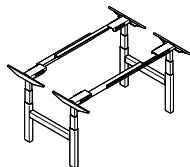

Extended Range Media Table Base

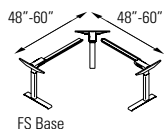

FS Base

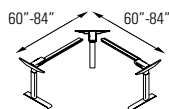

FL Base

Standard Range 90° Base, Equal Sides

MODEL# DIMENSIONS FREIGHT CLASS WT./LBS. CUBIC FT. LIST PRICE

D x W x H

FT62BSF24	24 x -- x 22.5-48.5	60	72	1.47	\$1887
FT62BLF24	24 x -- x 22.5-48.5	60	72	1.47	\$1892
FT62BSF30	30 x -- x 22.5-48.5	60	72	1.47	\$1897
FT62BLF30	30 x -- x 22.5-48.5	60	72	1.47	\$1903

Single sided height adjustable bases includes two height adjustable columns with "T" feet, one set of cross rails for surface support and two short beams to attach the columns to a trough kit. Combine with single surfaces & trough kits (sold separately) to create a complete workstation. Use 23" deep worksurfaces with FT62BSF24 + FT62BLF24. Use 29" deep worksurfaces with FT62BSF30 + FT62BLF30. **30" or larger depth worksurfaces cannot be used with benching bases.** Duplex receptacles are not included, please specify separately. For enhanced collision detection, an Anti Collision Desk Sensor is included with every base. Standard up/down controller with 2 memory positions, reminder settings + Bluetooth capability is standard - specify **(S)**. For a Display controller with height readout, 4 memory positions, reminder settings + Bluetooth capabilities, specify **(D)**, add **\$117** list. Specify paint finish: Black **(BLK)**, Charcoal **(CHR)**, Designer White **(DWT)**, Fog **(FOG)**, Nevada **(NEV)**, Silver **(SIL)**, Taupe **(TPE)**, Tungsten **(TUN)**. UL Listed: UL 962.

FTM5B2BSF	54-60 x 60 x 27.5-47	60	123	2.94	\$3080
FTM5B2BLF	54-60 x 60 x 27.5-47	60	123	2.94	\$3089

Kit includes two beams, four cantilevers, four standard range columns and two controllers. SF indicates small base for 60" sided tables. LF indicates large base for 66" to 84" sided tables. For enhanced collision detection, an Anti Collision Desk Sensor is included with every base. Standard up/down controller with 2 memory positions, reminder settings + Bluetooth capability is standard - specify **(S)**. For a Display controller with height readout, 4 memory positions, reminder settings + Bluetooth capabilities, specify **(D)**, add **\$117** list. Specify paint finish: Black **(BLK)**, Charcoal **(CHR)**, Designer White **(DWT)**, Fog **(FOG)**, Nevada **(NEV)**, Silver **(SIL)**, Taupe **(TPE)**, Tungsten **(TUN)**. UL Listed: UL 962.

FTM6B2BSF	54-60 x 60 x 22.5-48.5	60	123	2.94	\$3253
FTM6B2BLF	54-60 x 60 x 22.5-48.5	60	123	2.94	\$3264

Kit includes two beams, four cantilevers, four extended range columns and two controllers. SF indicates small base for 60" sided tables. LF indicates large base for 66" to 84" sided tables. For enhanced collision detection, an Anti Collision Desk Sensor is included with every base. Standard up/down controller with 2 memory positions, reminder settings + Bluetooth capability is standard - specify **(S)**. For a Display controller with height readout, 4 memory positions, reminder settings + Bluetooth capabilities, specify **(D)**, add **\$117** list. Specify paint finish: Black **(BLK)**, Charcoal **(CHR)**, Designer White **(DWT)**, Fog **(FOG)**, Nevada **(NEV)**, Silver **(SIL)**, Taupe **(TPE)**, Tungsten **(TUN)**. UL Listed: UL 962.

FT539FS24CL	54-60 x 42-60 x 27.5-47	60	101	1.47	\$2011
FT539FS30CL	54-60 x 42-60 x 27.5-47	60	101	1.47	\$2023
FT539FL24CL	66-84 x 66-84 x 27.5-47	60	101	1.47	\$2047
FT539FL30CL	66-84 x 66-84 x 27.5-47	60	101	1.47	\$2030

Kit includes two equal length beams, three cantilevers, one standard range corner column, two standard range columns, and two C styled feet. **FS** indicates small base for 54" to 60" sided tables. **FL** indicates large base: 66" to 84" sided tables. For 23" deep worksurfaces, use 24" CL leg. For 29" and 35" deep worksurface, use 30" CL leg. For enhanced collision detection, an Anti Collision Desk Sensor is included with every base.

Standard up/down controller with 2 memory positions, reminder settings + Bluetooth capability is standard - specify **(S)**. For a Display controller with height readout, 4 memory positions, reminder settings + Bluetooth capabilities, specify **(D)**, add **\$59** list. Specify paint finish: Black **(BLK)**, Charcoal **(CHR)**, Designer White **(DWT)**, Fog **(FOG)**, Nevada **(NEV)**, Silver **(SIL)**, Taupe **(TPE)**, Tungsten **(TUN)**. UL Listed: UL 962.

- When using a 23" d return with the FT539FS30CL/LF30CL a 24" foot must be ordered separately. See FTFOOT24TL/CL (619) for specification information.

Required specifications

Base finish

Optional specifications

Digital handset

BASES

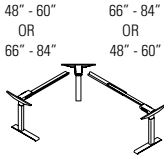

Standard Range 90° Base, Unequal Sides

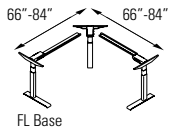
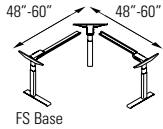

Extended Range 90° Base, Equal Sides*

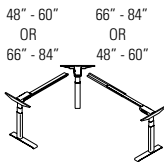

Extended Range 90° Base, Unequal Sides*

MODEL#	DIMENSIONS D x W x H	FREIGHT CLASS	WT/LBS.	CUBIC FT.	LIST PRICE
FT539FSL24CL	66-84 x 42-60 x 27.5-47	60	101	1.47	\$2030
FT539FSL30CL	66-84 x 42-60 x 27.5-47	60	101	1.47	\$2040

Kit includes two beams (one small, one large), three cantilevers, one standard range corner column, two standard range columns, and two C styled feet. For 23" deep worksurfaces, use 24" CL leg. For 29" and 35" deep worksurface, use 30" CL leg. For enhanced collision detection, an Anti Collision Desk Sensor is included with every base.

Standard up/down controller with 2 memory positions, reminder settings + Bluetooth capability is standard - specify **(S)**. For a Display controller with height readout, 4 memory positions, reminder settings + Bluetooth capabilities, specify **(D)**, add **\$59** list. Specify paint finish: Black **(BLK)**, Charcoal **(CHR)**, Designer White **(DWT)**, Fog **(FOG)**, Nevada **(NEV)**, Silver **(SIL)**, Taupe **(TPE)**, Tungsten **(TUN)**. UL Listed: UL 962.

- When using a 23"d return with the FT539FSL30CL a 24" foot must be ordered separately. See FTFOOT24TL/CL (619) for specification information.

FT639FS24CL	48-60 x 42-60 x 22.5-48.5	60	101	1.47	\$2148
FT639FS30CL	48-60 x 42-60 x 22.5-48.5	60	101	1.47	\$2159
FT639FL24CL	66-84 x 66-84 x 22.5-48.5	60	101	1.47	\$2184
FT639FL30CL	66-84 x 66-84 x 22.5-48.5	60	101	1.47	\$2195

Kit includes two equal length beams, three cantilevers, one extended range corner column, two extended range columns, and two C styled feet. **FS** indicates small base for 54" to 60" sided tables. **FL** indicates large base: 66" to 84" sided tables. For 23" deep worksurfaces, use 24" CL leg. For 29" and 35" deep worksurface, use 30" CL leg. For enhanced collision detection, an Anti Collision Desk Sensor is included with every base.

Standard up/down controller with 2 memory positions, reminder settings + Bluetooth capability is standard - specify **(S)**. For a Display controller with height readout, 4 memory positions, reminder settings + Bluetooth capabilities, specify **(D)**, add **\$59** list. Specify paint finish: Black **(BLK)**, Charcoal **(CHR)**, Designer White **(DWT)**, Fog **(FOG)**, Nevada **(NEV)**, Silver **(SIL)**, Taupe **(TPE)**, Tungsten **(TUN)**. UL Listed: UL 962.

- When using a 23"d return with the FT639FS30CL/LF30CL a 24" foot must be ordered separately. See FTFOOT24TL/CL (619) for specification information.

FT639FSL24CL	48-84 x 48-60 x 22.5-48.5	60	101	1.47	\$2166
FT639FSL30CL	48-84 x 48-60 x 22.5-48.5	60	101	1.47	\$2177

Kit includes two beams (one small, one large), three cantilevers, one extended range corner column, two extended range columns, and two C styled feet. For 23" deep worksurfaces, use 24" CL leg. For 29" and 35" deep worksurface, use 30" CL leg. For enhanced collision detection, an Anti Collision Desk Sensor is included with every base.

Standard up/down controller with 2 memory positions, reminder settings + Bluetooth capability is standard - specify **(S)**. For a Display controller with height readout, 4 memory positions, reminder settings + Bluetooth capabilities, specify **(D)**, add **\$59** list. Specify paint finish: Black **(BLK)**, Charcoal **(CHR)**, Designer White **(DWT)**, Fog **(FOG)**, Nevada **(NEV)**, Silver **(SIL)**, Taupe **(TPE)**, Tungsten **(TUN)**. UL Listed: UL 962.

- When using a 23"d return with the FT639FSL30CL a 24" foot must be ordered separately. See FTFOOT24TL/CL (619) for specification information.

Required specifications

Top finish
Base finish
Foot style
Foot configuration

Optional specifications

HP laminate
Digital handset
Grommet
Insulation type

Accessories

Keyboard tray
Power block

LAMINATE LEG SHROUDS

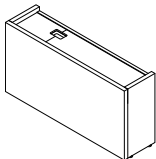

Laminate Leg Shroud, for C-Leg - Left**

MODEL# DIMENSIONS FREIGHT CLASS WT/LBS. CUBIC FT. LIST PRICE

D x W x H

FTB23L	9 x 23 x 18	65	47	2	\$571
FTB29L	9 x 29 x 18	70	55	3	\$591
FTB35L	9 x 35 x 18	70	67	3	\$616

Laminate housing to cover a FreeFit C-leg on the left side. Includes a felt liner at the top. Short side panel is removable to access interior. Specify laminate finish, PVC edge finish and felt finish.

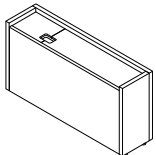

Laminate Leg Shroud, for C-Leg - Right**

FTB23R	9 x 23 x 18	65	47	2	\$571
FTB29R	9 x 29 x 18	70	55	3	\$591
FTB35R	9 x 35 x 18	70	67	3	\$616

Laminate housing to cover a FreeFit C-leg on the right side. Includes a felt liner at the top. Short side panel is removable to access interior. Specify laminate finish, PVC edge finish and felt finish.

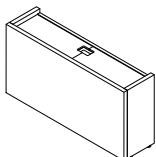

Laminate Leg Shroud for T-Leg**

FTB23	9 x 23 x 18	65	47	2	\$571
FTB29	9 x 29 x 18	70	55	3	\$591
FTB35	9 x 35 x 18	70	67	3	\$616

Laminate housing to cover a FreeFit T-leg. Includes a felt liner at the top. Short side panel is removable to access interior. Specify laminate finish, PVC edge finish and felt finish.

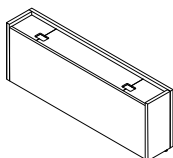

Laminate Leg Shroud for Media Bases

FTB54	9 x 54 x 18	70	110	5	\$1162
FTB64	9 x 64 x 18	70	134	6	\$1352

Laminate shroud for a FreeFit media table base. Includes a felt liner at the top. Side panel is removable to access interior. Specify laminate finish, PVC edge finish and felt finish.

Required specifications

- Laminate finish
- Edge finish
- Felt finish

POWER DELIVERY/CABLE MANAGEMENT

MODEL#

DIMENSIONS

FREIGHT CLASS

WT./LBS.

CUBIC FT.

LIST PRICE

D x W x H

4-2-2 Wiring Schematic

8-Wire Shared Neutral

"2 + 2" - 2 Utility Circuits, 2 Dedicated

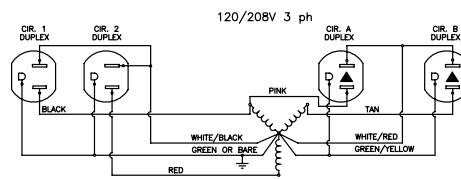
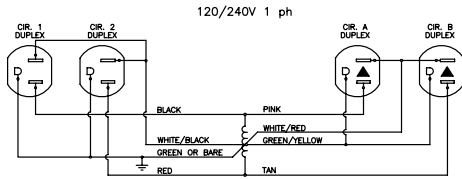

8 Wires	4 Circuits	Receptacles	Specifications
4 Lines (12 ga.)	2 Utility circuits	Duplex - Up to 12 duplex receptacles per circuit	System rated for connection to a grounded 120/240 V single phase, 20A, 60Hz or 120/208 V, 3 phase, 20A, 60Hz branch circuit for U.S. and 15A if product is marked with a C-UL Mark. Outlets rated 15A max.
2 Neutrals (10 ga.)	2 Dedicated Circuits	(Up to 48 per infeed)	
2 Grounds (12 ga.)			

TROUGH KITS

MODEL#

DIMENSIONS

FREIGHT CLASS

WT./LBS.

CUBIC FT.

LIST PRICE



Back-to-Back Trough Kit

FTB2B48KITNB	--	92.5	3.50	.30	\$2422
FTB2B54KITNB	--	92.5	3.50	.30	\$2496
FTB2B60KITNB	--	92.5	3.50	.30	\$2622
FTB2B66KITNB	--	92.5	3.50	.30	\$2672
FTB2B72KITNB	--	92.5	3.50	.30	\$2703

For back-to-back benching applications. Trough kits contain all items needed for a standard back-to-back workstation when combined with the back-to-back height adjustable base and worksurfaces (both sold separately). Kits include two cable chains and one back-to-back power trough with distribution housing included. Specify duplexes separately.

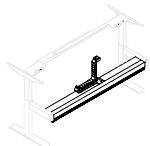

Single Sided Trough Kit

FTSGL48KITNB	--	92.5	3.50	.30	\$1582
FTSGL54KITNB	--	92.5	3.50	.30	\$1658
FTSGL60KITNB	--	92.5	3.50	.30	\$1752
FTSGL66KITNB	--	92.5	3.50	.30	\$1801
FTSGL72KITNB	--	92.5	3.50	.30	\$1852

For single-sided benching applications. Trough kits contain all items needed for a single sided workstation when combined with the single-sided height adjustable base and worksurfaces (both sold separately). Kits include two cable chains and one back-to-back power trough with distribution housing included. Specify duplexes separately.

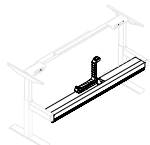

End of Run Trough Kit

FTSGL51T24KITNB	--	92.5	3.50	.30	\$1658
-----------------	----	------	------	-----	---------------

For perpendicular end of run benching applications. Trough kits contain all items needed for a standard back-to-back workstation when combined with the back-to-back height adjustable base and worksurfaces (both sold separately). Kits include two cable chains and one back-to-back power trough with distribution housing included. Specify duplexes separately.

Required specifications

Base finish

ACCESS DOORS

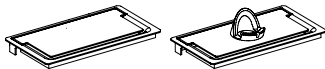

GAADG

GAADGDH

Access Door Module

MODEL# DIMENSIONS FREIGHT CLASS WT/LBS. CUBIC FT. LIST PRICE

D x W x H

GAADG	5.54 x 10.09 x 1.08	--	2	0.04	\$90
GAADGDH	5.54 x 10.09 x 1.08	--	2	0.04	\$97

Soft close door is set back from edge to allow for cable pass thru when closed. Available in all standard base finishes. GAADGDH includes device holder for most mobile phones or tablets. Holder is only available in White. FreeFit can only accommodate one grommet per worksurface.

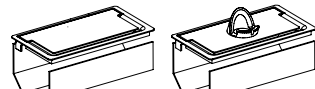

GAADCT

GAADCTDH

Access Door Module w/Cable Tray

GAADCT	5.54 x 10.09 x 5.07	--	4	0.19	\$145
GAADCTDH	5.54 x 10.09 x 5.07	--	4	0.19	\$153

Soft close door is set back from edge to allow for cable pass thru when closed. Cable tray comes standard with one telecom knockout and platform to mount a power bar. Sides are open for easy access. Available in all standard base finishes. GAADCTDH includes device holder for most mobile phones or tablets. Holder is only available in White. FreeFit can only accommodate one grommet per worksurface.

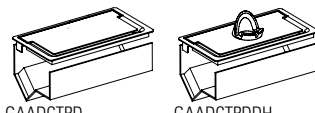

GAADCTPD

GAADCTPDDH

Access Door Module w/Cable Tray and Power Bar

GAADCTPD	5.54 x 10.09 x 6.96	--	4	0.20	\$307
GAADCTPDDH	5.54 x 10.09 x 6.96	--	4	0.20	\$316

Soft close door is set back from edge to allow for cable pass thru when closed. Cable tray comes standard with one telecom knockout and platform to mount a powerbar. Power bar with 3 simplex and 2 USB, CSA Certified. Sides are open for easy access. Available in all standard base finishes. GAADCTPDDH includes device holder for most mobile phones or tablets. Holder is only available in White. FreeFit can only accommodate one grommet per worksurface.

ELECTRICAL COMPONENTS

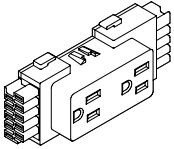

Duplex Receptacles

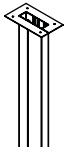

Ceiling Feed Post*



Ceiling Feed Harness

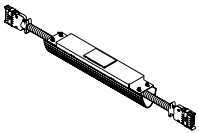

Table to Table Connector*

MODEL#	DIMENSIONS D x W x H	FREIGHT CLASS	WT/LBS.	CUBIC FT.	LIST PRICE
BRTE8D1	1.25 x 4.63 x 2	70	.10	.01	\$42
BRTE8D2	1.25 x 4.63 x 2	70	.10	.01	\$42
BRTE8DA	1.25 x 4.63 x 2	70	.10	.01	\$42
BRTE8DB	1.25 x 4.63 x 2	70	.10	.01	\$42
BRTE8DXW1	1.25 x 4.63 x 2	70	.10	.01	\$59
BRTE8DXW2	1.25 x 4.63 x 2	70	.10	.01	\$59
BRTE8DXWA	1.25 x 4.63 x 2	70	.10	.01	\$59
BRTE8DXWB	1.25 x 4.63 x 2	70	.10	.01	\$59

Snaps into Power Distribution Housing. Up to 13 duplex receptacles per circuit. XW identifies white color plastic, all others standard in black.

- BRTE8D1 / BRTE8DXW1 - Circuit #1 (utility circuit)
- BRTE8D2 / BRTE8DXW2 - Circuit #2 (utility circuit)
- BRTE8DA / BRTE8DXWA - Circuit A (dedicated circuit)
- BRTE8DB / BRTE8DXWB - Circuit B (dedicated circuit)

BWAECF	2.5 x 4.74 x 99.32	92.5	3.50	.30	\$429
--------	--------------------	------	------	-----	--------------

Ceiling pole brings ceiling feed conduit and data cables from the ceiling down to Power troughs height. Accommodates 10' ceiling heights. A two part construction allows power/data conduit lay-in. Includes mounting hardware and ceiling bezel. Ceiling feed harness sold separately.

BWAEECFH120	6 x 6 x 120	250	5	2	\$530
BWAEECFH144	6 x 6 x 144	250	6	3	\$588

Ceiling feed provides a single power entry from ceiling, through Ceiling pole into Power Trough, into Power Distribution Housing. An 8-wire (4-circuit) metal conduit harness with included metal junction box for hard wiring to the building power supply above ceiling tile. Must be hard wired to the building power supply by a licensed electrician. Ceiling feed post sold separately.

FTAETTC12	2.3 x 16 x 3	60	6	.12	\$409
FTAETTC18	2.3 x 22 x 3	60	8	.15	\$442
FTAETTC24	2.3 x 28 x 3	60	9	.18	\$466
FTAETTC30	2.3 x 34 x 3	60	10.60	.22	\$492
FTAETTC36	2.3 x 40 x 3	60	12	.24	\$516
FTAETTC42	2.3 x 46 x 3	60	11.60	.28	\$555
FTAETTC48	2.3 x 52 x 3	60	14	.30	\$591

Connects Freefit legs and trough provide to power data/communication pass thru. Connector kit consists of formed steel housing, mounting brackets, housing to housing harness (jumper) and one charcoal grey extruded data/communication cable manager. Knock out on top cover allows for ceiling post connection. Cover included. Specify paint finish.

- FTAETTC12 is used between two single sided or back to back stations that are 70"w (72" nominal) or less.
- FTAETTC18 is used between two single sided or back to back stations that are 76"w (78" nominal).
- FTAETTC24 is used between two single sided or back to back stations that are 82"w (84" nominal), or when separating two stations (up to 70"w) with a 12"w storage piece.
- FTAETTC30 is used to separate 2 workstations 70"w (72" nominal) or less with an 18"w storage unit in between the surfaces.
- FTAETTC36 is used between two single sided or back to back stations that are 70"w (72" nominal) or less with (2) 12"w storage units or (1) 24"w storage unit.
- FTAETTC42 is used between two single sided or back to back stations that are 70"w (72" nominal) or less with (2) 15"w storage units or (1) 30"w storage unit
- FTAETTC48 is used between two single sided or back to back stations that are 70"w (72" nominal) or less with (2) 18"w storage units or (1) 36"w storage unit.

Required specifications

Base finish*

ELECTRICAL COMPONENTS

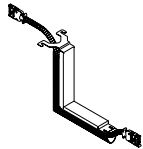
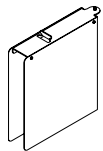

Table to Bridges Connector*



Leg Wire Manager*



Base Feed*

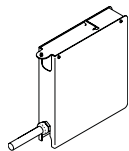

Base Feed* - New York Electrical

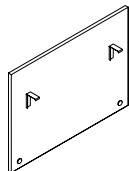

Back-to-Back End Gable*

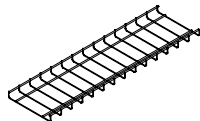

Under Worksurface Cable Basket

MODEL# DIMENSIONS FREIGHT CLASS WT./LBS. CUBIC FT. LIST PRICE

D x W x H

FTTABRC	14 x 2.3 x 15	100	2.40	.28	\$347
---------	---------------	-----	------	-----	--------------

Connects Freefit back-to-back benching to Bridges 29"H table with below worksurface power trough. Please specify paint finish on bracket. Wire manager is always Charcoal.

FTACCL	3.2 x 2 x 16	70	.06	.06	\$531
--------	--------------	----	-----	-----	--------------

Provides wire management from under FreeFit worksurface, down the leg and to the floor. Can only be used on FreeFit regular and media tables. Not for use on back-to-back tables. Kit includes wire manager housing, magnets, screws and cable chain. Magnetically fastens to the FreeFit leg and cable chain is screwed to worksurfaces. Please specify housing paint finish.

FTAEFF	8.75 x 2 x 10.8	92.5	3.50	.30	\$880
--------	-----------------	------	------	-----	--------------

Floor feed housing for FreeFit benching applications only. Includes liquitite whip , 72"L. Must be hard wired to the building power supply by a licensed electrician.

FTAEFF-NYC	14 x 2.55 x 13.41	92.5	3.50	.30	\$743
------------	-------------------	------	------	-----	--------------

Floor feed housing for FreeFit benching applications only. Includes liquitite whip , 72"L. Must be hard wired to the building power supply by a licensed electrician.

FTAEG18H	30.65 x .75 x 18	60	10	.24	\$479
FTAEG22H	30.65 x .75 x 22	60	13	.30	\$516

Optional back-to-back FreeFit Benching end gable is intended to be installed at the end of a FreeFit back-to-back table run. Made of 3/4" thermally fused laminate, it reduces the number of visible elements below the worksurface. Two heights are available. Specify FTAEG18H for extended range bases and FTAEG22H for standard range bases.

FFTCB36	8 x 8 x 1	70	.36	.03	\$121
FFTCB48	8 x 16 x 1	70	.73	.07	\$135
FFTCB54	8 x 22 x 1	70	1.01	.10	\$140
FFTCB60	8 x 28 x 1	70	1.20	.13	\$147
FFTCB66	8 x 34 x 1	70	1.56	.15	\$171
FFTCB72	8 x 40 x 1	70	1.80	.18	\$179
FFTCB78	8 x 46 x 1	92.5	2.16	.21	\$190
FFTCB84	8 x 52 x 1	100	2.39	.24	\$197

Shallow, 8" wide basket manages cable excess. It can be easily unclipped from steel brackets (included). Specify cable basket 30" shorter than worksurface. Steel wire construction, chrome finish baskets; black steel hanging brackets, fasteners.

Required specifications

Base finish*

ELECTRICAL COMPONENTS/ACCESSORIES



Cable Snake

MODEL#	DIMENSIONS D x W x H	FREIGHT CLASS	WT/LBS.	CUBIC FT.	LIST PRICE
BRACS	2 x 8 x 30	70	3	.19	\$153
BRACSH	2 x 8 x 49	70	3	.19	\$290

Flexible cable management trough. Two pathways within the snake, one for data/communication and one for routing power cables. Translucent White finish only.

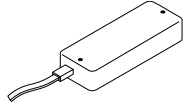

Battery and Charger

FTBATT	8 x 3 x 1.5	70	1.54	.02	\$466
--------	-------------	----	------	-----	--------------

Battery Pak with charging cable mounts to the underside of the worksurface. Features LED bars indicating capacity level and audio alarm when it needs to be charged. On a full charge, the table can cycle from 35 to 45 stroke lengths depending upon the range of column selected and load on the table.

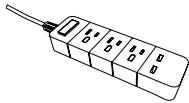

Power Bar with USB

BWAEGC00158GC	1 x 2.3 x 1.3	70	1	.50	\$146
---------------	---------------	----	---	-----	--------------

Power Bar with 3 receptacles + 2 USB and power switch. Standard with 6' cord. Rating 15A, 125V, AC 60Hz, 1875W. USB output 5V, 2.6A (max.) White case, white cord. Available to retrofit CTL/CTR or CTDHL/CTDHR.

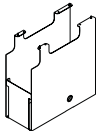

PC Holder

FTACPU	21 x 8 x 21	300	3.57	2.04	\$447
--------	-------------	-----	------	------	--------------

Accepts tower CPU's with a width range from 7.6" to 2.25" - and a maximum height of 18". Durable sheet metal construction. Please specify paint finish.

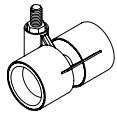

Dual Wheel Casters

BRTLCS	2.7 x 2.5 x 2.6	70	0.06	.01	\$35
--------	-----------------	----	------	-----	-------------

Locking caster. Interchangeable with glides on FreeFit bases. 40mm dia. caster with 8mm thread. White body, light grey tires.

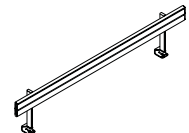

Single Table Accessory Rail*

BRLBST36	2.95 x 33 x 16	65	5.90	.26	\$417
BRLBST42	2.95 x 39 x 16	70	6.44	.30	\$439
BRLBST48	2.95 x 45 x 16	70	6.98	.35	\$455
BRLBST54	2.95 x 51 x 16	70	7.52	.39	\$472
BRLBST60	2.95 x 57 x 16	70	8.07	.43	\$482
BRLBST66	2.95 x 63 x 16	70	8.61	.48	\$499
BRLBST72	2.95 x 69 x 16	70	9.15	.52	\$516
BRLBST78	2.95 x 75 x 16	70	9.69	.56	\$532
BRLBST84	2.95 x 81 x 16	70	10.24	.61	\$548

Table mounted accessory rail. Compatible with standard Bins, Trays and Sorters. Includes end caps and mounting hardware. Please specify paint finish. To ensure proper connection and clearance on tables 46" wide and up, choose accessory rail 13" smaller than the actual table width (70" wide table gets 57" wide rail). Tables 40" wide and smaller use 33" wide accessory rail.

Required specifications

Base finish*

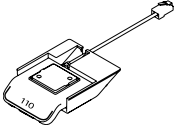
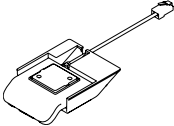
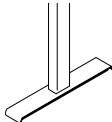
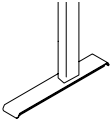
ACCESSORIES	MODEL#	DIMENSIONS	FREIGHT CLASS	WT/LBS.	CUBIC FT.	LIST PRICE
 <p>Anti-Collision Desk Sensor USB Plug</p>	D x W x H					
	FTACDS	8 x 3 x 1.5	60	1.54	.01	\$49
<p>Provides enhanced anti-collision detection. Plugs directly into leg column. Only one USB plug required for table assembly. This is a replacement part. One sensor ships standard with every table.</p>						
 <p>Reminder Controller - LED Display + Bluetooth</p>	FTDPG1C	3 x 4.3 x 1	70	0.4	.01	\$108
	<p>Up/down drive with 4 memory positions. LED light strip reminder, table height display. Bluetooth enabled, connects to Desk Control App. This is a replacement part. Every base comes standard with a controller.</p>					
 <p>Diode Reminder Controller - Memory + Bluetooth</p>	FTDPG1M	3 x 4.3 x 1	70	0.4	.01	\$44
	<p>Up/down drive with 2 memory positions. Bluetooth enabled, connects to Desk Control App. This is a replacement part. Every base comes standard with a controller.</p>					
 <p>Display Handset</p>	FTDHNBT	3 x 4.3 x 1	70	1	.01	\$110
	<p>Up/down drive with 3 memory positions and table height display. Must be specified separately from standard tables and replaced in the field. Use where Bluetooth capabilities are restricted.</p>					
 <p>T-Foot*</p>	FTFOOT24TL	23 x 3 x 1.16	60	4.4	.10	\$121
	FTFOOT30TL	29 x 3 x 1.16	60	4.85	.10	\$131
<p>Replacement single "T" foot or as an optional addition to a 3 leg table.</p>						
 <p>C-Foot*</p>	FTFOOT24CL	23 x 3 x 1.16	60	4.4	.10	\$133
	FTFOOT30CL	29 x 3 x 1.16	60	4.85	.10	\$144
<p>Replacement single "C" foot or as an optional addition to a 3 leg table.</p>						
 <p>Replacement Glides</p>	FTSETGLIDE	- x - x 1.5	70	.06	.10	\$9
	<p>Set of two with 1/2" adjustment.</p>					
 <p>TV Mount</p>	FTMT5145	4 x 51 x 40.5	250	16.82	4.8	\$915
	<p>TV mount for FreeFit media tables. Includes the TV/Display bracket and mounting hardware. Maximum TV size is 50".</p>					

Required specifications

Base finish*

PANTRY STORAGE - 42"H

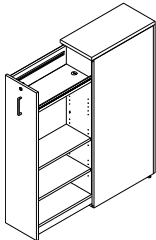

Left (NL) shown

Pantry Storage

MODEL#	DIMENSIONS D x W x H	FREIGHT CLASS	WT/LBS.	CUBIC FT.	LIST PRICE	HP ADD
FFPO1224H42NL	24 x 12 x 42	70	128	7	\$2318	\$29
FFPO1230H42NL	30 x 12 x 42	70	143	9	\$2435	\$35
FFPO1236H42NL	36 x 12 x 42	85	157	11	\$2551	\$40
FFPO1224H42NR	24 x 12 x 42	70	128	7	\$2318	\$29
FFPO1230H42NR	30 x 12 x 42	70	143	9	\$2435	\$35
FFPO1236H42NR	36 x 12 x 42	85	157	11	\$2551	\$40
FFPO1824H42NL	24 x 18 x 42	85	156	11	\$2668	\$40
FFPO1830H42NL	30 x 18 x 42	85	172	13	\$2796	\$51
FFPO1836H42NL	36 x 18 x 42	92.5	187	16	\$2923	\$62
FFPO1824H42NR	24 x 18 x 42	85	156	11	\$2668	\$40
FFPO1830H42NR	30 x 18 x 42	85	172	13	\$2796	\$51
FFPO1836H42NR	36 x 18 x 42	92.5	187	16	\$2923	\$62

The pull out cabinet serves as a multifunctional, customizable storage unit that both defines space and enhances privacy in an open plan environment. Internal organization consists of two fixed shelves on the top and bottom. The two middle shelves are adjustable. Two accessory rails (each 18.25" long) are standard and will accept metal accessories (sold separately - see previous page). Interior cabinet shelves and back are standard in Designer White. Cabinet shell, drawer and top can be specified in any standard laminate. FFPOxxxx will not allow binders.

- For Dry-erase marker board, specify **DE** and **add \$392**. If specified, the dry-erase marker laminate will be applied to the external surface of the pull-out drawer side wall.

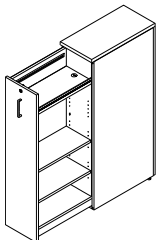

Left (NL) shown

Pantry Storage - w/USB

FFPO1224H42NLUSB	24 x 12 x 42	70	128	7	\$2892	\$29
FFPO1230H42NLUSB	30 x 12 x 42	70	143	9	\$3009	\$35
FFPO1236H42NLUSB	36 x 12 x 42	85	157	11	\$3126	\$40
FFPO1224H42NRUSB	24 x 12 x 42	70	128	7	\$2892	\$29
FFPO1230H42NRUSB	30 x 12 x 42	70	143	9	\$3009	\$35
FFPO1236H42NRUSB	36 x 12 x 42	85	157	11	\$3126	\$40
FFPO1824H42NLUSB	24 x 18 x 42	85	156	11	\$3242	\$40
FFPO1830H42NLUSB	30 x 18 x 42	85	172	13	\$3370	\$51
FFPO1836H42NLUSB	36 x 18 x 42	92.5	187	16	\$3497	\$62
FFPO1824H42NRUSB	24 x 18 x 42	85	156	11	\$3242	\$40
FFPO1830H42NRUSB	30 x 18 x 42	85	172	13	\$3370	\$51
FFPO1836H42NRUSB	36 x 18 x 42	92.5	187	16	\$3497	\$62

The pull out cabinet serves as a multifunctional, customizable storage unit that both defines space and enhances privacy in an open plan environment. Internal organization consists of two fixed shelves on the top and bottom. Top shelf comes with grey felt surface and grommet which allows for cable passage from the USB outlet (located below the top shelf). USB outlet includes one USB-A and one USB-C port. A 2-prong power cord exits the cabinet through the floor at the back. The two middle shelves are adjustable. Two accessory rails (each 18.25" long) are standard and will accept metal accessories (sold separately - see previous page). Interior cabinet shelves and back are standard in Designer White. Cabinet shell, drawer and top can be specified in any standard laminate. FFPOxxxx will not allow binders.

- For Dry-erase marker board, specify **DE** and **add \$392**. If specified, the dry-erase marker laminate will be applied to the external surface of the pull-out drawer side wall.

Required specifications

Laminate finish

Optional specifications

HP laminate
Dry-erase board

PANTRY STORAGE - 49.5"H

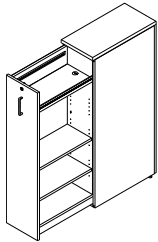

Left (NL) shown

Pantry Storage

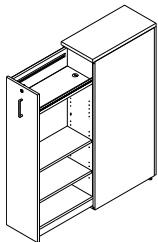

Left (NL) shown

Pantry Storage - w/USB

MODEL#	DIMENSIONS	FREIGHT CLASS	WT/LBS.	CUBIC FT.	LIST PRICE	HP ADD
D x W x H						
FFPO1224NL	24 x 12 x 49.5	70	133	8	\$2472	\$77
FFPO1230NL	30 x 12 x 49.5	85	148	10	\$2591	\$96
FFPO1236NL	36 x 12 x 49.5	92.5	162	15	\$2708	\$109
FFPO1224NR	24 x 12 x 49.5	70	133	8	\$2472	\$77
FFPO1230NR	30 x 12 x 49.5	85	148	10	\$2591	\$96
FFPO1236NR	36 x 12 x 49.5	92.5	162	15	\$2708	\$109
FFPO1824NL	24 x 18 x 49.5	85	161	12	\$2871	\$104
FFPO1830NL	30 x 18 x 49.5	92.5	177	15	\$2997	\$128
FFPO1836NL	36 x 18 x 49.5	92.5	192	18	\$3129	\$147
FFPO1824NR	24 x 18 x 49.5	85	161	12	\$2871	\$104
FFPO1830NR	30 x 18 x 49.5	92.5	177	15	\$2997	\$128
FFPO1836NR	36 x 18 x 49.5	92.5	192	18	\$3129	\$147

The pull out cabinet serves as a multifunctional, customizable storage unit that both defines space and enhances privacy in an open plan environment. Internal organization consists of two fixed shelves on the top and bottom. The two middle shelves are adjustable. Two accessory rails (each 18.25" long) are standard and will accept metal accessories (sold separately - see previous page). Interior cabinet shelves and back are standard in Designer White. Cabinet shell, drawer and top can be specified in any standard laminate. FFPOxxxx will not allow binders.

- For Dry-erase marker board, specify **DE** and **add \$392**. If specified, the dry-erase marker laminate will be applied to the external surface of the pull-out drawer side wall.

FFPO1224NLUSB	24 x 12 x 49.5	70	133	8	\$3046	\$77
FFPO1230NLUSB	30 x 12 x 49.5	85	148	10	\$3165	\$96
FFPO1236NLUSB	36 x 12 x 49.5	92.5	162	15	\$3284	\$109
FFPO1224NRUSB	24 x 12 x 49.5	70	133	8	\$3046	\$77
FFPO1230NRUSB	30 x 12 x 49.5	85	148	10	\$3165	\$96
FFPO1236NRUSB	36 x 12 x 49.5	92.5	162	15	\$3284	\$109
FFPO1824NLUSB	24 x 18 x 49.5	85	161	12	\$3442	\$104
FFPO1830NLUSB	30 x 18 x 49.5	92.5	177	15	\$3573	\$128
FFPO1836NLUSB	36 x 18 x 49.5	92.5	192	18	\$3705	\$147
FFPO1824NRUSB	24 x 18 x 49.5	85	161	12	\$3442	\$104
FFPO1830NRUSB	30 x 18 x 49.5	92.5	177	15	\$3573	\$128
FFPO1836NRUSB	36 x 18 x 49.5	92.5	192	18	\$3705	\$147

The pull out cabinet serves as a multifunctional, customizable storage unit that both defines space and enhances privacy in an open plan environment. Internal organization consists of two fixed shelves on the top and bottom. Top shelf comes with grey felt surface and grommet which allows for cable passage from the USB outlet (located below the top shelf). USB outlet includes one USB-A and one USB-C port. A 2-prong power cord exits the cabinet through the floor at the back. The two middle shelves are adjustable. Two accessory rails (each 18.25" long) are standard and will accept metal accessories (sold separately - see previous page). Interior cabinet shelves and back are standard in Designer White. Cabinet shell, drawer and top can be specified in any standard laminate. FFPOxxxx will not allow binders.

- For Dry-erase marker board, specify **DE** and **add \$392**. If specified, the dry-erase marker laminate will be applied to the external surface of the pull-out drawer side wall.

Required specifications

Laminate finish

Optional specifications

HP laminate
Dry-erase board

PANTRY STORAGE - 54"H

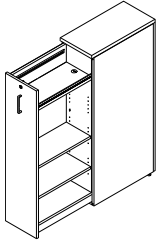

Left (NL) shown

Pantry Storage

MODEL#	DIMENSIONS D x W x H	FREIGHT CLASS	WT/LBS.	CUBIC FT.	LIST PRICE	HP ADD
FFPO1224H54NL	24 x 12 x 54	70	138	9	\$2551	\$29
FFPO1230H54NL	30 x 12 x 54	85	153	11	\$2673	\$29
FFPO1236H54NL	36 x 12 x 54	92.5	167	14	\$2796	\$40
FFPO1224H54NR	24 x 12 x 54	70	138	9	\$2551	\$29
FFPO1230H54NR	30 x 12 x 54	85	153	11	\$2673	\$29
FFPO1236H54NR	36 x 12 x 54	92.5	167	14	\$2796	\$40
FFPO1824H54NL	24 x 18 x 54	92.5	166	14	\$2956	\$40
FFPO1830H54NL	30 x 18 x 54	92.5	182	17	\$3090	\$51
FFPO1836H54NL	36 x 18 x 54	100	197	20	\$3223	\$57
FFPO1824H54NR	24 x 18 x 54	92.5	166	14	\$2956	\$40
FFPO1830H54NR	30 x 18 x 54	92.5	182	17	\$3090	\$51
FFPO1836H54NR	36 x 18 x 54	100	197	20	\$3223	\$57

The pull out cabinet serves as a multifunctional, customizable storage unit that both defines space and enhances privacy in an open plan environment. Internal organization consists of two fixed shelves on the top and bottom. The two middle shelves are adjustable. Two accessory rails (each 18.25" long) are standard and will accept metal accessories (sold separately - see previous page). Interior cabinet shelves and back are standard in Designer White. Cabinet shell, drawer and top can be specified in any standard laminate. FFPOxxxx will not allow binders.

- For Dry-erase marker board, specify **DE** and **add \$392**. If specified, the dry-erase marker laminate will be applied to the external surface of the pull-out drawer side wall.

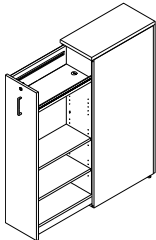

Left (NL) shown

Pantry Storage - w/USB

FFPO1224H54NLUSB	24 x 12 x 54	70	138	9	\$3126	\$29
FFPO1230H54NLUSB	30 x 12 x 54	85	153	11	\$3248	\$29
FFPO1236H54NLUSB	36 x 12 x 54	92.5	167	14	\$3370	\$40
FFPO1224H54NRUSB	24 x 12 x 54	70	138	9	\$3126	\$29
FFPO1230H54NRUSB	30 x 12 x 54	85	153	11	\$3248	\$29
FFPO1236H54NRUSB	36 x 12 x 54	92.5	167	14	\$3370	\$40
FFPO1824H54NLUSB	24 x 18 x 54	92.5	166	14	\$3530	\$40
FFPO1830H54NLUSB	30 x 18 x 54	92.5	182	17	\$3665	\$51
FFPO1836H54NLUSB	36 x 18 x 54	100	197	20	\$3798	\$57
FFPO1824H54NRUSB	24 x 18 x 54	92.5	166	14	\$3530	\$40
FFPO1830H54NRUSB	30 x 18 x 54	92.5	182	17	\$3665	\$51
FFPO1836H54NRUSB	36 x 18 x 54	100	197	20	\$3798	\$57

The pull out cabinet serves as a multifunctional, customizable storage unit that both defines space and enhances privacy in an open plan environment. Internal organization consists of two fixed shelves on the top and bottom. Top shelf comes with grey felt surface and grommet which allows for cable passage from the USB outlet (located below the top shelf). USB outlet includes one USB-A and one USB-C port. A 2-prong power cord exits the cabinet through the floor at the back. The two middle shelves are adjustable. Two accessory rails (each 18.25" long) are standard and will accept metal accessories (sold separately - see previous page). Interior cabinet shelves and back are standard in Designer White. Cabinet shell, drawer and top can be specified in any standard laminate. FFPOxxxx will not allow binders.

- For Dry-erase marker board, specify **DE** and **add \$392**. If specified, the dry-erase marker laminate will be applied to the external surface of the pull-out drawer side wall.

Required specifications

Laminate finish

Optional specifications

HP laminate
Dry-erase board

CUBE PEDESTALS

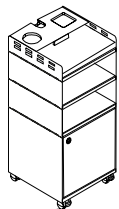

Left (BBFMKL) shown

Mobile Pedestal - BBF

MODEL# DIMENSIONS FREIGHT CLASS WT./LBS. CUBIC FT. LIST PRICE

D x W x H

Without lock:

FTSSP12BBFMKL	12 x 12 x 28	70	35	2.33	\$873
FTSSP12BBFMKR	12 x 12 x 28	70	35	2.33	\$873

With Lock:

FTSSP12BBFMKL	12 x 12 x 28	70	35	2.33	\$951
FTSSP12BBFMKR	12 x 12 x 28	70	35	2.33	\$951

Mobile pedestal with two open boxes in the middle, one file box at the bottom and a top accessory tray. File box interior dimensions: 11-7/8"H x 11-13/16"W x 10-7/16"D. Includes four locking casters, metal wire divider and optional lock (must specify "K" before the left or right option). Metal wire divider is chrome and sits 3-7/16" from either side and is interchangeable. File door lock, if specified, is located on the top right corner for the right pedestal and top left corner for the left pedestal. Bottom, middle and top shelves, front door and back are made of 3/4" LP laminate. Sides are made of powder coated metal. Accessory tray is PET felt. Shipped RTA (ready to assemble).

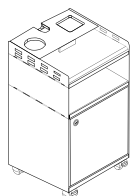

Left (BFMKL) shown

Mobile Pedestal - BF

Without lock:

FTSSP12BFMKL	12 x 12 x 22	70	28	1.83	\$685
FTSSP12BFMR	12 x 12 x 22	70	28	1.83	\$685

With Lock:

FTSSP12BFMKL	12 x 12 x 22	70	28	1.83	\$762
FTSSP12BFMKR	12 x 12 x 22	70	28	1.83	\$762

Mobile pedestal with one open box in the middle, one file box at the bottom and a top accessory tray. File box interior dimensions: 11-7/8"H x 11-13/16"W x 10-7/16"D. Includes four locking casters, metal wire divider and optional lock (must specify "K" before the left or right option). Metal wire divider is chrome and sits 3-7/16" from either side and is interchangeable. File door lock, if specified, is located on the top right corner for the right pedestal and top left corner for the left pedestal. Bottom, middle and top shelves, front door and back are made of 3/4" LP laminate. Sides are made of powder coated metal. Accessory tray is PET felt. Shipped RTA (ready to assemble).

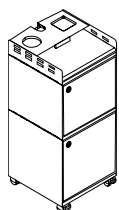

Left (SFMKL) shown

Mobile Pedestal - FF

Without lock:

FTSSP12SFMKL	12 x 12 x 28	70	35	2.33	\$796
FTSSP12SFMR	12 x 12 x 28	70	35	2.33	\$796

With Lock:

FTSSP12SFMKL	12 x 12 x 28	70	35	2.33	\$996
FTSSP12SFMKR	12 x 12 x 28	70	35	2.33	\$996

Mobile pedestal with one closed storage box at the top, one file box at the bottom and a top accessory tray. File box interior dimensions: 11-7/8"H x 11-13/16"W x 10-7/16"D. Closed storage box interior dimensions: 10-1/2"H x 11-13/16"W x 10-7/16"D. Includes four locking casters, metal wire divider and optional lock (must specify "K" before the left or right option). Metal wire divider is chrome and sits 3-7/16" from either side and is interchangeable. Door locks, if specified are located on the top right corner for the right pedestal and top left corner for the left pedestal of each box. Bottom, middle and top shelves, front door and back are made of 3/4" LP laminate. Sides are made of powder coated metal. Accessory tray is PET felt. Shipped RTA (ready to assemble).

Required specifications

- Metal finish
- Laminate finish

HANGING PEDESTALS

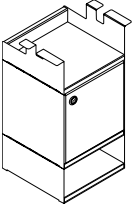

Left (BFBKL) shown

Hanging Pedestal - BFB

MODEL#	DIMENSIONS	FREIGHT CLASS	WT/LBS.	CUBIC FT.	LIST PRICE
--------	------------	---------------	---------	-----------	------------

D x W x H

Without lock:

FTSSPH12BFBKL	12 x 12 x 24	92.5	26	2.33	\$679
FTSSPH12BFBRR	12 x 12 x 24	92.5	26	2.33	\$679

With Lock:

FTSSPH12BFBKLL	12 x 12 x 24	92.5	26	2.33	\$755
FTSSPH12BFBKRR	12 x 12 x 24	92.5	26	2.33	\$755

Hanging pedestal with one file box in the middle and two open boxes, one at the top and one at the bottom. Attaches to the underside of a worksurface with supplied screws. File box interior dimensions: 11-7/8"H x 11-13/16"W x 10-7/16"D. Includes metal wire divider and optional lock (must specify "K" before the left or right option). Metal wire divider is chrome and sits 3-7/16" from either side and is interchangeable. File door lock, if specified, is located on the top right corner for the right pedestal and top left corner for the left pedestal. Bottom, middle and top shelves, front door and back are made of 3/4" LP laminate. Sides are made of powder coated metal. Shipped RTA (ready to assemble).

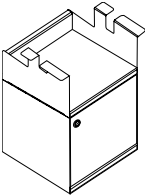

Left (BFBKL) shown

Hanging Pedestal - FB

Without lock:

FTSSPH12BFL	12 x 12 x 18.5	92.5	20	1.83	\$490
FTSSPH12BFR	12 x 12 x 18.5	92.5	20	1.83	\$490

With Lock:

FTSSPH12BFLKLL	12 x 12 x 18.5	92.5	20	1.83	\$568
FTSSPH12BFLKRR	12 x 12 x 18.5	92.5	20	1.83	\$568

Hanging pedestal with one file box at the bottom and one open box at the top. Attaches to the underside of a worksurface with supplied screws. File box interior dimensions: 11-7/8"H x 11-13/16"W x 10-7/16"D. Includes metal wire divider and optional lock (must specify "K" before the left or right option). Metal wire divider is chrome and sits 3-7/16" from either side and is interchangeable. File door lock, if specified, is located on the top right corner for the right pedestal and top left corner for the left pedestal. Bottom, middle and top shelves, front door and back are made of 3/4" LP laminate. Sides are made of powder coated metal. Shipped RTA (ready to assemble).

Required specifications

Metal finish
Laminate finish

HANGING PEDESTALS

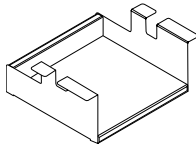

Hanging Pedestal Box*

MODEL#	DIMENSIONS D x W x H	FREIGHT CLASS	WT./LBS.	CUBIC FT.	LIST PRICE
FTSSPH12B	12 x 12 x 6	125	6	0.96	\$190

Hanging pedestal open box. Attaches to the underside of a worksurface with supplied screws to create an open box. Bottom, middle and top shelves, front door and back are made of 3/4" LP laminate. Sides are made of powder coated metal. Shipped RTA (ready to assemble).

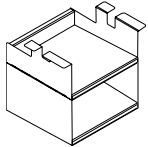

Hanging Pedestal - Two Open Boxes*

FTSSPH12BB	12 x 12 x 6	100	12	1.42	\$379
------------	-------------	-----	----	------	--------------

Hanging pedestal with two open boxes. Attaches to the underside of a worksurface with supplied screws. Bottom, middle and top shelves, front door and back are made of 3/4" LP laminate. Sides are made of powder coated metal. Shipped RTA (ready to assemble).

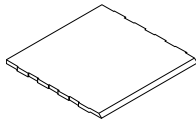

Felt Shelf Liner

FTFELT03BC	12 x 12 x 6	70	0.01	0.03	\$36
------------	-------------	----	------	------	-------------

Felt shelf liner can be added to any closed back shelf. Front edge is cut at 45°.

Required specifications

- Metal finish*
- Laminate finish*

BACK-TO-BACK TABLE - 21"H DIVIDERS

D x W x H

- FreeFit table mounted dividers for single table or single table row; recessed 6.5" at both ends (for example - 72" (70" actual) FreeFit table mounted divider measures 57").
- The center of all dividers is always mounted 2.250" from worksurface's rear edge. Please note the gap between the divider and the worksurface therefore varies, depending on the divider thickness (1.250" framed dividers, 0.750" frameless LP and 0.250" frameless glass).
- 48" (33" actual) - 66" (51" actual) dividers have 2 mounting brackets.
- 72" (57" actual) dividers have 3 mounting brackets.

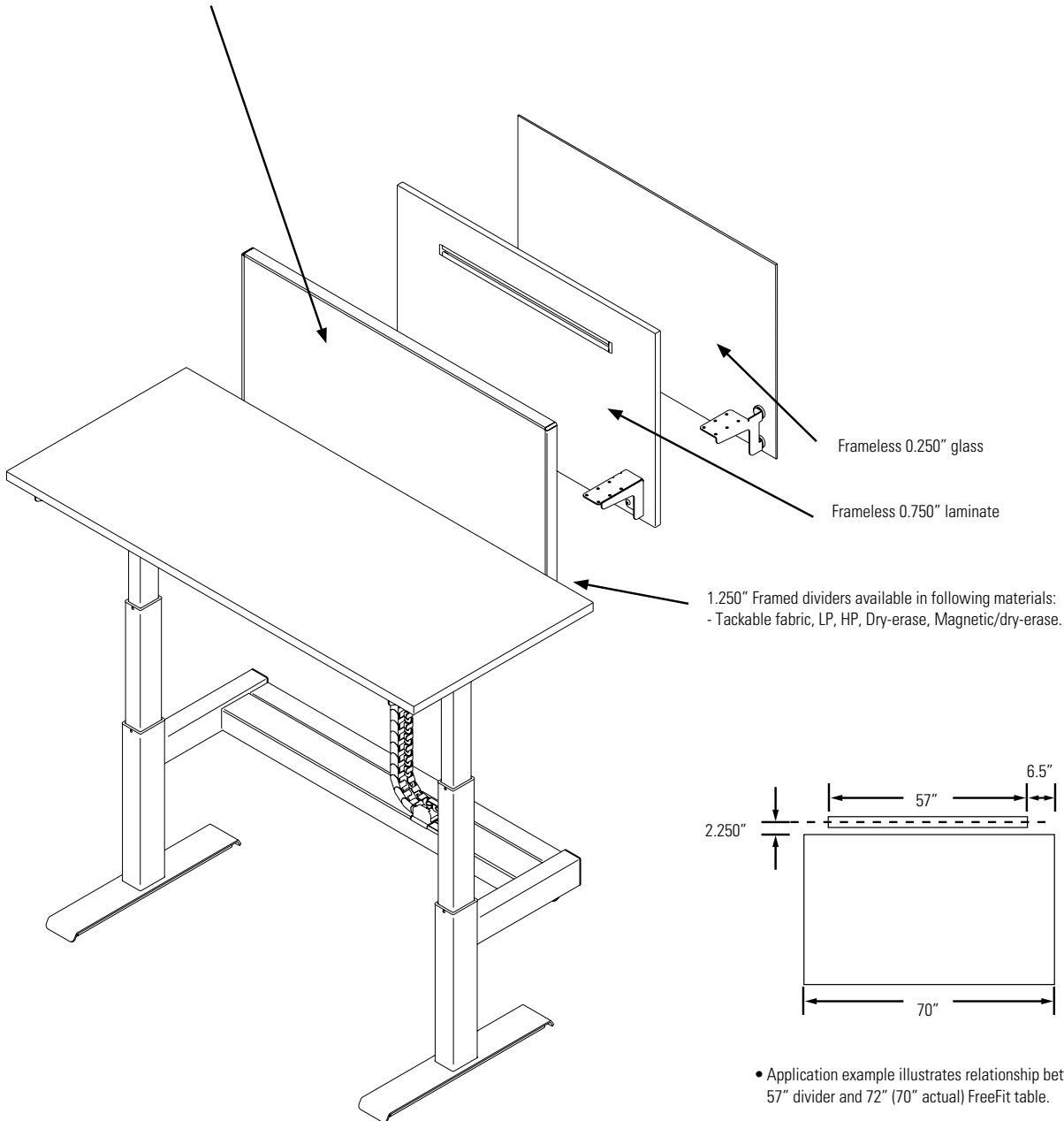

- Application example illustrates relationship between 57" divider and 72" (70" actual) FreeFit table.

- Example Order:
 BWATMFD72
 (actual dimension of 57") for
 BWA2D3072A8
 (actual dimension of 70").

BACK-TO-BACK TABLE - 37"H DIVIDERS

FreeFit Back-to-Back stationary dividers; stationary, shared, secured to table structure; recessed 6.5" at both ends (for example - 72" (70" actual) FreeFit table mounted divider measures 57").

The center of all dividers is always mounted 2.250" from worksurface's rear edge. Please note the gap between the divider and the worksurface therefore varies, depending on the divider thickness (1.250" Framed dividers, 0.750" frameless LP and 0.250" frameless glass).

48" (33" actual) divider for 48" (46" actual) table
 54" (39" actual) divider for 54" (52" actual) table
 60" (45" actual) divider for 60" (58" actual) table
 66" (51" actual) divider for 66" (64" actual) table
 72" (57" actual) divider for 72" (70" actual) table

Framed dividers (Tackable fabric, LP, HP, Dryerase, Magnetic/dry-erase)
 Frameless LP
 Frameless glass

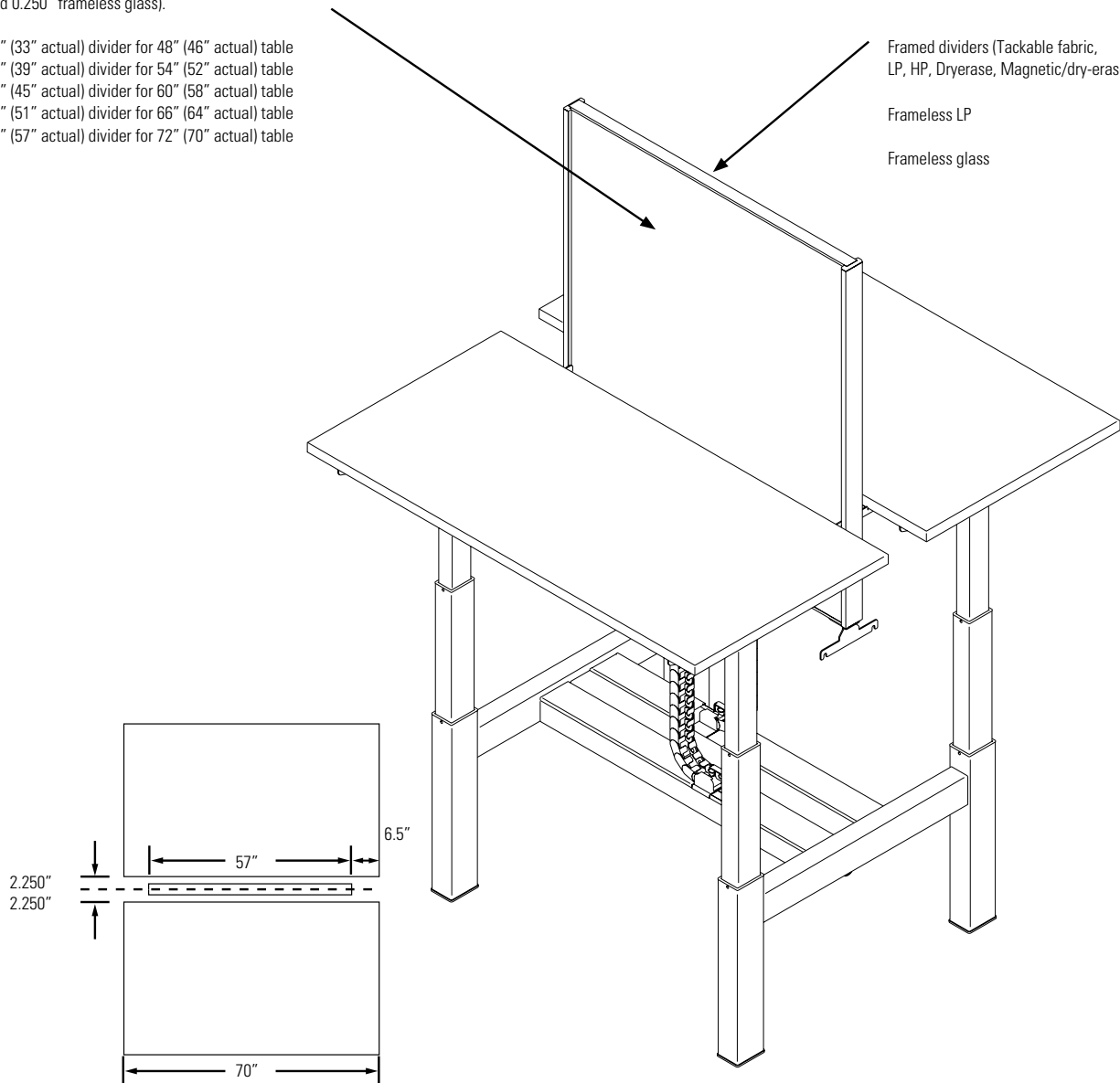

Application example illustrates relationship between 57" shared divider and 72" (70" actual) FreeFit Back-to-Back table.

- Example Order:
 BWASFD72
 (actual dimension of 57") for
 BWA2D6072A8
 (actual dimension of 70").

FELT DIVIDERS

- 9mm thick panels offered in 9 finishes
- Made from 100% PET (polyester) fiber with a high content (50%) of post-recycled material, free of added chemicals, binders and adhesives
- Lightweight panels are tackable, impact and tear resistant, bacteria resistant, moisture resistant, and installation friendly
- Variation in fiber mix and color are inherent to the character of the product

D x W x H

FELT COLORS

BLK	Black	MTS	Mist
BRI	Brick	PWT	Pewter
DEN	Denim	SHR	Shamrock
GPH	Graphite	WHT	White
HVT	Harvest		

BRACKET FINISH

BLK	Black	NEV	Nevada
CHR	Charcoal	SIL	Silver
DWT	Designer White	TPE	Taupe
FOG	Fog	TUN	Tungsten

FELT DIVIDERS

MODEL#

DIMENSIONS

FREIGHT CLASS

WT./LBS.

CUBIC FT.

LIST PRICE

BWAFMPSN36	4.17 x 21 x 13.94	70	1.84	0.71	\$187
BWAFMPSN42	4.17 x 27 x 13.94	250	2.32	0.91	\$204
BWAFMPSN48	4.17 x 33 x 13.94	250	2.44	1.11	\$284
BWAFMPSN54	4.17 x 39 x 13.94	250	2.86	1.31	\$319
BWAFMPSN60	4.17 x 45 x 13.94	250	3.27	1.51	\$360
BWAFMPSN66	4.17 x 51 x 13.94	250	3.68	1.72	\$508
BWAFMPSN72	4.17 x 57 x 13.94	250	4.09	1.92	\$541

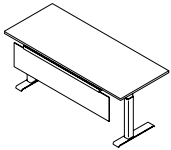

Modesty Felt Divider

9mm thick PET felt divider is tackable. Fastens to the underside of the worksurface. Installed divider measures 15" below top of the worksurface. Kit includes felt modesty, support extrusion and left and right brackets. Available in 9 PET felt colors. Please specify.

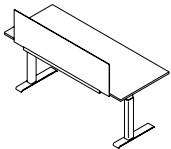

Parallel Felt Divider

BWAFPN36	5.86 x 21 x 18.24	300	2.21	1.3	\$199
BWAFPN42	5.86 x 27 x 18.24	300	2.77	1.67	\$224
BWAFPN48	5.86 x 33 x 18.24	300	2.82	2.04	\$304
BWAFPN54	5.86 x 39 x 18.24	300	3.29	2.41	\$340
BWAFPN60	5.86 x 45 x 18.24	300	3.75	2.78	\$387
BWAFPN66	5.86 x 51 x 18.24	300	4.22	3.15	\$543
BWAFPN72	5.86 x 57 x 18.24	300	4.69	3.53	\$579

Connects parallel on Freefit tables. 9mm thick PET felt divider is tackable. Installed divider measures 15.7" high from the top of the worksurface. Kit includes felt divider, support extrusion and left and right brackets. Available in 9 PET felt colors. Please specify.

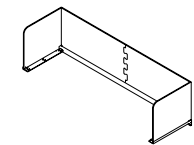

Single

BWAFWR2346	18.46 x 46.84 x 18.24	65	26.58	1.07	\$586
BWAFWR2352	18.46 x 52.84 x 18.24	65	28.4	1.21	\$620
BWAFWR2358	18.46 x 58.84 x 18.24	65	30.22	1.34	\$653
BWAFWR2364	18.46 x 64.84 x 18.24	60	32.02	0.74	\$863
BWAFWR2370	18.46 x 70.84 x 18.24	60	33.84	0.81	\$920
BWAFWR2946	24.46 x 46.84 x 18.24	65	30.74	1.07	\$663
BWAFWR2952	24.46 x 52.84 x 18.24	60	32.55	0.6	\$872
BWAFWR2958	24.46 x 58.84 x 18.24	60	34.37	0.67	\$930
BWAFWR2964	24.46 x 64.84 x 18.24	60	36.19	0.74	\$987
BWAFWR2970	24.46 x 70.84 x 18.24	60	38	0.81	\$1045

End of Run:

BWAFWR2351	18.46 x 51.34 x 18.24	65	27.94	1.05	\$591
BWAFWR2951	24.46 x 51.34 x 18.24	60	32.09	0.62	\$871
BWAFWR2363	18.46 x 63.34 x 18.24	70	31.57	1.5	\$860
BWAFWR2963	24.46 x 63.34 x 18.24	60	35.73	0.87	\$984

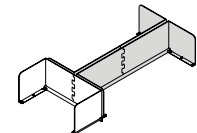

End of Run

Felt Wrap Around Divider*

Wraps around Freefit tables to provide privacy. 9mm thick PET felt divider is tackable. Fastens to the underside of the worksurface. Installed divider measures 15.7" from the top of the worksurface. Divider extends 1.5" past the back of the worksurface. Please choose standard base finish for the extrusion and brackets. PET is available in 9 felt colors. Please specify.

- Anodized Aluminum extrusion - Add **\$156** list upcharge
- **Note:** Cannot use ceiling feed option with this divider.

Required Specifications

Felt color
Bracket finish

Optional Specifications

Anodized extrusion

FELT DIVIDERS

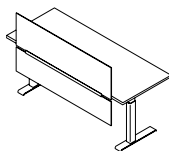

Felt Parallel Divider

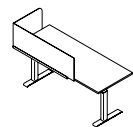

Corner Wrap Felt Divider

MODEL# DIMENSIONS FREIGHT CLASS WT/LBS. CUBIC FT. LIST PRICE

D x W x H

BWAFPDN36	5.86 x 21 x 30.68	300	2.79	2.18	\$294
BWAFPDN42	5.86 x 27 x 30.68	300	3.56	2.81	\$321
BWAFPDN48	5.86 x 33 x 30.68	150	3.82	3.43	\$456
BWAFPDN54	5.86 x 39 x 30.68	150	4.5	4.06	\$505
BWAFPDN60	5.86 x 45 x 30.68	150	5.17	4.68	\$589
BWAFPDN66	5.86 x 51 x 30.68	150	5.85	5.31	\$902
BWAFPDN72	5.86 x 57 x 30.68	150	6.53	5.93	\$957

Felt divider and modesty panel kit secures to the rear bottom of a regular FreeFit table and provides privacy above and below the worksurface. 9mm thick PET felt divider is tackable. Installed divider measures 15.7" from the top of the worksurface and 15" below the top of the worksurface. Kit includes two felt dividers, support extrusion and left and right brackets. Available in 9 PET felt colors. Please specify.

BW AFC2432L	18.52 x 32.46 x 18.24	150	3.82	6.35	\$414
BW AFC2432R	18.52 x 32.46 x 18.24	150	3.82	6.35	\$414
BW AFC2438L	18.52 x 38.46 x 18.24	250	5.46	7.52	\$472
BW AFC2438R	18.52 x 38.46 x 18.24	250	5.46	7.52	\$472
BW AFC2448L	18.52 x 47.46 x 18.24	250	6.16	9.28	\$508
BW AFC2448R	18.52 x 47.46 x 18.24	250	6.16	9.28	\$508

BW AFC3032L	24.52 x 32.46 x 18.24	250	5.72	8.40	\$467
BW AFC3032R	24.52 x 32.46 x 18.24	250	5.72	8.40	\$467
BW AFC3038L	24.52 x 38.46 x 18.24	250	6.19	9.95	\$501
BW AFC3038R	24.52 x 38.46 x 18.24	250	6.19	9.95	\$501
BW AFC3048L	24.52 x 47.46 x 18.24	250	6.89	12.28	\$538
BW AFC3048R	24.52 x 47.46 x 18.24	250	6.89	12.28	\$538

Felt Corner Wrap secures to the side and rear bottom of a FreeFit table, wraps around one side and provides limited privacy. 9mm thick PET felt divider is tackable. Installed divider measures 15.7" from the top of the worksurface. Kit includes felt dividers, support extrusion and large and small brackets. Available in 9 PET felt colors. Please specify.

Required Specifications

- Felt color
- Bracket finish

TABLE MOUNTED DIVIDERS

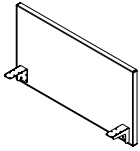

Table Mounted Framed Divider, Fabric*

MODEL#	DIMENSIONS D x W x H	FREIGHT CLASS	WT/LBS.	CUBIC FT.	LIST PRICE
BWATMFD48	1.25 x 33 x 21.5	85	16	1.23	\$431
BWATMFD54	1.25 x 39 x 21.5	85	18	1.46	\$532
BWATMFD60	1.25 x 45 x 21.5	85	20	1.68	\$581
BWATMFD66	1.25 x 51 x 21.5	85	22	1.90	\$652
BWATMFD72	1.25 x 57 x 21.5	85	26	2.13	\$712

Connects parallel on Freefit single and back-to-back tables. Fabric divider is tackable. Fastens to the underside of the worksurface. 1.625" gap between worksurface and divider allows for cable pass-through. Installed divider measures 15.7" from top of worksurface and 5.75" below the worksurface. 48" to 66" dividers include 2 support brackets. 72" divider includes 3 support brackets. Available in the following textiles:

- Global: **Anchorage, Lola, and Merge.**

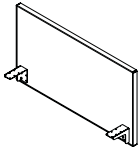

Table Mounted Framed Divider, Laminate**

MODEL#	DIMENSIONS D x W x H	FREIGHT CLASS	WT/LBS.	CUBIC FT.	LIST PRICE	HP ADD	DE ADD	DM ADD
BWATMLD48	1.25 x 33 x 21.5	85	35	1.23	\$283	\$165	\$340	\$519
BWATMLD54	1.25 x 39 x 21.5	85	39	1.46	\$319	\$213	\$424	\$655
BWATMLD60	1.25 x 45 x 21.5	85	44	1.68	\$379	\$225	\$446	\$697
BWATMLD66	1.25 x 51 x 21.5	85	48	1.90	\$436	\$308	\$932	\$1382
BWATMLD72	1.25 x 57 x 21.5	85	52	2.13	\$475	\$311	\$926	\$1373

Connects parallel on Freefit single and back-to-back tables. Divider infill can be specified in low pressure laminate (**LP**), high pressure laminate (**HP**), dry erase whiteboard (**DE**) or dry erase magnetic whiteboard (**DM**) user side only. Fastens to the underside of the worksurface. 1.625" gap between worksurface and divider allows for cable pass-through. Installed divider measures 15.7" from top of worksurface and 5.75" below the worksurface. 48" to 66" dividers include 2 support brackets. 72" divider includes 3 support brackets. When dry erase magnetic whiteboard (DM) is specified it is applied user side ONLY and dry erase whiteboard (DE) is applied on the opposite side.

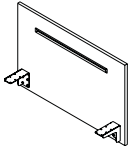

Table Mounted Laminate Divider**

BWATMLLD48	.75 x 33 x 21.5	125	16	1.23	\$339
BWATMLLD54	.75 x 39 x 21.5	125	18	1.46	\$359
BWATMLLD60	.75 x 45 x 21.5	125	20	1.68	\$380
BWATMLLD66	.75 x 51 x 21.5	125	22	1.90	\$561
BWATMLLD72	.75 x 57 x 21.5	125	26	2.13	\$580

Connects parallel on Freefit single and back-to-back tables. Laminate divider with integrated accessory rail, installed on one side only. Integrated anodized aluminum accessory rail, white cut out and rail trims; white power coat brackets. 3/4" LP PVC edged boards. Specify laminate and PVC edge. Fastens to the underside of the worksurface. 1.88" gap between worksurface and divider allows for cable pass-through. Installed divider measures 15.7" from top of worksurface and 5.75" below the worksurface. 48" to 66" dividers include 2 support brackets. 72" divider includes 3 support brackets.

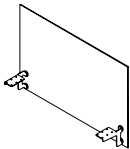

Table Mounted Glass Divider

BWATMGD48	.25 x 33 x 21.5	125	16	1.23	\$724
BWATMGD54	.25 x 39 x 21.5	125	19	1.46	\$779
BWATMGD60	.25 x 45 x 21.5	125	22	1.68	\$834
BWATMGD66	.25 x 51 x 21.5	125	24	1.90	\$884
BWATMGD72	.25 x 57 x 21.5	125	28	2.13	\$942

Frameless glass divider connects parallel on Freefit single and back-to-back tables. Tempered glass, acid etched on one side (similar to frosted), satin chrome disc fasteners and white powder coated steel support brackets. Fastens to the underside of the worksurface. 2.13" gap between worksurface and divider allows for cable pass-through. Installed divider measures 15.7" from top of worksurface and 4.75" below the worksurface. 48" to 66" dividers include 2 support brackets. 72" divider includes 3 support brackets. 1/2" radius on all four corners.

Required specifications

- Fabric*
- Laminate finish**
- Metal frame finish

STATIONARY DIVIDERS

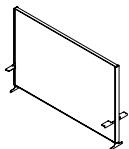

Stationary Framed Divider, Fabric*

MODEL#	DIMENSIONS D x W x H	FREIGHT CLASS	WT/LBS.	CUBIC FT.	LIST PRICE
BWASFD48	1.25 x 33 x 37.2	92.5	25	2.13	\$941
BWASFD54	1.25 x 39 x 37.2	92.5	28	2.52	\$959
BWASFD60	1.25 x 45 x 37.2	92.5	31	2.91	\$990
BWASFD66	1.25 x 51 x 37.2	92.5	34	3.29	\$1052
BWASFD72	1.25 x 57 x 37.2	92.5	37	3.68	\$1344

Provides a stationary framed divider between back-to-back height adjustable tables. Fabric divider is tackable. Divider is anchored to the base and captured between two aluminum upright tracks. The uprights have sliding brackets that connect the worksurfaces to the divider providing continuous support as it travels up and down. 1.625" gap between worksurface and divider allows for cable pass-through. Installed divider measures 54" from floor. Available in the following textiles:

- Global: **Anchorage, Lola, and Merge**

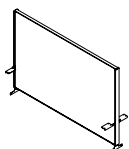

Stationary Framed Divider, Laminate**

MODEL#	DIMENSIONS D x W x H	FREIGHT CLASS	WT/LBS.	CUBIC FT.	LIST PRICE	HP ADD	DE ADD	DM ADD
BWASLD48	2 x 33 x 37.2	65	58	2.13	\$1194	\$405	\$849	\$2224
BWASLD54	2 x 39 x 37.2	65	66	2.52	\$1287	\$434	\$893	\$2338
BWASLD60	2 x 45 x 37.2	65	73	2.91	\$1308	\$435	\$893	\$2339
BWASLD66	2 x 51 x 37.2	65	81	3.29	\$1407	\$486	\$1951	\$4694
BWASLD72	2 x 57 x 37.2	65	88	3.68	\$1923	\$724	\$1875	\$5003

Provides a stationary framed divider between back-to-back height adjustable tables. Divider infill can be specified in low pressure laminate (**LP**), high pressure laminate (**HP**), dry erase whiteboard (**DE**) or dry erase magnetic whiteboard (**DM**) user side only. Divider is anchored to the base and captured between two aluminum upright tracks. The uprights have sliding brackets that connect the worksurfaces to the divider providing continuous support as it travels up and down. 1.625" gap between worksurface and divider allows for cable pass-through. Installed divider measures 54" from floor.

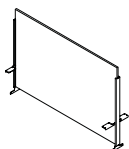

Stationary Laminate Divider**

BWASLLD48	2 x 33 x 37.2	85	28	2.13	\$685
BWASLLD54	2 x 39 x 37.2	85	33	2.52	\$706
BWASLLD60	2 x 45 x 37.2	85	37	2.91	\$725
BWASLLD66	2 x 51 x 37.2	85	41	3.29	\$1098
BWASLLD72	2 x 57 x 37.2	85	46	3.68	\$1120

Provides a stationary laminate divider between back-to-back height adjustable tables. Divider is anchored to the base and captured between two aluminum upright tracks. The uprights have sliding brackets that connect the worksurfaces to the divider providing continuous support as it travels up and down. 1.88" gap between worksurface and divider allows for cable pass-through. Installed divider measures 54" from floor.

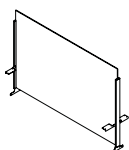

Stationary Glass Divider

BWASGD48	2 x 33 x 37.2	85	30	2.13	\$642
BWASGD54	2 x 39 x 37.2	85	34	2.52	\$730
BWASGD60	2 x 45 x 37.2	85	39	2.91	\$828
BWASGD66	2 x 51 x 37.2	85	43	3.29	\$918
BWASGD72	2 x 57 x 37.2	85	48	3.68	\$1006

Provides a stationary glass divider between back-to-back height adjustable tables. Tempered glass, acid etched on one side (similar to frosted), satin chrome disc fasteners and white powder coated steel support brackets. Divider is anchored to the base and captured between two aluminum upright tracks. The uprights have sliding brackets that connect the worksurfaces to the divider providing continuous support as it travels up and down. 2.13" gap between worksurface and divider allows for cable pass-through. 1/2" radius on top two corners.

Required specifications

- Fabric*
- Laminate finish**
- Metal frame finish

WELLNESS SCREENS- POLYCARBONATE

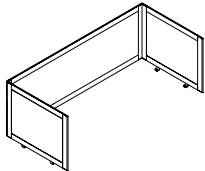

24" H Polycarbonate Divider Screen

MODEL#	DIMENSIONS D x W x H	FREIGHT CLASS	WT./LBS.	CUBIC FT.	LIST PRICE
FFTDP2436H24	31.75 x 34 x 24.6	125	26.55	3.94	\$1126
FFTDP2442H24	31.75 x 40 x 24.6	125	28.10	4.59	\$1162
FFTDP2448H24	31.75 x 46 x 24.6	150	29.65	5.25	\$1194
FFTDP2454H24	31.75 x 52 x 24.6	150	31.20	5.94	\$1229
FFTDP2460H24	31.75 x 58 x 24.6	150	32.75	6.56	\$1263
FFTDP2466H24	31.75 x 64 x 24.6	150	34.30	7.22	\$1295
FFTDP2472H24	31.75 x 70 x 24.6	150	35.85	7.88	\$1331
FFTDP2478H24	31.75 x 76 x 24.6	150	37.40	8.53	\$1366
FFTDP2484H24	31.75 x 82 x 24.6	150	38.95	9.19	\$1399
FFTDP3036H24	37.75 x 34 x 24.6	100	40.50	4.72	\$1205
FFTDP3042H24	37.75 x 40 x 24.6	125	42.05	5.51	\$1241
FFTDP3048H24	37.75 x 46 x 24.6	125	43.60	6.29	\$1275
FFTDP3054H24	37.75 x 52 x 24.6	125	45.15	7.08	\$1312
FFTDP3060H24	37.75 x 58 x 24.6	150	46.70	7.85	\$1344
FFTDP3066H24	37.75 x 64 x 24.6	150	48.25	8.65	\$1377
FFTDP3072H24	37.75 x 70 x 24.6	150	49.80	9.44	\$1412
FFTDP3078H24	37.75 x 76 x 24.6	150	51.35	10.22	\$1446
FFTDP3084H24	37.75 x 82 x 24.6	150	52.90	11.01	\$1481

Powder coated aluminum frame, translucent ribbed polycarbonate. Includes all hardware to connect. Brackets are painted steel. Side dividers extend 7.25" from the front edge of each surface. Back divider extends over the back edge of the worksurface by 1.5", allowing for cable pass-through to trough. Width and depth are nominal sizes representing the sizes of the FreeFit table. Allow for .25" overhang at the sides, 1.5" at the back, and 7.25" at the front. Frame and hardware available in Black (BLK), Charcoal (CHR), Designer White (DWT), Fog (FOG), Nevada (NEV), Silver (SIL), Taupe (TPE), Tungsten (TUN).

- FFTDP24xxH24 are for configurations with 23" deep surfaces.
- FFTDP30xxH24 are for configurations with 29" deep surfaces.

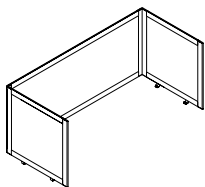

30" H Polycarbonate Divider Screen

FFTDP2436H30	31.75 x 34 x 30.6	125	26.55	3.94	\$1263
FFTDP2442H30	31.75 x 40 x 30.6	125	28.10	4.59	\$1304
FFTDP2448H30	31.75 x 46 x 30.6	150	29.65	5.25	\$1344
FFTDP2454H30	31.75 x 52 x 30.6	150	31.20	5.91	\$1382
FFTDP2460H30	31.75 x 58 x 30.6	150	32.75	6.56	\$1422
FFTDP2466H30	31.75 x 64 x 30.6	150	34.30	7.22	\$1460
FFTDP2472H30	31.75 x 70 x 30.6	150	35.85	7.88	\$1500
FFTDP2478H30	31.75 x 76 x 30.6	150	37.40	8.53	\$1538
FFTDP2484H30	31.75 x 82 x 30.6	150	38.95	9.19	\$1578
FFTDP3036H30	37.75 x 34 x 30.6	100	40.50	4.72	\$1340
FFTDP3042H30	37.75 x 40 x 30.6	125	42.05	5.51	\$1382
FFTDP3048H30	37.75 x 46 x 30.6	125	43.60	6.29	\$1421
FFTDP3054H30	37.75 x 52 x 30.6	125	45.15	7.08	\$1457
FFTDP3060H30	37.75 x 58 x 30.6	150	46.70	7.87	\$1496
FFTDP3066H30	37.75 x 64 x 30.6	150	48.25	8.65	\$1537
FFTDP3072H30	37.75 x 70 x 30.6	150	49.80	9.44	\$1573
FFTDP3078H30	37.75 x 76 x 30.6	150	51.35	10.22	\$1615
FFTDP3084H30	37.75 x 82 x 30.6	150	52.90	11.01	\$1655

Powder coated aluminum frame, translucent ribbed polycarbonate. Includes all hardware to connect. Brackets are painted steel. Side dividers extend 7.25" from the front edge of each surface. Back divider extends over the back edge of the worksurface by 1.5", allowing for cable pass-through to trough. Width and depth are nominal sizes representing the sizes of the FreeFit table. Allow for .25" overhang at the sides, 1.5" at the back, and 7.25" at the front. Frame and hardware available in Black (BLK), Charcoal (CHR), Designer White (DWT), Fog (FOG), Nevada (NEV), Silver (SIL), Taupe (TPE), Tungsten (TUN).

- FFTDP24xxH30 are for configurations with 23" deep surfaces.
- FFTDP30xxH30 are for configurations with 29" deep surfaces.

Required specifications
Frame finish

WELLNESS SCREENS - GLASS

MODEL# DIMENSIONS FREIGHT CLASS WT/LBS. CUBIC FT. LIST PRICE FRST ADD

D x W x H

FFTDG2436H24	31.50 x 36 x 24.60	125	26.55	3.94	\$1569	\$318
FFTDG2442H24	31.50 x 42 x 24.60	125	28.10	4.59	\$1621	\$325
FFTDG2448H24	31.50 x 48 x 24.60	150	29.65	5.25	\$1674	\$338
FFTDG2454H24	31.50 x 54 x 24.60	150	31.20	5.91	\$1724	\$350
FFTDG2460H24	31.50 x 60 x 24.60	150	32.75	6.56	\$1782	\$358
FFTDG2466H24	31.50 x 66 x 24.60	150	34.30	7.22	\$1829	\$371
FFTDG2472H24	31.50 x 72 x 24.60	150	35.85	7.88	\$1894	\$383
FFTDG2478H24	31.50 x 78 x 24.60	150	37.40	8.53	\$1932	\$391
FFTDG2484H24	31.50 x 84 x 24.60	150	38.95	9.19	\$1983	\$403
FFTDG3036H24	37.75 x 36 x 24.60	100	40.50	4.72	\$1674	\$338
FFTDG3042H24	37.75 x 42 x 24.60	125	42.05	5.51	\$1719	\$345
FFTDG3048H24	37.75 x 48 x 24.60	125	43.60	6.29	\$1770	\$358
FFTDG3054H24	37.75 x 54 x 24.60	150	45.15	7.08	\$1822	\$371
FFTDG3060H24	37.75 x 60 x 24.60	150	46.70	7.87	\$1874	\$378
FFTDG3066H24	37.75 x 66 x 24.60	150	48.25	8.65	\$1932	\$391
FFTDG3072H24	37.75 x 72 x 24.60	150	49.80	9.44	\$1977	\$396
FFTDG3078H24	37.75 x 78 x 24.60	150	51.35	10.22	\$2029	\$409
FFTDG3084H24	37.75 x 84 x 24.60	150	52.90	11.01	\$2082	\$423

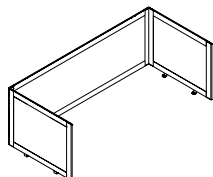

24" H Single Table Glass Divider Screen

Provides privacy in an open plan environment. Easy to clean table mounted partitions. Powder coated aluminum frame with 4mm clear (CLR) glass. Includes all hardware to connect. Brackets are painted steel. Side dividers extend 6.237" from the front edge of each surface. Back divider extends over the back edge of the worksurface by 1.5", allowing for cable pass-through to trough. Width and depth are nominal sizes representing the sizes of the FreeFit table. Allow for .25" overhang at the sides, 1.5" at the back, and 6.237" at the front. Frame and hardware available in Black (BLK), Charcoal (CHR), Designer White (DWT), Fog (FOG), Nevada (NEV), Silver (SIL), Taupe (TPE), Tungsten (TUN). End trim cap is only available in Charcoal (CHR). **Add 20%** upcharge for frosted glass (FRST).

- **FFTDG24xxH24 are for configurations with 24" deep surfaces.**
- **FFTDG30xxH24 are for configurations with 30" deep surfaces.**

FFTDG2436H30	31.50 x 36 x 30.60	125	28.85	3.97	\$1647	\$333
FFTDG2442H30	31.50 x 42 x 30.60	125	30.40	4.59	\$1699	\$345
FFTDG2448H30	31.50 x 48 x 30.60	125	31.95	5.25	\$1749	\$350
FFTDG2454H30	31.50 x 54 x 30.60	150	33.50	5.91	\$1808	\$365
FFTDG2460H30	31.50 x 60 x 30.60	150	35.05	6.56	\$1861	\$378
FFTDG2466H30	31.50 x 66 x 30.60	150	36.60	7.22	\$1907	\$383
FFTDG2472H30	31.50 x 72 x 30.60	150	38.15	7.88	\$1945	\$391
FFTDG2478H30	31.50 x 78 x 30.60	150	39.70	8.53	\$2016	\$409
FFTDG2484H30	31.50 x 84 x 30.60	150	41.25	9.19	\$2074	\$416
FFTDG3036H30	37.75 x 36 x 30.60	100	42.80	4.72	\$1749	\$350
FFTDG3042H30	37.75 x 42 x 30.60	100	44.35	5.51	\$1808	\$365
FFTDG3048H30	37.75 x 48 x 30.60	125	45.90	6.29	\$1854	\$378
FFTDG3054H30	37.75 x 54 x 30.60	125	47.45	7.08	\$1907	\$383
FFTDG3060H30	37.75 x 60 x 30.60	125	49	7.87	\$1965	\$396
FFTDG3066H30	37.75 x 66 x 30.60	150	50.55	8.65	\$2016	\$409
FFTDG3072H30	37.75 x 72 x 30.60	150	52.10	9.44	\$2041	\$409
FFTDG3078H30	37.75 x 78 x 30.60	150	53.65	10.22	\$2120	\$429
FFTDG3084H30	37.75 x 84 x 30.60	150	55.20	11.01	\$2172	\$436

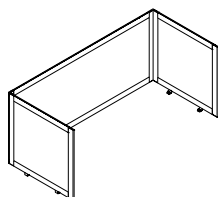

30" H Single Table Glass Divider Screen

Provides privacy in an open plan environment. Easy to clean table mounted partitions. Powder coated aluminum frame with 4mm clear (CLR) glass. Includes all hardware to connect. Brackets are painted steel. Side dividers extend 6.237" from the front edge of each surface. Back divider extends over the back edge of the worksurface by 1.5", allowing for cable pass-through to trough. Width and depth are nominal sizes representing the sizes of the Bridges configuration. Allow for .25" overhang at the sides, 1.5" at the back, and 6.237" at the front. Frame and hardware available in Black (BLK), Charcoal (CHR), Designer White (DWT), Fog (FOG), Nevada (NEV), Silver (SIL), Taupe (TPE), Tungsten (TUN). End trim cap is only available in Charcoal (CHR). **Add 20%** upcharge for frosted glass (FRST).

- **FFTDG24xxH30 are for configurations with 24" deep surfaces.**
- **FFTDG30xxH30 are for configurations with 30" deep surfaces.**

Required specifications
Frame finish

Optional specifications
Frosted glass (FRST)

FELT DIVIDER SCREENS

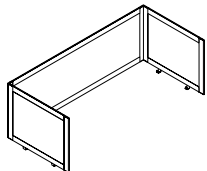

24" H Single Table Felt Divider Screen

MODEL#	DIMENSIONS	FREIGHT CLASS	WT./LBS.	CUBIC FT.	LIST PRICE
D x W x H					
FFTDF2436H24	31.50 x 36 x 24.60	125	22.55	3.94	\$937
FFTDF2442H24	31.50 x 42 x 24.60	125	24.10	4.59	\$961
FFTDF2448H24	31.50 x 48 x 24.60	150	25.65	5.25	\$986
FFTDF2454H24	31.50 x 54 x 24.60	150	27.20	5.91	\$1010
FFTDF2460H24	31.50 x 60 x 24.60	150	28.75	6.56	\$1037
FFTDF2466H24	31.50 x 66 x 24.60	150	30.30	7.22	\$1063
FFTDF2472H24	31.50 x 72 x 24.60	150	31.85	7.88	\$1086
FFTDF2478H24	31.50 x 78 x 24.60	150	33.40	8.53	\$1111
FFTDF2484H24	31.50 x 84 x 24.60	150	34.95	9.19	\$1160
FFTDF3036H24	37.75 x 36 x 24.60	100	36.50	4.72	\$968
FFTDF3042H24	37.75 x 42 x 24.60	125	38.05	5.51	\$1056
FFTDF3048H24	37.75 x 48 x 24.60	125	39.60	6.29	\$1019
FFTDF3054H24	37.75 x 54 x 24.60	150	41.15	7.08	\$1044
FFTDF3060H24	37.75 x 60 x 24.60	150	41.70	7.87	\$1069
FFTDF3066H24	37.75 x 66 x 24.60	150	44.25	8.65	\$1095
FFTDF3072H24	37.75 x 72 x 24.60	150	45.80	9.44	\$1117
FFTDF3078H24	37.75 x 78 x 24.60	150	47.35	10.22	\$1142
FFTDF3084H24	37.75 x 84 x 24.60	150	48.90	11.01	\$1193

Provides privacy in an open plan environment. Powder coated aluminum frame with 9mm felt. Includes all hardware to connect. Brackets are painted steel. Side dividers extend 6.237" from the front edge of each surface. Back divider extends over the back edge of the worksurface by 1.5", allowing for cable pass-through to trough. Width and depth are nominal sizes representing the sizes of the FreeFit table. Allow for .25" overhang at the sides, 1.5" at the back, and 6.237" at the front. Frame and hardware available in Black (BLK), Charcoal (CHR), Designer White (DWT), Fog (FOG), Nevada (NEV), Silver (SIL), Taupe (TPE), Tungsten (TUN). End trim cap is only available in Charcoal (CHR). 9mm PET felt material is tackable and available in 9 colors.

- FFTDF24xxH24 are for configurations with 24" deep surfaces.
- FFTDF30xxH24 are for configurations with 30" deep surfaces.

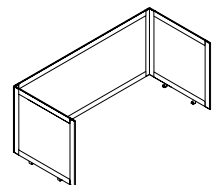

30" H Single Table Felt Divider Screen

FFTDF2436H30	31.50 x 36 x 30.60	125	24.85	3.97	\$930
FFTDF2442H30	31.50 x 42 x 30.60	125	26.40	4.59	\$954
FFTDF2448H30	31.50 x 48 x 30.60	125	27.95	5.25	\$976
FFTDF2454H30	31.50 x 54 x 30.60	150	29.50	5.91	\$999
FFTDF2460H30	31.50 x 60 x 30.60	150	31.05	6.56	\$1022
FFTDF2466H30	31.50 x 66 x 30.60	150	32.60	7.22	\$1045
FFTDF2472H30	31.50 x 72 x 30.60	150	34.14	7.88	\$1069
FFTDF2478H30	31.50 x 78 x 30.60	150	34.70	8.53	\$1092
FFTDF2484H30	31.50 x 84 x 30.60	150	37.25	9.19	\$1147
FFTDF3036H30	37.75 x 36 x 30.60	100	38.80	4.72	\$975
FFTDF3042H30	37.75 x 42 x 30.60	100	40.35	5.51	\$998
FFTDF3048H30	37.75 x 48 x 30.60	125	41.90	6.29	\$1021
FFTDF3054H30	37.75 x 54 x 30.60	125	43.45	7.08	\$1044
FFTDF3060H30	37.75 x 60 x 30.60	125	45	7.87	\$1069
FFTDF3066H30	37.75 x 66 x 30.60	150	46.55	8.65	\$1092
FFTDF3072H30	37.75 x 72 x 30.60	150	48.10	9.44	\$1114
FFTDF3078H30	37.75 x 78 x 30.60	150	49.65	10.22	\$1137
FFTDF3084H30	37.75 x 84 x 30.60	150	51.20	11.01	\$1191

Provides privacy in an open plan environment. Powder coated aluminum frame with 9mm felt. Includes all hardware to connect. Brackets are painted steel. Side dividers extend 6.237" from the front edge of each surface. Back divider extends over the back edge of the worksurface by 1.5", allowing for cable pass-through to trough. Width and depth are nominal sizes representing the sizes of the Bridges configuration. Allow for .25" overhang at the sides, 1.5" at the back, and 6.237" at the front. Frame and hardware available in Black (BLK), Charcoal (CHR), Designer White (DWT), Fog (FOG), Nevada (NEV), Silver (SIL), Taupe (TPE), Tungsten (TUN). End trim cap is only available in Charcoal (CHR). 9mm PET felt material is tackable and available in 9 colors.

- FFTDF24xxH30 are for configurations with 24" deep surfaces.
- FFTDF30xxH30 are for configurations with 30" deep surfaces.

Required Specifications

Frame finish
Felt finish



Designed by Zoey Chu, **JUNCTION™** provides an affordable solution for boardroom, classroom and presentation room applications. Offered in 20", 24" and 30" depths and a variety of table top shapes to create unique configurations.

A freestanding or shared leg configuration with the unique "Y" leg allows you to either create a permanent table or one that can be reconfigured quickly and easily. A straight leg is available for use with half round and keystone tops.

Shared leg configurations allow more legroom and can also decrease cost because they use fewer components. Freestanding configurations provide more flexibility for changing environments.

Features and Benefits

- Tops are 1" thick and constructed of 45 lb. density particleboard.
- Optional Radius Corners (RM) available at no upcharge.
- Optional modesty panel with integrated wire trough available.
- Casters available with or without manual locks provide mobility.
- Black grommets for convenient wire management can be ordered factory installed.
- Optional, easy-to-use thumbscrews allow installation without tools.
- JUNCTION™ tops are available in Global laminate finishes with 2 leg options.



Y Leg Design



Modesty Panel



Shared leg configuration provides more legroom and decreases the overall costs

GENERAL INFORMATION

- Junction is a series of multi-purpose tables for classroom, training room and boardroom applications
- Ability for tables to be set up as freestanding or shared leg configuration
- Unique design by Zooey Chu
- Half round, trapezoid and Keystone tops are available to create a variety of configurations
- Rectangular tops are available in 20", 24" and 30" depths
- Optional modesty panels with integrated wire troughs are available for use with rectangular tops
- Optional large electrical manager provides a safe environment for equipment wires
- Special width tops are available. Use next size up.
- Shipped R.T.A. (Ready to Assemble). Each component is packaged individually; Legs are shipped one per carton.
- For environmental certifications, please visit globalfurnituregroup.com

WORKSURFACES

- Tops are 1" thick, made of 45 lb. density particle board covered on both sides with high performance thermally fused laminate.
- Laminate finishes are available in High Pressure. Contact Customer care for a quote.
- If other than a Global standard laminate finish is preferred, contact Customer Care. Information needed includes the name of the laminate manufacturer, color name, number and model of table. You will then be given a quote for this special order.
- Products specified with the high pressure laminate option are finished on the underside of the surface with a kraft paper backing.

CONSTRUCTION

- Rectangular tops 54" in length and longer include a steel support channel for structural rigidity
- Tops are pre-drilled with threaded steel inserts
- Special width tops are available. Use next size up.
- Adjustable levelers offer up to 1" adjustability.

EDGE DETAIL

- Tops are sealed with Global's preferred edge in matching color.
- Optional Radius corners (**RM**) are available on rectangular tops at no upcharge.

LEGS

- Unique Y design
- Straight leg available for assembly with Half Round tops and Keystone tops
- Heavy duty steel construction
- Coated with environmentally friendly recycled paint that provides a durable finish
- Black plastic leveling glides offer 5/8" adjustability
- Available in Black (**TBL**), Cloud (**TIV**), Designer White (**TDW**), Fog (**TFO**), Frost (**TFR**), Kalua (**TKA**), Latte (**TLA**), Mocha (**TMO**), Nevada (**TNE**), Sand (**TSN**), Shadow (**TSH**), Toast (**TOA**) or Tungsten (**TTU**) finish.
- Y Legs: 17.5" leg span - 20"D top, 21.5" leg span - 24"D top, 24.5" leg span - 30"D top.

CASTERS

- Optional casters are available
- 1½" Dual wheel casters with or without manual lock. Full 360° swivel.
- Can be used in any combination with or without standard glides
- Suggested for carpeted surfaces
- Available in Black only
- Sold in packages of two

GANGING

- Ganging plates are available for ganging workstations together
- Ganging plates are black epoxy coated steel plates with two thumbscrews
- Provides maximum stability and torque reduction

FLUSH PLATE

- Suggested for top clusters (fixed configurations for additional stability)
- Sold individually and shipped with two thumbscrews for mounting
- No tools required
- Flush plate allows for ganging together of two or more tops

WIRE MANAGEMENT

- Available for managing additional larger wires and power connectors
- 3½" high x 4¼" deep Black PVC channel attaches to the underside of top

1. SPECIFY MODEL NUMBER

2. SPECIFY FINISH

Laminate Finishes:

ACJ	Absolute Acajou	NBL	Noce Biondo
ASN	Asian Night	NGL	Noce Grigio
AWC	Avant Cherry	NEL	Noce Leggero
AWH	Avant Honey	NML	Noce Medio
BLK	Black	QTM	Quartered Mahogany
BZD	Blizzard	SBY	Sheer Beauty
BRC	Brushed Cobalt	SDT	Stonedust
CMB	Clear Maple	SOG	Storm Grey
CGY	Custom Grey	WHE	Walnut Heights
DES	Dark Espresso	WHC	White Chocolate
DWT	Designer White	WCR	Winter Cherry
FAS	Fashionista		
FCL	First Class		

Legs:

TBL	Black
TIV	Cloud
TDW	Designer White
TFO	Fog
TFR	Frost
TKA	Kalua
TLA	Latte
TMO	Mocha
TNE	Nevada
TSN	Sand
TSH	Shadow
TOA	Toast
TTU	Tungsten

3. SPECIFY OPTIONS

Modesty Panels

- 11¼" high panel attaches to the underside of rectangular tops
- Standard with integrated wire trough
- Available in black PVC

Grommets

- Grommets are available in **Rectangular and Trapezoid** Tops (left, center or right). See below for available locations. Order as: **AG1, AG2 or AG3. Add \$96.** For **Keystone** worksurface locations, order as **AG2. Add \$96.**
- Grommet hole dimensions are 3¼" wide x 1 7/8" deep.

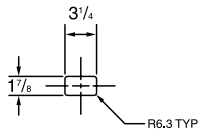

- Grommets may be placed at non-standard locations. Order as: **AGS - Add \$96.** A drawing must be supplied with vertical and horizontal dimensions to the center of the cut-out (as in drawing above). Please refer to CUSTOM GROMMET LOCATION FORM in the back reference section.

Power Block

- A Power Block (model **PMSADM**) may be ordered on all worksurfaces.
- A Power Block is a rectangular worksurface power/data module with one electrical duplex receptacle and two data (RJ45) receptacles. 9' black cord included. Power Block dimensions are 3½" deep x 6½" wide x 2¾" high.
- To purchase a Power Block, you must specify both the Power Block cut-out location and the Power Block model #. Order Power Block as **PMSADM, ADD \$330.** Power Blocks are available in standard worksurface locations (left, center or right). Order as **E1, E2 or E3. Add \$96.**



Power Block **PMSADM, Add \$330**

EXAMPLES OF GROMMET AND POWER BLOCK POSITIONS

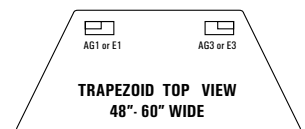
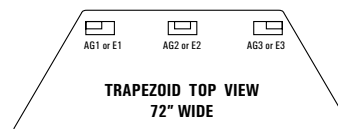
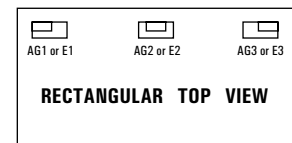
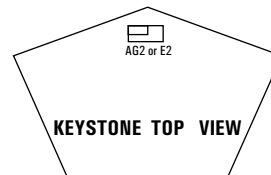

VILLA CUTOUTS

- Optional Villa cutout available in standard worksurface locations (left, center or right) for **Rectangular Tables.** Order as: **V1, V2 or V3. Add \$96 for each cutout.**
- Villa cutouts may be placed at non-standard locations. Please contact customer service.

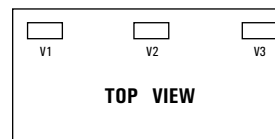

RECTANGULAR TOPS

MODEL# DIMENSIONS FREIGHT CLASS WT/LBS. CUBIC FT. LIST PRICE

D x W x H

JNR2042	20 x 42 x 1	65	26	1.1	\$371
JNR2048	20 x 48 x 1	65	29	1.15	\$414
JNRU2054	20 x 54 x 1	65	33	1.3	\$513
JNRU2060	20 x 60 x 1	65	37	1.4	\$552
JNRU2066	20 x 66 x 1	65	41	1.55	\$596
JNRU2072	20 x 72 x 1	65	45	1.66	\$636
JNR2442	24 x 42 x 1	65	31	1.25	\$371
JNR2448	24 x 48 x 1	65	35	1.4	\$414
JNRU2454	24 x 54 x 1	65	42	1.52	\$513
JNRU2460	24 x 60 x 1	65	47	1.67	\$552
JNRU2466	24 x 66 x 1	65	52	1.82	\$596
JNRU2472	24 x 72 x 1	65	57	2	\$636
JNR3042	30 x 42 x 1	65	38	1.51	\$451
JNR3048	30 x 48 x 1	65	44	1.7	\$475
JNRU3054	30 x 54 x 1	65	52	1.9	\$590
JNRU3060	30 x 60 x 1	65	59	2.1	\$633
JNRU3066	30 x 66 x 1	65	64	2.26	\$677
JNRU3072	30 x 72 x 1	65	70	2.5	\$721

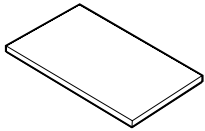

Rectangular Top

Pre-drilled with threaded steel inserts for freestanding and linking installations. **Tops 54" and longer are standard with a 16 gauge steel support channel.**

HALF ROUND TOPS

MODEL # DIMENSIONS FREIGHT CLASS WT/LB. CUBIC FT. LIST PRICE

JNHFS2040	20 x 40 x 1	70	23	1.05	\$393
JNHFS2048	20 x 48 x 1	65	27.5	1.15	\$407
JNHFS2448	24 x 48 x 1	65	34	1.4	\$437
JNHFS2454	27 x 54 x 1	65	38.25	1.52	\$516
JNHFS3060	30 x 60 x 1	60	53	1.67	\$566
JNHFS3066	33 x 66 x 1	60	58.3	1.82	\$708

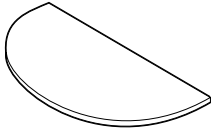

Half Round Top

Pre-drilled with threaded steel inserts for freestanding and linking installations. Four legs are required for freestanding configurations.

- **JNHFS2040/JNHFS2048** for use with 20" deep joining edge
- **JNHFS2448/JNHFS2454** for use with 24" deep joining edge
- **JNHFS3060/JNHFS3066** for use with 30" deep joining edge

TRAPEZOID TOPS

MODEL # DIMENSIONS FREIGHT CLASS WT/LB. CUBIC FT. LIST PRICE

JNTT2048	15.25 x 48 x 1	65	27.5	1.15	\$384
JNTT2060	15.25 x 60 x 1	65	34	1.4	\$456
JNTT2448	20.5 x 48 x 1	65	33	1.4	\$434
JNTT2460	20.5 x 60 x 1	65	41.25	1.67	\$522
JNTT3060	25.75 x 60 x 1	65	50.5	2.1	\$570
JNTT3072	25.75 x 72 x 1	65	61	2.5	\$636

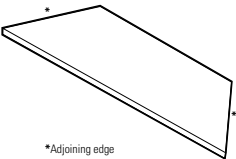

*Adjoining edge

Trapezoid Top

Pre-drilled with threaded steel inserts for linking installations. **Not freestanding.**

- **JNTT2048/JNTT2060** for use with 20" deep joining edge
- **JNTT2448/JNTT2460** for use with 24" deep joining edge
- **JNTT3060/JNTT3072** for use with 30" deep joining edge

Required Specifications
Finish

Optional Specifications
Grommet

Accessories
Power Block

KEYSTONE TOPS

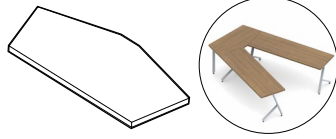

Keystone Top

MODEL#	DIMENSIONS	FREIGHT CLASS	WT/LBS.	CUBIC FT.	LIST PRICE
--------	------------	---------------	---------	-----------	------------

	D x W x H				
JN5S2424	24 x 42 x 1	65	35	1.4	\$443
JN5S3030	30 x 54 x 1	65	53	2.1	\$566

Pre-drilled with threaded steel inserts for linking installations. **Keystone shape is for V configurations/shared applications only; not intended for freestanding applications.**

- **JN5S2424** for use with 20" deep joining edge
- **JN5S3030** for use with 24" deep joining edge

MODESTY PANELS



Modesty Panel

MODEL #	DIMENSIONS	FREIGHT CLASS	WT/LB.	CUBIC FT.	LIST PRICE
---------	------------	---------------	--------	-----------	------------

JNMP42	6.92 x 29.19 x 11.25	250	3.7	1.5	\$307
JNMP48	6.92 x 35.19 x 11.25	250	4.5	1.75	\$344
JNMP54	6.92 x 41.19 x 11.25	250	5	2	\$385
JNMP60	6.92 x 47.19 x 11.25	250	5.9	2.25	\$423
JNMP66	6.92 x 53.19 x 11.25	250	6.6	2.5	\$453
JNMP72	6.92 x 59.19 x 11.25	250	7.4	2.75	\$492

For use with **JNR rectangular tops**. 11 ¼" high, Black plastic, attractive ribbed design. Includes integrated wire trough. Connects to predrilled holes in table top.

WIRE MANAGEMENT



Wire Manager

MODEL #	DIMENSIONS	FREIGHT CLASS	WT/LB.	CUBIC FT.	LIST PRICE
---------	------------	---------------	--------	-----------	------------

JNEC5S	4.14 x 12.5 x 3.63	70	1	0.1	\$83
--------	--------------------	----	---	-----	-------------

For use with **JN5S Keystone Tops**. For managing additional wires and power connectors. 3/2"H Black PVC channel connects to predrilled holes in table top.



Wire Manager





JNEC42	4.14 x 41.75 x 3.63	125	2.52	0.33	\$195
JNEC48	4.14 x 47.75 x 3.63	125	2.88	0.38	\$226
JNEC54	4.14 x 53.75 x 3.63	125	3.24	0.43	\$256
JNEC60	4.14 x 59.75 x 3.63	125	3.6	0.48	\$283
JNEC66	4.14 x 65.75 x 3.63	125	3.96	0.53	\$296
JNEC72	4.14 x 71.75 x 3.63	125	4.32	0.58	\$385

For use with **JNR Rectangular Tops**. For managing additional wires and power connectors. 3/2"H Black PVC channel connects to predrilled holes in the table top.

Required Specifications
Finish

Optional Specifications
Grommet

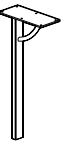
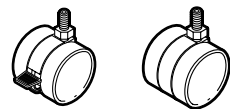
Accessories
Power Block

LEGS	MODEL#	DIMENSIONS D x W x H	FREIGHT CLASS	WT./LBS.	CUBIC FT.	LIST PRICE
 "Y" Leg	GJNLEG20	17.25 x 2 x 27.5	150	8.5	2	\$294
<p>Leg span is 17½". Leveling glides are standard. For assembly with 20" deep tops</p> <ul style="list-style-type: none"> List price is per each leg. See 637 for available finishes. 						
 "Y" Leg	GJNLEG24	21.5 x 2 x 27.5	150	10	2.5	\$294
<p>Leg span is 21½". Leveling glides are standard. For assembly with 24" deep tops</p> <ul style="list-style-type: none"> List Price is per each leg. See 637 for available finishes. 						
 "Y" Leg	GJNLEG30	24.5 x 2 x 27.5	250	11	2.85	\$317
<p>Leg span is 24½". Leveling glides are standard. For assembly with 30" deep tops</p> <ul style="list-style-type: none"> List Price is per each leg. See 637 for available finishes. 						
 Straight Leg	JNLEG	1 x 2 x 27.3	150	6	1.3	\$260
<p>Leveling glides are standard. For assembly with half round and keystone tops. Mounting plate is 11" deep by 5" wide.</p> <ul style="list-style-type: none"> List Price is per each leg. See 637 for available finishes. 						
 Casters	JNCP	--	--	--	--	\$63
<p>Set of (2) 1½" dual wheel casters, one locking. Suggested for carpeted surfaces. Casters are fully interchangeable with glides. Black only.</p> <ul style="list-style-type: none"> For use with Junction units only Casters DO NOT affect table height 						
 Thumbscrews	JNTS	--	--	--	--	\$36
<p>Triangular thumbscrew with ¾" steel thread. Set of 4. Can be used in place of factory supplied screws to allow installation of "Y" legs to tops without tools. Black only.</p>						

Required Specifications
Finish

Optional Specifications
Grommet (Keystone)

Accessories
Power Block (Keystone)

ACCESSORIES

MODEL# DIMENSIONS FREIGHT CLASS WT./LBS. CUBIC FT. LIST PRICE

D x W x H

JNGFP	--	--	--	--	\$66
-------	----	----	----	----	-------------

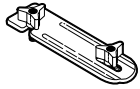

Ganging Flush Plate

Black epoxy coated steel plates with 2 thumbscrews included. Used to connect table tops together for additional stability or for connecting freestanding tops together. Holes with steel inserts are located in the corner of the tops to accommodate this plate. Sold individually.

JNFP1	5.25 d x 5.25 w	--	--	--	\$36
-------	-----------------	----	----	----	-------------

JNFP4	5.25 d x 5.25 w	--	--	--	\$133
-------	-----------------	----	----	----	--------------

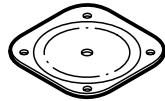

Flush Plate

Assures alignment on adjoining worksurfaces of the same height. Bolts included. Available in Black only.

JNFP1 - 1 per carton.

JNFP4 - 4 per carton.

Required Specifications

Finish



Kadin adds modern flair to your meeting space. From formal conference rooms to intimate meeting spaces or open forums, Kadin fits wherever people meet. Choose from round, square or rectangular tops in a variety of sizes with multiple edge options. Table depths start at 36", available widths are almost limitless. Surfaces are offered in architectural grade veneer and high-pressure laminate. The beautifully sculpted leg support maximizes leg clearance to keep guests comfortable. Extending from the leg support, the beam structure and connectors create visual interest as people come together. Pre-configured base assemblies make it easy to specify.

Features and Benefits

- Constructed of 45lb. density particleboard with high pressure laminate or grade A veneers
- 3 top shapes
- Solid die-cast aluminum leg with adjustable glide
- 5 edge options
- Metal bases available in 8 finishes
- Beam available in 7 finishes to match leg



90° connector



60° connector (for three leg tables only)



Beam construction

GENERAL INFORMATION

- Laminate or veneer tops with multiple edge options
- Three top shapes - round, square, rectangular
- Pre-configured assemblies make specifying easy
- Kadin pairs perfectly with storage from a number of Global desking series
- For environmental certifications, please visit globalfurnituregroup.com

**TABLES WITH LAMINATE TOPS:
CONSTRUCTION**

- Constructed of 45 lb. density particleboard with high pressure laminate
- Tables are pre-drilled with factory installed inserts for easy metal-to-metal base connection
- Solid die-cast aluminum leg with adjustable glide

WORKSURFACES

- Available in 1-1/16" or 1-7/16" high pressure laminate tops with a 3mm PVC edge trim or 1-3/16" high pressure laminate top with a 3mm PVC edge trim
- Laminate surfaces offer a selection of matching + coordinating edge band, specify separately from the surface finish
- Tables up to and including 96" long are manufactured in one piece, 108" to 180" long are manufactured in two pieces, and over 192" are manufactured in three pieces. If woodgrain laminate is chosen, the woodgrain pattern may not line up.
- Tables in two or three pieces will have the joining edge finished; hardware will be shipped for assembly
- Products specified with the high pressure laminate option are finished on the underside of the surface with a kraft paper backing.

EDGES

- Tables with **B** Edge are 1-1/16" thick and have a 3mm PVC edge
- Tables with a **W** Edge are 1-7/16" thick and have a 3mm PVC edge
- Tables with a **KL** edge are 1-3/16" thick with a 3mm PVC edge and a 2" undercut knife profile
- Square and Rectangular Tables with a **B** or **W** edge have a 1" radius at each corner. For 90° corners, please add **NR** at the end of the product code. No upcharge.
- Square and Rectangular tables with a **KL** edge have 90° corners. There is no radius corner option for the KL edge.

**TABLES WITH VENEER TOPS:
CONSTRUCTION**

- Constructed of 45 lb. density particleboard with grade A veneers
- Tables are pre-drilled with factory installed inserts for easy metal-to-metal base connection
- Solid die-cast aluminum leg with adjustable glide

WORKSURFACES

- 1-3/16" thick veneer tops with choice of edge.
- Tables up to and including 96" long are manufactured in one piece, 108" to 180" long are manufactured in two pieces, and over 192" are manufactured in three pieces.
- Veneer wood grain will run with the **length** of the table and align at the seam up to 180"
- Veneer wood grain will run with the **depth** of the table (i.e. cross grain) on tables 192" and up.
- Tables in two or three pieces will have the joining edge finished; hardware will be shipped for assembly

EDGES

- Tables with a **FV** edge are 1-3/16" thick with a flat 3mm hardwood edge, stained to match to veneer.
- Tables with a **KV** edge are 1-3/16" thick with a flat 3mm hardwood edge and 2" undercut knife edge profile.
- Square and Rectangular Tables with the **FV** and **KV** edge have 90° corners. There is no radius corner option.

GROMMETS

- Grommets available in standard table top locations (left, center or right).
Order as: **AG1, AG2 or AG3. Add \$96**
- Grommet hole dimensions are 3 1/4" wide x 1 7/8" deep.

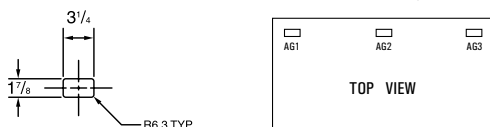

- Actual grommet locations will vary according to base selection.

WIRE MANAGEMENT

- For vertical and horizontal wire management, please refer to wire management section below, or Productivity Solutions on page 474.

CUT-OUTS FOR POWER BLOCKS

- Optional cut-out available in standard worksurface locations (left, center or right) for all table shapes. **Add \$96 for each cut-out.**
- Cut-outs may be placed at non-standard locations. Please contact customer care.
- Match power block desired with cut-out code and location from above grid
- Power module cut-out locations are not available on all models – please see diagrams to the right for restrictions.

*Oasis Mini is not available on 36"D models due to space restrictions caused by beam placement. **Only available on 60" square and 60" round 4-leg tables.**

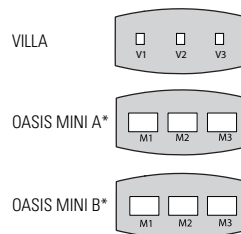
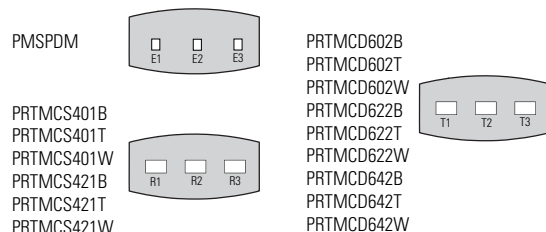

1. SPECIFY MODEL NUMBER

2. SPECIFY FINISH

LAMINATE FINISHES

ACJ	Absolute Acajou	FCL	First Class
ASN	Asian Night	NBL	Noce Biondo
AWC	Avant Cherry	NGL	Noce Grigio
AWH	Avant Honey	NEL	Noce Leggero
BLK	Black	NML	Noce Medio
BRC	Brushed Cobalt	QTM	Quartered Mahogany
BZD	Blizzard	SBY	Sheer Beauty
CMB	Clear Maple	SDT	Stonedust
CGY	Custom Grey	SOG	Storm Grey
DES	Dark Espresso	WHE	Walnut Heights
DWT	Designer White	WHC	White Chocolate
FAS	Fashionista	WCR	Winter Cherry

LEG FINISHES

CHM	Chrome	BLK	Black
CHR	Charcoal	DWT	Designer White
NEV	Nevada	SIL	Silver
TPE	Taupe	TUN	Tungsten

BEAM FINISHES

BLK	Black	CHR	Charcoal
DWT	Designer White	NEV	Nevada
SIL	Silver	TPE	Taupe
TUN	Tungsten		

VENEER FINISHES:

Code	Finish	Veneer Type	Cut
AMW	Almond Cherry	Cherry	Flat Sliced
ACW	Amber Cherry	Cherry	Flat Sliced
BTW	Biscotti	White Oak	Rift
CAW	Cocoa Walnut	Walnut	Flat Sliced
CRW	Coral	White Oak	Rift
DCW	Dark Cherry	Cherry	Flat Sliced
DWW	Dark Walnut	Walnut	Flat Sliced
EWV	Espresso Walnut	Walnut	Flat Sliced
EVW	Evening Oak	White Oak	Rift
GRW	Grey on Oak	White Oak	Rift
HAW	Hazelnut	Maple	Flat Sliced
JAW	Java	White Oak	Rift
LTW	Latte Walnut	Walnut	Flat Sliced
MHW	Mahogany on Walnut	Walnut	Flat Sliced
MTW	Milestone	White Oak	Rift
MPW	Natural Maple	Maple	Flat Sliced
NLW	Natural Walnut	Walnut	Flat Sliced
RCW	Red Cherry	Cherry	Flat Sliced
ULW	Umber Walnut	Walnut	Flat Sliced

EDGE FINISHES (Laminate Surfaces Only)

AAE	Absolute Acajou	NBL	Noce Biondo
ASE	Asian Night	NGL	Noce Grigio
ACE	Avant Cherry	NEL	Noce Leggero
AHE	Avant Honey	NML	Noce Medio
BLK	Black	QTM	Quartered Mahogany
BZD	Blizzard	SBY	Sheer Beauty
BRC	Brushed Cobalt	SIL	Silver
CHR	Charcoal (use w/SOG)	SDT	Stonedust
CME	Clear Maple	SOG	Storm Grey
CGY	Custom Grey	TPE	Taupe
DEE	Dark Espresso	WHE	Walnut Heights
DWE	Designer White	CBE	White Chocolate
FAS	Fashionista	WCE	Winter Cherry
FCL	First Class		

3. SPECIFY OPTIONS

Edge Options:

"B" Edges

Laminate surface with PVC edge

HP (B) 1-1/16" Thickness



"W" Edges

Laminate surface with PVC edge

HP (W) 1-7/16" Thickness



"KL" Edges

Laminate surface with PVC edge

HP (KL) 1-3/16" Thickness

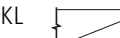

"FV" Edges

Veneer surface with Hardwood edge

(FV) 1-3/16" Thickness



"KV" Edges

Veneer surface with Hardwood edge

(KV) 1-3/16" Thickness

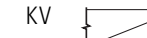

CUT-OUT LOCATIONS:

Square Table - position 2 only

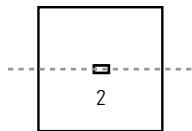

Round Table - position 2 only

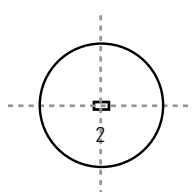

Rectangular Table

- Cut-out only in position 2: LKD3648, LKD3654, LKD4248, LKD4254, LKD4854
- One cut-out choice only (position 1, 2 or 3): LKD3660, LKD3666, LKD3672, LKD4260, LKD4266, LKD4272
- Up to 3 cut-outs in position 1, 2 and/or 3: LKD3678, LKD3684, LKD3696, LKD4278, LKD4284, LKD4296, LKD4878, LKD4884, LKD4896

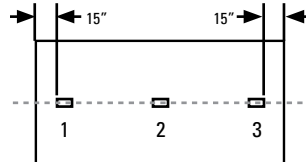

Rectangular Table - 2 piece top

- Up to 2 cut-outs in position 1 and/or 3 - all sizes

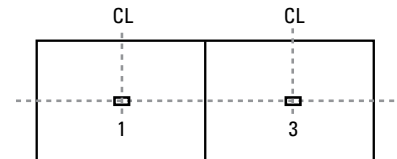

Rectangular Table - 3 piece top

- Up to 3 cut-outs in position 1, 2 and/or 3 - all sizes

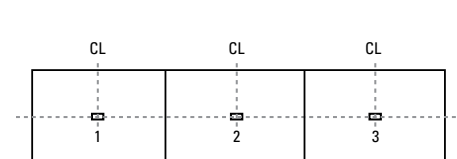

Note: Grommet orientation follows the length of table.

SQUARE TABLES - LAMINATE

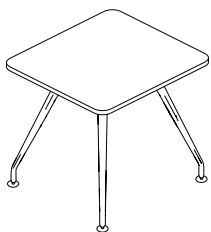

Square Table - Laminate Top*

MODEL#	DIMENSIONS D x W x H	FREIGHT CLASS	WT/LBS.	CUBIC FT.	B-EDGE	W-EDGE	KL-EDGE
LKD3636	36 x 36 x 29-29.5	100	73	4	\$1824	\$2049	\$2124
LKD4242	42 x 42 x 29-29.5	100	86	4	\$2181	\$2395	\$2575
LKD4848	48 x 48 x 29-29.5	92.5	107	5	\$2560	\$2821	\$2996
LKD5454	54 x 54 x 29-29.5	85	120	5	\$2819	\$3136	\$3588
LKD6060	60 x 60 x 29-29.5	92.5	135	6	\$3107	\$3486	\$4106

Tops feature 3mm pvc edge and metal inserts for ease of assembly to base. Also includes four legs, four 90-degree connectors and four leg beams.

SQUARE TABLES - VENEER

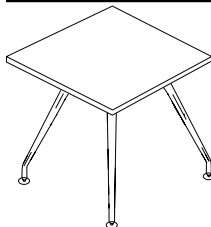

Square Table - Veneer Top

MODEL#	DIMENSIONS D x W x H	FREIGHT CLASS	WT/LBS.	CUBIC FT.	B-EDGE	W-EDGE	KL-EDGE
LKD3636K	36 x 36 x 29-29.5	100	73	4	\$2529	\$2619	
LKD4242K	42 x 42 x 29-29.5	92.5	86	4	\$3012	\$3133	
LKD4848K	48 x 48 x 29-29.5	92.5	107	5	\$3568	\$3726	
LKD5454K	54 x 54 x 29-29.5	85	120	5	\$4321	\$4518	
LKD6060K	60 x 60 x 29-29.5	92.5	135	6	\$5015	\$5257	

Tops feature hardwood edge and metal inserts for ease of assembly to base. Also includes four legs, four 90-degree connectors and four leg beams.

ROUND TABLES - LAMINATE

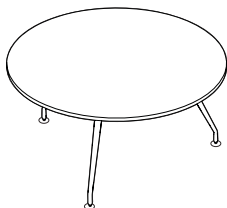

Round Table - 3 Legs*

MODEL#	DIMENSIONS D x W x H	FREIGHT CLASS	WT/LBS.	CUBIC FT.	B-EDGE	W-EDGE	KL-EDGE
LKD36DIA	36 x 36 x 29-29.5	92.5	66	3	\$1470	\$1701	\$1981
LKD42DIA	42 x 42 x 29-29.5	85	78	3	\$1813	\$2029	\$2532
LKD48DIA	48 x 48 x 29-29.5	85	99	4	\$2152	\$2421	\$3074
LKD54DIA	54 x 54 x 29-29.5	85	111	4	\$2412	\$2737	\$3758
LKD60DIA	60 x 60 x 29-29.5	85	126	5	\$2694	\$3083	\$4429

Tops feature 3mm pvc edge and metal inserts for ease of assembly to base. Also includes three legs, three 60-degree connectors and three leg beams.



Round Table - 4 Legs*

LKD436DIA	36 x 36 x 29-29.5	100	66	3	\$1911	\$2136	\$2302
LKD442DIA	42 x 42 x 29-29.5	92.5	78	3	\$2181	\$2395	\$2792
LKD448DIA	48 x 48 x 29-29.5	92.5	99	4	\$2560	\$2821	\$3385
LKD454DIA	54 x 54 x 29-29.5	85	111	4	\$2819	\$3136	\$4003
LKD460DIA	60 x 60 x 29-29.5	92.5	126	5	\$3107	\$3486	\$4700

Tops feature 3mm pvc edge and metal inserts for ease of assembly to base. Also includes four legs, four 90-degree connectors and four leg beams.

Required Specifications

Top Finish
Leg Finish
Edge Finish*
Edge Style

Optional Specifications

Grommet

Accessories

Power Block

ROUND TABLES - VENEER

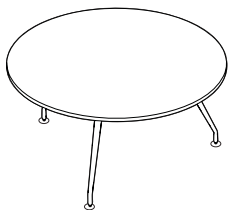

Round Table - 3 Legs



Round Table - 4 Legs

MODEL# DIMENSIONS FREIGHT CLASS WT/LBS. CUBIC FT. FV EDGE KV EDGE

	D x W x H						
LKD36DIAK	36 x 36 x 29-29.5	92.5	66	3	\$2408	\$2522	
LKD42DIAK	42 x 42 x 29-29.5	85	78	3	\$3033	\$3184	
LKD48DIAK	48 x 48 x 29-29.5	85	99	4	\$3735	\$3943	
LKD54DIAK	54 x 54 x 29-29.5	85	111	4	\$4622	\$4877	
LKD60DIAK	60 x 60 x 29-29.5	85	126	5	\$5524	\$5835	

Tops feature hardwood edge and metal inserts for ease of assembly to base. Also includes three legs, three 60-degree connectors and three leg beams.

LKD436DIAK	36 x 36 x 29-29.5	100	66	3	\$2634	\$2748	
LKD442DIAK	42 x 42 x 29-29.5	92.5	78	3	\$3271	\$3422	
LKD448DIAK	48 x 48 x 29-29.5	92.5	99	4	\$4022	\$4230	
LKD454DIAK	54 x 54 x 29-29.5	85	111	4	\$4842	\$5097	
LKD460DIAK	60 x 60 x 29-29.5	92.5	126	5	\$5769	\$6080	

Tops feature hardwood edge and metal inserts for ease of assembly to base. Also includes four legs, four 90-degree connectors and four leg beams.

RECTANGULAR TABLES - LAMINATE

B-EDGE W-EDGE KL-EDGE

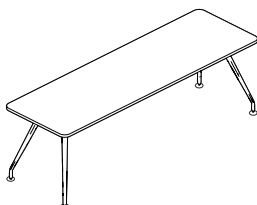

Rectangular Table*

LKD3648	36 x 48 x 29-29.5	100	75	4	\$2258	\$2488	\$2553
LKD3654	36 x 54 x 29-29.5	92.5	81	4	\$2357	\$2614	\$2788
LKD3660	36 x 60 x 29-29.5	100	88	5	\$2458	\$2738	\$2956
LKD3666	36 x 66 x 29-29.5	100	95	5	\$2560	\$2865	\$3123
LKD3672	36 x 72 x 29-29.5	92.5	101	5	\$2658	\$2985	\$3291
LKD3678	36 x 78 x 29-29.5	92.5	105	5	\$2758	\$3110	\$3460
LKD3684	36 x 84 x 29-29.5	92.5	108	5	\$2859	\$3237	\$3627
LKD3696	36 x 96 x 29-29.5	100	115	6	\$3061	\$3487	\$3965
LKD4248	42 x 48 x 29-29.5	92.5	87	4	\$2418	\$2645	\$2774
LKD4254	42 x 54 x 29-29.5	100	90	5	\$2538	\$2789	\$3033
LKD4260	42 x 60 x 29-29.5	100	94	5	\$2657	\$2926	\$3229
LKD4266	42 x 66 x 29-29.5	92.5	101	5	\$2774	\$3069	\$3422
LKD4272	42 x 72 x 29-29.5	92.5	106	5	\$2895	\$3210	\$3620
LKD4278	42 x 78 x 29-29.5	100	110	6	\$3010	\$3350	\$3812
LKD4284	42 x 84 x 29-29.5	100	113	6	\$3130	\$3492	\$4007
LKD4296	42 x 96 x 29-29.5	92.5	129	6	\$3368	\$3774	\$4398
LKD4854	48 x 54 x 29-29.5	100	94	5	\$2753	\$3030	\$3283
LKD4860	48 x 60 x 29-29.5	100	99	5	\$2885	\$3189	\$3504
LKD4866	48 x 66 x 29-29.5	100	107	6	\$3018	\$3343	\$3724
LKD4872	48 x 72 x 29-29.5	100	114	6	\$3151	\$3501	\$3946
LKD4878	48 x 78 x 29-29.5	92.5	120	6	\$3282	\$3662	\$4166
LKD4884	48 x 84 x 29-29.5	92.5	125	6	\$3416	\$3818	\$4387
LKD4896	48 x 96 x 29-29.5	92.5	149	7	\$3678	\$4131	\$4828

Tops feature 3mm pvc edge and metal inserts for ease of assembly to base. Also includes four legs, four 90-degree connectors and four leg beams.

Required Specifications

- Top Finish
- Leg Finish
- Edge Finish*
- Edge Style

Optional Specifications

- Grommet

Accessories

- Power Block

RECTANGULAR TABLES - LAMINATE

MODEL# DIMENSIONS FREIGHT CLASS WT/LBS. CUBIC FT. B-EDGE W-EDGE KL-EDGE

D x W x H

LKD36108	36 x 108 x 29-29.5	92.5	154	7	\$4210	\$4526	\$5009
LKD36120	36 x 120 x 29-29.5	125	164	8	\$4425	\$4777	\$5344
LKD42108	42 x 108 x 29-29.5	150	124	8	\$4491	\$4850	\$5491
LKD42120	42 x 120 x 29-29.5	150	141	9	\$4728	\$5120	\$5880
LKD48108	48 x 108 x 29-29.5	150	127	9	\$4831	\$5220	\$5982
LKD48120	48 x 120 x 29-29.5	150	151	9	\$5101	\$5535	\$6420
LKD48132	48 x 132 x 29-29.5	150	164	10	\$5365	\$5840	\$6864
LKD48144	48 x 144 x 29-29.5	125	181	10	\$5433	\$5915	\$7296
LKD48156	48 x 156 x 29-29.5	150	191	11	\$5893	\$6445	\$7747
LKD48168	48 x 168 x 29-29.5	125	206	11	\$6156	\$6741	\$8188
LKD48180	48 x 180 x 29-29.5	125	220	12	\$6615	\$7270	\$8636
LKD54144	54 x 144 x 29-29.5	150	193	11	\$6069	\$6626	\$8011
LKD54168	54 x 168 x 29-29.5	150	214	12	\$6653	\$7290	\$9000
LKD60144	60 x 144 x 29-29.5	150	206	12	\$6429	\$7033	\$8656
LKD60168	60 x 168 x 29-29.5	150	227	13	\$7064	\$7759	\$9744

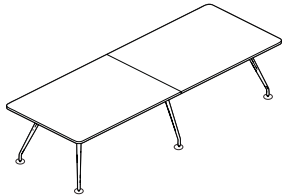

Rectangular Table - 2 piece top

Tops feature 3mm pvc edge and metal inserts for ease of assembly to base. Also includes six legs, four 90-degree connectors, two 3-way connectors and four leg beams.

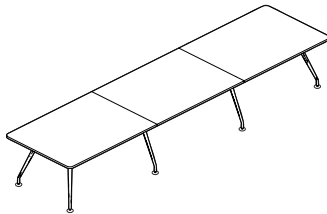

Rectangular Table - 3 piece top

LKD48192	48 x 192 x 29-29.5	150	279	14	\$7442	\$8105	\$9772
LKD54192	54 x 192 x 29-29.5	150	288	15	\$8000	\$8724	\$10697
LKD54216	54 x 216 x 29-29.5	150	270	16	\$8578	\$9387	\$11679
LKD54240	54 x 240 x 29-29.5	150	298	17	\$9161	\$10057	\$12669
LKD60192	60 x 192 x 29-29.5	150	257	16	\$8473	\$9257	\$11551
LKD60216	60 x 216 x 29-29.5	150	283	17	\$9110	\$9987	\$12643
LKD60240	60 x 240 x 29-29.5	150	311	18	\$9744	\$10711	\$13730

Tops feature 3mm pvc edge and metal inserts for ease of assembly to base. Also includes eight legs, four 90-degree connectors, four 3-way connectors and eight leg beams.

Required Specifications

Top Finish
Leg Finish
Edge Finish
Edge Style

Optional Specifications

Grommet

Accessories

Power Block

RECTANGULAR TABLES - VENEER

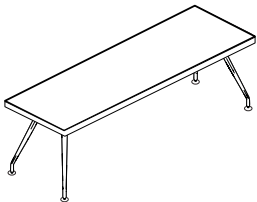

Rectangular Table

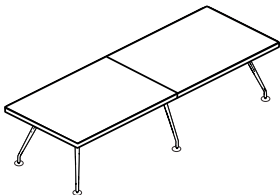

Rectangular Table - 2 piece top

MODEL#	DIMENSIONS D x W x H	FREIGHT CLASS	WT/LBS.	CUBIC FT.	FV EDGE	KV EDGE
LKD3648K	36 x 48 x 29-29.5	100	75	4	\$2979	\$3095
LKD3654K	36 x 54 x 29-29.5	92.5	81	4	\$3269	\$3401
LKD3660K	36 x 60 x 29-29.5	100	88	5	\$3492	\$3639
LKD3666K	36 x 66 x 29-29.5	100	95	5	\$3715	\$3877
LKD3672K	36 x 72 x 29-29.5	92.5	101	5	\$3938	\$4111
LKD3678K	36 x 78 x 29-29.5	92.5	105	5	\$4162	\$4353
LKD3684K	36 x 84 x 29-29.5	92.5	108	5	\$4387	\$4592
LKD3696K	36 x 96 x 29-29.5	100	115	6	\$4834	\$5068
LKD4248K	42 x 48 x 29-29.5	92.5	87	4	\$3272	\$3408
LKD4254K	42 x 54 x 29-29.5	100	90	5	\$3596	\$3750
LKD4260K	42 x 60 x 29-29.5	100	94	5	\$3856	\$4026
LKD4266K	42 x 66 x 29-29.5	92.5	101	5	\$4114	\$4301
LKD4272K	42 x 72 x 29-29.5	92.5	106	5	\$4373	\$4578
LKD4278K	42 x 78 x 29-29.5	100	110	6	\$4633	\$4852
LKD4284K	42 x 84 x 29-29.5	100	113	6	\$4890	\$5129
LKD4296K	42 x 96 x 29-29.5	92.5	129	6	\$5409	\$5678
LKD4854K	48 x 54 x 29-29.5	100	94	5	\$3926	\$4104
LKD4860K	48 x 60 x 29-29.5	100	99	5	\$4218	\$4414
LKD4866K	48 x 66 x 29-29.5	100	107	6	\$4513	\$4727
LKD4872K	48 x 72 x 29-29.5	100	114	6	\$4806	\$5040
LKD4878K	48 x 78 x 29-29.5	92.5	120	6	\$5100	\$5355
LKD4884K	48 x 84 x 29-29.5	92.5	125	6	\$5395	\$5665
LKD4896K	48 x 96 x 29-29.5	92.5	149	7	\$5982	\$6293

Tops feature hardwood edge and metal inserts for ease of assembly to base. Also includes four legs, four 90-degree connectors and four leg beams.

LKD36108K	36 x 108 x 29-29.5	125	154	7	\$5971	\$6233
LKD36120K	36 x 120 x 29-29.5	125	164	8	\$6419	\$6709
LKD42108K	42 x 108 x 29-29.5	150	124	8	\$6625	\$6930
LKD42120K	42 x 120 x 29-29.5	150	141	9	\$7141	\$7480
LKD48108K	48 x 108 x 29-29.5	150	127	9	\$7275	\$7622
LKD48120K	48 x 120 x 29-29.5	150	151	9	\$7863	\$8248
LKD48132K	48 x 132 x 29-29.5	150	164	10	\$8450	\$8876
LKD48144K	48 x 144 x 29-29.5	125	181	10	\$9038	\$9499
LKD48156K	48 x 156 x 29-29.5	150	191	11	\$9627	\$10128
LKD48168K	48 x 168 x 29-29.5	125	206	11	\$10214	\$10752
LKD48180K	48 x 180 x 29-29.5	125	220	12	\$10802	\$11380
LKD54144K	54 x 144 x 29-29.5	150	193	11	\$9965	\$10486
LKD54168K	54 x 168 x 29-29.5	150	214	12	\$11281	\$11890
LKD60144K	60 x 144 x 29-29.5	150	206	12	\$10829	\$11407
LKD60168K	60 x 168 x 29-29.5	150	227	13	\$12284	\$12959

Tops feature hardwood edge and metal inserts for ease of assembly to base. Also includes six legs, four 90-degree connectors, two 3-way connectors and four leg beams.

Required Specifications

Top Finish
Leg Finish
Edge Style

Optional Specifications

Grommet

Accessories

Power Block

RECTANGULAR TABLES - VENEER

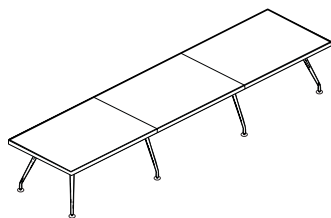

Rectangular Table - 3 piece top

MODEL# DIMENSIONS FREIGHT CLASS WT/LBS. CUBIC FT. FV EDGE KV EDGE

	D x W x H					
LKD48192K	48 x 192 x 29-29.5	150	279	14	\$12092	\$12707
LKD54192K	54 x 192 x 29-29.5	150	288	15	\$13305	\$13998
LKD54216K	54 x 216 x 29-29.5	150	270	16	\$14622	\$15401
LKD54240K	54 x 240 x 29-29.5	150	298	17	\$15937	\$16802
LKD60192K	60 x 192 x 29-29.5	150	257	16	\$14456	\$15226
LKD60216K	60 x 216 x 29-29.5	150	283	17	\$15911	\$16776
LKD60240K	60 x 240 x 29-29.5	150	311	18	\$17367	\$18327

Tops feature hardwood edge and metal inserts for ease of assembly to base. Also includes eight legs, four 90-degree connectors, four 3-way connectors and eight leg beams.

Required Specifications

Top Finish
Leg Finish
Edge Style

Optional Specifications

Grommet

Accessories

Power Block

WIRE MANAGEMENT



Cable Snake

MODEL #	DIMENSIONS D x W x H	FREIGHT CLASS	WT/LB.	CUBIC FT.	LIST PRICE
PCSN01	-- x -- x --	92.5	2.10	.20	\$135

Flexible cable management. Provides access to power/data from floor to underside of worksurface where it attaches. Two pathways within Cable Snake. Length under desk is 31.25". Silver (**SIL**) plastic only.



Cable Snake

BRTCS	2 x 8 x 30	70	3	.19	\$152
-------	------------	----	---	-----	--------------

Flexible cable management trough. Two pathways within the snake, one for data/communication and one for routing power cables. Translucent White finish only.

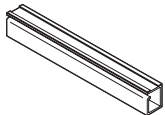

Wire Manager

PEWM5.5	2 x 66 x 2	70	.60	.10	\$198
PEWM5	2 x 60 x 2	70	.60	.10	\$166
PEWM4.5	2 x 54 x 2	70	.50	.10	\$148
PEWM4	2 x 48 x 2	70	.50	.10	\$135
PEWM3.5	2 x 42 x 2	70	.40	.10	\$116
PEWM3	2 x 36 x 2	70	.40	.10	\$104
PEWM2.5	2 x 30 x 2	70	.30	.10	\$85
PEWM2	2 x 24 x 2	70	.30	.10	\$70
PEWM1.5	2 x 18 x 2	70	.20	.10	\$55
PEWM1	2 x 12 x 2	70	.20	.10	\$40

Plastic tray flexes to receive and hold electrical and data wires. Quickly attaches with two strips of double-sided tape. Black (**BLK**) only.

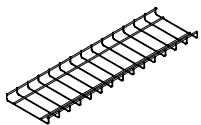

Power/Data Cable Basket

BRTCB76KIT	8 x 34 x 1	70	1.56	.15	\$263
BRTCB70	8 x 70 x 1	100	3.22	.34	\$191
BRTCB64	8 x 64 x 1	92.5	2.94	.29	\$178
BRTCB58	8 x 58 x 1	92.5	2.66	.26	\$172
BRTCB52	8 x 52 x 1	100	2.39	.24	\$162
BRTCB46	8 x 46 x 1	92.5	2.16	.21	\$153
BRTCB40	8 x 40 x 1	70	1.80	.18	\$145
BRTCB34	8 x 34 x 1	70	1.56	.15	\$139
BRTCB28	8 x 28 x 1	70	1.20	.13	\$123
BRTCB22	8 x 22 x 1	70	1.01	.10	\$115
BRTCB16	8 x 16 x 1	70	.73	.07	\$108
BRTCB8	8 x 8 x 1	70	.36	.03	\$97

Shallow, 8" wide basket manages cable excess and serves to manage cords and cables. It can be easily unclipped from spring steel brackets (included) to rearrange cable connections from below worksurface. Spring steel brackets can suspend the Cable Basket below the worksurface where it keeps the cords and cables off the floor and manages them along the horizontal plane - between floor monuments and Storage Vertical Cable Manager, for example. Tall storage cabinet's legs provide easy access to the Cable Basket where it can easily be unclipped from spring steel brackets to rearrange cable connections. Steel wire construction, chrome finish baskets; black spring steel hanging brackets, fasteners.

SWAP TABLES

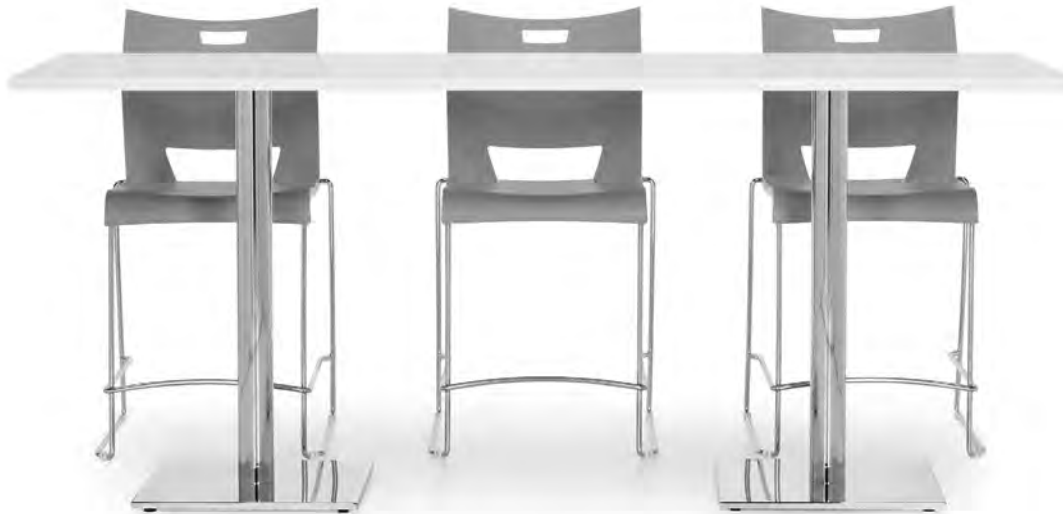

Global's Swap collection is a comprehensive offering including laptop tables, casual meeting tables, café tables, huddle tables and more. Suitable for a variety of applications: break rooms, dedicated/enclosed meeting rooms, casual/open area meeting spaces (lounge, seated, counter and bar height options), and private office (accommodate smaller 3-4 person discussions). Tops and bases are sold separately for ease of specification. Mix and match capabilities to create spaces for multi-purpose use. Choose your top, choose your base. Create the combination you desire for the way you want to work.

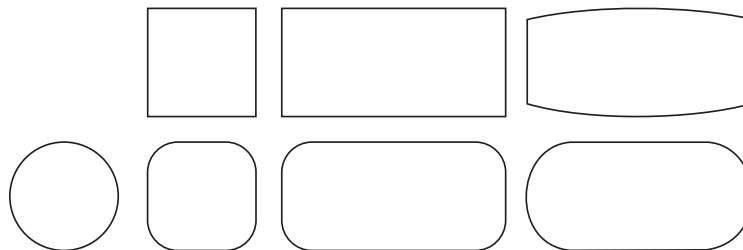

Top shapes



1/2" thick steel square and round metal bases



Optional power & data modules (on select top sizes)



Factory installed metal inserts for easy metal-to-metal base connection

Features and Benefits

- Tops are available in various materials to help perfect your interior design. Material choices include: (1) thermally fused laminate, (2) high pressure laminate (3) veneer and (4) solid surface.
- (1) High performance thermally fused laminate tops are 1" thick, with 45 lb. density particle board and feature 2mm thick edgeband.
- (2) High pressure laminate tops are 1-3/16" thick, with either 2mm flat edge or knife edge profiles. Tops with flat edge have 45 lb. density particle board core, tops with knife edge have MDF core.
- (3) Veneer tops are 1-3/16" thick overall with matching flat edge or knife edge
- (4) Solid surface tops are 1-1/4" thick with a plywood or particleboard melamine subtop depending on size, available with flat edge or knife edge
- Bases are constructed of a solid steel metal plate and cover - round or square.
- Power block cut-outs are available on most tables.
- 6 heights:
Coffee table height at 16"H
End table height at 22"H
Lounge height at 27"H
Seated height at 29"H
Counter height at 36"H
Bar height at 41.5"H

GENERAL INFORMATION

- Swap is a series of tables for use in casual meeting spaces, lounges, café areas and more.
- The right proportions, flawless surfaces and a solid foundation is sure to become your favorite table series to spec.
- Finish palette coordinates with most Global laminate and veneer casegoods series, as well as a variety of solid surface options to choose from – tables can stand-alone or blend with other solutions.
- Each component is packed individually. Bases are shipped assembled, 1 per carton. Easy to assemble.
- Global's counter and bar height stools are a perfect compliment to Swap tables with counter and bar height bases.
- For environmental certifications, please visit globalfurnituregroup.com

WORKSURFACES

- **Four** material choices: high performance thermally fused laminate, high pressure laminate, veneer and solid surface.
- **Thermally fused laminate** tops are 1" thick overall, constructed of 45 lb. density particle board core; 2 mm thick flat edge band to match, contrast with, or complement the top surface or corresponding base finish.
- **High pressure laminate** tops are 1-3/16" thick overall with choice of edge detail. 2mm thick flat edge to match, contrast with or complement the top surface or corresponding base finish on a 45lbs density particle board core. Also available with knife edge detail; edge finish would match top surface; core material is MDF. Recommended for counter applications or other high use areas. Product codes with **suffix LK** indicate high pressure laminate with knife edge.
- **Veneer** tops are 1-3/16" thick overall with choice of edge detail - flat edge or knife edge. Edge finish to correspond to surface finish. When flat edge, core material is 45 lbs density particle board; when knife edge, core material is MDF. Product codes with **suffix V** indicate veneer.
- **Solid surface** tops are 1.25" thick overall with choice of edge detail - flat edge or knife edge. Solid surface material is 0.5" thick with built up edge profile over a particle board or plywood subtop depending on overall top size. Product codes with **suffix SF** indicate solid surface with flat edge; product codes with **suffix SK** indicate solid surface with knife edge. There is no edge finish selection on solid surface tops. For detailed material information, please reference WilsonArt's Solid Surface collection.
- Please see model # for pricing and availability of various material and edge options.
- Refer to 653 or the Global website for available finish options
- While not all sizes are available in all materials:
 - Worksurfaces of 96" or less in length are standard in one piece (1 carton)
 - Worksurfaces 120" to 144" in length are standard in two pieces (2 cartons)
 - Worksurfaces 96", 120" and 144" x 48" include support channels

BASES

- **Caution:** to meet BIFMA standards for performance and stability, appropriate base size must be specified with corresponding top sizes identified. **Top plates and base plates vary by base size and will only work with table shape sizes as referenced on the following pages.**
- Bases are constructed of a round or square solid steel metal plate for counter balance, covered with a finished steel shroud, affixed with four bolts to a 3" diameter cold rolled steel tube.
- GRB14H25 attach to tops with a 6" x 6" steel plate, welded to a 1.5" diameter steel tube, bolted to a 0.5" thick solid steel counter balance. Not to be used on tops greater than 22" x 22" in size.
- GSB13H25 and GSOB13H25 attach to tops with a 6" x 6" steel plate, welded to a 1.5" diameter steel tube, bolted to a 0.5" thick solid steel counter balance. Not to be used on tops greater than 22" x 22" in size.
- GRB22H15, GRB22H21, GRB22H26, GRB22, GRB22H35, GRB22H41, GSB19H15, GSB19H21, GSB19H26,w GSB19, GSB19H35 and GSB19H41 attach to tops with a 6" x 6" steel plate, welded to a 3" diameter steel tube, bolted to a 0.5" thick solid steel counter balance.
- GRB28, GRB34, GSB23 and GSB28 attach to tops with an 11" x 11" steel plate, welded to a 4" diameter steel tube, bolted to a 0.375" thick solid steel counter balance.
- Bases are available PAINTED in "Sandtex" finish for extra durability. Also available in plated finishes (see 653) at an upcharge and with an extended lead time. Please see model # for pricing.
- All bases include six height adjustable glides with 0.75" of adjustability.
- Round bases available in 22", 28" and 34" dia.
- Square bases available in 18.5", 22.5" and 28.5".

1. SPECIFY MODEL NUMBER

2. SPECIFY FINISHES

Laminate Finishes (thermally fused and high pressure laminates):

ACJ	Absolute Acajou	FCL	First Class
ASN	Asian Night	NBL	Noce Biondo
AWC	Avant Cherry	NGL	Noce Grigio
AWH	Avant Honey	NEL	Noce Leggero
BLK	Black	NML	Noce Medio
BZD	Blizzard	QTM	Quartered Mahogany
BRC	Brushed Cobalt	SBY	Sheer Beauty
CMB	Clear Maple	SOG	Storm Grey
CGY	Custom Grey	SDT	Stonedust
DES	Dark Espresso	WHE	Walnut Heights
DWT	Designer White	WHC	White Chocolate
FAS	Fashionista	WCR	Winter Cherry

VNW	Vintage Cherry	Cherry	Flat Sliced
WLW	Walnut	Walnut	Flat Sliced
WCW	Warm Cherry	Cherry	Flat Sliced
WMW	White Maple	Maple	Flat Sliced

Solid Surface (applicable for product codes ending in **SF** or **SK** only):

Grade 1			
SWH Designer White			
Grade 2 (upcharge applies)			
SBT	Beige Tempest	SHS	Hot Stone
SBX	Black Onyx Mirage	SFW	Frosty White Mirage
SMG	Milk Glass Spectra	SNM	Northern Melange

Veneer Finishes (applicable for product codes ending in **V** only):

Code	Finish	Veneer Type	Cut
AMW	Almond Cherry	Cherry	Flat Sliced
ACW	Amber Cherry	Cherry	Flat Sliced
BTW	Biscotti	White Oak	Rift
CAW	Cocoa Walnut	Walnut	Flat Sliced
CRW	Coral	White Oak	Rift
DCW	Dark Cherry	Cherry	Flat Sliced
DWW	Dark Walnut	Walnut	Flat Sliced
EWV	Espresso Walnut	Walnut	Flat Sliced
EVW	Evening Oak	White Oak	Rift
GRW	Grey on Oak	White Oak	Rift
HAW	Hazelnut	Maple	Flat Sliced
JAW	Java	White Oak	Rift
LTW	Latte Walnut	Walnut	Flat Sliced
MHW	Mahogany on Walnut	Walnut	Flat Sliced
MTW	Milestone	White Oak	Rift
MPW	Natural Maple	Maple	Flat Sliced
NLW	Natural Walnut	Walnut	Flat Sliced
RCW	Red Cherry	Cherry	Flat Sliced
ULW	Umber Walnut	Walnut	Flat Sliced

Bases (paint):			
TBL	Black	TIN	Ink
TBZ	Buzz Blue	TKA	Kalua
TCC	Cactus	TLA	Latte
TCR	Carrot	TMO	Mocha
TIV	Cloud	TNE	Nevada
TDW	Designer White	TSN	Sand
TDJ	Dijon	TSR	Scarlet
TEG	Eggplant	TSH	Shadow
TFO	Fog	TOA	Toast
TFR	Frost	TTU	Tungsten

Bases (plated) (upcharge applies):

CHM	Polished Chrome
BCH	Brushed Chrome
ACO	Antique Copper
SBR	Satin Brass

3. SPECIFY EDGE PROFILE (where applicable)

Thermally fused laminate and HP with flat edge:

- Default profile **FE** - Flat edge
- **R3** optional for 3" radiused corners, excluding round tops, racetrack and boatshaped

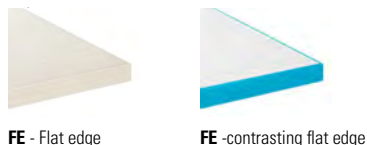

Solid surface tops product codes ending in **SF**:

- Default profile **FE** - Flat edge
- **R3** optional for 3" radiused corners, excluding round tops

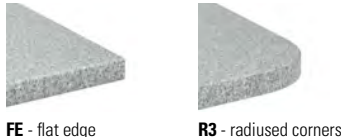

High pressure laminate tops product codes ending in **LK**, always knife edge.



Solid surface tops product codes ending in **SK**:

- Default profile **KS** - Knife Edge
- **KR** optional for knife edge with 3" radiused corners, excluding round tops



Veneer tops product codes ending in **V**:

- Default profile **FE** - Flat Edge
- **KS** optional for knife edge

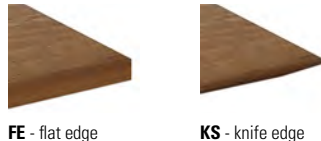

4. SPECIFY EDGE FINISH

Edge finish only applicable for thermally fused laminate tops and HPL tops with FE flat edge

AAE Absolute Acajou	FCL First Class
ASE Asian Night	FOG Fog
ACE Avant Cherry	LAB Latte
AHE Avant Honey	NBL Noce Biondo
BLK Black	NGL Noce Grigio
BZD Blizzard	NEL Noce Leggero
BRC Brushed Cobalt	NML Noce Medio
BZB Buzz Blue	QTM Quartered Mahogany
CCT Cactus	SAR Scarlet
CRO Carrot	SBY Sheer Beauty
CME Clear Maple	SHW Shadow
CGY Custom Grey	SDT Stonedust
DEE Dark Espresso	SOG Storm Grey
DWE Designer White	WHE Walnut Heights
DJN Dijon	CBE White Chocolate
FAS Fashionista	WCE Winter Cherry

5. SPECIFY OPTIONS



POWER BLOCKS AND CUT-OUT LOCATIONS

- A power block delivers power/data to the table surface
- Power block modules are ordered separately
- Not all power block locations are available on all table sizes. Please refer to the top/base chart on the following pages for more information.
- To purchase a power block, you must specify the power block cut-out location when ordering the top and order the power block separately.
- Optional cut-out available in standard worksurface locations (left, center or right) for all table shapes.
- Order as **E1, M1, R1, T1, V1**, etc. **Add \$96** for each cut-out.
- Cut-outs may be placed in non-standard locations.
- Order as **ES, MS, RS, TS**, or **VS - Add \$96**.

A drawing must be supplied with vertical and horizontal dimensions to the center of the cut-out. Please refer to the CUSTOM GROMMET LOCATION FORM in the back reference section. Cut-outs may NOT be placed directly over the bases.

- Select power block from Productivity Solutions, beginning on page 491.

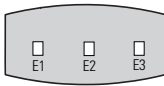
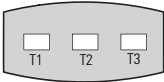
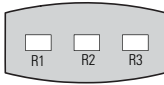
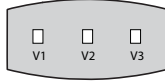
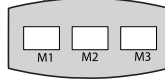
POWER BLOCK OPTIONS AND CUT-OUT LOCATIONS

PMSPPM		PRTMCD602B PRTMCD602T PRTMCD602W PRTMCD622B PRTMCD622T	
PRTMCS401B PRTMCS401T PRTMCS401W PRTMCS421B PRTMCS421T PRTMCS421W		PRTMCD622W PRTMCD642B PRTMCD642T PRTMCD642W	
VILLA			
*OASIS MINI A			
*OASIS MINI B			

*M cut-out not available on Solid Surface tops



TABLE NOTES - ESTIMATED CAPACITY

- Use the following to determine the size of a table and the number of chairs needed for a conference area.
- All estimates are based on an average chair width of 23" with a 4" clearance between chairs. Adjust accordingly for a different chair size.

Top Size	NUMBER OF CHAIRS					
	Round	Square	Rectangular	Boat	Racetrack	
24 x 24	2	2	N/A	N/A	N/A	
24 x 30	N/A	N/A	2-3	N/A	N/A	
24 x 36	N/A	N/A	3-4	N/A	N/A	
30 x 30	3	4	N/A	N/A	N/A	
30 x 36	N/A	N/A	4	N/A	N/A	
30 x 42	N/A	N/A	4	N/A	N/A	
36 x 36	4	4	N/A	N/A	N/A	
36 x 42	N/A	N/A	4	N/A	N/A	
42 x 42	4	4	N/A	N/A	N/A	
48 x 48	4	4	N/A	N/A	N/A	
54 x 54	5	6	N/A	N/A	N/A	
60 x 60	5	6	N/A	N/A	N/A	
24 x 60	N/A	N/A	4-6	N/A	N/A	
24 x 66	N/A	N/A	4-6	N/A	N/A	
24 x 72	N/A	N/A	4-6	N/A	N/A	
24 x 84	N/A	N/A	4-6	N/A	N/A	
24 x 96	N/A	N/A	6-8	N/A	N/A	
30 x 60	N/A	N/A	4-6	4-6	4-6	
30 x 66	N/A	N/A	4-6	4-6	4-6	
30 x 72	N/A	N/A	4-6	4-6	4-6	
30 x 84	N/A	N/A	4-6	4-6	4-6	
30 x 96	N/A	N/A	6-8	6-8	6-8	
36 x 60	N/A	N/A	4-6	4-6	4-6	
36 x 66	N/A	N/A	4-6	4-6	4-6	
36 x 72	N/A	N/A	4-6	4-6	4-6	
36 x 84	N/A	N/A	4-6	4-6	4-6	
36 x 96	N/A	N/A	6-8	6-8	6-8	
48 x 84	N/A	N/A	6-8	6-8	6-8	
48 x 96	N/A	N/A	6-8	6-8	6-8	
48 x 120	N/A	N/A	8-10	8-10	8-10	
48 x 144	N/A	N/A	10-12	10-12	10-12	





S SWAP TABLES - NOTES

APPLICABLE BASE OPTIONS FOR CORRESPONDING TOP											POWER MGMT OPTIONS	
Table Shape/Size	Model # for Top	Lounge Height 27"H		Seated Height 28.5"H		Counter Height 36"H		Bar Height 41.5"H		Base Qty.	# top pieces	Optional cut-outs in tops applicable for power modules ordered separately
		Round base 22"	Square base 19"	Round base 22", 28", 34"	Square base 18.5", 22.5", 28.5"	Round base 22"	Square base 18.5"	Round base 22"	Square base 18.5"			
Round ○												
Nominal base plate dimension indicated by 4th and 5th characters in base model numbers.												
24" diameter	GRBTP24_	GRB22H26	GSB19H26	GRB22	GSB19	GRB22H35	GSB19H35	GRB22H41	GSB19H41	1	1	None
30" diameter	GRBTP30_	GRB22H26	GSB19H26	GRB22	GSB19	GRB22H35	GSB19H35	GRB22H41	GSB19H41	1	1	None
36" diameter	GRBTP36_	GRB22H26	GSB19H26	GRB22	GSB19	GRB22H35	GSB19H35	GRB22H41	GSB19H41	1	1	None
42" diameter	GRBTP42_	N/A	N/A	GRB28	GSB23	N/A	N/A	N/A		1	1	None
48" diameter	GRBTP48_	N/A	N/A	GRB28	GSB23	N/A	N/A	N/A		1	1	None
54" diameter	GRBTP54_	N/A	N/A	GRB34	GSB28	N/A	N/A	N/A		1	1	None
60" diameter	GRBTP60_	N/A	N/A	GRB34	GSB28	N/A	N/A	N/A		1	1	None
Square □												
24" square	GSBTP24_	GRB22H26	GSB19H26	GRB22	GSB19	GRB22H35	GSB19H35	GRB22H41	GSB19H41	1	1	None
30" square	GSBTP30_	GRB22H26	GSB19H26	GRB22	GSB19	GRB22H35	GSB19H35	GRB22H41	GSB19H41	1	1	None
36" square	GSBTP36_	GRB22H26	GSB19H26	GRB22	GSB19	GRB22H35	GSB19H35	GRB22H41	GSB19H41	1	1	None
42" square	GSBTP42_	N/A	N/A	GRB28	GSB23	N/A	N/A	N/A	N/A	1	1	None
54" square	GSBTP54_	N/A	N/A	N/A	N/A	N/A	N/A	N/A	N/A	1	1	None
60" square	GSBTP60_	N/A	N/A	N/A	N/A	N/A	N/A	N/A	N/A	1	1	None
Rectangular ▭												
30x24 Rectangular	GSBTP2430_	GRB22H26	GSB19H26	GRB22	GSB19	GRB22H35	GSB19H35	GRB22H41	GSB19H41	1	1	None
36x24 Rectangular	GSBTP2436_	GRB22H26	GSB19H26	GRB22	GSB19	GRB22H35	GSB19H35	GRB22H41	GSB19H41	1	1	None
36x30 Rectangular	GSBTP3036_	GRB22H26	GSB19H26	GRB22	GSB19	GRB22H35	GSB19H35	GRB22H41	GSB19H41	1	1	None
42x30 Rectangular	GSBTP3042_	N/A	N/A	GRB28	GSB23	N/A	N/A	N/A	N/A	1	1	None
42x36 Rectangular	GSBTP3642_	N/A	N/A	GRB28	GSB23	N/A	N/A	N/A	N/A	1	1	None
60x24 Rectangular	GRT5STP_	GRB22H26	GSB19H26	N/A	N/A	GRB22H35	GSB19H35	GRB22H41	GSB19H41	2	1	Center: A2, E2, J2, K2, M2, R2, T2, U2, V2
66x24 Rectangular	GRT5HSTP_	GRB22H26	GSB19H26	N/A	N/A	GRB22H35	GSB19H35	GRB22H41	GSB19H41	2	1	
72x24 Rectangular	GRT6STP_	GRB22H26	GSB19H26	N/A	N/A	GRB22H35	GSB19H35	GRB22H41	GSB19H41	2	1	
84x24 Rectangular	GRT7STP_	GRB22H26	GSB19H26	N/A	N/A	GRB22H35	GSB19H35	GRB22H41	GSB19H41	2	1	3 positions - Left/ Center/Right
96x24 Rectangular	GRT8STP_	GRB22H26	GSB19H26	N/A	N/A	GRB22H35	GSB19H35	GRB22H41	GSB19H41	2	1	
60x30 Rectangular	GRT5NTP_	GRB22H26	GSB19H26	GRB22	GSB19	GRB22H35	GSB19H35	GRB22H41	GSB19H41	2	1	Center: A2, E2, J2, K2, M2, R2, T2, U2, V2
60x36 Rectangular	GRT5TP_	GRB22H26	GSB19H26	GRB22	GSB19	GRB22H35	GSB19H35	GRB22H41	GSB19H41	2	1	
66x30 Rectangular	GRT5NHTP_	GRB22H26	GSB19H26	GRB22	GSB19	GRB22H35	GSB19H35	GRB22H41	GSB19H41	2	1	
66x36 Rectangular	GRT5HTP_	GRB22H26	GSB19H26	GRB22	GSB19	GRB22H35	GSB19H35	GRB22H41	GSB19H41	2	1	
72x30 Rectangular	GRT6NTP_	GRB22H26	GSB19H26	GRB22	GSB19	GRB22H35	GSB19H35	GRB22H41	GSB19H41	2	1	
72x36 Rectangular	GRT6TP_	GRB22H26	GSB19H26	GRB22	GSB19	GRB22H35	GSB19H35	GRB22H41	GSB19H41	2	1	3 positions - Left/ Center/Right A1/2/3, E1/2/3, J1/2/3, K1/2/3, M1/2/3, R1/2/3, T1/2/3, U1/2/3, V1/2/3
84x30 Rectangular	GRT7NTP_	GRB22H26	GSB19H26	GRB22	GSB19	GRB22H35	GSB19H35	GRB22H41	GSB19H41	2	1	
84x36 Rectangular	GRT7TP_	GRB22H26	GSB19H26	GRB22	GSB19	GRB22H35	GSB19H35	GRB22H41	GSB19H41	2	1	
96x30 Rectangular	GRT8NTP_	GRB22H26	GSB19H26	GRB22	GSB19	GRB22H35	GSB19H35	GRB22H41	GSB19H41	2	1	
96x36 Rectangular	GRT8TP_	GRB22H26	GSB19H26	GRB22	GSB19	GRB22H35	GSB19H35	GRB22H41	GSB19H41	2	1	
96x42 Rectangular	GRT8MTP_	N/A	N/A	GRB28	GSB23	N/A	N/A	N/A	N/A	2	1	Both ends: A1/3, E1/3, J1/3, K1/3, M1/3, R1/3, T1/3, U1/3, V1/3
96x48 Rectangular	GRT8WTP_	N/A	N/A	GRB28	GSB23	N/A	N/A	N/A	N/A	2	1	
120x48 Rectangular	GRT10WTP_	N/A	N/A	GRB28	GSB23	N/A	N/A	N/A	N/A	3	2	Both ends: A1/3, E1/3, J1/3, K1/3, M1/3, R1/3, T1/3, U1/3, V1/3
144x48 Rectangular	GRT12WTP_	N/A	N/A	GRB28	GSB23	N/A	N/A	N/A	N/A	3	2	

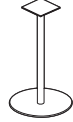
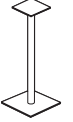
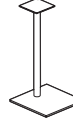
APPLICABLE BASE OPTIONS FOR CORRESPONDING TOP											POWER MGMT OPTIONS	
Table Shape/Size	Model # for Top	Lounge Height 27"H		Seated Height 28.5"H		Counter Height 36"H		Bar Height 41.5"h		Base Qty.	# top pieces	Optional cut-outs in tops applicable for power modules ordered separately
		Round base 22"	Square base 19"	Round base 22", 28", 34"	Square base 18.5", 22.5", 28.5"	Round base 22"	Square base 18.5"	Round base 22"	Square base 18.5"			
Racetrack  Nominal base plate dimension indicated by 4th and 5th characters in base model numbers.												
60x24 Racetrack	GRC5STP_	GRB22H26	GSB19H26	N/A	N/A	GRB22H35	GSB19H35	GRB22H41	GSB19H41	2	1	Center: A2, E2, J2, K2, M2, R2, T2, U2, V2
66x24 Racetrack	GRC5HSTP_	GRB22H26	GSB19H26	N/A	N/A	GRB22H35	GSB19H35	GRB22H41	GSB19H41	2	1	
72x24 Racetrack	GRC6STP_	GRB22H26	GSB19H26	N/A	N/A	GRB22H35	GSB19H35	GRB22H41	GSB19H41	2	1	
84x24 Racetrack	GRC7STP_	GRB22H26	GSB19H26	N/A	N/A	GRB22H35	GSB19H35	GRB22H41	GSB19H41	2	1	3 positions - Left/ Center/Right
96x24 Racetrack	GRC8STP_	GRB22H26	GSB19H26	N/A	N/A	GRB22H35	GSB19H35	GRB22H41	GSB19H41	2	1	
60x30 Racetrack	GRC5NTP_	GRB22H26	GSB19H26	GRB22	GSB19	GRB22H35	GSB19H35	GRB22H41	GSB19H41	2	1	Center: A2, E2, J2, K2, M2, R2, T2, U2, V2
60x36 Racetrack	GRC5TP_	GRB22H26	GSB19H26	GRB22	GSB19	GRB22H35	GSB19H35	GRB22H41	GSB19H41	2	1	
66x30 Racetrack	GRC5NHTP_	GRB22H26	GSB19H26	GRB22	GSB19	GRB22H35	GSB19H35	GRB22H41	GSB19H41	2	1	
66x36 Racetrack	GRC5HTP_	GRB22H26	GSB19H26	GRB22	GSB19	GRB22H35	GSB19H35	GRB22H41	GSB19H41	2	1	
72x30 Racetrack	GRC6NTP_	GRB22H26	GSB19H26	GRB22	GSB19	GRB22H35	GSB19H35	GRB22H41	GSB19H41	2	1	
72x36 Racetrack	GRC6TP_	GRB22H26	GSB19H26	GRB22	GSB19	GRB22H35	GSB19H35	GRB22H41	GSB19H41	2	1	
84x30 Racetrack	GRC7NTP_	GRB22H26	GSB19H26	GRB22	GSB19	GRB22H35	GSB19H35	GRB22H41	GSB19H41	2	1	3 positions - Left/ Center/Right (E1/2/3, V1/2/3; M1/2/3, A1/2/3, J1/2/3, K1/2/3, R1/2/3, T1/2/3, U1/2/3
84x36 Racetrack	GRC7TP_	GRB22H26	GSB19H26	GRB22	GSB19	GRB22H35	GSB19H35	GRB22H41	GSB19H41	2	1	
96x30 Racetrack	GRC8NTP_	GRB22H26	GSB19H26	GRB22	GSB19	GRB22H35	GSB19H35	GRB22H41	GSB19H41	2	1	
96x36 Racetrack	GRC8TP_	GRB22H26	GSB19H26	GRB22	GSB19	GRB22H35	GSB19H35	GRB22H41	GSB19H41	2	1	
96x42 Racetrack	GRC8MTP_	N/A	N/A	GRB28	GSB23	N/A	N/A	N/A	N/A	2	1	
96x48 Racetrack	GRC8WTP_	N/A	N/A	GRB28	GSB23	N/A	N/A	N/A	N/A	2	1	
120x48 Racetrack	GRC10WTP_	N/A	N/A	GRB28	GSB23	N/A	N/A	N/A	N/A	3	2	Both ends: A1/3, E1/3, J1/3, K1/3, M1/3, R1/3, T1/3, U1/3
144x48 Racetrack	GRC12WTP_	N/A	N/A	GRB28	GSB23	N/A	N/A	N/A	N/A	3	2	
Boat Shape 												
60x30 Boat shape	GBT5NTP_	GRB22H26	GSB19H26	GRB22	GSB19	GRB22H35	GSB19H35	GRB22H41	GSB19H41	2	1	Center: A2, E2, J2, K2, M2, R2, T2, U2, V2
60x36 Boat shape	GBT5TP_	GRB22H26	GSB19H26	GRB22	GSB19	GRB22H35	GSB19H35	GRB22H41	GSB19H41	2	1	
66x30 Boat shape	GBT5NHTP_	GRB22H26	GSB19H26	GRB22	GSB19	GRB22H35	GSB19H35	GRB22H41	GSB19H41	2	1	
66x36 Boat shape	GBT5HTP_	GRB22H26	GSB19H26	GRB22	GSB19	GRB22H35	GSB19H35	GRB22H41	GSB19H41	2	1	
72x30 Boat shape	GBT6NTP_	GRB22H26	GSB19H26	GRB22	GSB19	GRB22H35	GSB19H35	GRB22H41	GSB19H41	2	1	
72x36 Boat shape	GBT6TP_	GRB22H26	GSB19H26	GRB22	GSB19	GRB22H35	GSB19H35	GRB22H41	GSB19H41	2	1	
84x30 Boat shape	GBT7NTP_	GRB22H26	GSB19H26	GRB22	GSB19	GRB22H35	GSB19H35	GRB22H41	GSB19H41	2	1	3 positions - Left/ Center/Right A1/2/3, E1/2/3, J1/2/3, K1/2/3, M1/2/3, R1/2/3, T1/2/3, U1/2/3, V1/2/3
84x36 Boat shape	GBT7TP_	GRB22H26	GSB19H26	GRB22	GSB19	GRB22H35	GSB19H35	GRB22H41	GSB19H41	2	1	
96x30 Boat shape	GBT8NTP_	GRB22H26	GSB19H26	GRB22	GSB19	GRB22H35	GSB19H35	GRB22H41	GSB19H41	2	1	
96x36 Boat shape	GBT8TP_	GRB22H26	GSB19H26	GRB22	GSB19	GRB22H35	GSB19H35	GRB22H41	GSB19H41	2	1	
96x42 Boat shape	GBT8MTP_	N/A	N/A	GRB28	GSB23	N/A	N/A	N/A	N/A	2	1	
96x48 Boat shape	GBT8WTP_	N/A	N/A	GRB28	GSB23	N/A	N/A	N/A	N/A	2	1	
120x48 Boat shape	GBT10WTP_	N/A	N/A	GRB28	GSB23	N/A	N/A	N/A	N/A	3	2	Both ends: A1/3, E1/3, J1/3, K1/3, M1/3, R1/3, T1/3, U1/3, V1/3
144x48 Boat shape	GBT12WTP_	N/A	N/A	GRB28	GSB23	N/A	N/A	N/A	N/A	3	2	

S SWAP TABLES - NOTES

APPLICABLE BASE OPTIONS FOR CORRESPONDING TOP						POWER MGMT OPTIONS		
Table Shape/Size	Model # for Top	Laptop height 25.6"H				Base Qty.	# top pieces	Optional cut-outs in tops applicable for power modules ordered separately
		Round base 14" Centered column 	Square base 12.5" Centered column 	Round base N/A	Square base 12.5" Offset column 			
Round Laptop Tables <input type="radio"/> <i>Nominal base plate dimension indicated by 4th and 5th characters in base model numbers.</i>								
16.5" dia centered base	GRBTP16_	GRB14H25	GSB13H25	N/A	N/A	1	1	None
20" dia centered base	GRBTP20_	GRB14H25	GSB13H25	N/A	N/A	1	1	None
22" dia centered base	GRBTP22_	GRB14H25	GSB13H25	N/A	N/A	1	1	None
16.5" dia offset base	GRBOTP16_	N/A	N/A	N/A	GSOB13H25	1	1	None
20" dia offset base	GRBOTP20_	N/A	N/A	N/A	GSOB13H25	1	1	None
22" dia offset base	GRBOTP22_	N/A	N/A	N/A	GSOB13H25	1	1	None
Square Laptop Tables <input type="checkbox"/>								
16.5"x16.5" centered base	GSBTP16_	GRB14H25	GSB13H25	N/A	N/A	1	1	None
20"x20" centered base	GSBTP20_	GRB14H25	GSB13H25	N/A	N/A	1	1	None
22"x22" centered base	GSBTP22_	GRB14H25	GSB13H25	N/A	N/A	1	1	None
16.5"x16.5" offset base	GSBOTP16_	N/A	N/A	N/A	GSOB13H25	1	1	None
20"x20" offset base	GSBOTP20_	N/A	N/A	N/A	GSOB13H25	1	1	None
22"x22" offset base	GSBOTP22_	N/A	N/A	N/A	GSOB13H25	1	1	None
Rectangular Laptop Tables <input type="checkbox"/>								
16"x20" centered base	GSBTP1620_	GRB14H25	GSB13H25	N/A	N/A	1	1	None
16"x22" centered base	GSBTP1622_	GRB14H25	GSB13H25	N/A	N/A	1	1	None
16"x20" offset base	GSBOT1620_	N/A	N/A	N/A	GSOB13H25	1	1	None
16"x22" offset base	GSBOT1622_	N/A	N/A	N/A	GSOB13H25	1	1	None

APPLICABLE BASE OPTIONS FOR CORRESPONDING TOP						POWER MGMT OPTIONS		
Table Shape/Size	Model # for Top	Coffee Table 16"H		End Table 22"H		Base Qty.	# top pieces	Optional cut-outs in tops applicable for power modules ordered separately
		Round base 22" 	Square base 18.5" 	Round base 22" 	Square base 18.5" 			
Round Coffee/End Tables <input type="radio"/> <i>*Nominal base plate dimension indicated by 4th and 5th characters in base model numbers.</i>								
24" dia	GRBTP24_	GRB22H15	GSB19H15	GRB22H21	GSB19H21	1	1	None
30" dia	GRBTP30_	GRB22H15	GSB19H15	GRB22H21	GSB19H21	1	1	None
36" dia	GRBTP36_	GRB22H15	GSB19H15	GRB22H21	GSB19H21	1	1	None
Square Coffee/End Tables <input type="checkbox"/>								
24" square	GSBTP24_	GRB22H15	GSB19H15	GRB22H21	GSB19H21	1	1	None
30" square	GSBTP30_	GRB22H15	GSB19H15	GRB22H21	GSB19H21	1	1	None
36" square	GSBTP36_	GRB22H15	GSB19H15	GRB22H21	GSB19H21	1	1	None

ROUND LAPTOP TABLES FOR CENTER BASE **MODEL#** **DIMENSIONS** **FREIGHT CLASS** **WT/LBS.** **CUBIC FT.** **LIST PRICE** **HP ADD** **GR. 2 ADD** **R3 ADD** **KS ADD**



Round laptop table for center base

D x W x H

TFL, flat edge ⁽¹⁾

GRBTP16	16 x 16.5 x 1	70	6	0.3	\$214	\$100	n/a	n/a	n/a
GRBTP20	20 x 20 x 1	70	9	0.5	\$245	\$115	n/a	n/a	n/a
GRBTP22	22 x 22 x 1	70	9	0.5	\$277	\$126	n/a	n/a	n/a

HPL, knife edge

GRBTP16LK	16 x 16.5 x 1.19	125	7.5	1	\$525	n/a	n/a	n/a	n/a
GRBTP20LK	20 x 20 x 1.19	125	11	1.5	\$596	n/a	n/a	n/a	n/a
GRBTP22LK	22 x 22 x 1.19	150	11	2	\$645	n/a	n/a	n/a	n/a

Veneer ⁽²⁾

GRBTP16V	16 x 16.5 x 1.19	125	7.5	1	\$790	n/a	n/a	n/a	\$75
GRBTP20V	20 x 20 x 1.19	125	11	1.5	\$856	n/a	n/a	n/a	\$75
GRBTP22V	22 x 22 x 1.19	150	11	2	\$921	n/a	n/a	n/a	\$75

Solid Surface, flat edge ⁽³⁾

GRBTP16SF	16 x 16.5 x 1.25	70	11	0.6	\$1652	n/a	\$87	n/a	n/a
GRBTP20SF	20 x 20 x 1.25	70	16	1	\$1939	n/a	\$116	n/a	n/a
GRBTP22SF	22 x 22 x 1.25	70	20	1	\$2031	n/a	\$168	n/a	n/a

Solid Surface, knife edge ⁽³⁾

GRBTP16SK	16 x 16.5 x 1.25	70	11	0.6	\$1749	n/a	\$99	n/a	n/a
GRBTP20SK	20 x 20 x 1.25	70	16	1	\$2043	n/a	\$121	n/a	n/a
GRBTP22SK	22 x 22 x 1.25	70	20	1	\$2140	n/a	\$173	n/a	n/a

Only applicable bases to use with above tops: GRB14H25 or GSB13H25 round or square base with centered column (see 665). Tops feature metal inserts for ease of assembly to base. One base required.

Required Specifications

Top finish
Edge finish⁽¹⁾

Optional Specifications

HP laminate⁽¹⁾
Knife edge⁽²⁾
Grade 2 solid surface⁽³⁾

Applicable Bases

GRB14H25
GSB13H25

S SWAP TABLES

SQUARE LAPTOP TABLES FOR CENTER BASE

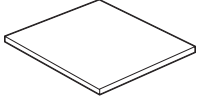

Square Tops, for Center Base

MODEL#	DIMENSIONS	FREIGHT CLASS	WT/LBS.	CUBIC FT.	LIST PRICE	HP ADD	GR. 2 ADD	R3 ADD	KS ADD
D x W x H									
TFL, flat edge ^{(1) (4)}									
GSBTP16	16.5 x 16.5 x 1	65	7	0.3	\$214	\$100	n/a	\$22	n/a
GSBTP20	20 x 20 x 1	70	11	0.5	\$245	\$115	n/a	\$25	n/a
GSBTP22	22 x 22 x 1	65	13	0.5	\$277	\$126	n/a	\$28	n/a
HPL, knife edge									
GSBTP16LK	16.5 x 16.5 x 1.19	100	8.5	1	\$350	n/a	n/a	n/a	n/a
GSBTP20LK	20 x 20 x 1.19	100	13	1.5	\$440	n/a	n/a	n/a	n/a
GSBTP22LK	22 x 22 x 1.19	100	16	2	\$480	n/a	n/a	n/a	n/a
Veneer ⁽²⁾									
GSBTP16V	16.5 x 16.5 x 1.19	100	8.5	1	\$451	n/a	n/a	n/a	\$71
GSBTP20V	20 x 20 x 1.19	100	13	1.5	\$565	n/a	n/a	n/a	\$86
GSBTP22V	22 x 22 x 1.19	100	16	2	\$620	n/a	n/a	n/a	\$96
Solid Surface, flat edge ^{(3) (4)}									
GSBTP16SF	16.5 x 16.5 x 1.25	65	14	0.6	\$1415	n/a	\$81	\$96	n/a
GSBTP20SF	20 x 20 x 1.25	70	21	1	\$1697	n/a	\$121	\$96	n/a
GSBTP22SF	22 x 22 x 1.25	65	26	1	\$1789	n/a	\$145	\$96	n/a
Solid Surface, knife edge ^{(3) (4)}									
GSBTP16SK	16.5 x 16.5 x 1.25	65	14	0.6	\$1749	n/a	\$99	\$202	n/a
GSBTP20SK	20 x 20 x 1.25	70	21	1	\$2043	n/a	\$128	\$202	n/a
GSBTP22SK	22 x 22 x 1.25	65	26	1	\$2140	n/a	\$173	\$202	n/a

Only applicable bases to use with above tops: GRB14H25 or GSB13H25 round or square base with centered column (see 665). Tops feature metal inserts for ease of assembly to base. One base required.

Required Specifications

Top finish
Edge finish⁽¹⁾

Optional Specifications

HP laminate⁽¹⁾
Knife edge⁽²⁾
Grade 2 solid surface⁽³⁾
3" radiused corners⁽⁴⁾

Applicable Bases

GRB14H25
GSB13H25

RECTANGULAR LAPTOP TABLES FOR CENTER BASE MODEL# DIMENSIONS FREIGHT CLASS WT/LBS. CUBIC FT. LIST PRICE HP ADD GR. 2 ADD R3 ADD KS ADD

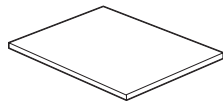

Rectangular Tops, for Center Base

D x W x H

TFL, flat edge ^{(1) (4)}

GSBTP1620	20 x 16 x 1	65	9	0.4	\$223	\$110	n/a	\$21	n/a
GSBTP1622	22 x 16 x 1	70	11	0.5	\$255	\$115	n/a	\$26	n/a

HPL, knife edge

GSBTP1620LK	16 x 20 x 1.19	92.5	11	1	\$451	n/a	n/a	n/a	n/a
GSBTP1622LK	16 x 22 x 1.19	100	13	1.5	\$495	n/a	n/a	n/a	n/a

Veneer ⁽²⁾

GSBTP1620V	16 x 20 x 1.19	92.5	11	1	\$556	n/a	n/a	n/a	\$86
GSBTP1622V	16 x 22 x 1.19	100	13	1.5	\$611	n/a	n/a	n/a	\$90

Solid Surface, flat edge ^{(3) (4)}

GSBTP1620SF	20 x 16 x 1.25	70	17	0.8	\$1571	n/a	\$99	\$96	n/a
GSBTP1622SF	22 x 16 x 1.25	65	19	0.8	\$1593	n/a	\$104	\$96	n/a

Solid Surface, knife edge ^{(3) (4)}

GSBTP1620SK	20 x 16 x 1.25	70	17	0.8	\$1887	n/a	\$121	\$202	n/a
GSBTP1622SK	22 x 16 x 1.25	65	19	0.8	\$1922	n/a	\$139	\$202	n/a

Only applicable bases to use with above tops: GRB14H25 or GSB13H25 round or square base with centered column (see 665). Tops feature metal inserts for ease of assembly to base. One base required.

Required Specifications

Top finish
Edge finish⁽¹⁾

Optional Specifications

HP laminate⁽¹⁾
Knife edge⁽²⁾
Grade 2 solid surface⁽³⁾
3" radiused corners⁽⁴⁾

Applicable Bases

GRB14H25
GSB13H25

S SWAP TABLES

ROUND LAPTOP TABLES FOR OFFSET BASE



Round laptop table for offset base

MODEL#	DIMENSIONS	FREIGHT CLASS	WT/LBS.	CUBIC FT.	LIST PRICE	HP ADD	GR. 2 ADD	R3 ADD	KS ADD
--------	------------	---------------	---------	-----------	------------	--------	-----------	--------	--------

D x W x H

TFL, flat edge ⁽¹⁾

GRBOTP16	16 x 16.5 x 1	70	6	0.3	\$214	\$100	n/a	n/a	n/a
GRBOTP20	20 x 20 x 1	70	9	0.5	\$245	\$115	n/a	n/a	n/a
GRBOTP22	22 x 22 x 1	70	11	0.7	\$277	\$126	n/a	n/a	n/a

HPL, knife edge

GRBOTP16LK	16 x 16.5 x 1.19	100	8	1	\$525	n/a	n/a	n/a	n/a
GRBOTP20LK	20 x 20 x 1.19	100	13	1.5	\$596	n/a	n/a	n/a	n/a
GRBOTP22LK	22 x 22 x 1.19	100	16	2	\$645	n/a	n/a	n/a	n/a

Veneer ⁽²⁾

GRBOTP16V	16 x 16.5 x 1.19	100	8	1	\$790	n/a	n/a	n/a	\$75
GRBOTP20V	20 x 20 x 1.19	100	13	1.5	\$856	n/a	n/a	n/a	\$75
GRBOTP22V	22 x 22 x 1.19	100	16	2	\$921	n/a	n/a	n/a	\$75

Solid Surface, flat edge ⁽³⁾

GRBOTP16SF	16 x 16.5 x 1.25	70	11	0.6	\$1652	n/a	\$87	n/a	n/a
GRBOTP20SF	20 x 20 x 1.25	70	16	1	\$1939	n/a	\$116	n/a	n/a
GRBOTP22SF	22 x 22 x 1.25	70	20	1	\$2031	n/a	\$168	n/a	n/a

Solid Surface, knife edge ⁽³⁾

GRBOTP16SK	16 x 16.5 x 1.25	70	11	0.6	\$1749	n/a	\$99	n/a	n/a
GRBOTP20SK	20 x 20 x 1.25	70	16	1	\$2043	n/a	\$121	n/a	n/a
GRBOTP22SK	22 x 22 x 1.25	70	20	1	\$2140	n/a	\$173	n/a	n/a

Only applicable base to use with above tops: GSOB13H25 square base with offset column (see 665). Tops feature metal inserts for ease of assembly to base. One base required.

Required Specifications

Top finish
Edge finish⁽¹⁾

Optional Specifications

HP laminate⁽¹⁾
Knife edge⁽²⁾
Grade 2 solid surface⁽³⁾

Applicable Bases

GSOB13H25

SQUARE LAPTOP TABLES FOR CENTER BASE **MODEL#** **DIMENSIONS** **FREIGHT CLASS** **WT/LBS.** **CUBIC FT.** **LIST PRICE** **HP ADD** **GR. 2 ADD** **R3 ADD** **KS ADD**

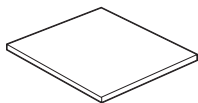

Square Tops, for Offset Base

D x W x H

TFL, flat edge ⁽¹⁾⁽⁴⁾

GSBOTP16	16.5 x 16.5 x 1	65	7	0.3	\$214	\$100	n/a	\$22	n/a
GSBOTP20	20 x 20 x 1	70	11	0.5	\$245	\$115	n/a	\$25	n/a
GSBOTP22	22 x 22 x 1	70	13	0.7	\$277	\$126	n/a	\$28	n/a

HPL, knife edge

GSBOTP16LK	16.5 x 16.5 x 1.19	100	8.5	1	\$350	n/a	n/a	n/a	n/a
GSBOTP20LK	20 x 20 x 1.19	100	13	1.5	\$440	n/a	n/a	n/a	n/a
GSBOTP22LK	22 x 22 x 1.19	100	16	2	\$480	n/a	n/a	n/a	n/a

Veneer ⁽²⁾

GSBOTP16V	16.5 x 16.5 x 1.19	100	8.5	1	\$451	n/a	n/a	n/a	\$71
GSBOTP20V	20 x 20 x 1.19	100	13	1.5	\$565	n/a	n/a	n/a	\$86
GSBOTP22V	22 x 22 x 1.19	100	16	2	\$620	n/a	n/a	n/a	\$96

Solid Surface, flat edge ⁽³⁾⁽⁴⁾

GSBOTP16SF	16.5 x 16.5 x 1.25	65	14	0.6	\$1415	n/a	\$81	\$96	n/a
GSBOTP20SF	20 x 20 x 1.25	70	21	1	\$1697	n/a	\$121	\$96	n/a
GSBOTP22SF	22 x 22 x 1.25	65	26	1	\$1789	n/a	\$145	\$96	n/a

Solid Surface, knife edge ⁽³⁾⁽⁴⁾

GSBOTP16SK	16.5 x 16.5 x 1.25	65	14	0.6	\$1749	n/a	\$99	\$202	n/a
GSBOTP20SK	20 x 20 x 1.25	70	21	1	\$2043	n/a	\$128	\$202	n/a
GSBOTP22SK	22 x 22 x 1.25	65	26	1	\$2140	n/a	\$173	\$202	n/a

Only applicable base to use with above tops: GSOB13H25 square base with offset column (see 665). Tops feature metal inserts for ease of assembly to base. One base required.

Required Specifications

Top finish
Edge finish⁽¹⁾

Optional Specifications

HP laminate⁽¹⁾
Knife edge⁽²⁾
Grade 2 solid surface⁽³⁾
3" radiused corners⁽⁴⁾

Applicable Bases

GSOB13H25

S SWAP TABLES

RECTANGULAR LAPTOP TABLES FOR OFFSET BASE

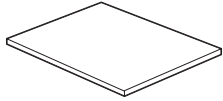

Rectangular Tops, for Offset Base

MODEL#	DIMENSIONS	FREIGHT CLASS	WT/LBS.	CUBIC FT.	LIST PRICE	HP ADD	GR. 2 ADD	R3 ADD	KS ADD
--------	------------	---------------	---------	-----------	------------	--------	-----------	--------	--------

D x W x H

TFL, flat edge ^{(1) (4)}

GSBOT1620	20 x 16 x 1	65	9	0.4	\$223	\$110	n/a	\$23	n/a
GSBOT1622	22 x 16 x 1	70	11	0.5	\$255	\$115	n/a	\$24	n/a

HPL, knife edge

GSBOT1620LK	16 x 20 x 1.19	125	11	1.5	\$451	n/a	n/a	n/a	n/a
GSBOT1622LK	16 x 22 x 1.19	125	13	2	\$495	n/a	n/a	n/a	n/a

Veneer ⁽²⁾

GSBOT1620V	16 x 20 x 1.19	125	11	1.5	\$556	n/a	n/a	n/a	\$86
GSBOT1622V	16 x 22 x 1.19	125	13	2	\$611	n/a	n/a	n/a	\$90

Solid Surface, flat edge ^{(3) (4)}

GSBOT1620SF	20 x 16 x 1.25	70	17	0.8	\$1571	n/a	\$99	\$96	n/a
GSBOT1622SF	22 x 16 x 1.25	65	19	0.8	\$1593	n/a	\$104	\$96	n/a

Solid Surface, knife edge ^{(3) (4)}

GSBOT1620SK	20 x 16 x 1.25	70	17	0.8	\$1887	n/a	\$121	\$202	n/a
GSBOT1622SK	22 x 16 x 1.25	65	19	0.8	\$1922	n/a	\$139	\$202	n/a

Only applicable base to use with above tops: GSOB13H25 square base with offset column (see 665). Tops feature metal inserts for ease of assembly to base. One base required.

Required Specifications

Top finish
Edge finish⁽¹⁾

Optional Specifications

HP laminate⁽¹⁾
Knife edge⁽²⁾
Grade 2 solid surface⁽³⁾
3" radiused corners⁽⁴⁾

Applicable Bases

GSOB13H25

LAPTOP TABLE BASES **MODEL#** **DIMENSIONS** **FREIGHT CLASS** **WT./LBS.** **CUBIC FT.** **LIST PRICE** **CHM/BCH** **ACO/SBR**

D x W x H

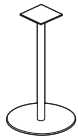

14" Round Centered Base

GRB14H25	14 x 14 x 24.5	150	17.54	3.5	\$749	\$86	\$209
----------	----------------	-----	-------	-----	--------------	-------------	--------------



12.5" Square Centered Base

GSB13H25	12.5 x 12.5 x 24.5	150	17.11	3.5	\$775	\$86	\$226
----------	--------------------	-----	-------	-----	--------------	-------------	--------------

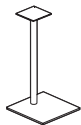

12.5" Square Offset Base

GSOB13H25	12.5 x 12.5 x 24.5	150	17.11	3.5	\$775	\$86	\$226
-----------	--------------------	-----	-------	-----	--------------	-------------	--------------

1.5" diameter column. Weighted base for balance includes cover plate, 0.5" adjustable glides to level on uneven surfaces. Screws included with base for attaching to appropriate top(s). Available in paint finishes listed on 653; plated finishes as available on 653 (upcharge applies).

Required Specifications
Finish

Optional Specifications
Plated finish

S SWAP TABLES

ROUND TOPS, 24-36"



MODEL# DIMENSIONS FREIGHT CLASS WT/LBS. CUBIC FT. LIST PRICE HP ADD GR. 2 ADD R3 ADD KS ADD

D x W x H

TFL, flat edge ⁽¹⁾

GRBTP24	24 x 24 x 1	70	16	1	\$245	\$124	n/a	n/a	n/a
GRBTP30	30 x 30 x 1	70	25	1.5	\$283	\$143	n/a	n/a	n/a
GRBTP36	36 x 36 x 1	70	36	2	\$361	\$183	n/a	n/a	n/a

HPL, knife edge

GRBTP24LK	24 x 24 x 1.19	100	19	2	\$750	n/a	n/a	n/a	n/a
GRBTP30LK	30 x 30 x 1.19	92.5	30	3	\$940	n/a	n/a	n/a	n/a
GRBTP36LK	36 x 36 x 1.19	92.5	43	4	\$1126	n/a	n/a	n/a	n/a

Veneer ⁽²⁾

GRBTP24V	24 x 24 x 1.19	100	19	2	\$911	n/a	n/a	n/a	\$61
GRBTP30V	30 x 30 x 1.19	92.5	30	3	\$1101	n/a	n/a	n/a	\$75
GRBTP36V	36 x 36 x 1.19	92.5	43	4	\$1301	n/a	n/a	n/a	\$75

Solid Surface, flat edge ⁽³⁾

GRBTP24SF	24 x 24 x 1.25	70	24	1.2	\$2083	n/a	\$168	n/a	n/a
GRBTP30SF	29.8 x 29.8 x 1.25	70	37	1.8	\$2273	n/a	\$231	n/a	n/a
GRBTP36SF	36 x 36 x 1.25	70	53	2.5	\$2905	n/a	\$346	n/a	n/a

Solid Surface, knife edge ⁽³⁾

GRBTP24SK	24 x 24 x 1.25	70	24	1.2	\$2140	n/a	\$180	n/a	n/a
GRBTP30SK	29.8 x 29.8 x 1.25	70	37	1.8	\$2358	n/a	\$248	n/a	n/a
GRBTP36SK	36 x 36 x 1.25	70	53	2.5	\$3077	n/a	\$369	n/a	n/a

Round Tops, 24-36"

Only applicable bases to use with above tops: GRB22Hxx or GSB19Hxx round or square base @ 15", 21" 26", 28" 35" or 40.5"H (see 669). Tops feature metal inserts for ease of assembly to base. One base required.

Required Specifications

Top finish
Edge finish⁽¹⁾

Optional Specifications

HP laminate⁽¹⁾
Knife edge⁽²⁾
Grade 2 solid surface⁽³⁾

Applicable Bases

GRB22H15 GRB22H35 GSB19H26
GRB22H21 GRB22H41 GSB19
GRB22H26 GSB19H15 GSB19H35
GRB22 GSB19H21 GSB19H41

SQUARE TOPS, 24-36"

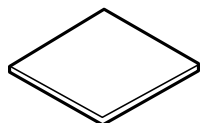

MODEL# DIMENSIONS FREIGHT CLASS WT/LBS. CUBIC FT. LIST PRICE HP ADD GR. 2 ADD R3 ADD KS ADD

D x W x H

TFL, flat edge ⁽¹⁾⁽⁴⁾

GSBTP24	24 x 24 x 1	70	20	1	\$252	\$128	n/a	\$26	n/a
GSBTP30	30 x 30 x 1	70	30	1.5	\$293	\$147	n/a	\$36	n/a
GSBTP36	36 x 36 x 1	70	44	2	\$371	\$186	n/a	\$38	n/a

HPL, knife edge

GSBTP24LK	24 x 24 x 1.19	85	24	2	\$675	n/a	n/a	n/a	n/a
GSBTP30LK	30 x 30 x 1.19	85	36	3	\$740	n/a	n/a	n/a	n/a
GSBTP36LK	36 x 36 x 1.19	85	53	4	\$801	n/a	n/a	n/a	n/a

Veneer ⁽²⁾

GSBTP24V	24 x 24 x 1.19	85	24	2	\$940	n/a	n/a	n/a	\$65
GSBTP30V	30 x 30 x 1.19	85	36	3	\$1001	n/a	n/a	n/a	\$71
GSBTP36V	36 x 36 x 1.19	85	53	4	\$1065	n/a	n/a	n/a	\$65

Solid Surface, flat edge ⁽³⁾⁽⁴⁾

GSBTP24SF	24 x 24 x 1.25	65	30	1.2	\$1841	n/a	\$173	\$96	n/a
GSBTP30SF	29.8 x 29.8 x 1.25	65	47	1.8	\$2273	n/a	\$231	\$96	n/a
GSBTP36SF	36 x 36 x 1.25	65	68	2.5	\$2956	n/a	\$282	\$96	n/a

Solid Surface, knife edge ⁽³⁾⁽⁴⁾

GSBTP24SK	24 x 24 x 1.25	65	30	1.2	\$1898	n/a	\$185	\$202	n/a
GSBTP30SK	29.8 x 29.8 x 1.25	65	47	1.8	\$2847	n/a	\$260	\$202	n/a
GSBTP36SK	36 x 36 x 1.25	65	68	2.5	\$3526	n/a	\$323	\$202	n/a

Square Tops, 24-36"

Only applicable bases to use with above tops: GRB22Hxx or GSB19Hxx round or square base @ 15", 21" 26", 28" 35" or 40.5"H (see 669). Tops feature metal inserts for ease of assembly to base. One base required. .

Required Specifications

Top finish
Edge finish⁽¹⁾

Optional Specifications

HP laminate⁽¹⁾, Knife edge⁽²⁾
Grade 2 solid surface⁽³⁾
3" radiused corners⁽⁴⁾

Applicable Bases

GRB22H15	GRB22H35	GSB19H26
GRB22H21	GRB22H41	GSB19
GRB22H26	GSB19H15	GSB19H35
GRB22	GSB19H21	GSB19H41

S SWAP TABLES

RECTANGULAR TOPS, SMALL

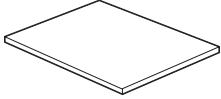

Rectangular Tops, small

MODEL# DIMENSIONS FREIGHT CLASS WT./LBS. CUBIC FT. LIST PRICE HP ADD GR. 2 ADD R3 ADD KS ADD

D x W x H

TFL, flat edge ^{(1) (4)}

GSBTP2430	24 x 30 x 1	70	20	0.91	\$281	\$128	n/a	\$29	n/a
GSBTP2436	24 x 36 x 1	70	24	1.08	\$305	\$139	n/a	\$31	n/a
GSBTP3036	30 x 36 x 1	65	31	1.34	\$353	\$160	n/a	\$36	n/a

HPL, knife edge

GSBTP2430LK	24 x 30 x 1.19	100	24	2.5	\$675	n/a	n/a	n/a	n/a
GSBTP2436LK	24 x 36 x 1.19	100	29	3	\$801	n/a	n/a	n/a	n/a
GSBTP3036LK	30 x 36 x 1.19	92.5	37	3.5	\$845	n/a	n/a	n/a	n/a

Veneer ⁽²⁾

GSBTP2430V	24 x 30 x 1.19	100	24	2.5	\$940	n/a	n/a	n/a	\$65
GSBTP2436V	24 x 36 x 1.19	100	29	3	\$1001	n/a	n/a	n/a	\$71
GSBTP3036V	30 x 36 x 1.19	92.5	37	3.5	\$1065	n/a	n/a	n/a	\$65

Solid Surface, flat edge ^{(3) (4)}

GSBTP2430SF	29.8 x 24 x 1.25	70	38	1.8	\$1991	n/a	\$173	\$96	n/a
GSBTP2436SF	36 x 24 x 1.25	70	45	2.1	\$2244	n/a	\$220	\$96	n/a
GSBTP3036SF	36 x 29.8 x 1.25	65	57	2.1	\$2548	n/a	\$242	\$96	n/a

Solid Surface, knife edge ^{(3) (4)}

GSBTP2430SK	29.8 x 24 x 1.25	70	38	1.8	\$2399	n/a	\$213	\$202	n/a
GSBTP2436SK	36 x 24 x 1.25	70	45	2.1	\$2605	n/a	\$265	\$202	n/a
GSBTP3036SK	36 x 29.8 x 1.25	65	57	2.1	\$2939	n/a	\$294	\$202	n/a

Applicable bases to use with above tops: GRB22Hxx or GSB19Hxx round or square base @ 15", 21" 26", 28" 35" or 40.5"H (see 669). Tops feature metal inserts for ease of assembly to base. One base required.

Required Specifications

Top finish
Edge finish⁽¹⁾

Optional Specifications

HP laminate⁽¹⁾, Knife edge⁽²⁾
Grade 2 solid surface⁽³⁾
3" radius corners⁽⁴⁾

Applicable Bases

GRB22H15	GRB22H35	GSB19H26
GRB22H21	GRB22H41	GSB19
GRB22H26	GSB19H15	GSB19H35
GRB22	GSB19H21	GSB19H41

BASES FOR TOPS 24"-36"

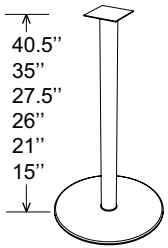

22" Dia Round Bases*

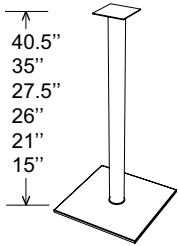

18.5" Square Bases*

MODEL#	DIMENSIONS	FREIGHT CLASS	WT./LBS.	CUBIC FT.	LIST PRICE	CHM/BCH	ACO/SBR
--------	------------	---------------	----------	-----------	------------	---------	---------

D x W x H

GRB22H15	22 x 22 x 15	92.5	47.6	4.69	\$907	\$147	\$270
GRB22H21	22 x 22 x 21	125	48.6	6.45	\$922	\$136	\$250
GRB22H26	22 x 22 x 26	150	50	8.63	\$934	\$147	\$270
GRB22	22 x 22 x 28	150	55	9.33	\$870	\$147	\$270
GRB22H35	22 x 22 x 35	150	57.1	12	\$912	\$145	\$308
GRB22H41	22 x 22 x 40.5	150	58.3	14	\$928	\$160	\$316

GRB22H15 - coffee table height

GRB22H21 - end table height

GRB22H26 - lounge height

GRB22 - seated height

GRB22H35 - counter height

GRB22H41 - bar height

GSB19H15	18.5 x 18.5 x 15	85	43.7	3.52	\$922	\$133	\$249
GSB19H21	18.5 x 18.5 x 21	100	44.8	4.84	\$934	\$133	\$249
GSB19H26	18.5 x 18.5 x 26	125	47	5.94	\$1004	\$133	\$259
GSB19	18.5 x 18.5 x 28	100	50	6.06	\$942	\$145	\$319
GSB19H35	18.5 x 18.5 x 35	125	51.8	7.52	\$999	\$145	\$319
GSB19H41	18.5 x 18.5 x 40.5	125	53.2	8.77	\$1034	\$160	\$319

GSB19H15 - coffee table height

GSB19H21 - end table height

GSB19H26 - lounge height

GSB19 - seated height

GSB19H35 - counter height

GSB19H41 - bar height

Base comes fully assembled and features 0.5" adjustable glides to level on uneven surfaces. Screws included with base for attaching to appropriate top(s). Available in paint finishes listed on 653; plated finishes as available on 653 (upcharge applies).

Required Specifications

Finish

Optional Specifications

Plated finish*

S SWAP TABLES

ROUND TOPS, 42"-48"



Round Tops, 42-48"

MODEL#	DIMENSIONS	FREIGHT CLASS	WT/LBS.	CUBIC FT.	LIST PRICE	HP ADD	GR. 2 ADD	R3 ADD	KS ADD
--------	------------	---------------	---------	-----------	------------	--------	-----------	--------	--------

D x W x H

TFL, flat edge ⁽¹⁾

GRBTP42	42 x 42 x 1	70	44	2.5	\$503	\$254	n/a	n/a	n/a
GRBTP48	48 x 48 x 1	70	56	3	\$537	\$269	n/a	n/a	n/a

HPL, knife edge

GRBTP42LK	42 x 42 x 1.19	92.5	53	5	\$1400	n/a	n/a	n/a	n/a
GRBTP48LK	48 x 48 x 1.19	92.5	67	6.5	\$1600	n/a	n/a	n/a	n/a

Veneer ⁽²⁾

GRBTP42V	42 x 42 x 1.19	92.5	53	5	\$1681	n/a	n/a	n/a	\$71
GRBTP48V	48 x 48 x 1.19	92.5	67	6.5	\$1921	n/a	n/a	n/a	\$80

Solid Surface, flat edge ⁽³⁾

GRBTP42SF	42 x 42 x 1.25	70	73	3.4	\$3939	n/a	\$443	n/a	n/a
GRBTP48SF	48 x 48 x 1.25	70	95	4.3	\$4486	n/a	\$564	n/a	n/a

Solid Surface, knife edge ⁽³⁾

GRBTP42SK	42 x 42 x 1.25	70	73	3.4	\$4147	n/a	\$495	n/a	n/a
GRBTP48SK	48 x 48 x 1.25	70	95	4.3	\$5003	n/a	\$628	n/a	n/a

Applicable bases to use with above tops: GRB28 or GSB23 round or square base @ 28" (see 672). Tops feature metal inserts for ease of assembly to base. One base required.

Required Specifications

Top finish
Edge finish⁽¹⁾

Optional Specifications

HP laminate⁽¹⁾
Knife edge⁽²⁾
Grade 2 solid surface⁽³⁾

Applicable Bases

GRB28
GSB23

SQUARE + RECTANGULAR TOPS, 42"

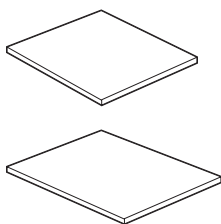

Square and Rectangular Tops

MODEL#	DIMENSIONS	FREIGHT CLASS	WT/LBS.	CUBIC FT.	LIST PRICE	HP ADD	GR. 2 ADD	R3 ADD	KS ADD
--------	------------	---------------	---------	-----------	------------	--------	-----------	--------	--------

D x W x H

TFL, flat edge ^{(1) (4)}

GSBTP3042	30 x 42 x 1	65	36	1.55	\$414	\$187	n/a	\$42	n/a
GSBTP3642	36 x 42 x 1	65	43	1.86	\$519	\$236	n/a	\$56	n/a
GSBTP42	42 x 42 x 1	65	58	2.5	\$512	\$259	n/a	\$52	n/a

HPL, knife edge

GSBTP3042LK	30 x 42 x 1.19	92.5	43	4	\$991	n/a	n/a	n/a	n/a
GSBTP3642LK	36 x 42 x 1.19	92.5	52	4.5	\$1050	n/a	n/a	n/a	n/a
GSBTP42LK	42 x 42 x 1.19	85	70	5	\$1096	n/a	n/a	n/a	n/a

Veneer ⁽²⁾

GSBTP3042V	30 x 42 x 1.19	92.5	43	4	\$1246	n/a	n/a	n/a	\$56
GSBTP3642V	36 x 42 x 1.19	92.5	52	4.5	\$1301	n/a	n/a	n/a	\$65
GSBTP42V	42 x 42 x 1.19	85	70	5	\$1525	n/a	n/a	n/a	\$71

Solid Surface, flat edge ^{(3) (4)}

GSBTP3042SF	42 x 29.8 x 1.25	65	66	2.9	\$2675	n/a	\$294	\$96	n/a
GSBTP3642SF	42 x 36 x 1.25	65	79	2.9	\$3434	n/a	\$393	\$96	n/a
GSBTP42SF	42 x 42 x 1.25	65	92	3.4	\$3577	n/a	\$426	\$96	n/a

Solid Surface, knife edge ^{(3) (4)}

GSBTP3042SK	42 x 29.8 x 1.25	65	66	2.9	\$3135	n/a	\$346	\$202	n/a
GSBTP3642SK	42 x 36 x 1.25	65	79	2.9	\$3963	n/a	\$467	\$202	n/a
GSBTP42SK	42 x 42 x 1.25	65	92	3.4	\$4147	n/a	\$519	\$202	n/a

Applicable bases to use with above tops: GRB28 or GSB23 round or square base @ 28" (see 672). Tops feature metal inserts for ease of assembly to base. One base required.

Required Specifications

Top finish
Edge finish⁽¹⁾

Optional Specifications

HP laminate⁽¹⁾
Knife edge⁽²⁾
Grade 2 solid surface⁽³⁾
3" radiused corners⁽⁴⁾

Applicable Bases

GRB28
GSB23

S SWAP TABLES

BASES FOR TOPS 42" - 48"

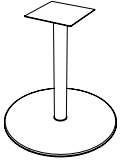

28" Round Base

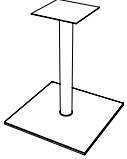

23" Square Base

MODEL# DIMENSIONS FREIGHT CLASS WT/LBS. CUBIC FT. LIST PRICE CHM/BCH ACO/SBR

D x W x H

GRB28	28 x 28 x 28	125	100	15.63	\$1498	\$160	\$452
seated height							

GSB23	22.5 x 22.5 x 28	100	82	9.33	\$1377	\$89	\$287
seated height							

Base comes fully assembled and features 0.5" adjustable glides to level on uneven surfaces. Screws included with base for attaching to appropriate top(s). Available in paint finishes listed on 653; plated finishes as available on 653 (upcharge applies).

Required Specifications
Finish

Optional Specifications
Plated finish

ROUND TOPS, 54"-60"

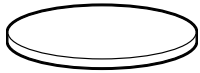

MODEL#	DIMENSIONS	FREIGHT CLASS	WT/LBS.	CUBIC FT.	LIST PRICE	HP ADD	GR. 2 ADD	R3 ADD	KS ADD
--------	------------	---------------	---------	-----------	------------	--------	-----------	--------	--------

D x W x H

TFL, flat edge ⁽¹⁾

GRBTP54	54 x 54 x 1	70	73	4.5	\$717	\$360	n/a	n/a	n/a
GRBTP60	60 x 60 x 1	70	92	5	\$741	\$373	n/a	n/a	n/a

HPL, knife edge

GRBTP54LK	54 x 54 x 1.19	92.5	88	8	\$1805	n/a	n/a	n/a	n/a
GRBTP60LK	60 x 60 x 1.19	92.5	110	10	\$2225	n/a	n/a	n/a	n/a

Veneer ⁽²⁾

GRBTP54V	54 x 54 x 1.19	92.5	88	8	\$2451	n/a	n/a	n/a	\$96
GRBTP60V	60 x 60 x 1.19	92.5	110	10	\$3026	n/a	n/a	n/a	\$104

Solid Surface, flat edge ⁽³⁾

GRBTP54SF	54 x 54 x 1.25	70	120	5.4	\$4859	n/a	\$691	n/a	n/a
GRBTP60SF	60 x 60 x 1.25	70	148	6.7	\$6383	n/a	\$863	n/a	n/a

Solid Surface, knife edge ⁽³⁾

GRBTP54SK	54 x 54 x 1.25	70	120	5.4	\$5745	n/a	\$869	n/a	n/a
GRBTP60SK	60 x 60 x 1.25	70	148	6.7	\$7028	n/a	\$1053	n/a	n/a

Round Tops, 54"-60"

Applicable bases to use with above tops: GRB34 or GSB28 round or square base @ 28" (see 674). Tops feature metal inserts for ease of assembly to base. One base required.

Required Specifications

Top finish
Edge finish⁽¹⁾

Optional Specifications

HP laminate⁽¹⁾
Knife edge⁽²⁾
Grade 2 solid surface⁽³⁾

Applicable Bases

GRB34
GSB28

S SWAP TABLES

BASES FOR TOPS 54" - 60" ROUND

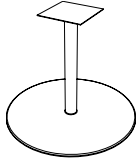

34" Round Base

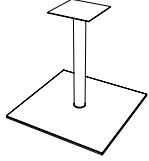

28" Square Base

MODEL#	DIMENSIONS	FREIGHT CLASS	WT./LBS.	CUBIC FT.	LIST PRICE	CHM/BCH	ACO/SBR
--------	------------	---------------	----------	-----------	------------	---------	---------

D x W x H							
GRB34	34 x 34 x 28	125	135	20.56	\$1831	\$160	\$546
seated height							

GSB28	28.5 x 28.5 x 28	125	125	15.63	\$1710	\$75	\$295
seated height							

Base comes fully assembled and features 0.5" adjustable glides to level on uneven surfaces. Screws included with base for attaching to appropriate top(s). Available in paint finishes listed on 653; plated finishes as available on 653 (upcharge applies).

Required Specifications
Finish

Optional Specifications
Plated finish

RECTANGULAR LOUNGE TOPS, 24"D

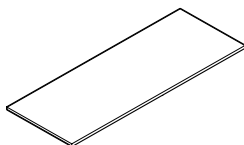

MODEL# DIMENSIONS FREIGHT CLASS WT/LBS. CUBIC FT. LIST PRICE HP ADD GR. 2 ADD R3 ADD KS ADD

D x W x H

TFL, flat edge ⁽¹⁾⁽⁴⁾

GRT5STP	24 x 60 x 1	65	41	1.79	\$472	\$214	n/a	\$48	n/a
GRT5HSTP	24 x 66 x 1	65	46	1.97	\$552	\$252	n/a	\$56	n/a
GRT6STP	24 x 72 x 1	65	49	2.14	\$576	\$260	n/a	\$58	n/a
GRT7STP	24 x 84 x 1	65	57	2.49	\$666	\$302	n/a	\$67	n/a
GRT8STP	24 x 96 x 1	65	66	2.84	\$715	\$322	n/a	\$72	n/a

HPL, knife edge

GRT5STPLK	24 x 60 x 1.19	85	49	4	\$1001	n/a	n/a	n/a	n/a
GRT5HSTPLK	24 x 66 x 1.19	85	55	4.5	\$1065	n/a	n/a	n/a	n/a
GRT6STPLK	24 x 72 x 1.19	92.5	59	5	\$1126	n/a	n/a	n/a	n/a
GRT7STPLK	24 x 84 x 1.19	85	68	5.5	\$1250	n/a	n/a	n/a	n/a
GRT8STPLK	24 x 96 x 1.19	85	79	6.5	\$1425	n/a	n/a	n/a	n/a

Veneer ⁽²⁾

GRT5STPV	24 x 60 x 1.19	85	49	4	\$1250	n/a	n/a	n/a	\$65
GRT5HSTPV	24 x 66 x 1.19	85	55	4.5	\$1316	n/a	n/a	n/a	\$65
GRT6STPV	24 x 72 x 1.19	92.5	59	5	\$1440	n/a	n/a	n/a	\$65
GRT7STPV	24 x 84 x 1.19	85	68	5.5	\$1691	n/a	n/a	n/a	\$65
GRT8STPV	24 x 96 x 1.19	85	79	6.5	\$1940	n/a	n/a	n/a	\$65

Solid Surface, flat edge ⁽³⁾⁽⁴⁾

GRT5STPSF	24 x 60 x 1.25	65	75	2.8	\$3854	n/a	\$432	\$96	n/a
GRT5HSTPSF	24 x 66 x 1.25	65	83	3.1	\$4026	n/a	\$443	\$96	n/a
GRT6STPSF	24 x 71.8 x 1.25	65	90	3.3	\$4245	n/a	\$455	\$96	n/a
GRT7STPSF	24 x 84 x 1.25	65	105	3.9	\$4716	n/a	\$593	\$96	n/a
GRT8STPSF	24 x 96 x 1.25	65	120	4.4	\$5176	n/a	\$605	\$96	n/a

Solid Surface, knife edge ⁽³⁾⁽⁴⁾

GRT5STPSK	24 x 60 x 1.25	65	75	2.8	\$4342	n/a	\$461	\$202	n/a
GRT5HSTPSK	24 x 66 x 1.25	65	83	3.1	\$4515	n/a	\$484	\$202	n/a
GRT6STPSK	24 x 71.8 x 1.25	65	90	3.3	\$4733	n/a	\$507	\$202	n/a
GRT7STPSK	24 x 84 x 1.25	65	105	3.9	\$5394	n/a	\$656	\$202	n/a
GRT8STPSK	24 x 96 x 1.25	65	120	4.4	\$5871	n/a	\$680	\$202	n/a

Applicable bases to use with above tops: GRB22Hxx round or GSB19Hxx square base @ 26"H, 35"H & 40.5"H (see 680). Tops feature metal inserts for ease of assembly to base. Two bases required. 24"D tops not recommended with 28"H bases.

Rectangular Lounge Tops

Required Specifications

Top finish
Edge finish⁽¹⁾

Optional Specifications

HP laminate⁽¹⁾, Knife edge⁽²⁾
Grade 2 solid surface⁽³⁾
3" radiused corners⁽⁴⁾
Cut-out for grommet/power blocks

Applicable Bases

GRB22H26 GSB19H26
GRB22H35 GSB19H35
GRB22H41 GSB19H41

S SWAP TABLES

RACETRACK TOPS, 24"D

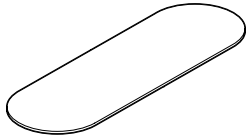

Racetrack Tops, 24"D

MODEL#	DIMENSIONS	FREIGHT CLASS	WT/LBS.	CUBIC FT.	LIST PRICE	HP ADD	GR. 2 ADD	R3 ADD	KS ADD
--------	------------	---------------	---------	-----------	------------	--------	-----------	--------	--------

D x W x H

TFL, flat edge ⁽¹⁾

GRC5STP	24 x 60 x 1	65	41	1.79	\$472	\$214	n/a	n/a	n/a
GRC5HSTP	24 x 66 x 1	65	46	1.97	\$552	\$252	n/a	n/a	n/a
GRC6STP	24 x 72 x 1	65	49	2.14	\$576	\$260	n/a	n/a	n/a
GRC7STP	24 x 84 x 1	65	57	2.49	\$666	\$302	n/a	n/a	n/a
GRC8STP	24 x 96 x 1	65	66	2.84	\$715	\$322	n/a	n/a	n/a

HPL, knife edge

GRC5STPLK	24 x 60 x 1.19	85	49	4	\$1250	n/a	n/a	n/a	n/a
GRC5HSTPLK	24 x 66 x 1.19	85	55	4.5	\$1375	n/a	n/a	n/a	n/a
GRC6STPLK	24 x 72 x 1.19	92.5	59	5	\$1501	n/a	n/a	n/a	n/a
GRC7STPLK	24 x 84 x 1.19	85	68	5.5	\$1626	n/a	n/a	n/a	n/a
GRC8STPLK	24 x 96 x 1.19	85	79	6.5	\$1750	n/a	n/a	n/a	n/a

Veneer ⁽²⁾

GRC5STPV	24 x 60 x 1.19	85	49	4	\$1501	n/a	n/a	n/a	\$225
GRC5HSTPV	24 x 66 x 1.19	85	55	4.5	\$1651	n/a	n/a	n/a	\$250
GRC6STPV	24 x 72 x 1.19	92.5	59	5	\$1801	n/a	n/a	n/a	\$270
GRC7STPV	24 x 84 x 1.19	85	68	5.5	\$2100	n/a	n/a	n/a	\$270
GRC8STPV	24 x 96 x 1.19	85	79	6.5	\$2400	n/a	n/a	n/a	\$270

Applicable bases to use with above tops: GRB22Hxx round or GSB19Hxx square base @ 26"H, 35"H & 40.5"H (see 680). Tops feature metal inserts for ease of assembly to base. **Two bases required.** 24"D tops not recommended with 28"H bases.

Required Specifications

Top finish
Edge finish⁽¹⁾

Optional Specifications

HP laminate⁽¹⁾, Knife edge⁽²⁾
Grade 2 solid surface⁽³⁾
3" radiused corners⁽⁴⁾
Cut-out for grommet/power blocks

Applicable Bases, two required

GRB22H26 GSB19H26
GRB22 GSB19
GRB22H35 GSB19H35
GRB22H41 GSB19H41

RECTANGULAR TOPS, 60"-96"W

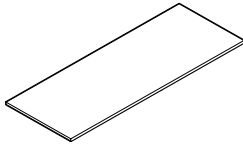

MODEL#	DIMENSIONS	FREIGHT CLASS	WT/LBS.	CUBIC FT.	LIST PRICE	HP ADD	GR. 2 ADD	R3 ADD	KS ADD
--------	------------	---------------	---------	-----------	------------	--------	-----------	--------	--------

D x W x H

TFL, flat edge ^{(1) (4)}

GRT5NTP	30 x 60 x 1	70	46	2.5	\$538	\$272	n/a	\$54	n/a
GRT5NHTP	30 x 66 x 1	65	56	2.44	\$543	\$246	n/a	\$55	n/a
GRT6NTP	30 x 72 x 1	70	62	3	\$584	\$294	n/a	\$59	n/a
GRT7NTP	30 x 84 x 1	100	72	7.5	\$727	\$366	n/a	\$73	n/a
GRT8NTP	30 x 96 x 1	100	80	8.5	\$791	\$397	n/a	\$80	n/a
GRT5TP	36 x 60 x 1	92.5	70	6.6	\$551	\$248	n/a	\$56	n/a
GRT5HTP	36 x 66 x 1	92.5	79	7.21	\$580	\$263	n/a	\$58	n/a
GRT6TP	36 x 72 x 1	100	72	8	\$673	\$337	n/a	\$68	n/a
GRT7TP	36 x 84 x 1	100	85	8.75	\$782	\$394	n/a	\$79	n/a
GRT8TP	36 x 96 x 1	92.5	94	9	\$856	\$431	n/a	\$86	n/a

HPL, knife edge

GRT5NTPLK	30 x 60 x 1.19	92.5	55	5	\$1115	n/a	n/a	n/a	n/a
GRT5NHTPLK	30 x 66 x 1.19	85	67	5.5	\$1225	n/a	n/a	n/a	n/a
GRT6NTPLK	30 x 72 x 1.19	85	74	6	\$1341	n/a	n/a	n/a	n/a
GRT7NTPLK	30 x 84 x 1.19	85	86	7	\$1556	n/a	n/a	n/a	n/a
GRT8NTPLK	30 x 96 x 1.19	85	96	8	\$1780	n/a	n/a	n/a	n/a
GRT5TPLK	36 x 60 x 1.19	85	84	6	\$1341	n/a	n/a	n/a	n/a
GRT5HTPLK	36 x 66 x 1.19	85	95	6.5	\$1470	n/a	n/a	n/a	n/a
GRT6TPLK	36 x 72 x 1.19	85	86	7	\$1605	n/a	n/a	n/a	n/a
GRT7TPLK	36 x 84 x 1.19	85	102	8	\$1870	n/a	n/a	n/a	n/a
GRT8TPLK	36 x 96 x 1.19	85	113	9	\$2140	n/a	n/a	n/a	n/a

Veneer ⁽²⁾

GRT5NTPV	30 x 60 x 1.19	92.5	55	5	\$1550	n/a	n/a	n/a	\$75
GRT5NHTPV	30 x 66 x 1.19	85	67	5.5	\$1655	n/a	n/a	n/a	\$75
GRT6NTPV	30 x 72 x 1.19	85	74	6	\$1780	n/a	n/a	n/a	\$96
GRT7NTPV	30 x 84 x 1.19	85	86	7	\$2081	n/a	n/a	n/a	\$111
GRT8NTPV	30 x 96 x 1.19	85	96	8	\$2375	n/a	n/a	n/a	\$126
GRT5TPV	36 x 60 x 1.19	85	84	6	\$1780	n/a	n/a	n/a	\$96
GRT5HTPV	36 x 66 x 1.19	85	95	6.5	\$1951	n/a	n/a	n/a	\$126
GRT6TPV	36 x 72 x 1.19	85	86	7	\$2126	n/a	n/a	n/a	\$141
GRT7TPV	36 x 84 x 1.19	85	102	8	\$2480	n/a	n/a	n/a	\$175
GRT8TPV	36 x 96 x 1.19	85	113	9	\$2841	n/a	n/a	n/a	\$175

Solid Surface, flat edge ^{(3) (4)}

GRT5NTPSF	29.8 x 60 x 1.25	65	94	3.4	\$4015	n/a	\$426	\$96	n/a
GRT5NHTPSF	29.8 x 66 x 1.25	65	104	3.8	\$4308	n/a	\$495	\$96	n/a
GRT6NTPSF	29.8 x 71.8 x 1.25	65	113	4.1	\$4918	n/a	\$691	\$96	n/a
GRT7NTPSF	29.8 x 84 x 1.25	65	132	4.8	\$5705	n/a	\$680	\$96	n/a
GRT8NTPSF	29.8 x 96 x 1.25	65	150	5.4	\$6280	n/a	\$881	\$96	n/a
GRT5TPSF	36 x 60 x 1.25	65	113	4.1	\$5343	n/a	\$633	\$96	n/a
GRT5HTPSF	36 x 66 x 1.25	65	124	4.5	\$5515	n/a	\$633	\$96	n/a
GRT6TPSF	36 x 71.8 x 1.25	65	135	4.9	\$6091	n/a	\$691	\$96	n/a
GRT7TPSF	36 x 84 x 1.25	65	158	5.7	\$6625	n/a	\$834	\$96	n/a
GRT8TPSF	36 x 96 x 1.25	65	180	6.5	\$7108	n/a	\$875	\$96	n/a

Solid Surface, knife edge ^{(3) (4)}

GRT5NTPSK	29.8 x 60 x 1.25	65	94	3.4	\$4394	n/a	\$484	\$202	n/a
GRT5NHTPSK	29.8 x 66 x 1.25	65	104	3.8	\$4745	n/a	\$564	\$202	n/a
GRT6NTPSK	29.8 x 71.8 x 1.25	65	113	4.1	\$5349	n/a	\$772	\$202	n/a
GRT7NTPSK	29.8 x 84 x 1.25	65	132	4.8	\$6136	n/a	\$772	\$202	n/a
GRT8NTPSK	29.8 x 96 x 1.25	65	150	5.4	\$6815	n/a	\$984	\$202	n/a
GRT5TPSK	36 x 60 x 1.25	65	113	4.1	\$5918	n/a	\$714	\$202	n/a
GRT5HTPSK	36 x 66 x 1.25	65	124	4.5	\$6067	n/a	\$725	\$202	n/a
GRT6TPSK	36 x 71.8 x 1.25	65	135	4.9	\$6722	n/a	\$794	\$202	n/a
GRT7TPSK	36 x 84 x 1.25	65	158	5.7	\$7263	n/a	\$950	\$202	n/a
GRT8TPSK	36 x 96 x 1.25	65	180	6.5	\$7734	n/a	\$1002	\$202	n/a

Applicable bases to use with above tops, TWO bases required: rounds GRB22H26, GRB22, GRB22H35, GRB22H41, or squares GSB19H26, GSB19, GSB19H35, GSB19H41(see 680). Tops feature metal inserts for ease of assembly to base.

Rectangular Tops*

Required Specifications

Top finish
Edge finish⁽¹⁾

Optional Specifications

HP laminate⁽¹⁾, Knife edge⁽²⁾
Grade 2 solid surface⁽³⁾
3" radiused corners⁽⁴⁾
Cut-out for grommet/power blocks

Applicable Bases, two required

GRB22H26 GSB19H26
GRB22 GSB19
GRB22H35 GSB19H35
GRB22H41 GSB19H41

RACETRACK TOPS, 60"-96"W

MODEL# DIMENSIONS FREIGHT CLASS WT/LBS. CUBIC FT. LIST PRICE HP ADD GR. 2 ADD R3 ADD KS ADD

D x W x H

TFL, flat edge ⁽¹⁾

GRC5NTP	30 x 60 x 1	70	46	2.5	\$547	\$275	n/a	n/a	n/a
GRC5NHTP	30 x 66 x 1	65	56	2.44	\$553	\$252	n/a	n/a	n/a
GRC6NTP	30 x 72 x 1	70	62	3	\$594	\$299	n/a	n/a	n/a
GRC7NTP	30 x 84 x 1	100	72	7.5	\$740	\$372	n/a	n/a	n/a
GRC8NTP	30 x 96 x 1	100	80	8.5	\$807	\$405	n/a	n/a	n/a
GRC5TP	36 x 60 x 1	92.5	70	6.6	\$562	\$255	n/a	n/a	n/a
GRC5HTP	36 x 66 x 1	92.5	79	7.21	\$591	\$267	n/a	n/a	n/a
GRC6TP	36 x 72 x 1	100	72	7.5	\$684	\$344	n/a	n/a	n/a
GRC7TP	36 x 84 x 1	100	85	8.75	\$799	\$401	n/a	n/a	n/a
GRC8TP	36 x 96 x 1	92.5	94	9	\$873	\$438	n/a	n/a	n/a

HPL, knife edge

GRC5NTPLK	30 x 60 x 1.19	92.5	55	5	\$1560	n/a	n/a	n/a	n/a
GRC5NHTPLK	30 x 66 x 1.19	85	67	5.5	\$1710	n/a	n/a	n/a	n/a
GRC6NTPLK	30 x 72 x 1.19	85	74	6	\$1870	n/a	n/a	n/a	n/a
GRC7NTPLK	30 x 84 x 1.19	85	86	7	\$2010	n/a	n/a	n/a	n/a
GRC8NTPLK	30 x 96 x 1.19	85	96	8	\$2160	n/a	n/a	n/a	n/a
GRC5TPLK	36 x 60 x 1.19	85	84	6	\$1710	n/a	n/a	n/a	n/a
GRC5HTPLK	36 x 66 x 1.19	85	95	6.5	\$1860	n/a	n/a	n/a	n/a
GRC6TPLK	36 x 72 x 1.19	85	86	7	\$2020	n/a	n/a	n/a	n/a
GRC7TPLK	36 x 84 x 1.19	85	102	8	\$2320	n/a	n/a	n/a	n/a
GRC8TPLK	36 x 96 x 1.19	85	113	9	\$2621	n/a	n/a	n/a	n/a

Veneer ⁽²⁾

GRC5NTPV	30 x 60 x 1.19	92.5	55	5	\$1765	n/a	n/a	n/a	\$265
GRC5NHTPV	30 x 66 x 1.19	85	67	5.5	\$1906	n/a	n/a	n/a	\$286
GRC6NTPV	30 x 72 x 1.19	85	74	6	\$2050	n/a	n/a	n/a	\$305
GRC7NTPV	30 x 84 x 1.19	85	86	7	\$2396	n/a	n/a	n/a	\$356
GRC8NTPV	30 x 96 x 1.19	85	96	8	\$2731	n/a	n/a	n/a	\$405
GRC5TPV	36 x 60 x 1.19	85	84	6	\$2050	n/a	n/a	n/a	\$305
GRC5HTPV	36 x 66 x 1.19	85	95	6.5	\$2246	n/a	n/a	n/a	\$335
GRC6TPV	36 x 72 x 1.19	85	86	7	\$2446	n/a	n/a	n/a	\$366
GRC7TPV	36 x 84 x 1.19	85	102	8	\$2856	n/a	n/a	n/a	\$366
GRC8TPV	36 x 96 x 1.19	85	113	9	\$3265	n/a	n/a	n/a	\$485

Applicable bases to use with above tops, TWO bases required: rounds GRB22H26, GRB22, GRB22H35, GRB22H41, or squares GSB19H26, GSB19, GSB19H35, GSB19H41 (see 680). Tops feature metal inserts for ease of assembly to base.

Racetrack Tops, 60"-96"W

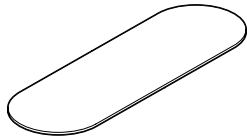

Required Specifications

Top finish
Edge finish⁽¹⁾

Optional Specifications

HP laminate⁽¹⁾
Knife edge⁽²⁾
Cut-out for grommet/power blocks

Applicable Bases, two required

GRB22H26 GSB19H26
GRB22 GSB19
GRB22H35 GSB19H35
GRB22H41 GSB19H41

BOAT SHAPED, 60"-96"W

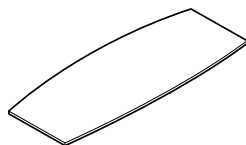

MODEL# DIMENSIONS FREIGHT CLASS WT/LBS. CUBIC FT. LIST PRICE HP ADD GR. 2 ADD R3 ADD KS ADD

D x W x H

TFL, flat edge ⁽¹⁾

GBT5NTP	30 x 60 x 1	70	46	2.5	\$547	\$275	n/a	n/a	n/a
GBT5NHTP	30 x 66 x 1	65	56	2.44	\$553	\$252	n/a	n/a	n/a
GBT6NTP	30 x 72 x 1	70	62	3	\$594	\$299	n/a	n/a	n/a
GBT7NTP	30 x 84 x 1	100	72	7.5	\$740	\$372	n/a	n/a	n/a
GBT8NTP	30 x 96 x 1	100	80	8.5	\$807	\$405	n/a	n/a	n/a
GBT5TP	36 x 60 x 1	92.5	70	6.6	\$562	\$255	n/a	n/a	n/a
GBT5HTP	36 x 66 x 1	92.5	79	7.21	\$591	\$267	n/a	n/a	n/a
GBT6TP	36 x 72 x 1	100	72	7.5	\$684	\$344	n/a	n/a	n/a
GBT7TP	36 x 84 x 1	100	85	8.75	\$799	\$401	n/a	n/a	n/a
GBT8TP	36 x 96 x 1	92.5	94	9	\$873	\$438	n/a	n/a	n/a

HPL, knife edge

GBT5NTPLK	30 x 60 x 1.19	92.5	55	5	\$1560	n/a	n/a	n/a	n/a
GBT5NHTPLK	30 x 66 x 1.19	85	67	5.5	\$1710	n/a	n/a	n/a	n/a
GBT6NTPLK	30 x 72 x 1.19	85	74	6	\$1870	n/a	n/a	n/a	n/a
GBT7NTPLK	30 x 84 x 1.19	85	86	7	\$2010	n/a	n/a	n/a	n/a
GBT8NTPLK	30 x 96 x 1.19	85	96	8	\$2160	n/a	n/a	n/a	n/a
GBT5TPLK	36 x 60 x 1.19	85	84	6	\$1710	n/a	n/a	n/a	n/a
GBT5HTPLK	36 x 66 x 1.19	85	95	6.5	\$1860	n/a	n/a	n/a	n/a
GBT6TPLK	36 x 72 x 1.19	85	86	7	\$2020	n/a	n/a	n/a	n/a
GBT7TPLK	36 x 84 x 1.19	85	102	8	\$2320	n/a	n/a	n/a	n/a
GBT8TPLK	36 x 96 x 1.19	85	113	9	\$2621	n/a	n/a	n/a	n/a

Veneer ⁽²⁾

GBT5NTPV	30 x 60 x 1.19	92.5	55	5	\$1765	n/a	n/a	n/a	\$265
GBT5NHTPV	30 x 66 x 1.19	85	67	5.5	\$1906	n/a	n/a	n/a	\$286
GBT6NTPV	30 x 72 x 1.19	85	74	6	\$2050	n/a	n/a	n/a	\$305
GBT7NTPV	30 x 84 x 1.19	85	86	7	\$2396	n/a	n/a	n/a	\$356
GBT8NTPV	30 x 96 x 1.19	85	96	8	\$2731	n/a	n/a	n/a	\$405
GBT5TPV	36 x 60 x 1.19	85	84	6	\$2050	n/a	n/a	n/a	\$305
GBT5HTPV	36 x 66 x 1.19	85	95	6.5	\$2246	n/a	n/a	n/a	\$335
GBT6TPV	36 x 72 x 1.19	85	86	7	\$2446	n/a	n/a	n/a	\$366
GBT7TPV	36 x 84 x 1.19	85	102	8	\$2856	n/a	n/a	n/a	\$426
GBT8TPV	36 x 96 x 1.19	85	113	9	\$3265	n/a	n/a	n/a	\$485

Boat-Shaped Tops, 60"-96"W

Applicable bases to use with above tops, TWO bases required: rounds GRB22H26, GRB22, GRB22H35, GRB22H41, OR squares GSB19H26, GSB19, GSB19H35, GSB19H41 (see 680). Tops feature metal inserts for ease of assembly to base.

- GBTxNPT - 30"D at center, 24"D at ends; GBTxTP - 36"D at center, 28"D at ends.

Required Specifications

Top finish
Edge finish⁽¹⁾

Optional Specifications

HP laminate⁽¹⁾
Knife edge⁽²⁾
Cut-out for grommet/power blocks

Applicable Bases, two required

GRB22H26	GSB19H26
GRB22	GSB19
GRB22H35	GSB19H35
GRB22H41	GSB19H41

SWAP TABLES

BASES FOR TOPS 60" - 96" WIDE

MODEL# DIMENSIONS FREIGHT CLASS WT./LBS. CUBIC FT. LIST PRICE CHM/BCH ACO/SBR

D x W x H

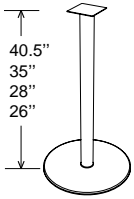

22" Dia Round Bases

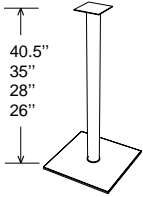

18.5" Square Bases

GRB22H26	22 x 22 x 26	150	50	8.63	\$934	\$147	\$270
GRB22	22 x 22 x 28	150	55	9.33	\$870	\$147	\$270
GRB22H35	22 x 22 x 35	150	57.1	12	\$912	\$145	\$308
GRB22H41	22 x 22 x 40.5	150	58.3	14	\$928	\$160	\$316

GRB22H26 - lounge height **GRB22** - seated height **GRB22H35** - counter height **GRB22H41** - bar height

GSB19H26	18.5 x 18.5 x 26	125	47	5.94	\$1004	\$133	\$259
GSB19	18.5 x 18.5 x 28	100	50	6.06	\$942	\$145	\$319
GSB19H35	18.5 x 18.5 x 35	125	51.8	7.52	\$999	\$145	\$319
GSB19H41	18.5 x 18.5 x 40.5	125	53.2	8.77	\$1034	\$160	\$319

GSB19H26 - lounge height **GSB19** - seated height **GSB19H35** - counter height **GSB19H41** - bar height

Base comes fully assembled and features 0.5" adjustable glides to level on uneven surfaces. Screws included with base for attaching to appropriate top(s). Available in paint finishes listed on 653; plated finishes as available on 653 (upcharge applies).

Required Specifications
Finish

Optional Specifications
Plated finish

RECTANGULAR TOPS 96" - 144"

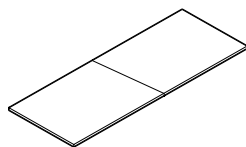

Rectangular Tops, 96-144"

MODEL#	DIMENSIONS	FREIGHT CLASS	WT/LBS.	CUBIC FT.	LIST PRICE	HP ADD	GR. 2 ADD	R3 ADD	KS ADD
--------	------------	---------------	---------	-----------	------------	--------	-----------	--------	--------

D x W x H

TFL, flat edge ⁽¹⁾⁽⁴⁾

1 Piece top - 2 bases required

GRT8MTP	42 x 96 x 1	92.5	128	11.84	\$1442	\$652	n/a	\$145	n/a
GRT8WTP	48 x 96 x 1	85	190	14	\$1460	\$556	n/a	\$147	n/a

2 Piece tops - 3 bases required

GRT10WTP	48 x 120 x 1	85	220	17	\$1836	\$744	n/a	\$184	n/a
GRT12WTP	48 x 144 x 1	65	262	10.5	\$2139	\$842	n/a	\$214	n/a

HPL, knife edge

1 Piece top - 2 bases required

GRT8MTPLK	42 x 96 x 1.19	85	154	11	\$2925	n/a	n/a	n/a	n/a
GRT8WTPLK	48 x 96 x 1.19	70	228	12	\$3280	n/a	n/a	n/a	n/a

2 Piece tops - 3 bases required

GRT10WTPLK	48 x 120 x 1.19	70	264	15	\$4450	n/a	n/a	n/a	n/a
GRT12WTPLK	48 x 144 x 1.19	70	314	18	\$5326	n/a	n/a	n/a	n/a

Veneer ⁽²⁾

1 Piece top - 2 bases required

GRT8MTPV	42 x 96 x 1.19	85	154	11	\$3741	n/a	n/a	n/a	\$371
GRT8WTPV	48 x 96 x 1.19	70	228	12	\$4216	n/a	n/a	n/a	\$421

2 Piece tops - 3 bases required

GRT10WTPV	48 x 120 x 1.19	70	264	15	\$5615	n/a	n/a	n/a	\$561
GRT12WTPV	48 x 144 x 1.19	70	314	18	\$6720	n/a	n/a	n/a	\$670

Applicable bases to use with above tops: round GRB28 or square GSB23. TWO bases required for 96"W tops or THREE bases required for 120" & 144"W tops (see 684). Tops feature metal inserts for ease of assembly to base.

Required Specifications

Top finish
Edge finish⁽¹⁾

Optional Specifications

HP laminate⁽¹⁾
Knife edge⁽²⁾
3" radiused corners⁽⁴⁾
Cut-out for grommet/power blocks

Applicable Bases

GRB28
GSB23

S SWAP TABLES

RACETRACK TOPS 96" - 144"

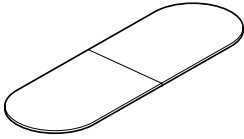

Racetrack Tops, 96-144"

MODEL#	DIMENSIONS	FREIGHT CLASS	WT/LBS.	CUBIC FT.	LIST PRICE	HP ADD	GR. 2 ADD	R3 ADD	KS ADD
D x W x H									
TFL, flat edge ⁽¹⁾									
1 Piece top - 2 bases required									
GRC8MTP	42 x 96 x 1	92.5	128	11.84	\$1442	\$652	n/a	n/a	n/a
GRC8WTP	48 x 96 x 1	85	190	14	\$1460	\$566	n/a	n/a	n/a
2 Piece tops - 3 bases required									
GRC10WTP	48 x 120 x 1	85	220	17	\$1836	\$760	n/a	n/a	n/a
GRC12WTP	48 x 144 x 1	85	262	21	\$2139	\$859	n/a	n/a	n/a
HPL, knife edge									
1 Piece top - 2 bases required									
GRC8MTPLK	42 x 96 x 1.19	85	154	11	\$3501	n/a	n/a	n/a	n/a
GRC8WTPLK	48 x 96 x 1.19	70	228	12	\$4001	n/a	n/a	n/a	n/a
2 Piece tops - 3 bases required									
GRC10WTPLK	48 x 120 x 1.19	70	264	15	\$5001	n/a	n/a	n/a	n/a
GRC12WTPLK	48 x 144 x 1.19	70	314	18	\$6001	n/a	n/a	n/a	n/a
Veneer ⁽²⁾									
1 Piece top - 2 bases required									
GRC8MTPV	42 x 96 x 1.19	85	154	11	\$4450	n/a	n/a	n/a	\$445
GRC8WTPV	48 x 96 x 1.19	70	228	12	\$4950	n/a	n/a	n/a	\$495
2 Piece tops - 3 bases required									
GRC10WTPV	48 x 120 x 1.19	70	264	15	\$6501	n/a	n/a	n/a	\$651
GRC12WTPV	48 x 144 x 1.19	70	314	18	\$7701	n/a	n/a	n/a	\$771

Applicable bases to use with above tops: round GRB28 or square GSB23. TWO bases required for 96"W tops or THREE bases required for 120" & 144"W tops (see 684). Tops feature metal inserts for ease of assembly to base.

Required Specifications

Top finish
Edge finish⁽¹⁾

Optional Specifications

HP laminate⁽¹⁾
Knife edge⁽²⁾
Cut-out for grommet/power blocks

Applicable Bases

GRB28
GSB23

BOAT TOPS 96" - 144"

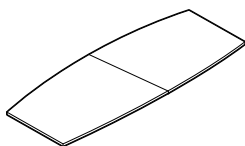

Boat Tops, 96"-144"

MODEL#	DIMENSIONS	FREIGHT CLASS	WT/LBS.	CUBIC FT.	LIST PRICE	HP ADD	GR. 2 ADD	R3 ADD	KS ADD
--------	------------	---------------	---------	-----------	------------	--------	-----------	--------	--------

D x W x H

TFL, flat edge ⁽¹⁾

1 Piece top - 2 bases required

GBT8MTP	42 x 96 x 1	92.5	128	11.84	\$1442	\$652	n/a	n/a	n/a
GBT8WTP	48 x 96 x 1	85	190	14	\$1460	\$566	n/a	n/a	n/a

2 Piece tops - 3 bases required

GBT10WTP	48 x 120 x 1	85	220	17	\$1836	\$760	n/a	n/a	n/a
GBT12WTP	48 x 144 x 1	85	262	21	\$2139	\$859	n/a	n/a	n/a

HPL, knife edge

1 Piece top - 2 bases required

GBT8MTPLK	42 x 96 x 1.19	85	154	11	\$3501	n/a	n/a	n/a	n/a
GBT8WTPLK	48 x 96 x 1.19	70	228	12	\$4001	n/a	n/a	n/a	n/a

2 Piece tops - 3 bases required

GBT10WTPLK	48 x 120 x 1.19	70	264	15	\$5001	n/a	n/a	n/a	n/a
GBT12WTPLK	48 x 144 x 1.19	70	314	18	\$6001	n/a	n/a	n/a	n/a

Veneer ⁽²⁾

1 Piece top - 2 bases required

GBT8MTPV	42 x 96 x 1.19	85	154	11	\$4450	n/a	n/a	n/a	\$445
GBT8WTPV	48 x 96 x 1.19	70	228	12	\$4950	n/a	n/a	n/a	\$495

2 Piece tops - 3 bases required

GBT10WTPV	48 x 120 x 1.19	70	264	15	\$6501	n/a	n/a	n/a	\$651
GBT12WTPV	48 x 144 x 1.19	70	314	18	\$7701	n/a	n/a	n/a	\$771

Applicable bases to use with above tops: round GRB28 or square GSB23. TWO bases required for 96"W tops or THREE bases required for 120" & 144"W tops (see 684). Tops feature metal inserts for ease of assembly to base.

- GBTxM - 42" deep at center and 33" deep at ends; GBTxW - 48" deep at center and 38" deep at ends.

Required Specifications

Top finish
Edge finish⁽¹⁾

Optional Specifications

HP laminate⁽¹⁾
Knife edge⁽²⁾
Cut-out for grommet/power blocks

Applicable Bases

GRB28
GSB23

S SWAP TABLES

BASES FOR TOPS 96"- 144" WIDE

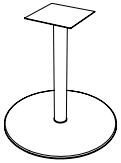

28" Dia Round Base

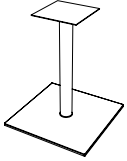

23" Square Base

MODEL#	DIMENSIONS	FREIGHT CLASS	WT./LBS.	CUBIC FT.	LIST PRICE	CHM/BCH	ACO/SBR
--------	------------	---------------	----------	-----------	------------	---------	---------

D x W x H							
GRB28	28 x 28 x 28	125	100	15.63	\$1498	\$160	\$452

seated height

GSB23	22.5 x 22.5 x 28	100	82	9.33	\$1377	\$89	\$287
-------	------------------	-----	----	------	---------------	-------------	--------------

seated height

Base comes fully assembled and features 0.5" adjustable glides to level on uneven surfaces. Screws included with base for attaching to appropriate top(s). Available in paint finishes listed on 653; plated finishes as available on 653 (upcharge applies).

Required Specifications

Finish

Optional Specifications

Plated finish

RECTANGULAR TOPS FOR DUAL COLUMN BASE **MODEL#** **DIMENSIONS** **FREIGHT CLASS** **WT/LBS.** **CUBIC FT.** **LIST PRICE** **HP ADD GR. 2 ADD** **R3 ADD** **KS ADD**

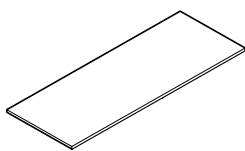

D x W x H

TFL, flat edge ⁽¹⁾⁽⁴⁾

GRTD5TP	36 x 60 x 1	100	60	6.6	\$655	\$305	n/a	\$66	n/a
GRTD5HTP	36 x 66 x 1	100	69	7.21	\$715	\$334	n/a	\$72	n/a
GRTD6TP	36 x 72 x 1	100	75	7.82	\$737	\$343	n/a	\$74	n/a
GRTD5MTP	42 x 60 x 1	100	73	7.62	\$727	\$337	n/a	\$73	n/a
GRTD5HMTP	42 x 66 x 1	100	81	8.32	\$776	\$361	n/a	\$78	n/a
GRTD6MTP	42 x 72 x 1	100	89	9.02	\$799	\$371	n/a	\$80	n/a

HPL, knife edge

GRTD5TPLK	36 x 60 x 1.19	85	72	6	\$1341	n/a	n/a	n/a	n/a
GRTD5HTPLK	36 x 66 x 1.19	85	83	6.5	\$1470	n/a	n/a	n/a	n/a
GRTD6TPLK	36 x 72 x 1.19	85	90	7	\$1605	n/a	n/a	n/a	n/a
GRTD5MTPLK	42 x 60 x 1.19	85	88	7	\$1556	n/a	n/a	n/a	n/a
GRTD5HMTPK	42 x 66 x 1.19	85	97	7.5	\$1716	n/a	n/a	n/a	n/a
GRTD6MTPLK	42 x 72 x 1.19	85	107	8	\$1870	n/a	n/a	n/a	n/a

Veneer ⁽²⁾

GRTD5TPV	36 x 60 x 1.19	85	72	6	\$1780	n/a	n/a	n/a	\$181
GRTD5HTPV	36 x 66 x 1.19	85	83	6.5	\$1951	n/a	n/a	n/a	\$196
GRTD6TPV	36 x 72 x 1.19	85	90	7	\$2126	n/a	n/a	n/a	\$210
GRTD5MTPV	42 x 60 x 1.19	85	88	7	\$2071	n/a	n/a	n/a	\$206
GRTD5HMTPV	42 x 66 x 1.19	85	97	7.5	\$2275	n/a	n/a	n/a	\$225
GRTD6MTPV	42 x 72 x 1.19	85	107	8	\$2480	n/a	n/a	n/a	\$250

Rectangular Top*

Top features metal inserts for ease of assembly to base. One dual column base #GDCB36H28 required (see 688). Limited cut-out options available for power modules include A2, E2, J2, V2 or AG2 only. Power modules corresponding to applicable cut-out codes ordered separately.

Required Specifications

Top finish
Edge finish⁽¹⁾

Optional Specifications

HP laminate⁽¹⁾
Knife edge⁽²⁾
3" radiused corners⁽⁴⁾
Cut-out for grommet/power blocks

Applicable Bases

GDCB36H28

S SWAP TABLES

RACETRACK TOPS FOR DUAL COLUMN BASE

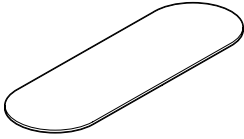

MODEL# DIMENSIONS FREIGHT CLASS WT/LBS. CUBIC FT. LIST PRICE HP ADD GR. 2 ADD R3 ADD KS ADD

D x W x H

TFL, flat edge ⁽¹⁾

GRCD5TP	36 x 60 x 1	100	60	6.6	\$655	\$305	n/a	n/a	n/a
GRCD5HTP	36 x 66 x 1	100	69	7.21	\$715	\$334	n/a	n/a	n/a
GRCD6TP	36 x 72 x 1	100	75	7.82	\$737	\$343	n/a	n/a	n/a
GRCD5MTP	42 x 60 x 1	100	73	7.62	\$727	\$337	n/a	n/a	n/a
GRCD5HMTP	42 x 66 x 1	100	81	8.32	\$776	\$361	n/a	n/a	n/a
GRCD6MTP	42 x 72 x 1	100	89	9.02	\$799	\$371	n/a	n/a	n/a

HPL, knife edge

GRCD5TPLK	36 x 60 x 1.19	85	72	6	\$1875	n/a	n/a	n/a	n/a
GRCD5HTPLK	36 x 66 x 1.19	85	83	6.5	\$2001	n/a	n/a	n/a	n/a
GRCD6TPLK	36 x 72 x 1.19	85	90	7	\$2126	n/a	n/a	n/a	n/a
GRCD5MTPLK	42 x 60 x 1.19	85	88	7	\$2250	n/a	n/a	n/a	n/a
GRCD5HMTPK	42 x 66 x 1.19	85	97	7.5	\$2375	n/a	n/a	n/a	n/a
GRCD6MTPLK	42 x 72 x 1.19	85	107	8	\$2501	n/a	n/a	n/a	n/a

Veneer ⁽²⁾

GRCD5TPV	36 x 60 x 1.19	85	72	6	\$2250	n/a	n/a	n/a	\$225
GRCD5HTPV	36 x 66 x 1.19	85	83	6.5	\$2375	n/a	n/a	n/a	\$236
GRCD6TPV	36 x 72 x 1.19	85	90	7	\$2501	n/a	n/a	n/a	\$250
GRCD5MTPV	42 x 60 x 1.19	85	88	7	\$2626	n/a	n/a	n/a	\$265
GRCD5HMTPV	42 x 66 x 1.19	85	97	7.5	\$2750	n/a	n/a	n/a	\$276
GRCD6MTPV	42 x 72 x 1.19	85	107	8	\$2875	n/a	n/a	n/a	\$286

Racetrack Tops for Dual Column Base

Top features metal inserts for ease of assembly to base. One dual column base #GDCB36H28 required (see 688). Limited cut-out options available for power modules include A2, E2, J2, V2 or AG2 only. Power modules corresponding to applicable cut-out codes ordered separately.

Required Specifications

Top finish
Edge finish⁽¹⁾

Optional Specifications

HP laminate⁽¹⁾
Knife edge⁽²⁾
Cut-out for grommet/power blocks

Applicable Bases

GDCB36H28

BOAT SHAPED TOPS FOR DUAL COLUMN BASE **MODEL#** **DIMENSIONS** **FREIGHT CLASS** **WT/LBS.** **CUBIC FT.** **LIST PRICE** **HP ADD GR. 2 ADD** **R3 ADD** **KS ADD**

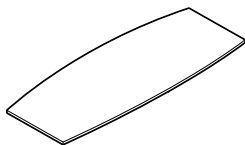

D x W x H

TFL, flat edge ⁽¹⁾

GBTD5TP	36 x 60 x 1	100	60	6.6	\$655	\$305	n/a	n/a	n/a
GBTD5HTP	36 x 66 x 1	100	69	7.21	\$715	\$334	n/a	n/a	n/a
GBTD6TP	36 x 72 x 1	100	75	7.82	\$737	\$343	n/a	n/a	n/a
GBTD5MTP	42 x 60 x 1	100	73	7.62	\$727	\$337	n/a	n/a	n/a
GBTD5HMTP	42 x 66 x 1	100	81	8.32	\$776	\$361	n/a	n/a	n/a
GBTD6MTP	42 x 72 x 1	100	89	9.02	\$799	\$371	n/a	n/a	n/a

HPL, knife edge

GBTD5TPLK	36 x 60 x 1.19	85	72	6	\$1875	n/a	n/a	n/a	n/a
GBTD5HTPLK	36 x 66 x 1.19	85	83	6.5	\$2001	n/a	n/a	n/a	n/a
GBTD6TPLK	36 x 72 x 1.19	85	90	7	\$2126	n/a	n/a	n/a	n/a
GBTD5MTPLK	42 x 60 x 1.19	85	88	7	\$2250	n/a	n/a	n/a	n/a
GBTD5HMTPK	42 x 66 x 1.19	85	97	7.5	\$2375	n/a	n/a	n/a	n/a
GBTD6MTPLK	42 x 72 x 1.19	85	107	8	\$2501	n/a	n/a	n/a	n/a

Veneer ⁽²⁾

GBTD5TPV	36 x 60 x 1.19	85	72	6	\$2250	n/a	n/a	n/a	\$225
GBTD5HTPV	36 x 66 x 1.19	85	83	6.5	\$2375	n/a	n/a	n/a	\$236
GBTD6TPV	36 x 72 x 1.19	85	90	7	\$2501	n/a	n/a	n/a	\$250
GBTD5MTPV	42 x 60 x 1.19	85	88	7	\$2626	n/a	n/a	n/a	\$265
GBTD5HMTPV	42 x 66 x 1.19	85	97	7.5	\$2750	n/a	n/a	n/a	\$276
GBTD6MTPV	42 x 72 x 1.19	85	107	8	\$2875	n/a	n/a	n/a	\$286

Boat Tops for Dual Column Base

Top features metal inserts for ease of assembly to base. One dual column base #GDCB36H28 required (see 688). Limited cut-out options available for power modules include A2, E2, J2, V2 or AG2 only. Power modules corresponding to applicable cut-out codes ordered separately.

Boat tops:

- 36" deep at the center, are 28" deep across ends; 42" deep at the center, are 33" deep at the ends.

Required Specifications

Top finish
Edge finish⁽¹⁾

Optional Specifications

HP laminate⁽¹⁾
Knife edge⁽²⁾
Cut-out for grommet/power blocks

Applicable Bases

GDCB36H28

S SWAP TABLES

DUAL COLUMN BASE FOR GxTDxxx TOPS

MODEL#

DIMENSIONS

FREIGHT CLASS

WT./LBS.

CUBIC FT.

LIST PRICE

CHM/BCH

ACO/SBR

D x W x H

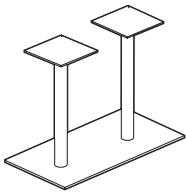

28"H Dual Column Base

Base valid for tops on pages 693-695:

GDCB36H28	36 x 19 x 28	100	116.23	12.16	\$2430	\$567	\$934
seated height							

Order the quantity of bases as indicated by each top size.

Base ships knocked-down; assembly required. Features 0.5" adjustable glides to level on uneven surfaces. Screws included with base for attaching to appropriate top(s). Available in paint finishes listed on 653; plated finishes as available on 653 (upcharge applies).

Required Specifications

Finish

Optional Specifications

Plated finish

HUDDLE TABLES OVERVIEW

- Three heights available: seated desk height - 29", counter height - 36", bar height - 41.5" with D top, wedge, rectangular or soft ellipse shaped tops.
- Bring teams together to huddle, share and collaborate.
- Tops include metal inserts for ease of assembly to metal base. All tops are standard with an edge scoop to help manage cables from wall mounted flat screen monitors and/or edge mounting power module (PS305057/PS305002 as an example). Support channels are included with tops over 60" wide.
- Optional cut-outs available where noted. Add **\$96** per cut-out. Only available in position 1 or position 2.

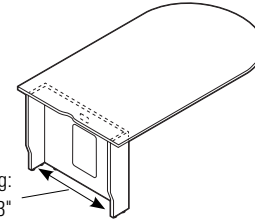
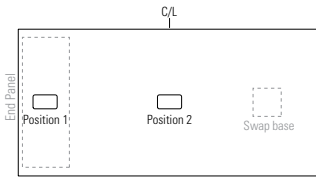

Interior width for base opening:
27.13"/33.3"/39.13"

Please take note when used in conjunction with Zira wall panels.

- Laminate kits are sold separately from metal bases for huddle tables.
- Metal bases ship fully assembled and include 0.5" adjustable glides and metal screws for attaching to the top. Be sure to specify bases specific to huddle tables GRHB22Hxx or GSB19Hxx.

D-TOP HUDDLE TABLES

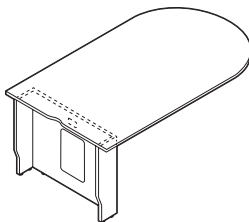

29"H D-Top Huddle

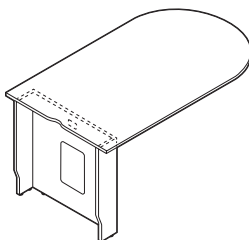

36"H D-Top Huddle

MODEL#	DIMENSIONS D x W x H	FREIGHT CLASS	WT./LBS.	CUBIC FT.	LIST PRICE	HP ADD
GDH364829	48 x 36 x 29	70	77.05	3.94	\$1068	\$333
GDH366029	60 x 36 x 29	70	86.95	4.46	\$1302	\$472
GDH367229	72 x 36 x 29	70	97	4.98	\$1452	\$563
GDH426029	60 x 42 x 29	70	99.82	5.18	\$1461	\$540
GDH427229	72 x 42 x 29	70	111.5	5.78	\$1637	\$644
GDH428429	84 x 42 x 29	92.5	123.1	11.98	\$1811	\$751
GDH429629	96 x 42 x 29	92.5	134.74	13.3	\$1957	\$836
GDH486029	60 x 48 x 29	70	112.6	5.88	\$1629	\$611
GDH487229	72 x 48 x 29	70	126	6.58	\$1824	\$729
GDH488429	84 x 48 x 29	92.5	139.24	13.5	\$1950	\$805
GDH489629	96 x 48 x 29	92.5	152.56	15	\$2109	\$901

Laminate u-base support is 8"D with 7" inside clearance to wall. Access wall through 14.5"H x 9.5"W hinged door with touch latch in front panel of u-base support. U-base includes 0.5" adjustable glides. U-base side panels are tapered at the bottom to clear most baseboards. Cut-outs available in positions 1 and 2 only; except 36" x 48"D models (cut-out available in position 1 only).

- Metal bases sold separately. Compatible with **GRHB22H28** or **GSHB19H28** only (see 694).

GDH364836	48 x 36 x 36	70	85.95	4.3	\$1102	\$333
GDH366036	60 x 36 x 36	70	95.85	4.84	\$1335	\$472
GDH367236	72 x 36 x 36	70	105.9	5.36	\$1483	\$563
GDH426036	60 x 42 x 36	70	109.82	5.6	\$1497	\$540
GDH427236	72 x 42 x 36	70	121.5	6.22	\$1672	\$644
GDH428436	84 x 42 x 36	92.5	133.1	12.4	\$1847	\$751
GDH429636	96 x 42 x 36	92.5	144.74	13.74	\$1994	\$836
GDH486036	60 x 48 x 36	70	123.6	6.38	\$1669	\$611
GDH487236	72 x 48 x 36	70	137	7.08	\$1865	\$729
GDH488436	84 x 48 x 36	92.5	150.24	14	\$1991	\$805
GDH489636	96 x 48 x 36	92.5	163.56	15.5	\$2149	\$901

Laminate u-base support is 8"D with 7" inside clearance to wall. Access wall through 14.5"H x 9.5"W hinged door with touch latch in front panel of u-base support. U-base includes 0.5" adjustable glides. U-base side panels are tapered at the bottom to clear most baseboards. Cut-outs available in positions 1 and 2 only; except 36" x 48"D models (cut-out available in position 1 only).

- Metal bases sold separately. Compatible with **GRHB22H35** or **GSHB19H35** only (see 694).

Required Specifications

Top finish
Laminate base finish
Edge

Optional Specifications

HP laminate
Power block cut-out

Accessories

Power block

S SWAP TABLES

D-TOP HUDDLE TABLES

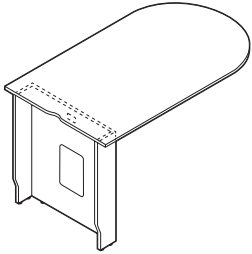

41.5"H D-Top Huddle

MODEL#	DIMENSIONS	FREIGHT CLASS	WT/LBS.	CUBIC FT.	LIST PRICE	HP ADD
--------	------------	---------------	---------	-----------	------------	--------

D x W x H

GDH364841	48 x 36 x 41.5	70	92.65	4.58	\$1158	\$333
GDH366041	60 x 36 x 41.5	70	102.55	5.1	\$1390	\$472
GDH367241	72 x 36 x 41.5	70	112.6	5.62	\$1542	\$563
GDH426041	60 x 42 x 41.5	70	117.32	5.92	\$1561	\$540
GDH427241	72 x 42 x 41.5	70	129	6.52	\$1738	\$644
GDH428441	84 x 42 x 41.5	92.5	140.6	12.72	\$1915	\$751
GDH429641	96 x 42 x 41.5	92.5	152.24	14.06	\$2059	\$836
GDH486041	60 x 48 x 41.5	70	130.1	6.74	\$1741	\$611
GDH487241	72 x 48 x 41.5	70	143.5	7.42	\$1936	\$729
GDH488441	84 x 48 x 41.5	92.5	156.74	14.52	\$2064	\$805
GDH489641	96 x 48 x 41.5	92.5	170.06	15.84	\$2223	\$901

Laminate u-base support is 8"D with 7" inside clearance to wall. Access wall through 14.5"H x 9.5"W hinged door with touch latch in front panel of u-base support. U-base includes 0.5" adjustable glides. U-base side panels are tapered at the bottom to clear most baseboards. Cut-outs available in positions 1 and 2 only; except 36" x 48"D models (cut-out available in position 1 only).

- Metal bases sold separately. Compatible with **GRHB22H41** or **GSHB19H41** only (see 694).

Required Specifications

Top finish
Laminate base finish
Edge

Optional Specifications

HP laminate
Power block cut-out

Accessories

Power block

WEDGE HUDDLE TABLES

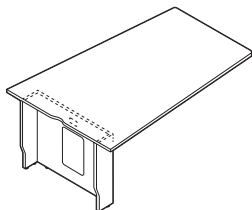

29"H Wedge Huddle

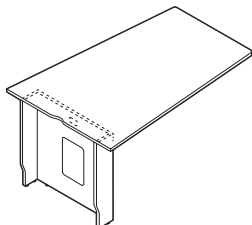

36"H Wedge Huddle

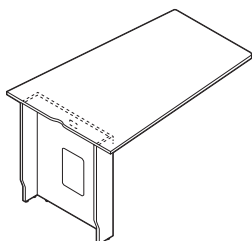

41.5"H Wedge Huddle

MODEL#	DIMENSIONS D x W x H	FREIGHT CLASS	WT./LBS.	CUBIC FT.	LIST PRICE	HP ADD
GWH486029	60 x 48 x 29	70	112.6	5.88	\$1626	\$607
GWH487229	72 x 48 x 29	70	126	6.58	\$1824	\$729
GWH488429	84 x 48 x 29	92.5	139.24	13.5	\$1950	\$805
GWH489629	96 x 48 x 29	92.5	152.56	15	\$2109	\$901

Laminate u-base support is 8"D with 7" inside clearance to wall. Access wall through 14.5"H x 9.5"W hinged door with touch latch in front panel of u-base support. U-base includes 0.5" adjustable glides. U-base side panels are tapered at the bottom to clear most baseboards. Cut-outs available in positions 1 and 2 only.

- Metal bases sold separately. Compatible with **GRHB22H28** or **GSHB19H28** only (see 694).

GWH486036	60 x 48 x 36	70	123.6	6.38	\$1665	\$607
GWH487236	72 x 48 x 36	70	137	7.08	\$1865	\$729
GWH488436	84 x 48 x 36	92.5	150.24	14	\$1991	\$805
GWH489636	96 x 48 x 36	92.5	163.56	15.5	\$2149	\$901

Laminate u-base support is 8"D with 7" inside clearance to wall. Access wall through 14.5"H x 9.5"W hinged door with touch latch in front panel of u-base support. U-base includes 0.5" adjustable glides. U-base side panels are tapered at the bottom to clear most baseboards. Cut-outs available in positions 1 and 2 only.

- Metal bases sold separately. Compatible with **GRHB22H35** or **GSHB19H35** only (see 694).

GWH486041	60 x 48 x 41.5	70	130.1	6.74	\$1736	\$607
GWH487241	72 x 48 x 41.5	70	143.5	7.42	\$1936	\$729
GWH488441	84 x 48 x 41.5	92.5	156.74	14.34	\$2064	\$805
GWH489641	96 x 48 x 41.5	92.5	170.06	15.84	\$2223	\$901

Laminate u-base support is 8"D with 7" inside clearance to wall. Access wall through 14.5"H x 9.5"W hinged door with touch latch in front panel of u-base support. U-base includes 0.5" adjustable glides. U-base side panels are tapered at the bottom to clear most baseboards. Cut-outs available in positions 1 and 2 only.

- Metal bases sold separately. Compatible with **GRHB22H41** or **GSHB19H41** only (see 694).

Required Specifications

Top finish
Laminate base finish
Edge

Optional Specifications

HP laminate
Power block cut-out

Accessories

Power block

S SWAP TABLES

RECTANGULAR HUDDLE TABLES

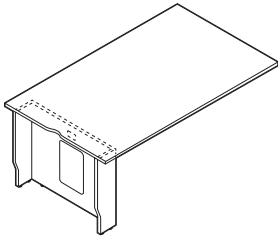

29"H Rectangular Huddle

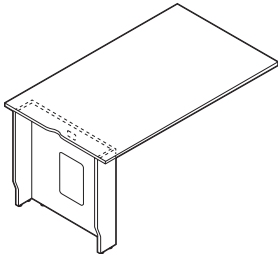

36"H Rectangular Huddle

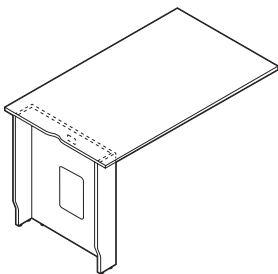

41.5"H Rectangular Huddle*

MODEL#	DIMENSIONS	FREIGHT CLASS	WT./LBS.	CUBIC FT.	LIST PRICE	HP ADD
--------	------------	---------------	----------	-----------	------------	--------

D x W x H

GRH364829	48 x 36 x 29	70	77.05	3.94	\$1068	\$333
GRH366029	60 x 36 x 29	70	86.95	4.46	\$1302	\$472
GRH367229	72 x 36 x 29	70	97	4.98	\$1452	\$563
GRH426029	60 x 42 x 29	70	99.82	5.18	\$1461	\$540
GRH427229	72 x 42 x 29	100	111.5	5.78	\$1637	\$644
GRH428429	84 x 42 x 29	92.5	123.1	11.98	\$1811	\$751
GRH429629	96 x 42 x 29	150	134.74	13.3	\$1957	\$836
GRH486029	60 x 48 x 29	70	112.6	5.88	\$1629	\$611
GRH487229	72 x 48 x 29	70	126	6.58	\$1824	\$729
GRH488429	84 x 48 x 29	92.5	139.24	13.5	\$1950	\$805
GRH489629	96 x 48 x 29	92.5	152.56	15	\$2109	\$901

Laminate u-base support is 8"D with 7" inside clearance to wall. Access wall through 14.5"H x 9.5"W hinged door with touch latch in front panel of u-base support. U-base includes 0.5" adjustable glides. U-base side panels are tapered at the bottom to clear most baseboards. Cut-outs available in positions 1 and 2 only; except 36" x 48"D models (cut-out available in position 1 only).

- Metal bases sold separately. Compatible with **GRHB22H28** or **GSHB19H28** only (see 694)

GRH364836	48 x 36 x 36	70	85.95	4.3	\$1102	\$333
GRH366036	60 x 36 x 36	70	95.85	4.84	\$1335	\$472
GRH367236	72 x 36 x 36	70	105.9	5.36	\$1483	\$563
GRH426036	60 x 42 x 36	70	109.82	5.6	\$1497	\$540
GRH427236	72 x 42 x 36	70	121.5	6.22	\$1672	\$644
GRH428436	84 x 42 x 36	92.5	133.1	12.4	\$1847	\$751
GRH429636	96 x 42 x 36	92.5	144.74	13.74	\$1994	\$836
GRH486036	60 x 48 x 36	70	123.6	6.38	\$1669	\$611
GRH487236	72 x 48 x 36	70	137	7.08	\$1865	\$729
GRH488436	84 x 48 x 36	92.5	150.24	14	\$1991	\$805
GRH489636	96 x 48 x 36	150	163.56	15.5	\$2149	\$901

Laminate u-base support is 8"D with 7" inside clearance to wall. Access wall through 14.5"H x 9.5"W hinged door with touch latch in front panel of u-base support. U-base includes 0.5" adjustable glides. U-base side panels are tapered at the bottom to clear most baseboards. Cut-outs available in positions 1 and 2 only; except 36" x 48"D models (cut-out available in position 1 only).

- Metal bases sold separately. Compatible with **GRHB22H35** or **GSHB19H35** only (see 694).

GRH364841	48 x 36 x 41.5	70	92.65	4.58	\$1158	\$333
GRH366041	60 x 36 x 41.5	70	102.55	5.1	\$1390	\$472
GRH367241	72 x 36 x 41.5	70	112.6	5.62	\$1542	\$563
GRH426041	60 x 42 x 41.5	70	117.32	5.92	\$1561	\$540
GRH427241	72 x 42 x 41.5	70	129	6.52	\$1738	\$644
GRH428441	84 x 42 x 41.5	92.5	140.6	12.72	\$1915	\$751
GRH429641	96 x 42 x 41.5	92.5	152.24	14.06	\$2059	\$836
GRH486041	60 x 48 x 41.5	70	130.1	6.74	\$1741	\$611
GRH487241	72 x 48 x 41.5	70	143.5	7.42	\$1936	\$729
GRH488441	84 x 48 x 41.5	92.5	156.74	14.34	\$2064	\$805
GRH489641	96 x 48 x 41.5	92.5	170.06	15.84	\$2223	\$901

Laminate u-base support is 8"D with 7" inside clearance to wall. Access wall through 14.5"H x 9.5"W hinged door with touch latch in front panel of u-base support. U-base includes 0.5" adjustable glides. U-base side panels are tapered at the bottom to clear most baseboards. Cut-outs available in positions 1 and 2 only; except 36" x 48"D models (cut-out available in position 1 only).

- Metal bases sold separately. Compatible with **GRHB22H41** or **GSHB19H41** only (see 694).

Required Specifications

Top finish
Laminate base finish
Edge

Optional Specifications

HP laminate
Power block cut-out

Accessories

Power block

SOFT ELLIPSE HUDDLE TABLES

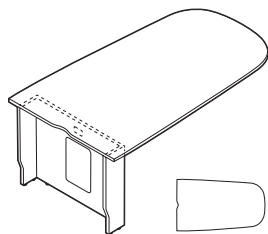

29"H Soft Ellipse Huddle

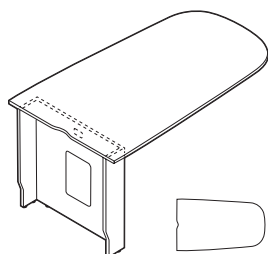

36"H Soft Ellipse Huddle

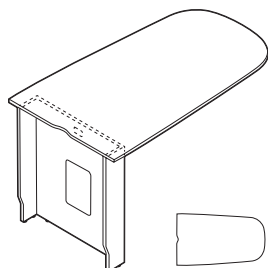

41.5"H Soft Ellipse Huddle*

MODEL#	DIMENSIONS D x W x H	FREIGHT CLASS	WT./LBS.	CUBIC FT.	LIST PRICE	HP ADD
GSEH364829	48 x 36 x 29	70	77.05	3.94	\$1068	\$333
GSEH366029	60 x 36 x 29	70	86.95	4.46	\$1302	\$472
GSEH367229	72 x 36 x 29	70	97	4.98	\$1452	\$563
GSEH426029	60 x 42 x 29	70	99.82	5.18	\$1461	\$540
GSEH427229	72 x 42 x 29	70	111.5	5.78	\$1637	\$644
GSEH428429	84 x 42 x 29	92.5	123.1	11.98	\$1811	\$751
GSEH429629	96 x 42 x 29	92.5	134.7	13.3	\$1957	\$836
GSEH486029	60 x 48 x 29	70	112.6	11.78	\$1629	\$611
GSEH487229	72 x 48 x 29	70	126	6.58	\$1824	\$729
GSEH488429	84 x 48 x 29	92.5	139.2	13.5	\$1950	\$805
GSEH489629	96 x 48 x 29	92.5	152.6	15	\$2109	\$901

Laminate u-base support is 8"D with 7" inside clearance to wall. Access wall through 14.5"H x 9.5"W hinged door with touch latch in front panel of u-base support. U-base includes 0.5" adjustable glides. U-base side panels are tapered at the bottom to clear most baseboards. Cut-outs available in positions 1 and 2 only; except 36" x 48"D models (cut-out available in position 1 only).

- Metal bases sold separately. Compatible with **GRHB22H28** or **GSHB19H28** only (see 694).

GSEH364836	48 x 36 x 36	70	86	4.3	\$1102	\$333
GSEH366036	60 x 36 x 36	70	95.9	4.84	\$1335	\$472
GSEH367236	72 x 36 x 36	70	105.9	5.36	\$1483	\$563
GSEH426036	60 x 42 x 36	70	109.8	5.6	\$1497	\$540
GSEH427236	72 x 42 x 36	70	121.5	6.22	\$1672	\$644
GSEH428436	84 x 42 x 36	92.5	133.1	12.4	\$1847	\$751
GSEH429636	96 x 42 x 36	92.5	144.74	13.74	\$1994	\$836
GSEH486036	60 x 48 x 36	70	123.6	12.76	\$1669	\$611
GSEH487236	72 x 48 x 36	70	137	7.08	\$1865	\$729
GSEH488436	84 x 48 x 36	92.5	150.24	14	\$1991	\$805
GSEH489636	96 x 48 x 36	92.5	163.56	15.5	\$2149	\$901

Laminate u-base support is 8"D with 7" inside clearance to wall. Access wall through 14.5"H x 9.5"W hinged door with touch latch in front panel of u-base support. U-base includes 0.5" adjustable glides. U-base side panels are tapered at the bottom to clear most baseboards. Cut-outs available in positions 1 and 2 only; except 36" x 48"D models (cut-out available in position 1 only).

- Metal bases sold separately. Compatible with **GRHB22H35** or **GSHB19H35** only (see 694).

GSEH364841	48 x 36 x 41.5	92.5	92.65	9.16	\$1158	\$333
GSEH366041	60 x 36 x 41.5	70	102.55	5.1	\$1390	\$472
GSEH367241	72 x 36 x 41.5	70	112.6	5.62	\$1542	\$563
GSEH426041	60 x 42 x 41.5	70	117.32	5.92	\$1561	\$540
GSEH427241	72 x 42 x 41.5	70	129	6.52	\$1738	\$644
GSEH428441	84 x 42 x 41.5	92.5	140.6	12.72	\$1915	\$751
GSEH429641	96 x 42 x 41.5	92.5	152.24	14.06	\$2059	\$836
GSEH486041	60 x 48 x 41.5	70	130.1	6.74	\$1741	\$611
GSEH487241	72 x 48 x 41.5	70	143.5	14.86	\$1936	\$729
GSEH488441	84 x 48 x 41.5	92.5	156.74	14.34	\$2064	\$805
GSEH489641	96 x 48 x 41.5	92.5	170.06	15.84	\$2223	\$901

Laminate u-base support is 8"D with 7" inside clearance to wall. Access wall through 14.5"H x 9.5"W hinged door with touch latch in front panel of u-base support. U-base includes 0.5" adjustable glides. U-base side panels are tapered at the bottom to clear most baseboards. Cut-outs available in positions 1 and 2 only; except 36" x 48"D models (cut-out available in position 1 only).

- Metal bases sold separately. Compatible with **GRHB22H41** or **GSHB19H41** only (see 694).

Required Specifications

Top finish
Laminate base finish
Edge

Optional Specifications

HP laminate
Power block cut-out

Accessories

Power block

S SWAP TABLES

HUDDLE BASES

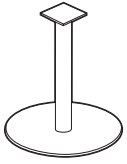

22" Round Huddle Base

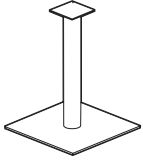

18.5" Square Huddle Base

MODEL#	DIMENSIONS	FREIGHT CLASS	WT/LBS.	CUBIC FT.	LIST PRICE	CHM/BCH	ACO/SBR
--------	------------	---------------	---------	-----------	------------	---------	---------

D x W x H

SELECT BASE COMPATIBLE WITH TOP HEIGHT:

GRHB22H28	22 x 22 x 28	92.5	10	1	\$1048	\$125	\$303
GRHB22H35	22 x 22 x 35	150	62	12.67	\$1048	\$150	\$327
GRHB22H41	22 x 22 x 40.5	150	63	14.17	\$1093	\$157	\$328

GRHB22H28 - seated height **GRHB22H35** - counter height **GRHB22H41** - bar height

Metal base ships fully assembled. Features 0.5" adjustable glides to level on uneven surfaces. Screws included with base for attaching to appropriate huddle table laminate pieces. Be sure to double check huddle table laminate pieces and metal bases are correct corresponding heights. Available in paint finishes listed on 653; plated finishes as available on 653 (upcharge applies).

GSHB19H28	18.5 x 18.5 x 28	125	55	6.94	\$1120	\$121	\$304
GSHB19H35	18.5 x 18.5 x 35	125	57	8.8	\$1120	\$137	\$350
GSHB19H41	18.5 x 18.5 x 40.5	150	58	9.84	\$1173	\$150	\$332

GSHB19H28 - seated height **GSHB19H35** - counter height **GSHB19H41** - bar height

Metal base ships fully assembled. Features 0.5" adjustable glides to level on uneven surfaces. Screws included with base for attaching to appropriate huddle table laminate pieces. Be sure to double check huddle table laminate pieces and metal bases are correct corresponding heights. Available in paint finishes listed on 653; plated finishes as available on 653 (upcharge applies).

Required Specifications

Finish

Optional Specifications

Plated finish



Terina is a simple flip top table series that transforms any space into sophisticated areas for training, meetings and collaboration. Terina features unique and elegant aluminum, angled t-leg design paired with high pressure laminate or veneer surface, with optional modesty panels. Surface power modules offer an easy way to charge electronic devices without the need to drop down cords. Wires are managed below the worksurface with snap-in cable clips. Terina can be ganged together with optional flush ganging plates. Single hand release mechanism is active from the center of the user side of the table. Tables can be nested together in an upright position to minimize storage space.

Features and Benefits

- Training, meeting or conferencing. A multi-purpose table that allows you quickly and simply adapt your space to suit your needs.
- Simple flip top mechanism designed for single handed operation.
- Tops offered in high pressure laminate or wood veneer
- 10" modesty panel articulates when tables fold down
- Legs and crossbeam offered in 7 paint finishes
- Optional flush ganging plates
- Tables can be nested together when not in use.

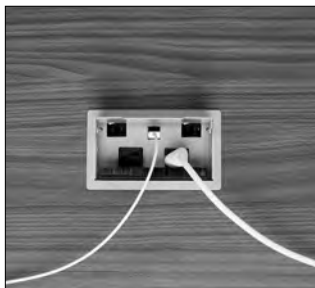

Optional power block includes power and data

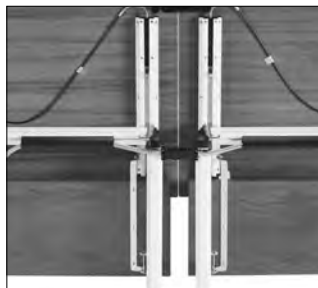

Optional ganging plates and daisy chain power management



Tables can be nested together when not in use.

GENERAL INFORMATION

- Terina flip top tables transform any space into sophisticated areas for training, meetings and collaboration.
- Simple flip top mechanism is designed for one handed operation.
- Unique, angled “T” leg design.
- Shipped R.T.A. (Ready to Assemble).
- For environmental certifications, please visit globalfurnituregroup.com.

WORKSURFACES

- Laminate surfaces are 1-1/16” thick tops constructed of 45 lb. density particle board with high pressure laminate and finished on the underside of the surface with a kraft paper backing.
- Veneer surfaces are 1-3/16” thick tops constructed of 45 lb. density particle board and are balanced on the underside with veneer (unfinished)
- Worksurfaces are pre-drilled for alignment of the Terina base

BASE

- Tables feature an aluminum leg, cross beam and die-cast foot.
- Legs and cross beam are available in (7) different finish options.
- Die-cast foot is always in polished aluminum finish.
- Foot span is 23”

EDGING

- Laminate surfaces offer a selection of matching + coordinated edgeband. Specify separately from the surface finish.
- Veneer tops are finished with a 6mm hardwood edge, stained to match

CASTERS

- Casters are standard on all tables.
- 2-3/8” dual wheel casters with manual lock. Full 360° swivel.
- Suggested for carpeted surfaces.
- Available in grey only

GANGING PLATES

- Ganging plates are available for ganging adjoining tables together.
- Ganging plates are black epoxy coated steel plates with two thumbscrews

WIRE MANAGEMENT

- Wire management option is a snap-in channel that fits on the interior of the leg or on the underside of the flip-top cross beam

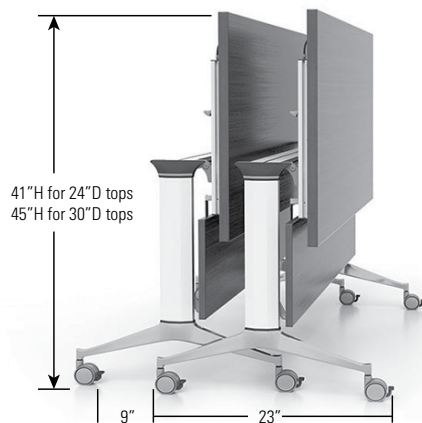

MODESTY PANELS

- 10” modesty panel affixes to the top and base, articulating when it folds down.
- Available in all standard laminates
- Modesty panels up to 60”w have vertical grain. Modesty panels 66” and wider will have horizontal grain.

LAMINATE FINISHES

ACJ	Absolute Acajou	NBL	Noce Biondo
ASN	Asian Night	NGL	Noce Grigio
AWC	Avant Cherry	NEL	Noce Leggero
AWH	Avant Honey	NML	Noce Medio
BLK	Black	QTM	Quartered Mahogany
BZD	Blizzard	SBY	Sheer Beauty
BRC	Brushed Cobalt	SOG	Storm Grey
CMB	Clear Maple	SDT	Stonedust
DES	Dark Espresso	WHE	Walnut Heights
DWT	Designer White	WHC	White Chocolate
FAS	Fashionista	WCR	Winter Cherry
FCL	First Class		

EDGE FINISHES (Laminate Surfaces Only)

AAE	Absolute Acajou	NBL	Noce Biondo
ASE	Asian Night	NGL	Noce Grigio
ACE	Avant Cherry	NEL	Noce Leggero
AHE	Avant Honey	NML	Noce Medio
BLK	Black	QTM	Quartered Mahogany
BRC	Brushed Cobalt	SBY	Sheer Beauty
BZD	Blizzard	SIL	Silver
CHR	Charcoal (<i>use w/SOG</i>)	SDT	Stonedust
CME	Clear Maple	TPE	Taupe
DEE	Dark Espresso	WHE	Walnut Heights
DWE	Designer White	CBE	White Chocolate
FAS	Fashionista	WCE	Winter Cherry
FCL	First Class		

LEG FINISHES

BLK	Black	CHR	Charcoal
DWT	Designer White	NEV	Nevada
SIL	Silver	TPE	Taupe
TUN	Tungsten		

VEENER FINISHES:

Code	Finish	Veneer Type	Cut
AMW	Almond Cherry	Cherry	Flat Sliced
ACW	Amber Cherry	Cherry	Flat Sliced
BTW	Biscotti	White Oak	Rift
CAW	Cocoa Walnut	Walnut	Flat Sliced
CRW	Coral	White Oak	Rift
DCW	Dark Cherry	Cherry	Flat Sliced
DWW	Dark Walnut	Walnut	Flat Sliced
EWV	Espresso Walnut	Walnut	Flat Sliced
EVW	Evening Oak	White Oak	Rift
GRW	Grey on Oak	White Oak	Rift
HAW	Hazelnut	Maple	Flat Sliced
JAW	Java	White Oak	Rift
LTW	Latte Walnut	Walnut	Flat Sliced
MHW	Mahogany on Walnut	Walnut	Flat Sliced
MTW	Milestone	White Oak	Rift
MPW	Natural Maple	Maple	Flat Sliced
NLW	Natural Walnut	Walnut	Flat Sliced
RCW	Red Cherry	Cherry	Flat Sliced
ULW	Umber Walnut	Walnut	Flat Sliced
VNW	Vintage Cherry	Cherry	Flat Sliced
WLW	Walnut	Walnut	Flat Sliced
WCW	Warm Cherry	Cherry	Flat Sliced
WMW	White Maple	Maple	Flat Sliced

GROMMETS

- Grommets are available in all tops (left, center or right). Order as: **AG1, AG2 or AG3. Add \$96.**
- Grommet hole dimensions are 3 1/4" wide x 1 7/8" deep.
- Available on all table widths and depths
- Please note limited user space when cut-outs are specified. See dimensions on diagram below.**

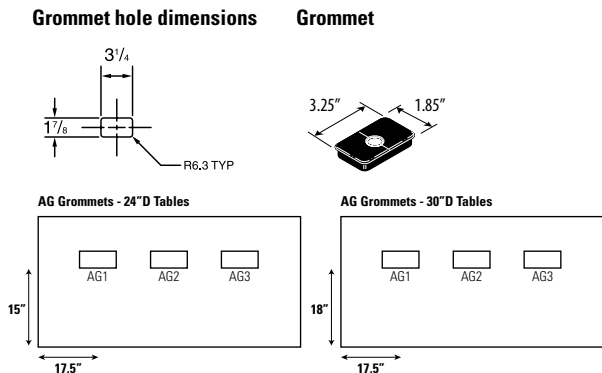

- Grommets may be placed at non-standard locations. Order as: **AGS - Add \$96.** A drawing must be supplied with vertical and horizontal dimensions to the center of the cut-out (as in drawing above). Please refer to CUSTOM GROMMET LOCATION FORM in the back reference section.

POWER BLOCK

- A Power Block (model **PMSPDM**) may be ordered on all worksurfaces.
- A Power Block is a rectangular worksurface power/data module with one electrical duplex receptacle and two data (RJ45) receptacles. 9' black cord included. Power Block dimensions are 3 1/2" deep x 6 1/2" wide x 2 3/4" high.
- A Power Block cut-out (for model **PMSPDM**) may be ordered for **tops 60" and up in any standard location.** Order as **E1, E2 or E3. Add \$96.**
- A Power Block cut-out (for model **PMSPDM**) may be ordered in the **center position only for 48" and 54" tops.** Order as **E2. Add \$96.**

- To purchase a Power Block, you must specify both the Power Block cut-out location and the Power Block model #. Order Power Block as **PMSPDM, Add \$330.**
- Please note limited user space when cut-outs are specified. See dimensions on diagram below.**



Power Block **PMSPDM, Add \$330**

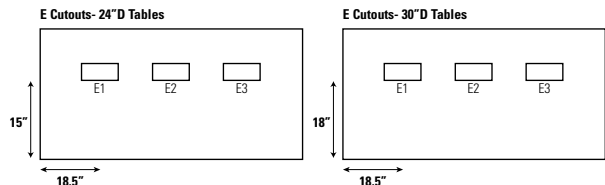

VILLA CUT-OUTS

- A Villa cut-out may be ordered for **tops 60" and up in any standard location.** Order as: **V1, V2 or V3 - Add \$96 for each cut-out.**
- A Villa cut-out may be ordered in the **center position only for 48" and 54" tops.** Order as: **V2 - Add \$96.**
- Villa with USB is not compatible with Terina tables**
- Please note limited user space when cut-outs are specified. See dimensions on diagram below.**

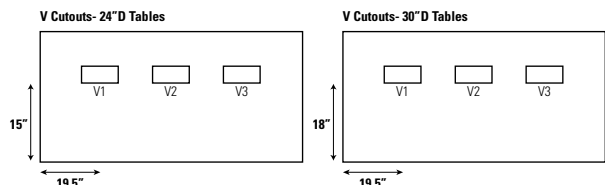

RECTANGULAR TABLES



Rectangular Table - Laminate Top*

MODEL#	DIMENSIONS D x W x H	FREIGHT CLASS	WT/LBS.	CUBIC FT.	LIST PRICE
GFT2472R	24 x 72 x 29	100	66	6.98	\$1900
GFT2466R	24 x 66 x 29	250	61	20.96	\$1863
GFT2460R	24 x 60 x 29	250	55	20.96	\$1832
GFT2454R	24 x 54 x 29	250	53	17.96	\$1790
GFT2448R	24 x 48 x 29	250	48	17.96	\$1638
GFT3072R	30 x 72 x 29	100	68	6.98	\$1958
GFT3066R	30 x 66 x 29	100	66	6.98	\$1938
GFT3060R	30 x 60 x 29	100	61	6.98	\$1907
GFT3054R	30 x 54 x 29	100	55	5.99	\$1863
GFT3048R	30 x 48 x 29	100	53	5.99	\$1749

Tables feature a flip-top **laminated** worksurface for ease of storage. Single hand release mechanism is active from the center of the user side of the table. Leg can be painted in a variety of finishes. Foot is always in polished aluminum. Each table can be ganged together with GFCNGFP ganging plates (see next page). Modesty panels are available (see GFTxxM).

- Casters are available in grey only.



Rectangular Table - Veneer Top

GFT2472RV	24 x 72 x 29	100	66	6.98	\$3154
GFT2466RV	24 x 66 x 29	250	61	20.96	\$2999
GFT2460RV	24 x 60 x 29	250	55	20.96	\$2842
GFT2454RV	24 x 54 x 29	250	53	17.96	\$2753
GFT2448RV	24 x 48 x 29	250	48	17.96	\$2660
GFT3072RV	30 x 72 x 29	100	68	6.98	\$3626
GFT3066RV	30 x 66 x 29	100	66	6.98	\$3428
GFT3060RV	30 x 60 x 29	100	66	6.98	\$3229
GFT3054RV	30 x 54 x 29	100	55	5.99	\$3023
GFT3048RV	30 x 48 x 29	100	53	5.99	\$2822

Tables feature a flip-top **veneer** worksurface for ease of storage. Single hand release mechanism is active from the center of the user side of the table. Leg can be painted in a variety of finishes. Foot is always in polished aluminum. Each table can be ganged together with GFCNGFP ganging plates (see next page). Modesty panels are available (see GFTxxMx).

- Casters are available in grey only.

POWER/DATA



Duo Module

MODEL#	DIMENSIONS	FREIGHT CLASS	WT/LBS.	CUBIC FT.	LIST PRICE
BRED50	3.2 x 5.5 x 1.8	70	2.50	.14	\$386

The duo power module is completely integrated with a mounting clamp to attach to the edge of a worksurface. Provides two outlets and two 2.1 amp USB ports. White face plate, outlets and bracket; 72" long three-prong black cord, silver body.

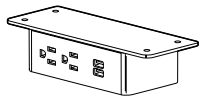

Duo Under Module

BREDU51	2.8 x 5.5 x 1.8	70	2.50	.14	\$335
---------	-----------------	----	------	-----	--------------

The duo under power module comes with a thin flush mounting bracket to attach to the underside of a worksurface or above worksurface shelves. Provides two outlets and two 2.1 amp USB ports. White face plate, outlets and brackets; 72" long three-prong black cord, silver body.

Required Specifications

Top finish
Leg finish
Edge finish*

Optional Specifications

Grommet

Accessories

Power block
Wire management
Ganging plate

MODESTY PANELS

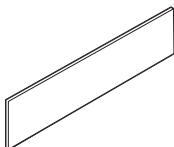

Modesty Panel - Laminate*

MODEL# DIMENSIONS FREIGHT CLASS WT/LBS. CUBIC FT. LIST PRICE

D x W x H

GFT72M	.75 x 70 x 10	92.5	20	2	\$346
GFT66M	.75 x 64 x 10	100	18	2	\$329
GFT60M	.75 x 58 x 10	70	15	1	\$316
GFT54M	.75 x 52 x 10	85	13	1	\$303
GFT48M	.75 x 46 x 10	92.5	11	1	\$288

Laminate modesty panel for use on GFTxxxxR Tables. Articulating modesty panel includes necessary hardware to attach. Can be retrofitted.

- Modesty panels up to 60" w have vertical grain. Modesty panels 66" and wider will have horizontal grain.

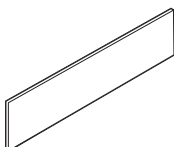

Modesty Panel - Veneer

GFT72MV	.75 x 70 x 10	92.5	20	2	\$964
GFT66MV	.75 x 64 x 10	100	18	2	\$896
GFT60MV	.75 x 58 x 10	70	15	1	\$814
GFT54MV	.75 x 52 x 10	85	13	1	\$732
GFT48MV	.75 x 46 x 10	92.5	11	1	\$664

Veneer modesty panel for use on GFTxxxxR Tables. Articulating modesty panel includes necessary hardware to attach. Can be retrofitted.

- Modesty panels up to 60" w have vertical grain. Modesty panels 66" and wider will have horizontal grain.

WIRE MANAGEMENT

MODEL# DIMENSIONS FREIGHT CLASS WT/LBS. CUBIC FT. LIST PRICE



Wire Manager

GFTCM04BLK	2 x 10 x 2	70	1	1	\$54
------------	------------	----	---	---	-------------

Set of four, 10" long grey plastic extrusions. Can be snapped into the inside of each leg for wire management from the surface to the floor, or snapped into the cross beam of the table to keep wires tucked neatly below the worksurface.

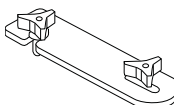

Ganging Flush Plate

GFCNGFP	.1 x 5 x 2.5	70	1	.01	\$54
---------	--------------	----	---	-----	-------------

Black epoxy coated steel plates with 2 thumbscrews included. Used to connect worksurfaces together. Holes with steel inserts are located in the corner of the tops to accommodate this plate. Sold individually.

Required Specifications

- Finish
- Edge finish*



Zook was designed for today's dynamic and diverse learning environments. The tables are lightweight and can be reconfigured easily to create interactive environments and support collaboration.

Choose from a variety of organic and geometric shaped table tops to optimize flexibility. They are available in a wide array of sizes and finishes in both thermally fused laminate and high pressure laminate. Zook's color palette also includes nine new bold finishes available in high pressure laminate only.

Tops are available in 1" thick thermally fused laminate or 1-1/16" high pressure laminate with Global's preferred matching edge or a new optional ergo friendly edge.

Features and Benefits

- Tops are 1" thick thermally fused laminate or 1-1/16" high pressure laminate.
- Tops are constructed of 45 lb. density particle board.
- Global's preferred matching edge or optional ergo friendly edge.
- Tops are available in organic and geometric shapes.
- Surfaces include factory installed metal inserts for solid and secure leg connections.
- Group table's cable tower is constructed from thermally fused laminate with a removable access panel and inside clearance of 9" x 9". Available on group tables ZK44848P, ZK45959P and ZK65990 only.
- Easy to assemble



Variety of organic and geometric shapes



Multiple table configurations. Ideal for group study and encouraging collaboration.



Optional ergo friendly edge

GENERAL INFORMATION

- Zook is a series of tables designed for classrooms and diverse learning environments.
- Organic shapes and rectangular tops are available to create a variety of configurations that naturally bring people together.
- Choose from Zook group tables for groups of 4 to 6 people comfortably, pod tables for individuals, activity tables, or flip top tables.
- Create spaces that encourage discussion and the sharing of ideas
- Supports multi-use, active learning spaces and a variety of teaching styles
- Materials and workmanship stand up to the rigorous demands of today's learning environments
- Shipped easy to assemble. Tops include factory installed metal inserts to accept leg attachment.
- For environmental certifications, please visit globalfurnituregroup.com.

ZOOK GROUP TABLES

- Organic shaped tops available in three sizes: 48" x 48", 59" x 59" or 59" x 90".
- Tops supported by 3" diameter fixed height post legs.
- Select models available with cut-out options for power modules; these select models also include a cable tower for managing cables to floor monuments..

ZOOK POD TABLES

- Available in four geometric shapes; three that when used adjacent to one another, can create various pod configurations as well as rectangular tables in a number of sizes.
- ADA compliant heights available for select models.
- 1.5" diameter fixed height post legs.
- Tables may be specified on levelers or with casters for greater mobility and flexibility

ZOOK ACTIVITY TABLES

- Available in three shapes, all based on a 54" wide footprint.
- Tops are available with two types of mating edges: curved or straight. When planning to mate tables, do not mix mating edge styles.
- 2" diameter tapered legs on levelers or casters.

ZOOK FLIP-TOP TABLES

- Available in three sizes, 30"w x 22"d with concave shaped top; 30"w x 24"d and 60"w x 24"d rectangular top with radius corners.
- Supported by Y legs, equipped with smooth glide casters (two locking). Tungsten (TTU) finish only.
- 60"w tables optional with AG1, AG2, AG3 grommet; ZKFR3024 available with optional AG2 grommet
- Modesty panels are available separately in Tungsten (TUN) finish only.
- Tops and bases sold separately.
- **Caution:** to meet BIFMA standards for performance and stability, appropriate base size must be specified with corresponding top sizes identified.

WORKSURFACES

- Tops are available in 1" thick thermally fused laminate or 1-1/16" thick high pressure laminate
- Available in many finishes in both thermally fused laminate or high pressure laminate
- Worksurface core is made of 45 lb. density particleboard
- Surfaces include factory-installed metal inserts for solid and secure leg connections

WRITEABLE SURFACE OPTION

- Available on group, pod, activity, flip-top and rectangular tables
- High gloss White, non-magnetic dry-erase surface
- Complementary or contrasting edge to be specified, darker edge finish recommended
- Specify (WRW) for top finish. For upcharge, refer to finish option per product.

EDGE DETAIL

- Global's preferred (2mm flat edge) matching edge is standard
- Optional ergo-friendly edge is available at an upcharge (varies by item; see product for details).
- Rectangular tops feature rounded 2.5" radius corners



Ergo friendly edge



2mm flat edge

LEGS

- **Group tables:** 3" diameter steel post legs, 28" high with adjustable 3" diameter plastic glides. Each leg includes a 6" x 6" metal top plate and ships with truss head screws to connect to tops. See 702 for available finishes.
- **Pod tables:** 1.5" diameter tube steel legs, available with adjustable levelers or dual wheel locking casters. Each leg includes top plate and hardware for mounting. See 702 for available finishes. Optional Chrome (CHM) finish is available for pod tables only. **Add \$78** for three-legged models or **add \$102** for four-legged models
- **Activity tables:** 2" diameter tapered legs available with adjustable levelers or optional locking casters. Each leg includes top plate and hardware for mounting. See 702 for available finishes. Optional Chrome (CHM) finish is available. **Add \$164.**

Group tables

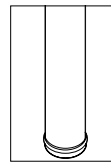

3" dia. leg

Pod tables

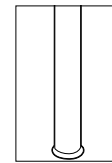

1.5" dia. leg

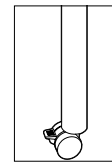

1.5" dia. leg with caster

Activity Tables

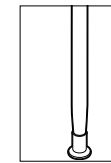

Tapered leg with leveler

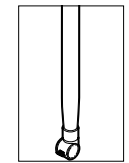

Tapered leg with caster

CASTERS

- Pod table models ending in C indicate legs equipped with 1.5" dia locking casters. Casters are black only.
- Activity table models ending in C indicate legs equipped with 2" dia locking casters. Casters are black only.

GROUP TABLE with CABLE TOWER

- Constructed from thermally fused laminate with a removable access panel
- Inside clearance of 8" x 8.6" will conceal most floor monuments, but still provide easy access.
- Available on group tables ZK44848P, ZK45959P and ZK65990P only.
- Must specify cut-out option when ordering group tables to accommodate select power module. Power modules sold separately.
- Available in Black (BLK), Brushed Cobalt (BRC) or Designer White (DWT) finish

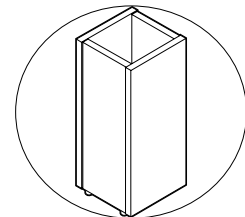

Cable tower

1. SPECIFY MODEL NUMBER

2. SPECIFY TOP FINISH

Thermally Fused and High Pressure Laminate Finishes:

ACJ	Absolute Acajou	CGY	Custom Grey	NML	Noce Medio
ASN	Asian Night	DES	Dark Espresso	QTM	Quartered Mahogany
AWC	Avant Cherry	DWT	Designer White	SBY	Sheer Beauty
AWH	Avant Honey	FAS	Fashionista	SOG	Storm Grey
BLK	Black	FCL	First Class	SDT	Stonedust
BZD	Blizzard	NBL	Noce Biondo	WHE	Walnut Heights
BRC	Brushed Cobalt	NGL	Noce Grigio	WHC	White Chocolate
CMB	Clear Maple	NEL	Noce Leggero	WCR	Winter Cherry

3. SPECIFY EDGE FINISH

2mm Thick Edgebanding:

AAE	Absolute Acajou	FCL	First Class
ASE	Asian Night	FOG	Fog
ACE	Avant Cherry	LAB	Latte
AHE	Avant Honey	NBL	Noce Biondo
BLK	Black	NGL	Noce Grigio
BRC	Brushed Cobalt	NEL	Noce Leggero
BZB	Buzz Blue	NML	Noce Medio
BZD	Blizzard	QTM	Quartered Mahogany
CCT	Cactus	SAR	Scarlet
CRO	Carrot	SBY	Sheer Beauty
CME	Clear Maple	SHW	Shadow
CGY	Custom Grey	SDT	Stonedust
DEE	Dark Espresso	SOG	Storm Grey
DWE	Designer White	WHE	Walnut Heights
DJN	Dijon	CBE	White Chocolate
FAS	Fashionista	WCE	Winter Cherry

Ergo Friendly Edge Finishes (optional - upcharge applies)

EBL	Black
ECP	Latte
ECG	Charcoal Grey
EDW	Designer White
EGR	Grey

4. SPECIFY LEG FINISH

Legs:

TBL	Black
TBZ	Buzz Blue
TCC	Cactus
TCR	Carrot
TIV	Cloud
TDW	Designer White
TDJ	Dijon
TEG	Eggplant
TFO	Fog
TFR	Frost
TIN	Ink
TKA	Kalua
TLA	Latte
TMO	Mocha
TNE	Nevada
TSN	Sand
TSR	Scarlet
TSH	Shadow
TOA	Toast
TTU	Tungsten
CHM	Chrome**

**Upcharges apply for CHM. Refer to model for upcharges.

Note: Leg finish is not optional for flip-top tables. Available in Tungsten (TTU) only.

FINISH	ACTIVITY	FLIP-TOP	GROUP	POD
Black TBL	•	N/A	•	•
Buzz Blue TBZ	•	N/A	•	•
Cactus TCC	•	N/A	•	•
Carrot TCR	•	N/A	•	•
Chrome CHM	•	N/A	N/A	•
Cloud TIV	•	N/A	•	•
Designer White TDW	•	N/A	•	•
Dijon TDJ	•	N/A	•	•
Eggplant TEG	•	N/A	•	•
Fog TFO	•	N/A	•	•
Frost TFR	•	N/A	•	•
Ink TIN	•	N/A	•	•
Kalua TKA	•	N/A	•	•
Latte TLA	•	N/A	•	•
Mocha TMO	•	N/A	•	•
Nevada TNE	•	N/A	•	•
Sand TSN	•	N/A	•	•
Scarlet TSR	•	N/A	•	•
Shadow TSH	•	N/A	•	•
Toast TOA	•	N/A	•	•
Tungsten TTU	•	•	•	•

SPECIFY CABLE TOWER FINISH - ZK44848P, ZK45959P and ZK65990P only

Cable Tower Finishes:

- BLK Black
- BRC Brushed Cobalt
- DWT Designer White

SPECIFY CUT-OUT OPTION - remember to order power module separately

POWER BLOCK AND CUT-OUT OPTIONS

- A power block delivers power/data to the table surface.
- Power block modules must be ordered separately and available for models ZK44848P, ZK45959P and ZK65990P only.
- Must specify the power block cut-out option when ordering the table.
- Optional cut-out available in the **center position** only and corresponds to select power modules. Order as **R2** or **T2** depending on the power module ordered.
- For a custom size cut-out (must be in center position), please contact Customer Care
- Select power block option from Productivity Solutions, beginning on page 462.

PRTMCS401B
 PRTMCS401T
 PRTMCS401W
 PRTMCS421B
 PRTMCS421T
 PRTMCS421W

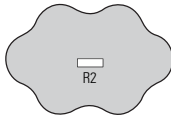

PRTMCD602B
 PRTMCD602T
 PRTMCD602W
 PRTMCD622B
 PRTMCD622T
 PRTMCD622W
 PRTMCD642B
 PRTMCD642T
 PRTMCD642W

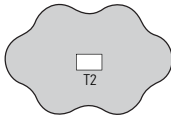

- Match power block desired with cut-out code and location from above grid.
- Example: For power block module # PRTMCS401B, specify cut-out option R2.

MODPOWER DAISY CHAIN SOLUTION

- Add flexible power and USB charging to select Zook tables. Connect up to four units with a single corded infeed with NEMA plug.
- ModPower units are sold separately, refer to Productivity Solutions 465.
- Begin run with a starter unit which includes a corded infeed. Add additional middle or end units as required. Middle and end units are equipped with connecting cables.
- On-surface modules clamp on or screw mount to the table tops.
- In-surface modules require table top cut-outs for mounting. Specify cut-out option:
 - **MPS** for a single cut-out to accommodate one ModPower in-surface unit (cut-out will be centered on the approach side) for **ZKRxxxx(L/C), ZKFR3024* and ZKFR6024*. Add \$96**
 - **MPD** for two cut-outs in the left and right positions, 15" from ends to center of unit on the approach side for **ZKR54xx(L/C), ZKR60xx(L/C), ZKR72xx(L/C) and ZKFR6024*. Add \$192.**

**Note: not for use with Zook flip-top tables if optional modesty panel is specified.*

EXAMPLE ZOOK ORDER CODES:

Group table

ZK65590P	-ACJ	-HPL	-ECG	-TTU	-BRC	-U2
Model #	Top finish	High pressure laminate	Ergo friendly edge and finish	Leg finish	Cable tower finish	Cut out option

Pod table

ZK412529L	-ACJ	-HPL	-WHE	-TTU
Model #	Top finish	High pressure laminate	2mm edge finish	Leg finish

4-6 PERSON GROUP TABLES

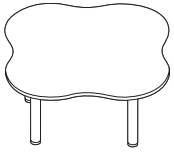

4-Person Table, 20"H

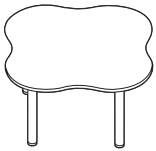

4-Person Table, 29"H

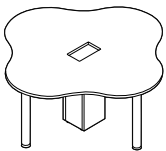

4-Person Table w/Cable Tower, 29"H*

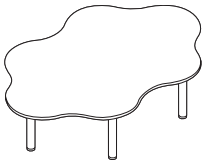

6-Person Table, 20"H

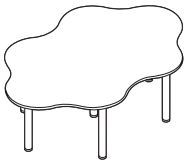

6-Person Table, 29"H

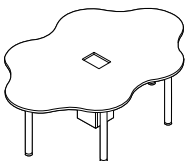

6-Person Table w/Cable Tower, 29"H*

MODEL#	DIMENSIONS D x W x H	FREIGHT CLASS	WT/LBS.	CUBIC FT.	LIST PRICE	HP ADD	ERGO EDGE	WRW
ZK4484820	48 x 48 x 20	60	92	7.10	\$1089	\$317	\$91	\$341
ZK4595920	59 x 59 x 20	65	123	9	\$1119	\$375	\$193	\$510

4-person table includes top and four steel post legs. Top includes factory installed metal inserts for solid and secure leg connections. Legs are 3" in diameter x 19" high each with an adjustable 3" diameter plastic glide and a 6" x 6" metal top plate. Shipped easy to assemble in 5 cartons.

ZK44848	48 x 48 x 29	60	215	7.10	\$1159	\$317	\$91	\$341
ZK45959	59 x 59 x 29	65	220	9.20	\$1192	\$375	\$193	\$510

4-person table includes top and four steel post legs. Top includes factory installed metal inserts for solid and secure leg connections. Legs are 3" in diameter x 28" high each with an adjustable 3" diameter plastic glide and a 6" x 6" metal top plate. Shipped easy to assemble in 5 cartons.

ZK44848P	48 x 48 x 29	65	265	8.86	\$1581	\$317	\$91	\$341
ZK45959P	59 x 59 x 29	65	270	10.96	\$1613	\$375	\$193	\$510

4-person table includes top, four steel post legs and cable tower. Top includes factory installed metal inserts for solid and secure leg connections. Legs are 3" in diameter x 28" high each with an adjustable 3" diameter plastic glide and a 6" x 6" metal top plate. Shipped easy to assemble in 6 cartons. For power block options, see page 462.

ZK6599020	59 x 90 x 20	70	247.50	14	\$1731	\$657	\$285	\$845
-----------	--------------	----	--------	----	---------------	--------------	--------------	--------------

6-person table includes top and seven steel post legs. Top includes factory installed metal inserts for solid and secure leg connections. Legs are 3" in diameter x 19" high each with an adjustable 3" diameter plastic glide and a 6" x 6" metal top plate. Shipped easy to assemble in 8 cartons.

ZK65990	59 x 90 x 29	70	245	13.43	\$1842	\$657	\$285	\$845
---------	--------------	----	-----	-------	---------------	--------------	--------------	--------------

6-person table includes top and seven steel post legs. Top includes factory installed metal inserts for solid and secure leg connections. Legs are 3" in diameter x 28" high each with an adjustable 3" diameter plastic glide and a 6" x 6" metal top plate. Shipped easy to assemble in 8 cartons.

ZK65990P	59 x 90 x 29	70	295	15.28	\$2180	\$657	\$285	\$845
----------	--------------	----	-----	-------	---------------	--------------	--------------	--------------

6-person table includes top, seven steel post legs and cable tower. Top includes factory installed metal inserts for solid and secure leg connections. Legs are 3" in diameter x 28" high with an adjustable 3" diameter plastic glide and a 6" x 6" metal top plate. Shipped easy to assemble in 8 cartons. For power block options, see page 462.

Required specifications

Top finish
Edge finish
Leg finish

Optional specifications

HP laminate
Ergo friendly edge and finish
Power block cut-out*
Writeable surface (WRW)

Accessories

Power block*

POD TABLES **MODEL#** **DIMENSIONS** **FREIGHT CLASS** **WT/LBS.** **CUBIC FT.** **LIST PRICE** **HP ADD** **ERGO EDGE** **WRW**

Sample pod table configurations

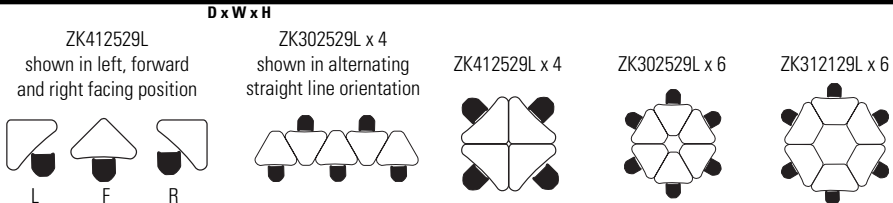

POD TABLES - 29" HIGH **MODEL#** **DIMENSIONS** **FREIGHT CLASS** **WT/LBS.** **CUBIC FT.** **LIST PRICE** **HP ADD** **ERGO EDGE** **WRW**



Small Pod Table w/3 Legs

ZK302529L	24.6 x 30 x 29	70	37	2	\$391	\$69	\$31	\$156
-----------	----------------	----	----	---	--------------	-------------	-------------	--------------

Triangular table with three round tube 18 gauge steel legs. Can be used individually, can alternate front-to-back in a straight row, or can be arranged in groups of six to create a round table effect. Top includes factory installed metal inserts for solid and secure leg connections. Legs are 1.5" in diameter x 28" high with adjustable levelers. Shipped easy to assemble in 4 cartons, top separate from legs; legs individually packed.

- Chrome (CHM) is available on legs. **Add \$78** list.



Medium Pod Table w/4 Legs

ZK352129L	20.9 x 35 x 29	70	41	2.40	\$492	\$83	\$37	\$156
-----------	----------------	----	----	------	--------------	-------------	-------------	--------------

Trapezoid table with four round tube 18 gauge steel legs. Can be used individually or can be arranged in groups of six to create a round table effect. Top includes factory installed metal inserts for solid and secure leg connections. Legs are 1.5" in diameter x 28" high with adjustable levelers. Shipped easy to assemble in 5 cartons, top separate from legs; legs individually packed.

- Chrome (CHM) is available on legs. **Add \$102** list.

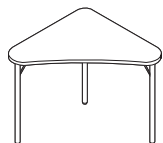

Large Pod Table w/3 Legs

ZK412529L	25.7 x 41 x 29	70	48	2.24	\$505	\$106	\$44	\$182
-----------	----------------	----	----	------	--------------	--------------	-------------	--------------

Triangular table with three round tube 18 gauge steel legs. Can be used individually or can be arranged in groups of four to create a square table effect. Top includes factory installed metal inserts for solid and secure leg connections. Legs are 1.5" in diameter x 28" high with adjustable levelers. Shipped easy to assemble in 4 cartons, top separate from legs; legs individually packed.

- Chrome (CHM) is available on legs. **Add \$78** list.

Required specifications

- Top finish
- Edge finish
- Leg finish

Optional specifications

- HP laminate
- Ergo friendly edge and finish
- Writeable surface (WRW)
- Chrome (CHM) legs

POD TABLES - 32" HIGH

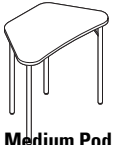

Medium Pod Table w/4 Legs



Large Pod Table w/3 Legs

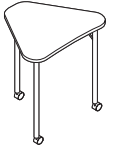

Small Mobile Pod Table w/3 Legs

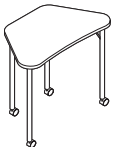

Medium Mobile Pod Table w/4 Legs

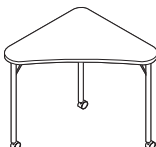

Large Mobile Pod Table w/3 Legs

MODEL#	DIMENSIONS D x W x H	FREIGHT CLASS	WT/LBS.	CUBIC FT.	LIST PRICE	HP ADD	ERGO EDGE	WRW
ZK352132L	20.9 x 35 x 32	70	41	2.55	\$502	\$83	\$37	\$156

ADA compliant table with four round tube 18 gauge steel legs. Can be used individually or can be arranged in groups of six to create a round table effect. Top includes factory installed metal inserts for solid and secure leg connections. Legs are 1.5" in diameter x 31" high with adjustable levelers. Shipped easy to assemble in 5 cartons, top separate from legs; legs individually packed.

- Chrome (CHM) is available on legs. **Add \$102** list.

ZK412532L	25.7 x 41 x 32	70	48	2.36	\$510	\$106	\$44	\$182
-----------	----------------	----	----	------	-------	-------	------	-------

ADA compliant table with three round tube 18 gauge steel legs. Can be used individually or can be arranged in groups of four to create a square table effect. Top includes factory installed metal inserts for solid and secure leg connections. Legs are 1.5" in diameter x 31" high with adjustable levelers. Shipped easy to assemble in 4 cartons, top separate from legs; legs individually packed.

- Chrome (CHM) is available on legs. **Add \$78** list.

ZK302529C	24.6 x 30 x 29	70	37	2	\$418	\$69	\$31	\$156
-----------	----------------	----	----	---	-------	------	------	-------

Triangular table with three round tube 18 gauge steel legs. Can be used individually, can alternate front-to-back in a straight row, or can be arranged in groups of six to create a round table effect. Top includes factory installed metal inserts for solid and secure leg connections. Legs are 1.5" in diameter x 28" high with 1.5" dual wheel locking casters. Shipped easy to assemble in 4 cartons, top separate from legs; legs individually packed.

- Chrome (CHM) is available on legs. **Add \$78** list.

ZK352129C	20.9 x 35 x 29	70	41	2.40	\$531	\$83	\$37	\$156
-----------	----------------	----	----	------	-------	------	------	-------

Trapezoid table with four round tube 18 gauge steel legs. Can be used individually or can be arranged in groups of six to create a round table effect. Top includes factory installed metal inserts for solid and secure leg connections. Legs are 1.5" in diameter x 28" high with 1.5" dual wheel locking casters. Shipped easy to assemble in 5 cartons, top separate from legs; legs individually packed.

- Chrome (CHM) is available on legs. **Add \$102** list.

ZK412529C	25.7 x 41 x 29	70	48	2.24	\$534	\$106	\$44	\$182
-----------	----------------	----	----	------	-------	-------	------	-------

Triangular table with three round tube 18 gauge steel legs. Can be used individually or can be arranged in groups of four to create a square table effect. Top includes factory installed metal inserts for solid and secure leg connections. Legs are 1.5" in diameter x 28" high with 1.5" dual wheel locking casters. Shipped easy to assemble in 4 cartons, top separate from legs; legs individually packed.

- Chrome (CHM) is available on legs. **Add \$78** list.

Required specifications

Top finish
Edge finish
Leg finish

Optional specifications

HP laminate
Ergo friendly edge and finish
Writeable surface (WRW)
Chrome (CHM) legs

RECTANGULAR TABLES - 29" HIGH

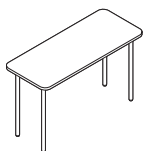

Rectangular Table, 20" Deep

MODEL #	DIMENSIONS D x W x H	FREIGHT CLASS	WT/LB.	CUBIC FT.	LIST PRICE	HP ADD	ERGO EDGE	WRW
ZKR3020L	20 x 30 x 29	70	50	2.55	\$465	\$110	\$35	\$144
ZKR3620L	20 x 36 x 29	70	51	2.65	\$481	\$130	\$37	\$156
ZKR4820L	20 x 48 x 29	70	58	2.95	\$531	\$171	\$44	\$177
ZKR5420L	20 x 54 x 29	70	64	3.15	\$616	\$194	\$48	\$187
ZKR6020L	20 x 60 x 29	70	70	3.25	\$640	\$214	\$52	\$198
ZKR7220L	20 x 72 x 29	65	85	3.55	\$700	\$258	\$58	\$214

Table with four round tube 18 gauge steel legs. Legs are 1.5" in diameter x 28" high with adjustable levelers. Top features 2.5" radius rounded corners and includes factory installed metal inserts for solid and secure leg connections. Tables 54" and wider include support channel. Shipped easy to assemble in 5 cartons, top separate from legs; legs individually packed.

- Chrome (CHM) is available on legs. **Add \$102** list.

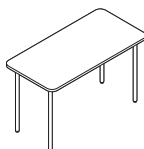

Rectangular Table, 24" Deep

ZKR3024L	24 x 30 x 29	70	51	2.75	\$468	\$130	\$36	\$156
ZKR3624L	24 x 36 x 29	70	53	2.85	\$505	\$158	\$38	\$166
ZKR4824L	24 x 48 x 29	70	59	3.25	\$563	\$206	\$45	\$193
ZKR5424L	24 x 54 x 29	70	65	3.35	\$653	\$232	\$50	\$202
ZKR6024L	24 x 60 x 29	70	71	3.55	\$681	\$256	\$53	\$214
ZKR7224L	24 x 72 x 29	70	86	3.95	\$745	\$307	\$60	\$240

Table with four round tube 18 gauge steel legs. Legs are 1.5" in diameter x 28" high with adjustable levelers. Top features 2.5" radius rounded corners and includes factory installed metal inserts for solid and secure leg connections. Tables 54" and wider include support channel. Shipped easy to assemble in 5 cartons, top separate from legs; legs individually packed.

- Chrome (CHM) is available on legs. **Add \$102** list.

MOBILE RECTANGULAR TABLES - 29" HIGH

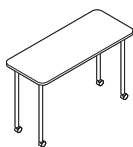

Mobile Rectangular Table, 20" Deep

MODEL #	DIMENSIONS	FREIGHT CLASS	WT/LB.	CUBIC FT.	LIST PRICE	HP ADD	ERGO EDGE	WRW
ZKR3020C	20 x 30 x 29	70	50	2.55	\$504	\$110	\$35	\$144
ZKR3620C	20 x 36 x 29	70	51	2.65	\$516	\$130	\$37	\$156
ZKR4820C	20 x 48 x 29	70	58	2.95	\$566	\$171	\$44	\$177
ZKR5420C	20 x 54 x 29	70	64	3.15	\$654	\$194	\$48	\$187
ZKR6020C	20 x 60 x 29	70	70	3.25	\$678	\$214	\$52	\$198
ZKR7220C	20 x 72 x 29	65	85	3.55	\$737	\$258	\$58	\$214

Table with four round tube 18 gauge steel legs. Legs are 1.5" in diameter x 28" high with 1.5" dual wheel locking casters. Top features 2.5" radius rounded corners and includes factory installed metal inserts for solid and secure leg connections. Tables 54" and wider include support channel. Shipped easy to assemble in 5 cartons, top separate from legs; legs individually packed.

- Chrome (CHM) is available on legs. **Add \$102** list.

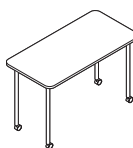

Mobile Rectangular Table, 24" Deep

ZKR3024C	24 x 30 x 29	70	51	2.75	\$507	\$130	\$36	\$156
ZKR3624C	24 x 36 x 29	70	53	2.85	\$543	\$158	\$38	\$166
ZKR4824C	24 x 48 x 29	70	59	3.25	\$602	\$206	\$45	\$193
ZKR5424C	24 x 54 x 29	70	65	3.35	\$691	\$232	\$50	\$202
ZKR6024C	24 x 60 x 29	70	71	3.55	\$719	\$256	\$53	\$214
ZKR7224C	24 x 72 x 29	70	86	3.95	\$785	\$307	\$60	\$240

Table with four round tube 18 gauge steel legs. Legs are 1.5" in diameter x 28" high with 1.5" dual wheel locking casters. Top features 2.5" radius rounded corners and includes factory installed metal inserts for solid and secure leg connections. Tables 54" and wider include support channel. Shipped easy to assemble in 5 cartons, top separate from legs; legs individually packed.

- Chrome (CHM) is available on legs. **Add \$102** list.

Required specifications

Top finish
Edge finish
Leg finish

Optional specifications

HP laminate
Ergo friendly edge and finish
Writeable surface (WRW)
Chrome (CHM) legs

ACTIVITY TABLES

Sample activity table configurations

D x W x H

Straight mating edges

ZK54RECTL x 2

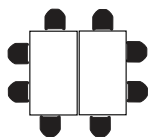

ZK54RNDSL x 2



ZK54HEXSL x 2

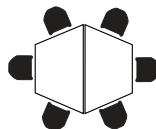

Curved mating edges

ZK54WAVCL x 2

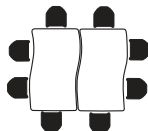

ZK54RDCL x 2



ZK54HEXCL x 2

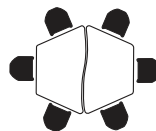

Mixed shapes
Curved mating edges shown.
Can also do the same with
straight mating edge tables.

ZK54RDCL x 2
ZK54WAVCL x 1

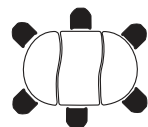

ZK54RDCL x 2
ZK54WAVCL x 2

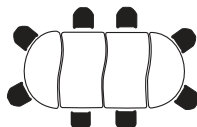

ZK54HEXCL x 2
ZK54WAVCL x 1

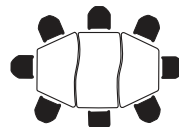

ACTIVITY TABLES - 29" HIGH, CURVED

MODEL#

DIMENSIONS

FREIGHT CLASS

WT/LBS.

CUBIC FT.

LIST PRICE HP ADD ERGO EDGE WRW

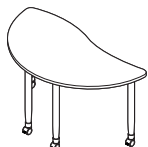

Curved Half Round w/Casters

ZK54RDCC

28.4 x 54 x 28.75

65

67.4

1.40

\$937

\$214

\$56

\$202

44.3" inside clearance between legs on curved edge, 22.9" on narrow depth side and 24" on other side. Dual leg position on front interferes with users sitting on ends in a racetrack configuration, oriented to seat two - one on either side. Top includes factory installed inserts for metal-to-metal leg connection. Shipped easy to assemble in 2 cartons, top separate from leg.

- Chrome (CHM) is available on legs. **Add \$164** list.

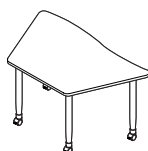

Curved Half Hex w/Casters

ZK54HEXCC

32.4 x 54 x 28.75

65

76.4

1.49

\$1010

\$246

\$66

\$202

42.9" inside clearance between legs on curved edge, 22.3" on narrow depth side and 24" on other side. 22.8" on straight end. Top includes factory installed inserts for metal-to-metal leg connection. Shipped easy to assemble in 2 cartons, top separate from leg.

- Chrome (CHM) is available on legs. **Add \$164** list.

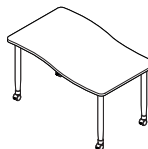

Wave w/Casters

ZK54WAVCC

33.8 x 54 x 28.75

65

77.4

1.52

\$1042

\$262

\$79

\$202

44.9" inside clearance between legs on curved edge, 21.9" on sides. Top includes factory installed inserts for metal-to-metal leg connection. Shipped easy to assemble in 2 cartons, top separate from leg.

- Chrome (CHM) is available on legs. **Add \$164** list.

Required specifications

Top finish
Edge finish
Leg finish

Optional specifications

HP laminate
Ergo friendly edge and finish
Writeable surface (WRW)
Chrome (CHM) legs

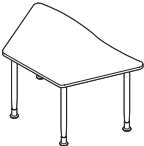
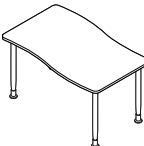
ACTIVITY TABLES - 29" HIGH, CURVED	MODEL #	DIMENSIONS	FREIGHT CLASS	WT/LB.	CUBIC FT.	LIST PRICE	HP ADD	ERGO EDGE	WRW
 <p data-bbox="142 324 412 348">Curved Half Round w/Levelers*</p>	ZK54RNDCL	D x W x H 28.4 x 54 x 28.25	65	67.4	1.40	\$929	\$214	\$56	\$202
<p data-bbox="545 324 1523 435">44.3" inside clearance between legs on curved edge, 22.9" on narrow depth side and 24" on other side. Dual leg position on front interferes with users sitting on ends in a racetrack configuration, oriented to seat two - one on either side. Top includes factory installed inserts for metal-to-metal leg connection. Levelers offer 1.25" of height adjustability. Shipped easy to assemble in 2 cartons, top separate from leg.</p> <ul data-bbox="545 441 954 465" style="list-style-type: none"> • Chrome (CHM) is available on legs. Add \$164 list. 									
 <p data-bbox="142 683 391 707">Curved Half Hex w/Levelers*</p>	ZK54HEXCL	32.4 x 54 x 28.25	65	76.4	1.49	\$1003	\$246	\$66	\$202
<p data-bbox="545 683 1523 768">42.9" inside clearance between legs on curved edge, 22.3" on narrow depth side and 24" on other side. 22.8" on straight end. Top includes factory installed inserts for metal-to-metal leg connection. Levelers offer 1.25" of height adjustability. Shipped easy to assemble in 2 cartons, top separate from leg.</p> <ul data-bbox="545 774 954 798" style="list-style-type: none"> • Chrome (CHM) is available on legs. Add \$164 list. 									
 <p data-bbox="142 1012 302 1036">Wave w/Levelers*</p>	ZK54WAVCL	33.8 x 54 x 28.25	65	77.4	1.52	\$1034	\$262	\$79	\$202
<p data-bbox="545 1012 1523 1070">44.9" inside clearance between legs on curved edge, 21.9" on sides. Top includes factory installed inserts for metal-to-metal leg connection. Levelers offer 1.25" of height adjustability. Shipped easy to assemble in 2 cartons, top separate from leg.</p> <ul data-bbox="545 1076 954 1100" style="list-style-type: none"> • Chrome (CHM) is available on legs. Add \$164 list. 									

Required specifications

Top finish
Edge finish
Leg finish

Optional specifications

HP laminate
Ergo friendly edge and finish
Writeable surface (WRW)
Chrome (CHM) legs

ACTIVITY TABLES - 29" HIGH, STRAIGHT

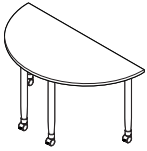

Straight Half Round w/Casters

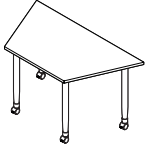

Straight Half Hex w/Casters

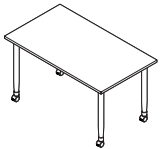

Rectangular w/Casters

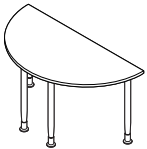

Straight Half Round w/Levelers

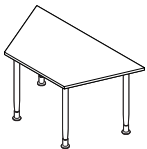

Straight Half Hex w/Levelers

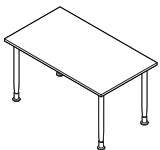

Rectangular w/Levelers

MODEL #	DIMENSIONS D x W x H	FREIGHT CLASS	WT/LB.	CUBIC FT.	LIST PRICE	HP ADD	ERGO EDGE	WRW
ZK54RNDSC	28.4 x 54 x 28.75	65	67.4	1.40	\$885	\$189	N/A	\$202
<p>44.2" inside clearance between legs on long side, 23.7" on the sides. Dual leg position on front interferes with users sitting on ends in a racetrack configuration, oriented to seat two - one on either side. Top includes factory installed inserts for metal-to-metal leg connection. Shipped easy to assemble in 2 cartons, top separate from leg.</p> <ul style="list-style-type: none"> • Chrome (CHM) is available on legs. Add \$164 list. 								
ZK54HEXSC	32.4 x 54 x 28.75	65	73.4	1.49	\$914	\$204	N/A	\$202
<p>40.6" inside clearance between legs on long side, 21.4" on sides and 22.3" on short side. Top includes factory installed inserts for metal-to-metal leg connection. Shipped easy to assemble in 2 cartons, top separate from leg.</p> <ul style="list-style-type: none"> • Chrome (CHM) is available on legs. Add \$164 list. 								
ZK54RECTC	33.8 x 54 x 28.75	65	73.4	1.52	\$965	\$227	N/A	\$202
<p>45.3" inside clearance between legs on long sides and 22.3" on short sides. Top includes factory installed inserts for metal-to-metal leg connection. Shipped easy to assemble in 2 cartons, top separate from leg.</p> <ul style="list-style-type: none"> • Chrome (CHM) is available on legs. Add \$164 list. 								
ZK54RNDSL	28.4 x 54 x 28.25	65	67.4	1.40	\$877	\$189	N/A	\$202
<p>44.2" inside clearance between legs on long side, 23.7" on the sides. Dual leg position on front interferes with users sitting on ends in a racetrack configuration, oriented to seat two - one on either side. Top includes factory installed inserts for metal-to-metal leg connection. Levelers offer 1.25" of height adjustability. Shipped easy to assemble in 2 cartons, top separate from leg.</p> <ul style="list-style-type: none"> • Chrome (CHM) is available on legs. Add \$164 list. 								
ZK54HEXSL	32.4 x 54 x 28.25	65	73.4	1.49	\$907	\$204	N/A	\$202
<p>40.6" inside clearance between legs on long side, 21.4" on sides and 22.3" on short side. Top includes factory installed inserts for metal-to-metal leg connection. Levelers offer 1.25" of height adjustability. Shipped easy to assemble in 2 cartons, top separate from leg.</p> <ul style="list-style-type: none"> • Chrome (CHM) is available on legs. Add \$164 list. 								
ZK54RECTL	33.8 x 54 x 28.25	65	73.4	1.52	\$958	\$227	N/A	\$202
<p>45.3" inside clearance between legs on long sides and 22.3" on short sides. Top includes factory installed inserts for metal-to-metal leg connection. Levelers offer 1.25" of height adjustability. Shipped easy to assemble in 2 cartons, top separate from leg.</p> <ul style="list-style-type: none"> • Chrome (CHM) is available on legs. Add \$164 list. 								

Required specifications

Top finish
Edge finish
Leg finish

Optional specifications

HP laminate
Writeable surface (WRW)
Chrome (CHM) legs

FLIP-TOP TABLES **MODEL#** **DIMENSIONS** **FREIGHT CLASS** **WT/LBS.** **CUBIC FT.** **LIST PRICE** **HP ADD** **ERGO EDGE** **WRW**

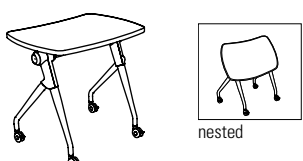

Flip-Top Table, Contoured Top

D x W x H

Top: ZKFC3022T	22 x 30 x 29.5	150	20.6	2.03	\$248	\$127	\$93	\$150
Base: ZKFTB30		125	26.5	3.6	\$685	n/a	n/a	n/a

Mobile flip-top table with smooth glide locking casters. Easy to operate twist knob with integrated thumb tab. Top includes factory installed inserts for metal-to-metal leg connection. When nested, each additional table adds 5.25" to footprint needed for storage. Optional modesty (ZKFTM30) available separately. Top and base shipped separately. Legs available in Tungsten (TUN) only.

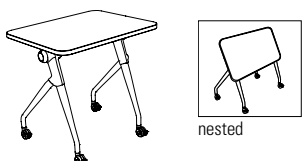

Flip-Top Table, Rectangular Top**

Top: ZKFR3024T	24 x 30 x 29.5	70	21.5	1.03	\$277	\$139	\$108	\$156
Base: ZKFTB30		125	26.5	3.6	\$685	n/a	n/a	n/a

Mobile flip-top table with smooth glide locking casters. Easy to operate twist knob with integrated thumb tab. Top includes factory installed inserts for metal-to-metal leg connection. When nested, each additional table adds 5.25" to footprint needed for storage. Optional modesty (ZKFTM30) available separately. Top and base shipped separately. Legs available in Tungsten (TUN) only.

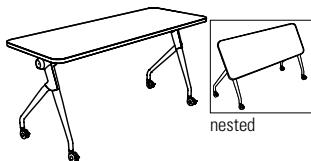

Flip-Top Table, Rectangular Top*

Top: ZKFR6024T	24 x 60 x 29.5	70	43	1.92	\$405	\$207	\$112	\$214
Base: ZKFTB60		100	31	3.86	\$778	n/a	n/a	n/a

Mobile flip-top table with smooth glide locking casters. Easy to operate twist knob with integrated thumb tab. Top includes factory installed inserts for metal-to-metal leg connection. When nested, each additional table adds 5.25" to footprint needed for storage. Optional modesty (ZKFTM60) available separately. Top and base shipped separately. Legs available in Tungsten (TUN) only.

MODESTY PANELS FOR FLIP-TOP TABLES **MODEL#** **DIMENSIONS** **FREIGHT CLASS** **WT/LBS.** **CUBIC FT.** **LIST PRICE**



Modesty for ZKFC3022 and ZKFC3024

ZKFTM30	0.5 x 17.8 x 13.8	60	6.6	0.22	\$66
---------	-------------------	----	-----	------	-------------

Hardware included to attach to ZKFC3022 or ZKFR3024. Tungsten finish only. Shipped in 1 carton.

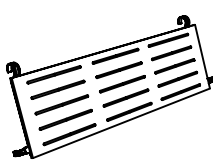

Modesty for ZKFR6024

ZKFTM60	0.5 x 47.3 x 13.8	65	14.3	0.57	\$129
---------	-------------------	----	------	------	--------------

Hardware included to attach **ZKFR6024**. Tungsten finish only. Shipped in 1 carton.

Required Specifications	Optional Specifications
Top finish	HP laminate
Edge finish	Ergo friendly edge and finish
	Writeable surface (WRW)

C CITI TABLES

CITI TABLES	MODEL#	DIMENSIONS	FREIGHT CLASS	WT/LBS.	CUBIC FT.	LIST PRICE
		D x W x H				

Notes

- Citi tables complement the contemporary timeless decor of many offices.
- Legs are **standard** in Tungsten (**TTU**) and also available in Black (**TBL**) or Shadow (**TSH**) at no charge. A Chrome (**CHM**) finish is available. **Add \$110.**
- Table tops are available in either tempered glass or laminate
- Citi tables are offered in the following finishes to coordinate with Global casegoods and wood seating:

ACJ	Absolute Acajou	FCL	First Class
ASN	Asian Night	NBL	Noce Biondo
AWC	Avant Cherry	NGL	Noce Grigio
AWH	Avant Honey	NEL	Noce Leggero
BLK	Black	NML	Noce Medio
BZD	Blizzard	QTM	Quartered Mahogany
BRC	Brushed Cobalt	SBY	Sheer Beauty
CMB	Clear Maple	SOG	Storm Grey
CGY	Custom Grey	SDT	Stonedust
DES	Dark Espresso	WHE	Walnut Heights
DWT	Designer White	WHC	White Chocolate
FAS	Fashionista	WCR	Winter Cherry

CITI TABLES	MODEL#	DIMENSIONS	FREIGHT CLASS	WT/LBS.	CUBIC FT.	LIST PRICE
-------------	--------	------------	---------------	---------	-----------	------------

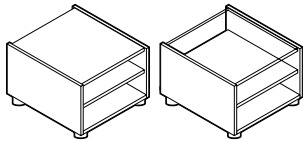

End Table

7885	20 x 24 x 20	100	53	6	\$827	
(laminate top)						
7886	20 x 24 x 20	92.5	60	6	\$1166	
(glass top)						

Metal tubular legs. Laminate or tempered glass tops available.

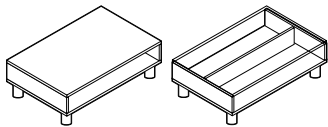

Coffee Table - Rectangular

7887	20 x 40 x 15	100	60	6.50	\$863	
(laminate top)						
7888	20 x 40 x 15	92.5	75	6.50	\$1343	
(glass top)						

Metal tubular legs. Laminate or tempered glass tops available.

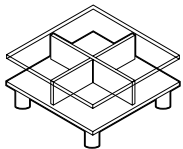

Coffee Table - Square

7889	33 x 33 x 15	92.5	90	8.75	\$1630	
(glass top)						

Metal tubular legs. Tempered glass top.

Required Specifications

Finish

COAT TREES

MODEL# DIMENSIONS FREIGHT CLASS WT/LBS. CUBIC FT. LIST PRICE



Coat Tree

	D x W x H				
PCOS2	25 x 25 x 60	300	8	4.67	\$501
PCOS3	25 x 25 x 60	300	8	4.67	\$501

Square tube metal frame, complete with four Chrome double hooks. Adjustable glides. 60" high. Ships UPS.

- 3 per carton
- PCOS2 is finished in **Black**.
- PCOS3 is finished in **Chrome**.



Coat Tree

PCT	25 x 25 x 65	250	6	3	\$642
-----	--------------	-----	---	---	--------------

Square tube wood frame. Complete with four satin brass double hooks. 65" high. Available in the following finishes: Absolute (AAM), Black (BKM), Cherry (ACM), English Oak (EOM), Gray (HGM), Honey (AHM), Maple (AVM), Medium Walnut (MWM), Night (ASM), Sandy Beach (SBM), Mahogany (TMM), Fruitwood (TFM), White (WHM), Winter Cherry (WCM) and Walnut (TWM). Ships assembled via UPS.

- 1 per carton

Required Specifications

Finish

L LAMINATE OCCASIONAL TABLES

LAMINATE OCCASIONAL TABLES	MODEL#	DIMENSIONS	FREIGHT CLASS	WT/LBS.	CUBIC FT.	LIST PRICE
D x W x H						

Notes:

- High pressure laminate exterior with adjustable plastic glides
- Premium cylinder tables have a flexible plywood core construction ideal for institutional and high traffic environments
- Ideal for reception areas - colors coordinate with all Global desks, conference tables and accessories.
- Ships assembled in one carton.
- Available to either match or coordinate with most Global laminate desk series. Available finishes:

ACJ	Absolute Acajou	FCL	First Class
ASN	Asian Night	NBL	Noce Biondo
AWC	Avant Cherry	NGL	Noce Grigio
AWH	Avant Honey	NEL	Noce Leggero
BLK	Black	NML	Noce Medio
BZD	Blizzard	QTM	Quartered Mahogany
BRC	Brushed Cobalt	SBY	Sheer Beauty
CMB	Clear Maple	SOG	Storm Grey
CGY	Custom Grey	SDT	Stonedust
DES	Dark Espresso	WHE	Walnut Heights
DWT	Designer White	WHC	White Chocolate
FAS	Fashionista	WCR	Winter Cherry

LAMINATE OCCASIONAL TABLES	MODEL#	DIMENSIONS	FREIGHT CLASS	WT/LBS.	CUBIC FT.	LIST PRICE
----------------------------	--------	------------	---------------	---------	-----------	------------

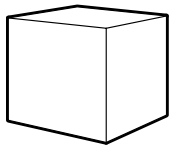

Cube Table

GCU1816	18 x 18 x 16	85	40	3.30	\$615
GCU1821	18 x 18 x 21	92.5	46	4	\$717
GCU2416	24 x 24 x 16	92.5	63	6	\$717
GCU2421	24 x 24 x 21	92.5	83	7	\$717

3/4" plywood covered in high pressure laminate. Plastic glides. **Flush base.**

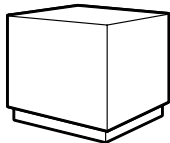

Plinth Cube Table

GCUP1816	18 x 18 x 16	85	40	3	\$680
GCUP1821	18 x 18 x 21	92.5	46	4	\$785
GCUP2416	24 x 24 x 16	92.5	63	6	\$785
GCUP2421	24 x 24 x 21	92.5	83	7	\$785

3/4" plywood covered in high pressure laminate. Plastic glides. **Recessed base.**

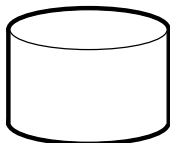

Cylinder Table

GCY1816	18 x 18 x 16	85	43	3.30	\$615
GCY1821	18 x 18 x 21	92.5	49	4.30	\$717
GCY2416	24 x 24 x 16	125	47	6	\$717
GCY2421	24 x 24 x 21	100	66	7	\$717
GCY3016	30 x 30 x 16	125	59	8	\$815
GCY3021	30 x 30 x 21	125	78	11	\$815

3/8" foundation board covered in high pressure laminate. Plastic glides. **Flush base.**

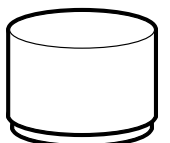

Plinth Cylinder Table

GCYP1816	18 x 18 x 16	85	43	3.30	\$680
GCYP1821	18 x 18 x 21	92.5	49	4.30	\$785
GCYP2416	24 x 24 x 16	125	47	6	\$785
GCYP2421	24 x 24 x 21	100	66	7	\$785
GCYP3016	30 x 30 x 16	125	59	8	\$891
GCYP3021	30 x 30 x 21	125	78	11	\$891

3/8" foundation board covered in high pressure laminate. Plastic glides. **Recessed base.**

Required Specifications

Finish

LAMINATE OCCASIONAL TABLES

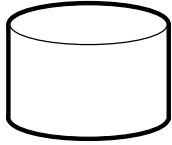

Premium Cylinder Table

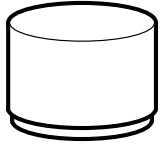

Premium Plinth Cylinder Table

MODEL# DIMENSIONS FREIGHT CLASS WT/LBS. CUBIC FT. LIST PRICE

D x W x H

CPFD1816	18 x 18 x 16	150	30	7	\$1024
CPFD1821	18 x 18 x 21	150	30	7	\$1053
CPFD2416	24 x 24 x 16	250	42	11.50	\$1063
CPFD2421	24 x 24 x 21	250	42	11.50	\$1091
CPFD3016	30 x 30 x 16	250	52	17	\$1203
CPFD3021	30 x 30 x 21	250	52	17	\$1327

1 1/32" plywood covered in high pressure laminate. Plastic glides. **Flush base.**

CPPD1816	18 x 18 x 16	150	30	7	\$1078
CPPD1821	18 x 18 x 21	150	30	7	\$1106
CPPD2416	24 x 24 x 16	250	42	11.50	\$1117
CPPD2421	24 x 24 x 21	250	42	11.50	\$1144
CPPD3016	30 x 30 x 16	250	52	17	\$1277
CPPD3021	30 x 30 x 21	250	52	17	\$1400

1 1/32" plywood covered in high pressure laminate. Plastic glides. **Recessed base.**

Required Specifications

Finish

D DRIFT TABLES

TABLES WITH SLED BASE

MODEL#

DIMENSIONS

FREIGHT CLASS

WT/LBS.

CUBIC FT.

LIST PRICE

HP ADD

GR. 2 ADD

DRIFT TABLES



model 8041R2616C
26"W x 16" H Round Table,
Laminate Surface, Flat Edge,
Chrome Base



model 8042SQ2816I
28"W x 16" H Square Table,
Laminate Surface, Flat Edge,
Sled Base



Model 8042SQ2816W
28"W x 16" H Square Table,
Laminate Surface, Flat Edge
Wood Base



For Drift seating, see page

EXAMPLE OF TABLE ORDER CODE:

8041R2616I	TFL	ACJ	TBL	CG
Model Number	Surface Type	Top HPL Finish	Base Finish (Sled Base)	Glide Type (Sled Base)

STANDARD FEATURES

- Tables are available in three shapes, multiple sizes, two edge styles, three top materials and three base types including: sled, wood and polished Chrome bases.
- Table bases are fixed and do not swivel.
- Wood bases are made from beechwood and are available in all standard wood finishes.
- Sled bases are standard in painted metal.
- Chrome base tables are available in polished Chrome only.
- All table tops are available with flat edge. High pressure laminate (HPL) and solid surface top tables are also available with knife edge.
- Laminate flat edge tops are available in either (TFL) 1" thick thermally fused laminate with 2mm edgeband or (HPL) 1-1/16" thick high pressure laminate with 2mm edgeband, with upcharge.
- Laminate knife edge tops are 1-3/16" thick with 2.5mm edgeband, available in high pressure laminate (HPL) only.
- Solid surface table tops are 1.25" thick, available on models with flat or knife edge. For detailed material information, please reference WilsonArt's Solid Surface collection.
- Wood and Chrome bases are equipped with White non-marking polycarbonate glides suitable for most hard and carpeted floor surfaces.
- Sled bases are available with clear polycarbonate glides, standard.
- Wood and sled bases may be specified with a variety of optional glide types to suit various flooring materials. (See Glide Types for additional glide options and upcharges.)
- Tables are shipped fully assembled.

Add option codes in the following order:

- **Model Number**
Specify model number
- **Surface Type** (Laminate, Flat Edge Tables)
(TFL) Thermally fused laminate
(HPL) High pressure laminate
- **Top Finish** (TFL or HPL laminate, flat edge tables and HPL laminate knife edge tables only)
HPL upcharges apply -see model
(ACJ) Absolute Acajou (ASN) Asian Night
(AWC) Avant Cherry (AWH) Avant Honey
(BLK) Black (BZD) Blizzard
(BRC) Brushed Cobalt (CMB) Clear Maple
(CGY) Custom Grey (DES) Dark Espresso
(DWT) Designer White (FAS) Fashionista
(FCL) First Class (NBL) Noce Biondo
(NGL) Noce Grigio (NEL) Noce Leggero
(NML), Noce Medio (QTM) Quartered Mahogany
(SBY) Sheer Beauty (SOG) Storm Grey
(SDT) Stonedust (WCR) Winter Cherry
(WHC) White Chocolate (WHE) Walnut Heights
- **Top Finish** (solid surface, flat and knife edge tables)
Grade 1
(SWH) Designer White
Grade 2, Upcharge applicable, see models.
(SBT) Beige Tempest
(SBX) Black Onyx Mirage
(SMG) Milk Glass Spectra
(SFW) Frosty White Mirage
(SHS) Hot Stone
(SNM) Northern Melange
- **Base finish** (sled base models only)
Paint finishes:
(TBL) Black (TTU) Tungsten
(TSH) Shadow (TDW) Designer White
(TNE) Nevada (TLA) Latte
(TKA) Kalua (TMO) Mocha
(TOA) Toast (TFO) Fog
(TIV) Cloud (TSN) Sand
(TFR) Frost (TDJ) Dijon
(TCR) Carrot (TSR) Scarlet
(TCC) Cactus (TBZ) Buzz Blue
(TEG) Eggplant (TIN) Ink

Metallic finish:
(CHM) Chrome. Add \$42
- **Base Finish** (Chrome base only)
(CHM) Chrome
- **Glide Type** (sled base)
(CG) Clear, polycarbonate glide for most floor surfaces (standard)
(XG) No glide for carpeted surfaces, no charge
(SG) Steel cushioned glide for carpeted surface. Add \$34
(RG) Rubber, non-slip glide for most hard floor surfaces. Add \$34
(FG) Felt glide for most hard floor surfaces. Add \$34
- **Glide Type** (wood base)
(NM) White non-marking nylon glide for most surfaces (standard)
(SG) Steel cushioned glides for carpeted surfaces. Add \$34.
(RG) Non-slip rubber glides for most hard floor surfaces. Add \$34.
(FG) Felt glides for most hard floor surfaces. Add \$34.

TABLES WITH SLED BASE



Round Table with Sled Base

MODEL#	DIMENSIONS	FREIGHT CLASS	WT./LBS.	CUBIC FT.	LIST PRICE	HP ADD	GR. 2 ADD
Laminate, flat edge (TFL laminate)							
8041R2616I	26 x 26 x 16	250	35	10.25	\$561	\$98	n/a
8041R3016I	30 x 30 x 16	250	44	13	\$591	\$115	n/a
8041R2120I	21 x 21 x 20	250	29	8.75	\$587	\$97	n/a
Laminate, knife edge (HPL laminate)							
8041R2616IK	26 x 26 x 16	250	35	10.25	\$1199	n/a	n/a
8041R3016IK	30 x 30 x 16	250	44	13	\$1284	n/a	n/a
8041R2120IK	21 x 21 x 20	250	29	8.75	\$996	n/a	n/a
Solid surface, flat edge							
8041R2616ISF	26 x 26 x 16	150	48	10.25	\$2343	n/a	\$158
8041R3016ISF	30 x 30 x 16	150	61	13	\$2522	n/a	\$218
8041R2120ISF	21 x 21 x 20	150	37.5	8.75	\$2204	n/a	\$109
Solid surface, knife edge							
8041R2616ISK	26 x 26 x 16	150	48	10.25	\$2397	n/a	\$169
8041R3016ISK	30 x 30 x 16	150	61	13	\$2603	n/a	\$234
8041R2120ISK	21 x 21 x 20	150	37.5	8.75	\$2302	n/a	\$115

Finished height will vary depending on material top. Shipped fully assembled in 1 carton.



Square Table with Sled Base

Laminate, flat edge (TFL laminate)							
8042SQ2216I	22 x 22 x 16	150	34	8	\$561	\$98	n/a
8042SQ2816I	28 x 28 x 16	250	44	11.75	\$591	\$115	n/a
8042SQ1920I	19 x 19 x 20	250	29	7.75	\$568	\$88	n/a
Laminate, knife edge (HPL laminate)							
8042SQ2216IK	22 x 22 x 16	150	34	8	\$996	n/a	n/a
8042SQ2816IK	28 x 28 x 16	250	44	11.75	\$1248	n/a	n/a
8042SQ1920IK	19 x 19 x 20	250	29	7.75	\$955	n/a	n/a
Solid surface, flat edge							
8042SQ2216ISF	22 x 22 x 16	150	39.5	8	\$2065	n/a	\$136
8042SQ2816ISF	28 x 28 x 16	150	62.5	11.75	\$2365	n/a	\$218
8042SQ1920ISF	19 x 19 x 20	150	38	7.75	\$1976	n/a	\$164
Solid surface, knife edge							
8042SQ2216ISK	22 x 22 x 16	150	39.5	8	\$2397	n/a	\$164
8042SQ2816ISK	28 x 28 x 16	150	62.5	11.75	\$2819	n/a	\$245
8042SQ1920ISK	19 x 19 x 20	150	38	7.75	\$2302	n/a	\$120

Finished height will vary depending on material top. Shipped fully assembled in 1 carton.



Oval Table with Sled Base

Laminate, flat edge (TFL laminate)							
8043OV2616I	26 x 22 x 16	150	36.5	8.75	\$561	\$98	n/a
8043OV3116I	31 x 26 x 16	250	46	11.75	\$591	\$115	n/a
8043OV2220I	22 x 18 x 20	250	34	10.75	\$587	\$97	n/a
Laminate, knife edge (HPL laminate)							
8043OV2616IK	26 x 22 x 16	150	36.5	8.75	\$1199	n/a	n/a
8043OV3116IK	31 x 26 x 16	250	46	11.75	\$1365	n/a	n/a
8043OV2220IK	22 x 18 x 20	250	34	10.75	\$1113	n/a	n/a
Solid surface, flat edge							
8043OV2616ISF	26 x 22 x 16	150	42	8.75	\$2343	n/a	\$158
8043OV3116ISF	31 x 26 x 16	150	60	11.75	\$2522	n/a	\$218
8043OV2220ISF	22 x 18 x 20	250	38	10.75	\$2204	n/a	\$109
Solid surface, knife edge							
8043OV2616ISK	26 x 22 x 16	150	42	8.75	\$2397	n/a	\$169
8043OV3116ISK	31 x 26 x 16	150	60	11.75	\$2603	n/a	\$234
8043OV2220ISK	22 x 18 x 20	250	38	10.75	\$2302	n/a	\$115

Finished height will vary depending on material top. Shipped fully assembled in 1 carton.

Required Specifications

Surface type
Top finish
Base finish
Glide type

Optional Specifications

HP laminate
Grade 2 solid surface
Cut-out for grommet/power blocks
Plated base finish

Accessories

Power block

D DRIFT TABLES

TABLES WITH SLED BASE



Round Table with Polished Chrome Base



Round Table with Wood Base



Square Table with Polished Chrome Base

MODEL#	DIMENSIONS	FREIGHT CLASS	WT/LBS.	CUBIC FT.	LIST PRICE	HP ADD	GR. 2 ADD
--------	------------	---------------	---------	-----------	------------	--------	-----------

D x W x H

Laminate, flat edge (TFL laminate)

8041R2616C	26 x 26 x 16	250	38	10.75	\$1058	\$98	n/a
8041R3016C	30 x 30 x 16	250	45	13	\$1088	\$115	n/a

Laminate, knife edge (HPL laminate)

8041R2616CK	26 x 26 x 16	250	38	10.75	\$1696	n/a	n/a
8041R3016CK	30 x 30 x 16	250	45	13	\$1782	n/a	n/a

Solid surface, flat edge

8041R2616CSF	26 x 26 x 16	150	51	10.75	\$2840	n/a	\$158
8041R3016CSF	30 x 30 x 16	150	62.5	13	\$3019	n/a	\$218

Solid surface, knife edge

8041R2616CSK	26 x 26 x 16	150	51	10.75	\$2894	n/a	\$169
8041R3016CSK	30 x 30 x 16	250	31.25	13	\$3101	n/a	\$234

Finished height will vary depending on material top. Shipped fully assembled in 1 carton.

Laminate, flat edge (TFL laminate)

8041R2616W	26 x 26 x 16	250	32	10.75	\$1204	\$98	n/a
8041R3016W	30 x 30 x 16	250	40	13	\$1234	\$115	n/a

Laminate, knife edge (HPL laminate)

8041R2616WK	26 x 26 x 16	250	32	10.75	\$1842	n/a	n/a
8041R3016WK	30 x 30 x 16	250	40	13	\$1927	n/a	n/a

Solid surface, flat edge

8041R2616WSF	26 x 26 x 16	150	45.5	10.75	\$2985	n/a	\$158
8041R3016WSF	30 x 30 x 16	150	57.5	13	\$3165	n/a	\$218

Solid surface, knife edge

8041R2616WSK	26 x 26 x 16	150	45.5	10.75	\$3040	n/a	\$169
8041R3016WSK	30 x 30 x 16	150	57.5	13	\$3246	n/a	\$234

Finished height will vary depending on material top. Shipped fully assembled in 1 carton.

Laminate, flat edge (TFL laminate)

8042SQ2216C	22.75 x 22.75 x 16	150	36	7.75	\$1058	\$98	n/a
8042SQ2816C	28.5 x 28.5 x 16	250	45	11.5	\$1088	\$115	n/a

Laminate, knife edge (HPL laminate)

8042SQ2216CK	22.75 x 22.75 x 16	150	36	7.75	\$1493	n/a	n/a
8042SQ2816CK	28.5 x 28.5 x 16	250	45	11.5	\$1588	n/a	n/a

Solid surface, flat edge

8042SQ2216CSF	22.75 x 22.75 x 16	150	41	7.75	\$2563	n/a	\$136
8042SQ2816CSF	28.5 x 28.5 x 16	150	57.5	11.5	\$2862	n/a	\$218

Solid surface, knife edge

8042SQ2216CSK	22.75 x 22.75 x 16	150	41	7.75	\$2894	n/a	\$164
8042SQ2816CSK	28.5 x 28.5 x 16	150	57.5	11.5	\$3316	n/a	\$245

Finished height will vary depending on material top. Shipped fully assembled in 1 carton.

Required Specifications

Surface type
Top finish
Base finish
Glide type

Optional Specifications

HP laminate
Grade 2 solid surface
Cut-out for grommet/power blocks
Plated base finish

Accessories

Power block

TABLES WITH SLED BASE

MODEL#	DIMENSIONS	FREIGHT CLASS	WT/LBS.	CUBIC FT.	LIST PRICE	HP ADD	GR. 2 ADD
--------	------------	---------------	---------	-----------	------------	--------	-----------

D x W x H

Laminate, flat edge (HPL laminate)

8042SQ2216W	22.75 x 22.75 x 16	250	30	7.75	\$1204	\$98	n/a
8042SQ2816W	28.5 x 28.5 x 16	250	39	11.5	\$1234	\$115	n/a

Laminate, knife edge (HPL laminate)

8042SQ2216WK	22.75 x 22.75 x 16	250	30	7.75	\$1639	n/a	n/a
8042SQ2816WK	28.5 x 28.5 x 16	250	39	11.5	\$1734	n/a	n/a

Solid surface, flat edge

8042SQ2216WSF	22.75 x 22.75 x 16	150	36	7.75	\$2708	n/a	\$136
8042SQ2816WSF	28.5 x 28.5 x 16	150	59	11.5	\$3008	n/a	\$218

Solid surface, knife edge

8042SQ2216WSK	22.75 x 22.75 x 16	150	36	7.75	\$3040	n/a	\$164
8042SQ2816WSK	28.5 x 28.5 x 16	150	59	11.5	\$3462	n/a	\$245

Finished height will vary depending on material top. Shipped fully assembled in 1 carton.



Square Table with Wood Base



Oval Table with Polished Chrome Base

Laminate, flat edge

8043OV2616C	26 x 22 x 16	150	38	9.25	\$1058	\$98	n/a
8043OV3116C	31 x 26 x 16	250	44	11.75	\$1088	\$115	n/a

Laminate, knife edge

8043OV2616CK	26 x 22 x 16	150	38	9.25	\$1696	n/a	n/a
8043OV3116CK	31 x 26 x 16	250	44	11.75	\$1862	n/a	n/a

Solid surface, flat edge

8043OV2616CSF	26 x 22 x 16	150	49.5	9.25	\$2840	n/a	\$158
8043OV3116CSF	31 x 26 x 16	150	61.5	11.75	\$3019	n/a	\$218

Solid surface, knife edge

8043OV2616CSK	26 x 22 x 16	150	49.5	9.25	\$2894	n/a	\$169
8043OV3116CSK	31 x 26 x 16	150	61.5	11.75	\$3101	n/a	\$234

Finished height will vary depending on material top. Shipped fully assembled in 1 carton.



Oval Table with Wood Base

Laminate, flat edge

8043OV2616W	26 x 22 x 16	250	32	9.25	\$1204	\$98	n/a
8043OV3116W	31 x 26 x 16	250	39	11.75	\$1234	\$115	n/a

Laminate, knife edge

8043OV2616WK	26 x 22 x 16	250	32	9.25	\$1842	n/a	n/a
8043OV3116WK	31 x 26 x 16	250	39	11.75	\$2008	n/a	n/a

Solid surface, flat edge

8043OV2616WSF	26 x 22 x 16	150	44.5	9.25	\$2985	n/a	\$158
8043OV3116WSF	31 x 26 x 16	150	56.5	11.75	\$3165	n/a	\$218

Solid surface, knife edge

8043OV2616WSK	26 x 22 x 16	150	44.5	9.25	\$3040	n/a	\$169
8043OV3116WSK	31 x 26 x 16	150	56.5	11.75	\$3246	n/a	\$234

Finished height will vary depending on material top. Shipped fully assembled in 1 carton.

Required Specifications

Surface type
Top finish
Base finish
Glide type

Optional Specifications

HP laminate
Grade 2 solid surface
Cut-out for grommet/power blocks
Plated base finish

Accessories

Power block

L LITE LIFT II

LITE LIFT II	MODEL#	DIMENSIONS D x W x H	FREIGHT CLASS	WT/LBS.	CUBIC FT.	LIST PRICE
--------------	--------	-------------------------	---------------	---------	-----------	------------

Notes:

- Lightweight construction allows tables to easily and safely be lifted and moved by one person.
- Polypropylene top is fully water resistant and easy to clean and maintain.
- Thick, high impact radius corner helps protect individuals from injury.
- Folding legs automatically lock by a gravity activated mechanism when opened.
- Non-marring plastic glides protect floors from scratching when tables are moved.
- Structural side aprons allow tables to easily stack.
- Lite Lift II tables pass all BIFMA standards for strength and stability.
- **Available in Oyster Grey finish only.**

LITE LIFT II TABLES	MODEL#	DIMENSIONS	FREIGHT CLASS	WT/LBS.	CUBIC FT.	LIST PRICE
---------------------	--------	------------	---------------	---------	-----------	------------

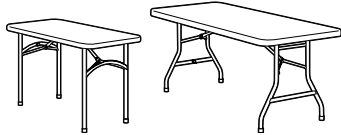

MVLFRT48 MVLFRT60-MVLFRT96

Rectangular Folding Table

MVLFRT48	24 x 48 x 29.25	85	23	1.57	\$310
MVLFRT60	30 x 60 x 29.25	92.5	30	2.54	\$413
MVLFRT72	30 x 72 x 29.25	92.5	36	3.06	\$485
MVLFRT96	30 x 96 x 29.25	92.5	50	4.79	\$712

Lightweight, textured, polypropylene Oyster Grey finish top. High impact radius corners. 19 gauge 11/8" diameter steel tubular legs with welded crossbars automatically lock. Legs finished in scuff resistant textured Charcoal Grey epoxy paint. Shipped fully assembled.

- Available in Oyster Grey finish with Charcoal Grey legs only.
- **Note:** Prices shown are for Global Distribution Center, not delivered pricing. All orders will be charged freight, except orders containing other Global products totaling \$2,000 list or more, before adding folding tables and folding chairs. Any Inside Delivery & Set-up charge for these products must be quoted separately.

RIVER+ TABLES

RIVER+ TABLES

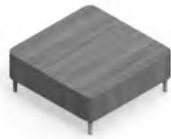

42" Square Coffee Table
model R27858



Outside Curve End Table
model R27864



18" Dia. Round Laptop Table
model 7743

STANDARD FEATURES

- A modular series that is composed of straight and curved sections, as well as freestanding units.
- Linking units can be used together in any combination with River+ seating and bench units to create a wide variety of layouts. Ganging hardware is standard and is factory installed. Ganging hardware swivels out of the way when not in use.
- Front and back faces of end (linking) tables angles slightly inwards. This inward slant matches the inward angles of River seating so all units coordinate in visual appearance.
- The standard 6.5", welded steel legs are straight (vertical) as standard. Linking models are optionally available with an angled back leg to visually align with River+ seating units.
- Legs are standard in Chrome with Black, non-marking, height adjustable glides.
- Tables are made with high pressure laminate. Custom high pressure laminate finishes will be considered upon request.
- Laptop tables have 1" thick laminate tops.
- Laptop table painted metal base finishes are available in Black and Tungsten only.

OPTIONAL FEATURES

- Legs of coffee and end (linking) tables are available in 3" (**S3**) and 8" (**S8**) heights. All leg heights are available with fixed-to-floor (**F3**) and (**F8**) options. Add \$100.
- To match adjacent lounge seating, straight front and angled back 6.5" or 8" legs are available on linking/end tables. Specify (**SA**). No upcharge.
- Power units are available on all tables except laptop tables. Each unit includes one AC outlet and two USB-a, 10 watt charging ports. Add \$661 upcharge per unit.
- Power location options include top, front or end. See electrical placement diagrams. Electrical units must be factory installed.
- Power units are available in either Jet Black (**J**) or White (**W**) with 120", three-prong matching cords.
- Most products can be weighted to reduce the ease of movement. For additional weight options, specify (**CW**). See each model for available additional weight and upcharge.

Please add option codes in the following order:

- **Model number**
R27855 to R27858 Square coffee tables
R27859 Rectangular coffee table
R27860 to R27861 Round coffee tables
R27862 to R27864 Linking/end tables
7443 and 7745 Freestanding tables
- **Laminate finishes**
(ACJ) Absolute Acajou **(ASN)** Asian Night
(AWC) Avant Cherry **(AWH)** Avant Honey
(BLK) Black **(BZD)** Blizzard
(BRC) Brushed Cobalt **(CMB)** Clear Maple
(CGY) Custom Grey **(DES)** Dark Espresso
(DWT) Designer White **(FAS)** Fashionista
(FCL) First Class **(NBL)** Noce Biondo
(NGL) Noce Grigio **(NEL)** Noce Leggero
(NML), Noce Medio **(QTM)** Quartered Mahogany
(SBY) Sheer Beauty **(SOG)** Storm Grey
(SDT) Stonedust **(WCR)** Winter Cherry
(WHC) White Chocolate **(WHE)** Walnut Heights
(colors shown on website)
- **Leg selection**
(S6) Standard height (6.5") w/adjustable glides. No upcharge.
(S3) Low (3") w/adjustable glides. No upcharge.
(S8) High (8") w/adjustable glides. No upcharge.
(F6) Standard height (6.5"), fixed to floor. Add \$100.
(F3) Low (3"), fixed to floor. Add \$100.
(F8) High (8"), fixed to floor. Add \$100.
- **Leg angle** (linking/end tables only)
(AST) Straight legs. No upcharge.
(SA) Straight front legs, angled back legs. No upcharge.
- **Leg finish**
(CHM) Chrome **(TBL)** Black
(TDW) Designer White **(TFO)** Fog
(TFR) Frost **(TIV)** Cloud
(TLA) Latte **(TMO)** Mocha
(TNE) Nevada **(TOA)** Toast
(TSH) Shadow **(TSN)** Sand
(TTU) Tungsten
- **Additional weight**
(CW) Additional weight. Upcharges vary, see model.
- **Power/USB unit position** (coffee and linking/end tables only, as shown below).
Add \$661 per unit.
(NP) No power (no upcharge)
(LE1) Left end (coffee table only)
(LE2) Right end (coffee table only)
(F3) Front center (coffee table only)
(T1) Top
- **Power unit finish**
(J) Jet Black
(W) White
- **(TP) Tamperproof fasteners.** Add \$160.

EXAMPLE RIVER+ TABLE ORDER CODE:

R27858	-ACJ	-S6	-AS	-CM	-	-T1	-W	-
Model number	Laminate	Leg selection	Leg angle	Leg finish	Additional weight	Power/USB	Power finish	Fasteners

ELECTRICAL PLACEMENT

Coffee Tables

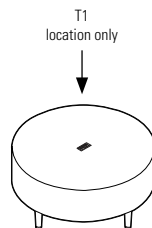
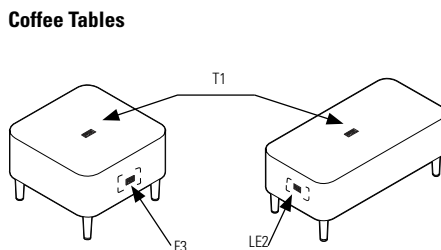

Linking Tables

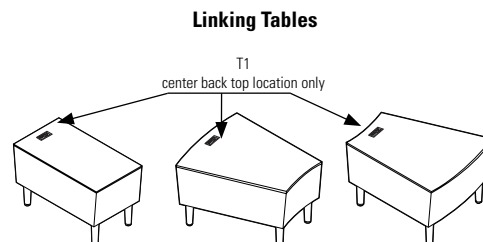

R RIVER+ TABLES

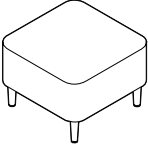
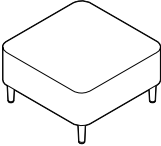
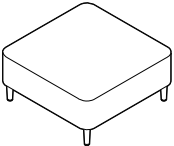
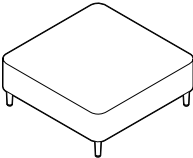
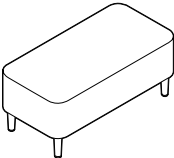
RIVER+ TABLES	MODEL#	DIMENSIONS	FREIGHT CLASS	WT/LBS.	CUBIC FT.	LIST PRICE
 <p>24" Square Coffee Table</p>	R27855	24 x 24 x 17	250	40	10.7	\$1484
	<p>Freestanding unit only. 1 per carton. For power/USB unit, see electrical placement chart. • Add \$733 for 36 lbs. (CW)</p>					
 <p>30" Square Coffee Table</p>	R27856	30 x 30 x 17	250	53	15.3	\$1563
	<p>Freestanding unit only. 1 per carton. For power/USB unit, see electrical placement chart. • Add \$632 for 27 lbs. (CW)</p>					
 <p>36" Square Coffee Table</p>	R27857	36 x 36 x 17	250	75	20.6	\$1791
	<p>Freestanding unit only. 1 per carton. For power/USB unit, see electrical placement chart. No counterweight.</p>					
 <p>42" Square Coffee Table</p>	R27858	42 x 42 x 17	150	115	26.7	\$1991
	<p>Freestanding unit only. 1 per carton. For power/USB unit, see electrical placement chart. No counterweight.</p>					
 <p>Rectangular Coffee Table</p>	R27859	20 x 40 x 17	250	55	14.2	\$1626
	<p>Freestanding unit only. 1 per carton. For power/USB unit, see electrical placement chart. • Add \$317 for 18 lbs. (CW)</p>					

Required Specifications

Top finish
 Leg finish

Optional Specifications

Counterweight

Accessories

Power Block

ROUND COFFEE TABLES

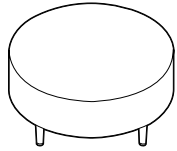

36" Dia. Round Coffee Table

MODEL#	DIMENSIONS	FREIGHT CLASS	WT/LBS.	CUBIC FT.	LIST PRICE
R27860	36 x 36 x 17	150	63	15.3	\$1927

D x W x H

R27860 36 x 36 x 17 150 63 15.3 \$1927

Freestanding unit only. 1 per carton.
 For power/USB unit, see electrical placement chart.
 • Add \$317 for 18 lbs. (CW)

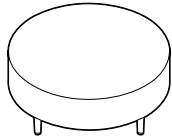

42" Dia. Round Coffee Table

R27861 42 x 42 x 17 150 85 20.6 \$2113

Freestanding unit only. 1 per carton.
 For power/USB unit, see electrical placement chart. No counterweight.

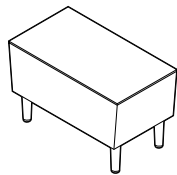

Rectangular End Table

R27862 15 x 28 x 17 300 40 20.6 \$1578

1 per carton. Includes ganging hardware (2 sides).
 For power/USB unit, see electrical placement chart.
 • Add \$632 for 36 lbs. (CW)

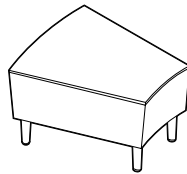

Inside Curve End Table

R27863 17 x 28 x 17 250 47 13.3 \$2073

1 per carton. Includes ganging hardware (2 sides).
 For power/USB unit, see electrical placement chart.
 • Add \$632 for 36 lbs. (CW)

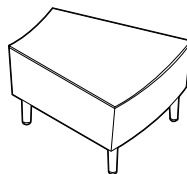

Outside Curve End Table

R27864 17 x 28 x 17 250 47 13.3 \$2073

1 per carton. Includes ganging hardware (2 sides).
 For power/USB unit, see electrical placement chart.
 • Add \$632 for 36 lbs. (CW)

Required Specifications

Top finish
 Leg finish

Optional Specifications

Counterweight

Accessories

Power Block

S SIRENA TABLES

RECTANGULAR TOP	MODEL#	DIMENSIONS D x W x H	FREIGHT CLASS	WT/LBS.	CUBIC FT.	LIST PRICE
-----------------	--------	-------------------------	---------------	---------	-----------	------------

Notes:

- Modern tables for reception areas, meeting rooms, and private office use.
- Sirena tables are offered in the following finishes to coordinate with Global desking and wood seating:

ACJ Absolute Acajou	DES Dark Espresso	NML Noce Medio
ASN Asian Night	DWT Designer White	SBY Sheer Beauty
AWC Avant Cherry	FAS Fashionista	SDT Stonedust
AWH Avant Honey	FCL First Class	WHE Walnut Heights
BZD Blizzard	NBL Noce Biondo	WHC White Chocolate
CMB Clear Maple	NGL Noce Grigio	WCR Winter Cherry
CGY Custom Grey	NEL Noce Leggero	

- Laminate tops are 1.5" thick to coordinate with Global desking and wood seating
- Table legs are available in Black (**TBL**) or Tungsten (**TTU**) at no upcharge. Not available in Chrome.
- Legs are 1.5" steel tubing, tapered toward the bottom of the leg to 0.875", equipped with self-leveling pivoting steel glide.

SIRENA TABLES	MODEL#	DIMENSIONS	FREIGHT CLASS	WT/LBS.	CUBIC FT.	LIST PRICE
---------------	--------	------------	---------------	---------	-----------	------------

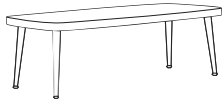

Coffee Table

3400	22 x 48 x 15	250	52	17.25	\$1856
------	--------------	-----	----	-------	---------------

Rectangular coffee table.



Coffee Table

3401	22 x 56 x 15	250	60	19.75	\$2052
------	--------------	-----	----	-------	---------------

Rectangular coffee table.



End Table

3402	22 x 17 x 15	250	26	7.75	\$1489
------	--------------	-----	----	------	---------------

Rectangular end table.

Required Specifications
Finish

Optional Specifications
Grommet

Accessories
Power Block

WIND TABLES	MODEL#	DIMENSIONS	FREIGHT CLASS	WT/LBS.	CUBIC FT.	LIST PRICE
-------------	--------	------------	---------------	---------	-----------	------------

Notes:

D x W x H

- Wind tables complement the modern decor of many offices.
- Legs are standard in Chrome (**CHM**). Also available in Black (**TBL**), Shadow (**TSH**) or Tungsten (**TTU**) finish at no upcharge.
- 1" laminate tops are offered in the following finishes to coordinate with Global casegoods and wood seating:

ACJ	Absolute Acajou	DWT	Designer White	SDT	Stonedust
ASN	Asian Night	FAS	Fashionista	WHE	Walnut Heights
AWC	Avant Cherry	FCL	First Class	WHC	White Chocolate
AWH	Avant Honey	NBL	Noce Biondo	WCR	Winter Cherry
BLK	Black	NGL	Noce Grigio		
BZD	Blizzard	NEL	Noce Leggero		
BRC	Brushed Cobalt	NML	Noce Medio		
CMB	Clear Maple	QTM	Quartered Mahogany		
CGY	Custom Grey	SBY	Sheer Beauty		
DES	Dark Espresso	SOG	Storm Grey		

- Table tops are available in high pressure laminate at a 20% upcharge for the following model numbers: 3366, 3367, 3368, 3870 and 3871; specify (**HPL**) in addition to the finish. HPL is not available on 3878, 3879 or 3880.

WIND TABLES	MODEL#	DIMENSIONS	FREIGHT CLASS	WT/LBS.	CUBIC FT.	LIST PRICE
-------------	--------	------------	---------------	---------	-----------	------------



Square Corner Table

3366	24 x 24 x 17	250	36	11.50	\$933
------	--------------	-----	----	-------	--------------

Steel tubular base. Tops are available with a laminate finish. Shipped assembled in 1 carton.



Rectangular Coffee Table

3367	20 x 48 x 15	250	52	16	\$1234
------	--------------	-----	----	----	---------------

Steel tubular base. Tops are available with a laminate finish. Shipped assembled in 1 carton.



Square Coffee Table

3368	36 x 36 x 15	250	66	22	\$1670
------	--------------	-----	----	----	---------------

Steel tubular base. Tops are available with a laminate finish. Shipped assembled in 1 carton.



Round Corner Table

3870	24 x 24 x 17	250	35	11.50	\$1020
------	--------------	-----	----	-------	---------------

Steel tubular base. Tops are available with a laminate finish. Shipped assembled in 1 carton.

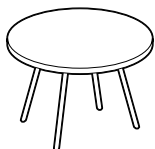

Round Coffee Table

3871	36 x 36 x 15	250	57	22	\$1501
------	--------------	-----	----	----	---------------

Steel tubular base in Chrome finish.

Required Specifications

Top finish
Leg finish

W WIND LINEAR TABLES

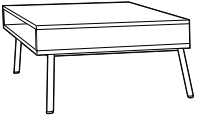
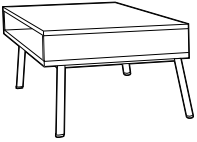
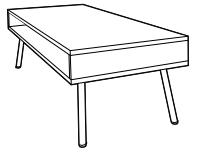
WIND LINEAR TABLES	MODEL#	DIMENSIONS	FREIGHT CLASS	WT/LBS.	CUBIC FT.	LIST PRICE
 Freestanding Rectangular End Table		D x W x H				
	3878	25 x 20 x 16	250	38	11.50	\$1334
	Steel tubular base. Laminate top is 5" thick with opening on front for storage and visual recess at rear. Shipped assembled in 1 carton.					
 Freestanding Corner Table	3879	25 x 25 x 16	250	40	11.50	\$1455
	Steel tubular base. Laminate top is 5" thick with opening on front for storage and visual recess at rear. Shipped assembled in 1 carton.					
 Freestanding Coffee Table	3880	54 x 20 x 15	250	52	16	\$1623
	Steel tubular base. Laminate top is 5" thick with opening on front for storage and visual recess at rear. Shipped assembled in 1 carton.					

WORK TABLES	MODEL#	DIMENSIONS	FREIGHT CLASS	WT/LBS.	CUBIC FT.	LIST PRICE
-------------	--------	------------	---------------	---------	-----------	------------

Notes:

- Work tables are offered in the following top finishes to coordinate with Global casegoods and wood seating:

ACJ	Absolute Acajou	FCL	First Class
ASN	Asian Night	NBL	Noce Biondo
AWC	Avant Cherry	NGL	Noce Grigio
AWH	Avant Honey	NEL	Noce Leggero
BLK	Black	NML	Noce Medio
BZD	Blizzard	QTM	Quartered Mahogany
BRC	Brushed Cobalt	SBY	Sheer Beauty
CMB	Clear Maple	SOG	Storm Grey
CGY	Custom Grey	SDT	Stonedust
DES	Dark Espresso	WHE	Walnut Heights
DWT	Designer White	WHC	White Chocolate
FAS	Fashionista	WCR	Winter Cherry

- Legs available in Chrome (**CHM**) or Black (**TBL**)

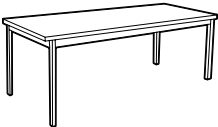
WORK TABLES	MODEL#	DIMENSIONS	FREIGHT CLASS	WT/LBS.	CUBIC FT.	LIST PRICE
 Work Tables	GATMS6030	30 x 60 x 29	70	132	8	\$690
	GATMS7230	30 x 72 x 29	92.5	87	8	\$786
	GATMS7236	36 x 72 x 29	70	132	8	\$968
	1" high performance thermally fused laminate with self edge top. Black metal skirt. Rectangular top with metal legs and leveling glides. Self edge is standard. Shipped easy to assemble in 1 carton.					

Required Specifications
Top finish

Optional Specifications
Leg finish