

T TABLE POWER + TECHNOLOGY SOLUTIONS™ - NOTES

- Global is pleased to offer a range of sophisticated electrical and technology options for training and conference tables.
- Worksurface cut-outs for units must be specified separately, please see appropriate product note pages for details.
- Daisy chaining is generally defined as having multiple power units connect to one another from a single electrical infeed source.
- The daisy-chain units below utilize a 4-wire, 2 circuit system (when hardwired by a licensed electrician to a building power source) or can run a single circuit (when utilizing the 42AP1-72 plug and play infeed).
- The following maximums are to National Electric Code (NEC) – some local codes vary from NEC code – it is the customer's responsibility to follow all applicable local codes and guidelines.

Product	Max units per circuit
Villa I	8 units per circuit
Villa USB A+C	8 units per circuit
Oasis Mini A	3 units per circuit
Oasis Mini B	3 units per circuit
Oasis Mini USB A+C	3 units per circuit

Electrical System

4-2 Wiring Schematic
 4-Wire Shared Neutral
 Complies with National Electric Code
 UL Listed
 All circuits rated for 20 AMP

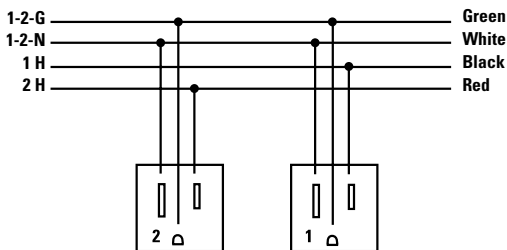

VILLA I AND VILLA USB A+C DETAILS

- Each Villa unit is available two ways. Corded units includes three-prong plugs to connect directly into a standard outlet. DaisyLink kits can be specified separately to daisy-chain multiple units off of a single infeed. Infeeds are specified separately.
- Villa I units include two power outlets and either two knockouts or two data ports included, **all accessible at the surface**.
- Villa USB A+C includes (1) 2.4A Reversible USB-A Charging Port & (1) 60-Watt USB-C Power Delivery Port with GaN Technology, **all accessible at the surface**.

OASIS MINI DETAILS

- Each Oasis Mini (except for Chicago Mini Oasis) is available two ways. Corded units includes three-prong plugs to connect directly into a standard outlet. DaisyLink units must have interconnecting cords specified separately to daisy-chain multiple units off of a single infeed. Infeeds are specified separately.
- Oasis Mini A units includes six power outlets and two telecom plate knockouts
- Oasis Mini B units includes four power outlets and three telecom plate knockouts
- Oasis Mini USB A+C units include six power outlets, (1) 2.4A Reversible USB-A Charging Port & (1) 60-Watt USB-C Power Delivery Port with GaN Technology and one telecom plate knockout.

TELECOM PLATE DETAILS

- Telecom plates are for use on Oasis Mini units only, providing a means to provide different types of telephone, data and audio visual connections to the worksurface. For every telecom plate knockout on a Oasis Mini unit, please specify one telecom plate. If telecom plates are not required, it is recommended blank telecom plates are specified - see page 625 for details.

EXAMPLE LAYOUTS - TRAINING TABLES

- Single Power Block Kits Available on training tables 36" – 72" (**must specify V2 cut-out on table**):
- Each single block kit includes 1 Power Block and 1 Grommet Cover, 1 Female/Female Interconnecting Cable and 1 Female/Male Interconnecting Cable. Cable clamps for management of these cables are also included.

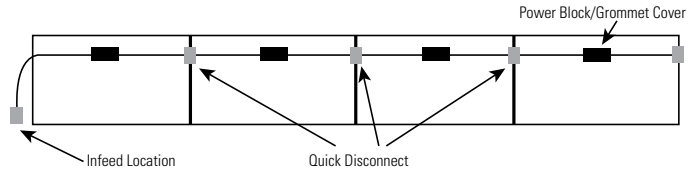

- Double Power Block Kits Available on 60", 66" and 72" (must specify V1 and V3 cut-out on table):
- Each double block kit includes 2 Power Blocks and 2 Grommet Covers, 2 Female/Female Interconnecting Cable and 1 Female/Male Interconnecting Cable. Cable clamps for management of these cables are also included.

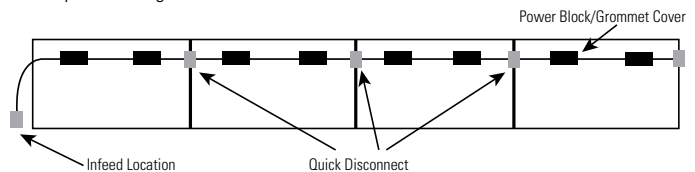

VILLA CUT-OUTS

- Optional Villa cut-out available in standard worksurface locations (left, center or right) **for Rectangular Tables**. Order as: **V1, V2 or V3**. Add \$103 for each cut-out.
- Villa cut-outs may be placed at non-standard locations. Please contact customer service.

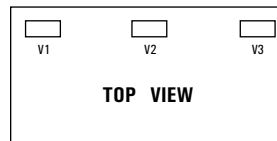

OASIS MINI CUT-OUTS

- Optional Oasis Mini cut-out available in standard worksurface locations (left, center or right) **for Rectangular Tables**. Order as: **M1, M2 or M3**. Add \$103 for each cut-out.
- Oasis Mini cut-outs may be placed at non-standard locations. Please contact customer care.

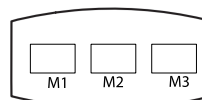

VILLA I, CENTER POSITION- DAISYLINK KITS

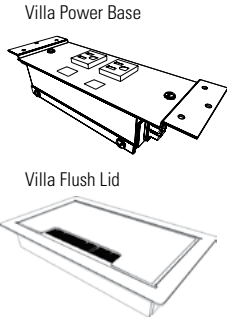

Data Knockouts, No Data Ports

MODEL#	DIMENSIONS D x W x H	FREIGHT CLASS	WT/LBS.	CUBIC FT.	LIST PRICE
VIF-41-DKO_72SK	--	70	9	.45	\$529
VIF-41-DKO_66SK	--	70	9	.45	\$529
VIF-41-DKO_60SK	--	70	9	.45	\$529
VIF-41-DKO_54K	--	70	9	.45	\$529
VIF-41-DKO_48K	--	70	9	.45	\$529
VIF-41-DKO_42K	--	70	9	.45	\$529
VIF-41-DKO_36K	--	70	9	.45	\$529

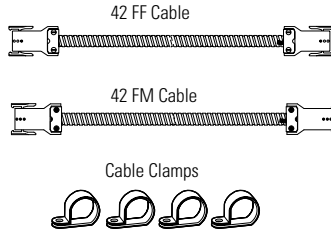

Includes **one power block** with **two power receptacles** and two knockouts for data, grommet cover, one female/female interconnecting cable, one female/male interconnecting cable and four cable clamps. **V2 cut-out must be specified on training table** (see product notes section for more details and cut-out upcharge). **Power Infeed required and sold separate** (see page 627). For multiple circuit configurations, please contact customer service. UL listed: UL 183 and CSA Certified.

- Replace _ with **B** for **Black**
- Replace _ with **S** for **Silver Pearl**
- Villa DaisyLink kits are not recommended for use on 2gether tables or Zira Boardroom Tables

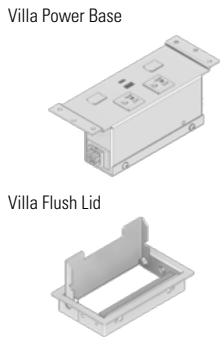

**Villa I USB A+C
Data Knockouts, No Data Ports**

185317.S1_36	--	60	23	.23	\$724
185317.S1_42	--	60	23	.23	\$724
185317.S1_48	--	60	23	.23	\$724
185317.S1_54	--	60	23	.23	\$724
185317.S1_60	--	60	23	.23	\$724
185317.S1_66	--	60	23	.23	\$724
185317.S1_72	--	70	10	.45	\$724

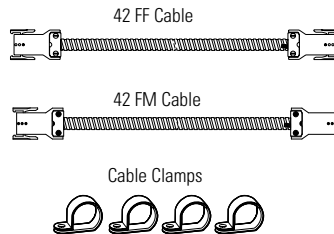

Includes **one power block** with **two power receptacles, one 2.4A Reversible USB-A Charging Port & one 60-Watt USB-C Power Delivery Port with GaN Technology** and two knockouts for data, grommet cover, one female/female interconnecting cable, one female/male interconnecting cable and four cable clamps. **V2 cut-out must be specified on training table** (see product notes section for more details and cut-out upcharge). **Power Infeed required and sold separate** (see page 627). For multiple circuit configurations, please contact customer service. UL listed: UL 183 and CSA Certified.

- Replace _ with **04** for **Black**
- Replace _ with **25** for **Silver Pearl**
- Villa DaisyLink kits are not recommended for use on 2gether tables or Zira Boardroom Tables
- Not compatible with Terina tables or Junction wire managers (JNECxx)

Required Specifications

Finish
Power Infeed
Cut-out location

T TABLE POWER + TECHNOLOGY SOLUTIONS

VILLA I, CENTER POSITION- DAISYLINK KITS

MODEL# DIMENSIONS FREIGHT CLASS WT./LBS. CUBIC FT. LIST PRICE

D x W x H

GL-VIF41KO_60DK	--	60	18	.23	\$985
GL-VIF41KO_66DK	--	60	18	.23	\$985
GL-VIF41KO_72DK	--	60	18	.23	\$985

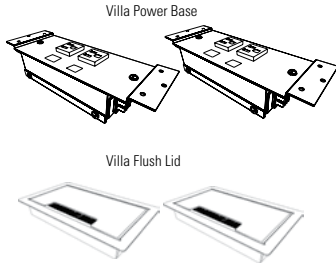

Data Knockouts, No Data Ports

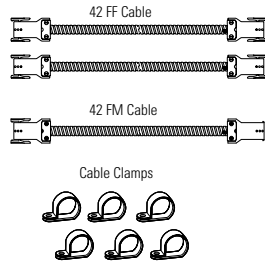

Includes **two power blocks** with **two power receptacles** and two knockouts for data in each block, two grommet covers, two female/female interconnecting cables, one female/male interconnecting cable and 6 cable clamps. **V1 & V3 cut-outs must be specified on training table** (see product notes section for more details and cut-out upcharge). **Power Infeed required and sold separate** (see page 627). For multiple circuit configurations, please contact customer service. UL listed: UL 183 and CSA Certified.

- Replace _ with **B** for **Black**
- Replace _ with **S** for **Silver Pearl**
- Villa DaisyLink kits are not recommended for use on 2gether tables or Zira Boardroom Tables

185317.D1._.60	--	60	23	.23	\$1379
185317.D1._.66	--	60	23	.23	\$1379
185317.D1._.72	--	60	23	.23	\$1379

Villa Power Base

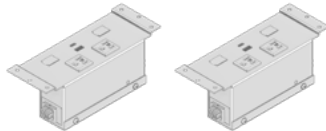

Villa Flush Lid

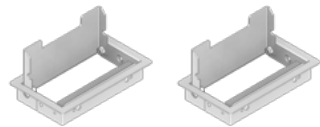

Villa I USB A+C

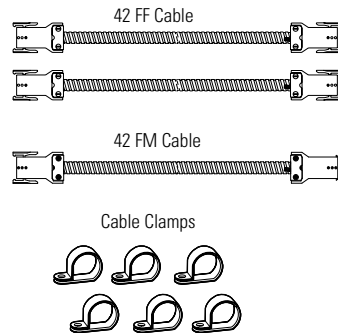

Includes **two power blocks** with **two power receptacles**, **one 2.4A Reversible USB-A Charging Port & one 60-Watt USB-C Power Delivery Port with GaN Technology** and two knockouts for data, grommet cover, two female/female interconnecting cables, one female/male interconnecting cable and four cable clamps. **V1 & V3 cut-outs must be specified on training table** (see product notes section for more details and cut-out upcharge). **Power Infeed required and sold separate** (see page 627). For multiple circuit configurations, please contact customer service. UL listed: UL 183 and CSA Certified.

- Replace _ with **04** for **Black**
- Replace _ with **25** for **Silver Pearl**
- Villa DaisyLink kits are not recommended for use on 2gether tables or Zira Boardroom Tables
- Not compatible with Terina tables or Junction wire managers (JNECxx)

Required Specifications

Finish
Power Infeed
Cut-out location

VILLA I - CORDED UNITS

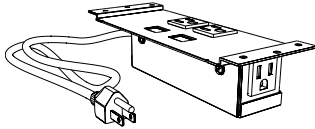

Villa I, Data Knockouts, No Data Ports Coded

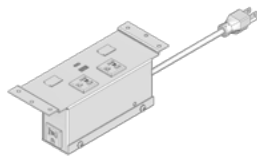

Villa I, USB A+C Corded

MODEL#	DIMENSIONS	FREIGHT CLASS	WT/LBS.	CUBIC FT.	LIST PRICE
--------	------------	---------------	---------	-----------	------------

	D x W x H				
VIL-C-DKO-_-108	3.25 x 8.75 x 2.25	100	4	.45	\$266
VIL-C-DKO-_-72	3.25 x 8.75 x 2.25	100	4	.45	\$266

Villa I with 3-prong plug. Includes **two power receptacles** and two knockouts for data. A third convenience receptacle is provided below the worksurface. **V1, V2 or V3 cut-out(s) must be specified on training table** (see product notes section for more details and cut-out upcharge). **Grommet cover is required and sold separate** (see page 623). UL listed: UL 962A and CUL listed.

- Replace _ with **B** for **Black**
- Replace _ with **S** for **Silver Pearl**
- Compatible with Zira Collaborative tables
- -108 models include a 108" long cord. -72 models include a 72" long cord.

Silver:

305288.02.25.09	--	85	6	.45	\$440
-----------------	----	----	---	-----	--------------

Black:

305288.02.04.09	--	85	6	.45	\$440
-----------------	----	----	---	-----	--------------

Villa USB A+C with 3-prong plug. Includes **two power receptacles**, (1) 2.4A Reversible USB-A Charging Port & (1) 60-Watt USB-C Power Delivery Port with GaN Technology and two knockouts for data. A third convenience receptacle is provided below the worksurface. **V1, V2 or V3 cut-out(s) must be specified on training table** (see product notes section for more details and cut-out upcharge). **Grommet cover is required and sold separate** (see page 623). UL listed: UL 962A and CUL listed.

- Compatible with Zira Collaborative tables
- Includes a 108" long cord.

Required Specifications

Finish
Power Infeed
Cut-out location

T TABLE POWER + TECHNOLOGY SOLUTIONS

VILLA DAISYLINK

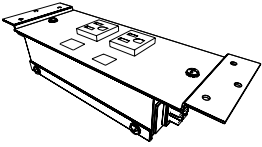

Villa, DaisyLink

MODEL#	DIMENSIONS	FREIGHT CLASS	WT/LBS.	CUBIC FT.	LIST PRICE
--------	------------	---------------	---------	-----------	------------

D x W x H

VIL-4-1-DKO-__	--	100	4	.45	\$233
----------------	----	-----	---	-----	-------

Villa I for use in hardwire or DaisyLink applications. Includes **two power receptacles** and **two knockouts for data in each block**. **V1, V2 or V3 cut-out(s) must be specified on table** (see product notes section for more details and cut-out upcharge). **Power infeed required and sold separate** (see page 627). *Please see our **Daisy-Chain guide** on page 628 for appropriate cable lengths and important notes.* **Grommet cover is required and sold separate** (see page 623). UL listed: UL 183 and CSA Certified.

- Replace __ with **B** for **Black** or **S** for **Silver Pearl**
- Villa DaisyLink kits are not recommended for use on 2gether tables.
- Not compatible with Zira Collaborative tables.
- Intended for use on Zira Boardroom tables, Kadin and Swap tables

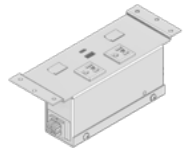

Villa USB A+C, DaisyLink

306025.02.__C1	--	85	6	.45	\$429
----------------	----	----	---	-----	-------

Villa USB A+C for use in hardwire or DaisyLink applications. Includes **two power receptacles**, **(1) 2.4A Reversible USB-A Charging Port & (1) 60-Watt USB-C Power Delivery Port with GaN Technology**, and **two knockouts for data in each block**. **V1, V2 or V3 cut-out(s) must be specified on table** (see product notes section for more details and cut-out upcharge). **Power infeed and connecting cables sold separate** (see page 627). *Please see our **Daisy-Chain guide** on page 628 for appropriate cable lengths and important notes.* **Grommet cover is required and sold separate** (see page 623). UL listed: UL 183 and CSA Certified.

- Replace __ with **04** for **Black** • Replace __ with **25** for **Silver Pearl**
- Villa DaisyLink kits are not recommended for use on 2gether tables
- Not compatible with Zira Collaborative tables, Terina tables or Junction wire managers (JNECxx)
- Intended for use on Zira Boardroom tables, Kadin and Swap tables

DATA KNOCKOUT ACCESSORIES

MODEL#	DIMENSIONS	FREIGHT CLASS	WT/LBS.	CUBIC FT.	LIST PRICE
--------	------------	---------------	---------	-----------	------------



Data Jack

RJ45-B	--	70	.50	.08	\$73
--------	----	----	-----	-----	------

RJ45 cat6 punch down data jack, Siemon™ brand. Used in any open data knockout on Villa + Villa USB A+C only. Black only.



HDMI Jack

HDMI-KEY-B	--	70	9	.45	\$84
------------	----	----	---	-----	------

HDMI keystone jack, female/female. Used in any open data knockout on Villa + Villa USB A+C only. Black only.



USB 2.0 Type-A Jack

USB-20AA-B-72K	--	100	4	.45	\$165
----------------	----	-----	---	-----	-------

USB 2.0 Type-A keystone, female/female. This jack transfers data. To use for power, order PUBSTRSF separately. Used in any open data knockout on Villa + Villa USB A+C only. Black only.

Required Specifications

Finish
Power Infeed
Cut-out location

VILLA GROMMET COVER

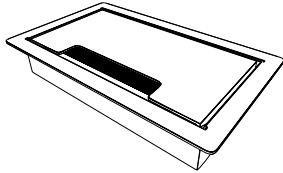

Villa Grommet Cover

MODEL#	DIMENSIONS	FREIGHT CLASS	WT/LBS.	CUBIC FT.	LIST PRICE
--------	------------	---------------	---------	-----------	------------

	D x W x H				
VIL-GROM-F-__	3.5 x 5.75 x .94	70	1	.08	\$135

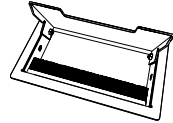

Powder coated flush metal grommet to be used with Villa I and Villa II **corded** series power blocks. Cut-outs in tables must be specified separately. **V1, V2 or V3 cut-out(s) must be specified on training table** (see product notes section for more details and cut-out upcharge). **Grommet cover remains open while in use.**

- **Cannot be used with PMSPDM.**
- Replace __ with **B** for **Black** or **S** for **Silver Pearl**

OASIS MINI

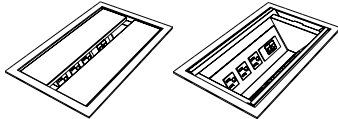

Oasis Mini A, Corded

MODEL#	DIMENSIONS	FREIGHT CLASS	WT/LBS.	CUBIC FT.	LIST PRICE
--------	------------	---------------	---------	-----------	------------

OAM-A-PC-__	15 x 9 x 5.25	92.5	16	1.53	\$1945
-------------	---------------	------	----	------	---------------



Mini Oasis A unit. 15" Trough with six power receptacles, two telecom plate cut-outs (**telecom plates sold separate**, see page 625) and two 108" 3-prong plugs. **M1, M2 or M3 cut-out(s) must be specified on conference table** (see product notes section for more details and cut-out upcharge). Cut-out dimensions: 14.12" x 8.25". UL Listed: UL 962A.

- **Cannot be daisy-chained.**
- Replace __ with **B** for **Black** or **S** for **Silver Pearl**

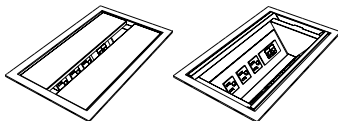

Oasis Mini A, DaisyLink Version

OAM-A-PC-4-1-__	15 x 9 x 5.25	92.5	16	1.53	\$2227
-----------------	---------------	------	----	------	---------------



For hardwire and daisy chain applications. Mini Oasis A unit. 15" Trough with six power receptacles, two telecom plate cut-outs (**telecom plates sold separate**, see page 625). **Power infeed sold separate** (see page 627). **M1, M2 or M3 cut-out(s) must be specified on conference table** (see product notes section for more details and cut-out upcharge). For multiple circuit configurations, please contact customer service. *Please see our **Daisy-Chain guide** on page 628 for appropriate cable lengths and important notes.* UL Listed: UL 183.

- Replace __ with **B** for **Black** or **S** for **Silver Pearl**

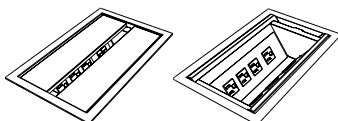

Oasis Mini B, Corded

OAM-B-PC-__	15 x 9 x 5.25	92.5	16	1.53	\$1945
-------------	---------------	------	----	------	---------------



Mini Oasis B unit. 15" Trough with four power receptacles, three telecom plate cut-outs (**telecom plates sold separate**, see page 625) and one 108" 3-prong plug. **M1, M2 or M3 cut-out(s) must be specified on conference table** (see product notes section for more details and cut-out upcharge). UL Listed: UL 962A.

- **Cannot be daisy-chained.**
- Replace __ with **B** for **Black** or **S** for **Silver Pearl**

Required Specifications

- Finish
- Power Infeed
- Cut-out location

T TABLE POWER + TECHNOLOGY SOLUTIONS

OASIS MINI

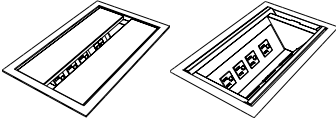
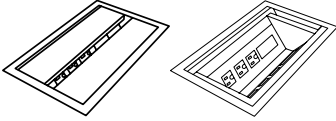
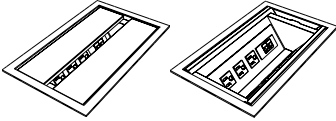
MODEL#	DIMENSIONS	FREIGHT CLASS	WT/LBS.	CUBIC FT.	LIST PRICE
D x W x H					
OAM-B-PC-4-1-__	15 x 9 x 5.25	92.5	16	1.53	\$2227
					
<p>Oasis Mini B, DaisyLink Version</p> <p>For hardwire and daisy chain applications. Mini Oasis B unit. 15" Trough with four power receptacles, three telecom plate cut-outs (telecom plates sold separate, see page 625). Power infeed sold separate (see page 627). M1, M2 or M3 cut-out(s) must be specified on conference table (see product notes section for more details and cut-out upcharge). For multiple circuit configurations, please contact customer service. <i>Please see our Daisy-Chain guide on page 628 for appropriate cable lengths and important notes.</i> UL Listed: UL 183.</p> <ul style="list-style-type: none"> • Replace __ with B for Black • Replace __ with S for Silver Pearl 					
<hr/>					
305300.03__09	15 x 9 x 5.25	92.5	16	1.53	\$2177
					
<p>Oasis Mini USB A+C, Corded</p> <p>Mini Oasis USB unit. 15" trough with six power receptacles, (1) 2.4A Reversible USB-A Charging Port & (1) 60-Watt USB-C Power Delivery Port with GaN Technology and one telecom plate cut-out (telecom plates sold separate, see page 625) and two 108" 3-prong plugs. M1, M2 or M3 cut-out(s) must be specified on conference table (see product notes section for more details and cut-out upcharge). UL Listed: UL 962A.</p> <ul style="list-style-type: none"> • Cannot be daisy-chained. • Replace __ with 04 for Black or 27 for Silver Pearl 					
<hr/>					
306023.03__C1	15 x 9 x 5.25	92.5	16	1.53	\$2457
					
<p>Oasis Mini USB A+C, DaisyLink Version</p> <p>For hardwire and daisy chain applications. Mini Oasis USB unit. 15" trough with six power receptacles, one 2.4A reversible USB-A charging port & one 60-Watt USB-C Power Delivery Port with GaN Technology, and one telecom plate cut-out (telecom plates sold separate, see page 625). Power infeed sold separate (see page 627). M1, M2 or M3 cut-out(s) must be specified on conference table (see product notes section for more details and cut-out upcharge). For multiple circuit configurations, please contact customer service. <i>Please see our Daisy-Chain guide on page 628 for appropriate cable lengths and important notes.</i> UL Listed: UL 183.</p> <ul style="list-style-type: none"> • Replace __ with 04 for Black or 27 for Silver Pearl 					
<hr/>					
GL-OAMPD_P72HW	15 x 9 x 5.25	92.5	16	1.53	\$2652
					
<p>Oasis Mini, Chicago Code</p> <p>Mini Oasis for Chicago code includes electrical trough with (2) separate hardwire inserts. Each insert includes (3) simplex outlets and (1) telecom plate cut-out (telecom plates sold separate, see page 625). M1, M2 or M3 cut-out(s) must be specified on conference table (see product notes section for more details and cut-out upcharge). Each component is UL Listed: UL 962A.</p> <ul style="list-style-type: none"> • Cannot be daisy-chained. • Replace __ with B for Black • Replace __ with S for Silver Pearl 					

Required Specifications

Finish
Power Infeed
Cut-out location

TOP TELECOM PLATES

D x W x H

NOT COMPATIBLE WITH VILLA UNITS

TOP TELECOM PLATE	MODEL	CONFIGURATION	LIST PRICE
	A-__-A-B	Telecom plate with RJ11 Cat 3 Phone and RJ45 Cat 6 Data	\$116
	A-__-B-B	(2) RJ45 Cat 6 Connectors	\$151
	A-__-B-B-B	(3) RJ45 Cat 6 Connectors	\$220
	A-__-B-B-B-B	(4) RJ45 Cat 6 Connectors	\$292
	A-__-B-C51-L	RJ45 Cat 6 Data, Mini-Stereo Inline and 15 pin HD VGA Female/Female with 72" patch cord attached.	\$260
	A-__-B-B-C51	(2) RJ45 Cat 6 Data and (1) 15 pin HD VGA Female/Female with 72" patch cord attached.	\$271
	A-__-A-B-102	RJ11 Cat 3 phone, RJ45 Cat 6 Data and USB with 72" patch cord attached.	\$260
	A-__-B	RJ45 Cat 6 Data	\$81
	A-__-C51-L	Mini Stereo Inline and 15 pin HD VGA Female/Female with 72" patch cord attached.	\$204
	A-__-CRDMINDER	Cordminder Plate - 2 5/8" holes and 1 7/8" holes	\$46
	A-__-C45-C51-L	HDMI Female/Female with 36" patch cord attached. Mini Stereo Inline and 15 Pin HD VGA Female/Female with 72" patch cord attached.	\$355





Required Specifications

- Finish
- Power Infeed
- Cut-out location

T TABLE POWER + TECHNOLOGY SOLUTIONS

TOP TELECOM PLATES

D x W x H

TOP TELECOM PLATE	MODEL	CONFIGURATION	LIST PRICE
	A-__-C45	HDMI Female/Female with 36" patch cord attached.	\$175
	A-__-A-B-B	(1) RJ11 Cat 3 Phone and (2) RJ45 Cat 6 data.	\$190
	A-__	Blank telecom plate	\$29
	A-__-102	USB with 72" patch cord attached.	\$81
	A-__-C51	15 pin HD VGA Female/Female with 72" patch cord attached.	\$131

- Replace _ with **BL** for **Black**
- Replace _ with **GR** for **Grey**

Required Specifications

Finish
Power Infeed
Cut-out location

POWER INFEEDS

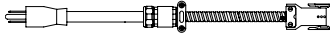

Plug and Play Infeed

	D x W x H				
42AP1-72	--	--	--	--	\$261

Single Circuit 20 AMP Power Infeed with 72" 3-prong plug. Provides single power entry from floor or wall mounted standard power supply. Connects to Oasis Mini or Villa units that require a separate infeed. UL Listed: UL 1286.



Multi-Circuit Hardwire Power Infeed

42SB2-108	--	--	--	--	\$217
42SB2-72	--	--	--	--	\$169
42SB2-36	--	--	--	--	\$123

Multi-Circuit Hardwire Infeed (up to 20 AMPS per circuit), two circuits. Provides single power entry from floor or wall located building power supply. Connects to Oasis Mini or Villa units that require a power infeed. **TO BE HARDWIRED BY A LICENSED ELECTRICIAN.** UL Listed: UL 183.

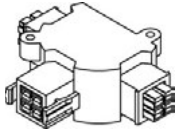

3 Way Power Splitter

DAISY-T	--	70	1	1	\$200
---------	----	----	---	---	--------------

Daisy-T power manager includes two male and one female connection. For use in splitting a power source two ways. UL Listed: UL 183.

Required Specifications

- Finish
- Power Infeed
- Cut-out location

T TABLE POWER + TECHNOLOGY SOLUTIONS

TOP TELECOM PLATES



Interconnecting Cables

D x W x H

42FF-__	Female/Female
42FM-__	Female/Male

UL Listed: UL 183 and CSA Certified. For appropriate quantity and sizes, please refer to the chart on the next page.

Interconnecting Cables - Common Cable Lengths (in inches)

Female/Female

42FF-27	\$124
42FF-38	\$138
42FF-41	\$142
42FF-50	\$155
42FF-53	\$159
42FF-63	\$170
42FF-65	\$174
42FF-75	\$187
42FF-76	\$188
42FF-77	\$189
42FF-82	\$196
42FF-85	\$200
42FF-86	\$201
42FF-89	\$206

42FF-97	\$231
42FF-98	\$231
42FF-100	\$219
42FF-101	\$222
42FF-103	\$222
42FF-110	\$234
42FF-113	\$240

Female/Male

42FM-12	\$111
42FM-27	\$129
42FM-38	\$143
42FM-41	\$149
42FM-50	\$161
42FM-63	\$178
42FM-75	\$193
42FM-82	\$203
42FM-85	\$175
42FM-86	\$208
42FM-97	\$231
42FM-98	\$231
42FM-100	\$245
42FM-110	\$245

DRAWING 1A - OASIS MINI A & OASIS MINI USB

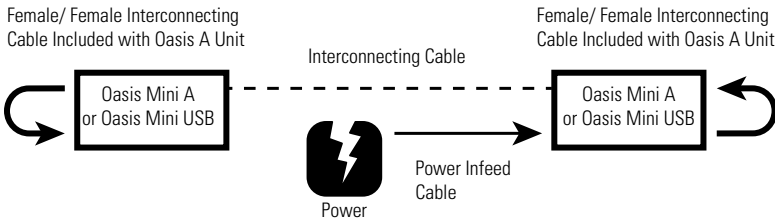

DRAWING 1B - OASIS MINI B

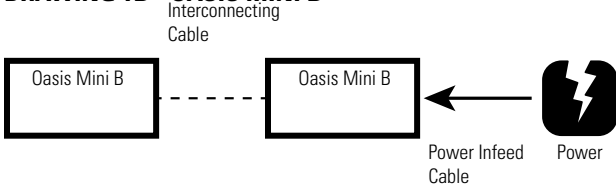

DRAWING 2A - OASIS MINI A & OASIS MINI USB

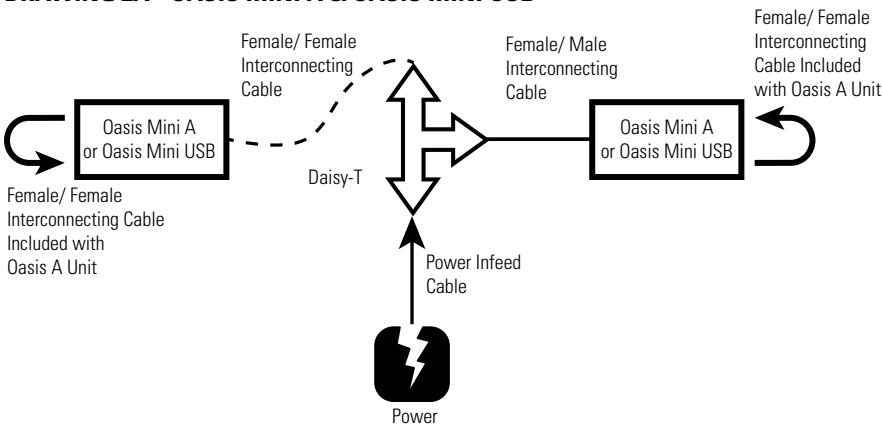

DRAWING 2B - OASIS MINI B

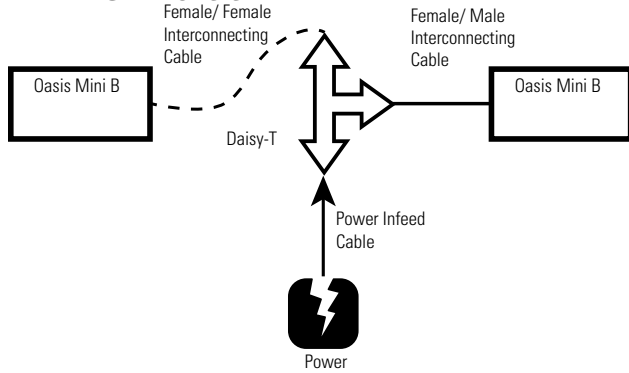

DRAWING 3 - OASIS MINI A & OASIS MINI USB

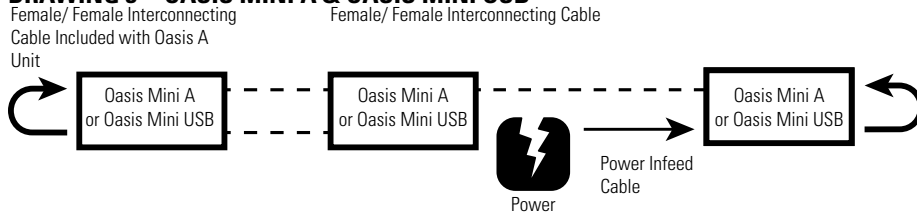

DRAWING 4 - OASIS MINI A & OASIS MINI USB

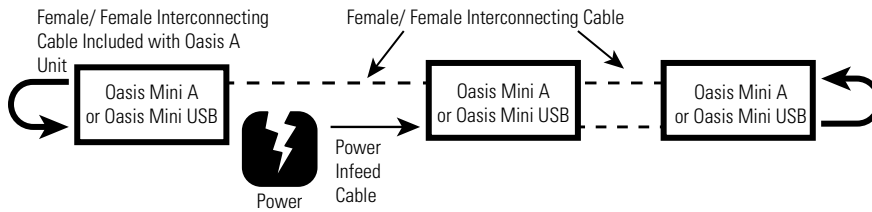

DRAWING 5 - OASIS MINI B

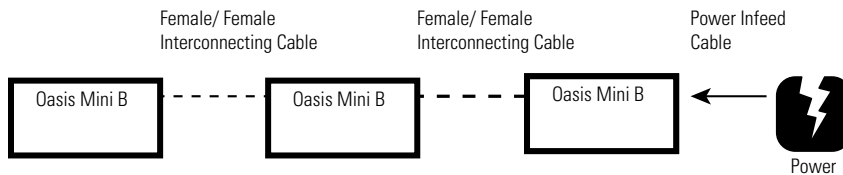

DRAWING 6 - OASIS MINI B

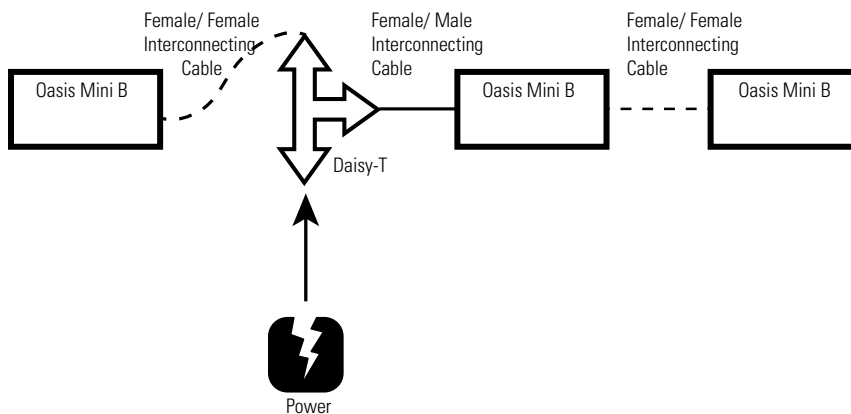

OASIS MINI A, B & USB CABLE LENGTHS NEEDED FOR DAISY-CHAINING

Model #	Villa DaisyLink, Oasis Mini USB Oasis Mini A Oasis Mini B	Villa DaisyLink, Oasis Mini USB Oasis Mini A Oasis Mini B	Oasis Mini USB Oasis Mini A	Oasis Mini USB Oasis Mini A	Villa DaisyLink or Oasis Mini B	Villa DaisyLink or Oasis Mini B
Cut-out Positions	V1, V3, M1, M3	V1, V3, M1, M3	M1, M2 & M3	M1, M2 & M3	V1, V2, V3, M1, M2, M3	V1, V2, V3, M1, M2, M3
Infeed Position	Left or Right	Center	Left or Right	Center	Left or Right	Center
Reference	Drawing 1A/1B	Drawing 2A/2B	Drawing 3	Drawing 4	Drawing 5	Drawing 6
Z4896BE Z4896RTE Z4896REE Z4896BW	(1) 42FF-53 SPECIFY INFEED	(1) 42FF-27 (1) 42FM-27 (1) DAISY-T SPECIFY INFEED	N/A	N/A	N/A	N/A
Z48120BE Z48120RTE Z48120REE Z48120BW	(1) 42FF-76 SPECIFY INFEED	(1) 42FF-38 (1) 42FM-38 (1) DAISY-T SPECIFY INFEED	(3) 42FF-41 SPECIFY INFEED	(3) 42FF-41 SPECIFY INFEED	(2) 42FF-41 SPECIFY INFEED	(2) 42FF-41 (1) 42FM-12 (1) DAISY-T SPECIFY INFEED
Z48144BE Z48144RTE Z48144REE Z48144BW	(1) 42FF-100 SPECIFY INFEED	(1) 42FF-50 (1) 42FM-50 (1) DAISY-T SPECIFY INFEED	(3) 42FF-53 SPECIFY INFEED	(3) 42FF-53 SPECIFY INFEED	(2) 42FF-53 SPECIFY INFEED	(2) 42FF-53 (1) 42FM-12 (1) DAISY-T SPECIFY INFEED
Z48168BE Z48168RTE Z48168REE Z48168BW	(1) 42FF-63 (1) 42FM-63 SPECIFY INFEED	1) 42FF-63 (1) 42FM-63 (1) DAISY-T SPECIFY INFEED	(3) 42FF-65 SPECIFY INFEED	(3) 42FF-65 SPECIFY INFEED	(2) 42FF-65 SPECIFY INFEED	(2) 42FF-65 (1) 42FM-12 (1) DAISY-T SPECIFY INFEED
Z48192BE Z48192RTE Z48192REE Z48192BW	(1) 42FF-75 (1) 42FM-75 SPECIFY INFEED	1) 42FF-75 (1) 42FM-75 (1) DAISY-T SPECIFY INFEED	(3) 42FF-77 SPECIFY INFEED	(3) 42FF-77 SPECIFY INFEED	(2) 42FF-77 SPECIFY INFEED	(2) 42FF-77 (1) 42FM-12 (1) DAISY-T SPECIFY INFEED
Z48216BE Z48216RTE Z48216REE Z48216BW	(1) 42FF-86 (1) 42FM-86 SPECIFY INFEED	1) 42FF-85 (1) 42FM-85 (1) DAISY-T SPECIFY INFEED	(3) 42FF-89 SPECIFY INFEED	(3) 42FF-89 SPECIFY INFEED	(2) 42FF-89 SPECIFY INFEED	(2) 42FF-89 (1) 42FM-12 (1) DAISY-T SPECIFY INFEED
Z48240BE Z48240RTE Z48240REE Z48240BW	(1) 42FF-98 (1) 42FM-98 SPECIFY INFEED	1) 42FF-97 (1) 42FM-97 (1) DAISY-T SPECIFY INFEED	(3) 42FF-101 SPECIFY INFEED	(3) 42FF-101 SPECIFY INFEED	(2) 42FF-101 SPECIFY INFEED	(2) 42FF-101 (1) 42FM-12 (1) DAISY-T SPECIFY INFEED
Z48264BE Z48264RTE Z48264REE Z48264BW	(1) 42FF-110 (1) 42FM-110 SPECIFY INFEED	(1) 42FF-110 (1) 42FM-110 (1) DAISY-T SPECIFY INFEED	(3) 42FF-113 SPECIFY INFEED	(3) 42FF-113 SPECIFY INFEED	(2) 42FF-113 SPECIFY INFEED	(2) 42FF-113 (1) 42FM-12 (1) DAISY-T SPECIFY INFEED
Z48288BE Z48288RTE Z48288REE Z48288BW	(1) 42FF-82 (2) 42FM-82 SPECIFY INFEED	(2) 42FF-41 (2) 42FM-41 (1) DAISY-T SPECIFY INFEED	(3) 42FF-63 (3) 42FM-63 SPECIFY INFEED	(3) 42FF-63 (3) 42FM-63 SPECIFY INFEED	(2) 42FF-63 (2) 42FM-63 SPECIFY INFEED	(2) 42FF-63 (2) 42FM-63 (1) DAISY-T SPECIFY INFEED

tables and accessories

café, meeting and conference

Anywhere Table Collection.....	634	Kadin.....	772
Collaborative Spaces.....	673	Swap.....	781

training

2gether.....	635	Edventure.....	719
Bungee.....	648	FreeFit.....	725
Bungee SL.....	650	Junction.....	765
Connectables.....	700	Terina.....	826
Duet.....	716	Zook.....	830

reception and occasional

Citi.....	842	River+ tables.....	853
Drift tables.....	848	Wind.....	856
Lite Lift II.....	852	Work tables.....	858
Occasional tables.....	844		

GENERAL INFORMATION

- 2gether is a series of multi-purpose flip-top tables for collaboration, classroom, training and conference applications.
- “Easy Touch” mechanism allows you to flip the tables up or down with maximum ease
- Adjustable leveling casters provide smooth mobility
- Offset “Y” sculpted legs allow for parallel space-saving table nesting, to minimize footprint required for storage
- Optional modesty panels with integrated wire troughs are available
- Grommets are available on 24” deep worksurfaces
- Available sizes: 18”D x 60”W, 24”D x 60”W and 72”W
- Shipped easy to assemble. Each component is packaged individually; legs are shipped 1 per carton.
- For environmental certifications, please visit globalfurnituregroup.com

WORKSURFACES

- 1” thick tops are constructed of 45 lb. density particleboard with high performance thermally fused laminate

CONSTRUCTION

- “Easy touch” lever located at both sides of table for flip-top operation from either side
- Global’s preferred matching edge
- Tops are pre-drilled with threaded steel inserts
- Tops 60” and 72” wide feature a built-in support bar
- 14.25” high optional articulating modesty panel attaches to underside of flip-top
- Bumpers on legs and undercarriage prevent tables from being damaged while nested
- Grommets optional on 24” deep tops only
- Champagne base finish
- Products specified with the high pressure laminate option are finished on the underside of the surface with a kraft paper backing.

LAMINATE FINISHES

ACJ	Absolute Acajou	FCL	First Class
ASN	Asian Night	NBL	Noce Biondo
AWC	Avant Cherry	NGL	Noce Grigio
AWH	Avant Honey	NEL	Noce Leggero
BLK	Black	NML	Noce Medio
BZD	Blizzard	QTM	Quartered Mahogany
BRC	Brushed Cobalt	SBY	Sheer Beauty
CMB	Clear Maple	SOG	Storm Grey
CGY	Custom Grey	SDT	Stonedust
DES	Dark Espresso	WHE	Walnut Heights
DWT	Designer White	WHC	White Chocolate
FAS	Fashionista	WCR	Winter Cherry

GANGING PLATES

- Ganging plates are available for ganging adjoining tables together.
- Ganging plates are black epoxy coated steel plates with two thumbscrews

GROMMETS

- Available only on 24” deep worksurfaces
- Additional grommets available in standard worksurface locations (left, center or right). Order as: **AG1, AG2 or AG3. Add \$103**
- Grommet hole dimensions are 3 ¼” wide x 1 7/8” deep.

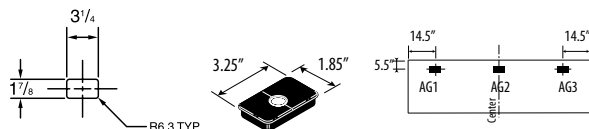

- Grommets may be placed at non-standard locations. Order as: **AGS - Add \$103** A drawing must be supplied with vertical and horizontal dimensions to the center of the cut-out (as in drawing above). Please refer to CUSTOM GROMMET LOCATION FORM in the back reference section.

POWER BLOCK

- Available only on 24” deep worksurfaces
- A Power Block is a rectangular worksurface power/data module with one electrical duplex receptacle and two data (RJ45) receptacles. 9’ black cord included. Power Block dimensions are 3 ½” deep x 6 ½” wide x 2 ¾” high.
- A Power Block (model **PMSPDM**) may be ordered for **24” Deep Tables** in place of standard grommets.
- To purchase a Power Block, you must specify both the Power Block cut-out location and the Power Block model #. Order Power Block as **PMSPDM, Add \$352**. Power Blocks are available in standard worksurface locations (left, center or right). Order as **E1, E2 or E3. Add \$103**.

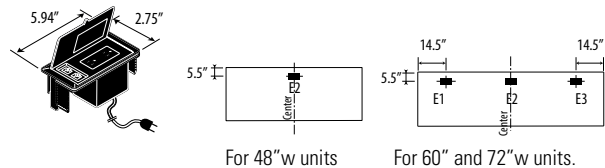

Power Block **PMSPDM, Add \$352** Specify location **E1, E2 or E3, Add \$103**

VILLA CUT-OUTS

- Available only on 24” deep worksurfaces
- A Villa Power Block is available for daisy-chaining or corded for use on individual tables (see page 619 for Villa details). Villa Power Block dimensions vary by model. Villa cut-out dimensions are 3” deep x 5 ¼” wide.
- Villa DaisyLink **kits** are not for use on 2gether tables.
- A Villa cut-out may be ordered for 24” Deep Tables. Order as **V1, V2 or V3, Add \$103 for each cut-out**.
- Order Villa Power Block and Villa Grommet Cover separately, see page 619 for pricing and details

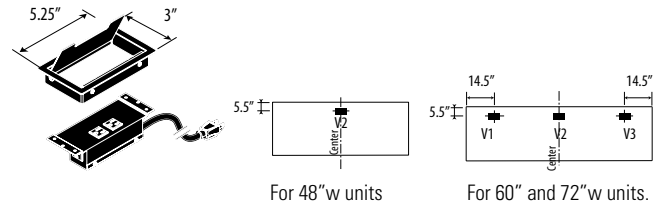

MODPOWER DAISY CHAIN SOLUTION

- Add flexible power and USB charging to 2gether tables. Connect up to four units with a single corded infeed with NEMA plug.
- ModPower units are sold separately, refer to Productivity Solutions page 609.
- Begin run with a starter unit which includes a corded infeed. Add additional middle or end units as required. Middle and end units are equipped with connecting cables.
- To be used with rectangular tables **IT2460RX** and **IT2472RX** only.
- On-surface modules clamp on or screw mount to the table tops.
- In-surface modules require table top cut-outs for mounting. Specify cut-out option:
 - **MPS** for a single cut-out to accommodate one ModPower in-surface unit (cut-out will be centered on the approach side). **Add \$103**
 - **MPD** for two cut-outs in the left and right positions, 15” from ends to center of unit on approach side. **Add \$204**.

RECTANGULAR TOP

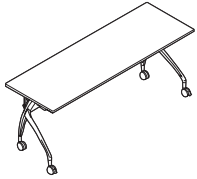

Rectangular Table - Flip-Top

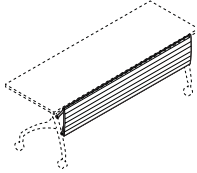

Modesty Panel

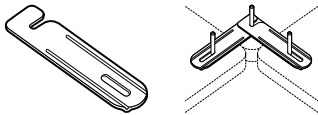

Ganging Connector

MODEL#	DIMENSIONS D x W x H	FREIGHT CLASS	WT/LBS.	CUBIC FT.	LIST PRICE	HPL ADD
IT2472RX	24 x 72 x 29	92.5	97.20	8.68	\$2383	\$292
IT2460RX	24 x 60 x 29	92.5	86	7.68	\$2228	\$258
IT1860RX	18 x 60 x 29	92.5	75	6.98	\$2145	\$228

Flip-top table on four adjustable leveling casters, two locking. Easy-touch lever located at both ends of the table allows for activation on either side of the table; offset Y leg accommodates in-line nesting for space-saving storage. Nested dimensions: first 18D tables: 22.2" + 5.6" per additional table nested; first 24D tables: 25.1" + 5.6" per additional table nested. . Wire management channel included. Champagne finish leg. Black/dark grey casters. Optional articulating modesty panel available. Shipped easy to assemble in 3 cartons.

IT72MP	2.75 x 63 x 14.25	125	13.20	2	\$350	
IT60MP	2.75 x 51 x 14.25	125	11.40	1.60	\$322	

Articulating modesty for use with flip-top 2gether tables. Champagne finish.

CNGFP	5 x 2.5 x 1.13	70	.20	.10	\$74	
-------	----------------	----	-----	-----	-------------	--

Black epoxy coated 13 gauge steel with 2 thumbscrews included. Used to connect tabletops together for additional stability or for connecting freestanding tops together. Holes with steel inserts are located in the corner of all tops to accommodate this plate. **Sold individually.**

Required Specifications
Laminate finish

Optional Specifications
HP laminate

Accessories
Modesty panel
Ganging connector



Sturdy and economically priced, Global's Anywhere Table Collection is ideal for boardrooms, meeting spaces and cafeterias.

Table tops are offered in seven shapes - round, square, rectangular, boat, racetrack, rectangular with bow ends, and wedge - and a variety of bases (including metal options, laminate drum base, arch base or slab base). Add to this an impressive variety of laminate finishes that can be mixed and matched and you'll find Global can satisfy any and every business need.

From cafeterias to large boardrooms, from traditional to contemporary, Global's range of table components, shapes, sizes and colors will enhance any office décor.

Features and Benefits

- Tables 96" wide or less are standard with one-piece tops.
- Tables 120" and 144" wide are standard with two-piece tops.
- Tops are available in 1" thick thermally fused laminate, or 1-1/16" and 1-1/2" thick high pressure laminate.
- All tops are edged with 2mm thick matching or complementary finish edgeband.
- Square, rectangular and wedge shaped tops are standard with 90° corners. Optional with 2" corner radius corners.

GENERAL INFORMATION

- Practical and economical table solutions for cafeteria, meeting spaces and more.
- Tops are available in 1" thick thermally fused laminate, in 1-1/16" or 1 1/2" thick high pressure laminate or ultra matte high pressure laminate.
- Multiple base styles available including metal options, and laminate drum base, arch base or slab base.
- Tables up to 96" wide are standard with one-piece tops; 120" and 144" wide are standard with two-piece tops.
- Variety of top shapes available: round, square, rectangular, boat, racetrack, rectangular with bow ends, and wedge.
- All tops are edged with 2mm thick matching, complementary or contrasting finish edgeband.
- Integrated power distribution solutions available, specified separately.
- For environmental certifications, please visit globalfurnituregroup.com

CONSTRUCTION

- 1" thick tops are made of 45 lb. density particle board covered on both sides with high performance, thermally fused laminate with 2mm thick edgeband. Tops are optional in high pressure laminate (HPL) and ultra matte high pressure laminate (UML) in 1 1/16" and 1 1/2" thick material, bottom surface is finished with kraft paper backing.
- Square, rectangular and wedge shaped tops are standard with 90° corner radius. Optional 2" corner radius available. Specify option **(2R)**. Refer to model for upcharge.

BASES

- Drum bases are high pressure laminate over a sonotube inner wall, capped top and bottom with particle board supports. 1 1/2" dia. glides offer 1/2" of leveling adjustment. No additional counterweight required.
- Powering drum bases: drum bases include a 3" dia. cut-out in the bottom to allow cords to exit near the levelers. They are not equipped with internal wire pass-throughs for daisy chaining. To accommodate top-access wiring, a 3" diameter cut-out can be field-added to the upper side of the base as needed.
- Laminate slab bases and cross bases are 1" thick thermally fused laminate. 1" dia. glides offer 1/2" of leveling adjustment.
- Laminate arch bases for 36"D tops are 4 3/8" thick; for 48"D tops are 5" thick overall. Interior frame is covered in masonite and HPL on curved side; flat side is thermally fused laminate. 1 1/2" dia. glides offer 1/2" of leveling adjustment.
- Two 5 1/2"H x 1" thick support panels run between each slab or arch base component creating a concealed cavity for cable management.
- Tapered blade base (with two and four blade style feet) consists of 2" dia. column, 16 GA steel with 12 GA mounting plate; the four feet base mounting plate is 11"x 11", the two feet style uses a trapezoid shape mounting plate 11" x 5.5". 1.5" dia. glides offer 1/2" of leveling adjustment.
- Round tubular base (with three or four round tube feet) consists of 2" dia. column, 16 GA steel with 2" dia. feet, 12 GA mounting plate; the four feet base mounting plate is 11"x 11", the three feet style uses a trapezoid shaped mounting plate 11" x 5.5". The 1.5" dia. glides offer 1/2" of leveling adjustment.
- Trumpet base consists of 2" dia. column and 24" dia. spun metal base, 12 GA mounting plate 11"x 11". Trumpet base does not have leveling glides.

LAMINATE AND EDGE BAND FINISHES

- Thermally fused laminate (**1TF**) and high pressure laminate (**1HP, 2HP**) available in all finishes.
- Ultra matte high pressure laminate (**1UM, 2UM**) available in select finishes* only.

ACJ Absolute Acajou	FCL First Class
ASN Asian Night	NBL Noce Biondo
AWC Avant Cherry	NGL Noce Grigio
AWH Avant Honey	NEL Noce Leggero
BLK Black*	NML Noce Medio
BZD Blizzard*	QTM Quartered Mahogany
BRC Brushed Cobalt	SBY Sheer Beauty
CMB Clear Maple	SDT Stonedust*
CGY Custom Grey*	SOG Storm Grey*
DES Dark Espresso	WHE Walnut Heights
DWT Designer White*	WHC White Chocolate
FAS Fashionista	WCR Winter Cherry

- Select material type:
 - **1TF** for product with 1" thick thermally fused laminate top
 - **1HP** for product with 1 1/16" thick high pressure laminate top, upcharge applies
 - **2HP** for product with 1 1/2" thick high pressure laminate top, upcharge applies
 - **1UM** for product with 1 1/16" thick ultra matte high pressure laminate top, upcharge applies
 - **2UM** for product with 1 1/2" thick ultra matte high pressure laminate top, upcharge applies
- Upcharges vary by product size.
- 2mm thick edgeband finish to be specified separately from top surface in contrasting or matching finish.
- Laminate base finish to be specified separately in contrasting or matching finish to surface.

METAL BASE FINISHES

- Available for TRD4TSxx, TSQ4TSxx, TRD4RSxx, TSQ4RSxx, TRD2Txx, TSQ2Txx and TRT2Txxxx, TRB2Txxxx, TBT2Txxxx, TRC2Txxxx, TWG2Txxxx tables.

Paint finishes

TBL Black	TIN Ink
TBZ Buzz Blue	TKA Kalua
TCC Cactus	TLA Latte
TCR Carrot	TMO Mocha
TIV Cloud	TNE Nevada
TDW Designer White	TSN Sand
TDJ Dijon	TSR Scarlet
TEG Eggplant	TSH Shadow
TFO Fog	TOA Toast
TFR Frost	TTU Tungsten

Plated finishes - upcharge applies (see chart below)





BCH Brushed Chrome
CHM Polished Chrome

PLATED FINISH UPCHARGES	CHM	BCH
4-prong single tapered base or round tubular:		
T__4TS__	\$28	\$84
T__4RS__	\$28	\$84
Trumpet base:		
TRDTT__	\$39	\$95
TSQTT__	\$39	\$95
2-prong tapered base:		
T__2T7236	\$56	\$167
T__2T9636	\$56	\$167
T__2T9648	\$56	\$167
T__2T12036	\$84	\$250
T__2T12048	\$84	\$250
T__2T14448	\$84	\$250

GROMMETS AND CUT-OUTS FOR POWER BLOCKS

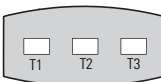
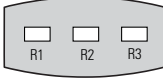
- Power blocks can be specified separately to deliver power and data to the table surface.
 - Not all cut-out/power block locations are available on all table sizes due to base positioning. Please refer to the table on the right.
 - To purchase a power block, you must specify the power block cut-out location when ordering the top and order the power block separately.
 - Standard cut-out options are centerline on the table horizontally; position 1 (left), position 2 (center) or position 3 (right).
Order as **AG1, E1, M1, R1, T1, V1**, etc. **Add \$103** for each cut-out.
 - Multiple cut-outs may be ordered and multiple power blocks may be accommodated.
 - Select power block option from Productivity Solutions, beginning on page page 606.
 - Cut-outs may be placed in non-standard locations.
Order as **AGS, ES, MS, RS, TS**, or **VS** - **Add \$103**.
- A drawing must be supplied with vertical and horizontal dimensions to the center of the cut-out.

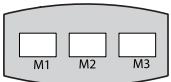
POWER BLOCK OPTIONS AND CUT-OUT LOCATIONS

PMSPPDM		PRTMCD602B PRTMCD602T PRTMCD602W	
PRTMCS401B PRTMCS401T PRTMCS401W PRTMCS421B PRTMCS421T PRTMCS421W		PRTMCD622B PRTMCD622T PRTMCD622W PRTMCD642B PRTMCD642T PRTMCD642W	
VILLA*			
OASIS MINI A*			
OASIS MINI B*			

*Drum bases not equipped for daisy chain models. See base notes for clarification.

SPECIFICATIONS

- Specifications marked with an * are applicable to only those products which have the * symbol beside the product name.

SHIPPING

- Shipped easy to assemble.

CUT-OUT OPTIONS

Model #	Position 1	Position 2	Position 3	Custom
tables with one centered metal base				
TRD4TS_	N/A	N/A	N/A	N/A
TSQ4TS_	N/A	N/A	N/A	N/A
TRD4RS_	N/A	N/A	N/A	N/A
TSQ4RS_	N/A	N/A	N/A	N/A
TRD4T_	N/A	N/A	N/A	N/A
TSQ4T_	N/A	N/A	N/A	N/A
TRDXB_	N/A	N/A	N/A	N/A
TSQXB_	N/A	N/A	N/A	N/A
	<i>add 1 to code (e.g. E1)</i>	<i>add 2 to code (e.g. E2)</i>	<i>add 3 to code (e.g. E3)</i>	
drum base tables				
T__DM7236	AG, E, R, T, V	N/A	AG, E, R, T, V	S
T__DM9636	AG, E, R, T, V	AG, E, M, R, T, V	AG, E, R, T, V	S
T__DM9648	AG, E, R, T, V	N/A	AG, E, R, T, V	S
T__DM12036	AG, E, R, T, V	AG, E, R, T, V	AG, E, R, T, V	S
T__DM12048	AG, E, M, R, T, V	AG, E, M, R, T, V	AG, E, M, R, T, V	S
T__DM14448	AG, E, M, R, T, V	AG, E, M, R, T, V	AG, E, M, R, T, V	S
slab base tables				
T__LS7236	N/A	AG, E, R, T, V	N/A	S
T__LS9636	AG, E, R, T, V	AG, E, R, T, V	AG, E, R, T, V	S
T__LS9648	AG, E, M, R, T, V	AG, E, M, R, T, V	AG, E, M, R, T, V	S
T__LS12036	AG, E, R, T, V	AG, E, R, T, V	AG, E, R, T, V	S
T__LS12048	AG, E, M, R, T, V	AG, E, M, R, T, V	AG, E, M, R, T, V	S
T__LS14448	AG, E, M, R, T, V	AG, E, M, R, T, V	AG, E, M, R, T, V	S
arch base tables				
T__AH7236	N/A	AG, E, R, T, V	N/A	S
T__AH9636	AG, E, R, T, V	AG, E, R, T, V	AG, E, R, T, V	S
T__AH9648	AG, E, M, R, T, V	AG, E, M, R, T, V	AG, E, M, R, T, V	S
T__AH12036	AG, E, R, T, V	AG, E, R, T, V	AG, E, R, T, V	S
T__AH12048	AG, E, M, R, T, V	AG, E, M, R, T, V	AG, E, M, R, T, V	S
T__AH14448	AG, E, M, R, T, V	AG, E, M, R, T, V	AG, E, M, R, T, V	S
tables with 2 or 3 tapered blade bases				
T__2T7236	N/A	AG, E, M, R, T, V	N/A	S
T__2T9636	AG, E, M, R, T, V	AG, E, M, R, T, V	AG, E, M, R, T, V	S
T__2T9648	AG, E, M, R, T, V	AG, E, M, R, T, V	AG, E, M, R, T, V	S
T__2T12036	AG, E, M, R, T, V	N/A	AG, E, M, R, T, V	S
T__2T12048	AG, E, M, R, T, V	N/A	AG, E, M, R, T, V	S
T__2T14448	AG, E, M, R, T, V	N/A	AG, E, M, R, T, V	S

BASE SIZE CHARTS (table width is nominal)

Round or Square Tops:

Top	Slab	Drum	Arch	Cross	4-Prong Tapered	Trumpet	Tube
24"	N/A	N/A	N/A	N/A	N/A	24"	N/A
30"	N/A	N/A	N/A	N/A	28"	24"	26"
36"	N/A	N/A	N/A	N/A	32"	24"*	30"
42"	N/A	N/A	N/A	30"	32"	N/A	N/A
48"	N/A	N/A	N/A	30"	N/A	N/A	N/A
60"	N/A	N/A	N/A	36"	N/A	N/A	N/A

*36" square top with trumpet base not available.

Rectangular, Rectangular with Bow Ends, Boat, Racetrack or Wedge Tops:

Top	Slab	Drum	Arch	Cross	2-Prong Tapered	Trumpet
36" x 72"	24"	18"	24"	n/a	32"	n/a
36" x 96"	24"	18"	24"	n/a	32"	n/a
48" x 96"	28"	18"	28"	n/a	32"	n/a
48" x 120"	28"	24"	28"	n/a	32"	n/a
48" x 144"	28"	24"	28"	n/a	32"	n/a

TABLE NOTES - ESTIMATED CAPACITY

- Use the following chart as a guideline to determine the size of a table and the number of chairs needed. All estimates are based on an average chair width of 23" with a 4" clearance between chairs. Adjust accordingly for a different chair size.

Top Size	NUMBER OF CHAIRS						
	Round	Square	Rectangular	Rectangular w/bow ends	Boat	Racetrack	Wedge
30" x 30"	3	3	N/A	N/A	N/A	N/A	N/A
36" x 36"	4	4	N/A	N/A	N/A	N/A	N/A
42" x 42"	4	4	N/A	N/A	N/A	N/A	N/A
48" x 48"	4	4	N/A	N/A	N/A	N/A	N/A
60" x 60"	5	6	N/A	N/A	N/A	N/A	N/A
30" x 60"	N/A	N/A	4-6	4-6	4-6	4-6	N/A
36" x 72"	N/A	N/A	4-6	4-6	4-6	4-6	4-6
36" x 96"	N/A	N/A	6-8	6-8	6-8	6-8	6-8
48" x 96"	N/A	N/A	6-8	6-8	6-8	6-8	6-8
48" x 120"	N/A	N/A	8-10	8-10	8-10	8-10	8-10
48" x 144"	N/A	N/A	10-12	10-12	10-12	10-12	10-12

A ANYWHERE TABLE COLLECTION - NOTES

BASE OPTIONS

Laminate



cross base
(round and square tables)



arch base



drum base



slab base

Metal



4-prong tapered base
(round and square tables)



tubular base
(round and square tables)



trumpet base
(round and square tables)



2-prong tapered base

TABLE TOP STYLES



round



square



boat



rectangular



rectangular, bow end



racetrack



wedge

- Square, rectangular and wedge shaped tops are available with optional radiused corners. Upcharge applies.
- Edge profiles:



1.5" HPL top (**2HP**)



1" TFL top (**1TF**)



2" radius corner (**2R**)

Not shown:

- (**1HP**) 1-1/16" HPL top
- (**1UM**) 1-1/16" UM HPL top
- (**2UM**) 1.5" UM HPL top

ROUND AND SQUARE TABLES



Round Table, Tapered Blade Base

MODEL#	DIMENSIONS D x W x H	FREIGHT CLASS	WT/LBS.	CUBIC FT.	1" TOP				
					1"HP	1"HP / 2"HP	1"UM	2"UM	2R
TRD4TS30	30 x 30 x 29	150	35.5	8.04	\$486	\$98 / \$118	\$235 / \$268	n/a	
TRD4TS36	36 x 36 x 29	150	48	11.8	\$571	\$129 / \$155	\$309 / \$351	n/a	
TRD4TS42	42 x 42 x 29	150	62	12.3	\$665	\$177 / \$212	\$424 / \$482	n/a	

1" thick thermally fused **round top** with four prong metal tapered blade base. High pressure laminate (HPL) and ultra matte high pressure laminate (UML) tops optional in 1-1/16" and 1.5" thick. Overall height increases when HPL material selected. Overall weight increases when 1.5" thick HPL tops selected, contact Customer Care. Base available in paint or plated finishes; upcharge applies for plated finishes. Shipped easy to assemble in 2 cartons.



Square Table, Tapered Blade Base*

TSQ4TS30	30 x 30 x 29	150	35.5	8.1	\$486	\$98 / \$118	\$235 / \$268	\$23
TSQ4TS36	36 x 36 x 29	150	48	11.8	\$571	\$129 / \$155	\$309 / \$351	\$30
TSQ4TS42	42 x 42 x 29	150	62	12.3	\$665	\$177 / \$212	\$424 / \$482	\$40

1" thick thermally fused **square top** with four prong metal tapered blade base. Radius corners top (**2R**) optional, upcharge applies. High pressure laminate (HPL) and ultra matte high pressure laminate (UML) tops optional in 1-1/16" and 1.5" thick. Overall height increases when HPL material selected. Overall weight increases when 1.5" thick HPL tops selected, contact Customer Care. Base available in paint or plated finishes; upcharge applies for plated finishes. Shipped easy to assemble in 2 cartons.



Round Table, Tubular Steel Base

TRD4RS30	30 x 30 x 29	150	36	8.3	\$515	\$98 / \$118	\$235 / \$268	n/a
TRD4RS36	36 x 36 x 29	150	49	11.8	\$634	\$129 / \$155	\$309 / \$351	n/a

1" thick thermally fused round top with round tubular steel base. High pressure laminate (HPL) and ultra matte high pressure laminate (UML) tops optional in 1-1/16" and 1.5" thick. Overall height increases when HPL material selected. Overall weight increases when 1.5" thick HPL tops selected, contact Customer Care. Base available in paint or plated finishes; upcharge applies for plated finishes. Shipped easy to assemble in 2 cartons.



Square Table, Tubular Steel Base*

TSQ4RS30	30 x 30 x 29	150	36	8.3	\$515	\$98 / \$118	\$235 / \$268	\$23
TSQ4RS36	36 x 36 x 29	150	49	11.8	\$634	\$129 / \$155	\$309 / \$351	\$30

1" thick thermally fused square top with round tubular steel base. Radius corners top (**2R**) optional, upcharge applies. High pressure laminate (HPL) and ultra matte high pressure laminate (UML) tops optional in 1-1/16" and 1.5" thick. Overall height increases when HPL material selected. Overall weight increases when 1.5" thick HPL tops selected, contact Customer Care. Base available in paint or plated finishes; upcharge applies for plated finishes. Shipped easy to assemble in 2 cartons.



Round Table, Trumpet Base

TRDTT24	24 x 24 x 29	250	33	12.7	\$755	\$63 / \$76	\$151 / \$171	n/a
TRDTT30	30 x 30 x 29	250	42	13.1	\$820	\$98 / \$118	\$235 / \$268	n/a
TRDTT36	36 x 36 x 29	150	54	13.5	\$897	\$129 / \$155	\$309 / \$351	n/a

1" thick thermally fused round top with metal trumpet base. High pressure laminate (HPL) and ultra matte high pressure laminate (UML) tops optional in 1-1/16" and 1.5" thick. Overall height increases when HPL material selected. Overall weight increases when 1.5" thick HPL tops selected, contact Customer Care. Base available in paint or plated finishes; upcharge applies for plated finishes. Shipped easy to assemble in 2 cartons.

Required Specifications

Top material/thickness
Top finish
Top edge finish
Base finish

Optional Specifications

Plated base finish
Radius corners*

A ANYWHERE TABLE COLLECTION

ROUND AND SQUARE TABLES



Square Table, Trumpet Base^{1*}

MODEL#	DIMENSIONS D x W x H	FREIGHT CLASS	WT/LBS.	CUBIC FT.	1"TOP	1"HPL/1.5"HPL ADD	1"UML/1.5"UML ADD	2R ADD
TSQTT24	24 x 24 x 29	250	33	12.7	\$755	\$63 / \$76	\$151 / \$171	\$16
TSQTT30	30 x 30 x 29	250	42	13.1	\$820	\$98 / \$118	\$235 / \$268	\$23

1" thick thermally fused **square top** with metal trumpet base. Radius corners top (**2R**) optional, upcharge applies. *36" Square not available.* High pressure laminate (HPL) and ultra matte high pressure laminate (UML) tops optional in 1-1/16" and 1.5" thick. Overall height increases when HPL material selected. Overall weight increases when 1.5" thick HPL tops selected, contact Customer Care. Base available in paint or plated finishes; upcharge applies for plated finishes. Shipped easy to assemble in 2 cartons.



Round Table, Laminate Cross Base

TRDXB42	42 x 42 x 29	70	72	4	\$815	\$177 / \$212	\$424 / \$482	n/a
TRDXB48	48 x 48 x 29	70	91	5	\$970	\$201 / \$241	\$482 / \$548	n/a
TRDXB60	60 x 60 x 29	70	144	8.8	\$1324	\$287 / \$345	\$689 / \$783	n/a

1" thick thermally fused **round top** with laminate cross base. High pressure laminate (HPL) and ultra matte high pressure laminate (UML) tops optional in 1-1/16" and 1.5" thick. Overall height increases when HPL material selected. Overall weight increases when 1.5" thick HPL tops selected, contact Customer Care. Specify laminate finish for top and base separately. Shipped easy to assemble in 2 cartons.



Square Table, Laminate Cross Base^{1*}

TSQXB42	42 x 42 x 29	70	72	4	\$815	\$177 / \$212	\$424 / \$482	\$40
TSQXB48	48 x 48 x 29	70	91	5	\$970	\$201 / \$241	\$482 / \$548	\$50
TSQXB60	60 x 60 x 29	70	144	8.8	\$1361	\$287 / \$345	\$689 / \$783	\$74

1" thick thermally fused **square top** with laminate cross base. Radius corners top (**2R**) optional, upcharge applies. High pressure laminate (HPL) and ultra matte high pressure laminate (UML) tops optional in 1-1/16" and 1.5" thick. Overall height increases when HPL material selected. Overall weight increases when 1.5" thick HPL tops selected, contact Customer Care. Specify laminate finish for top and base separately. Shipped easy to assemble in 2 cartons.

Required Specifications

Top material/thickness
Top finish
Edge
Base finish

Optional Specifications

HP laminate
Plated base finish
Radius corners*

DRUM BASE TABLES

MODEL#	DIMENSIONS	FREIGHT CLASS	WT/LBS.	CUBIC FT.	1"TOP	1"HPL/1.5"HPL ADD	1"UML/1.5"UML ADD	2R ADD
--------	------------	---------------	---------	-----------	-------	-------------------	-------------------	--------

D x W x H

TRTDM7236	36 x 72 x 29	85	215	15.2	\$1690	\$246 / \$295	\$589 / \$670	\$58
TRTDM9636	36 x 96 x 29	92.5	240	23	\$1882	\$342 / \$410	\$820 / \$932	\$77
TRTDM9648	48 x 96 x 29	125	274	35.6	\$2402	\$418 / \$502	\$820 / \$932	\$100



Rectangular Table, Drum Base*

One piece 1" thick thermally fused **rectangular top** with two laminate drum bases. Radius corners top (**2R**) optional, upcharge applies. High pressure laminate (HPL) and ultra matte high pressure laminate (UML) tops optional in 1-1/16" and 1.5" thick. Overall height increases when HPL material selected. Overall weight increases when 1.5" thick HPL tops selected, contact Customer Care. Specify laminate finish for top and bases separately. Shipped easy to assemble in 3 cartons.



Rectangular Table, Drum Base*

TRTDM12036	36 x 120 x 29	100	274	31.92	\$2850	\$537 / \$644	\$1287 / \$1463	\$118
TRTDM12048	48 x 120 x 29	125	374	49.7	\$3552	\$646 / \$775	\$1550 / \$1761	\$144
TRTDM14448	48 x 144 x 29	125	412	53.08	\$3779	\$736 / \$884	\$1767 / \$2007	\$167

Two piece 1" thick thermally fused **rectangular top** with three laminate drum bases. Radius corners top (**2R**) optional, upcharge applies. High pressure laminate (HPL) and ultra matte high pressure laminate (UML) tops optional in 1-1/16" and 1.5" thick. Overall height increases when HPL material selected. Overall weight increases when 1.5" thick HPL tops selected, contact Customer Care. Specify laminate finish for top and bases separately. Shipped easy to assemble in 4 cartons.



Rectangular Table, Drum Base Bow Ends

TRBDM7236	36 x 72 x 29	92.5	240	23	\$1690	\$246 / \$295	\$589 / \$670	n/a
TRBDM9636	36 x 96 x 29	85	215	15.2	\$1882	\$342 / \$410	\$820 / \$932	n/a
TRBDM9648	48 x 96 x 29	125	274	35.6	\$2402	\$418 / \$502	\$1003 / \$1139	n/a

One piece 1" thick thermally fused **rectangular top with bow ends**; two laminate drum bases. High pressure laminate tops optional in 1-1/16" and 1.5" thick. Overall height increases when HPL material selected. Overall weight increases when 1.5" thick HPL tops selected, contact Customer Care. Specify laminate finish for top and bases separately. Shipped easy to assemble in 3 cartons.



Rectangular Table, Drum Base Bow Ends

TRBDM12036	36 x 120 x 29	92.5	334	31.92	\$2850	\$537 / \$644	\$1287 / \$1463	n/a
TRBDM12048	48 x 120 x 29	125	374	49.7	\$3552	\$646 / \$775	\$1550 / \$1761	n/a
TRBDM14448	48 x 144 x 29	125	412	53.08	\$3779	\$736 / \$884	\$1767 / \$2007	n/a

Two piece 1" thick thermally fused **rectangular top with bow ends**; three laminate drum bases. High pressure laminate tops optional in 1-1/16" and 1.5" thick. Overall height increases when HPL material selected. Overall weight increases when 1.5" thick HPL tops selected, contact Customer Care. Specify laminate finish for top and bases separately. Shipped easy to assemble in 3 cartons.



Boat Shaped Table, Drum Base

TBTDM7236	36 x 72 x 29	85	215	15.2	\$1690	\$246 / \$295	\$589 / \$670	n/a
TBTDM9636	36 x 96 x 29	92.5	240	23	\$1882	\$342 / \$410	\$820 / \$932	n/a
TBTDM9648	48 x 96 x 29	125	274	35.6	\$2402	\$418 / \$502	\$1003 / \$1139	n/a

One piece 1" thick thermally fused **boat shaped top** with two laminate drum bases. High pressure laminate (HPL) and ultra matte high pressure laminate (UML) tops optional in 1-1/16" and 1.5" thick. Overall height increases when HPL material selected. Overall weight increases when 1.5" thick HPL tops selected, contact Customer Care. Specify laminate finish for top and bases separately. Shipped easy to assemble in 3 cartons.

Required Specifications

Top material/thickness
Top finish
Edge
Base finish

Optional Specifications

Cut-out for grommet/power blocks
Radius corners*

Accessories

Power block

A ANYWHERE TABLE COLLECTION

DRUM BASE TABLES



Boat-Shaped Table, Drum Base

MODEL#	DIMENSIONS D x W x H	FREIGHT CLASS	WT/LBS.	CUBIC FT.	1"TOP	1"HPL/1.5"HPL ADD	1"UML/1.5"UML ADD	2R ADD
TBTDM12036	36 x 120 x 29	92.5	334	31.92	\$2850	\$537 / \$644	\$1287 / \$1463	n/a
TBTDM12048	48 x 120 x 29	125	374	49.7	\$3552	\$646 / \$775	\$1550 / \$1761	n/a
TBTDM14448	48 x 144 x 29	125	412	53.08	\$3779	\$736 / \$884	\$1767 / \$2007	n/a

Two piece 1" thick thermally fused **boat shaped top** with three laminate drum bases. High pressure laminate (HPL) and ultra matte high pressure laminate (UML) tops optional in 1-1/16" and 1.5" thick. Overall height increases when HPL material selected. Overall weight increases when 1.5" thick HPL tops selected, contact Customer Care. Specify laminate finish for top and bases separately. Shipped easy to assemble in 4 cartons.



Racetrack Table, Drum Base

TRCDM7236	36 x 72 x 29	85	215	15.2	\$1690	\$246 / \$295	\$589 / \$670	n/a
TRCDM9636	36 x 96 x 29	92.5	240	23	\$1882	\$342 / \$410	\$820 / \$932	n/a
TRCDM9648	48 x 96 x 29	125	274	35.6	\$2402	\$418 / \$502	\$1003 / \$1139	n/a

One piece 1" thick thermally fused **racetrack top** with two laminate drum bases. High pressure laminate (HPL) and ultra matte high pressure laminate (UML) tops optional in 1-1/16" and 1.5" thick. Overall height increases when HPL material selected. Overall weight increases when 1.5" thick HPL tops selected, contact Customer Care. Specify laminate finish for top and bases separately. Shipped easy to assemble in 3 cartons.



Racetrack Table, Drum Base

TRCDM12036	36 x 120 x 29	92.5	334	31.92	\$2850	\$537 / \$644	\$1287 / \$1463	n/a
TRCDM12048	48 x 120 x 29	125	374	49.7	\$3552	\$646 / \$775	\$1550 / \$1761	n/a
TRCDM14448	48 x 144 x 29	125	412	53.08	\$3779	\$736 / \$884	\$1767 / \$2007	n/a

Two piece 1" thick thermally fused **racetrack top** with three laminate drum bases. High pressure laminate (HPL) and ultra matte high pressure laminate (UML) tops optional in 1-1/16" and 1.5" thick. Overall height increases when HPL material selected. Overall weight increases when 1.5" thick HPL tops selected, contact Customer Care. Specify laminate finish for top and bases separately. Shipped easy to assemble in 4 cartons.



Wedge Table, Drum Base*

TWGDM7236	48-36 x 72 x 29	85	215	15.2	\$1690	\$246 / \$295	\$589 / \$670	\$58
TWGDM9636	48-36 x 96 x 29	92.5	240	23	\$1882	\$342 / \$410	\$820 / \$932	\$77
TWGDM9648	60-48 x 96 x 29	125	274	35.6	\$2402	\$418 / \$502	\$1003 / \$1139	\$100

One piece 1" thick thermally fused **wedge top** with two laminate drum bases. Radius corners top (**2R**) optional, upcharge applies. High pressure laminate (HPL) and ultra matte high pressure laminate (UML) tops optional in 1-1/16" and 1.5" thick. Overall height increases when HPL material selected. Overall weight increases when 1.5" thick HPL tops selected, contact Customer Care. Specify laminate finish for top and bases separately. Shipped easy to assemble in 3 cartons.



Wedge Table, Drum Base*

TWGDM12048	60-48 x 120 x 29	125	374	49.7	\$3552	\$646 / \$775	\$1550 / \$1761	\$144
TWGDM14448	60-48 x 144 x 29	125	412	53.08	\$3779	\$736 / \$884	\$1767 / \$2007	\$167

Two piece 1" thick thermally fused **wedge top** with three laminate drum bases. Radius corners top (**2R**) optional, upcharge applies. High pressure laminate (HPL) and ultra matte high pressure laminate (UML) tops optional in 1-1/16" and 1.5" thick. Overall height increases when HPL material selected. Overall weight increases when 1.5" thick HPL tops selected, contact Customer Care. Specify laminate finish for top and bases separately. Shipped easy to assemble in 4 cartons.

Required Specifications

Top material/thickness
Top finish
Edge
Base finish

Optional Specifications

Cut-out for grommet/power blocks
Radius corners*

Accessories

Power block

SLAB BASE TABLES

MODEL# DIMENSIONS FREIGHT CLASS WT/LBS. CUBIC FT. 1TF TOP 1"HPL/1.5"HPL ADD 1"UML/1.5"UML ADD 2R ADD

D x W x H

TRTLS7236	36 x 72 x 29	65	137	5.99	\$1086	\$246 / \$295	\$589 / \$670	\$58
TRTLS9636	36 x 96 x 29	85	189.5	14.07	\$1343	\$342 / \$410	\$820 / \$932	\$77
TRTLS9648	48 x 96 x 29	85	237	17.54	\$1617	\$418 / \$502	\$1003 / \$1139	\$100



Rectangular Table, Slab Base*

One piece 1" thick thermally fused **rectangular top** with laminate slab bases. Radius corners top (2R) optional, upcharge applies. High pressure laminate (HPL) and ultra matte high pressure laminate (UML) tops optional in 1-1/16" and 1.5" thick. Overall height increases when HPL material selected. Overall weight increases when 1.5" thick HPL tops selected, contact Customer Care. 5.5"H runners between base components, creating a concealed cavity for power modules. Specify laminate finish for top and bases separately. Shipped easy to assemble in 3 cartons.

TRTLS12036	36 x 120 x 29	85	259	19.94	\$2035	\$537 / \$644	\$1287 / \$1463	\$118
TRTLS12048	48 x 120 x 29	85	319	23.74	\$2366	\$646 / \$775	\$1550 / \$1761	\$144
TRTLS14448	48 x 144 x 29	85	365	27.63	\$2660	\$736 / \$884	\$1767 / \$2007	\$167



Rectangular Table, Slab Base*

Two piece 1" thick thermally fused **rectangular top** with laminate slab bases. Radius corners top (2R) optional, upcharge applies. High pressure laminate (HPL) and ultra matte high pressure laminate (UML) tops optional in 1-1/16" and 1.5" thick. Overall height increases when HPL material selected. Overall weight increases when 1.5" thick HPL tops selected, contact Customer Care. 5.5"H runners between base components, creating a concealed cavity for power modules. Specify laminate finish for top and bases separately. Shipped easy to assemble in 4 cartons.

TRBLS7236	36 x 72 x 29	65	137	5.99	\$1086	\$246 / \$295	\$589 / \$670	n/a
TRBLS9636	36 x 96 x 29	85	189.5	14.07	\$1343	\$342 / \$410	\$820 / \$932	n/a
TRBLS9648	48 x 96 x 29	85	237	17.54	\$1617	\$418 / \$502	\$1003 / \$1139	n/a



Rectangular Table, Slab Base Bow Ends

One piece 1" thick thermally fused **rectangular top with bow ends**; laminate slab bases. High pressure laminate (HPL) and ultra matte high pressure laminate (UML) tops optional in 1-1/16" and 1.5" thick. Overall height increases when HPL material selected. Overall weight increases when 1.5" thick HPL tops selected, contact Customer Care. 5.5"H runners between base components, creating a concealed cavity for power modules. Specify laminate finish for top and bases separately. Shipped easy to assemble in 3 cartons.

TRBLS12036	36 x 120 x 29	85	259	19.94	\$2035	\$537 / \$644	\$1287 / \$1463	n/a
TRBLS12048	48 x 120 x 29	85	319	23.74	\$2366	\$646 / \$775	\$1550 / \$1761	n/a
TRBLS14448	48 x 144 x 29	85	365	27.63	\$2660	\$736 / \$884	\$1767 / \$2007	n/a



Rectangular Table, Slab Base Bow Ends

Two piece 1" thick thermally fused **rectangular top with bow ends**; laminate slab bases. High pressure laminate (HPL) and ultra matte high pressure laminate (UML) tops optional in 1-1/16" and 1.5" thick. Overall height increases when HPL material selected. Overall weight increases when 1.5" thick HPL tops selected, contact Customer Care. 5.5"H runners between base components, creating a concealed cavity for power modules. Specify laminate finish for top and bases separately. Shipped easy to assemble in 3 cartons.

TBTL7236	36 x 72 x 29	65	137	5.99	\$1086	\$246 / \$295	\$589 / \$670	n/a
TBTL9636	36 x 96 x 29	85	189.5	14.07	\$1343	\$342 / \$410	\$820 / \$932	n/a
TBTL9648	48 x 96 x 29	85	237	17.54	\$1617	\$418 / \$502	\$1003 / \$1139	n/a



Boat Shaped Table, Slab Base

One piece 1" thick thermally fused **boat shaped top** with laminate slab bases. High pressure laminate (HPL) and ultra matte high pressure laminate (UML) tops optional in 1-1/16" and 1.5" thick. Overall height increases when HPL material selected. Overall weight increases when 1.5" thick HPL tops selected, contact Customer Care. 5.5"H runners between base components, creating a concealed cavity for power modules. Specify laminate finish for top and bases separately. Shipped easy to assemble in 3 cartons.

Required Specifications

Top material/thickness
Top finish
Edge
Base finish

Optional Specifications

Cut-out for grommet/power blocks
Radius corners*

Accessories

Power block

A ANYWHERE TABLE COLLECTION

SLAB BASE TABLES



Boat-Shaped Table, Slab Base

MODEL#	DIMENSIONS D x W x H	FREIGHT CLASS	WT/LBS.	CUBIC FT.	11FT TOP	1"HPL/1.5"HPL ADD	1"UML/1.5"UML ADD	2R ADD
TBTL12036	36 x 120 x 29	85	259	19.94	\$2035	\$537 / \$644	\$1287 / \$1463	n/a
TBTL12048	48 x 120 x 29	85	319	23.74	\$2366	\$646 / \$775	\$1550 / \$1761	n/a
TBTL14448	48 x 144 x 29	85	365	27.63	\$2660	\$736 / \$884	\$1767 / \$2007	n/a

Two piece 1" thick thermally fused **boat shaped top** with laminate slab bases. High pressure laminate (HPL) and ultra matte high pressure laminate (UML) tops optional in 1-1/16" and 1.5" thick. Overall height increases when HPL material selected. Overall weight increases when 1.5" thick HPL tops selected, contact Customer Care. 5.5"H runners between base components, creating a concealed cavity for power modules. Specify laminate finish for top and bases separately. Shipped easy to assemble in 3 cartons.



Racetrack Table, Slab Base

TRCLS7236	36 x 72 x 29	65	137	5.99	\$1086	\$246 / \$295	\$589 / \$670	n/a
TRCLS9636	36 x 96 x 29	85	189.5	14.07	\$1343	\$342 / \$410	\$820 / \$932	n/a
TRCLS9648	48 x 96 x 29	85	237	17.54	\$1617	\$418 / \$502	\$1003 / \$1139	n/a

One piece 1" thick thermally fused **racetrack top** with laminate slab bases. High pressure laminate (HPL) and ultra matte high pressure laminate (UML) tops optional in 1-1/16" and 1.5" thick. Overall height increases when HPL material selected. Overall weight increases when 1.5" thick HPL tops selected, contact Customer Care. 5.5"H runners between base components, creating a concealed cavity for power modules. Specify laminate finish for top and bases separately. Shipped easy to assemble in 3 cartons.



Racetrack Table, Slab Base

TRCLS12036	36 x 120 x 29	85	259	19.94	\$2035	\$537 / \$644	\$1287 / \$1463	n/a
TRCLS12048	48 x 120 x 29	85	319	23.74	\$2366	\$646 / \$775	\$1550 / \$1761	n/a
TRCLS14448	48 x 144 x 29	85	365	27.63	\$2660	\$736 / \$884	\$1767 / \$2007	n/a

Two piece 1" thick thermally fused **racetrack top** with laminate slab bases. High pressure laminate (HPL) and ultra matte high pressure laminate (UML) tops optional in 1-1/16" and 1.5" thick. Overall height increases when HPL material selected. Overall weight increases when 1.5" thick HPL tops selected, contact Customer Care. 5.5"H runners between base components, creating a concealed cavity for power modules. Specify laminate finish for top and bases separately. Shipped easy to assemble in 3 cartons.



Wedge Table, Slab Base*

TWGLS7236	48-36 x 72 x 29	65	137	5.99	\$1086	\$246 / \$295	\$589 / \$670	\$58
TWGLS9636	48-36 x 96 x 29	85	189.5	14.07	\$1343	\$342 / \$410	\$920 / \$932	\$77
TWGLS9648	60-48 x 96 x 29	85	237	17.54	\$1617	\$418 / \$502	\$1003 / \$1139	\$100

One piece 1" thick thermally fused **wedge top** with laminate slab bases. Radius corners top (**2R**) optional, upcharge applies. High pressure laminate (HPL) and ultra matte high pressure laminate (UML) tops optional in 1-1/16" and 1.5" thick. Overall height increases when HPL material selected. Overall weight increases when 1.5" thick HPL tops selected, contact Customer Care. 5.5"H runners between base components, creating a concealed cavity for power modules. Specify laminate finish for top and bases separately. Shipped easy to assemble in 3 cartons.



Wedge Table, Slab Base*

TWGLS12048	60-48 x 120 x 29	85	365	27.63	\$2366	\$646 / \$775	\$1550 / \$1761	\$144
TWGLS14448	60-48 x 144 x 29	85	365	27.63	\$2660	\$736 / \$884	\$1767 / \$2007	\$167

Two piece 1" thick thermally fused **wedge top** with laminate slab bases. Radius corners top (**2R**) optional, upcharge applies. High pressure laminate (HPL) and ultra matte high pressure laminate (UML) tops optional in 1-1/16" and 1.5" thick. Overall height increases when HPL material selected. Overall weight increases when 1.5" thick HPL tops selected, contact Customer Care. 5.5"H runners between base components, creating a concealed cavity for power modules. Specify laminate finish for top and bases separately. Shipped easy to assemble in 3 cartons.

Required Specifications

Top material/thickness
Top finish
Edge
Base finish

Optional Specifications

Cut-out for grommet/power blocks
Radius corners*

Accessories

Power block

ARCH BASE TABLES



Rectangular Table, Arch Base Bow Ends



Rectangular Table, Arch Base Bow Ends



Boat Shaped Table, Arch Base



Boat-Shaped Table, Arch Base

MODEL#	DIMENSIONS	FREIGHT CLASS	WT/LBS.	CUBIC FT.	1"FT TOP	1"UML/1.5"UML ADD	1"UML/1.5"UML LADD	2R ADD	
D x W x H									
TRBAH7236	36 x 72 x 29	70	157	8.56	\$1498	\$246 / \$295	\$589 / \$670	n/a	
TRBAH9636	36 x 96 x 29	85	209.5	16.65	\$1756	\$342 / \$410	\$820 / \$932	n/a	
TRBAH9648	48 x 96 x 29	85	257	21.14	\$2168	\$418 / \$502	\$1003 / \$1139	n/a	

One piece 1" thick thermally fused **rectangular top with bow ends**; laminate arch bases. High pressure laminate (HPL) and ultra matte high pressure laminate (UML) tops optional in 1-1/16" and 1.5" thick. Overall height increases when HPL material selected. Overall weight increases when 1.5" thick HPL tops selected, contact Customer Care. 5.5"H runners between base components, creating a concealed cavity for power modules. Specify laminate finish for top and bases separately. Shipped easy to assemble in 3 cartons.

TRBAH12036	36 x 120 x 29	85	278	20.66	\$2433	\$537 / \$644	\$1287 / \$1463	n/a
TRBAH12048	48 x 120 x 29	85	329	25.93	\$2902	\$646 / \$775	\$1550 / \$1761	n/a
TRBAH14448	48 x 144 x 29	85	375	29.82	\$3197	\$736 / \$884	\$1767 / \$2007	n/a

Two piece 1" thick thermally fused **rectangular top with bow ends**; laminate arch bases. High pressure laminate (HPL) and ultra matte high pressure laminate (UML) tops optional in 1-1/16" and 1.5" thick. Overall height increases when HPL material selected. Overall weight increases when 1.5" thick HPL tops selected, contact Customer Care. 5.5"H runners between base components, creating a concealed cavity for power modules. Specify laminate finish for top and bases separately. Shipped easy to assemble in 3 cartons.

TBTAH7236	36 x 72 x 29	70	157	8.56	\$1498	\$246 / \$295	\$589 / \$670	n/a
TBTAH9636	36 x 96 x 29	85	209.5	16.65	\$1756	\$342 / \$410	\$820 / \$932	n/a
TBTAH9648	48 x 96 x 29	85	257	21.14	\$2168	\$418 / \$502	\$1003 / \$1139	n/a

One piece 1" thick thermally fused **boat shaped top** with laminate arch bases. High pressure laminate (HPL) and ultra matte high pressure laminate (UML) tops optional in 1-1/16" and 1.5" thick. Overall height increases when HPL material selected. Overall weight increases when 1.5" thick HPL tops selected, contact Customer Care. 5.5"H runners between base components, creating a concealed cavity for power modules. Specify laminate finish for top and bases separately. Shipped easy to assemble in 3 cartons.

TBTAH12036	36 x 120 x 29	85	278	20.66	\$2433	\$537 / \$644	\$1287 / \$1463	n/a
TBTAH12048	48 x 120 x 29	85	329	25.93	\$2902	\$646 / \$775	\$1550 / \$1761	n/a
TBTAH14448	48 x 144 x 29	85	375	29.82	\$3197	\$736 / \$884	\$1767 / \$2007	n/a

Two piece 1" thick thermally fused **boat shaped top** with laminate arch bases. High pressure laminate (HPL) and ultra matte high pressure laminate (UML) tops optional in 1-1/16" and 1.5" thick. Overall height increases when HPL material selected. Overall weight increases when 1.5" thick HPL tops selected, contact Customer Care. 5.5"H runners between base components, creating a concealed cavity for power modules. Specify laminate finish for top and bases separately. Shipped easy to assemble in 3 cartons.

Required Specifications

Top material/thickness
Top finish
Edge
Base finish

Optional Specifications

Cut-out for grommet/power blocks

Accessories

Power block

A ANYWHERE TABLE COLLECTION

TABLES W/TAPERED BLADE BASE

TAPERED BLADE BASE NOTES:

- Tables with 2 bases: foot is a slight V

D x W x H

- Tables with 3 bases: middle base is straight

TAPERED BLADE BASE TABLES

MODEL# DIMENSIONS FREIGHT CLASS WT/LBS. CUBIC FT. 11FTOP 1"HPL/1.5"HPLADD 1"UML/1.5"UMLADD 2RADD

D x W x H

TRT2T7236	36 x 72 x 28.75	92.5	103	10.18	\$1258	\$246 / \$295	\$589 / \$670	\$60
TRT2T9636	36 x 96 x 28.75	100	148.5	17.96	\$1451	\$342 / \$410	\$820 / \$932	\$80
TRT2T9648	48 x 96 x 28.75	100	187	21.05	\$1681	\$418 / \$502	\$1003 / \$1139	\$103



Rectangular Table, Tapered Blade Base*

One piece 1" thick thermally fused rectangular top with (2) two-prong metal tapered blade bases. Radius corners top (2R) optional, upcharge applies. High pressure laminate (HPL) and ultra matte high pressure laminate (UML) tops optional in 1-1/16" and 1.5" thick. Overall height increases when HPL material selected. Overall weight increases when 1.5" thick HPL tops selected, contact Customer Care. Base available in paint or plated finishes; upcharge applies for plated finishes. Shipped easy to assemble in 3 cartons.



Rectangular Table, Tapered Blade Base*

TRT2T12036	36 x 120 x 28.75	100	192	22.93	\$2186	\$537 / \$644	\$1287 / \$1463	\$122
TRT2T12048	48 x 120 x 28.75	100	240	26.74	\$2452	\$646 / \$775	\$1550 / \$1761	\$149
TRT2T14448	48 x 144 x 28.75	100	280	30.12	\$2680	\$736 / \$884	\$1767 / \$2007	\$171

Two piece 1" thick thermally fused rectangular top with (3) two-prong metal tapered blade bases. Radius corners top (2R) optional, upcharge applies. High pressure laminate (HPL) and ultra matte high pressure laminate (UML) tops optional in 1-1/16" and 1.5" thick. Overall height increases when HPL material selected. Overall weight increases when 1.5" thick HPL tops selected, contact Customer Care. Base available in paint or plated finishes; upcharge applies for plated finishes. Shipped easy to assemble in 3 cartons.



Rectangular Table, Tapered Blade Base Bow Ends

TRB2T7236	36 x 72 x 28.75	92.5	103	10.18	\$1258	\$246 / \$295	\$589 / \$670	n/a
TRB2T9636	36 x 96 x 28.75	100	148.5	17.96	\$1451	\$342 / \$410	\$820 / \$932	n/a
TRB2T9648	48 x 96 x 28.75	100	187	21.05	\$1681	\$418 / \$502	\$1003 / \$1139	n/a

One piece 1" thick thermally fused rectangular top with bow ends; (2) two-prong metal tapered blade bases. High pressure laminate (HPL) and ultra matte high pressure laminate (UML) tops optional in 1-1/16" and 1.5" thick. Overall height increases when HPL material selected. Overall weight increases when 1.5" thick HPL tops selected, contact Customer Care. Base available in paint or plated finishes; upcharge applies for plated finishes. Shipped easy to assemble in 3 cartons.



Rectangular Table, Tapered Blade Base Bow Ends

TRB2T12036	36 x 120 x 29.5	100	192	22.93	\$2186	\$537 / \$644	\$1287 / \$1463	n/a
TRB2T12048	48 x 120 x 29.5	100	240	26.74	\$2452	\$646 / \$775	\$1550 / \$1761	n/a
TRB2T14448	48 x 144 x 29.5	100	280	30.12	\$2680	\$736 / \$884	\$1767 / \$2007	n/a

Two piece 1" thick thermally fused rectangular top with bow ends; (3) two-prong metal tapered blade bases. High pressure laminate (HPL) and ultra matte high pressure laminate (UML) tops optional in 1-1/16" and 1.5" thick. Overall height increases when HPL material selected. Overall weight increases when 1.5" thick HPL tops selected, contact Customer Care. Base available in paint or plated finishes; upcharge applies for plated finishes. Shipped easy to assemble in 3 cartons.



Boat Shaped Table, Tapered Blade Base

TBT2T7236	36 x 72 x 28.75	92.5	103	10.18	\$1258	\$246 / \$295	\$589 / \$670	n/a
TBT2T9636	36 x 96 x 28.75	100	148.5	17.96	\$1451	\$342 / \$410	\$820 / \$932	n/a
TBT2T9648	48 x 96 x 28.75	100	187	21.05	\$1681	\$418 / \$502	\$1003 / \$1139	n/a

One piece 1" thick thermally fused boat shaped top with (2) two-prong metal tapered blade bases. High pressure laminate (HPL) and ultra matte high pressure laminate (UML) tops optional in 1-1/16" and 1.5" thick. Overall height increases when HPL material selected. Overall weight increases when 1.5" thick HPL tops selected, contact Customer Care. Base available in paint or plated finishes; upcharge applies for plated finishes. Shipped easy to assemble in 3 cartons.

Required Specifications

Top material/thickness
Top finish
Edge
Base finish

Optional Specifications

Plated base finish
Cut-out for grommet/power blocks
Radius corners*

Accessories

Power block

TAPERED BLADE BASE TABLES

MODEL#	DIMENSIONS	FREIGHT CLASS	WT/LBS.	CUBIC FT.	1"FTOP	1"HPL/1.5"HPLADD	1"UML/1.5"UMLADD	2RADD
--------	------------	---------------	---------	-----------	--------	------------------	------------------	-------

D x W x H

TBT2T12036	36 x 120 x 28.75	100	192	22.93	\$2186	\$537 / \$644	\$1287 / \$1463	n/a
TBT2T12048	48 x 120 x 28.75	100	240	26.74	\$2452	\$646 / \$775	\$1550 / \$1761	n/a
TBT2T14448	48 x 144 x 28.75	100	280	30.12	\$2680	\$736 / \$884	\$1767 / \$2007	n/a



Boat Shaped Table, Tapered Blade Base

Two piece 1" thick thermally fused boat shaped top with (3) two-prong metal tapered blade bases. High pressure laminate (HPL) and ultra matte high pressure laminate (UML) tops optional in 1-1/16" and 1.5" thick. Overall height increases when HPL material selected. Overall weight increases when 1.5" thick HPL tops selected, contact Customer Care. Base available in paint or plated finishes; upcharge applies for plated finishes. Shipped easy to assemble in 3 cartons.



Racetrack Table, Tapered Blade Base

TRC2T7236	36 x 72 x 28.75	92.5	103	10.18	\$1258	\$246 / \$295	\$589 / \$670	n/a
TRC2T9636	36 x 96 x 28.75	100	148.5	17.96	\$1451	\$342 / \$410	\$820 / \$932	n/a
TRC2T9648	48 x 96 x 28.75	100	187	21.05	\$1681	\$418 / \$502	\$1003 / \$1139	n/a

One piece 1" thick thermally fused boat shaped top with (2) two-prong metal tapered blade bases. High pressure laminate (HPL) and ultra matte high pressure laminate (UML) tops optional in 1-1/16" and 1.5" thick. Overall height increases when HPL material selected. Overall weight increases when 1.5" thick HPL tops selected, contact Customer Care. Base available in paint or plated finishes; upcharge applies for plated finishes. Shipped easy to assemble in 3 cartons.



Racetrack Table, Tapered Blade Base

TRC2T12036	36 x 120 x 28.75	100	192	22.93	\$2186	\$537 / \$644	\$1287 / \$1463	n/a
TRC2T12048	48 x 120 x 28.75	100	240	26.74	\$2452	\$646 / \$775	\$1550 / \$1761	n/a
TRC2T14448	48 x 144 x 28.75	100	280	30.12	\$2680	\$736 / \$884	\$1767 / \$2007	n/a

Two piece 1" thick thermally fused boat shaped top with (3) two-prong metal tapered blade bases. High pressure laminate (HPL) and ultra matte high pressure laminate (UML) tops optional in 1-1/16" and 1.5" thick. Overall height increases when HPL material selected. Overall weight increases when 1.5" thick HPL tops selected, contact Customer Care. Base available in paint or plated finishes; upcharge applies for plated finishes. Shipped easy to assemble in 3 cartons.



Wedge Table, Tapered Blade Base*

TWG2T7236	48-36 x 72 x 29.5	92.5	103	10.18	\$1258	\$246 / \$295	\$589 / \$670	\$60
TWG2T9636	48-36 x 96 x 29.5	100	148.5	17.96	\$1451	\$342 / \$410	\$820 / \$932	\$80
TWG2T9648	60-48 x 96 x 29.5	100	187	21.05	\$1681	\$418 / \$502	\$1003 / \$1139	\$103

One piece 1" thick thermally fused **wedge top** with (2) two-prong metal tapered blade bases. Radius corners top (**2R**) optional, upcharge applies. High pressure laminate (HPL) and ultra matte high pressure laminate (UML) tops optional in 1-1/16" and 1.5" thick. Overall height increases when HPL material selected. Overall weight increases when 1.5" thick HPL tops selected, contact Customer Care. Base available in paint or plated finishes; upcharge applies for plated finishes. Shipped easy to assemble in 3 cartons.



Wedge Table, Tapered Blade Base*

TWG2T12048	60-48 x 120 x 29.5	100	240	26.74	\$2452	\$646 / \$775	\$1550 / \$1761	\$149
TWG2T14448	60-48 x 144 x 29.5	100	280	30.12	\$2680	\$736 / \$884	\$1767 / \$2007	\$171

Two piece 1" thick thermally fused **wedge top** with (3) two-prong metal tapered blade bases. Radius corners top (**2R**) optional, upcharge applies. High pressure laminate (HPL) and ultra matte high pressure laminate (UML) tops optional in 1-1/16" and 1.5" thick. Overall height increases when HPL material selected. Overall weight increases when 1.5" thick HPL tops selected, contact Customer Care. Base available in paint or plated finishes; upcharge applies for plated finishes. Shipped easy to assemble in 3 cartons.

Required Specifications

Top material/thickness
Top finish
Edge
Base finish

Optional Specifications

Plated base finish
Cut-out for grommet/power blocks
Radius corners*

Accessories

Power block

BUNGEE™ TABLES



Bungee is a series of freestanding tables and accessories designed for classrooms, training rooms, boardrooms and any other multi-functional space that may require frequent configurations. Tables are sold complete with legs and Bungee cords so they may quickly and easily be connected together without searching for tools or worrying about loose parts.

Bungee tables feature rounded corners with a unique “bubble molding” that is engineered to compress under the tension of the Bungee cords. The compressed molding creates a seal that serves to locate and align interconnected tables while also providing a soft and forgiving edge.

Choose from a variety of top shapes and laminate finishes to create your individual style. In addition, most tables offer a choice of tapered legs or spider legs in a Tungsten or Black finish with adjustable levelers or optional casters. Optional modesty panels, grommets, wire management and power blocks further enhance your workspace.



Flip-Top tables can be nested and easily stored by activating the single hand release mechanism from the left or right side.

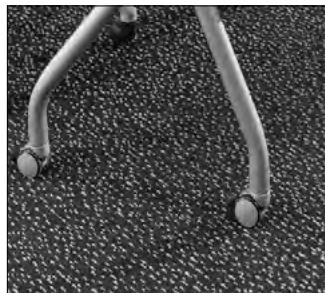

Optional locking casters are available in Tungsten or Black (standard on Flip-Top models).

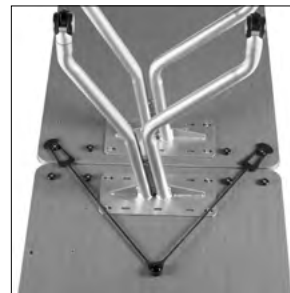

Bungee cords are utilized to quickly and easily reconfigure tables

Features and Benefits

- Bungee tables are complete with Top, Legs and Bungee cords
- Bungee cords provide a fast and easy method of reconfiguring tables without requiring a tool
- Tops are 1” thick and are offered in a variety of shapes and sizes
- Legs are offered in tapered or spider design in a Tungsten or Black finish.
- Levelers on legs are standard.
- Laminate modesty panels and filler modesty inserts help conceal wires and enhance visual appeal
- Wire management tracks neatly contain wires, using two separate channels for data and voice wires
- Optional grommets or power blocks offer technological flexibility
- Models with handles feature a bow handle in Silver or Black Nickel finish
- Metal feet are height adjustable and offered in Black or Tungsten finish
- Boardrooms were never easier to specify - table “sets” and accessories such as AV Cabinets and Credenza Buffets are specified with one model number

GENERAL INFORMATION

- Bungee is a series of freestanding tables and accessories designed for classrooms, training rooms, boardrooms and any other multifunctional space that requires frequent reconfigurations.
- Bungee tables come complete with a work top, a set of legs and built-in Bungee cord connectors
- Bungee cords allow the movement and reconfiguration of tables without a risk of damage or losing loose parts
- High pressure tops are available in all Bungee laminate finishes at an extended lead time - see model # for pricing.
- Ultra matte high pressure laminate tops are available in all Bungee solid laminate finishes at an extended lead time - see model # for pricing
- Unique "bubble molding" edging is specially engineered to create a secure seal to align interconnected tables. Alternate edge options are available.
- For environmental certifications, please visit globalfurnituregroup.com

CONSTRUCTION

- Tops are 1" thick thermally fused laminate (**TFL**); optional in 1-1/16" thick high pressure laminate (**HPL** - upcharge applies) or ultra matte high pressure laminate (**UML** - upcharge applies). Modesty panels are 11/16" thick.
- All components are made of 45 lb. commercial density particle board, covered on both sides with high performance, thermally fused laminate.
- Tops 54" and over feature a built-in support bar.
- Products specified with the high pressure laminate option (**HPL**) are finished on the underside of the surface with a kraft paper backing.

BUNGEE CORDS

- Bungee cords are patented elastic devices designed to provide a rapid, no-tool method of attaching tables of the same depth.
- The elastic nature of cords allows two connected tables to be moved around without risk of damage to the table top or connecting hardware.
- Bungee cords are included with all freestanding tables and carry a lifetime warranty.

LEGS

- Tables feature two styles of legs - tapered leg and spider leg. Available in Black (**TBL**) or Tungsten (**TTU**) finish. For added durability, paint finish is textured.
- Levelers are standard. Levelers adjust 3mm-10mm in height. Optional locking casters are available at no upcharge, specify Black (**TBC**) or Tungsten (**TTC**). For added durability, paint finish is textured.

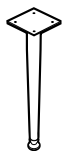

Tapered Leg



Spider Leg

HANDLES

- Metal handles are standard on all drawers and doors. Handles are offered in two finishes: Silver (**HS**) or Black Nickel (**HT**), please specify
- Handle finish will match leg finish.



bow handle, Silver finish (**HS**)



bow handle, Black Nickel finish (**HT**)

FEET

- Metal feet are standard on all cabinets. Feet adjust 3/4" in height.
- Feet are available in Tungsten Finish (**TTU**) or Black Finish (**BLK**).



TTU - Tungsten



BLK - Black Nickel

EDGE DETAIL

- Bungee comes with a choice of four edge styles (check model for edge availability):



A3 - square corner, standard edge



AR - square corner, bicut edge



AS - square corner, Silver



AB - square corner, Black



BS - rounded corner, Silver



BB - rounded corner, Black

- **BB/BS** - Bungee Bubble Edge: unique "bubble" molding is engineered to compress under the tension of the Bungee cords, creating a seal that serves to locate and align interconnected tables.
- **AB/AS** - Split color PVC edge: edge matches split color aesthetic of the bubble edge, but allows for 90 degree corners and a cleaner look.
- **A3** - Global's preferred edge. Coordinates well with Adaptabilities and Zira 1" tops.
- **AR** - Bicut edge. Coordinates well with Zira 1" tops.
- **NOTE**: Trapezoid tables can only be specified with Bubble Edge (Rounded Corners).
- **NOTE**: Boardroom Table sets allow for all edge types but ONLY with rounded corners (when AS/AB/A3/AR are selected, the table will be produced with rounded corners).

B BUNGEE™ TABLES - NOTES / HOW TO SPECIFY

MODESTY PANELS

- Panels are 9.5" high, recessed 3/4" from the back and inset 7" from the sides.
- Available in all Bungee laminate finishes.
- Edge available in Silver finish (**SI**) or Black finish (**BK**). Please specify.

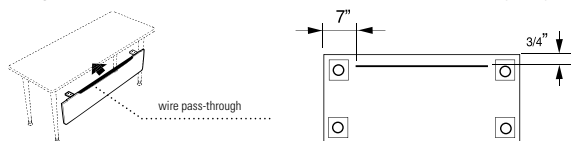

FILLER MODESTY PANELS

- Used to fill the space between two modesty panels when two tables are linked together. Helps conceal wires and enhance visual appeal.
- Reversible - Black on one side, Silver on the other.

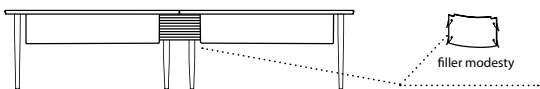

WIRE MANAGEMENT

- Wire management tracks are mounted to the underside of the worksurface. Available in 5" and 22" track lengths.
- 5" track includes one wire clamp; 22" track includes two wire clamps.
- Data and voice wires can be routed separately using two separate channels on each clamp.
- Available in Black only.

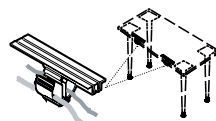

5" Wire Management Track

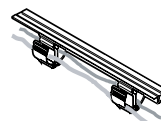

22" Wire Management Track

HOW TO SPECIFY BUNGEE TABLES

1. SPECIFY MODEL NUMBER

2. SPECIFY MATERIAL TYPE

- **TFL** for product with thermally fused laminate tops
- **HPL** for product with high pressure laminate tops (upcharge applies)
- **UML** for product with ultra matte high pressure laminate tops (upcharge applies)

3. SPECIFY FINISH

LAMINATE FINISHES

Thermally fused laminate (**TFL**) and high pressure laminate (**HPL**) available in all finishes. Ultra matte high pressure (**UML**) available on select finishes* only.

ACJ	Absolute Acajou	FCL	First Class
ASN	Asian Night	NBL	Noce Biondo
AWC	Avant Cherry	NGL	Noce Grigio
AWH	Avant Honey	NEL	Noce Leggero
BLK	Black*	NML	Noce Medio
BZD	Blizzard*	QTM	Quartered Mahogany
BRC	Brushed Cobalt	SBY	Sheer Beauty
CMB	Clear Maple	SDT	Stonedust*
CGY	Custom Grey*	SOG	Storm Grey*
DES	Dark Espresso	WHE	Walnut Heights
DWT	Designer White*	WHC	White Chocolate
FAS	Fashionista	WCR	Winter Cherry

Edge:

BB	Bungee bubble edge with Black trim
BS	Bungee bubble edge with Silver trim
AB	Split color edge with Black trim
AS	Split color edge with Silver trim
A3	Matching edge
AR	Matching bicut edge

Legs with Glides:

TBL	Black
TTU	Tungsten

Handles:

HS	Silver
HT	Black Nickel

Feet:

BLK	Black Nickel
------------	--------------

Legs with Casters:

TBC	Black
TTC	Tungsten

Modesty Panel Edge:

SI	Silver
BK	Black Nickel

TTU	Tungsten
------------	----------

4. SPECIFY OPTIONS

GROMMETS

- Optional Grommets available in standard worksurface locations (left, center or right) **for Rectangular Tops 48" and up**. Order as: **AG1, AG2 or AG3 - Add \$103**
- Additional grommets are available in **center position only for Rectangular Tops (36", 42" and 48") and Trapezoid Tables**. Order as **AG2 - Add \$103**.
- Grommet hole dimensions are 3 1/4" wide x 1 7/8" deep.
- Grommets may be placed at non-standard locations. Order as: **AGS - Add \$103**. A drawing must be supplied with vertical and horizontal dimensions to the center of the cut-out (as in drawing above). Please refer to CUSTOM GROMMET LOCATION FORM in the back reference section.

Grommet hole dimensions

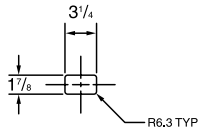

Grommet

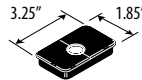

Rectangular Tops

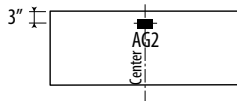

For 36" and 42" wide units

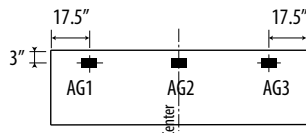

For 48", 60" and 72" wide units



Trapezoid Tables

Grommet Location - **AG2...Add \$103**

POWER BLOCK

- A Power Block is a rectangular worksurface power/data module with one electrical duplex receptacle and two data (RJ45) receptacles. 9' black cord included. Power Block dimensions are 3 1/2" deep x 6 1/2" wide x 2 3/4" high.
- A Power Block (model **PMSPDM**) may be ordered for **Rectangular Tables 60" and up** in place of standard grommets. Order as **E1, E2 or E3 - Add \$103**.
- Additional Power Blocks are available in **center position only for Rectangular Tops (36", 42" and 48") and Trapezoid Tables**. Order as **E2 - Add \$103**.
- To purchase a Power Block, you must specify both the Power Block cut-out location and the Power Block model #. Order Power Block as **PMSPDM, Add \$352**.
- Power Blocks are available in standard worksurface locations (left, center or right). Order as **E1, E2 or E3. Add \$103**.
- **See above for examples of placement.**



Power Block **PMSPDM Add \$352**

Rectangular Tops

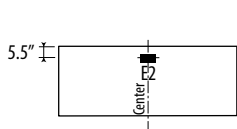

For 36", 42" and 48" wide units

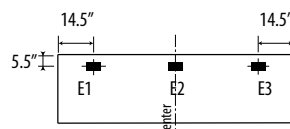

For 60" and 72" wide units

VILLA CUT-OUTS

- Optional Villa cut-out available in standard worksurface locations (left, center or right) **for Rectangular Tables 60" and up**. Order as: **V1, V2 or V3 - Add \$103 for each cut-out**.
- Additional power block cut-outs are available in **center position only for Rectangular Tops (36", 42" and 48") and Trapezoid Tables**. Order as **V2 - Add \$103**.
- Villa cut-outs may be placed at non-standard locations. Please contact customer care.
- To purchase a Villa Power Block, you must specify both the Villa Power Block cut-out location and the Power Block model #. Please see page 619 for Villa models.

Rectangular Tops

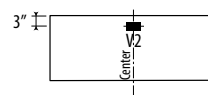

For 36", 42" and 48" wide units

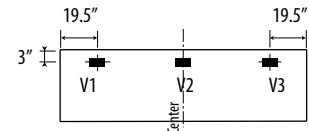

For 60" and 72" wide units

MODPOWER DAISY CHAIN SOLUTION

- Add flexible power and USB charging to Bungee rectangular tables. Connect up to four units with a single corded infeed with NEMA plug.
- ModPower units are sold separately, refer to Productivity Solutions page 609.
- Begin run with a starter unit which includes a corded infeed. Add additional middle or end units as required. Middle and end units are equipped with connecting cables.
- On-surface modules clamp on or screw mount to the table tops.
- In-surface modules require table top cut-outs for mounting. Specify cut-out option:
 - **MPS** for a single cut-out to accommodate one ModPower in-surface unit (cut-out will be centered on the approach side) for **42" to 72" wide non-flip tables and 48" to 72" wide flip tables. Add \$103**
 - **MPD** for two cut-outs in the left and right positions, 18.25" from ends to center of unit on approach side for **60", 66" and 72" wide rectangular tables. Add \$205**.

B BUNGEE™ TABLES - NOTES

CONNECTING CONDITIONS

- Bungee cords allow for fast and easy reconfiguring of tables whenever needed. Due to the elastic nature of the Bungee cord, two tables connected with Bungee cords can be moved around without risk of damage to the table top or the connecting hardware.
- Connecting tables is simple and intuitive. Tools are not required and there are no loose parts that may be misplaced.
- Bungee cords connect tables of the same depth in all directions.
- Rectangular Tables 48" and longer connect in both Straight and "L" configurations. Rectangular Tables 36" and 42" connect in Straight configurations only.

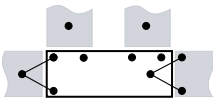
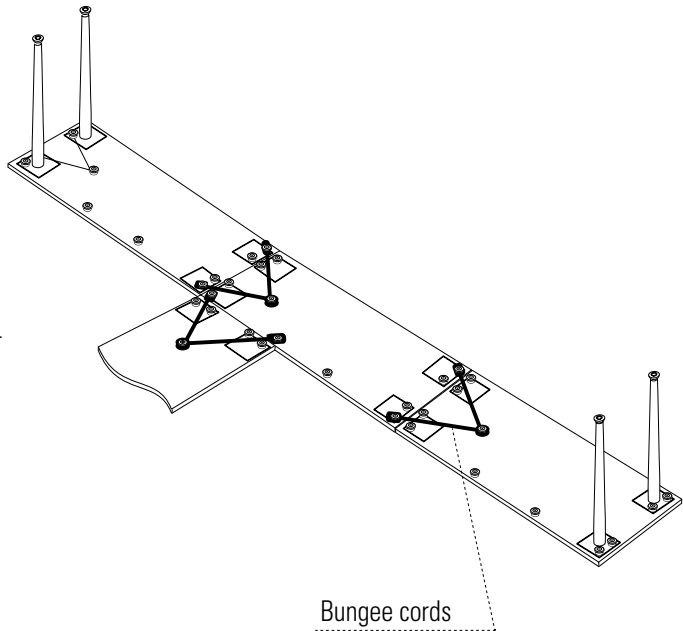

Rectangular Tables

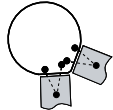

Round Wedge Tables

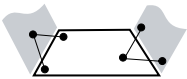

Trapezoid Tables

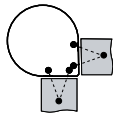

Teardrop Tables

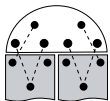

Half Moon Tables

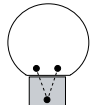

Flat Round Tables

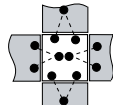

Square Tables



Keystone Tables

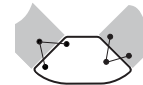

Wedge Tables

SAMPLE TABLE CONFIGURATIONS

- The following table configurations can be created using Bungee Boardroom Table Sets only.

Meeting/Boardroom Table



Meeting/Boardroom Table



Training

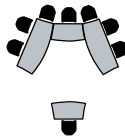

Lecture / AV Presentations

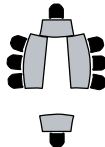

Small Teaming Stations



Large Teaming Stations



Meeting/Boardroom Table

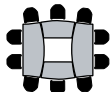

Training

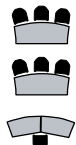

FLIP TOP TABLE NESTING DIAGRAM

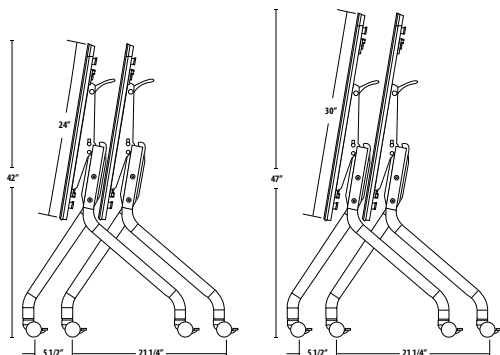

RECTANGULAR TABLES

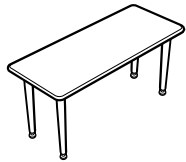
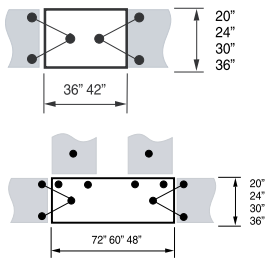

Rectangular Table - Tapered Legs

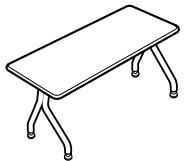
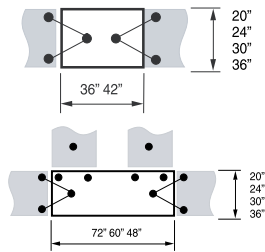

Rectangular Table - Spider Legs

MODEL#	DIMENSIONS D x W x H	FREIGHT CLASS	WT/LBS.	CUBIC FT.	LIST PRICE	HPL ADD	UML ADD
B2036REF	20 x 36 x 28.7	92.5	59	5.26	\$931	\$190	\$227
B2042REF	20 x 42 x 28.7	92.5	62	5.76	\$965	\$252	\$301
B2048REF	20 x 48 x 28.7	92.5	67	6	\$1002	\$252	\$301
B2060REF	20 x 60 x 28.7	92.5	74	7	\$1134	\$346	\$413
B2072REF	20 x 72 x 28.7	92.5	81	7.26	\$1243	\$391	\$468
B2436REF	24 x 36 x 28.7	92.5	65	5.76	\$986	\$190	\$227
B2442REF	24 x 42 x 28.7	92.5	69	6	\$1019	\$252	\$301
B2448REF	24 x 48 x 28.7	92.5	72	6.5	\$1053	\$252	\$301
B2460REF	24 x 60 x 28.7	92.5	82	7.26	\$1216	\$376	\$450
B2472REF	24 x 72 x 28.7	92.5	91	8	\$1313	\$584	\$700
B3036REF	30 x 36 x 28.7	100	70	7.26	\$973	\$354	\$422
B3042REF	30 x 42 x 28.7	92.5	78	7.5	\$1019	\$391	\$468
B3048REF	30 x 48 x 28.7	92.5	81	7.5	\$1046	\$376	\$514
B3060REF	30 x 60 x 28.7	92.5	92	8.26	\$1216	\$470	\$514
B3072REF	30 x 72 x 28.7	92.5	102	9	\$1332	\$584	\$700
B3642REF	36 x 42 x 28.7	150	83	15	\$1117	\$376	\$450
B3648REF	36 x 48 x 28.7	92.5	91	8	\$1225	\$356	\$450
B3660REF	36 x 60 x 28.7	92.5	103	9	\$1332	\$442	\$561
B3672REF	36 x 72 x 28.7	92.5	116	10	\$1488	\$561	\$672

Freestanding table includes four tapered legs with levellers and Bungee cords. Each table can be "Bungee-tied" to other tables of the same depth. Shipped RTA (ready to assemble). Modesty panels available, see page 657.

- **Tables 48" and longer connect in both Straight and "L" configurations**
- **Tables 36" and 42" connect in Straight configurations only.**
- Available with optional locking casters, specify option "TBC" or "TTC".

B2036RES	20 x 36 x 28.7	100	57	6.76	\$1046	\$190	\$227
B2042RES	20 x 42 x 28.7	100	60	7.26	\$1081	\$252	\$301
B2048RES	20 x 48 x 28.7	100	65	7.5	\$1117	\$252	\$301
B2060RES	20 x 60 x 28.7	100	72	8.5	\$1258	\$346	\$413
B2072RES	20 x 72 x 28.7	100	79	8.76	\$1374	\$391	\$468
B2436RES	24 x 36 x 28.7	100	62	7.26	\$1107	\$190	\$227
B2442RES	24 x 42 x 28.7	150	64	15	\$1134	\$252	\$301
B2448RES	24 x 48 x 28.7	125	71	10	\$1177	\$252	\$301
B2460RES	24 x 60 x 28.7	125	80	10.76	\$1332	\$376	\$450
B2472RES	24 x 72 x 28.7	125	89	11.26	\$1443	\$584	\$700
B3036RES	30 x 36 x 28.7	125	72	10.26	\$1134	\$354	\$422
B3042RES	30 x 42 x 28.7	125	80	10.5	\$1169	\$391	\$468
B3048RES	30 x 48 x 28.7	125	83	10.5	\$1206	\$431	\$514
B3060RES	30 x 60 x 28.7	100	94	11.26	\$1374	\$431	\$514
B3072RES	30 x 72 x 28.7	100	104	12	\$1473	\$585	\$704

Freestanding table includes two spider legs with levellers and Bungee cords. Each table can be "Bungee-tied" to other tables of the same depth. Shipped RTA (ready to assemble). Modesty panels available, see page 657.

- **Tables 48" and longer connect in both Straight and "L" configurations**
- **Tables 36" and 42" connect in Straight configurations only.**
- Available with optional locking casters, specify option "TBC" or "TTC".

Required Specifications

Top material
Top finish
Edge
Leg finish

Optional Specifications

Grommet
Casters
Modesty panel

Accessories

Power block

B BUNGEE™ TABLES

TRAPEZOID TABLES

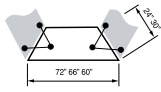
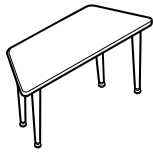

Trapezoid Table - Tapered Legs*

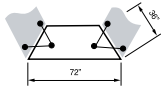
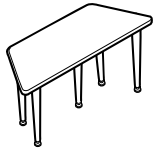

Trapezoid Table - Tapered Legs*

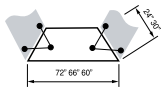
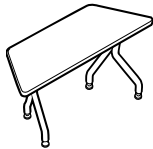

Trapezoid Table - Spider Legs*

MODEL#	DIMENSIONS D x W x H	FREIGHT CLASS	WT/LBS.	CUBIC FT.	LIST PRICE	HPL ADD	UML ADD
B2460TRF	24 x 60 x 28.7	100	71	7.5	\$1117	\$376	\$450
B2466TRF	24 x 66 x 28.7	100	74	8	\$1145	\$584	\$700
B2472TRF	24 x 72 x 28.7	100	78	8.26	\$1231	\$584	\$700
B3060TRF	30 x 60 x 28.7	100	78	8.5	\$1193	\$431	\$514
B3066TRF	30 x 66 x 28.7	100	81	9.5	\$1243	\$584	\$700
B3072TRF	30 x 72 x 28.7	100	85	9.5	\$1321	\$584	\$700

Freestanding table includes four tapered legs with levelers and Bungee cords. Each table can be "Bungee-tied" to other tables of the same depth. Shipped RTA (ready to assemble). Modesty panels available, see page 657.

- Available with bubble edge (BB or BS) only.

B3672TRF	36 x 72 x 28.7	100	91	10.5	\$1525	\$561	\$672
----------	----------------	-----	----	------	---------------	--------------	--------------

Freestanding table includes five tapered legs with levelers and Bungee cords. Each table can be "Bungee-tied" to other tables of the same depth. Shipped RTA (ready to assemble). Modesty panels available, see page 657.

- Available with bubble edge (BB or BS) only.
- Available with optional locking casters, specify option "TBC" or "TTC".

B2060TRS	20 x 60 x 28.7	125	67	8.76	\$1206	\$346	\$413
B2066TRS	20 x 66 x 28.7	125	68	9	\$1243	\$391	\$468
B2072TRS	20 x 72 x 28.7	125	74	9.26	\$1292	\$391	\$468
B2460TRS	24 x 60 x 28.7	125	69	9.26	\$1243	\$376	\$450
B2466TRS	24 x 66 x 28.7	125	72	9.76	\$1292	\$584	\$700
B2472TRS	24 x 72 x 28.7	125	76	10	\$1347	\$584	\$700
B3060TRS	30 x 60 x 28.7	125	79	11.5	\$1336	\$431	\$514
B3066TRS	30 x 66 x 28.7	125	83	12.5	\$1386	\$584	\$700
B3072TRS	30 x 72 x 28.7	125	87	12.5	\$1462	\$584	\$700

Freestanding table includes two spider legs with levelers and Bungee cords. Each table can be "Bungee-tied" to other tables of the same depth. Shipped RTA (ready to assemble). Modesty panels available, see page 657.

- Available with bubble edge (BB or BS) only.
- Available with optional locking casters, specify option "TBC" or "TTC".

KEYSTONE TABLES

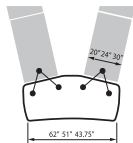
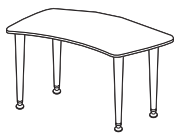

Keystone Table - Tapered Legs

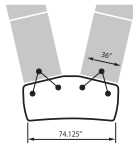
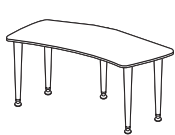

Keystone Table - Tapered Legs

B30KSF	30 x 62 x 28.7	150	69	15.2	\$1185	\$470	\$561
B24KSF	24 x 51 x 28.7	150	60	13	\$1096	\$316	\$375
B20KSF	20 x 43.75 x 28.7	150	58	13	\$1083	\$252	\$301

Freestanding table includes four tapered legs with levelers and Bungee cords. Each table can be "Bungee-tied" to other tables of 24" and 30" depth. Shipped RTA (ready to assemble). Modesty panels or Filler Modestys are NOT available.

B36KSF	36 x 74.13 x 28.7	150	84	16.8	\$1463	\$662	\$792
--------	-------------------	-----	----	------	---------------	--------------	--------------

Freestanding table includes five tapered legs with levelers and Bungee cords. Each table can be "Bungee-tied" to other tables of 24" and 30" depth. Shipped RTA (ready to assemble). Modesty panels or Filler Modestys are NOT available.

Required Specifications

Top material
Top finish
Edge
Leg finish

Optional Specifications

Grommet
Casters
Modesty panel*
HP laminate

Accessories

Power block

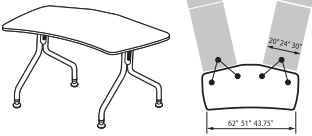
KEYSTONE TABLE	MODEL#	DIMENSIONS	FREIGHT CLASS	WT./LBS.	CUBIC FT.	LIST PRICE	HPL ADD	
		D x W x H						
	B30KSS	30 x 62 x 28.7	150	77	15.2	\$1383	\$468	\$561
	B24KSS	24 x 51 x 28.7	150	66	13	\$1287	\$292	\$375
	B20KSS	20 x 43.75 x 28.7	150	64	13	\$1265	\$252	\$301

Freestanding table includes two spider legs with levelers and Bungee cords. Each table can be "Bungee-tied" to other tables of 24" and 30" depth. Shipped RTA (ready to assemble). Modesty panels or Filler Modestys are NOT available.

- Available with optional locking casters, specify option "TBC" or "TTC".

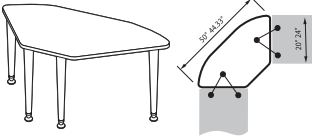
WEDGE TABLES	MODEL#	DIMENSIONS	FREIGHT CLASS	WT./LBS.	CUBIC FT.	LIST PRICE	HPL ADD	
	B24WEF	24 x 63 x 28.7	150	54	13.2	\$1146	\$315	\$375
	B20WEF	20 x 57 x 28.7	150	46	10.2	\$1050	\$252	\$301

Freestanding table includes four tapered legs with levelers and Bungee cords. Each table can be "Bungee-tied" to other tables of the same depth. Shipped RTA (ready to assemble). Modesty panels are NOT available.

- Available with optional locking casters, specify option "TBC" or "TTC".

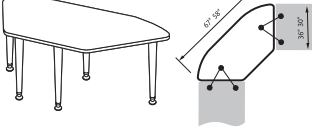
	B36WEF	36 x 80 x 28.7	150	84	18.8	\$1561	\$561	\$672
	B30WEF	30 x 70 x 28.7	150	70	14.4	\$1383	\$391	\$468

Freestanding table includes five tapered legs with levelers and Bungee cords. Each table can be "Bungee-tied" to other tables of the same depth. Shipped RTA (ready to assemble). Modesty panels are NOT available.

- Available with optional locking casters, specify option "TBC" or "TTC".

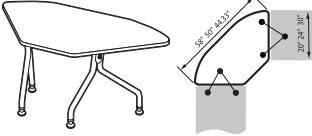
	B30WES	30 x 70 x 28.7	150	73	14.4	\$1370	\$395	\$468
	B24WES	24 x 63 x 28.7	150	62	13.2	\$1280	\$315	\$375
	B20WES	20 x 57 x 28.7	150	52	10.2	\$1185	\$252	\$301

Freestanding table includes two spider legs with levelers and Bungee cords. Each table can be "Bungee-tied" to other tables of the same depth. Shipped RTA (ready to assemble). Modesty panels are NOT available.

- Available with optional locking casters, specify option "TBC" or "TTC".

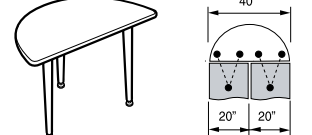
HALF MOON TABLES	MODEL#	DIMENSIONS	FREIGHT CLASS	WT./LBS.	CUBIC FT.	LIST PRICE	HPL ADD	
	B2040HMF	20 x 40 x 28.7	100	49	6	\$737	\$252	\$301

Freestanding table includes three tapered legs with levelers and Bungee cords. Each table can be "Bungee-tied" to other tables of the same depth. Shipped RTA (ready to assemble). Modesty panels or Filler Modestys are NOT available.

- Available with optional locking casters, specify option "TBC" or "TTC".

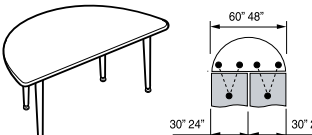
	B2448HMF	24 x 48 x 28.7	100	69	7.76	\$959	\$252	\$301
	B3060HMF	30 x 60 x 28.7	100	81	8.5	\$1019	\$431	\$514

Freestanding table includes four tapered legs with levelers and Bungee cords. Each table can be "Bungee-tied" to other tables of the same depth. Shipped RTA (ready to assemble). Modesty panels or Filler Modestys are NOT available.

- Available with optional locking casters, specify option "TBC" or "TTC".

Required Specifications

Top material
Top finish
Edge
Leg finish

Optional Specifications

Casters
HP laminate

Accessories

Power block (position 2 only)

B BUNGEE™ TABLES

HALF MOON TABLES

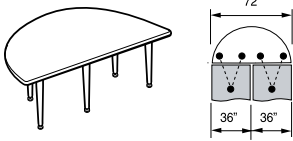

Half Moon Table - Tapered Legs

MODEL#	DIMENSIONS D x W x H	FREIGHT CLASS	WT/LBS.	CUBIC FT.	LIST PRICE	HPL ADD	UML ADD
B3672HMF	36 x 72 x 28.7	100	110	11.5	\$1434	\$561	\$672

Freestanding table includes five tapered legs with levellers and Bungee cords. Each table can be "Bungee-tied" to other tables of the same depth. Shipped RTA (ready to assemble). Modesty panels or Filler Modestys are NOT available.

- Available with optional locking casters, specify option "TBC" or "TTC".

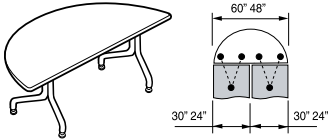

Half Moon Table - Spider Legs

B2448HMS	24 x 48 x 28.7	125	67	9.26	\$1090	\$252	\$301
B3060HMS	30 x 60 x 28.7	125	83	11.5	\$1169	\$431	\$514

Freestanding table includes two spider legs with levellers and Bungee cords. Each table can be "Bungee-tied" to other tables of the same depth. Shipped RTA (ready to assemble). Modesty panels or Filler Modestys are NOT available.

- Available with optional locking casters, specify option "TBC" or "TTC".

SQUARE TABLES

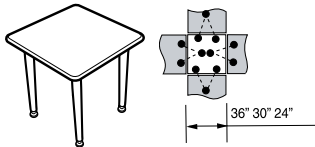

Square Table - Tapered Legs

B2424SQF	24 x 24 x 28.7	92.5	55	4.6	\$912	\$161	\$190
B3030SQF	30 x 30 x 28.7	100	65	7.5	\$931	\$238	\$283
B3636SQF	36 x 36 x 28.7	100	78	8	\$1064	\$283	\$338

Freestanding table includes four tapered legs with levellers and Bungee cords. Each table can be "Bungee-tied" to other tables of the same depth. Shipped RTA (ready to assemble). Modesty panels available, see page 657.

- Available with optional locking casters, specify option "TBC" or "TTC".

ROUND WEDGE TABLES

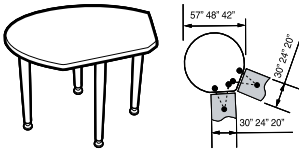

Round Wedge 120° Table

B2042RWF	20 x 42 x 28.7	100	76	8.26	\$1019	\$547	\$653
B2448RWF	24 x 48 x 28.7	125	85	10.76	\$1046	\$547	\$653
B3057RWF	30 x 57 x 28.7	100	102	12	\$1243	\$779	\$931

Freestanding table includes four tapered legs with levellers and Bungee cords. Each table can be "Bungee-tied" to other tables of the same depth. Shipped RTA (ready to assemble). Modesty panels or Filler Modestys are NOT available.

- Available with bubble edge (BB or BS) only.
- Available with optional locking casters, specify option "TBC" or "TTC".

TEARDROP TABLES

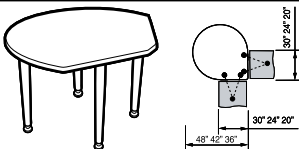

Teardrop 90° Table

B2036TDF	20 x 36 x 28.7	100	71	8	\$959	\$354	\$422
B2442TDF	24 x 42 x 28.7	100	81	8.5	\$1046	\$547	\$653
B3048TDF	30 x 48 x 28.7	100	91	11	\$1150	\$509	\$607

Freestanding table includes four tapered legs with levellers and Bungee cords. Each table can be "Bungee-tied" to other tables of the same depth. Shipped RTA (ready to assemble). Modesty panels or Filler Modestys are NOT available.

- Available with bubble edge (BB or BS) only.
- Available with optional locking casters, specify option "TBC" or "TTC".

Required Specifications

Top material
Top finish
Edge
Leg finish

Optional Specifications

Casters
HP laminate

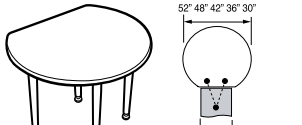
FLAT ROUND TABLES	MODEL#	DIMENSIONS	FREIGHT CLASS	WT./LBS.	CUBIC FT.	LIST PRICE	HPL ADD	UML ADD
 <p>Flat Round Table*</p>		D x W x H						
	B2030FRF	20 x 30 x 28.7	100	56	6	\$931	\$316	\$375
	B2036FRF	20 x 36 x 28.7	100	66	7.26	\$931	\$354	\$422
	B2436FRF	24 x 36 x 28.7	100	64	7.26	\$931	\$354	\$422
	B2442FRF	24 x 42 x 28.7	100	76	8.26	\$1107	\$547	\$653
	B3042FRF	30 x 42 x 28.7	100	74	8	\$1107	\$547	\$653
	B3048FRF	30 x 48 x 28.7	100	88	11	\$1107	\$500	\$653
	B3648FRF	36 x 48 x 28.7	125	85	11	\$1225	\$779	\$598
	B3652FRF	36 x 52 x 28.7	100	93	11	\$1225	\$779	\$931

Freestanding table includes four tapered legs with levellers and Bungee cords. Each table can be "Bungee-tied" to other tables of the same depth. Shipped RTA (ready to assemble). Modesty panels or Filler Modestys are NOT available.

- Available with bubble edge (BB or BS) only.
- Available with optional locking casters, specify option "TBC" or "TTC".

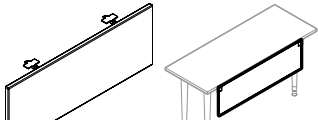
MODESTY PANELS	MODEL#	DIMENSIONS	FREIGHT CLASS	WT./LBS.	CUBIC FT.	LIST PRICE
 <p>Modesty Panel</p>	BX36QMP	.69 x 21 x 9.6	250	3	1.3	\$122
	BX42QMP	.69 x 27 x 9.6	250	4	1.4	\$128
	BX48QMP	.69 x 33 x 9.6	250	4	1.6	\$136
	BX60QMP	.69 x 45 x 9.6	250	5	2.1	\$147
	BX66QMP	.69 x 51 x 9.6	250	6	2.4	\$154
	BX72QMP	.69 x 57 x 9.6	250	7	2.6	\$161

For use on **Rectangular** and **Square** Tables. Includes hinged mounting bracket. Available in all Bungee laminate finishes. Edge available in Silver finish (SI) or Black finish (BK).

- Modesty panel model number indicates the width of table to be used on.

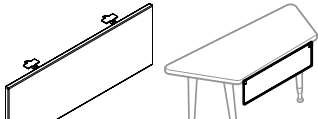
 <p>Modesty Panel</p>	BXM60QMP	.69 x 27 x 9.6	300	4	2.1	\$128
	BXM66QMP	.69 x 33 x 9.6	300	4	2.4	\$136
	BXM72QMP	.69 x 39 x 9.6	300	5	2.6	\$141
	BXL60QMP	.69 x 21 x 9.6	300	3	2.1	\$126
	BXL66QMP	.69 x 27 x 9.6	300	4	2.4	\$128
	BXL72QMP	.69 x 33 x 9.6	300	4	2.6	\$136

For use on **Trapezoid** Tables. Includes hinged mounting bracket. Intended for use on the short side of the table; may be used on long side but leaves a larger gap. Available in all Bungee laminate finishes. Edge available in Silver finish (SI) or Black finish (BK).

- Modesty panel model number indicates the width of table to be used on.
- Specify **BXM** models for 24" D tables and **BXL** models for 30" D tables.

 <p>Modesty Panel</p>	BXWQMP	.69 x 27 x 9.6	250	4	1.5	\$128
---	--------	----------------	-----	---	-----	--------------

For use on **Wedge** Tables. Includes hinged mounting bracket. Intended for use on the short side of the table. Available in all Bungee laminate finishes. Edge available in Silver finish (SI) or Black finish (BK).

Required Specifications

Top material*
Top finish
Edge
Leg finish*

Optional Specifications

Casters*
HP laminate*

B BUNGEE™ TABLES

FILLER MODESTY PANELS



Filler Modesty Panel - Straight

MODEL#	DIMENSIONS	FREIGHT CLASS	WT/LBS.	CUBIC FT.	LIST PRICE
--------	------------	---------------	---------	-----------	------------

	D x W x H				
BSFMS	.25 x 21 x 9	70	1	0.03	\$134

Used to fill the space between two **square** modesty panels where tables are linked in a straight configuration. Available in Silver (**SI**) or Black (**BK**). Please specify.



Filler Modesty Panel - Straight to Wedge

BSWFM	9 x 19.6 x .25	70	1	1.5	\$144
-------	----------------	----	---	-----	--------------

Used to fill the space between a straight modesty panel and a wedge table. Use for regular wedge table - tapered legs and flip-top wedge - spider legs. Available in Silver (**SI**) or Black (**BK**). Please specify.

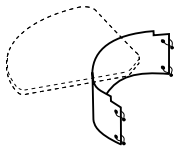

Filler Modesty Panel - Inside Curve

B23IFMS	.06 x 23 x 9	250	3	1.5	\$160
B29IFMS	.06 x 29 x 9	250	3	1.5	\$160
B30IFMS	.06 x 30 x 9	70	3	0.15	\$160

Used to fill the space (inside curve) between two modesty panels where tables are linked at an angle or curve. Use for the inside curve of Round Wedge Tables, Teardrop Tables, or Trapezoid Tables. Available in Silver (**SI**) or Black (**BK**). Please specify.

- Use model **B23IFMS** for Trapezoid Tables inside curve only.
- Use model **B29IFMS** for Teardrop Tables inside curve only.
- Use model **B30IFMS** for Round Wedge Tables inside curve only.

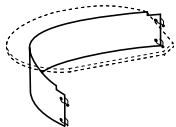

Filler Modesty Panel - Outside Curve

B56S	.06 x 56 x 9	250	4	1.5	\$229
B62S	.06 x 62 x 9	250	4	1.5	\$249
B71S	.06 x 71 x 9	250	4	1.5	\$300

Used to fill the space (outside curve) between two modesty panels where tables are linked at an angle or curve. Use for Teardrop Tables only (**B2036TDF**, **B2442TDF** and **B3048TDF**). Available in Silver (**SI**) or Black (**BK**). Please specify.

- Use model **B56S** for **B2036TDF** Teardrop Tables outside curve only.
- Use model **B62S** for **B2442TDF** Teardrop Tables outside curve only.
- Use model **B71S** for **B3048TDF** Teardrop Tables outside curve only.

Required Specifications

Finish

WIRE MANAGEMENT	MODEL#	DIMENSIONS	FREIGHT CLASS	WT/LBS.	CUBIC FT.	LIST PRICE	HPL ADD	UML ADD
		D x W x H						
	BWMS5	2 x 5 x 3.5	70	1	.10	\$19	N/A	N/A
	BWMD22	2 x 22 x 3.5	70	1	.10	\$26	N/A	N/A

Wire Management - 5" /22" Track

Retrofittable track mounts to the underside of worksurface. Includes wire clamp that can route data and voice wires separately. Black only.

- For a 5" track, order model **BWMS5** - includes one wire clamp.
- For a 22" track, order model **BWMD22** - includes two wire clamps.

BOARDROOM TABLE SETS	Meeting/Boardroom Table		Training	Lecture / AV Presentations	Small Teaming Stations	Large Teaming Stations		
11 Foot Configurations 	Meeting/Boardroom Table	Meeting/Boardroom Table	Training	Lecture / AV Presentations	Small Teaming Stations	Large Teaming Stations		
	Meeting/Boardroom Table	Training	Training	Lecture / AV Presentations	Small Teaming Stations	Large Teaming Stations		
Boardroom Table Set - 11 foot	BK132F	60 x 132 x 28.7	70	290	19.25	\$4495	\$1711	\$2047
	Set includes four freestanding tables with tapered legs and Bungee cords for tool free ganging. Leg finish or legs with casters optional, see page 649. Shipped easy to assemble in 6 cartons. Modesty panel set available, order BXK132QMP .							
	• Due to the unique geometry of the tables, all edge types will feature rounded corners.							
	Meeting/Boardroom Table	Meeting/Boardroom Table	Training	Lecture / AV Presentations	Small Teaming Stations	Large Teaming Stations		
	Meeting/Boardroom Table	Training	Training	Lecture / AV Presentations	Small Teaming Stations	Large Teaming Stations		
Boardroom Table Set - 11 foot	BK132S	60 x 132 x 28.7	85	290	22.25	\$5043	\$1711	\$2047
	Set includes four freestanding tables with spider legs and Bungee cords for tool free ganging. Leg finish or legs with casters optional, see page 649. Shipped easy to assemble in 6 cartons. Modesty panel set available, order BXK132QMP .							
	• Due to the unique geometry of the tables, all edge types will feature rounded corners.							
	Meeting/Boardroom Table	Meeting/Boardroom Table	Training	Lecture / AV Presentations	Small Teaming Stations	Large Teaming Stations		
	Meeting/Boardroom Table	Training	Training	Lecture / AV Presentations	Small Teaming Stations	Large Teaming Stations		
Modesty Panel Set for Boardroom Table	BXK132QMP	.69 x 45 x 9.6	92.5	13	1.10	\$495	N/A	N/A
	For use on 11 foot Boardroom Table Set . Includes mounting bracket and wire access sweep. Available in all Bungee laminate finishes.							

Required Specifications

- Top finish
- Edge
- Leg finish

Optional Specifications

- Casters
- Grommet
- Modesty panel
- HP laminate

B BUNGEE™ TABLES

BOARDROOM TABLE SETS

13/15 Foot Configurations

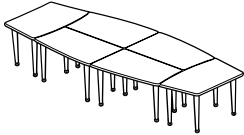

Boardroom Table Set - 13 and 15 foot

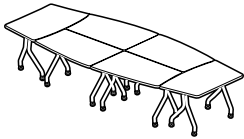

Boardroom Table Set - 13 and 15 foot

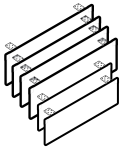

Modesty Panel Set for Boardroom Table

MODEL#	DIMENSIONS D x W x H	FREIGHT CLASS	WT/LBS.	CUBIC FT.	LIST PRICE	HPL ADD	UML ADD
	Meeting/Boardroom Table	Lecture / AV Presentations	Training		Small Teaming Stations	Large Teaming Stations	
	Meeting/Boardroom Table	Lecture / AV Presentations	Meeting/Boardroom Table	Training	Small Teaming Stations		
BK156F	60 x 156 x 28.7	85	374	26.25	\$6616	\$2170	\$2607
BK180F	60 x 180 x 28.7	85	420	29.75	\$7209	\$2479	\$2977

Set includes six freestanding tables with **tapered legs** and Bungee cords for tool free ganging. Leg finish or legs with casters optional, see page 649 . Shipped easy to assemble in 9 cartons. Modesty panel set available, order **BK156QMP/ BK180QMP**.

- Due to the unique geometry of the tables, all edge types will feature rounded corners.

BK156S	60 x 156 x 28.7	85	374	28.75	\$6826	\$2170	\$2607
BK180S	60 x 180 x 28.7	85	420	32.50	\$7401	\$2479	\$2977

Set includes six freestanding tables with **spider legs** and Bungee cords for tool free ganging. Leg finish or legs with casters optional, see page 649 . Shipped easy to assemble in 9 cartons. Modesty panel set available, order **BK156QMP/ BK180QMP**.

- Due to the unique geometry of the tables, all edge types will feature rounded corners.

BXK156QMP	.69 x 33 x 9.6	125	20	2.9	\$837	N/A	N/A
BXK180QMP	.69 x 45 x 9.6	125	25	3.2	\$801	N/A	N/A

For use on **13 & 15 foot Boardroom Table Set**. Includes mounting bracket and wire access sweep. Available in all Bungee laminate finishes. Edge available in Silver finish (**SI**) or Black finish (**BK**).

- Use model **BXK156QMP** for **BK156F/S** Boardroom Table Set.
- Use model **BXK180QMP** for **BK180F/S** Boardroom Table Set.

Required Specifications

Top material
Top finish
Edge
Leg + caster finish

Optional Specifications

Grommet
Modesty panel
HP laminate

Accessories

Power block

RECTANGULAR TABLE - FLIP TOP

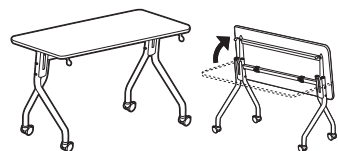
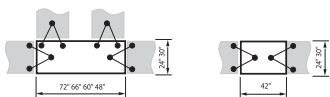

Flip-Top Rectangular Table - Spider Legs

MODEL#	DIMENSIONS	FREIGHT CLASS	WT/LBS.	CUBIC FT.	LIST PRICE	HPL ADD	UML ADD
	D x W x H						
BX2442RES	24 x 42 x 29.2	250	66	20.75	\$1656	\$249	\$301
BX2448RES	24 x 48 x 29.2	250	72	23.5	\$1678	\$249	\$301
BX2460RES	24 x 60 x 29.2	250	84	29	\$1717	\$309	\$375
BX2466RES	24 x 66 x 29.2	250	97	31.75	\$1732	\$370	\$450
BX2472RES	24 x 72 x 29.2	250	102	34.75	\$1764	\$370	\$450
BX3042RES	30 x 42 x 29.2	250	73	25.5	\$1656	\$309	\$375
BX3048RES	30 x 48 x 29.2	250	73	28.75	\$1678	\$309	\$375
BX3060RES	30 x 60 x 29.2	250	94	35.75	\$1724	\$384	\$468
BX3066RES	30 x 66 x 29.2	250	106	39.25	\$1742	\$461	\$561
BX3072RES	30 x 72 x 29.2	250	112	42.5	\$1780	\$461	\$561

Table features a flip-top worksurface for ease of storage. Single hand release mechanism can be activated from left or right side of the table. Tables can be nested when folded. Each table can be "Bungee-tied" to other tables of the same depth. Folding modesty panels available, see next page.

- **Tables 48" and longer connect in both Straight and "L" configurations**
- **Standard with locking casters**
- **Due to hardware placement, tables placed in back-to-back configurations will not be able to be "Bungee-tied" together.**

TRAPEZOID TABLES - FLIP TOP

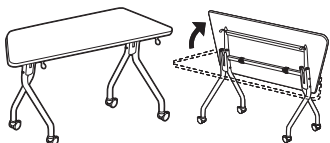
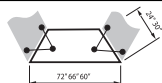

Flip-Top Trapezoid Table - Spider Legs

BX2460TRS	24 x 60 x 29.2	150	112	28	\$1552	\$309	\$375
BX2466TRS	24 x 66 x 29.2	250	112	31	\$1578	\$370	\$450
BX2472TRS	24 x 72 x 29.2	250	112	33	\$1600	\$370	\$450
BX3060TRS	30 x 60 x 29.2	250	112	35.5	\$1586	\$384	\$468
BX3066TRS	30 x 66 x 29.2	250	112	39	\$1609	\$461	\$561
BX3072TRS	30 x 72 x 29.2	250	112	42.5	\$1632	\$461	\$561

Table features a flip-top worksurface for ease of storage. Single hand release mechanism can be activated from left or right side of the table. Tables can be nested when folded. Each table can be "Bungee-tied" to other tables of the same depth. Folding modesty panels available, see next page.

- **Available with bubble edge (BB or BS) only.**
- **Standard with locking casters**

KEYSTONE TABLES - FLIP TOP

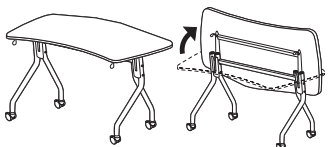

Flip-Top Keystone Table - Spider Legs

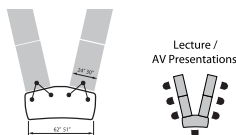

BX24KSS	24 x 51 x 29.2	125	112	16.5	\$1544	\$309	\$375
BX30KSS	30 x 62 x 29.2	125	112	16.5	\$1609	\$461	\$561

Table features a flip-top worksurface for ease of storage. Single hand release mechanism can be activated from left or right side of the table. Tables can be nested when folded. Each table can be "Bungee-tied" to other tables of the same depth.

- **Modesty panels or Filler Modestys are NOT available.**
- **Standard with locking casters**

Required Specifications

Top material
Top finish
Edge
Leg + caster finish

Optional Specifications

Grommet
Modesty panel
HP laminate

Accessories

Power block

B BUNGEE™ TABLES

WEDGE TABLES - FLIP TOP

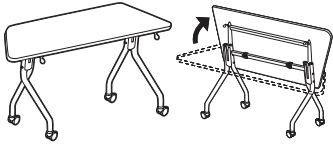

Flip-Top Wedge Table - Spider Legs

MODEL#	DIMENSIONS	FREIGHT CLASS	WT/LBS.	CUBIC FT.	LIST PRICE	HPL ADD	UML ADD
BX24WES	24 x 63 x 29	60	76	33	\$1944	\$442	\$538
BX30WES	30 x 70 x 29.2	250	84	33	\$1976	\$442	\$538

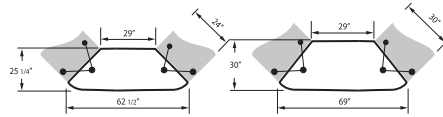
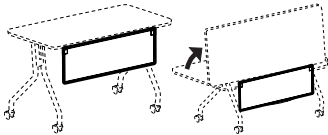

Table features a flip-top worksurface for ease of storage. Single hand release mechanism can be activated from left or right side of the table. Tables can be nested when folded. Each table can be "Bungee-tied" to other tables of the same depth. Folding modesty panels available, see below.

- Standard with locking casters

MODESTY PANELS - FLIP TOP



Modesty Panel

MODEL#	DIMENSIONS	FREIGHT CLASS	WT/LBS.	CUBIC FT.	LIST PRICE
BX36QMP	.69 x 21 x 9.6	250	3	1.3	\$122
BX42QMP	.69 x 27 x 9.6	250	4	1.4	\$128
BX48QMP	.69 x 33 x 9.6	250	4	1.6	\$136
BX60QMP	.69 x 45 x 9.6	250	5	2.1	\$147
BX66QMP	.69 x 51 x 9.6	250	6	2.4	\$154
BX72QMP	.69 x 57 x 9.6	250	7	2.6	\$161

For use on **Flip Top Rectangular Tables**. Includes hinged mounting bracket. Available in all Bungee laminate finishes. Edge available in Silver finish (**SI**) or Black finish (**BK**).

- Modesty panel model number indicates the width of table to be used on.

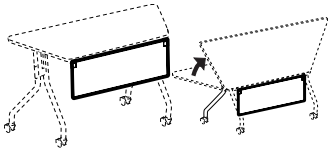

Modesty Panel

BXM60QMP	.69 x 27 x 9.6	300	4	2.1	\$128
BXM66QMP	.69 x 33 x 9.6	300	4	2.4	\$136
BXM72QMP	.69 x 39 x 9.6	300	5	2.6	\$141
BXL60QMP	.69 x 21 x 9.6	300	3	2.1	\$126
BXL66QMP	.69 x 27 x 9.6	300	4	2.4	\$128
BXL72QMP	.69 x 33 x 9.6	300	4	2.6	\$136

For use on **Flip Top Trapezoid Tables**. Includes hinged mounting bracket. Intended for use on the short side of the table; may be used on long side but leaves a larger gap. Available in all Bungee laminate finishes. Edge available in Silver finish (**SI**) or Black finish (**BK**).

- Modesty panel model number indicates the width of table to be used on.
- Specify **BXM** models for 24"D tables and **BXL** models for 30"D tables.

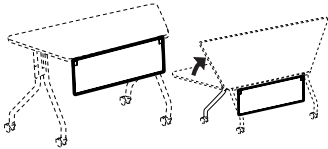

Modesty Panel

BXWQMP	.69 x 27 x 9.6	250	4	1.5	\$128
--------	----------------	-----	---	-----	--------------

For use on **Flip Top Wedge Tables**. Includes hinged mounting bracket. Intended for use on the short side of the table. Available in all Bungee laminate finishes. Edge available in Silver finish (**SI**) or Black finish (**BK**).

- Modesty panel model number indicates the width of table to be used on.

Required Specifications

Top material
Top finish
Edge
Leg + caster finish

Optional Specifications

Grommet
Modesty panel
HP laminate

Accessories

Power block

BOARDROOM TABLE SET - FLIP TOP

MODEL# DIMENSIONS FREIGHT CLASS WT./LBS. CUBIC FT. LIST PRICE HPL ADD UML ADD

D x W x H

4 pc. Configurations

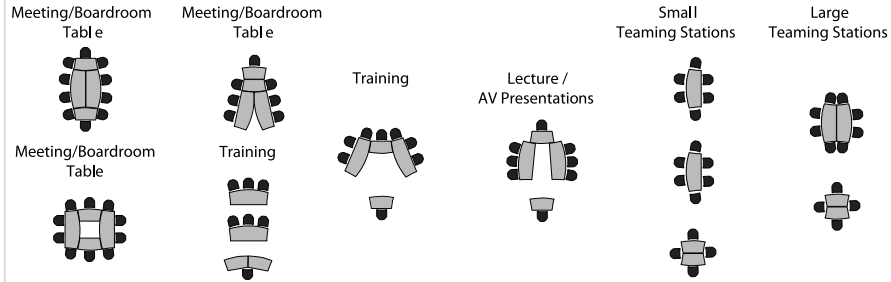

Boardroom Table Set - 4pc. Flip Top

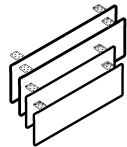

Square Modesty Panel Set for 4pc. Flip Top Table

BXK132S	60 x 132 x 29.2	250	352	151.25	\$6350	\$1748	\$2139
---------	-----------------	-----	-----	--------	---------------	---------------	---------------

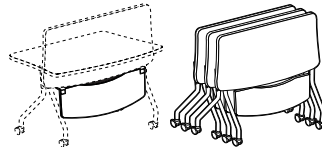

Set includes four freestanding tables with **spider legs** and Bungee cords for tool free ganging. Only legs with casters available, see page 649 for finish choices. All tables feature a flip top worksurface for ease of storage. Single hand release mechanism can be activated from left or right side of table. Tables can be nested when folded. Shipped in 4 cartons. Modesty panel set available, order **BXK132QMP**.

- **Due to the unique geometry of the tables, all edge types will feature rounded corners.**

BXK132QMP	.69 x 45 x 9.6	150	13	2.5	\$495	N/A	N/A
-----------	----------------	-----	----	-----	--------------	-----	-----

For use on **4 pc. flip top table kits**. Modesty panels flip down for storage. Features black wire access sweep. Available in all Bungee laminate finishes. Edge available in Silver finish (**SI**) or Black finish (**BK**).

Required Specifications

Top material
Top finish
Edge
Leg + caster finish

Optional Specifications

HP laminate

B BUNGEE™ TABLES

MODESTY PANEL SETS

MODEL#

DIMENSIONS

FREIGHT CLASS

WT/LBS.

CUBIC FT.

LIST PRICE

HPL ADD

UML ADD

D x W x H

6 pc. Configurations

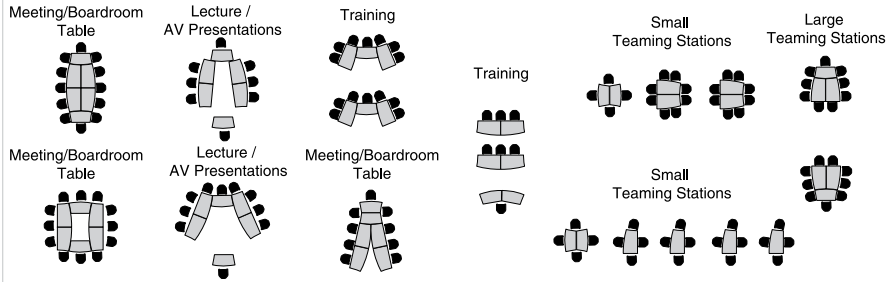

MODEL#	DIMENSIONS	FREIGHT CLASS	WT/LBS.	CUBIC FT.	LIST PRICE	HPL ADD	UML ADD
BXK156S	60 x 156 x 29.2	250	452	181.75	\$9400	\$2018	\$2463
BXK180S	60 x 180 x 29.2	250	507	209.50	\$9628	\$2321	\$2838



Boardroom Table Set - 6pc. Flip Top

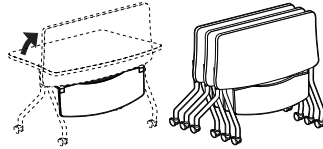

Set includes six freestanding tables with **spider legs** and Bungee cords for tool free ganging. Only legs with casters available, see page 649 for finish choices. All tables feature a flip top worksurface for ease of storage. Single hand release mechanism can be activated from left or right side of table. Tables can be nested when folded. Shipped in 6 cartons. Modesty panel set available, order **BXK156QMP/ BXK180QMP**.

• **Due to the unique geometry of the tables, all edge types will feature rounded corners.**

BXK156QMP	.69 x 33 x 9.6	125	20	2.9	\$837	N/A	N/A
BXK180QMP	.69 x 45 x 9.6	125	25	3.2	\$801	N/A	N/A

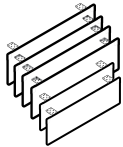

Square Modesty Panel Set for 6 pc. Flip Top Table

For use on **6 pc. flip top table kits**. Modesty panels flip down for storage. Features black wire access sweep. Available in all Bungee laminate finishes. Edge available in Silver finish (**SI**) or Black finish (**BK**).

Required Specifications

Top material
Top finish
Edge
Leg + caster finish

Optional Specifications

Grommet

Accessories

Power block

ACCESSORIES **MODEL#** **DIMENSIONS** **FREIGHT CLASS** **WT./LBS.** **CUBIC FT.** **LIST PRICE** **HPL ADD** **UML ADD**

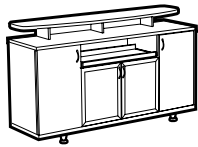

Credenza Buffet

D x W x H								
B2072BUF	20 x 72 x 42	100	305	37.50	\$3921	\$579	\$690	

Pull-out shelf. Top transaction shelf is edged with bubble molding. Side storage compartments feature a laminate door and one adjustable shelf each. Center storage features frosted aluminum doors with one adjustable shelf. Leveler feet are standard.

- Some assembly required.

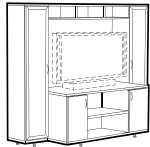

Audio/Visual Cabinet

B249072AV	24 x 90 x 72	92.5	530	52.52	\$6463	\$584	\$700	
-----------	--------------	------	-----	-------	--------	-------	-------	--

Top pigeon holes and center adjustable shelf accommodate electronic equipment, CDs and other media. Bottom storage compartments feature laminate doors and one adjustable shelf. Side storage towers feature frosted aluminum doors with three adjustable shelves each. Accommodates TVs up to 58" w x 34" h x 24" d.

- Some assembly required.



Lectern

B44LEC	17 x 22 x 44	250	36	12.50	\$986	N/A	N/A	
--------	--------------	-----	----	-------	-------	-----	-----	--

Features angled stand with pencil ledge. Locking casters. **Specify CS or CK.**

Required Specifications

Top material
Top finish
Edge
Leg finish

Optional Specifications

Grommet

Accessories

Power block

B BUNGEE SL™ - NOTES

GENERAL INFORMATION

- Introducing Bungee SL - a product line to complement and coordinate with the top selling Bungee training tables series.
- Bungee SL takes the popular aesthetic of the Bungee series and allows tables to be specified in shared leg and permanent applications - great for benching, training, teaming and academic areas.
- Bungee SL tops and legs are sold separately, increasing the flexibility of the product in the future and allows for space saving in areas where real estate is a premium.
- High pressure tops are available in all Bungee SL laminates at an extended lead time - please refer to model # for pricing.
- Ultra matte high pressure laminate tops are available in all Bungee SL solid laminate finishes at an extended lead time - see model # for pricing
- For environmental certifications, please visit globalfurnituregroup.com

CONSTRUCTION

- Tops are 1" thick thermally fused laminate (**TFL**); optional in 1-1/16" thick high pressure laminate (**HPL** - upcharge applies) or ultra matte high pressure laminate (**UML** - upcharge applies). Modesty panels are 11/16" thick.
- All laminate components are made of 45 lb. density particle board with high performance thermally fused laminate surface or high pressure laminate surface with a kraft paper backing.
- Tops 60" and over feature a built-in support bar. The support bar is 10" from the **approach** side, and clearance to the bottom of the support bar is 27" from the floor.
- **BUNGEE CORDS ARE NOT INCLUDED AND ARE NOT COMPATIBLE WITH BUNGEE SL TOPS**

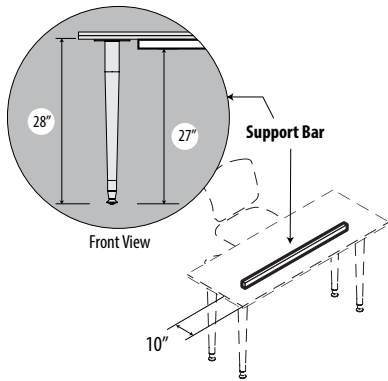

- **BB/BS** - Bungee bubble edge: unique "bubble" molding found on original Bungee
- **AB/AS** - Split color PVC edge: edge matches split color aesthetic of the bubble edge, but allows for 90 degree corners and a cleaner look.
- **A3** - 2mm preferred matching edge. Coordinates well with Adaptabilities and Zira 1" tops.
- **AR** - Bicut edge. Coordinates well with Adaptabilities and Zira 1" tops.

LEGS

- Two leg styles are available: tapered and spider leg. Available in Black (**TBL**) or Tungsten (**TTU**) finish, please specify. For added durability, paint finish is textured. Levelers are standard; casters are not available for Bungee SL legs. Levelers adjust 3mm - 10mm in height.

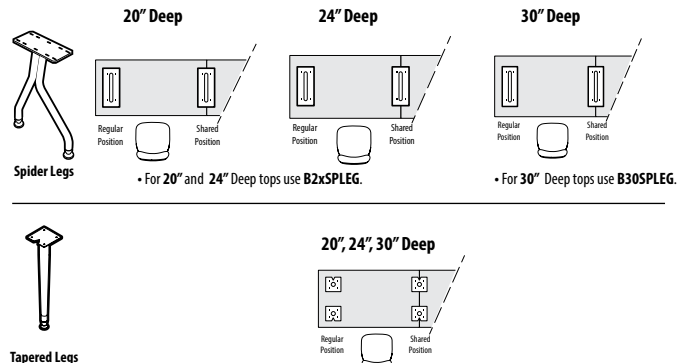

EDGE DETAIL

- Bungee SL comes with a choice of four edge styles:



A3 - square corner, standard edge



AR - square corner, bicut edge



AS - square corner, Silver



AB - square corner, Black



BS - rounded corner, Silver



BB - rounded corner, Black

MODESTY PANELS

- For modesty panels without power and data management, please see **Bungee modesty panels**, page 648

WIRE MANAGEMENT / POWER OPTIONS

- Refer to **Productivity Solutions** for additional power and charging solutions.

SPECIFICATIONS

- Specifications marked with an * are applicable to only those products which have the * symbol beside the product name.

1. SPECIFY MODEL NUMBER

2. SPECIFY MATERIAL TYPE

- **TFL** for product with thermally fused laminate tops
- **HPL** for product with high pressure laminate tops (upcharge applies)
- **UML** for product with ultra matte high pressure laminate tops (upcharge applies)

3. SPECIFY FINISH

LAMINATE FINISHES

Thermally fused laminate (**TFL**) and high pressure laminate (**HPL**) available in all finishes. Ultra matte high pressure (**UML**) available on select finishes* only.

ACJ	Absolute Acajou	FCL	First Class
ASN	Asian Night	NBL	Noce Biondo
AWC	Avant Cherry	NGL	Noce Grigio
AWH	Avant Honey	NEL	Noce Leggero
BLK	Black*	NML	Noce Medio
BZD	Blizzard*	QTM	Quartered Mahogany
BRC	Brushed Cobalt	SBY	Sheer Beauty
CMB	Clear Maple	SDT	Stonedust*
CGY	Custom Grey*	SOG	Storm Grey*
DES	Dark Espresso	WHE	Walnut Heights
DWT	Designer White*	WHC	White Chocolate
FAS	Fashionista	WCR	Winter Cherry

Edge:

BB	Bungee bubble edge with Black trim
BS	Bungee bubble edge with Silver trim
AB	Split color edge with Black trim
AS	Split color edge with Silver trim
A3	Matching edge
AR	Matching bicut edge

Legs with Glides:

TBL	Black
TTU	Tungsten

Handles:

HS	Silver
HT	Black Nickel

Modesty Panel Edge:

SI	Silver
BK	Black Nickel

Feet:

BLK	Black Nickel	TTU	Tungsten
------------	--------------	------------	----------

4. SPECIFY OPTIONS

GROMMETS

- Optional grommets available in standard worksurface locations (left, center or right) **for rectangular tops 48" and up**. Order as: **AG1, AG2 or AG3 - Add \$103**
- Optional grommets are available in **center position only** for **rectangular tops (36" and 42")**, **keystone, half moon and wedge tops**. Order as **AG2 - Add \$103**.
- Grommet hole dimensions are 3.25" wide x 1.875" deep.
- Grommets may be placed at non-standard locations. Order as: **AGS - Add \$103**. A drawing must be supplied with vertical and horizontal dimensions to the center of the cut-out (as in drawing below). Please refer to CUSTOM GROMMET LOCATION FORM in the back reference section.

Grommet hole dimensions

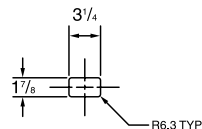

Grommet

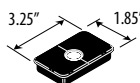

Keystone

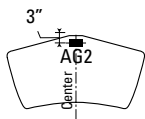

Half Moon

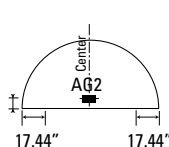

Wedge

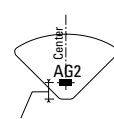

Rectangular Tops

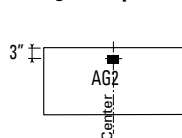

For **36"** and **42"** wide units

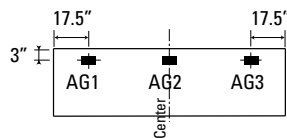

For **48"**, **60"** and **72"** wide units

4. SPECIFY OPTIONS (CONT'D)

POWER BLOCK

- A power block is a rectangular worksurface power/data module with one electrical duplex receptacle and two data (RJ45) receptacles. 9' black cord included. Power block dimensions are 3.5"D x 6.5"W x 2.75"H. Power block cut-out dimensions are 2.75"D x 6"W.
- A power block cut-out (model **PMSPPDM**) may be ordered for **rectangular tops** (48" and up) in place of standard grommets. Order as **E1, E2 or E3. Add \$103.**
- A power block cut-out (model **PMSPPDM**) may be ordered in the **center position** only for **rectangular tops** (36" and 42"), **keystone and half moon tops.** Order as **E2. Add \$103.**
- To purchase a power block, you must specify both the power block cut-out location and the power block model #. Order power block separately as **PMSPPDM. Add \$352.**

Keystone

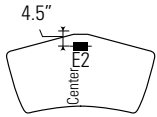

Half Moon

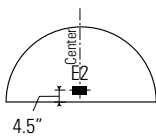

Power Block

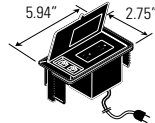

Rectangular Tops

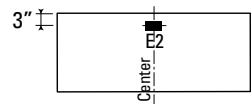

For **36", 42"** and **48"** wide units

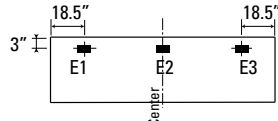

For **60"** and **72"** wide units

VILLA POWER BLOCK (CORDED VERSION ONLY)

- A Villa power block (corded) is available in four options (see page 620 for details). Villa power block (corded) dimensions vary by model. Villa cut-out dimensions are 3"D x 5.25"W.
- A Villa cut-out may be ordered for **rectangular tops 48" and up.** Order as **V1, V2 or V3 - Add \$103 for each cut-out.**
- A Villa cut-out may be ordered in the **center position only** for **rectangular tops** (36" and 42"), **keystone and half moon tops.** Order as **V2 - Add \$103.**
- Order Villa power block and Villa grommet cover separately. See page 620 for pricing and details.

Keystone

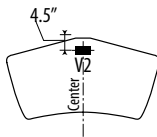

Half Moon

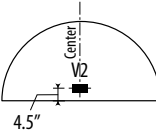

Villa Power Block

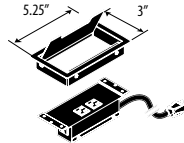

Rectangular Tops

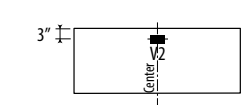

For **36", 42"** and **48"** wide units

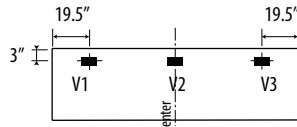

For **60"** and **72"** wide units

MODPOWER DAISY CHAIN SOLUTION

- Add flexible power and USB charging to Bungee SL rectangular tables. Connect up to four units with a single corded infeed with NEMA plug.
- ModPower units are sold separately, refer to Productivity Solutions page 609.
- Begin run with a starter unit which includes a corded infeed. Add additional middle or end units as required. Middle and end units are equipped with connecting cables.
- On-surface modules clamp on or screw mount to the table tops.
- In-surface modules require table top cut-outs for mounting. Specify cut-out option:
 - **MPS** for a single cut-out to accommodate one ModPower in-surface unit (cut-out will be centered on the approach side) for **42" to 72" wide rectangular tables. Add \$103**
 - **MPD** for two cut-outs in the left and right positions, 18.25" from ends to center of unit on approach side for **60", 66" and 72" wide rectangular tables. Add \$205.**

TOPS WITH SQUARE CORNERS (A3, AR OR AB/AS EDGE)	MODEL#	DIMENSIONS	FREIGHT CLASS	WT/LBS.	CUBIC FT.	LIST PRICE	HPL ADD	UML ADD
		D x W x H						
	BS3072REC	30 x 72 x 1	70	60	4	\$613	\$527	\$630
	BS3060REC	30 x 60 x 1	70	53	3.4	\$512	\$438	\$528
	BS3048REC	30 x 48 x 1	70	46	2.7	\$315	\$353	\$422
	BS3042REC	30 x 42 x 1	70	42	2.4	\$306	\$309	\$371
	BS3036REC	30 x 36 x 1	70	38	2.1	\$244	\$267	\$315
<hr/>								
	BS2472REC	24 x 72 x 1	70	51	3.3	\$536	\$422	\$505
	BS2460REC	24 x 60 x 1	70	44	2.8	\$468	\$353	\$422
	BS2448REC	24 x 48 x 1	70	37	2.3	\$268	\$282	\$338
	BS2442REC	24 x 42 x 1	70	33	2	\$253	\$250	\$297
	BS2436REC	24 x 36 x 1	70	29	1.8	\$239	\$213	\$255
<hr/>								
	BS2072REC	20 x 72 x 1	85	43	2.9	\$498	\$353	\$422
	BS2060REC	20 x 60 x 1	70	37	2.4	\$422	\$297	\$357
	BS2048REC	20 x 48 x 1	70	30	2	\$252	\$250	\$297
	BS2042REC	20 x 42 x 1	70	27	1.8	\$233	\$213	\$255
	BS2036REC	20 x 36 x 1	70	24	1.5	\$219	\$213	\$255



Rectangular Top - Square Corners

Rectangular 1" thick worksurface with **Square Corners**. Can accept Tapered (B29TPLEG) or Spider Legs (B2XSPLEG / B30SPLEG) in "end of run" or shared leg positions. Tops 60" and up include a built-in support bar. Shipped RTA (ready to assemble). Compatible with standard modesty panels (see page 573).

- For worksurfaces to be used as a return, please see Return Tops.
- Legs sold separately.

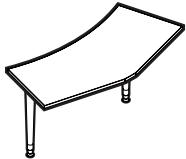

Keystone Top - Square Corners*

BS30KSF	30.5 x 62.75 x 28.7	150	37	7.2	\$1185	\$527	\$630
BS24KSF	28.75 x 52 x 28.7	150	29	5.6	\$1096	\$385	\$463
BS20KSF	27.75 x 44 x 28.7	150	25	4.8	\$1083	\$319	\$380

1" thick worksurface with **Square Corners**. Includes (2) Tapered legs. *Not available with Spider Legs*. Connects to other tops of 20", 24" or 30" depths. Shipped RTA (ready to assemble). Modesty panels or filler panels are NOT available.

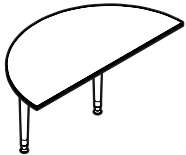

Half Moon Top - Square Corners*

BS3060HMF	29.75 x 59.4 x 28.7	150	36	6.6	\$1019	\$438	\$528
BS2448HMF	24 x 48.2 x 28.7	150	24	4.6	\$959	\$282	\$338

1" thick worksurface with **Square Corners**. Includes (2) Tapered legs. *Not available with Spider Legs*. Connects to other tables equaling the same length. Shipped RTA (ready to assemble). Modesty panels or filler panels are NOT available.

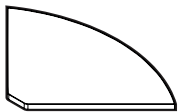

90° Wedge Top - Square Corners

BS24WE	26.8 x 26.8 x 1	92.5	15	1.5	\$297	\$250	\$297
BS20WE	22.8 x 22.8 x 1	100	10	1.2	\$219	\$213	\$255

1" thick worksurface with **Square Corners**. Can accept Tapered (B29TPLEG) or Spider Legs (B2XSPLEG / B30SPLEG) in shared positions only. Shipped RTA (ready to assemble). Accepts filler modesty panels.

- Legs sold separately.

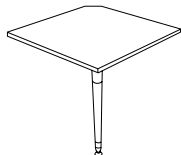

90° Corner - Square Corners*

BS30CN	33.2 x 33.2 x 28.7	125	36	2.50	\$665	\$207	\$255
--------	--------------------	-----	----	------	-------	-------	-------

Connects to 30" Deep Rectangular Tables. Includes (1) Tapered leg. *Not available with Spider Legs*.

Required Specifications

Top material
Top finish
Edge detail
Leg finish*

Optional Specifications

Grommet position or power block cut-out
Modesty panel

Accessories

Power block
Villa Power Block (Corded)

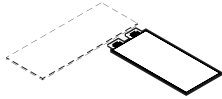

Rectangular Return Tops - Square Corners

MODEL#	DIMENSIONS D x W x H	FREIGHT CLASS	WT/LBS.	CUBIC FT.	LIST PRICE	HPL ADD	UML ADD
BS3054RRE	30 x 54 x 1	70	50	3.1	\$335	\$397	\$473
BS3048RRE	30 x 48 x 1	70	46	2.7	\$315	\$353	\$422
BS3042RRE	30 x 42 x 1	70	42	2.4	\$306	\$309	\$371
BS3036RRE	30 x 36 x 1	70	38	2.1	\$244	\$267	\$315
BS2454RRE	24 x 54 x 1	70	40	2.5	\$290	\$319	\$380
BS2448RRE	24 x 48 x 1	70	37	2.3	\$268	\$282	\$338
BS2442RRE	24 x 42 x 1	70	33	2	\$253	\$250	\$297
BS2436RRE	24 x 36 x 1	70	29	1.8	\$239	\$213	\$255
BS2054RRE	20 x 54 x 1	70	33	2.2	\$275	\$267	\$315
BS2048RRE	20 x 48 x 1	70	30	2	\$252	\$238	\$283
BS2042RRE	20 x 42 x 1	70	27	1.8	\$233	\$213	\$255
BS2036RRE	20 x 36 x 1	70	24	1.5	\$219	\$178	\$213

Rectangular 1" thick worksurface with **Square Corners**. Includes two flat brackets to attach to another worksurface on one end. Can accept Tapered (B29TPLEG) or Spider Legs (B2XSPLEG / B30SPLEG) on the other end. 54" tops include a built-in support bar. Shipped RTA (ready to assemble). Compatible with standard modesty panels (see page 657).

- For worksurfaces to be used as a main surface, please see Rectangular Tops.
- Legs sold separately.

TOPS WITH ROUNDED CORNERS (BB/BS EDGES ONLY)

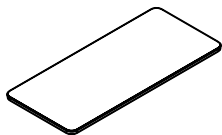

Rectangular Top - Rounded Corners*

BB3072REC	30 x 72 x 1	85	59	4	\$785	\$527	\$630
BB3060REC	30 x 60 x 1	70	52	3.4	\$657	\$438	\$528
BB3048REC	30 x 48 x 1	70	45	2.7	\$400	\$353	\$422
BB3042REC	30 x 42 x 1	70	41	2.4	\$391	\$309	\$371
BB3036REC	30 x 36 x 1	70	37	2.1	\$316	\$267	\$315
BB2472REC	24 x 72 x 1	70	50	3.3	\$688	\$422	\$505
BB2460REC	24 x 60 x 1	70	43	2.8	\$599	\$353	\$422
BB2448REC	24 x 48 x 1	70	36	2.3	\$340	\$282	\$338
BB2442REC	24 x 42 x 1	70	32	2	\$325	\$250	\$297
BB2436REC	24 x 36 x 1	70	28	1.8	\$306	\$213	\$255
BB2072REC	20 x 72 x 1	85	42	2.9	\$638	\$353	\$422
BB2060REC	20 x 60 x 1	70	36	2.4	\$540	\$297	\$357
BB2048REC	20 x 48 x 1	85	29	2	\$322	\$250	\$297
BB2042REC	20 x 42 x 1	85	26	1.8	\$297	\$213	\$255
BB2036REC	20 x 36 x 1	70	23	1.5	\$277	\$213	\$255

Rectangular 1" thick worksurface with **Rounded Corners**. Can accept Tapered (B29TPLEG) or Spider Legs (B2XSPLEG / B30SPLEG) in "end of run" or shared leg positions. Tops 60" and up include a built-in support bar. Shipped RTA (ready to assemble). Compatible standard modesty panels (see page 657).

- For worksurfaces to be used as a return, please see Return Tops
- Legs sold separately.

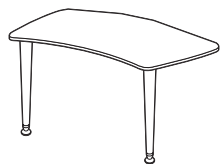

Keystone Top - Rounded Corners**

BB30KSF	30.5 x 62.75 x 28.7	150	36	7.2	\$1185	\$527	\$630
BB24KSF	28.75 x 52 x 28.7	150	28	5.6	\$1096	\$385	\$463
BB20KSF	27.75 x 44 x 28.7	150	24	4.8	\$1083	\$319	\$380

1" thick worksurface with **Rounded Corners**. Includes (2) Tapered legs. *Not available with Spider Legs*. Connects to other tops of 20", 24" or 30" depths. Shipped RTA (ready to assemble). Modesty panels or filler panels are NOT available.

Required Specifications

Top material
Top finish
Edge detail
Leg finish**

Optional Specifications

Grommet position or power block cut-out
Modesty panel*

Accessories

Power block
Villa Power Block (Corded)

MODEL#	DIMENSIONS	FREIGHT CLASS	WT/LBS.	CUBIC FT.	LIST PRICE	HPL ADD	UML ADD
--------	------------	---------------	---------	-----------	------------	---------	---------

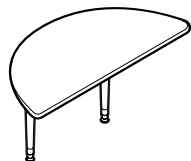

Half Moon Top - Rounded Corners*

	D x W x H						
BB3060HMF	29.75 x 59.4 x 28.7	150	35	6.6	\$1019	\$438	\$528
BB2448HMF	24 x 48.2 x 28.7	150	23	4.6	\$959	\$282	\$338

1" thick worksurface with **Rounded Corners**. Includes (2) Tapered legs. *Not available with Spider Legs*. Connects to other tables equaling the same length. Shipped RTA (ready to assemble). Modesty panels or filler panels are NOT available.



90° Wedge Top - Rounded Corners

BB24WE	26.8 x 26.8 x 1	100	14	1.5	\$380	\$250	\$297
BB20WE	22.8 x 22.8 x 1	125	9	1.2	\$277	\$213	\$255

1" thick worksurface with **Rounded Corners**. Can accept Tapered (B29TPLEG) or Spider Legs (B2XSPLEG / B30SPLEG) in shared positions only. Shipped RTA (ready to assemble). Accepts filler modesty panels.

- Legs sold separately.

BB3054RRE	30 x 54 x 1	70	50	3.06	\$430	\$397	\$473
BB3048RRE	30 x 48 x 1	70	46	2.75	\$400	\$353	\$422
BB3042RRE	30 x 42 x 1	70	42	2.44	\$391	\$309	\$371
BB3036RRE	30 x 36 x 1	70	38	2.13	\$316	\$267	\$315

BB2454RRE	24 x 54 x 1	70	40	2.54	\$370	\$319	\$380
BB2448RRE	24 x 48 x 1	70	37	2.28	\$340	\$282	\$338
BB2442RRE	24 x 42 x 1	70	33	2.03	\$325	\$250	\$297
BB2436RRE	24 x 36 x 1	70	29	1.77	\$306	\$213	\$255

BB2054RRE	20 x 54 x 1	70	33	2.2	\$351	\$267	\$315
BB2048RRE	20 x 48 x 1	70	30	1.97	\$322	\$238	\$283
BB2042RRE	20 x 42 x 1	70	27	1.75	\$297	\$213	\$255
BB2036RRE	20 x 36 x 1	70	24	1.53	\$277	\$178	\$213

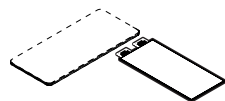

Rectangular Return Tops - Rounded Corners

Rectangular 1" thick worksurface with **Rounded Corners**. Includes two flat brackets to attach to another worksurface on one end. Can accept Tapered (B29TPLEG) or Spider Legs (B2XSPLEG / B30SPLEG) on the other end. 54" tops include a built-in support bar. Shipped RTA (ready to assemble). Compatible with standard modesty panels (see page 573).

- For worksurfaces to be used as a main surface, please see Rectangular Tops
- Legs sold separately.

BB30CN	33.17 x 33.17 x 28.7	125	36	2.50	\$715	\$207	\$255
--------	----------------------	-----	----	------	--------------	--------------	--------------

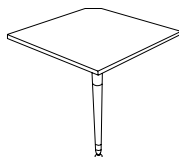

90° Corner - Rounded Corners*

Connects to 30" Deep Rectangular Tables. Includes (1) Tapered leg. *Not available with Spider Legs*.

Required Specifications

Top material
Top finish
Edge detail
Leg finish*



Optional Specifications

Grommet position or power block cut-out
Filler Modesty Panel (Wedge Tops only)
Modesty Panel (Rectangular Return Tops)

Accessories

Power block
Villa power block (Corded)

B BUNGEE SL™

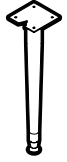
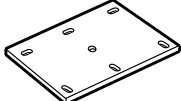
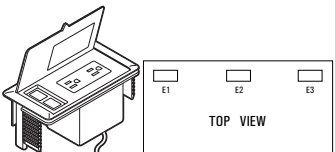
LEGS	MODEL#	DIMENSIONS D x W x H	FREIGHT CLASS	WT./LBS.	CUBIC FT.	LIST PRICE
 <p>Spider Legs for 30" D Tables*</p>	B30SPLEG	25 x 6 x 27.7	150	16	2.9	\$430
<p>Spider leg with levellers. Shipped/sold one per carton. Tops sold separately.</p> <ul style="list-style-type: none"> • Available in Tungsten (TTU) or Black (TBL). Please specify. • To be used with 30" D tops only 						
 <p>Spider Legs for 20" & 24" D Tables*</p>	B2XSPLEG	20 x 6 x 27.7	125	14	2.2	\$371
<p>Spider leg with levellers. Shipped/sold one per carton. Tops sold separately.</p> <ul style="list-style-type: none"> • Available in Tungsten (TTU) or Black (TBL). Please specify. • To be used with 20" & 24" deep tops only 						
 <p>Tapered Leg*</p>	B29TPLEG	6 x 6 x 27.7	85	11	0.8	\$176
<p>Tapered leg with levellers for tables of all depths. Shipped/sold one per carton. Tops sold separately.</p> <ul style="list-style-type: none"> • Available in Tungsten (TTU) or Black (TBL). Please specify. 						
 <p>Flat Bracket</p>	B6PLT	6 x 6 x .25	70	2	0.1	\$61
<p>To be used as a mending plate for Bungee SL. Black only. Shipped/sold one per pack.</p>						
 <p>Power/Data Block</p>	PMSPPDM	3.5 x 6.5 x 2.75	70	2	.10	\$352
<p>Worksurface power and data module. Two power receptacles and two data receptacles. 9' cord. Specify position and add \$103 for cut-out in worksurface. See diagram E1/E2/E3 for specification location. Black (BLK) only.</p>						

Required Specifications

Leg finish*



Bring people together. Collaborative Spaces™ fosters teamwork through adaptable environments that can transform at a moment's notice or evolve over time. Optimize existing spaces with individual pieces or create new ones with the full range of mobile team carts, work tables and accessories. Scale up, scale down, create a space for the way you work.

Collaborative Spaces' range of laptop tables can transform any area into a productive workspace. Hospitality carts to support team meetings in relaxed settings, with all the essentials to keep the team fueled up.

Create learning hubs with large workshop and collaboration tables and shelf carts for all the resources they require to get their ideas out into the world. Collaborative Spaces is designed to withstand demanding environments in education.

Features and Benefits

- Tables offered with small (1.5") or large (9") radius corners
- Tables are available with glides or casters
- Media units and power accessories provide means for hybrid collaboration
- Accessories like undersurface bag hooks and trays for bag drops keep items out of the way and off the floor.
- PET felt screens provide privacy and noise reduction while dividing space. PET felt screens clip onto shelf carts with included brackets.
- Laptop shelves and media trays can be added to media carts.
- Wire management accessories at the leg and undersurface hide excess cables.
- Undersurface power modules can be positioned anywhere along the table edge.



Optional recessed power tray



Optional steel mesh tray keeps bags and other personal items off the floor



Cart mounted PET Felt privacy panel

GENERAL INFORMATION

- Collaborative Spaces™ includes a range of products that complement each other.
- Series includes collaboration and workshop tables in three heights: 29", 36" and 42"; occasional tables, laptop tables, team carts, and a variety of accessories.
- Aluminum beams provide strength and rigidity for long term use.
- Combine elements to demark space, absorb ambient noise and afford visual privacy.
- PET felt wire manager hangs from underside of worksurface to organize wires.
- High pressure tops available in all Collaborative Spaces laminate finishes at an extended lead time. Please see model # for pricing.
- Ultra matte high pressure laminate tops are available in all Collaborative Spaces solid laminate finishes at an extended lead time.
- Collaborative Spaces' robust aluminum framework supports high-traffic applications and is 100% recyclable.
- For environmental certifications, please visit globalfurnituregroup.com.

CONSTRUCTION

- All tables are standard in high performance thermally fused laminate. Optional high pressure (HPL) laminate or ultra matte high pressure laminate (UML) available.
- High performance thermally fused laminate tops are 1" thick particle board and have a flat 3mm edge profile on all sides
- High pressure (HPL) laminate tops are 1-1/16" thick laminate particle board and have a flat 3mm edge profile on all sides
- Ultra matte high pressure (UML) laminate tops are 1-1/16" thick laminate particle board and have a flat 3mm edge profile on all sides
- Laminate surfaces offer a selection of matching + coordinating edgeband. Specify separately from the surface finish.

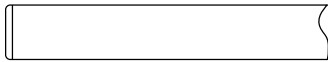

- Products specified with the high pressure laminate or ultra matte high pressure laminate option are finished on the underside of the surface with a kraft paper backing.
- Grommet location must be specified at the time of order or it will default to a no grommet option.
- Power modules and grommets are not included and must be specified separately.
- Table legs and bases are painted aluminum finish.
- Tables are shipped knocked down and must be assembled on site.
- Corner radius for small radius table tops is 1.5".
- Corner radius for large radius tables tops is 9".
- Top end overhang for large tables is 10.5"
- Worksurface support beams and footrests (where applicable) are centered for tables 18" and 24" deep.
- Worksurface support beams and footrests (where applicable) are 9" from the outside table edges for tables 30" deep.
- Worksurface support beams and footrests (where applicable) are 12" from the outside table edges for tables 36 to 48" deep.
- The top of footrests on café height tables is 8.4" above the floor.
- The top of footrests on bar height tables is 14.4" above the floor.
- Cart shelf load capacities : 120 lbs. for 42" wide (Hospitality Cart), 140 lbs. for 48" wide and 175 lbs. for 60" wide.

HOW TO SPECIFY:

Example: SCTWSL2472:

SC	Spaces Collaborative	<i>Other Options:</i>	C Cafe height table - 36"
W	Work height table - 29"		B Bar height table - 42"
S	Small radius - 1.5"		L Large radius - 9"
L	Levelers		C Casters, available in Black (BLK) or Grey (GRC)
24	Depth		
72	Width		
LP	Low pressure laminate	HPL - High pressure laminate	UML - Ultra matte laminate

FINISHES

Metal Finishes:

BLK	Black
BZD	Blizzard
CHR	Charcoal
DWT	Designer White
TIN	Ink
NEV	Nevada
SIL	Silver
SDT	Stonedust
TPE	Taupe
TUN	Tungsten

TFL and HPL Laminate Finishes (thermally fused and high pressure laminates):

ACJ	Absolute Acajou
ASN	Asian Night
AWC	Avant Cherry
AWH	Avant Honey
BLK	Black
BZD	Blizzard
BRC	Brushed Cobalt - Coordinates with TUN edgeband finish
CGY	Custom Grey - Coordinates with SIL edgeband finish
CMB	Clear Maple
DES	Dark Espresso
DWT	Designer White
FAS	Fashionista
FCL	First Class
NBL	Noce Biondo
NGL	Noce Grigio
NEL	Noce Leggero
NML	Noce Medio
QTM	Quartered Mahogany
SBY	Sheer Beauty
SDT	Stonedust
SOG	Storm Grey - Coordinates with CHR edgeband finish
WHC	White Chocolate
WHE	Walnut Heights
WCR	Winter Cherry

Ultra Matte Laminate Finishes:

BLK	Black
BZD	Blizzard
CGY	Custom Grey
DWT	Designer White
SDT	Stonedust
SOG	Storm Grey

Edgeband Finishes:

AAE Absolute Acajou	NGL Noce Grigio
ASE Asian Night	NEL Noce Leggero
ACE Avant Cherry	NML Noce Medio
AHE Avant Honey	NEV Nevada
BLK Black	QTM Quartered Mahogany
BRC Brushed Cobalt	SBY Sheer Beauty
BZD Blizzard	SIL Silver (use w/CGY)
CHR Charcoal (use w/SOG)	SDT Stonedust
CME Clear Maple	TPE Taupe
DEE Dark Espresso	TUN Tungsten (use w/BRC)
DWE Designer White	WHE Walnut Heights
FAS Fashionista	CBE White Chocolate
FCL First Class	WCE Winter Cherry
NBL Noce Biondo	

Caster Finish:

BLK Black	Black
GRC Grey	Grey

PET Felt Colors:

(AMT) Amethyst	(APR) Apricot
(BLK) Black	(BSK) Blue Smoke
(BRI) Brick	(CNN) Carnation
(DEN) Denim	(EMD) Emerald
(GPH) Graphite	(HVT) Harvest
(LAP) Lapis	(MTS) Mist
(NVY) Navy	(PWT) Pewter
(RBY) Ruby	(SHR) Shamrock
(SFR) Sunflower	(WHT) White

POWER ACCESSORY CUT-OUT LOCATIONS

- Cut-outs for SCTAPT_x / SCTAPR_x power modules available centered on depth, in center position only. Order as **O2**, add **\$103**.
- Cut-out not available for 18" and 24" deep tables.
- These rules apply to both small and large radius table tops. *Small radius top shown.*

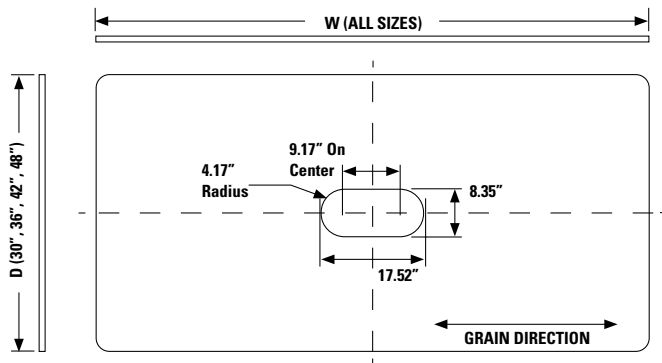

- Cut-outs for SCTAPS_x / SCTAOTC_x power modules available, centered on depth in left, center and right positions. Order as **C1**, **C2**, **C3**, add **\$103**.
- Cut-out not available for 18" and 24" deep tables.
- **C2** cut-outs available on all table widths. Add **\$103**.
- **C1** and **C3** cut-outs only available on 90" + 96" w tables. Add **\$103**.
- These rules apply to both small and large radius table tops. *Small radius top shown.*

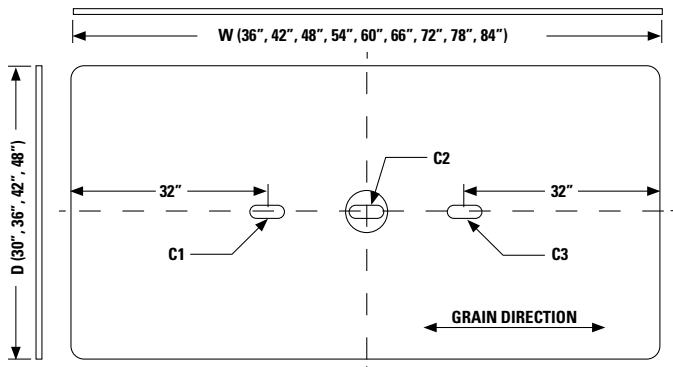

COLLABORATION TABLES - 29"H

MODEL#	DIMENSIONS D x W x H	FREIGHT CLASS	WT/LBS.	CUBIC FT.	LIST PRICE	HPL ADD	UML ADD
SCTWD1836	18 x 36 x 29	70	35.54	2.33	\$760	\$90	\$261
SCTWD1842	18 x 42 x 29	70	38.52	2.52	\$790	\$109	\$311
SCTWD1848	18 x 48 x 29	70	47.05	2.71	\$874	\$124	\$353
SCTWD1854	18 x 54 x 29	70	50.88	2.9	\$913	\$139	\$397
SCTWD1860	18 x 60 x 29	70	54.7	3.08	\$947	\$208	\$494
SCTWD1866	18 x 66 x 29	70	58.52	3.27	\$992	\$233	\$548
SCTWD1872	18 x 72 x 29	70	62.34	3.46	\$1037	\$252	\$596
SCTWD2436	24 x 36 x 29	85	41.51	3.11	\$814	\$124	\$332
SCTWD2442	24 x 42 x 29	85	45.49	3.36	\$854	\$144	\$416
SCTWD2448	24 x 48 x 29	70	55.02	3.61	\$943	\$163	\$493
SCTWD2454	24 x 54 x 29	70	59.83	3.86	\$997	\$183	\$569
SCTWD2460	24 x 60 x 29	70	64.65	4.11	\$1037	\$271	\$702
SCTWD2466	24 x 66 x 29	70	69.46	4.36	\$1091	\$301	\$752
SCTWD2472	24 x 72 x 29	70	74.27	4.61	\$1140	\$331	\$803
SCTWD3036	30 x 36 x 29	85	47.47	3.89	\$868	\$154	\$410
SCTWD3042	30 x 42 x 29	85	52.45	4.2	\$919	\$177	\$541
SCTWD3048	30 x 48 x 29	85	62.98	4.51	\$1017	\$203	\$588
SCTWD3054	30 x 54 x 29	85	68.78	4.83	\$1076	\$227	\$637
SCTWD3060	30 x 60 x 29	85	74.59	5.14	\$1125	\$340	\$791
SCTWD3066	30 x 66 x 29	85	80.4	5.45	\$1185	\$374	\$845
SCTWD3072	30 x 72 x 29	60	86.2	2.76	\$1243	\$409	\$906

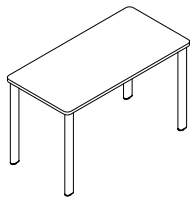

**Core Collaboration Table, 29"H,
Small Radius, Levelers**

Consists of four individual legs and one surface with a small 1.5" radius at each corner.

- Worksurface choice of thermally fused or high pressure laminate with PVC edge.
- Legs are painted extruded aluminum. Levelers have 1" adjustment for leveling.
- Tables from 48" to 72" include a center worksurface support beam.
- Center worksurface support beam eliminates the possibility of a grommet cut-out.

Required specifications

Laminate finish
Edge finish
Paint finish

Optional specifications

HP or UM laminate

Accessories

Table leg cable organizer,
PET felt modesty panel,
Table mounted bag hook,
Nik power modules, PET felt wire manager

COLLABORATION TABLES - 29"H

MODEL#	DIMENSIONS	FREIGHT CLASS	WT/LBS.	CUBIC FT.	LIST PRICE	HPL ADD	UML ADD
D x W x H							
SCTWWSL1836	18 x 36 x 29	70	40.05	2.33	\$1159	\$94	\$267
SCTWWSL1842	18 x 42 x 29	70	43.65	2.52	\$1234	\$109	\$310
SCTWWSL1848	18 x 48 x 29	70	50.15	2.71	\$1470	\$124	\$353
SCTWWSL1854	18 x 54 x 29	70	53.75	2.9	\$1505	\$138	\$397
SCTWWSL1860	18 x 60 x 29	70	57.34	3.08	\$1564	\$154	\$441
SCTWWSL1866	18 x 66 x 29	70	60.93	3.27	\$1598	\$169	\$484
SCTWWSL1872	18 x 72 x 29	70	64.52	3.46	\$1678	\$183	\$527
SCTWWSL1878	18 x 78 x 29	70	68.12	3.65	\$1712	\$198	\$571
SCTWWSL1884	18 x 84 x 29	70	71.71	3.83	\$1746	\$212	\$616
SCTWWSL1890	18 x 90 x 29	70	75.31	4.02	\$1875	\$227	\$658
SCTWWSL1896	18 x 96 x 29	70	78.9	4.21	\$1905	\$247	\$707
SCTWWSL2436	24 x 36 x 29	85	43.05	3.11	\$1249	\$124	\$332
SCTWWSL2442	24 x 42 x 29	85	46.65	3.36	\$1332	\$144	\$416
SCTWWSL2448	24 x 48 x 29	85	53.15	3.61	\$1574	\$163	\$494
SCTWWSL2454	24 x 54 x 29	85	56.75	3.86	\$1618	\$183	\$569
SCTWWSL2460	24 x 60 x 29	85	60.34	4.11	\$1687	\$203	\$635
SCTWWSL2466	24 x 66 x 29	85	63.93	4.36	\$1727	\$222	\$673
SCTWWSL2472	24 x 72 x 29	85	67.52	4.61	\$1815	\$242	\$715
SCTWWSL2478	24 x 78 x 29	85	71.12	4.86	\$1855	\$267	\$765
SCTWWSL2484	24 x 84 x 29	85	74.71	5.11	\$1894	\$287	\$823
SCTWWSL2490	24 x 90 x 29	85	78.31	5.36	\$2033	\$306	\$882
SCTWWSL2496	24 x 96 x 29	85	81.9	5.61	\$2072	\$325	\$939
SCTWWSL3036	30 x 36 x 29	92.5	46.05	3.89	\$1500	\$153	\$410
SCTWWSL3042	30 x 42 x 29	92.5	49.65	4.2	\$1633	\$178	\$542
SCTWWSL3048	30 x 48 x 29	85	56.15	4.51	\$1914	\$203	\$588
SCTWWSL3054	30 x 54 x 29	85	59.75	4.83	\$1963	\$227	\$638
SCTWWSL3060	30 x 60 x 29	85	63.34	5.14	\$2067	\$257	\$708
SCTWWSL3066	30 x 66 x 29	85	66.93	5.45	\$2117	\$281	\$753
SCTWWSL3072	30 x 72 x 29	85	70.52	5.76	\$2259	\$306	\$804
SCTWWSL3078	30 x 78 x 29	85	74.12	6.08	\$2333	\$331	\$856
SCTWWSL3084	30 x 84 x 29	92.5	77.71	6.7	\$2383	\$355	\$937
SCTWWSL3090	30 x 90 x 29	85	81.31	6.39	\$2619	\$380	\$1098
SCTWWSL3096	30 x 96 x 29	85	84.9	7.01	\$2668	\$405	\$1079

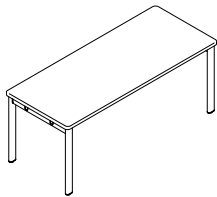

**Standard Collaboration Table, 29"H,
Small Radius, Levelers**

Consists of two leg assemblies, worksurface support beams, and worksurface with a small 1.5" radius at each corner.

- Worksurface choice of thermally fused or high pressure laminate with PVC edge.
- Legs are painted extruded aluminum. Levelers have 1" adjustment for leveling.
- Cut-outs for power modules are limited to specific sizes/configurations, please see "Power Accessory Cut-out Locations".
- 18" and 24" deep tables feature one worksurface support beam.
- 30" deep tables feature two worksurface support beams.

Required specifications

Laminate finish
Edge finish
Paint finish

Optional specifications

HP or UM laminate
Power accessory cut-out

Accessories

Table leg cable organizer,
PET felt modesty panel,
Table mounted bag hook,
Nik power modules, PET felt wire manager

COLLABORATION TABLES - 36" CAFE HEIGHT

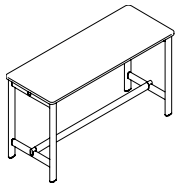

For 18" and 24"D surfaces

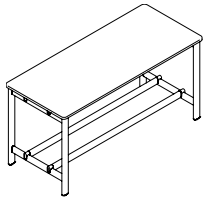

For 30"D tables, 36" to 72"W

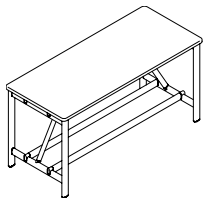

For 30"D tables, 78" to 96"W

Café Height Collaboration Table, 36"H, Small Radius, Levelers

MODEL#	DIMENSIONS D x W x H	FREIGHT CLASS	WT/LBS.	CUBIC FT.	LIST PRICE	HPL ADD	UML ADD
SCTCSL1836	18 x 36 x 36	70	50.14	2.33	\$1648	\$94	\$267
SCTCSL1842	18 x 42 x 36	70	54.34	2.52	\$1766	\$109	\$310
SCTCSL1848	18 x 48 x 36	65	61.46	2.71	\$2003	\$119	\$348
SCTCSL1854	18 x 54 x 36	65	65.66	2.9	\$2033	\$139	\$397
SCTCSL1860	18 x 60 x 36	65	69.87	3.08	\$2126	\$149	\$436
SCTCSL1866	18 x 66 x 36	65	74.07	3.27	\$2156	\$168	\$484
SCTCSL1872	18 x 72 x 36	65	78.28	3.46	\$2284	\$183	\$527
SCTCSL1878	18 x 78 x 36	65	82.48	3.65	\$2318	\$199	\$572
SCTCSL1884	18 x 84 x 36	65	86.69	3.83	\$2348	\$218	\$620
SCTCSL1890	18 x 90 x 36	65	90.9	4.02	\$2575	\$227	\$658
SCTCSL1896	18 x 96 x 36	65	95.1	4.21	\$2604	\$247	\$707
SCTCSL2436	24 x 36 x 36	70	67.83	3.11	\$1766	\$124	\$331
SCTCSL2442	24 x 42 x 36	70	74.58	3.36	\$1894	\$144	\$416
SCTCSL2448	24 x 48 x 36	65	84.23	3.61	\$2136	\$163	\$494
SCTCSL2454	24 x 54 x 36	65	90.98	3.86	\$2175	\$183	\$568
SCTCSL2460	24 x 60 x 36	65	97.73	4.11	\$2274	\$203	\$635
SCTCSL2466	24 x 66 x 36	65	104.48	4.36	\$2314	\$227	\$679
SCTCSL2472	24 x 72 x 36	65	111.23	4.61	\$2451	\$242	\$714
SCTCSL2478	24 x 78 x 36	65	117.98	4.86	\$2490	\$267	\$765
SCTCSL2484	24 x 84 x 36	65	124.73	5.11	\$2530	\$287	\$822
SCTCSL2490	24 x 90 x 36	65	131.48	5.36	\$2762	\$306	\$881
SCTCSL2496	24 x 96 x 36	65	138.23	5.61	\$2807	\$321	\$934
SCTCSL3036	30 x 36 x 36	70	86.09	3.89	\$2215	\$154	\$410
SCTCSL3042	30 x 42 x 36	65	95.44	4.2	\$2437	\$177	\$542
SCTCSL3048	30 x 48 x 36	65	107.7	4.51	\$2683	\$207	\$593
SCTCSL3054	30 x 54 x 36	65	117.05	4.83	\$2732	\$233	\$643
SCTCSL3060	30 x 60 x 36	65	126.41	5.14	\$2895	\$257	\$708
SCTCSL3066	30 x 66 x 36	65	135.76	5.45	\$2944	\$282	\$753
SCTCSL3072	30 x 72 x 36	65	145.11	5.76	\$3186	\$302	\$799
SCTCSL3078	30 x 78 x 36	65	156.91	6.08	\$3418	\$331	\$856
SCTCSL3084	30 x 84 x 36	65	166.26	6.7	\$3467	\$355	\$936
SCTCSL3090	30 x 90 x 36	65	175.62	6.39	\$3896	\$380	\$1098
SCTCSL3096	30 x 96 x 36	65	184.97	7.01	\$3945	\$405	\$1079

Consists of two leg assemblies, worksurface support beam(s), footrest(s), and one worksurface with a small 1.5" radius at each corner.

- Worksurface choice of thermally fused or high pressure laminate with PVC edge.
- Legs are painted extruded aluminum. Levelers have 1" adjustment for leveling.
- Cut-outs for power modules are limited to specific sizes/configurations, please see "Power Accessory Cut-out Locations".
- 18" and 24" deep tables feature one worksurface support beam and one footrest.
- 30" deep tables feature two worksurface support beams and two footrests.
- 30" deep tables 78" wide and greater include a reinforcement cantilever for added stability.

Required specifications

Laminate finish
Edge finish
Paint finish

Optional specifications

HP or UM laminate
Power accessory cut-out

Accessories

Table leg cable organizer,
PET felt modesty panel,
Table mounted bag hook,
Nik power modules, PET felt wire manager

COLLABORATION TABLES - 42" BAR HEIGHT

MODEL#	DIMENSIONS	FREIGHT CLASS	WT/LBS.	CUBIC FT.	LIST PRICE	HPL ADD	UML ADD
D x W x H							
SCTBSL1836	18 x 36 x 42	65	70.28	3.11	\$1781	\$89	\$262
SCTBSL1842	18 x 42 x 42	65	77.02	3.36	\$1899	\$104	\$305
SCTBSL1848	18 x 48 x 42	65	86.68	3.61	\$2130	\$124	\$353
SCTBSL1854	18 x 54 x 42	65	93.43	3.86	\$2166	\$139	\$397
SCTBSL1860	18 x 60 x 42	65	100.18	4.11	\$2254	\$154	\$441
SCTBSL1866	18 x 66 x 42	65	106.93	4.36	\$2289	\$168	\$484
SCTBSL1872	18 x 72 x 42	65	113.68	4.61	\$2417	\$183	\$528
SCTBSL1878	18 x 78 x 42	65	120.43	4.86	\$2447	\$198	\$571
SCTBSL1884	18 x 84 x 42	65	127.18	5.11	\$2481	\$212	\$615
SCTBSL1890	18 x 90 x 42	65	133.93	5.36	\$2703	\$226	\$658
SCTBSL1896	18 x 96 x 42	65	140.67	5.61	\$2738	\$242	\$702
SCTBSL2436	24 x 36 x 42	65	52.58	2.33	\$1899	\$124	\$332
SCTBSL2442	24 x 42 x 42	65	56.79	2.52	\$2027	\$139	\$411
SCTBSL2448	24 x 48 x 42	65	63.9	2.71	\$2269	\$163	\$494
SCTBSL2454	24 x 54 x 42	65	68.11	2.9	\$2308	\$183	\$568
SCTBSL2460	24 x 60 x 42	65	72.31	3.08	\$2407	\$203	\$635
SCTBSL2466	24 x 66 x 42	65	76.52	3.27	\$2447	\$222	\$673
SCTBSL2472	24 x 72 x 42	65	80.72	3.46	\$2580	\$247	\$720
SCTBSL2478	24 x 78 x 42	65	84.93	3.65	\$2624	\$262	\$760
SCTBSL2484	24 x 84 x 42	65	89.13	3.83	\$2663	\$287	\$823
SCTBSL2490	24 x 90 x 42	65	93.34	4.02	\$2895	\$306	\$882
SCTBSL2496	24 x 96 x 42	65	97.55	4.21	\$2935	\$326	\$939
SCTBSL3036	30 x 36 x 42	65	88.53	3.89	\$2348	\$149	\$405
SCTBSL3042	30 x 42 x 42	65	97.89	4.2	\$2565	\$178	\$542
SCTBSL3048	30 x 48 x 42	65	110.14	4.51	\$2816	\$203	\$588
SCTBSL3054	30 x 54 x 42	65	117.05	4.83	\$2865	\$227	\$638
SCTBSL3060	30 x 60 x 42	65	126.41	5.14	\$3028	\$252	\$703
SCTBSL3066	30 x 66 x 42	65	135.76	5.45	\$3077	\$277	\$748
SCTBSL3072	30 x 72 x 42	65	145.11	5.76	\$3315	\$306	\$804
SCTBSL3078	30 x 78 x 42	65	159.35	6.08	\$3551	\$331	\$856
SCTBSL3084	30 x 84 x 42	65	168.71	6.7	\$3600	\$355	\$937
SCTBSL3090	30 x 90 x 42	65	178.06	6.39	\$4029	\$380	\$1099
SCTBSL3096	30 x 96 x 42	65	187.41	7.01	\$4078	\$405	\$1080

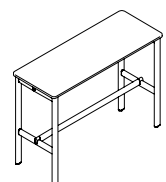

For 18" and 24"D surfaces

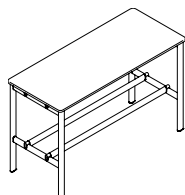

For 30"D tables, 36" to 72"W

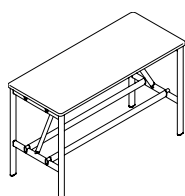

For 30"D tables, 78" to 96"W

Bar Height Collaboration Table, 42"H, Small Radius, Levelers

Consists of two leg assemblies, worksurface support beam(s), footrest(s), and one worksurface with a small 1.5" radius at each corner.

- Worksurface choice of thermally fused or high pressure laminate with PVC edge.
- Legs are painted extruded aluminum. Levelers have 1" adjustment for leveling.
- Cut-outs for power modules are limited to specific sizes/configurations, please see "Power Accessory Cut-out Locations".
- 18" and 24" deep tables feature one worksurface support beam and one footrest.
- 30" deep tables feature two worksurface support beams and two footrests.
- 30" deep tables 78" wide and greater include a reinforcement cantilever for added stability.

Required specifications

Laminate finish
Edge finish
Paint finish

Optional specifications

HP or UM laminate
Power accessory cut-out

Accessories

Table leg cable organizer,
PET felt modesty panel,
Table mounted bag hook,
Nik power modules, PET felt wire manager

WORKSHOP TABLES - 29"H

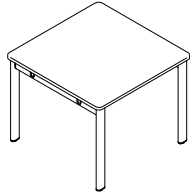

**Workshop Table, 29"H,
Small Radius, Levelers**

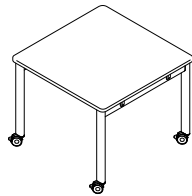

**Workshop Table, 29"H,
Small Radius, Casters***

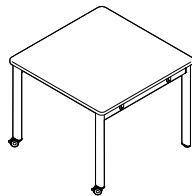

**Workshop Table, 29"H,
Small Radius, Casters/Levelers***

MODEL#	DIMENSIONS D x W x H	FREIGHT CLASS	WT./LBS.	CUBIC FT.	LIST PRICE	HPL ADD	UML ADD
SCTSWSL3636	36 x 36 x 29	70	79.31	4.67	\$1594	\$183	\$527
SCTSWSL3642	36 x 42 x 29	70	88.73	5.04	\$1791	\$218	\$638
SCTSWSL3648	36 x 48 x 29	70	101.24	5.42	\$2023	\$241	\$714
SCTSWSL3654	36 x 54 x 29	70	110.76	5.79	\$2077	\$276	\$805
SCTSWSL3660	36 x 60 x 29	70	120.27	6.17	\$2190	\$306	\$891
SCTSWSL4242	42 x 42 x 29	70	99.72	5.88	\$1825	\$253	\$722
SCTSWSL4248	42 x 48 x 29	70	113.52	6.32	\$2121	\$287	\$854
SCTSWSL4254	42 x 54 x 29	70	124.41	6.76	\$2185	\$321	\$958
SCTSWSL4260	42 x 60 x 29	70	135.31	7.19	\$2308	\$355	\$1058
SCTSWSL4848	48 x 48 x 29	70	125.8	7.22	\$2235	\$321	\$926
SCTSWSL4854	48 x 54 x 29	70	138.07	7.72	\$2304	\$365	\$1084
SCTSWSL4860	48 x 60 x 29	70	150.35	8.22	\$2432	\$409	\$1203

Consists of two leg assemblies, two worksurface support beams, and one worksurface with a small 1.5" radius at each corner.

- Worksurface choice of thermally fused or high pressure laminate with PVC edge.
- Legs are painted extruded aluminum. Levelers have 1" adjustment for leveling.
- Cut-outs for power modules are limited to specific sizes/configurations, please see "Power Accessory Cut-out Locations".

SCTSWSC3636	36 x 36 x 29	70	79.4	4.67	\$1875	\$183	\$528
SCTSWSC3642	36 x 42 x 29	70	88.92	5.04	\$2012	\$218	\$638
SCTSWSC3648	36 x 48 x 29	70	101.33	5.42	\$2244	\$242	\$714
SCTSWSC3654	36 x 54 x 29	70	110.85	5.79	\$2299	\$276	\$805
SCTSWSC3660	36 x 60 x 29	70	120.36	6.17	\$2412	\$306	\$891
SCTSWSC4242	42 x 42 x 29	70	99.81	5.88	\$2106	\$248	\$717
SCTSWSC4248	42 x 48 x 29	70	113.61	6.32	\$2343	\$286	\$854
SCTSWSC4254	42 x 54 x 29	70	124.5	6.76	\$2407	\$98	\$739
SCTSWSC4260	42 x 60 x 29	70	135.4	7.19	\$2530	\$356	\$1058
SCTSWSC4848	48 x 48 x 29	70	125.89	7.22	\$2451	\$326	\$931
SCTSWSC4854	48 x 54 x 29	70	138.16	7.72	\$2526	\$365	\$1084
SCTSWSC4860	48 x 60 x 29	70	150.44	8.22	\$2653	\$184	\$1203

Consists of two leg assemblies, two worksurface support beams, and one worksurface with a small 1.5" radius at each corner.

- Worksurface choice of thermally fused or high pressure laminate with PVC edge.
- Legs are painted extruded aluminum. Casters are lockable, in a choice of two finishes - Black (BLK) or Grey (GRC).
- Cut-outs for power modules are limited to specific sizes/configurations, please see "Power Accessory Cut-out Locations".

SCTWSX3636	36 x 36 x 29	70	79.36	4.67	\$1731	\$184	\$527
SCTWSX3642	36 x 42 x 29	70	88.87	5.04	\$1875	\$212	\$633
SCTWSX3648	36 x 48 x 29	70	101.29	5.42	\$2136	\$242	\$715
SCTWSX3654	36 x 54 x 29	70	110.8	5.79	\$2190	\$276	\$805
SCTWSX3660	36 x 60 x 29	70	120.31	6.17	\$2304	\$306	\$892
SCTWSX4242	42 x 42 x 29	70	99.77	5.88	\$1969	\$247	\$717
SCTWSX4248	42 x 48 x 29	70	113.56	6.32	\$2235	\$282	\$849
SCTWSX4254	42 x 54 x 29	70	124.46	6.76	\$2299	\$321	\$959
SCTWSX4260	42 x 60 x 29	70	135.36	7.19	\$2417	\$355	\$1057
SCTWSX4848	48 x 48 x 29	70	125.71	7.22	\$2343	\$325	\$932
SCTWSX4854	48 x 54 x 29	70	137.99	7.72	\$2417	\$366	\$1084
SCTWSX4860	48 x 60 x 29	70	150.27	8.22	\$2545	\$405	\$1198

Consists of one leg assembly with casters, one leg assembly with levelers, two worksurface support beams, and one worksurface with a small 1.5" radius at each corner.

- Worksurface choice of thermally fused or high pressure laminate with PVC edge.
- Legs are painted extruded aluminum. Casters are lockable, in a choice of two finishes - Black (BLK) or Grey (GRC). Levelers have 1" adjustment for leveling.
- Cut-outs for power modules are limited to specific sizes/configurations, please see "Power Accessory Cut-out Locations".

Required specifications

Laminate finish
Edge finish
Paint finish
Caster finish*

Optional specifications

HP or UM laminate
Grommet option

Accessories

Table leg cable organizer
Table mounted bag hook
Nik power modules
PET felt wire manager

LARGE COLLABORATION TABLES - 29"H

MODEL#	DIMENSIONS	FREIGHT CLASS	WT/LBS.	CUBIC FT.	LIST PRICE	HPL ADD	UML ADD
D x W x H							
SCTLWSL3666	36 x 66 x 29	70	129.78	6.54	\$2250	\$335	\$976
SCTLWSL3672	36 x 72 x 29	70	139.3	6.92	\$2402	\$366	\$1060
SCTLWSL3678	36 x 78 x 29	70	148.81	7.29	\$2481	\$396	\$1141
SCTLWSL3684	36 x 84 x 29	70	158.32	7.67	\$2535	\$430	\$1233
SCTLWSL3690	36 x 90 x 29	70	167.84	8.04	\$2782	\$458	\$1320
SCTLWSL3696	36 x 96 x 29	70	177.35	8.42	\$2841	\$488	\$1403
SCTLWSL4266	42 x 66 x 29	70	146.21	7.63	\$2372	\$390	\$1029
SCTLWSL4272	42 x 72 x 29	70	127.1	8.07	\$2530	\$430	\$1123
SCTLWSL4278	42 x 78 x 29	70	168	8.51	\$2619	\$464	\$1210
SCTLWSL4284	42 x 84 x 29	70	178.89	8.94	\$2683	\$499	\$1301
SCTLWSL4290	42 x 90 x 29	70	189.79	9.38	\$2940	\$533	\$1394
SCTLWSL4296	42 x 96 x 29	70	200.68	9.82	\$3004	\$567	\$1480
SCTLWSL4866	48 x 66 x 29	70	162.63	8.72	\$2505	\$450	\$1319
SCTLWSL4872	48 x 72 x 29	70	174.91	9.22	\$2674	\$488	\$1432
SCTLWSL4878	48 x 78 x 29	70	187.18	9.72	\$2767	\$528	\$1544
SCTLWSL4884	48 x 84 x 29	70	199.46	10.22	\$2841	\$568	\$1658
SCTLWSL4890	48 x 90 x 29	70	211.74	10.72	\$3103	\$612	\$1785
SCTLWSL4896	48 x 96 x 29	70	224.01	11.22	\$3176	\$651	\$1891

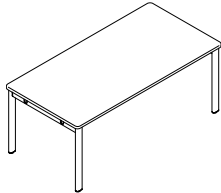

Large Collaboration Table, 29"H, Small Radius, Levelers

Consists of two leg assemblies, two worksurface support beams, and one worksurface with a small 1.5" radius at each corner.

- Worksurface choice of thermally fused or high pressure laminate with PVC edge.
- Legs are painted extruded aluminum. Levelers have 1" adjustment for leveling.
- Cut-outs for power modules are limited to specific sizes/configurations, please see "Power Accessory Cut-out Locations".

SCTLWLL3666	36 x 66 x 29	70	123.52	6.54	\$2190	\$336	\$975
SCTLWLL3672	36 x 72 x 29	70	133.03	6.92	\$2250	\$365	\$1060
SCTLWLL3678	36 x 78 x 29	70	142.55	7.29	\$2363	\$395	\$1141
SCTLWLL3684	36 x 84 x 29	70	152.06	7.67	\$2417	\$430	\$1233
SCTLWLL3690	36 x 90 x 29	70	161.57	8.04	\$2570	\$458	\$1321
SCTLWLL3696	36 x 96 x 29	70	171.09	8.42	\$2649	\$488	\$1402
SCTLWLL4266	42 x 66 x 29	70	139.94	7.63	\$2314	\$395	\$1035
SCTLWLL4272	42 x 72 x 29	70	150.84	8.07	\$2378	\$430	\$1123
SCTLWLL4278	42 x 78 x 29	70	161.73	8.51	\$2501	\$464	\$1210
SCTLWLL4284	42 x 84 x 29	70	172.63	8.94	\$2565	\$498	\$1301
SCTLWLL4290	42 x 90 x 29	70	183.52	9.38	\$2723	\$533	\$1393
SCTLWLL4296	42 x 96 x 29	70	194.42	9.82	\$2787	\$568	\$1480
SCTLWLL4866	48 x 66 x 29	70	156.37	8.72	\$2447	\$449	\$1318
SCTLWLL4872	48 x 72 x 29	70	168.64	9.22	\$2520	\$489	\$1431
SCTLWLL4878	48 x 78 x 29	70	180.92	9.72	\$2649	\$528	\$1544
SCTLWLL4884	48 x 84 x 29	70	193.2	10.22	\$2723	\$567	\$1658
SCTLWLL4890	48 x 90 x 29	70	205.48	10.72	\$2890	\$608	\$1780
SCTLWLL4896	48 x 96 x 29	70	217.75	11.22	\$2984	\$652	\$1890

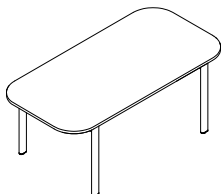

Large Collaboration Table, 29"H, Large Radius, Levelers

Consists of two leg assemblies, two worksurface support beams, and one worksurface with a large 9" radius at each corner with 10.5" overhang on each end.

- Worksurface choice of thermally fused or high pressure laminate with PVC edge.
- Legs are painted extruded aluminum. Levelers have 1" adjustment for leveling.
- Cut-outs for power modules are limited to specific sizes/configurations, please see "Power Accessory Cut-out Locations".
- *Large radius tables are not compatible with SCTAMxx and SCTAMTx Media Units.*

Required specifications

Laminate finish
Edge finish
Paint finish

Optional specifications

HP or UM laminate
Power accessory cut-out

Accessories

Collaboration table media unit,
Table leg cable organizer,
Table mounted bag hook,
Nik power modules, PET felt wire manager

LARGE COLLABORATION TABLES - 29"H

MODEL#	DIMENSIONS D x W x H	FREIGHT CLASS	WT/LBS.	CUBIC FT.	LIST PRICE	HPL ADD	UML ADD
SCTLWSC3666	36 x 66 x 29	70	129.87	6.54	\$2471	\$336	\$976
SCTLWSC3672	36 x 72 x 29	70	139.39	6.92	\$2624	\$366	\$1060
SCTLWSC3678	36 x 78 x 29	70	148.9	7.29	\$2703	\$395	\$1141
SCTLWSC3684	36 x 84 x 29	70	158.41	7.67	\$2757	\$430	\$1233
SCTLWSC3690	36 x 90 x 29	70	167.93	8.04	\$3004	\$458	\$1321
SCTLWSC3696	36 x 96 x 29	70	177.44	8.42	\$3062	\$489	\$1403
SCTLWSC4266	42 x 66 x 29	70	146.3	7.63	\$2595	\$389	\$1029
SCTLWSC4272	42 x 72 x 29	70	157.19	8.07	\$2752	\$430	\$1124
SCTLWSC4278	42 x 78 x 29	70	168.09	8.51	\$2841	\$464	\$1210
SCTLWSC4284	42 x 84 x 29	70	178.98	8.94	\$2905	\$499	\$1301
SCTLWSC4290	42 x 90 x 29	70	189.88	9.38	\$3161	\$533	\$1394
SCTLWSC4296	42 x 96 x 29	70	200.77	9.82	\$2974	\$572	\$1485
SCTLWSC4866	48 x 66 x 29	70	162.72	8.72	\$2728	\$449	\$1319
SCTLWSC4872	48 x 72 x 29	70	175	9.22	\$2895	\$488	\$1432
SCTLWSC4878	48 x 78 x 29	70	187.27	9.22	\$2989	\$528	\$1544
SCTLWSC4884	48 x 84 x 29	70	199.55	10.22	\$3062	\$568	\$1658
SCTLWSC4890	48 x 90 x 29	70	211.83	10.72	\$3324	\$612	\$1785
SCTLWSC4896	48 x 96 x 29	70	224.1	11.22	\$3398	\$651	\$1891

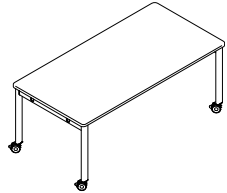

Large Collaboration Table, 29"H, Small Radius, Casters*

- Consists of two leg assemblies, two worksurface support beams, and one worksurface with a small 1.5" radius at each corner.
- Worksurface choice of thermally fused or high pressure laminate with PVC edge.
 - Legs are painted extruded aluminum. Casters are lockable, in a choice of two finishes - Black (BLK) or Grey (GRC).
 - Cut-outs for power modules are limited to specific sizes/configurations, please see "Power Accessory Cut-out Locations".

SCTLWLC3666	36 x 66 x 29	70	123.61	6.54	\$2412	\$336	\$975
SCTLWLC3672	36 x 72 x 29	70	133.12	6.92	\$2471	\$366	\$1060
SCTLWLC3678	36 x 78 x 29	70	142.64	7.29	\$2584	\$396	\$1141
SCTLWLC3684	36 x 84 x 29	70	152.15	7.67	\$2639	\$430	\$1233
SCTLWLC3690	36 x 90 x 29	70	161.66	8.04	\$2792	\$458	\$1321
SCTLWLC3696	36 x 96 x 29	70	171.18	8.42	\$2871	\$488	\$1402
SCTLWLC4266	42 x 66 x 29	70	140.03	7.63	\$2535	\$395	\$1035
SCTLWLC4272	42 x 72 x 29	70	150.93	8.07	\$2599	\$430	\$1123
SCTLWLC4278	42 x 78 x 29	70	161.82	8.51	\$2723	\$464	\$1210
SCTLWLC4284	42 x 84 x 29	70	172.72	8.94	\$2787	\$499	\$1301
SCTLWLC4290	42 x 90 x 29	70	183.62	9.38	\$2944	\$533	\$1393
SCTLWLC4296	42 x 96 x 29	70	194.51	9.82	\$3034	\$567	\$1480
SCTLWLC4866	48 x 66 x 29	70	156.46	8.72	\$2668	\$449	\$1318
SCTLWLC4872	48 x 72 x 29	70	168.73	9.22	\$2743	\$488	\$1432
SCTLWLC4878	48 x 78 x 29	70	181.01	9.72	\$2871	\$528	\$1544
SCTLWLC4884	48 x 84 x 29	70	193.29	10.22	\$2944	\$568	\$1658
SCTLWLC4890	48 x 90 x 29	70	205.57	10.72	\$3112	\$606	\$1780
SCTLWLC4896	48 x 96 x 29	70	217.84	11.22	\$3206	\$651	\$1891

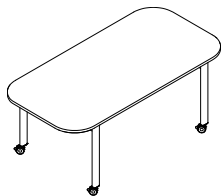

Large Collaboration Table, 29"H, Large Radius, Casters

- Consists of two leg assemblies, two worksurface support beams, and one worksurface with a large 9" radius at each corner with 10.5" overhang on each end.
- Worksurface choice of thermally fused or high pressure laminate with PVC edge.
 - Legs are painted extruded aluminum. Casters are lockable, in a choice of two finishes - Black (BLK) or Grey (GRC).
 - Cut-outs for power modules are limited to specific sizes/configurations, please see "Power Accessory Cut-out Locations".
 - Large radius tables are not compatible with SCTAMxx and SCTAMTx Media Units.

Required specifications

Laminate finish
Edge finish
Paint finish
Caster finish

Optional specifications

HP or UM laminate
Grommet option

Accessories

Collaboration table media unit*, Table leg cable organizer, PET felt modesty panel, Table mounted bag hook, Nik power modules, PET felt wire manager

WORKSHOP TABLES - 36"H

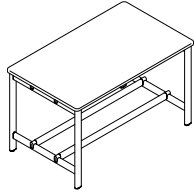

**Café Height Workshop Table, 36"H
Small Radius, Levelers**

MODEL#	DIMENSIONS	FREIGHT CLASS	WT/LBS.	CUBIC FT.	LIST PRICE	HPL ADD	UML ADD
D x W x H							
SCTSCSL3636	36 x 36 x 36	70	96.82	5.67	\$2343	\$183	\$527
SCTSCSL3642	36 x 42 x 36	70	107.56	6.21	\$2570	\$217	\$638
SCTSCSL3648	36 x 48 x 36	70	121.2	6.75	\$2831	\$242	\$715
SCTSCSL3654	36 x 54 x 36	70	131.93	7.29	\$2886	\$276	\$805
SCTSCSL3660	36 x 60 x 36	70	142.67	7.83	\$3058	\$306	\$892
SCTSCSL4242	42 x 42 x 36	70	119.68	7.05	\$2634	\$252	\$722
SCTSCSL4248	42 x 48 x 36	70	134.7	7.65	\$2955	\$286	\$854
SCTSCSL4254	42 x 54 x 36	70	146.81	8.26	\$3019	\$321	\$958
SCTSCSL4260	42 x 60 x 36	70	158.93	8.86	\$3201	\$355	\$1058
SCTSCSL4848	48 x 48 x 36	70	148.2	8.56	\$3103	\$325	\$931
SCTSCSL4854	48 x 54 x 36	70	161.7	9.22	\$3176	\$366	\$1084
SCTSCSL4860	48 x 60 x 36	70	175.2	9.89	\$3364	\$405	\$1198

Consists of two leg assemblies, two worksurface support beams, dual footrests and one worksurface with a small 1.5" radius at each corner.

- Worksurface choice of thermally fused or high pressure laminate with PVC edge.
- Legs are painted extruded aluminum. Levelers have 1" adjustment for leveling.
- Cut-outs for power modules are limited to specific sizes/configurations, please see "Power Accessory Cut-out Locations".

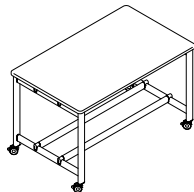

**Café Height Workshop Table, 36"H
Small Radius, Casters***

SCTSCSC3636	36 x 36 x 36	70	96.66	5.67	\$2599	\$184	\$528
SCTSCSC3642	36 x 42 x 36	70	107.39	6.21	\$2826	\$212	\$633
SCTSCSC3648	36 x 48 x 36	70	107.39	6.21	\$3083	\$247	\$720
SCTSCSC3654	36 x 54 x 36	70	131.77	7.29	\$3142	\$271	\$800
SCTSCSC3660	36 x 60 x 36	70	142.5	7.83	\$3309	\$306	\$892
SCTSCSC4242	42 x 42 x 36	70	119.51	7.05	\$2944	\$248	\$717
SCTSCSC4248	42 x 48 x 36	70	134.53	7.65	\$3210	\$282	\$849
SCTSCSC4254	42 x 54 x 36	70	146.65	8.26	\$3275	\$320	\$959
SCTSCSC4260	42 x 60 x 36	70	158.77	8.86	\$3452	\$356	\$1057
SCTSCSC4848	48 x 48 x 36	70	148.03	8.56	\$3358	\$326	\$932
SCTSCSC4854	48 x 54 x 36	70	161.53	9.22	\$3428	\$370	\$1089
SCTSCSC4860	48 x 60 x 36	70	175.03	9.89	\$3615	\$409	\$1203

Consists of two leg assemblies, two worksurface support beams, dual footrests and one worksurface with a small 1.5" radius at each corner.

- Worksurface choice of thermally fused or high pressure laminate with PVC edge.
- Legs are painted extruded aluminum. Casters are lockable, in a choice of two finishes - Black (**BLK**) or Grey (**GRC**).
- Cut-outs for power modules are limited to specific sizes/configurations, please see "Power Accessory Cut-out Locations".

Required specifications

Laminate finish
Edge finish
Paint finish
Caster finish*

Optional specifications

HP or UM laminate
Grommet option

Accessories

Collaboration table media unit, Table leg cable organizer, PET felt modesty panel, Wire mesh storage tray, Table mounted bag hook, Nik power modules, PET felt wire manager

LARGE COLLABORATION TABLES - 36"H

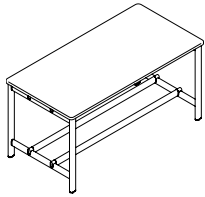

For 66" and 72"W tables

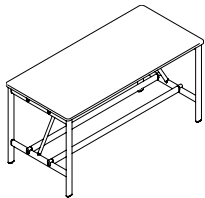

For 78" to 96"W tables

Large Café Height Collaboration Table, 36"H, Small Radius, Levelers*

MODEL#	DIMENSIONS D x W x H	FREIGHT CLASS	WT./LBS.	CUBIC FT.	LIST PRICE	HPL ADD	UML ADD
SCTLCSL3666	36 x 66 x 36	70	153.4	8.38	\$3112	\$336	\$975
SCTLCSL3672	36 x 72 x 36	70	164.14	8.92	\$3358	\$366	\$1059
SCTLCSL3678	36 x 78 x 36	70	177.32	9.46	\$3606	\$395	\$1141
SCTLCSL3684	36 x 84 x 36	70	188.05	10	\$3660	\$429	\$1233
SCTLCSL3690	36 x 90 x 36	70	198.79	10.54	\$4099	\$454	\$1315
SCTLCSL3696	36 x 96 x 36	70	209.52	11.08	\$4153	\$488	\$1402
SCTLCSL4266	42 x 66 x 36	70	171.05	9.47	\$3265	\$390	\$1029
SCTLCSL4272	42 x 72 x 36	70	183.17	10.07	\$3516	\$430	\$1123
SCTLCSL4278	42 x 78 x 36	70	197.73	10.67	\$3768	\$464	\$1209
SCTLCSL4284	42 x 84 x 36	70	209.84	11.28	\$3832	\$445	\$1301
SCTLCSL4290	42 x 90 x 36	70	221.96	11.88	\$4281	\$533	\$1394
SCTLCSL4296	42 x 96 x 36	70	234.08	12.49	\$4345	\$568	\$1480
SCTLCSL4866	48 x 66 x 36	70	188.69	10.56	\$3437	\$445	\$1313
SCTLCSL4872	48 x 72 x 36	70	202.19	11.22	\$3699	\$488	\$1432
SCTLCSL4878	48 x 78 x 36	70	218.14	11.89	\$3955	\$529	\$1544
SCTLCSL4884	48 x 84 x 36	70	231.63	12.56	\$4029	\$567	\$1658
SCTLCSL4890	48 x 90 x 36	70	245.13	13.22	\$4483	\$606	\$1780
SCTLCSL4896	48 x 96 x 36	70	258.63	13.89	\$4552	\$651	\$1890

Consists of two leg assemblies, two worksurface support beams, dual footrests, and one worksurface with a small 1.5" radius at each corner.

- Worksurface choice of thermally fused or high pressure laminate with PVC edge.
- Legs are painted extruded aluminum. Levelers have 1" adjustment for leveling.
- Cut-outs for power modules are limited to specific sizes/configurations, please see "Power Accessory Cut-out Locations".
- Tables 78" wide and greater include a reinforcement cantilever for added stability.

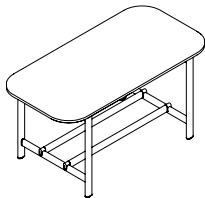

For 66" and 72"W tables

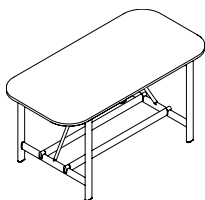

For 78" to 96"W tables

Large Café Height Collaboration Table, 36"H, Large Radius, Levelers

SCTLCLL3666	36 x 66 x 36	70	143.48	8.38	\$2998	\$336	\$976
SCTLCLL3672	36 x 72 x 36	70	154.21	8.92	\$3053	\$370	\$1065
SCTLCLL3678	36 x 78 x 36	70	164.95	9.46	\$3225	\$396	\$1141
SCTLCLL3684	36 x 84 x 36	70	175.68	10	\$3285	\$424	\$1228
SCTLCLL3690	36 x 90 x 36	70	186.42	10.54	\$3531	\$454	\$1315
SCTLCLL3696	36 x 96 x 36	70	199.6	11.08	\$3773	\$488	\$1402
SCTLCLL4266	42 x 66 x 36	70	161.12	9.47	\$3152	\$390	\$1029
SCTLCLL4272	42 x 72 x 36	70	173.24	10.07	\$3216	\$424	\$1118
SCTLCLL4278	42 x 78 x 36	70	185.36	10.67	\$3394	\$458	\$1204
SCTLCLL4284	42 x 84 x 36	70	197.47	11.28	\$3457	\$498	\$1301
SCTLCLL4290	42 x 90 x 36	70	209.59	11.88	\$3709	\$538	\$1399
SCTLCLL4296	42 x 96 x 36	70	224.15	12.49	\$3512	\$572	\$1485
SCTLCLL4866	48 x 66 x 36	70	178.77	10.56	\$3319	\$450	\$1318
SCTLCLL4872	48 x 72 x 36	125	688	99	\$3394	\$488	\$1432
SCTLCLL4878	48 x 78 x 36	125	726	107	\$3581	\$528	\$1544
SCTLCLL4884	48 x 84 x 36	70	219.26	12.56	\$3649	\$572	\$1664
SCTLCLL4890	48 x 90 x 36	70	232.76	13.22	\$3915	\$608	\$1780
SCTLCLL4896	48 x 96 x 36	70	248.71	13.89	\$4172	\$651	\$1890

Consists of two leg assemblies, two worksurface support beams, dual footrests, and one worksurface with a large 9" radius at each corner with 10.5" overhang on each end.

- Worksurface choice of thermally fused or high pressure laminate with PVC edge.
- Legs are painted extruded aluminum. Levelers have 1" adjustment for leveling.
- Cut-outs for power modules are limited to specific sizes/configurations, please see "Power Accessory Cut-out Locations".
- Tables 78" wide and greater include a reinforcement cantilever for added stability.
- *Large radius tables are not compatible with SCTAMxx and SCTAMTx Media Units.*

Required specifications

Laminate finish
Edge finish
Paint finish

Optional specifications

HP or UM laminate
Power accessory cut-out

Accessories

Collaboration table media unit*, Table leg cable organizer, PET felt modesty panel, Wire mesh storage tray, Table mounted bag hook, Nik power modules, PET felt wire manager

LARGE COLLABORATION TABLES - 36"H

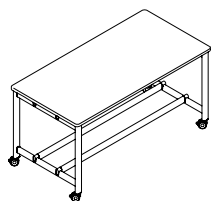

For 66" and 72"W tables

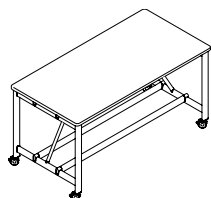

For 78" to 96"W tables

Large Café Height Collaboration Table, 36"H, Small Radius, Casters*

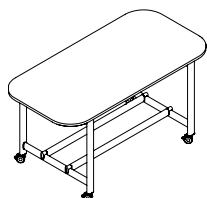

For 66" and 72"W tables

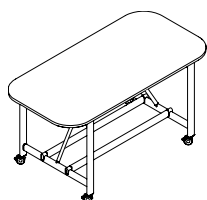

For 78" to 96"W tables

Large Café Height Collaboration Table, 36"H, Large Radius, Casters

MODEL#	DIMENSIONS D x W x H	FREIGHT CLASS	WT./LBS.	CUBIC FT.	LIST PRICE	HPL ADD	UML ADD
SCTLCSC3666	36 x 66 x 36	70	153.24	8.38	\$3369	\$335	\$976
SCTLCSC3672	36 x 72 x 36	70	163.97	8.92	\$3615	\$366	\$1060
SCTLCSC3678	36 x 78 x 36	70	177.15	9.46	\$3857	\$395	\$1141
SCTLCSC3684	36 x 84 x 36	70	187.89	10	\$3915	\$425	\$1228
SCTLCSC3690	36 x 90 x 36	70	198.62	10.54	\$4350	\$458	\$1321
SCTLCSC3696	36 x 96 x 36	70	209.36	11.08	\$4409	\$484	\$1397
SCTLCSC4266	42 x 66 x 36	70	170.88	9.47	\$3516	\$390	\$1029
SCTLCSC4272	42 x 72 x 36	70	183	10.07	\$3773	\$424	\$1118
SCTLCSC4278	42 x 78 x 36	70	197.56	10.67	\$4024	\$460	\$1204
SCTLCSC4284	42 x 84 x 36	70	209.68	11.28	\$4088	\$499	\$1301
SCTLCSC4290	42 x 90 x 36	70	221.8	11.88	\$4532	\$533	\$1394
SCTLCSC4296	42 x 96 x 36	70	233.91	12.41	\$4596	\$568	\$1480
SCTLCSC4866	48 x 66 x 36	70	188.53	10.56	\$3689	\$450	\$1319
SCTLCSC4872	48 x 72 x 36	70	202.03	11.22	\$3951	\$488	\$1432
SCTLCSC4878	48 x 78 x 36	70	217.97	11.89	\$4212	\$529	\$1545
SCTLCSC4884	48 x 84 x 36	70	231.47	12.56	\$4281	\$572	\$1664
SCTLCSC4890	48 x 90 x 36	70	244.97	13.22	\$4734	\$612	\$1786
SCTLCSC4896	48 x 96 x 36	70	258.47	13.89	\$4808	\$651	\$1891

Consists of two leg assemblies, two worksurface support beams, dual footrests, and one worksurface with a small 1.5" radius at each corner.

- Worksurface choice of thermally fused or high pressure laminate with PVC edge.
- Legs are painted extruded aluminum. Casters are lockable, in a choice of two finishes - Black (BLK) or Grey (GRC).
- Cut-outs for power modules are limited to specific sizes/configurations, please see "Power Accessory Cut-out Locations".
- Tables 78" wide and greater include a reinforcement cantilever for added stability.

SCTLCLC3666	36 x 66 x 36	70	143.31	8.38	\$3250	\$336	\$975
SCTLCLC3672	36 x 72 x 36	70	154.05	8.92	\$3309	\$366	\$1060
SCTLCLC3678	36 x 78 x 36	70	164.78	9.46	\$3477	\$400	\$1146
SCTLCLC3684	36 x 84 x 36	70	175.52	10	\$3536	\$424	\$1227
SCTLCLC3690	36 x 90 x 36	70	186.25	10.54	\$3782	\$460	\$1321
SCTLCLC3696	36 x 96 x 36	70	199.43	11.08	\$4024	\$489	\$1402
SCTLCLC4266	42 x 66 x 36	70	160.96	9.47	\$3403	\$390	\$1029
SCTLCLC4272	42 x 72 x 36	70	173.07	10.07	\$3467	\$424	\$1118
SCTLCLC4278	42 x 78 x 36	70	185.19	10.67	\$3645	\$464	\$1210
SCTLCLC4284	42 x 84 x 36	70	197.31	11.28	\$3709	\$499	\$1301
SCTLCLC4290	42 x 90 x 36	70	209.43	11.88	\$3965	\$533	\$1394
SCTLCLC4296	42 x 96 x 36	70	223.98	12.49	\$4217	\$567	\$1480
SCTLCLC4866	48 x 66 x 36	70	178.6	10.56	\$3576	\$445	\$1313
SCTLCLC4872	48 x 72 x 36	70	192.1	11.22	\$3645	\$488	\$1431
SCTLCLC4878	48 x 78 x 36	70	205.6	11.89	\$3832	\$528	\$1544
SCTLCLC4884	48 x 84 x 36	70	219.1	12.56	\$3906	\$568	\$1658
SCTLCLC4890	48 x 90 x 36	70	232.6	13.22	\$4168	\$612	\$1786
SCTLCLC4896	48 x 96 x 36	70	248.54	12.89	\$4429	\$651	\$1891

Consists of two leg assemblies, two worksurface support beams, dual footrests, and one worksurface with a large 9" radius at each corner with 10.5" overhang on each end.

- Worksurface choice of thermally fused or high pressure laminate with PVC edge.
- Legs are painted extruded aluminum. Casters are lockable, in a choice of two finishes - Black (BLK) or Grey (GRC).
- Cut-outs for power modules are limited to specific sizes/configurations, please see "Power Accessory Cut-out Locations".
- Tables 78" wide and greater include a reinforcement cantilever for added stability.
- Large radius tables are not compatible with SCTAMxx and SCTAMTx Media Units.

Required specifications

Laminate finish
Edge finish
Paint finish
Caster finish

Optional specifications

HP or UM laminate
Power accessory cut-out

Accessories

Collaboration table media unit*, Table leg cable organizer, PET felt modesty panel, Wire mesh storage tray, Table mounted bag hook, Nik power modules, PET felt wire manager

LARGE COLLABORATION TABLES - 42"H

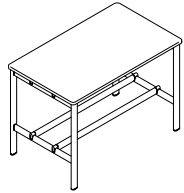

**Bar Height Workshop Table, 42"H
Small Radius, Levelers**

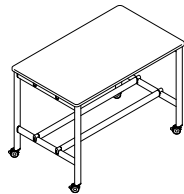

**Bar Height Workshop Table, 42"H
Small Radius, Casters***

MODEL#	DIMENSIONS D x W x H	FREIGHT CLASS	WT/LBS.	CUBIC FT.	LIST PRICE	HPL ADD	UML ADD
SCTSBSL3636	36 x 36 x 42	70	99.27	5.67	\$2477	\$183	\$528
SCTSBSL3642	36 x 42 x 42	70	110	6.21	\$2703	\$212	\$633
SCTSBSL3648	36 x 48 x 42	70	123.64	6.75	\$2959	\$248	\$720
SCTSBSL3654	36 x 54 x 42	70	134.38	7.29	\$3019	\$271	\$800
SCTSBSL3660	36 x 60 x 42	70	145.11	7.83	\$3186	\$306	\$892
SCTSBSL4242	42 x 42 x 42	70	122.12	7.05	\$2822	\$247	\$717
SCTSBSL4248	42 x 48 x 42	70	137.14	7.65	\$3088	\$286	\$855
SCTSBSL4254	42 x 54 x 42	70	149.26	8.26	\$3152	\$321	\$959
SCTSBSL4260	42 x 60 x 42	70	161.38	8.86	\$3329	\$356	\$1058
SCTSBSL4848	48 x 48 x 42	70	150.64	8.56	\$3236	\$325	\$932
SCTSBSL4854	48 x 54 x 42	70	164.14	9.22	\$3309	\$366	\$1084
SCTSBSL4860	48 x 60 x 42	70	177.64	9.89	\$3492	\$411	\$1203

Consists of two leg assemblies, two worksurface support beams, dual footrests and one worksurface with a small 1.5" radius at each corner.

- Worksurface choice of thermally fused or high pressure laminate with PVC edge.
- Legs are painted extruded aluminum. Levelers have 1" adjustment for leveling.
- Cut-outs for power modules are limited to specific sizes/configurations, please see "Power Accessory Cut-out Locations".

SCTSBSL3636	36 x 36 x 42	70	99.1	5.67	\$2653	\$184	\$528
SCTSBSL3642	36 x 42 x 42	70	109.84	6.21	\$2880	\$212	\$633
SCTSBSL3648	36 x 48 x 42	70	123.48	6.75	\$3137	\$247	\$720
SCTSBSL3654	36 x 54 x 42	70	134.21	7.29	\$3195	\$272	\$800
SCTSBSL3660	36 x 60 x 42	70	144.95	7.83	\$3364	\$306	\$892
SCTSBSL4242	42 x 42 x 42	70	121.95	7.05	\$2998	\$248	\$717
SCTSBSL4248	42 x 48 x 42	70	136.98	7.65	\$3265	\$282	\$849
SCTSBSL4254	42 x 54 x 42	70	149.09	8.26	\$3329	\$321	\$959
SCTSBSL4260	42 x 60 x 42	70	161.21	8.86	\$3506	\$355	\$1057
SCTSBSL4848	48 x 48 x 42	70	150.47	8.56	\$3413	\$326	\$932
SCTSBSL4854	48 x 54 x 42	70	163.97	9.22	\$3487	\$365	\$1084
SCTSBSL4860	48 x 60 x 42	70	177.47	9.89	\$3669	\$409	\$1203

Consists of two leg assemblies, two worksurface support beams, dual footrests and one worksurface with a small 1.5" radius at each corner.

- Worksurface choice of thermally fused or high pressure laminate with PVC edge.
- Legs are painted extruded aluminum. Casters are lockable, in a choice of two finishes - Black (BLK) or Grey (GRC).
- Cut-outs for power modules are limited to specific sizes/configurations, please see "Power Accessory Cut-out Locations".

Required specifications

Laminate finish
Edge finish
Paint finish
Caster finish*

Optional specifications

HP or UM laminate
Power accessory cut-out

Accessories

Collaboration table media unit, Table leg cable organizer, PET felt modesty panel, Wire mesh storage tray, Table mounted bag hook, Nik power modules, PET felt wire manager

LARGE COLLABORATION TABLES - 42"H

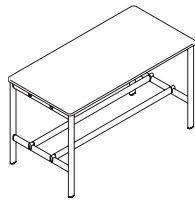

For 66" and 72"W tables

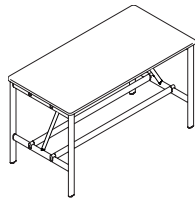

For 78" to 96"W tables

Large Bar Height Collaboration Table, 42"H, Small Radius, Levelers*

MODEL#	DIMENSIONS D x W x H	FREIGHT CLASS	WT/LBS.	CUBIC FT.	LIST PRICE	HPL ADD	UML ADD
SCTLBSL3666	36 x 66 x 42	70	155.85	8.38	\$3246	\$336	\$976
SCTLBSL3672	36 x 72 x 42	70	166.58	8.92	\$3492	\$366	\$1060
SCTLBSL3678	36 x 78 x 42	70	179.76	9.46	\$3763	\$395	\$1141
SCTLBSL3684	36 x 84 x 42	70	190.5	10	\$3817	\$430	\$1233
SCTLBSL3690	36 x 90 x 42	70	201.23	10.54	\$4256	\$458	\$1321
SCTLBSL3696	36 x 96 x 42	70	211.97	11.08	\$4311	\$488	\$1402
SCTLBSL4266	42 x 66 x 42	70	173.49	9.47	\$3394	\$389	\$1029
SCTLBSL4272	42 x 72 x 42	70	185.61	10.07	\$3649	\$425	\$1118
SCTLBSL4278	42 x 78 x 42	70	200.17	10.67	\$3930	\$460	\$1204
SCTLBSL4284	42 x 84 x 42	70	212.29	11.28	\$3994	\$499	\$1301
SCTLBSL4290	42 x 90 x 42	70	224.41	11.88	\$4438	\$533	\$1394
SCTLBSL4296	42 x 96 x 42	70	236.52	12.49	\$4502	\$462	\$1480
SCTLBSL4866	48 x 66 x 42	70	191.14	10.56	\$3566	\$449	\$1319
SCTLBSL4872	48 x 72 x 42	70	204.64	11.22	\$3827	\$488	\$1431
SCTLBSL4878	48 x 78 x 42	70	220.58	11.89	\$4118	\$529	\$1545
SCTLBSL4884	48 x 84 x 42	70	234.08	12.56	\$4187	\$572	\$1664
SCTLBSL4890	48 x 90 x 42	70	247.58	13.22	\$4641	\$612	\$1786
SCTLBSL4896	48 x 96 x 42	70	261.08	13.89	\$4714	\$652	\$1891

Consists of two leg assemblies, two worksurface support beams, dual footrests, and one worksurface with a small 1.5" radius at each corner.

- Worksurface choice of thermally fused or high pressure laminate with PVC edge.
- Legs are painted extruded aluminum. Levelers have 1" adjustment for leveling.
- Cut-outs for power modules are limited to specific sizes/configurations, please see "Power Accessory Cut-out Locations".
- Tables 78" wide and greater include a reinforcement cantilever for added stability.

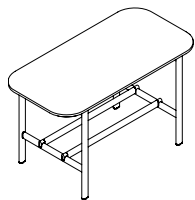

For 66" and 90"W tables

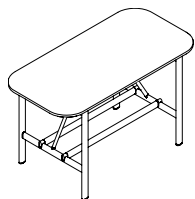

For 96"W tables

Large Bar Height Collaboration Table, 42"H, Large Radius, Levelers

SCTLBLL3666	36 x 66 x 42	70	145.92	8.38	\$3132	\$331	\$970
SCTLBLL3672	36 x 72 x 42	70	156.66	8.92	\$3186	\$366	\$1060
SCTLBLL3678	36 x 78 x 42	70	167.39	9.46	\$3521	\$395	\$1141
SCTLBLL3684	36 x 84 x 42	70	178.13	10	\$3576	\$261	\$1067
SCTLBLL3690	36 x 90 x 42	70	188.86	10.54	\$3822	\$297	\$1160
SCTLBLL3696	36 x 96 x 42	70	202.04	11.08	\$3902	\$488	\$1402
SCTLBLL4266	42 x 66 x 42	70	163.57	9.47	\$3280	\$390	\$1029
SCTLBLL4272	42 x 72 x 42	70	175.68	10.07	\$3344	\$425	\$1118
SCTLBLL4278	42 x 78 x 42	70	187.8	10.67	\$3684	\$301	\$1049
SCTLBLL4284	42 x 84 x 42	70	199.92	11.28	\$3748	\$336	\$1140
SCTLBLL4290	42 x 90 x 42	70	212.04	11.88	\$4005	\$370	\$1233
SCTLBLL4296	42 x 96 x 42	70	226.6	12.49	\$4093	\$572	\$1480
SCTLBLL4866	48 x 66 x 42	70	181.21	10.56	\$3452	\$445	\$1313
SCTLBLL4872	48 x 72 x 42	70	194.71	11.22	\$3521	\$488	\$1431
SCTLBLL4878	48 x 78 x 42	70	208.21	11.89	\$3876	\$360	\$1378
SCTLBLL4884	48 x 84 x 42	70	221.71	12.56	\$3945	\$405	\$1498
SCTLBLL4890	48 x 90 x 42	70	235.21	13.22	\$4207	\$449	\$1625
SCTLBLL4896	48 x 96 x 42	70	251.15	13.89	\$4305	\$651	\$1891

Consists of two leg assemblies, two worksurface support beams, dual footrests, and one worksurface with a large 9" radius at each corner with 10.5" overhang on each end.

- Worksurface choice of thermally fused or high pressure laminate with PVC edge.
- Legs are painted extruded aluminum. Levelers have 1" adjustment for leveling.
- Cut-outs for power modules are limited to specific sizes/configurations, please see "Power Accessory Cut-out Locations".
- Tables 96" wide and greater include a reinforcement cantilever for added stability.
- Large radius tables are not compatible with SCTAMxx and SCTAMTx Media Units.

Required specifications

Laminate finish
Edge finish
Paint finish

Optional specifications

HP or UM laminate
Power accessory cut-out

Accessories

Collaboration table media unit*, Table leg cable organizer, PET felt modesty panel, Wire mesh storage tray, Table mounted bag hook, Nik power modules, PET felt wire manager

LARGE COLLABORATION TABLES - 42"H

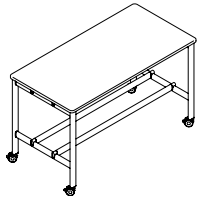

For 66" and 72"W tables

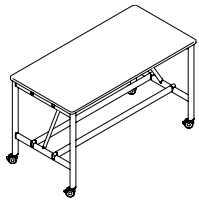

For 78" to 96"W tables

Large Bar Height Collaboration Table, 42"H, Small Radius, Casters*

MODEL#	DIMENSIONS D x W x H	FREIGHT CLASS	WT/LBS.	CUBIC FT.	LIST PRICE	HPL ADD	UML ADD
SCTLBSC3666	36 x 66 x 42	70	155.68	8.38	\$3422	\$336	\$976
SCTLBSC3672	36 x 72 x 42	70	166.42	8.92	\$3669	\$366	\$1060
SCTLBSC3678	36 x 78 x 42	70	179.6	9.46	\$3941	\$395	\$1141
SCTLBSC3684	36 x 84 x 42	70	190.33	10	\$3994	\$430	\$1233
SCTLBSC3690	36 x 90 x 42	70	201.07	10.54	\$4434	\$458	\$1321
SCTLBSC3696	36 x 96 x 42	70	211.8	11.08	\$4487	\$489	\$1402
SCTLBSC4266	42 x 66 x 42	70	173.33	9.47	\$3570	\$390	\$1029
SCTLBSC4272	42 x 72 x 42	70	185.45	10.07	\$3827	\$424	\$1118
SCTLBSC4278	42 x 78 x 42	70	200	10.67	\$4108	\$460	\$1204
SCTLBSC4284	42 x 84 x 42	70	212.12	11.28	\$4172	\$494	\$1296
SCTLBSC4290	42 x 90 x 42	70	224.24	11.88	\$4616	\$533	\$1394
SCTLBSC4296	42 x 96 x 42	70	236.36	12.49	\$4680	\$567	\$1480
SCTLBSC4866	48 x 66 x 42	70	190.97	10.56	\$3743	\$450	\$1319
SCTLBSC4872	48 x 72 x 42	70	204.47	11.22	\$4005	\$488	\$1431
SCTLBSC4878	48 x 78 x 42	70	220.41	11.89	\$4296	\$528	\$1545
SCTLBSC4884	48 x 84 x 42	70	233.91	12.56	\$4365	\$572	\$1664
SCTLBSC4890	48 x 90 x 42	70	247.41	13.22	\$4819	\$612	\$1786
SCTLBSC4896	48 x 96 x 42	70	260.91	13.89	\$4892	\$647	\$1885

Consists of two leg assemblies, two worksurface support beams, dual footrests, and one worksurface with a small 1.5" radius at each corner.

- Worksurface choice of thermally fused or high pressure laminate with PVC edge.
- Legs are painted extruded aluminum. Casters are lockable, in a choice of two finishes - Black (BLK) or Grey (GRC).
- Cut-outs for power modules are limited to specific sizes/configurations, please see "Power Accessory Cut-out Locations".
- Tables 78" wide and greater include a reinforcement cantilever for added stability.

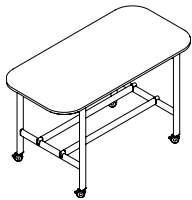

For 66" and 90"W tables



For 96"W tables

Large Bar Height Collaboration Table, 42"H, Large Radius, Casters

SCTLBLC3666	36 x 66 x 42	70	145.75	8.38	\$3304	\$336	\$975
SCTLBLC3672	36 x 72 x 42	70	156.49	8.92	\$3364	\$365	\$1060
SCTLBLC3678	36 x 78 x 42	70	167.23	9.46	\$3531	\$400	\$1146
SCTLBLC3684	36 x 84 x 42	70	177.96	10	\$3591	\$424	\$1228
SCTLBLC3690	36 x 90 x 42	70	188.7	10.54	\$3837	\$460	\$1321
SCTLBLC3696	36 x 96 x 42	70	201.87	11.08	\$4078	\$489	\$1402
SCTLBLC4266	42 x 66 x 42	70	163.4	9.47	\$3457	\$390	\$1029
SCTLBLC4272	42 x 72 x 42	70	175.52	10.07	\$3521	\$424	\$1118
SCTLBLC4278	42 x 78 x 42	70	187.63	10.67	\$3699	\$464	\$1210
SCTLBLC4284	42 x 84 x 42	70	199.75	11.28	\$3763	\$498	\$1301
SCTLBLC4290	42 x 90 x 42	70	211.87	11.88	\$4020	\$533	\$1394
SCTLBLC4296	42 x 96 x 42	70	226.43	12.49	\$4271	\$567	\$1480
SCTLBLC4866	48 x 66 x 42	70	181.04	10.56	\$3630	\$445	\$1313
SCTLBLC4872	48 x 72 x 42	70	197.54	11.22	\$3699	\$488	\$1431
SCTLBLC4878	48 x 78 x 42	70	208.04	11.89	\$3887	\$528	\$1544
SCTLBLC4884	48 x 84 x 42	70	221.54	12.56	\$3960	\$567	\$1658
SCTLBLC4890	48 x 90 x 42	70	235.04	13.22	\$4221	\$613	\$1786
SCTLBLC4896	48 x 96 x 42	70	250.98	13.89	\$4483	\$651	\$1891

Consists of two leg assemblies, two worksurface support beams, dual footrests, and one worksurface with a large 9" radius at each corner with 10.5" overhang on each end.

- Worksurface choice of thermally fused or high pressure laminate with PVC edge.
- Legs are painted extruded aluminum. Casters are lockable, in a choice of two finishes - Black (BLK) or Grey (GRC).
- Cut-outs for power modules are limited to specific sizes/configurations, please see "Power Accessory Cut-out Locations".
- Tables 96" wide and greater include a reinforcement cantilever for added stability.
- Large radius tables are not compatible with SCTAMxx and SCTAMTx Media Units.

Required specifications

Laminate finish
Edge finish
Paint finish
Caster finish

Optional specifications

HP or UM laminate
Power accessory cut-out

Accessories

Collaboration table media unit*, Table leg cable organizer, PET felt modesty panel, Wire mesh storage tray, Table mounted bag hook, Nik power modules, PET felt wire manager

COLLABORATION TABLES - 42" H

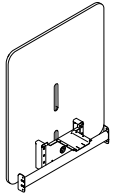

Collaboration Table Media Unit*

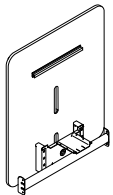

Collaboration Table Media Unit* with TV Mount

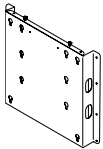

TV Mount



Table Leg Cable Organizer

MODEL#	DIMENSIONS D x W x H	FREIGHT CLASS	WT./LBS.	CUBIC FT.	LIST PRICE	HPL ADD	UML ADD
SCTAM36	11.25 x 36 x 43	150	46.28	10.08	\$966	n/a	n/a
SCTAM42	11.25 x 42 x 43	150	52.5	11.76	\$991	n/a	n/a
SCTAM48	11.25 x 48 x 43	150	58.83	13.44	\$1067	n/a	n/a

Can be affixed to all small radius tables of the same nominal width. User side is thermally fused laminate to accept TV mounts. Side facing away from users features a tackable PET panel affixed to the thermally fused laminate with a 0.5" inset.

- Worksurface available in thermally fused laminate only.
- PET felt available in all standard finishes.
- Brackets and reinforcement bar is painted metal.
- TV mount not included.
- Units 36" wide can accept TV's up to 40", not exceeding 50 lbs.
- Units 42" wide can accept TV's up to 43", not exceeding 50 lbs.
- Units 48" wide can accept TV's up to 55", not exceeding 50 lbs.

SCTAMT36	11.25 x 36 x 43	150	47.58	10.08	\$1216	n/a	n/a
SCTAMT42	11.25 x 42 x 43	150	53.8	11.76	\$1240	n/a	n/a
SCTAMT48	11.25 x 48 x 43	150	60.13	13.44	\$1316	n/a	n/a

Can be affixed to all small radius tables of the same nominal width. User side is thermally fused laminate and includes a TV mount. Side facing away from users features a tackable PET panel affixed to the thermally fused laminate with a 0.5" inset.

- Worksurface available in thermally fused laminate only.
- PET felt backer available in all standard finishes.
- Brackets and reinforcement bar is painted metal.
- Units 36" wide can accept TV's up to 40", not exceeding 50 lbs.
- Units 42" wide can accept TV's up to 43", not exceeding 50 lbs.
- Units 48" wide can accept TV's up to 55", not exceeding 50 lbs.

SCTVMT	1.5 x 1.5 x 3	70	6.43	0.29	\$200		
--------	---------------	----	------	------	--------------	--	--

Can be used on collaborative table media unit (SCTAMTxx), media cart (SCCMxx) and Office Spaces backboards. TV and video conferencing units not included. Hardware for mounting TV included. Maximum TV size is 55". Note: TV frame must be securely attached to laminate panel. Care should be taken to attach TV frame using correct fasteners. Failure to do so may result in collapse of the unit and subsequent possible injury. Available in Black (BLK) only.

SCTAL23	2.21 x 2.965 x 23	70	0.6	0.09	\$44		
---------	-------------------	----	-----	------	-------------	--	--

Organizer snaps on to any leg to manage wires vertically. Black only.

Required specifications

- Laminate finish
- Felt finish*
- Paint finish

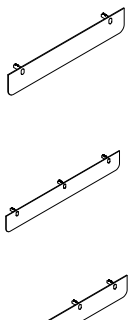
ACCESSORIES	MODEL#	DIMENSIONS	FREIGHT CLASS	WT./LBS.	CUBIC FT.	LIST PRICE
		D x W x H				
	SCTAP36	4.75 x 33 x 11	70	1.78	1	\$98
	SCTAP42	4.75 x 39 x 11	70	1.99	1.18	\$106
	SCTAP48	4.75 x 45 x 11	300	2.14	1.36	\$106
	SCTAP54	4.75 x 51 x 11	300	2.38	1.54	\$111
	SCTAP60	4.75 x 57 x 11	300	2.53	1.72	\$134
	SCTAP66	4.75 x 63 x 11	300	2.68	1.9	\$139
	SCTAP72	4.75 x 69 x 11	300	2.87	2.09	\$144
	SCTAP78	4.75 x 75 x 11	300	3.05	2.27	\$149
	SCTAP84	4.75 x 81 x 11	300	3.23	2.45	\$163
	SCTAP90	4.75 x 87 x 11	300	3.41	2.63	\$178
	SCTAP96	4.75 x 93 x 11	300	3.59	2.81	\$193

PET Felt Modesty Panel*

PET felt modesty panel with metal brackets for use on Core, Standard and Workshop tables.

- Specify matching nominal width to table.
- Modesty panels 36" to 54" include two brackets.
- Modesty panels 60" to 90" include three brackets.
- Modesty panels 96" include four brackets.
- PET felt available in standard finishes.

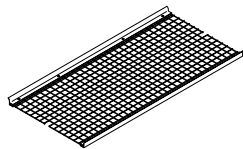

Wire Mesh Storage Tray

SCTAT4848	22 x 42 x 1.6	100	7.85	0.98	\$264
SCTAT4854	22 x 48 x 1.6	100	8.97	1.1	\$297
SCTAT4860	22 x 54 x 1.6	100	10.09	1.22	\$336
SCTAT4866	22 x 60 x 1.6	100	11.19	1.34	\$381
SCTAT4872	22 x 66 x 1.6	100	12.29	1.47	\$507
SCTAT4878	22 x 72 x 1.6	100	13.4	1.59	\$521
SCTAT4884	22 x 78 x 1.6	100	14.52	1.71	\$538
SCTAT4890	22 x 84 x 1.6	100	15.62	1.83	\$621
SCTAT4896	22 x 90 x 1.6	100	16.72	1.96	\$639

Steel storage tray is attached between dual stretchers on tables 48"d x 48"w and larger.

- Specify matching nominal width to table.
- Cannot be combined with SCTAM/SCTAMT media units on tables with casters larger than 78"w.

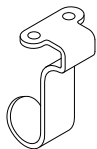
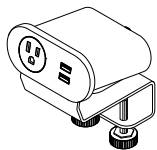

Table-mounted Bag Hook**

SCTAH	0.65 x 1.5 x 3.5	70	0.3	0.01	\$22
-------	------------------	----	-----	------	-------------

Steel hook for use on Collaborative tables. Specify standard metal paint finish. Maximum capacity of 10 lbs.



Nik Edge/Clamp Mount Power Module

SCTAPEA	2.10 x 6 x 3.7	60	4	0.03	\$608
SCTAPEB	2.10 x 6 x 3.7	60	4	0.03	\$578
SCTAPEC	2.10 x 6 x 3.7	60	4	0.03	\$671
SCTAPED	2.10 x 6 x 3.7	60	4	0.03	\$795
SCTAPEE	2.10 x 6 x 3.7	60	4	0.03	\$593

Black with black receptacles, 10ft cord. Specify configuration, last letter of the code represents the following:

- A = 1 AC, 1 USB-A 1.5A charge port, 1 USB-A 2.4A quick charge port
- B = 2 AC
- C = 2 AC, 1 USB-A 1.5A charge port, 1 USB-A 2.4A quick charge port
- D = 1 AC, 1 USB-A 1.5A charge port, 1 USB-A 2.4A quick charge port, 1 60W USB-C charge port
- E = 3 AC

Required specifications

PET felt finish*

Paint finish**

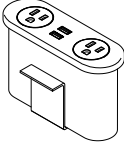
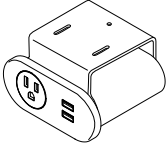
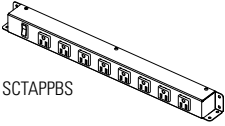
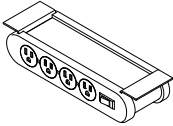
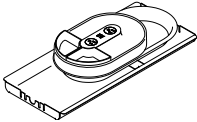
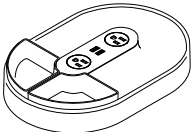
ACCESSORIES	MODEL#	DIMENSIONS D x W x H	FREIGHT CLASS	WT/LBS.	CUBIC FT.	LIST PRICE
 <p>Nik In-Surface Power Module</p>	SCTAPSC	2.10 x 6 x 3.7	60	4	0.03	\$681
	SCTAPSD	2.10 x 6 x 3.7	60	4	0.03	\$849
	SCTAPSE	2.10 x 6 x 3.7	60	4	0.03	\$598
	<p>Black with black receptacles, 10ft cord. Corresponding cut-out option is C1, C2 or C3 (where applicable). Specify configuration, last letter of the code represents the following:</p> <ul style="list-style-type: none"> • C = 2 AC, 1 USB-A 1.5A charge port, 1 USB-A 2.4A quick charge port • D = 1 AC, 1 USB-A 1.5A charge port, 1 USB-A 2.4A quick charge port, 1 60W USB-C charge port • E = 3 AC 					
 <p>Nik Below Surface Power Module</p>	SCTAPBA	2.10 x 6 x 3.7	60	4	0.03	\$474
	SCTAPBB	2.10 x 6 x 3.7	60	4	0.03	\$430
	SCTAPBC	2.10 x 6 x 3.7	60	4	0.03	\$504
	SCTAPBD	2.10 x 6 x 3.7	60	4	0.03	\$622
	SCTAPBE	2.10 x 6 x 3.7	60	4	0.03	\$440
<p>Black with black receptacles, 10ft cord. Specify configuration, last letter of the code represents the following:</p> <ul style="list-style-type: none"> • A = 1 AC, 1 USB-A 1.5A charge port, 1 USB-A 2.4A quick charge port • B = 2 AC • C = 2 AC, 1 USB-A 1.5A charge port, 1 USB-A 2.4A quick charge port • D = 1 AC, 1 USB-A 1.5A charge port, 1 USB-A 2.4A quick charge port, 1 60W USB-C charge port • E = 3 AC 						
 <p>SCTAPPBS</p>  <p>SCTAPPBD</p> <p>Below Surface Power Bar</p>	SCTAPPBS	1.95 x 21 x 1.95	60	2.7	0.06	\$366
	SCTAPPBD	4 x 10.6 x 2.3	60	2.7	0.06	\$898
<p>Available in black only.</p> <ul style="list-style-type: none"> • Single (SCTAPPBS) includes 8 outlets on a single side • Double (SCTAPPBD) includes 4 outlets on each side of the bar. Built-in circuit breaker. 						
 <p>Collaborative Spaces Power Tray</p>	SCTAPTC	10.51 x 23.26 x 4.53	85	7.73	0.64	\$1012
	SCTAPTD	10.51 x 23.26 x 4.53	85	7.73	0.64	\$1179
	SCTAPTE	10.51 x 23.26 x 4.53	85	7.73	0.64	\$928
<p>Black plastic power tray with removable grey accessory trays. Top tray is offset for cable storage underneath. Recessed tray sits 3.7" below surface to keep cables out of sight. 10ft. cord. Corresponding cut-out option is O2 (where applicable). Specify configuration, last letter of the code represents the following:</p> <ul style="list-style-type: none"> • C = 2 AC, 1 USB-A 1.5A charge port, 1 USB-A 2.4A quick charge port • D = 1 AC, 1 USB-A 1.5A charge port, 1 USB-A 2.4A quick charge port, 1 60W USB-C charge port • E = 3 AC 						
 <p>Collaborative Spaces Organizer Tray</p>	SCTAOTC	8.32 x 12.40 x 4.28	70	1.5	0.26	\$756
	SCTAOTD	8.32 x 12.40 x 4.28	70	1.5	0.26	\$919
	SCTAOTE	8.32 x 12.40 x 4.28	70	1.5	0.26	\$671
<p>Black plastic power tray with removable grey accessory trays. 10ft. cord. Corresponding cut-out option is C1, C2 or C3 (where applicable). Specify configuration, last letter of the code represents the following:</p> <ul style="list-style-type: none"> • C = 2 AC, 1 USB-A 1.5A charge port, 1 USB-A 2.4A quick charge port • D = 1 AC, 1 USB-A 1.5A charge port, 1 USB-A 2.4A quick charge port, 1 60W USB-C charge port • E = 3 AC 						

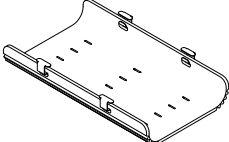
ACCESSORIES	MODEL#	DIMENSIONS	FREIGHT CLASS	WT./LBS.	CUBIC FT.	LIST PRICE
 <p>Collaborative Spaces Recessed Power Tray</p>		D x W x H				
	SCTAPRC	10.51 x 23.26 x 6.4	125	6.06	0.91	\$898
	SCTAPRD	10.51 x 23.26 x 6.4	125	6.06	0.91	\$1061
	SCTAPRE	10.51 x 23.26 x 6.4	125	6.06	0.91	\$814
	<p>Black plastic power tray. Recessed tray sits 3.7" below surface to keep cables out of sight. 10ft. cord. Corresponding cut-out option is O2 (where applicable). Specify configuration, last letter of the code represents the following:</p> <ul style="list-style-type: none"> • C = 2 AC, 1 USB-A 1.5A charge port, 1 USB-A 2.4A quick charge port • D = 1 AC, 1 USB-A 1.5A charge port, 1 USB-A 2.4A quick charge port, 1 60W USB-C charge port • E = 3 AC 					
 <p>Collaborative Spaces PET Felt* Wire Manager</p>	SCTACT	26 x 11 x 4	70	1.1	0.66	\$104
	<p>PET Felt Wire Manager hangs from four brackets under the surface. Includes Black painted metal brackets. PET felt available in standard finishes.</p>					

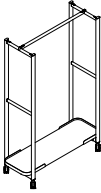
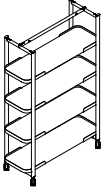
TEAM CARTS	MODEL#	DIMENSIONS	FREIGHT CLASS	WT./LBS.	CUBIC FT.	LIST PRICE
 <p>Coat Rack Cart</p>	SCCR1848	18 x 48 x 72	300	56.82	36.04	\$2346
	SCCR1860	18 x 60 x 72	300	62.77	45.05	\$2420
	<p>Cart includes side rails for compatible accessories and a single top rail for hanging coats, jackets, etc.</p> <ul style="list-style-type: none"> • Shelf available in thermally fused laminate. • Painted aluminum frame available in standard paint finishes. • 48" w cart shelf has a capacity of 140 lbs., evenly distributed. • 60" w cart shelf has a capacity of 175 lbs., evenly distributed • Casters are lockable, in a choice of two finishes - Black (BLK) or Grey (GRC). 					
 <p>Shelf Cart*</p>	SCCS1848	18 x 48 x 72	250	123.88	36.04	\$4387
	<p>Cart includes four fixed shelves with metal trim detail. Vertical rails accept PET privacy panels (sold separately) to create space division within open areas.</p> <ul style="list-style-type: none"> • Horizontal top rail accepts compatible accessories. • Shelf available in thermally fused laminate. • Painted aluminum frame available in standard paint finishes. • Each shelf has a capacity of 140 lbs., evenly distributed. • Casters are lockable, in a choice of two finishes - Black (BLK) or Grey (GRC). 					

Required specifications

PET felt finish*
 Laminate finish Edge finish
 Paint finish Caster finish

Accessories

PET privacy panel (*shelf cart only*)
 Accessory cup
 Hook for team cart
 Laptop shelf (*coat rack cart only*)

TEAM CARTS **MODEL#** **DIMENSIONS** **FREIGHT CLASS** **WT./LBS.** **CUBIC FT.** **LIST PRICE**

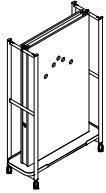

Media Cart

	D x W x H				
SCCMPE1848	18 x 48 x 72	150	171.42	36.04	\$4534
SCCMPE1860	18 x 60 x 72	150	214.23	45.05	\$5089
SCCMNE1848	18 x 48 x 72	150	170.92	36.04	\$4313
SCCMNE1860	18 x 60 x 72	150	213.73	45.05	\$4866

Cart includes includes a bottom shelf and thermally fused laminate TV board. Short side panels feature small cut-out for wire pass through and hook for wire management.

- Side rails accept compatible accessories.
- Shelf available in thermally fused laminate.
- Back panel is removable for access to cavity for cable management. Back panel is only available in whiteboard.
- SCCMEP models include a power bar (SCCAMP) mounted internally.
- SCCMNE models do not include any power.
- Units 48" wide can accept TV's up to 42" (diagonal), not exceeding 50lbs.
- Units 60" wide can accept TV's up to 55" (diagonal), not exceeding 50lbs.
- Painted aluminum frame available in standard paint finishes
- Casters are lockable, in a choice of two finishes - Black (**BLK**) or Grey (**GRC**).
- Note: TV mount included. *TV and video conferencing units are not included.*

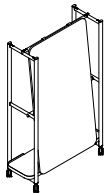

Single-Sided Whiteboard Cart

SCCSW1848	18 x 48 x 72	250	106.37	36.04	\$3885
SCCSW1860	18 x 60 x 72	150	191.07	45.05	\$4554

Cart includes one fixed shelf with metal trim detail, accessible from behind whiteboard. Front of vertical whiteboard panel is whiteboard only.

- Side rails accept compatible accessories.
- Back of vertical whiteboard panel is Designer White laminate (DWT) with Designer White edging (DWE).
- Shelf available in thermally fused laminate.
- Painted aluminum frame available in standard paint finishes.
- Casters are lockable, in a choice of two finishes - Black (**BLK**) or Grey (**GRC**).

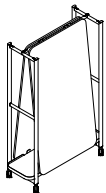

Double-Sided Whiteboard Cart

SCCDW1848	18 x 48 x 72	150	153.96	36.04	\$5238
SCCDW1860	18 x 60 x 72	150	191.07	45.05	\$6484

Cart includes one fixed shelf with metal trim detail, accessible from behind whiteboard. Front of vertical whiteboard panels is whiteboard only.

- Side rails accept compatible accessories.
- Back of vertical whiteboard panel is Designer White laminate (DWT) with Designer White edging (DWE).
- Shelf available in thermally fused laminate.
- Painted aluminum frame available in standard paint finishes.
- Casters are lockable, in a choice of two finishes - Black (**BLK**) or Grey (**GRC**).

Required specifications

Laminate finish
Edge finish
Paint finish
Caster finish

Accessories

Concealed power unit (SCCMNExxxx only)
Media tray (SCCMPExxxx/MNExxxx only)
Accessory cup

Hook for team cart
Laptop shelf

TEAM CARTS

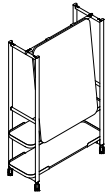

Combo Whiteboard Cart

MODEL#	DIMENSIONS D x W x H	FREIGHT CLASS	WT/LBS.	CUBIC FT.	LIST PRICE
SCCCW1848	18 x 48 x 72	250	115.66	36.04	\$4193
SCCCW1860	18 x 60 x 72	250	150.33	45.05	\$4819

Cart includes two fixed shelves with metal trim detail, accessible from behind whiteboard. Bottom shelf is accessible from both sides of cart; top shelf accessible from behind write board. Front of vertical whiteboard panel is whiteboard only.

- Side rails accept compatible accessories.
- Back of vertical whiteboard panel is Designer White laminate (DWT) with Designer White edging (DWE).
- Shelves available in thermally fused laminate.
- Painted aluminum frame available in standard paint finishes.
- 48" w cart shelf has a capacity of 140 lbs., evenly distributed.
- 60" w cart shelf has a capacity of 175 lbs., evenly distributed
- Casters are lockable, in a choice of two finishes - Black (**BLK**) or Grey (**GRC**).

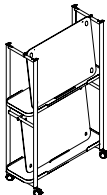

Removable Whiteboard Cart

SCCRW1848	18 x 48 x 72	150	188	42.05	\$6466
SCCRW1860	18 x 60 x 72	150	245.61	52.56	\$7383

Cart includes two fixed shelves with spacers for removable whiteboards. Includes five lightweight removable whiteboard panels.

- One whiteboard can be stored at the top and four at the bottom.
- Cart accepts five lightweight removable whiteboard panels maximum.
- Whiteboards feature whiteboard front; back in Designer White laminate (DWT) with Designer White edging (DWE).
- Hanging bracket finish matches the cart frame finish.
- Shelves available in thermally fused laminate.
- Side rails accept compatible accessories.
- Painted aluminum frame available in standard paint finishes.
- Casters are lockable, in a choice of two finishes - Black (**BLK**) or Grey (**GRC**).

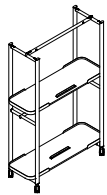

Empty Removable Whiteboard Cart

SCCEW1848	18 x 48 x 72	300	82.31	42.05	\$3167
SCCEW1860	18 x 60 x 72	250	105.7	52.56	\$3350

Cart includes two fixed shelves with spacers for removable whiteboards.

- Cart accepts five lightweight removable whiteboard panels maximum.
- One whiteboard can be stored at the top and four at the bottom.
- To order Removable Whiteboard, specify SCCAWB3336 for the 48" wide cart and SCCAWB3348 for the 60" wide cart.
- Hanging bracket finish matches the cart frame finish.
- Shelves available in thermally fused laminate.
- Side rails accept compatible accessories.
- Painted aluminum frame available in standard paint finishes.
- Casters are lockable, in a choice of two finishes - Black (**BLK**) or Grey (**GRC**).

Required specifications

Laminate finish
Edge finish
Paint finish
Caster finish

Accessories

Accessory cup
Hook for team cart
Whiteboard
Laptop shelf

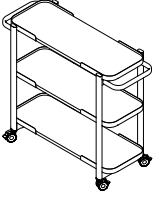
TEAM CARTS	MODEL#	DIMENSIONS	FREIGHT CLASS	WT/LBS.	CUBIC FT.	LIST PRICE
 <p>Hospitality Cart*</p>		D x W x H				
	SCHC2233	22 x 43 x 41	150	81.31	15.39	\$3423
	SCHC2239	22 x 49 x 41	150	95	17.96	\$3564
			Cart includes three fixed shelves with metal trim.			
			<ul style="list-style-type: none"> • Surfaces available in thermally fused laminate. • Legs and handles are painted aluminum available in standard paint finishes. • 33" w cart shelf has a capacity of 120 lbs., evenly distributed. • 39" w cart shelf has a capacity of 140 lbs., evenly distributed • Casters are lockable, in a choice of two finishes - Black (BLK) or Grey (GRC). • Note: size is inclusive of handles, shelf sizing is approximately 10" shorter. 			

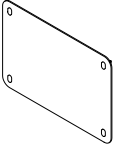
TEAM CART ACCESSORIES	MODEL#	DIMENSIONS	FREIGHT CLASS	WT/LBS.	CUBIC FT.	LIST PRICE
 <p>Cart Mounted PET Felt Privacy Panels**</p>	SCCAPP3248	0.5 x 48 x 32	85	4.16	0.32	\$289
	SCCAPP3260	0.5 x 60 x 32	85	5.16	0.4	\$428
			Lightweight removable PET Felt panels, specify SCCAPP3248 for the 48" w cart and SCCAPP3260 for the 60" w cart.			
			<ul style="list-style-type: none"> • Snaps onto (SCCEWxxxx) vertical rails at various shelf heights to create space division and privacy. • Cover caps painted metal finish should be specified to match the cart finish. • PET felt available in standard finishes. 			

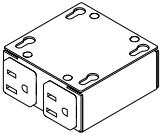
 <p>Concealed Power Unit</p>	SCCAMP	3 x 3 x 1.5	70	0.5	0.01	\$325
			Provided inside SCCMEPxxxx media units, can be added to SCCNMExxxx in field. Includes two AC outlets. 110V-120V, 15A. 10ft cord.			
			<ul style="list-style-type: none"> • Compatible with Mobile Media Carts only. • Black (BLK) finish only. 			

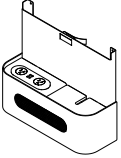
 <p>Media Tray**</p>	SCCAMT	5.60 x 14.57 x 13.80	70	12	0.65	\$720
	SCCAMTPC	5.60 x 14.57 x 13.80	70	12	0.65	\$1401
	SCCAMTPD	5.60 x 14.57 x 13.80	70	12	0.65	\$1569
	SCCAMTPE	5.60 x 14.57 x 13.80	70	12	0.65	\$1318
			Attaches to the front of the SCCMEPxxxx/SCCNMExxxx to provide a wire catch, wireless receiver area and easily accessible power at the front of the media carts			
			<ul style="list-style-type: none"> • Compatible with Mobile Media Carts only. • Tray is painted metal with a PET Felt insert. PET felt available in standard finishes. • SCCAMT is empty and has no power capabilities. • Specify configuration, last letter of the code represents the following • C = 2 AC, 1 USB-A 1.5A charge port, 1 USB-A 2.4A quick charge port • D = 1 AC, 1 USB-A 1.5A charge port, 1 USB-A 2.4A quick charge port, 1 60W USB-C charge port • E = 3 AC 			

Required specifications

- Laminate finish / Edge finish*
- Paint finish*
- Caster finish*
- PET Felt finish**

TEAM CART ACCESSORIES

MODEL# DIMENSIONS FREIGHT CLASS WT/LBS. CUBIC FT. LIST PRICE

D x W x H



Accessory Cup

SCCAC	3 x 3 x 1.5	70	0.15	0.02	\$15
-------	-------------	----	------	------	-------------

Hangs onto any team cart horizontal top or side rail. Black (BLK) finish only.

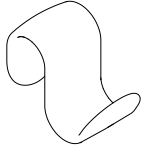

Hook for Team Cart

SCCAH	3 x 3 x 1.5	70	0.1	0.01	\$11
-------	-------------	----	-----	------	-------------

Hangs onto any team cart horizontal top or side rail. Black (BLK) finish only. Maximum capacity of 10lbs.

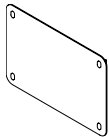

Whiteboard¹

SCCAWB3336	0.50 x 36 x 33	60	17.62	0.34	\$648
SCCAWB3348	0.50 x 48 x 33	400	23.32	46	\$801

Lightweight removable whiteboard panels. Specify SCCAWB3336 for the 48" w cart and SCCAWB3348 for the 60" w cart.

- Back of whiteboard is Designer White (DWT) with Designer White edging (DWE).
- Cover caps painted metal finish should be specified to match the cart finish.
- Horizontal and vertical mounting on wall rail(s).

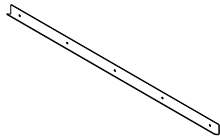

Whiteboard Wall Rail

SCCAWBR36	1 x 36 x 2	70	1.27	0.04	\$67
SCCAWBR48	1 x 48 x 2	70	1.71	0.05	\$83
SCCAWBR72	1 x 72 x 2	60	2.54	0.08	\$129
SCCAWBR96	1 x 96 x 2	60	3.42	0.11	\$159

Wall rail for whiteboards. Accepts SCCAWBxxxx. Metal extrusion in Black (BLK) only.

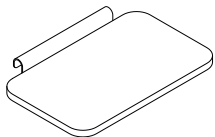

Laptop Shelf*

SCCAL1219	12 x 19 x 3	65	11.07	0.4	\$315
-----------	-------------	----	-------	-----	--------------

Laminate laptop shelf with dual bracket. Can be flipped vertically to store when cart is not in use.

- Shelf available in thermally fused laminate.
- Bracket included is painted metal finish and should be specified to match the cart finish.

Required specifications

- Laminate finish*
- Edge finish*
- Paint finish*¹

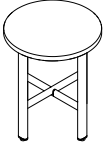
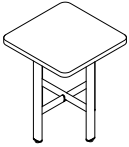
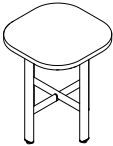
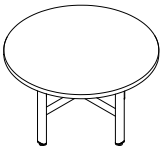
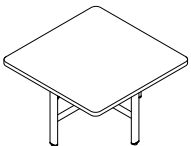
OCCASIONAL TABLES	MODEL#	DIMENSIONS	FREIGHT CLASS	WT./LBS.	CUBIC FT.	LIST PRICE	HPL ADD	UML ADD	
 <p>Occasional Side Table, Round Top</p>	D x W x H								
	SCOR1818	18 x 18 x 21	150	18.52	3.94	\$711	n/a	\$137	
	SCOR2424	24 x 24 x 21	250	26.53	7.01	\$837	n/a	\$252	
		Includes leg assembly, cross beams and one worksurface. <ul style="list-style-type: none"> • Surface available in thermally fused laminate. • Legs and cross beam are painted aluminum available in standard paint finishes. 							
 <p>Occasional Side Table, Square Top</p>	D x W x H								
	SCOC1818	18 x 18 x 21	150	21.12	3.94	\$711	n/a	\$137	
	SCOC2424	24 x 24 x 21	150	31.2	7.01	\$837	n/a	\$252	
		Includes leg assembly, cross beams and one worksurface with a small 1.5" radius at each corner. <ul style="list-style-type: none"> • Surface available in thermally fused laminate. • Legs and cross beam are painted aluminum available in standard paint finishes. 							
 <p>Occasional Side Table, Square Top, Larger Radius</p>	D x W x H								
	SCOCL1818	18 x 18 x 21	150	21.12	3.94	\$711	n/a	\$128	
	SCOCL2424	24 x 24 x 21	150	31.2	7.01	\$837	n/a	\$248	
		Includes leg assembly, cross beams and one worksurface with a larger 9" radius at each corner. <ul style="list-style-type: none"> • Surface available in thermally fused laminate. • Legs and cross beam are painted aluminum available in standard paint finishes. 							
 <p>Occasional Coffee Table, Round Top</p>	D x W x H								
	SCOCR2424	24 x 24 x 17	150	25.55	5.67	\$810	n/a	\$275	
	SCOCR3030	30 x 30 x 17	150	35.76	8.86	\$960	n/a	\$386	
	SCOCR3636	36 x 36 x 17	250	48.13	12.76	\$1141	n/a	\$584	
		Includes leg assembly, cross beams and one worksurface. <ul style="list-style-type: none"> • Surface available in thermally fused laminate. • Legs and cross beam are painted aluminum available in standard paint finishes. 							
 <p>Occasional Coffee Table, Square Top</p>	D x W x H								
	SCOCS2424	24 x 24 x 17	150	30.22	5.67	\$810	n/a	\$275	
	SCOCS3030	30 x 30 x 17	150	43.1	8.86	\$960	n/a	\$386	
		Includes leg assembly, cross beams and one worksurface with a small 1.5" radius at each corner. <ul style="list-style-type: none"> • Surface available in thermally fused laminate. • Legs and cross beam are painted aluminum available in standard paint finishes. 							

Required specifications

Laminate finish
Edge finish
Paint finish

Optional specifications

UM laminate

OCCASIONAL TABLES

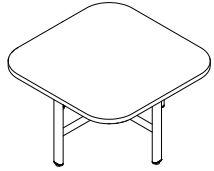

Occasional Coffee Table, Square Top, Larger Radius

MODEL#	DIMENSIONS D x W x H	FREIGHT CLASS	WT/LBS.	CUBIC FT.	LIST PRICE	HPL ADD	UML ADD
SCOCSL2424	24 x 24 x 17	150	29.11	5.67	\$810	n/a	\$275
SCOCSL3030	30 x 30 x 17	150	41.99	8.86	\$960	n/a	\$386

Includes leg assembly, cross beams and one worksurface with a larger 9" radius at each corner.

- Surface available in thermally fused laminate.
- Legs and cross beam are painted aluminum available in standard paint finishes.

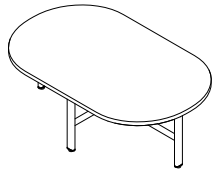

Occasional Coffee Table, Racetrack Top

SCOCC2442	24 x 42 x 17	150	42.78	9.93	\$1018	n/a	\$466
SCOCC3048	30 x 48 x 17	150	57.13	14.18	\$1211	n/a	\$684

Includes leg assembly, cross beams and one racetrack worksurface.



- Surface available in thermally fused laminate.
- Legs and cross beam are painted aluminum available in standard paint finishes.

Required specifications

Laminate finish
Edge finish
Paint finish

Optional specifications

UM laminate

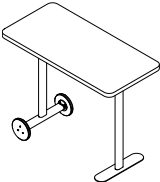
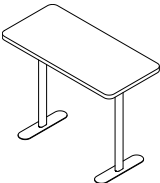
LAPTOP TABLES	MODEL#	DIMENSIONS	FREIGHT CLASS	WT/LBS.	CUBIC FT.	LIST PRICE	HPL ADD	UML ADD
 <p>Laptop Table, Racetrack Top, Wheel and Foot Base</p>	SCLCC1633	16 x 33 x 26	250	25.6	6.51	\$1258	n/a	\$227
	<p>Includes leg assembly and two wheels with rubber trim, one leg assembly with a foot, and one racetrack surface.</p> <ul style="list-style-type: none"> • Two bag hooks included, one on the exterior of each leg, mounted just under the surface for easy access. • Each bag hook accepts up to 10 lbs. and is painted to match the legs. • Legs, beams and hook are painted aluminum available in standard paint finishes. • Wheel insert is painted to match the legs and beams. • Surface available in thermally fused laminate. 							
 <p>Laptop Table, Racetrack Top, Foot Base</p>	SCLCB1633	16 x 33 x 26	250	23.85	6.51	\$760	n/a	\$239
	<p>Includes two leg assemblies with a foot and one racetrack surface.</p> <ul style="list-style-type: none"> • Two bag hooks included, one on the exterior of each leg, mounted just under the surface for easy access. • Each bag hook accepts up to 10 lbs. and is painted to match the legs. • Legs, beams and hook are painted aluminum available in standard paint finishes. • Surface available in thermally fused laminate. 							
 <p>Laptop Table, Rectangular Top, Wheel and Foot Base</p>	SCLTC1633	16 x 33 x 26	150	27.64	6.51	\$1258	n/a	\$227
	<p>Includes leg assembly and two wheels with rubber trim, one leg assembly with a foot, and one rectangular surface with a small 1.5" radius at each corner.</p> <ul style="list-style-type: none"> • Two bag hooks included, one on the exterior of each leg, mounted just under the surface for easy access. • Each bag hook accepts up to 10 lbs. and is painted to match the legs. • Legs, beams and hooks are painted aluminum available in standard paint finishes. • Wheel insert is painted to match the legs and beams. • Surface available in thermally fused laminate. 							
 <p>Laptop Table, Rectangular Top, Foot Base</p>	SCLTB1633	16 x 33 x 26	250	25.88	6.51	\$760	n/a	\$239
	<p>Includes two leg assemblies with a foot and one rectangular surface with a small 1.5" radius at each corner.</p> <ul style="list-style-type: none"> • Two bag hooks included, one on the exterior of each leg, mounted just under the surface for easy access. • Each bag hook accepts up to 10 lbs. and is painted to match the legs. • Legs, beams and hook are painted aluminum available in standard paint finishes. • Surface available in thermally fused laminate. 							

Required specifications

Laminate finish
Edge finish
Paint finish

Optional specifications

UM laminate



ConnectTABLES® provides solutions for a variety of day-to-day work environments. Designed as easy-to-use linking or freestanding tables, ConnectTABLES is limited only by your imagination.

Open Conference

Many ConnectTABLES® tops can be assembled to be freestanding. When combined with locking casters and the flip top "T" leg, the result is easy storage and complete portability.

Meeting Rooms

ConnectTABLES® modular units will provide quick and affordable answers for all sizes and shapes of rooms and applications.

Educational and Training Rooms

ConnectTABLES® table tops configure easily into temporary or permanent educational applications.

Features and Benefits

- Optional, easy-to-use thumbscrews allow installation without tools.
- Optional zinc-plated steel ganging hardware connects free standing tops without moving "T" Leg position.
- Optional modesty panel wire management unit available.
- Casters will not affect table height when used in conjunction with or in place of glides.
- Optional Black grommets for convenient wire management can be ordered "factory installed".
- Tops are 1" thick and constructed of 45 lb. density particleboard.
- Optional casters available with or without manual locks provide mobility.
- ConnectTABLES® tops are available in all Global laminate finishes with three leg and two edge color options.



T Leg with leveling glides



Modesty Panel

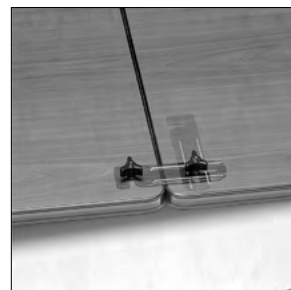

Optional ganging connector

GENERAL INFORMATION

- ConnecTABLES® is an affordable and highly flexible system of modular tables. Designed as easy-to-use linking or freestanding tables, ConnecTABLES adapts to most every requirement: seminar or training room, meeting room, personal workstations, educational, conferencing and team cluster workgroups.
- ConnecTABLES have nine basic top shapes available in various sizes.
- ConnecTABLES edges **do not match** any other Global product in either color or style.
- For environmental certifications, please visit globalfurnituregroup.com.

WORKSURFACES

- Tops are 1" thick, made of 45 lb. density particle board covered on both sides with high performance thermally fused laminate. Optional high pressure laminate tops are 1-1/16" thick.
- Laminate finishes are available in High Pressure. Contact Customer Care for a quote.
- If other than a Global standard laminate finish is preferred, contact Customer Care. Information needed includes the name of the laminate manufacturer, color name, number and model of table. You will then be given a quote for this special order.
- **ConnecTABLES® edges do not match any other Global product in either color or style.**
- Products specified with the high pressure laminate option are finished on the underside of the surface with a kraft paper backing.

CONSTRUCTION

- Some components can stand alone when the "T" base is set in the freestanding position. When the "T" base is in the linking position, all the components can be used in grouping configurations (clusters).
- Optional wire grommets not available on 45° wedge and the 60° triangle.
- Rectangular tops 54" in length and longer are supplied with a 16" gauge steel support channel. Top is pre-drilled for placement.
- Shipped RTA (ready to assemble). Quick and easy to assemble.
- Special width tops are available. Use next size up.
- Adjustable levelers offer up to 1" adjustability.
- Elliptical column cover, glides, casters, thumbscrews and endcaps available in Black only.
- Must specify top, edge, and "T" base color with each order.

LEGS

- "T" leg is coated with environmentally friendly, recyclable paint electrostatically applied epoxy powder coating for a very durable finish in three colors as specified below. Only the bottom horizontal portion of the painted leg is visible.
- Black plastic leveling glides offer 1" adjustability.
- Two black plastic elliptical column caps cover each leg column.
- Casters will not affect table height when used in conjunction with or in place of glides.
- Casters can facilitate mobility in installations which need to be moved frequently.

LAMINATE FINISHES

ACJ	Absolute Acajou	FCL	First Class
ASN	Asian Night	NBL	Noce Biondo
AWC	Avant Cherry	NGL	Noce Grigio
AWH	Avant Honey	NEL	Noce Leggero
BLK	Black	NML	Noce Medio
BZD	Blizzard	QTM	Quartered Mahogany
BRC	Brushed Cobalt	SBY	Sheer Beauty
CMB	Clear Maple	SOG	Storm Grey
CGY	Custom Grey	SDT	Stonedust
DES	Dark Espresso	WHE	Walnut Heights
DWT	Designer White	WHC	White Chocolate
FAS	Fashionista	WCR	Winter Cherry

EDGE COLORS

Black (BK) Grey (GR)

LEG COLORS

Black (TBL) Shadow (TSH)
Tungsten (TTU) Chrome (CHM) - optional on foot only, upcharge applies

GROMMETS

- Optional Grommets available in standard worksurface locations (left, center or right) **for Rectangular Tables**. Order as: **AG1, AG2 or AG3. Add \$103**
- Grommet hole dimensions are 3 1/4" wide x 1 7/8" deep.

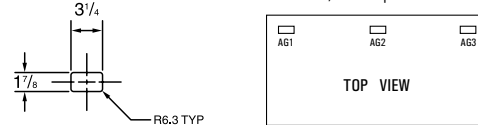

- Grommets may be placed at non-standard locations. Order as: **AGS - Add \$103**. A drawing must be supplied with vertical and horizontal dimensions to the center of the cut-out (as in drawing above). Please refer to CUSTOM GROMMET LOCATION FORM in the back reference section.
- If adding **Cove mini power block** to **AG** cut-out, cannot use with modesties.

POWER BLOCK

- An individually corded power block (model **PMSPDM**) may be ordered on all worksurfaces. Units cannot be daisy chained and cannot be used with modesties.
- Power block is configured with one electrical duplex receptacle and two data (RJ45) receptacles. 9' black cord included. Power block dimensions are 3.5" deep x 6.5" wide x 2.75" high.
- To purchase a power block, you must specify both the power block cut-out location and the power block model #. Order power block as **PMSPDM. Add \$352**. Power Blocks are available in standard worksurface locations (left, center or right). Order as **E1, E2 or E3. Add \$103**.

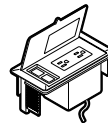

Power Block **PMSPDM, Add \$352**

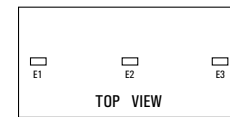

Specify location **E1, E2 or E3, Add \$103**.

EXAMPLES OF GROMMET AND POWER BLOCK POSITIONS

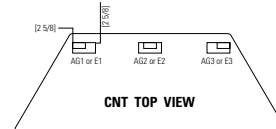
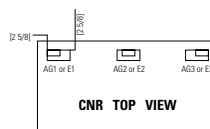

MODPOWER DAISY CHAIN SOLUTION

- Add flexible power and USB charging to ConnecTables rectangular tables. Connect up to four units with a single corded infeed with NEMA plug.
- ModPower units are sold separately, refer to Productivity Solutions page 609.
- Begin run with a starter unit which includes a corded infeed. Add additional middle or end units as required. Middle and end units are equipped with connecting cables.
- On-surface modules clamp on or screw mount to the table tops.
- In-surface modules require table top cut-outs for mounting. Specify cut-out option:
 - **MPS** for a single cut-out to accommodate one ModPower in-surface unit (cut-out will be centered on the approach side) for **30" to 72" wide rectangular tables. Add \$103**
 - **MPD** for two cut-outs in the left and right positions, 18.25" from ends to center of unit on approach side for **60", 66" and 72" wide rectangular tables. Add \$204**.

C CONNECTABLES® - NOTES

VILLA CUT-OUTS

- Optional Villa cut-out available in standard worksurface locations (left, center or right) for **Rectangular Tables**. Order as: **V1, V2 or V3** - Add \$103 for each cut-out.
- Villa cut-outs may be placed at non-standard locations. Please contact customer care.

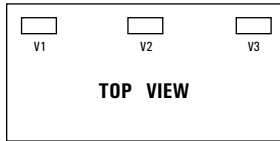

TOP & EDGE OPTIONS

- ConnectTABLES® have nine basic top shapes available in various sizes. All top shapes have a variety of straight or curved edges which are referred to as **Working (W)**, **Connecting (C) or End (E) edges**. Edges can also have a combination of edge types as shown.

*cannot freestand

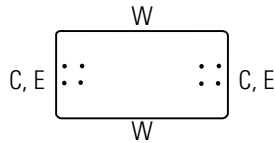

Rectangle

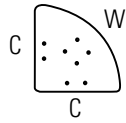

Quarter Round*

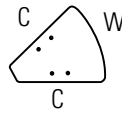

45° Wedge*

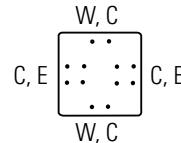

Square

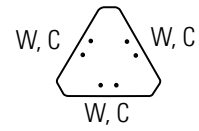

60° Triangle*

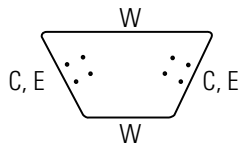

Trapezoid

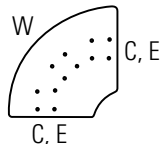

90° Crescent

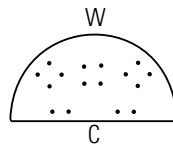

Half Round

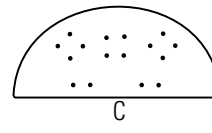

Extended Half Round*

Working Edge (1) - Edges designated with the letter "W" indicate that this is a **working** or sitting edge. These edges can be connected with optional ganging hardware in free-standing applications.

Connecting Edge (2) - Edges designated with the letter "C" indicate that this is a **connecting** edge. These edges can be connected to any other connecting edge of equal width, regardless of the top shape or size.

End Edge (3) - Edges designated with the letter "E" indicate that this is an **end** edge or an edge that can finish a run of tops. If a top has two end edges it can be freestanding. 90° crescent tops can be freestanding if the optional center leg is added.

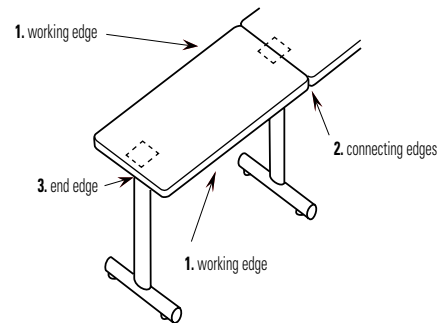

FREESTANDING AND CONNECTING CONDITIONS

Freestanding tables are defined as any one worksurface supported by two or more legs;

connecting tables are defined as more than one work surface supported by a single leg at each point of connection. The rule for determining the quantity of legs of an open configuration is the number of worksurfaces plus one (**See Figure 1**).

On closed configurations, the number of legs is equal to the number of worksurfaces (**See Figure 2**). There are some exceptions, such as when optional third legs are used on quarter round or 90° crescent shapes.

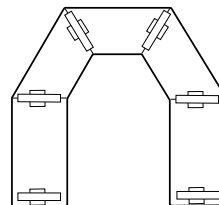

Figure 1. Open Configuration
Number of Surfaces = 5
Number of Legs = 6

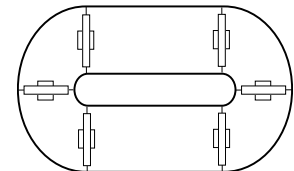

Figure 2. Closed Configuration
Number of Surfaces = 6
Number of Legs = 6

FREESTANDING CONDITIONS

- All square, rectangle and trapezoid shapes are able to act as freestanding tables (**Figure 3**).
- When Trapezoid tops are freestanding, legs must be on the outer left and right sides (**Figure 4**).
- 90° crescent work surfaces have provision for an optional third center leg for additional stability when heavy loads are applied to the outside edge. They can also be used as freestanding tables when a third leg is added (**Figure 5**).
- All freestanding tables can be connected with optional ganging hardware.
- Freestanding tables can be ganged with connected tables in some cases, providing that the number and size of connected tables is easily movable (**Figure 6**).
- **DO NOT DRAG TABLES WHEN RE-CONFIGURING.**

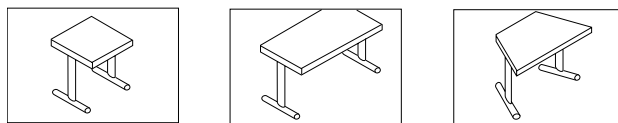
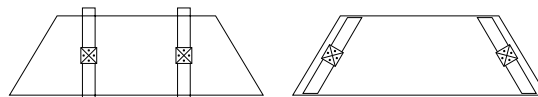

Figure 3 - Freestanding Tables



Incorrect

Correct

Figure 4 - Trapezoid Tops

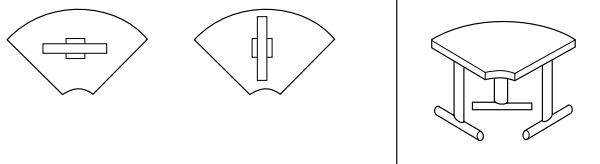

Figure 5 - Adding a Third Leg

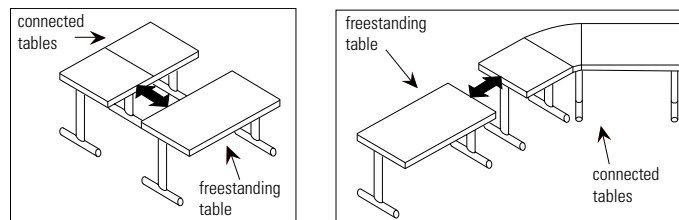

Figure 6 - Ganging with Connected Tables

CONNECTING CONDITIONS

- Any two worksurfaces of equal depth (24"D, 30"D or 36"D) can be connected with one leg, at the connecting or end edges (**Figure 8**).
- Half round work surfaces can be used in the following ways: They must be of equal width when connected to each other (**Figure 7**) or the connecting shapes must be equal to half the width of the connecting half round (**Figure 8**).
- ConnectABLES® is designed with the leg to be fastened parallel to connecting edges, but in some cases you may wish to fasten legs at 90° to connecting edges. This could allow for increased leg or knee clearance, depending on the intended use (**Figure 9**).
- Quarter round and 90° crescent work surfaces have provision for an optional third leg for additional stability when heavy loads are applied to the outside edge. For quarter round work surfaces, it is recommended that configuration "A" be used since the outside end of the center leg in configuration "B" is almost flush with the outside edge of the worksurface. If configuration "B" is installed against a wall or where there will be no traffic flow, then configuration "B" can be used.

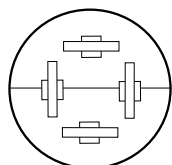

Figure 7

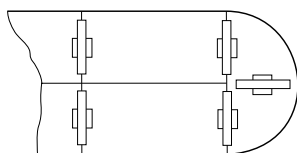

Figure 8

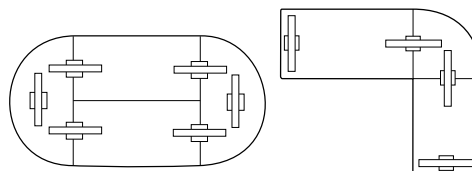
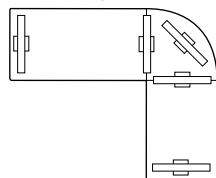
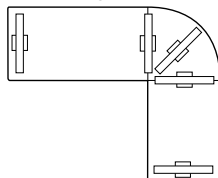

Figure 9 - 90° Leg Connections



Configuration A



Configuration B

C CONNECTABLES® - PUTTING IT ALL TOGETHER

Legs are fastened to worksurfaces utilizing a steel-to-steel connection. Each leg comes equipped with four ¼" x 7/8" machine screws. Screws are inserted through the four oval shaped holes only. Do not use wood screws! When fastening legs to work surfaces, hand thread screws into position to prevent any cross threading. When all screws have been hand threaded, tighten firmly with screwdriver to secure. Optional thumbscrews can be used in place of machine screws. Thumbscrews eliminate the need for a screwdriver, whether assembling or disassembling tables. **Do not use power tools for assembly of legs.**

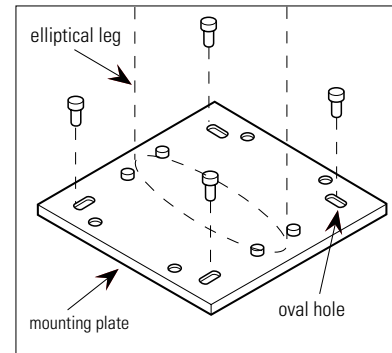

FREESTANDING TABLES

1. Turn work surface upside-down on clean floor. (You may want to use carton from packaging as a protective assembly surface to protect the top from scratching.)
2. Position leg mounting plate holes over threaded steel inserts in top.
3. Fasten each leg to top with four ¼" x 7/8" screws.
4. Turn table right-side up.
5. Level table by adjusting glides.

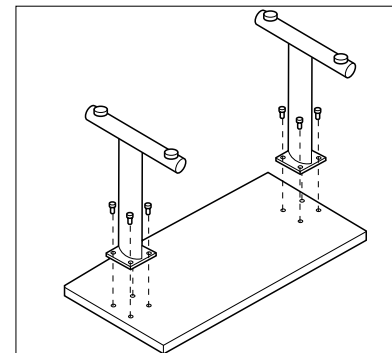

CONNECTING TABLES

1. Determine approximate location of desired configuration in room and turn work surfaces upside-down on floor. (Remember you are working in reverse.)
2. Position leg mounting plate so it is centered over the connecting edge of the first work surface. Fasten leg with two ¼" x 7/8" screws.
3. Repeat step 2 and 3 on the opposite edge of the first work surface.
4. Turn table right-side up.
5. Turn table right-side up and fasten to the previous top from the underside.
6. To add additional work surfaces repeat step 6.
7. When all the tops have been connected, level complete configuration by adjusting glides.

Note: Use the same procedures as above when using optional thumb screws.

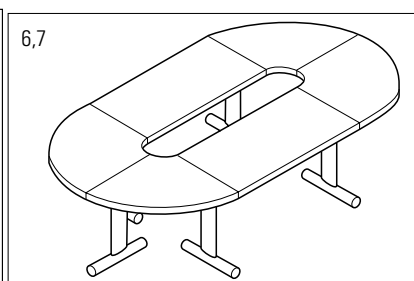
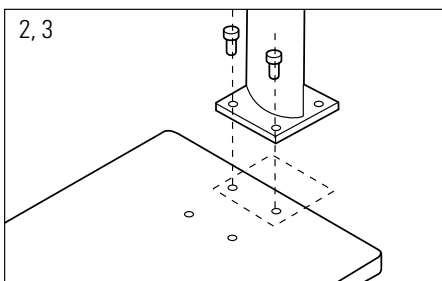
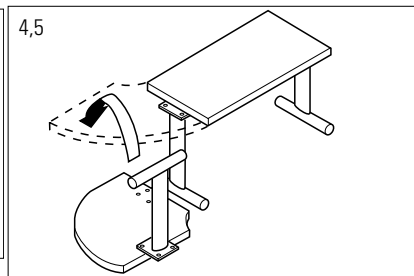
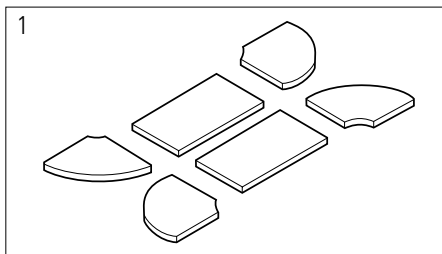

OPTIONAL CASTERS

1. Turn work surface upside-down on floor.
2. Remove existing glide if previously installed.
3. Fasten caster to T-leg by threading caster stem into base of T-leg and secure by tightening lock nut.
4. If casters are used in combination with gliders, level table by adjusting glides.

Note: Casters are available in locking or non-locking styles.

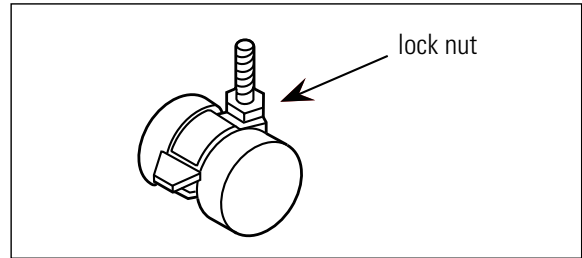
**OPTIONAL GANGING HARDWARE**

1. Optional ganging hardware should be used when quick and frequent reconfigurations are required.
2. Turn work surfaces to be ganged upside-down on floor.
3. Remove ganging hardware from package. Holes with steel inserts are located in the corner of tops.
4. Fasten ganging hardware to each work surface with supplied thumb screws.
5. Projected arm from ganging hardware can pivot out of the way when not in use.

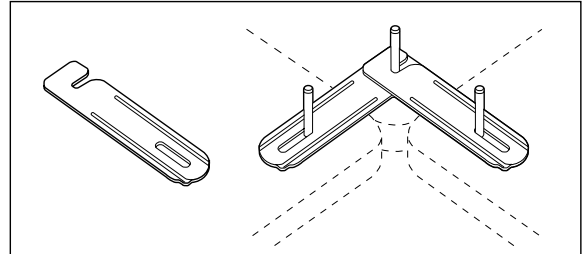

SQUARE TOPS

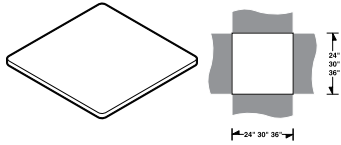

Square Top

MODEL#	DIMENSIONS	FREIGHT CLASS	WT/LBS.	CUBIC FT.	LIST PRICE	HP ADD
	D x W x H					
CNS2424	24 x 24 x 1	70	18	1	\$460	\$231
CNS3030	30 x 30 x 1	70	27	1.56	\$560	\$282
CNS3636	36 x 36 x 1	70	39	2	\$600	\$302

T-mold edging. Predrilled with threaded steel inserts for freestanding and linking installations.

RECTANGULAR TOPS

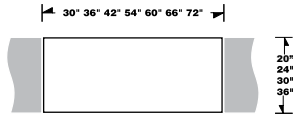

Rectangle Top

MODEL #	DIMENSIONS	FREIGHT CLASS	WT/LB.	CUBIC FT.	LIST PRICE	HP ADD
CNR2030	20 x 30 x 1	70	22	1.25	\$333	\$169
CNR2036	36 x 20 x 1	60	22.5	0.46	\$369	\$186
CNR2042	20 x 42 x 1	70	31	1.75	\$397	\$200
CNR2048	20 x 48 x 1	70	35	2	\$441	\$223
CNRU2054	20 x 54 x 1	60	33.75	0.69	\$547	\$276
CNRU2060	20 x 60 x 1	65	37.5	1.4	\$588	\$297
CNRU2066	20 x 66 x 1	60	41.25	0.84	\$636	\$322
CNRU2072	20 x 72 x 1	60	45	1	\$679	\$340
CNR2430	24 x 30 x 1	70	22	1.25	\$333	\$169
CNR2436	24 x 36 x 1	70	26	1.5	\$369	\$186
CNR2442	24 x 42 x 1	70	31	1.75	\$397	\$200
CNR2448	24 x 48 x 1	70	35	2	\$441	\$223
CNRU2454	24 x 54 x 1	70	42	2.34	\$547	\$276
CNRU2460	24 x 60 x 1	70	47	2.5	\$588	\$297
CNRU2466	24 x 66 x 1	70	52	2.8	\$636	\$322
CNRU2472	24 x 72 x 1	70	57	3	\$679	\$340
CNR3036	30 x 36 x 1	70	33	1.88	\$441	\$223
CNR3042	30 x 42 x 1	70	38	2.19	\$481	\$241
CNR3048	30 x 48 x 1	70	44	2.5	\$509	\$257
CNRU3054	30 x 54 x 1	70	52	2.8	\$629	\$316
CNRU3060	30 x 60 x 1	70	59	3.13	\$676	\$339
CNRU3066	30 x 66 x 1	70	64	3.44	\$722	\$364
CNRU3072	30 x 72 x 1	70	70	3.75	\$768	\$386
CNR3642	36 x 42 x 1	60	52.5	1.6	\$636	\$322
CNR3648	36 x 48 x 1	60	60	1.8	\$696	\$350
CNRU3654	36 x 54 x 1	60	70	2	\$841	\$422
CNRU3660	36 x 60 x 1	60	78	2.2	\$932	\$470
CNRU3666	36 x 66 x 1	60	87	2.4	\$1021	\$514
CNRU3672	36 x 72 x 1	60	94	2.6	\$1111	\$559

T-mold edging. Predrilled with threaded steel inserts for freestanding and linking installations. **Tops 54" and longer are standard with a 16 gauge steel support channel.**

TRAPEZOID TOPS

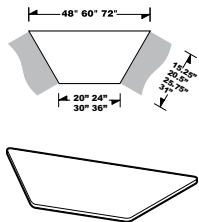

Trapezoid Top

MODEL #	DIMENSIONS	FREIGHT CLASS	WT/LB.	CUBIC FT.	LIST PRICE	HP ADD
CNT2048	17.5 x 48 x 1	60	26.25	0.55	\$464	\$234
CNT2060	17.5 x 60 x 1	65	44	1.85	\$556	\$281
CNT2448	20.5 x 48 x 1	92.5	21	2	\$464	\$234
CNT2460	20.5 x 60 x 1	65	44	1.85	\$556	\$281
CNT3060	25.75 x 60 x 1	92.5	35	3.13	\$609	\$306
CNT3072	25.75 x 72 x 1	60	66	2.2	\$679	\$340
CNT3660	31 x 60 x 1	60	66	2.2	\$867	\$436
CNT3672	31 x 72 x 1	65	79.2	3.5	\$1035	\$520

T-mold edging. Predrilled with threaded steel inserts for freestanding and linking installations.

Required Specifications

Top Finish
Edge Finish

Optional Specifications

Grommet

Accessories

Power Block

90° CRESCENT TOPS

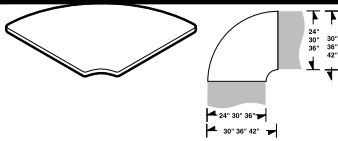

90° Crescent Top

MODEL#	DIMENSIONS	FREIGHT CLASS	WT/LBS.	CUBIC FT.	LIST PRICE	HP ADD
	D x W x H					
CNC2430	30 x 30 x 1	85	20	1.56	\$485	\$243
CNC3036	36 x 36 x 1	85	30	2.25	\$687	\$344
CNC3642	42 x 42 x 1	70	50	3.15	\$943	\$473

T-mold edging. Predrilled with threaded steel inserts for freestanding and linking installations.

- **CNC2430** for use with 24" deep tops
- **CNC3036** for use with 30" deep tops
- **CNC3642** for use with 36" deep tops
- **CNC2430** does not require a center leg

QUARTER ROUND TOPS

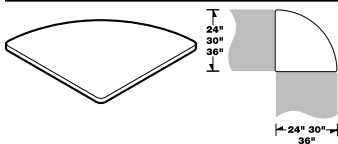

Quarter Round Top

MODEL #	DIMENSIONS	FREIGHT CLASS	WT/LB.	CUBIC FT.	LIST PRICE	HP ADD
CNQ2424	24 x 24 x 1	85	14	1	\$306	\$155
CNQ3030	30 x 30 x 1	85	21	1.56	\$370	\$187
CNQ3636	36 x 36 x 1	60	45	1.3	\$524	\$264

T-mold edging. Predrilled with threaded steel inserts for **linking installations ONLY**.

45° WEDGE TOPS

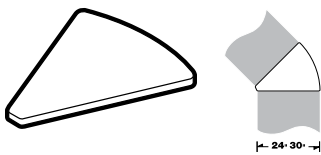

45° Wedge Top

MODEL #	DIMENSIONS	FREIGHT CLASS	WT/LB.	CUBIC FT.	LIST PRICE	HP ADD
CNW2424	24 x 24 x 1	92.5	10	1	\$327	\$167
CNW3030	30 x 30 x 1	100	14	1.56	\$398	\$200

T-mold edging. Predrilled with threaded steel inserts for **linking installations ONLY**.

THREE WAY CONNECTOR TOPS

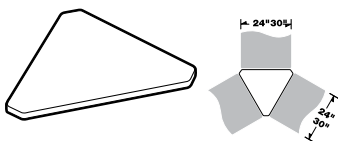

Three Way Connector Top

MODEL #	DIMENSIONS	FREIGHT CLASS	WT/LB.	CUBIC FT.	LIST PRICE	HP ADD
CNY2424	24 x 24 x 1	85	13	1	\$306	\$155
CNY3030	30 x 30 x 1	92.5	18	1.56	\$370	\$187

T-mold edging. Predrilled with threaded steel inserts for **linking installations ONLY**.

HALF ROUND TOPS

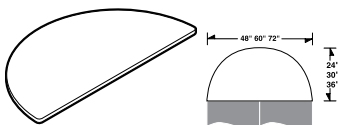

Half Round Top

MODEL #	DIMENSIONS	FREIGHT CLASS	WT/LB.	CUBIC FT.	LIST PRICE	HP ADD
CNHFS2448	24 x 48 x 1	70	36	2	\$467	\$235
CNHFS3060	30 x 60 x 1	70	56	3.13	\$604	\$305
CNHFS3672	36 x 72 x 1	65	81	3.3	\$1035	\$520

T-mold edging. Predrilled with threaded steel inserts for freestanding and linking installations.

- *Requires two legs for freestanding*

EXTENDED HALF ROUND TOPS

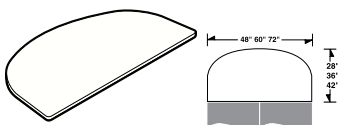

Extended Half Round Top

MODEL #	DIMENSIONS	FREIGHT CLASS	WT/LB.	CUBIC FT.	LIST PRICE	HP ADD
CNHE24	28 x 48 x 1	65	50	1.88	\$571	\$287
CNHE30	36 x 60 x 1	65	75	2.87	\$794	\$400
CNHE36	42 x 72 x 1	65	102	3.88	\$1263	\$633

T-mold edging. Predrilled with threaded steel inserts for **linking installations ONLY**.

Required Specifications

Top Finish
Edge Finish

Optional Specifications

Grommet

Accessories

Power Block

MODESTY PANELS

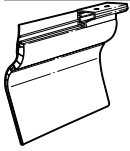

Modesty Panel



Modesty Panel

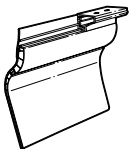

Modesty Panel

MODEL#	DIMENSIONS D x W x H	FREIGHT CLASS	WT./LBS.	CUBIC FT.	LIST PRICE
CNCA2430	2.75 x 35 x 11.75	150	2.8	0.5	\$272
CNCA3036	2.75 x 43 x 11.75	150	3.3	0.6	\$317
CNCA3642	2.75 x 53 x 11.75	150	3.9	0.7	\$415

For use with **CNC crescent tops**. 11 3/4" high, Black plastic, attractive ribbed design. Includes two fold-away installation clips and flexible privacy strips. Connects to predrilled holes in table top.

- *Can not be used when worksurface tops are attached to flip top legs.*

CNOA2424	2.75 x 27 x 11.75	150	2.2	0.4	\$233
CNOA3030	2.75 x 35 x 11.75	150	2.8	0.5	\$272
CNOA3636	2.75 x 44 x 11.75	150	3.3	0.6	\$317

For use with **CNQ quarter round tops**. 11 3/4" high, Black plastic, attractive ribbed design. Includes two fold-away installation clips and flexible privacy strips. Connects to predrilled holes in table top.

- *Can not be used when worksurface tops are attached to flip top legs.*

CNRA2030	2.75 x 29 x 11.75	150	2.8	0.5	\$233
CNRA2036	2.75 x 35 x 11.75	150	3.3	0.6	\$272
CNRA2042	2.75 x 41 x 11.75	150	3.9	0.7	\$317
CNRA2048	2.75 x 47 x 11.75	150	4.4	0.8	\$359
CNRA2054	2.75 x 53 x 11.75	150	5	0.9	\$415
CNRA2060	2.75 x 59 x 11.75	150	5.5	1	\$450
CNRA2066	2.75 x 65 x 11.75	150	6.1	1.1	\$494
CNRA2072	2.75 x 71 x 11.75	150	6.6	1.2	\$538

CNRA2430	2.75 x 29 x 11.75	150	2.8	0.5	\$233
CNRA2436	2.75 x 35 x 11.75	150	3.3	0.6	\$272
CNRA2442	2.75 x 41 x 11.75	150	3.9	0.7	\$317
CNRA2448	2.75 x 47 x 11.75	150	4.4	0.8	\$359
CNRA2454	2.75 x 53 x 11.75	150	5	0.9	\$415
CNRA2460	2.75 x 59 x 11.75	150	5.5	1	\$450
CNRA2466	2.75 x 65 x 11.75	150	6.1	1.1	\$494
CNRA2472	2.75 x 71 x 11.75	150	6.6	1.2	\$538

CNRA3036	2.75 x 35 x 11.75	150	3.3	0.6	\$272
CNRA3042	2.75 x 41 x 11.75	150	3.9	0.7	\$317
CNRA3048	2.75 x 47 x 11.75	150	4.4	0.8	\$359
CNRA3054	2.75 x 53 x 11.75	150	5	0.9	\$415
CNRA3060	2.75 x 59 x 11.75	150	5.5	1	\$450
CNRA3066	2.75 x 65 x 11.75	150	6.1	1.1	\$494
CNRA3072	2.75 x 71 x 11.75	150	6.6	1.2	\$538

CNRA3642	2.75 x 41 x 11.75	150	3.9	0.7	\$317
CNRA3648	2.75 x 47 x 11.75	150	4.4	0.8	\$359
CNRA3654	2.75 x 53 x 11.75	150	5	0.9	\$415
CNRA3660	2.75 x 59 x 11.75	150	5.5	1	\$450
CNRA3666	2.75 x 65 x 11.75	150	6.1	1.1	\$494
CNRA3672	2.75 x 71 x 11.75	150	6.6	1.2	\$538

For use with **CNR/CNRU rectangular tops**. 11 3/4" high, Black plastic, attractive ribbed design. Includes two fold-away installation clips and flexible privacy strips. Connects to predrilled holes in table top.

- *Can not be used when worksurface tops are attached to flip top legs.*

Required Specifications

Top Finish
Edge Finish

Optional Specifications

Grommet

Accessories

Power Block

MODESTY PANELS

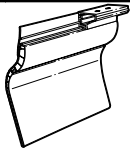

Modesty Panel

MODEL# DIMENSIONS FREIGHT CLASS WT/LBS. CUBIC FT. LIST PRICE

D x W x H

CNSA2424	2.75 x 23 x 11.75	150	2.2	0.4	\$186
CNSA3030	2.75 x 29 x 11.75	150	2.8	0.5	\$233
CNSA3636	2.75 x 35 x 11.75	150	3.3	0.6	\$272

For use with **long side of CNS square tops**. 11 3/4" high, Black plastic, attractive ribbed design. Includes two fold-away installation clips and flexible privacy strips. Connects to predrilled holes in table top.

- *Can not be used when worksurface tops are attached to flip top legs.*

CNTA2048L	20 x 43	150	4.4	0.8	\$317
CNTA2060L	2.750 x 55	150	5.5	1.2	\$415

CNTA2448L	2.75 x 43 x 11.75	150	4.4	0.8	\$317
CNTA2460L	2.75 x 55 x 11.75	150	5.5	1.2	\$415

CNTA3060L	2.75 x 55 x 11.75	150	5.5	1.2	\$415
CNTA3072L	2.75 x 67 x 11.75	150	6.6	1.4	\$494

CNTA3660L	2.75 x 55 x 11.75	150	5.5	1.2	\$415
CNTA3672L	2.75 x 67 x 11.75	150	6.6	1.4	\$494

For use with **long side of CNT trapezoid tops**. 11 3/4" high, Black plastic, attractive ribbed design. Includes two fold-away installation clips and flexible privacy strips. Connects to predrilled holes in table top.

- *Can not be used when worksurface tops are attached to flip top legs.*

CNTA2048S	20 x 24	150	2.2	0.4	\$186
CNTA2060S	20 x 36	150	2.8	0.5	\$272

CNTA2448S	2.75 x 23 x 11.75	150	2.2	0.4	\$186
CNTA2460S	2.75 x 35 x 11.75	150	2.2	0.4	\$272

CNTA3060S	2.75 x 29 x 11.75	150	2.8	0.5	\$233
CNTA3072S	2.75 x 41 x 11.75	150	2.8	0.5	\$317

CNTA3660S	2.75 x 23 x 11.75	150	3.3	0.6	\$186
CNTA3672S	2.75 x 35 x 11.75	150	3.3	0.6	\$272

For use with **short side of CNT trapezoid tops**. 11 3/4" high, Black plastic, attractive ribbed design. Includes two fold-away installation clips and flexible privacy strips. Connects to predrilled holes in table top.

- *Can not be used when worksurface tops are attached to flip top legs.*

CNWA2424	2.75 x 17 x 11.75	150	2.2	0.4	\$144
CNWA3030	2.75 x 22 x 11.75	150	2.8	0.5	\$186

For use with **CNW wedge tops**. 11 3/4" high, Black plastic, attractive ribbed design. Includes two fold-away installation clips and flexible privacy strips. Connects to predrilled holes in table top.

- *Can not be used when worksurface tops are attached to flip top legs.*

CNYA2424	2.75 x 22 x 11.75	150	2.2	0.4	\$175
CNYA3030	2.75 x 27 x 11.75	150	2.8	0.5	\$212

For use with **CNY triangle tops**. 11 3/4" high, Black plastic, attractive ribbed design. Includes two fold-away installation clips and flexible privacy strips. Connects to predrilled holes in table top.

- *Can not be used when worksurface tops are attached to flip top legs.*

Modesty Panel

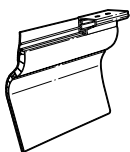

Modesty Panel

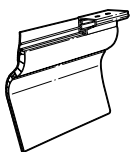

Modesty Panel

Required Specifications

Top Finish
Edge Finish

Optional Specifications

Grommet

Accessories

Power Block

WIRE MANAGEMENT UNITS

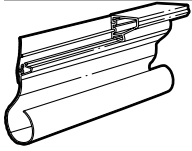

Wire Management Unit

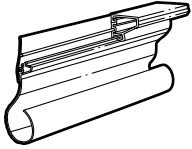

Wire Management Unit

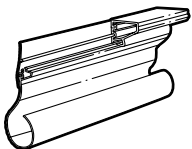

Wire Management Unit

MODEL#	DIMENSIONS D x W x H	FREIGHT CLASS	WT./LBS.	CUBIC FT.	LIST PRICE
CNCB2430	2.75 x 35 x 6	70	1.5	0.5	\$206
CNCB3036	2.75 x 43 x 6	70	1.8	0.6	\$229
CNCB3642	2.75 x 53 x 6	250	2.1	0.7	\$298

For use with **CNC crescent tops**. 6" high, Black plastic, attractive ribbed design. Includes two fold-away installation clips and flexible privacy strips. Connects to predrilled holes in table top. Can be used with or without wire management grommet.

- *Cannot be used when worksurface tops are attached to flip top legs.*

CNQB2424	2.75 x 27 x 6	70	1.2	0.4	\$173
CNQB3030	2.75 x 35 x 6	70	1.5	0.5	\$206
CNQB3636	2.75 x 44 x 6	70	1.8	0.6	\$265

For use with **CNQ quarter round tops**. 6" high, Black plastic, attractive ribbed design. Includes two fold-away installation clips and flexible privacy strips. Connects to predrilled holes in table top. Can be used with or without wire management grommet.

- *Cannot be used when worksurface tops are attached to flip top legs.*

CNRB2030	2.75 x 29 x 6	70	1.5	0.5	\$173
CNRB2036	2.75 x 35 x 6	70	1.8	0.6	\$206
CNRB2042	2.75 x 41 x 6	250	2.1	0.7	\$229
CNRB2048	2.75 x 47 x 6	250	2.4	0.8	\$317
CNRB2054	2.75 x 53 x 6	250	2.7	0.9	\$333
CNRB2060	2.75 x 59 x 6	250	3	1	\$333
CNRB2066	2.75 x 65 x 6	250	3.3	1.1	\$333
CNRB2072	2.75 x 71 x 6	250	3.6	1.2	\$450
CNRB2430	2.75 x 29 x 6	70	1.5	0.5	\$173
CNRB2436	2.75 x 35 x 6	70	1.8	0.6	\$206
CNRB2442	2.75 x 41 x 6	250	2.1	0.7	\$229
CNRB2448	2.75 x 47 x 6	250	2.4	0.8	\$317
CNRB2454	2.75 x 53 x 6	250	2.7	0.9	\$333
CNRB2460	2.75 x 59 x 6	250	3	1	\$333
CNRB2466	2.75 x 65 x 6	250	3.3	1.1	\$333
CNRB2472	2.75 x 71 x 6	250	3.6	1.2	\$450
CNRB3036	2.75 x 35 x 6	70	1.8	0.6	\$206
CNRB3042	2.75 x 41 x 6	250	2.1	0.7	\$229
CNRB3048	2.75 x 47 x 6	250	2.4	0.8	\$265
CNRB3054	2.75 x 53 x 6	250	2.7	0.9	\$298
CNRB3060	2.75 x 59 x 6	250	3	1	\$333
CNRB3066	2.75 x 65 x 6	250	3.3	1.1	\$392
CNRB3072	2.75 x 71 x 6	250	3.6	1.2	\$450
CNRB3642	2.75 x 41 x 6	250	2.1	0.7	\$229
CNRB3648	2.75 x 47 x 6	250	2.4	0.8	\$298
CNRB3654	2.75 x 53 x 6	250	2.7	0.9	\$298
CNRB3660	2.75 x 59 x 6	250	3	1	\$333
CNRB3666	2.75 x 65 x 6	250	3.3	1.1	\$333
CNRB3672	2.75 x 71 x 6	250	3.6	1.2	\$450

For use with **CNR/CNRU rectangular tops**. 6" high, Black plastic, attractive ribbed design. Includes two fold-away installation clips and flexible privacy strips. Connects to predrilled holes in table top. Can be used with or without wire management grommet.

- *Cannot be used when worksurface tops are attached to flip top legs.*

Required Specifications

Top Finish
Edge Finish

Optional Specifications

Grommet

Accessories

Power Block

WIRE MANAGEMENT UNITS

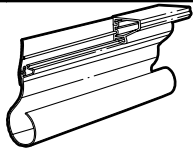

Wire Management Unit

MODEL#	DIMENSIONS	FREIGHT CLASS	WT/LBS.	CUBIC FT.	LIST PRICE
--------	------------	---------------	---------	-----------	------------

D x W x H

CNSB2424	2.75 x 23 x 6	70	1.8	0.4	\$138
CNSB3030	2.75 x 29 x 6	70	1.5	0.5	\$173
CNSB3636	2.75 x 35 x 6	70	1.8	0.6	\$206

For use with **CNS square tops**. 6" high, Black plastic, attractive ribbed design. Includes two fold-away installation clips and flexible privacy strips. Connects to predrilled holes in table top. Can be used with or without wire management grommet.

- *Cannot be used when worksurface tops are attached to flip top legs.*

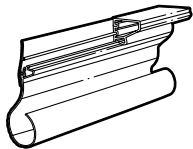

Wire Management Unit

CNTB2048L	0 x 43	250	2.4	0.8	\$229
CNTB2060L	0 x 55	250	3	1	\$298

CNTB2448L	2.75 x 43 x 6	250	2.4	0.8	\$229
CNTB2460L	2.75 x 55 x 6	250	3	1	\$298

CNTB3060L	2.75 x 55 x 6	250	3	1	\$298
CNTB3072L	2.75 x 67 x 6	250	3.6	1.2	\$415

CNTB3660L	2.75 x 55 x 6	250	3	1	\$298
CNTB3672L	2.75 x 67 x 6	250	3.6	1.2	\$415

For use with **long side of CNT trapezoid tops**. 6" high, Black plastic, attractive ribbed design. Includes two fold-away installation clips and flexible privacy strips. Connects to predrilled holes in table top. Can be used with or without wire management grommet.

- *Cannot be used when worksurface tops are attached to flip top legs.*

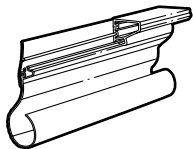

Wire Management Unit

CNTB2048S	0 x 24	70	1.2	0.4	\$138
CNTB2060S	0 x 36	70	1.5	0.5	\$206

CNTB2448S	2.75 x 23 x 6	70	1.2	0.4	\$138
CNTB2460S	2.75 x 35 x 6	70	1.2	0.4	\$206

CNTB3060S	2.75 x 29 x 6	70	1.5	0.5	\$173
CNTB3072S	2.75 x 41 x 6	70	1.5	0.5	\$229

CNTB3660S	2.75 x 23 x 6	70	1.8	0.6	\$138
CNTB3672S	2.75 x 35 x 6	70	1.8	0.6	\$206

For use with **short side of CNT trapezoid tops**. 6" high, Black plastic, attractive ribbed design. Includes two fold-away installation clips and flexible privacy strips. Connects to predrilled holes in table top. Can be used with or without wire management grommet.

- *Can not be used when worksurface tops are attached to flip top legs.*

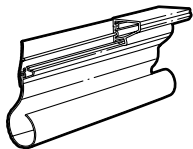

Wire Management Unit

CNWB2424	2.75 x 17 x 6	70	1.2	0.4	\$113
CNWB3030	2.75 x 22 x 6	70	1.5	0.5	\$138

For use with **CNW wedge tops**. 6" high, Black plastic, attractive ribbed design. Includes two fold-away installation clips and flexible privacy strips. Connects to predrilled holes in table top. Can be used with or without wire management grommet.

- *Cannot be used when worksurface tops are attached to flip top legs.*

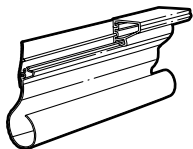

Wire Management Unit

CNYB2424	2.75 x 22 x 6	70	1.2	0.4	\$138
CNYB3030	2.75 x 27 x 6	70	1.5	0.5	\$173

For use with **CNY triangle tops**. 6" high, Black plastic, attractive ribbed design. Includes two fold-away installation clips and flexible privacy strips. Connects to predrilled holes in table top. Can be used with or without wire management grommet.

- *Cannot be used when worksurface tops are attached to flip top legs.*

Required Specifications

Top Finish
Edge Finish

Optional Specifications

Grommet

Accessories

Power Block

MODESTY PANEL WITH WIRE MANAGEMENT

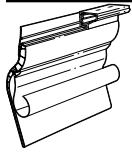

Modesty Panel with Wire Management

MODEL#	DIMENSIONS D x W x H	FREIGHT CLASS	WT./LBS.	CUBIC FT.	LIST PRICE
CNCC2430	2.75 x 35 x 11.75	100	4.3	0.5	\$298
CNCC3036	2.75 x 43 x 11.75	100	5.1	0.6	\$338
CNCC3642	2.75 x 53 x 11.75	100	6	0.7	\$438

For use with **CNC crescent tops**. 11 3/4" high, Black plastic, attractive ribbed design. Includes two fold-away installation clips and flexible privacy strips. Connects to predrilled holes in table top. Can be used with or without wire management grommet.

- *Can not be used when worksurface tops are attached to flip top legs.*

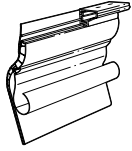

Modesty Panel with Wire Management

CNQC2424	2.75 x 27 x 11.75	100	3.4	0.4	\$249
CNQC3030	2.75 x 35 x 11.75	100	4.3	0.5	\$298
CNQC3636	2.75 x 44 x 11.75	100	5.1	0.6	\$338

For use with **CNC quarter round tops**. 11 3/4" high, Black plastic, attractive ribbed design. Includes two fold-away installation clips and flexible privacy strips. Connects to predrilled holes in table top. Can be used with or without wire management grommet.

- *Can not be used when worksurface tops are attached to flip top legs.*

CNRC2030	2.75 x 29 x 11.75	100	4.3	0.5	\$249
CNRC2036	2.75 x 35 x 11.75	100	5.1	0.6	\$298
CNRC2042	2.75 x 41 x 11.75	100	6	0.7	\$338
CNRC2048	2.75 x 47 x 11.75	100	6.8	0.8	\$393
CNRC2054	2.75 x 53 x 11.75	100	7.7	0.9	\$438
CNRC2060	2.75 x 59 x 11.75	100	8.5	1	\$486
CNRC2066	2.75 x 65 x 11.75	100	9.4	1.1	\$526
CNRC2072	2.75 x 71 x 11.75	100	10.2	1.2	\$556

CNRC2430	2.75 x 29 x 11.75	100	4.3	0.5	\$249
CNRC2436	2.75 x 35 x 11.75	100	5.1	0.6	\$298
CNRC2442	2.75 x 41 x 11.75	100	6	0.7	\$338
CNRC2448	2.75 x 47 x 11.75	100	6.8	0.8	\$393
CNRC2454	2.75 x 53 x 11.75	100	7.7	0.9	\$438
CNRC2460	2.75 x 59 x 11.75	100	8.5	1	\$486
CNRC2466	2.75 x 65 x 11.75	100	9.4	1.1	\$526
CNRC2472	2.75 x 71 x 11.75	100	10.2	1.2	\$556

CNRC3036	2.75 x 35 x 11.75	100	5.1	0.6	\$298
CNRC3042	2.75 x 41 x 11.75	100	6	0.7	\$338
CNRC3048	2.75 x 47 x 11.75	100	6.8	0.8	\$393
CNRC3054	2.75 x 53 x 11.75	100	7.7	0.9	\$438
CNRC3060	2.75 x 59 x 11.75	100	8.5	1	\$486
CNRC3066	2.75 x 65 x 11.75	100	9.4	1.1	\$526
CNRC3072	2.75 x 71 x 11.75	100	10.2	1.2	\$556

CNRC3642	2.75 x 41 x 11.75	100	6	0.7	\$338
CNRC3648	2.75 x 47 x 11.75	100	6.8	0.8	\$393
CNRC3654	2.75 x 53 x 11.75	100	7.7	0.9	\$438
CNRC3660	2.75 x 59 x 11.75	100	8.5	1	\$486
CNRC3666	2.75 x 65 x 11.75	100	9.4	1.1	\$526
CNRC3672	2.75 x 71 x 11.75	100	10.2	1.2	\$556

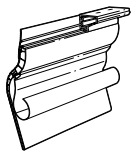

Modesty Panel with Wire Management

For use with **CNR/CNRU rectangular tops**. 11 3/4" high, Black plastic, attractive ribbed design. Includes two fold-away installation clips and flexible privacy strips. Connects to predrilled holes in table top. Can be used with or without wire management grommet.

- *Can not be used when worksurface tops are attached to flip top legs.*

Required Specifications

Top Finish
Leg Finish
Edge Finish

Optional Specifications

Grommet

Accessories

Power Block

MODESTY PANEL WITH WIRE MANAGEMENT

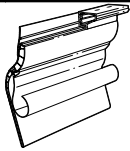

Modesty Panel with Wire Management

MODEL# DIMENSIONS FREIGHT CLASS WT./LBS. CUBIC FT. LIST PRICE

D x W x H

CNSC2424	2.75 x 23 x 11.75	100	3.5	0.4	\$206
CNSC3030	2.75 x 29 x 11.75	100	4.3	0.5	\$249
CNSC3636	2.75 x 35 x 11.75	100	5.1	0.6	\$298

For use with **CNC square tops**. 11 3/4" high, Black plastic, attractive ribbed design. Includes two fold-away installation clips and flexible privacy strips. Connects to predrilled holes in table top. Can be used with or without wire management grommet.

- *Can not be used when worksurface tops are attached to flip top legs.*

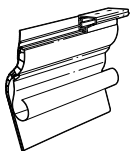

Modesty Panel with Wire Management

CNTC2048L	2.75 x 43 x 11.75	100	6.8	0.8	\$338
CNTC2060L	2.75 x 55 x 11.75	100	8.5	1	\$438
CNTC2448L	2.75 x 43 x 11.75	100	6.8	0.8	\$338
CNTC2460L	2.75 x 55 x 11.75	100	8.5	1	\$438
CNTC3060L	2.75 x 55 x 11.75	100	8.5	1	\$438
CNTC3072L	2.75 x 67 x 11.75	100	10.2	1.2	\$526
CNTC3660L	2.75 x 55 x 11.75	100	8.5	1	\$438
CNTC3672L	2.75 x 67 x 11.75	100	10.2	1.2	\$526

For use with **long side of CNT trapezoid tops**. 11 3/4" high, Black plastic, attractive ribbed design. Includes two fold-away installation clips and flexible privacy strips. Connects to predrilled holes in table top. Can be used with or without wire management grommet.

- *Can not be used when worksurface tops are attached to flip top legs.*

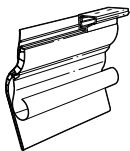

Modesty Panel with Wire Management

CNTC2048S	2.75 x 23 x 11.75	100	3.4	0.4	\$206
CNTC2060S	2.75 x 35 x 11.75	100	3.5	0.5	\$298
CNTC2448S	2.75 x 23 x 11.75	100	3.4	0.4	\$206
CNTC2460S	2.75 x 35 x 11.75	100	3.4	0.4	\$298
CNTC3060S	2.75 x 29 x 11.75	100	4.3	0.5	\$249
CNTC3072S	2.75 x 41 x 11.75	100	4.3	0.5	\$338
CNTC3660S	2.75 x 23 x 11.75	100	5.1	0.6	\$206
CNTC3672S	2.75 x 35 x 11.75	100	5.1	0.6	\$298

For use with **short side of CNT trapezoid tops**. 11 3/4" high, Black plastic, attractive ribbed design. Includes two fold-away installation clips and flexible privacy strips. Connects to predrilled holes in table top. Can be used with or without wire management grommet.

- *Can not be used when worksurface tops are attached to flip top legs.*

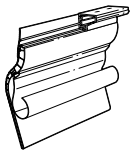

Modesty Panel with Wire Management

CNWC2424	2.75 x 17 x 11.75	100	3.4	0.4	\$169
CNWC3030	2.75 x 22 x 11.75	100	4.3	0.5	\$206

For use with **CNW wedge tops**. 11 3/4" high, Black plastic, attractive ribbed design. Includes two fold-away installation clips and flexible privacy strips. Connects to predrilled holes in table top. Can be used with or without wire management grommet.

- *Can not be used when worksurface tops are attached to flip top legs.*

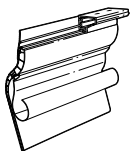

Modesty Panel with Wire Management

CNYC2424	2.75 x 22 x 11.75	100	3.4	0.4	\$206
CNYC3030	2.75 x 27 x 11.75	100	4.3	0.5	\$249

For use with **CNY triangle tops**. 11 3/4" high, Black plastic, attractive ribbed design. Includes two fold-away installation clips and flexible privacy strips. Connects to predrilled holes in table top. Can be used with or without wire management grommet.

- *Can not be used when worksurface tops are attached to flip top legs.*

Required Specifications

Top Finish
Leg Finish
Edge Finish

Optional Specifications

Grommet

Accessories

Power Block

T LEGS

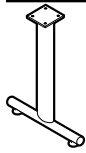

"T" Leg

MODEL#	DIMENSIONS D x W x H	FREIGHT CLASS	WT./LBS.	CUBIC FT.	LIST PRICE
GCNTLEG18	5.25 x 17.1 x 27.63	125	15	2.1	\$314
GCNTLG18P	5.25 x 17.1 x 27.63	100	17	2.1	\$616

18" long with plastic elliptical column cover, leveling glides and end caps. **For assembly with 20" tops.**

- For a single leg, order **GCNTLEG18**.
- For a pair of legs (set of 2), order **GCNTLG18P**.
- Chrome (CHM) is available (on foot only). **Add \$103** list for model GCNTLEG18 and **\$199** list for model GCNTLG18P.

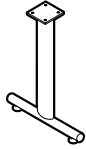

"T" Leg

GCNTLEG24	5.25 x 20.8 x 27.63	150	9	2.1	\$314
GCNTLG24P	5.25 x 20.8 x 27.63	100	17	2.1	\$616

20" long with plastic elliptical column cover, leveling glides and end caps. **For assembly with 24" tops.**

- For a single leg, order **GCNTLEG24**.
- For a pair of legs (set of 2), order **GCNTLG24P**.
- Chrome (CHM) is available (on foot only). **Add \$103** list for model GCNTLEG24 and **\$199** list for model GCNTLG24P.

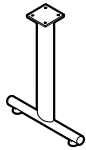

"T" Leg

GCNTLEG30	5.25 x 27.25 x 27.63	250	10	2.6	\$338
GCNTLG30P	5.25 x 27.25 x 27.63	125	19	2.6	\$671

26" long with plastic elliptical column cover, leveling glides and end caps. **For assembly with 30" tops.**

- For a single leg, order **GCNTLEG30**.
- For a pair of legs (set of 2), order **GCNTLG30P**.
- Chrome (CHM) is available (on foot only). **Add \$103** list for model GCNTLEG30 and **\$199** list for model GCNTLG30P.

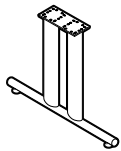

"T" Leg

GCNTLEG36	5.75 x 33.25 x 27.63	150	14	3.3	\$679
GCNTLG36P	5.25 x 33.25 x 27.63	100	27	3.3	\$1345

32" long with double post plastic elliptical column cover, leveling glides and end caps. **For assembly with 36" tops.**

- For a single leg, order **GCNTLEG36**.
- For a pair of legs (set of 2), order **GCNTLG36P**.
- Chrome (CHM) is available (on foot only). **Add \$103** list for model GCNTLEG36 and **\$199** list for model GCNTLG36P.

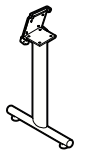

Flip Top "T" Leg

CNTFLEG24	1.75 x 20.8 x 28	150	10	2.4	\$583
-----------	------------------	-----	----	-----	--------------

20" long with plastic elliptical column cover, leveling glides and end caps. **For assembly with 24" deep rectangular and square tops only.** Hinged plate with locking mechanism to lock in open or closed position. Cannot be installed with thumbscrews.

- *Can not be used when modesty panels and wire management are attached to worksurface tops.*
- List Price is per **each leg**.
- Chrome (CHM) is available (on foot only). **Add \$103** list.

Required Specifications

Leg Finish

T LEGS

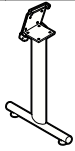

Flip Top "T" Leg

MODEL#	DIMENSIONS	FREIGHT CLASS	WT./LBS.	CUBIC FT.	LIST PRICE
--------	------------	---------------	----------	-----------	------------

D x W x H

CNTFLEG30	1.75 x 27.25 x 28	150	14	3	\$616
-----------	-------------------	-----	----	---	-------

26" long with plastic elliptical column cover, leveling glides and end caps. **For assembly with 30" deep rectangular and square tops only.** Hinged plate with locking mechanism to lock in open or closed position. Cannot be installed with thumbscrews.

- Can not be used when modesty panels and wire management are attached to worksurface tops.
- List Price is per **each leg**.
- Chrome (CHM) is available (on foot only). **Add \$103** list

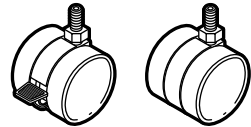

Casters

CNCP	- x - x 1.5	70	0.8	0.05	\$68
------	-------------	----	-----	------	------

Set of (2) 1½" dual wheel casters, one locking. Suggested for hard floor surfaces and industrial carpeting. Casters are fully interchangeable with glides. Black only.

- For use with *ConnecTABLES* units only.
- Casters **DO NOT** affect table height.



Thumbscrews

CNTS	1.25 x 1.25 x 1.5	70	0.04	0.02	\$43
------	-------------------	----	------	------	------

Triangular thumbscrew with ¾" steel thread. Set of 4. Can be used in place of factory supplied screws to allow installation of "T" legs to tops without tools. Black only.

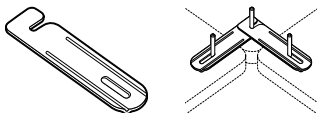

Ganging Connector

CNGFP	5 x 2.5 x 1.13	70	0.2	0.1	\$74
-------	----------------	----	-----	-----	------

Black epoxy coated 13 gauge steel with 2 thumbscrews included. Used to connect tabletops together for additional stability or for connecting freestanding tops together. Holes with steel inserts are located in the corner of all tops to accommodate this plate. **Sold individually.**

Required Specifications

Leg Finish



Duet tables are multi-purpose stacking tables that offer optimum space utilization and flexibility. Their personality and simple design make them ideal for use in any learning or training environment at post-secondary and adult levels. Temporarily and easily convert auditoriums and other spaces into examination and seminar spaces. They can be partnered with stacking chairs such as Duet or Popcorn in matching or complementary colors (stacking chairs can be found in the Multi-Purpose section of the Seating price list).

The one-piece molded top and modesty are gently contoured providing an eased edge with an elegant waterfall transition from top to modesty.

Tops are available in a wide array of colors in 0.5" thick polypropylene. Polypropylene material offers strength and ease of cleaning with a slightly textured surface to offer scratch resistance.

Features and Benefits

- One-piece molded top and modesty are 0.5" thick polypropylene.
- Tables are rated 250 lbs. capacity.
- Surface includes factory installed metal inserts for solid and secure connection to the sled frame.
- 0.5" diameter solid steel rod sled frame.
- Bumpers on the underside for protection when stacking.
- Model with ADA width compliant frame is available.
- Shipped fully assembled.



One-piece top and modesty.



Stacks 5 high on floor or 20 high on dolly.



Ganging frame to keep tables evenly aligned.

GENERAL INFORMATION

- Duet tables are multi-purpose stacking tables ideal for auditoriums, seminars or any learning or training environment.
- Lightweight and easy to handle whether stacking for storage or setting up a room.
- Made of durable materials to withstand more demanding environments.
- Shipped fully assembled. Packaged 4 per carton.
- Global products are in compliance with stringent emission guidelines set out by the Greenguard Environmental Institute under the standards for low emitting products and materials. www.greenguard.org.
- Covered by Global's Lifetime Warranty.
- For environmental certifications, please visit globalfurnituregroup.com

WORKSURFACES

- Top and modesty are a one-piece injection molded design in 0.5" thick polypropylene.
- Available in a wide array of colors (see right column "FINISHES") to complement any space or to define sections by color.
- One-piece molded top and modesty are contoured providing an eased user edge, with an elegant waterfall transition from top to modesty.

26"W x 18"D x 9.75"H

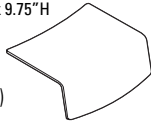

CONSTRUCTION

- Surface includes molded in threaded inserts to provide a secure metal-to-metal connection to the sled frame.
- Bumpers are included on the underside of top and inside modesty to protect surfaces when stacking.

FRAME

- 0.5" diameter solid steel rod sled frame.
- Available in a durable Chrome finish.
- Model with ganging frame keeps tables evenly positioned and aligned. No tools or fasteners required for ganging; the frames simply interlock.
- Model with ADA compliant frame is also available. The frame is 33" wide and the polypropylene top/modesty remain a constant size.
- Tables are standard without glides and are suitable for carpet, rubber or cork flooring.
- Glide options are available (see right column "GLIDES"). Glides must be chosen to best suit flooring type and site conditions. Upcharges apply.

DOLLY

- For space saving storage and transport.
- Constructed from 1.5" x 0.5" steel tubing with heavy duty casters (two locking) and a removable handle.
- Dolly can stack up to 20 tables.
- Stacking height on dolly is up to 68".

FINISHES

BZB	Buzz Blue	FRO	Frost
CCT	Cactus	INK	Ink
CRO	Carrot	LAB	Latte
IVC	Cloud	BLK	Night
DJN	Dijon	SND	Sand
EGP	Eggplant	SAR	Scarlet
FOG	Fog	SHW	Shadow

GLIDES

- CG** Clear polycarbonate (for carpet, rubber or concrete flooring). Height added to table: 0.18". **Add \$19/set.**
- SG** Glides with stainless steel pads (for carpet or rubber flooring). Height added to table: 0.17". **Add \$36/set.**
- FG** Glides with felt pads (for vinyl, cork or laminate flooring). Height added to table: 0.24". **Add \$36/set.**
- RG** Glides with rubber pads (for vinyl, hardwood, laminate, stone or ceramic flooring). Height added to table: 0.16". **Add \$36/set.**

SPECIFICATIONS

- Specifications marked with an * are applicable to only those products which have the * symbol beside the product name.

EXAMPLE DUET TABLE ORDER CODE:

Duet stacking table, polypropylene surface in Latte, clear polycarbonate glides

DTS1828P	-LAB	-CG
Model #	Surface finish	Glides

D DUET™ TABLES

STACKING TABLES

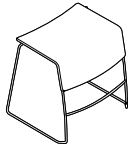

Stacking Table*

MODEL#	DIMENSIONS D x W x H	FREIGHT CLASS	WT./LBS.	CUBIC FT.	LIST PRICE
DTS1828P	25 x 29 x 28	150	26	17.75	\$545

One-piece polypropylene top and modesty with Chrome frame. Shipped fully assembled, 4 per carton.

- Price shown is per table. It is recommended to order in multiples of 4.
- Please be sure to select the appropriate glide (see previous page) for the flooring surface, as scratches could occur.
- Worksurface is 18" D x 28" W

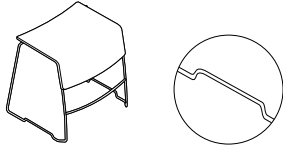

Stacking Table, Ganging Frame*

DTS1828PG	25 x 30.75 x 28	150	26	17.75	\$581
-----------	-----------------	-----	----	-------	--------------

One-piece polypropylene top and modesty with Chrome ganging frame. Shipped fully assembled, 4 per carton.

- Price shown is per table. It is recommended to order in multiples of 4.
- Please be sure to select the appropriate glide (see previous page) for the flooring surface, as scratches could occur.
- Worksurface is 18" D x 28" W

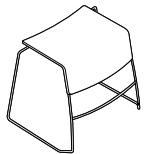

Stacking Table, 32" Wide*

DTA1832P	25 x 33 x 28	150	26	17.75	\$616
----------	--------------	-----	----	-------	--------------

ADA (American with Disabilities Act) compliant. 33" wide. One-piece polypropylene top and modesty with Chrome frame. Underside clearance is 27.1"H (extra height if glides are selected). Stacks up to 5 high on floor only; dolly does not accommodate. Shipped fully assembled, 4 per carton.

- Price shown is per table. It is recommended to order in multiples of 4.
- Please be sure to select the appropriate glide (see previous page) for the flooring surface, as scratches could occur.
- Worksurface is 18" D x 32" W

DOLLY

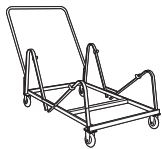

Dolly

MODEL #	DIMENSIONS	FREIGHT CLASS	WT./LB.	CUBIC FT.	LIST PRICE
DTD20	29.5 x 63 x 38.5	250	50	21	\$791

For use with tables DTS1828P and DTS1828PG. Can stack up to 20 tables. Black only. Removable handle for storage. Shipped fully assembled in 1 carton.

Required Specifications
Finish

Optional Specifications
Grommet

Accessories
Power Block



Edventure is a value series collection that offers a range of teacher desks, student desks and study carrels for more traditional learning environments. Designed to withstand daily rigorous use, traditional style meets modern performance.

Tops are available in a wide array of finishes in 1" thick thermally fused laminate or 1 1/16" high pressure laminate with matching or complementary 2mm PVC edgebanding. Edventure's color palette also includes nine new bold finishes available on select components in high pressure laminate only.

Mobile teacher desks offer versatility with storage options for educators on the move.

Single and connecting study carrels create quiet work areas with optional power and data to stay connected.

Features and Benefits

- Tops are 1" thick thermally fused laminate or 1 1/16" high pressure laminate.
- Tops are constructed of 45 lb. density particle board.
- Matching or complementary 2mm PVC edgebanding.
- Surfaces include factory installed metal inserts for solid and secure leg connections.
- H-leg design on teacher and student desks.
- Teacher's desk includes modesty panel and is available with or without casters.
- Teacher's desk with left or right hand box/box/file pedestal available on casters only.
- Study carrel features curved side panels for seated privacy with a 29"H worksurface.
- Easy to assemble.



H-legs with cross bar.



Mobile teacher desk with modesty panel.



Freestanding and add-on study carrels.

GENERAL INFORMATION

- Edventure series is an affordable collection of teacher desks, student desks and study carrels with personal storage options, that bring a traditional element to the classroom.
- Simple and elegant design respects space requirements to accommodate various teaching styles.
- Edventure series is a high achiever, built to withstand the most demanding environments.
- Shipped easy to assemble.
- For environmental certifications, please visit globalfurnituregroup.com

WORKSURFACES

- Tops are available in 1" thick thermally fused laminate or 1 1/16" thick high pressure laminate.
- Available in an array of finishes in both thermally fused laminate or high pressure laminate.
- Products specified with the high pressure laminate option are finished on the underside of the surface with a kraft paper backing.

CONSTRUCTION

- Top core is made of 45 lb. density particle board.
- Surfaces include factory installed metal inserts for solid and secure leg connections.

EDGE DETAIL

- Global's preferred 2mm PVC edgbanding is standard.
- Edgbanding may be specified in a matching or a complementary finish for tops in standard Global laminates.

LEGS

- H-legs are 28" high and constructed from 2" x 2" square tubing with a 1" x 2" rectangular cross bar and adjustable leveling glides.
- Available in Black (**TBL**), Buzz Blue (**TBZ**), Cactus (**TCC**), Carrot (**TCR**), Cloud (**TIV**), Designer White (**TDW**), Dijon (**TDJ**), Eggplant (**TEG**), Fog (**TFO**), Frost (**TFR**), Ink (**TIN**), Kalua (**TKA**), Latte (**TLA**), Mocha (**TMO**), Nevada (**TNE**), Sand (**TSN**), Scarlet (**TSR**), Shadow (**TSH**), Toast (**TOA**) or Tungsten (**TTU**) painted finishes, Sandtex finish applied.

CASTERS

- Teacher desks are available with locking casters. See models ending in C.
- Casters are 3.5" high overall.

MODESTY PANELS

- 12"H modesty panel is included with teacher desks.
- Available in an array of finishes (see page 721) in thermally fused laminate with matching edges only.

STUDY CARRELS

- Study carrels feature a 29" high worksurface and curved side panels for privacy.
- Freestanding (starter) and add-on models are available. Legs and privacy panels are shared between adjoining add-on carrels.
- The back panel is inset to hide connecting fasteners from user's view. The inset back also creates a wire drop for the optional LED task light cord.
- Carrels with an optional shelf are available. See models ending in **S**.
- Optional LED task light is available for carrel with shelf, see page 724
- Optional ModPower daisy-chain solution is available to bring power, USB charging or data to the carrel surface for desktop access, refer to Productivity Solutions, Power & Data, page 609.

SPECIFICATIONS

- Specifications marked with an * are applicable to only those products which have the * symbol beside the product name.

GROMMETS

- Optional grommets are available in standard worksurface locations (left, center or right) for **teacher desks** and **study carrels**. Order as: **AG1, AG2** or **AG3**. Add **\$103**.
- Grommet hole dimensions are 3.25"W x 1.875"D
 - ENSTxxxx, ENAC2924/3524, ENFC3024/3624 models - **AG2** option only
 - ENFC6024/7224, ENFC5924/7124 models - **AG1 and AG3** option only

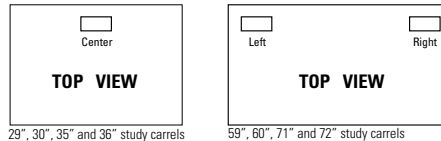

POWER BLOCK

- A power block is a rectangular worksurface power/data module with one electrical duplex receptacle and two data (RJ45) receptacles. 9' Black cord included. Power block dimensions are 6.5"W x 3.5"D x 2.75"H. Units cannot be daisy-chained.
 - ENSTxxxx, ENAC2924/3524, ENFC3024/3624 models - **E2** option only
 - ENFC6024/7224, ENFC5924/7124 models - **E1 and E3** option only

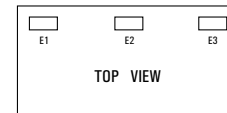
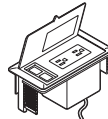

Power block **PMSPDM**. Add **\$352**. Specify location **E1, E2** or **E3**. Add **\$103**.

VILLA CUT-OUTS

- Optional Villa cut-out available in standard worksurface locations (left, center or right) for Rectangular tables. Order as: **V1, V2** or **V3** - Add **\$103 for each cut-out**.
 - ENSTxxxx, ENAC2924/3524, ENFC3024/3624 models - **V2** option only
 - ENFC6024/7224, ENFC5924/7124 models - **V1 and V3** option only

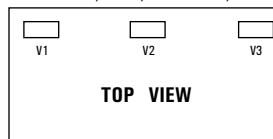

MODPOWER DAISY CHAIN SOLUTION

- Add flexible power and USB charging to Edventure study carrels. Connect up to four units with a single corded infeed with NEMA plug.
- ModPower units are sold separately, refer to Productivity Solutions on page 609.
- Begin run with a starter unit which includes a corded infeed. Add additional middle or end units as required. Middle and end units are equipped with connecting cables.
- On-surface modules clamp on or screw mount to the table tops.
- In-surface modules require table top cut-outs for mounting. Specify cut-out option:
 - **MPS** for a single cut-out to accommodate one ModPower in-surface unit (cut-out will be centered on the back edge of surface) for **29" to 72" wide study carrels**. Add **\$103**
 - **MPD** for two cut-outs in the left and right positions, 15" from ends to center of unit on the back edge of surface for **59" to 72" wide study carrels**. Add **\$204**.

FINISHES

Thermally Fused or High Pressure Laminate Tops

ACJ	Absolute Acajou	FCL	First Class
ASN	Asian Night	NBL	Noce Biondo
AWC	Avant Cherry	NGL	Noce Grigio
AWH	Avant Honey	NEL	Noce Leggero
BLK	Black	NML	Noce Medio
BZD	Blizzard	QTM	Quartered Mahogany
BRC	Brushed Cobalt	SBY	Sheer Beauty
CMB	Clear Maple	SOG	Storm Grey
CGY	Custom Grey	SDT	Stonedust
DES	Dark Espresso	WHE	Walnut Heights
DWT	Designer White	WHC	White Chocolate
FAS	Fashionista	WCR	Winter Cherry

Leg finishes

TBL	Black	TIN	Ink
TBZ	Buzz Blue	TKA	Kalua
TCC	Cactus	TLA	Latte
TCR	Carrot	TMO	Mocha
TIV	Cloud	TNE	Nevada
TDW	Designer White	TSN	Sand
TDJ	Dijon	TSR	Scarlet
TEG	Eggplant	TSH	Shadow
TFO	Fog	TOA	Toast
TFR	Frost	TTU	Tungsten

Note: Modesty panel available in thermally fused laminate finishes only. Modesty panel and pedestal edging will match thermally fused laminate finish specified.

2mm Thick Edgebanding

AAE	Absolute Acajou	FCL	First Class
ASE	Asian Night	NBL	Noce Biondo
ACE	Avant Cherry	NGL	Noce Grigio
AHE	Avant Honey	NEL	Noce Leggero
BLK	Black	NML	Noce Medio
BRC	Brushed Cobalt	QTM	Quartered Mahogany
BZD	Blizzard	SBY	Sheer Beauty
CME	Clear Maple	SDT	Stonedust
CGY	Custom Grey	SOG	Storm Grey
DEE	Dark Espresso	WHE	Walnut Heights
DWE	Designer White	CBE	White Chocolate
FAS	Fashionista	WCE	Winter Cherry

TO SPECIFY:

1. SPECIFY MODEL NUMBER

2. SPECIFY THE FOLLOWING:

FOR TEACHER AND STUDENT DESKS:

- Top finish
- Optional HP laminate
- Edge finish (top only)
- Modesty finish if applicable
- Pedestal finish if applicable
- Leg finish
- Optional AG grommet or cut-out for PMSpdm, if applicable
- Optional key alike or select number (#101-120) applicable with teacher's desks with pedestals

FOR STUDY CARRELS:

- Top surface finish (shelf, if applicable, will be in the same finish)
- Optional HP laminate
- Edge finish
- Leg finish
- Surround finish (side and back panels)
- Optional cut-out(s) for ModPower components

EXAMPLE EDVENTURE ORDER CODES:

Teacher desk

ENTD7230	-ACJ	-HPL	-AAE	-TTU	-ACJ
Model #	Top finish	High pressure laminate	Edge finish	Leg finish	Modesty panel finish

Study carrel

ENFC3024	-ACJ	-HPL	-AAE	-TTU	-ACJ	-MPS
Model #	Top finish	High pressure laminate	Top edge finish	Leg finish	Surround finish	Cut-out for ModPower

TEACHER DESKS

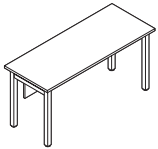

Teacher Desk, 24" D

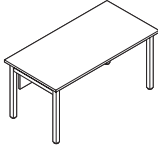

Teacher Desk, 30" D

MODEL#	DIMENSIONS D x W x H	FREIGHT CLASS	WT/LB.	CUBIC FT.	LIST PRICE	HP ADD
ENTD4824	24 x 48 x 29	70	74	4.6	\$1141	\$180
ENTD5424	24 x 54 x 29	70	80	4.7	\$1155	\$207
ENTD6024	24 x 60 x 29	70	86	4.9	\$1172	\$221

12"H modesty panel included. Shipped easy to assemble in 2 cartons.

ENTD6030	30 x 60 x 29	70	96	6.4	\$1247	\$239
ENTD6630	30 x 66 x 29	70	103	6.6	\$1289	\$291
ENTD7230	30 x 72 x 29	70	110	6.8	\$1332	\$311

12"H modesty panel included. Shipped easy to assemble in 2 cartons.

MOBILE TEACHER DESKS

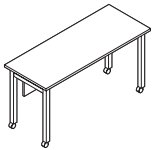

Mobile Teacher Desk, 24" D

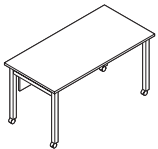

Mobile Teacher Desk, 30" D

MODEL#	DIMENSIONS	FREIGHT CLASS	WT/LB.	CUBIC FT.	LIST PRICE	HP ADD
ENTD4824C	24 x 48 x 29	70	75	4.6	\$1323	\$180
ENTD5424C	24 x 54 x 29	70	81	4.7	\$1339	\$194
ENTD6024C	24 x 60 x 29	70	87	4.9	\$1356	\$209

12"H modesty panel included. Shipped easy to assemble in 2 cartons.

ENTD6030C	30 x 60 x 29	70	98	5.4	\$1431	\$223
-----------	--------------	----	----	-----	---------------	--------------

12"H modesty panel included. Shipped easy to assemble in 2 cartons.

ET6024BBFLC	24 x 60 x 29	85	155	12.37	\$2541	\$208
ET6624BBFLC	24 x 66 x 29	85	161	12.57	\$2586	\$223
ET7224BBFLC	24 x 72 x 29	85	167	12.75	\$2635	\$238

ET6030BBFLC	30 x 60 x 29	85	193	14.67	\$2685	\$223
ET6630BBFLC	30 x 66 x 29	85	201	14.85	\$2732	\$272
ET7230BBFLC	30 x 72 x 29	85	210	15.06	\$2780	\$292

Inset 12"H modesty panel and flush left hand locking box/box/file pedestal included. Top box drawer is non-locking. Shipped easy to assemble (BBF pedestal is fully assembled) in 3 cartons.

ET6024BBFRC	24 x 60 x 29	85	155	12.37	\$2541	\$208
ET6624BBFRC	24 x 66 x 29	85	161	12.57	\$2586	\$223
ET7224BBFRC	24 x 72 x 29	85	167	12.75	\$2635	\$238

ET6030BBFRC	30 x 60 x 29	85	193	14.67	\$2685	\$223
ET6630BBFRC	30 x 66 x 29	85	201	14.85	\$2732	\$272
ET7230BBFRC	30 x 72 x 29	85	210	15.06	\$2780	\$292

Inset 12"H modesty panel and flush right hand locking box/box/file pedestal included. Top box drawer is non-locking. Shipped easy to assemble (BBF pedestal is fully assembled) in 3 cartons.

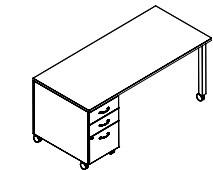

Mobile Teacher Desk, BBF - Left*

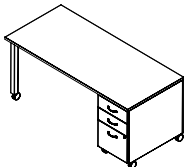

Mobile Teacher Desk, BBF - Right*

Required specifications

Top finish
Edge finish
Leg finish
Modesty finish

Pedestal finish*

Optional specifications

HP laminate*
AG grommet or cut-out for PMSPDM*
Key alike/select key*

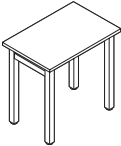
STUDENT DESK	MODEL#	DIMENSIONS	FREIGHT CLASS	WT/LBS.	CUBIC FT.	LIST PRICE	HP ADD
 <p>Student Desk**</p>		D x W x H					
	ENST3020	20 x 30 x 29	85	49	3.9	\$579	\$123

Shipped easy to assemble in 2 cartons.

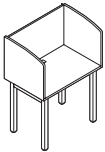
FREESTANDING OR STARTER STUDY CARRELS	MODEL #	DIMENSIONS	FREIGHT CLASS	WT/LB.	CUBIC FT.	LIST PRICE	HP ADD	CUT-OUT ADD
 <p>Freestanding/Starter Study Carrel*</p>	ENFC3024	24 x 30 x 50	70	89	4.44	\$1113	\$127	\$103
	ENFC3624	24 x 36 x 50	70	97.5	4.72	\$1162	\$149	\$103
	ENFC6024	24 x 60 x 50	70	115	5.8	\$1355	\$221	\$205
	ENFC7224	24 x 72 x 50	70	123.5	6.34	\$1448	\$254	\$205

Features a 29" high worksurface with curved side privacy panels. Shown with optional cut-out. Bring power and USB charging to the user with ModPower components, see page 609. Shipped easy to assemble in 2 cartons.

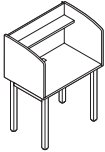
 <p>Freestanding/Starter Study Carrel w/Shelf*</p>	ENFC3024S	24 x 30 x 50	70	93	4.44	\$1170	\$147	\$103
	ENFC3624S	24 x 36 x 50	70	102.5	4.72	\$1225	\$171	\$103
	ENFC6024S	24 x 60 x 50	70	122	5.8	\$1452	\$262	\$205
	ENFC7224S	24 x 72 x 50	70	131.5	6.34	\$1561	\$300	\$205

Features a 29" high worksurface with curved side privacy panels. Shown with optional cut-out. Shelf is 6" deep and accepts optional LED task light. Bring power and USB charging to the user with ModPower components, see page 609. Shipped easy to assemble in 2 cartons.

Required specifications

- Top finish*
- Edge finish*
- Leg finish*
- Surround finish*

Optional specifications

- HP laminate*
- Cut-out for ModPower*

Accessories

- LED task light*

ADD-ON STUDY CARRELS

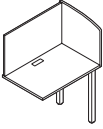

Add-On Study Carrel*

MODEL #	DIMENSIONS D x W x H	FREIGHT CLASS	WT/LB.	CUBIC FT.	LIST PRICE	HP ADD	CUT-OUT ADD
ENAC2924	24 x 29 x 50	85	63	4.4	\$837	\$127	\$103
ENAC3524	24 x 35 x 50	70	71.5	4.67	\$884	\$149	\$103
ENAC5924	24 x 59 x 50	70	89	5.75	\$1083	\$221	\$205
ENAC7124	24 x 71 x 50	70	97.5	6.3	\$1176	\$254	\$205

Features a 29" high worksurface with curved side privacy panels. Shown with optional cut-out. Bring power and USB charging to the user with ModPower components, see page 609. Shipped easy to assemble in 2 cartons.

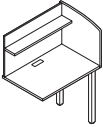

Add-On Study Carrel w/Shelf*

ENAC2924S	24 x 29 x 50	70	67	4.4	\$890	\$147	\$103
ENAC3524S	24 x 35 x 50	70	76.5	4.67	\$946	\$171	\$103
ENAC5924S	24 x 59 x 50	70	96	5.75	\$1183	\$262	\$205
ENAC7124S	24 x 59 x 50	70	105.5	6.3	\$1289	\$300	\$205

Features a 29" high worksurface with curved side privacy panels. Shown with optional cut-out. Shelf is 6" deep and accepts optional LED task light. Bring power and USB charging to the user with ModPower components, see page 609.. Clearance from worksurface to shelf is 14". Shipped easy to assemble in 2 cartons.

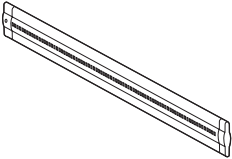

LED Task Light

PLED30	1.5 x 15.5 x .5	150	2	.50	\$522
PLED50	1.5 x 23.5 x .5	150	2	.50	\$601
PLED100	1.5 x 43.5 x .5	125	3	.50	\$697

Energy efficient LED. Ultra slim design. Suitable for mounting on the underside of the shelf of a study carrel. 6' power cord.

Required specifications

Top finish*
Edge finish*
Leg finish*
Surround finish*

Optional specifications

HP laminate*
Cut-out for Cove Daisylink modules*

Accessories

Cove Daisylink modules*
LED task lights*



FreeFit offers a universal freestanding design with finish options on bases and surfaces that allow you to easily integrate with existing Global workstation configurations, becoming a part of your workspace. With two concealed motors on each base, FreeFit adjusts at 1.5" per second while emitting just 44db. Select from two table ranges – standard range accommodates most users, while extended range meets BIFMA ergonomics guidelines accommodating an extensive array of user needs.

Features and Benefits

- Tops are 1" thick thermally fused laminate or 1 1/16" high pressure laminate
- Tops are constructed of 45 lb. density particle board
- Worksurfaces are sold separate from the base
- Steel constructed leg tubing, feet and cross bar
- Table frames include expandable width upper cross bars
- Standard up/down handset. Optional digital readout handset.



Add a 3rd leg kit to create an electric height adjustable L station.

GENERAL INFORMATION

- FreeFit Height Adjustable Tables allow for easy movement from sitting to standing and back throughout the day.
- FreeFit offers a universal freestanding design with finish options on the bases and surfaces that allow you to easily integrate with existing Global workstation configurations, becoming a part of your office space.
- Can be used alone or in conjunction with Global desks. Please note Global desks are 1" or 1.5" thick
- For environmental certifications, please visit globalfurnituregroup.com

ORDERING GUIDELINES

CODES

The price list uses a numbering system with meaningful alphanumeric characters to create a simple to understand product number. This makes specifying the product much easier and more accurate.

SPECIFICATION EXAMPLE OF A HEIGHT ADJUSTABLE TABLE:

Ordered as components, please order:

1. BASE

PRODUCT CODE: **FT** - FreeFit
5 - Standard Range Legs
2 - Leg Quantity
SF - Small Frame
24 - Depth

OPTIONS:

Frame Style: **5** - Standard Range Frame 27.5" to 47"
6 - Extended Range Frame 22.5" to 48.5"

Leg Quantity: **1** - 1 leg for return kit
2 - 2 leg table kit
4 - 4 leg table kit

Frame Size: **BF** - Base Frame, for 30" to 42" wide tables
SF - Small Frame, for 48" to 60" wide tables
LF - Large Frame, for 66" to 84" wide tables

Worksurface Depth: **24** - For 23" deep worksurfaces
30 - For 29" and 35" deep worksurfaces

Leg Style: **CL** - C-shaped table leg
TL - T-shaped table leg

Controller Style: **S** - Standard controller
D - Display controller, add \$47 list (\$94 list for back-to-back benching and media tables).

Base Finish: BLK Black
DWT Designer White
TUN Tungsten

2. TOP

PRODUCT CODE: **FTWR2436**

Top: **LP** - Low Pressure laminate, 1" thick
HP - High Pressure laminate, 1-1/16" thick

Top Finish Laminate: Select Color

Top PVC Edge Finish: Select Color

3. ACCESSORIES

PRODUCT CODE: **FTAEC12**

Base Finish: BLK Black
BZD Blizzard
CHR Charcoal
DWT Designer White
FOG Fog
NEV Nevada
SIL Silver
SDT Stonedust
TPE Taupe
TUN Tungsten

CONSTRUCTION

- Table frames feature 3.15" x 1.97" rectangular outer leg with larger tube attached to the foot.
- Open base design with ample room for chair and user's legs
- Flat foot design includes ½" adjustable glides
- Table frames include expandable width upper cross bars.
- Open base design has no lower crossbars.
- All table frames are easy to assemble with few parts.
- Tables are designed so that the paint will never mar on the leg during operation.
- Steel construction of the leg assembly tubing, feet and upper structure assemblies.
- Powder coat finishes for bases are offered in Black (BLK), Charcoal (CHR), Designer White (DWT), Fog (FOG), Nevada (NEV), Silver (SIL), Taupe (TPE) or Tungsten (TUN).
- All standard Global laminate finishes are available.
- All bases lift 350 lbs on two leg tables.
- Operates at 1.5" per second.
- 108" 3-prong power cord
- Standard Range Frame adjusts from 27.5" to 47" including the worksurface.
- Extended Range Frame adjusts from 22.5" to 48.5" including the worksurface.
- Worksurfaces and troughs are sold separate from the base.
- 1" thick tops constructed of 45 lb. density particle board with high performance thermally fused laminate.
- Laminate surfaces offer a selection of matching + coordinating edgeband. Specify separately from the surface finish.
- Products specified with the high pressure laminate option are 1-1/16" thick and finished on the underside of the surface with a kraft paper backing.
- Steel constructed leg tubing, feet and cross bar.
- Back-to-back benching kits feature a pad foot with ½" adjustable glides
- Foot on single sided benching is 3.55"W x 1"H (with glides fully recessed).
- **Caution:** to meet BIFMA standards for performance and stability, appropriate base size must be specified with corresponding top sizes identified.
- All products meet or exceed ANSI-BIFMA X5.5-2014 and 7.1 VOC. and CSA-C22.2 No. 6809, CAN/CGSB-44.228-2008.
- **All components** are UL 962 listed.

STANDARD RANGE COLUMNS

The 2-part lifting column is a perfect choice for a wide range of different desk applications in the office.

- Compact design where guide and actuator functions are an integrated unit
- Reinforced column and optimized motor housing design for extra strength and stability
- Max. load 350 lbs. for 2 legged configurations; 525 lbs. for 3 legged configurations.
- Max. speed 1.5"/second unloaded
- Standard installation dimension 25.4"
- Standard stroke length 19.7"
- Weight: Approximately 14.3 lbs. per column
- Column dimensions: 1.97" x 3.15" (outer profile) and 1.71" x 2.89" (inner profile)
- Motor housing dimensions: 6.97" x 3.82" x 1.81"
- Low noise level
- No visible gliding pads
- Standard Range Tables have 2-stages and feature an adjustment range of 27.5" – 45.5" (18" travel).

EXTENDED RANGE COLUMNS

The 3-part construction ensures a short installation dimension combined with a long stroke length making the Extended Range Column the optimum choice no matter the height of the person using it. The middle profile of the column moves synchronously so the profiles are always in the same height optimizing the desk design and the stability.

- Compact design where guide and actuator functions are an integrated unit
- Reinforced column and optimized motor housing design for extra strength and stability
- Max. load 350 lbs. for 2 legged configurations; 525 lbs. for 3 legged configurations.
- Max. speed 1.5"/second unloaded
- Installation dimension: 22" / 20.4" (BIFMA)
- Stroke length: 25.6" / 26.2" (BIFMA)

- Weight: 17.2 lbs. per column
- Column dimensions: 1.97" x 3.15" (outer profile), 1.71" x 2.89" (middle profile), 1.46" x 2.64" (inner profile)
- Low noise level
- No visible gliding pads



Standard range (2 stage)

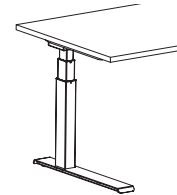

Extended range (3-stage)

FOOT TYPE

- FreeFit offers two foot styles, either a "T" or "C".
- Feet offered in two lengths: 22.75" and 28".
- Foot offers a recessed connection for the column and connects from the bottom with 4 bolts.
- Adjustable glides are standard

DESK MOUNT FRAME

- Can be specified in three lengths:
 - Base frame (**BF**) for use with 28" - 40" tops
 - Short frame (**SF**) for use with 46" - 58" tops
 - Long frame (**LF**) for use with 64" - 82" tops
- All metal parts are Black
- Cantilever length: 21.7"
- Central or off-center placement of columns (T-desk or C-desk)
- Includes all connecting hardware

CONTROL BOX

- Two leg tables come standard with a 200 W Control Box
 - Mains voltage 120 VAC, 60 Hz
 - Ultra-compact; 8.25" long
 - Lightweight control box; weight is approximately 1 lb.
- Three Leg Tables come standard with a 300 W Control Box
 - can be connected up to 4 columns
 - Mains voltage 100-240 VAC, 50-60 Hz (universal)
 - Ultra-compact; 10.5" long
 - Lightweight control box; weight is approximately 1.1 lbs.
- Common features for the (200 W and 300 W):
 - Ultra-low; only 1.5" high
 - Environment: Operation Storage
 - Ambient temperature: 5 to 40 °C -10 to +50 °C
 - Relative humidity: 20 to 80 % at 30 °C 20 to 80 % at 30 °C
 - Atmospheric pressure: 700 to 1060 hPa 700 to 1060 hPa
 - Compact high-power SMPS (Switch Mode Power Supply)
 - Color: Black
 - Protection against overload (EOP), by individual current limitation
 - The control box is designed with a soft start/stop function
 - Autodetection of the number and type of columns connected
 - Cable grooves at the bottom to optimise cable management
 - White plugs for easy recognition when mounting/dismounting
 - PVC-Free™
 - Low standby power consumption – only 0.1 W.
 - Exchangeable standard mains cable

STANDARD HANDSET

- Features Bluetooth® connection, two favorite positions and an LED reminder to prompt users to change position.
- Controller is activated by tilting the desk panel in the same direction as the desk is intended to drive.
- Pulsating orange and green LED lights remind users to change positions.
- Using the integrated Bluetooth® and downloading the Desk Control App, users can also be reminded via notifications on their computer or smart devices.
- Black only. Black cable with RJ45 modular plug. 63" long.
- PVC-Free™, featuring ZERO™. Very low power consumption in standby mode.
- Approved according to EN 60335-1 and UL962

DISPLAY HANDSET

- Features Bluetooth® connection, four favorite positions, a display to guide users, and a light strip to prompt users to change position.
- Controller is activated by tilting the desk panel in the same direction as the desk is intended to drive.
- Display controller features a modern, discreet design with a glossy surface and integrated display to ensure a clean and minimalist design.
- The display provides guidance to users when operating the desk.
- Via pulsating orange and green lights, the light strip reminds users to change positions.
- Using the integrated Bluetooth® and downloading the Desk Control App, users can also be reminded via notifications on their computer or smart devices.
- Black only. Black cable with RJ45 modular plug. 63" long.
- PVC-Free™, featuring ZERO™. Very low power consumption in standby mode.
- Approved according to EN 60335-1 and UL962
- Specify **(D)**, add **\$63** list (**\$125** list for back-to-back benching and media tables).
- A basic handset without Bluetooth® capabilities is available and must be purchased separately, replacing the **S** or **D** handset in the field. See 745 for details and pricing.

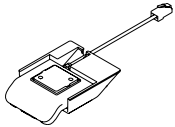

Standard handset (**S**)

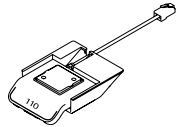

Display handset (**D**)

ANTI-COLLISION SENSOR

- Features enhanced Anti-Collision protection which can limit material damage to a desk or an object if a collision occurs during driving of the desk.
- The sensor is a compact plug-in adapter based on gyroscope-technology, and it detects even slight tilting of the desk when the desk is driving up or down.
- Upon detected tilting, the system stops and drives in the opposite direction to avoid collision and damage to the desk or the object.
- The sensor can detect both hard and soft obstacles.
- The Anti-Collision Sensor is standard on all desks.
- Reacts to angle changes bigger than 0.7° per second
- Just plug it in – no mounting required
- ZERO™ power capable
- PVC-Free™

BATTERY BOX

- A high-performance lithium-Ion battery with a capacity of 2.15 Ah.
- On a full charge the table can cycle from 35 to 45 stroke lengths based upon the range of column selected and load on the table.
- Compact unit for easy handling and installation
- Battery alarm (audio) when charging is needed
- Battery charging indicator (LED light bars) indicating the capacity level
- Thermal switch protection, overcurrent protection
- Color: black
- Battery capacity: 2.15 Ah / 52 Wh
- Nominal voltage: 24 V DC
- Discharge current: 9 A (max)
- Maximum charging voltage: 40 V DC
- Charging current: 0.5 A
- Weight: 1.32 lbs.

USAGE

- Ambient temperature: 41 to 104 °C
- Storage temperature: 32 to 113 °C

Approved according to:

- EN 62133 (Battery safety testing)
- UL 1642 (Lithium cells, standard test)
- UN 38.3 (transportation of Lithium batteries)
- UL 2054 (Household and commercial batteries)
- EN 60335-1 with CBH Advanced

GROMMETS

- Grommets available in standard worksurface locations - see diagram on next page for specific position. Order as: **AG1, AG2 or AG3. Add \$103.**

GROMMET WITH ACCESS DOOR OPTIONS FOR FREEFIT BENCHING

- Access door option is specified by first selecting a grommet position left or right of center, use code GL or GR, add \$83 list (see diagram on next page for specific position).
- Access doors are specified separately, using the code + list pricing below.
- Available in Black (**BLK**), Designer White (**DWT**) or Tungsten (**TUN**) paint finishes
- Device holder is only available in white plastic.
- CSA certified power bar includes (3) outlets and (2) charging USB ports (2.1 amp).

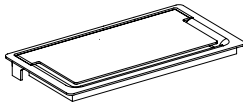

Standard Access Door (**GAADG**). Add **\$96.**

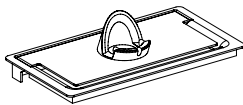

Access Door with Device Holder (**GAADGDH**). Add **\$104.**

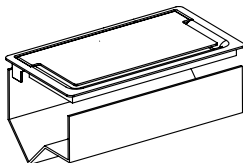

Access Door with Cable Tray (**GAADCT**). Add **\$155.**

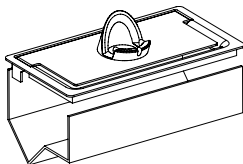

Access Door with Cable Tray & Device Holder (**GAADCTDH**). Add **\$163.**

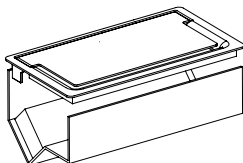

Access Door with Cable Tray & Power Bar (**GAADCTPD**). Add **\$327.**

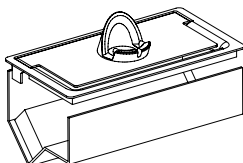

Access Door with Cable Tray, Power Bar & Device Holder (**GAADCTPDDH**). Add **\$337.**

FINISHES

Laminate Top Finishes:

- ACJ Absolute Acajou
- ASN Asian Night
- AWC Avant Cherry
- AWH Avant Honey
- BLK Black - Coordinates with BLK metal frame finish
- BZD Blizzard
- BRC Brushed Cobalt - Coordinates with TUN edgeband finish
- CMB Clear Maple
- CGY Custom Grey - Coordinates with SIL edgeband finish
- DES Dark Espresso
- DWT Designer White - Coordinates with DWT Metal Frame Finish
- FAS Fashionista
- FCL First Class
- NBL Noce Biondo
- NGL Noce Grigio
- NEL Noce Leggero
- NML Noce Medio
- QTM Quartered Mahogany
- SBY Sheer Beauty
- SDT Stonedust
- SOG Storm Grey
- STG String
- WHE Walnut Heights
- WHC White Chocolate
- WCR Winter Cherry

Base Finishes

- BLK Black
- BZD Blizzard*
- CHR Charcoal
- DWT Designer White
- FOG Fog
- NEV Nevada
- SIL Silver
- SDT Stonedust*
- TPE Taupe
- TUN Tungsten
- *textured finish*

Edgeband Finishes:

- AAE Absolute Acajou
- ASE Asian Night
- ACE Avant Cherry
- AHE Avant Honey
- BLK Black
- BZD Blizzard
- BRC Brushed Cobalt
- CHR Charcoal (*use w/SOG*)
- CME Clear Maple
- DEE Dark Espresso
- DWE Designer White
- FAS Fashionista
- FCL First Class
- NBL Noce Biondo
- NGL Noce Grigio
- NEL Noce Leggero
- NML Noce Medio
- NEV Nevada (*use w/STG*)
- QTM Quartered Mahogany
- SBY Sheer Beauty
- SIL Silver (*use w/CGY*)
- SDT Stonedust
- TPE Taupe
- WHE Walnut Heights
- CBE White Chocolate
- WCE Winter Cherry

ACCESS DOOR CUT-OUT DIMENSIONS

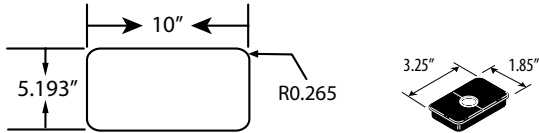

CUT-OUT LOCATIONS

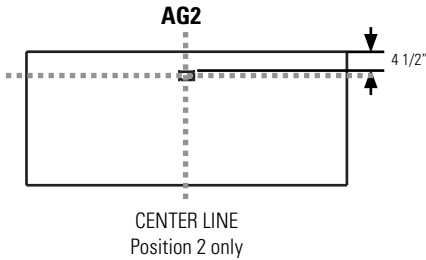

Rectangular Worksurfaces: 46", 52" & 58"
End of Run Table Top: 51"
Rectangular Return/Extension Return Worksurface: All sizes

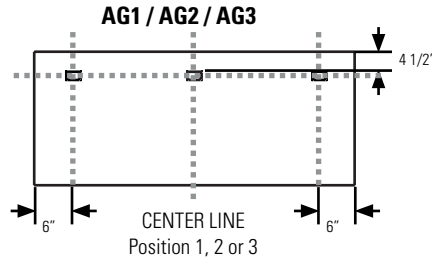

Rectangular Worksurfaces: 64", 70", 76", & 82"
End of Run Table Top: 63"

Access Door grommet in left position (GL)

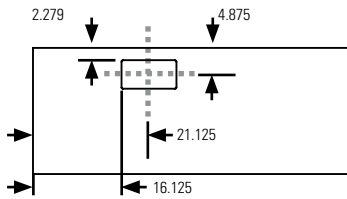

Access Door grommet in right position (GR)

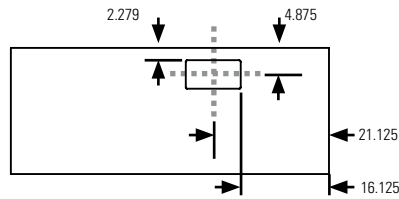

Select one or the other; both options are not available in one surface.
Rectangular Worksurfaces: 46"-82"
End of Run Table Top: 51" & 63"

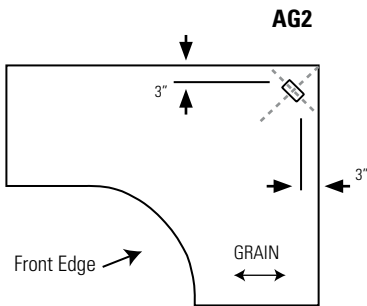

90° Corner Table Tops
Extended 90° Corner Table Tops

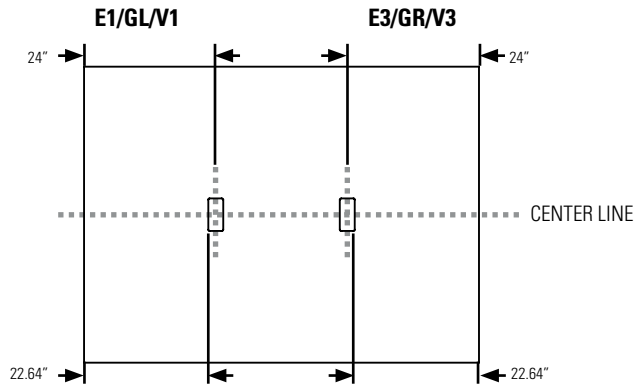

Media Table Tops

WORKSURFACES



Rectangular Return Worksurfaces

MODEL#	DIMENSIONS D x W x H	FREIGHT CLASS	WT/LBS.	CUBIC FT.	LIST PRICE	HP ADD
FTWRR2329	23 x 29 x 1	70	20	1.16	\$290	\$72
FTWRR2335	23 x 35 x 1	70	24	1.40	\$392	\$86
FTWRR2341	23 x 41 x 1	70	28	1.64	\$433	\$113
FTWRR2347	23 x 47 x 1	70	32	1.88	\$455	\$136
FTWRR2353	23 x 53 x 1	70	36	2.12	\$487	\$153
FTWRR2359	23 x 59 x 1	70	40	2.36	\$536	\$171
FTWRR2929	29 x 29 x 1	70	25	1.46	\$363	\$89
FTWRR2935	29 x 35 x 1	70	30	1.76	\$536	\$103
FTWRR2941	29 x 41 x 1	70	35	2.06	\$536	\$144
FTWRR2947	29 x 47 x 1	70	40	2.36	\$543	\$153
FTWRR2953	29 x 53 x 1	70	46	2.67	\$555	\$153
FTWRR2959	29 x 59 x 1	70	51	2.97	\$647	\$178

Rectangular return worksurfaces are non-handed and can be interchanged on site. Includes two flat brackets for connection. For use with FT51SR/LR or FT61SR/LR. To determine the appropriate return base, use the following chart:

Main Surface	Return Surface	Return Base
FTWR23xx	FTWRR(23/29)29	FT51/61SR
FTWR23xx	FTWRR(23/29)35	FT51/61SR
FTWR23xx	FTWRR(23/29)41	FT51/61SR
FTWR23xx	FTWRR(23/29)47	FT51/61LR
FTWR23xx	FTWRR(23/29)53	FT51/61LR
FTWR23xx	FTWRR(23/29)59	FT51/61LR
FTWR29xx	FTWRR(23/29)29	FT51/61SR
FTWR29xx	FTWRR(23/29)35	FT51/61SR
FTWR29xx	FTWRR(23/29)41	FT51/61LR
FTWR29xx	FTWRR(23/29)47	FT51/61LR
FTWR29xx	FTWRR(23/29)53	FT51/61LR
FTWR29xx	FTWRR(23/29)59	FT51/61LR



Rectangular End of Run Worksurfaces

FTWR2351	23 x 51 x 1	70	40	2.02	\$531	\$171
FTWR2362	23 x 62 x 1	70	44	2.50	\$557	\$178
FTWR2951	29 x 51 x 1	70	50	2.54	\$557	\$178
FTWR2962	29 x 62 x 1	70	55	3.15	\$570	\$285

Rectangular return worksurfaces are non-handed and can be interchanged on site.

- For 23" deep worksurfaces, use with FT52xx24 or FT62xx24.
- For 29" deep worksurfaces, use with FT52xx30 or FT62xx30.
- For back-to-back bases, please use the following chart:
 FTWR(23/29)51, FT52BSF24/30 or FT62BSF24/30
 FTWR(23/29)62, FT52BLF24/30 or FT62BLF24/30

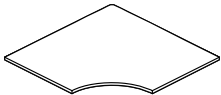

90° Corner Worksurface

FTWCC234023	40 x 40 x 1	60	80	1.5	\$503	\$364
FTWCC234623	46 x 46 x 1	60	95	2	\$634	\$476
FTWCC235223	52 x 52 x 1	70	80	4.69	\$780	\$602
FTWCC235823	58 x 58 x 1	70	100	5.84	\$941	\$743
FTWCC294029	40 x 40 x 1	60	80	1.5	\$503	\$364
FTWCC294629	46 x 46 x 1	70	63	3.67	\$634	\$476
FTWCC295229	52 x 52 x 1	70	80	4.69	\$780	\$602
FTWCC295829	58 x 58 x 1	70	100	5.84	\$941	\$743

For tables that connect with 23" deep worksurfaces, use with FT539FS24CL or FT639FS24CL. For tables that connect with 29" deep worksurfaces, use with FT539FS30CL or FT639FS30CL.

Required specifications

Top finish
Edge finish

Optional specifications

HP laminate
Grommet

EXTENDED CORNER WORKSURFACES **MODEL#** **DIMENSIONS** **FREIGHT CLASS** **WT/LBS.** **CUBIC FT.** **LIST PRICE** **HP ADD**

D x W x H

FTWEC23584023	58 x 40 x 1	60	115	2.6	\$1187	\$297
FTWEC23644023	64 x 40 x 1	60	127	2.8	\$1319	\$329
FTWEC23704023	70 x 40 x 1	60	138	3.1	\$1441	\$362
FTWEC23764023	76 x 40 x 1	60	150	3.3	\$1539	\$379
FTWEC23824023	82 x 40 x 1	60	162	3.6	\$1633	\$406
FTWEC23584623	58 x 46 x 1	60	115	2.55	\$1240	\$309
FTWEC23644623	64 x 46 x 1	60	127	2.81	\$1379	\$344
FTWEC23704623	70 x 46 x 1	60	138	3.07	\$1507	\$378
FTWEC23764623	76 x 46 x 1	60	150	3.34	\$1609	\$399
FTWEC23824623	82 x 46 x 1	60	162	3.6	\$1707	\$426
FTWEC23585223	58 x 52 x 1	60	130	2.88	\$1276	\$321
FTWEC23645223	64 x 52 x 1	60	143	3.18	\$1420	\$356
FTWEC23705223	70 x 52 x 1	60	156	3.48	\$1552	\$389
FTWEC23765223	76 x 52 x 1	60	170	3.77	\$1657	\$411
FTWEC23825223	82 x 52 x 1	60	183	4.07	\$1756	\$438
FTWEC23645823	64 x 58 x 1	60	160	3.54	\$1462	\$364
FTWEC23705823	70 x 58 x 1	60	174	3.88	\$1599	\$400
FTWEC23765823	76 x 58 x 1	60	189	4.21	\$1707	\$425
FTWEC23825823	82 x 58 x 1	60	204	4.54	\$1809	\$455
FTWEC29584029	58 x 40 x 1	60	115	2.2	\$1235	\$308
FTWEC29644029	64 x 40 x 1	60	127	2.4	\$1374	\$340
FTWEC29704029	70 x 40 x 1	60	138	2.7	\$1499	\$376
FTWEC29764029	76 x 40 x 1	60	150	2.9	\$1600	\$394
FTWEC29824029	82 x 40 x 1	60	162	3.1	\$1697	\$424
FTWEC29584629	58 x 46 x 1	60	115	2.55	\$1291	\$322
FTWEC29644629	64 x 46 x 1	60	127	2.81	\$1434	\$357
FTWEC29704629	70 x 46 x 1	60	138	3.07	\$1567	\$394
FTWEC29764629	76 x 46 x 1	60	150	3.34	\$1673	\$413
FTWEC29824629	82 x 46 x 1	60	152	3.6	\$1774	\$441
FTWEC29585229	58 x 52 x 1	60	130	2.88	\$1330	\$334
FTWEC29645229	64 x 52 x 1	60	143	3.18	\$1476	\$370
FTWEC29705229	70 x 52 x 1	60	156	3.48	\$1615	\$404
FTWEC29765229	76 x 52 x 1	60	170	3.77	\$1722	\$426
FTWEC29825229	82 x 52 x 1	60	183	4.07	\$1828	\$456
FTWEC29645829	64 x 58 x 1	60	160	3.54	\$1520	\$380
FTWEC29705829	70 x 58 x 1	60	174	3.88	\$1664	\$415
FTWEC29765829	76 x 58 x 1	60	189	4.21	\$1774	\$440
FTWEC29825829	82 x 58 x 1	60	204	4.54	\$1881	\$469

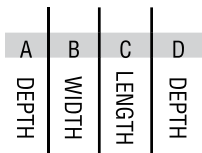
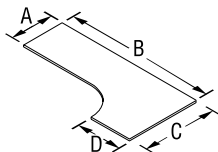

Ext. 90° Corner Worksurface, Left

For tables that connect with 23" deep (**A** and **D**) worksurfaces, use with FT539F(S/L)24CL or FT639F(S/L)24CL bases. For tables that connect with 29" deep (**A** and **D**) worksurfaces, use with FT539F(S/L)30CL or FT639F(S/L)30CL bases. Must use with FTWRExxx return surfaces only.

Required specifications

Top finish
Edge finish

Optional specifications

HP laminate
Grommet

MODEL# DIMENSIONS FREIGHT CLASS WT./LBS. CUBIC FT. LIST PRICE HP ADD

D x W x H

FTWEC23405823	58 x 40 x 1	60	115	2.6	\$1187	\$300
FTWEC23406423	64 x 40 x 1	60	127	2.8	\$1319	\$329
FTWEC23407023	70 x 40 x 1	60	138	3.1	\$1441	\$362
FTWEC23407623	76 x 40 x 1	60	150	3.3	\$1539	\$379
FTWEC23408223	82 x 40 x 1	60	162	3.6	\$1633	\$406
FTWEC23465823	58 x 46 x 1	60	115	2.55	\$1240	\$309
FTWEC23466423	64 x 46 x 1	60	127	2.81	\$1379	\$344
FTWEC23467023	70 x 46 x 1	60	138	3.07	\$1507	\$378
FTWEC23467623	76 x 46 x 1	60	150	3.34	\$1609	\$399
FTWEC23468223	82 x 46 x 1	60	162	3.6	\$1707	\$426
FTWEC23525823	58 x 52 x 1	60	130	2.88	\$1276	\$321
FTWEC23526423	64 x 52 x 1	60	143	3.18	\$1420	\$356
FTWEC23527023	70 x 52 x 1	60	156	3.48	\$1552	\$389
FTWEC23527623	76 x 52 x 1	60	170	3.77	\$1657	\$411
FTWEC23528223	82 x 52 x 1	60	183	4.07	\$1756	\$438
FTWEC23586423	64 x 58 x 1	60	160	3.54	\$1462	\$364
FTWEC23587023	70 x 58 x 1	60	174	3.88	\$1599	\$400
FTWEC23587623	76 x 58 x 1	60	189	4.21	\$1707	\$425
FTWEC23588223	82 x 58 x 1	60	204	4.54	\$1809	\$455

FTWEC29405829	58 x 40 x 1	60	115	2.2	\$1235	\$308
FTWEC29406429	64 x 40 x 1	60	127	2.4	\$1374	\$340
FTWEC29407029	70 x 40 x 1	60	138	2.7	\$1499	\$376
FTWEC29407629	76 x 40 x 1	60	127	2.4	\$1600	\$394
FTWEC29408229	82 x 40 x 1	60	162	3.1	\$1697	\$424
FTWEC29465829	58 x 46 x 1	60	115	2.55	\$1291	\$322
FTWEC29466429	64 x 46 x 1	60	127	2.81	\$1434	\$357
FTWEC29467029	70 x 46 x 1	60	138	3.07	\$1567	\$394
FTWEC29467629	76 x 46 x 1	60	150	3.34	\$1673	\$413
FTWEC29468229	82 x 46 x 1	60	162	3.6	\$1774	\$441
FTWEC29525829	58 x 52 x 1	60	130	2.88	\$1330	\$334
FTWEC29526429	64 x 52 x 1	60	143	3.18	\$1476	\$370
FTWEC29527029	70 x 52 x 1	60	156	3.48	\$1615	\$404
FTWEC29527629	76 x 52 x 1	60	170	3.77	\$1722	\$426
FTWEC29528229	82 x 52 x 1	60	183	4.07	\$1828	\$456
FTWEC29586429	64 x 58 x 1	60	160	3.54	\$1520	\$380
FTWEC29587029	70 x 58 x 1	60	174	3.88	\$1664	\$415
FTWEC29587629	76 x 58 x 1	60	189	4.21	\$1774	\$440
FTWEC29588229	82 x 58 x 1	60	204	4.54	\$1881	\$469

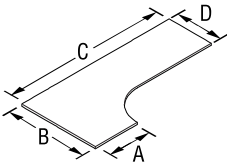

Ext. 90° Corner Worksurface, Right

For tables that connect with 23" deep (A and D) worksurfaces, use with FT539F(S/L)24CL or FT639F(S/L)24CL bases. For tables that connect with 29" deep (A and D) worksurfaces, use with FT539F(S/L)30CL or FT639F(S/L)30CL bases. Must use with FTWRExxxx return surfaces only.

FTWRE2324	23 x 24 x 1	70	16	0.96	\$225	\$72
FTWRE2330	23 x 30 x 1	70	20	1.2	\$244	\$72
FTWRE2336	23 x 36 x 1	70	25	1.44	\$272	\$86
FTWRE2924	29 x 24 x 1	70	21	1.21	\$267	\$79
FTWRE2930	29 x 30 x 1	70	26	1.51	\$284	\$89
FTWRE2936	29 x 36 x 1	70	31	1.81	\$329	\$103

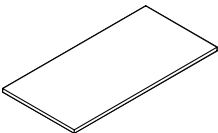

Rectangular Extension**
Return Worksurface

Worksurfaces to be used only with Extended 90° Corner Worksurfaces. Includes two flat brackets for connection.

- FTWRE23 to be used with FTWEC23xxxx23
- FTWRE29 to be used with FTWEC29xxxx29

Required specifications

Top finish
Edge finish

Optional specifications

HP laminate
Grommet

BASES

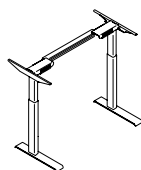

Standard Range Base*

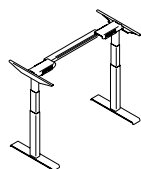

Extended Range Base*

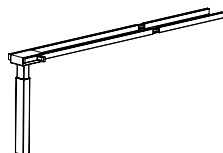

Standard Range Return Kit

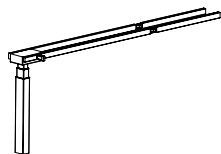

Extended Range Return Kit

MODEL# DIMENSIONS FREIGHT CLASS WT/LBS. CUBIC FT. LIST PRICE

D x W x H

FT52BF24	24 x 30-42 x 27.5-47	60	67	1.47	\$1337
FT52SF24	24 x 48-60 x 27.5-47	60	67	1.47	\$1472
FT52LF24	24 x 66-84 x 27.5-47	60	67	1.47	\$1479
FT52BF30	30-36 x 30-42 x 27.5-47	60	67	1.47	\$1348
FT52SF30	30-36 x 48-60 x 27.5-47	60	67	1.47	\$1483
FT52LF30	30-36 x 66-84 x 27.5-47	60	67	1.47	\$1489

Kit includes one beam, two cantilevers, two standard range columns, and two C or T styled feet. **BF** indicates base frame for 28" to 40" tables. **SF** indicates small frame for 46" to 58" tables. **LF** indicates large frame: 64" to 82" tables. For 23" deep worksurfaces, use 24" leg. For 29" and 35" deep worksurface, use 30" leg. For enhanced collision detection, an Anti Collision Desk Sensor is included with every base. Standard up/down controller with 2 memory positions, reminder settings + Bluetooth capability is standard - specify **(S)**. For a Display controller with height readout, 4 memory positions, reminder settings + Bluetooth capabilities, specify **(D)**, add **\$63** list. Specify paint finish: Black (**BLK**), Charcoal (**CHR**), Designer White (**DWT**), Fog (**FOG**), Nevada (**NEV**), Silver (**SIL**), Taupe (**TPE**), Tungsten (**TUN**). UL Listed: UL 962.

FT62BF24	24 x 30-42 x 22.5-48.5	60	67	1.47	\$1429
FT62SF24	24 x 48-60 x 22.5-48.5	60	67	1.47	\$1569
FT62LF24	24 x 66-84 x 22.5-48.5	60	67	1.47	\$1577
FT62BF30	30-36 x 30-42 x 22.5-48.5	60	67	1.47	\$1439
FT62SF30	30-36 x 48-60 x 22.5-48.5	60	67	1.47	\$1582
FT62LF30	30-36 x 66-84 x 22.5-48.5	60	67	1.47	\$1586

Kit includes one beam, two cantilevers, two extended range columns, and two C or T styled feet. **BF** indicates base frame for 28" to 40" tables. **SF** indicates small frame for 46" to 58" tables. **LF** indicates large frame: 64" to 82" tables. For 23" deep worksurfaces, use 24" leg. For 29" and 35" deep worksurface, use 30" leg. For enhanced collision detection, an Anti Collision Desk Sensor is included with every base. Standard up/down controller with 2 memory positions, reminder settings + Bluetooth capability is standard - specify **(S)**. For a Display controller with height readout, 4 memory positions, reminder settings + Bluetooth capabilities, specify **(D)**, add **\$63** list. Specify paint finish: Black (**BLK**), Charcoal (**CHR**), Designer White (**DWT**), Fog (**FOG**), Nevada (**NEV**), Silver (**SIL**), Taupe (**TPE**), Tungsten (**TUN**). UL Listed: UL 962.

FT51SRNL	-- x 24-48 x 27.5-47	60	61	1.47	\$901
FT51LRNL	-- x 54-72 x 27.5-47	60	61	1.47	\$920

Kit includes one beam, one cantilever, one standard range columns, and one pad foot. See chart on 732 to determine whether SR or LR kit is required. For 23" deep worksurfaces, use 24" return. For 29" and 35" deep worksurface, use 30" return. Specify paint finish: Black (**BLK**), Charcoal (**CHR**), Designer White (**DWT**), Fog (**FOG**), Nevada (**NEV**), Silver (**SIL**), Taupe (**TPE**), Tungsten (**TUN**). UL Listed: UL 962.

- When using the return kit for a 23"d return and a 29"/35" deep desk, a new foot must be ordered separately. See FTFOOT24TL/CL (745) for specification information.

FT61SRNL	-- x 24-48 x 22.5-48.5	60	61	1.47	\$948
FT61LRNL	-- x 54-72 x 22.5-48.5	60	61	1.47	\$968

Kit includes one beam, one cantilever, one standard range columns, and one pad foot. See chart on 732 to determine whether SR or LR kit is required. For 23" deep worksurfaces, use 24" return. For 29" and 35" deep worksurface, use 30" return. Specify paint finish: Black (**BLK**), Charcoal (**CHR**), Designer White (**DWT**), Fog (**FOG**), Nevada (**NEV**), Silver (**SIL**), Taupe (**TPE**), Tungsten (**TUN**). UL Listed: UL 962.

- When using the return kit for a 23"d return and a 29"/35" deep desk, a new foot must be ordered separately. See FTFOOT24TL/CL (745) for specification information.

Required specifications

Base finish
Leg style*

Optional specifications

Digital handset

BASES	MODEL#	DIMENSIONS	FREIGHT CLASS	WT/LBS.	CUBIC FT.	LIST PRICE
-------	--------	------------	---------------	---------	-----------	------------

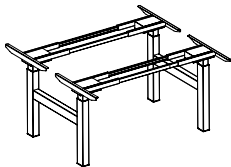

Back-to-Back Standard Range Base

	D x W x H					
FT54BSFNL	24 x -- x 27.5-47	60	123	2.94		\$3281
FT54BLFNL	24 x -- x 27.5-47	60	123	2.94		\$3290

Back-to-back height adjustable bases includes four height adjustable columns with pad feet, two sets of cross rails for surface support and two short beams to attach the columns back-to-back. Combine with surfaces & trough kits (sold separately) to create a complete workstation. For 50.5" depth, use two x 23" deep worksurfaces. For 62.5" depth, use two x 29" deep worksurfaces. **30" or larger depth worksurfaces cannot be used with Back to Back bases.** Duplex receptacles are not included, please specify separately. For enhanced collision detection, an Anti Collision Desk Sensor is included with every base. Standard up/down controller with 2 memory positions, reminder settings + Bluetooth capability is standard - specify **(S)**. For a Display controller with height readout, 4 memory positions, reminder settings + Bluetooth capabilities, specify **(D)**, add **\$125** list. Specify paint finish: Black **(BLK)**, Charcoal **(CHR)**, Designer White **(DWT)**, Fog **(FOG)**, Nevada **(NEV)**, Silver **(SIL)**, Taupe **(TPE)**, Tungsten **(TUN)**. UL Listed: UL 962.

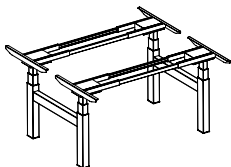

Back-to-Back Extended Range Base

FT64BSFNL	10 x -- x 22.5-48.5	60	123	2.94		\$3465
FT64BLFNL	10 x -- x 22.5-48.5	60	123	2.94		\$3477

Back-to-back height adjustable bases includes four height adjustable columns with pad feet, two sets of cross rails for surface support and two short beams to attach the columns back-to-back. Combine with surfaces & trough kits (sold separately) to create a complete workstation. For 50.5" depth, use two x 23" deep worksurfaces. For 62.5" depth, use two x 29" deep worksurfaces. **30" or larger depth worksurfaces cannot be used with Back to Back bases.** Duplex receptacles are not included, please specify separately. For enhanced collision detection, an Anti Collision Desk Sensor is included with every base. Standard up/down controller with 2 memory positions, reminder settings + Bluetooth capability is standard - specify **(S)**. For a Display controller with height readout, 4 memory positions, reminder settings + Bluetooth capabilities, specify **(D)**, add **\$125** list. Specify paint finish: Black **(BLK)**, Charcoal **(CHR)**, Designer White **(DWT)**, Fog **(FOG)**, Nevada **(NEV)**, Silver **(SIL)**, Taupe **(TPE)**, Tungsten **(TUN)**. UL Listed: UL 962.

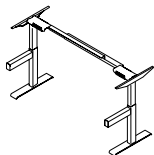

Standard Range Single Frame

FT52BSF24	24 x -- x 27.5-47	60	72	1.47		\$1855
FT52BLF24	24 x -- x 27.5-47	60	72	1.47		\$1865
FT52BSF30	30 x -- x 27.5-47	60	72	1.47		\$1924
FT52BLF30	30 x -- x 27.5-47	60	72	1.47		\$1935

Single sided height adjustable bases includes two height adjustable columns with "T" feet, one set of cross rails for surface support and two short beams to attach the columns to a trough kit. Combine with single surfaces & trough kits (sold separately) to create a complete workstation. Use 23" deep worksurfaces with FT52BSF24 + FT52BLF24. Use 29" deep worksurfaces with FT52BSF30 + FT52BLF30. **30" or larger depth worksurfaces cannot be used with benching bases.** Duplex receptacles are not included, please specify separately. For enhanced collision detection, an Anti Collision Desk Sensor is included with every base. Standard up/down controller with 2 memory positions, reminder settings + Bluetooth capability is standard - specify **(S)**. For a Display controller with height readout, 4 memory positions, reminder settings + Bluetooth capabilities, specify **(D)**, add **\$125** list. Specify paint finish: Black **(BLK)**, Charcoal **(CHR)**, Designer White **(DWT)**, Fog **(FOG)**, Nevada **(NEV)**, Silver **(SIL)**, Taupe **(TPE)**, Tungsten **(TUN)**. UL Listed: UL 962.

Required specifications

Base finish
Leg style*

Optional specifications

Digital handset

BASES	MODEL#	DIMENSIONS	FREIGHT CLASS	WT./LBS.	CUBIC FT.	LIST PRICE
-------	--------	------------	---------------	----------	-----------	------------

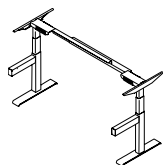

Extended Range Single Frame

	D x W x H					
FT62BSF24	24 x -- x 22.5-48.5	60	72	1.47		\$2010
FT62BLF24	24 x -- x 22.5-48.5	60	72	1.47		\$2015
FT62BSF30	30 x -- x 22.5-48.5	60	72	1.47		\$2021
FT62BLF30	30 x -- x 22.5-48.5	60	72	1.47		\$2027

Single sided height adjustable bases includes two height adjustable columns with "T" feet, one set of cross rails for surface support and two short beams to attach the columns to a trough kit. Combine with single surfaces & trough kits (sold separately) to create a complete workstation. Use 23" deep worksurfaces with FT62BSF24 + FT62BLF24. Use 29" deep worksurfaces with FT62BSF30 + FT62BLF30. **30" or larger depth worksurfaces cannot be used with benching bases.** Duplex receptacles are not included, please specify separately. For enhanced collision detection, an Anti Collision Desk Sensor is included with every base. Standard up/down controller with 2 memory positions, reminder settings + Bluetooth capability is standard - specify **(S)**. For a Display controller with height readout, 4 memory positions, reminder settings + Bluetooth capabilities, specify **(D)**, add **\$125** list. Specify paint finish: Black **(BLK)**, Charcoal **(CHR)**, Designer White **(DWT)**, Fog **(FOG)**, Nevada **(NEV)**, Silver **(SIL)**, Taupe **(TPE)**, Tungsten **(TUN)**. UL Listed: UL 962.

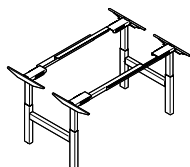

Standard Range Media Table Base

FTM5B2BSF	54-60 x 60 x 27.5-47	60	123	2.94		\$3281
FTM5B2BLF	54-60 x 60 x 27.5-47	60	123	2.94		\$3290

Kit includes two beams, four cantilevers, four standard range columns and two controllers. SF indicates small base for 60" sided tables. LF indicates large base for 66" to 84" sided tables. For enhanced collision detection, an Anti Collision Desk Sensor is included with every base. Standard up/down controller with 2 memory positions, reminder settings + Bluetooth capability is standard - specify **(S)**. For a Display controller with height readout, 4 memory positions, reminder settings + Bluetooth capabilities, specify **(D)**, add **\$125** list. Specify paint finish: Black **(BLK)**, Charcoal **(CHR)**, Designer White **(DWT)**, Fog **(FOG)**, Nevada **(NEV)**, Silver **(SIL)**, Taupe **(TPE)**, Tungsten **(TUN)**. UL Listed: UL 962.

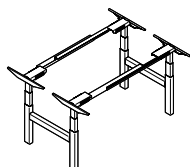

Extended Range Media Table Base

FTM6B2BSF	54-60 x 60 x 22.5-48.5	60	123	2.94		\$3465
FTM6B2BLF	54-60 x 60 x 22.5-48.5	60	123	2.94		\$3477

Kit includes two beams, four cantilevers, four extended range columns and two controllers. SF indicates small base for 60" sided tables. LF indicates large base for 66" to 84" sided tables. For enhanced collision detection, an Anti Collision Desk Sensor is included with every base. Standard up/down controller with 2 memory positions, reminder settings + Bluetooth capability is standard - specify **(S)**. For a Display controller with height readout, 4 memory positions, reminder settings + Bluetooth capabilities, specify **(D)**, add **\$125** list. Specify paint finish: Black **(BLK)**, Charcoal **(CHR)**, Designer White **(DWT)**, Fog **(FOG)**, Nevada **(NEV)**, Silver **(SIL)**, Taupe **(TPE)**, Tungsten **(TUN)**. UL Listed: UL 962.

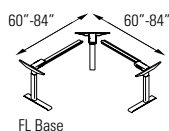
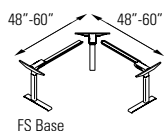

Standard Range 90° Base, Equal Sides

FT539FS24CL	54-60 x 42-60 x 27.5-47	60	101	1.47		\$2142
FT539FS30CL	54-60 x 42-60 x 27.5-47	60	101	1.47		\$2155
FT539FL24CL	66-84 x 66-84 x 27.5-47	60	101	1.47		\$2181
FT539FL30CL	66-84 x 66-84 x 27.5-47	60	101	1.47		\$2162

Kit includes two equal length beams, three cantilevers, one standard range corner column, two standard range columns, and two C styled feet. FS indicates small base for 54" to 60" sided tables. FL indicates large base: 66" to 84" sided tables. For 23" deep worksurfaces, use 24" CL leg. For 29" and 35" deep work surface, use 30" CL leg. For enhanced collision detection, an Anti Collision Desk Sensor is included with every base.

Standard up/down controller with 2 memory positions, reminder settings + Bluetooth capability is standard - specify **(S)**. For a Display controller with height readout, 4 memory positions, reminder settings + Bluetooth capabilities, specify **(D)**, add **\$63** list. Specify paint finish: Black **(BLK)**, Charcoal **(CHR)**, Designer White **(DWT)**, Fog **(FOG)**, Nevada **(NEV)**, Silver **(SIL)**, Taupe **(TPE)**, Tungsten **(TUN)**. UL Listed: UL 962.

- When using a 23" d return with the FT539FS30CL/LF30CL a 24" foot must be ordered separately. See FTFOOT24TL/CL (745) for specification information.

Required specifications
Base finish

Optional specifications
Digital handset

BASES	MODEL#	DIMENSIONS	FREIGHT CLASS	WT/LBS.	CUBIC FT.	LIST PRICE
-------	--------	------------	---------------	---------	-----------	------------

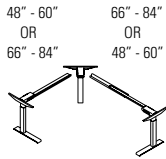

Standard Range 90° Base, Unequal Sides

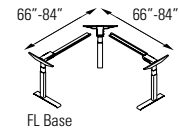
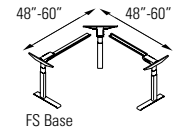

Extended Range 90° Base, Equal Sides*

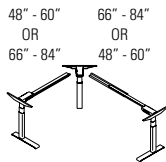

Extended Range 90° Base, Unequal Sides*

	D x W x H					
FT539FSL24CL	66-84 x 42-60 x 27.5-47	60	101	1.47		\$2162
FT539FSL30CL	66-84 x 42-60 x 27.5-47	60	101	1.47		\$2173

Kit includes two beams (one small, one large), three cantilevers, one standard range corner column, two standard range columns, and two C styled feet. For 23" deep worksurfaces, use 24" CL leg. For 29" and 35" deep worksurface, use 30" CL leg. For enhanced collision detection, an Anti Collision Desk Sensor is included with every base.

Standard up/down controller with 2 memory positions, reminder settings + Bluetooth capability is standard - specify **(S)**. For a Display controller with height readout, 4 memory positions, reminder settings + Bluetooth capabilities, specify **(D)**, add **\$63** list. Specify paint finish: Black **(BLK)**, Charcoal **(CHR)**, Designer White **(DWT)**, Fog **(FOG)**, Nevada **(NEV)**, Silver **(SIL)**, Taupe **(TPE)**, Tungsten **(TUN)**. UL Listed: UL 962.

- When using a 23"d return with the FT539FSL30CL a 24" foot must be ordered separately. See FTFOOT24TL/CL (745) for specification information.

FT639FS24CL	48-60 x 42-60 x 22.5-48.5	60	101	1.47		\$2288
FT639FS30CL	48-60 x 42-60 x 22.5-48.5	60	101	1.47		\$2300
FT639FL24CL	66-84 x 66-84 x 22.5-48.5	60	101	1.47		\$2326
FT639FL30CL	66-84 x 66-84 x 22.5-48.5	60	101	1.47		\$2338

Kit includes two equal length beams, three cantilevers, one extended range corner column, two extended range columns, and two C styled feet. **FS** indicates small base for 54" to 60" sided tables. **FL** indicates large base: 66" to 84" sided tables. For 23" deep worksurfaces, use 24" CL leg. For 29" and 35" deep worksurface, use 30" CL leg. For enhanced collision detection, an Anti Collision Desk Sensor is included with every base.

Standard up/down controller with 2 memory positions, reminder settings + Bluetooth capability is standard - specify **(S)**. For a Display controller with height readout, 4 memory positions, reminder settings + Bluetooth capabilities, specify **(D)**, add **\$63** list. Specify paint finish: Black **(BLK)**, Charcoal **(CHR)**, Designer White **(DWT)**, Fog **(FOG)**, Nevada **(NEV)**, Silver **(SIL)**, Taupe **(TPE)**, Tungsten **(TUN)**. UL Listed: UL 962.

- When using a 23"d return with the FT639FS30CL/LF30CL a 24" foot must be ordered separately. See FTFOOT24TL/CL (745) for specification information.

FT639FSL24CL	48-84 x 48-60 x 22.5-48.5	60	101	1.47		\$2307
FT639FSL30CL	48-84 x 48-60 x 22.5-48.5	60	101	1.47		\$2319

Kit includes two beams (one small, one large), three cantilevers, one extended range corner column, two extended range columns, and two C styled feet. For 23" deep worksurfaces, use 24" CL leg. For 29" and 35" deep worksurface, use 30" CL leg. For enhanced collision detection, an Anti Collision Desk Sensor is included with every base.

Standard up/down controller with 2 memory positions, reminder settings + Bluetooth capability is standard - specify **(S)**. For a Display controller with height readout, 4 memory positions, reminder settings + Bluetooth capabilities, specify **(D)**, add **\$63** list. Specify paint finish: Black **(BLK)**, Charcoal **(CHR)**, Designer White **(DWT)**, Fog **(FOG)**, Nevada **(NEV)**, Silver **(SIL)**, Taupe **(TPE)**, Tungsten **(TUN)**. UL Listed: UL 962.

- When using a 23"d return with the FT639FSL30CL a 24" foot must be ordered separately. See FTFOOT24TL/CL (745) for specification information.

Required specifications

Top finish
Base finish
Foot style
Foot configuration

Optional specifications

HP laminate
Digital handset
Grommet
Insulation type

Accessories

Keyboard tray
Power block

LAMINATE LEG SHROUDS **MODEL#** **DIMENSIONS** **FREIGHT CLASS** **WT./LBS.** **CUBIC FT.** **LIST PRICE**

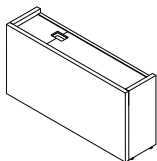

Laminate Leg Shroud, for C-Leg - Left**

	D x W x H				
FTB23L	9 x 23 x 18	65	47	2	\$609
FTB29L	9 x 29 x 18	70	55	3	\$630
FTB35L	9 x 35 x 18	70	67	3	\$657

Laminate housing to cover a FreeFit C-leg on the left side. Includes a felt liner at the top. Short side panel is removable to access interior. Specify laminate finish, PVC edge finish and felt finish.

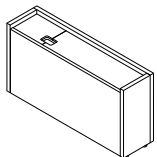

Laminate Leg Shroud, for C-Leg - Right**

FTB23R	9 x 23 x 18	65	47	2	\$609
FTB29R	9 x 29 x 18	70	55	3	\$630
FTB35R	9 x 35 x 18	70	67	3	\$657

Laminate housing to cover a FreeFit C-leg on the right side. Includes a felt liner at the top. Short side panel is removable to access interior. Specify laminate finish, PVC edge finish and felt finish.

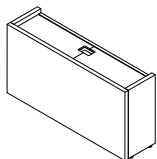

Laminate Leg Shroud for T-Leg**

FTB23	9 x 23 x 18	65	47	2	\$609
FTB29	9 x 29 x 18	70	55	3	\$630
FTB35	9 x 35 x 18	70	67	3	\$657

Laminate housing to cover a FreeFit T-leg. Includes a felt liner at the top. Short side panel is removable to access interior. Specify laminate finish, PVC edge finish and felt finish.

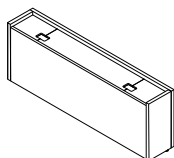

Laminate Leg Shroud for Media Bases

FTB54	9 x 54 x 18	70	110	5	\$1238
FTB64	9 x 64 x 18	70	134	6	\$1440

Laminate shroud for a FreeFit media table base. Includes a felt liner at the top. Side panel is removable to access interior. Specify laminate finish, PVC edge finish and felt finish.

Required specifications

- Laminate finish
- Edge finish
- Felt finish

POWER DELIVERY/CABLE MANAGEMENT

MODEL#

DIMENSIONS

FREIGHT CLASS

WT/LBS.

CUBIC FT.

LIST PRICE

D x W x H

4-2-2 Wiring Schematic

8-Wire Shared Neutral

"2 + 2" - 2 Utility Circuits, 2 Dedicated

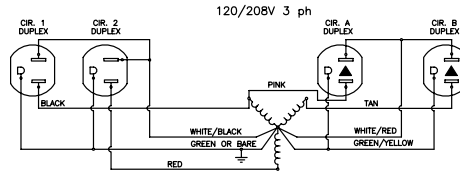
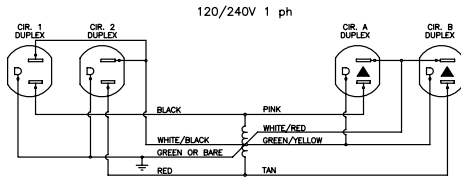

8 Wires	4 Circuits	Receptacles	Specifications
4 Lines (12 ga.)	2 Utility circuits	Duplex - Up to 12 duplex receptacles per circuit	System rated for connection to a grounded 120/240 V single phase, 20A, 60Hz or 120/208 V, 3 phase, 20A, 60Hz branch circuit for U.S. and 15A if product is marked with a C-UL Mark. Outlets rated 15A max.
2 Neutrals (10 ga.)	2 Dedicated Circuits	(Up to 48 per infeed)	
2 Grounds (12 ga.)			

TROUGH KITS

MODEL#

DIMENSIONS

FREIGHT CLASS

WT/LBS.

CUBIC FT.

LIST PRICE



Back-to-Back Trough Kit

FTB2B48KITNB	--	92.5	3.50	.30	\$2580
FTB2B54KITNB	--	92.5	3.50	.30	\$2659
FTB2B60KITNB	--	92.5	3.50	.30	\$2793
FTB2B66KITNB	--	92.5	3.50	.30	\$2846
FTB2B72KITNB	--	92.5	3.50	.30	\$2879

For back-to-back benching applications. Trough kits contain all items needed for a standard back-to-back workstation when combined with the back-to-back height adjustable base and worksurfaces (both sold separately). Kits include two neoprene socks and one back-to-back power trough with distribution housing included. Specify duplexes separately.

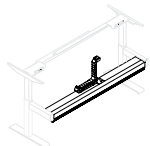

Single Sided Trough Kit

FTSGL48KITNB	--	92.5	3.50	.30	\$1685
FTSGL54KITNB	--	92.5	3.50	.30	\$1766
FTSGL60KITNB	--	92.5	3.50	.30	\$1866
FTSGL66KITNB	--	92.5	3.50	.30	\$1919
FTSGL72KITNB	--	92.5	3.50	.30	\$1973

For single-sided benching applications. Trough kits contain all items needed for a single sided workstation when combined with the single-sided height adjustable base and worksurfaces (both sold separately). Kits include two neoprene socks and one back-to-back power trough with distribution housing included. Specify duplexes separately.

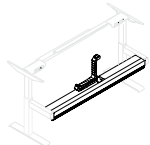

End of Run Trough Kit

FTSGL51T24KITNB	--	92.5	3.50	.30	\$1766
-----------------	----	------	------	-----	---------------

For perpendicular end of run benching applications. Trough kits contain all items needed for a standard back-to-back workstation when combined with the back-to-back height adjustable base and worksurfaces (both sold separately). Kits include two neoprene socks and one back-to-back power trough with distribution housing included. Specify duplexes separately.

Required specifications

Base finish

ACCESS DOORS **MODEL#** **DIMENSIONS** **FREIGHT CLASS** **WT/LBS.** **CUBIC FT.** **LIST PRICE**



Access Door Module

	D x W x H				
GAADG	5.54 x 10.09 x 1.08	--	2	0.04	\$96
GAADGDH	5.54 x 10.09 x 1.08	--	2	0.04	\$104

Soft close door is set back from edge to allow for cable pass thru when closed. Available in all standard base finishes. GAADGDH includes device holder for most mobile phones or tablets. Holder is only available in White. FreeFit can only accommodate one grommet per worksurface.

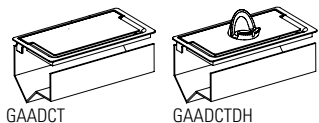

Access Door Module w/Cable Tray

GAADCT	5.54 x 10.09 x 5.07	--	4	0.19	\$155
GAADCTDH	5.54 x 10.09 x 5.07	--	4	0.19	\$163

Soft close door is set back from edge to allow for cable pass thru when closed. Cable tray comes standard with one telecom knockout and platform to mount a power bar. Sides are open for easy access. Available in all standard base finishes. GAADCTDH includes device holder for most mobile phones or tablets. Holder is only available in White. FreeFit can only accommodate one grommet per worksurface.

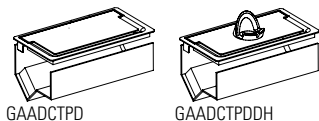

Access Door Module w/Cable Tray and Power Bar

GAADCTPD	5.54 x 10.09 x 6.96	--	4	0.20	\$327
GAADCTPDDH	5.54 x 10.09 x 6.96	--	4	0.20	\$337

Soft close door is set back from edge to allow for cable pass thru when closed. Cable tray comes standard with one telecom knockout and platform to mount a powerbar. Power bar with 3 simplex and 2 USB, CSA Certified. Sides are open for easy access. Available in all standard base finishes. GAADCTPDDH includes device holder for most mobile phones or tablets. Holder is only available in White. FreeFit can only accommodate one grommet per worksurface.

ELECTRICAL COMPONENTS

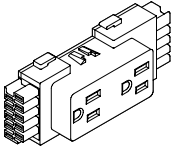

Duplex Receptacles

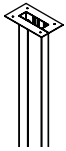

Ceiling Feed Post*



Ceiling Feed Harness

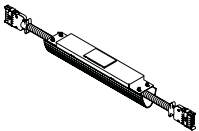

Table to Table Connector*

MODEL#	DIMENSIONS D x W x H	FREIGHT CLASS	WT/LBS.	CUBIC FT.	LIST PRICE
BRTE8D1	1.25 x 4.63 x 2	70	.10	.01	\$45
BRTE8D2	1.25 x 4.63 x 2	70	.10	.01	\$45
BRTE8DA	1.25 x 4.63 x 2	70	.10	.01	\$45
BRTE8DB	1.25 x 4.63 x 2	70	.10	.01	\$45
BRTE8DXW1	1.25 x 4.63 x 2	70	.10	.01	\$63
BRTE8DXW2	1.25 x 4.63 x 2	70	.10	.01	\$63
BRTE8DXWA	1.25 x 4.63 x 2	70	.10	.01	\$63
BRTE8DXWB	1.25 x 4.63 x 2	70	.10	.01	\$63

Snaps into Power Distribution Housing. Up to 13 duplex receptacles per circuit. XW identifies white color plastic, all others standard in black.

- BRTE8D1 / BRTE8DXW1 - Circuit #1 (utility circuit)
- BRTE8D2 / BRTE8DXW2 - Circuit #2 (utility circuit)
- BRTE8DA / BRTE8DXWA - Circuit A (dedicated circuit)
- BRTE8DB / BRTE8DXWB - Circuit B (dedicated circuit)

BWAECEF	2.5 x 4.74 x 99.32	92.5	3.50	.30	\$457
---------	--------------------	------	------	-----	--------------

Ceiling pole brings ceiling feed conduit and data cables from the ceiling down to Power troughs height. Accommodates 10' ceiling heights. A two part construction allows power/data conduit lay-in. Includes mounting hardware and ceiling bezel. Ceiling feed harness sold separately.

BWAEECFH120	6 x 6 x 120	250	5	2	\$565
BWAEECFH144	6 x 6 x 144	250	6	3	\$627

Ceiling feed provides a single power entry from ceiling, through Ceiling pole into Power Trough, into Power Distribution Housing. An 8-wire (4-circuit) metal conduit harness with included metal junction box for hard wiring to the building power supply above ceiling tile. Must be hard wired to the building power supply by a licensed electrician. Ceiling feed post sold separately.

FTAETTC12	2.3 x 16 x 3	60	6	.12	\$436
FTAETTC18	2.3 x 22 x 3	60	8	.15	\$471
FTAETTC24	2.3 x 28 x 3	60	9	.18	\$497
FTAETTC30	2.3 x 34 x 3	60	10.60	.22	\$524
FTAETTC36	2.3 x 40 x 3	60	12	.24	\$550
FTAETTC42	2.3 x 46 x 3	60	11.60	.28	\$592
FTAETTC48	2.3 x 52 x 3	60	14	.30	\$630

Connects Freefit legs and trough provide to power data/communication pass thru. Connector kit consists of formed steel housing, mounting brackets, housing to housing harness (jumper) and one charcoal grey extruded data/communication cable manager. Knock out on top cover allows for ceiling post connection. Cover included. Specify paint finish.

- FTAETTC12 is used between two single sided or back to back stations that are 70" w (72" nominal) or less.
- FTAETTC18 is used between two single sided or back to back stations that are 76" w (78" nominal).
- FTAETTC24 is used between two single sided or back to back stations that are 82" w (84" nominal), or when separating two stations (up to 70" w) with a 12" w storage piece.
- FTAETTC30 is used to separate 2 workstations 70" w (72" nominal) or less with an 18" w storage unit in between the surfaces.
- FTAETTC36 is used between two single sided or back to back stations that are 70" w (72" nominal) or less with (2) 12" w storage units or (1) 24" w storage unit.
- FTAETTC42 is used between two single sided or back to back stations that are 70" w (72" nominal) or less with (2) 15" w storage units or (1) 30" w storage unit
- FTAETTC48 is used between two single sided or back to back stations that are 70" w (72" nominal) or less with (2) 18" w storage units or (1) 36" w storage unit.

Required specifications

Base finish*

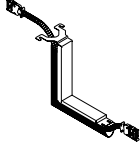
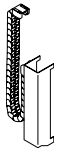
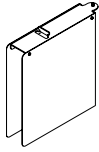
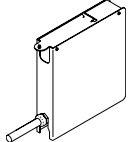
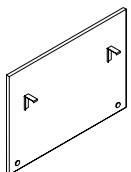
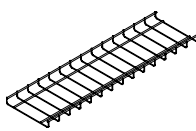
ELECTRICAL COMPONENTS	MODEL#	DIMENSIONS	FREIGHT CLASS	WT./LBS.	CUBIC FT.	LIST PRICE																																																
 <p>Table to Bridges Connector*</p>	D x W x H																																																					
	FTTABRC	14 x 2.3 x 15	100	2.40	.28	\$370																																																
<p>Connects Freefit back-to-back benching to Bridges 29"H table with below worksurface power trough. Please specify paint finish on bracket. Wire manager is always Charcoal.</p>																																																						
 <p>Leg Wire Manager*</p>	<table border="1"> <tr> <td>FTACCL</td> <td>3.2 x 2 x 16</td> <td>70</td> <td>.06</td> <td>.06</td> <td>\$566</td> </tr> </table>						FTACCL	3.2 x 2 x 16	70	.06	.06	\$566																																										
	FTACCL	3.2 x 2 x 16	70	.06	.06	\$566																																																
<p>Provides wire management from under FreeFit worksurface, down the leg and to the floor. Can only be used on FreeFit regular and media tables. Not for use on back-to-back tables. Kit includes wire manager housing, magnets, screws and neoprene socks. Magnetically fastens to the FreeFit leg and cable chain is screwed to worksurfaces. Please specify housing paint finish.</p>																																																						
 <p>Base Feed*</p>	<table border="1"> <tr> <td>FTAEFF</td> <td>8.75 x 2 x 10.8</td> <td>92.5</td> <td>3.50</td> <td>.30</td> <td>\$938</td> </tr> </table>						FTAEFF	8.75 x 2 x 10.8	92.5	3.50	.30	\$938																																										
	FTAEFF	8.75 x 2 x 10.8	92.5	3.50	.30	\$938																																																
<p>Floor feed housing for FreeFit benching applications only. Includes liquitite whip , 72"L. Must be hard wired to the building power supply by a licensed electrician.</p>																																																						
 <p>Base Feed* - New York Electrical</p>	<table border="1"> <tr> <td>FTAEFF-NYC</td> <td>14 x 2.55 x 13.41</td> <td>92.5</td> <td>3.50</td> <td>.30</td> <td>\$792</td> </tr> </table>						FTAEFF-NYC	14 x 2.55 x 13.41	92.5	3.50	.30	\$792																																										
	FTAEFF-NYC	14 x 2.55 x 13.41	92.5	3.50	.30	\$792																																																
<p>Floor feed housing for FreeFit benching applications only. Includes liquitite whip , 72"L. Must be hard wired to the building power supply by a licensed electrician.</p>																																																						
 <p>Back-to-Back End Gable*</p>	<table border="1"> <tr> <td>FTAEG18H</td> <td>30.65 x .75 x 18</td> <td>60</td> <td>10</td> <td>.24</td> <td>\$511</td> </tr> <tr> <td>FTAEG22H</td> <td>30.65 x .75 x 22</td> <td>60</td> <td>13</td> <td>.30</td> <td>\$550</td> </tr> </table>						FTAEG18H	30.65 x .75 x 18	60	10	.24	\$511	FTAEG22H	30.65 x .75 x 22	60	13	.30	\$550																																				
	FTAEG18H	30.65 x .75 x 18	60	10	.24	\$511																																																
	FTAEG22H	30.65 x .75 x 22	60	13	.30	\$550																																																
<p>Optional back-to-back FreeFit Benching end gable is intended to be installed at the end of a FreeFit back-to-back table run. Made of 3/4" thermally fused laminate, it reduces the number of visible elements below the worksurface. Two heights are available. Specify FTAEG18H for extended range bases and FTAEG22H for standard range bases.</p>																																																						
 <p>Under Worksurface Cable Basket</p>	<table border="1"> <tr> <td>FFTCB36</td> <td>8 x 8 x 1</td> <td>70</td> <td>.36</td> <td>.03</td> <td>\$129</td> </tr> <tr> <td>FFTCB48</td> <td>8 x 16 x 1</td> <td>70</td> <td>.73</td> <td>.07</td> <td>\$144</td> </tr> <tr> <td>FFTCB54</td> <td>8 x 22 x 1</td> <td>70</td> <td>1.01</td> <td>.10</td> <td>\$150</td> </tr> <tr> <td>FFTCB60</td> <td>8 x 28 x 1</td> <td>70</td> <td>1.20</td> <td>.13</td> <td>\$157</td> </tr> <tr> <td>FFTCB66</td> <td>8 x 34 x 1</td> <td>70</td> <td>1.56</td> <td>.15</td> <td>\$183</td> </tr> <tr> <td>FFTCB72</td> <td>8 x 40 x 1</td> <td>70</td> <td>1.80</td> <td>.18</td> <td>\$191</td> </tr> <tr> <td>FFTCB78</td> <td>8 x 46 x 1</td> <td>92.5</td> <td>2.16</td> <td>.21</td> <td>\$203</td> </tr> <tr> <td>FFTCB84</td> <td>8 x 52 x 1</td> <td>100</td> <td>2.39</td> <td>.24</td> <td>\$210</td> </tr> </table>						FFTCB36	8 x 8 x 1	70	.36	.03	\$129	FFTCB48	8 x 16 x 1	70	.73	.07	\$144	FFTCB54	8 x 22 x 1	70	1.01	.10	\$150	FFTCB60	8 x 28 x 1	70	1.20	.13	\$157	FFTCB66	8 x 34 x 1	70	1.56	.15	\$183	FFTCB72	8 x 40 x 1	70	1.80	.18	\$191	FFTCB78	8 x 46 x 1	92.5	2.16	.21	\$203	FFTCB84	8 x 52 x 1	100	2.39	.24	\$210
	FFTCB36	8 x 8 x 1	70	.36	.03	\$129																																																
	FFTCB48	8 x 16 x 1	70	.73	.07	\$144																																																
	FFTCB54	8 x 22 x 1	70	1.01	.10	\$150																																																
	FFTCB60	8 x 28 x 1	70	1.20	.13	\$157																																																
	FFTCB66	8 x 34 x 1	70	1.56	.15	\$183																																																
	FFTCB72	8 x 40 x 1	70	1.80	.18	\$191																																																
	FFTCB78	8 x 46 x 1	92.5	2.16	.21	\$203																																																
	FFTCB84	8 x 52 x 1	100	2.39	.24	\$210																																																
	<p>Shallow, 8" wide basket manages cable excess. It can be easily unclipped from steel brackets (included). Specify cable basket 30" shorter than worksurface. Steel wire construction, chrome finish baskets; black steel hanging brackets, fasteners.</p>																																																					

Required specifications

Base finish*

ELECTRICAL COMPONENTS/ACCESSORIES



Cable Snake

MODEL#	DIMENSIONS D x W x H	FREIGHT CLASS	WT/LBS.	CUBIC FT.	LIST PRICE
BRACS	2 x 8 x 30	70	3	.19	\$163
BRACSH	2 x 8 x 49	70	3	.19	\$309

Flexible cable management trough. Two pathways within the snake, one for data/communication and one for routing power cables. Translucent White finish only.

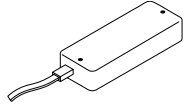

Battery and Charger

FTBATT	8 x 3 x 1.5	70	1.54	.02	\$497
--------	-------------	----	------	-----	--------------

Battery Pak with charging cable mounts to the underside of the worksurface. Features LED bars indicating capacity level and audio alarm when it needs to be charged. On a full charge, the table can cycle from 35 to 45 stroke lengths depending upon the range of column selected and load on the table.

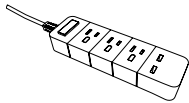

Power Bar with USB

BWAEGC00158GC	1 x 2.3 x 1.3	70	1	.50	\$156
---------------	---------------	----	---	-----	--------------

Power Bar with 3 receptacles + 2 USB and power switch. Standard with 6' cord. Rating 15A, 125V, AC 60Hz, 1875W. USB output 5V, 2.6A (max.) White case, white cord. Available to retrofit CTL/CTR or CTDHL/CTDHR.

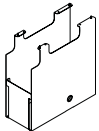

PC Holder

FTACPU	21 x 8 x 21	300	3.57	2.04	\$477
--------	-------------	-----	------	------	--------------

Accepts tower CPU's with a width range from 7.6" to 2.25" - and a maximum height of 18". Durable sheet metal construction. Please specify paint finish.



Dual Wheel Casters

BRTLCS	2.7 x 2.5 x 2.6	70	0.06	.01	\$38
--------	-----------------	----	------	-----	-------------

Locking caster. Interchangeable with glides on FreeFit two leg bases only. 40mm dia. caster with 8mm thread. White body, light grey tires.

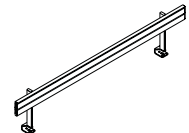

Single Table Accessory Rail*

BRLBST36	2.95 x 33 x 16	65	5.90	.26	\$445
BRLBST42	2.95 x 39 x 16	70	6.44	.30	\$468
BRLBST48	2.95 x 45 x 16	70	6.98	.35	\$485
BRLBST54	2.95 x 51 x 16	70	7.52	.39	\$503
BRLBST60	2.95 x 57 x 16	70	8.07	.43	\$514
BRLBST66	2.95 x 63 x 16	70	8.61	.48	\$532
BRLBST72	2.95 x 69 x 16	70	9.15	.52	\$550
BRLBST78	2.95 x 75 x 16	70	9.69	.56	\$567
BRLBST84	2.95 x 81 x 16	70	10.24	.61	\$584

Table mounted accessory rail. Compatible with standard Bins, Trays and Sorters. Includes end caps and mounting hardware. Please specify paint finish. To ensure proper connection and clearance on tables 46" wide and up, choose accessory rail 13" smaller than the actual table width (70" wide table gets 57" wide rail). Tables 40" wide and smaller use 33" wide accessory rail.

Required specifications

Base finish*

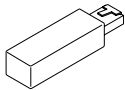
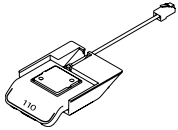
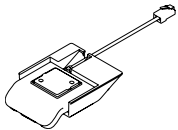
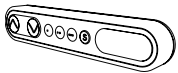
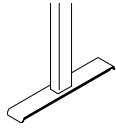
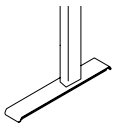
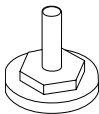
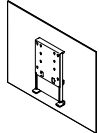
ACCESSORIES	MODEL#	DIMENSIONS	FREIGHT CLASS	WT/LBS.	CUBIC FT.	LIST PRICE
 <p>Anti-Collision Desk Sensor USB Plug</p>		D x W x H				
	FTACDS	8 x 3 x 1.5	60	1.54	.01	\$53
<p>Provides enhanced anti-collision detection. Plugs directly into control box. Only one USB plug required for table assembly. This is a replacement part. One sensor ships standard with every table.</p>						
 <p>Reminder Controller - LED Display + Bluetooth</p>	FTDPG1C	3 x 4.3 x 1	70	0.4	.01	\$116
	<p>Up/down drive with 4 memory positions. LED light strip reminder, table height display. Bluetooth enabled, connects to Desk Control App. This is a replacement part. Every base comes standard with a controller.</p>					
 <p>Diode Reminder Controller - Memory + Bluetooth</p>	FTDPG1M	3 x 4.3 x 1	70	0.4	.01	\$47
	<p>Up/down drive with 2 memory positions. Bluetooth enabled, connects to Desk Control App. This is a replacement part. Every base comes standard with a controller.</p>					
 <p>Display Handset</p>	FTDHNBT	3 x 4.3 x 1	70	1	.01	\$118
	<p>Up/down drive with 3 memory positions and table height display. Must be specified separately from standard tables and replaced in the field. Use where Bluetooth capabilities are restricted.</p>					
 <p>T-Foot*</p>	FTFOOT24TL	23 x 3 x 1.16	60	4.4	.10	\$129
	FTFOOT30TL	29 x 3 x 1.16	60	4.85	.10	\$140
<p>Replacement single "T" foot or as an optional addition to a 3 leg table.</p>						
 <p>C-Foot*</p>	FTFOOT24CL	23 x 3 x 1.16	60	4.4	.10	\$142
	FTFOOT30CL	29 x 3 x 1.16	60	4.85	.10	\$154
<p>Replacement single "C" foot or as an optional addition to a 3 leg table.</p>						
 <p>Replacement Glides</p>	FTSETGLIDE	- x - x 1.5	70	.06	.10	\$10
	<p>Set of two with 1/2" adjustment.</p>					
 <p>TV Mount</p>	FTMT5145	4 x 51 x 40.5	250	16.82	4.8	\$975
	<p>TV mount for FreeFit media tables. Includes the TV/Display bracket and mounting hardware. Maximum TV size is 50".</p>					

Required specifications

Base finish*

PANTRY STORAGE - 42"H

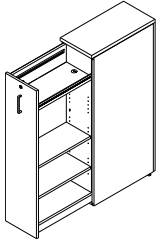

Left (NL) shown

Pantry Storage

MODEL#	DIMENSIONS D x W x H	FREIGHT CLASS	WT/LBS.	CUBIC FT.	LIST PRICE	HP ADD
FFPO1224H42NL	24 x 12 x 42	70	128	7	\$2469	\$31
FFPO1230H42NL	30 x 12 x 42	70	143	9	\$2594	\$38
FFPO1236H42NL	36 x 12 x 42	85	157	11	\$2717	\$43
FFPO1224H42NR	24 x 12 x 42	70	128	7	\$2469	\$31
FFPO1230H42NR	30 x 12 x 42	70	143	9	\$2594	\$38
FFPO1236H42NR	36 x 12 x 42	85	157	11	\$2717	\$43
FFPO1824H42NL	24 x 18 x 42	85	156	11	\$2842	\$43
FFPO1830H42NL	30 x 18 x 42	85	172	13	\$2978	\$55
FFPO1836H42NL	36 x 18 x 42	92.5	187	16	\$3113	\$67
FFPO1824H42NR	24 x 18 x 42	85	156	11	\$2842	\$43
FFPO1830H42NR	30 x 18 x 42	85	172	13	\$2978	\$55
FFPO1836H42NR	36 x 18 x 42	92.5	187	16	\$3113	\$67

The pull out cabinet serves as a multifunctional, customizable storage unit that both defines space and enhances privacy in an open plan environment. Internal organization consists of two fixed shelves on the top and bottom. The two middle shelves are adjustable. Two accessory rails (each 18.25" long) are standard and will accept metal accessories (sold separately - see previous page). Interior cabinet shelves and back are standard in Designer White. Cabinet shell, drawer and top can be specified in any standard laminate. FFPOxxxx will not allow binders.

- For Dry-erase marker board, specify **DE** and **add \$418**. If specified, the dry-erase marker laminate will be applied to the external surface of the pull-out drawer side wall.

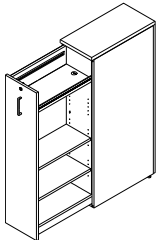

Left (NL) shown

Pantry Storage - w/USB

FFPO1224H42NLUSB	24 x 12 x 42	70	128	7	\$3080	\$31
FFPO1230H42NLUSB	30 x 12 x 42	70	143	9	\$3205	\$38
FFPO1236H42NLUSB	36 x 12 x 42	85	157	11	\$3330	\$43
FFPO1224H42NRUSB	24 x 12 x 42	70	128	7	\$3080	\$31
FFPO1230H42NRUSB	30 x 12 x 42	70	143	9	\$3205	\$38
FFPO1236H42NRUSB	36 x 12 x 42	85	157	11	\$3330	\$43
FFPO1824H42NLUSB	24 x 18 x 42	85	156	11	\$3453	\$43
FFPO1830H42NLUSB	30 x 18 x 42	85	172	13	\$3590	\$55
FFPO1836H42NLUSB	36 x 18 x 42	92.5	187	16	\$3725	\$67
FFPO1824H42NRUSB	24 x 18 x 42	85	156	11	\$3453	\$43
FFPO1830H42NRUSB	30 x 18 x 42	85	172	13	\$3590	\$55
FFPO1836H42NRUSB	36 x 18 x 42	92.5	187	16	\$3725	\$67

The pull out cabinet serves as a multifunctional, customizable storage unit that both defines space and enhances privacy in an open plan environment. Internal organization consists of two fixed shelves on the top and bottom. Top shelf comes with grey felt surface and grommet which allows for cable passage from the USB outlet (located below the top shelf). USB outlet includes one USB-A and one USB-C port. A 2-prong power cord exits the cabinet through the floor at the back. The two middle shelves are adjustable. Two accessory rails (each 18.25" long) are standard and will accept metal accessories (sold separately - see previous page). Interior cabinet shelves and back are standard in Designer White. Cabinet shell, drawer and top can be specified in any standard laminate. FFPOxxxx will not allow binders.

- For Dry-erase marker board, specify **DE** and **add \$418**. If specified, the dry-erase marker laminate will be applied to the external surface of the pull-out drawer side wall.

Required specifications

Laminate finish

Optional specifications

HP laminate
Dry-erase board

PANTRY STORAGE - 49.5"H

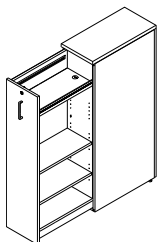

Left (NL) shown

Pantry Storage

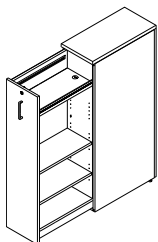

Left (NL) shown

Pantry Storage - w/USB

MODEL#	DIMENSIONS	FREIGHT CLASS	WT/LBS.	CUBIC FT.	LIST PRICE	HP ADD
D x W x H						
FFPO1224NL	24 x 12 x 49.5	70	133	8	\$2633	\$83
FFPO1230NL	30 x 12 x 49.5	85	148	10	\$2760	\$103
FFPO1236NL	36 x 12 x 49.5	92.5	162	15	\$2885	\$117
FFPO1224NR	24 x 12 x 49.5	70	133	8	\$2633	\$83
FFPO1230NR	30 x 12 x 49.5	85	148	10	\$2760	\$103
FFPO1236NR	36 x 12 x 49.5	92.5	162	15	\$2885	\$117
FFPO1824NL	24 x 18 x 49.5	85	161	12	\$3058	\$111
FFPO1830NL	30 x 18 x 49.5	92.5	177	15	\$3192	\$137
FFPO1836NL	36 x 18 x 49.5	92.5	192	18	\$3333	\$157
FFPO1824NR	24 x 18 x 49.5	85	161	12	\$3058	\$111
FFPO1830NR	30 x 18 x 49.5	92.5	177	15	\$3192	\$137
FFPO1836NR	36 x 18 x 49.5	92.5	192	18	\$3333	\$157

The pull out cabinet serves as a multifunctional, customizable storage unit that both defines space and enhances privacy in an open plan environment. Internal organization consists of two fixed shelves on the top and bottom. The two middle shelves are adjustable. Two accessory rails (each 18.25" long) are standard and will accept metal accessories (sold separately - see previous page). Interior cabinet shelves and back are standard in Designer White. Cabinet shell, drawer and top can be specified in any standard laminate. FFPOxxxx will not allow binders.

- For Dry-erase marker board, specify **DE** and **add \$418**. If specified, the dry-erase marker laminate will be applied to the external surface of the pull-out drawer side wall.

FFPO1224NLUSB	24 x 12 x 49.5	70	133	8	\$3244	\$83
FFPO1230NLUSB	30 x 12 x 49.5	85	148	10	\$3371	\$103
FFPO1236NLUSB	36 x 12 x 49.5	92.5	162	15	\$3498	\$117
FFPO1224NRUSB	24 x 12 x 49.5	70	133	8	\$3244	\$83
FFPO1230NRUSB	30 x 12 x 49.5	85	148	10	\$3371	\$103
FFPO1236NRUSB	36 x 12 x 49.5	92.5	162	15	\$3498	\$117
FFPO1824NLUSB	24 x 18 x 49.5	85	161	12	\$3666	\$111
FFPO1830NLUSB	30 x 18 x 49.5	92.5	177	15	\$3806	\$137
FFPO1836NLUSB	36 x 18 x 49.5	92.5	192	18	\$3946	\$157
FFPO1824NRUSB	24 x 18 x 49.5	85	161	12	\$3666	\$111
FFPO1830NRUSB	30 x 18 x 49.5	92.5	177	15	\$3806	\$137
FFPO1836NRUSB	36 x 18 x 49.5	92.5	192	18	\$3946	\$157

The pull out cabinet serves as a multifunctional, customizable storage unit that both defines space and enhances privacy in an open plan environment. Internal organization consists of two fixed shelves on the top and bottom. Top shelf comes with grey felt surface and grommet which allows for cable passage from the USB outlet (located below the top shelf). USB outlet includes one USB-A and one USB-C port. A 2-prong power cord exits the cabinet through the floor at the back. The two middle shelves are adjustable. Two accessory rails (each 18.25" long) are standard and will accept metal accessories (sold separately - see previous page). Interior cabinet shelves and back are standard in Designer White. Cabinet shell, drawer and top can be specified in any standard laminate. FFPOxxxx will not allow binders.

- For Dry-erase marker board, specify **DE** and **add \$418**. If specified, the dry-erase marker laminate will be applied to the external surface of the pull-out drawer side wall.

Required specifications

Laminate finish

Optional specifications

HP laminate
Dry-erase board

PANTRY STORAGE - 54"H

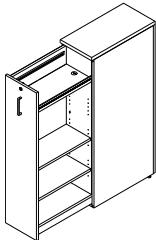

Left (NL) shown

Pantry Storage

MODEL#	DIMENSIONS D x W x H	FREIGHT CLASS	WT/LBS.	CUBIC FT.	LIST PRICE	HP ADD
FFPO1224H54NL	24 x 12 x 54	70	138	9	\$2717	\$31
FFPO1230H54NL	30 x 12 x 54	85	153	11	\$2847	\$31
FFPO1236H54NL	36 x 12 x 54	92.5	167	14	\$2978	\$43
FFPO1224H54NR	24 x 12 x 54	70	138	9	\$2717	\$31
FFPO1230H54NR	30 x 12 x 54	85	153	11	\$2847	\$31
FFPO1236H54NR	36 x 12 x 54	92.5	167	14	\$2978	\$43
FFPO1824H54NL	24 x 18 x 54	92.5	166	14	\$3149	\$43
FFPO1830H54NL	30 x 18 x 54	92.5	182	17	\$3291	\$55
FFPO1836H54NL	36 x 18 x 54	100	197	20	\$3433	\$61
FFPO1824H54NR	24 x 18 x 54	92.5	166	14	\$3149	\$43
FFPO1830H54NR	30 x 18 x 54	92.5	182	17	\$3291	\$55
FFPO1836H54NR	36 x 18 x 54	100	197	20	\$3433	\$61

The pull out cabinet serves as a multifunctional, customizable storage unit that both defines space and enhances privacy in an open plan environment. Internal organization consists of two fixed shelves on the top and bottom. The two middle shelves are adjustable. Two accessory rails (each 18.25" long) are standard and will accept metal accessories (sold separately - see previous page). Interior cabinet shelves and back are standard in Designer White. Cabinet shell, drawer and top can be specified in any standard laminate. FFPOxxxx will not allow binders.

- For Dry-erase marker board, specify **DE** and **add \$418**. If specified, the dry-erase marker laminate will be applied to the external surface of the pull-out drawer side wall.

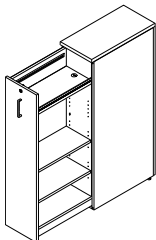

Left (NL) shown

Pantry Storage - w/USB

FFPO1224H54NLUSB	24 x 12 x 54	70	138	9	\$3330	\$31
FFPO1230H54NLUSB	30 x 12 x 54	85	153	11	\$3460	\$31
FFPO1236H54NLUSB	36 x 12 x 54	92.5	167	14	\$3590	\$43
FFPO1224H54NRUSB	24 x 12 x 54	70	138	9	\$3330	\$31
FFPO1230H54NRUSB	30 x 12 x 54	85	153	11	\$3460	\$31
FFPO1236H54NRUSB	36 x 12 x 54	92.5	167	14	\$3590	\$43
FFPO1824H54NLUSB	24 x 18 x 54	92.5	166	14	\$3760	\$43
FFPO1830H54NLUSB	30 x 18 x 54	92.5	182	17	\$3904	\$55
FFPO1836H54NLUSB	36 x 18 x 54	100	197	20	\$4045	\$61
FFPO1824H54NRUSB	24 x 18 x 54	92.5	166	14	\$3760	\$43
FFPO1830H54NRUSB	30 x 18 x 54	92.5	182	17	\$3904	\$55
FFPO1836H54NRUSB	36 x 18 x 54	100	197	20	\$4045	\$61

The pull out cabinet serves as a multifunctional, customizable storage unit that both defines space and enhances privacy in an open plan environment. Internal organization consists of two fixed shelves on the top and bottom. Top shelf comes with grey felt surface and grommet which allows for cable passage from the USB outlet (located below the top shelf). USB outlet includes one USB-A and one USB-C port. A 2-prong power cord exits the cabinet through the floor at the back. The two middle shelves are adjustable. Two accessory rails (each 18.25" long) are standard and will accept metal accessories (sold separately - see previous page). Interior cabinet shelves and back are standard in Designer White. Cabinet shell, drawer and top can be specified in any standard laminate. FFPOxxxx will not allow binders.

- For Dry-erase marker board, specify **DE** and **add \$418**. If specified, the dry-erase marker laminate will be applied to the external surface of the pull-out drawer side wall.

Required specifications

Laminate finish

Optional specifications

HP laminate
Dry-erase board

PANTRY STORAGE W/WARDROBE

MODEL# DIMENSIONS FREIGHT CLASS WT/LBS. CUBIC FT. LIST PRICE HP ADD

D x W x H

FFPW1224H42NL	24 x 12 x 42	70	128	7	\$2969	\$34
FFPW1230H42NL	30 x 12 x 42	70	143	9	\$3105	\$41
FFPW1236H42NL	36 x 12 x 42	85	157	11	\$3238	\$51
FFPW1824H42NL	24 x 18 x 42	85	156	11	\$3438	\$52
FFPW1830H42NL	30 x 18 x 42	85	172	13	\$3588	\$63
FFPW1836H42NL	36 x 18 x 42	92.5	187	16	\$3738	\$76
FFPW1224NL	24 x 12 x 50	70	133	8	\$3236	\$30
FFPW1230NL	30 x 12 x 50	85	148	10	\$3378	\$59
FFPW1236NL	36 x 12 x 50	92.5	162	15	\$3521	\$85
FFPW1824NL	24 x 18 x 50	85	161	12	\$3781	\$59
FFPW1830NL	30 x 18 x 50	92.5	177	15	\$3935	\$97
FFPW1836NL	36 x 18 x 50	92.5	192	18	\$4091	\$128
FFPW1224H54NL	24 x 12 x 54	70	138	9	\$3298	\$32
FFPW1230H54NL	30 x 12 x 54	85	153	11	\$3439	\$38
FFPW1236H54NL	36 x 12 x 54	92.5	167	14	\$3583	\$44
FFPW1824H54NL	24 x 18 x 54	92.5	166	14	\$3855	\$44
FFPW1830H54NL	30 x 18 x 54	92.5	182	17	\$4009	\$57
FFPW1836H54NL	36 x 18 x 54	100	197	20	\$4166	\$64
FFPW1224H42NR	24 x 12 x 42	70	128	7	\$2969	\$34
FFPW1230H42NR	30 x 12 x 42	70	143	9	\$3105	\$41
FFPW1236H42NR	36 x 12 x 42	85	157	11	\$3238	\$51
FFPW1824H42NR	24 x 18 x 42	85	156	11	\$3438	\$52
FFPW1830H42NR	30 x 18 x 42	85	172	13	\$3588	\$63
FFPW1836H42NR	36 x 18 x 42	92.5	187	16	\$3738	\$76
FFPW1224NR	24 x 12 x 50	70	133	8	\$3236	\$30
FFPW1230NR	30 x 12 x 50	85	148	10	\$3378	\$59
FFPW1236NR	36 x 12 x 50	92.5	162	15	\$3521	\$85
FFPW1824NR	24 x 18 x 50	85	161	12	\$3781	\$59
FFPW1830NR	30 x 18 x 50	92.5	177	15	\$3935	\$97
FFPW1836NR	36 x 18 x 50	92.5	192	18	\$4091	\$128
FFPW1224H54NR	24 x 12 x 54	70	138	9	\$3298	\$32
FFPW1230H54NR	30 x 12 x 54	85	153	11	\$3439	\$38
FFPW1236H54NR	36 x 12 x 54	92.5	167	14	\$3583	\$44
FFPW1824H54NR	24 x 18 x 54	92.5	166	14	\$3855	\$44
FFPW1830H54NR	30 x 18 x 54	92.5	182	17	\$4009	\$57
FFPW1836H54NR	36 x 18 x 54	100	197	20	\$4166	\$64

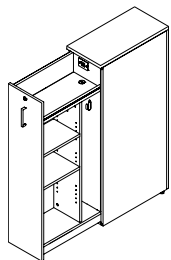

Left (NL) shown

Pantry Storage w/Wardrobe

The pull out cabinet serves as a multifunctional, customizable storage unit that both defines space and enhances privacy in an open plan environment. Internal organization consists of one fixed shelf at the top. The two middle shelves are adjustable. Wardrobe includes coat hook. Interior cabinet shelves and back are standard in Designer White. Cabinet shell, drawer and top can be specified in any standard laminate. FFPW12xx will not accept binders.

- For Dry-erase marker board, specify **DE** and **add \$418**. If specified, the dry-erase marker laminate will be applied to the external surface of the pull-out drawer side wall.

Required specifications

Laminate finish

Optional specifications

HP laminate
Dry-erase board

PANTRY STORAGE W/WARDROBE

MODEL# DIMENSIONS FREIGHT CLASS WT/LBS. CUBIC FT. LIST PRICE HP ADD

D x W x H

FFPW1224H42NLUSB	24 x 12 x 42	70	128	7	\$3645	\$34
FFPW1230H42NLUSB	30 x 12 x 42	70	143	9	\$3781	\$41
FFPW1236H42NLUSB	36 x 12 x 42	85	157	11	\$3914	\$51
FFPW1824H42NLUSB	24 x 18 x 42	85	158	11	\$4115	\$52
FFPW1830H42NLUSB	30 x 18 x 42	85	172	13	\$4266	\$63
FFPW1836H42NLUSB	36 x 18 x 42	92.5	187	16	\$4415	\$76
FFPW1224NLUSB	24 x 12 x 50	70	133	8	\$3912	\$30
FFPW1230NLUSB	30 x 12 x 50	85	148	10	\$4055	\$59
FFPW1236NLUSB	36 x 12 x 50	92.5	162	15	\$4199	\$85
FFPW1824NLUSB	24 x 18 x 50	85	161	12	\$4459	\$59
FFPW1830NLUSB	30 x 18 x 50	92.5	177	15	\$4611	\$97
FFPW1836NLUSB	36 x 18 x 50	92.5	192	18	\$4767	\$128
FFPW1224H54NLUSB	24 x 12 x 54	70	138	9	\$3975	\$32
FFPW1230H54NLUSB	30 x 12 x 54	85	153	11	\$4117	\$38
FFPW1236H54NLUSB	36 x 12 x 54	92.5	167	14	\$4260	\$44
FFPW1824H54NLUSB	24 x 18 x 54	92.5	166	14	\$4531	\$44
FFPW1830H54NLUSB	30 x 18 x 54	92.5	182	17	\$4686	\$57
FFPW1836H54NLUSB	36 x 18 x 54	100	197	20	\$4842	\$64
FFPW1224H42NRUSB	24 x 12 x 42	70	128	7	\$3645	\$34
FFPW1230H42NRUSB	30 x 12 x 42	70	143	9	\$3781	\$41
FFPW1236H42NRUSB	36 x 12 x 42	85	157	11	\$3914	\$51
FFPW1824H42NRUSB	24 x 18 x 42	85	158	11	\$4115	\$52
FFPW1830H42NRUSB	30 x 18 x 42	85	172	13	\$4266	\$63
FFPW1836H42NRUSB	36 x 18 x 42	92.5	187	16	\$4415	\$76
FFPW1224NRUSB	24 x 12 x 50	70	133	8	\$3912	\$30
FFPW1230NRUSB	30 x 12 x 50	85	148	10	\$4055	\$59
FFPW1236NRUSB	36 x 12 x 50	92.5	162	15	\$4199	\$85
FFPW1824NRUSB	24 x 18 x 50	85	161	12	\$4459	\$59
FFPW1830NRUSB	30 x 18 x 50	92.5	177	15	\$4611	\$97
FFPW1836NRUSB	36 x 18 x 50	92.5	192	18	\$4767	\$128
FFPW1224H54NRUSB	24 x 12 x 54	70	138	9	\$3975	\$32
FFPW1230H54NRUSB	30 x 12 x 54	85	153	11	\$4117	\$38
FFPW1236H54NRUSB	36 x 12 x 54	92.5	167	14	\$4260	\$44
FFPW1824H54NRUSB	24 x 18 x 54	92.5	166	14	\$4531	\$44
FFPW1830H54NRUSB	30 x 18 x 54	92.5	182	17	\$4686	\$57
FFPW1836H54NRUSB	36 x 18 x 54	100	197	20	\$4842	\$64

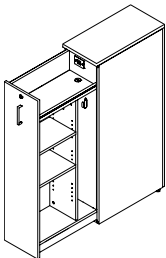

Left (NL) shown

Pantry Storage w/Wardrobe and USB

The pull out cabinet serves as a multifunctional, customizable storage unit that both defines space and enhances privacy in an open plan environment. Internal organization consists of one fixed shelf at the top. Top shelf comes with grey felt surface and grommet which allows for cable passage from the USB outlet (located below the top shelf). USB outlet includes one USB-A and one USB-C port. A 2-prong power cord exits the cabinet through the floor at the back. The two middle shelves are adjustable. Wardrobe includes coat hook. Interior cabinet shelves and back are standard in Designer White. Cabinet shell, drawer and top can be specified in any standard laminate. FFPW12xx will not accept binders.

- For Dry-erase marker board, specify **DE** and add **\$418**. If specified, the dry-erase marker laminate will be applied to the external surface of the pull-out drawer side wall.

Required specifications

Laminate finish

Optional specifications

HP laminate
Dry-erase board

PANTRY STORAGE ACCESSORIES	MODEL#	DIMENSIONS	FREIGHT CLASS	WT./LBS.	CUBIC FT.	LIST PRICE
----------------------------	--------	------------	---------------	----------	-----------	------------

PANTRY STORAGE

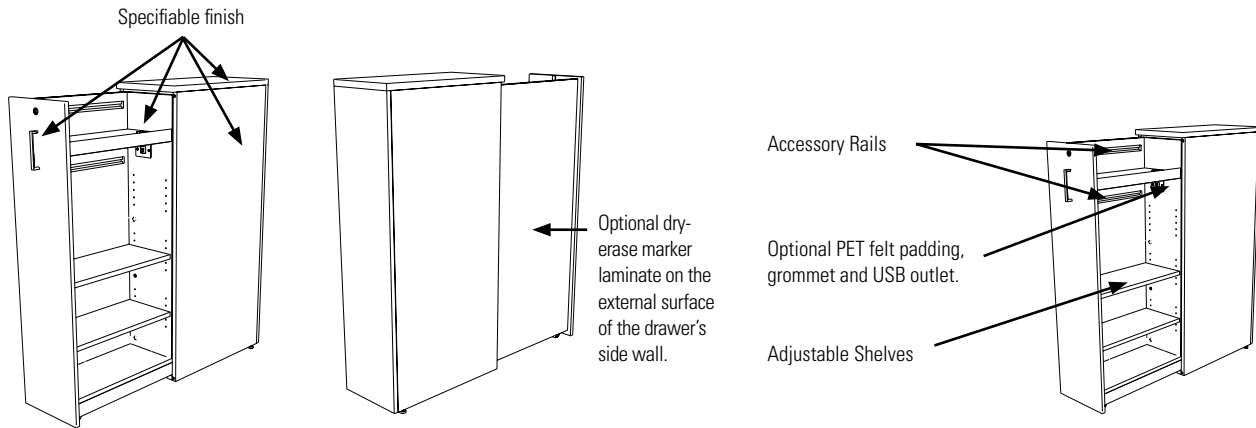

Integrated accessory rails

Two accessory rails (each 18.25" long) are provided to further enhance customization with metal accessories.

Upper Accessory Rail:

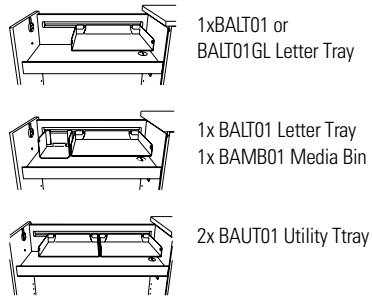

Lower Accessory Rail:

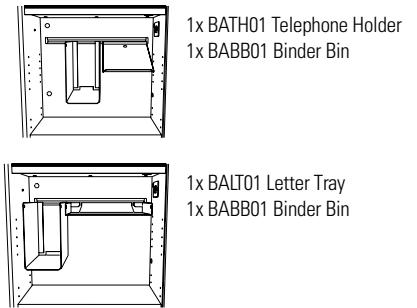
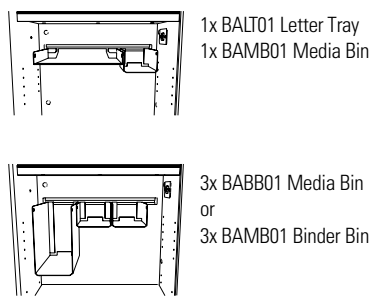

WARDROBE PANTRY STORAGE

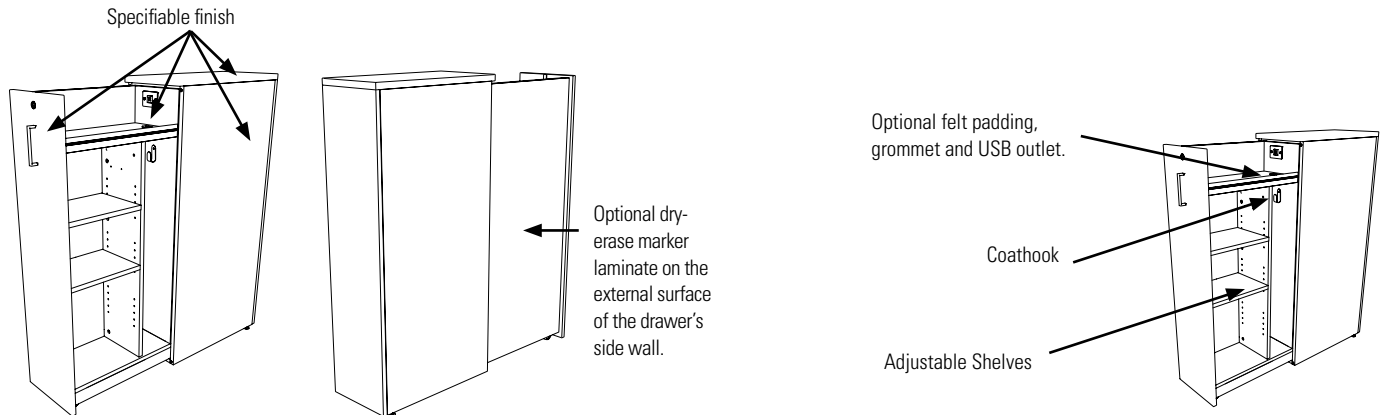

PANTRY STORAGE W/WARDROBE

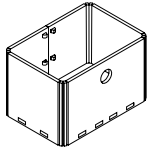

Felt Pantry Storage Bin*

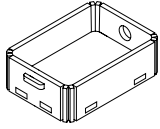

Felt Pantry Storage Tray*

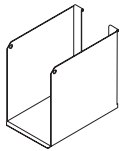

Binder Bin**

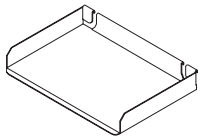

Letter/Legal Tray**

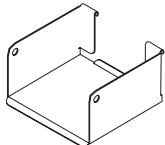

Media Bin**

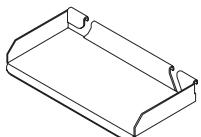

Utility Tray**

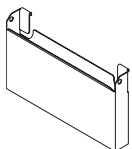

Mail Box**

MODEL#	DIMENSIONS	FREIGHT CLASS	WT./LBS.	CUBIC FT.	LIST PRICE	HP ADD
--------	------------	---------------	----------	-----------	------------	--------

D x W x H

FFPSB0912	8.6 x 11.8 x 7.5	70	8.6	0.03	\$72	
-----------	------------------	----	-----	------	-------------	--

Crafted from recycled PET felt, felt bins are an intuitive and versatile organization solution within pantry units. Felt is 9mm. Specify finish.

FFPST0609	5.9 x 8.6 x 2.6	70	0.28	0.08	\$30	
-----------	-----------------	----	------	------	-------------	--

Crafted from recycled PET felt, felt trays are an intuitive and versatile organization solution within pantry units. Felt is 9mm. Specify finish.

BABB01	10.25 x 4 x 9	100	2	.21	\$75	
--------	---------------	-----	---	-----	-------------	--

Load bar/accessory rail mounted metal binder bin.

BALTO1 (Letter)	9.25 x 13.5 x 2	70	.05	.15	\$62	
BALTO1LGL (Legal)	9.25 x 15 x 2	70	.05	.15	\$76	

Load bar/accessory rail mounted metal letter or legal tray.

BAMB01	5.25 x 5.75 x 3	70	.08	.05	\$62	
--------	-----------------	----	-----	-----	-------------	--

Load bar/accessory rail mounted metal media bin.

BAUT01	3.75 x 5.75 x 3	70	.05	.02	\$41	
--------	-----------------	----	-----	-----	-------------	--

Load bar/accessory rail mounted metal utility tray.

BAPP01	2.75 x 16 x 9	100	2	.25	\$94	
--------	---------------	-----	---	-----	-------------	--

Load bar/accessory rail mounted metal mail box.

Required specifications

Laminate finish

Optional specifications

HP laminate
Dry-erase board

PANTRY STORAGE ACCESSORIES

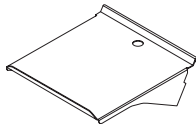

Telephone Holder

MODEL#	DIMENSIONS D x W x H	FREIGHT CLASS	WT/LBS.	CUBIC FT.	LIST PRICE
BATH01	10 x 9 x 2	125	2	.26	\$91

Load bar/accessory rail mounted metal telephone holder.

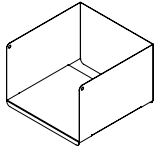

Elevated Shelf Binder Bin

BRTEBBIN	12 x 12 x 8	100	6	.66	\$193
----------	-------------	-----	---	-----	--------------

Load bar/accessory rail mounted elevated shelf binder bin.

Required specifications
Felt finish

HANGING PEDESTALS

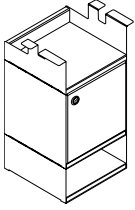

Left (BFBKL) shown

Hanging Pedestal - BFB

MODEL#	DIMENSIONS D x W x H	FREIGHT CLASS	WT/LBS.	CUBIC FT.	LIST PRICE
Without lock:					
FTSSPH12BFBKL	12 x 12 x 24	92.5	26	2.33	\$724
FTSSPH12BFBR	12 x 12 x 24	92.5	26	2.33	\$724

With Lock:					
FTSSPH12BFBKL	12 x 12 x 24	92.5	26	2.33	\$805
FTSSPH12BFBKR	12 x 12 x 24	92.5	26	2.33	\$805

Hanging pedestal with one file box in the middle and two open boxes, one at the top and one at the bottom. Attaches to the underside of a worksurface with supplied screws. File box interior dimensions: 11-7/8"H x 11-13/16"W x 10-7/16"D. Includes metal wire divider and optional lock (must specify "K" before the left or right option). Metal wire divider is chrome and sits 3-7/16" from either side and is interchangeable. File door lock, if specified, is located on the top right corner for the right pedestal and top left corner for the left pedestal. Bottom, middle and top shelves, front door and back are made of 3/4" LP laminate. Sides are made of powder coated metal. Shipped RTA (ready to assemble).

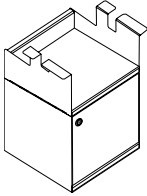

Left (BFKL) shown

Hanging Pedestal - FB

Without lock:					
FTSSPH12BFL	12 x 12 x 18.5	92.5	20	1.83	\$522
FTSSPH12BFR	12 x 12 x 18.5	92.5	20	1.83	\$522
With Lock:					
FTSSPH12BFKL	12 x 12 x 18.5	92.5	20	1.83	\$605
FTSSPH12BFKR	12 x 12 x 18.5	92.5	20	1.83	\$605

Hanging pedestal with one file box at the bottom and one open box at the top. Attaches to the underside of a worksurface with supplied screws. File box interior dimensions: 11-7/8"H x 11-13/16"W x 10-7/16"D. Includes metal wire divider and optional lock (must specify "K" before the left or right option). Metal wire divider is chrome and sits 3-7/16" from either side and is interchangeable. File door lock, if specified, is located on the top right corner for the right pedestal and top left corner for the left pedestal. Bottom, middle and top shelves, front door and back are made of 3/4" LP laminate. Sides are made of powder coated metal. Shipped RTA (ready to assemble).

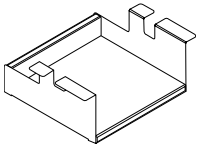

Hanging Pedestal Box*

FTSSPH12B	12 x 12 x 6	125	6	0.96	\$203
-----------	-------------	-----	---	------	--------------

Hanging pedestal open box. Attaches to the underside of a worksurface with supplied screws to create an open box. Bottom, middle and top shelves, front door and back are made of 3/4" LP laminate. Sides are made of powder coated metal. Shipped RTA (ready to assemble).

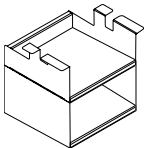

Hanging Pedestal - Two Open Boxes*

FTSSPH12BB	12 x 12 x 6	100	12	1.42	\$404
------------	-------------	-----	----	------	--------------

Hanging pedestal with two open boxes. Attaches to the underside of a worksurface with supplied screws. Bottom, middle and top shelves, front door and back are made of 3/4" LP laminate. Sides are made of powder coated metal. Shipped RTA (ready to assemble).

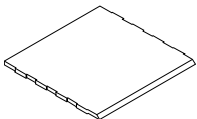

Felt Shelf Liner

FTFELT03BC	12 x 12 x 6	70	0.01	0.03	\$39
------------	-------------	----	------	------	-------------

Felt shelf liner can be added to any closed back shelf. Front edge is cut at 45°.

Required specifications

Metal finish*
Laminate finish*

BACK-TO-BACK TABLE - 21"H DIVIDERS

D x W x H

- FreeFit table mounted dividers for single table or single table row; recessed 6.5" at both ends (for example - 72" (70" actual) FreeFit table mounted divider measures 57").
- The center of all dividers is always mounted 2.250" from worksurface's rear edge. Please note the gap between the divider and the worksurface therefore varies, depending on the divider thickness (1.250" framed dividers, 0.750" frameless LP and 0.250" frameless glass).
- 48" (33" actual) - 66" (51" actual) dividers have 2 mounting brackets.
- 72" (57" actual) dividers have 3 mounting brackets.

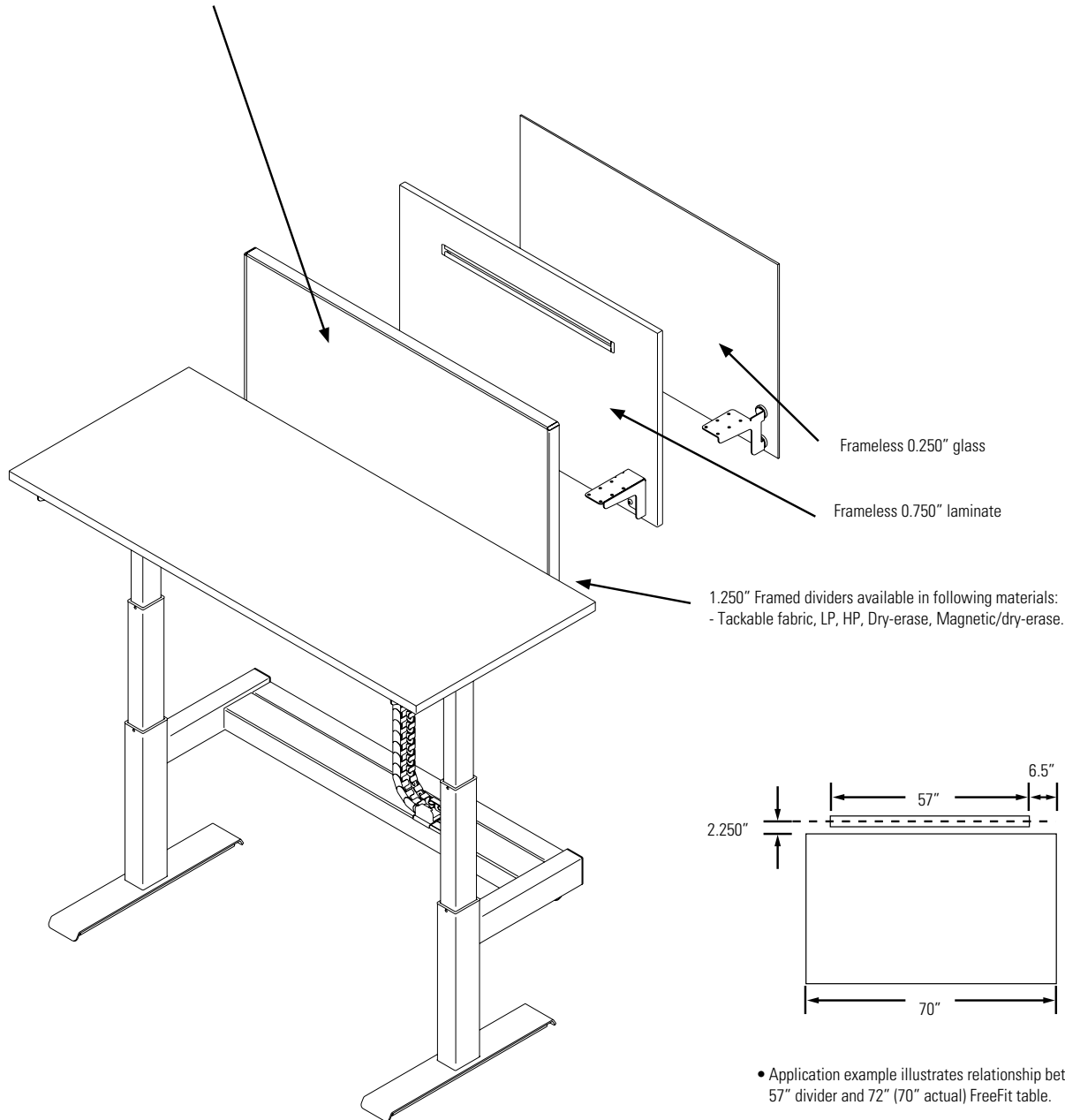

- Application example illustrates relationship between 57" divider and 72" (70" actual) FreeFit table.

- Example Order:
 BWATMFD72
 (actual dimension of 57") for
 BWA2D3072A8
 (actual dimension of 70").

BACK-TO-BACK TABLE - 37"H DIVIDERS

D x W x H

FreeFit Back-to-Back stationary dividers; stationary, shared, secured to table structure; recessed 6.5" at both ends (for example - 72" (70" actual) FreeFit table mounted divider measures 57").

The center of all dividers is always mounted 2.250" from worksurface's rear edge. Please note the gap between the divider and the worksurface therefore varies, depending on the divider thickness (1.250" Framed dividers, 0.750" frameless LP and 0.250" frameless glass).

- 48" (33" actual) divider for 48" (46" actual) table
- 54" (39" actual) divider for 54" (52" actual) table
- 60" (45" actual) divider for 60" (58" actual) table
- 66" (51" actual) divider for 66" (64" actual) table
- 72" (57" actual) divider for 72" (70" actual) table

- Framed dividers (Tackable fabric, LP, HP, Dryerase, Magnetic/dry-erase)
- Frameless LP
- Frameless glass

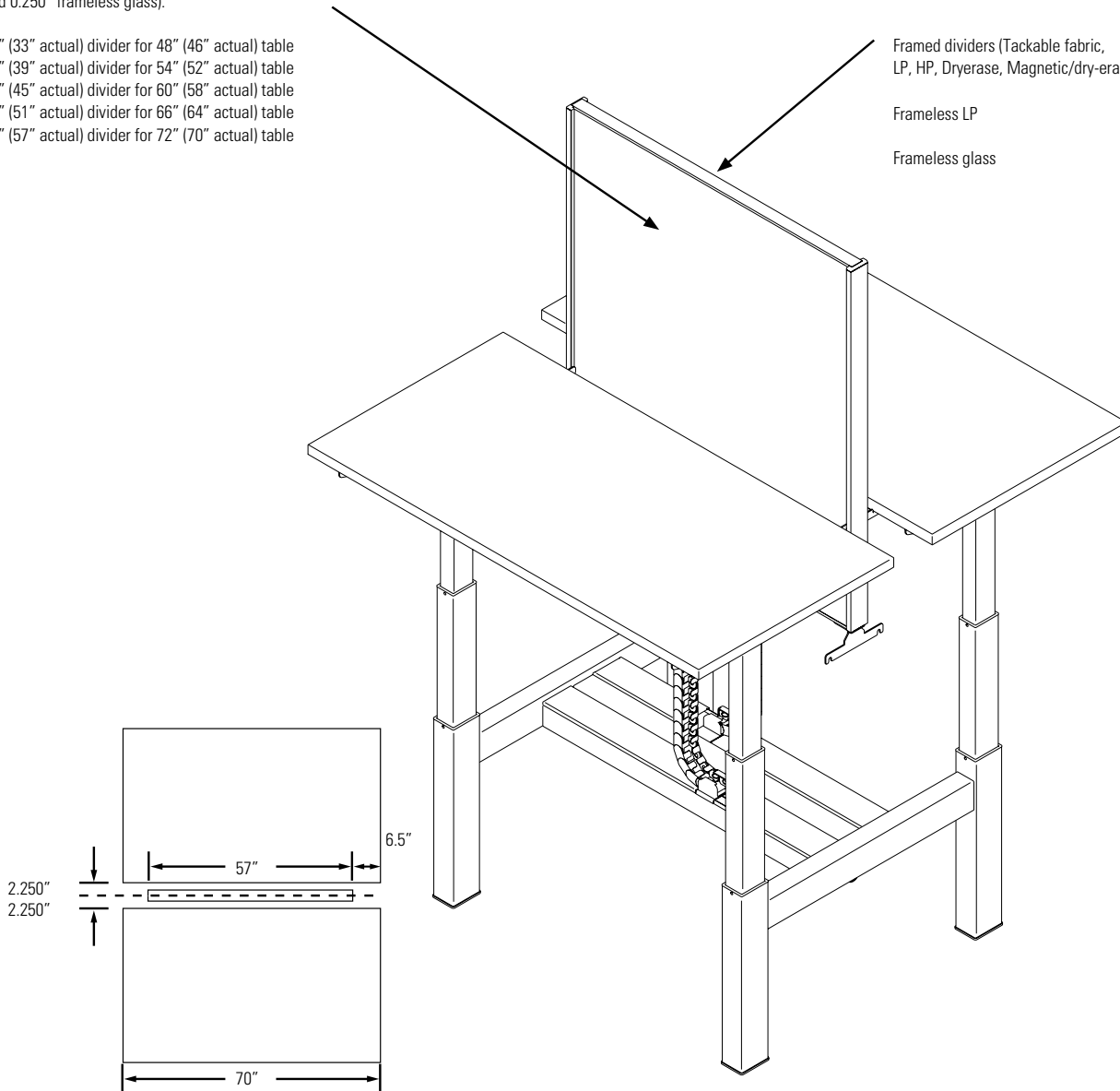

Application example illustrates relationship between 57" shared divider and 72" (70" actual) FreeFit Back-to-Back table.

- Example Order:
 BWASFD72
 (actual dimension of 57") for
 BWA2D6072A8
 (actual dimension of 70").

FELT DIVIDERS MODEL# DIMENSIONS FREIGHT CLASS WT./LBS. CUBIC FT. LIST PRICE

- 9mm thick panels offered in 18 finishes
- Made from 100% PET (polyester) fiber with a high content (50%) of post-recycled material, free of added chemicals, binders and adhesives
- Lightweight panels are tackable, impact and tear resistant, bacteria resistant, moisture resistant, and installation friendly
- Variation in fiber mix and color are inherent to the character of the product

FELT COLORS

- | | |
|-----------------|------------------|
| (AMT) Amethyst | (APR) Apricot |
| (BLK) Black | (BSK) Blue Smoke |
| (BRI) Brick | (CNN) Carnation |
| (DEN) Denim | (EMD) Emerald |
| (GPH) Graphite | (HVT) Harvest |
| (LAP) Lapis | (MTS) Mist |
| (NVY) Navy | (PWT) Pewter |
| (RBY) Ruby | (SHR) Shamrock |
| (SFR) Sunflower | (WHT) White |

BRACKET FINISH

BLK	Black	NEV	Nevada
CHR	Charcoal	SIL	Silver
DWT	Designer White	TPE	Taupe
FOG	Fog	TUN	Tungsten

FELT DIVIDERS MODEL# DIMENSIONS FREIGHT CLASS WT./LBS. CUBIC FT. LIST PRICE

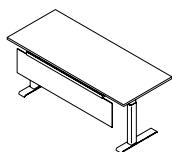

Modesty Felt Divider

BWAFMPSN36	4.17 x 21 x 13.94	70	1.84	0.71	\$200
BWAFMPSN42	4.17 x 27 x 13.94	250	2.32	0.91	\$218
BWAFMPSN48	4.17 x 33 x 13.94	250	2.44	1.11	\$303
BWAFMPSN54	4.17 x 39 x 13.94	250	2.86	1.31	\$340
BWAFMPSN60	4.17 x 45 x 13.94	250	3.27	1.51	\$384
BWAFMPSN66	4.17 x 51 x 13.94	250	3.68	1.72	\$542
BWAFMPSN72	4.17 x 57 x 13.94	250	4.09	1.92	\$577

9mm thick PET felt divider is tackable. Fastens to the underside of the worksurface. Installed divider measures 15" below top of the worksurface. Kit includes felt modesty, support extrusion and left and right brackets. Available in 9 PET felt colors. Please specify.

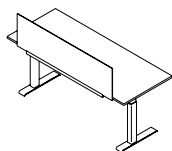

Parallel Felt Divider

BWAFPN36	5.86 x 21 x 18.24	300	2.21	1.3	\$212
BWAFPN42	5.86 x 27 x 18.24	300	2.77	1.67	\$239
BWAFPN48	5.86 x 33 x 18.24	300	2.82	2.04	\$324
BWAFPN54	5.86 x 39 x 18.24	300	3.29	2.41	\$363
BWAFPN60	5.86 x 45 x 18.24	300	3.75	2.78	\$413
BWAFPN66	5.86 x 51 x 18.24	300	4.22	3.15	\$579
BWAFPN72	5.86 x 57 x 18.24	300	4.69	3.53	\$617

Connects parallel on Freefit tables. 9mm thick PET felt divider is tackable. Installed divider measures 15.7" high from the top of the worksurface. Kit includes felt divider, support extrusion and left and right brackets.

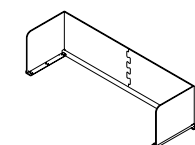

Single

BWAFWR2346	18.46 x 46.84 x 18.24	65	26.58	1.07	\$625
BWAFWR2352	18.46 x 52.84 x 18.24	65	28.4	1.21	\$661
BWAFWR2358	18.46 x 58.84 x 18.24	65	30.22	1.34	\$696
BWAFWR2364	18.46 x 64.84 x 18.24	60	32.02	0.74	\$920
BWAFWR2370	18.46 x 70.84 x 18.24	60	33.84	0.81	\$980
BWAFWR2946	24.46 x 46.84 x 18.24	65	30.74	1.07	\$707
BWAFWR2952	24.46 x 52.84 x 18.24	60	32.55	0.6	\$929
BWAFWR2958	24.46 x 58.84 x 18.24	60	34.37	0.67	\$991
BWAFWR2964	24.46 x 64.84 x 18.24	60	36.19	0.74	\$1052
BWAFWR2970	24.46 x 70.84 x 18.24	60	38	0.81	\$1113

End of Run:

BWAFWR2351	18.46 x 51.34 x 18.24	65	27.94	1.05	\$630
BWAFWR2951	24.46 x 51.34 x 18.24	60	32.09	0.62	\$928
BWAFWR2363	18.46 x 63.34 x 18.24	70	31.57	1.5	\$916
BWAFWR2963	24.46 x 63.34 x 18.24	60	35.73	0.87	\$1048

Wraps around Freefit tables to provide privacy. 9mm thick PET felt divider is tackable. Fastens to the underside of the worksurface. Installed divider measures 15.7" from the top of the worksurface. Divider extends 1.5" past the back of the worksurface. Please choose standard base finish for the extrusion and brackets.

- Anodized Aluminum extrusion - Add **\$167!** list upcharge
- **Note:** Cannot use ceiling feed option with this divider.

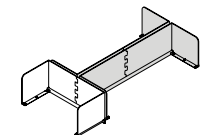

End of Run

Felt Wrap Around Divider*

Required Specifications

- Felt color
- Bracket finish

Optional Specifications

- Anodized extrusion

FELT DIVIDERS

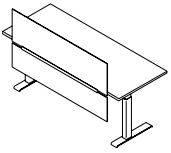

Felt Parallel Divider

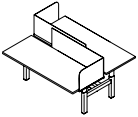
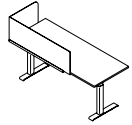

Corner Wrap Felt Divider

MODEL#	DIMENSIONS	FREIGHT CLASS	WT/LBS.	CUBIC FT.	LIST PRICE
--------	------------	---------------	---------	-----------	------------

D x W x H

BWAFPDN36	5.86 x 21 x 30.68	300	2.79	2.18	\$314
BWAFPDN42	5.86 x 27 x 30.68	300	3.56	2.81	\$342
BWAFPDN48	5.86 x 33 x 30.68	150	3.82	3.43	\$486
BWAFPDN54	5.86 x 39 x 30.68	150	4.5	4.06	\$538
BWAFPDN60	5.86 x 45 x 30.68	150	5.17	4.68	\$628
BWAFPDN66	5.86 x 51 x 30.68	150	5.85	5.31	\$961
BWAFPDN72	5.86 x 57 x 30.68	150	6.53	5.93	\$1020

Felt divider and modesty panel kit secures to the rear bottom of a regular FreeFit table and provides privacy above and below the worksurface. 9mm thick PET felt divider is tackable. Installed divider measures 15.7" from the top of the worksurface and 15" below the top of the worksurface. Kit includes two felt dividers, support extrusion and left and right brackets.

BWAF2432L	18.52 x 32.46 x 18.24	150	3.82	6.35	\$441
BWAF2432R	18.52 x 32.46 x 18.24	150	3.82	6.35	\$441
BWAF2438L	18.52 x 38.46 x 18.24	250	5.46	7.52	\$503
BWAF2438R	18.52 x 38.46 x 18.24	250	5.46	7.52	\$503
BWAF2448L	18.52 x 47.46 x 18.24	250	6.16	9.28	\$542
BWAF2448R	18.52 x 47.46 x 18.24	250	6.16	9.28	\$542

BWAF3032L	24.52 x 32.46 x 18.24	250	5.72	8.40	\$498
BWAF3032R	24.52 x 32.46 x 18.24	250	5.72	8.40	\$498
BWAF3038L	24.52 x 38.46 x 18.24	250	6.19	9.95	\$534
BWAF3038R	24.52 x 38.46 x 18.24	250	6.19	9.95	\$534
BWAF3048L	24.52 x 47.46 x 18.24	250	6.89	12.28	\$573
BWAF3048R	24.52 x 47.46 x 18.24	250	6.89	12.28	\$573

Felt Corner Wrap secures to the side and rear bottom of a FreeFit table, wraps around one side and provides limited privacy. 9mm thick PET felt divider is tackable. Installed divider measures 15.7" from the top of the worksurface. Kit includes felt dividers, support extrusion and large and small brackets.

Required Specifications

Felt color
Bracket finish

TABLE MOUNTED DIVIDERS

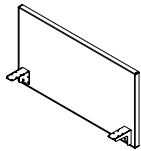

Table Mounted Framed Divider, Fabric*

MODEL#	DIMENSIONS D x W x H	FREIGHT CLASS	WT/LBS.	CUBIC FT.	LIST PRICE
BWATMFD48	1.25 x 33 x 21.5	85	16	1.23	\$460
BWATMFD54	1.25 x 39 x 21.5	85	18	1.46	\$567
BWATMFD60	1.25 x 45 x 21.5	85	20	1.68	\$619
BWATMFD66	1.25 x 51 x 21.5	85	22	1.90	\$695
BWATMFD72	1.25 x 57 x 21.5	85	26	2.13	\$759

Connects parallel on Freefit single and back-to-back tables. Fabric divider is tackable. Fastens to the underside of the worksurface. 1.625" gap between worksurface and divider allows for cable pass-through. Installed divider measures 15.7" from top of worksurface and 5.75" below the worksurface. 48" to 66" dividers include 2 support brackets. 72" divider includes 3 support brackets. Available in the following textiles:

- Global: **Anchorage, Lola, and Merge.**

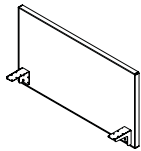

Table Mounted Framed Divider, Laminate**

MODEL#	DIMENSIONS D x W x H	FREIGHT CLASS	WT/LBS.	CUBIC FT.	LIST PRICE	HP ADD	DE ADD	DM ADD
BWATMLD48	1.25 x 33 x 21.5	85	35	1.23	\$302	\$176	\$363	\$553
BWATMLD54	1.25 x 39 x 21.5	85	39	1.46	\$340	\$227	\$452	\$698
BWATMLD60	1.25 x 45 x 21.5	85	44	1.68	\$404	\$240	\$475	\$743
BWATMLD66	1.25 x 51 x 21.5	85	48	1.90	\$465	\$329	\$993	\$1472
BWATMLD72	1.25 x 57 x 21.5	85	52	2.13	\$506	\$332	\$987	\$1463

Connects parallel on Freefit single and back-to-back tables. Divider infill can be specified in low pressure laminate (**LP**), high pressure laminate (**HP**), dry erase whiteboard (**DE**) or dry erase magnetic whiteboard (**DM**) user side only. Fastens to the underside of the worksurface. 1.625" gap between worksurface and divider allows for cable pass-through. Installed divider measures 15.7" from top of worksurface and 5.75" below the worksurface. 48" to 66" dividers include 2 support brackets. 72" divider includes 3 support brackets. When dry erase magnetic whiteboard (DM) is specified it is applied user side ONLY and dry erase whiteboard (DE) is applied on the opposite side.

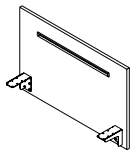

Table Mounted Laminate Divider**

BWATMLLD48	.75 x 33 x 21.5	125	16	1.23	\$362
BWATMLLD54	.75 x 39 x 21.5	125	18	1.46	\$383
BWATMLLD60	.75 x 45 x 21.5	125	20	1.68	\$405
BWATMLLD66	.75 x 51 x 21.5	125	22	1.90	\$598
BWATMLLD72	.75 x 57 x 21.5	125	26	2.13	\$618

Connects parallel on Freefit single and back-to-back tables. Laminate divider with integrated accessory rail, installed on one side only. Integrated anodized aluminum accessory rail, white cut out and rail trims; white power coat brackets. 3/4" LP PVC edged boards. Specify laminate and PVC edge. Fastens to the underside of the worksurface. 1.88" gap between worksurface and divider allows for cable pass-through. Installed divider measures 15.7" from top of worksurface and 5.75" below the worksurface. 48" to 66" dividers include 2 support brackets. 72" divider includes 3 support brackets.

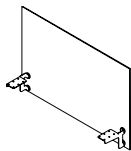

Table Mounted Glass Divider

BWATMGD48	.25 x 33 x 21.5	125	16	1.23	\$772
BWATMGD54	.25 x 39 x 21.5	125	19	1.46	\$830
BWATMGD60	.25 x 45 x 21.5	125	22	1.68	\$889
BWATMGD66	.25 x 51 x 21.5	125	24	1.90	\$942
BWATMGD72	.25 x 57 x 21.5	125	28	2.13	\$1004

Frameless glass divider connects parallel on Freefit single and back-to-back tables. Tempered glass, acid etched on one side (similar to frosted), satin chrome disc fasteners and white powder coated steel support brackets. Fastens to the underside of the worksurface. 2.13" gap between worksurface and divider allows for cable pass-through. Installed divider measures 15.7" from top of worksurface and 4.75" below the worksurface. 48" to 66" dividers include 2 support brackets. 72" divider includes 3 support brackets. 1/2" radius on all four corners.

Required specifications

- Fabric*
- Laminate finish**
- Metal frame finish

STATIONARY DIVIDERS

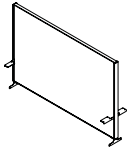

Stationary Framed Divider, Fabric*

MODEL#	DIMENSIONS D x W x H	FREIGHT CLASS	WT./LBS.	CUBIC FT.	LIST PRICE
BWASFD48	1.25 x 33 x 37.2	92.5	25	2.13	\$1003
BWASFD54	1.25 x 39 x 37.2	92.5	28	2.52	\$1022
BWASFD60	1.25 x 45 x 37.2	92.5	31	2.91	\$1055
BWASFD66	1.25 x 51 x 37.2	92.5	34	3.29	\$1121
BWASFD72	1.25 x 57 x 37.2	92.5	37	3.68	\$1432

Provides a stationary framed divider between back-to-back height adjustable tables. Fabric divider is tackable. Divider is anchored to the base and captured between two aluminum upright tracks. The uprights have sliding brackets that connect the worksurfaces to the divider providing continuous support as it travels up and down. 1.625" gap between worksurface and divider allows for cable pass-through. Installed divider measures 54" from floor. Available in the following textiles:

- Global: **Anchorage, Lola, and Merge**

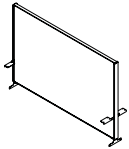

Stationary Framed Divider, Laminate**

MODEL#	DIMENSIONS D x W x H	FREIGHT CLASS	WT./LBS.	CUBIC FT.	LIST PRICE	HP ADD	DE ADD	DM ADD
BWASLD48	2 x 33 x 37.2	65	58	2.13	\$1272	\$432	\$905	\$2369
BWASLD54	2 x 39 x 37.2	65	66	2.52	\$1371	\$463	\$952	\$2490
BWASLD60	2 x 45 x 37.2	65	73	2.91	\$1394	\$464	\$952	\$2492
BWASLD66	2 x 51 x 37.2	65	81	3.29	\$1499	\$518	\$2078	\$5000
BWASLD72	2 x 57 x 37.2	65	88	3.68	\$2048	\$772	\$1997	\$5329

Provides a stationary framed divider between back-to-back height adjustable tables. Divider infill can be specified in low pressure laminate (**LP**), high pressure laminate (**HP**), dry erase whiteboard (**DE**) or dry erase magnetic whiteboard (**DM**) user side only. Divider is anchored to the base and captured between two aluminum upright tracks. The uprights have sliding brackets that connect the worksurfaces to the divider providing continuous support as it travels up and down. 1.625" gap between worksurface and divider allows for cable pass-through. Installed divider measures 54" from floor.

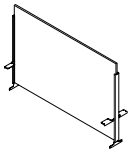

Stationary Laminate Divider**

BWASLLD48	2 x 33 x 37.2	85	28	2.13	\$730
BWASLLD54	2 x 39 x 37.2	85	33	2.52	\$752
BWASLLD60	2 x 45 x 37.2	85	37	2.91	\$773
BWASLLD66	2 x 51 x 37.2	85	41	3.29	\$1170
BWASLLD72	2 x 57 x 37.2	85	46	3.68	\$1193

Provides a stationary laminate divider between back-to-back height adjustable tables. Divider is anchored to the base and captured between two aluminum upright tracks. The uprights have sliding brackets that connect the worksurfaces to the divider providing continuous support as it travels up and down. 1.88" gap between worksurface and divider allows for cable pass-through. Installed divider measures 54" from floor.

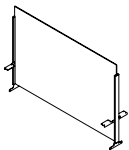

Stationary Glass Divider

BWASGD48	2 x 33 x 37.2	85	30	2.13	\$684
BWASGD54	2 x 39 x 37.2	85	34	2.52	\$778
BWASGD60	2 x 45 x 37.2	85	39	2.91	\$882
BWASGD66	2 x 51 x 37.2	85	43	3.29	\$978
BWASGD72	2 x 57 x 37.2	85	48	3.68	\$1072

Provides a stationary glass divider between back-to-back height adjustable tables. Tempered glass, acid etched on one side (similar to frosted), satin chrome disc fasteners and white powder coated steel support brackets. Divider is anchored to the base and captured between two aluminum upright tracks. The uprights have sliding brackets that connect the worksurfaces to the divider providing continuous support as it travels up and down. 2.13" gap between worksurface and divider allows for cable pass-through. 1/2" radius on top two corners.

Required specifications

- Fabric*
- Laminate finish**
- Metal frame finish

WELLNESS SCREENS- POLYCARBONATE

MODEL# DIMENSIONS FREIGHT CLASS WT/LBS. CUBIC FT. LIST PRICE

D x W x H

FFTDP2436H24	31.75 x 34 x 24.6	125	26.55	3.94	\$1200
FFTDP2442H24	31.75 x 40 x 24.6	125	28.10	4.59	\$1238
FFTDP2448H24	31.75 x 46 x 24.6	150	29.65	5.25	\$1272
FFTDP2454H24	31.75 x 52 x 24.6	150	31.20	5.94	\$1309
FFTDP2460H24	31.75 x 58 x 24.6	150	32.75	6.56	\$1346
FFTDP2466H24	31.75 x 64 x 24.6	150	34.30	7.22	\$1380
FFTDP2472H24	31.75 x 70 x 24.6	150	35.85	7.88	\$1418
FFTDP2478H24	31.75 x 76 x 24.6	150	37.40	8.53	\$1455
FFTDP2484H24	31.75 x 82 x 24.6	150	38.95	9.19	\$1490

FFTDP3036H24	37.75 x 34 x 24.6	100	40.50	4.72	\$1284
FFTDP3042H24	37.75 x 40 x 24.6	125	42.05	5.51	\$1322
FFTDP3048H24	37.75 x 46 x 24.6	125	43.60	6.29	\$1358
FFTDP3054H24	37.75 x 52 x 24.6	125	45.15	7.08	\$1398
FFTDP3060H24	37.75 x 58 x 24.6	150	46.70	7.85	\$1432
FFTDP3066H24	37.75 x 64 x 24.6	150	48.25	8.65	\$1467
FFTDP3072H24	37.75 x 70 x 24.6	150	49.80	9.44	\$1504
FFTDP3078H24	37.75 x 76 x 24.6	150	51.35	10.22	\$1540
FFTDP3084H24	37.75 x 82 x 24.6	150	52.90	11.01	\$1578

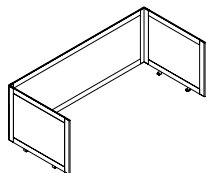

24" H Polycarbonate Divider Screen

Powder coated aluminum frame, translucent ribbed polycarbonate. Includes all hardware to connect. Brackets are painted steel. Side dividers extend 7.25" from the front edge of each surface. Back divider extends over the back edge of the worksurface by 1.5", allowing for cable pass-through to trough. Width and depth are nominal sizes representing the sizes of the FreeFit table. Allow for .25" overhang at the sides, 1.5" at the back, and 7.25" at the front. Frame and hardware available in Black (BLK), Charcoal (CHR), Designer White (DWT), Fog (FOG), Nevada (NEV), Silver (SIL), Taupe (TPE), Tungsten (TUN).

- FFTDP24xxH24 are for configurations with 23" deep surfaces.
- FFTDP30xxH24 are for configurations with 29" deep surfaces.

FFTDP2436H30	31.75 x 34 x 30.6	125	26.55	3.94	\$1346
FFTDP2442H30	31.75 x 40 x 30.6	125	28.10	4.59	\$1389
FFTDP2448H30	31.75 x 46 x 30.6	150	29.65	5.25	\$1432
FFTDP2454H30	31.75 x 52 x 30.6	150	31.20	5.91	\$1472
FFTDP2460H30	31.75 x 58 x 30.6	150	32.75	6.56	\$1515
FFTDP2466H30	31.75 x 64 x 30.6	150	34.30	7.22	\$1555
FFTDP2472H30	31.75 x 70 x 30.6	150	35.85	7.88	\$1598
FFTDP2478H30	31.75 x 76 x 30.6	150	37.40	8.53	\$1638
FFTDP2484H30	31.75 x 82 x 30.6	150	38.95	9.19	\$1681

FFTDP3036H30	37.75 x 34 x 30.6	100	40.50	4.72	\$1428
FFTDP3042H30	37.75 x 40 x 30.6	125	42.05	5.51	\$1472
FFTDP3048H30	37.75 x 46 x 30.6	125	43.60	6.29	\$1514
FFTDP3054H30	37.75 x 52 x 30.6	125	45.15	7.08	\$1552
FFTDP3060H30	37.75 x 58 x 30.6	150	46.70	7.87	\$1594
FFTDP3066H30	37.75 x 64 x 30.6	150	48.25	8.65	\$1637
FFTDP3072H30	37.75 x 70 x 30.6	150	49.80	9.44	\$1676
FFTDP3078H30	37.75 x 76 x 30.6	150	51.35	10.22	\$1720
FFTDP3084H30	37.75 x 82 x 30.6	150	52.90	11.01	\$1763

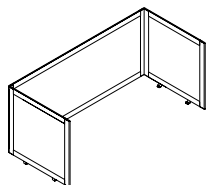

30" H Polycarbonate Divider Screen

Powder coated aluminum frame, translucent ribbed polycarbonate. Includes all hardware to connect. Brackets are painted steel. Side dividers extend 7.25" from the front edge of each surface. Back divider extends over the back edge of the worksurface by 1.5", allowing for cable pass-through to trough. Width and depth are nominal sizes representing the sizes of the FreeFit table. Allow for .25" overhang at the sides, 1.5" at the back, and 7.25" at the front. Frame and hardware available in Black (BLK), Charcoal (CHR), Designer White (DWT), Fog (FOG), Nevada (NEV), Silver (SIL), Taupe (TPE), Tungsten (TUN).

- FFTDP24xxH30 are for configurations with 23" deep surfaces.
- FFTDP30xxH30 are for configurations with 29" deep surfaces.

Required specifications

- Fabric*
- Laminate finish**
- Metal frame finish

WELLNESS SCREENS - GLASS

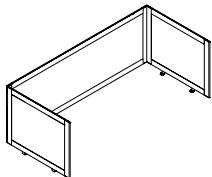

24" H Single Table Glass Divider Screen

MODEL#	DIMENSIONS D x W x H	FREIGHT CLASS	WT./LBS.	CUBIC FT.	LIST PRICE	FRST ADD
FFTDG2436H24	31.50 x 36 x 24.60	125	26.55	3.94	\$1671	\$339
FFTDG2442H24	31.50 x 42 x 24.60	125	28.10	4.59	\$1727	\$347
FFTDG2448H24	31.50 x 48 x 24.60	150	29.65	5.25	\$1783	\$360
FFTDG2454H24	31.50 x 54 x 24.60	150	31.20	5.91	\$1837	\$373
FFTDG2460H24	31.50 x 60 x 24.60	150	32.75	6.56	\$1898	\$382
FFTDG2466H24	31.50 x 66 x 24.60	150	34.30	7.22	\$1948	\$396
FFTDG2472H24	31.50 x 72 x 24.60	150	35.85	7.88	\$2018	\$408
FFTDG2478H24	31.50 x 78 x 24.60	150	37.40	8.53	\$2058	\$417
FFTDG2484H24	31.50 x 84 x 24.60	150	38.95	9.19	\$2112	\$430
FFTDG3036H24	37.75 x 36 x 24.60	100	40.50	4.72	\$1783	\$360
FFTDG3042H24	37.75 x 42 x 24.60	125	42.05	5.51	\$1831	\$368
FFTDG3048H24	37.75 x 48 x 24.60	125	43.60	6.29	\$1886	\$382
FFTDG3054H24	37.75 x 54 x 24.60	150	45.15	7.08	\$1941	\$396
FFTDG3060H24	37.75 x 60 x 24.60	150	46.70	7.87	\$1996	\$403
FFTDG3066H24	37.75 x 66 x 24.60	150	48.25	8.65	\$2058	\$417
FFTDG3072H24	37.75 x 72 x 24.60	150	49.80	9.44	\$2106	\$422
FFTDG3078H24	37.75 x 78 x 24.60	150	51.35	10.22	\$2161	\$436
FFTDG3084H24	37.75 x 84 x 24.60	150	52.90	11.01	\$2218	\$451

Provides privacy in an open plan environment. Easy to clean table mounted partitions. Powder coated aluminum frame with 4mm clear (CLR) glass. Includes all hardware to connect. Brackets are painted steel. Side dividers extend 6.237" from the front edge of each surface. Back divider extends over the back edge of the worksurface by 1.5", allowing for cable pass-through to trough. Width and depth are nominal sizes representing the sizes of the FreeFit table. Allow for .25" overhang at the sides, 1.5" at the back, and 6.237" at the front. Frame and hardware available in Black (**BLK**), Charcoal (**CHR**), Designer White (**DWT**), Fog (**FOG**), Nevada (**NEV**), Silver (**SIL**), Taupe (**TPE**), Tungsten (**TUN**). End trim cap is only available in Charcoal (CHR). **Add 20%** upcharge for frosted glass (**FRST**).

- **FFTDG24xxH24 are for configurations with 24" deep surfaces.**
- **FFTDG30xxH24 are for configurations with 30" deep surfaces.**

Required specifications
Frame finish

Optional specifications
Frosted glass (FRST)

WELLNESS SCREENS - GLASS

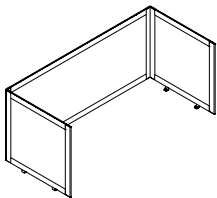

30" H Single Table Glass Divider Screen

MODEL#	DIMENSIONS	FREIGHT CLASS	WT./LBS.	CUBIC FT.	LIST PRICE	FRST ADD
D x W x H						
FFTDG2436H30	31.50 x 36 x 30.60	125	28.85	3.97	\$1755	\$355
FFTDG2442H30	31.50 x 42 x 30.60	125	30.40	4.59	\$1810	\$368
FFTDG2448H30	31.50 x 48 x 30.60	125	31.95	5.25	\$1863	\$373
FFTDG2454H30	31.50 x 54 x 30.60	150	33.50	5.91	\$1926	\$389
FFTDG2460H30	31.50 x 60 x 30.60	150	35.05	6.56	\$1982	\$403
FFTDG2466H30	31.50 x 66 x 30.60	150	36.60	7.22	\$2031	\$408
FFTDG2472H30	31.50 x 72 x 30.60	150	38.15	7.88	\$2072	\$417
FFTDG2478H30	31.50 x 78 x 30.60	150	39.70	8.53	\$2148	\$436
FFTDG2484H30	31.50 x 84 x 30.60	150	41.25	9.19	\$2209	\$444
FFTDG3036H30	37.75 x 36 x 30.60	100	42.80	4.72	\$1863	\$373
FFTDG3042H30	37.75 x 42 x 30.60	100	44.35	5.51	\$1926	\$389
FFTDG3048H30	37.75 x 48 x 30.60	125	45.90	6.29	\$1975	\$403
FFTDG3054H30	37.75 x 54 x 30.60	125	47.45	7.08	\$2031	\$408
FFTDG3060H30	37.75 x 60 x 30.60	125	49	7.87	\$2093	\$422
FFTDG3066H30	37.75 x 66 x 30.60	150	50.55	8.65	\$2148	\$436
FFTDG3072H30	37.75 x 72 x 30.60	150	52.10	9.44	\$2174	\$436
FFTDG3078H30	37.75 x 78 x 30.60	150	53.65	10.22	\$2258	\$457
FFTDG3084H30	37.75 x 84 x 30.60	150	55.20	11.01	\$2314	\$465

Provides privacy in an open plan environment. Easy to clean table mounted partitions. Powder coated aluminum frame with 4mm clear (CLR) glass. Includes all hardware to connect. Brackets are painted steel. Side dividers extend 6.237" from the front edge of each surface. Back divider extends over the back edge of the worksurface by 1.5", allowing for cable pass-through to trough. Width and depth are nominal sizes representing the sizes of the Bridges configuration. Allow for .25" overhang at the sides, 1.5" at the back, and 6.237" at the front. Frame and hardware available in Black (BLK), Charcoal (CHR), Designer White (DWT), Fog (FOG), Nevada (NEV), Silver (SIL), Taupe (TPE), Tungsten (TUN). End trim cap is only available in Charcoal (CHR).

Add 20% upcharge for frosted glass (FRST).

- **FFTDG24xxH30 are for configurations with 24" deep surfaces.**
- **FFTDG30xxH30 are for configurations with 30" deep surfaces.**

Required specifications
Frame finish

Optional specifications
Frosted glass (FRST)

FELT DIVIDER SCREENS

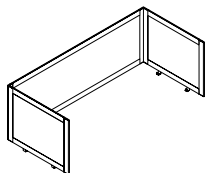

24" H Single Table Felt Divider Screen

MODEL#	DIMENSIONS	FREIGHT CLASS	WT./LBS.	CUBIC FT.	LIST PRICE
D x W x H					
FFTDF2436H24	31.50 x 36 x 24.60	125	22.55	3.94	\$998
FFTDF2442H24	31.50 x 42 x 24.60	125	24.10	4.59	\$1024
FFTDF2448H24	31.50 x 48 x 24.60	150	25.65	5.25	\$1051
FFTDF2454H24	31.50 x 54 x 24.60	150	27.20	5.91	\$1076
FFTDF2460H24	31.50 x 60 x 24.60	150	28.75	6.56	\$1105
FFTDF2466H24	31.50 x 66 x 24.60	150	30.30	7.22	\$1133
FFTDF2472H24	31.50 x 72 x 24.60	150	31.85	7.88	\$1157
FFTDF2478H24	31.50 x 78 x 24.60	150	33.40	8.53	\$1184
FFTDF2484H24	31.50 x 84 x 24.60	150	34.95	9.19	\$1236
FFTDF3036H24	37.75 x 36 x 24.60	100	36.50	4.72	\$1031
FFTDF3042H24	37.75 x 42 x 24.60	125	38.05	5.51	\$1125
FFTDF3048H24	37.75 x 48 x 24.60	125	39.60	6.29	\$1086
FFTDF3054H24	37.75 x 54 x 24.60	150	41.15	7.08	\$1112
FFTDF3060H24	37.75 x 60 x 24.60	150	41.70	7.87	\$1139
FFTDF3066H24	37.75 x 66 x 24.60	150	44.25	8.65	\$1167
FFTDF3072H24	37.75 x 72 x 24.60	150	45.80	9.44	\$1190
FFTDF3078H24	37.75 x 78 x 24.60	150	47.35	10.22	\$1217
FFTDF3084H24	37.75 x 84 x 24.60	150	48.90	11.01	\$1271

Provides privacy in an open plan environment. Powder coated aluminum frame with 9mm felt. Includes all hardware to connect. Brackets are painted steel. Side dividers extend 6.237" from the front edge of each surface. Back divider extends over the back edge of the worksurface by 1.5", allowing for cable pass-through to trough. Width and depth are nominal sizes representing the sizes of the FreeFit table. Allow for .25" overhang at the sides, 1.5" at the back, and 6.237" at the front. Frame and hardware available in Black (BLK), Charcoal (CHR), Designer White (DWT), Fog (FOG), Nevada (NEV), Silver (SIL), Taupe (TPE), Tungsten (TUN). End trim cap is only available in Charcoal (CHR). 9mm PET felt material is tackable and available in 9 colors.

- FFTDF24xxH24 are for configurations with 24" deep surfaces.
- FFTDF30xxH24 are for configurations with 30" deep surfaces.

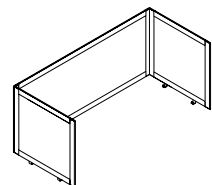

30" H Single Table Felt Divider Screen

FFTDF2436H30	31.50 x 36 x 30.60	125	24.85	3.97	\$991
FFTDF2442H30	31.50 x 42 x 30.60	125	26.40	4.59	\$1017
FFTDF2448H30	31.50 x 48 x 30.60	125	27.95	5.25	\$1040
FFTDF2454H30	31.50 x 54 x 30.60	150	29.50	5.91	\$1064
FFTDF2460H30	31.50 x 60 x 30.60	150	31.05	6.56	\$1089
FFTDF2466H30	31.50 x 66 x 30.60	150	32.60	7.22	\$1113
FFTDF2472H30	31.50 x 72 x 30.60	150	34.14	7.88	\$1139
FFTDF2478H30	31.50 x 78 x 30.60	150	34.70	8.53	\$1163
FFTDF2484H30	31.50 x 84 x 30.60	150	37.25	9.19	\$1222
FFTDF3036H30	37.75 x 36 x 30.60	100	38.80	4.72	\$1039
FFTDF3042H30	37.75 x 42 x 30.60	100	40.35	5.51	\$1063
FFTDF3048H30	37.75 x 48 x 30.60	125	41.90	6.29	\$1088
FFTDF3054H30	37.75 x 54 x 30.60	125	43.45	7.08	\$1112
FFTDF3060H30	37.75 x 60 x 30.60	125	45	7.87	\$1139
FFTDF3066H30	37.75 x 66 x 30.60	150	46.55	8.65	\$1163
FFTDF3072H30	37.75 x 72 x 30.60	150	48.10	9.44	\$1187
FFTDF3078H30	37.75 x 78 x 30.60	150	49.65	10.22	\$1211
FFTDF3084H30	37.75 x 84 x 30.60	150	51.20	11.01	\$1269

Provides privacy in an open plan environment. Powder coated aluminum frame with 9mm felt. Includes all hardware to connect. Brackets are painted steel. Side dividers extend 6.237" from the front edge of each surface. Back divider extends over the back edge of the worksurface by 1.5", allowing for cable pass-through to trough. Width and depth are nominal sizes representing the sizes of the Bridges configuration. Allow for .25" overhang at the sides, 1.5" at the back, and 6.237" at the front. Frame and hardware available in Black (BLK), Charcoal (CHR), Designer White (DWT), Fog (FOG), Nevada (NEV), Silver (SIL), Taupe (TPE), Tungsten (TUN). End trim cap is only available in Charcoal (CHR). 9mm PET felt material is tackable and available in 9 colors.

- FFTDF24xxH30 are for configurations with 24" deep surfaces.
- FFTDF30xxH30 are for configurations with 30" deep surfaces.

Required Specifications

Frame finish
Felt finish



Designed by Zoey Chu, **JUNCTION™** provides an affordable solution for boardroom, classroom and presentation room applications. Offered in 20", 24" and 30" depths and a variety of table top shapes to create unique configurations.

A freestanding or shared leg configuration with the unique "Y" leg allows you to either create a permanent table or one that can be reconfigured quickly and easily. A straight leg is available for use with half round and keystone tops.

Shared leg configurations allow more legroom and can also decrease cost because they use fewer components. Freestanding configurations provide more flexibility for changing environments.

Features and Benefits

- Tops are 1" thick and constructed of 45 lb. density particleboard.
- Optional Radius Corners (RM) available at no upcharge.
- Optional modesty panel with integrated wire trough available.
- Casters available with or without manual locks provide mobility.
- Black grommets for convenient wire management can be ordered factory installed.
- Optional, easy-to-use thumbscrews allow installation without tools.
- JUNCTION™ tops are available in Global laminate finishes with 2 leg options.



Y Leg Design



Modesty Panel



Shared leg configuration provides more legroom and decreases the overall costs

GENERAL INFORMATION

- Junction is a series of multi-purpose tables for classroom, training room and boardroom applications
- Ability for tables to be set up as freestanding or shared leg configuration
- Unique design by Zooey Chu
- Half round, trapezoid and Keystone tops are available to create a variety of configurations
- Rectangular tops are available in 20", 24" and 30" depths
- Optional modesty panels with integrated wire troughs are available for use with rectangular tops
- Optional large electrical manager provides a safe environment for equipment wires
- Special width tops are available. Use next size up.
- Shipped R.T.A. (Ready to Assemble). Each component is packaged individually; Legs are shipped one per carton.
- For environmental certifications, please visit globalfurnituregroup.com

WORKSURFACES

- Tops are 1" thick, made of 45 lb. density particle board covered on both sides with high performance thermally fused laminate.
- Laminate finishes are available in High Pressure. Contact Customer care for a quote.
- If other than a Global standard laminate finish is preferred, contact Customer Care. Information needed includes the name of the laminate manufacturer, color name, number and model of table. You will then be given a quote for this special order.
- Products specified with the high pressure laminate option are finished on the underside of the surface with a kraft paper backing.

CONSTRUCTION

- Rectangular tops 54" in length and longer include a steel support channel for structural rigidity
- Tops are pre-drilled with threaded steel inserts
- Special width tops are available. Use next size up.
- Adjustable levelers offer up to 1" adjustability.

EDGE DETAIL

- Tops are sealed with Global's preferred edge in matching color.
- Optional Radius corners (**RM**) are available on rectangular tops at no upcharge.

LEGS

- Unique Y design
- Straight leg available for assembly with Half Round tops and Keystone tops
- Heavy duty steel construction
- Coated with environmentally friendly recycled paint that provides a durable finish
- Black plastic leveling glides offer 5/8" adjustability
- Available in Black (**TBL**), Cloud (**TIV**), Designer White (**TDW**), Fog (**TFO**), Frost (**TFR**), Kalua (**TKA**), Latte (**TLA**), Mocha (**TMO**), Nevada (**TNE**), Sand (**TSN**), Shadow (**TSH**), Toast (**TOA**) or Tungsten (**TTU**) finish.
- Y Legs: 17.5" leg span - 20"D top, 21.5" leg span - 24"D top, 24.5" leg span - 30"D top.

CASTERS

- Optional casters are available
- 1½" Dual wheel casters with or without manual lock. Full 360° swivel.
- Can be used in any combination with or without standard glides
- Suggested for carpeted surfaces
- Available in Black only
- Sold in packages of two

GANGING

- Ganging plates are available for ganging workstations together
- Ganging plates are black epoxy coated steel plates with two thumbscrews
- Provides maximum stability and torque reduction

FLUSH PLATE

- Suggested for top clusters (fixed configurations for additional stability)
- Sold individually and shipped with two thumbscrews for mounting
- No tools required
- Flush plate allows for ganging together of two or more tops

WIRE MANAGEMENT

- Available for managing additional larger wires and power connectors
- 3½" high x 4¼" deep Black PVC channel attaches to the underside of top

1. SPECIFY MODEL NUMBER

2. SPECIFY FINISH

Laminate Finishes:

ACJ	Absolute Acajou	NBL	Noce Biondo
ASN	Asian Night	NGL	Noce Grigio
AWC	Avant Cherry	NEL	Noce Leggero
AWH	Avant Honey	NML	Noce Medio
BLK	Black	QTM	Quartered Mahogany
BZD	Blizzard	SBY	Sheer Beauty
BRC	Brushed Cobalt	SDT	Stonedust
CMB	Clear Maple	SOG	Storm Grey
CGY	Custom Grey	WHE	Walnut Heights
DES	Dark Espresso	WHC	White Chocolate
DWT	Designer White	WCR	Winter Cherry
FAS	Fashionista		
FCL	First Class		

Legs:

TBL	Black
TIV	Cloud
TDW	Designer White
TFO	Fog
TFR	Frost
TKA	Kalua
TLA	Latte
TMO	Mocha
TNE	Nevada
TSN	Sand
TSH	Shadow
TOA	Toast
TTU	Tungsten

3. SPECIFY OPTIONS

MODESTY PANELS

- 11¼" high panel attaches to the underside of rectangular tops
- Standard with integrated wire trough
- Available in black PVC

GROMMETS

- Grommets are available in **Rectangular and Trapezoid** Tops (left, center or right). See below for available locations. Order as: **AG1, AG2 or AG3. Add \$103.** For **Keystone** worksurface locations, order as **AG2. Add \$103.**
- Grommet hole dimensions are 3 ¾" wide x 1 7/8" deep.

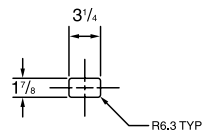

- Grommets may be placed at non-standard locations. Order as: **AGS - Add \$103.** A drawing must be supplied with vertical and horizontal dimensions to the center of the cut-out (as in drawing above). Please refer to CUSTOM GROMMET LOCATION FORM in the back reference section.

POWER BLOCK

- A Power Block (model **PMSPDM**) may be ordered on all worksurfaces.
- A Power Block is a rectangular worksurface power/data module with one electrical duplex receptacle and two data (RJ45) receptacles. 9' black cord included. Power Block dimensions are 3 ½" deep x 6 ½" wide x 2 ¾" high.
- To purchase a Power Block, you must specify both the Power Block cut-out location and the Power Block model #. Order Power Block as **PMSPDM, ADD \$352.** Power Blocks are available in standard worksurface locations (left, center or right). Order as **E1, E2 or E3. Add \$103.**



Power Block **PMSPDM, Add \$352**

EXAMPLES OF GROMMET AND POWER BLOCK POSITIONS

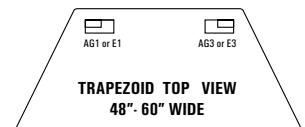
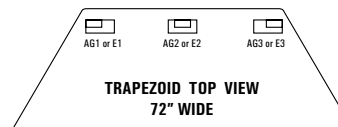
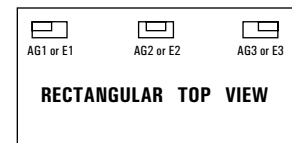
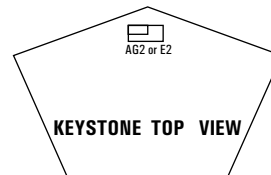

VILLA CUT-OUTS

- Optional Villa cut-out available in standard worksurface locations (left, center or right) for **Rectangular Tables.** Order as: **V1, V2 or V3. Add \$103 for each cut-out.**
- Villa cut-outs may be placed at non-standard locations. Please contact customer care.

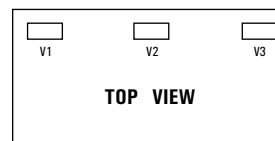

MODPOWER DAISY CHAIN SOLUTION

- Add flexible power and USB charging to Junction rectangular tables. Connect up to four units with a single corded infeed with NEMA plug.
- ModPower units are sold separately, refer to Productivity Solutions page 609.
- Begin run with a starter unit which includes a corded infeed. Add additional middle or end units as required. Middle and end units are equipped with connecting cables.
- On-surface modules clamp on or screw mount to the table tops.
- In-surface modules require table top cut-outs for mounting. Specify cut-out option:
 - **MPS** for a single cut-out to accommodate one ModPower in-surface unit (cut-out will be centered on the approach side) for **30" to 72" wide rectangular tables. Add \$103**
 - **MPD** for two cut-outs in the left and right positions, 18.25" from ends to center of unit on approach side for **60", 66" and 72" wide rectangular tables. Add \$204.**

RECTANGULAR TOPS

MODEL# DIMENSIONS FREIGHT CLASS WT/LBS. CUBIC FT. LIST PRICE

D x W x H

JNR2042	20 x 42 x 1	65	26	1.1	\$396
JNR2048	20 x 48 x 1	65	29	1.15	\$441
JNRU2054	20 x 54 x 1	65	33	1.3	\$547
JNRU2060	20 x 60 x 1	65	37	1.4	\$588
JNRU2066	20 x 66 x 1	65	41	1.55	\$635
JNRU2072	20 x 72 x 1	65	45	1.66	\$678
JNR2442	24 x 42 x 1	65	31	1.25	\$396
JNR2448	24 x 48 x 1	65	35	1.4	\$441
JNRU2454	24 x 54 x 1	65	42	1.52	\$547
JNRU2460	24 x 60 x 1	65	47	1.67	\$588
JNRU2466	24 x 66 x 1	65	52	1.82	\$635
JNRU2472	24 x 72 x 1	65	57	2	\$678
JNR3042	30 x 42 x 1	65	38	1.51	\$481
JNR3048	30 x 48 x 1	65	44	1.7	\$506
JNRU3054	30 x 54 x 1	65	52	1.9	\$629
JNRU3060	30 x 60 x 1	65	59	2.1	\$675
JNRU3066	30 x 66 x 1	65	64	2.26	\$722
JNRU3072	30 x 72 x 1	65	70	2.5	\$768

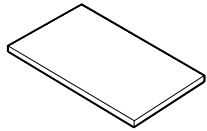

Rectangular Top

Pre-drilled with threaded steel inserts for freestanding and linking installations. **Tops 54" and longer are standard with a 16 gauge steel support channel.**

HALF ROUND TOPS

MODEL # DIMENSIONS FREIGHT CLASS WT/LB. CUBIC FT. LIST PRICE

JNHFS2040	20 x 40 x 1	70	23	1.05	\$419
JNHFS2048	20 x 48 x 1	65	27.5	1.15	\$434
JNHFS2448	24 x 48 x 1	65	34	1.4	\$466
JNHFS2454	27 x 54 x 1	65	38.25	1.52	\$550
JNHFS3060	30 x 60 x 1	60	53	1.67	\$603
JNHFS3066	33 x 66 x 1	60	58.3	1.82	\$755

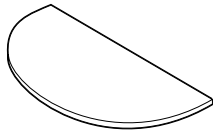

Half Round Top

Pre-drilled with threaded steel inserts for freestanding and linking installations. Four legs are required for freestanding configurations.

- **JNHFS2040/JNHFS2048** for use with 20" deep joining edge
- **JNHFS2448/JNHFS2454** for use with 24" deep joining edge
- **JNHFS3060/JNHFS3066** for use with 30" deep joining edge

TRAPEZOID TOPS

MODEL # DIMENSIONS FREIGHT CLASS WT/LB. CUBIC FT. LIST PRICE

JNTT2048	15.25 x 48 x 1	65	27.5	1.15	\$409
JNTT2060	15.25 x 60 x 1	65	34	1.4	\$486
JNTT2448	20.5 x 48 x 1	65	33	1.4	\$463
JNTT2460	20.5 x 60 x 1	65	41.25	1.67	\$556
JNTT3060	25.75 x 60 x 1	65	50.5	2.1	\$608
JNTT3072	25.75 x 72 x 1	65	61	2.5	\$678

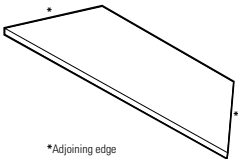

*Adjoining edge

Trapezoid Top

Pre-drilled with threaded steel inserts for linking installations. **Not freestanding.**

- **JNTT2048/JNTT2060** for use with 20" deep joining edge
- **JNTT2448/JNTT2460** for use with 24" deep joining edge
- **JNTT3060/JNTT3072** for use with 30" deep joining edge

Required Specifications
Finish

Optional Specifications
Grommet

Accessories
Power Block

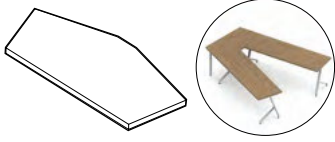
KEYSTONE TOPS	MODEL#	DIMENSIONS	FREIGHT CLASS	WT/LBS.	CUBIC FT.	LIST PRICE
		D x W x H				
	JN5S2424	24 x 42 x 1	65	35	1.4	\$472
	JN5S3030	30 x 54 x 1	65	53	2.1	\$603

Keystone Top

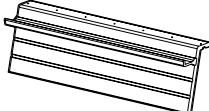

Pre-drilled with threaded steel inserts for linking installations. **Keystone shape is for V configurations/shared applications only; not intended for freestanding applications.**

- **JN5S2424** for use with 24" deep joining edge
- **JN5S3030** for use with 30" deep joining edge

MODESTY PANELS	MODEL #	DIMENSIONS	FREIGHT CLASS	WT/LB.	CUBIC FT.	LIST PRICE
	JNMP42	6.92 x 29.19 x 11.25	250	3.7	1.5	\$327
	JNMP48	6.92 x 35.19 x 11.25	250	4.5	1.75	\$367
	JNMP54	6.92 x 41.19 x 11.25	250	5	2	\$411
	JNMP60	6.92 x 47.19 x 11.25	250	5.9	2.25	\$451
	JNMP66	6.92 x 53.19 x 11.25	250	6.6	2.5	\$483
	JNMP72	6.92 x 59.19 x 11.25	250	7.4	2.75	\$524

Modesty Panel





For use with **JNR rectangular tops**. 11 1/4" high, Black plastic, attractive ribbed design. Includes integrated wire trough. Connects to predrilled holes in table top.

WIRE MANAGEMENT	MODEL #	DIMENSIONS	FREIGHT CLASS	WT/LB.	CUBIC FT.	LIST PRICE
	JNEC5S	4.14 x 12.5 x 3.63	70	1	0.1	\$89
	<p>For use with JN5S Keystone Tops. For managing additional wires and power connectors. 3/2"H Black PVC channel connects to predrilled holes in table top.</p>					
	JNEC42	4.14 x 41.75 x 3.63	125	2.52	0.33	\$208
	JNEC48	4.14 x 47.75 x 3.63	125	2.88	0.38	\$241
	JNEC54	4.14 x 53.75 x 3.63	125	3.24	0.43	\$273
	JNEC60	4.14 x 59.75 x 3.63	125	3.6	0.48	\$302
	JNEC66	4.14 x 65.75 x 3.63	125	3.96	0.53	\$316
	JNEC72	4.14 x 71.75 x 3.63	125	4.32	0.58	\$411
	<p>For use with JNR Rectangular Tops. For managing additional wires and power connectors. 3/2"H Black PVC channel connects to predrilled holes in the table top.</p>					

Required Specifications
Finish

Optional Specifications
Grommet

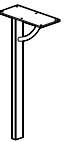
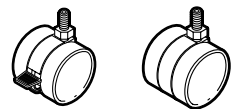
Accessories
Power Block

LEGS	MODEL#	DIMENSIONS D x W x H	FREIGHT CLASS	WT./LBS.	CUBIC FT.	LIST PRICE
 "Y" Leg	GJNLEG20	17.25 x 2 x 27.5	150	8.5	2	\$314
<p>Leg span is 17½". Leveling glides are standard. For assembly with 20" deep tops</p> <ul style="list-style-type: none"> List price is per each leg. See 767 for available finishes. 						
 "Y" Leg	GJNLEG24	21.5 x 2 x 27.5	150	10	2.5	\$314
<p>Leg span is 21½". Leveling glides are standard. For assembly with 24" deep tops</p> <ul style="list-style-type: none"> List Price is per each leg. See 767 for available finishes. 						
 "Y" Leg	GJNLEG30	24.5 x 2 x 27.5	250	11	2.85	\$338
<p>Leg span is 24½". Leveling glides are standard. For assembly with 30" deep tops</p> <ul style="list-style-type: none"> List Price is per each leg. See 767 for available finishes. 						
 Straight Leg	JNLEG	1 x 2 x 27.3	150	6	1.3	\$277
<p>Leveling glides are standard. For assembly with half round and keystone tops. Mounting plate is 11" deep by 5" wide.</p> <ul style="list-style-type: none"> List Price is per each leg. See 767 for available finishes. 						
 Casters	JNCP	--	--	--	--	\$68
<p>Set of (2) 1½" dual wheel casters, one locking. Suggested for carpeted surfaces. Casters are fully interchangeable with glides. Black only.</p> <ul style="list-style-type: none"> For use with Junction units only Casters DO NOT affect table height 						
 Thumbscrews	JNTS	--	--	--	--	\$39
<p>Triangular thumbscrew with ¾" steel thread. Set of 4. Can be used in place of factory supplied screws to allow installation of "Y" legs to tops without tools. Black only.</p>						

Required Specifications
Finish

Optional Specifications
Grommet (Keystone)

Accessories
Power Block (Keystone)

ACCESSORIES **MODEL#** **DIMENSIONS** **FREIGHT CLASS** **WT./LBS.** **CUBIC FT.** **LIST PRICE**

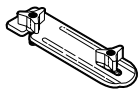

Ganging Flush Plate

	D x W x H					
JNGFP	--	--	--	--	--	\$71

Black epoxy coated steel plates with 2 thumbscrews included. Used to connect table tops together for additional stability or for connecting freestanding tops together. Holes with steel inserts are located in the corner of the tops to accommodate this plate. Sold individually.

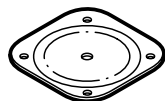

Flush Plate

JNFP1	5.25 d x 5.25 w	--	--	--	--	\$39
JNFP4	5.25 d x 5.25 w	--	--	--	--	\$142

Assures alignment on adjoining worksurfaces of the same height. Bolts included. Available in Black only.

JNFP1 - 1 per carton.

JNFP4 - 4 per carton.

Required Specifications
Finish



Kadin adds modern flair to your meeting space. From formal conference rooms to intimate meeting spaces or open forums, Kadin fits wherever people meet. Choose from round, square or rectangular tops in a variety of sizes with multiple edge options. Table depths start at 36", available widths are almost limitless. Surfaces are offered in architectural grade veneer and high-pressure laminate. The beautifully sculpted leg support maximizes leg clearance to keep guests comfortable. Extending from the leg support, the beam structure and connectors create visual interest as people come together. Pre-configured base assemblies make it easy to specify.

Features and Benefits

- Constructed of 45lb. density particleboard with high pressure laminate or grade A veneers
- 3 top shapes
- Solid die-cast aluminum leg with adjustable glide
- 5 edge options
- Metal bases available in 8 finishes
- Beam available in 7 finishes to match leg



90° connector



60° connector (for three leg tables only)



Beam construction

GENERAL INFORMATION

- Laminate or veneer tops with multiple edge options
- Three top shapes - round, square, rectangular
- Pre-configured assemblies make specifying easy
- Kadin pairs perfectly with storage from a number of Global desking series
- For environmental certifications, please visit globalfurnituregroup.com

**TABLES WITH LAMINATE TOPS:
CONSTRUCTION**

- Constructed of 45 lb. density particleboard with high pressure laminate
- Tables are pre-drilled with factory installed inserts for easy metal-to-metal base connection
- Solid die-cast aluminum leg with adjustable glide

WORKSURFACES

- Available in 1-1/16" or 1-7/16" high pressure laminate or ultra matte high pressure laminate (**UML**) tops with a 3mm PVC edge or 1-3/16" high pressure laminate top with a 3mm PVC edge trim.
- Laminate surfaces offer a selection of matching + coordinating edge band, specify separately from the surface finish
- Tables up to and including 96" long are manufactured in one piece, 108" to 180" long are manufactured in two pieces, and over 192" are manufactured in three pieces. *If woodgrain laminate is chosen, the woodgrain pattern may not line up.*
- Tables in two or three pieces will have the joining edge finished; hardware will be shipped for assembly
- Products specified with the high pressure laminate option are finished on the underside of the surface with a kraft paper backing.

EDGES

- Tables with **B** Edge are 1-1/16" thick and have a 3mm PVC edge
- Tables with a **W** Edge are 1-7/16" thick and have a 3mm PVC edge
- Tables with a **KL** edge are 1-3/16" thick with a 3mm PVC edge and a 2" undercut knife profile
- Square and Rectangular Tables with a **B** or **W** edge have a 1" radius at each corner. For 90° corners, please add **NR** at the end of the product code. No upcharge.
- Square and Rectangular tables with a **KL** edge have 90° corners. There is no radius corner option for the KL edge.

GROMMETS

- Grommets available in standard table top locations (left, center or right).
Order as: **AG1, AG2 or AG3. Add \$103**
- Grommet hole dimensions are 3 1/4" wide x 1 7/8" deep.

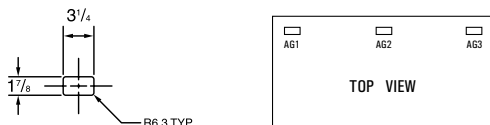

- Actual grommet locations will vary according to base selection.

WIRE MANAGEMENT

- For vertical and horizontal wire management, please refer to wire management section below, or Productivity Solutions on page 474.

CUT-OUTS FOR POWER BLOCKS

- Optional cut-out available in standard worksurface locations (left, center or right) for all table shapes. **Add \$103 for each cut-out.**
- Cut-outs may be placed at non-standard locations. Please contact customer care.
- Match power block desired with cut-out code and location from above grid
- Power module cut-out locations are not available on all models – please see diagrams to the right for restrictions.

***Oasis Mini** is not available on 36"D models due to space restrictions caused by beam placement. **Only available on 60" square and 60" round 4-leg tables.**

**TABLES WITH VENEER TOPS:
CONSTRUCTION**

- Constructed of 45 lb. density particleboard with grade A veneers
- Tables are pre-drilled with factory installed inserts for easy metal-to-metal base connection
- Solid die-cast aluminum leg with adjustable glide

WORKSURFACES

- 1-3/16" thick veneer tops with choice of edge.
- Tables up to and including 96" long are manufactured in one piece, 108" to 180" long are manufactured in two pieces, and over 192" are manufactured in three pieces.
- Veneer wood grain will run with the **length** of the table and align at the seam up to 180"
- Veneer wood grain will run with the **depth** of the table (i.e. cross grain) on tables 192" and up.
- Tables in two or three pieces will have the joining edge finished; hardware will be shipped for assembly

EDGES

- Tables with a **FV** edge are 1-3/16" thick with a flat 3mm hardwood edge, stained to match to veneer.
- Tables with a **KV** edge are 1-3/16" thick with a flat 3mm hardwood edge and 2" undercut knife edge profile.
- Square and Rectangular Tables with the **FV** and **KV** edge have 90° corners. There is no radius corner option.

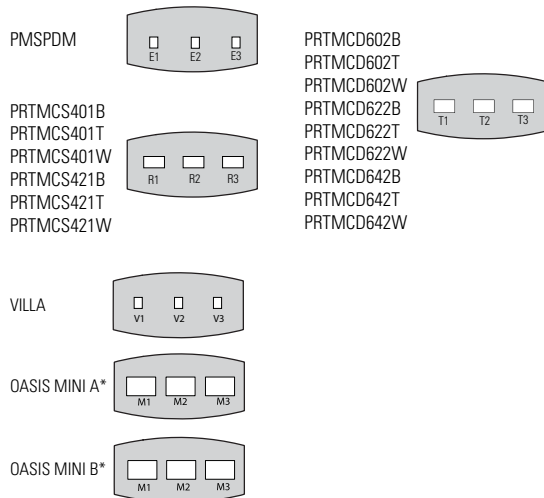

1. SPECIFY MODEL NUMBER

2. SPECIFY FINISH

LAMINATE FINISHES

• Ultra matte high pressure laminate (**UML**) available in select finishes* only.

ACJ Absolute Acajou	FCL First Class
ASN Asian Night	NBL Noce Biondo
AWC Avant Cherry	NGL Noce Grigio
AWH Avant Honey	NEL Noce Leggero
BLK Black*	NML Noce Medio
BZD Blizzard*	QTM Quartered Mahogany
BRC Brushed Cobalt	SBY Sheer Beauty
CMB Clear Maple	SDT Stonedust*
CGY Custom Grey*†	SOG Storm Grey* ††
DES Dark Espresso	WHE Walnut Heights
DWT Designer White*	WHC White Chocolate
FAS Fashionista	WCR Winter Cherry

†Coordinates w/SIL edgeband finish ††Coordinates w/CHR edgeband finish

LEG FINISHES

CHM Chrome	BLK Black
CHR Charcoal	BZD Blizzard*
DWT Designer White	NEV Nevada
SIL Silver	SDT Stonedust*
TPE Taupe	TUN Tungsten

*textured finish

BEAM FINISHES

BLK Black	CHR Charcoal
DWT Designer White	NEV Nevada
SIL Silver	TPE Taupe
TUN Tungsten	

VENEER FINISHES:

Code	Finish	Veneer Type	Cut
AMW	Almond Cherry	Cherry	Flat Sliced
ACW	Amber Cherry	Cherry	Flat Sliced
BTW	Biscotti	White Oak	Rift
CAW	Cocoa Walnut	Walnut	Flat Sliced
CRW	Coral	White Oak	Rift
DCW	Dark Cherry	Cherry	Flat Sliced
DWW	Dark Walnut	Walnut	Flat Sliced
EWV	Espresso Walnut	Walnut	Flat Sliced
EVW	Evening Oak	White Oak	Rift
GRW	Grey on Oak	White Oak	Rift
HAW	Hazelnut	Maple	Flat Sliced
JAW	Java	White Oak	Rift
LTW	Latte Walnut	Walnut	Flat Sliced
MHW	Mahogany on Walnut	Walnut	Flat Sliced
MTW	Milestone	White Oak	Rift
MPW	Natural Maple	Maple	Flat Sliced
NLW	Natural Walnut	Walnut	Flat Sliced
RCW	Red Cherry	Cherry	Flat Sliced
ULW	Umber Walnut	Walnut	Flat Sliced

EDGE FINISHES (Laminate Surfaces Only)

AAE Absolute Acajou	NBL Noce Biondo
ASE Asian Night	NGL Noce Grigio
ACE Avant Cherry	NEL Noce Leggero
AHE Avant Honey	NML Noce Medio
BLK Black	QTM Quartered Mahogany
BZD Blizzard	SBY Sheer Beauty
BRC Brushed Cobalt	SIL Silver (use w/CGY)
CHR Charcoal (use w/SOG)	SDT Stonedust
CME Clear Maple	TPE Taupe
DEE Dark Espresso	WHE Walnut Heights
DWE Designer White	CBE White Chocolate
FAS Fashionista	WCE Winter Cherry
FCL First Class	

3. SPECIFY OPTIONS

Edge Options:

"B" Edges

Laminate surface with PVC edge

HP (**B**) 1-1/16" thick
UM (**BUM**) 1-1/16" thick



"W" Edges

Laminate surface with PVC edge

HP (**W**) 1-7/16" thick
UM (**WUM**) 1-7/16" thick



"KL" Edges

Laminate surface with PVC edge

HP (**KL**) 1-3/16" thick
UM (**KLUM**) 1-3/16" thick



"FV" Edges

Veneer surface with Hardwood edge

(**FV**) 1-3/16" thick



"KV" Edges

Veneer surface with Hardwood edge

(**KV**) 1-3/16" thick

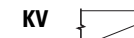

CUT-OUT LOCATIONS:

Square Table - position 2 only

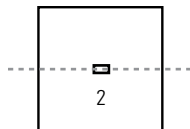

Round Table - position 2 only

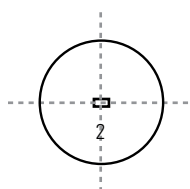

Rectangular Table

- Cut-out only in position 2: LKD3648, LKD3654, LKD4248, LKD4254, LKD4854
- One cut-out choice only (position 1, 2 or 3): LKD3660, LKD3666, LKD3672, LKD4260, LKD4266, LKD4272
- Up to 3 cut-outs in position 1, 2 and/or 3: LKD3678, LKD3684, LKD3696, LKD4278, LKD4284, LKD4296, LKD4878, LKD4884, LKD4896

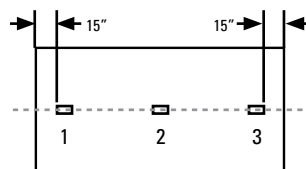

Rectangular Table - 2 piece top

- Up to 2 cut-outs in position 1 and/or 3 - all sizes

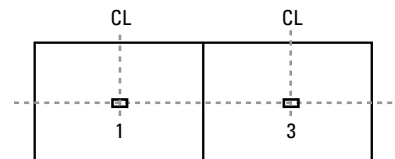

Rectangular Table - 3 piece top

- Up to 3 cut-outs in position 1, 2 and/or 3 - all sizes

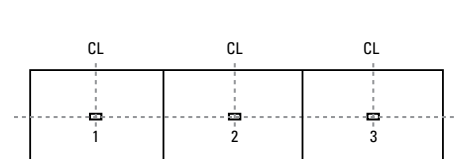

Note: Grommet orientation follows the length of table.

SQUARE TABLES - LAMINATE

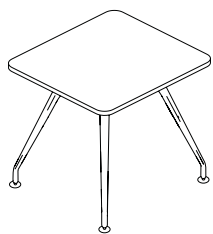

Square Table - Laminate Top*

MODEL#	DIMENSIONS	FREIGHT CLASS	WT/LBS.	CUBIC FT.	B EDGE	BUM EDGE	W EDGE	WUM EDGE	KLEGE	KLUM EDGE
D x W x H										
LKD3636	36 x 36 x 29-29.5	100	73	4	\$1943	\$2180	\$2183	\$2577	\$2263	\$2664
LKD4242	42 x 42 x 29-29.5	100	86	4	\$2323	\$2611	\$2551	\$2994	\$2743	\$3206
LKD4848	48 x 48 x 29-29.5	92.5	107	5	\$2727	\$3126	\$3005	\$3588	\$3192	\$3842
LKD5454	54 x 54 x 29-29.5	85	120	5	\$3003	\$3539	\$3341	\$4108	\$3822	\$4667
LKD6060	60 x 60 x 29-29.5	92.5	135	6	\$3309	\$3996	\$3713	\$4678	\$4373	\$5446

Tops feature 3mm pvc edge and metal inserts for ease of assembly to base. Also includes four legs, four 90-degree connectors and four leg beams.

SQUARE TABLES - VENEER

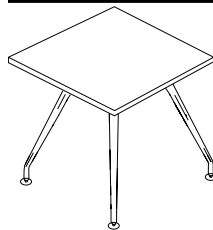

Square Table - Veneer Top

MODEL #	DIMENSIONS	FREIGHT CLASS	WT/LBS.	CUBIC FT.	FV EDGE	KV EDGE
LKD3636K	36 x 36 x 29-29.5	100	73	4	\$2694	\$2790
LKD4242K	42 x 42 x 29-29.5	92.5	86	4	\$3208	\$3337
LKD4848K	48 x 48 x 29-29.5	92.5	107	5	\$3800	\$3969
LKD5454K	54 x 54 x 29-29.5	85	120	5	\$4602	\$4812
LKD6060K	60 x 60 x 29-29.5	92.5	135	6	\$5341	\$5599

Tops feature hardwood edge and metal inserts for ease of assembly to base. Also includes four legs, four 90-degree connectors and four leg beams.

SQUARE TABLES - LAMINATE

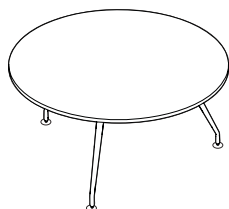

Round Table - 3 Legs*

MODEL#	DIMENSIONS	FREIGHT CLASS	WT/LBS.	CUBIC FT.	B EDGE	BUM EDGE	W EDGE	WUM EDGE	KLEGE	KLUM EDGE
LKD36DIA	36 x 36 x 29-29.5	92.5	66	3	\$1566	\$1835	\$1813	\$2244	\$2111	\$2527
LKD42DIA	42 x 42 x 29-29.5	85	78	3	\$1931	\$2278	\$2162	\$2662	\$2697	\$3178
LKD48DIA	48 x 48 x 29-29.5	85	99	4	\$2292	\$2753	\$2579	\$3239	\$3274	\$3928
LKD54DIA	54 x 54 x 29-29.5	85	111	4	\$2569	\$3172	\$2916	\$3757	\$4003	\$4847
LKD60DIA	60 x 60 x 29-29.5	85	126	5	\$2870	\$3634	\$3285	\$4335	\$4718	\$5776

Tops feature 3mm pvc edge and metal inserts for ease of assembly to base. Also includes three legs, three 60-degree connectors and three leg beams.

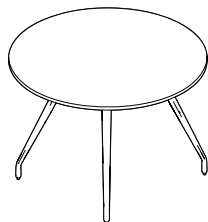

Round Table - 4 Legs*

LKD436DIA	36 x 36 x 29-29.5	100	66	3	\$2036	\$2188	\$2276	\$2590	\$2453	\$2769
LKD442DIA	42 x 42 x 29-29.5	92.5	78	3	\$2323	\$2630	\$2551	\$3013	\$2974	\$3524
LKD448DIA	48 x 48 x 29-29.5	92.5	99	4	\$2727	\$3143	\$3005	\$3619	\$3606	\$4218
LKD454DIA	54 x 54 x 29-29.5	85	111	4	\$3003	\$3563	\$3341	\$4142	\$4264	\$5072
LKD460DIA	60 x 60 x 29-29.5	92.5	126	5	\$3309	\$4029	\$3713	\$4719	\$5006	\$6026

Tops feature 3mm pvc edge and metal inserts for ease of assembly to base. Also includes four legs, four 90-degree connectors and four leg beams.

Required Specifications

Top Finish
Leg Finish
Edge Finish*
Edge Style

Optional Specifications

Grommet

Accessories

Power Block

ROUND TABLES - VENEER

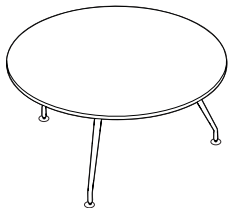

Round Table - 3 Legs

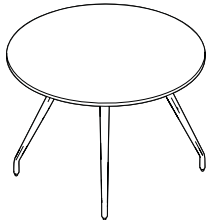

Round Table - 4 Legs

MODEL# DIMENSIONS FREIGHT CLASS WT/LBS. CUBIC FT. FV EDGE KV EDGE

	D x W x H						
LKD36DIAK	36 x 36 x 29-29.5	92.5	66	3	\$2565	\$2687	
LKD42DIAK	42 x 42 x 29-29.5	85	78	3	\$3231	\$3392	
LKD48DIAK	48 x 48 x 29-29.5	85	99	4	\$3978	\$4200	
LKD54DIAK	54 x 54 x 29-29.5	85	111	4	\$4923	\$5195	
LKD60DIAK	60 x 60 x 29-29.5	85	126	5	\$5884	\$6216	

Tops feature hardwood edge and metal inserts for ease of assembly to base. Also includes three legs, three 60-degree connectors and three leg beams.

LKD436DIAK	36 x 36 x 29-29.5	100	66	3	\$2806	\$2928	
LKD442DIAK	42 x 42 x 29-29.5	92.5	78	3	\$3484	\$3645	
LKD448DIAK	48 x 48 x 29-29.5	92.5	99	4	\$4284	\$4506	
LKD454DIAK	54 x 54 x 29-29.5	85	111	4	\$5157	\$5429	
LKD460DIAK	60 x 60 x 29-29.5	92.5	126	5	\$6144	\$6476	

Tops feature hardwood edge and metal inserts for ease of assembly to base. Also includes four legs, four 90-degree connectors and four leg beams.

RECTANGULAR TABLES - LAMINATE

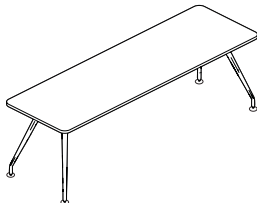

Rectangular Table*

MODEL# DIMENSIONS FREIGHT CLASS WT/LBS. CUBIC FT. B EDGE BUM EDGE WEDGE WUM EDGE KLE EDGE KLUM EDGE

LKD3648	36 x 48 x 29-29.5	100	75	4	\$2405	\$2688	\$2650	\$3100	\$2720	\$3172
LKD3654	36 x 54 x 29-29.5	92.5	81	4	\$2511	\$2844	\$2785	\$3301	\$2971	\$3484
LKD3660	36 x 60 x 29-29.5	100	88	5	\$2618	\$3006	\$2917	\$3503	\$3149	\$3736
LKD3666	36 x 66 x 29-29.5	100	95	5	\$2727	\$3165	\$3052	\$3708	\$3327	\$3986
LKD3672	36 x 72 x 29-29.5	92.5	101	5	\$2831	\$3321	\$3180	\$3904	\$3506	\$4271
LKD3678	36 x 78 x 29-29.5	92.5	105	5	\$2938	\$3475	\$3313	\$4105	\$3686	\$4487
LKD3684	36 x 84 x 29-29.5	92.5	108	5	\$3045	\$3637	\$3448	\$4313	\$3863	\$4737
LKD3696	36 x 96 x 29-29.5	100	115	6	\$3260	\$3954	\$3714	\$4716	\$4223	\$5238
LKD4248	42 x 48 x 29-29.5	92.5	87	4	\$2576	\$2950	\$2818	\$3356	\$2956	\$3501
LKD4254	42 x 54 x 29-29.5	100	90	5	\$2703	\$3141	\$2971	\$3588	\$3231	\$3854
LKD4260	42 x 60 x 29-29.5	100	94	5	\$2830	\$3328	\$3117	\$3811	\$3440	\$4144
LKD4266	42 x 66 x 29-29.5	92.5	101	5	\$2955	\$3370	\$3270	\$4045	\$3646	\$4434
LKD4272	42 x 72 x 29-29.5	92.5	106	5	\$3084	\$3546	\$3420	\$4269	\$3857	\$4725
LKD4278	42 x 78 x 29-29.5	100	110	6	\$3206	\$3716	\$3569	\$4501	\$4061	\$5015
LKD4284	42 x 84 x 29-29.5	100	113	6	\$3334	\$3895	\$3720	\$4730	\$4269	\$5305
LKD4296	42 x 96 x 29-29.5	92.5	129	6	\$3587	\$4245	\$4020	\$5186	\$4684	\$5886
LKD4854	48 x 54 x 29-29.5	100	94	5	\$2932	\$3440	\$3228	\$3933	\$3497	\$4235
LKD4860	48 x 60 x 29-29.5	100	99	5	\$3073	\$3649	\$3397	\$4195	\$3733	\$4565
LKD4866	48 x 66 x 29-29.5	100	107	6	\$3215	\$3862	\$3562	\$4444	\$3967	\$4895
LKD4872	48 x 72 x 29-29.5	100	114	6	\$3356	\$4071	\$3729	\$4700	\$4203	\$5224
LKD4878	48 x 78 x 29-29.5	92.5	120	6	\$3496	\$4278	\$3901	\$4961	\$4438	\$5555
LKD4884	48 x 84 x 29-29.5	92.5	125	6	\$3639	\$4491	\$4068	\$5216	\$4674	\$5884
LKD4896	48 x 96 x 29-29.5	92.5	149	7	\$3918	\$4909	\$4401	\$5725	\$5143	\$6544

Tops feature 3mm pvc edge and metal inserts for ease of assembly to base. Also includes four legs, four 90-degree connectors and four leg beams.

Required Specifications

Top Finish
Leg Finish
Edge Finish*
Edge Style

Optional Specifications

Grommet

Accessories

Power Block

RECTANGULAR TABLES - LAMINATE

MODEL# DIMENSIONS FREIGHT CLASS WT/LBS. CUBIC FT. B EDGE BUM EDGE W EDGE WUM EDGE KL EDGE KLUM EDGE

D x W x H

LKD36108	36 x 108 x 29-29.5	92.5	154	7	\$4484	\$5341	\$4821	\$5919	\$5335	\$6423
LKD36120	36 x 120 x 29-29.5	125	164	8	\$4713	\$5683	\$5088	\$6323	\$5692	\$6924
LKD42108	42 x 108 x 29-29.5	150	124	8	\$4783	\$5795	\$5166	\$6452	\$5848	\$7155
LKD42120	42 x 120 x 29-29.5	150	141	9	\$5036	\$6174	\$5454	\$6891	\$6263	\$7736
LKD48108	48 x 108 x 29-29.5	150	127	9	\$5146	\$6300	\$5561	\$7012	\$6372	\$7900
LKD48120	48 x 120 x 29-29.5	150	151	9	\$5433	\$6734	\$5896	\$7528	\$6838	\$8560
LKD48132	48 x 132 x 29-29.5	150	164	10	\$5714	\$7150	\$6220	\$8015	\$7311	\$9219
LKD48144	48 x 144 x 29-29.5	125	181	10	\$5787	\$7246	\$6301	\$8129	\$7772	\$9879
LKD48156	48 x 156 x 29-29.5	150	191	11	\$6277	\$7994	\$6865	\$9005	\$8252	\$10539
LKD48168	48 x 168 x 29-29.5	125	206	11	\$6557	\$8411	\$7181	\$9487	\$8722	\$11199
LKD48180	48 x 180 x 29-29.5	125	220	12	\$7045	\$9162	\$7743	\$10359	\$9198	\$11858
LKD54144	54 x 144 x 29-29.5	150	193	11	\$6464	\$8293	\$7058	\$9316	\$8533	\$10913
LKD54168	54 x 168 x 29-29.5	150	214	12	\$7086	\$9226	\$7765	\$10402	\$9586	\$12391
LKD60144	60 x 144 x 29-29.5	150	206	12	\$6847	\$8877	\$7491	\$9984	\$9219	\$11883
LKD60168	60 x 168 x 29-29.5	150	227	13	\$7524	\$9896	\$8265	\$11175	\$10379	\$13521

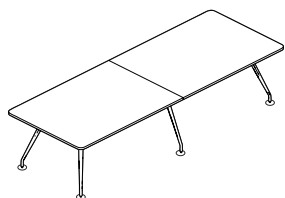

Rectangular Table - 2 piece top

Tops feature 3mm pvc edge and metal inserts for ease of assembly to base. Also includes six legs, four 90-degree connectors, two 3-way connectors and four leg beams.

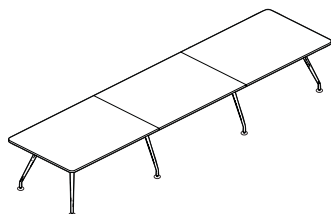

Rectangular Table - 3 piece top

LKD48192	48 x 192 x 29-29.5	150	279	14	\$7926	\$9982	\$8633	\$11199	\$10408	\$13194
LKD54192	54 x 192 x 29-29.5	150	288	15	\$8520	\$10889	\$9292	\$12219	\$11393	\$14568
LKD54216	54 x 216 x 29-29.5	150	270	16	\$9136	\$11815	\$9998	\$13306	\$12439	\$16047
LKD54240	54 x 240 x 29-29.5	150	298	17	\$9757	\$12751	\$10712	\$14395	\$13494	\$17525
LKD60192	60 x 192 x 29-29.5	150	257	16	\$9024	\$11660	\$9859	\$13103	\$12303	\$15862
LKD60216	60 x 216 x 29-29.5	150	283	17	\$9703	\$12680	\$10638	\$14295	\$13466	\$17500
LKD60240	60 x 240 x 29-29.5	150	311	18	\$10378	\$13703	\$11408	\$15483	\$14624	\$19136

Tops feature 3mm pvc edge and metal inserts for ease of assembly to base. Also includes eight legs, four 90-degree connectors, four 3-way connectors and eight leg beams.

Required Specifications

Top Finish
Leg Finish
Edge Finish
Edge Style

Optional Specifications

Grommet

Accessories

Power Block

RECTANGULAR TABLES - VENEER

MODEL# DIMENSIONS FREIGHT CLASS WT/LBS. CUBIC FT. FV EDGE KV EDGE

D x W x H

LKD3648K	36 x 48 x 29-29.5	100	75	4	\$3173	\$3297
LKD3654K	36 x 54 x 29-29.5	92.5	81	4	\$3482	\$3623
LKD3660K	36 x 60 x 29-29.5	100	88	5	\$3719	\$3876
LKD3666K	36 x 66 x 29-29.5	100	95	5	\$3957	\$4130
LKD3672K	36 x 72 x 29-29.5	92.5	101	5	\$4194	\$4379
LKD3678K	36 x 78 x 29-29.5	92.5	105	5	\$4433	\$4637
LKD3684K	36 x 84 x 29-29.5	92.5	108	5	\$4673	\$4892
LKD3696K	36 x 96 x 29-29.5	100	115	6	\$5149	\$5399
LKD4248K	42 x 48 x 29-29.5	92.5	87	4	\$3485	\$3630
LKD4254K	42 x 54 x 29-29.5	100	90	5	\$3830	\$3995
LKD4260K	42 x 60 x 29-29.5	100	94	5	\$4107	\$4289
LKD4266K	42 x 66 x 29-29.5	92.5	101	5	\$4382	\$4582
LKD4272K	42 x 72 x 29-29.5	92.5	106	5	\$4658	\$4877
LKD4278K	42 x 78 x 29-29.5	100	110	6	\$4935	\$5169
LKD4284K	42 x 84 x 29-29.5	100	113	6	\$5208	\$5463
LKD4296K	42 x 96 x 29-29.5	92.5	129	6	\$5761	\$6048
LKD4854K	48 x 54 x 29-29.5	100	94	5	\$4182	\$4372
LKD4860K	48 x 60 x 29-29.5	100	99	5	\$4493	\$4702
LKD4866K	48 x 66 x 29-29.5	100	107	6	\$4807	\$5035
LKD4872K	48 x 72 x 29-29.5	100	114	6	\$5119	\$5369
LKD4878K	48 x 78 x 29-29.5	92.5	120	6	\$5432	\$5704
LKD4884K	48 x 84 x 29-29.5	92.5	125	6	\$5746	\$6034
LKD4896K	48 x 96 x 29-29.5	92.5	149	7	\$6371	\$6703

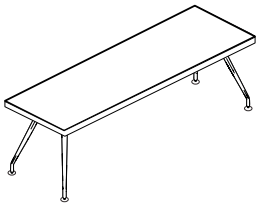

Rectangular Table

Tops feature hardwood edge and metal inserts for ease of assembly to base. Also includes four legs, four 90-degree connectors and four leg beams.

LKD36108K	36 x 108 x 29-29.5	125	154	7	\$6360	\$6640
LKD36120K	36 x 120 x 29-29.5	125	164	8	\$6837	\$7146
LKD42108K	42 x 108 x 29-29.5	150	124	8	\$7056	\$7381
LKD42120K	42 x 120 x 29-29.5	150	141	9	\$7606	\$7968
LKD48108K	48 x 108 x 29-29.5	150	127	9	\$7748	\$8118
LKD48120K	48 x 120 x 29-29.5	150	151	9	\$8375	\$8786
LKD48132K	48 x 132 x 29-29.5	150	164	10	\$9000	\$9454
LKD48144K	48 x 144 x 29-29.5	125	181	10	\$9626	\$10117
LKD48156K	48 x 156 x 29-29.5	150	191	11	\$10253	\$10787
LKD48168K	48 x 168 x 29-29.5	125	206	11	\$10878	\$11451
LKD48180K	48 x 180 x 29-29.5	125	220	12	\$11505	\$12121
LKD54144K	54 x 144 x 29-29.5	150	193	11	\$10613	\$11168
LKD54168K	54 x 168 x 29-29.5	150	214	12	\$12015	\$12664
LKD60144K	60 x 144 x 29-29.5	150	206	12	\$11533	\$12149
LKD60168K	60 x 168 x 29-29.5	150	227	13	\$13083	\$13802

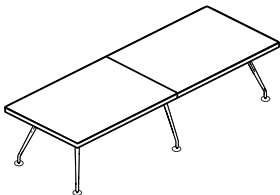

Rectangular Table - 2 piece top

Tops feature hardwood edge and metal inserts for ease of assembly to base. Also includes six legs, four 90-degree connectors, two 3-way connectors and four leg beams.

Required Specifications

Top Finish
Leg Finish
Edge Style

Optional Specifications

Grommet

Accessories

Power Block

RECTANGULAR TABLES - VENEER

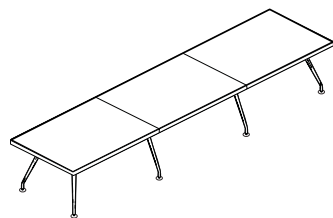

Rectangular Table - 3 piece top

MODEL#	DIMENSIONS	FREIGHT CLASS	WT/LBS.	CUBIC FT.	FV EDGE	KV EDGE
--------	------------	---------------	---------	-----------	---------	---------

D x W x H

LKD48192K	48 x 192 x 29-29.5	150	279	14	\$12878	\$13533
LKD54192K	54 x 192 x 29-29.5	150	288	15	\$14170	\$14909
LKD54216K	54 x 216 x 29-29.5	150	270	16	\$15573	\$16403
LKD54240K	54 x 240 x 29-29.5	150	298	17	\$16973	\$17895
LKD60192K	60 x 192 x 29-29.5	150	257	16	\$15396	\$16217
LKD60216K	60 x 216 x 29-29.5	150	283	17	\$16946	\$17868
LKD60240K	60 x 240 x 29-29.5	150	311	18	\$18496	\$19519

Tops feature hardwood edge and metal inserts for ease of assembly to base. Also includes eight legs, four 90-degree connectors, four 3-way connectors and eight leg beams.

Required Specifications

Top Finish
Leg Finish
Edge Style

Optional Specifications

Grommet

Accessories

Power Block

WIRE MANAGEMENT



Cable Snake

MODEL #	DIMENSIONS D x W x H	FREIGHT CLASS	WT/LB.	CUBIC FT.	LIST PRICE
PCSN01	-- x -- x --	92.5	2.10	.20	\$144

Flexible cable management. Provides access to power/data from floor to underside of worksurface where it attaches. Two pathways within Cable Snake. Length under desk is 31.25". Silver (**SIL**) plastic only.



Cable Snake

BRTCS	2 x 8 x 30	70	3	.19	\$162
-------	------------	----	---	-----	--------------

Flexible cable management trough. Two pathways within the snake, one for data/communication and one for routing power cables. Translucent White finish only.

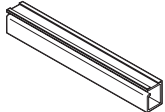

Wire Manager

PEWM5.5	2 x 66 x 2	70	.60	.10	\$211
PEWM5	2 x 60 x 2	70	.60	.10	\$177
PEWM4.5	2 x 54 x 2	70	.50	.10	\$158
PEWM4	2 x 48 x 2	70	.50	.10	\$144
PEWM3.5	2 x 42 x 2	70	.40	.10	\$124
PEWM3	2 x 36 x 2	70	.40	.10	\$111
PEWM2.5	2 x 30 x 2	70	.30	.10	\$91
PEWM2	2 x 24 x 2	70	.30	.10	\$75
PEWM1.5	2 x 18 x 2	70	.20	.10	\$59
PEWM1	2 x 12 x 2	70	.20	.10	\$43

Plastic tray flexes to receive and hold electrical and data wires. Quickly attaches with two strips of double-sided tape. Black (**BLK**) only.

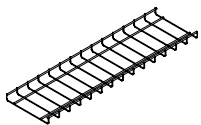

Power/Data Cable Basket

BRTCB76KIT	8 x 34 x 1	70	1.56	.15	\$281
BRTCB70	8 x 70 x 1	100	3.22	.34	\$204
BRTCB64	8 x 64 x 1	92.5	2.94	.29	\$190
BRTCB58	8 x 58 x 1	92.5	2.66	.26	\$184
BRTCB52	8 x 52 x 1	100	2.39	.24	\$173
BRTCB46	8 x 46 x 1	92.5	2.16	.21	\$163
BRTCB40	8 x 40 x 1	70	1.80	.18	\$155
BRTCB34	8 x 34 x 1	70	1.56	.15	\$149
BRTCB28	8 x 28 x 1	70	1.20	.13	\$131
BRTCB22	8 x 22 x 1	70	1.01	.10	\$123
BRTCB16	8 x 16 x 1	70	.73	.07	\$116
BRTCB8	8 x 8 x 1	70	.36	.03	\$104

Shallow, 8" wide basket manages cable excess and serves to manage cords and cables. It can be easily unclipped from spring steel brackets (included) to rearrange cable connections from below worksurface. Spring steel brackets can suspend the Cable Basket below the worksurface where it keeps the cords and cables off the floor and manages them along the horizontal plane - between floor monuments and Storage Vertical Cable Manager, for example. Tall storage cabinet's legs provide easy access to the Cable Basket where it can easily be unclipped from spring steel brackets to rearrange cable connections. Steel wire construction, chrome finish baskets; black spring steel hanging brackets, fasteners.

SWAP TABLES

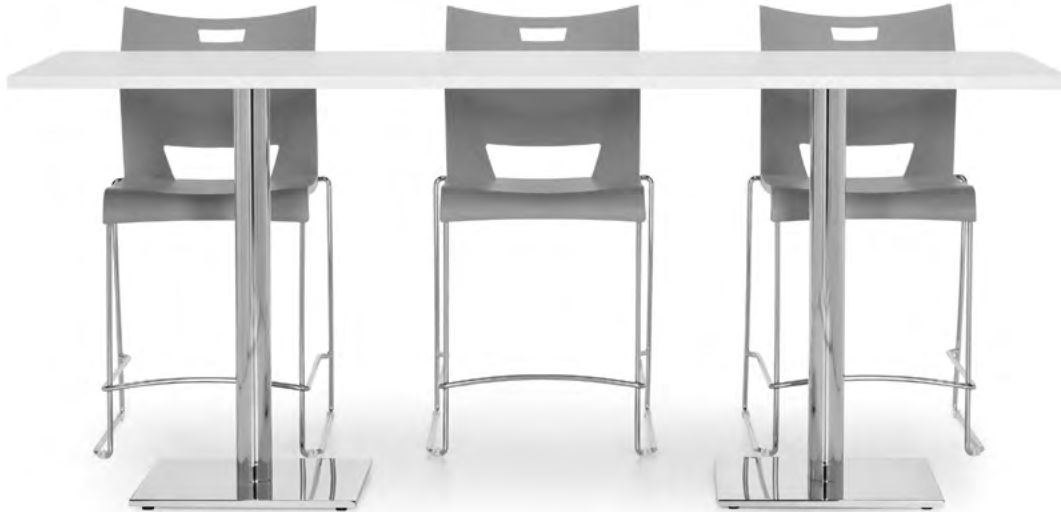

Global's Swap collection is a comprehensive offering including laptop tables, casual meeting tables, café tables, huddle tables and more. Suitable for a variety of applications: break rooms, dedicated/enclosed meeting rooms, casual/open area meeting spaces (lounge, seated, counter and bar height options), and private office (accommodate smaller 3-4 person discussions). Tops and bases are sold separately for ease of specification. Mix and match capabilities to create spaces for multi-purpose use. Choose your top, choose your base. Create the combination you desire for the way you want to work.

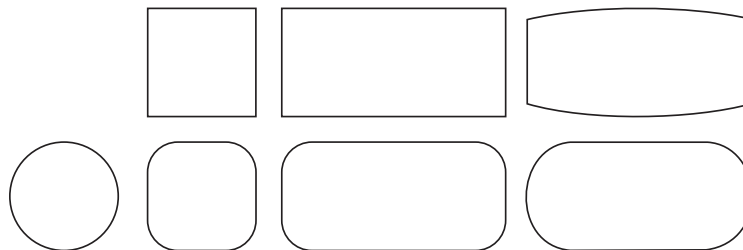

Top shapes



1/2" thick steel square and round metal bases



Optional power & data modules (on select top sizes)



Factory installed metal inserts for easy metal-to-metal base connection

Features and Benefits

- Tops are available in various materials to help perfect your interior design. Material choices include: (1) thermally fused laminate, (2) high pressure laminate (3) veneer and (4) solid surface.
- (1) High performance thermally fused laminate tops are 1" thick, with 45 lb. density particle board and feature 2mm thick edgeband.
- (2) High pressure laminate tops are 1-3/16" thick, with either 2mm flat edge or knife edge profiles. Tops with flat edge have 45 lb. density particle board core, tops with knife edge have MDF core.
- (3) Veneer tops are 1-3/16" thick overall with matching flat edge or knife edge
- (4) Solid surface tops are 1-1/4" thick with a plywood or particleboard melamine subtop depending on size, available with flat edge or knife edge
- Bases are constructed of a solid steel metal plate and cover - round or square.
- Power block cut-outs are available on most tables.
- 6 heights:
Coffee table height at 16"H
End table height at 22"H
Lounge height at 27"H
Seated height at 29"H
Counter height at 36"H
Bar height at 41.5"H

GENERAL INFORMATION

- Swap is a series of tables for use in casual meeting spaces, lounges, café areas and more.
- The right proportions, flawless surfaces and a solid foundation is sure to become your favorite table series to spec.
- Finish palette coordinates with most Global laminate and veneer casegoods series, as well as a variety of solid surface options to choose from – tables can stand-alone or blend with other solutions.
- Each component is packed individually. Bases are shipped assembled, 1 per carton. Easy to assemble.
- Global's counter and bar height stools are a perfect complement to Swap tables with counter and bar height bases.
- For environmental certifications, please visit globalfurnituregroup.com

WORKSURFACES

- **Four** material choices: high performance thermally fused laminate, high pressure laminate, veneer and solid surface.
- **Thermally fused laminate** tops are 1" thick overall, constructed of 45 lb. density particle board core; 2 mm thick flat edge band to match, contrast with, or complement the top surface or corresponding base finish.
- **High pressure laminate** tops are 1-3/16" thick overall with choice of edge detail. 2mm thick flat edge to match, contrast with or complement the top surface or corresponding base finish on a 45lbs density particle board core. Also available with knife edge detail; edge finish would match top surface; core material is MDF. Recommended for counter applications or other high use areas. Product codes with **suffix LK** indicate high pressure laminate with knife edge.
- **Veneer** tops are 1-3/16" thick overall with choice of edge detail - flat edge or knife edge. Edge finish to correspond to surface finish. When flat edge, core material is 45 lbs density particle board; when knife edge, core material is MDF. Product codes with **suffix V** indicate veneer.
- **Solid surface** tops are 1.25" thick overall with choice of edge detail - flat edge or knife edge. Solid surface material is 0.5" thick with built up edge profile over a particle board or plywood subtop depending on overall top size. Product codes with **suffix SF** indicate solid surface with flat edge; product codes with **suffix SK** indicate solid surface with knife edge. There is no edge finish selection on solid surface tops. For detailed material information, please reference WilsonArt's Solid Surface collection.
- Please see model # for pricing and availability of various material and edge options.
- Refer to 783 or the Global website for available finish options
- While not all sizes are available in all materials:
 - Worksurfaces of 96" or less in length are standard in one piece (1 carton)
 - Worksurfaces 120" to 144" in length are standard in two pieces (2 cartons)
 - Worksurfaces 96", 120" and 144" x 48" include support channels

BASES

- **Caution:** to meet BIFMA standards for performance and stability, appropriate base size must be specified with corresponding top sizes identified. **Top plates and base plates vary by base size and will only work with table shape sizes as referenced on the following pages.**
- Bases are constructed of a round or square solid steel metal plate for counter balance, covered with a finished steel shroud, affixed with four bolts to a 3" diameter cold rolled steel tube.
- GRB14H25 attach to tops with a 6" x 6" steel plate, welded to a 1.5" diameter steel tube, bolted to a 0.5" thick solid steel counter balance. Not to be used on tops greater than 22" x 22" in size.
- GSB13H25 and GSOB13H25 attach to tops with a 6" x 6" steel plate, welded to a 1.5" diameter steel tube, bolted to a 0.5" thick solid steel counter balance. Not to be used on tops greater than 22" x 22" in size.
- GRB22H15, GRB22H21, GRB22H26, GRB22, GRB22H35, GRB22H41, GSB19H15, GSB19H21, GSB19H26,w GSB19, GSB19H35 and GSB19H41 attach to tops with a 6" x 6" steel plate, welded to a 3" diameter steel tube, bolted to a 0.5" thick solid steel counter balance.
- **Top plate and base plate of GRB22 and GSB19 models in all heights, have pass-through cut-outs to accommodate a single port simplex or dual USB module to deliver power or USB charging to the surface.** This allows the module to be mounted directly above the base and to pass the unit's cord through the base column resulting in the cord and plug head exiting from the bottom of the base for plugging into a floor or wall mount power source.
- GRB28, GRB34, GSB23 and GSB28 attach to tops with an 11" x 11" steel plate, welded to a 4" diameter steel tube, bolted to a 0.375" thick solid steel counter balance.
- Bases are available PAINTED in "Sandtex" finish for extra durability. Also available in plated finishes (see 783) at an upcharge and with an extended lead time. Please see model # for pricing.
- All bases include six height adjustable glides with 0.75" of adjustability.
- Round bases available in 22", 28" and 34" dia.
- Square bases available in 18.5", 22.5" and 28.5".

1. SPECIFY MODEL NUMBER

2. SPECIFY FINISHES

Laminate Finishes (thermally fused and high pressure laminates):

ACJ	Absolute Acajou	FCL	First Class
ASN	Asian Night	NBL	Noce Biondo
AWC	Avant Cherry	NGL	Noce Grigio
AWH	Avant Honey	NEL	Noce Leggero
BLK	Black	NML	Noce Medio
BZD	Blizzard	QTM	Quartered Mahogany
BRC	Brushed Cobalt	SBY	Sheer Beauty
CMB	Clear Maple	SOG	Storm Grey
CGY	Custom Grey	SDT	Stonedust
DES	Dark Espresso	WHE	Walnut Heights
DWT	Designer White	WHC	White Chocolate
FAS	Fashionista	WCR	Winter Cherry

Bases (paint finishes):

TBL	Black	TIN	Ink
TBZ	Buzz Blue	TKA	Kalua
TCC	Cactus	TLA	Latte
TCR	Carrot	TMO	Mocha
TIV	Cloud	TNE	Nevada
TDW	Designer White	TSN	Sand
TDJ	Dijon	TSR	Scarlet
TEG	Eggplant	TSH	Shadow
TFO	Fog	TOA	Toast
TFR	Frost	TTU	Tungsten

Solid Surface (applicable for product codes ending in **SF** or **SK** only):

Grade 1:

SWH Designer White

Grade 2 (upcharge applies):

SBT	Beige Tempest	SHS	Hot Stone
SBX	Black Onyx Mirage	SFW	Frosty White Mirage
SMG	Milk Glass Spectra	SNM	Northern Melange

Bases (plated finishes - upcharge applies):

CHM	Polished Chrome
BCH	Brushed Chrome

Veneer Finishes (applicable for product codes ending in **V** only):

Code	Finish	Veneer Type	Cut	JAW	White Oak	Rift
AMW	Almond Cherry	Cherry	Flat Sliced	LTH	Walnut	Flat Sliced
ACW	Amber Cherry	Cherry	Flat Sliced	MHW	Walnut	Flat Sliced
BTW	Biscotti	White Oak	Rift	MTW	White Oak	Rift
CAW	Cocoa Walnut	Walnut	Flat Sliced	MPW	Maple	Flat Sliced
CRW	Coral	White Oak	Rift	NLW	Walnut	Flat Sliced
DCW	Dark Cherry	Cherry	Flat Sliced	RCW	Cherry	Flat Sliced
DWW	Dark Walnut	Walnut	Flat Sliced	ULW	Walnut	Flat Sliced
EWV	Espresso Walnut	Walnut	Flat Sliced	VNW	Cherry	Flat Sliced
EVW	Evening Oak	White Oak	Rift	WLW	Walnut	Flat Sliced
GRW	Grey on Oak	White Oak	Rift	WCW	Cherry	Flat Sliced
HAW	Hazelnut	Maple	Flat Sliced	WMW	Maple	Flat Sliced

3. SPECIFY EDGE PROFILE (where applicable)

- Thermally fused laminate and high pressure with flat edge tops:
 - Flat edge (**FE**) - default profile
 - 3" radiused corners (**R3**) - optional for square and rectangular tops, upcharge applies.



FE - Flat edge **FE** - contrasting flat edge

- High pressure laminate tops (models ending in **LK**):
 - Knife edge only



- Veneer tops (models ending in **V**):
 - Flat edge (**FE**) - default profile
 - Knife edge (**KS**) - optional



FE - flat edge **KS** - knife edge

- Solid surface tops (models ending in **SF**):
 - Flat edge (**FE**) - default profile
 - 3" radiused corners (**R3**) - optional for square and rectangular tops, upcharge applies.

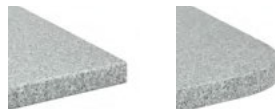

FE - flat edge **R3** - radiused corners

- Solid surface tops (models ending in **SK**):
 - Knife edge (**KS**) - default profile
 - Knife edge with 3" radiused corners (**KR**), optional for square and rectangular tops, upcharge applies

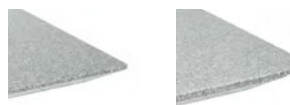

KS - knife edge **KR** - solid surface knife edge w/3" radiused corners

4. SPECIFY EDGE FINISH

Edge finish only applicable for thermally fused laminate tops and HPL tops with FE flat edge

AAE Absolute Acajou	CGY Custom Grey	NML Noce Medio
ASE Asian Night	DEE Dark Espresso	QTM Quartered Mahogany
ACE Avant Cherry	DWE Designer White	SBY Sheer Beauty
AHE Avant Honey	FAS Fashionista	SDT Stonedust
BLK Black	FCL First Class	SOG Storm Grey
BZD Blizzard	NBL Noce Biondo	WHE Walnut Heights
BRC Brushed Cobalt	NGL Noce Grigio	CBE White Chocolate
CME Clear Maple	NEL Noce Leggero	WCE Winter Cherry

5. SPECIFY OPTIONS

POWER BLOCKS AND CUT-OUT LOCATIONS

- A power block delivers power/data to the table surface
 - Power block modules are ordered separately
 - Not all power block locations are available on all table sizes. Please refer to the top/base chart on the following pages for more information.
 - To purchase a power block, you must specify the power block cut-out location when ordering the top and order the power block separately.
 - Optional cut-out available in standard worksurface locations (left, center or right) for all table shapes.
 - Order as **E1, M1, R1, T1, V1**, etc. **Add \$103** for each cut-out.
 - Cut-outs may be placed in non-standard locations.
Order as **ES, MS, RS, TS**, or **VS** - **Add \$103**.
- A drawing must be supplied with vertical and horizontal dimensions to the center of the cut-out. Please refer to the CUSTOM GROMMET LOCATION FORM in the back reference section. Cut-outs may NOT be placed directly over the bases.
- Select power block option from Productivity Solutions pages 459-462.

SINGLE PORT MODULES

- Single port module with one tamper resistant simplex or one USB-A + USB-C charging port centered over the base, available for tops supported with single GRB22xx or GSB19xx base in any height
- Specify optional cut-out (**Q2**) to accommodate when specifying tops. **Add \$103**
- Modules are listed on product pages with applicable tops and bases. Modules are ordered separately.

SPUSBACRW72
SPUSBACRB72
SPTRSMXRW72
SPTRSMXRB72



- For White face plate modules, specify code ending in (**W72**); for Black face plate modules, specify code ending in (**B72**)

POWER BLOCK OPTIONS AND CUT-OUT LOCATIONS

PMSPPDM		PRTMCD602B PRTMCD602T PRTMCD602W	
PRTMCS401B PRTMCS401T PRTMCS401W PRTMCS421B PRTMCS421T PRTMCS421W		PRTMCD622B PRTMCD622T PRTMCD622W PRTMCD642B PRTMCD642T PRTMCD642W	
VILLA			
*OASIS MINI A			
*OASIS MINI B			

*M cut-out not available on Solid Surface tops

SPECIFICATIONS

- Required and optional specifications marked with an * on the pricelist pages with products are applicable to only those products which have the * symbol beside the product name.



TABLE NOTES - ESTIMATED CAPACITY

- Use the following to determine the size of a table and the number of chairs needed for a conference area.
- All estimates are based on an average chair width of 23" with a 4" clearance between chairs. Adjust accordingly for a different chair size.





Top Size	NUMBER OF CHAIRS					
	Round	Square	Rectangular	Boat	Racetrack	
24 x 24	2	2	N/A	N/A	N/A	
24 x 30	N/A	N/A	2-3	N/A	N/A	
24 x 36	N/A	N/A	3-4	N/A	N/A	
30 x 30	3	4	N/A	N/A	N/A	
30 x 36	N/A	N/A	4	N/A	N/A	
30 x 42	N/A	N/A	4	N/A	N/A	
36 x 36	4	4	N/A	N/A	N/A	
36 x 42	N/A	N/A	4	N/A	N/A	
42 x 42	4	4	N/A	N/A	N/A	
48 x 48	4	4	N/A	N/A	N/A	
54 x 54	5	6	N/A	N/A	N/A	
60 x 60	5	6	N/A	N/A	N/A	
24 x 60	N/A	N/A	4-6	N/A	N/A	
24 x 66	N/A	N/A	4-6	N/A	N/A	
24 x 72	N/A	N/A	4-6	N/A	N/A	
24 x 84	N/A	N/A	4-6	N/A	N/A	
24 x 96	N/A	N/A	6-8	N/A	N/A	
30 x 60	N/A	N/A	4-6	4-6	4-6	
30 x 66	N/A	N/A	4-6	4-6	4-6	
30 x 72	N/A	N/A	4-6	4-6	4-6	
30 x 84	N/A	N/A	4-6	4-6	4-6	
30 x 96	N/A	N/A	6-8	6-8	6-8	
36 x 60	N/A	N/A	4-6	4-6	4-6	
36 x 66	N/A	N/A	4-6	4-6	4-6	
36 x 72	N/A	N/A	4-6	4-6	4-6	
36 x 84	N/A	N/A	4-6	4-6	4-6	
36 x 96	N/A	N/A	6-8	6-8	6-8	
48 x 84	N/A	N/A	6-8	6-8	6-8	
48 x 96	N/A	N/A	6-8	6-8	6-8	
48 x 120	N/A	N/A	8-10	8-10	8-10	
48 x 144	N/A	N/A	10-12	10-12	10-12	

S SWAP TABLES - NOTES

APPLICABLE BASE OPTIONS FOR CORRESPONDING TOP											POWER MGMT OPTIONS	
Table Shape/Size	Model # for Top	Lounge Height 27"H		Seated Height 28.5"H		Counter Height 36"H		Bar Height 41.5"h		Base Qty.	# top pieces	Optional cut-outs in tops applicable for power modules ordered separately
		Round base 22"	Square base 19"	Round base 22", 28", 34"	Square base 18.5", 22.5", 28.5"	Round base 22"	Square base 18.5"	Round base 22"	Square base 18.5"			
Round <input type="radio"/> Nominal base plate dimension indicated by 4th and 5th characters in base model numbers.												
24" diameter	GRBTP24_	GRB22H26	GSB19H26	GRB22	GSB19	GRB22H35	GSB19H35	GRB22H41	GSB19H41	1	1	Q2 only
30" diameter	GRBTP30_	GRB22H26	GSB19H26	GRB22	GSB19	GRB22H35	GSB19H35	GRB22H41	GSB19H41	1	1	Q2 only
36" diameter	GRBTP36_	GRB22H26	GSB19H26	GRB22	GSB19	GRB22H35	GSB19H35	GRB22H41	GSB19H41	1	1	Q2 only
42" diameter	GRBTP42_	N/A	N/A	GRB28	GSB23	N/A	N/A	N/A		1	1	None
48" diameter	GRBTP48_	N/A	N/A	GRB28	GSB23	N/A	N/A	N/A		1	1	None
54" diameter	GRBTP54_	N/A	N/A	GRB34	GSB28	N/A	N/A	N/A		1	1	None
60" diameter	GRBTP60_	N/A	N/A	GRB34	GSB28	N/A	N/A	N/A		1	1	None
Square <input type="checkbox"/>												
24" square	GSBTP24_	GRB22H26	GSB19H26	GRB22	GSB19	GRB22H35	GSB19H35	GRB22H41	GSB19H41	1	1	Q2 only
30" square	GSBTP30_	GRB22H26	GSB19H26	GRB22	GSB19	GRB22H35	GSB19H35	GRB22H41	GSB19H41	1	1	Q2 only
36" square	GSBTP36_	GRB22H26	GSB19H26	GRB22	GSB19	GRB22H35	GSB19H35	GRB22H41	GSB19H41	1	1	Q2 only
42" square	GSBTP42_	N/A	N/A	GRB28	GSB23	N/A	N/A	N/A	N/A	1	1	None
54" square	GSBTP54_	N/A	N/A	N/A	N/A	N/A	N/A	N/A	N/A	1	1	None
60" square	GSBTP60_	N/A	N/A	N/A	N/A	N/A	N/A	N/A	N/A	1	1	None
Rectangular <input type="checkbox"/>												
30x24 Rectangular	GSBTP2430_	GRB22H26	GSB19H26	GRB22	GSB19	GRB22H35	GSB19H35	GRB22H41	GSB19H41	1	1	Q2 only
36x24 Rectangular	GSBTP2436_	GRB22H26	GSB19H26	GRB22	GSB19	GRB22H35	GSB19H35	GRB22H41	GSB19H41	1	1	Q2 only
36x30 Rectangular	GSBTP3036_	GRB22H26	GSB19H26	GRB22	GSB19	GRB22H35	GSB19H35	GRB22H41	GSB19H41	1	1	Q2 only
42x30 Rectangular	GSBTP3042_	N/A	N/A	GRB28	GSB23	N/A	N/A	N/A	N/A	1	1	None
42x36 Rectangular	GSBTP3642_	N/A	N/A	GRB28	GSB23	N/A	N/A	N/A	N/A	1	1	None
60x24 Rectangular	GRT5STP_	GRB22H26	GSB19H26	N/A	N/A	GRB22H35	GSB19H35	GRB22H41	GSB19H41	2	1	Center: E2, M2, R2, T2, V2
66x24 Rectangular	GRT5HSTP_	GRB22H26	GSB19H26	N/A	N/A	GRB22H35	GSB19H35	GRB22H41	GSB19H41	2	1	
72x24 Rectangular	GRT6STP_	GRB22H26	GSB19H26	N/A	N/A	GRB22H35	GSB19H35	GRB22H41	GSB19H41	2	1	
84x24 Rectangular	GRT7STP_	GRB22H26	GSB19H26	N/A	N/A	GRB22H35	GSB19H35	GRB22H41	GSB19H41	2	1	3 positions - Left/ Center/Right
96x24 Rectangular	GRT8STP_	GRB22H26	GSB19H26	N/A	N/A	GRB22H35	GSB19H35	GRB22H41	GSB19H41	2	1	
60x30 Rectangular	GRT5NTP_	GRB22H26	GSB19H26	GRB22	GSB19	GRB22H35	GSB19H35	GRB22H41	GSB19H41	2	1	Center: E2, M2, R2, T2, V2
60x36 Rectangular	GRT5TP_	GRB22H26	GSB19H26	GRB22	GSB19	GRB22H35	GSB19H35	GRB22H41	GSB19H41	2	1	
66x30 Rectangular	GRT5NHTP_	GRB22H26	GSB19H26	GRB22	GSB19	GRB22H35	GSB19H35	GRB22H41	GSB19H41	2	1	
66x36 Rectangular	GRT5HTP_	GRB22H26	GSB19H26	GRB22	GSB19	GRB22H35	GSB19H35	GRB22H41	GSB19H41	2	1	
72x30 Rectangular	GRT6NTP_	GRB22H26	GSB19H26	GRB22	GSB19	GRB22H35	GSB19H35	GRB22H41	GSB19H41	2	1	
72x36 Rectangular	GRT6TP_	GRB22H26	GSB19H26	GRB22	GSB19	GRB22H35	GSB19H35	GRB22H41	GSB19H41	2	1	3 positions - Left/ Center/Right E1/2/3, M1/2/3, R1/2/3, T1/2/3, V1/2/3
84x30 Rectangular	GRT7NTP_	GRB22H26	GSB19H26	GRB22	GSB19	GRB22H35	GSB19H35	GRB22H41	GSB19H41	2	1	
84x36 Rectangular	GRT7TP_	GRB22H26	GSB19H26	GRB22	GSB19	GRB22H35	GSB19H35	GRB22H41	GSB19H41	2	1	
96x30 Rectangular	GRT8NTP_	GRB22H26	GSB19H26	GRB22	GSB19	GRB22H35	GSB19H35	GRB22H41	GSB19H41	2	1	
96x36 Rectangular	GRT8TP_	GRB22H26	GSB19H26	GRB22	GSB19	GRB22H35	GSB19H35	GRB22H41	GSB19H41	2	1	
96x42 Rectangular	GRT8MTP_	N/A	N/A	GRB28	GSB23	N/A	N/A	N/A	N/A	2	1	Both ends: E1/3, M1/3, R1/3, T1/3, V1/3
96x48 Rectangular	GRT8WTP_	N/A	N/A	GRB28	GSB23	N/A	N/A	N/A	N/A	2	1	
120x48 Rectangular	GRT10WTP_	N/A	N/A	GRB28	GSB23	N/A	N/A	N/A	N/A	3	2	
144x48 Rectangular	GRT12WTP_	N/A	N/A	GRB28	GSB23	N/A	N/A	N/A	N/A	3	2	

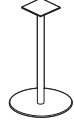
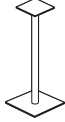
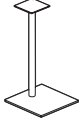
APPLICABLE BASE OPTIONS FOR CORRESPONDING TOP											POWER MGMT OPTIONS	
Table Shape/Size	Model # for Top	Lounge Height 27"H		Seated Height 28.5"H		Counter Height 36"H		Bar Height 41.5"h		Base Qty.	# top pieces	Optional cut-outs in tops applicable for power modules ordered separately
		Round base 22"	Square base 19"	Round base 22", 28", 34"	Square base 18.5", 22.5", 28.5"	Round base 22"	Square base 18.5"	Round base 22"	Square base 18.5"			
Racetrack  Nominal base plate dimension indicated by 4th and 5th characters in base model numbers.												
60X24 Racetrack	GRC5STP_	GRB22H26	GSB19H26	N/A	N/A	GRB22H35	GSB19H35	GRB22H41	GSB19H41	2	1	Center: E2, M2, R2, T2, V2
66X24 Racetrack	GRC5HSTP_	GRB22H26	GSB19H26	N/A	N/A	GRB22H35	GSB19H35	GRB22H41	GSB19H41	2	1	
72X24 Racetrack	GRC6STP_	GRB22H26	GSB19H26	N/A	N/A	GRB22H35	GSB19H35	GRB22H41	GSB19H41	2	1	
84X24 Racetrack	GRC7STP_	GRB22H26	GSB19H26	N/A	N/A	GRB22H35	GSB19H35	GRB22H41	GSB19H41	2	1	
96X24 Racetrack	GRC8STP_	GRB22H26	GSB19H26	N/A	N/A	GRB22H35	GSB19H35	GRB22H41	GSB19H41	2	1	3 positions - Left/ Center/Right
60x30 Racetrack	GRC5NTP_	GRB22H26	GSB19H26	GRB22	GSB19	GRB22H35	GSB19H35	GRB22H41	GSB19H41	2	1	
60X36 Racetrack	GRC5TP_	GRB22H26	GSB19H26	GRB22	GSB19	GRB22H35	GSB19H35	GRB22H41	GSB19H41	2	1	
66x30 Racetrack	GRC5NHTP_	GRB22H26	GSB19H26	GRB22	GSB19	GRB22H35	GSB19H35	GRB22H41	GSB19H41	2	1	
66X36 Racetrack	GRC5HTP_	GRB22H26	GSB19H26	GRB22	GSB19	GRB22H35	GSB19H35	GRB22H41	GSB19H41	2	1	Center: E2, M2, R2, T2, V2
72x30 Racetrack	GRC6NTP_	GRB22H26	GSB19H26	GRB22	GSB19	GRB22H35	GSB19H35	GRB22H41	GSB19H41	2	1	
72x36 Racetrack	GRC6TP_	GRB22H26	GSB19H26	GRB22	GSB19	GRB22H35	GSB19H35	GRB22H41	GSB19H41	2	1	
84x30 Racetrack	GRC7NTP_	GRB22H26	GSB19H26	GRB22	GSB19	GRB22H35	GSB19H35	GRB22H41	GSB19H41	2	1	
84X36 Racetrack	GRC7TP_	GRB22H26	GSB19H26	GRB22	GSB19	GRB22H35	GSB19H35	GRB22H41	GSB19H41	2	1	3 positions - Left/ Center/Right: E1/2/3, M1/2/3, R1/2/3, T1/2/3, V1/2/3
96x30 Racetrack	GRC8NTP_	GRB22H26	GSB19H26	GRB22	GSB19	GRB22H35	GSB19H35	GRB22H41	GSB19H41	2	1	
96x36 Racetrack	GRC8TP_	GRB22H26	GSB19H26	GRB22	GSB19	GRB22H35	GSB19H35	GRB22H41	GSB19H41	2	1	
96x42 Racetrack	GRC8MTP_	N/A	N/A	GRB28	GSB23	N/A	N/A	N/A	N/A	2	1	
96x48 Racetrack	GRC8WTP_	N/A	N/A	GRB28	GSB23	N/A	N/A	N/A	N/A	2	1	Both ends: E1/3, M1/3, R1/3, T1/3
120x48 Racetrack	GRC10WTP_	N/A	N/A	GRB28	GSB23	N/A	N/A	N/A	N/A	3	2	
144x48 Racetrack	GRC12WTP_	N/A	N/A	GRB28	GSB23	N/A	N/A	N/A	N/A	3	2	
Boat Shape 												
60x30 Boat shape	GBT5NTP_	GRB22H26	GSB19H26	GRB22	GSB19	GRB22H35	GSB19H35	GRB22H41	GSB19H41	2	1	Center: E2, M2, R2, T2, V2
60X36 Boat shape	GBT5TP_	GRB22H26	GSB19H26	GRB22	GSB19	GRB22H35	GSB19H35	GRB22H41	GSB19H41	2	1	
66x30 Boat shape	GBT5NHTP_	GRB22H26	GSB19H26	GRB22	GSB19	GRB22H35	GSB19H35	GRB22H41	GSB19H41	2	1	
66X36 Boat shape	GBT5HTP_	GRB22H26	GSB19H26	GRB22	GSB19	GRB22H35	GSB19H35	GRB22H41	GSB19H41	2	1	
72x30 Boat shape	GBT6NTP_	GRB22H26	GSB19H26	GRB22	GSB19	GRB22H35	GSB19H35	GRB22H41	GSB19H41	2	1	3 positions - Left/ Center/Right: E1/2/3, M1/2/3, R1/2/3, T1/2/3, V1/2/3
72x36 Boat shape	GBT6TP_	GRB22H26	GSB19H26	GRB22	GSB19	GRB22H35	GSB19H35	GRB22H41	GSB19H41	2	1	
84x30 Boat shape	GBT7NTP_	GRB22H26	GSB19H26	GRB22	GSB19	GRB22H35	GSB19H35	GRB22H41	GSB19H41	2	1	
84X36 Boat shape	GBT7TP_	GRB22H26	GSB19H26	GRB22	GSB19	GRB22H35	GSB19H35	GRB22H41	GSB19H41	2	1	
96x30 Boat shape	GBT8NTP_	GRB22H26	GSB19H26	GRB22	GSB19	GRB22H35	GSB19H35	GRB22H41	GSB19H41	2	1	Both ends: E1/3, M1/3, R1/3, T1/3, V1/3
96x36 Boat shape	GBT8TP_	GRB22H26	GSB19H26	GRB22	GSB19	GRB22H35	GSB19H35	GRB22H41	GSB19H41	2	1	
96X42 Boat shape	GBT8MTP_	N/A	N/A	GRB28	GSB23	N/A	N/A	N/A	N/A	2	1	
96x48 Boat shape	GBT8WTP_	N/A	N/A	GRB28	GSB23	N/A	N/A	N/A	N/A	2	1	
120x48 Boat shape	GBT10WTP_	N/A	N/A	GRB28	GSB23	N/A	N/A	N/A	N/A	3	2	Both ends: E1/3, M1/3, R1/3, T1/3, V1/3
144x48 Boat shape	GBT12WTP_	N/A	N/A	GRB28	GSB23	N/A	N/A	N/A	N/A	3	2	

S SWAP TABLES - NOTES

APPLICABLE BASE OPTIONS FOR CORRESPONDING TOP						POWER MGMT OPTIONS		
Table Shape/Size	Model # for Top	Laptop height 25.6"H				Base Qty.	# top pieces	Optional cut-outs in tops applicable for power modules ordered separately
		Round base 14" Centered column 	Square base 12.5" Centered column 	Round base N/A	Square base 12.5" Offset column 			
Round Laptop Tables <input checked="" type="checkbox"/> <i>Nominal base plate dimension indicated by 4th and 5th characters in base model numbers.</i>								
16.5" dia centered base	GRBTP16_	GRB14H25	GSB13H25	N/A	N/A	1	1	None
20" dia centered base	GRBTP20_	GRB14H25	GSB13H25	N/A	N/A	1	1	None
22" dia centered base	GRBTP22_	GRB14H25	GSB13H25	N/A	N/A	1	1	None
16.5" dia offset base	GRBOTP16_	N/A	N/A	N/A	GSOB13H25	1	1	None
20" dia offset base	GRBOTP20_	N/A	N/A	N/A	GSOB13H25	1	1	None
22" dia offset base	GRBOTP22_	N/A	N/A	N/A	GSOB13H25	1	1	None
Square Laptop Tables <input type="checkbox"/>								
16.5"x16.5" centered base	GSBTP16_	GRB14H25	GSB13H25	N/A	N/A	1	1	None
20"x20" centered base	GSBTP20_	GRB14H25	GSB13H25	N/A	N/A	1	1	None
22"x22" centered base	GSBTP22_	GRB14H25	GSB13H25	N/A	N/A	1	1	None
16.5"x16.5" offset base	GSBOTP16_	N/A	N/A	N/A	GSOB13H25	1	1	None
20"x20" offset base	GSBOTP20_	N/A	N/A	N/A	GSOB13H25	1	1	None
22"x22" offset base	GSBOTP22_	N/A	N/A	N/A	GSOB13H25	1	1	None
Rectangular Laptop Tables <input type="checkbox"/>								
16"x20" centered base	GSBTP1620_	GRB14H25	GSB13H25	N/A	N/A	1	1	None
16"x22" centered base	GSBTP1622_	GRB14H25	GSB13H25	N/A	N/A	1	1	None
16"x20" offset base	GSBOT1620_	N/A	N/A	N/A	GSOB13H25	1	1	None
16"x22" offset base	GSBOT1622_	N/A	N/A	N/A	GSOB13H25	1	1	None
APPLICABLE BASE OPTIONS FOR CORRESPONDING TOP						POWER MGMT OPTIONS		
Table Shape/Size	Model # for Top	Coffee Table 16"H		End Table 22"H		Base Qty.	# top pieces	Optional cut-outs in tops applicable for power modules ordered separately
		Round base 22" 	Square base 18.5" 	Round base 22" 	Square base 18.5" 			
Round Coffee/End Tables <input checked="" type="checkbox"/> <i>*Nominal base plate dimension indicated by 4th and 5th characters in base model numbers.</i>								
24" dia	GRBTP24_	GRB22H15	GSB19H15	GRB22H21	GSB19H21	1	1	Q2 only
30" dia	GRBTP30_	GRB22H15	GSB19H15	GRB22H21	GSB19H21	1	1	Q2 only
36" dia	GRBTP36_	GRB22H15	GSB19H15	GRB22H21	GSB19H21	1	1	Q2 only
Square Coffee/End Tables <input type="checkbox"/>								
24" square	GSBTP24_	GRB22H15	GSB19H15	GRB22H21	GSB19H21	1	1	Q2 only
30" square	GSBTP30_	GRB22H15	GSB19H15	GRB22H21	GSB19H21	1	1	Q2 only
36" square	GSBTP36_	GRB22H15	GSB19H15	GRB22H21	GSB19H21	1	1	Q2 only

ROUND LAPTOP TABLES FOR CENTER BASE

MODEL# DIMENSIONS FREIGHT CLASS WT/LBS. CUBIC FT. LIST PRICE HP ADD GR. 2 ADD R3 ADD KS ADD



Round laptop table for center base

D x W x H

TFL, flat edge ⁽¹⁾

GRBTP16	16 x 16.5 x 1	70	6	0.3	\$228	\$107	n/a	n/a	n/a
GRBTP20	20 x 20 x 1	70	9	0.5	\$261	\$123	n/a	n/a	n/a
GRBTP22	22 x 22 x 1	70	9	0.5	\$296	\$135	n/a	n/a	n/a

HPL, knife edge

GRBTP16LK	16 x 16.5 x 1.19	125	7.5	1	\$560	n/a	n/a	n/a	n/a
GRBTP20LK	20 x 20 x 1.19	125	11	1.5	\$635	n/a	n/a	n/a	n/a
GRBTP22LK	22 x 22 x 1.19	150	11	2	\$687	n/a	n/a	n/a	n/a

Veneer ⁽²⁾

GRBTP16V	16 x 16.5 x 1.19	125	7.5	1	\$842	n/a	n/a	n/a	\$80
GRBTP20V	20 x 20 x 1.19	125	11	1.5	\$912	n/a	n/a	n/a	\$80
GRBTP22V	22 x 22 x 1.19	150	11	2	\$981	n/a	n/a	n/a	\$80

Solid Surface, flat edge ⁽³⁾

GRBTP16SF	16 x 16.5 x 1.25	70	11	0.6	\$1760	n/a	\$93	n/a	n/a
GRBTP20SF	20 x 20 x 1.25	70	16	1	\$2066	n/a	\$124	n/a	n/a
GRBTP22SF	22 x 22 x 1.25	70	20	1	\$2164	n/a	\$179	n/a	n/a

Solid Surface, knife edge ⁽³⁾

GRBTP16SK	16 x 16.5 x 1.25	70	11	0.6	\$1863	n/a	\$106	n/a	n/a
GRBTP20SK	20 x 20 x 1.25	70	16	1	\$2176	n/a	\$129	n/a	n/a
GRBTP22SK	22 x 22 x 1.25	70	20	1	\$2280	n/a	\$185	n/a	n/a

Only applicable bases to use with above tops: GRB14H25 or GSB13H25 round or square base with centered column (see 795). Tops feature metal inserts for ease of assembly to base. One base required.

Required Specifications

Top finish
Edge finish⁽¹⁾

Optional Specifications

HP laminate⁽¹⁾
Knife edge⁽²⁾
Grade 2 solid surface⁽³⁾

Applicable Bases

GRB14H25
GSB13H25

S SWAP TABLES

SQUARE LAPTOP TABLES FOR CENTER BASE

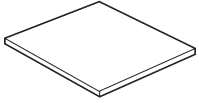

Square Tops, for Center Base

MODEL# DIMENSIONS FREIGHT CLASS WT/LBS. CUBIC FT. LIST PRICE HP ADD GR. 2 ADD R3 ADD KS ADD

D x W x H

TFL, flat edge ^{(1) (4)}

GSBTP16	16.5 x 16.5 x 1	65	7	0.3	\$228	\$107	n/a	\$24	n/a
GSBTP20	20 x 20 x 1	70	11	0.5	\$261	\$123	n/a	\$27	n/a
GSBTP22	22 x 22 x 1	65	13	0.5	\$296	\$135	n/a	\$30	n/a

HPL, knife edge

GSBTP16LK	16.5 x 16.5 x 1.19	100	8.5	1	\$373	n/a	n/a	n/a	n/a
GSBTP20LK	20 x 20 x 1.19	100	13	1.5	\$469	n/a	n/a	n/a	n/a
GSBTP22LK	22 x 22 x 1.19	100	16	2	\$512	n/a	n/a	n/a	n/a

Veneer ⁽²⁾

GSBTP16V	16.5 x 16.5 x 1.19	100	8.5	1	\$481	n/a	n/a	n/a	\$76
GSBTP20V	20 x 20 x 1.19	100	13	1.5	\$602	n/a	n/a	n/a	\$92
GSBTP22V	22 x 22 x 1.19	100	16	2	\$661	n/a	n/a	n/a	\$103

Solid Surface, flat edge ^{(3) (4)}

GSBTP16SF	16.5 x 16.5 x 1.25	65	14	0.6	\$1507	n/a	\$87	\$103	n/a
GSBTP20SF	20 x 20 x 1.25	70	21	1	\$1808	n/a	\$129	\$103	n/a
GSBTP22SF	22 x 22 x 1.25	65	26	1	\$1906	n/a	\$155	\$103	n/a

Solid Surface, knife edge ^{(3) (4)}

GSBTP16SK	16.5 x 16.5 x 1.25	65	14	0.6	\$1863	n/a	\$106	\$216	n/a
GSBTP20SK	20 x 20 x 1.25	70	21	1	\$2176	n/a	\$137	\$216	n/a
GSBTP22SK	22 x 22 x 1.25	65	26	1	\$2280	n/a	\$185	\$216	n/a

Only applicable bases to use with above tops: GRB14H25 or GSB13H25 round or square base with centered column (see 795). Tops feature metal inserts for ease of assembly to base. One base required.

Required Specifications

Top finish
Edge finish⁽¹⁾

Optional Specifications

HP laminate⁽¹⁾
Knife edge⁽²⁾
Grade 2 solid surface⁽³⁾
3" radiused corners⁽⁴⁾

Applicable Bases

GRB14H25
GSB13H25

RECTANGULAR LAPTOP TABLES FOR CENTER BASE **MODEL#** **DIMENSIONS** **FREIGHT CLASS** **WT/LBS.** **CUBIC FT.** **LIST PRICE** **HP ADD GR. 2 ADD** **R3 ADD** **KS ADD**

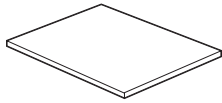

Rectangular Tops, for Center Base

D x W x H

TFL, flat edge ^{(1) (4)}

GSBTP1620	20 x 16 x 1	65	9	0.4	\$238	\$118	n/a	\$23	n/a
GSBTP1622	22 x 16 x 1	70	11	0.5	\$272	\$123	n/a	\$28	n/a

HPL, knife edge

GSBTP1620LK	16 x 20 x 1.19	92.5	11	1	\$481	n/a	n/a	n/a	n/a
GSBTP1622LK	16 x 22 x 1.19	100	13	1.5	\$528	n/a	n/a	n/a	n/a

Veneer ⁽²⁾

GSBTP1620V	16 x 20 x 1.19	92.5	11	1	\$593	n/a	n/a	n/a	\$92
GSBTP1622V	16 x 22 x 1.19	100	13	1.5	\$651	n/a	n/a	n/a	\$96

Solid Surface, flat edge ^{(3) (4)}

GSBTP1620SF	20 x 16 x 1.25	70	17	0.8	\$1674	n/a	\$106	\$103	n/a
GSBTP1622SF	22 x 16 x 1.25	65	19	0.8	\$1697	n/a	\$111	\$103	n/a

Solid Surface, knife edge ^{(3) (4)}

GSBTP1620SK	20 x 16 x 1.25	70	17	0.8	\$2010	n/a	\$129	\$216	n/a
GSBTP1622SK	22 x 16 x 1.25	65	19	0.8	\$2047	n/a	\$149	\$216	n/a

Only applicable bases to use with above tops: GRB14H25 or GSB13H25 round or square base with centered column (see 795). Tops feature metal inserts for ease of assembly to base. One base required.

Required Specifications

Top finish
Edge finish⁽¹⁾

Optional Specifications

HP laminate⁽¹⁾
Knife edge⁽²⁾
Grade 2 solid surface⁽³⁾
3" radiused corners⁽⁴⁾

Applicable Bases

GRB14H25
GSB13H25

S SWAP TABLES

ROUND LAPTOP TABLES FOR OFFSET BASE



Round laptop table for offset base

MODEL#	DIMENSIONS	FREIGHT CLASS	WT/LBS.	CUBIC FT.	LIST PRICE	HP ADD	GR. 2 ADD	R3 ADD	KS ADD
--------	------------	---------------	---------	-----------	------------	--------	-----------	--------	--------

D x W x H

TFL, flat edge ⁽¹⁾

GRBOTP16	16 x 16.5 x 1	70	6	0.3	\$228	\$107	n/a	n/a	n/a
GRBOTP20	20 x 20 x 1	70	9	0.5	\$261	\$123	n/a	n/a	n/a
GRBOTP22	22 x 22 x 1	70	11	0.7	\$296	\$135	n/a	n/a	n/a

HPL, knife edge

GRBOTP16LK	16 x 16.5 x 1.19	100	8	1	\$560	n/a	n/a	n/a	n/a
GRBOTP20LK	20 x 20 x 1.19	100	13	1.5	\$635	n/a	n/a	n/a	n/a
GRBOTP22LK	22 x 22 x 1.19	100	16	2	\$687	n/a	n/a	n/a	n/a

Veneer ⁽²⁾

GRBOTP16V	16 x 16.5 x 1.19	100	8	1	\$842	n/a	n/a	n/a	\$80
GRBOTP20V	20 x 20 x 1.19	100	13	1.5	\$912	n/a	n/a	n/a	\$80
GRBOTP22V	22 x 22 x 1.19	100	16	2	\$981	n/a	n/a	n/a	\$80

Solid Surface, flat edge ⁽³⁾

GRBOTP16SF	16 x 16.5 x 1.25	70	11	0.6	\$1760	n/a	\$93	n/a	n/a
GRBOTP20SF	20 x 20 x 1.25	70	16	1	\$2066	n/a	\$124	n/a	n/a
GRBOTP22SF	22 x 22 x 1.25	70	20	1	\$2164	n/a	\$179	n/a	n/a

Solid Surface, knife edge ⁽³⁾

GRBOTP16SK	16 x 16.5 x 1.25	70	11	0.6	\$1863	n/a	\$106	n/a	n/a
GRBOTP20SK	20 x 20 x 1.25	70	16	1	\$2176	n/a	\$129	n/a	n/a
GRBOTP22SK	22 x 22 x 1.25	70	20	1	\$2280	n/a	\$185	n/a	n/a

Only applicable base to use with above tops: GSOB13H25 square base with offset column (see 795). Tops feature metal inserts for ease of assembly to base. One base required.

Required Specifications

Top finish
Edge finish⁽¹⁾

Optional Specifications

HP laminate⁽¹⁾
Knife edge⁽²⁾
Grade 2 solid surface⁽³⁾

Applicable Bases

GSOB13H25

SQUARE LAPTOP TABLES FOR CENTER BASE **MODEL#** **DIMENSIONS** **FREIGHT CLASS** **WT/LBS.** **CUBIC FT.** **LIST PRICE** **HP ADD** **GR. 2 ADD** **R3 ADD** **KS ADD**

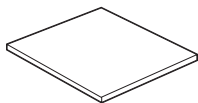

Square Tops, for Offset Base

D x W x H

TFL, flat edge ^{(1) (4)}

GSBOTP16	16.5 x 16.5 x 1	65	7	0.3	\$228	\$107	n/a	\$24	n/a
GSBOTP20	20 x 20 x 1	70	11	0.5	\$261	\$123	n/a	\$27	n/a
GSBOTP22	22 x 22 x 1	70	13	0.7	\$296	\$135	n/a	\$30	n/a

HPL, knife edge

GSBOTP16LK	16.5 x 16.5 x 1.19	100	8.5	1	\$373	n/a	n/a	n/a	n/a
GSBOTP20LK	20 x 20 x 1.19	100	13	1.5	\$469	n/a	n/a	n/a	n/a
GSBOTP22LK	22 x 22 x 1.19	100	16	2	\$512	n/a	n/a	n/a	n/a

Veneer ⁽²⁾

GSBOTP16V	16.5 x 16.5 x 1.19	100	8.5	1	\$481	n/a	n/a	n/a	\$76
GSBOTP20V	20 x 20 x 1.19	100	13	1.5	\$602	n/a	n/a	n/a	\$92
GSBOTP22V	22 x 22 x 1.19	100	16	2	\$661	n/a	n/a	n/a	\$103

Solid Surface, flat edge ^{(3) (4)}

GSBOTP16SF	16.5 x 16.5 x 1.25	65	14	0.6	\$1507	n/a	\$87	\$103	n/a
GSBOTP20SF	20 x 20 x 1.25	70	21	1	\$1808	n/a	\$129	\$103	n/a
GSBOTP22SF	22 x 22 x 1.25	65	26	1	\$1906	n/a	\$155	\$103	n/a

Solid Surface, knife edge ^{(3) (4)}

GSBOTP16SK	16.5 x 16.5 x 1.25	65	14	0.6	\$1863	n/a	\$106	\$216	n/a
GSBOTP20SK	20 x 20 x 1.25	70	21	1	\$2176	n/a	\$137	\$216	n/a
GSBOTP22SK	22 x 22 x 1.25	65	26	1	\$2280	n/a	\$185	\$216	n/a

Only applicable base to use with above tops: GSOB13H25 square base with offset column (see 795). Tops feature metal inserts for ease of assembly to base. One base required.

Required Specifications

Top finish
Edge finish⁽¹⁾

Optional Specifications

HP laminate⁽¹⁾
Knife edge⁽²⁾
Grade 2 solid surface⁽³⁾
3" radiused corners⁽⁴⁾

Applicable Bases

GSOB13H25

S SWAP TABLES

RECTANGULAR LAPTOP TABLES FOR OFFSET BASE

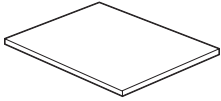

Rectangular Tops, for Offset Base

MODEL#	DIMENSIONS	FREIGHT CLASS	WT/LBS.	CUBIC FT.	LIST PRICE	HP ADD	GR. 2 ADD	R3 ADD	KS ADD
--------	------------	---------------	---------	-----------	------------	--------	-----------	--------	--------

D x W x H

TFL, flat edge ^{(1) (4)}

GSBOT1620	20 x 16 x 1	65	9	0.4	\$238	\$118	n/a	\$25	n/a
GSBOT1622	22 x 16 x 1	70	11	0.5	\$272	\$123	n/a	\$26	n/a

HPL, knife edge

GSBOT1620LK	16 x 20 x 1.19	125	11	1.5	\$481	n/a	n/a	n/a	n/a
GSBOT1622LK	16 x 22 x 1.19	125	13	2	\$528	n/a	n/a	n/a	n/a

Veneer ⁽²⁾

GSBOT1620V	16 x 20 x 1.19	125	11	1.5	\$593	n/a	n/a	n/a	\$92
GSBOT1622V	16 x 22 x 1.19	125	13	2	\$651	n/a	n/a	n/a	\$96

Solid Surface, flat edge ^{(3) (4)}

GSBOT1620SF	20 x 16 x 1.25	70	17	0.8	\$1674	n/a	\$106	\$103	n/a
GSBOT1622SF	22 x 16 x 1.25	65	19	0.8	\$1697	n/a	\$111	\$103	n/a

Solid Surface, knife edge ^{(3) (4)}

GSBOT1620SK	20 x 16 x 1.25	70	17	0.8	\$2010	n/a	\$129	\$216	n/a
GSBOT1622SK	22 x 16 x 1.25	65	19	0.8	\$2047	n/a	\$149	\$216	n/a

Only applicable base to use with above tops: GSOB13H25 square base with offset column (see 795). Tops feature metal inserts for ease of assembly to base. One base required.

Required Specifications

Top finish
Edge finish⁽¹⁾

Optional Specifications

HP laminate⁽¹⁾
Knife edge⁽²⁾
Grade 2 solid surface⁽³⁾
3" radiused corners⁽⁴⁾

Applicable Bases

GSOB13H25

LAPTOP TABLE BASES **MODEL#** **DIMENSIONS** **FREIGHT CLASS** **WT./LBS.** **CUBIC FT.** **LIST PRICE** **CHM/BCH**

D x W x H

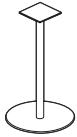

14" Round Centered Base

GRB14H25	14 x 14 x 24.5	150	17.54	3.5	\$798	\$92
----------	----------------	-----	-------	-----	--------------	-------------

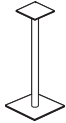

12.5" Square Centered Base

GSB13H25	12.5 x 12.5 x 24.5	150	17.11	3.5	\$826	\$92
----------	--------------------	-----	-------	-----	--------------	-------------

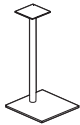

12.5" Square Offset Base

GSOB13H25	12.5 x 12.5 x 24.5	150	17.11	3.5	\$826	\$92
-----------	--------------------	-----	-------	-----	--------------	-------------

1.5" diameter column. Weighted base for balance includes cover plate, 0.5" adjustable glides to level on uneven surfaces. Screws included with base for attaching to appropriate top(s). Available in paint finishes listed on 783; plated finishes as available on 783 (upcharge applies).

Required Specifications
Finish

Optional Specifications
Plated finish

S SWAP TABLES

ROUND TOPS, 24-36"



MODEL# DIMENSIONS FREIGHT CLASS WT/LBS. CUBIC FT. LIST PRICE HP ADD GR. 2 ADD R3 ADD KS ADD

D x W x H

TFL, flat edge ⁽¹⁾

GRBTP24	24 x 24 x 1	70	16	1	\$261	\$133	n/a	n/a	n/a
GRBTP30	30 x 30 x 1	70	25	1.5	\$302	\$153	n/a	n/a	n/a
GRBTP36	36 x 36 x 1	70	36	2	\$385	\$195	n/a	n/a	n/a

HPL, knife edge

GRBTP24LK	24 x 24 x 1.19	100	19	2	\$799	n/a	n/a	n/a	n/a
GRBTP30LK	30 x 30 x 1.19	92.5	30	3	\$1002	n/a	n/a	n/a	n/a
GRBTP36LK	36 x 36 x 1.19	92.5	43	4	\$1200	n/a	n/a	n/a	n/a

Veneer ⁽²⁾

GRBTP24V	24 x 24 x 1.19	100	19	2	\$971	n/a	n/a	n/a	\$65
GRBTP30V	30 x 30 x 1.19	92.5	30	3	\$1173	n/a	n/a	n/a	\$80
GRBTP36V	36 x 36 x 1.19	92.5	43	4	\$1386	n/a	n/a	n/a	\$80

Solid Surface, flat edge ⁽³⁾

GRBTP24SF	24 x 24 x 1.25	70	24	1.2	\$2219	n/a	\$179	n/a	n/a
GRBTP30SF	29.8 x 29.8 x 1.25	70	37	1.8	\$2421	n/a	\$247	n/a	n/a
GRBTP36SF	36 x 36 x 1.25	70	53	2.5	\$3094	n/a	\$369	n/a	n/a

Solid Surface, knife edge ⁽³⁾

GRBTP24SK	24 x 24 x 1.25	70	24	1.2	\$2280	n/a	\$192	n/a	n/a
GRBTP30SK	29.8 x 29.8 x 1.25	70	37	1.8	\$2512	n/a	\$265	n/a	n/a
GRBTP36SK	36 x 36 x 1.25	70	53	2.5	\$3278	n/a	\$393	n/a	n/a

Round Tops, 24-36"

Only applicable bases to use with above tops: GRB22Hxx or GSB19Hxx round or square base @ 15", 21" 26", 28" 35" or 40.5"H (see 799). Tops feature metal inserts for ease of assembly to base. One base required.

Required Specifications

Top finish
Edge finish⁽¹⁾

Optional Specifications

HP laminate⁽¹⁾
Knife edge⁽²⁾
Grade 2 solid surface⁽³⁾
Q2 cut-out for single port module

Applicable Bases

GRB22H15 GRB22H35 GSB19H26
GRB22H21 GRB22H41 GSB19
GRB22H26 GSB19H15 GSB19H35
GRB22 GSB19H21 GSB19H41

SQUARE TOPS, 24-36"

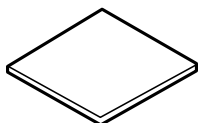

MODEL# DIMENSIONS FREIGHT CLASS WT/LBS. CUBIC FT. LIST PRICE HP ADD GR. 2 ADD R3 ADD KS ADD

D x W x H

TFL, flat edge ⁽¹⁾⁽⁴⁾

GSBTP24	24 x 24 x 1	70	20	1	\$269	\$137	n/a	\$28	n/a
GSBTP30	30 x 30 x 1	70	30	1.5	\$313	\$157	n/a	\$39	n/a
GSBTP36	36 x 36 x 1	70	44	2	\$396	\$199	n/a	\$41	n/a

HPL, knife edge

GSBTP24LK	24 x 24 x 1.19	85	24	2	\$719	n/a	n/a	n/a	n/a
GSBTP30LK	30 x 30 x 1.19	85	36	3	\$789	n/a	n/a	n/a	n/a
GSBTP36LK	36 x 36 x 1.19	85	53	4	\$854	n/a	n/a	n/a	n/a

Veneer ⁽²⁾

GSBTP24V	24 x 24 x 1.19	85	24	2	\$1002	n/a	n/a	n/a	\$70
GSBTP30V	30 x 30 x 1.19	85	36	3	\$1067	n/a	n/a	n/a	\$76
GSBTP36V	36 x 36 x 1.19	85	53	4	\$1135	n/a	n/a	n/a	\$70

Solid Surface, flat edge ⁽³⁾⁽⁴⁾

GSBTP24SF	24 x 24 x 1.25	65	30	1.2	\$1961	n/a	\$185	\$103	n/a
GSBTP30SF	29.8 x 29.8 x 1.25	65	47	1.8	\$2421	n/a	\$247	\$103	n/a
GSBTP36SF	36 x 36 x 1.25	65	68	2.5	\$3149	n/a	\$301	\$103	n/a

Solid Surface, knife edge ⁽³⁾⁽⁴⁾

GSBTP24SK	24 x 24 x 1.25	65	30	1.2	\$2022	n/a	\$198	\$216	n/a
GSBTP30SK	29.8 x 29.8 x 1.25	65	47	1.8	\$3033	n/a	\$277	\$216	n/a
GSBTP36SK	36 x 36 x 1.25	65	68	2.5	\$3756	n/a	\$344	\$216	n/a

Square Tops, 24-36"

Only applicable bases to use with above tops: GRB22Hxx or GSB19Hxx round or square base @ 15", 21" 26", 28" 35" or 40.5"H (see 799). Tops feature metal inserts for ease of assembly to base. One base required. .

Required Specifications

Top finish
Edge finish⁽¹⁾

Optional Specifications

HP laminate⁽¹⁾, Knife edge⁽²⁾
Grade 2 solid surface⁽³⁾
3" radiused corners⁽⁴⁾
Q2 cut-out for single port module

Applicable Bases

GRB22H15	GRB22H35	GSB19H26
GRB22H21	GRB22H41	GSB19
GRB22H26	GSB19H15	GSB19H35
GRB22	GSB19H21	GSB19H41

S SWAP TABLES

RECTANGULAR TOPS, SMALL

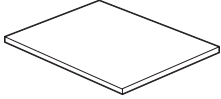

Rectangular Tops, small

MODEL# DIMENSIONS FREIGHT CLASS WT/LBS. CUBIC FT. LIST PRICE HP ADD GR. 2 ADD R3 ADD KS ADD

D x W x H

TFL, flat edge ^{(1) (4)}

GSBTP2430	24 x 30 x 1	70	20	0.91	\$300	\$137	n/a	\$31	n/a
GSBTP2436	24 x 36 x 1	70	24	1.08	\$325	\$149	n/a	\$34	n/a
GSBTP3036	30 x 36 x 1	65	31	1.34	\$376	\$171	n/a	\$39	n/a

HPL, knife edge

GSBTP2430LK	24 x 30 x 1.19	100	24	2.5	\$719	n/a	n/a	n/a	n/a
GSBTP2436LK	24 x 36 x 1.19	100	29	3	\$854	n/a	n/a	n/a	n/a
GSBTP3036LK	30 x 36 x 1.19	92.5	37	3.5	\$900	n/a	n/a	n/a	n/a

Veneer ⁽²⁾

GSBTP2430V	24 x 30 x 1.19	100	24	2.5	\$1002	n/a	n/a	n/a	\$70
GSBTP2436V	24 x 36 x 1.19	100	29	3	\$1067	n/a	n/a	n/a	\$76
GSBTP3036V	30 x 36 x 1.19	92.5	37	3.5	\$1135	n/a	n/a	n/a	\$70

Solid Surface, flat edge ^{(3) (4)}

GSBTP2430SF	29.8 x 24 x 1.25	70	38	1.8	\$2121	n/a	\$185	\$103	n/a
GSBTP2436SF	36 x 24 x 1.25	70	45	2.1	\$2390	n/a	\$235	\$103	n/a
GSBTP3036SF	36 x 29.8 x 1.25	65	57	2.1	\$2714	n/a	\$258	\$103	n/a

Solid Surface, knife edge ^{(3) (4)}

GSBTP2430SK	29.8 x 24 x 1.25	70	38	1.8	\$2555	n/a	\$227	\$216	n/a
GSBTP2436SK	36 x 24 x 1.25	70	45	2.1	\$2775	n/a	\$283	\$216	n/a
GSBTP3036SK	36 x 29.8 x 1.25	65	57	2.1	\$3131	n/a	\$314	\$216	n/a

Applicable bases to use with above tops: GRB22Hxx or GSB19Hxx round or square base @ 15", 21" 26", 28" 35" or 40.5"H (see 799). Tops feature metal inserts for ease of assembly to base. One base required.

Required Specifications

Top finish
Edge finish⁽¹⁾

Optional Specifications

HP laminate⁽¹⁾, Knife edge⁽²⁾
Grade 2 solid surface⁽³⁾
3" radiused corners⁽⁴⁾
Q2 cut-out for single port module

Applicable Bases

GRB22H15	GRB22H35	GSB19H26
GRB22H21	GRB22H41	GSB19
GRB22H26	GSB19H15	GSB19H35
GRB22	GSB19H21	GSB19H41

BASES FOR TOPS 24"-36"

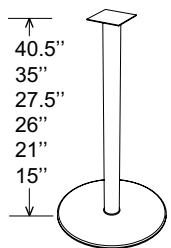

22" Dia Round Bases*

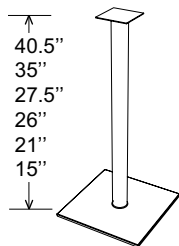

18.5" Square Bases*



Single Port Module w/USB-A + USB-C



Single Port Module w/one Simplex

MODEL#	DIMENSIONS D x W x H	FREIGHT CLASS	WT/LBS.	CUBIC FT.	LIST PRICE	CHM/BCH
GRB22H15	22 x 22 x 15	92.5	47.6	4.69	\$966	\$157
GRB22H21	22 x 22 x 21	125	48.6	6.45	\$982	\$145
GRB22H26	22 x 22 x 26	150	50	8.63	\$995	\$157
GRB22	22 x 22 x 28	150	55	9.33	\$927	\$157
GRB22H35	22 x 22 x 35	150	57.1	12	\$972	\$155
GRB22H41	22 x 22 x 40.5	150	58.3	14	\$989	\$171

GRB22H15 - coffee table height **GRB22H26** - lounge height **GRB22H35** - counter height
GRB22H21 - end table height **GRB22** - seated height **GRB22H41** - bar height

GSB19H15	18.5 x 18.5 x 15	85	43.7	3.52	\$982	\$142
GSB19H21	18.5 x 18.5 x 21	100	44.8	4.84	\$995	\$142
GSB19H26	18.5 x 18.5 x 26	125	47	5.94	\$1070	\$142
GSB19	18.5 x 18.5 x 28	100	50	6.06	\$1004	\$155
GSB19H35	18.5 x 18.5 x 35	125	51.8	7.52	\$1064	\$155
GSB19H41	18.5 x 18.5 x 40.5	125	53.2	8.77	\$1102	\$171

GSB19H15 - coffee table height **GSB19H26** - lounge height **GSB19H35** - counter height
GSB19H21 - end table height **GSB19** - seated height **GSB19H41** - bar height

Base comes fully assembled and features 0.5" adjustable glides to level on uneven surfaces. Screws included with base for attaching to appropriate top(s). Base top plate and base plate include pass-through for single port power or USB module (sold separately). Available in painted finishes listed on 783; plated finishes as available on 783 (upcharge applies).

White						
SPUSBACRW72	2.25 x - x 2.75	70	0.18	0.05	\$276	N/A
Black						
SPUSBACRB72	2.25 x - x 2.75	70	0.18	0.05	\$276	N/A

Single port module with USB-A and USB-C charging ports. Round module with 72" cord. Specify top with **Q2** cut-out to accommodate.

White						
SPTSRMXRW72	2.25 x - x 2.75	70	0.18	0.05	\$106	N/A
Black						
SPTSRMXRB72	2.25 x - x 2.75	70	0.18	0.05	\$106	N/A

Single port module with one tamper resistant simplex. Round module with 72" cord. Specify top with **Q2** cut-out to accommodate.

Required Specifications
Finish

Optional Specifications
Plated finish*
Cut-out

S SWAP TABLES

ROUND TOPS, 42"-48"



Round Tops, 42-48"

MODEL# DIMENSIONS FREIGHT CLASS WT/LBS. CUBIC FT. LIST PRICE HP ADD GR. 2 ADD R3 ADD KS ADD

D x W x H

TFL, flat edge ⁽¹⁾

GRBTP42	42 x 42 x 1	70	44	2.5	\$536	\$271	n/a	n/a	n/a
GRBTP48	48 x 48 x 1	70	56	3	\$572	\$287	n/a	n/a	n/a

HPL, knife edge

GRBTP42LK	42 x 42 x 1.19	92.5	53	5	\$1491	n/a	n/a	n/a	n/a
GRBTP48LK	48 x 48 x 1.19	92.5	67	6.5	\$1704	n/a	n/a	n/a	n/a

Veneer ⁽²⁾

GRBTP42V	42 x 42 x 1.19	92.5	53	5	\$1791	n/a	n/a	n/a	\$76
GRBTP48V	48 x 48 x 1.19	92.5	67	6.5	\$2046	n/a	n/a	n/a	\$86

Solid Surface, flat edge ⁽³⁾

GRBTP42SF	42 x 42 x 1.25	70	73	3.4	\$4196	n/a	\$472	n/a	n/a
GRBTP48SF	48 x 48 x 1.25	70	95	4.3	\$4778	n/a	\$601	n/a	n/a

Solid Surface, knife edge ⁽³⁾

GRBTP42SK	42 x 42 x 1.25	70	73	3.4	\$4417	n/a	\$528	n/a	n/a
GRBTP48SK	48 x 48 x 1.25	70	95	4.3	\$5329	n/a	\$669	n/a	n/a

Applicable bases to use with above tops: GRB28 or GSB23 round or square base @ 28" (see 802). Tops feature metal inserts for ease of assembly to base. One base required.

Required Specifications

Top finish
Edge finish⁽¹⁾

Optional Specifications

HP laminate⁽¹⁾
Knife edge⁽²⁾
Grade 2 solid surface⁽³⁾

Applicable Bases

GRB28
GSB23

SQUARE + RECTANGULAR TOPS, 42"

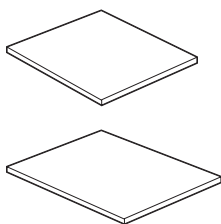

Square and Rectangular Tops

MODEL# DIMENSIONS FREIGHT CLASS WT/LBS. CUBIC FT. LIST PRICE HP ADD GR. 2 ADD R3 ADD KS ADD

D x W x H

TFL, flat edge ^{(1) (4)}

GSBTP3042	30 x 42 x 1	65	36	1.55	\$441	\$200	n/a	\$45	n/a
GSBTP3642	36 x 42 x 1	65	43	1.86	\$553	\$252	n/a	\$60	n/a
GSBTP42	42 x 42 x 1	65	58	2.5	\$546	\$276	n/a	\$56	n/a

HPL, knife edge

GSBTP3042LK	30 x 42 x 1.19	92.5	43	4	\$1056	n/a	n/a	n/a	n/a
GSBTP3642LK	36 x 42 x 1.19	92.5	52	4.5	\$1119	n/a	n/a	n/a	n/a
GSBTP42LK	42 x 42 x 1.19	85	70	5	\$1168	n/a	n/a	n/a	n/a

Veneer ⁽²⁾

GSBTP3042V	30 x 42 x 1.19	92.5	43	4	\$1327	n/a	n/a	n/a	\$60
GSBTP3642V	36 x 42 x 1.19	92.5	52	4.5	\$1386	n/a	n/a	n/a	\$70
GSBTP42V	42 x 42 x 1.19	85	70	5	\$1625	n/a	n/a	n/a	\$76

Solid Surface, flat edge ^{(3) (4)}

GSBTP3042SF	42 x 29.8 x 1.25	65	66	2.9	\$2849	n/a	\$314	\$103	n/a
GSBTP3642SF	42 x 36 x 1.25	65	79	2.9	\$3658	n/a	\$419	\$103	n/a
GSBTP42SF	42 x 42 x 1.25	65	92	3.4	\$3810	n/a	\$454	\$103	n/a

Solid Surface, knife edge ^{(3) (4)}

GSBTP3042SK	42 x 29.8 x 1.25	65	66	2.9	\$3339	n/a	\$369	\$216	n/a
GSBTP3642SK	42 x 36 x 1.25	65	79	2.9	\$4221	n/a	\$498	\$216	n/a
GSBTP42SK	42 x 42 x 1.25	65	92	3.4	\$4417	n/a	\$553	\$216	n/a

Applicable bases to use with above tops: GRB28 or GSB23 round or square base @ 28" (see 802). Tops feature metal inserts for ease of assembly to base. One base required.

Required Specifications

Top finish
Edge finish⁽¹⁾

Optional Specifications

HP laminate⁽¹⁾
Knife edge⁽²⁾
Grade 2 solid surface⁽³⁾
3" radiused corners⁽⁴⁾

Applicable Bases

GRB28
GSB23

S SWAP TABLES

BASES FOR TOPS 42" - 48"

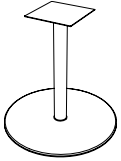

28" Round Base

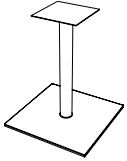

23" Square Base

MODEL# DIMENSIONS FREIGHT CLASS WT/LBS. CUBIC FT. LIST PRICE CHM/BCH

D x W x H

GRB28	28 x 28 x 28	125	100	15.63	\$1596	\$171
seated height						

GSB23	22.5 x 22.5 x 28	100	82	9.33	\$1467	\$95
seated height						

Base comes fully assembled and features 0.5" adjustable glides to level on uneven surfaces. Screws included with base for attaching to appropriate top(s). Available in paint finishes listed on 783; plated finishes as available on 783 (upcharge applies).

Required Specifications
Finish

Optional Specifications
Plated finish

ROUND TOPS, 54"-60"



MODEL#	DIMENSIONS	FREIGHT CLASS	WT/LBS.	CUBIC FT.	LIST PRICE	HP ADD	GR. 2 ADD	R3 ADD	KS ADD
--------	------------	---------------	---------	-----------	------------	--------	-----------	--------	--------

D x W x H

TFL, flat edge ⁽¹⁾

GRBTP54	54 x 54 x 1	70	73	4.5	\$764	\$384	n/a	n/a	n/a
GRBTP60	60 x 60 x 1	70	92	5	\$790	\$398	n/a	n/a	n/a

HPL, knife edge

GRBTP54LK	54 x 54 x 1.19	92.5	88	8	\$1923	n/a	n/a	n/a	n/a
GRBTP60LK	60 x 60 x 1.19	92.5	110	10	\$2370	n/a	n/a	n/a	n/a

Veneer ⁽²⁾

GRBTP54V	54 x 54 x 1.19	92.5	88	8	\$2611	n/a	n/a	n/a	\$103
GRBTP60V	60 x 60 x 1.19	92.5	110	10	\$3223	n/a	n/a	n/a	\$111

Solid Surface, flat edge ⁽³⁾

GRBTP54SF	54 x 54 x 1.25	70	120	5.4	\$5175	n/a	\$736	n/a	n/a
GRBTP60SF	60 x 60 x 1.25	70	148	6.7	\$6798	n/a	\$920	n/a	n/a

Solid Surface, knife edge ⁽³⁾

GRBTP54SK	54 x 54 x 1.25	70	120	5.4	\$6119	n/a	\$926	n/a	n/a
GRBTP60SK	60 x 60 x 1.25	70	148	6.7	\$7485	n/a	\$1122	n/a	n/a

Applicable bases to use with above tops: GRB34 or GSB28 round or square base @ 28" (see 804). Tops feature metal inserts for ease of assembly to base. One base required.

Round Tops, 54"-60"

Required Specifications

Top finish
Edge finish⁽¹⁾

Optional Specifications

HP laminate⁽¹⁾
Knife edge⁽²⁾
Grade 2 solid surface⁽³⁾

Applicable Bases

GRB34
GSB28

S SWAP TABLES

BASES FOR TOPS 54" - 60" ROUND

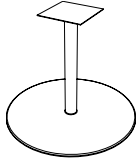

34" Round Base

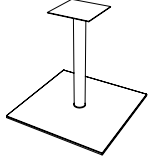

28" Square Base

MODEL#	DIMENSIONS	FREIGHT CLASS	WT./LBS.	CUBIC FT.	LIST PRICE	CHM/BCH
--------	------------	---------------	----------	-----------	------------	---------

D x W x H						
GRB34	34 x 34 x 28	125	135	20.56	\$1951	\$171
seated height						

GSB28	28.5 x 28.5 x 28	125	125	15.63	\$1822	\$80
seated height						

Base comes fully assembled and features 0.5" adjustable glides to level on uneven surfaces. Screws included with base for attaching to appropriate top(s). Available in paint finishes listed on 783; plated finishes as available on 783 (upcharge applies).

Required Specifications

Finish

Optional Specifications

Plated finish

RECTANGULAR LOUNGE TOPS, 24"D

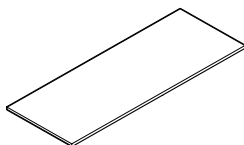

MODEL# DIMENSIONS FREIGHT CLASS WT/LBS. CUBIC FT. LIST PRICE HP ADD GR. 2 ADD R3 ADD KS ADD

D x W x H

TFL, flat edge ^{(1) (4)}

GRT5STP	24 x 60 x 1	65	41	1.79	\$503	\$228	n/a	\$52	n/a
GRT5HSTP	24 x 66 x 1	65	46	1.97	\$588	\$269	n/a	\$60	n/a
GRT6STP	24 x 72 x 1	65	49	2.14	\$614	\$277	n/a	\$62	n/a
GRT7STP	24 x 84 x 1	65	57	2.49	\$710	\$322	n/a	\$72	n/a
GRT8STP	24 x 96 x 1	65	66	2.84	\$762	\$343	n/a	\$77	n/a

HPL, knife edge

GRT5STPLK	24 x 60 x 1.19	85	49	4	\$1067	n/a	n/a	n/a	n/a
GRT5HSTPLK	24 x 66 x 1.19	85	55	4.5	\$1135	n/a	n/a	n/a	n/a
GRT6STPLK	24 x 72 x 1.19	92.5	59	5	\$1200	n/a	n/a	n/a	n/a
GRT7STPLK	24 x 84 x 1.19	85	68	5.5	\$1332	n/a	n/a	n/a	n/a
GRT8STPLK	24 x 96 x 1.19	85	79	6.5	\$1518	n/a	n/a	n/a	n/a

Veneer ⁽²⁾

GRT5STPV	24 x 60 x 1.19	85	49	4	\$1332	n/a	n/a	n/a	\$70
GRT5HSTPV	24 x 66 x 1.19	85	55	4.5	\$1402	n/a	n/a	n/a	\$70
GRT6STPV	24 x 72 x 1.19	92.5	59	5	\$1534	n/a	n/a	n/a	\$70
GRT7STPV	24 x 84 x 1.19	85	68	5.5	\$1801	n/a	n/a	n/a	\$70
GRT8STPV	24 x 96 x 1.19	85	79	6.5	\$2067	n/a	n/a	n/a	\$70

Solid Surface, flat edge ^{(3) (4)}

GRT5STPSF	24 x 60 x 1.25	65	75	2.8	\$4105	n/a	\$461	\$103	n/a
GRT5HSTPSF	24 x 66 x 1.25	65	83	3.1	\$4288	n/a	\$472	\$103	n/a
GRT6STPSF	24 x 71.8 x 1.25	65	90	3.3	\$4521	n/a	\$485	\$103	n/a
GRT7STPSF	24 x 84 x 1.25	65	105	3.9	\$5023	n/a	\$632	\$103	n/a
GRT8STPSF	24 x 96 x 1.25	65	120	4.4	\$5513	n/a	\$645	\$103	n/a

Solid Surface, knife edge ^{(3) (4)}

GRT5STPSK	24 x 60 x 1.25	65	75	2.8	\$4625	n/a	\$491	\$216	n/a
GRT5HSTPSK	24 x 66 x 1.25	65	83	3.1	\$4809	n/a	\$516	\$216	n/a
GRT6STPSK	24 x 71.8 x 1.25	65	90	3.3	\$5041	n/a	\$540	\$216	n/a
GRT7STPSK	24 x 84 x 1.25	65	105	3.9	\$5745	n/a	\$699	\$216	n/a
GRT8STPSK	24 x 96 x 1.25	65	120	4.4	\$6253	n/a	\$725	\$216	n/a

Applicable bases to use with above tops: GRB22Hxx round or GSB19Hxx square base @ 26"H, 35"H & 40.5"H (see 810). Tops feature metal inserts for ease of assembly to base. Two bases required. 24"D tops not recommended with 28"H bases.

Rectangular Lounge Tops

Required Specifications

Top finish
Edge finish⁽¹⁾

Optional Specifications

HP laminate⁽¹⁾, Knife edge⁽²⁾
Grade 2 solid surface⁽³⁾
3" radiused corners⁽⁴⁾
Cut-out for grommet/power blocks

Applicable Bases

GRB22H26 GSB19H26
GRB22H35 GSB19H35
GRB22H41 GSB19H41

S SWAP TABLES

RACETRACK TOPS, 24"D

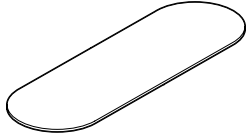

Racetrack Tops, 24"D

MODEL#	DIMENSIONS	FREIGHT CLASS	WT/LBS.	CUBIC FT.	LIST PRICE	HP ADD	GR. 2 ADD	R3 ADD	KS ADD
--------	------------	---------------	---------	-----------	------------	--------	-----------	--------	--------

D x W x H

TFL, flat edge ⁽¹⁾

GRC5STP	24 x 60 x 1	65	41	1.79	\$503	\$228	n/a	n/a	n/a
GRC5HSTP	24 x 66 x 1	65	46	1.97	\$588	\$269	n/a	n/a	n/a
GRC6STP	24 x 72 x 1	65	49	2.14	\$614	\$277	n/a	n/a	n/a
GRC7STP	24 x 84 x 1	65	57	2.49	\$710	\$322	n/a	n/a	n/a
GRC8STP	24 x 96 x 1	65	66	2.84	\$762	\$343	n/a	n/a	n/a

HPL, knife edge

GRC5STPLK	24 x 60 x 1.19	85	49	4	\$1332	n/a	n/a	n/a	n/a
GRC5HSTPLK	24 x 66 x 1.19	85	55	4.5	\$1465	n/a	n/a	n/a	n/a
GRC6STPLK	24 x 72 x 1.19	92.5	59	5	\$1599	n/a	n/a	n/a	n/a
GRC7STPLK	24 x 84 x 1.19	85	68	5.5	\$1732	n/a	n/a	n/a	n/a
GRC8STPLK	24 x 96 x 1.19	85	79	6.5	\$1864	n/a	n/a	n/a	n/a

Veneer ⁽²⁾

GRC5STPV	24 x 60 x 1.19	85	49	4	\$1599	n/a	n/a	n/a	\$240
GRC5HSTPV	24 x 66 x 1.19	85	55	4.5	\$1759	n/a	n/a	n/a	\$267
GRC6STPV	24 x 72 x 1.19	92.5	59	5	\$1919	n/a	n/a	n/a	\$288
GRC7STPV	24 x 84 x 1.19	85	68	5.5	\$2237	n/a	n/a	n/a	\$288
GRC8STPV	24 x 96 x 1.19	85	79	6.5	\$2556	n/a	n/a	n/a	\$288

Applicable bases to use with above tops: GRB22Hxx round or GSB19Hxx square base @ 26"H, 35"H & 40.5"H (see 810). Tops feature metal inserts for ease of assembly to base. **Two bases required.** 24"D tops not recommended with 28"H bases.

Required Specifications

Top finish
Edge finish⁽¹⁾

Optional Specifications

HP laminate⁽¹⁾, Knife edge⁽²⁾
Grade 2 solid surface⁽³⁾
3" radiused corners⁽⁴⁾
Cut-out for grommet/power blocks

Applicable Bases, two required

GRB22H26 GSB19H26
GRB22 GSB19
GRB22H35 GSB19H35
GRB22H41 GSB19H41

RECTANGULAR TOPS, 60"-96"W

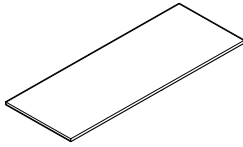

MODEL#	DIMENSIONS	FREIGHT CLASS	WT/LBS.	CUBIC FT.	LIST PRICE	HP ADD	GR. 2 ADD	R3 ADD	KS ADD
--------	------------	---------------	---------	-----------	------------	--------	-----------	--------	--------

D x W x H

TFL, flat edge ^{(1) (4)}

GRT5NTP	30 x 60 x 1	70	46	2.5	\$573	\$290	n/a	\$58	n/a
GRT5NHTP	30 x 66 x 1	65	56	2.44	\$579	\$262	n/a	\$59	n/a
GRT6NTP	30 x 72 x 1	70	62	3	\$622	\$314	n/a	\$63	n/a
GRT7NTP	30 x 84 x 1	100	72	7.5	\$775	\$390	n/a	\$78	n/a
GRT8NTP	30 x 96 x 1	100	80	8.5	\$843	\$423	n/a	\$86	n/a
GRT5TP	36 x 60 x 1	92.5	70	6.6	\$587	\$265	n/a	\$60	n/a
GRT5HTP	36 x 66 x 1	92.5	79	7.21	\$618	\$281	n/a	\$62	n/a
GRT6TP	36 x 72 x 1	100	72	8	\$717	\$359	n/a	\$73	n/a
GRT7TP	36 x 84 x 1	100	85	8.75	\$833	\$420	n/a	\$85	n/a
GRT8TP	36 x 96 x 1	92.5	94	9	\$912	\$460	n/a	\$92	n/a

HPL, knife edge

GRT5NTPLK	30 x 60 x 1.19	92.5	55	5	\$1188	n/a	n/a	n/a	n/a
GRT5NHTPLK	30 x 66 x 1.19	85	67	5.5	\$1305	n/a	n/a	n/a	n/a
GRT6NTPLK	30 x 72 x 1.19	85	74	6	\$1429	n/a	n/a	n/a	n/a
GRT7NTPLK	30 x 84 x 1.19	85	86	7	\$1658	n/a	n/a	n/a	n/a
GRT8NTPLK	30 x 96 x 1.19	85	96	8	\$1896	n/a	n/a	n/a	n/a
GRT5TPLK	36 x 60 x 1.19	85	84	6	\$1429	n/a	n/a	n/a	n/a
GRT5HTPLK	36 x 66 x 1.19	85	95	6.5	\$1566	n/a	n/a	n/a	n/a
GRT6TPLK	36 x 72 x 1.19	85	86	7	\$1710	n/a	n/a	n/a	n/a
GRT7TPLK	36 x 84 x 1.19	85	102	8	\$1992	n/a	n/a	n/a	n/a
GRT8TPLK	36 x 96 x 1.19	85	113	9	\$2280	n/a	n/a	n/a	n/a

Veneer ⁽²⁾

GRT5NTPV	30 x 60 x 1.19	92.5	55	5	\$1651	n/a	n/a	n/a	\$80
GRT5NHTPV	30 x 66 x 1.19	85	67	5.5	\$1763	n/a	n/a	n/a	\$80
GRT6NTPV	30 x 72 x 1.19	85	74	6	\$1896	n/a	n/a	n/a	\$103
GRT7NTPV	30 x 84 x 1.19	85	86	7	\$2217	n/a	n/a	n/a	\$119
GRT8NTPV	30 x 96 x 1.19	85	96	8	\$2530	n/a	n/a	n/a	\$135
GRT5TPV	36 x 60 x 1.19	85	84	6	\$1896	n/a	n/a	n/a	\$103
GRT5HTPV	36 x 66 x 1.19	85	95	6.5	\$2078	n/a	n/a	n/a	\$135
GRT6TPV	36 x 72 x 1.19	85	86	7	\$2265	n/a	n/a	n/a	\$151
GRT7TPV	36 x 84 x 1.19	85	102	8	\$2642	n/a	n/a	n/a	\$187
GRT8TPV	36 x 96 x 1.19	85	113	9	\$3026	n/a	n/a	n/a	\$187

Solid Surface, flat edge ^{(3) (4)}

GRT5NTPSF	29.8 x 60 x 1.25	65	94	3.4	\$4276	n/a	\$454	\$103	n/a
GRT5NHTPSF	29.8 x 66 x 1.25	65	104	3.8	\$4589	n/a	\$528	\$103	n/a
GRT6NTPSF	29.8 x 71.8 x 1.25	65	113	4.1	\$5238	n/a	\$736	\$103	n/a
GRT7NTPSF	29.8 x 84 x 1.25	65	132	4.8	\$6076	n/a	\$725	\$103	n/a
GRT8NTPSF	29.8 x 96 x 1.25	65	150	5.4	\$6689	n/a	\$939	\$103	n/a
GRT5TPSF	36 x 60 x 1.25	65	113	4.1	\$5691	n/a	\$675	\$103	n/a
GRT5HTPSF	36 x 66 x 1.25	65	124	4.5	\$5874	n/a	\$675	\$103	n/a
GRT6TPSF	36 x 71.8 x 1.25	65	135	4.9	\$6487	n/a	\$736	\$103	n/a
GRT7TPSF	36 x 84 x 1.25	65	158	5.7	\$7056	n/a	\$889	\$103	n/a
GRT8TPSF	36 x 96 x 1.25	65	180	6.5	\$7571	n/a	\$932	\$103	n/a

Solid Surface, knife edge ^{(3) (4)}

GRT5NTPSK	29.8 x 60 x 1.25	65	94	3.4	\$4680	n/a	\$516	\$216	n/a
GRT5NHTPSK	29.8 x 66 x 1.25	65	104	3.8	\$5054	n/a	\$601	\$216	n/a
GRT6NTPSK	29.8 x 71.8 x 1.25	65	113	4.1	\$5697	n/a	\$823	\$216	n/a
GRT7NTPSK	29.8 x 84 x 1.25	65	132	4.8	\$6535	n/a	\$823	\$216	n/a
GRT8NTPSK	29.8 x 96 x 1.25	65	150	5.4	\$7258	n/a	\$1048	\$216	n/a
GRT5TPSK	36 x 60 x 1.25	65	113	4.1	\$6303	n/a	\$761	\$216	n/a
GRT5HTPSK	36 x 66 x 1.25	65	124	4.5	\$6462	n/a	\$773	\$216	n/a
GRT6TPSK	36 x 71.8 x 1.25	65	135	4.9	\$7159	n/a	\$846	\$216	n/a
GRT7TPSK	36 x 84 x 1.25	65	158	5.7	\$7736	n/a	\$1012	\$216	n/a
GRT8TPSK	36 x 96 x 1.25	65	180	6.5	\$8237	n/a	\$1068	\$216	n/a

Applicable bases to use with above tops, TWO bases required: rounds GRB22H26, GRB22, GRB22H35, GRB22H41, or squares GSB19H26, GSB19, GSB19H35, GSB19H41(see 810). Tops feature metal inserts for ease of assembly to base.

Rectangular Tops*

Required Specifications

Top finish
Edge finish⁽¹⁾

Optional Specifications

HP laminate⁽¹⁾, Knife edge⁽²⁾
Grade 2 solid surface⁽³⁾
3" radiused corners⁽⁴⁾
Cut-out for grommet/power blocks

Applicable Bases, two required

GRB22H26 GSB19H26
GRB22 GSB19
GRB22H35 GSB19H35
GRB22H41 GSB19H41

S SWAP TABLES

RACETRACK TOPS, 60"-96"W

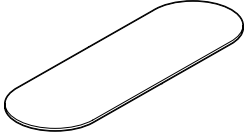

Racetrack Tops, 60"-96"W

MODEL# DIMENSIONS FREIGHT CLASS WT/LBS. CUBIC FT. LIST PRICE HP ADD GR. 2 ADD R3 ADD KS ADD

D x W x H

TFL, flat edge ⁽¹⁾

GRC5NTP	30 x 60 x 1	70	46	2.5	\$583	\$293	n/a	n/a	n/a
GRC5NHTP	30 x 66 x 1	65	56	2.44	\$589	\$269	n/a	n/a	n/a
GRC6NTP	30 x 72 x 1	70	62	3	\$633	\$319	n/a	n/a	n/a
GRC7NTP	30 x 84 x 1	100	72	7.5	\$789	\$397	n/a	n/a	n/a
GRC8NTP	30 x 96 x 1	100	80	8.5	\$860	\$432	n/a	n/a	n/a
GRC5TP	36 x 60 x 1	92.5	70	6.6	\$599	\$272	n/a	n/a	n/a
GRC5HTP	36 x 66 x 1	92.5	79	7.21	\$630	\$285	n/a	n/a	n/a
GRC6TP	36 x 72 x 1	100	72	7.5	\$729	\$367	n/a	n/a	n/a
GRC7TP	36 x 84 x 1	100	85	8.75	\$851	\$428	n/a	n/a	n/a
GRC8TP	36 x 96 x 1	92.5	94	9	\$930	\$467	n/a	n/a	n/a

HPL, knife edge

GRC5NTPLK	30 x 60 x 1.19	92.5	55	5	\$1662	n/a	n/a	n/a	n/a
GRC5NHTPLK	30 x 66 x 1.19	85	67	5.5	\$1822	n/a	n/a	n/a	n/a
GRC6NTPLK	30 x 72 x 1.19	85	74	6	\$1992	n/a	n/a	n/a	n/a
GRC7NTPLK	30 x 84 x 1.19	85	86	7	\$2141	n/a	n/a	n/a	n/a
GRC8NTPLK	30 x 96 x 1.19	85	96	8	\$2301	n/a	n/a	n/a	n/a
GRC5TPLK	36 x 60 x 1.19	85	84	6	\$1822	n/a	n/a	n/a	n/a
GRC5HTPLK	36 x 66 x 1.19	85	95	6.5	\$1981	n/a	n/a	n/a	n/a
GRC6TPLK	36 x 72 x 1.19	85	86	7	\$2152	n/a	n/a	n/a	n/a
GRC7TPLK	36 x 84 x 1.19	85	102	8	\$2471	n/a	n/a	n/a	n/a
GRC8TPLK	36 x 96 x 1.19	85	113	9	\$2792	n/a	n/a	n/a	n/a

Veneer ⁽²⁾

GRC5NTPV	30 x 60 x 1.19	92.5	55	5	\$1880	n/a	n/a	n/a	\$283
GRC5NHTPV	30 x 66 x 1.19	85	67	5.5	\$2030	n/a	n/a	n/a	\$305
GRC6NTPV	30 x 72 x 1.19	85	74	6	\$2184	n/a	n/a	n/a	\$325
GRC7NTPV	30 x 84 x 1.19	85	86	7	\$2552	n/a	n/a	n/a	\$380
GRC8NTPV	30 x 96 x 1.19	85	96	8	\$2909	n/a	n/a	n/a	\$432
GRC5TPV	36 x 60 x 1.19	85	84	6	\$2184	n/a	n/a	n/a	\$325
GRC5HTPV	36 x 66 x 1.19	85	95	6.5	\$2392	n/a	n/a	n/a	\$357
GRC6TPV	36 x 72 x 1.19	85	86	7	\$2605	n/a	n/a	n/a	\$390
GRC7TPV	36 x 84 x 1.19	85	102	8	\$3042	n/a	n/a	n/a	\$390
GRC8TPV	36 x 96 x 1.19	85	113	9	\$3478	n/a	n/a	n/a	\$517

Applicable bases to use with above tops, TWO bases required: rounds GRB22H26, GRB22, GRB22H35, GRB22H41, or squares GSB19H26, GSB19, GSB19H35, GSB19H41 (see 810). Tops feature metal inserts for ease of assembly to base.

Required Specifications

Top finish
Edge finish⁽¹⁾

Optional Specifications

HP laminate⁽¹⁾
Knife edge⁽²⁾
Cut-out for grommet/power blocks

Applicable Bases, two required

GRB22H26 GSB19H26
GRB22 GSB19
GRB22H35 GSB19H35
GRB22H41 GSB19H41

BOAT SHAPED, 60"-96"W

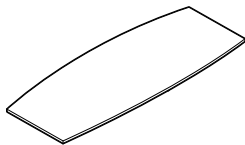

MODEL#	DIMENSIONS	FREIGHT CLASS	WT/LBS.	CUBIC FT.	LIST PRICE	HP ADD GR. 2 ADD	R3 ADD	KS ADD
--------	------------	---------------	---------	-----------	------------	------------------	--------	--------

D x W x H

TFL, flat edge ⁽¹⁾

GBT5NTP	30 x 60 x 1	70	46	2.5	\$583	\$293	n/a	n/a	n/a
GBT5NHTP	30 x 66 x 1	65	56	2.44	\$589	\$269	n/a	n/a	n/a
GBT6NTP	30 x 72 x 1	70	62	3	\$633	\$319	n/a	n/a	n/a
GBT7NTP	30 x 84 x 1	100	72	7.5	\$789	\$397	n/a	n/a	n/a
GBT8NTP	30 x 96 x 1	100	80	8.5	\$860	\$432	n/a	n/a	n/a
GBT5TP	36 x 60 x 1	92.5	70	6.6	\$599	\$272	n/a	n/a	n/a
GBT5HTP	36 x 66 x 1	92.5	79	7.21	\$630	\$285	n/a	n/a	n/a
GBT6TP	36 x 72 x 1	100	72	7.5	\$729	\$367	n/a	n/a	n/a
GBT7TP	36 x 84 x 1	100	85	8.75	\$851	\$428	n/a	n/a	n/a
GBT8TP	36 x 96 x 1	92.5	94	9	\$930	\$467	n/a	n/a	n/a

HPL, knife edge

GBT5NTPLK	30 x 60 x 1.19	92.5	55	5	\$1662	n/a	n/a	n/a	n/a
GBT5NHTPLK	30 x 66 x 1.19	85	67	5.5	\$1822	n/a	n/a	n/a	n/a
GBT6NTPLK	30 x 72 x 1.19	85	74	6	\$1992	n/a	n/a	n/a	n/a
GBT7NTPLK	30 x 84 x 1.19	85	86	7	\$2141	n/a	n/a	n/a	n/a
GBT8NTPLK	30 x 96 x 1.19	85	96	8	\$2301	n/a	n/a	n/a	n/a
GBT5TPLK	36 x 60 x 1.19	85	84	6	\$1822	n/a	n/a	n/a	n/a
GBT5HTPLK	36 x 66 x 1.19	85	95	6.5	\$1981	n/a	n/a	n/a	n/a
GBT6TPLK	36 x 72 x 1.19	85	86	7	\$2152	n/a	n/a	n/a	n/a
GBT7TPLK	36 x 84 x 1.19	85	102	8	\$2471	n/a	n/a	n/a	n/a
GBT8TPLK	36 x 96 x 1.19	85	113	9	\$2792	n/a	n/a	n/a	n/a

Veneer ⁽²⁾

GBT5NTPV	30 x 60 x 1.19	92.5	55	5	\$1880	n/a	n/a	n/a	\$283
GBT5NHTPV	30 x 66 x 1.19	85	67	5.5	\$2030	n/a	n/a	n/a	\$305
GBT6NTPV	30 x 72 x 1.19	85	74	6	\$2184	n/a	n/a	n/a	\$325
GBT7NTPV	30 x 84 x 1.19	85	86	7	\$2552	n/a	n/a	n/a	\$380
GBT8NTPV	30 x 96 x 1.19	85	96	8	\$2909	n/a	n/a	n/a	\$432
GBT5TPV	36 x 60 x 1.19	85	84	6	\$2184	n/a	n/a	n/a	\$325
GBT5HTPV	36 x 66 x 1.19	85	95	6.5	\$2392	n/a	n/a	n/a	\$357
GBT6TPV	36 x 72 x 1.19	85	86	7	\$2605	n/a	n/a	n/a	\$390
GBT7TPV	36 x 84 x 1.19	85	102	8	\$3042	n/a	n/a	n/a	\$454
GBT8TPV	36 x 96 x 1.19	85	113	9	\$3478	n/a	n/a	n/a	\$517

Boat-Shaped Tops, 60"-96"W

Applicable bases to use with above tops, TWO bases required: rounds GRB22H26, GRB22, GRB22H35, GRB22H41, OR squares GSB19H26, GSB19, GSB19H35, GSB19H41 (see 810). Tops feature metal inserts for ease of assembly to base.

- GBTxNPT - 30"D at center, 24"D at ends; GBTxTP - 36"D at center, 28"D at ends.

Required Specifications

Top finish
Edge finish⁽¹⁾

Optional Specifications

HP laminate⁽¹⁾
Knife edge⁽²⁾
Cut-out for grommet/power blocks

Applicable Bases, two required

GRB22H26	GSB19H26
GRB22	GSB19
GRB22H35	GSB19H35
GRB22H41	GSB19H41

S SWAP TABLES

BASES FOR TOPS 60" - 96" WIDE

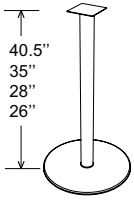

22" Dia Round Bases

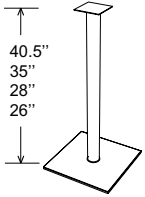

18.5" Square Bases

MODEL#	DIMENSIONS	FREIGHT CLASS	WT/LBS.	CUBIC FT.	LIST PRICE	CHM/BCH
--------	------------	---------------	---------	-----------	------------	---------

D x W x H

GRB22H26	22 x 22 x 26	150	50	8.63	\$995	\$157
GRB22	22 x 22 x 28	150	55	9.33	\$927	\$157
GRB22H35	22 x 22 x 35	150	57.1	12	\$972	\$155
GRB22H41	22 x 22 x 40.5	150	58.3	14	\$989	\$171

GRB22H26 - lounge height **GRB22** - seated height **GRB22H35** - counter height **GRB22H41** - bar height

GSB19H26	18.5 x 18.5 x 26	125	47	5.94	\$1070	\$142
GSB19	18.5 x 18.5 x 28	100	50	6.06	\$1004	\$155
GSB19H35	18.5 x 18.5 x 35	125	51.8	7.52	\$1064	\$155
GSB19H41	18.5 x 18.5 x 40.5	125	53.2	8.77	\$1102	\$171

GSB19H26 - lounge height **GSB19** - seated height **GSB19H35** - counter height **GSB19H41** - bar height

Base comes fully assembled and features 0.5" adjustable glides to level on uneven surfaces. Screws included with base for attaching to appropriate top(s). Available in paint finishes listed on 783; plated finishes as available on 783 (upcharge applies).

Required Specifications
Finish

Optional Specifications
Plated finish

RECTANGULAR TOPS 96" - 144"

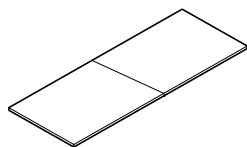

Rectangular Tops, 96-144"

MODEL#	DIMENSIONS	FREIGHT CLASS	WT/LBS.	CUBIC FT.	LIST PRICE	HP ADD	GR. 2 ADD	R3 ADD	KS ADD
--------	------------	---------------	---------	-----------	------------	--------	-----------	--------	--------

D x W x H

TFL, flat edge ⁽¹⁾⁽⁴⁾

1 Piece top - 2 bases required

GRT8MTP	42 x 96 x 1	92.5	128	11.84	\$1536	\$695	n/a	\$155	n/a
GRT8WTP	48 x 96 x 1	85	190	14	\$1555	\$593	n/a	\$157	n/a

2 Piece tops - 3 bases required

GRT10WTP	48 x 120 x 1	85	220	17	\$1956	\$793	n/a	\$196	n/a
GRT12WTP	48 x 144 x 1	65	262	10.5	\$2279	\$897	n/a	\$228	n/a

HPL, knife edge

1 Piece top - 2 bases required

GRT8MTPLK	42 x 96 x 1.19	85	154	11	\$3116	n/a	n/a	n/a	n/a
GRT8WTPLK	48 x 96 x 1.19	70	228	12	\$3494	n/a	n/a	n/a	n/a

2 Piece tops - 3 bases required

GRT10WTPLK	48 x 120 x 1.19	70	264	15	\$4740	n/a	n/a	n/a	n/a
GRT12WTPLK	48 x 144 x 1.19	70	314	18	\$5673	n/a	n/a	n/a	n/a

Veneer ⁽²⁾

1 Piece top - 2 bases required

GRT8MTPV	42 x 96 x 1.19	85	154	11	\$3985	n/a	n/a	n/a	\$396
GRT8WTPV	48 x 96 x 1.19	70	228	12	\$4491	n/a	n/a	n/a	\$449

2 Piece tops - 3 bases required

GRT10WTPV	48 x 120 x 1.19	70	264	15	\$5980	n/a	n/a	n/a	\$598
GRT12WTPV	48 x 144 x 1.19	70	314	18	\$7157	n/a	n/a	n/a	\$714

Applicable bases to use with above tops: round GRB28 or square GSB23. TWO bases required for 96"W tops or THREE bases required for 120" & 144"W tops (see 814). Tops feature metal inserts for ease of assembly to base.

Required Specifications

Top finish
Edge finish⁽¹⁾

Optional Specifications

HP laminate⁽¹⁾
Knife edge⁽²⁾
3" radiused corners⁽⁴⁾
Cut-out for grommet/power blocks

Applicable Bases

GRB28
GSB23

S SWAP TABLES

RACETRACK TOPS 96" - 144"

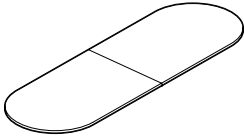

Racetrack Tops, 96-144"

MODEL#	DIMENSIONS	FREIGHT CLASS	WT/LBS.	CUBIC FT.	LIST PRICE	HP ADD	GR. 2 ADD	R3 ADD	KS ADD
D x W x H									
TFL, flat edge ⁽¹⁾									
1 Piece top - 2 bases required									
GRC8MTP	42 x 96 x 1	92.5	128	11.84	\$1536	\$695	n/a	n/a	n/a
GRC8WTP	48 x 96 x 1	85	190	14	\$1555	\$603	n/a	n/a	n/a
2 Piece tops - 3 bases required									
GRC10WTP	48 x 120 x 1	85	220	17	\$1956	\$810	n/a	n/a	n/a
GRC12WTP	48 x 144 x 1	85	262	21	\$2279	\$915	n/a	n/a	n/a
HPL, knife edge									
1 Piece top - 2 bases required									
GRC8MTPLK	42 x 96 x 1.19	85	154	11	\$3729	n/a	n/a	n/a	n/a
GRC8WTPLK	48 x 96 x 1.19	70	228	12	\$4262	n/a	n/a	n/a	n/a
2 Piece tops - 3 bases required									
GRC10WTPLK	48 x 120 x 1.19	70	264	15	\$5327	n/a	n/a	n/a	n/a
GRC12WTPLK	48 x 144 x 1.19	70	314	18	\$6392	n/a	n/a	n/a	n/a
Veneer ⁽²⁾									
1 Piece top - 2 bases required									
GRC8MTPV	42 x 96 x 1.19	85	154	11	\$4740	n/a	n/a	n/a	\$474
GRC8WTPV	48 x 96 x 1.19	70	228	12	\$5272	n/a	n/a	n/a	\$528
2 Piece tops - 3 bases required									
GRC10WTPV	48 x 120 x 1.19	70	264	15	\$6924	n/a	n/a	n/a	\$694
GRC12WTPV	48 x 144 x 1.19	70	314	18	\$8202	n/a	n/a	n/a	\$822

Applicable bases to use with above tops: round GRB28 or square GSB23. TWO bases required for 96"W tops or THREE bases required for 120" & 144"W tops (see 814). Tops feature metal inserts for ease of assembly to base.

Required Specifications

Top finish
Edge finish⁽¹⁾

Optional Specifications

HP laminate⁽¹⁾
Knife edge⁽²⁾
Cut-out for grommet/power blocks

Applicable Bases

GRB28
GSB23

BOAT TOPS 96" - 144"

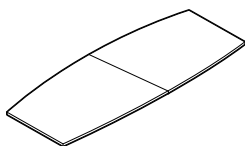

Boat Tops, 96"-144"

MODEL#	DIMENSIONS	FREIGHT CLASS	WT/LBS.	CUBIC FT.	LIST PRICE	HP ADD	GR. 2 ADD	R3 ADD	KS ADD
--------	------------	---------------	---------	-----------	------------	--------	-----------	--------	--------

D x W x H

TFL, flat edge ⁽¹⁾

1 Piece top - 2 bases required

GBT8MTP	42 x 96 x 1	92.5	128	11.84	\$1536	\$695	n/a	n/a	n/a
GBT8WTP	48 x 96 x 1	85	190	14	\$1555	\$603	n/a	n/a	n/a

2 Piece tops - 3 bases required

GBT10WTP	48 x 120 x 1	85	220	17	\$1956	\$810	n/a	n/a	n/a
GBT12WTP	48 x 144 x 1	85	262	21	\$2279	\$915	n/a	n/a	n/a

HPL, knife edge

1 Piece top - 2 bases required

GBT8MTPLK	42 x 96 x 1.19	85	154	11	\$3729	n/a	n/a	n/a	n/a
GBT8WTPLK	48 x 96 x 1.19	70	228	12	\$4262	n/a	n/a	n/a	n/a

2 Piece tops - 3 bases required

GBT10WTPLK	48 x 120 x 1.19	70	264	15	\$5327	n/a	n/a	n/a	n/a
GBT12WTPLK	48 x 144 x 1.19	70	314	18	\$6392	n/a	n/a	n/a	n/a

Veneer ⁽²⁾

1 Piece top - 2 bases required

GBT8MTPV	42 x 96 x 1.19	85	154	11	\$4740	n/a	n/a	n/a	\$474
GBT8WTPV	48 x 96 x 1.19	70	228	12	\$5272	n/a	n/a	n/a	\$528

2 Piece tops - 3 bases required

GBT10WTPV	48 x 120 x 1.19	70	264	15	\$6924	n/a	n/a	n/a	\$694
GBT12WTPV	48 x 144 x 1.19	70	314	18	\$8202	n/a	n/a	n/a	\$822

Applicable bases to use with above tops: round GRB28 or square GSB23. TWO bases required for 96"W tops or THREE bases required for 120" & 144"W tops (see 814). Tops feature metal inserts for ease of assembly to base.

- GBTxM - 42" deep at center and 33" deep at ends; GBTxW - 48" deep at center and 38" deep at ends.

Required Specifications

Top finish
Edge finish⁽¹⁾

Optional Specifications

HP laminate⁽¹⁾
Knife edge⁽²⁾
Cut-out for grommet/power blocks

Applicable Bases

GRB28
GSB23

S SWAP TABLES

BASES FOR TOPS 96"- 144" WIDE

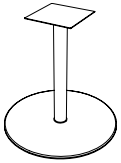

28" Dia Round Base

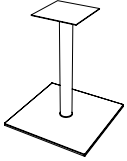

23" Square Base

MODEL# DIMENSIONS FREIGHT CLASS WT./LBS. CUBIC FT. LIST PRICE CHM/BCH

D x W x H

GRB28	28 x 28 x 28	125	100	15.63	\$1596	\$171
seated height						

GSB23	22.5 x 22.5 x 28	100	82	9.33	\$1467	\$95
seated height						

Base comes fully assembled and features 0.5" adjustable glides to level on uneven surfaces. Screws included with base for attaching to appropriate top(s). Available in paint finishes listed on 783; plated finishes as available on 783 (upcharge applies).

Required Specifications
Finish

Optional Specifications
Plated finish

RECTANGULAR TOPS FOR DUAL COLUMN BASE **MODEL#** **DIMENSIONS** **FREIGHT CLASS** **WT/LBS.** **CUBIC FT.** **LIST PRICE** **HP ADD GR. 2 ADD** **R3 ADD** **KS ADD**

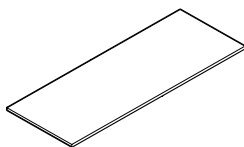

D x W x H

TFL, flat edge ⁽¹⁾⁽⁴⁾

GRTD5TP	36 x 60 x 1	100	60	6.6	\$698	\$325	n/a	\$71	n/a
GRTD5HTP	36 x 66 x 1	100	69	7.21	\$762	\$356	n/a	\$77	n/a
GRTD6TP	36 x 72 x 1	100	75	7.82	\$785	\$366	n/a	\$79	n/a
GRTD5MTP	42 x 60 x 1	100	73	7.62	\$775	\$359	n/a	\$78	n/a
GRTD5HMTP	42 x 66 x 1	100	81	8.32	\$827	\$385	n/a	\$84	n/a
GRTD6MTP	42 x 72 x 1	100	89	9.02	\$851	\$396	n/a	\$86	n/a

HPL, knife edge

GRTD5TPLK	36 x 60 x 1.19	85	72	6	\$1429	n/a	n/a	n/a	n/a
GRTD5HTPLK	36 x 66 x 1.19	85	83	6.5	\$1566	n/a	n/a	n/a	n/a
GRTD6TPLK	36 x 72 x 1.19	85	90	7	\$1710	n/a	n/a	n/a	n/a
GRTD5MTPLK	42 x 60 x 1.19	85	88	7	\$1658	n/a	n/a	n/a	n/a
GRTD5HMTPK	42 x 66 x 1.19	85	97	7.5	\$1828	n/a	n/a	n/a	n/a
GRTD6MTPLK	42 x 72 x 1.19	85	107	8	\$1992	n/a	n/a	n/a	n/a

Veneer ⁽²⁾

GRTD5TPV	36 x 60 x 1.19	85	72	6	\$1896	n/a	n/a	n/a	\$193
GRTD5HTPV	36 x 66 x 1.19	85	83	6.5	\$2078	n/a	n/a	n/a	\$209
GRTD6TPV	36 x 72 x 1.19	85	90	7	\$2265	n/a	n/a	n/a	\$224
GRTD5MTPV	42 x 60 x 1.19	85	88	7	\$2206	n/a	n/a	n/a	\$220
GRTD5HMTPV	42 x 66 x 1.19	85	97	7.5	\$2423	n/a	n/a	n/a	\$240
GRTD6MTPV	42 x 72 x 1.19	85	107	8	\$2642	n/a	n/a	n/a	\$267

Rectangular Top*

Top features metal inserts for ease of assembly to base. One dual column base #GDCB36H28 required (see 818). Limited cut-out options available for power modules include A2, E2, J2, V2 or AG2 only. Power modules corresponding to applicable cut-out codes ordered separately.

Required Specifications

Top finish
Edge finish⁽¹⁾

Optional Specifications

HP laminate⁽¹⁾
Knife edge⁽²⁾
3" radiused corners⁽⁴⁾
Cut-out for grommet/power blocks

Applicable Bases

GDCB36H28

S SWAP TABLES

RACETRACK TOPS FOR DUAL COLUMN BASE

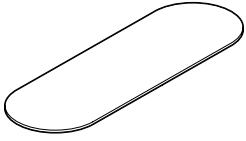

MODEL# DIMENSIONS FREIGHT CLASS WT/LBS. CUBIC FT. LIST PRICE HP ADD GR. 2 ADD R3 ADD KS ADD

D x W x H

TFL, flat edge ⁽¹⁾

GRCD5TP	36 x 60 x 1	100	60	6.6	\$698	\$325	n/a	n/a	n/a
GRCD5HTP	36 x 66 x 1	100	69	7.21	\$762	\$356	n/a	n/a	n/a
GRCD6TP	36 x 72 x 1	100	75	7.82	\$785	\$366	n/a	n/a	n/a
GRCD5MTP	42 x 60 x 1	100	73	7.62	\$775	\$359	n/a	n/a	n/a
GRCD5HMTP	42 x 66 x 1	100	81	8.32	\$827	\$385	n/a	n/a	n/a
GRCD6MTP	42 x 72 x 1	100	89	9.02	\$851	\$396	n/a	n/a	n/a

HPL, knife edge

GRCD5TPLK	36 x 60 x 1.19	85	72	6	\$1997	n/a	n/a	n/a	n/a
GRCD5HTPLK	36 x 66 x 1.19	85	83	6.5	\$2132	n/a	n/a	n/a	n/a
GRCD6TPLK	36 x 72 x 1.19	85	90	7	\$2265	n/a	n/a	n/a	n/a
GRCD5MTPLK	42 x 60 x 1.19	85	88	7	\$2397	n/a	n/a	n/a	n/a
GRCD5HMTPK	42 x 66 x 1.19	85	97	7.5	\$2530	n/a	n/a	n/a	n/a
GRCD6MTPLK	42 x 72 x 1.19	85	107	8	\$2664	n/a	n/a	n/a	n/a

Veneer ⁽²⁾

GRCD5TPV	36 x 60 x 1.19	85	72	6	\$2397	n/a	n/a	n/a	\$240
GRCD5HTPV	36 x 66 x 1.19	85	83	6.5	\$2530	n/a	n/a	n/a	\$252
GRCD6TPV	36 x 72 x 1.19	85	90	7	\$2664	n/a	n/a	n/a	\$267
GRCD5MTPV	42 x 60 x 1.19	85	88	7	\$2797	n/a	n/a	n/a	\$283
GRCD5HMTPV	42 x 66 x 1.19	85	97	7.5	\$2929	n/a	n/a	n/a	\$294
GRCD6MTPV	42 x 72 x 1.19	85	107	8	\$3062	n/a	n/a	n/a	\$305

Racetrack Tops for Dual Column Base

Top features metal inserts for ease of assembly to base. One dual column base #GDCB36H28 required (see 818). Limited cut-out options available for power modules include A2, E2, J2, V2 or AG2 only. Power modules corresponding to applicable cut-out codes ordered separately.

Required Specifications

Top finish
Edge finish⁽¹⁾

Optional Specifications

HP laminate⁽¹⁾
Knife edge⁽²⁾
Cut-out for grommet/power blocks

Applicable Bases

GDCB36H28

BOAT SHAPED TOPS FOR DUAL COLUMN BASE **MODEL#** **DIMENSIONS** **FREIGHT CLASS** **WT/LBS.** **CUBIC FT.** **LIST PRICE** **HP ADD GR. 2 ADD** **R3 ADD** **KS ADD**

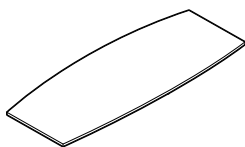

D x W x H

TFL, flat edge ⁽¹⁾

GBTD5TP	36 x 60 x 1	100	60	6.6	\$698	\$325	n/a	n/a	n/a
GBTD5HTP	36 x 66 x 1	100	69	7.21	\$762	\$356	n/a	n/a	n/a
GBTD6TP	36 x 72 x 1	100	75	7.82	\$785	\$366	n/a	n/a	n/a
GBTD5MTP	42 x 60 x 1	100	73	7.62	\$775	\$359	n/a	n/a	n/a
GBTD5HMTP	42 x 66 x 1	100	81	8.32	\$827	\$385	n/a	n/a	n/a
GBTD6MTP	42 x 72 x 1	100	89	9.02	\$851	\$396	n/a	n/a	n/a

HPL, knife edge

GBTD5TPLK	36 x 60 x 1.19	85	72	6	\$1997	n/a	n/a	n/a	n/a
GBTD5HTPLK	36 x 66 x 1.19	85	83	6.5	\$2132	n/a	n/a	n/a	n/a
GBTD6TPLK	36 x 72 x 1.19	85	90	7	\$2265	n/a	n/a	n/a	n/a
GBTD5MTPLK	42 x 60 x 1.19	85	88	7	\$2397	n/a	n/a	n/a	n/a
GBTD5HMTPK	42 x 66 x 1.19	85	97	7.5	\$2530	n/a	n/a	n/a	n/a
GBTD6MTPLK	42 x 72 x 1.19	85	107	8	\$2664	n/a	n/a	n/a	n/a

Veneer ⁽²⁾

GBTD5TPV	36 x 60 x 1.19	85	72	6	\$2397	n/a	n/a	n/a	\$240
GBTD5HTPV	36 x 66 x 1.19	85	83	6.5	\$2530	n/a	n/a	n/a	\$252
GBTD6TPV	36 x 72 x 1.19	85	90	7	\$2664	n/a	n/a	n/a	\$267
GBTD5MTPV	42 x 60 x 1.19	85	88	7	\$2797	n/a	n/a	n/a	\$283
GBTD5HMTPV	42 x 66 x 1.19	85	97	7.5	\$2929	n/a	n/a	n/a	\$294
GBTD6MTPV	42 x 72 x 1.19	85	107	8	\$3062	n/a	n/a	n/a	\$305

Boat Tops for Dual Column Base

Top features metal inserts for ease of assembly to base. One dual column base #GDCB36H28 required (see 818). Limited cut-out options available for power modules include A2, E2, J2, V2 or AG2 only. Power modules corresponding to applicable cut-out codes ordered separately.

Boat tops:

- 36" deep at the center, are 28" deep across ends; 42" deep at the center, are 33" deep at the ends.

Required Specifications

Top finish
Edge finish⁽¹⁾

Optional Specifications

HP laminate⁽¹⁾
Knife edge⁽²⁾
Cut-out for grommet/power blocks

Applicable Bases

GDCB36H28

S SWAP TABLES

DUAL COLUMN BASE FOR GxTDxxx TOPS

MODEL#

DIMENSIONS

FREIGHT CLASS

WT./LBS.

CUBIC FT.

LIST PRICE

CHM/BCH

D x W x H

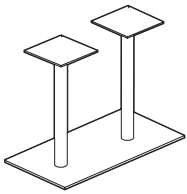

28"H Dual Column Base

Base valid for tops on pages 775-777:

GDCB36H28	36 x 19 x 28	100	116.23	12.16	\$2588	\$604
seated height						

Order the quantity of bases as indicated by each top size.

Base ships knocked-down; assembly required. Features 0.5" adjustable glides to level on uneven surfaces. Screws included with base for attaching to appropriate top(s). Available in paint finishes listed on 783; plated finishes as available on 783 (upcharge applies).

Required Specifications

Finish

Optional Specifications

Plated finish

HUDDLE TABLES OVERVIEW

- Three heights available: seated desk height - 29", counter height - 36", bar height - 41.5" with D top, wedge, rectangular or soft ellipse shaped tops.
- Bring teams together to huddle, share and collaborate.
- Tops include metal inserts for ease of assembly to metal base. All tops are standard with an edge scoop to help manage cables from wall mounted flat screen monitors and/or edge mounting power module (PS305057/PS305002 as an example). Support channels are included with tops over 60" wide.
- Optional cut-outs available where noted. Add **\$103** per cut-out. Only available in position 1 or position 2.

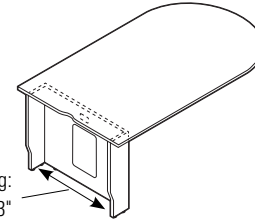
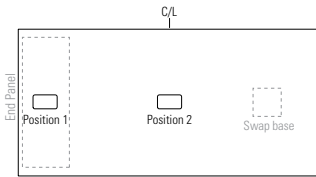

Interior width for base opening:
27.13"/33.3"/39.13"

Please take note when used in conjunction with Zira wall panels.

- Laminate kits are sold separately from metal bases for huddle tables.
- Metal bases ship fully assembled and include 0.5" adjustable glides and metal screws for attaching to the top. Be sure to specify bases specific to huddle tables GRHB22Hxx or GSB19Hxx.

D-TOP HUDDLE TABLES

MODEL#	DIMENSIONS	FREIGHT CLASS	WT./LBS.	CUBIC FT.	LIST PRICE	HP ADD
--------	------------	---------------	----------	-----------	------------	--------

D x W x H

GDH364829	48 x 36 x 29	70	77.05	3.94	\$1138	\$355
GDH366029	60 x 36 x 29	70	86.95	4.46	\$1387	\$503
GDH367229	72 x 36 x 29	70	97	4.98	\$1547	\$600
GDH426029	60 x 42 x 29	70	99.82	5.18	\$1556	\$576
GDH427229	72 x 42 x 29	70	111.5	5.78	\$1744	\$686
GDH428429	84 x 42 x 29	92.5	123.1	11.98	\$1929	\$800
GDH429629	96 x 42 x 29	92.5	134.74	13.3	\$2085	\$891
GDH486029	60 x 48 x 29	70	112.6	5.88	\$1735	\$651
GDH487229	72 x 48 x 29	70	126	6.58	\$1943	\$777
GDH488429	84 x 48 x 29	92.5	139.24	13.5	\$2077	\$858
GDH489629	96 x 48 x 29	92.5	152.56	15	\$2247	\$960

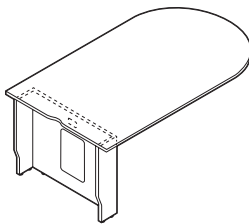

29"H D-Top Huddle

Laminate u-base support is 8"D with 7" inside clearance to wall. Access wall through 14.5"H x 9.5"W hinged door with touch latch in front panel of u-base support. U-base includes 0.5" adjustable glides. U-base side panels are tapered at the bottom to clear most baseboards. Cut-outs available in positions 1 and 2 only; except 36" x 48"D models (cut-out available in position 1 only).

- Metal bases sold separately. Compatible with **GRHB22H28** or **GSHB19H28** only (see 824).

GDH364836	48 x 36 x 36	70	85.95	4.3	\$1174	\$355
GDH366036	60 x 36 x 36	70	95.85	4.84	\$1422	\$503
GDH367236	72 x 36 x 36	70	105.9	5.36	\$1580	\$600
GDH426036	60 x 42 x 36	70	109.82	5.6	\$1595	\$576
GDH427236	72 x 42 x 36	70	121.5	6.22	\$1781	\$686
GDH428436	84 x 42 x 36	92.5	133.1	12.4	\$1968	\$800
GDH429636	96 x 42 x 36	92.5	144.74	13.74	\$2124	\$891
GDH486036	60 x 48 x 36	70	123.6	6.38	\$1778	\$651
GDH487236	72 x 48 x 36	70	137	7.08	\$1987	\$777
GDH488436	84 x 48 x 36	92.5	150.24	14	\$2121	\$858
GDH489636	96 x 48 x 36	92.5	163.56	15.5	\$2289	\$960

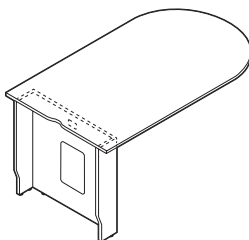

36"H D-Top Huddle

Laminate u-base support is 8"D with 7" inside clearance to wall. Access wall through 14.5"H x 9.5"W hinged door with touch latch in front panel of u-base support. U-base includes 0.5" adjustable glides. U-base side panels are tapered at the bottom to clear most baseboards. Cut-outs available in positions 1 and 2 only; except 36" x 48"D models (cut-out available in position 1 only).

- Metal bases sold separately. Compatible with **GRHB22H35** or **GSHB19H35** only (see 824).

Required Specifications

Top finish
Laminate base finish
Edge

Optional Specifications

HP laminate
Power block cut-out

Accessories

Power block

S SWAP TABLES

D-TOP HUDDLE TABLES

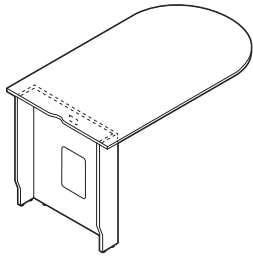

41.5"H D-Top Huddle

MODEL#	DIMENSIONS	FREIGHT CLASS	WT/LBS.	CUBIC FT.	LIST PRICE	HP ADD
--------	------------	---------------	---------	-----------	------------	--------

D x W x H

GDH364841	48 x 36 x 41.5	70	92.65	4.58	\$1234	\$355
GDH366041	60 x 36 x 41.5	70	102.55	5.1	\$1481	\$503
GDH367241	72 x 36 x 41.5	70	112.6	5.62	\$1643	\$600
GDH426041	60 x 42 x 41.5	70	117.32	5.92	\$1663	\$576
GDH427241	72 x 42 x 41.5	70	129	6.52	\$1851	\$686
GDH428441	84 x 42 x 41.5	92.5	140.6	12.72	\$2040	\$800
GDH429641	96 x 42 x 41.5	92.5	152.24	14.06	\$2193	\$891
GDH486041	60 x 48 x 41.5	70	130.1	6.74	\$1855	\$651
GDH487241	72 x 48 x 41.5	70	143.5	7.42	\$2062	\$777
GDH488441	84 x 48 x 41.5	92.5	156.74	14.52	\$2199	\$858
GDH489641	96 x 48 x 41.5	92.5	170.06	15.84	\$2368	\$960

Laminate u-base support is 8"D with 7" inside clearance to wall. Access wall through 14.5"H x 9.5"W hinged door with touch latch in front panel of u-base support. U-base includes 0.5" adjustable glides. U-base side panels are tapered at the bottom to clear most baseboards. Cut-outs available in positions 1 and 2 only; except 36" x 48"D models (cut-out available in position 1 only).

- Metal bases sold separately. Compatible with **GRHB22H41** or **GSHB19H41** only (see 824).

Required Specifications

Top finish
Laminate base finish
Edge

Optional Specifications

HP laminate
Power block cut-out

Accessories

Power block

WEDGE HUDDLE TABLES

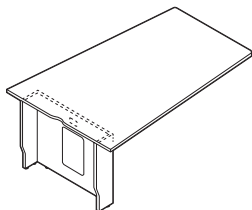

29"H Wedge Huddle

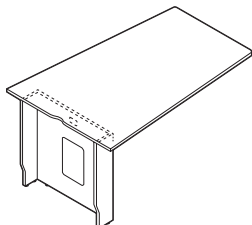

36"H Wedge Huddle

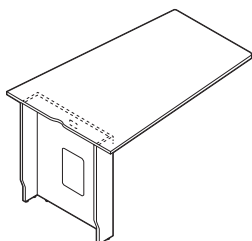

41.5"H Wedge Huddle

MODEL#	DIMENSIONS D x W x H	FREIGHT CLASS	WT./LBS.	CUBIC FT.	LIST PRICE	HP ADD
GWH486029	60 x 48 x 29	70	112.6	5.88	\$1732	\$647
GWH487229	72 x 48 x 29	70	126	6.58	\$1943	\$777
GWH488429	84 x 48 x 29	92.5	139.24	13.5	\$2077	\$858
GWH489629	96 x 48 x 29	92.5	152.56	15	\$2247	\$960

Long end is 48", narrow end 36". Laminate u-base support is 8"D with 7" inside clearance to wall. Access wall through 14.5"H x 9.5"W hinged door with touch latch in front panel of u-base support. U-base includes 0.5" adjustable glides. U-base side panels are tapered at the bottom to clear most baseboards. Cut-outs available in positions 1 and 2 only.

- Metal bases sold separately. Compatible with **GRHB22H28** or **GSHB19H28** only (see 824).

GWH486036	60 x 48 x 36	70	123.6	6.38	\$1774	\$647
GWH487236	72 x 48 x 36	70	137	7.08	\$1987	\$777
GWH488436	84 x 48 x 36	92.5	150.24	14	\$2121	\$858
GWH489636	96 x 48 x 36	92.5	163.56	15.5	\$2289	\$960

Long end is 48", narrow end 36". Laminate u-base support is 8"D with 7" inside clearance to wall. Access wall through 14.5"H x 9.5"W hinged door with touch latch in front panel of u-base support. U-base includes 0.5" adjustable glides. U-base side panels are tapered at the bottom to clear most baseboards. Cut-outs available in positions 1 and 2 only.

- Metal bases sold separately. Compatible with **GRHB22H35** or **GSHB19H35** only (see 824).

GWH486041	60 x 48 x 41.5	70	130.1	6.74	\$1849	\$647
GWH487241	72 x 48 x 41.5	70	143.5	7.42	\$2062	\$777
GWH488441	84 x 48 x 41.5	92.5	156.74	14.34	\$2199	\$858
GWH489641	96 x 48 x 41.5	92.5	170.06	15.84	\$2368	\$960

Long end is 48", narrow end 36". Laminate u-base support is 8"D with 7" inside clearance to wall. Access wall through 14.5"H x 9.5"W hinged door with touch latch in front panel of u-base support. U-base includes 0.5" adjustable glides. U-base side panels are tapered at the bottom to clear most baseboards. Cut-outs available in positions 1 and 2 only.

- Metal bases sold separately. Compatible with **GRHB22H41** or **GSHB19H41** only (see 824).

Required Specifications

Top finish
Laminate base finish
Edge

Optional Specifications

HP laminate
Power block cut-out

Accessories

Power block

S SWAP TABLES

RECTANGULAR HUDDLE TABLES

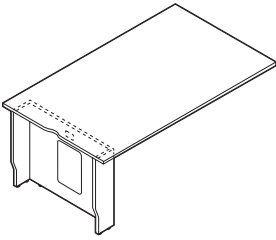

29"H Rectangular Huddle

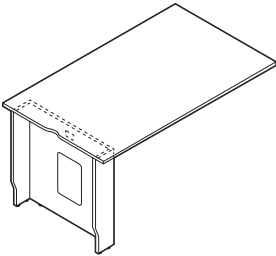

36"H Rectangular Huddle

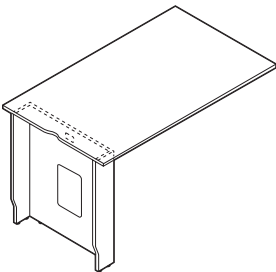

41.5"H Rectangular Huddle*

MODEL#	DIMENSIONS D x W x H	FREIGHT CLASS	WT./LBS.	CUBIC FT.	LIST PRICE	HP ADD
GRH364829	48 x 36 x 29	70	77.05	3.94	\$1138	\$355
GRH366029	60 x 36 x 29	70	86.95	4.46	\$1387	\$503
GRH367229	72 x 36 x 29	70	97	4.98	\$1547	\$600
GRH426029	60 x 42 x 29	70	99.82	5.18	\$1556	\$576
GRH427229	72 x 42 x 29	100	111.5	5.78	\$1744	\$686
GRH428429	84 x 42 x 29	92.5	123.1	11.98	\$1929	\$800
GRH429629	96 x 42 x 29	150	134.74	13.3	\$2085	\$891
GRH486029	60 x 48 x 29	70	112.6	5.88	\$1735	\$651
GRH487229	72 x 48 x 29	70	126	6.58	\$1943	\$777
GRH488429	84 x 48 x 29	92.5	139.24	13.5	\$2077	\$858
GRH489629	96 x 48 x 29	92.5	152.56	15	\$2247	\$960

Laminate u-base support is 8"D with 7" inside clearance to wall. Access wall through 14.5"H x 9.5"W hinged door with touch latch in front panel of u-base support. U-base includes 0.5" adjustable glides. U-base side panels are tapered at the bottom to clear most baseboards. Cut-outs available in positions 1 and 2 only; except 36" x 48"D models (cut-out available in position 1 only).

- Metal bases sold separately. Compatible with **GRHB22H28** or **GSHB19H28** only (see 824)

GRH364836	48 x 36 x 36	70	85.95	4.3	\$1174	\$355
GRH366036	60 x 36 x 36	70	95.85	4.84	\$1422	\$503
GRH367236	72 x 36 x 36	70	105.9	5.36	\$1580	\$600
GRH426036	60 x 42 x 36	70	109.82	5.6	\$1595	\$576
GRH427236	72 x 42 x 36	70	121.5	6.22	\$1781	\$686
GRH428436	84 x 42 x 36	92.5	133.1	12.4	\$1968	\$800
GRH429636	96 x 42 x 36	92.5	144.74	13.74	\$2124	\$891
GRH486036	60 x 48 x 36	70	123.6	6.38	\$1778	\$651
GRH487236	72 x 48 x 36	70	137	7.08	\$1987	\$777
GRH488436	84 x 48 x 36	92.5	150.24	14	\$2121	\$858
GRH489636	96 x 48 x 36	150	163.56	15.5	\$2289	\$960

Laminate u-base support is 8"D with 7" inside clearance to wall. Access wall through 14.5"H x 9.5"W hinged door with touch latch in front panel of u-base support. U-base includes 0.5" adjustable glides. U-base side panels are tapered at the bottom to clear most baseboards. Cut-outs available in positions 1 and 2 only; except 36" x 48"D models (cut-out available in position 1 only).

- Metal bases sold separately. Compatible with **GRHB22H35** or **GSHB19H35** only (see 824).

GRH364841	48 x 36 x 41.5	70	92.65	4.58	\$1234	\$355
GRH366041	60 x 36 x 41.5	70	102.55	5.1	\$1481	\$503
GRH367241	72 x 36 x 41.5	70	112.6	5.62	\$1643	\$600
GRH426041	60 x 42 x 41.5	70	117.32	5.92	\$1663	\$576
GRH427241	72 x 42 x 41.5	70	129	6.52	\$1851	\$686
GRH428441	84 x 42 x 41.5	92.5	140.6	12.72	\$2040	\$800
GRH429641	96 x 42 x 41.5	92.5	152.24	14.06	\$2193	\$891
GRH486041	60 x 48 x 41.5	70	130.1	6.74	\$1855	\$651
GRH487241	72 x 48 x 41.5	70	143.5	7.42	\$2062	\$777
GRH488441	84 x 48 x 41.5	92.5	156.74	14.34	\$2199	\$858
GRH489641	96 x 48 x 41.5	92.5	170.06	15.84	\$2368	\$960

Laminate u-base support is 8"D with 7" inside clearance to wall. Access wall through 14.5"H x 9.5"W hinged door with touch latch in front panel of u-base support. U-base includes 0.5" adjustable glides. U-base side panels are tapered at the bottom to clear most baseboards. Cut-outs available in positions 1 and 2 only; except 36" x 48"D models (cut-out available in position 1 only).

- Metal bases sold separately. Compatible with **GRHB22H41** or **GSHB19H41** only (see 824).

Required Specifications

Top finish
Laminate base finish
Edge

Optional Specifications

HP laminate
Power block cut-out

Accessories

Power block

SOFT ELLIPSE HUDDLE TABLES

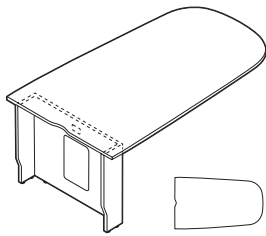

29"H Soft Ellipse Huddle

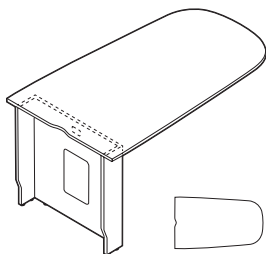

36"H Soft Ellipse Huddle

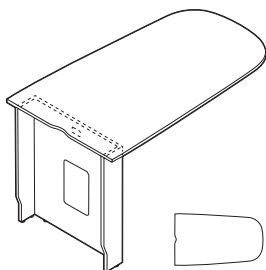

41.5"H Soft Ellipse Huddle*

MODEL#	DIMENSIONS D x W x H	FREIGHT CLASS	WT./LBS.	CUBIC FT.	LIST PRICE	HP ADD
GSEH364829	48 x 36 x 29	70	77.05	3.94	\$1138	\$355
GSEH366029	60 x 36 x 29	70	86.95	4.46	\$1387	\$503
GSEH367229	72 x 36 x 29	70	97	4.98	\$1547	\$600
GSEH426029	60 x 42 x 29	70	99.82	5.18	\$1556	\$576
GSEH427229	72 x 42 x 29	70	111.5	5.78	\$1744	\$686
GSEH428429	84 x 42 x 29	92.5	123.1	11.98	\$1929	\$800
GSEH429629	96 x 42 x 29	92.5	134.7	13.3	\$2085	\$891
GSEH486029	60 x 48 x 29	70	112.6	11.78	\$1735	\$651
GSEH487229	72 x 48 x 29	70	126	6.58	\$1943	\$777
GSEH488429	84 x 48 x 29	92.5	139.2	13.5	\$2077	\$858
GSEH489629	96 x 48 x 29	92.5	152.6	15	\$2247	\$960

Laminate u-base support is 8"D with 7" inside clearance to wall. Access wall through 14.5"H x 9.5"W hinged door with touch latch in front panel of u-base support. U-base includes 0.5" adjustable glides. U-base side panels are tapered at the bottom to clear most baseboards. Cut-outs available in positions 1 and 2 only; except 36" x 48"D models (cut-out available in position 1 only).

- Metal bases sold separately. Compatible with **GRHB22H28** or **GSHB19H28** only (see 824).

GSEH364836	48 x 36 x 36	70	86	4.3	\$1174	\$355
GSEH366036	60 x 36 x 36	70	95.9	4.84	\$1422	\$503
GSEH367236	72 x 36 x 36	70	105.9	5.36	\$1580	\$600
GSEH426036	60 x 42 x 36	70	109.8	5.6	\$1595	\$576
GSEH427236	72 x 42 x 36	70	121.5	6.22	\$1781	\$686
GSEH428436	84 x 42 x 36	92.5	133.1	12.4	\$1968	\$800
GSEH429636	96 x 42 x 36	92.5	144.74	13.74	\$2124	\$891
GSEH486036	60 x 48 x 36	70	123.6	12.76	\$1778	\$651
GSEH487236	72 x 48 x 36	70	137	7.08	\$1987	\$777
GSEH488436	84 x 48 x 36	92.5	150.24	14	\$2121	\$858
GSEH489636	96 x 48 x 36	92.5	163.56	15.5	\$2289	\$960

Laminate u-base support is 8"D with 7" inside clearance to wall. Access wall through 14.5"H x 9.5"W hinged door with touch latch in front panel of u-base support. U-base includes 0.5" adjustable glides. U-base side panels are tapered at the bottom to clear most baseboards. Cut-outs available in positions 1 and 2 only; except 36" x 48"D models (cut-out available in position 1 only).

- Metal bases sold separately. Compatible with **GRHB22H35** or **GSHB19H35** only (see 824).

GSEH364841	48 x 36 x 41.5	92.5	92.65	9.16	\$1234	\$355
GSEH366041	60 x 36 x 41.5	70	102.55	5.1	\$1481	\$503
GSEH367241	72 x 36 x 41.5	70	112.6	5.62	\$1643	\$600
GSEH426041	60 x 42 x 41.5	70	117.32	5.92	\$1663	\$576
GSEH427241	72 x 42 x 41.5	70	129	6.52	\$1851	\$686
GSEH428441	84 x 42 x 41.5	92.5	140.6	12.72	\$2040	\$800
GSEH429641	96 x 42 x 41.5	92.5	152.24	14.06	\$2193	\$891
GSEH486041	60 x 48 x 41.5	70	130.1	6.74	\$1855	\$651
GSEH487241	72 x 48 x 41.5	70	143.5	14.86	\$2062	\$777
GSEH488441	84 x 48 x 41.5	92.5	156.74	14.34	\$2199	\$858
GSEH489641	96 x 48 x 41.5	92.5	170.06	15.84	\$2368	\$960

Laminate u-base support is 8"D with 7" inside clearance to wall. Access wall through 14.5"H x 9.5"W hinged door with touch latch in front panel of u-base support. U-base includes 0.5" adjustable glides. U-base side panels are tapered at the bottom to clear most baseboards. Cut-outs available in positions 1 and 2 only; except 36" x 48"D models (cut-out available in position 1 only).

- Metal bases sold separately. Compatible with **GRHB22H41** or **GSHB19H41** only (see 824).

Required Specifications

Top finish
Laminate base finish
Edge

Optional Specifications

HP laminate
Power block cut-out

Accessories

Power block

S SWAP TABLES

HUDDLE BASES

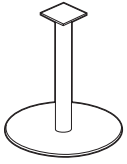

22" Round Huddle Base

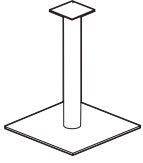

18.5" Square Huddle Base

MODEL#	DIMENSIONS	FREIGHT CLASS	WT./LBS.	CUBIC FT.	LIST PRICE	CHM/BCH
--------	------------	---------------	----------	-----------	------------	---------

D x W x H

SELECT BASE COMPATIBLE WITH TOP HEIGHT:

GRHB22H28	22 x 22 x 28	92.5	10	1	\$1117	\$134
GRHB22H35	22 x 22 x 35	150	62	12.67	\$1117	\$160
GRHB22H41	22 x 22 x 40.5	150	63	14.17	\$1165	\$168

GRHB22H28 - seated height **GRHB22H35** - counter height **GRHB22H41** - bar height

Metal base ships fully assembled. Features 0.5" adjustable glides to level on uneven surfaces. Screws included with base for attaching to appropriate huddle table laminate pieces. Be sure to double check huddle table laminate pieces and metal bases are correct corresponding heights. Available in paint finishes listed on 783; plated finishes as available on 783 (upcharge applies).

GSHB19H28	18.5 x 18.5 x 28	125	55	6.94	\$1193	\$129
GSHB19H35	18.5 x 18.5 x 35	125	57	8.8	\$1193	\$146
GSHB19H41	18.5 x 18.5 x 40.5	150	58	9.84	\$1250	\$160

GSHB19H28 - seated height **GSHB19H35** - counter height **GSHB19H41** - bar height

Metal base ships fully assembled. Features 0.5" adjustable glides to level on uneven surfaces. Screws included with base for attaching to appropriate huddle table laminate pieces. Be sure to double check huddle table laminate pieces and metal bases are correct corresponding heights. Available in paint finishes listed on 783; plated finishes as available on 783 (upcharge applies).

Required Specifications

Finish

Optional Specifications

Plated finish



Terina is a simple flip top table series that transforms any space into sophisticated areas for training, meetings and collaboration. Terina features unique and elegant aluminum, angled t-leg design paired with high pressure laminate or veneer surface, with optional modesty panels. Surface power modules offer an easy way to charge electronic devices without the need to drop down cords. Wires are managed below the worksurface with snap-in cable clips. Terina can be ganged together with optional flush ganging plates. Single hand release mechanism is active from the center of the user side of the table. Tables can be nested together in an upright position to minimize storage space.

Features and Benefits

- Training, meeting or conferencing. A multi-purpose table that allows you quickly and simply adapt your space to suit your needs.
- Simple flip top mechanism designed for single handed operation.
- Tops offered in high pressure laminate or wood veneer
- 10" modesty panel articulates when tables fold down
- Legs and crossbeam offered in 7 paint finishes
- Optional flush ganging plates
- Tables can be nested together when not in use.

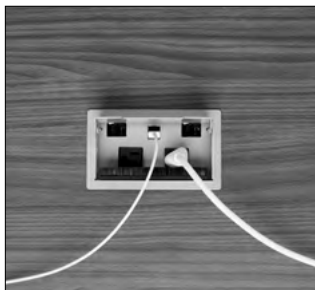

Optional power block includes power and data

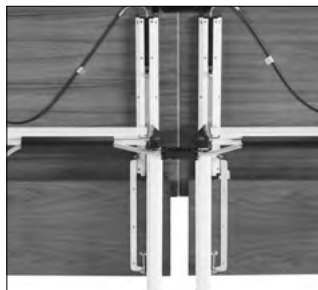

Optional ganging plates and daisy chain power management



Tables can be nested together when not in use.

GENERAL INFORMATION

- Terina flip top tables transform any space into sophisticated areas for training, meetings and collaboration.
- Simple flip top mechanism is designed for one handed operation.
- Unique, angled “T” leg design.
- Shipped R.T.A. (Ready to Assemble).
- For environmental certifications, please visit globalfurnituregroup.com.

WORKSURFACES

- Laminate surfaces are 1-1/16” thick tops constructed of 45 lb. density particle board with high pressure laminate and finished on the underside of the surface with a kraft paper backing.
- Veneer surfaces are 1-3/16” thick tops constructed of 45 lb. density particle board and are balanced on the underside with veneer (unfinished)
- Worksurfaces are pre-drilled for alignment of the Terina base

BASE

- Tables feature an aluminum leg, cross beam and die-cast foot.
- Legs and cross beam are available in (7) different finish options.
- Die-cast foot is always in polished aluminum finish.
- Foot span is 23”

EDGING

- Laminate surfaces offer a selection of matching + coordinated edgeband. Specify separately from the surface finish.
- Veneer tops are finished with a 6mm hardwood edge, stained to match

CASTERS

- Casters are standard on all tables.
- 2-3/8” dual wheel casters with manual lock. Full 360° swivel.
- Suggested for carpeted surfaces.
- Available in grey only

GANGING PLATES

- Ganging plates are available for ganging adjoining tables together.
- Ganging plates are black epoxy coated steel plates with two thumbscrews

WIRE MANAGEMENT

- Wire management option is a snap-in channel that fits on the interior of the leg or on the underside of the flip-top cross beam

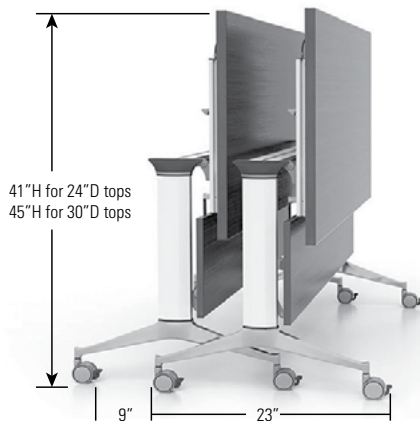

MODESTY PANELS

- 10” modesty panel affixes to the top and base, articulating when it folds down.
- Available in all standard laminates
- Modesty panels up to 60”w have vertical grain. Modesty panels 66” and wider will have horizontal grain.

LAMINATE FINISHES

ACJ	Absolute Acajou	FCL	First Class
ASN	Asian Night	NBL	Noce Biondo
AWC	Avant Cherry	NGL	Noce Grigio
AWH	Avant Honey	NEL	Noce Leggero
BLK	Black	NML	Noce Medio
BZD	Blizzard	QTM	Quartered Mahogany
BRC	Brushed Cobalt	SBY	Sheer Beauty
CMB	Clear Maple	SOG	Storm Grey
CGY	Custom Grey*	SDT	Stonedust
DES	Dark Espresso	WHE	Walnut Heights
DWT	Designer White	WHC	White Chocolate
FAS	Fashionista	WCR	Winter Cherry

*coordinates with SIL edgeband finish

EDGE FINISHES (Laminate Surfaces Only)

AAE	Absolute Acajou	NBL	Noce Biondo
ASE	Asian Night	NGL	Noce Grigio
ACE	Avant Cherry	NEL	Noce Leggero
AHE	Avant Honey	NML	Noce Medio
BLK	Black	QTM	Quartered Mahogany
BRC	Brushed Cobalt	SBY	Sheer Beauty
BZD	Blizzard	SIL	Silver*
CHR	Charcoal (use w/SOG)	SDT	Stonedust
CME	Clear Maple	TPE	Taupe
DEE	Dark Espresso	WHE	Walnut Heights
DWE	Designer White	CBE	White Chocolate
FAS	Fashionista	WCE	Winter Cherry
FCL	First Class		*coordinates with CGY laminate

LEG FINISHES

BLK	Black	BZD	Blizzard*
CHR	Charcoal	DWT	Designer White
NEV	Nevada	SIL	Silver
SDT	Stonedust*	TPE	Taupe
TUN	Tungsten		

*textured finish

VENEER FINISHES:

Code	Finish	Veneer Type	Cut
AMW	Almond Cherry	Cherry	Flat Sliced
ACW	Amber Cherry	Cherry	Flat Sliced
BTW	Biscotti	White Oak	Rift
CAW	Cocoa Walnut	Walnut	Flat Sliced
CRW	Coral	White Oak	Rift
DCW	Dark Cherry	Cherry	Flat Sliced
DWW	Dark Walnut	Walnut	Flat Sliced
EWV	Espresso Walnut	Walnut	Flat Sliced
EVW	Evening Oak	White Oak	Rift
GRW	Grey on Oak	White Oak	Rift
HAW	Hazelnut	Maple	Flat Sliced
JAW	Java	White Oak	Rift

Code	Finish	Veneer Type	Cut
LTW	Latte Walnut	Walnut	Flat Sliced
MHW	Mahogany on Walnut	Walnut	Flat Sliced
MTW	Milestone	White Oak	Rift
MPW	Natural Maple	Maple	Flat Sliced
NLW	Natural Walnut	Walnut	Flat Sliced
RCW	Red Cherry	Cherry	Flat Sliced
ULW	Umber Walnut	Walnut	Flat Sliced
VNW	Vintage Cherry	Cherry	Flat Sliced
WLW	Walnut	Walnut	Flat Sliced
WCW	Warm Cherry	Cherry	Flat Sliced
WMW	White Maple	Maple	Flat Sliced

GROMMETS

- Grommets are available in all tops (left, center or right). Order as: **AG1, AG2 or AG3. Add \$103.**
- Grommet hole dimensions are 3 ¼" wide x 1 7/8" deep.
- Available on all table widths and depths.
- Placement of cut-outs for in-surface power modules is by request. Typical placement for Terina tables is 17" from user edge on 30"D tops or 14" for 24"D tops so as not to interfere with the operation of the GFTxxM folding modesty. If not using a modesty, a custom cut-out location can be requested.
- Grommets may be placed at non-standard locations. Order as: **AGS - Add \$103.** A drawing must be supplied with vertical and horizontal dimensions to the center of the cut-out (as in drawing above). Please refer to CUSTOM GROMMET LOCATION FORM in the back reference section.
- **Please note limited user space when cut-outs are specified. See dimensions on diagram below.**

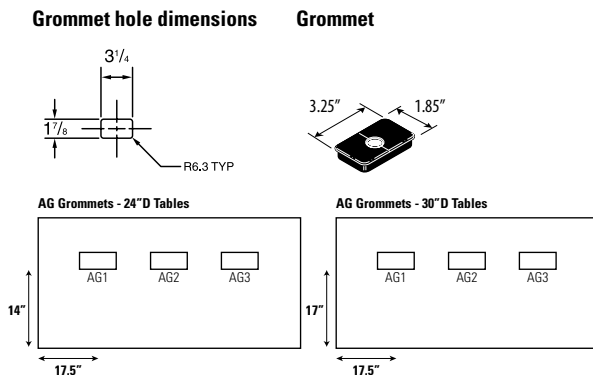

POWER BLOCK

- A Power Block (model **PMSPDM**) may be ordered on all worksurfaces.
- A Power Block is a rectangular worksurface power/data module with one electrical duplex receptacle and two data (RJ45) receptacles. 9' black cord included. Power Block dimensions are 3 ½" deep x 6 ½" wide x 2 ¾" high.
- A Power Block cut-out (for model **PMSPDM**) may be ordered for **tops 60" and up in any standard location.** Order as **E1, E2 or E3. Add \$103.**
- A Power Block cut-out (for model **PMSPDM**) may be ordered in the **center position only for 48" and 54" tops.** Order as **E2. Add \$103.**
- To purchase a Power Block, you must specify both the Power Block cut-out location and the Power Block model #. Order Power Block as **PMSPDM, Add \$352.**
- **Please note limited user space when cut-outs are specified. See dimensions on diagram below.**



Power Block **PMSPDM, Add \$352**

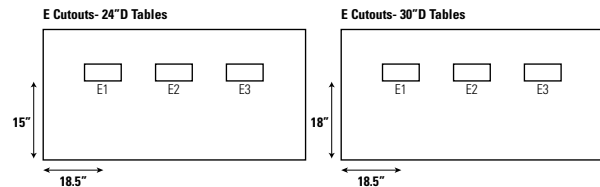

VILLA CUT-OUTS

- A Villa cut-out may be ordered for **tops 60" and up in any standard location.** Order as: **V1, V2 or V3 - Add \$103 for each cut-out.**
- A Villa cut-out may be ordered in the **center position only for 48" and 54" tops.** Order as: **V2 - Add \$103.**
- **Villa with USB is not compatible with Terina tables**
- **Please note limited user space when cut-outs are specified. See dimensions on diagram below.**

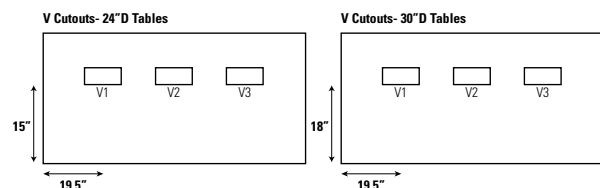

RECTANGULAR TABLES



Rectangular Table - Laminate Top*

MODEL#	DIMENSIONS D x W x H	FREIGHT CLASS	WT/LBS.	CUBIC FT.	LIST PRICE
GFT2472R	24 x 72 x 29	100	66	6.98	\$2024
GFT2466R	24 x 66 x 29	250	61	20.96	\$1985
GFT2460R	24 x 60 x 29	250	55	20.96	\$1952
GFT2454R	24 x 54 x 29	250	53	17.96	\$1907
GFT2448R	24 x 48 x 29	250	48	17.96	\$1745
GFT3072R	30 x 72 x 29	100	68	6.98	\$2086
GFT3066R	30 x 66 x 29	100	66	6.98	\$2064
GFT3060R	30 x 60 x 29	100	61	6.98	\$2031
GFT3054R	30 x 54 x 29	100	55	5.99	\$1985
GFT3048R	30 x 48 x 29	100	53	5.99	\$1863

Tables feature a flip-top **laminated** worksurface for ease of storage. Single hand release mechanism is active from the center of the user side of the table. Leg can be painted in a variety of finishes. Foot is always in polished aluminum. Each table can be ganged together with GFCNGFP ganging plates (see next page). Modesty panels are available (see GFTxxM).

- Casters are available in grey only.



Rectangular Table - Veneer Top

GFT2472RV	24 x 72 x 29	100	66	6.98	\$3360
GFT2466RV	24 x 66 x 29	250	61	20.96	\$3194
GFT2460RV	24 x 60 x 29	250	55	20.96	\$3027
GFT2454RV	24 x 54 x 29	250	53	17.96	\$2932
GFT2448RV	24 x 48 x 29	250	48	17.96	\$2833
GFT3072RV	30 x 72 x 29	100	68	6.98	\$3862
GFT3066RV	30 x 66 x 29	100	66	6.98	\$3651
GFT3060RV	30 x 60 x 29	100	66	6.98	\$3439
GFT3054RV	30 x 54 x 29	100	55	5.99	\$3220
GFT3048RV	30 x 48 x 29	100	53	5.99	\$3006

Tables feature a flip-top **veneer** worksurface for ease of storage. Single hand release mechanism is active from the center of the user side of the table. Leg can be painted in a variety of finishes. Foot is always in polished aluminum. Each table can be ganged together with GFCNGFP ganging plates (see next page). Modesty panels are available (see GFTxxMx).

- Casters are available in grey only.

MODESTY PANELS

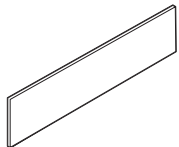

Modesty Panel - Laminate*

MODEL#	DIMENSIONS	FREIGHT CLASS	WT/LBS.	CUBIC FT.	LIST PRICE
GFT72M	.75 x 70 x 10	92.5	20	2	\$369
GFT66M	.75 x 64 x 10	100	18	2	\$351
GFT60M	.75 x 58 x 10	70	15	1	\$337
GFT54M	.75 x 52 x 10	85	13	1	\$323
GFT48M	.75 x 46 x 10	92.5	11	1	\$307

Laminated modesty panel for use on GFTxxxR Tables. Articulating modesty panel includes necessary hardware to attach. Can be retrofitted.

- Modesty panels up to 60" w have vertical grain. Modesty panels 66" and wider will have horizontal grain.

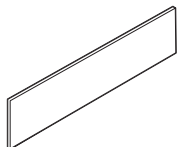

Modesty Panel - Veneer

GFT72MV	.75 x 70 x 10	92.5	20	2	\$1027
GFT66MV	.75 x 64 x 10	100	18	2	\$955
GFT60MV	.75 x 58 x 10	70	15	1	\$867
GFT54MV	.75 x 52 x 10	85	13	1	\$780
GFT48MV	.75 x 46 x 10	92.5	11	1	\$708

Veneer modesty panel for use on GFTxxxR Tables. Articulating modesty panel includes necessary hardware to attach. Can be retrofitted.

- Modesty panels up to 60" w have vertical grain. Modesty panels 66" and wider will have horizontal grain.

Required Specifications

Top finish
Leg finish
Edge finish*

Optional Specifications

Grommet

Accessories

Power block
Wire management
Ganging plate

POWER/DATA



Clamp Mount 2 Power/USB-A&C

MODEL# DIMENSIONS FREIGHT CLASS WT/LBS. CUBIC FT. LIST PRICE

	D x W x H				
PS3525057	3.2 x 5.5 x 3	60	3.01	0.2	\$533
PS3525002	3.2 x 5.5 x 3	60	3.01	0.2	\$533

Ashley Duo clamp mount power module with two 15 amp 120 Volt AC receptacles; 2.4 amp USB-A port and 60 watt USB-C power delivery port, 10' power cord with molded plug, UL listed: UL 962A. Clamp accommodates worksurfaces 0.5" to 1.5" thick; fastened with thumb screws.

- PS3525057 - White module with Silver bracket.
- PS3525002 - Black module with Silver bracket



Under Mount 2 Power/USB-A&C

PS3526057	2.8 x 5.5 x 1.8	60	3.2	0.2	\$533
PS3526002	2.8 x 5.5 x 1.8	60	3.2	0.2	\$533

Ashley Duo under mount power module with two 15 amp 120 Volt AC receptacles; 2.4 amp USB-A port and 60 watt USB-C power delivery port, 10' power cord with molded plug, UL listed: UL 962A. Mountable under most worksurfaces. Installation template provided.

- PS3526057 - White module with Silver bracket
- PS3526002 - Black module with Silver bracket.



Clamp Mount 3 Power/USB-A&C

PS3526957	3.2 x 5.5 x 3	60	3.01	0.2	\$613
PS3526902	3.2 x 5.5 x 3	60	3.01	0.2	\$613

Ashley Trio clamp mount power module with three 15-amp 120 Volt AC receptacles; 2.4-amp USB-A port and 60 watt USB-C power delivery port, 10' power cord with molded plug, and an adapter kit containing blank cover, HDMI, RJ45 or VGA adapter brackets. NOTE: HDMI, RJ45 and VGA connectors are not included. UL listed: UL 962A. Clamp accommodates worksurfaces 0.5" to 1.5" thick; fastened with thumb screws.

- PS305217 - White module with Silver bracket.
- PS305212 - Black module with Silver bracket

WIRE MANAGEMENT



Wire Manager

MODEL# DIMENSIONS FREIGHT CLASS WT/LBS. CUBIC FT. LIST PRICE

GFTCM04BLK	2 x 10 x 2	70	1	1	\$58
------------	------------	----	---	---	------

Set of four, 10" long grey plastic extrusions. Can be snapped into the inside of each leg for wire management from the surface to the floor, or snapped into the cross beam of the table to keep wires tucked neatly below the worksurface.

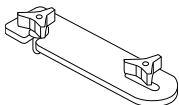

Ganging Flush Plate

GFCNGFP	.1 x 5 x 2.5	70	1	.01	\$58
---------	--------------	----	---	-----	------

Black epoxy coated steel plates with 2 thumbscrews included. Used to connect worksurfaces together. Holes with steel inserts are located in the corner of the tops to accommodate this plate. Sold individually.

Required Specifications

- Finish
- Edge finish*



Zook was designed for today's dynamic and diverse learning environments. The tables are lightweight and can be reconfigured easily to create interactive environments and support collaboration.

Choose from a variety of organic and geometric shaped table tops to optimize flexibility. They are available in a wide array of sizes and finishes in both thermally fused laminate and high pressure laminate. Zook's color palette also includes nine new bold finishes available in high pressure laminate only.

Tops are available in 1" thick thermally fused laminate or 1-1/16" high pressure laminate with Global's preferred matching edge or a new optional ergo friendly edge.

Features and Benefits

- Tops are 1" thick thermally fused laminate or 1-1/16" high pressure laminate.
- Tops are constructed of 45 lb. density particle board.
- Global's preferred matching edge or optional ergo friendly edge.
- Tops are available in organic and geometric shapes.
- Surfaces include factory installed metal inserts for solid and secure leg connections.
- Group table's cable tower is constructed from thermally fused laminate with a removable access panel and inside clearance of 9" x 9". Available on group tables ZK44848P, ZK45959P and ZK65990 only.
- Easy to assemble



Variety of organic and geometric shapes



Multiple table configurations. Ideal for group study and encouraging collaboration.

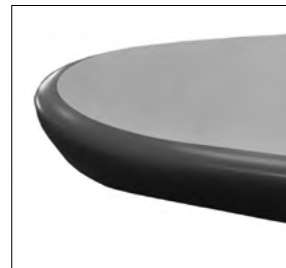

Optional ergo friendly edge

GENERAL INFORMATION

- Zook is a series of tables designed for classrooms and diverse learning environments.
- Organic shapes and rectangular tops are available to create a variety of configurations that naturally bring people together.
- Choose from Zook group tables for groups of 4 to 6 people comfortably, pod tables for individuals, activity tables, or flip top tables.
- Create spaces that encourage discussion and the sharing of ideas
- Supports multi-use, active learning spaces and a variety of teaching styles
- Materials and workmanship stand up to the rigorous demands of today's learning environments
- Shipped easy to assemble. Tops include factory installed metal inserts to accept leg attachment.
- For environmental certifications, please visit globalfurnituregroup.com.

ZOOK GROUP TABLES

- Organic shaped tops available in three sizes: 48" x 48", 59" x 59" or 59" x 90".
- Tops supported by 3" diameter fixed height post legs.
- Select models available with cut-out options for power modules; these select models also include a cable tower for managing cables to floor monuments..

ZOOK POD TABLES

- Available in four geometric shapes; three that when used adjacent to one another, can create various pod configurations as well as rectangular tables in a number of sizes.
- ADA compliant heights available for select models.
- 1.5" diameter fixed height post legs.
- Tables may be specified on levelers or with casters for greater mobility and flexibility

ZOOK ACTIVITY TABLES

- Available in three shapes, all based on a 54" wide footprint.
- Tops are available with two types of mating edges: curved or straight. When planning to mate tables, do not mix mating edge styles.
- 2" diameter tapered legs on levelers or casters.

ZOOK FLIP-TOP TABLES

- Available in three sizes, 30"w x 22"d with concave shaped top; 30"w x 24"d and 60"w x 24"d rectangular top with radius corners.
- Supported by Y legs, equipped with smooth glide casters (two locking). Tungsten (TTU) finish only.
- 60"w tables optional with AG1, AG2, AG3 grommet; ZKFR3024 available with optional AG2 grommet
- Modesty panels are available separately in Tungsten (TUN) finish only.
- Tops and bases sold separately.
- **Caution:** to meet BIFMA standards for performance and stability, appropriate base size must be specified with corresponding top sizes identified.

WORKSURFACES

- Tops are available in 1" thick thermally fused laminate or 1-1/16" thick high pressure laminate
- Available in many finishes in both thermally fused laminate or high pressure laminate
- Worksurface core is made of 45 lb. density particleboard
- Surfaces include factory-installed metal inserts for solid and secure leg connections

WRITEABLE SURFACE OPTION

- Available on group, pod, activity, flip-top and rectangular tables
- High gloss White, non-magnetic dry-erase surface
- Complementary or contrasting edge to be specified, darker edge finish recommended
- Specify (WRW) for top finish. For upcharge, refer to finish option per product.

EDGE DETAIL

- Global's preferred (2mm flat edge) matching edge is standard
- Optional ergo-friendly edge is available at an upcharge (varies by item; see product for details).
- Rectangular tops feature rounded 2.5" radius corners



Ergo friendly edge

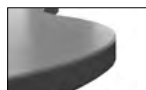

2mm flat edge

LEGS

- **Group tables:** 3" diameter steel post legs, 28" high with adjustable 3" diameter plastic glides. Each leg includes a 6" x 6" metal top plate and ships with truss head screws to connect to tops. See 832 for available finishes.
- **Pod tables:** 1.5" diameter tube steel legs, available with adjustable levelers or dual wheel locking casters. Each leg includes top plate and hardware for mounting. See 832 for available finishes. Optional Chrome (CHM) finish is available for pod tables only. **Add \$84** for three-legged models or **add \$109** for four-legged models
- **Activity tables:** 2" diameter tapered legs available with adjustable levelers or optional locking casters. Each leg includes top plate and hardware for mounting. See 832 for available finishes. Optional Chrome (CHM) finish is available. **Add \$175.**

Group tables

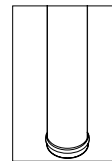

3" dia. leg

Pod tables

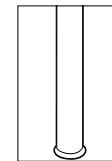

1.5" dia. leg

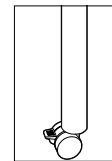

1.5" dia. leg with caster

Activity Tables

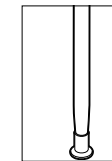

Tapered leg with leveler

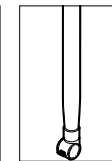

Tapered leg with caster

CASTERS

- Pod table models ending in C indicate legs equipped with 1.5" dia locking casters. Casters are black only.
- Activity table models ending in C indicate legs equipped with 2" dia locking casters. Casters are black only.

GROUP TABLE with CABLE TOWER

- Constructed from thermally fused laminate with a removable access panel
- Inside clearance of 8" x 8.6" will conceal most floor monuments, but still provide easy access.
- Available on group tables ZK44848P, ZK45959P and ZK65990P only.
- Must specify cut-out option when ordering group tables to accommodate select power module. Power modules sold separately.
- Available in Black (BLK), Brushed Cobalt (BRC) or Designer White (DWT) finish

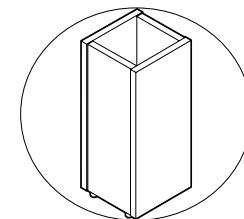

Cable tower

1. SPECIFY MODEL NUMBER

2. SPECIFY TOP FINISH

Thermally Fused and High Pressure Laminate Finishes:

ACJ	Absolute Acajou	CGY	Custom Grey	NML	Noce Medio
ASN	Asian Night	DES	Dark Espresso	QTM	Quartered Mahogany
AWC	Avant Cherry	DWT	Designer White	SBY	Sheer Beauty
AWH	Avant Honey	FAS	Fashionista	SOG	Storm Grey
BLK	Black	FCL	First Class	SDT	Stonedust
BZD	Blizzard	NBL	Noce Biondo	WHE	Walnut Heights
BRC	Brushed Cobalt	NGL	Noce Grigio	WHC	White Chocolate
CMB	Clear Maple	NEL	Noce Leggero	WCR	Winter Cherry

3. SPECIFY EDGE FINISH

2mm Thick Edgebanding:

AAE	Absolute Acajou	FCL	First Class
ASE	Asian Night	NBL	Noce Biondo
ACE	Avant Cherry	NGL	Noce Grigio
AHE	Avant Honey	NEL	Noce Leggero
BLK	Black	NML	Noce Medio
BRC	Brushed Cobalt	QTM	Quartered Mahogany
BZD	Blizzard	SBY	Sheer Beauty
CME	Clear Maple	SDT	Stonedust
CGY	Custom Grey	SOG	Storm Grey
DEE	Dark Espresso	WHE	Walnut Heights
DWE	Designer White	CBE	White Chocolate
FAS	Fashionista	WCE	Winter Cherry

Ergo Friendly Edge Finishes (optional - upcharge applies)

EBL	Black
ECP	Latte
ECG	Charcoal Grey
EDW	Designer White
EGR	Grey

4. SPECIFY LEG FINISH

Legs:

TBL	Black
TBZ	Buzz Blue
TCC	Cactus
TCR	Carrot
TIV	Cloud
TDW	Designer White
TDJ	Dijon
TEG	Eggplant
TFO	Fog
TFR	Frost
TIN	Ink
TKA	Kalua
TLA	Latte
TMO	Mocha
TNE	Nevada
TSN	Sand
TSR	Scarlet
TSH	Shadow
TOA	Toast
TTU	Tungsten
CHM	Chrome**

**Upcharges apply for CHM. Refer to model for upcharges.

Note: Leg finish is not optional for flip-top tables. Available in Tungsten (TTU) only.

FINISH	ACTIVITY	FLIP-TOP	GROUP	POD
Black TBL	•	N/A	•	•
Buzz Blue TBZ	•	N/A	•	•
Cactus TCC	•	N/A	•	•
Carrot TCR	•	N/A	•	•
Chrome CHM	•	N/A	N/A	•
Cloud TIV	•	N/A	•	•
Designer White TDW	•	N/A	•	•
Dijon TDJ	•	N/A	•	•
Eggplant TEG	•	N/A	•	•
Fog TFO	•	N/A	•	•
Frost TFR	•	N/A	•	•
Ink TIN	•	N/A	•	•
Kalua TKA	•	N/A	•	•
Latte TLA	•	N/A	•	•
Mocha TMO	•	N/A	•	•
Nevada TNE	•	N/A	•	•
Sand TSN	•	N/A	•	•
Scarlet TSR	•	N/A	•	•
Shadow TSH	•	N/A	•	•
Toast TOA	•	N/A	•	•
Tungsten TTU	•	•	•	•

SPECIFY CABLE TOWER FINISH - ZK44848P, ZK45959P and ZK65990P only

Cable Tower Finishes:

- BLK Black
- BRC Brushed Cobalt
- DWT Designer White

SPECIFY CUT-OUT OPTION - remember to order power module separately

POWER BLOCK AND CUT-OUT OPTIONS

- A power block delivers power/data to the table surface.
- Power block modules must be ordered separately and available for models ZK44848P, ZK45959P and ZK65990P only.
- Must specify the power block cut-out option when ordering the table.
- Optional cut-out available in the **center position** only and corresponds to select power modules. Order as **R2** or **T2** depending on the power module ordered.
- For a custom size cut-out (must be in center position), please contact Customer Care
- Select power block option from Productivity Solutions, beginning on page 606.

PRTMCS401B
 PRTMCS401T
 PRTMCS401W
 PRTMCS421B
 PRTMCS421T
 PRTMCS421W

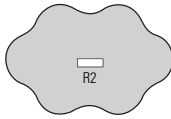

PRTMCD602B
 PRTMCD602T
 PRTMCD602W
 PRTMCD622B
 PRTMCD622T
 PRTMCD622W
 PRTMCD642B
 PRTMCD642T
 PRTMCD642W

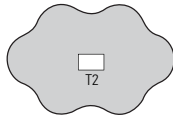

- Match power block desired with cut-out code and location from above grid.
- Example: For power block module # PRTMCS401B, specify cut-out option R2.

MODPOWER DAISY CHAIN SOLUTION

- Add flexible power and USB charging to select Zook tables. Connect up to four units with a single corded infeed with NEMA plug.
- ModPower units are sold separately, refer to Productivity Solutions 609.
- Begin run with a starter unit which includes a corded infeed. Add additional middle or end units as required. Middle and end units are equipped with connecting cables.
- On-surface modules clamp on or screw mount to the table tops.
- In-surface modules require table top cut-outs for mounting. Specify cut-out option:
 - **MPS** for a single cut-out to accommodate one ModPower in-surface unit (cut-out will be centered on the approach side) for **ZKRxxxx(L/C), ZKFR3024* and ZKFR6024*. Add \$103**
 - **MPD** for two cut-outs in the left and right positions, 15" from ends to center of unit on the approach side for **ZKR54xx(L/C), ZKR60xx(L/C), ZKR72xx(L/C) and ZKFR6024*. Add \$204.**

**Note: not for use with Zook flip-top tables if optional modesty panel is specified.*

EXAMPLE ZOOK ORDER CODES:

Group table

ZK65590P	-ACJ	-HPL	-ECG	-TTU	-BRC	-U2
Model #	Top finish	High pressure laminate	Ergo friendly edge and finish	Leg finish	Cable tower finish	Cut out option

Pod table

ZK412529L	-ACJ	-HPL	-WHE	-TTU
Model #	Top finish	High pressure laminate	2mm edge finish	Leg finish

4-6 PERSON GROUP TABLES

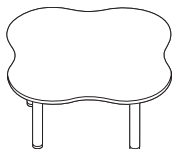

4-Person Table, 20"H

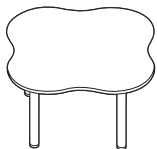

4-Person Table, 29"H

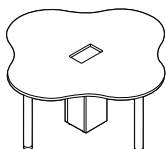

4-Person Table w/Cable Tower, 29"H*

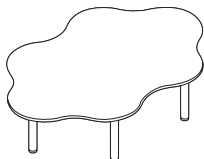

6-Person Table, 20"H

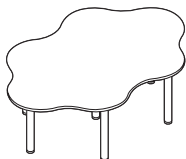

6-Person Table, 29"H

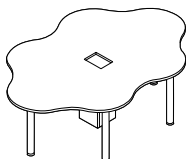

6-Person Table w/Cable Tower, 29"H*

MODEL#	DIMENSIONS D x W x H	FREIGHT CLASS	WT/LBS.	CUBIC FT.	LIST PRICE	HP ADD	ERGO EDGE	WRW
ZK4484820	48 x 48 x 20	60	92	7.10	\$1160	\$338	\$97	\$364
ZK4595920	59 x 59 x 20	65	123	9	\$1192	\$400	\$206	\$544

4-person table includes top and four steel post legs. Top includes factory installed metal inserts for solid and secure leg connections. Legs are 3" in diameter x 19" high each with an adjustable 3" diameter plastic glide and a 6" x 6" metal top plate. Shipped easy to assemble in 5 cartons.

ZK44848	48 x 48 x 29	60	215	7.10	\$1235	\$338	\$97	\$364
ZK45959	59 x 59 x 29	65	220	9.20	\$1270	\$400	\$206	\$544

4-person table includes top and four steel post legs. Top includes factory installed metal inserts for solid and secure leg connections. Legs are 3" in diameter x 28" high each with an adjustable 3" diameter plastic glide and a 6" x 6" metal top plate. Shipped easy to assemble in 5 cartons.

ZK44848P	48 x 48 x 29	65	265	8.86	\$1684	\$338	\$97	\$364
ZK45959P	59 x 59 x 29	65	270	10.96	\$1718	\$400	\$206	\$544

4-person table includes top, four steel post legs and cable tower. Top includes factory installed metal inserts for solid and secure leg connections. Legs are 3" in diameter x 28" high each with an adjustable 3" diameter plastic glide and a 6" x 6" metal top plate. Shipped easy to assemble in 6 cartons. For power block options, see page 606.

ZK6599020	59 x 90 x 20	70	247.50	14	\$1844	\$700	\$304	\$900
-----------	--------------	----	--------	----	---------------	--------------	--------------	--------------

6-person table includes top and seven steel post legs. Top includes factory installed metal inserts for solid and secure leg connections. Legs are 3" in diameter x 19" high each with an adjustable 3" diameter plastic glide and a 6" x 6" metal top plate. Shipped easy to assemble in 8 cartons.

ZK65990	59 x 90 x 29	70	245	13.43	\$1962	\$700	\$304	\$900
---------	--------------	----	-----	-------	---------------	--------------	--------------	--------------

6-person table includes top and seven steel post legs. Top includes factory installed metal inserts for solid and secure leg connections. Legs are 3" in diameter x 28" high each with an adjustable 3" diameter plastic glide and a 6" x 6" metal top plate. Shipped easy to assemble in 8 cartons.

ZK65990P	59 x 90 x 29	70	295	15.28	\$2322	\$700	\$304	\$900
----------	--------------	----	-----	-------	---------------	--------------	--------------	--------------

6-person table includes top, seven steel post legs and cable tower. Top includes factory installed metal inserts for solid and secure leg connections. Legs are 3" in diameter x 28" high with an adjustable 3" diameter plastic glide and a 6" x 6" metal top plate. Shipped easy to assemble in 8 cartons. For power block options, see page 606.

Required specifications

Top finish
Edge finish
Leg finish

Optional specifications

HP laminate
Ergo friendly edge and finish
Power block cut-out*
Writeable surface (WRW)

Accessories

Power block*

POD TABLES **MODEL#** **DIMENSIONS** **FREIGHT CLASS** **WT/LBS.** **CUBIC FT.** **LIST PRICE** **HP ADD** **ERGO EDGE** **WRW**

Sample pod table configurations

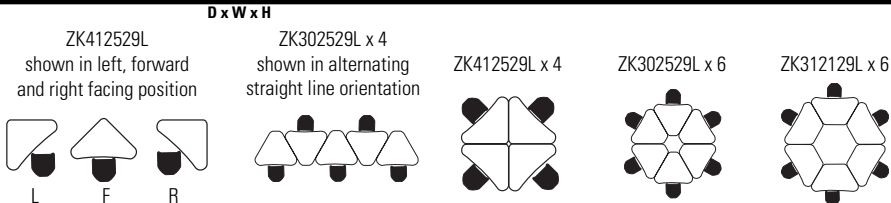

POD TABLES - 29" HIGH **MODEL#** **DIMENSIONS** **FREIGHT CLASS** **WT/LBS.** **CUBIC FT.** **LIST PRICE** **HP ADD** **ERGO EDGE** **WRW**



Small Pod Table w/3 Legs

ZK302529L	24.6 x 30 x 29	70	37	2	\$417	\$74	\$34	\$167
-----------	----------------	----	----	---	--------------	-------------	-------------	--------------

Triangular table with three round tube 18 gauge steel legs. Can be used individually, can alternate front-to-back in a straight row, or can be arranged in groups of six to create a round table effect. Top includes factory installed metal inserts for solid and secure leg connections. Legs are 1.5" in diameter x 28" high with adjustable levelers. Shipped easy to assemble in 4 cartons, top separate from legs; legs individually packed.

- Chrome (CHM) is available on legs. **Add \$84** list.

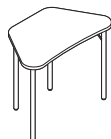

Medium Pod Table w/4 Legs

ZK352129L	20.9 x 35 x 29	70	41	2.40	\$524	\$89	\$40	\$167
-----------	----------------	----	----	------	--------------	-------------	-------------	--------------

Trapezoid table with four round tube 18 gauge steel legs. Can be used individually or can be arranged in groups of six to create a round table effect. Top includes factory installed metal inserts for solid and secure leg connections. Legs are 1.5" in diameter x 28" high with adjustable levelers. Shipped easy to assemble in 5 cartons, top separate from legs; legs individually packed.

- Chrome (CHM) is available on legs. **Add \$109** list.

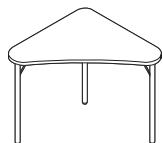

Large Pod Table w/3 Legs

ZK412529L	25.7 x 41 x 29	70	48	2.24	\$538	\$113	\$47	\$194
-----------	----------------	----	----	------	--------------	--------------	-------------	--------------

Triangular table with three round tube 18 gauge steel legs. Can be used individually or can be arranged in groups of four to create a square table effect. Top includes factory installed metal inserts for solid and secure leg connections. Legs are 1.5" in diameter x 28" high with adjustable levelers. Shipped easy to assemble in 4 cartons, top separate from legs; legs individually packed.

- Chrome (CHM) is available on legs. **Add \$84** list.

Required specifications

- Top finish
- Edge finish
- Leg finish

Optional specifications

- HP laminate
- Ergo friendly edge and finish
- Writeable surface (WRW)
- Chrome (CHM) legs

POD TABLES - 32" HIGH



Medium Pod Table w/4 Legs



Large Pod Table w/3 Legs

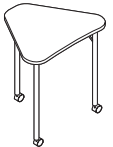

Small Mobile Pod Table w/3 Legs

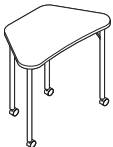

Medium Mobile Pod Table w/4 Legs

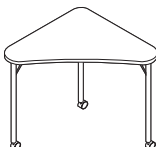

Large Mobile Pod Table w/3 Legs

MODEL#	DIMENSIONS D x W x H	FREIGHT CLASS	WT/LBS.	CUBIC FT.	LIST PRICE	HP ADD	ERGO EDGE	WRW
ZK352132L	20.9 x 35 x 32	70	41	2.55	\$535	\$89	\$40	\$167

ADA compliant table with four round tube 18 gauge steel legs. Can be used individually or can be arranged in groups of six to create a round table effect. Top includes factory installed metal inserts for solid and secure leg connections. Legs are 1.5" in diameter x 31" high with adjustable levelers. Shipped easy to assemble in 5 cartons, top separate from legs; legs individually packed.

- Chrome (CHM) is available on legs. **Add \$109** list.

ZK412532L	25.7 x 41 x 32	70	48	2.36	\$544	\$113	\$47	\$194
-----------	----------------	----	----	------	-------	-------	------	-------

ADA compliant table with three round tube 18 gauge steel legs. Can be used individually or can be arranged in groups of four to create a square table effect. Top includes factory installed metal inserts for solid and secure leg connections. Legs are 1.5" in diameter x 31" high with adjustable levelers. Shipped easy to assemble in 4 cartons, top separate from legs; legs individually packed.

- Chrome (CHM) is available on legs. **Add \$84** list.

ZK302529C	24.6 x 30 x 29	70	37	2	\$446	\$74	\$34	\$167
-----------	----------------	----	----	---	-------	------	------	-------

Triangular table with three round tube 18 gauge steel legs. Can be used individually, can alternate front-to-back in a straight row, or can be arranged in groups of six to create a round table effect. Top includes factory installed metal inserts for solid and secure leg connections. Legs are 1.5" in diameter x 28" high with 1.5" dual wheel locking casters. Shipped easy to assemble in 4 cartons, top separate from legs; legs individually packed.

- Chrome (CHM) is available on legs. **Add \$84** list.

ZK352129C	20.9 x 35 x 29	70	41	2.40	\$566	\$89	\$40	\$167
-----------	----------------	----	----	------	-------	------	------	-------

Trapezoid table with four round tube 18 gauge steel legs. Can be used individually or can be arranged in groups of six to create a round table effect. Top includes factory installed metal inserts for solid and secure leg connections. Legs are 1.5" in diameter x 28" high with 1.5" dual wheel locking casters. Shipped easy to assemble in 5 cartons, top separate from legs; legs individually packed.

- Chrome (CHM) is available on legs. **Add \$109** list.

ZK412529C	25.7 x 41 x 29	70	48	2.24	\$569	\$113	\$47	\$194
-----------	----------------	----	----	------	-------	-------	------	-------

Triangular table with three round tube 18 gauge steel legs. Can be used individually or can be arranged in groups of four to create a square table effect. Top includes factory installed metal inserts for solid and secure leg connections. Legs are 1.5" in diameter x 28" high with 1.5" dual wheel locking casters. Shipped easy to assemble in 4 cartons, top separate from legs; legs individually packed.

- Chrome (CHM) is available on legs. **Add \$84** list.

Required specifications

Top finish
Edge finish
Leg finish

Optional specifications

HP laminate
Ergo friendly edge and finish
Writeable surface (WRW)
Chrome (CHM) legs

RECTANGULAR TABLES - 29" HIGH

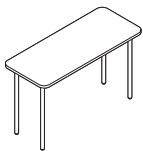

Rectangular Table, 20" Deep

MODEL #	DIMENSIONS D x W x H	FREIGHT CLASS	WT/LB.	CUBIC FT.	LIST PRICE	HP ADD	ERGO EDGE	WRW
ZKR3020L	20 x 30 x 29	70	50	2.55	\$496	\$118	\$38	\$154
ZKR3620L	20 x 36 x 29	70	51	2.65	\$513	\$139	\$40	\$167
ZKR4820L	20 x 48 x 29	70	58	2.95	\$566	\$183	\$47	\$189
ZKR5420L	20 x 54 x 29	70	64	3.15	\$657	\$207	\$52	\$200
ZKR6020L	20 x 60 x 29	70	70	3.25	\$682	\$228	\$56	\$211
ZKR7220L	20 x 72 x 29	65	85	3.55	\$746	\$275	\$62	\$228

Table with four round tube 18 gauge steel legs. Legs are 1.5" in diameter x 28" high with adjustable levelers. Top features 2.5" radius rounded corners and includes factory installed metal inserts for solid and secure leg connections. Tables 54" and wider include support channel. Shipped easy to assemble in 5 cartons, top separate from legs; legs individually packed.

- Chrome (CHM) is available on legs. **Add \$109** list.

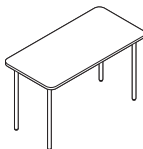

Rectangular Table, 24" Deep

ZKR3024L	24 x 30 x 29	70	51	2.75	\$499	\$139	\$39	\$167
ZKR3624L	24 x 36 x 29	70	53	2.85	\$538	\$169	\$41	\$177
ZKR4824L	24 x 48 x 29	70	59	3.25	\$600	\$220	\$48	\$206
ZKR5424L	24 x 54 x 29	70	65	3.35	\$696	\$248	\$54	\$216
ZKR6024L	24 x 60 x 29	70	71	3.55	\$726	\$273	\$57	\$228
ZKR7224L	24 x 72 x 29	70	86	3.95	\$794	\$327	\$64	\$256

Table with four round tube 18 gauge steel legs. Legs are 1.5" in diameter x 28" high with adjustable levelers. Top features 2.5" radius rounded corners and includes factory installed metal inserts for solid and secure leg connections. Tables 54" and wider include support channel. Shipped easy to assemble in 5 cartons, top separate from legs; legs individually packed.

- Chrome (CHM) is available on legs. **Add \$109** list.

MOBILE RECTANGULAR TABLES - 29" HIGH

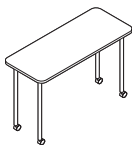

Mobile Rectangular Table, 20" Deep

MODEL #	DIMENSIONS	FREIGHT CLASS	WT/LB.	CUBIC FT.	LIST PRICE	HP ADD	ERGO EDGE	WRW
ZKR3020C	20 x 30 x 29	70	50	2.55	\$537	\$118	\$47	\$154
ZKR3620C	20 x 36 x 29	70	51	2.65	\$550	\$139	\$40	\$167
ZKR4820C	20 x 48 x 29	70	58	2.95	\$603	\$183	\$47	\$189
ZKR5420C	20 x 54 x 29	70	64	3.15	\$697	\$207	\$52	\$200
ZKR6020C	20 x 60 x 29	70	70	3.25	\$723	\$228	\$56	\$211
ZKR7220C	20 x 72 x 29	65	85	3.55	\$785	\$275	\$62	\$228

Table with four round tube 18 gauge steel legs. Legs are 1.5" in diameter x 28" high with 1.5" dual wheel locking casters. Top features 2.5" radius rounded corners and includes factory installed metal inserts for solid and secure leg connections. Tables 54" and wider include support channel. Shipped easy to assemble in 5 cartons, top separate from legs; legs individually packed.

- Chrome (CHM) is available on legs. **Add \$109** list.

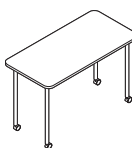

Mobile Rectangular Table, 24" Deep

ZKR3024C	24 x 30 x 29	70	51	2.75	\$540	\$139	\$39	\$167
ZKR3624C	24 x 36 x 29	70	53	2.85	\$579	\$169	\$41	\$177
ZKR4824C	24 x 48 x 29	70	59	3.25	\$642	\$220	\$48	\$206
ZKR5424C	24 x 54 x 29	70	65	3.35	\$736	\$248	\$54	\$216
ZKR6024C	24 x 60 x 29	70	71	3.55	\$766	\$273	\$57	\$228
ZKR7224C	24 x 72 x 29	70	86	3.95	\$837	\$327	\$64	\$256

Table with four round tube 18 gauge steel legs. Legs are 1.5" in diameter x 28" high with 1.5" dual wheel locking casters. Top features 2.5" radius rounded corners and includes factory installed metal inserts for solid and secure leg connections. Tables 54" and wider include support channel. Shipped easy to assemble in 5 cartons, top separate from legs; legs individually packed.

- Chrome (CHM) is available on legs. **Add \$109** list.

Required specifications

Top finish
Edge finish
Leg finish

Optional specifications

HP laminate
Ergo friendly edge and finish
Writeable surface (WRW)
Chrome (CHM) legs

ACTIVITY TABLES

Sample activity table configurations

D x W x H

Straight mating edges

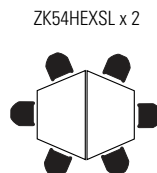
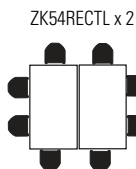

Curved mating edges

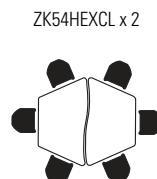
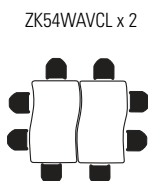

Mixed shapes
Curved mating edges shown.
Can also do the same with
straight mating edge tables.

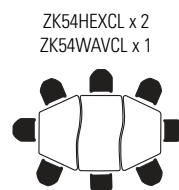
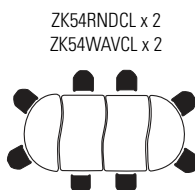

ACTIVITY TABLES - 29" HIGH, CURVED

MODEL# DIMENSIONS FREIGHT CLASS WT/LBS. CUBIC FT. LIST PRICE HP ADD ERGO EDGE WRW

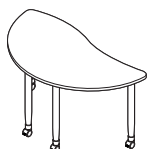

Curved Half Round w/Casters

ZK54RDCC 28.4 x 54 x 28.75 65 67.4 1.40 \$998 \$228 \$60 \$216

44.3" inside clearance between legs on curved edge, 22.9" on narrow depth side and 24" on other side. Dual leg position on front interferes with users sitting on ends in a racetrack configuration, oriented to seat two - one on either side. Top includes factory installed inserts for metal-to-metal leg connection. Shipped easy to assemble in 2 cartons, top separate from leg.

- Chrome (CHM) is available on legs. **Add \$175** list.

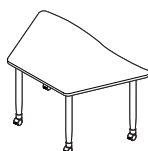

Curved Half Hex w/Casters

ZK54HEXCC 32.4 x 54 x 28.75 65 76.4 1.49 \$1076 \$262 \$71 \$216

42.9" inside clearance between legs on curved edge, 22.3" on narrow depth side and 24" on other side. 22.8" on straight end. Top includes factory installed inserts for metal-to-metal leg connection. Shipped easy to assemble in 2 cartons, top separate from leg.

- Chrome (CHM) is available on legs. **Add \$175** list.

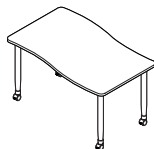

Wave w/Casters

ZK54WAVCC 33.8 x 54 x 28.75 65 77.4 1.52 \$1110 \$280 \$85 \$216

44.9" inside clearance between legs on curved edge, 21.9" on sides. Top includes factory installed inserts for metal-to-metal leg connection. Shipped easy to assemble in 2 cartons, top separate from leg.

- Chrome (CHM) is available on legs. **Add \$175** list.

Required specifications

Top finish
Edge finish
Leg finish

Optional specifications

HP laminate
Ergo friendly edge and finish
Writeable surface (WRW)
Chrome (CHM) legs

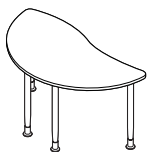
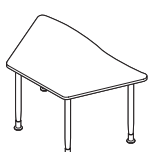
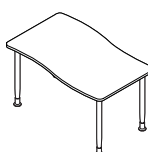
ACTIVITY TABLES - 29" HIGH, CURVED	MODEL #	DIMENSIONS D x W x H	FREIGHT CLASS	WT/LB.	CUBIC FT.	LIST PRICE	HP ADD	ERGO EDGE	WRW
 <p data-bbox="138 318 414 348">Curved Half Round w/Levelers*</p>	ZK54RNDCL	28.4 x 54 x 28.25	65	67.4	1.40	\$990	\$228	\$60	\$216
<p data-bbox="544 318 1523 433">44.3" inside clearance between legs on curved edge, 22.9" on narrow depth side and 24" on other side. Dual leg position on front interferes with users sitting on ends in a racetrack configuration, oriented to seat two - one on either side. Top includes factory installed inserts for metal-to-metal leg connection. Levelers offer 1.25" of height adjustability. Shipped easy to assemble in 2 cartons, top separate from leg.</p> <ul data-bbox="544 439 950 469" style="list-style-type: none"> • Chrome (CHM) is available on legs. Add \$175 list. 									
 <p data-bbox="138 671 397 701">Curved Half Hex w/Levelers*</p>	ZK54HEXCL	32.4 x 54 x 28.25	65	76.4	1.49	\$1069	\$262	\$71	\$216
<p data-bbox="544 671 1523 766">42.9" inside clearance between legs on curved edge, 22.3" on narrow depth side and 24" on other side. 22.8" on straight end. Top includes factory installed inserts for metal-to-metal leg connection. Levelers offer 1.25" of height adjustability. Shipped easy to assemble in 2 cartons, top separate from leg.</p> <ul data-bbox="544 772 950 802" style="list-style-type: none"> • Chrome (CHM) is available on legs. Add \$175 list. 									
 <p data-bbox="138 1003 300 1034">Wave w/Levelers*</p>	ZK54WAVCL	33.8 x 54 x 28.25	65	77.4	1.52	\$1102	\$280	\$85	\$216
<p data-bbox="544 1003 1523 1064">44.9" inside clearance between legs on curved edge, 21.9" on sides. Top includes factory installed inserts for metal-to-metal leg connection. Levelers offer 1.25" of height adjustability. Shipped easy to assemble in 2 cartons, top separate from leg.</p> <ul data-bbox="544 1070 950 1100" style="list-style-type: none"> • Chrome (CHM) is available on legs. Add \$175 list. 									

Required specifications

Top finish
Edge finish
Leg finish

Optional specifications

HP laminate
Ergo friendly edge and finish
Writeable surface (WRW)
Chrome (CHM) legs

ACTIVITY TABLES - 29" HIGH, STRAIGHT

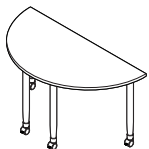

Straight Half Round w/Casters

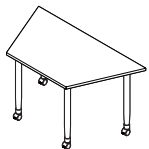

Straight Half Hex w/Casters

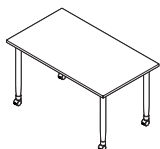

Rectangular w/Casters

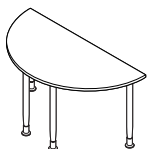

Straight Half Round w/Levelers

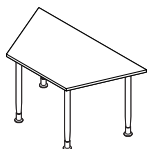

Straight Half Hex w/Levelers

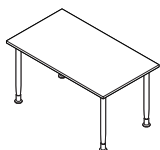

Rectangular w/Levelers

MODEL #	DIMENSIONS D x W x H	FREIGHT CLASS	WT/LB.	CUBIC FT.	LIST PRICE	HP ADD	ERGO EDGE	WRW
ZK54RNDSC	28.4 x 54 x 28.75	65	67.4	1.40	\$943	\$202	N/A	\$216
<p>44.2" inside clearance between legs on long side, 23.7" on the sides. Dual leg position on front interferes with users sitting on ends in a racetrack configuration, oriented to seat two - one on either side. Top includes factory installed inserts for metal-to-metal leg connection. Shipped easy to assemble in 2 cartons, top separate from leg.</p> <ul style="list-style-type: none"> • Chrome (CHM) is available on legs. Add \$175 list. 								
ZK54HEXSC	32.4 x 54 x 28.75	65	73.4	1.49	\$974	\$218	N/A	\$216
<p>40.6" inside clearance between legs on long side, 21.4" on sides and 22.3" on short side. Top includes factory installed inserts for metal-to-metal leg connection. Shipped easy to assemble in 2 cartons, top separate from leg.</p> <ul style="list-style-type: none"> • Chrome (CHM) is available on legs. Add \$175 list. 								
ZK54RECTC	33.8 x 54 x 28.75	65	73.4	1.52	\$1028	\$242	N/A	\$216
<p>45.3" inside clearance between legs on long sides and 22.3" on short sides. Top includes factory installed inserts for metal-to-metal leg connection. Shipped easy to assemble in 2 cartons, top separate from leg.</p> <ul style="list-style-type: none"> • Chrome (CHM) is available on legs. Add \$175 list. 								
ZK54RNDSL	28.4 x 54 x 28.25	65	67.4	1.40	\$935	\$202	N/A	\$216
<p>44.2" inside clearance between legs on long side, 23.7" on the sides. Dual leg position on front interferes with users sitting on ends in a racetrack configuration, oriented to seat two - one on either side. Top includes factory installed inserts for metal-to-metal leg connection. Levelers offer 1.25" of height adjustability. Shipped easy to assemble in 2 cartons, top separate from leg.</p> <ul style="list-style-type: none"> • Chrome (CHM) is available on legs. Add \$175 list. 								
ZK54HEXSL	32.4 x 54 x 28.25	65	73.4	1.49	\$966	\$218	N/A	\$216
<p>40.6" inside clearance between legs on long side, 21.4" on sides and 22.3" on short side. Top includes factory installed inserts for metal-to-metal leg connection. Levelers offer 1.25" of height adjustability. Shipped easy to assemble in 2 cartons, top separate from leg.</p> <ul style="list-style-type: none"> • Chrome (CHM) is available on legs. Add \$175 list. 								
ZK54RECTL	33.8 x 54 x 28.25	65	73.4	1.52	\$1021	\$242	N/A	\$216
<p>45.3" inside clearance between legs on long sides and 22.3" on short sides. Top includes factory installed inserts for metal-to-metal leg connection. Levelers offer 1.25" of height adjustability. Shipped easy to assemble in 2 cartons, top separate from leg.</p> <ul style="list-style-type: none"> • Chrome (CHM) is available on legs. Add \$175 list. 								

Required specifications

Top finish
Edge finish
Leg finish

Optional specifications

HP laminate
Writeable surface (WRW)
Chrome (CHM) legs

FLIP-TOP TABLES **MODEL#** **DIMENSIONS** **FREIGHT CLASS** **WT/LBS.** **CUBIC FT.** **LIST PRICE** **HP ADD** **ERGO EDGE** **WRW**

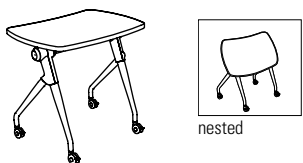

Flip-Top Table, Contoured Top

		D x W x H							
Top:	ZKFC3022T	22 x 30 x 29.5	150	20.6	2.03	\$265	\$136	\$100	\$160
Base:	ZKFTB30		125	26.5	3.6	\$730	n/a	n/a	n/a

Mobile flip-top table with smooth glide locking casters. Easy to operate twist knob with integrated thumb tab. Top includes factory installed inserts for metal-to-metal leg connection. When nested, each additional table adds 5.25" to footprint needed for storage. Optional modesty (ZKFTM30) available separately. Top and base shipped separately. Legs available in Tungsten (TUN) only.

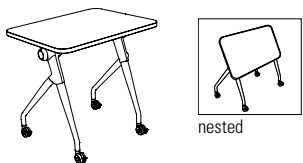

Flip-Top Table, Rectangular Top**

Top:	ZKFR3024T	24 x 30 x 29.5	70	21.5	1.03	\$296	\$149	\$116	\$167
Base:	ZKFTB30		125	26.5	3.6	\$730	n/a	n/a	n/a

Mobile flip-top table with smooth glide locking casters. Easy to operate twist knob with integrated thumb tab. Top includes factory installed inserts for metal-to-metal leg connection. When nested, each additional table adds 5.25" to footprint needed for storage. Optional modesty (ZKFTM30) available separately. Top and base shipped separately. Legs available in Tungsten (TUN) only.

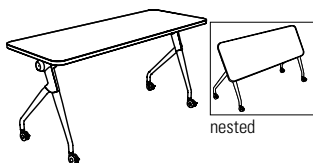

Flip-Top Table, Rectangular Top*

Top:	ZKFR6024T	24 x 60 x 29.5	70	43	1.92	\$432	\$221	\$120	\$228
Base:	ZKFTB60		100	31	3.86	\$829	n/a	n/a	n/a

Mobile flip-top table with smooth glide locking casters. Easy to operate twist knob with integrated thumb tab. Top includes factory installed inserts for metal-to-metal leg connection. When nested, each additional table adds 5.25" to footprint needed for storage. Optional modesty (ZKFTM60) available separately. Top and base shipped separately. Legs available in Tungsten (TUN) only.

MODESTY PANELS FOR FLIP-TOP TABLES **MODEL#** **DIMENSIONS** **FREIGHT CLASS** **WT/LBS.** **CUBIC FT.** **LIST PRICE**



Modesty for ZKFC3022 and ZKFC3024

ZKFTM30	0.5 x 17.8 x 13.8	60	6.6	0.22	\$71
---------	-------------------	----	-----	------	-------------

Hardware included to attach to ZKFC3022 or ZKFR3024. Tungsten finish only. Shipped in 1 carton.

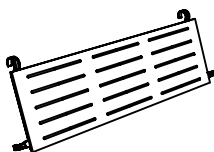

Modesty for ZKFR6024

ZKFTM60	0.5 x 47.3 x 13.8	65	14.3	0.57	\$138
---------	-------------------	----	------	------	--------------

Hardware included to attach **ZKFR6024**. Tungsten finish only. Shipped in 1 carton.

Required Specifications

Top finish
Edge finish

Optional Specifications

HP laminate
Ergo friendly edge and finish
Writeable surface (WRW)

C CITI TABLES

CITI TABLES	MODEL#	DIMENSIONS	FREIGHT CLASS	WT/LBS.	CUBIC FT.	LIST PRICE
-------------	--------	------------	---------------	---------	-----------	------------

D x W x H

Notes

- Citi tables complement the contemporary timeless decor of many offices.
- Legs are **standard** in Tungsten (**TTU**) and also available in Black (**TBL**) or Shadow (**TSH**) at no charge. A Chrome (**CHM**) finish is available. **Add \$117.**
- Table tops are available in laminate
- Citi tables are offered in the following finishes to coordinate with Global casegoods and wood seating:

ACJ	Absolute Acajou	FCL	First Class
ASN	Asian Night	NBL	Noce Biondo
AWC	Avant Cherry	NGL	Noce Grigio
AWH	Avant Honey	NEL	Noce Leggero
BLK	Black	NML	Noce Medio
BZD	Blizzard	QTM	Quartered Mahogany
BRC	Brushed Cobalt	SBY	Sheer Beauty
CMB	Clear Maple	SOG	Storm Grey
CGY	Custom Grey	SDT	Stonedust
DES	Dark Espresso	WHE	Walnut Heights
DWT	Designer White	WHC	White Chocolate
FAS	Fashionista	WCR	Winter Cherry

CITI TABLES	MODEL#	DIMENSIONS	FREIGHT CLASS	WT/LBS.	CUBIC FT.	LIST PRICE
-------------	--------	------------	---------------	---------	-----------	------------

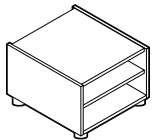

End Table

7885	20 x 24 x 20	100	53	6	\$873
------	--------------	-----	----	---	--------------

Metal tubular legs. Shipped assembled in 1 carton.

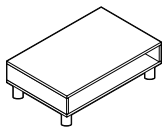

Coffee Table - Rectangular

7887	20 x 40 x 15	100	60	6.50	\$911
------	--------------	-----	----	------	--------------

Metal tubular legs. Shipped assembled in 1 carton.

Required Specifications

Finish

COAT TREES **MODEL#** **DIMENSIONS** **FREIGHT CLASS** **WT./LBS.** **CUBIC FT.** **LIST PRICE**



Coat Tree

	D x W x H					
PCOS2	25 x 25 x 60	300	8	4.67	\$529	
PCOS3	25 x 25 x 60	300	8	4.67	\$529	

Square tube metal frame, complete with four Chrome double hooks. Adjustable glides. 60" high. Ships UPS.

- 3 per carton
- PCOS2 is finished in **Black**.
- PCOS3 is finished in **Chrome**.



Coat Tree

PCT	25 x 25 x 65	250	6	3	\$678	
-----	--------------	-----	---	---	--------------	--

Square tube wood frame. Complete with four satin brass double hooks. 65" high. Available in the following finishes: Absolute (AAM), Black (BKM), Cherry (ACM), English Oak (EOM), Gray (HGM), Honey (AHM), Maple (AVM), Medium Walnut (MWM), Night (ASM), Sandy Beach (SBM), Mahogany (TMM), Fruitwood (TFM), White (WHM), Winter Cherry (WCM) and Walnut (TWM). Ships assembled via UPS.

- 1 per carton

Required Specifications

Finish

L LAMINATE OCCASIONAL TABLES

CYLINDER AND CUBE OCCASIONAL TABLES

D x W x H

Notes:

- High pressure laminate exterior in standard HP finishes or solid ultra matte finishes with adjustable plastic glides; also available with solid surface top options.
- Premium cylinder tables have a flexible plywood core construction ideal for institutional and high traffic environments
- Ideal for reception areas - colors coordinate with all Global desks, conference tables and accessories.
- Shipped assembled in 1 carton.
- Available to either match or coordinate with most Global laminate desk series. Available finishes:

High Pressure Laminate (HPL)

ACJ Absolute Acajou	FCL First Class
ASN Asian Night	NBL Noce Biondo
AWC Avant Cherry	NGL Noce Grigio
AWH Avant Honey	NEL Noce Leggero
BLK Black	NML Noce Medio
BZD Blizzard	QTM Quartered Mahogany
BRC Brushed Cobalt	SBY Sheer Beauty
CMB Clear Maple	SOG Storm Grey
CGY Custom Grey	SDT Stonedust
DES Dark Espresso	WHE Walnut Heights
DWT Designer White	WHC White Chocolate
FAS Fashionista	WCR Winter Cherry

Ultra Matte Laminate (UML)

BLK Black
BZD Blizzard
CGY Custom Grey
DWT Designer White
SDT Stonedust
SOG Storm Grey

Solid Surface (SS) - top only

Grade 1	SWH Designer White
Grade 2 - upcharge applies	SBT Beige Tempest
	SBX Black Onyx Mirage
	SFW Frosty White Mirage
	SHS Hot Stone
	SMG Milk Glass Spectra
	SNM Northern Melange

Optional Power

- Cylinder and cube occasional tables have **optional Q2 cut-out** to accept single port module with one tamper resistant simplex or one USB-A + USB-C charging ports centered in the top surface. Tables all have a bottom exit to allow the single port module to be plugged into a floor power monument when placed over same. Upcharge applies. Add **\$103** for **Q2** cut-out. Modules are sold separately, see page 847. For White face plate modules, specify code ending in **(W72)**; for Black face plate modules, specify code ending in **(B72)**.

SPUSBACRW72
 SPUSBACRB72
 SPTRSMXRW72
 SPTRSMXRB72

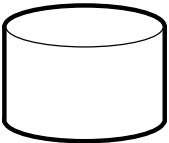
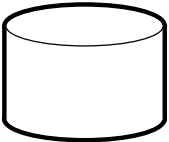

- Cube tables are equipped with non-adjustable glides and would require a cord escape if the table could not be placed over a floor outlet. Specify bottom notch (**BN**) if cord escape is required. Upcharge applies. Add **\$103**. Cylinder tables are equipped with height adjustable glides which can be extended to provide clearance for cord escape when required.

CYLINDER AND CUBE OCCASIONAL TABLES	MODEL#	DIMENSIONS	FREIGHT CLASS	WT/LBS.	CUBIC FT.	LIST PRICE	GRD. 2 ADD
	CPFD1816	18 x 18 x 16	250	23	6.5	\$1091	N/A
	CPFD1821	18 x 18 x 21	150	26.5	8	\$1122	N/A
	CPFD2416	24 x 24 x 16	250	32.5	11	\$1133	N/A
	CPFD2421	24 x 24 x 21	250	35	12.5	\$1162	N/A
	CPFD3016	30 x 30 x 16	250	45.5	15.5	\$1282	N/A
	CPFD3021	30 x 30 x 21	250	48	17	\$1414	N/A
11/32" thick flexible plywood covered in high pressure laminate. Adjustable plastic glides. Flush base.							
	CPFD1816UM	18 x 18 x 16	150	19	3.9	\$1272	N/A
	CPFD1821UM	18 x 18 x 21	150	22.5	5.1	\$1376	N/A
	CPFD2416UM	24 x 24 x 16	150	27	6.7	\$1448	N/A
	CPFD2421UM	24 x 24 x 21	250	29.5	8.6	\$1551	N/A
	CPFD3016UM	30 x 30 x 16	250	38.5	10.1	\$1717	N/A
	CPFD3021UM	30 x 30 x 21	250	41	13	\$1926	N/A
11/32" thick flexible plywood covered in ultra matte high pressure laminate. Select finish from UML options. Adjustable plastic glides. Flush base.							

Required Specifications
 Finish

Optional Specifications
 Q2 cut-out for single port module

CYLINDER AND CUBE OCCASIONAL TABLES **MODEL#** **DIMENSIONS** **FREIGHT CLASS** **WT/LBS.** **CUBIC FT.** **LIST PRICE** **GRD. 2 ADD**

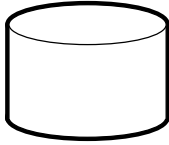

Premium Cylinder Table, Solid Surface Top

		D x W x H						
CPFD1816SS	18 x 18 x 16	125	29	3.9	\$1550	\$187		
CPFD1821SS	18 x 18 x 21	125	32.5	5.1	\$1577	\$187		
CPFD2416SS	24 x 24 x 16	125	45	6.7	\$1774	\$235		
CPFD2421SS	24 x 24 x 21	150	47.5	8.6	\$1799	\$235		
CPFD3016SS	30 x 30 x 16	125	66.5	10.1	\$2011	\$240		
CPFD3021SS	30 x 30 x 21	150	69	13	\$2127	\$240		

1 1/32" thick flexible plywood covered in high pressure laminate with solid surface top. Select solid surface top finish and HPL base finish options. Adjustable plastic glides. **Flush base.**

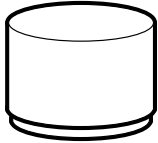

Premium Plinth Cylinder Table High Pressure Laminate

CPPD1816	18 x 18 x 16	150	27.5	6.5	\$1149	N/A		
CPPD1821	18 x 18 x 21	150	31	8	\$1178	N/A		
CPPD2416	24 x 24 x 16	250	38.7	11	\$1190	N/A		
CPPD2421	24 x 24 x 21	250	41.2	12.5	\$1219	N/A		
CPPD3016	30 x 30 x 16	250	54.5	15.5	\$1361	N/A		
CPPD3021	30 x 30 x 21	250	57	17	\$1491	N/A		

1 1/32" thick flexible plywood covered in high pressure laminate. Adjustable plastic glides. **Recessed base.**

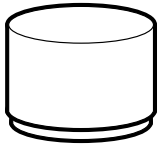

Premium Plinth Cylinder Table Ultra Matte Laminate

CPPD1816UM	18 x 18 x 16	125	23.5	3.9	\$1322	N/A		
CPPD1821UM	18 x 18 x 21	150	27	5.1	\$1426	N/A		
CPPD2416UM	24 x 24 x 16	150	33.2	6.7	\$1499	N/A		
CPPD2421UM	24 x 24 x 21	150	35.7	8.6	\$1601	N/A		
CPPD3016UM	30 x 30 x 16	150	47.5	10.1	\$1787	N/A		
CPPD3021UM	30 x 30 x 21	250	50	13	\$1995	N/A		

1 1/32" thick flexible plywood covered in ultra matte high pressure laminate. Select finish from UML options. Adjustable plastic glides. **Recessed base.**

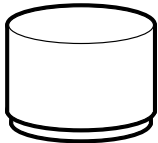

Premium Plinth Cylinder Table Solid Surface Top

CPPD1816SS	18 x 18 x 16	100	34	3.9	\$1600	\$187		
CPPD1821SS	18 x 18 x 21	125	39.5	5.1	\$1627	\$187		
CPPD2416SS	24 x 24 x 16	100	54	6.7	\$1824	\$235		
CPPD2421SS	24 x 24 x 21	125	60.5	8.6	\$1849	\$235		
CPPD3016SS	30 x 30 x 16	125	74.8	10.1	\$2081	\$240		
CPPD3021SS	30 x 30 x 21	125	83.3	13	\$2197	\$240		

1 1/32" thick flexible plywood covered in high pressure laminate with solid surface top. Select solid surface top finish and HPL base finish options. Adjustable plastic glides. **Recessed base.**

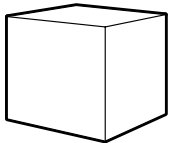

Cube Table, High Pressure Laminate*

CU1816	18 x 18 x 16	85	40	3.30	\$655	N/A		
CU1821	18 x 18 x 21	92.5	46	4	\$764	N/A		
CU2416	24 x 24 x 16	92.5	63	6	\$764	N/A		
CU2421	24 x 24 x 21	92.5	83	7	\$764	N/A		

0.75" thick plywood covered in high pressure laminate. Adjustable plastic glides. **Flush base.**

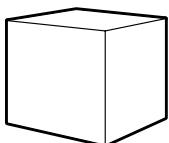

Cube Table, Ultra Matte Laminate*

CU1816UM	18 x 18 x 16	150	22	3.9	\$781	N/A		
CU1821UM	18 x 18 x 21	150	26	5.1	\$937	N/A		
CU2416UM	24 x 24 x 16	150	32.5	6.7	\$999	N/A		
CU2421UM	24 x 24 x 21	150	38	8.6	\$1076	N/A		
CU3016UM	29.75 x 29.75 x 16	150	43.8	10.1	\$1216	N/A		
CU3021UM	29.75 x 29.75 x 21	250	50.5	13	\$1309	N/A		

0.75" thick plywood covered in ultra matte high pressure laminate. Select finish from UML options. Adjustable plastic glides. **Flush base.**

Required Specifications
Finish

Optional Specifications
O2 cut-out for single port module
Bottom notch (BN)*

L LAMINATE OCCASIONAL TABLES

CYLINDER AND CUBE OCCASIONAL TABLES

MODEL#	DIMENSIONS	FREIGHT CLASS	WT/LBS.	CUBIC FT.	LIST PRICE	GRD. 2 ADD
	D x W x H					
CU1816SS	18 x 18 x 16	100	32	3.9	\$1059	\$187
CU1821SS	18 x 18 x 21	125	36	5.1	\$1138	\$187
CU2416SS	24 x 24 x 16	125	50.5	6.7	\$1325	\$235
CU2421SS	24 x 24 x 21	125	56	8.6	\$1325	\$235
CU3016SS	29.75 x 29.75 x 16	125	71.8	10.1	\$1670	\$267
CU3021SS	29.75 x 29.75 x 21	125	78.5	13	\$1670	\$267

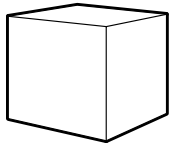

Cube Table, Solid Surface Top*

0.75" thick plywood covered in high pressure laminate with solid surface top. Select solid surface top finish and HPL base finish options. Adjustable plastic glides. **Flush base.**

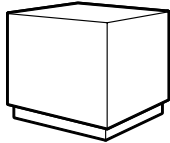

Plinth Cube Table, High Pressure Laminate*

CUP1816	18 x 18 x 16	85	40	3	\$725	N/A
CUP1821	18 x 18 x 21	92.5	46	4	\$837	N/A
CUP2416	24 x 24 x 16	92.5	63	6	\$837	N/A
CUP2421	24 x 24 x 21	92.5	83	7	\$837	N/A

0.75" thick plywood covered in high pressure laminate. Adjustable plastic glides. **Recessed base.**

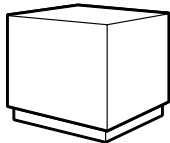

Plinth Cube Table, Ultra Matte Laminate*

CUP1816UM	18 x 18 x 16	125	24	3.9	\$829	N/A
CUP1821UM	18 x 18 x 21	150	29.5	5.1	\$992	N/A
CUP2416UM	24 x 24 x 16	150	36	6.7	\$1054	N/A
CUP2421UM	24 x 24 x 21	150	42.5	8.6	\$1131	N/A
CUP3016UM	29.75 x 29.75 x 16	150	46.8	10.1	\$1279	N/A
CUP3021UM	29.75 x 29.75 x 21	150	55.3	13	\$1372	N/A

0.75" thick plywood covered in ultra matte high pressure laminate. Select finish from UML options. Adjustable plastic glides. **Recessed base.**

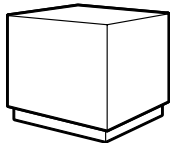

Plinth Cube Table, Solid Surface Top*

CUP1816SS	18 x 18 x 16	100	34	3.9	\$1107	\$187
CUP1821SS	18 x 18 x 21	125	39.5	5.1	\$1193	\$187
CUP2416SS	24 x 24 x 16	100	54	6.7	\$1380	\$235
CUP2421SS	24 x 24 x 21	125	60.5	8.6	\$1380	\$235
CUP3016SS	29.75 x 29.75 x 16	125	74.8	10.1	\$1733	\$267
CUP3021SS	29.75 x 29.75 x 21	125	83.3	13	\$1733	\$267

0.75" thick plywood covered in high pressure laminate with solid surface top. Select solid surface top finish and HPL base finish options. Adjustable plastic glides. **Recessed base.**

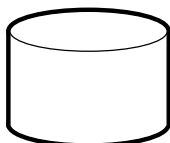

Cylinder Table, High Pressure Laminate

CY1816	18 x 18 x 16	85	43	3.30	\$655	N/A
CY1821	18 x 18 x 21	92.5	49	4.30	\$764	N/A
CY2416	24 x 24 x 16	125	47	6	\$764	N/A
CY2421	24 x 24 x 21	100	66	7	\$764	N/A
CY3016	30 x 30 x 16	125	59	8	\$868	N/A
CY3021	30 x 30 x 21	125	78	11	\$868	N/A

3/8" thick foundation board covered in high pressure laminate. Adjustable plastic glides. **Flush base.**

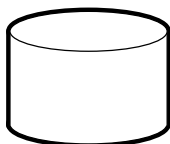

Cylinder Table, Ultra Matte Laminate

CY1816UM	18 x 18 x 16	150	17	3.9	\$781	N/A
CY1821UM	18 x 18 x 21	150	23	5.1	\$937	N/A
CY2416UM	24 x 24 x 16	250	28	8.6	\$999	N/A
CY2421UM	24 x 24 x 21	150	34	6.7	\$1076	N/A
CY3016UM	30 x 30 x 16	250	37.5	10.1	\$1216	N/A
CY3021UM	30 x 30 x 21	250	45.7	13	\$1309	N/A

3/8" thick foundation board covered in ultra matte high pressure laminate. Select finish from UML options. Adjustable plastic glides. **Flush base.**

Required Specifications

Finish

Optional Specifications

Q2 cut-out for single port module

Bottom notch (BN)*

CYLINDER AND CUBE OCCASIONAL TABLES

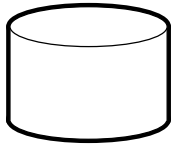

Cylinder Table, Solid Surface Top

MODEL#	DIMENSIONS D x W x H	FREIGHT CLASS	WT/LBS.	CUBIC FT.	LIST PRICE	GRD. 2 ADD
CY1816SS	18 x 18 x 16	125	27	3.9	\$1059	\$187
CY1821SS	18 x 18 x 21	125	33	5.1	\$1138	\$187
CY2416SS	24 x 24 x 16	125	46	6.7	\$1325	\$235
CY2421SS	24 x 24 x 21	125	52	8.6	\$1325	\$235
CY3016SS	30 x 30 x 16	125	65.5	10.1	\$1510	\$240
CY3021SS	30 x 30 x 21	150	73.7	13	\$1510	\$240

3/8" thick foundation board covered in high pressure laminate with solid surface top. Select solid surface top finish and HPL base finish options. Adjustable plastic glides. **Flush base.**

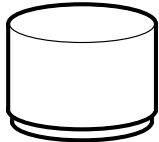

Plinth Cylinder Table, High Pressure Laminate

CYP1816	18 x 18 x 16	85	43	3.30	\$725	N/A
CYP1821	18 x 18 x 21	92.5	49	4.30	\$837	N/A
CYP2416	24 x 24 x 16	125	47	6	\$837	N/A
CYP2421	24 x 24 x 21	100	66	7	\$837	N/A
CYP3016	30 x 30 x 16	125	59	8	\$949	N/A
CYP3021	30 x 30 x 21	125	78	11	\$949	N/A

3/8" thick foundation board covered in high pressure laminate. Adjustable plastic glides. **Recessed base.**

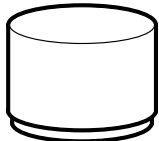

Plinth Cylinder Table, Ultra Matte Laminate

CYP1816UM	18 x 18 x 16	150	22.5	3.9	\$829	N/A
CYP1821UM	18 x 18 x 21	150	28	5.1	\$992	N/A
CYP2416UM	24 x 24 x 16	150	34.5	6.7	\$1054	N/A
CYP2421UM	24 x 24 x 21	150	40.5	8.6	\$1131	N/A
CYP3016UM	30 x 30 x 16	150	45.3	10.1	\$1279	N/A
CYP3021UM	30 x 30 x 21	150	53.5	13	\$1372	N/A

3/8" thick foundation board covered in ultra matte high pressure laminate. Select finish from UML options. Adjustable plastic glides. **Recessed base.**

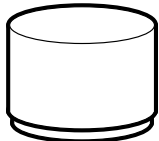

Plinth Cylinder Table, Solid Surface Top

CYP1816SS	18 x 18 x 16	100	32.5	3.9	\$1107	\$187
CYP1821SS	18 x 18 x 21	125	38	5.1	\$1193	\$187
CYP2416SS	24 x 24 x 16	125	52.5	6.7	\$1380	\$235
CYP2421SS	24 x 24 x 21	125	58.5	8.6	\$1380	\$235
CYP3016SS	30 x 30 x 16	125	73.3	10.1	\$1573	\$240
CYP3021SS	30 x 30 x 21	125	81.5	13	\$1573	\$240

3/8" thick foundation board covered in high pressure laminate with solid surface top. Select solid surface top finish and HPL base finish options. Adjustable plastic glides. **Recessed base.**

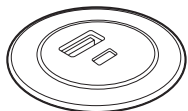

Single Port Module w/USB-A + USB-C

White

SPUSBACRW72	2.25 x - x 2.75	70	0.18	0.05	\$276	N/A
-------------	-----------------	----	------	------	--------------	-----

Black

SPUSBACRB72	2.25 x - x 2.75	70	0.18	0.05	\$276	N/A
-------------	-----------------	----	------	------	--------------	-----

Single port module with USB-A and USB-C charging ports. Round module with 72" cord. Specify top with **Q2** cut-out to accommodate.



Single Port Module w/one Simplex

White

SPTRSMXRW72	2.25 x - x 2.75	70	0.18	0.05	\$106	N/A
-------------	-----------------	----	------	------	--------------	-----

Black

SPTRSMXRB72	2.25 x - x 2.75	70	0.18	0.05	\$106	N/A
-------------	-----------------	----	------	------	--------------	-----

Single port module with one tamper resistant simplex. Round module with 72" cord. Specify top with **Q2** cut-out to accommodate.

Required Specifications

Finish

Optional Specifications

Q2 cut-out for single port module
Bottom notch (BN)*

DRIFT TABLES

DRIFT TABLES



model 8041R2616C
26"W x 16" H Round Table,
Laminate Surface, Flat Edge,
Chrome Base



model 8042SQ2816I
28"W x 16" H Square Table,
Laminate Surface, Flat Edge,
Sled Base



Model 8042SQ2816W
28"W x 16" H Square Table,
Laminate Surface, Flat Edge
Wood Base



For Drift seating, refer to the Seating List Price Book.

EXAMPLE OF TABLE ORDER CODE:

8041R2616I	TFL	ACJ	TBL	CG
Model Number	Surface Type	Top HPL Finish	Base Finish (Sled Base)	Glide Type (Sled Base)

STANDARD FEATURES

- Tables are available in three shapes, multiple sizes, two edge styles and three top materials. All offer three base option: sled, four-legged wood and a polished Chrome base.
- Table bases are fixed and do not swivel.
- Sled bases are available in two heights.
- Wood bases are made from beechwood and are available in all standard wood finishes.
- Sled bases are standard in paint and optionally available in Chrome. See upcharges.
- Chrome bases are available in polished chrome only.
- Table tops are available in either laminate or solid surface.
- Laminate flat edge tops are available in either a 1" thick thermally fused laminate (TFL) with 2mm edgeband or 1-1/16" thick high pressure laminate (HPL) or ultra matte high pressure laminate (UML) with 2mm edgeband (see models for upcharges).
- Laminate knife edge tops are only available in 1-3/16" thick high pressure laminate (HPL) or ultra matte high pressure laminate (UML) with 2.5mm edgeband.
- Solid surface table tops are 1.25" thick, available with flat or knife edge tops.
- Polished Chrome bases are equipped with White non-marking polycarbonate glides that are suitable for most hard and carpeted floor surfaces.
- Sled bases are available with clear polycarbonate glides, standard.
- Wood and sled bases may be specified with a variety of optional glide types to suit various flooring materials. (See Glide Types for additional glide options and upcharges.)
- Tables are shipped fully assembled.

Please specify based on the following criteria:

- **Model number** (suffix determines edge detail)
 - sled base models**
 - _____ I laminate flat edge
 - _____ K laminate knife edge
 - _____ SF solid surface flat edge
 - _____ SK solid surface knife edge
 - polished chrome base models**
 - _____ C laminate flat edge
 - _____ CK laminate knife edge
 - _____ CSF solid surface flat edge
 - _____ CSK solid surface knife edge
 - four-legged wood base models**
 - _____ W laminate flat edge
 - _____ WK laminate knife edge
 - _____ WSF solid surface flat edge
 - _____ WSK solid surface knife edge

Add option codes in the following order:

- **Top details**
 - LAMINATE**
 - Surface type** (laminate flat edge tables only)
 - (TFL) Thermally fused laminate
 - (HPL) High pressure laminate
 - (UML) High pressure laminate (*select colors only)
 - Top Finish** (see model for HPL or UML upcharges)
 - (ACJ) Absolute Acajou
 - (AWC) Avant Cherry
 - (BLK) Black*
 - (BRC) Brushed Cobalt
 - (CGY) Custom Grey*
 - (DWT) Designer White*
 - (FCL) First Class
 - (NGL) Noce Grigio
 - (NML) Noce Medio
 - (SBY) Sheer Beauty
 - (SDT) Stonedust*
 - (WHC) White Chocolate
 - (ASN) Asian Night
 - (AWH) Avant Honey
 - (BZD) Blizzard*
 - (CMB) Clear Maple
 - (DES) Dark Espresso
 - (FAS) Fashionista
 - (NBL) Noce Biondo
 - (NEL) Noce Leggero
 - (QTM) Quartered Mahogany
 - (SOG) Storm Grey*
 - (WCR) Winter Cherry
 - (WHE) Walnut Heights
 - SOLID SURFACE**
 - Top finish** (see model for grade 2 upcharges)
 - (SWH) Designer White - grade 1
 - (SBT) Beige Tempest - grade 2
 - (SBX) Black Onyx Mirage - grade 2
 - (SMG) Milk Glass Spectra - grade 2
 - (SFW) Frosty White Mirage - grade 2
 - (SHS) Hot Stone - grade 2
 - (SNM) Northern Melange - grade 2
- **Base finish**
 - SLED BASE**
 - For metal leg frame finish options, see page 863. Upcharges apply for the following plated finish:
 - (CHM) Chrome. Add \$42
 - WOOD BASE** (see coordination chart)
 - (AAM) Absolute
 - (AKM) Black
 - (ACM) Cherry
 - (EOM) English Oak
 - (ECM) Espresso Cafe
 - (TFM) Fruitwood
 - (HGM) Gray
 - (AHM) Honey
 - (TMM) Mahogany
 - (AVM) Maple
 - (MWM) Medium Walnut
 - (NLW) Natural Walnut
 - (ASM) Night
 - (NBM) Noce Biondo
 - (NGM) Noce Grigio
 - (NEM) Noce Leggero
 - (NMM) Noce Medio
 - (SKM) Shaker Cherry
 - (TWM) Walnut
 - (WTM) WC Cream
 - (WHM) White
 - (WCM) Winter Cherry
 - POLISHED CHROME BASE**
 - (CHM) Chrome.
- **Glide type**
 - SLED BASE GLIDES**
 - (CG) Clear, polycarbonate glide for most floor surfaces (standard)
 - (XG) No glide for carpeted surfaces, no charge
 - (SG) Steel cushioned glide for carpeted surface. Add \$36
 - (RG) Rubber, non-slip glide for most hard floor surfaces. Add \$36
 - (FG) Felt glide for most hard floor surfaces. Add \$36
 - WOOD BASE GLIDES**
 - (NM) White non-marking nylon glide for most surfaces (standard)
 - (SG) Steel cushioned glides for carpeted surfaces. Add \$36.
 - (RG) Non-slip rubber glides for most hard floor surfaces. Add \$36.
 - (FG) Felt glides for most hard floor surfaces. Add \$36.

TABLES WITH SLED BASE



Round Table with Sled Base

MODEL#	DIMENSIONS	FREIGHT CLASS	WT./LBS.	CUBIC FT.	LIST PRICE	HPL ADD	UML ADD	GR. 2 ADD	
Laminate, flat edge (TFL laminate)									
8041R2616I	26 x 26 x 16	250	35	10.25	\$592	\$104	\$237	n/a	
8041R3016I	30 x 30 x 16	250	44	13	\$624	\$122	\$237	n/a	
8041R2120I	21 x 21 x 20	250	29	8.75	\$620	\$103	\$237	n/a	
Laminate, knife edge (HPL laminate)									
8041R2616IK	26 x 26 x 16	250	35	10.25	\$1265	n/a	\$331	n/a	
8041R3016IK	30 x 30 x 16	250	44	13	\$1355	n/a	\$331	n/a	
8041R2120IK	21 x 21 x 20	250	29	8.75	\$1051	n/a	\$166	n/a	
Solid surface, flat edge									
8041R2616ISF	26 x 26 x 16	150	48	10.25	\$2472	n/a	n/a	\$167	
8041R3016ISF	30 x 30 x 16	150	61	13	\$2661	n/a	n/a	\$230	
8041R2120ISF	21 x 21 x 20	150	37.5	8.75	\$2326	n/a	n/a	\$115	
Solid surface, knife edge									
8041R2616ISK	26 x 26 x 16	150	48	10.25	\$2529	n/a	n/a	\$179	
8041R3016ISK	30 x 30 x 16	150	61	13	\$2747	n/a	n/a	\$247	
8041R2120ISK	21 x 21 x 20	150	37.5	8.75	\$2429	n/a	n/a	\$122	

Finished height will vary depending on material top. Shipped fully assembled in 1 carton.



Square Table with Sled Base

Laminate, flat edge (TFL laminate)									
8042SQ2216I	22 x 22 x 16	150	34	8	\$592	\$104	\$237	n/a	
8042SQ2816I	28 x 28 x 16	250	44	11.75	\$624	\$122	\$237	n/a	
8042SQ1920I	19 x 19 x 20	250	29	7.75	\$600	\$93	\$237	n/a	
Laminate, knife edge (HPL laminate)									
8042SQ2216IK	22 x 22 x 16	150	34	8	\$1051	n/a	\$166	n/a	
8042SQ2816IK	28 x 28 x 16	250	44	11.75	\$1317	n/a	\$331	n/a	
8042SQ1920IK	19 x 19 x 20	250	29	7.75	\$1008	n/a	\$166	n/a	
Solid surface, flat edge									
8042SQ2216ISF	22 x 22 x 16	150	39.5	8	\$2179	n/a	n/a	\$144	
8042SQ2816ISF	28 x 28 x 16	150	62.5	11.75	\$2496	n/a	n/a	\$230	
8042SQ1920ISF	19 x 19 x 20	150	38	7.75	\$2085	n/a	n/a	\$174	
Solid surface, knife edge									
8042SQ2216ISK	22 x 22 x 16	150	39.5	8	\$2529	n/a	n/a	\$174	
8042SQ2816ISK	28 x 28 x 16	150	62.5	11.75	\$2975	n/a	n/a	\$259	
8042SQ1920ISK	19 x 19 x 20	150	38	7.75	\$2429	n/a	n/a	\$127	

Finished height will vary depending on material top. Shipped fully assembled in 1 carton.



Oval Table with Sled Base

Laminate, flat edge (TFL laminate)									
8043OV2616I	26 x 22 x 16	150	36.5	8.75	\$592	\$104	\$237	n/a	
8043OV3116I	31 x 26 x 16	250	46	11.75	\$624	\$122	\$237	n/a	
8043OV2220I	22 x 18 x 20	250	34	10.75	\$620	\$103	\$237	n/a	
Laminate, knife edge (HPL laminate)									
8043OV2616IK	26 x 22 x 16	150	36.5	8.75	\$1265	n/a	\$331	n/a	
8043OV3116IK	31 x 26 x 16	250	46	11.75	\$1441	n/a	\$331	n/a	
8043OV2220IK	22 x 18 x 20	250	34	10.75	\$1175	n/a	\$166	n/a	
Solid surface, flat edge									
8043OV2616ISF	26 x 22 x 16	150	42	8.75	\$2472	n/a	n/a	\$167	
8043OV3116ISF	31 x 26 x 16	150	60	11.75	\$2661	n/a	n/a	\$230	
8043OV2220ISF	22 x 18 x 20	250	38	10.75	\$2326	n/a	n/a	\$115	
Solid surface, knife edge									
8043OV2616ISK	26 x 22 x 16	150	42	8.75	\$2529	n/a	n/a	\$179	
8043OV3116ISK	31 x 26 x 16	150	60	11.75	\$2747	n/a	n/a	\$247	
8043OV2220ISK	22 x 18 x 20	250	38	10.75	\$2429	n/a	n/a	\$122	

Finished height will vary depending on material top. Shipped fully assembled in 1 carton.

Required Specifications

Surface type
Top finish
Base finish
Glide type

Optional Specifications

HP laminate
Grade 2 solid surface
Cut-out for grommet/power blocks
Plated base finish

Accessories

Power block

D DRIFT TABLES



Round Table with Polished Chrome Base

MODEL#	DIMENSIONS	FREIGHT CLASS	WT/LBS.	CUBIC FT.	LIST PRICE	HPL ADD	UML ADD	GR. 2 ADD
D x W x H								
Laminate, flat edge (TFL laminate)								
8041R2616C	26 x 26 x 16	250	38	10.75	\$1117	\$104	\$237	n/a
8041R3016C	30 x 30 x 16	250	45	13	\$1148	\$122	\$237	n/a
Laminate, knife edge (HPL laminate)								
8041R2616CK	26 x 26 x 16	250	38	10.75	\$1790	n/a	\$331	n/a
8041R3016CK	30 x 30 x 16	250	45	13	\$1881	n/a	\$331	n/a
Solid surface, flat edge								
8041R2616CSF	26 x 26 x 16	150	51	10.75	\$2997	n/a	n/a	\$167
8041R3016CSF	30 x 30 x 16	150	62.5	13	\$3186	n/a	n/a	\$230
Solid surface, knife edge								
8041R2616CSK	26 x 26 x 16	150	51	10.75	\$3054	n/a	n/a	\$179
8041R3016CSK	30 x 30 x 16	250	31.25	13	\$3272	n/a	n/a	\$247

Finished height will vary depending on material top. Shipped fully assembled in 1 carton.



Round Table with Wood Base

Laminate, flat edge (TFL laminate)								
8041R2616W	26 x 26 x 16	250	32	10.75	\$1271	\$104	\$237	n/a
8041R3016W	30 x 30 x 16	250	40	13	\$1302	\$122	\$237	n/a
Laminate, knife edge (HPL laminate)								
8041R2616WK	26 x 26 x 16	250	32	10.75	\$1944	n/a	\$331	n/a
8041R3016WK	30 x 30 x 16	250	40	13	\$2033	n/a	\$331	n/a
Solid surface, flat edge								
8041R2616WSF	26 x 26 x 16	150	45.5	10.75	\$3150	n/a	n/a	\$167
8041R3016WSF	30 x 30 x 16	150	57.5	13	\$3340	n/a	n/a	\$230
Solid surface, knife edge								
8041R2616WSK	26 x 26 x 16	150	45.5	10.75	\$3208	n/a	n/a	\$179
8041R3016WSK	30 x 30 x 16	150	57.5	13	\$3425	n/a	n/a	\$247

Finished height will vary depending on material top. Shipped fully assembled in 1 carton.



Square Table with Polished Chrome Base

Laminate, flat edge (TFL laminate)								
8042SQ2216C	22.75 x 22.75 x 16	150	36	7.75	\$1117	\$104	\$237	n/a
8042SQ2816C	28.5 x 28.5 x 16	250	45	11.5	\$1148	\$122	\$237	n/a
Laminate, knife edge (HPL laminate)								
8042SQ2216CK	22.75 x 22.75 x 16	150	36	7.75	\$1576	n/a	\$166	n/a
8042SQ2816CK	28.5 x 28.5 x 16	250	45	11.5	\$1676	n/a	\$331	n/a
Solid surface, flat edge								
8042SQ2216CSF	22.75 x 22.75 x 16	150	41	7.75	\$2704	n/a	n/a	\$144
8042SQ2816CSF	28.5 x 28.5 x 16	150	57.5	11.5	\$3020	n/a	n/a	\$230
Solid surface, knife edge								
8042SQ2216CSK	22.75 x 22.75 x 16	150	41	7.75	\$3054	n/a	n/a	\$174
8042SQ2816CSK	28.5 x 28.5 x 16	150	57.5	11.5	\$3499	n/a	n/a	\$259

Finished height will vary depending on material top. Shipped fully assembled in 1 carton.

Required Specifications

Surface type
Top finish
Base finish
Glide type

Optional Specifications

Grade 2 solid surface
Cut-out for grommet/power blocks
Plated base finish

Accessories

Power block

MODEL#	DIMENSIONS	FREIGHT CLASS	WT./LBS.	CUBIC FT.	LIST PRICE	HPL ADD	UML ADD	GR. 2 ADD
--------	------------	---------------	----------	-----------	------------	---------	---------	-----------

D x W x H

Laminate, flat edge (HPL laminate)

8042SQ2216W	22.75 x 22.75 x 16	250	30	7.75	\$1271	\$104	\$237	n/a
8042SQ2816W	28.5 x 28.5 x 16	250	39	11.5	\$1302	\$122	\$237	n/a

Laminate, knife edge (HPL laminate)

8042SQ2216WK	22.75 x 22.75 x 16	250	30	7.75	\$1730	n/a	\$166	n/a
8042SQ2816WK	28.5 x 28.5 x 16	250	39	11.5	\$1830	n/a	\$331	n/a

Solid surface, flat edge

8042SQ2216WSF	22.75 x 22.75 x 16	150	36	7.75	\$2857	n/a	n/a	\$144
8042SQ2816WSF	28.5 x 28.5 x 16	150	59	11.5	\$3174	n/a	n/a	\$230

Solid surface, knife edge

8042SQ2216WSK	22.75 x 22.75 x 16	150	36	7.75	\$3208	n/a	n/a	\$174
8042SQ2816WSK	28.5 x 28.5 x 16	150	59	11.5	\$3653	n/a	n/a	\$259

Finished height will vary depending on material top. Shipped fully assembled in 1 carton.



Square Table with Wood Base



Oval Table with Polished Chrome Base



Oval Table with Wood Base

Laminate, flat edge

8043OV2616C	26 x 22 x 16	150	38	9.25	\$1117	\$104	\$237	n/a
8043OV3116C	31 x 26 x 16	250	44	11.75	\$1148	\$122	\$237	n/a

Laminate, knife edge

8043OV2616CK	26 x 22 x 16	150	38	9.25	\$1790	n/a	\$331	n/a
8043OV3116CK	31 x 26 x 16	250	44	11.75	\$1965	n/a	\$331	n/a

Solid surface, flat edge

8043OV2616CSF	26 x 22 x 16	150	49.5	9.25	\$2997	n/a	n/a	\$167
8043OV3116CSF	31 x 26 x 16	150	61.5	11.75	\$3186	n/a	n/a	\$230

Solid surface, knife edge

8043OV2616CSK	26 x 22 x 16	150	49.5	9.25	\$3054	n/a	n/a	\$179
8043OV3116CSK	31 x 26 x 16	150	61.5	11.75	\$3272	n/a	n/a	\$247

Finished height will vary depending on material top. Shipped fully assembled in 1 carton.

Laminate, flat edge

8043OV2616W	26 x 22 x 16	250	32	9.25	\$1271	\$104	\$237	n/a
8043OV3116W	31 x 26 x 16	250	39	11.75	\$1302	\$122	\$237	n/a

Laminate, knife edge

8043OV2616WK	26 x 22 x 16	250	32	9.25	\$1944	n/a	\$331	n/a
8043OV3116WK	31 x 26 x 16	250	39	11.75	\$2119	n/a	\$331	n/a

Solid surface, flat edge

8043OV2616WSF	26 x 22 x 16	150	44.5	9.25	\$3150	n/a	n/a	\$167
8043OV3116WSF	31 x 26 x 16	150	56.5	11.75	\$3340	n/a	n/a	\$230

Solid surface, knife edge

8043OV2616WSK	26 x 22 x 16	150	44.5	9.25	\$3208	n/a	n/a	\$179
8043OV3116WSK	31 x 26 x 16	150	56.5	11.75	\$3425	n/a	n/a	\$247

Finished height will vary depending on material top. Shipped fully assembled in 1 carton.

Required Specifications

Surface type
Top finish
Base finish
Glide type

Optional Specifications

HP laminate
Grade 2 solid surface
Cut-out for grommet/power blocks
Plated base finish

Accessories

Power block

L LITE LIFT II

LITE LIFT II	MODEL#	DIMENSIONS D x W x H	FREIGHT CLASS	WT/LBS.	CUBIC FT.	LIST PRICE
--------------	--------	-------------------------	---------------	---------	-----------	------------

Notes:

- Lightweight construction allows tables to easily and safely be lifted and moved by one person.
- Polypropylene top is fully water resistant and easy to clean and maintain.
- Thick, high impact radius corner helps protect individuals from injury.
- Folding legs automatically lock by a gravity activated mechanism when opened.
- Non-marring plastic glides protect floors from scratching when tables are moved.
- Structural side aprons allow tables to easily stack.
- Lite Lift II tables pass all BIFMA standards for strength and stability.
- **Available in Oyster Grey finish only.**

LITE LIFT II TABLES	MODEL#	DIMENSIONS	FREIGHT CLASS	WT/LBS.	CUBIC FT.	LIST PRICE
---------------------	--------	------------	---------------	---------	-----------	------------



Rectangular Folding Table

MVLFRT72	30 x 72 x 29.25	92.5	36	3.06	\$517
MVLFRT96	30 x 96 x 29.25	92.5	50	4.79	\$759

Lightweight, textured, polypropylene Oyster Grey finish top. High impact radius corners. 19 gauge 11/8" diameter steel tubular legs with welded crossbars automatically lock. Legs finished in scuff resistant textured Charcoal Grey epoxy paint. Shipped fully assembled.

- Available in Oyster Grey finish with Charcoal Grey legs only.
- **Note:** Prices shown are for Global Distribution Center, not delivered pricing. All orders will be charged freight, except orders containing other Global products totaling \$2,000 list or more, before adding folding tables and folding chairs. Any Inside Delivery & Set-up charge for these products must be quoted separately.

RIVER+ TABLES

RIVER+ TABLES

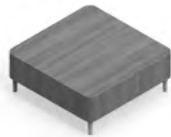

42" Square Coffee Table
model R27858



Outside Curve End Table
model R27864



18" Dia. Round Laptop Table
model 7743

STANDARD FEATURES

- A modular series that is composed of straight and curved sections, as well as freestanding units.
- Linking units can be used together in any combination with River+ seating and bench units to create a wide variety of layouts. Ganging hardware is standard and is factory installed. Ganging hardware swivels out of the way when not in use.
- Front and back faces of end (linking) tables angles slightly inwards. This inward slant matches the inward angles of River seating so all units coordinate in visual appearance.
- The standard 6.5", welded steel legs are straight (vertical) as standard. Linking models are optionally available with an angled back leg to visually align with River+ seating units.
- Legs are standard in Chrome with Black, non-marking, height adjustable glides.
- Tables are made with high pressure laminate. Custom high pressure laminate finishes will be considered upon request.
- Laptop tables have 1" thick laminate tops.
- Laptop table painted metal base finishes are available in Black and Tungsten only.

OPTIONAL FEATURES

- Legs of coffee and end (linking) tables are available in 3" (**S3**) and 8" (**S8**) heights. All leg heights are available with fixed-to-floor (**F3**) and (**F8**) options. Add \$106.
- To match adjacent lounge seating, straight front and angled back 6.5" or 8" legs are available on linking/end tables. Specify (**SA**). No upcharge.
- Power units are available on all tables except laptop tables. Each unit includes one AC outlet and two USB-a,10 watt charging ports. Add \$661 upcharge per unit.
- Power location options include top, front or end. See electrical placement diagrams. Electrical units must be factory installed.
- Power units are available in either Jet Black (**J**) or White (**W**) with 120", three-prong matching cords.
- Most products can be weighted to reduce the ease of movement. For additional weight options, specify (**CW**). See each model for available additional weight and upcharge.

Please add option codes in the following order:

- **Model number**
R27855 to R27858 Square coffee tables
R27859 Rectangular coffee table
R27860 to R27861 Round coffee tables
R27862 to R27864 Linking/end tables
7443 and 7745 Freestanding tables
- **Laminate finishes**
(ACJ) Absolute Acajou **(ASN)** Asian Night
(AWC) Avant Cherry **(AWH)** Avant Honey
(BLK) Black **(BZD)** Blizzard
(BRC) Brushed Cobalt **(CMB)** Clear Maple
(CGY) Custom Grey **(DES)** Dark Espresso
(DWT) Designer White **(FAS)** Fashionista
(FCL) First Class **(NBL)** Noce Biondo
(NGL) Noce Grigio **(NEL)** Noce Leggero
(NML), Noce Medio **(QTM)** Quartered Mahogany
(SBY) Sheer Beauty **(SOG)** Storm Grey
(SDT) Stonedust **(WCR)** Winter Cherry
(WHC) White Chocolate **(WHE)** Walnut Heights
(colors shown on website)
- **Leg selection**
(S6) Standard height (6.5") w/adjustable glides. No upcharge.
(S3) Low (3") w/adjustable glides. No upcharge.
(S8) High (8") w/adjustable glides. No upcharge.
(F6) Standard height (6.5"), fixed to floor. Add \$100.
(F3) Low (3"), fixed to floor. Add \$100.
(F8) High (8"), fixed to floor. Add \$100.
- **Leg angle** (linking/end tables only)
(AST) Straight legs. No upcharge.
(SA) Straight front legs, angled back legs. No upcharge.
- **Leg finish**
(CHM) Chrome **(TBL)** Black
(TDW) Designer White **(TFO)** Fog
(TFR) Frost **(TIV)** Cloud
(TLA) Latte **(TMO)** Mocha
(TNE) Nevada **(TOA)** Toast
(TSH) Shadow **(TSN)** Sand
(TTU) Tungsten
- **Additional weight**
(CW) Additional weight. Upcharges vary, see model.
- **Power/USB unit position** (coffee and linking/end tables only, as shown below).
Add \$661 per unit.
(NP) No power (no upcharge)
(LE1) Left end (coffee table only)
(LE2) Right end (coffee table only)
(F3) Front center (coffee table only)
(T1) Top
- **Power unit finish**
(J) Jet Black
(W) White
- **(TP) Tamperproof fasteners.** Add \$169.

EXAMPLE RIVER+ TABLE ORDER CODE:

R27858	-ACJ	-S6	-AS	-CM	-	-T1	-W	-
Model number	Laminate	Leg selection	Leg angle	Leg finish	Additional weight	Power/USB	Power finish	Fasteners

ELECTRICAL PLACEMENT

Coffee Tables

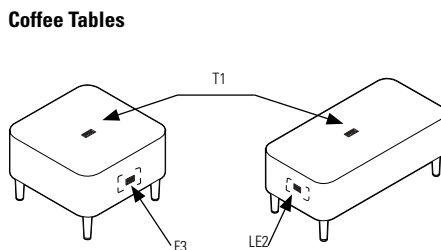

Linking Tables

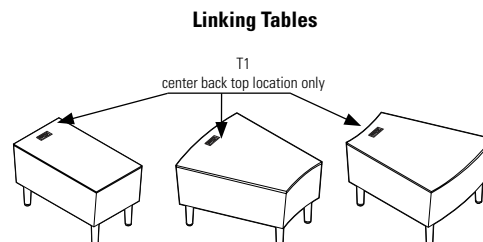

R RIVER+ TABLES

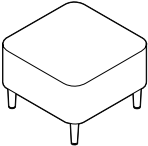
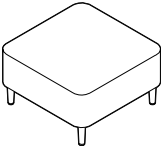
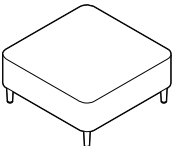
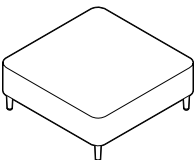
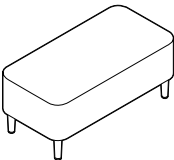
RIVER+ TABLES	MODEL#	DIMENSIONS	FREIGHT CLASS	WT/LBS.	CUBIC FT.	LIST PRICE
 <p>24" Square Coffee Table</p>	R27855	24 x 24 x 17	250	40	10.7	\$1566
	<p>Freestanding unit only. 1 per carton. For power/USB unit, see electrical placement chart. • Add \$540 for 36 lbs. (CW)</p>					
 <p>30" Square Coffee Table</p>	R27856	30 x 30 x 17	250	53	15.3	\$1649
	<p>Freestanding unit only. 1 per carton. For power/USB unit, see electrical placement chart. • Add \$405 for 27 lbs. (CW)</p>					
 <p>36" Square Coffee Table</p>	R27857	36 x 36 x 17	250	75	20.6	\$1890
	<p>Freestanding unit only. 1 per carton. For power/USB unit, see electrical placement chart. No counterweight.</p>					
 <p>42" Square Coffee Table</p>	R27858	42 x 42 x 17	150	115	26.7	\$2101
	<p>Freestanding unit only. 1 per carton. For power/USB unit, see electrical placement chart. No counterweight.</p>					
 <p>Rectangular Coffee Table</p>	R27859	20 x 40 x 17	250	55	14.2	\$1716
	<p>Freestanding unit only. 1 per carton. For power/USB unit, see electrical placement chart. • Add \$271 for 18 lbs. (CW)</p>					

Required Specifications

Top finish
 Leg finish

Optional Specifications

Counterweight

Accessories

Power Block

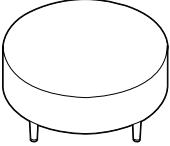
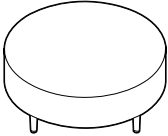
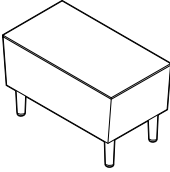
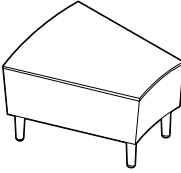
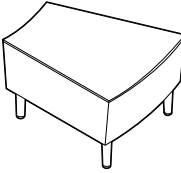
ROUND COFFEE TABLES	MODEL#	DIMENSIONS	FREIGHT CLASS	WT/LBS.	CUBIC FT.	LIST PRICE
 <p>36" Dia. Round Coffee Table</p>		D x W x H				
	R27860	36 x 36 x 17	150	63	15.3	\$2033
<p>Freestanding unit only. 1 per carton. For power/USB unit, see electrical placement chart. • Add \$271 for 18 lbs. (CW)</p>						
 <p>42" Dia. Round Coffee Table</p>						
	R27861	42 x 42 x 17	150	85	20.6	\$2230
<p>Freestanding unit only. 1 per carton. For power/USB unit, see electrical placement chart. No counterweight.</p>						
 <p>Rectangular End Table</p>						
	R27862	15 x 28 x 17	300	40	20.6	\$1665
<p>1 per carton. Includes ganging hardware (2 sides). For power/USB unit, see electrical placement chart. • Add \$540 for 36 lbs. (CW)</p>						
 <p>Inside Curve End Table</p>						
	R27863	17 x 28 x 17	250	47	13.3	\$2188
<p>1 per carton. Includes ganging hardware (2 sides). For power/USB unit, see electrical placement chart. • Add \$540 for 36 lbs. (CW)</p>						
 <p>Outside Curve End Table</p>						
	R27864	17 x 28 x 17	250	47	13.3	\$2188
<p>1 per carton. Includes ganging hardware (2 sides). For power/USB unit, see electrical placement chart. • Add \$540 for 36 lbs. (CW)</p>						

Required Specifications

Top finish
 Leg finish

Optional Specifications

Counterweight

Accessories

Power Block

W WIND TABLES

WIND TABLES





D x W x H

Notes:

- Wind tables complement the modern decor of many offices.
- Legs are standard in Chrome (**CHM**). Also available in Black (**TBL**), Shadow (**TSH**) or Tungsten (**TTU**) finish at no upcharge.
- 1" laminate tops are offered in the following finishes to coordinate with Global casegoods and wood seating:

ACJ	Absolute Acajou	DWT	Designer White	SDT	Stonedust
ASN	Asian Night	FAS	Fashionista	WHE	Walnut Heights
AWC	Avant Cherry	FCL	First Class	WHC	White Chocolate
AWH	Avant Honey	NBL	Noce Biondo	WCR	Winter Cherry
BLK	Black	NGL	Noce Grigio		
BZD	Blizzard	NEL	Noce Leggero		
BRC	Brushed Cobalt	NML	Noce Medio		
CMB	Clear Maple	QTM	Quartered Mahogany		
CGY	Custom Grey	SBY	Sheer Beauty		
DES	Dark Espresso	SOG	Storm Grey		

- Table tops are available in high pressure laminate at a 20% upcharge for the following model numbers: 3366, 3367, 3368, 3870 and 3871; specify (**HPL**) in addition to the finish. HPL is not available on 3878, 3879 or 3880.

WIND TABLES	MODEL#	DIMENSIONS	FREIGHT CLASS	WT/LBS.	CUBIC FT.	LIST PRICE
	3366	24 x 24 x 17	250	36	11.50	\$985
Square Corner Table	Steel tubular base. Tops are available with a laminate finish. Shipped assembled in 1 carton.					
	3367	20 x 48 x 15	250	52	16	\$1302
Rectangular Coffee Table	Steel tubular base. Tops are available with a laminate finish. Shipped assembled in 1 carton.					
	3368	36 x 36 x 15	250	66	22	\$1762
Square Coffee Table	Steel tubular base. Tops are available with a laminate finish. Shipped assembled in 1 carton.					
	3870	24 x 24 x 17	250	35	11.50	\$1077
Round Corner Table	Steel tubular base. Tops are available with a laminate finish. Shipped assembled in 1 carton.					
	3871	36 x 36 x 15	250	57	22	\$1584
Round Coffee Table	Steel tubular base in Chrome finish.					

Required Specifications
Finish

Optional Specifications
Grommet

Accessories
Power Block

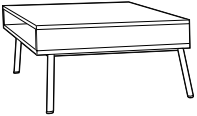
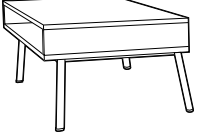
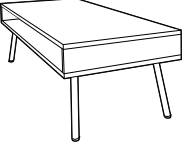
WIND LINEAR TABLES	MODEL#	DIMENSIONS	FREIGHT CLASS	WT/LBS.	CUBIC FT.	LIST PRICE
 <p>Freestanding Rectangular End Table</p>		D x W x H				
	3878	25 x 20 x 16	250	38	11.50	\$1408
Steel tubular base. Laminate top is 5" thick with opening on front for storage and visual recess at rear. Shipped assembled in 1 carton.						
 <p>Freestanding Corner Table</p>						
	3879	25 x 25 x 16	250	40	11.50	\$1536
Steel tubular base. Laminate top is 5" thick with opening on front for storage and visual recess at rear. Shipped assembled in 1 carton.						
 <p>Freestanding Coffee Table</p>						
	3880	54 x 20 x 15	250	52	16	\$1713
Steel tubular base. Laminate top is 5" thick with opening on front for storage and visual recess at rear. Shipped assembled in 1 carton.						

Required Specifications

Top finish
Leg finish

W WORK TABLES

WORK TABLES

D x W x H

Notes:

- Work tables are offered in the following top finishes to coordinate with Global casegoods and wood seating:

ACJ	Absolute Acajou	FCL	First Class
ASN	Asian Night	NBL	Noce Biondo
AWC	Avant Cherry	NGL	Noce Grigio
AWH	Avant Honey	NEL	Noce Leggero
BLK	Black	NML	Noce Medio
BZD	Blizzard	QTM	Quartered Mahogany
BRC	Brushed Cobalt	SBY	Sheer Beauty
CMB	Clear Maple	SOG	Storm Grey
CGY	Custom Grey	SDT	Stonedust
DES	Dark Espresso	WHE	Walnut Heights
DWT	Designer White	WHC	White Chocolate
FAS	Fashionista	WCR	Winter Cherry

- Legs available in Chrome (**CHM**)

WORK TABLES



Work Tables

MODEL#	DIMENSIONS	FREIGHT CLASS	WT/LBS.	CUBIC FT.	LIST PRICE
--------	------------	---------------	---------	-----------	------------

GATMS6030	30 x 60 x 29	70	132	8	\$735
GATMS7230	30 x 72 x 29	92.5	87	8	\$838
GATMS7236	36 x 72 x 29	70	132	8	\$1031

1" high performance thermally fused laminate with self edge top. Black metal skirt. Rectangular top with metal legs and leveling glides. Self edge is standard. Shipped easy to assemble in 1 carton.

Required Specifications

Top finish